

SERVICE

VOL. 22

THE TECHNICAL JOURNAL OF THE TELEVISION-RADIO TRADE

NOVEMBER
1953

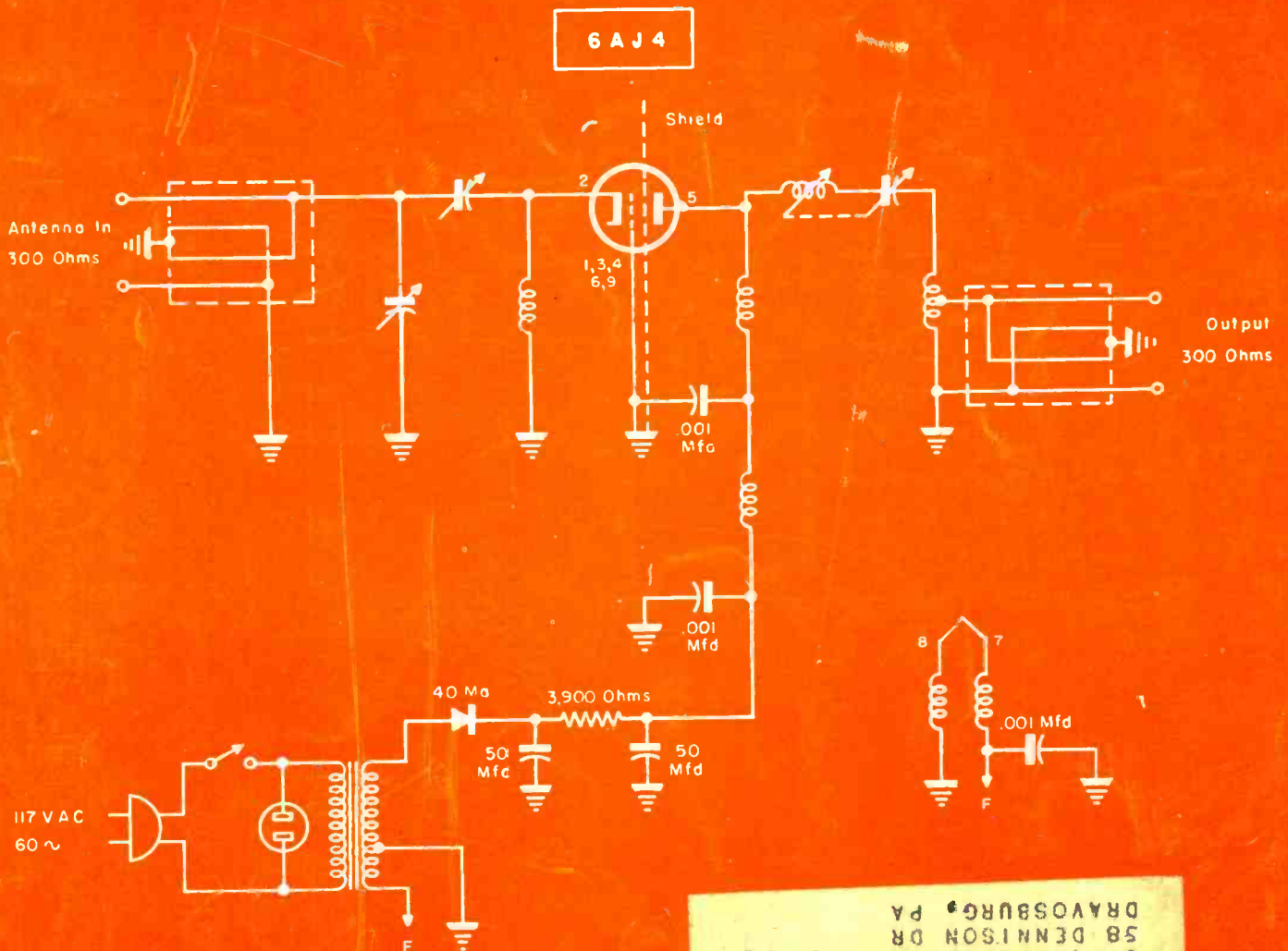

UHF booster featuring continuously-tuned
rf amplifier with grounded-grid triode.
[See circuit analysis, this issue]

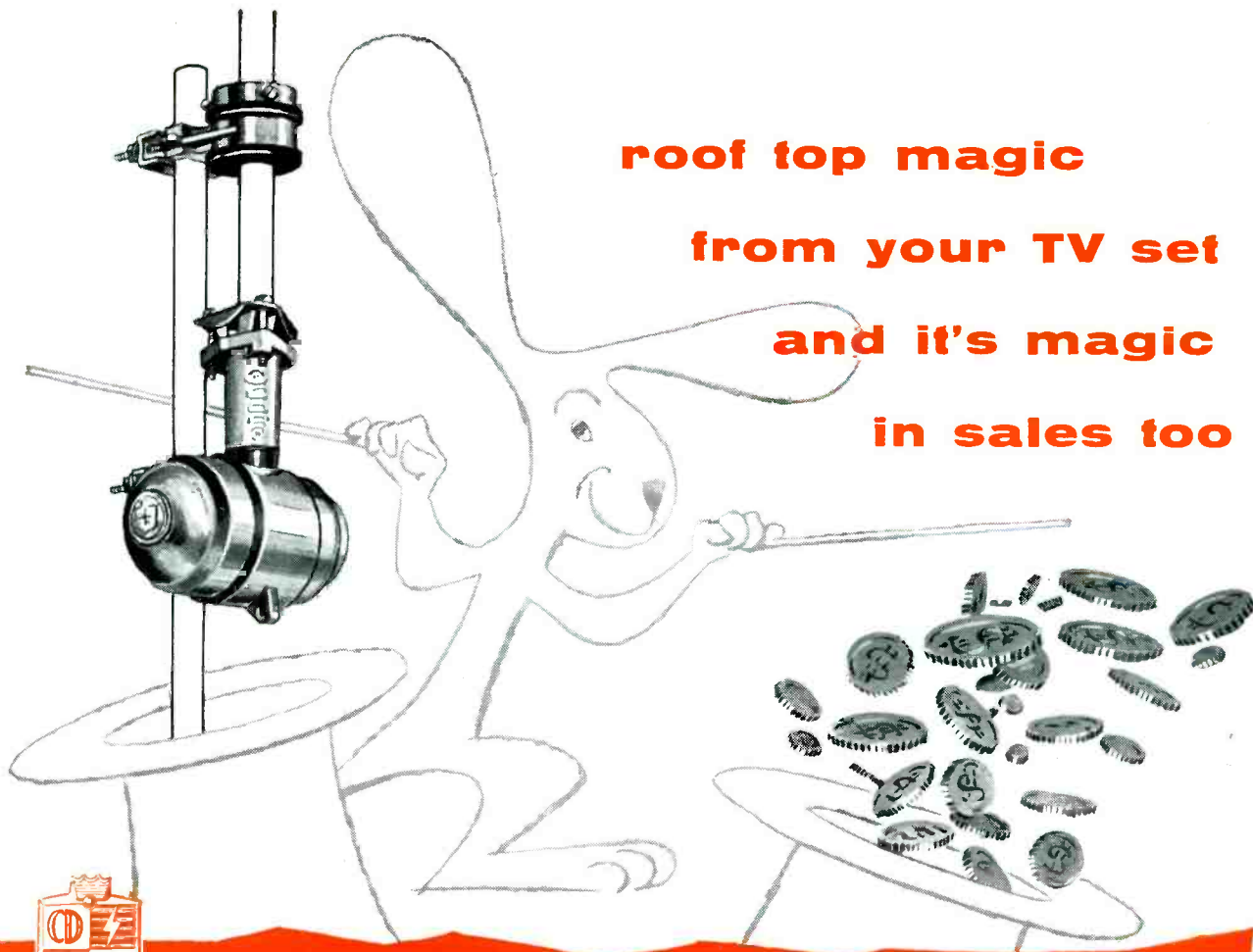

roof top magic

from your TV set

and it's magic

in sales too



the C·D·R Rotors

NATIONALLY PROMOTED IN TELEVISION

★ There's real MAGIC to the CDR ROTOR!
The way it IMPROVES any TV picture is magic
... the way it sells... is magic! BUT... the real
answer is quality manufacture of a proven design!

That adds up to continued dependable
performance... CDR ROTORS ARE BUILT TO
LAST... built to perform under any conditions!

NOW... MORE IN DEMAND THAN EVER
BEFORE with the BIG consumer advertising
campaign in full swing... if you don't
have your BIG CDR PROMOTION KIT with
selling and advertising aids... write us
for your kit... to help you sell EVEN MORE!

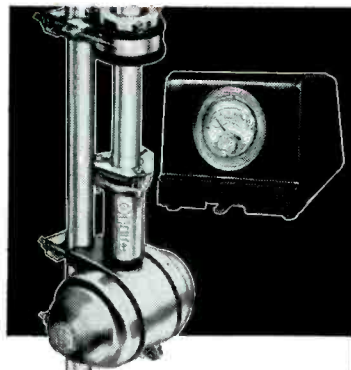

TR-12... a special combination value consisting of complete rotor including thrust bearing... handsome modern design cabinet with meter control dial **\$47.95**

TR-11... same as TR-12 without thrust bearing **\$44.95**

TR-2... the HEAVY DUTY rotor especially suited for special TV antenna installations. Complete rotor with "Compass Control" cabinet having illuminated "perfect pattern" dial. **\$49.95**

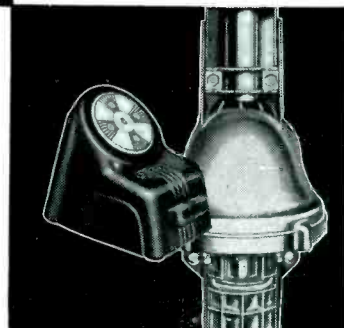

THE RADIART CORPORATION
CLEVELAND 13, OHIO



THE CORNELL-DUBILIER ELECTRIC CORP.
SOUTH PLAINFIELD, N. J.

NEW



TIGHTEST SEAL
LOCKS IN PERFORMANCE

TOUGHEST SHELL
LOCKS OUT TROUBLE



ATTRACTIVE YELLOW MOLDED PLASTIC SHELL

Non-inflammable. Will not burn or melt under soldering iron or flame.

BONDED SEAL

Positive, heat resistant, non-inflammable bond seals leads and shell, locks out humidity.

FIRMLY SECURED LEAD
Can't be pulled out, even under soldering iron heat.

ASTRON BLUE-POINT[†] MOLDED PLASTIC PAPER Capacitors

PATENT
PENDING

THE NEWEST ADDITION
TO THE **SM[†]** LINE

Yes, the ASTRON BLUE-POINT's *tighter seal* and *tougher shell* give you heat and moisture protection to a degree never before possible—providing a longer life and greater dependability than has ever been achieved in a molded plastic capacitor! BLUE-POINT is a capacitor you can rely on *completely*, under every condition.

BLUE-POINT is suitable for continuous operation at 85°C. The bonded seal uses a special thermo-setting, heat-resistant, non-inflammable bonding agent—*positive* protection

against moisture. Solder leads as close to the capacitor as you like—they *won't* pull out! Every BLUE-POINT is clearly marked with voltage and capacitance, bears outside foil identification. Every BLUE-POINT is *tested* and *guaranteed*. Look for the ASTRON BLUE-POINT when you buy capacitors from your jobber, or if he doesn't carry it, send us his name. Insist on ASTRON BLUE-POINT, the capacitor you *know* you can depend on. Order a supply today.

For complete performance characteristics, specifications and listings, write for Bulletin AB-20A

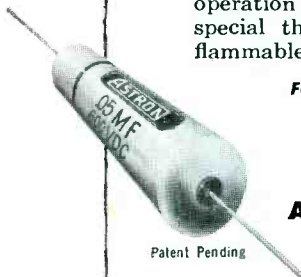

Patent Pending

DEPEND ON—INSIST ON

ASTRON CORPORATION



255 Grant Ave., E. Newark, N. J.

†Trade Mark

Safety Margin capacitors for every radio, television and electronic use.

THE JFD *super-jet*

JFD's JeT 213S outperforms all other VHF antennas covering the channel 2-13 spectrum.

Rugged, completely pre-assembled, the design of the SUPER-JET COMBINES THE BEST OF BOTH THE BALINE YAGI AND THE JeTENNA for unequalled deep fringe performance and flat-high gain no-dip response.

Narrow side lobes in the SUPER-JET provide highly directive UHF coverage equal in gain to stacked bowtie and reflector. An extra feature at no extra cost.

Delivers single 10-element Yagi performance on each channel.

Write for Form 230.

HERE ARE THE FACTS— COMPARE FOR YOURSELF.

JFD JeT 213 S	C H A N N E L S				
	Competitor A MATTRESS (4 STACK)	Competitor B RADAR SCREEN TYPE A	Competitor C RADAR SCREEN TYPE B	Competitor D CHS 2-13 YAGI	JFD JeT 213 S
6.5	4.50	0.75	0.0	4.0	2
7.5	5.00	3.25	3.0	5.0	3
9.5	5.75	4.5	4.0	7.0	4
8.5	3.00	3.5	3.25	6.25	5
8.5	2.50	3.5	3.0	5.0	6
11.0	3.50	6.0	4.5	5.25	7
11.0	1.00	7.0	7.0	6.0	8
12.0	0.0	6.5	7.0	5.25	9
12.0	.875	7.75	8.0	7.25	10
11.25	.875	8.0	10.0	9.25	11
12.75	.50	7.5	10.0	6.5	12
12.0	7.5	6.0	9.0	7.0	13

DB GAIN

YES	NO	NO	NO	NO	1" Square Cross Arm Completely Pre-Assembled
YES	NO	NO	NO	YES	
\$42.50	\$65.90	\$47.50	\$34.95	\$55.00	LIST PRICE

Model JeT 213 • single • \$20.75 list
Model JeT 213S* • stacked • \$42.50 list

*Complete with stacking transformers.

World's largest manufacturer of TV antennas and accessories.

outperforms
across
the nation

JFD MFG. CO.



BROOKLYN 4, N. Y.

Burton Browne adv

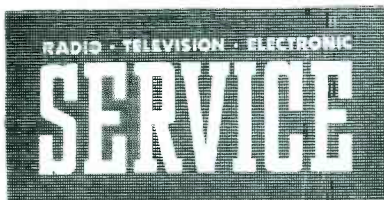

LEWIS WINNER
Editor

B. BLOCK
F. WALEN
Assistant Editors

Including SERVICE—A Monthly Digest of Radio and Allied Maintenance; RADIO MERCHANDISING, and TELEVISION MERCHANDISING. Registered U. S. Patent Office.

Association News	82
Audio Installation and Service (Conical Dome Speakers... Locating Amp Distortion). By Kenneth Stewart and Paul Edwards	44
Audio System Maintenance: Hi-Fi Tuners. By Mark Vino	52
Color TV Tube News. By E. A. Teverson	50
Continuous-Tuned UHF Booster (Cover). By Wyn Martin	30
Dual-Track Tape Recorder-Playback Models for 7 1/2" and 3 3/4" Speeds. By D. S. Cevans In the Field (Analyses of Generator Dot Size Variations... Differentiator-Integrator Circuitry... IF Amp Feedback)	38
Ser-Cuits (TV Chassis Production-Change Report). By M. W. Percy	40
Service Engineering (Installation-Maintenance of Gas-Fired Boiler Electronic Control System). By Thomas K. Beamer	58
Service... The National Scene	70
Servicing Helps (Auto-Radio... Instrument... TV Set Modifications). By T. L. Gilford	47
Sync-Circuit Performance (Chart-Analysis). By Clark R. Alisen	66
Systematic Servicing (Discussion of Novel Approach, Featuring Preventive Maintenance Plan). By J. C. Geist	56
Ten Years Ago	32
The NTSC Color TV Demonstration Before the FCC. By Donald Phillips	83
TV Antenna Digest (UHF/VHF Lightning Arrester Design... New Product Review). By Ralph G. Peters	36
TV Color Reception (Simplified Explanation of Compatible Color Operation). By W. Kay Brownes	60
Views and News. By Lewis Winner	34
	29

CIRCUITS

AM Detector-Load Circuit 10-Kc Filter	54
Color TV Receiving Setup During FCC Tests	36
Coupling Capacitors in Audio Amps	101
Crescent 903/907 Tape Recorder and Playback Amplifier	39
Dual-Track Tape-Amplifier System	38
FM Receiver Temperature-Compensated Oscillator	54
G. E. Stratopower Chassis; Fourth Run Model	59
Horizontal and Vertical Sync System; Relation to Other Circuits	57
IT 133A UHF AutoBooster (Cover)	30
Photocell and Amplifier Used in Gas-Fired Boiler-Control System	70
Sync System; Relation to Allied Circuitry	57
UHF Booster and VHF/UHF Coupler	31
UHF/VHF Filter-Type Crossover Network	31
UHF/VHF Lightning Arrester Circuitry	60
Variable IF Bandwidth Circuitry	52
Wavetrap Installation	52

COVER

Continuous-Tuned UHF Booster (IT 133A UHF AutoBooster)	30
--	----

SERVICING HELPS

Auto-Radio Antenna-Ground Installation	66
Auto-Radio Antenna Trimmer Adjustments	66
Auto-Radio '53 Pontiac Output Transformer Installation	68
Auto-Radio Relays in Signal Seeker Chassis	68
Auto-Radio 12-V Buffer Capacitor Replacement	68
Removing Twost on UHF	102
Safety-Glass Pix-Tube Precautions	69
Tube Check Suggestions	69

Index to Advertisers

Manufacturers	
Catalogs and Bulletins	90
Jobs and Flashes	111
News	92
New Parts . . . Tools . . . Instruments	76
On Book Row	81
Personnel	86
Rep Talk	88
TV Parts . . . Antennas . . . Accessories	74



Entire Contents Copyright 1953, Bryan Davis Publishing Co., Inc

Published monthly by Bryan Davis Publishing Co., Inc.

52 Vanderbilt Avenue, New York 17, N. Y.

Telephone Murray Hill 4-0170

Bryan S. Davis, Pres. Paul S. Weil, Vice-President F. Walen, Sec. A. Goebel, Cir. Prom. Mgr.
Mid-West Representative: Stuart J. Oston, 333 N. Michigan Ave., Chicago 1, Ill. Telephone DEarborn 2-3507
East-Central Representative: James C. Munn, 2253 Delaware Dr., Cleveland 6, Ohio. Telephone: Erievue 1-1726
Pacific Coast Representative: Brand & Brand, 1052 W. Sixth St., Los Angeles 14, Calif. Telephone: Michigan 1732
Metropolitan District Manager: Donald C. Weil, 52 Vanderbilt Ave., New York 17, N. Y.

Entered as second-class matter June 14, 1932, at the Post Office at New York, N. Y., under the Act of March 3, 1879. Subscription price: \$2.00 per year in the United States of America and Canada; 25 cents per copy; \$3.00 per year in foreign countries; 35 cents per copy.

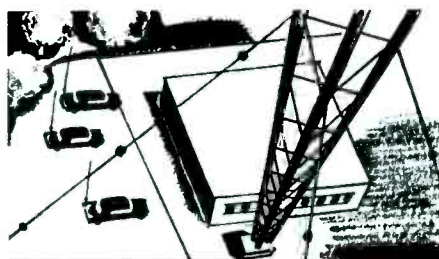

**NOW You Can
USE a LOW COST
TRANSMITTER
DIRECT FROM
YOUR AC SOURCE
for Fixed Stations with**



**MODEL "B"
POWER SUPPLY**

Pat. 2599748



Model B

No need to pay thousands for a fixed station transmitter when you can use a mobile transmitter with an Electro Model "B" DC Power Supply at a total cost of less than seven hundred dollars.

The Electro Model "B" is the only known DC power supply able to withstand mobile transmitter loads, as proven by actual use in the field. Simply plug into any 110 volt, 60 cycle outlet and convert AC to DC current to power these transmitters.

One Model "B" supplies up to 20 amperes at 6 volts for small mobile transmitters. Two Model "B's" connected in parallel supply up to 40 amperes at 6 volts for larger mobile transmitters.

Offers big savings for:
Police, fire, civil defense, taxi, forestry, pipeline and military radio communication systems.

**Send for FREE
detailed Bulletin BCS654**

Electro Products Laboratories

4501-SL Ravenswood Ave.,
Chicago 40, Ill.

Canada: Atlas Radio Corp. Ltd., Toronto, Ont.

TRIO

proudly announces

The New ZIG-ZAG

"TWIN-SIX"

(A significant addition to the Zig-Zag line)

... the greatest advance ever made in ALL-CHANNEL antenna design!

Not content to bring out just another all-channel antenna, TRIO studied and tested every other model available. Months of research produced the "Twin-Six", a Zig-Zag that provides all of the desirable features indicated above. Quantitative ratings for antennas are practically meaningless because of some exaggerated claims. For this reason, the "Twin-Six" is announced without the usual gain charts. The new "Twin-Six", however, equals and, in most cases, greatly exceeds the gains of these antennas on every channel. For instance, the "Twin-Six" showed a 2 to 6 db higher gain than a competitive antenna which is advertised as having a 12 db gain.

MINUTE-UP ASSEMBLY

There's no antenna easier to assemble. Shipped with all hardware mounted on the boom. Complete assembly consists of matching elements to color coded insulators and snapping on spring clips. Improper assembly impossible.



Insulators come mounted on boom and are so designed that "shorting-out" is impossible. Antenna elements mounted merely by snapping on the spring clips.

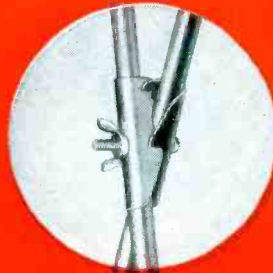

Pre-assembled high channel elements are swung into position and quickly locked by mating brackets.

NEW ZIG-ZAG "TWIN-SIX" OFFERS:

Measurable Higher Gain On All VHF Channels Than Any Other Single Bay All-Channel Antenna

PLUS

1. One Horizontal Bay Does It All!
2. Single Lead-In Operation!
3. Easy-Up, One Minute Assembly!
4. Rugged Construction Throughout — No Droop, No Sag! Light Weight — Attractive Appearance!
5. UHF Reception For All Primary Areas!
6. Low Standing Wave Ratio!
7. Built and Backed by TRIO — A Name You Can Trust!
8. Competitively Priced!



TRIO

MANUFACTURING CO. GRIGGSVILLE, ILL.



Team the new Zig-Zag "Twin-Six" with the dependable TRIO rotator for the maximum in TV enjoyment!

TRIPLETT

SWEEP GENERATOR MARKER 3434-A

Harmonics sufficient for UHF servicing.
Sweep Output better than 1 volt.

Three Markers (pip) variable oscillator, (dip) variable absorption, and plug-in crystal.

Three Test Instruments in one.

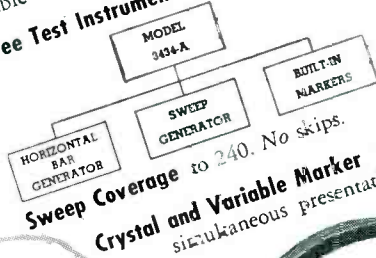

COMPARE THESE FEATURES WITH ANY SWEEP GENERATOR

There are 16 additional features incorporated, which make it a "must" for the radio technician. All, together, emphasize the superiority in dollar value of Triplett 3434-A. See this tester at your distributor's.



And now compare the Quality per dollar

TRIPLETT ELECTRICAL EQUIPMENT CO., BLUFFTON, OHIO

TRIPLETT
3434-A
TV-FM
SWEEP GENERATOR MARKER
\$199.50
USA Dealer Net
COMPLETE WITH ACCESSORIES
AND INSTRUCTION MANUAL

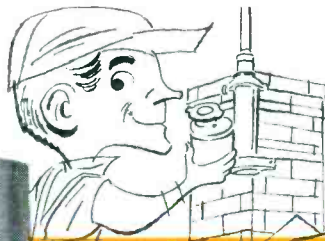

Why didn't someone do this before?



Only Superotor®

has the Quick Detachable Drive Unit

A **Leader** FIRST!



“TERRIFIC!” say TV servicemen — and you’ll echo their words when you see the amazing new Superotor. Imagine — a drive unit as easy to replace as a light bulb! Strictly a one-man job! No fussin’, no cussin’, — no need to dismount the antenna — no need to interrupt TV viewing while the drive unit is being serviced. Great? Yes! — and this is just one of FIVE major advances that put Superotor years ahead of anything on the market. No wonder the big switch is to Superotor!

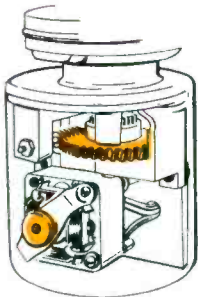

● Double Lock Stop Prevents Drift & Coast

A **Leader** FIRST!

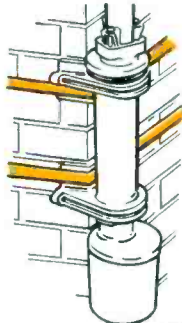

● Built-in Chimney Mount Design

A **Leader** FIRST!

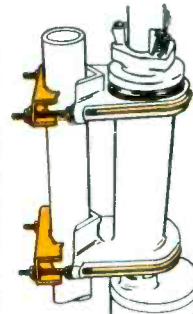

● Steel Reinforced Construction

A **Leader** FIRST!

VP* Tuning

*Vernier Precision

A **Leader** FIRST!

Patent Applied for Copyright



2925 EAST 55th ST., CLEVELAND 27, OHIO

LEADING THE WAY TO BETTER PRODUCTS

PHILCO TEST EQUIPMENT SPECIFICALLY DESIGNED FOR THE SERVICEMAN

AGAIN PHILCO LEADS THE INDUSTRY

Serviceman's needs seen as Philco's Engineering Goal

This new Philco VHF to UHF adapter pioneers a whole new approach to service problems and at the same time is the most economical and practical unit ever offered. Servicemen are taking full advantage of the introductory demonstrations of this amazing piece of equipment now offered by Philco distributors coast to coast.

The First and Only VHF to UHF Signal Generator Adapter

Continuing its engineering program designed to provide the serviceman with the best possible test equipment Philco Corporation now offers at a fraction of the usual cost an exclusive highly specialized adapter unit for converting the output of VHF TV servicing test equipment to UHF.

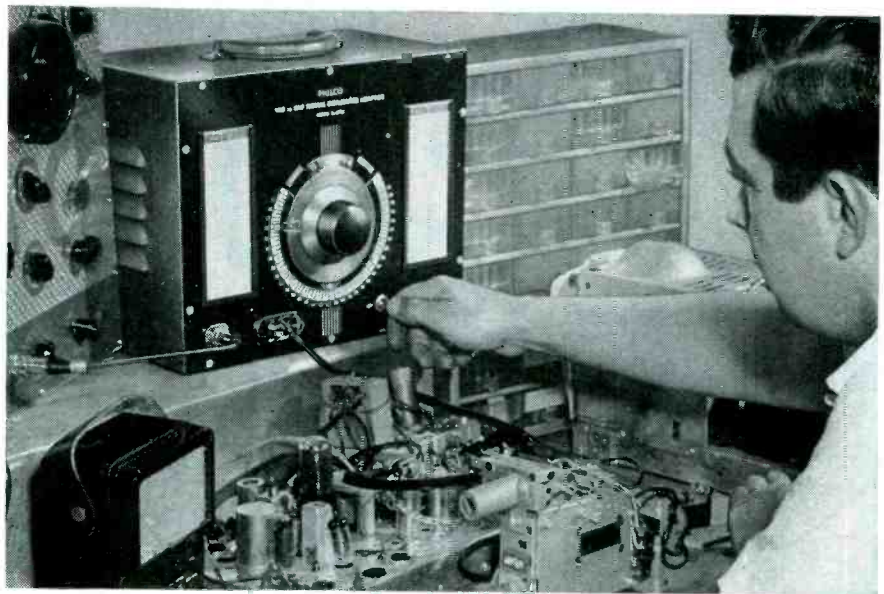

Under the trained eye of a Philco Serviceman the amazing model G-8000 VHF to UHF signal generator adapter is shown in action.



One of the Finest Vacuum Tube Voltmeters ever Designed

Facing up to the task of measuring high impedance circuits where loading effect must be kept to a minimum Philco has again designed a unit which meets the most rigid engineering specifications. All reports indicate this unit is unexcelled for complete and accurate measurements.

Practical Portable 3-inch Television Oscilloscope

The tremendous growth of television requires the most practical and versatile types of equipment to answer service needs. Philco has such equipment, particularly in its 3" scope which is 2½ times smaller than other 3" units, making it adaptable to either bench use or field servicing. High sensitivity and wide response make it ideal for TV work.

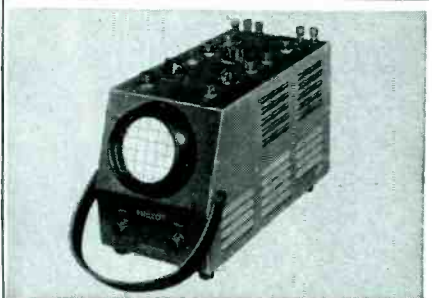

"Philco Test Equipment Specifically designed for the serviceman!" That's the theme of Philco's engineering program. A program which you, the serviceman, can depend upon to supply the very finest in service test equipment. Discover how easy it is to own a complete Philco Test Equipment Laboratory. Your Philco Distributor is eager to serve you by offering his new special payment plan to best accommodate your needs. Fill out the attached coupon as shown and mail to Philco Accessory Div.

PHILCO CORPORATION

Accessory Division

Allegheny Ave. & "A" St., Phila. 34, Pa.

I am interested in the Philco Test Equipment shown here. Please send me details of your SPECIAL PURCHASE PLAN for obtaining these units.

Please send FREE copy of your new booklet on Philco Test Equipment.

NAME

ADDRESS

CITY..... STATE.....

SERVICEMAN'S DIARY..as told to Ben Grim, **SPRAGUE PRODUCTS COMPANY**

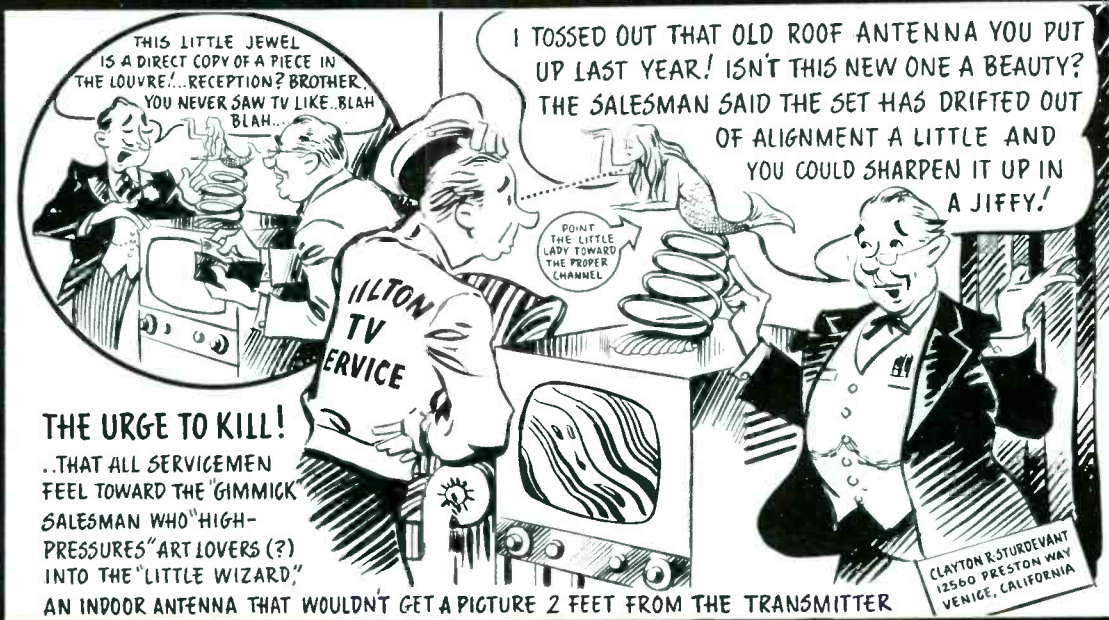

NEW DRESS for an OLD FAVORITE!

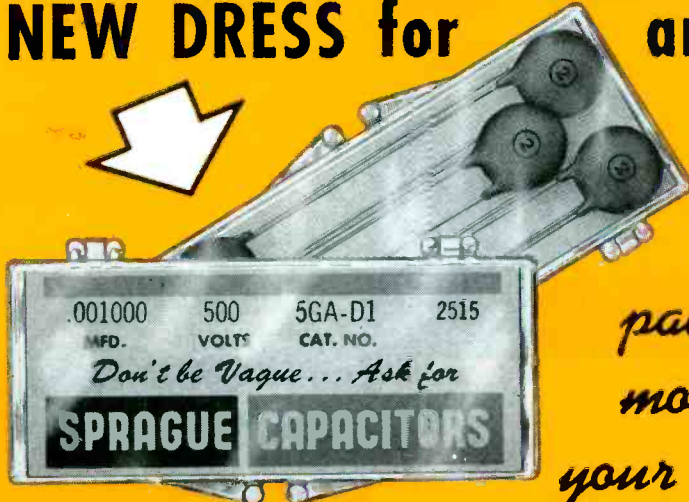

*Cera-Mite**
Capacitors are now packaged in the clear, molded Plasti-Pak* for your greater convenience

NOW the complete Sprague ceramic line for virtually every replacement need comes to you in the crystal-clear molded Plasti-Pak* box. This rigid, reusable container lets you see contents and capacitor ratings at a glance. There's a positive snap lock on this slim new space-saving polished styrene package with the hinged lid to eliminate spilling.
The Plasti-Pak is another of the service tested, forward-looking features for which you can depend on Sprague.
Remember, there's a Sprague ceramic capacitor or printed circuit for every replacement requirement.
And there are Sprague distributors in every major trading area. For the name and address of your nearest genuine Sprague parts depot, write to Sprague Products Company, 61 Marshall Street, North Adams, Mass.

Look To SPRAGUE For LEADERSHIP IN EVERY Type of CAPACITOR!

Do you have the complete Sprague Catalog C-609?

SPRAGUE  **WORLD'S LARGEST CAPACITOR MANUFACTURER**

SPRAGUE PRODUCTS CO IS THE DISTRIBUTORS' DIVISION OF THE SPRAGUE ELECTRIC COMPANY

it's always
better business
 to buy
better-made
 antennas

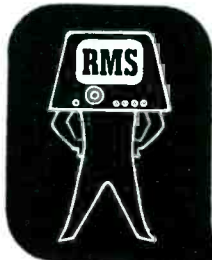

From your RMS line — the largest in this industry — you'll always find the antenna best suited for your area. All feature excellent gain and provide excellent quality with remarkable construction superiority. Work with RMS antennas and you'll see the important differences . . . count the hours saved in faster installation. They're priced right, too. See your local RMS Jobber.

RMS

2016 Bronxdale Avenue,
 New York 62, N. Y.

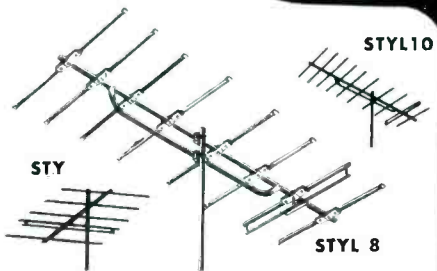

VHF Yagi — single channel — With unique steel brace on 8 & 10-element 10-band models. All-preassembled, all-aluminum; excellent gain.

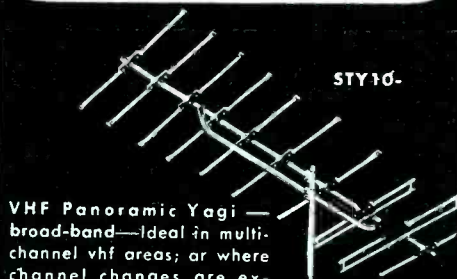

VHF Panoramic Yagi — broad-band — Ideal in multi-channel vhf areas; or where channel changes are expected. No hardware bag. No riveted parts. Step-up transformer and other elements preassembled, swing out and tighten.

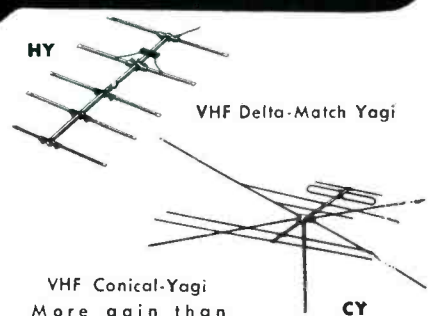

VHF Conical-Yagi
 More gain than stacked conical, single lead-in. Also stacked models.

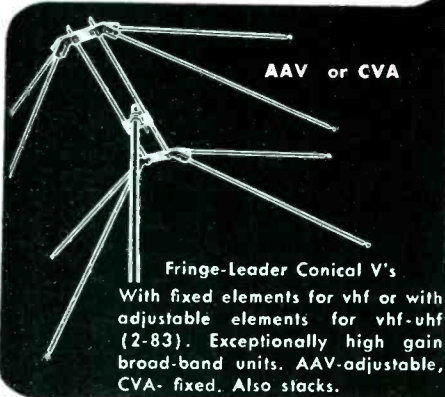

Fringe-Leader Conical V's
 With fixed elements for vhf or with adjustable elements for vhf-uhf (2-83). Exceptionally high gain broad-band units. AAV-adjustable, CVA- fixed. Also stacks.

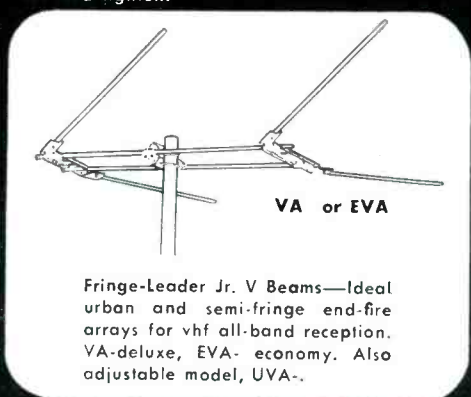

Fringe-Leader Jr. V Beams — Ideal urban and semi-fringe end-fire arrays for vhf all-band reception. VA-deluxe, EVA- economy. Also adjustable model, UVA-

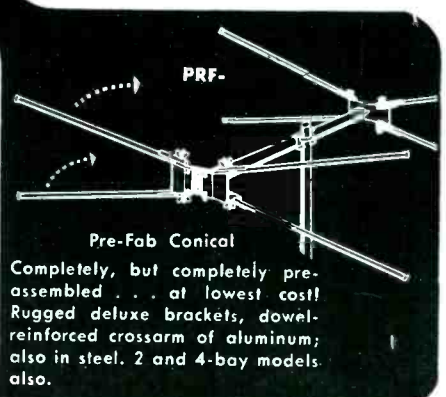

Pre-Fab Conical
 Completely, but completely pre-assembled . . . at lowest cost! Rugged deluxe brackets, dowel-reinforced crossarm of aluminum; also in steel. 2 and 4-bay models also.

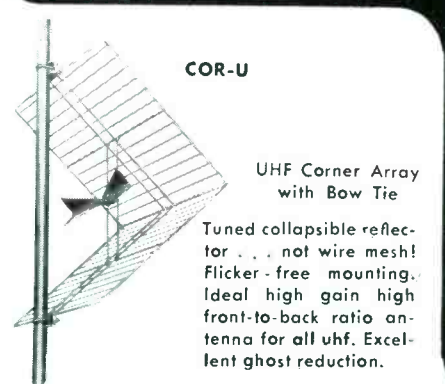

UHF Corner Array with Bow Tie
 Tuned collapsible reflector . . . not wire mesh! Flicker-free mounting. Ideal high gain high front-to-back ratio antenna for all uhf. Excellent ghost reduction.

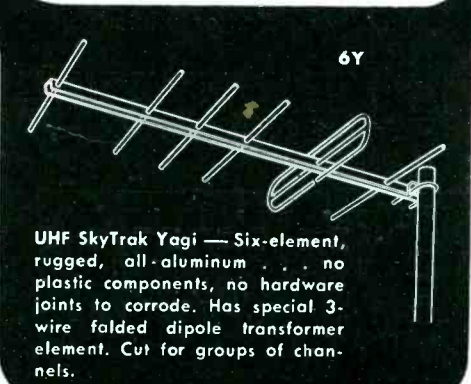

UHF SkyTrak Yagi — Six-element, rugged, all-aluminum . . . no plastic components, no hardware joints to corrode. Has special 3-wire folded dipole transformer element. Cut for groups of channels.

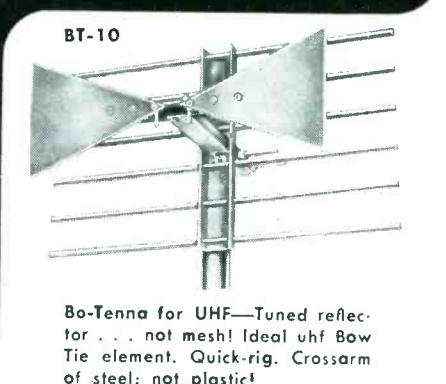

Bo-Tenna for UHF — Tuned reflector . . . not mesh! Ideal uhf Bow Tie element. Quick-rig. Crossarm of steel; not plastic!

... put this
PROOF

right into your
customer's
hand!



**BE SURE TO
ENTER THE
CQS CONTEST**



If you are using the CBS-Hytron *Certified Quality Service Kit*, you are eligible to enter. You simply tell in 25 words or less why you like the CQS Plan. As an eligible entrant, you get a famous CBS-Hytron Soldering Aid free. And you have a chance to win one of these 10 BIG prizes:

**FIRST PRIZE:
FORD PANEL TRUCK**

- Second Prize: \$1000 in Savings Bonds
- Third Prize: 600 in Savings Bonds
- Fourth Prize: 500 in Savings Bonds
- Fifth Prize: 400 in Savings Bonds
- Sixth Prize: 300 in Savings Bonds
- Seventh Prize: 200 in Savings Bonds
- Eighth Prize: 100 in Savings Bonds
- Ninth Prize: 50 in Savings Bonds
- Tenth Prize: 25 in Savings Bonds

Remember, your CBS-Hytron distributor's salesman can also win other big prizes. Be sure to write his name, too, on your Contest entry. Entry blanks are available in your CQS Kit . . . or from your CBS-Hytron distributor. Beat the closing date, Dec. 15, 1953.

PROVE to your customer he can put his confidence in you.

Lay all the facts before him. Hand him this *Certified Quality Service Tag*. The Tag he has been reading about in LIFE-POST ads sponsored for you by CBS-Hytron. The same ads (and there'll be more) that are prompting him to ask where he can find you, his *Certified Quality Service* dealer.

With this simple, easy-to-use Tag, *do what your customer wants*. *Certify* that your itemized charges are fair. *Certify* that your service . . . your ability . . . and your equipment guarantee him dependable, top-quality TV and radio repairs. Give your customer *tangible proof* that you are giving him his money's worth. Win *his* confidence. And *you* will gain more business . . . more profits. Put *your* convincing *Certified Quality Service Tags* to work right away.

GO A STEP FURTHER

Tie in with the whole *Certified Quality Service Plan* as advertised in LIFE and the POST.



Use your decal.



Use your window streamer.



Use your LIFE-POST display.

They are all part of the *Certified Quality Service Kit*. This Kit, including 250 CQS Tags imprinted with your name and address, is available on a special offer from your CBS-Hytron distributor. Or you can write for details on how to order direct. You can order more CQS Tags from your distributor, whenever you need them.

GO STILL FURTHER

Keep in close touch with your CBS-Hytron distributor. Watch soon for additional supporting material to identify you as a *Certified Quality Service* dealer:

1. CQS illuminated window sign
2. CQS metal flange sign
3. CQS direct-mail postal cards
4. CQS newspaper mats, etc.

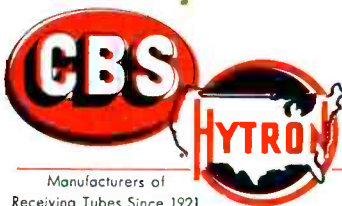

Manufacturers of
Receiving Tubes Since 1921

CBS-HYTRON, Main Office: Danvers, Mass.

A Division of Columbia Broadcasting System, Inc.

A member of the CBS family . . . CBS Radio • CBS Television
Columbia Records, Inc. • CBS Laboratories • CBS-Columbia, Inc. • and CBS-Hytron

RECEIVING . . . TRANSMITTING . . . SPECIAL-PURPOSE AND TV PICTURE TUBES • GERMANIUM DIODES AND TRANSISTORS

PROOF!

When measurement standards* are uniform
AMPHENOL antennas provide the best
 electrical characteristics

* All AMPHENOL VHF antenna measurements made
 in accordance with proposed RETMA standards.

LOW BAND

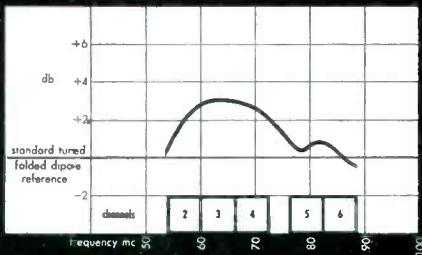

HIGH BAND

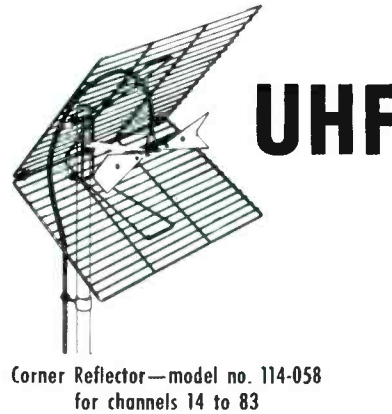
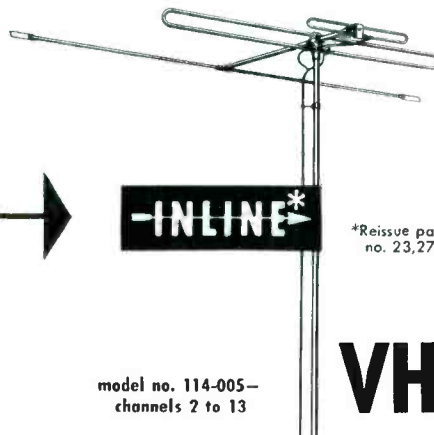
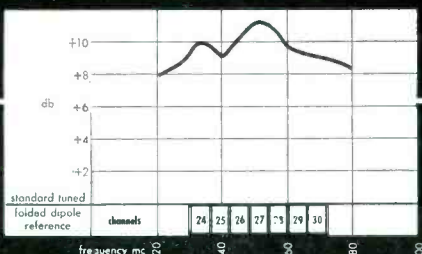
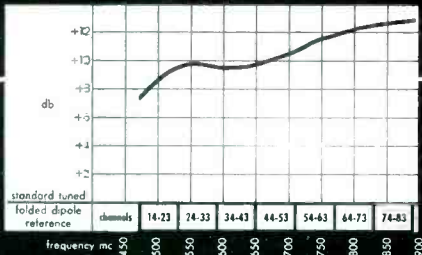
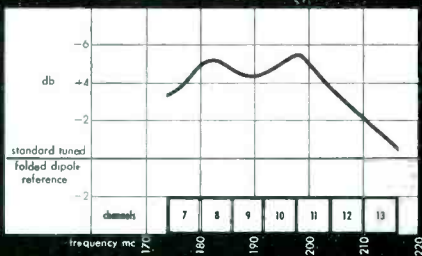

Advertisements claiming 40 db gain for gilded coat hangers will be a thing of the past with the adoption of proposed RETMA antenna measurement standards. By this move, all antenna manufacturers will measure the performance of their antennas by the same methods.

The adoption of uniform standards will not affect AMPHENOL literature, however, as all AMPHENOL antenna measurements are, and have been, made in accordance with these proposed standards. The gain charts to the left represent **reliable** indices to the characteristics of three representative AMPHENOL antennas—give **proof** of top performance.

The superb **electrical performance** of AMPHENOL antennas plus the famous AMPHENOL **craftsmanship construction** has made these antennas the first choice of dealers, servicemen and installers all over the nation. They have found the AMPHENOL line to be the **quality line** on both top **electrical performance** and **durable construction**.

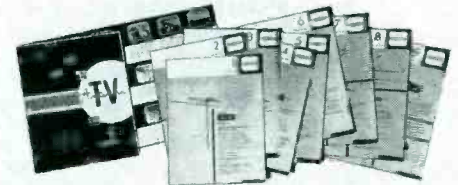

For complete information on every AMPHENOL antenna, be sure and get your copy of the free "TV Antenna Folio" which contains antenna and accessories catalog sheets with full electrical data. See your AMPHENOL distributor.



AMERICAN PHENOLIC CORPORATION

chicago 50, illinois



For TELEVISION-RADIO-RADAR INSTRUMENTS

**REMEMBER
ONE
NAME . . .**

FOR EVERY CIRCUIT PROTECTION PROBLEM

CONTROLS-AVIONICS

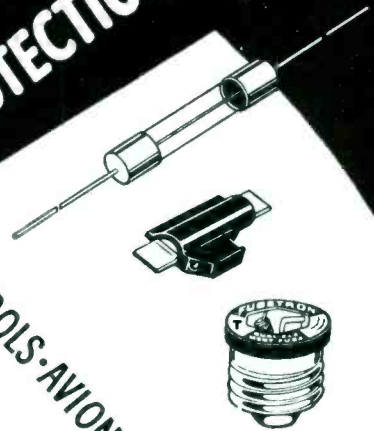

BUSS FOR FUSES

THE INDUSTRY'S *Most Complete* LINE

Here's why it pays to get all your fuses from this one reliable source:

More than a third of a century of service stands behind every fuse that bears the BUSS trademark. Your customers have faith in BUSS fuses. They know that the BUSS name represents fuses of unquestioned high quality.

To maintain these high standards, each BUSS fuse is **electronically tested** for correct calibration, construction and physical dimensions.

- **BE DOUBLY SAFE . . .** install BUSS fuses. They protect the product and your reputation. Your customers know BUSS fuses — famous for dependable protection in homes, industry and on the farm, ever since 1914.

Plus A COMPLETE LINE OF FUSE CLIPS, BLOCKS AND HOLDERS

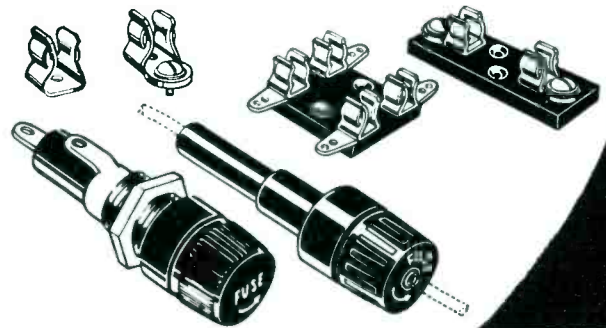

Bussmann Mfg. Co., University at Jefferson
St. Louis 7, Mo. (Division of McGraw Electric Co.)

Please send me bulletin SFB containing facts on BUSS small dimension fuses and fuse holders.

Name.....
 Title.....
 Company.....
 Address.....
 City & Zone..... State..... S-1153

 **FOR MORE INFORMATION**
mail this coupon today

CUSTOMERS EVERYWHERE KNOW
 SYLVANIA TUBES JUST
 CAN'T BE BEAT FOR QUALITY!



WHY SYLVANIA PRODUCTS MEAN BETTER BUSINESS!

YOU'RE really on board the *better-profit* special when you feature Sylvania Picture Tubes and Receiving Tubes.

Your customers know Sylvania as a pioneer in the development of fine radio and television products. From the very beginning, the name Sylvania has stood for the highest possible quality. And, as the industry has progressed and expanded, Sylvania has taken great care to maintain its recognized leadership.

Now, due to advanced manufacturing techniques and precision testing methods, Sylvania tubes can point to outstanding records, both in long life and fine performance. Today 7 of the 10 leading set manufacturers use Sylvania Picture Tubes and Receiving Tubes.

So, if you want *recognized quality* working on your side . . . *sell Sylvania!* Call your local Sylvania Distributor for the latest fall prices and money-making promotion offers, or write to: Sylvania Electric Products Inc., Dept. 3R-2411, 1740 Broadway, New York 19, N. Y.

**Television keeps telling
 about Sylvania quality**

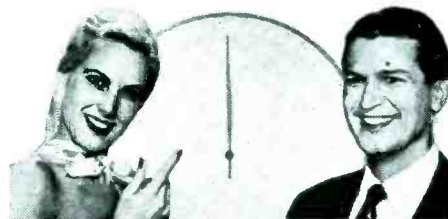

Sylvania's popular nation-wide television show "Beat the Clock" continues to tell millions of your customers week after week, all through the year, about the unbeatable quality of Sylvania products.

SYLVANIA



LIGHTING • RADIO • ELECTRONICS • TELEVISION

In Canada: Sylvania Electric (Canada) Ltd.
 University Tower Bldg., St. Catherine Street, Montreal, P. Q.

272 NEW DRY ELECTROLYTICS!

*Greatly Expanded Pyramid
Capacitor Replacement Line*

*Now Listed in Free
Supplement DE*

featuring
an entirely new
hermetically sealed
tubular with 6" flexible
insulated leads

TYPE TDL

Write for Free Catalog DE

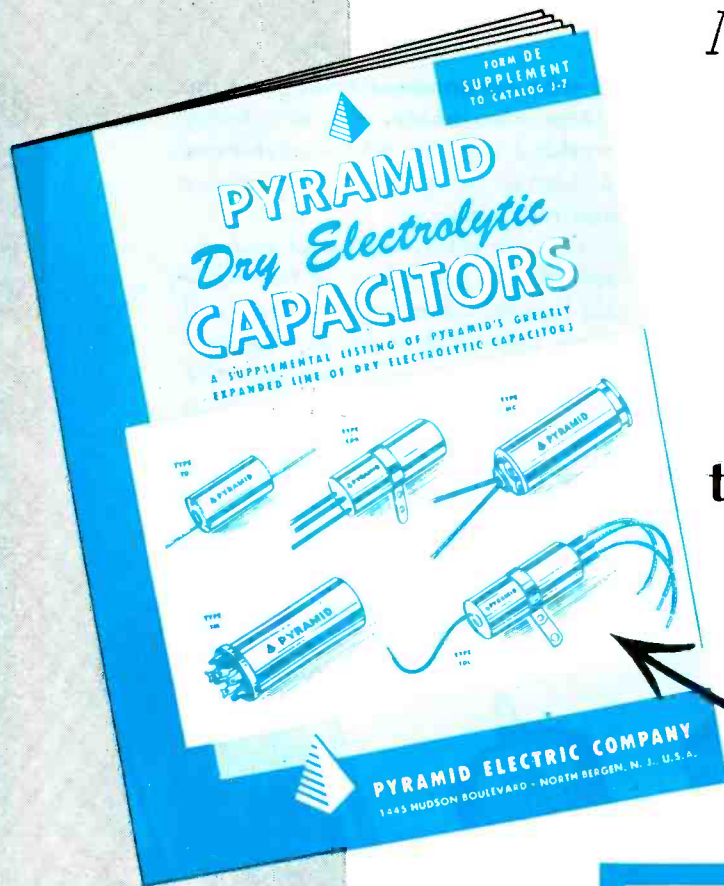

FREE

Mr. Serviceman:

Get this handy wrench for locking or unlocking the mounting ears of Pyramid's Twist-Mounts. See your distributor today and take advantage of this exceptional offer.

PYRAMID ELECTRIC COMPANY

1445 HUDSON BOULEVARD, NORTH BERGEN, N. J.

Again proving
tube-design
leadership...

40% OF 1952'S NEW RECEIVING TUBES WERE G-E DEVELOPMENTS... TWICE ANY OTHER MAKE

FOURTEEN out of thirty-five registered new receiving-tube designs—40%—were G-E, in the last calendar year, 1952. As still further proof of leadership, new G-E types numbered more than twice those of any other manufacturer!

Outstanding research and development by General Electric have given to the TV-radio industry its newest, most advanced tubes. You can be sure, when servicing latest-model receivers, that G-E tubes are available for every need—that G-E leadership

in tube development brings you the finest obtainable product. Every working day, you will receive extra dividends in superior performance and reliability.

You can expect more new and improved tubes from General Electric in the months ahead—types that will make your work easier and cut call-backs. Keep in touch with your G-E tube distributor for forthcoming new-tube announcements, each with a profit message for you! *Tube Dept., General Electric Co., Schenectady 5, N.Y.*

SHOWN BELOW: a few of the many new G-E tubes that are making money for service dealers.



You can put your confidence in—

GENERAL  ELECTRIC

161-1A8

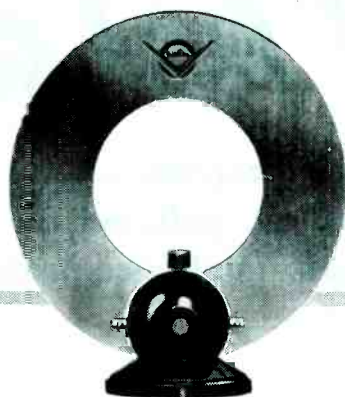

Radion's new **SUPER-BULLSEYE**
sells TV in every market because it's
the one **UHF-VHF** indoor antenna
that's extra-compact, smartly-styled.
A top performer because it's
Radion quality-built. Order now!

\$695 list

Radion

Export Sales Div. Scheel International, Inc.
4237 N. Lincoln Ave., Chgo. 18 • In Canada: A.T.R.
Armstrong Co., 59 St. Clair Ave., West, Toronto

Get the Super-Bullseye super-selling story . . . mail today!

THE RADION CORPORATION
1130 W. Wisconsin Ave., Chicago 14, Illinois

S-11

Please send information on the Super-Bullseye to:

Name _____

Firm _____

Address _____

City _____ Zone _____ State _____

NORTH, EAST, SOUTH, WEST...

Federal has a lead-in

Whatever the area or atmosphere... city or fringe... rain, snow ice, heat, dust, salt spray, polluted air or radiation... you'll find the answer in these quality-controlled cables by Federal —

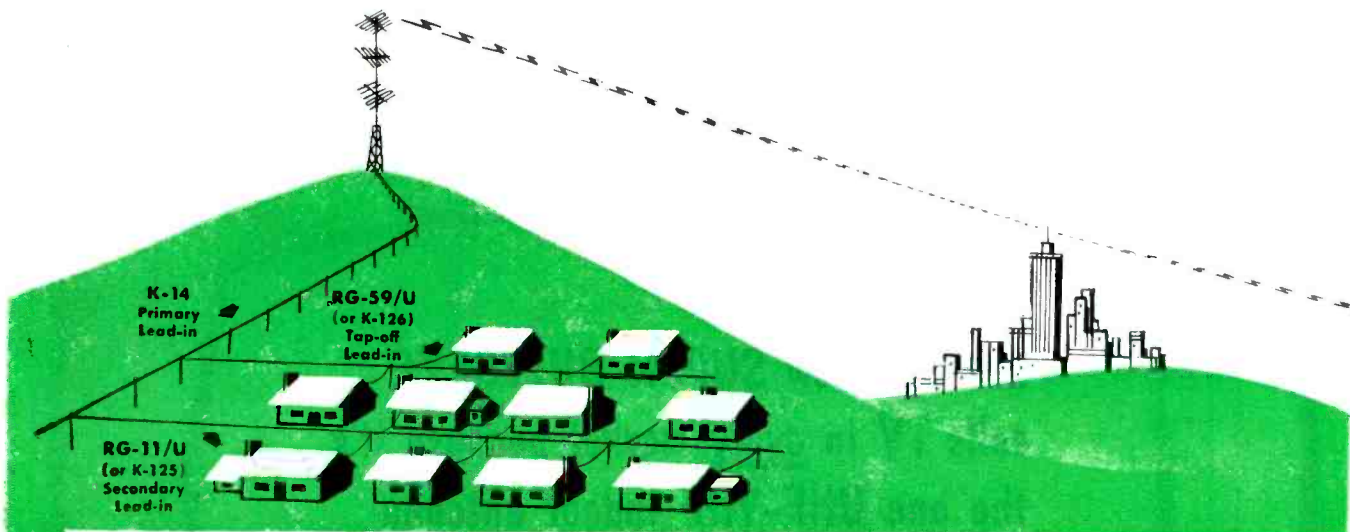

FOR COMMUNITY TV IT'S *Federal's* "BIG 5"



K-14—71-ohm shielded primary transmission line for community distribution systems. Famous for lowest line loss, long cable runs and fewer amplifiers required. Capacitance: 21.5 mmf/ft. Attenuation DB 100/ft: .57–50 Mc; .90–100 Mc; 1.42–200 Mc; 2.3–400 Mc.



RG-11/U—75-ohm shielded low-loss coaxial. One of the best small-diameter cables. Tops as a community TV secondary lead-in. Seven strands #26 tinned copper. Capacitance: 20.5 mmf/ft. Attenuation DB 100/ft: 1.5–50 Mc; 2.15–100 Mc; 3.2–200 Mc; 4.7–400 Mc.



RG-59/U—73-ohm coaxial TV lead-in cable. Highly efficient as a community system pole-to-house tap-off. Meets all needs wherever a high-grade installation is a must. Capacitance: 21 mmf/ft. Attenuation DB 100/ft: 2.7–50 Mc; 4.0–100 Mc; 5.7–200 Mc; 8.5–400 Mc.

Use these 2 for Community TV radiation:

FOR URBAN CENTERS



K-111—300-ohm shielded, balanced TV lead-in developed by FTR. Minimizes noise, snow, ghosts due to transmission line pick-ups. Ideal for many areas where good TV was impossible before. Capacitance: 4.2 mmf/ft. Attenuation DB 100/ft: 3.4–100 Mc; 6.6–400 Mc.



TV-1184—300-ohm dumbbell-shaped TV lead-in. A standard low-cost lead-in for areas without unusual conditions. Cinnamon-brown color is highly resistant to ultraviolet. Two conductors: 7/#28. Capacitance: 4 mmf/ft. Attenuation DB 100/ft: 1.28–100 Mc; 3.0–400 Mc.



TV-1182—300-ohm deluxe type heavy-duty TV lead-in with 90 mil. web. Insulated with "silver" polyethylene, Federal development that provides maximum weather protection and long life. Capacitance: 4 mmf/ft. Attenuation DB 100/ft: 1.22–100 Mc; 2.85–400 Mc.

Non-Radiating Lead-ins for MULTIPLEX TV SYSTEMS



K-125—75-ohm coaxial TV lead-in cable. Double-shielded and jacketed. Formerly listed as SP-75.



K-126—73-ohm coaxial TV lead-in cable. Double-shielded and jacketed. Formerly listed as SP-76.

K-125 alternates for RG-11/U as secondary lead-in
K-126 alternates for RG-59/U as tap-off lead-in

Wherever there are **TV** customers...

for the finest **VHF-UHF**

Federal's **TV-1185** *

...**"PIPELINE"** of the Air!



FOR FRINGE AREAS

TV-1182—Provides remarkably low line loss in fringe areas. Outstanding for resistance to weather and sunlight. Silver-colored insulation blends with any color scheme in home decoration.

K-200 (RG-86/U)—200-ohm heavy-duty ultra low-loss lead-in. Particularly adaptable to remote-area installations — especially long runs and multi-stack antennas. Also used with rombics.

**See your local
Federal Distributor
or write to
Federal direct
Dept. D-956**

**TV-1185's "Silver" pigmentation lets you
INSTALL IT and FORGET IT!**

FEDERAL's TV-1185 is virtually a "pipeline" for better-than-ever TV reception... VHF or UHF. Insulated with the revolutionary Federal-developed "silver" polyethylene, TV-1185 is amazingly tough, flexible and efficient.

TV-1185 leads in Weatherometer tests... fights heat, resists moisture and other destructive deposits... minimizes deterioration due to sunlight.

TV-1185 keeps the energy field inside the weather-proof sheath... providing exceptionally low loss... more constant impedance... a better TV picture regardless of area or length of lead. It's easy to install and tight-seal against all atmospheric conditions.

There's no finer tubular lead-in of its type on the market today!

Capacitance: 4 mmf/ft. Attenuation DB 100/ft:
0.5-10 Mc; 0.95-50 Mc; 1.25-100 Mc; 1.7-200 Mc;
2.6-400 Mc; 3.0-500 Mc; 4.5-1000 Mc.

Product of America's leading producer of solid dielectric coaxial cables.



Federal Telephone and Radio Company

SELENIUM-INTELIN DEPARTMENT

100 KINGSLAND ROAD, CLIFTON, N. J.

In Canada: Federal Electric Manufacturing Company, Ltd., Montreal, P. Q.

Export Distributors: International Standard Electric Corp., 67 Broad St., N. Y.

*“ . . . helping to keep
the business cycle
on an even keel . . . ”*



HARRY B. HIGGINS
President, Pittsburgh Plate Glass Company

“The employees of Pittsburgh Plate Glass Company since 1946, have purchased \$9,488,510 in United States Savings Bonds through the Payroll Savings Plan. This accumulation of assets will be of inestimable value in helping to keep the business cycle on an even keel by maintaining purchasing power for the future.”

Payroll Savings—the plan that protects—pays the employer triple benefits:

- it makes a good employee a better one—a serious saver with a definite plan for personal security.
- as enrollment on the plan goes to 60%, 70% employee participation, productivity increases, absenteeism decreases and accident records go down.
- and as Mr. Higgins points out, the systematic purchase of Defense Bonds through the Payroll Savings Plan is building a tremendous reserve of purchasing power.

Let's point up the third employer benefit with a few figures:

- On September 30, 1951, individuals held Series E Bonds totaling \$34.6 Billion—more than \$4.6 greater than on V-J Day.
- During the five calendar years (1946-1950) Defense Bonds sales provided:

—Cash to retire \$3 Billion A-D Savings Bonds (maturing Series).

—Cash to meet \$24 Billion redemptions of E, F and G Bonds.

—\$6 Billion (after providing cash for the payments enumerated above) that the U.S. Treasury could use to pay off bank-held debt.

And the figures are getting better every day—between January 1, 1951 and November 1, 1951, 1,200,000 employed men and women joined the Payroll Savings Plan.

If the employee participation on your Payroll Savings Plan is less than 60%, phone, wire or write to Savings Bond Division, U.S. Treasury Department, Suite 700, Washington Building, Washington, D.C. Your State Director will be glad to show you how you can participate in the triple benefits of the Payroll Savings Plan.

The U.S. Government does not pay for this advertising. The Treasury Department thanks, for their patriotic donation, the Advertising Council and

SERVICE



Now-Improved UHF Reception

Anywhere!

with  133-A

UHF AUTOBOOSTER



LIST PRICE

\$49.95

FOR FRINGE AREAS

- Lower Noise Figure—eliminates snow
- High Gain—compensates for strip or converter losses

FOR PRIMARY AREAS

- Increased Selectivity—eliminates interference
- Grounded Grid RF—suppresses oscillator radiation

Here for the first time is a high-gain, low noise amplifier continuously tunable over the entire UHF range, affording *clear, steady, interference-free* pictures even under unfavorable conditions! The IT-133A UHF Auto booster is an ideal working companion for all UHF and UHF-VHF systems in both fringe and primary areas.

Usable with indoor or outdoor antennas, the I.T.I. UHF Auto booster effectively increases station power nearly ten times. The added selectivity of the IT-133A reduces the spurious responses of some UHF strips and converters, which eliminate interference caused by amateur and commercial transmitters. Get *all* the details on this important new entry in the VHF-UHF field *today*.

WRITE
FOR TECHNICAL
DATA SHEET



INDUSTRIAL TELEVISION, INC.

369 Lexington Avenue

Clifton, New Jersey



If knowledge came in containers, almost anyone could pioneer in the design and development of Electron Tubes — might even match RAYTHEON'S remarkable record of achievement in the industry.

But the kind of "know-how" that has helped RAYTHEON achieve so many industry-wide firsts, and established Raytheon Tubes as the quality standards of the industry, comes only through years of dedication to a single objective. For *thirty-years* that objective has been to *make the finest Electron Tubes in the world*. And the precious "know-how" accumulated during this period is now being used to maintain RAYTHEON TUBES' leadership in the years to come.

That's why you can use Raytheon Radio and Television Tubes — today and tomorrow — with complete confidence that you are using the finest. Ask your Raytheon Tube Distributor for them.



RIGHT... FOR SOUND AND SIGHT



RAYTHEON MANUFACTURING COMPANY

Receiving Tube Division
 Newton, Mass., Chicago, Ill., Atlanta, Ga., Los Angeles, Calif.

Excellence in Electronics

RAYTHEON MAKES ALL THESE:
 RECEIVING AND PICTURE TUBES • RELIABLE SUBMINIATURE AND MINIATURE TUBES • GERMANIUM DIODES AND TRANSISTORS • NUCLEONIC TUBES • MICROWAVE TUBES



A Salute to the Independent Service Man*

EVER SINCE the days of 360-meter broadcasting, and that goes back to the early twenties, the neighborhood service shop has been one of the most popular and important centers in the community—not only to setowners, but to station operators, too.

Ever aware that Service Men represent the lone, potential physical link with the homes of local chassis owners, and are welcomed into the house to install and repair receivers, adjust antennas, and often offer technical advice on changes and developments in industry, broadcasters have always spread the red carpet out for the service boys. On many occasions station operators have cooperated with Service Men and supplied them with weekly program cards, carrying imprints of the shop's name and address, which could be left at homes during calls or mailed out on a periodic basis. Still others have gone a step further and supplied Service Men with throw-cloths, on which tools and equipment can be placed when making home repairs, which not only carry the name and address of the shop in bold letters, but the call letters of the cooperating station. And, in many areas, stations have also campaigned for Service Men by carrying sustaining announcements promoting local shop service.

Throughout the years this enthusiasm has always obtained, but a few weeks ago interest really zoomed, and on a spectacular scale. In New York City, the advertising and promotion manager of one of the most important TV and radio stations in the country, a key station in a nationwide network, sent the following message to the prexy of the local association: "We have long realized that thousands of reputable radio and television Service Men are responsible for keeping our radio and TV audience intact, by keeping Greater New York's millions of radios and TV receivers in trim. . . . We would like to salute members of your organization and encourage our listeners and viewers to contact reputable Service Men to insure good reception of our new fall radio and TV programs. . . . Would it be possible for you . . . to get in touch with us at the earliest opportunity to work out details?"

What a tribute—a gilded tribute—and startling display of respect for the ability of the independent Service Man.

And, on appearing before the station's executives, the association's prexy was told that they are willing to spend \$60,000 in spot announcements on radio and TV to promote the work of the independent Service Man, and applaud, too, his membership in the association¹. They felt that such a program would help them, for it would keep

every listener and viewer well informed with the fact that there are a large number of reliable independent Service Men available to keep sets in operation—perfect operation.

Commenting further on the program, the broadcasting officials declared that the independent Service Man is really their ally, and actually as vital in their overall operations as those directly associated with the station. Service Men, they said, are important to their program department, and a key factor in coverage-guarantee planning. In other words, they emphasized, the Service Man is a vital tool in their sales kit. They can keep more and more sets working, and aligned properly for perfect pickup.

Throughout the country similar concerted drives have been planned. The activity has been especially lively in the revitalized *v/hf* areas where higher power is now being pumped into the antenna, and also in the new ultrahigh zones. The plans not only revolve about fall programs, but broadcasts in the summer, winter and spring, as well. People listen in and look in all year round. Perhaps the folks might not be in their homes, but they're around, tuning in whether they're driving, or on vacation.

Set manufacturers have also swung into the parade, applauding the virtues of the independent Service Man. In the nation's leading national weeklies and monthlies, tube, set and component manufacturers have and are applauding the independent Service Man, urging consumers to call on their local service shop. They have become fully aware that it is the independent who is his loyal liaison in the network of communities throughout the country; always ready to serve and protect a manufacturer's reputation by insuring continuing performance and winning confidence in their products.

It is the independent who does that job, and will continue to do that job, notwithstanding new trends, involved developments, or those complex chassis that will appear with color TV.

Service Men have always accepted the challenge occasioned by new eras and new design concepts. They realize that they have a public trust, and are charged with the continuing responsibility of serving those in their community. They know that regardless of their location, be it a village, town, borough, or large metropolis, and regardless of the territory covered, whether it be just a few blocks or dozens of sprawling miles, there are many families of listeners or viewers who depend on their professional ability and skill to see that the sight and sound performance of their receivers is always the tops.

Service Men know that they have this obligation, and manufacturers and broadcasters have found that Service Men have kept faith and are more than entitled to a roaring salute for their sincerity and competence.—L. W.

* From a talk presented by *ye editor* at the 4th Annual TV-Radio-Electronic Service Industry Convention of the National Alliance of Television-Electronic Service Association, in Chicago.

¹ See National Scene report, this issue, page 47.

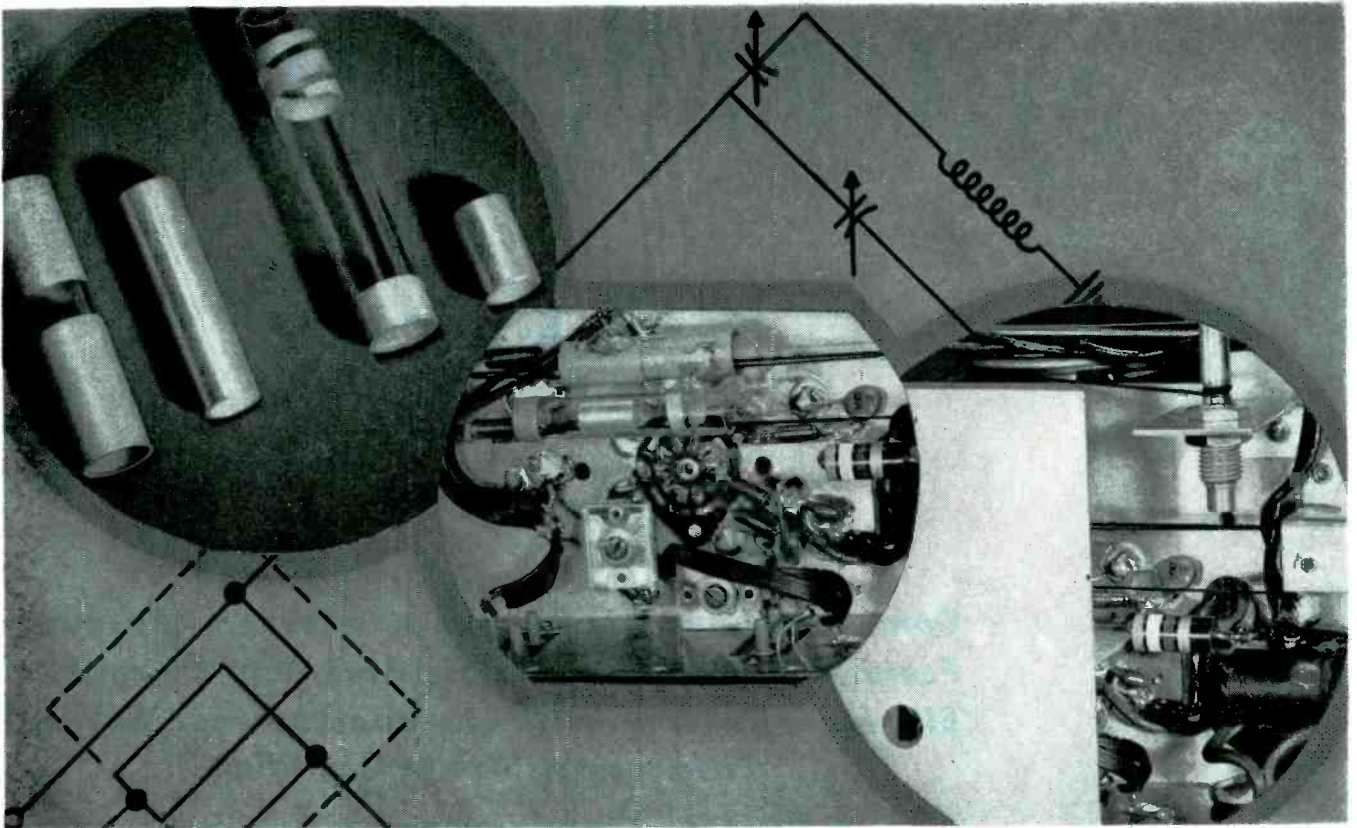

Figs. 2 (left), 3 (center) and 4 (right). Uhf tuning elements; and bottom views of chassis, with and without shield.

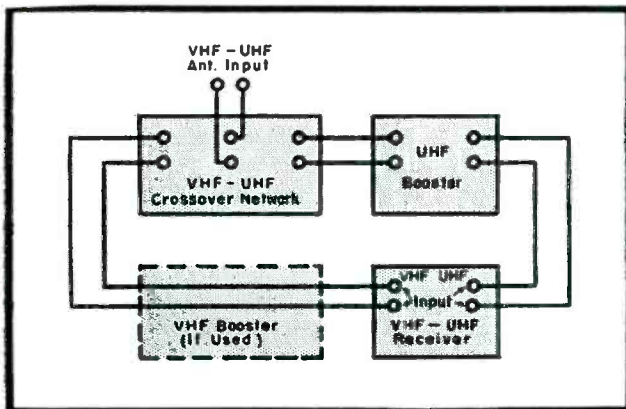

(Above)

Fig. 5. Block diagram showing uhf booster and vhf-uhf coupler.

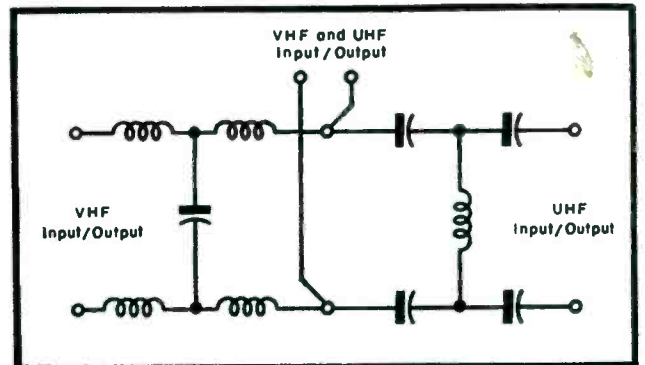

(Above)

Fig. 6. Schematic of filter-type crossover network***.

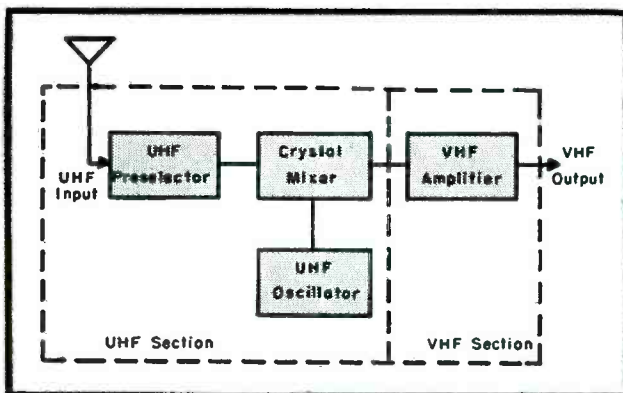

(Above)

Fig. 7. Block diagram of a uhf converter, illustrating its make-up with a uhf section and vhf booster.

(Right)

Fig. 9. Block diagram of wavemeter arrangement, showing sweep-booster-detector-'scope hookup.

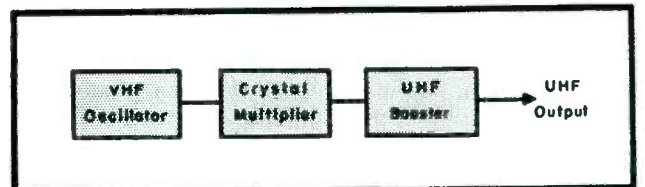

(Below)

Fig. 8. Block diagram illustrating use of amplifier with vhf oscillator and crystal multiplier to generate uhf signals.

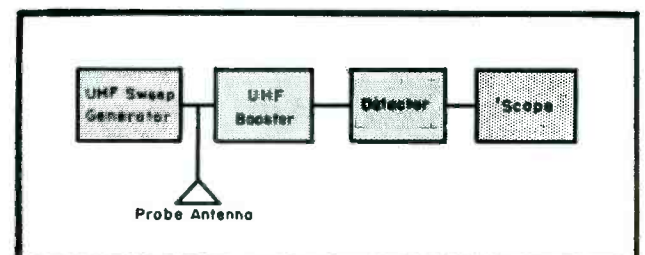

Systematic Servicing

by J. C. GEIST

Comprehensive Discussion of a Novel Approach, Featuring a Preventive Maintenance Plan, Designed to Eliminate Costly Callbacks and Increase General Efficiency of Service Operation.

ONE OF THE WEAKNESSES which has been carried over from broadcast radio service to TV service has been the tendency to do *spot repairing*; that is, repair a particular failure without regard for the general condition of the receiver. While this practice may not obtain in some of the larger service groups, many of the smaller shops have practically disregarded the possibilities of systematic preventive maintenance.

An effective example of the value of preventive maintenance appears in the servicing of mobile communication equipment. It is a general practice in this field to bring each unit in for a preventive maintenance check on a regular schedule. Procedures here involve a general visual inspection, check of power-supply voltages, alignment touch-up in the transmitter and receiver, replacement of transmitter tubes providing low grid excitation or low transmitter output, and replacement of receiver tubes contributing to low receiver sensitivity. By means of routine testing procedures weak tubes are replaced before an actual equipment failure is encountered; in putting the equipment back in peak performance, capacitors and resistors which are starting to fail are often discovered and replaced during the preventive maintenance operations.

It is true that mobile communication systems are generally in commercial use where out-of-service time is an important factor. Therefore, rou-

tine preventive maintenance is both more necessary and easier to control than for home receivers. However, routine maintenance is not unknown to the consumer. Automobile manufacturers, for instance, have certainly done a great deal to establish the need for routine maintenance in the mind of the individual motorist.

The Concept of Systematic Service

Television service can and should be considerably more than spot repair work; it can be a maintenance service for an established clientele. That is, it can mean keeping the TV installations of a number of permanent customers in proper operation, as opposed to making individual repairs for an ever changing group of customers as they might drift, because of dissatisfaction, from one TV shop to another.

It is of course possible to turn a *fast buck* by rushing from one quick repair to another without taking time to determine whether the sets are really offering best possible results. But, this is not the way to build an established neighborhood business, surely the aim of every sincere service shop owner. After all, the closer to the shop and the more concentrated the customers, the less time spent in traveling; a factor directly affecting the cost of doing business and the profit realized.

The effective application of systematic service can do much to change a

repair shop into a true TV maintenance service business. In *systematic service* every receiver is subjected to standard test and maintenance procedures, in addition to the repair of gross failures, so as to insure that the chassis are operating satisfactorily in all respects; thus insuring generally improved performance and reducing the total number of service calls. It is recognized that there is an inherent skepticism in the minds of many Service Men regarding any work leading to a reduction in the number of service calls. However, the generally improved performance resulting from the application of systematic service will, in the long run, result in a more stable and a more profitable business; first because of a reduction in the number of costly call-backs, and second because of a general increase in efficiency accompanying systematic operation.

How costly inefficient operation can be improved by the application of systematic service procedures was demonstrated a short while ago, when a second-hand TV chassis was purchased. The set was bought with the understanding that an intermittent pulling condition would be eliminated. Within a day after the receiver was delivered it was evident that the condition had not been corrected, but inspection indicated that two tubes, evidently thought to be the cause of the trouble, had been replaced. A check indicated that the horizontal oscillator tube was

microphonic and the power rectifier was so weak that the *B* voltage had been lowered to the point where overall performance was considerably degraded. Replacing these two tubes restored the receiver to proper operating condition. Had the sale been made to a *regular* customer a free service call would have been required to repair the receiver. On the other hand, routine testing procedures at the shop would have quickly shown that these two tubes were defective; thus saving the unprofitable call and probably the two tubes that were originally replaced.

Record Keeping

In the application of systematic service procedures an effective system of records is essential. At the very least these records should show for every receiver serviced: the manufacturer's type and serial number; customer's name, address and phone number; date of repair; labor, material and total bill to customer. Not only will such records be of value in justifying that subsequent failures are not in recently replaced parts, but the very fact that the complete service history of each receiver is available will do much to impress the customer with the professional and technical ability of the shop. And after all, *customer impression* is an important part of business.

As standard procedures are developed, shop service records can advantageously include a few key measurements which give an indication of receiver performance. Suggested key measurements would include primary current, *B* voltage, boosted *B* voltage, picture-tube second-anode voltage at both extremes of the brightness control, and some measure of receiver sensitivity. By establishing a recording of these measurements as a routine part of every service operation the general performance of the receiver can be automatically checked, and weaknesses can be corrected before they become gross failures. The recorded values will also be useful as a check during each subsequent service operation. The trick, of course, is to establish routine service procedure which will allow these measurements to be taken in an efficient manner, so that they will be useful as a service tool and not a costly burdensome operation.

Routine Test and Maintenance Procedures

The success of industry, in the production of complex equipment at reasonable cost, has been due to the ap-

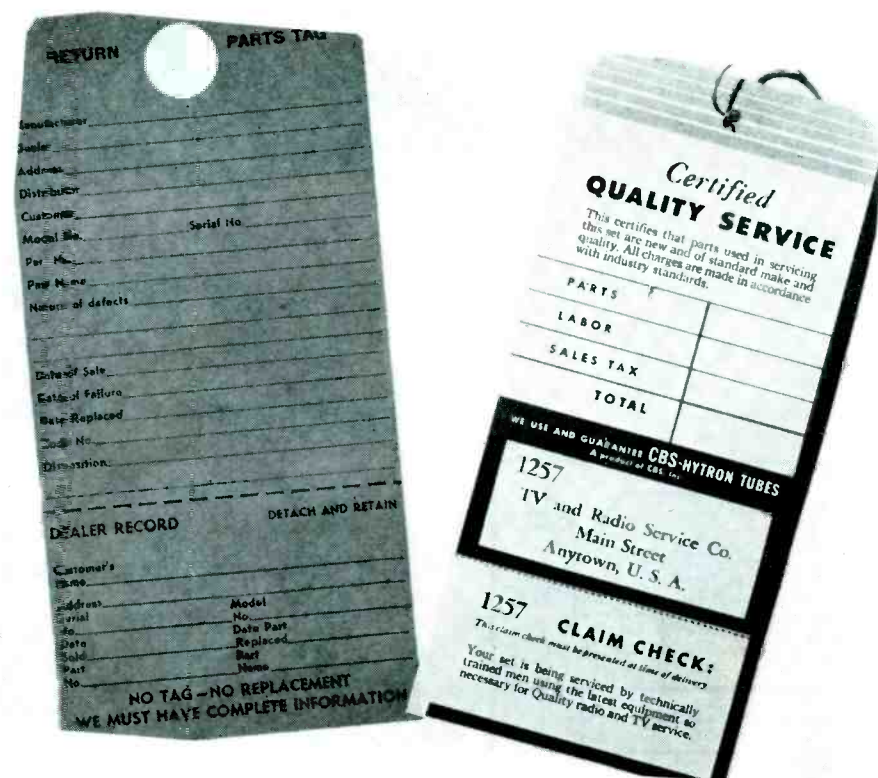

plication of production - engineering techniques which consist of breaking the manufacturing process down into planned routine operations of fabrication, assembly and testing. To make these operations successful the production personnel are furnished with handling equipment, tools and test equipment designed and arranged specifically for the job at hand. The basic concepts involved in the application of these techniques are quite simple, and it seems logical to apply them on a smaller scale to the servicing of complex electronic equipment such as TV receivers. In fulfillment of these concepts it is suggested that the following routine maintenance and service procedures be applied to each TV receiver brought into the shop for repair:

(1) *Dust chassis:* A vacuum cleaner, arranged to operate as a blower, can be used to blow dust and dirt from both top and underside of the chassis. This operation should be done in an area away from test benches, and preferably close to an exhaust fan.

(2) *Clean picture tube:* The area around the *hv* terminal should be cleaned with a non-corrosive cleaning fluid. The face of the tube should be cleaned with a cloth dampened with

water and then wiped dry with a soft cloth. Window cleaning fluids are not recommended since they tend to leave a film which collects dust.

(3) Replace channel selector dial after chassis is removed from cabinet (to prevent burring or breaking shaft with pliers).

(4) Record the following measurements with the line voltage adjusted to 117 volts: *A*—Primary (line) current; *B*—*B* voltage; *C*—Boosted *B* voltage; and *D*—Picture tube second anode voltage with brightness control at both extremes of range. (The difference in these readings will serve as a good indication of picture tube emission in an otherwise properly operating receiver). . . . These measurements should be recorded again after the receiver has been completely repaired and adjusted.

(5) Replace any necessary tubes or other parts to bring the foregoing measured values to normal ($\pm 15\%$ from rated values can usually be considered normal).

(6) Check *agc* voltage with and without signal: Improper *agc* operation can originate from a number of sources and can manifest itself in a number of ways. Because proper *agc* operation is basic to proper operation of a large portion of the receiver it is well to make this check early in the testing procedure. One should check the voltage at the connection of each stage along the bus to be sure that

(Continued on page 80)

CREDITS: Illustration, at left, courtesy G.E. At top (left), standardized return parts tag prepared by RETMA service committee, courtesy Capehart-Farnsworth. Top (right), service tag designed by CBS-Hytron.

TV COLOR

A Simplified Explanation of

Receiving Monochrome Signals From Color TV

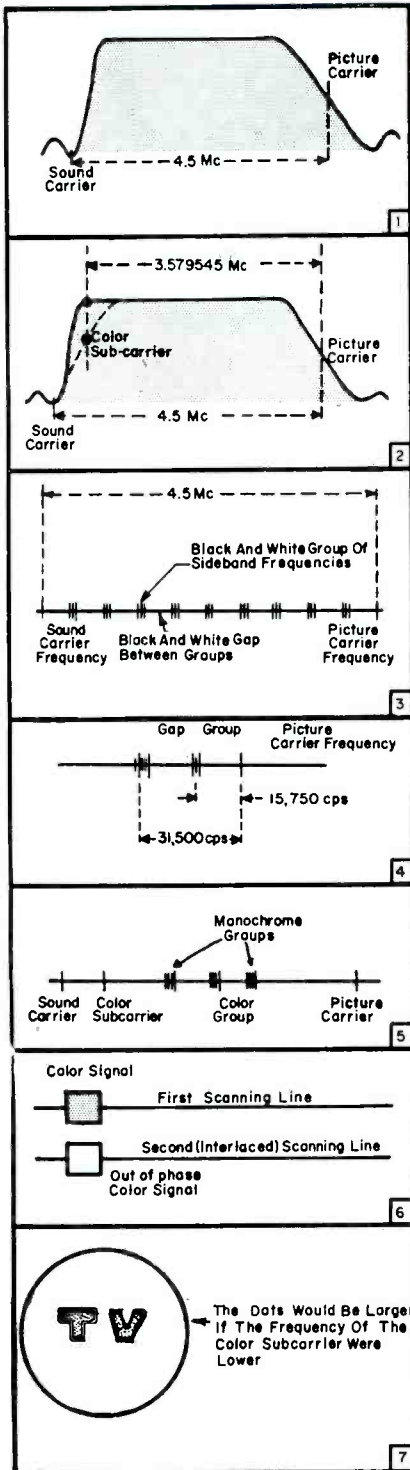

(1)

BLACK-AND-WHITE TV utilizes a picture carrier and a sound carrier, as illustrated at left.

(2)

COLOR TV utilizes a picture and sound carrier, and a color subcarrier. In practice, the color subcarrier is not transmitted, but is generated at the receiver; however, color *sideband* frequencies are transmitted, as shown at left. Note: At present, the color subcarrier is sometimes placed at the 50% point. (See 8 and 9 at right for detailed explanation of color subcarrier.)

(3)

WHEN THE BLACK-AND-WHITE video signal is checked with a frequency meter, it is found, as noted, that the interval between the picture and sound carrier is occupied by groups of video voltages, separated at all times by fixed gaps.

(4)

THE GROUPS in the black-and-white video signal are separated by the horizontal scanning frequency of 15,750 cps. The gaps in the black-and-white video signal are also separated by the horizontal scanning interval.

(5)

THE COLOR SIGNAL also has groups and gaps, and as illustrated, the frequency of the color subcarrier is chosen to make the color groups fall in the monochrome gaps.

(6)

THE COLOR SIGNAL is thus an addition to the monochrome signal. On a monochrome receiver the color signal appears in shades of gray. These shades of gray from the color signal should be made invisible on a monochrome receiver; thus the color signal is arranged to appear out of phase (dark to balance light) on alternate scanning lines. At normal viewing distance, the lines blend, and cancellation of the color signal is complete.

(7)

WHEN THE VIEWER is close to the screen, cancellation of the color signal in a monochrome receiver is not entirely complete, and, as shown, a dot structure becomes visible in the heavily modulated portions of the picture. The dots are similar in appearance to 4.5-mc *grain* in the picture, but are slightly coarser because of the use of a 3.579545-mc color subcarrier.

RECEPTION

Compatible Color Operation by W. KAY BROWNES

Color Reception of The Color TV Signal

(8)

THE COLOR SIGNAL, which is interleaved with the monochrome signal, does not have as wide a frequency band. It has been found that a 2-mc bandwidth is ample for the color information, since we are all color-blind to very small color patches. As noted here, the color subcarrier is not transmitted, but is suppressed at the transmitter and supplied at the receiver. The color sideband frequencies are transmitted. If the color subcarrier were transmitted, the dot structure would be noticeable.

(9)

ACTUALLY, it is not quite correct to say that the color subcarrier frequency is not transmitted; it is transmitted in bursts on the back porch of each horizontal sync pulse. However, the burst is converted to a sustained voltage of the same frequency at the receiver, so that the color subcarrier can be added to the color sidebands in the receiver, and the complete color signal made available.

(10)

A COLOR, such as red, not only has a red *hue*, but it also has a definite degree of *saturation*, which simply means whether it is a strong or a weak red. The color picture tube must not only be given information concerning the appearance of a red color, but that concerning the strength of the color.

(Sun and its rays, as shown, offer illustration of this effect. At A, sun approaching horizon appears pale red; as it sinks behind horizon (B) it appears deeper red.)

(11)

TO TRANSMIT INFORMATION concerning hue as well as saturation of the color signal, two color subcarriers can be used; these subcarriers have the identical *frequency*, but are timed differently, so that one subcarrier has a 90° phase difference from the other subcarrier. Although this may seem a difficult way to do an easy job, it must be remembered that this is one of the methods used to squeeze the color signal into the 6-mc band already occupied by the monochrome signal. The information present in the color signal is extracted by suitable circuits at the receiver.

(12)

TO TRANSMIT the hue information and the saturation, the color subcarrier must be amplitude modulated. The color subcarrier is, of course, split into two phases, as explained above, and the individual phases are separately modulated, as shown in the accompanying illustration.

(13)

COLOR MIXING in color TV is quite different from mixing paints. It might be therefore confusing to one until a clear distinction is made between mixing pigments and mixing spectral colors, or colored lights. To illustrate, when red light is mixed with green and violet light, white light is obtained.

(14)

IF RED LIGHT is mixed with green light, yellow light results. Now if violet light is mixed with green light, blue light appears.

THE FOREGOING is so, because our eyes contain three different types of sense organs, each of which responds (resonates to) light frequencies. Actually, the *red* and the *green* sense organs respond to a wide range of light frequencies, but they *peak up* in the regions from which they receive their names.

[To Be Continued]

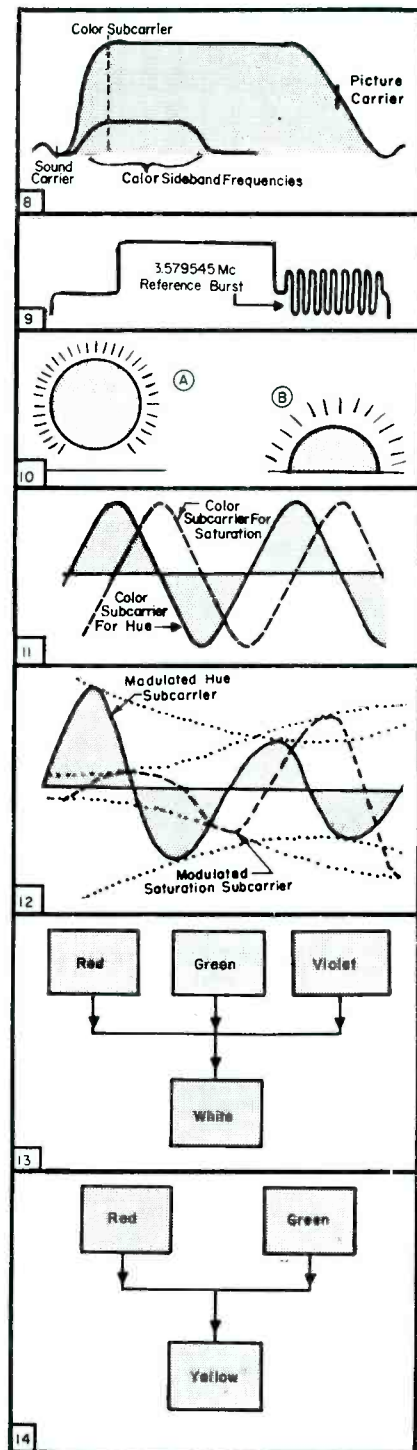

IN ACCORDANCE WITH the request of the FCC, the National Television System Committee held a technical demonstration of compatible color television at the Waldorf-Astoria Hotel in N. Y. City in mid-October.

Thirteen experimental color receivers, generally similar to those used in the NTSC field tests,[‡] were set up in the Starlight Roof room on the eighteenth floor of the hotel. These receivers were provided and operated by the manufacturers who developed them. In addition there were several typical commercial black-and-white receivers to show black-and-white reception of the color signals. All of the receivers were fed *rf* signals by a distribution amplifier.[‡]

Three antennas were located on the roof at the twenty-first floor level of the Waldorf to receive the broadcast signals on channels 2, 4, and *uhf* and feed the distribution amplifier. On *uhf* this distribution system was similar to the receiving systems normally used in hotels and the like. However, for reception of *uhf*, a *uhf* converter was inserted ahead of the distribution amplifier to convert the *uhf* signal to channel 6. During one part of the test involving *uhf* transmission[‡], transmission was by *uhf*; but as far as the individual receivers were concerned, the reception was on *uhf* channel 6. During a part of the program involving the studies of the transmission of NTSC signals by coax cable and by microwave relay, no broadcasting was employed. In this case the signal was brought to the Waldorf by means of a local video circuit; and there used to modulate a low-power signal generator to produce an *rf* signal on channel 3, which then was transmitted to

[‡]Preview of Color Problems, SERVICE, August, September, 1953. [‡]Provided by RCA.

On-the-Scene Review of Command Tests Requested by the Federal Communications Commission to Determine Commercial Practicality of Industry-Sponsored Compatible Color-Monochrome Television System

The NTSC COLOR TV Demonstration Before the FCC

by DONALD PHILLIPS

the several receivers through the distribution amplifier.

The first portion of the demonstration involved motion indoors with close-ups and medium length shots, and normal and rapid movements.[‡]

Signals originating at the Colonial Theater in N. Y. City were transmitted by a telephone circuit to the NBC

studios at the RCA Building, and thence to the WNBT transmitter at the Empire State Building. (WNBT operates on channel 4 with a visual power of 14.5 kw and aural power of 7.25 kw.)

In the second test a closed circuit was used; both coax cable and microwave relay were employed.

In this test, signals originating from the Colonial Theater were transmitted

[‡]By DuMont. [‡]The signal and broadcasting facilities for this part of the demonstration was provided through the courtesy of NBC.

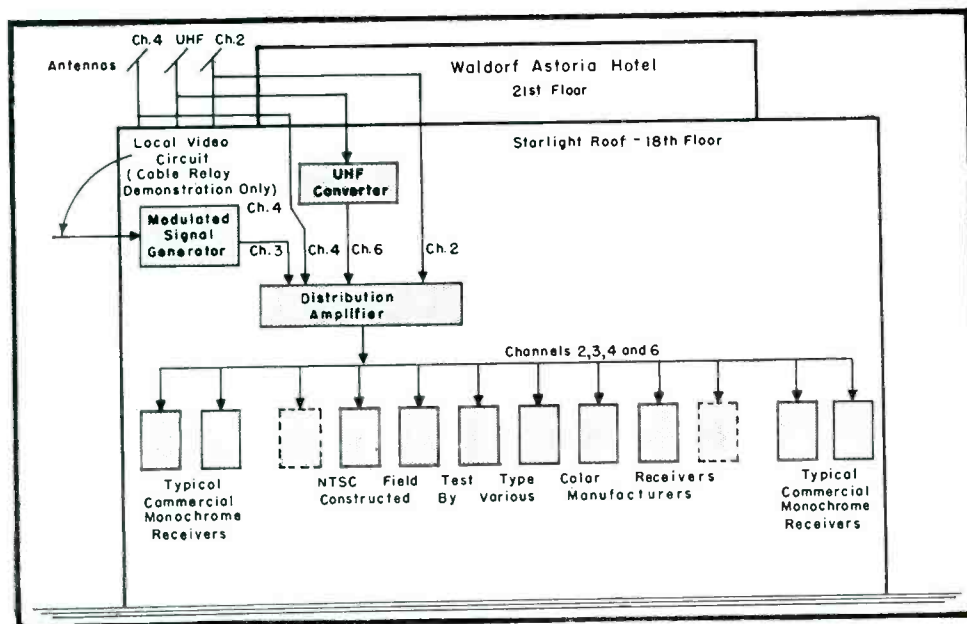
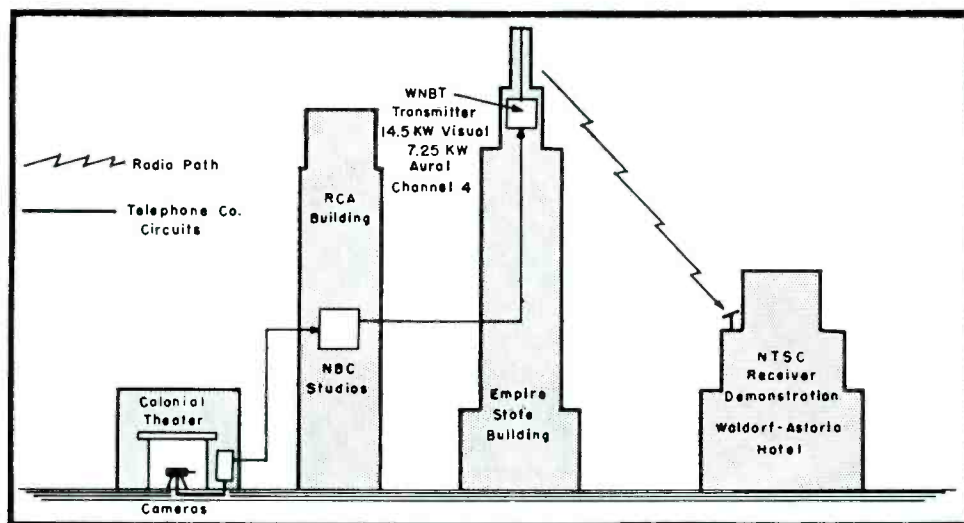

Fig. 1. General arrangements for color TV reception during FCC tests at Waldorf-Astoria in N. Y. City.

Fig. 2. Schematic of transmission circuit for color television from Colonial Theatre to WNBT, N. Y. City.



to the NBC control room on local telephone company circuits. For the radio relay circuit the signal was transmitted from the NBC control room to the telephone company television control room. For coax transmission, the signal was first modified by color conversion equipment which reduced the color subcarrier frequency from 3.6 to 2.4 mc. This equipment was located in the NBC control room. The modified signal was then transmitted to the telephone company television control room by local telephone company circuit. Similar facilities were provided to return the signal from the telephone company to the NBC control room and for re-converting the color subcarrier when transmitted over the coax cable.

The radio relay facilities comprised approximately 540 route miles type of a system specially equalized for NTSC color signals. Both ends of the radio circuit terminated at the telephone company television control room in New York. The radio relay path was

from New York to Washington (Garden City radio station) via Philadelphia and Baltimore and the return path from Washington to New York via Clark's Knob and Wyndmoor, Pa.

The coax facilities comprised approximately 500 miles of cable specially equalized for NTSC color signals. Both ends of the cable terminated at the telephone company TV control room in New York. The loop circuit was to Washington and back via Philadelphia and Baltimore.

For transmission over the coax cable experimental color subcarrier converters were provided by NBC at the NBC control room.

In demonstrating color TV on mo-

⁴The program material used during this test consisted of a number of special test slides prepared by Eastman Kodak for use by the committee during the many NTSC field tests. These slides were particularly selected to cover both the extreme range of color saturation available through the most advanced photographic processes, as well as long-range, medium, and close-up shots. Approximately 30 sets of matched slides were prepared and made available to the companies participating in the field test program.

tion outdoors and during typical outdoor scenes, CBS used a single camera on the roof of the CBS Building at 485 Madison Avenue, and a 3-camera remote pickup at the Museum of Modern Art, N. Y. City. Signals from the museum were transmitted by a 7,000-mc microwave link to 485 Madison Avenue, then by a telephone company circuit to the CBS television master control room in the Grand Central Terminal Building, and then by a telephone company circuit to the WCBS-TV transmitter at the Empire State Building; see Fig. 4, p. 108. (WCBS-TV operates on channel 2 with a visual *erp* of 43 kw and aural *erp* of 22 kw.)

The next portion of the program consisted of the NTSC color test slides and color test pattern.⁴

Slides were televised on flying spot slide scanners located at the DuMont experimental transmitter at 515 Madison Avenue. Signals from the scanners

(Continued on page 108)

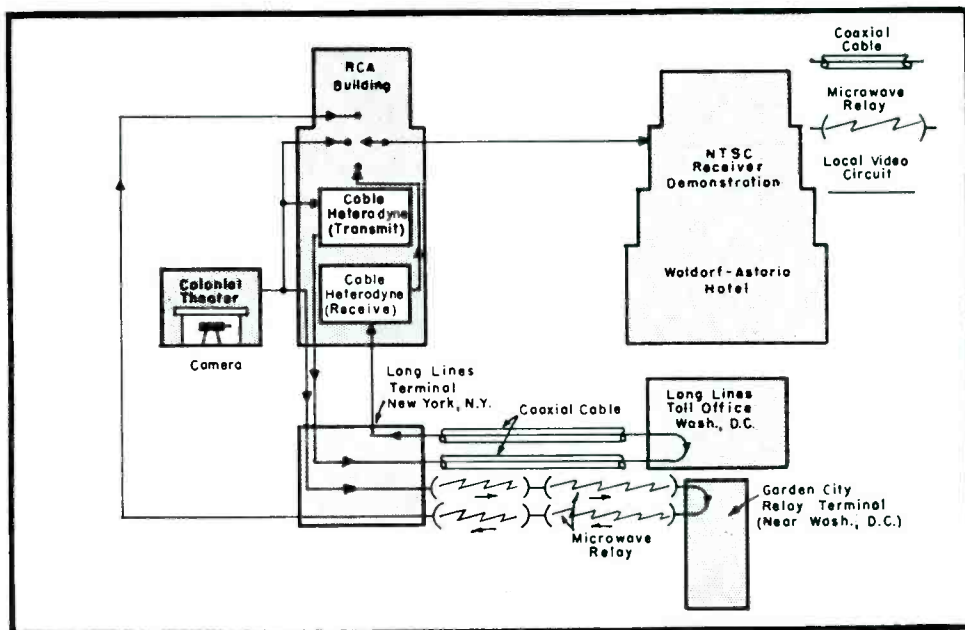

Fig. 3. Intercity coax cable and microwave relay test setup used in color TV test.



Dual-Track TAPE Recorder- Playback Models for 7 $\frac{1}{2}$ " and 3 $\frac{3}{4}$ " Speeds

by D. S. CEVANS

Part 2: Analysis of Circuitry Used in Playback and Recording Amplifier ... Power Supply ... Bias and Erase Oscillator ... Low Frequency Compensator

IN OUR INITIAL REPORT on tape recorders,¹ a dual-track two-speed unit was described.

In Fig. 2 appears another type of dual-track unit,* available for either fast (7 $\frac{1}{2}$ ips) or slow (3 $\frac{3}{4}$ ips) speed operation.

Finger-Tip Controls

These models feature two finger-tip controls which it is said permit fast

¹SERVICE, October, 1953.

²Shure TR-5.

*Crescent Industries 903 and 907.

forward, in either direction, in addition to instant manual braking.

The machines record in one direction, right to left, and use dual purpose heads²; i.e., record and erase functions are simultaneous.

External Recording Provision

The unit can record from radios, tuners, record players or microphones on 7" or smaller reels.

Recordings can be produced through an internal or external speaker or fed

on to any high-impedance amplifier input. A single jack distributes output and allows monitoring in play as well as record. These units also may be used on phono or *pa* amplifiers.

Playback Amplifier

The dual-purpose head is fed directly to the grid of a pentode (5879) which offers an average gain of 75. This stage employs a screen grid bleeder circuit and a balancing potentiometer, both of which are said to be very effective in reducing hum.

To prevent overloading of the second and third stages, where both *pre*- and *post*-equalization takes place, a volume control has been inserted in the plate of the first stage. When using the phono input the jack isolates the first stage. The combined gain of the second and third stages (12AX7) is approximately 100. The output of the third stage feeds a 6V6 power amplifier stage and also the monitoring jack, the latter being isolated by a 470,000-ohm resistor. The tone control circuit is in the plate of this stage providing a cut of 13 db at 5 kc.

B-Supply Isolation

A *B* supply that provides isolation between stages is obtained from a con-

Fig. 1. Block diagram of dual-track tape amplifier system.

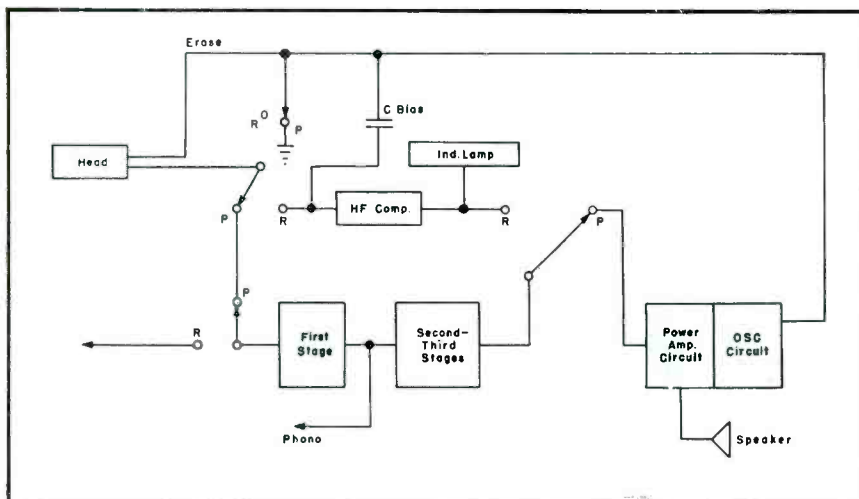

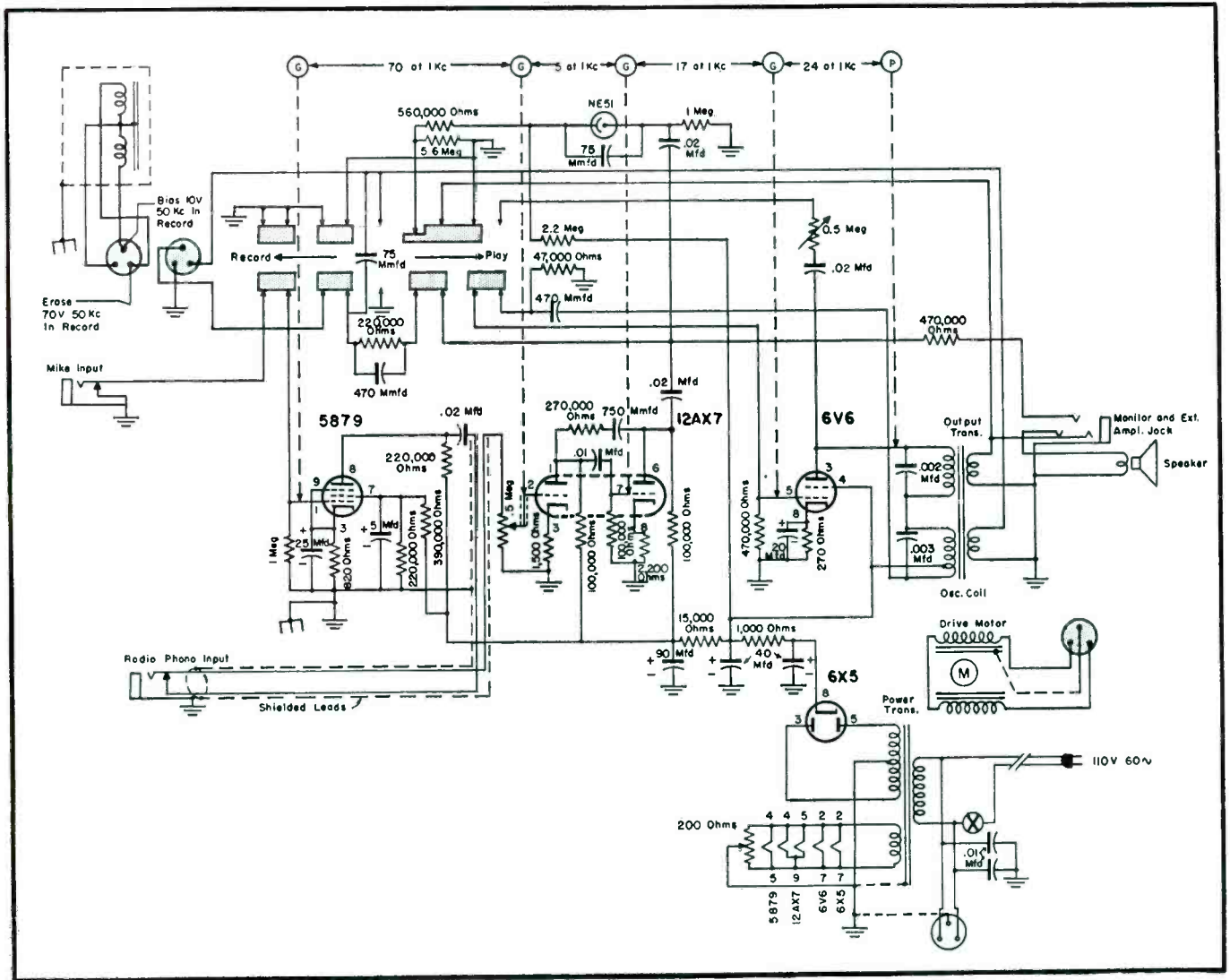

Fig. 2. Circuit of Crescent 903/907 tape recorder and playback amplifier and motor drive. Slide switch is shown in record position. Readings indicated were taken with vtvm between chassis and points shown, with head in.

ventional 6X5 rectifier circuit; line input is balanced.

Recording Amplifier

The first three stages operate as in playback, except for the input and output circuits. The mike jack is connected to the 5879 grid and the third plate now feeds the recording circuit and monitor jack. The recording circuit contains the only high frequency compensation within the unit and consists of a 470-mmfd capacitor shunting a 220,000-ohm resistor in series with the head and ground. This and the bias and erase circuits are grounded in playback.

Bias and Erase Oscillator

In the record position the 6V6 becomes a power oscillator and supplies both the 50-kc bias and erase currents. The oscillator coil is connected permanently in series with the output transformer. The secondary of this

coil feeds the erase coil directly and a 75-mmfd capacitor couples the bias to the junction of the head and the high frequency compensating network. The bias and erase currents are 1.2 and 55 ma, respectively.

Recording Indicator and Pilot Lamp

A *dc*-biased NE51 glow lamp serves to indicate when an average recording level of 5 db below saturation has been reached. In playback the *dc* bias is increased and the lamp glows continuously. Any *ac* bias voltages across the lamp are bypassed by a 75-mmfd capacitor. Good recording may be made at a level slightly below the indicating point and distortion will not occur if the level is increased appreciably above this point.

Low-Frequency Compensation

The 12AX7 stages contain the feedback type compensating circuits and the change of a 1500-mmfd capacitor

of the lower speed machine, to one of 750-mmfd, compensates the amplifier for the higher speed.

Another type of tape unit providing dual track recording, fast forward and rewind, tape speed of 3 3/4" per second, and high-impedance input for microphone, radio, record player, etc. Offers one hour of recording time from a 5" reel of tape. Model is 7" by 10" by 11 1/2" and weighs 14 pounds. (Telectotape; Telectrosonic Corp., 35-18 37th St., L. Is. City 1, N. Y.)



In The Field[‡]

Problem

Analysis

WHAT CAUSES the dot size to vary in a pattern produced by a dot generator?



THE DOTS VARY in size because of improper clipping of the differentiated pulses on alternate fields. A weak tube is usually responsible, but a leaky capacitor, or a resistor which has changed in value can also be the cause. A typical situation is shown in Fig. 1.

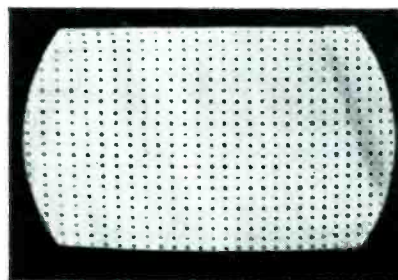

Fig. 1. Dot size variation from one horizontal scan to the next because of different clipping action in circuits which shape the differentiated pulses on even fields and odd fields. A faulty tube is usually responsible.

WHY IS IT that a differentiator or integrator cannot be tested with a signal generator or an audio oscillator?



DIFFERENTIATORS and integrators are a basic form of TV circuit which operate on *non-sinusoidal* waveforms. A sine wave cannot be differentiated or integrated. But a non-sinusoidal wave can be changed in shape by passage through a differentiating or integrating circuit. Accordingly, such circuits can be tested with pulse or with square-wave generators. The accompanying 'scope views show how the non-sinusoidal output from a horizontal oscillator becomes peaked in passing through a differentiator.

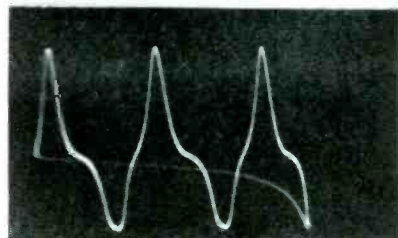
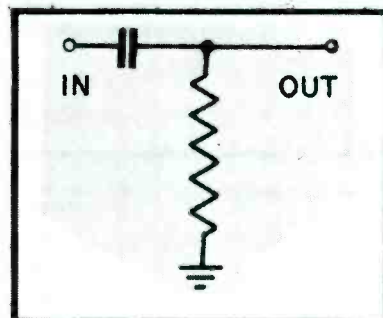
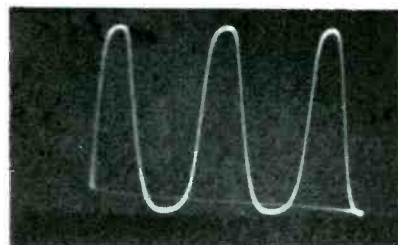

Fig. 2 a, b and c (top to bottom): At a appears a sine wave with some second and third harmonic content. A simple differentiating circuit is shown in b. (Differentiates when the time constant is made sufficiently short with respect to the applied frequency). In c we see an output waveform which shows result of differentiation, plus incidental circuit action.

WHAT RESULTS will appear if the *if* amplifier has severe feedback, and is just about to break into oscillation?



THIS WILL cause weak pictures with heavy interference, and a disruption of the normal sync action.

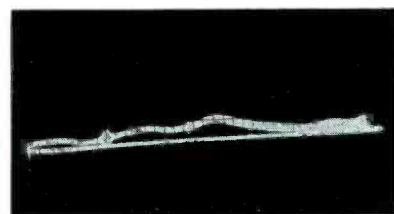

Fig. 3. Typical 'scope pattern obtained when the *if* amplifier has severe feedback.

[‡]Based on questions posed during meetings conducted by R. G. Middleton, senior engineer of Precision Apparatus Co., Inc., and author of *TV Trouble-Shooting and Repair Guide Book*, published by John F. Rider.

Causes of Dot Size Variation from Generator ... Differentiator and Integrator Circuitry ... Picture Tearing Causes ... Stray 60-Cycle Fields and Their Effect on 'Scope Operation ... Feedback in IF Amp

Problem

IF THE SYNC clipper preceding the differentiator does not clip the composite video signal at the proper level, what is the effect upon the output of the differentiator and upon the sync lock?



DOES A pulse, large compared with the audio signal, produce a loud buzz tone in sound?



WHEN ONE TOUCHES a probe to a source of 60-cycle *ac* voltage, one sees a good sine wave on the 'scope screen. However, when the stray 60-cycle field is used around the test bench as a source, the sine wave becomes very ragged and kinky. What is wrong with the 'scope in this instance?



Analysis

WHEN RESIDUES of pedestals and black signal are impressed upon the differentiator, the output waveform changes to a distorted random trigger voltage, which causes picture tearing, as shown in Fig. 5. Typical results of proper and improper clipping level are shown in Fig. 4.

Fig. 4. a and b: In a appears a clean output waveform obtained when sync clipper operates correctly. Output from clipper when video voltages enter due to improper clipping level is shown in b.

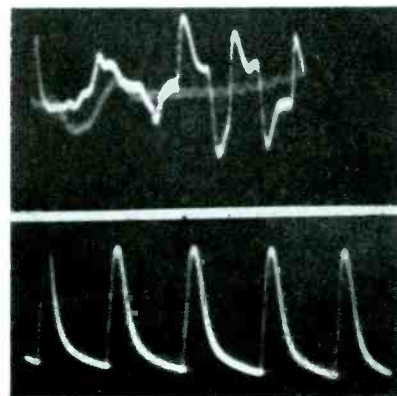
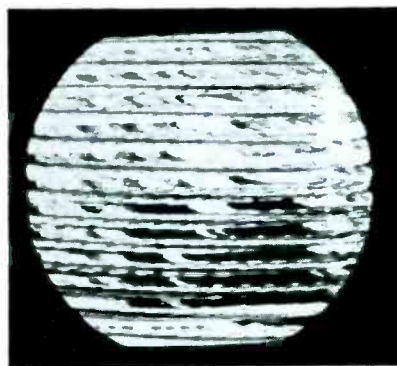
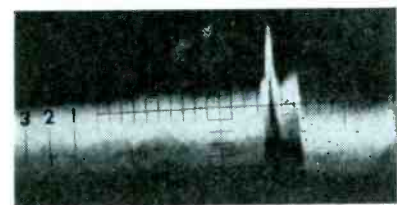

Fig. 5. Picture tears as a result of incorrect horizontal trigger voltage.



YES. Such a buzz pulse appears at the output of the ratio detector, as illustrated in Fig. 6.

Fig. 6. Waveform of buzz pulse, flanked and superimposed with audio voltage.



NOTHING IS WRONG with the 'scope. The condition observed is due to the method of applying the 60-cycle voltage to the high-impedance 'scope input. When a *conductive* connection is made to the 60-cycle voltage, the fundamental and harmonics which are present in the line voltage are reproduced without selective attenuation. However, when the probe is placed on the bench, and stray 60-cycle field is picked up, effectively there is *capacitive coupling* to the line voltage. This very small capacitance of the probe to the line provides a lower reactance for the higher-frequency harmonics in the line voltage. As a result, the fundamental is attenuated with respect to the harmonics, and a kinky pattern appears.

Fig. 7.—Kinky pattern which appears when fundamental is attenuated, with respect to harmonics.

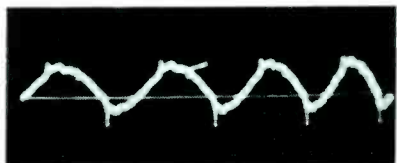



CHANNEL MASTER

introduces a

basically *new type*
of VHF antenna

the **CHAMPION***

the highest gain
all-channel VHF antenna
ever developed!

Featuring the unique new "Tri-Pole"

TRIPLE-POWERED DIPOLE

The 'Tri-Pole' is a new antenna system in which the Low Band folded dipole also functions as three folded dipoles tied together in phase on the High Band. This is the heart of the Champion, the secret of its phenomenal performance on all 12 VHF channels.

the **CHAMPION** is the most sensitive all-channel VHF antenna ever designed!

Stacked **CHAMPION** provides:
11-13 D B High Band gain
6½-7½ D B Low Band gain

Here is a totally NEW kind of antenna, completely different — in principal and performance — from any VHF antenna you've ever seen! Since the lifting of the TV freeze means a gradual disappearance of the single-channel VHF area, the VHF antenna of the future will be a *multi-channel* antenna. Prepare now for outstanding reception on *all* VHF channels — present and future — with Channel Master's super-sensitive **CHAMPION**! Outperforms every all-channel VHF antenna made today — and many Yagis, too!

COMPARE these features with the antenna you are now using:

- Folded dipoles throughout — give close to 300 ohms impedance across the entire band.
- Screen-type reflector provides high uniform gain on every channel, 2 through 13. Not frequency sensitive — this reflector provides more than twice as much extra gain as straight bar reflectors.
- Phase-correcting harness is built-in and fully assembled; the only wiring you do is to attach the lead-in.
- All-aluminum construction . . . lightweight, durable, non-corrosive.

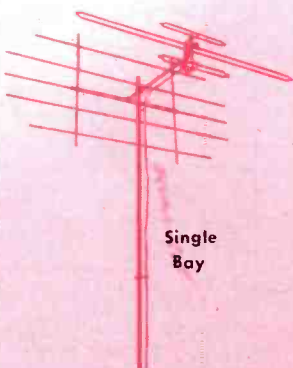

Single Bay

MARVEL OF PRE-ASSEMBLY

assembles faster than a 5-element yagi!

Collapsed "Pop-Up" screen opens instantly — no loose rods, elements or hardware. "Tri-Pole" assembly features automatic Spring Lock Action — all dipoles snap permanently into place without wing nuts or any other hardware.

It's a **CHAMPION** in any area!

- 1-bay—local areas
- 2-bay—secondary and fringe areas
- 4-bay—super-fringe areas

THIS ANTENNA...

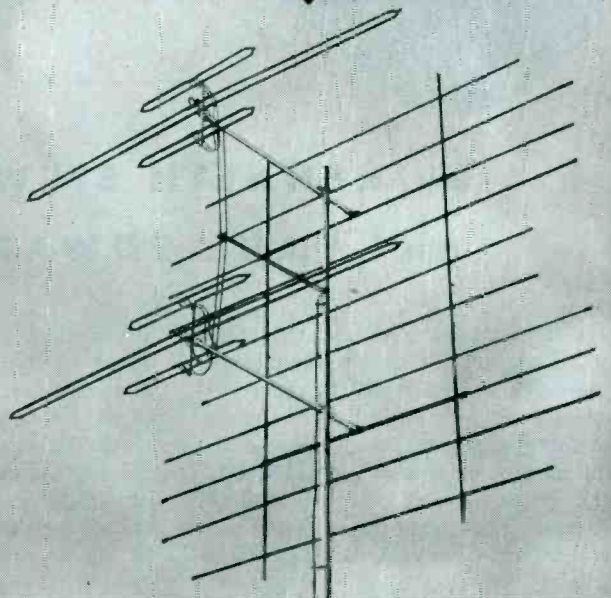

OUT-PERFORMS:

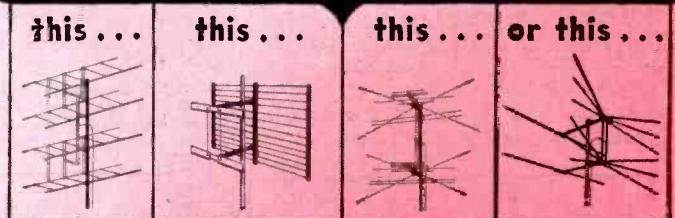

The 2-Bay **CHAMPION** actually gives you the performance of:

- Separate 5-element Yagis for every Low Band channel!
- Separate 10-element Yagis for every High Band channel!

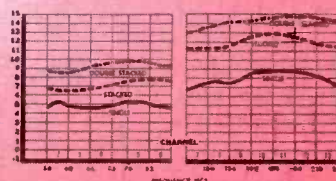

Model No.		List Price
325	Single Bay	\$20.83
325-2	2-Bay	\$42.36
325-4	4-Bay	\$88.89
Separate Stacking Harness		
325-3	2-Bay Harness	\$ 2.08
325-5	4-Bay Harness	\$ 4.15

Send for complete technical literature.

CHANNEL MASTER CORP.

ELLENVILLE, N. Y.



Action of Conical Dome Speakers . . .

Locating Distortion in Amplifiers (Knocking)*



by **KENNETH STEWART**
and **PAUL EDWARDS**

THE MOUNTING interest in high fidelity has sparked the development of an impressive array of wide-range components. A short while ago one manufacturer¹ announced the design of an unusual type of speaker², which it was said, is particularly adapted to *hi-fi* systems. This model features the use of a series of conical domes, with a damping ring in the outer suspension of a *lf* cone, conical domes fastened on the surface of the *lf* cone, and a *hf* vane-type diffuser.

Recently, a report on the action of the domes in this speaker was issued.

¹RCA Model LC1A.

*From notes prepared by Norman Crowhurst, British audio consultant.

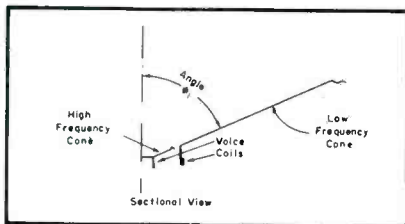

Figs. 1 and 2. Sectional views of dome speaker showing angles into which *hf* cone feeds, with and without conical domes applied to *lf* cone.

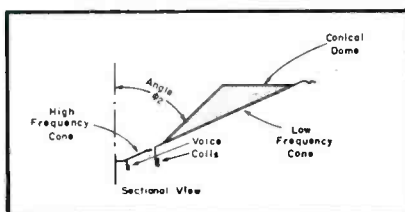

It was noted that the conical domes attached to the surface of the *lf* cone improve the performance in three ways: by decreasing the angle into which the *hf* cone feeds, thereby increasing the output of the *hf* cone; by diffusely reflecting some of the sound emitted by the *hf* cone, thereby eliminating discreet reflections; and by diffracting some of the sound emitted by the *lf* cone, thereby broadening the directivity pattern.

The angles, Φ , into which the *hf* cone feeds, without and with the conical domes applied to the *lf* cone, are design-

Fig. 3. Plan (top) and sectional (bottom) view of *hi-fi* speaker, revealing how some of the sound emitted by the *hf* cone is diffusely reflected by conical domes.

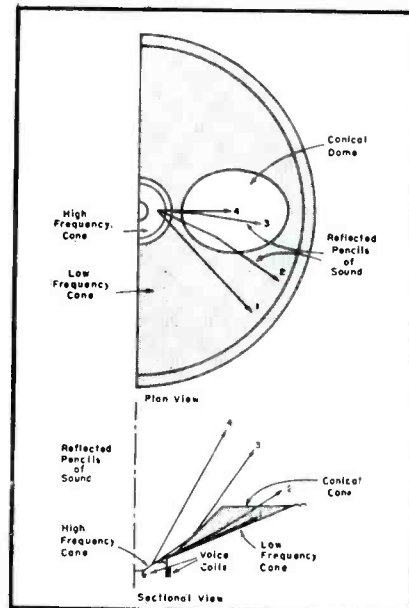

nated as 1 and 2, respectively, in Figs. 1 and 2. Since 2 is smaller than 1, the acoustic radiation load upon the cone is greater with the conical domes than without them. When the acoustic radiation load upon a direct radiator loudspeaker is increased, the sound power output is increased. Thus, it is said, it will be noted that the conical domes increase the *hf* sound radiated by the *hf* cone.

Some of the sound emitted by the *hf* cone is diffusely reflected by the conical domes, as shown in Fig. 3. Without the domes, there would be many similar reflections which would lead to re-enforcements and cancellations with the direct radiation. The result would be corresponding peaks and dips in the response of the *hf* cone. With the domes, it is claimed, the symmetry of the cone is upset and there are many reflections in different directions and of different path lengths; the reflections, therefore, cancel out and the net result is an improved response-frequency characteristic.

Some of the sound emitted by the *hf* cone is diffracted by the conical domes, as shown in Fig. 4; by diffraction is meant the bending of the sound around an obstacle. The pencils of sound designated 1 and 2 are diffracted, and the pencils of sound designated 3 to 7 are radiated directly from the *hf* cone. Thus it will be seen that the effect of the diffracted sound is to decrease the curvature of the wave front in the direction of 1, 2, and 3. As a result, the directivity pattern is broadened.

In this speaker, the two cones are actually direct radiators and are driven

(Continued on page 99)

Fig. 4. Another plan (top) and sectional (bottom) view of the dome speaker which shows how some of sound emitted by the *hf* cone is diffracted by conical domes.

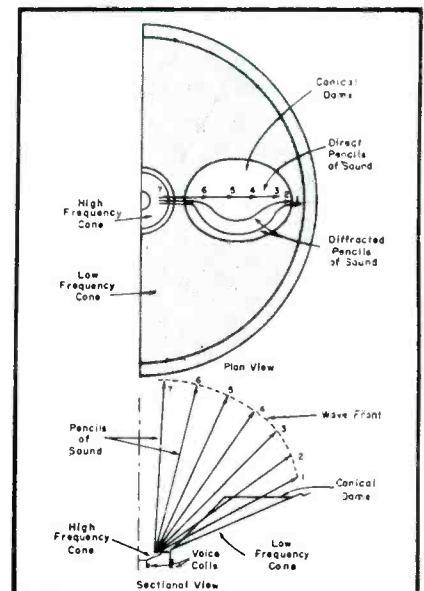

Highlights of New Audio Products: Hi-Watt Amps . . . Hi-Fi Systems . . .



Record player, with a continuously variable speed from 29 to 86 rpm. Although continuously variable in speed, the turntable is said to lock instantaneously, without the use of a stroboscope, at 33 $\frac{1}{3}$, 45 and 78. Driven by a constant velocity four-pole motor. Record player, which will accommodate records up to 16", features weighted turntable. Turntable top is covered with grooved rubber. Pickup arm, equipped with ball bearings, has a tracking pressure of only 4 to 6 grams in microgroove operation and is adjustable from 12 to 39 grams for normal operation. Transcription players contain a 10-watt amplifier. (Models VP-17 and VP-17X; David Eogen Co., 29 Ninth Ave., N. Y. 14, N. Y.)



Speaker cabinet designed by Oliver Read which it is said incorporates within its construction characteristics all three of the most popular speaker cabinet types. The design makes it possible to change the enclosure into an infinite baffle, bass reflex, or folded horn. Choice of the enclosure type is determined by the listener on the basis of room acoustics and his particular listening criteria. Three-in-one cabinet is 36" in height, 38 $\frac{1}{2}$ " wide and 17 $\frac{1}{2}$ " deep. Contains three ports with variable openings. (Fold-A-Flex; Stephens Manufacturing Corp., Culver City, Calif.)



Three-speed portable disc recorder, combination record player and 5-watt pa system available with or without built-in AM tuner. Models record directly from microphone, radio, tape or wire recorder, or from another phono, all independently or mixed. Automatic equalization for each speed is supplied by speed change switch. Microgroove or standard recordings can be cut or played back. At 33 $\frac{1}{3}$, 15 minutes of recording can be made on a 10" record. Recordings are made at 160 lines per inch. Adjustable cutting head and output jack for external speaker are provided. One pickup with tilting type cartridge is used for standard or ip playback. (Model RK6-R; Mark Simpson Manufacturing Co., 32-28 49th St., Long Island City 3, N. Y.)

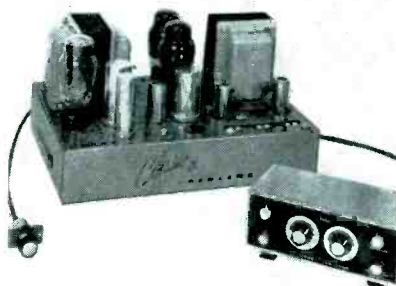

Amplifier said to provide 25 watts of power. Supplied with remote control. Remote control requires one cable that may be 100' long. Has six inputs for radio, TV, tape, crystal and two magnetic pickups. Features a Fletcher-Munson compensated volume control and crossover selector, plus a five position record condition compensator. (Classic 25; Newcomb Audio Products Co., 6824 Lexington Ave., Hollywood 38, Calif.)



Hi-fi system featuring intermatched components; record changer, tuner and amplifier in cabinet shown. Separate loudspeaker and housing also available. Line of components for varied setups offers choice of two AM-FM tuners (one having a built-in preamp for use with magnetic pickup), choice among four amplifiers, and among three speakers. (RCA)

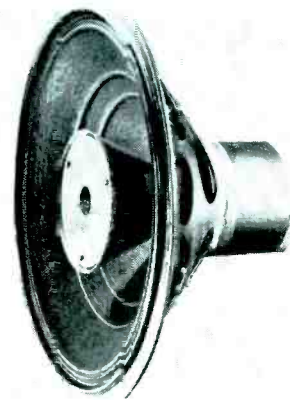

Speaker featuring Ticonal, a magnet steel said to provide a high flux density that, it is claimed, makes possible an air gap of twice the normal depth. Four models available; 8 $\frac{1}{2}$ ", 10", and two 12" models. Frequency response is said to vary from 40 to 13,500 cps in the 8 $\frac{1}{2}$ " to 40 to 20,000 cps in the 12" model. (Master range, made by Philips of Holland; distributed by Duotone, Keyport, N. J.)

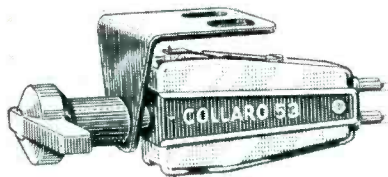

(Left)
Non-hygroscopic crystal cartridge with metal-sealed crystal. Designed to operate into a 1-megohm impedance. Two types are available. They differ only in overall frequency response and voltage output; one has a frequency response from 50 to 10,000 cycles \pm 4 db, and a .5 volt output; second has a frequency response from 50 to 12,000 cycles \pm 4 db, and .1 volt output. Both are of the turnover variety and are supplied with two interchangeable sapphire styli: .003" for standard, and .001" for microgroove. (Collaro types O and P; Rockbar Corporation, 215 E. 37th St., New York, N. Y.)

(Right)
Woofer and tweeter exhibited at recent Audio Fair in N. Y. City. (Lorenz models; Kingdom Products, Ltd., 23 Park Place, New York 7, N. Y.)



Sparkling Beauty

for the housetops



WARD'S

DYMON-VANE

CONICAL

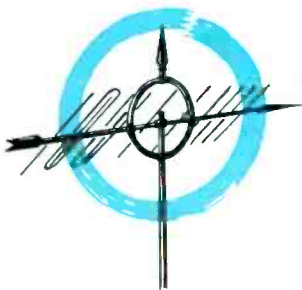

The Circle-vane . . .
first of Tele-vane
series for Channels
2 - 6 VHF.



Dave Chapman, S.I.D.
Famous designer of
the Ward Tele-vane
series of TV Antennas.

another in the Tele-vane Series

Ward flashes again with the handsome Dymon-vane, the second model in its new series of Tele-vane TV antennas. Reflecting the modern trend and decor the beautiful new Dymon-vane enhances any home and becomes a valuable prized addition. Clean cut in design, a flawless performer, the Dymon-vane stands out as a glittering solitaire among all other TV antennas. A conical antenna with aluminum elements and black permatube cross arm with wrought adornments, the Dymon-vane is designed for complete coverage of VHF Channels 2 - 13 in metropolitan, suburban and fringe areas.

The New Dymon-vane comes in single bay or two bay stacked models . . . folded and pre-assembled ready for easy installation.

THE WARD PRODUCTS CORP.

DIVISION OF THE GABRIEL COMPANY

1148 Euclid Avenue, Cleveland 15, Ohio

In Canada: Atlas Radio Co., Ltd., Toronto, Ont.



SERVICE... The National Scene

N. Y. ASS'N RECEIVES \$2,000-A-DAY RADIO-TV TUNEUP AIR-CAMPAIGN APPROPRIATION*--Millions of New Yorkers are now being urged, via one of the most extensive radio and TV schedules ever planned, that they can keep their chassis in perfect alignment and top condition by calling on members of ARTSNY. Four times daily, over the radio and television facilities of NBC, outstanding performers and key announcers of WNBT and WNBC are telling the folks that can rely on association members for . . . "dependable, fairly-priced service." And they are being told that all members of the group can be identified by a seal (shown on a slide over TV¹) and contacted through a central telephone number (also displayed on a TV slide¹).

COMMENTING ON THIS unusual program, involving more than \$2,000 worth of spots every day, the manager of these flagship stations said: "We have long realized that we at . . . these stations . . . rely on the hundreds of reputable Service Men who keep millions of radios and television sets in operation. We commend ARTSNY's continuing project of better, more fairly-priced service and its technical help to its membership."

TYPICAL ANNOUNCEMENTS now being aired and telecast tell listeners and viewers that . . . "Chances are you're planning on having the family car winterized, but what about your television set . . . are you sure that it's in top operating condition. . . . Get more enjoyment out of channel 4 . . . by contacting your nearest reputable Service Man. . . . When he displays this seal, you can be sure of dependable . . . service." Another announcement states that . . . "If your set is not in perfect alignment, you won't be able to get the reception the manufacturer intended. Your nearest Associated Radio-Television Service Men of New York member is equipped to give you dependable . . . service. Call . . . for your nearest ARTSNY Service Man." . . . Still another message points out that the . . . "Associated Radio-Television Service Men of New York is an organization dedicated to the promotion of better, more fairly-priced television and radio service. . . . When your neighborhood Service Man displays this seal . . . you know that you can depend on him." . . . In another spot, the stations are reminding everyone that a call to any member of the association will be a . . . "wise investment that will return . . . hundreds of hours of television fun." . . . The broadcaster has also begun to hammer away at the bold objectives of the association and their rigid code of ethics. Many of the stars, including Skitch Henderson, Tex and Jinx McCrary, Morey Amsterdam and Steve Allen, are devoting substantial time to the cause, too, describing the excellent work of association members, and their value to all set-owners who live in New York.

AT PRESENT, more than \$60,000 worth of time, covering one month's spots, have been allotted. It is believed that the drive will be repeated soon, and supplemented by a series of interviews with officials and members of the association, during choice evening and morning hours, by the station's stellar commentators, panel moderators and news announcers.

PIKE'S PEAK TO HAVE COMMUNITY-TV ANTENNA--The world-famous Pike's Peak, in the state of Washington, with an elevation of 4,000 feet, will soon be the home of a towering antenna for community-TV pickup of programs from Spokane, 120 airlines away. Installation is being made specifically for residents of Walla Walla, a city of 35,000, who will be able to tie in for reception, via a 11-mile 1¼-inch double coax cable, which will extend from antenna site down to the town, where it will be buried underground. . . . Cost to subscribers is expected to be about \$135 for initial installation of tiein. A monthly service and maintenance fee of \$3.50 is expected to obtain thereafter. . . . A sky-scrapping antenna is also being installed atop the 13,770-foot Mount McNamee in the Rockies, to pick up signals from Denver for feed to folks in Climax, Colorado, a mining town of about 2,000, located in the Rockies, about 11,400 feet above sea level and surrounded by even higher peaks. Mining company operators have underwritten the project, which is expected to cost about \$70,000.

*See editorial, this issue, p. 29. ¹See *Association News*, this issue, p. 82.

SERVICE... *The National Scene*

SPEAKER, AMPLIFIER, CIRCUITRY INNOVATIONS UNFOLDED AT AUDIO CONFERENCE--A number of noteworthy developments in the audio world were described during the recent audio-engineering society meet in New York. . . . Highlighted in several papers was the subject of binaural reproduction and recording. One specialist outlined an improvement that, it was said, helped to recreate a natural sound front through the use of a center channel which complements the sides. Using a stereodynamic amplifier, this effect is achieved by enlarging the sound front to a more natural perspective. The amplifier features use of dynamic control stages and an integrating third channel which is said to offer an increased illusion of spatial distribution in reproduction from a single and dual or binaural source.

IN A QUALITATIVE EXAMINATION of the relationships which exist between mechanical elements in a phono pickup today, another audio expert pointed out that enough experience has been gained and sufficient improvements have been made in associated components to consider another step which further increases bandwidth. Actually, it was noted, this has been done. For the pass band has been extended downward to 25 cycles and upward to 20,000 cycles. . . . However, study of the response curve of a pickup (moving iron magnetic cartridge), reveals that the pass band is limited at both ends by sharp roll-offs. At the low end this is caused by mechanical resonance between the tone arm and the cartridge, and at the high end by electrical resonance it is caused by the inductance of the cartridge and the distributed capacitance of the winding. In other words, it was said, the low-frequency limit can be determined by mechanical elements and the high-frequency response by electrical elements.

PROBING POWER-HANDLING capacity of speakers, another audio specialist noted that there are two methods that can be used in such a study. One is based on maximum permissible distortion, and the other is based on the physical strength of the unit. Both methods, it was said, should be used concurrently, because units with high distortion and good physical strength, or with low distortion and poor physical strength are both limited in power-handling capacity. . . . To fulfill these requirements in frequency response and polar distribution, with good efficiency and power-handling capacity and low distortion, a compound diffraction projector type of speaker has been designed. It was pointed out that it has now been adapted for high quality public-address work by coupling a reentrant woofer horn and a small tweeter to opposite sides of a single diaphragm.

AUTOMATIC VOLUME CONTROL, heretofore purely a receiver factor, has become extremely important in the audio system. According to a report by the director of engineering and research, and the chief electronic development engineer of a leading dictating-machine company, avc can be used to prevent overcutting in disc recording. It can also be used to reduce program volume range to increase the signal-to-noise ratio in limited-range recording systems. And in public-address systems, it serves to maintain output more nearly constant.

THE ADVANTAGES OF HORNS and their modern applications were reviewed in still another paper. . . . It was emphasized that horns cannot be arbitrarily chosen for a given driver, when the best possible performance is required. The horn throat area, cutoff frequency and correct flare parameter must be properly related to the driver moving-system constants. . . . It is difficult, it was said, to achieve a wide pass band in a single horn unit. Relatively large chamber clearances, combined with rugged moving systems, are required to reproduce the lower frequencies, while small clearances and light moving systems are required to obtain good efficiency at high frequency. The requirements of low-frequency power-handling capacity are therefore incompatible with hf requirements. This is one of the factors, it was noted, which has led to the use of multiple horns, each covering a part of the spectrum, and the development of hyperbolic cosine horns for such applications.

TELECTRONIC AGE HERE SAYS PICTURE-TUBE PIONEER--In a recent address before an industrial council group at a technical institute in N. Y., the prexy of one of the nation's leading crt and TV set companies declared that we have entered a new age . . . the Telectronic age . . . symbolizing electronics with visibility; an age which has begun to effect significant changes in our way of life . . . at home, in schools and in industry, too.--L. W.

Tescon's Amazing New "BIG JOE" Outperforms All VHF Antennas!

Now Tescon introduces the "Big Joe" antenna—the first antenna to cover *all* VHF channels with the highest gain. To this time, only the Yagi antenna—cut for a specific channel—gave such tremendous gain. Now the "Big Joe" challenges the Yagi's effectiveness, while giving equally superb reception on channels 2 through 13. "Big Joe" offers excellent directivity with complete absence of side lobes. "Big Joe," single bay (BJ-10) or stacked (BJ-20), is constructed with all-aluminum elements and aluminum crossarm. "Big Joe" is completely preassembled for easiest installation.

The most powerful VHF antenna ever designed—the "BIG JOE"!

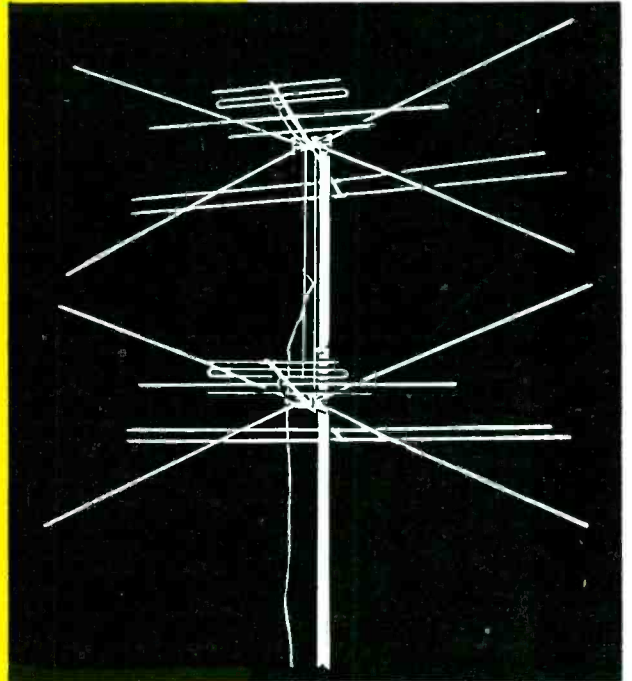

Write Tescon today for full details about "BIG JOE"

BJ-10 single bay — BJ-20 stacked
(\$15.95) list (\$32.95) list

ONLY \$15.95 LIST, IF YOU ORDER NOW!

TESCON

TV PRODUCTS COMPANY
SPRINGFIELD GARDENS 13, NEW YORK



it's
the
cats
whiskers... and just as sensitive!



©NTI

COLOR TV

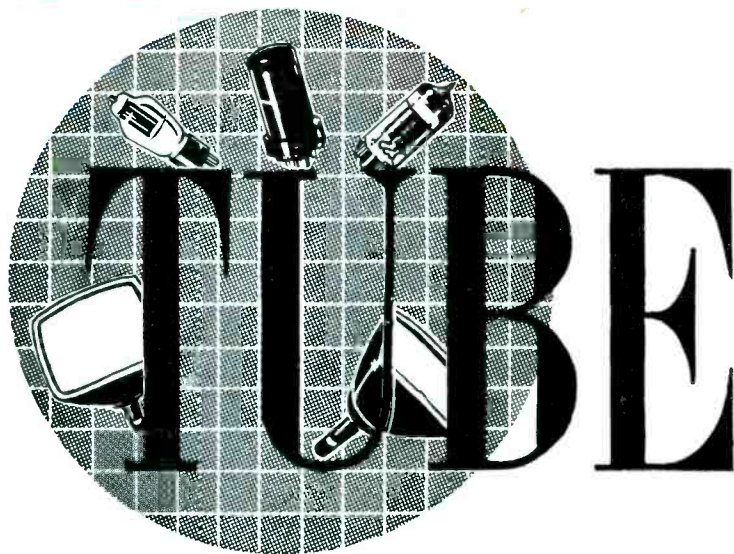

News — by E. A. TEVERSON

IT HAS BEEN SAID that one of the most acute problems in color TV is the picture tube. Many have accepted that challenge and with intriguing results. Recently, one manufacturer announced the development of an aluminized electromagnetically-deflected and electrostatically-focused direct-view, tricolor tube,¹ with a deflection angle of 45°, overall length of 26 $\frac{1}{8}$ " and featuring a phosphor-dot screen placed directly on the inside surface of a spherical face-plate.

The electron-gun assembly contains three matched, electrostatic-focus elec-

tron guns arranged in a triangular configuration, with each gun aligned parallel to and equidistant from the tube axis. The guns are also displaced from each other by an angle of 120°, measured in a plane perpendicular to the tube axis.

Phosphor Screen and Aperture Mask

By a unique method of screen processing, it has been found possible to place the tricolor phosphor-dot screen directly on the inside surface of the spherical face plate. This technique is

said to reduce dynamic focusing and convergence requirements.

The phosphor screen of the color tube contains some 250,000 phosphor dots of each primary color; a total of 750,000 phosphor dots. The dots are arranged in 250,000 triangular groups or triads, and each triad contains one red, one blue, and one green phosphor dot.

Another interesting feature of this tube is the aperture mask. A thin, arched mask, it is located between the phosphor screen and the electron-gun assembly. It contains approximately 250,000 round holes, one for each triad on the screen. Fig. 2 illustrates how this mask serves to insure that each beam will strike only the dots of a single color.

Mask and Screen Assembly

The mask assembly which consists of a curved mask with spring clips to hold it in place, is mounted on three hemispheres; these are raised points of glass molded around the edge of the face plate, beyond the picture area.

The mask contains three V-shaped surfaces which rest over the hemispheres and make use of the V-block principle for precise location. Since the mask is unstressed, it is free to expand and contract. This combination of a curved face plate and a curved, unstressed mask has been found to permit expansion and contraction without misregistration.

High-Voltage Requirements

Briefly, the *hv* requirements of this color tube are: anode, 20,000 volts with a maximum current drain of 600 microamperes; convergence electrode, 9,300 volts with a maximum drain of 5 microamperes; and focus electrode, 3,100 volts with a maximum drain of

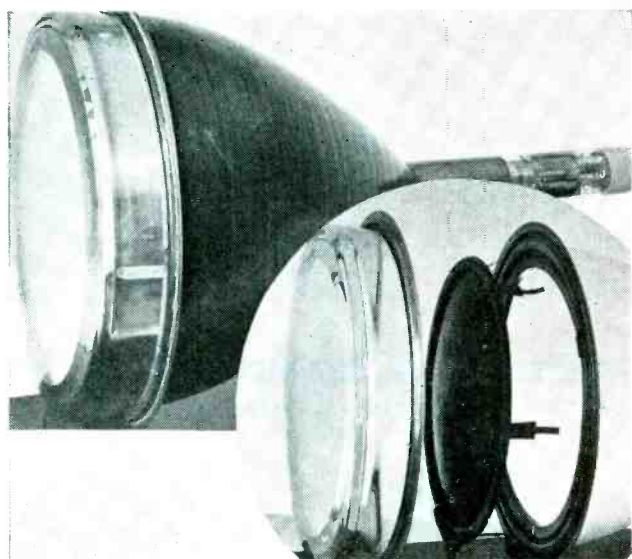

Fig. 1. Phosphor-dot screen and aperture-mask color picture tube

**Based on application and design notes prepared especially for SERVICE by Robert B. Tomer and William R. Sullivan of CBS-Hytron.*

© CBS Colortron

Exclusive Report on Phosphor-Dot-Screen / Aperture-Mask Color Tube: Mask and Screen Assembly, HV Requirements, Convergence, Beam-Positioning Magnets and the Deflection Yokes.

400 microamperes. In addition, the regulation of the anode and convergence voltages must be maintained within two per cent to prevent mis-registration. Consequently, a shunt regulator or corona discharge tube must be employed. Adjustment of the focus and convergence potentials can be achieved by the use of potentiometers in the high-voltage divider network.

Magnetic Shielding

Optimum performance of this tube necessitates proper shielding against the effects of the earth's magnetic field and stray fields around the picture tube. A magnetic shield of *MuMetal* or equivalent material must be placed over the bulb portion of the tube. Placement of magnetic components of the receiver so that the effect of their fields on the picture tube is minimized results in improved tube performance.

Convergence

Fig. 2 illustrates the conditions which exist at the center of the screen when the beams are properly aimed, or converged. This characteristic is known as *static convergence*. Fig. 4 (p. 85) illustrates the conditions that exist when the beams are deflected toward the edge of the screen. Because the convergence point and the aperture mask are not quite coincident, the convergence point must be varied in accordance with the position of the beams as they scan the phosphor screen. This is known as *dynamic convergence*.

Adjustment of convergence is accomplished by varying the voltage applied to the convergence electrode. This voltage is a combination of a

static and a dynamic voltage derived from the horizontal- and vertical-deflection circuits. It varies the focal length of the convergence lens in accordance with the position of the beams as they scan the phosphor screen. The spherical shape of the mask and screen of this color tube is said to reduce the dynamic-convergence voltage required and facilitate convergence adjustment in the receiver.

In the ideal case, the three beams leave the convergence lens so aligned that, when deflected, they approach the aperture mask at the correct angles properly converged. In the practical case, however, this is not always true. For this reason, it is necessary to employ external components to align properly the three beams.

Beam-Positioning Magnets

The first of these external components is a combination of three small, moveable permanent magnets, one for each beam. These magnets provide for adjustment of each of the beams, so that they will be properly acted upon by the convergence lens. The three magnets are mounted 120° apart on the circumference of a non-ferrous ring. The ring is located approximately 1½" from the tube axis in the grid-No. 2 region. Field strength of

these magnets is approximately 8 gauss.

Color-Purifying Coil

The other external component necessary for proper beam alignment is a color-purifying coil. The magnetic field produced by this coil is perpendicular to the tube axis. This field acts upon the three beams simultaneously and, by proper adjustment of its strength, and its axial and rotational position, the common axis of three beams can be positioned to achieve optimum color purity. The coil is located on the neck of the tube in the region of grids 2 and 3. The construction of the coil should allow it to be rotated and moved along the neck of the tube. A typical coil requires a current of slightly less than 10 milliamperes for proper color-purity adjustment.

After the beams have been acted upon by the alignment components and the convergence lens, they enter the deflection area. Here, the deflection yoke provides the required uniform magnetic fields that simultaneously deflect the three beams.

Deflection Yoke

As in black-and-white tubes, the deflection yoke consists of four electro-
(Continued on page 84)

Fig. 2. Portion of mask and screen showing the three beams passing through a hole in the mask and striking the phosphor dots of the associated triad.

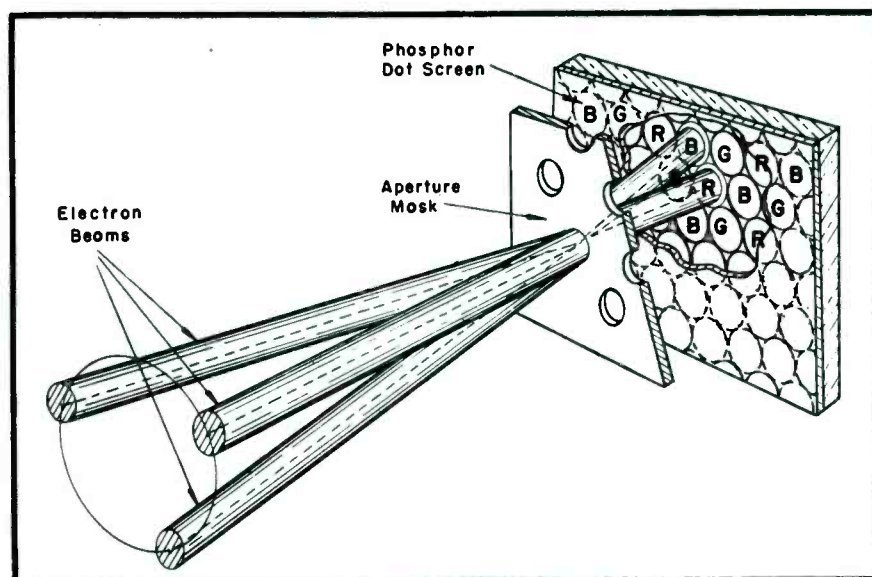

**Alignment . . . Correcting FM Tuner Drift . . .
Adjustments for Weak, Distorted or Noisy FM Signals
. . . Use of Temperature-Coefficient Capacitors . . . 10-Kc
Whistle-Filter Installations**

AUDIO System Maintenance: HI-FI Tuners

by MARK VINO

WHILE THE SERVICE of tuners is not, strictly speaking, in the audio field, it is an integral part of the maintenance of typical audio systems. More trouble is likely to develop in the tuner than in the other units.

High-fidelity AM tuners are of the broadband type; that is, the pass-band of the *rf* system for any one station frequency may be as high as 20 kc; 10 kc on each side of the station frequency. This allows a more extended treble audio frequency response (AM broadcasts do not all cut off at 5,000 cycles audio, as is commonly supposed), but also involves greater adjacent channel interference, and the reception of a very high-pitched, annoying whistle. The whistle, which is at 10 kc, is caused by heterodyning between transmitter carriers whose assigned frequency bands are adjacent to each other.

The interference from adjacent

channels is dealt with, in some tuner designs, by variable *if* bandwidth subject to the control of the user, who switches to narrow band operation when necessary. A typical circuit providing this feature is illustrated in Fig. 1. If the tuner does not incorporate such facilities, the only thing that can be done to alleviate the interference is to reduce tuner sensitivity by shortening the AM antenna, or to reduce sensitivity to one particular station by the installation of a wave trap, as illustrated in Fig. 2. The basic tuner design has sacrificed selectivity for improved high-frequency audio response.

Incorrect receiver alignment can also introduce crosstalk. The *if*'s must be on frequency, and the oscillator adjustments must furnish correct dial calibration. In some cases moving the stations on the dial, by adjusting the oscillator trimmer or paddler

for maximum station spread at the troublesome part of the band, may help.

The 10-kc whistle can be best eliminated by a *whistle filter*, sometimes called a *tweet filter*, which broad-band AM tuners should include in their original design. Where the tuner does not possess such filter, the only really effective measure is to install one. The 10-kc filters can be purchased quite reasonably, and instructions for installation are usually provided with the unit. Two commercial types are illustrated in Fig. 3, connected in the appropriate receiver circuits. A third type comes installed in a second *if* transformer can. Any one of these are well worth the installation trouble for AM reception on an extended frequency range system.

Ten-kc filters are sometimes included in the circuits of the audio amplifier instead of the tuner, as in Fig. 3

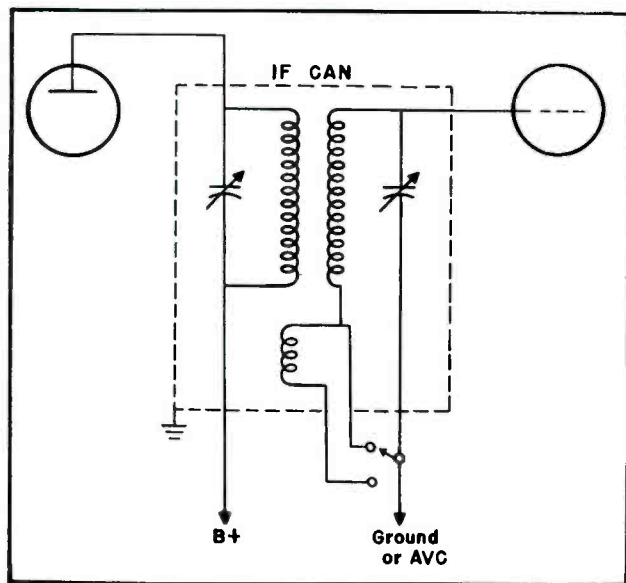
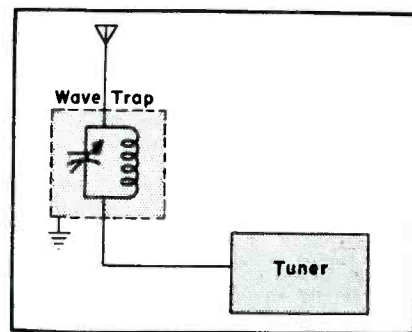

Fig. 1. Circuit which provides variable *if* bandwidth. The switch is shown in the narrow-band position; when the additional coil is switched in, the band-pass is widened by overcoupling.



(Above)

Fig. 2. Installation of a wavetrap to reduce receiver sensitivity to a particular interfering station. The trap must be tuned for minimum signal from the unwanted station. More than one trap may be used in series, each tuned to a different interfering signal.



37C1 or 43C1



37C2 or 43C2



Rear view of 43C1

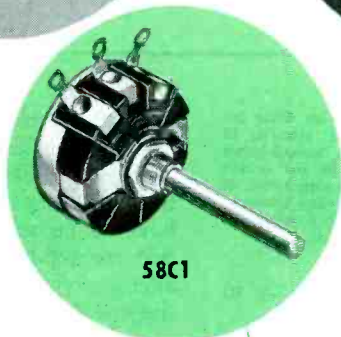

58C1

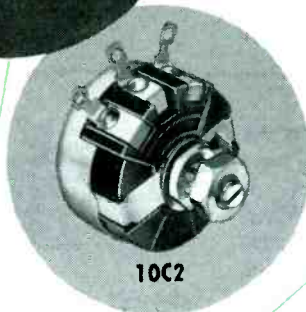

10C2



Where better-than-standard components are desirable...

CLAROSTAT C-Line Controls

A new line of composition-element and wire-wound controls designed specifically for custom-built, industrial, laboratory or other semi-critical applications. These controls are *de luxe versions* — mechanically and electrically — of the popular Clarostat standard types widely used in radio-TV sets and for the servicing thereof.

With factory-assembled fixed 1 1/2" round shaft (C1) or 1/8" screwdriver-slot shaft (C2) with split locking bushing.

All exposed metal parts have corrosion-resistant finish. Terminals have suitable finish for ease of soldering.

Close-fitting covers — no holes or cut-outs. Maximum protection against dust and dirt.

Ratings: 37C1 and 37C2 composition-element, 1 watt; 43C1 and 43C2 wire-wound, 2 watts; 58C1 and 58C2, 3 watts; 10C1 and 10C2, 4 watts.

Electrical tolerances plus/minus 10% for composition-element controls up to 100,000 ohms; plus/minus 20% from 100,000 ohms to 10 megohms.

Wire-wound controls within plus/minus 5% in all ohm-ages. Independent linearity to plus/minus 1% for 58C1 and 58C2, and 10C1 and 10C2 controls; for 43C1 and 43C2, plus/minus 2%.

Available with switches on special order.

Units sealed in dustproof plastic bags within standard Clarostat cartons. Factory-fresh appearance and condition, regardless of shelf life.

STAND PAT WITH
C

If you want still better-than-standard quality, performance and life, insist on Clarostat C-LINE controls.

CLAROSTAT Controls & Resistors

CLAROSTAT MFG. CO., INC., DOVER, NEW HAMPSHIRE

In Canada: Canadlan Marconi Co., Ltd., Toronto, Ontario

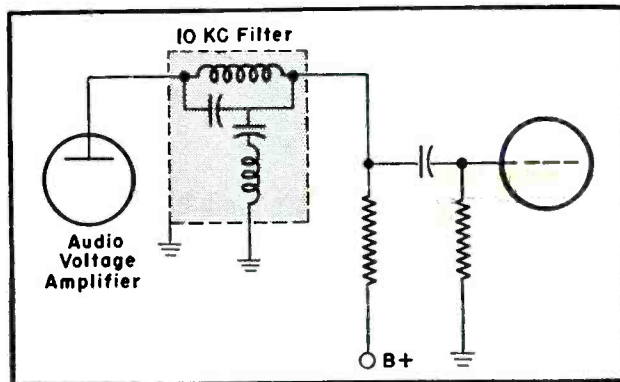
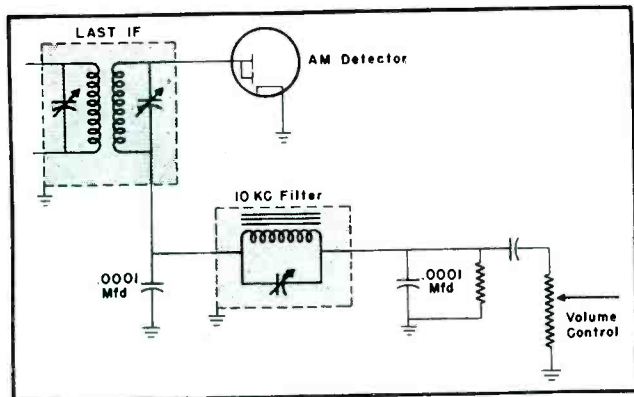

(right), since the rejection band at the whistle frequency can be made so narrow that little effect is apparent on FM or phono program material. When the filter includes variable trimmers, the screws are simply adjusted for minimum whistle, but care must be taken to avoid tuning against high-frequency oscillation from a source other than adjacent carrier heterodyning. The intercarrier whistle can be distinguished by the fact that as the dial is turned the whistle varies only in intensity, remaining constant in frequency.

Maintenance of FM Tuners: Drift

One of the common troubles that develop in FM tuners after a period of use is station drift. Some initial drift is normally expected in an FM tuner without *afc*, but the drift should not be excessive, and even more important, the tuner should become stable after it has warmed up.

The first attempted remedy for drift should be replacement of the oscillator or converter tube. When the tube electrodes sag or bend over relatively large distances, the interelectrode capacitances, and hence the frequency of oscillation is affected. Because the FM band is so much higher in frequency than the AM band, these small changes in capacitance become significant. (It is almost superfluous to add that an oscillator tube that is the cause

Fig. 3. At left is illustrated a 10-kc filter installed in an AM detector load circuit, to eliminate intercarrier whistle on broad-band tuners. A 10-kc filter installed in an audio circuit is shown at right. The rejection band of this type of whistle filter must be very narrow, in order not to interfere appreciably with FM or phono program material.

of large drift may check perfectly in the best of tube checkers.)

Another possible source of drift is lack of ventilation for the oscillator circuits, a lack which may be responsible for abnormal heating of the coil, tube, or tuning capacitor. It is interesting to note that certain military receivers, in which extreme stability is a primary requirement, have been designed with special heat-regulated compartments for the heterodyne oscillators. While such a procedure is unnecessary in home models, the drilling of a few judiciously-placed ventilating holes in the cabinet can help the heat situation greatly.

It is possible to reduce the temperature-caused instability of an FM tuner that does not have *afc* and whose drift is considered unsatisfactorily high. The oscillator coil and other circuit parts respond to temperature increases by expanding; normally increasing their inductance or capacitance, lowering the frequency of the oscillator tank circuit, and shifting stations upward on the dial. This effect may be counteracted by connecting a special type of capacitor, having a *negative temperature coefficient*, across the coil. As the temperature rises the capaci-

tance of this capacitor *decreases* rather than increases, compensating the change of inductance in the coil. The trimmer across the oscillator coil will have to be readjusted, of course, so that the total capacitance of the parallel combination of trimmer and negative-coefficient capacitor will be equal to the original capacitance to which the trimmer had been set.

Since it is impossible to judge the capacitance of the trimmer as originally adjusted, even when the range of trimmer capacitance (usually about 5 to 15 mmfd) is known, the correct value of the parallel compensating capacitor may first be determined experimentally. The trimmer is opened up to a value near its minimum, raising the oscillator frequency and shifting the stations downward on the dial. Test capacitors may then be connected temporarily (not held) across the oscillator coil or tuning capacitor to determine the value that will bring the stations back to their approximately correct dial positions. This will be the value of negative-coefficient capacitors to use, providing that sufficient leeway has been allowed for the trimmer to open up a little farther. For safety, a slightly lower value of compensating capacitor can be chosen, so that there will be no question of being able to set the trimmer to a value low enough for the total circuit capacitance to return to optimum. If the set has been over-compensated, and now drifts downward, the compensating capacitor is taking up too large a share of the total trimmer capacitance, and it must be reduced in value or moved to a cooler location. With permeability-tuned systems the problem is much simpler; the fixed oscillator capacitor should be simply replaced with a negative-coefficient capacitor of the same value.

In Fig. 4 is illustrated a temperature-compensated oscillator circuit, with typical values assigned to the capacitors. It is assumed that the original trimmer adjustment was for

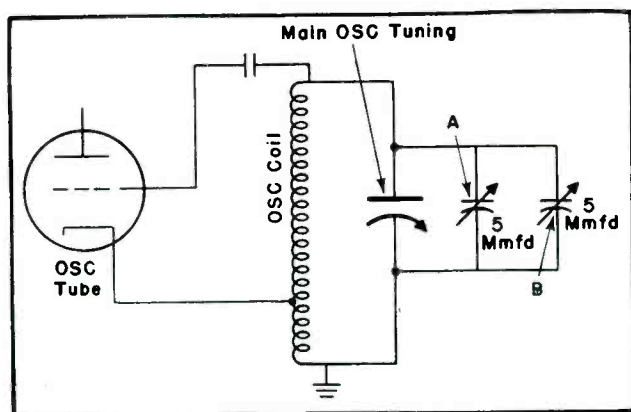

Fig. 4. Oscillator circuit of an FM receiver, temperature-compensated by installation of negative-temperature coefficient capacitor. The value of the parallel combination of trimmer and compensator must be equal to the capacitance at which the trimmer was originally set. At A is oscillator trimmer formerly set to 10 mmfd; at B is negative-coefficient capacitor.

(Continued on page 103)

famous

Telrex

4-BAY

"CONICAL-V-BEAMS"®

-the acknowledged champion in 1948 and STILL CHAMPION!

Install genuine Telrex "Conical-V-Beams," the Patented uni-directional, one transmission line array. Models for Ch. 2 to 13 or Ch. 2 to 83. See and hear the difference!

If UHF is available or expected, install Telrex "Duo-Band Conical-V-Beam" series. The perfect for rotation hi-gain... hi-F-to-B all-band one transmission line array with automatic transition from low to hi band with no lossy "distribution" pads.

"Conical-V-Beams" are designed for easy stacking as required for your particular reception area. 1 bay "C-V-B" for pri-area, 2 bay "C-V-B" for sec-area, 4 bay "C-V-B" for fringe areas... If a 4 bay "C-V-B" does not provide a usable TV picture, TV reception is either impossible or impractical!

Broadbanded single channel highest gain hi-F-to-B yagis also available from Telrex Antenna Headquarters, builders of world renowned communication yagis for amateur or commercial use.

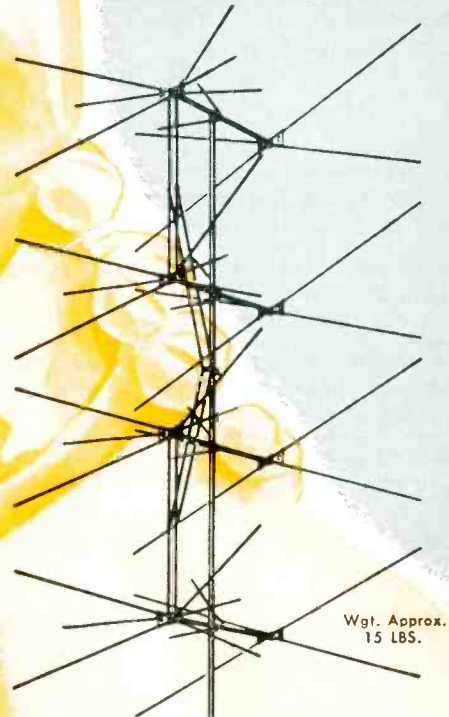

CHAMPION-FOR-DISTANCE MODEL 8X-TV*

The Ultimate in long distance arrays. Guaranteed to out-perform any antenna or combination of cut-to-frequency antennas. When used with Duo-Band splines it comprises the ultimate from Ch. 2 to 83. Unequaled for reception up to 200 miles.

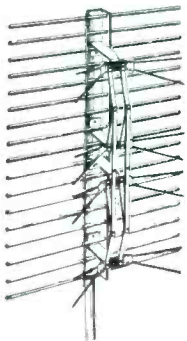

ULTRA-HI GAIN UHF "CONICAL-V-BEAM" MODEL 84

- Four bay uni-directional array
- All in-phase signal addition at all frequencies with no lobe splitting
- All-aluminum light weight and rugged

PRE-ASSEMBLED, PRECISION TUNED 5-ELEMENT YAGI

- High gain, broad-band response
- Excellent 300 ohm impedance match.

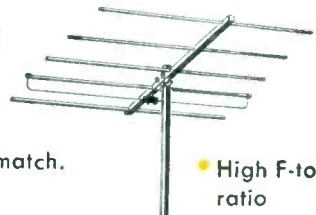

- High F-to-B ratio

WRITE FOR COMPLETE TELREX BULLETINS, TODAY!



*PATENTED

ASBURY PARK 4 NEW JERSEY

Insist on a genuine "Conical-V-Beam." Look for the Telrex Trade-Mark!

Condition	Cause	Control Method
Lack of noise immunity; picture tears when noise pulses are present. (11)	Lack of balance in phase-comparator; faulty flywheel circuit; spurious voltages in phase comparator.	Both sides of phase-comparator circuit should be checked with 'scope for proper waveform and peak-to-peak voltages. It is also important to check for spurious voltages with 'scope; and check <i>R</i> and <i>C</i> values in flywheel circuit: See block diagram at right; circle (1).
Edges of raster are straight, but edges of picture are curved. (No hum bars in picture.) (12)	Hum voltage or other spurious voltage is entering between video amplifier and phase comparator.	Tubes should be checked for heater-cathode leakage; <i>dc</i> supply lines with 'scope for spurious voltages. Decoupling capacitors should also be checked: See waveforms at right; circle (2).
Hammer head distorted. Top of picture may also be pulled. (13)	Disturbance of horizontal oscillator circuit by passage of vertical-sync pulse.	Here one should check for faulty differentiating circuit. Phase comparator circuit may be defective, or flywheel circuit may be faulty. Waveshape of sync voltage and peak-to-peak value should be inspected: See waveform at right; circle (3).
Picture weaves back and forth like a slow-waving flag; edges of raster are straight. (14)	Defect in anti-hunt circuit.	<i>R</i> and <i>C</i> values in anti-hunt circuit should be checked: See block diagram at right; circle (4).
Edges of picture are curved; hum bars in picture; edges of raster are straight. (15)	Hum voltage entering in video amplifier, or at picture detector.	Tubes should be checked for heater-cathode leakage, and capacitors in power supply should be checked too: See block diagram at right; circle (5).
Sync uncertain, sync pulse okeh in video amplifier, but badly clipped in sync section. (16)	Gassy picture tube, or defective <i>dc</i> restorer circuit.	Picture tube should be checked by substitution; <i>R</i> and <i>C</i> values in <i>dc</i> restorer circuit should be checked: See block diagram at right; circle (6).
Intermittent loss of sync (horizontal or vertical, or both). (17)	Unstable values of components in sync circuits, or in signal circuits; or fluctuating output from low-voltage power supply.	Capacitors should be checked for leakage, and resistors for changed values. All doubtful contacts and connection points also should be checked. Suspected components should be prodded and tugged while measuring voltages and resistances: See block diagrams at right; circle (7).
Picture occasionally loses sync completely during transmission of test pattern. (18)	Transmission of non-standard sync during tune-up and adjustments at transmitter.	One should switch to another channel for receiver tests
Random flutter of interlace, with noticeable blurring of picture. (19)	Interference voltages of a random nature are getting to the vertical-oscillator circuit.	Decoupling and common bypass capacitors in sync section should be checked, and waveform and peak-to-peak voltages at sync clipper output also should be checked: See block diagram at right; circle (9).
Pairing of interlace, with partial loss of picture definition. (10)	Horizontal pulses are entering the vertical-oscillator circuit.	One should check for defective <i>R</i> and <i>C</i> in the integrator; for pickup of ripple from the high-voltage system, and for pickup of stray fields from the horizontal-sweep system. Adequate decoupling of plate-voltage supply lines also should be checked: See block diagram and waveform at right; circle (10).
Take-off or squegging causes picture break-up, howling from speaker, and singing of horizontal-output transformer. (11)	Circuit faults permit positive feedback, cause sync and sweep system to take off.	Here, it is necessary to check for open decoupling and faulty feedback capacitors, defective resistors, open common bypass units. Neutralizing adjustment in sets utilizing sync-amplifier neutralization should be checked too.
One light bar and one dark bar in raster, with edges of raster hooked or curved. Simulates trouble in sync-control circuits, but bent raster is clue to other factors. (12)	60-cycle hum voltage in sweep circuit and in video amplifier (often in sync circuits also).	Strong hum voltage in plate-supply lines, due to fault in low-voltage power supply; half-wave systems only. Full-wave systems produce two light bars and two dark bars in raster: See block diagram and waveform at right; circle (12).
Loss of horizontal sync with retention of vertical sync. (13)	Trouble is localized to horizontal sync-control section.	In this instance, one should check for leaky coupling capacitors, resistors with changed values, and pulse feedback network in horizontal sync-control circuit: See waveform at right; circle (13).

Performance by CLARK R. ALISEN

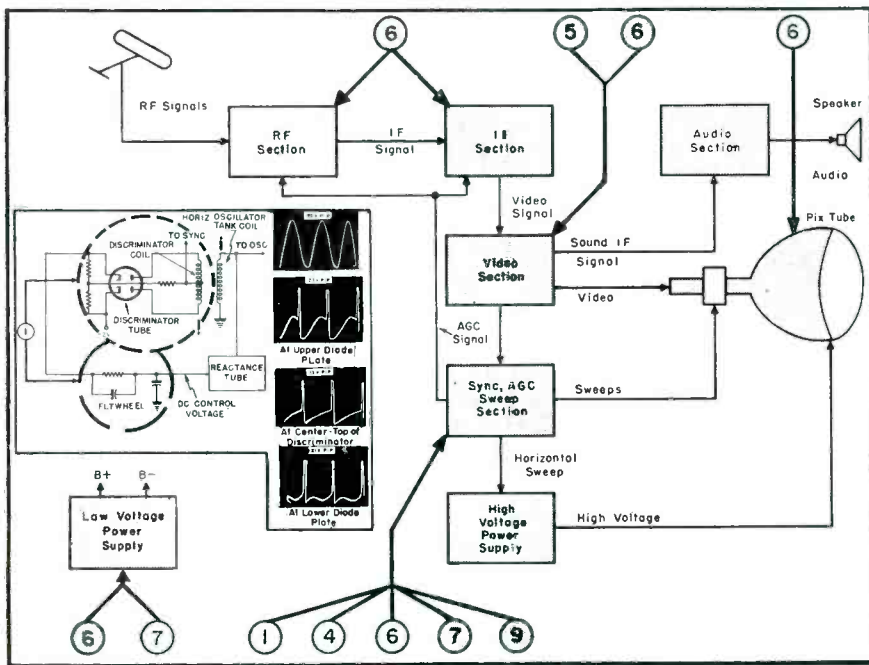

Above: Relation of sync system to other receiver sections.

(Right)

Troubleshooting waveforms, right: At 2, typical bending of picture, with raster unaffected; 2a, bending of vertical wedge caused by entry of interference voltages into comparator circuit; 3, distortion of hammer head by transients in horizontal sync-control circuits; 10, horizontal pulses mixed with vertical pulse at output of integrator, caused by faulty integrator circuit; 12, 60-cycle hum bars, with bending of raster; 13, loss of horizontal sync, with raster unaffected.

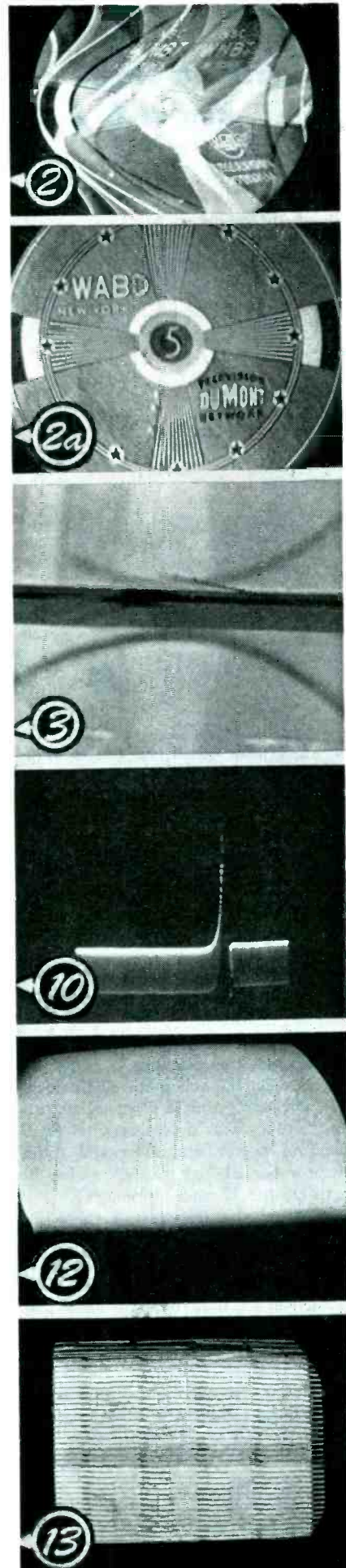

Below: Plan of horizontal and vertical-sync system, with relation to other receiver circuits.

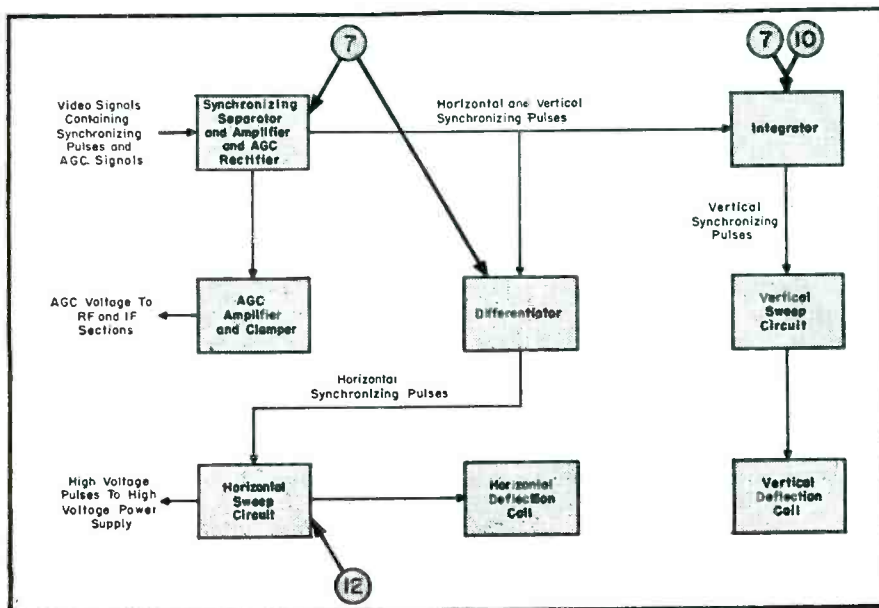

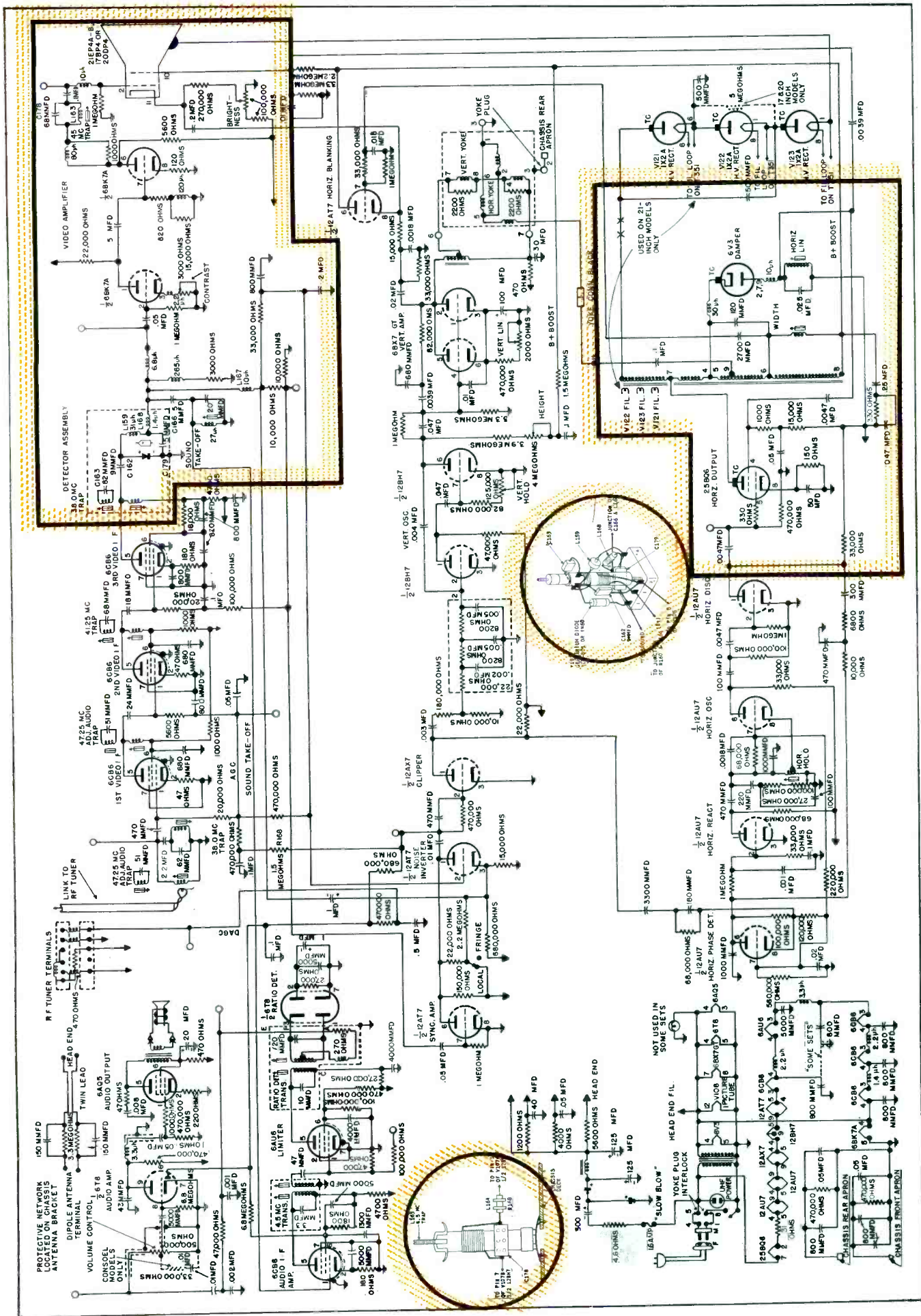



by **RALPH G. PETERS**

UHF/VHF Lightning-Arrester Design Notes*

THE INSTALLATION OF lightning arresters has become a basic requirement in many states, where insurance companies will not honor claims where proper grounding has not been afforded.

A lightning arrester placed within the antenna system affords an effective bypass for charges to ground.

The lightning arrester also serves to minimize the possibility of burn-outs at the front ends of receivers caused frequently by static charges of relatively high voltage set up by wind friction at the antenna and around the leadin.

Problem Due to UHF

The introduction of *uhf* TV in some instances retarded use of lightning arresters because it was found that these units caused severe signal attenuation at these frequencies. Thus it became necessary to design an arrester

which would work efficiently at these high frequencies.

UHF Type Study

In developing such units, a study of *vhf* types was initiated. It was found that these units had distributed capacities due to mechanical construction and a natural capacitance in the resistors themselves. At *vhf*, these capacities were found to be extremely low; thus the resulting high reactance (resistance) prevented the signal from being bypassed to ground, and lightning charges could pass unimpeded to earth. At *uhf*, however, the capacitive reactance in these designs were found to be low enough to cause loss of a good portion of the signal.

In the design of an arrester that would have negligible loss at the ultra-highs, a coil network was introduced,

as shown in the bottom view of Fig. 1, in addition to the carbon resistors in the contact circuits. In effect, the coils were found to act as a barricade to block *uhf* signals from going to ground. A 1-megohm resistor, in parallel with the coil, was inserted to permit high transient portions of the static charge, which might otherwise be blocked by the reactance of the coil, to be bypassed to ground through the resistor.

Low Distributed Capacity

The relatively small amount of distributed capacity that exists in the coils is in series with the larger distributed capacities present, as the result of the resistors and other parts of the arrester. Because these capacities are in series, they are now extremely low so as to present very high re-

(Continued on page 64; see new product review on page 62)

Fig. 1. Views of *vhf* (top) and *uhf* arresters (bottom).

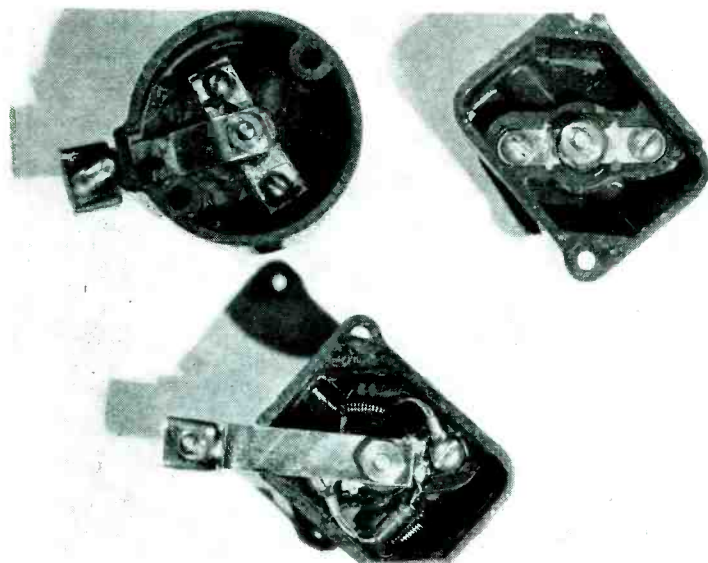

*From an exclusive report prepared for SERVICE by **Harold Merson**, chief electronic engineer, RMS.

Fig. 2. Circuitry of *uhf* (top) and *vhf* (bottom) lightning arresters.

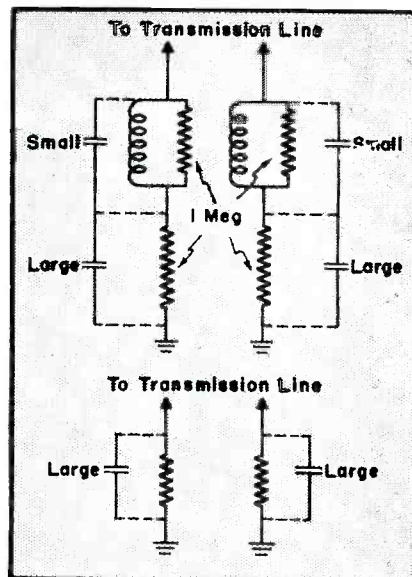

FREE-your Choice of NEW PHONO-CARTRIDGE CARRY-KIT or DISPLAY-DISPENSER



Handy All-Metal
Carry-Kit Holds
6 E-V Cartridges

Complete E-V
Interchangeability
Chart on both sides
makes servicing
positive and easy



PLUS
WINDOW or
DOOR DECAL



PLUS
REVISED SET-MODEL
REPLACEMENT GUIDE



6-Cartridge
Metal
Display
Dispenser
for Wall
or Shelf

10,000,000 PHONOGRAPHS ARE WAITING TO BE SERVICED

Get your share with these E-V aids to sales!

Again E-V gives you a positive profit-maker—and helps make you the authority on Phono-Service in your community!

Free of extra cost, from your E-V Distributor, you can get your choice of new Cartridge Carry-Kit or Display Dispenser plus professional Decal and up-to-date set-model Replacement Guide, with every purchase of any 6 E-V Phono Cartridges.

Furthermore, the new E-V high output, high compliance, permanent Ceramic Cartridges revolutionize servicing. They are *not* affected by moisture or heat—can be carried in your service kit or kept on display without fear of deterioration. And they are *directly interchangeable with silent-needle type crystal cartridges that do not use a thumb screw*—yet cost no more than crystal. They are part of the famous E-V Basic 6 Preferred Types that make over 92% of all cartridge replacements.

Take advantage of this offer now! Make money selling cartridge replacements. Cash in on the \$70,000,000 phono-cartridge modernization replacement market.

For a limited
time only.

SEE YOUR E-V
DISTRIBUTOR TODAY

Electro-Voice

BUCHANAN, MICHIGAN

Export: 13 E. 40th St., New York 16, U.S.A., Cable: Arlab

Each E-V Cartridge in
Two-Tone Jewel-like
Golden Yellow Plastic Box



New Product Survey: VHF-UHF Antennas . . . UHF Boosters and Converters . . . Antenna Couplers . . . Rotors . . . Control Systems

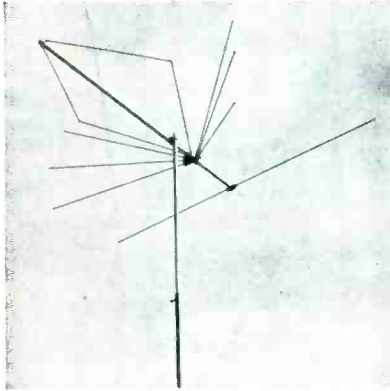

Preassembled all-aluminum antenna for channels 2 through 83 that includes a rhombic antenna for uhf and conical for vhf. Features use of exposed quarter-wave copper jumpers that are said to isolate uhf from vhf signals. Available in single and two-bay arrays. (JeT454. JeT454S; JFD Manufacturing Co., Inc., 6101 Sixteenth Ave., Brooklyn 4, N. Y.)

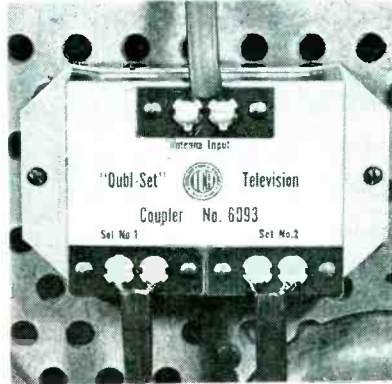

Antenna coupler, designed to permit the use of more than one TV receiver with a single antenna. Two types are available: the first which enables one antenna to feed two receivers; the second is a multi-set, which permits as many as four sets to function simultaneously. (6093 and 6094; Insuline Corp. of America, 3602 35 Ave. L. I. City 1, N. Y.)



Wavemeter designed for uhf TV band. Covers a range from 400 to 1000 mc. Coupling to the wavemeter tuning element is said to be facilitated by use of an external coupling loop, so designed as to permit access to the portion of the circuit under examination. Absorption circuit consists of a high Q resonant cavity tuned by means of a slug-type split stator capacitor. (Model U-3; Linear Equipment Laboratories, Brightwater Place, Massapequa, L. I., N. Y.)

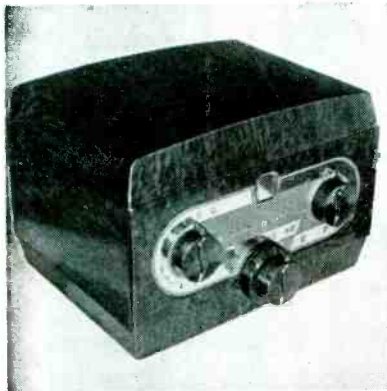

UHF converter-vhf booster combination unit mounted in marble-walnut plastic cabinet. (Sutton Electronic Co., Lexington, Ky.)

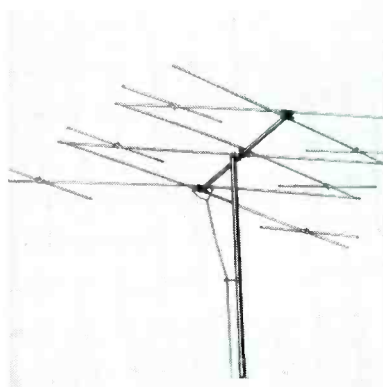

Single bay, all-channel vhf antenna, which it is said can also be used in primary uhf areas. (Twin-Six; Trio Manufacturing Co., Griggsville, Ill.)



A uhf-TV converter, with a printed circuit tuner. Cabinet is 3 1/2" x 6 1/2" x 8" (Model ES-1; Allen D. Cardwell Mfg. Corp., 96 Whiting Street, Plainville, Conn.)

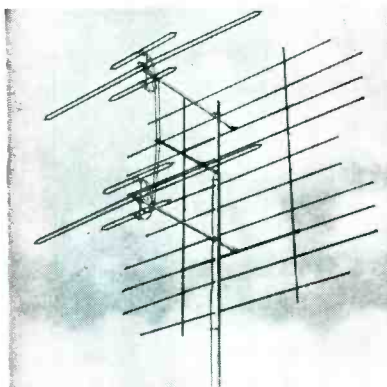

All-channel vhf antenna, which features a broad-band dipole system called the Tri-Pole. In this system, the low band dipole also functions as three half-wave dipoles tied together, in phase, on the high band. Antenna also employs a screen-type reflector. Collapsed screen has a scissor-type setup arrangement. Tri-Pole assembly has automatic spring lock action said to permit dipoles to snap permanently into place. (Model 325; Champion; Channel Master, Ellenville, N. Y.)

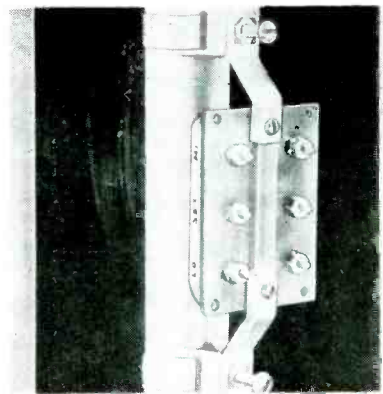

VHF antenna coupling device enclosed in a plastic housing with straps attached. Designed for use with broadband yagis such as the new Taco triple driven broadband yagis. May be employed in any combination of high-band and low-band antennas to feed a single transmission line to the receiver. (No. 1425; Technical Appliance Corp., Sherburne, N. Y.)

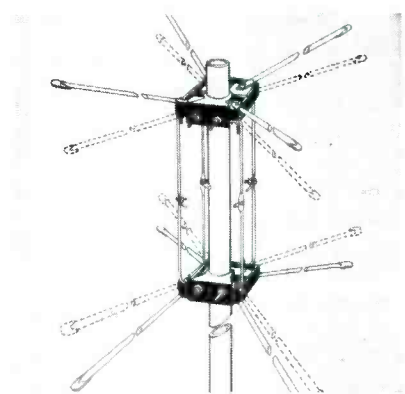

All-direction antenna (patented) with electronic polar beam selector switch. Models available for uhf and vhf channels. Nine different antenna combinations provided are said to allow for instantaneous orientation of the polar beams in all directions while the antenna remains stationary. (Models Super 60, Ultra 150 and Suburban 40; All-Channel Antenna Corp., 70-07 Queens Boulevard, Woodside 77, N. Y.)

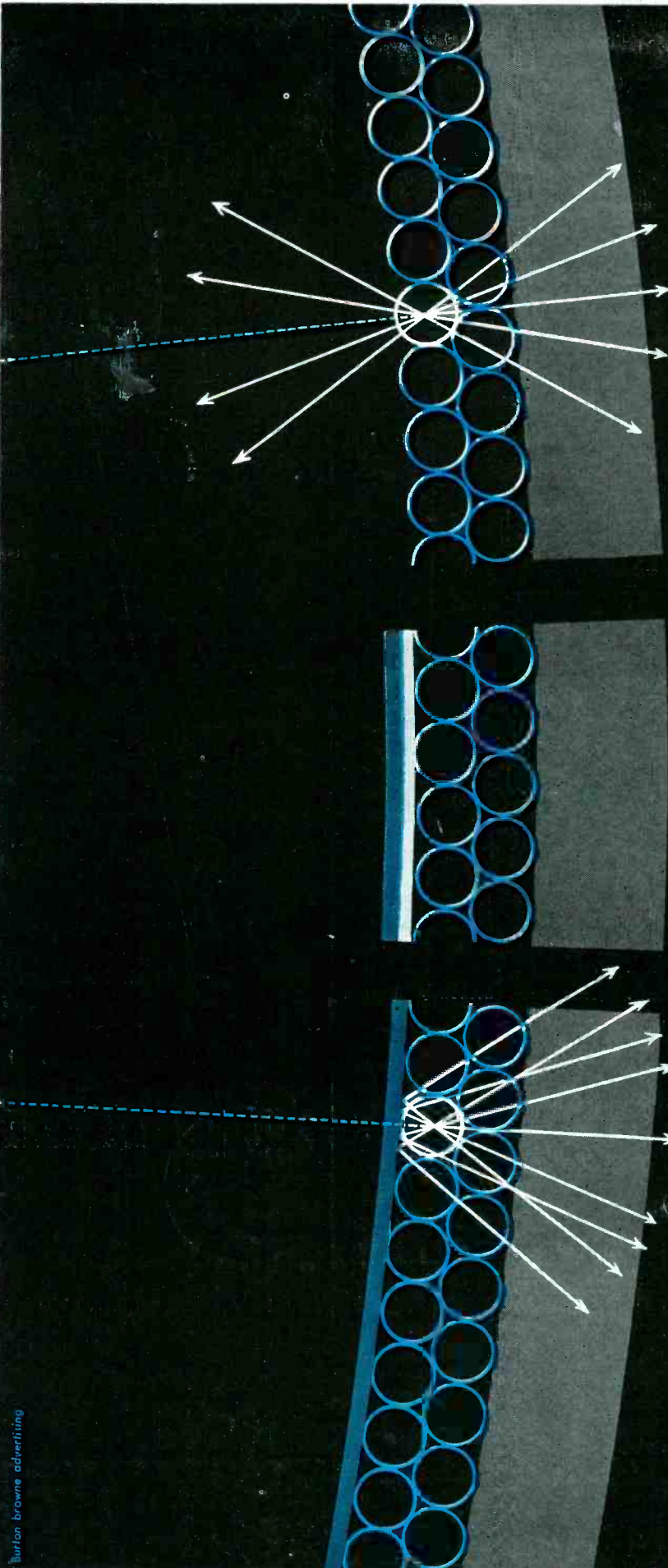

what
Aluminumizing
means

Aluminumizing means the efficient use of light—light is energy—energy is the pay-off.

Aluminumizing means a brighter TV picture, greater contrast, lower beam current, smaller spot size, sharper focus, reduced screen scorch—all from the efficient use of light.

On the inside of any TV tube face is a coating of phosphor crystals—the picture screen. As the electron beam—tracing the picture—strikes these crystals, they glow, giving off light in all directions. And there's the problem! Half the light thus generated is *inside* the tube, either lost to usefulness or lighting areas that should be dark. Both brightness and contrast suffer.

But—put a mirror behind the phosphor and “wandering” light is reflected back through the tube face. *Aluminumizing creates this desired mirror!*

To aluminumize a picture tube, deposit a nitrocellulose film evenly over the phosphor. Over that, deposit a film of aluminum only millionths of an inch thick—just thick enough to reflect the light and just thin enough to let the electrons pass through. Under heat, evaporate the nitrocellulose film to leave a thin smooth coating of aluminum. Result—an efficient light reflecting mirror to specifications.

Simple as it sounds, Rauland research engineers worked for three years to solve the problem and were among the first to do so.

Rauland

Perfection through Research

ZENITH Subsidiary

THE *American* IDEA

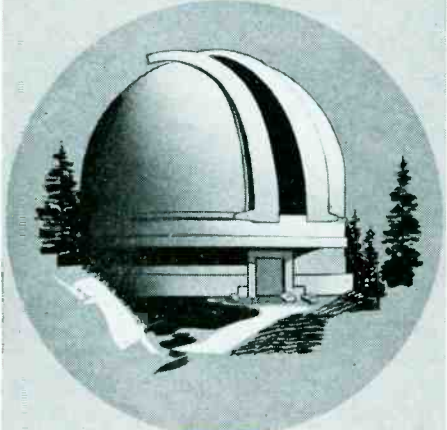

"To find and follow the better way" . . . Out of the vision of Dr. George Ellery Hale came the great "American Idea" that resulted in the creation of the "Glass Giant of Palomar"—world's largest telescope—to gather new light from the farthest stars for the searching eye of science.

With us, the "American Idea" is, by directed effort and applied know-how, to continue to lead in bringing you electronic products of the highest quality.

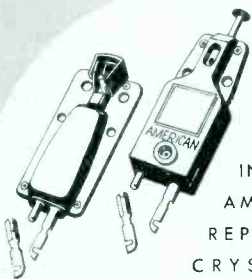

INSIST ON
AMERICAN
REPLACEMENT
CRYSTAL
CARTRIDGES

Send for FREE catalog 46



American microphone co.

370 South Fair Oaks Ave. • Pasadena, 1, Calif.

TV Antennas

(Continued from page 60)

actance*to ground.† Thus, the *uhf* signal can go through the transmission line to the set unimpeded.

Because of the wide variety of transmission lines offered for lower-loss reception at the ultrahigh frequencies, it was necessary to design the *uhf* lightning arrester so that it could take these various leadins. This was accomplished by introducing longer terminal studs and wider saw-toothed contact washers. The longer studs were found to permit lifting the washers higher for easier insertion of the transmission lines and the wide washers assured contact over the entire range of variations.

†Since these capacitances are in series, Kirchoff's law applies: the total capacitance in a series network will be smaller than the smallest capacitor in the network.



UHF multichannel converter peaked for single channel operation; tunable to receive any channel within a 20-channel range. Silver plated high-Q tuned circuits. Designed for use with 300-ohm *uhf* antenna. (Crest Labs, Rockaway Beach, N. Y.)

TV antenna roof mounting with a walk-up-drop lock design. Antenna and mast are inserted into 5½" long x 1½" o.d. x ½" thick mast holder from a horizontal at rest position. After two mast locking screws are tightened, the antenna and mast are walked up to a vertical position where it then drops into a special notch which holds the antenna erect. Two in-line holes allow the mounting to be screwed into the heavy roof cross member. A mast socket retainer is heavily embossed at six points. May be mounted on either a flat or pitched roof. (Model RM-15; South River Metal Products Co., Inc.)

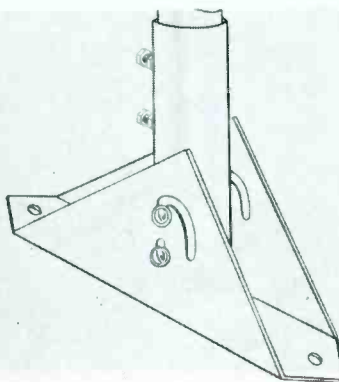

First Again!

to bring you
the alignment
tool you've
been asking
for!

X-57

PLASTIC
"Long Slim"
TELEVISION
SET
ALIGNMENT
TOOL

Made of New . . . Super-tough X-57 Plastic

Steel-like Strength . . . yet highly flexible

Extra Slim . . . only ⅛" in diameter

All Insulated . . . high di-electric

Stronger . . . More Durable than ordinary fibre alignment tools



Number	Blade Length	List
8987	7"	\$1.00
8988	12"	1.50
8989	16"	2.00

WRITE FOR YOUR COPY OF
THE NEW G-C No. 156 CATALOG

GENERAL CEMENT MFG. CO.
904 TAYLOR STREET
ROCKFORD • ILLINOIS

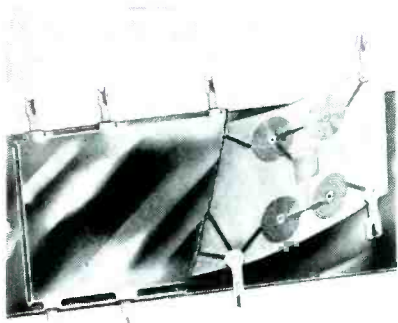

Triple-tie crossover filter which employs a printed circuit to eliminate the need for two down leads when both a uhf and vhf antenna are in operation. Unit is impregnated before encasement. Terminals are wide spaced to prevent shorting out by rain or ice. (UV-3; TV Products Co., Springfield Gardens, New York.)

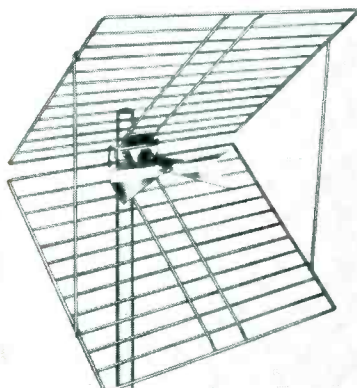

Factory-assembled uhf corner reflector antenna, with a gold-plated screen. Weather-proof plating is said to meet government anti-corrosion specifications. (Model 8984; Television Hardware Mfg. Co., Div. General Cement Mfg. Co., 904 Taylor Street, Rockford, Illinois.)

(Below)

Antenna rotator (top) offering a detachable drive unit, locking devices that are said to eliminate both drift and coast (a worm gear lock prevents drifting due to wind, and a motor brake prevents the transfer of motor inertia to the antenna), built-in chimney mount design, aluminum housing and antenna supports ringed with steel, and vernier precision tuning. Rotor can be rotated clockwise and counter-clockwise through 365°, at approximately one revolution per minute. It can be operated at more than 350' from the control box. Wide-span double ball bearing supports permit the use of extra heavy antennas, and will accommodate up to 2" lower, and 1½" upper masts. Control box (bottom) permits a reading of antenna position without rotating antenna. (Superrotor; Leader Electronics, Inc., 2925 E. 55 St., Cleveland, 27, O.)

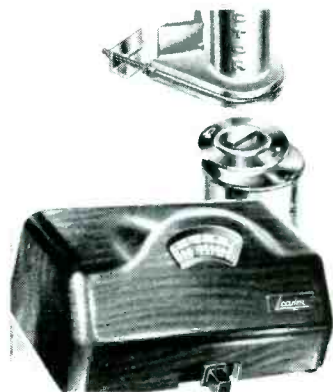

PAMPER YOUR TV AND RADIO SETS WITH DEPENDABLE OHMITE® REPLACEMENTS

Little Devil® COMPOSITION RESISTORS



Tiny, yes . . . but what dependability, ruggedness, and stability! And they provide an extra margin of safety—being rated at 70C rather than 40C. Completely sealed and insulated by molded plastic, they meet all JAN-R-11 requirements . . . are available in ½, 1, and 2-watt sizes in all RTMA values.

TYPE AB NOISE-FREE POTENTIOMETERS

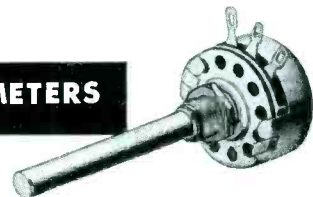

Because the resistance material in these units is solid-molded—not sprayed or painted on—continued use has practically no effect on the resistance. Often, the noise-level *decreases* with use . . . and they provide exceptionally long, trouble-free service. Rated at 2 watts, with a good safety factor.

BROWN DEVIL® AND DIVIDOHM® RESISTORS

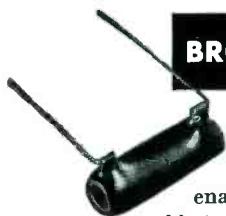

BROWN DEVIL fixed resistors and DIVIDOHM adjustable resistors are favorite vitreous-enamelled units! DIVIDOHM resistors are available in 10 to 200-watt sizes; BROWN DEVILS in 5, 10, and 20-watt sizes.



WRITE FOR
STOCK
CATALOG
OHMITE MFG. CO.
3642 Howard St.
Skokie, Illinois
(Suburb of Chicago)



Be Right With . . .

OHMITE

RHEOSTATS • RESISTORS • TAP SWITCHES

Servicing Helps

by T. L. GILFORD

**...Removing Static on VTVM Face Plates...
Tube Check Suggestions...Removing Tweets
in UHF Portion of Chassis... Auto Radio
Service Helps*: Repairing Antenna-
Grounding Sleeves... Antenna Trimmer
Adjustments... Servicing '53 Oldsmobiles
With Noisy-When-Jarred Problem... 12-V
Buffer Capacitor Replacements**

WHEN installing Motorola models SR3A6 or SR3M6 in the 1953 Studebakers, extreme caution must be used in mounting the control unit, as the space between this unit and one of the terminals of the ignition switch is very limited. Unless extreme care is used in mounting the control housing, it can short to the ignition switch.

Insulators¹ are now being enclosed, along with proper instructions, to eliminate this possibility.

One should make certain, too, when making an installation, that the lead connecting to this terminal of the ignition switch has the lug pointing down.

Auto-Radio Antenna Grounding Sleeve

THERE HAVE been occasional reports of noise in Cadillac auto radios which has been traced back to the antenna

Fig. 1. Mount suggestions for Motorola auto radio control unit on Studebaker '53 cars. An insulator (A) is placed over bracket and attached to tuner unit with a No. 8 sheet metal screw (Courtesy Motorola)

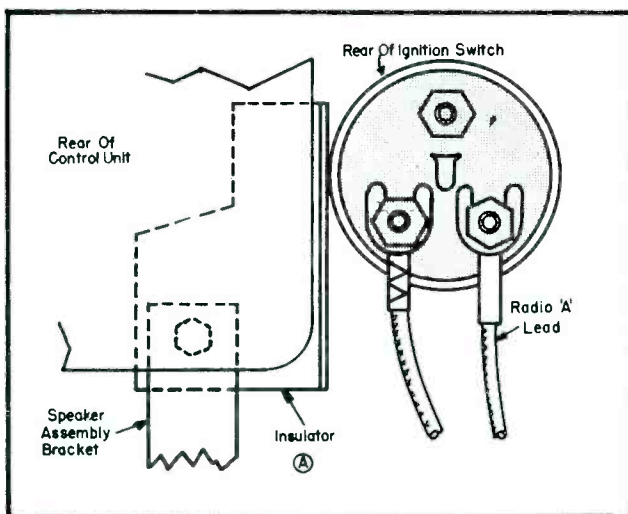

installation. This has been caused by a poor ground connection on the antenna shielding base. Investigation has shown that the grounding sleeve (Fig. 2) on that particular antenna did not cut through the insulating material on the underside of the fender because the spurs on the sleeve were not sufficiently sharp. To cure, the antenna should be removed and the grounding sleeve spurs filed to a sharper point. This will assure adequate ground at the antenna base and eliminate the noise picked up on the bottom portion of the antenna.

Antenna Trimmer Adjustment

ON ALL '51 Delco receivers the antenna trimmer adjustment should be

¹Motorola Part 14A531128.

* From TESTING TIPS, prepared by the DELCO RADIO DIVISION, and submitted by S. W. ARCHER, Delco Radio Service manager.

made on a weak station between the frequency of 600 and 1000 kc. This is a change from the 1400 kc setting formerly specified. The change has been made because it has been found that the coils will track better when the adjustment is made at the lower frequency and also because it is usually much easier to find a clear but weak signal in that portion of the broadcast band than in the congested 1400-kc region.

The adjustment should be made whenever a set is placed in a car, to match the input circuit to the car antenna and insure peak performance of the radio. Many complaints of poor reception have been completely eliminated by this simple adjustment of the antenna trimmer. In many remote and poor reception areas this shift will

(Continued on page 68)

Fig. 2. Antenna-grounding sleeve in Cadillac car, which on occasion does not cut through insulating material on underside of fender because spurs on sleeve are not sharp enough.

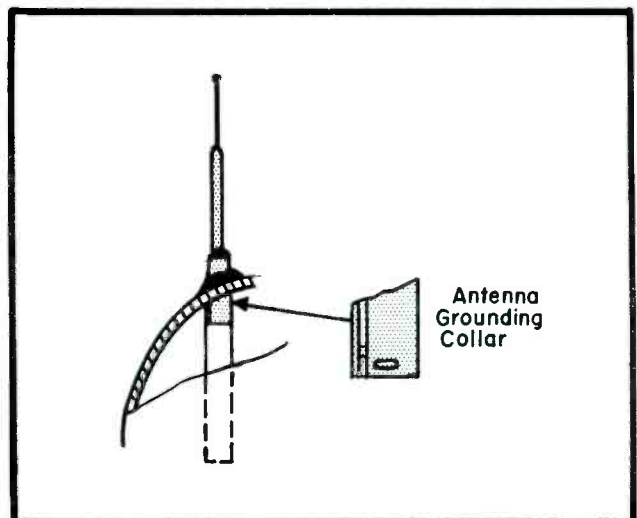

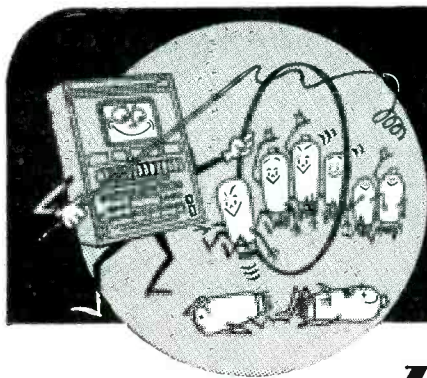

THE INSTRUMENT THAT DEMANDS **OVERALL PERFORMANCE** FROM THE TUBE UNDER TEST!

PRECISION SERIES 10-12

*Electronamic** Tube PERFORMANCE Tester

with 12 element free-point Master Lever Selector System

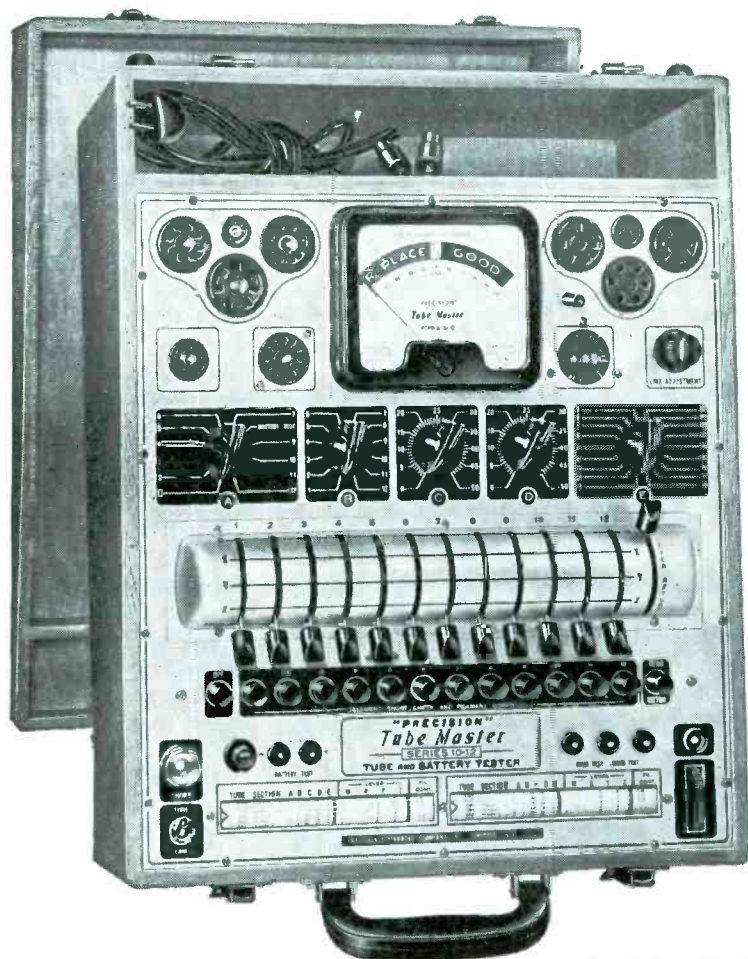

To test modern tubes for only one characteristic will not necessarily reveal **OVERALL PERFORMANCE CAPABILITIES**. Modern tube circuits look for more than just mutual conductance or other single factor.

It has been conclusively proven that even though a tube may work well in one circuit, it might fail to work in another—simply because different circuits demand different relative performance characteristics, such as amplification factor, plate resistance, power output, emissive capability, etc.

In the PRECISION "ELECTRONAMIC" Circuit, the tube under test is made to *perform* under appropriately phased and selected individual element potentials, encompassing a wide range of plate family characteristic curves. This COMPLETE PATH OF OPERATION is electronically integrated by the indicating meter circuit in the positive performance terms of *Replace-Weak-Good*.

The efficiency of this "Electronamic" test results from encompassing several fundamental tube characteristics, NOT JUST ONE. Accordingly, when a tube passes this demanding OVERALL PERFORMANCE test, it can be relied upon, to a very high degree, to work satisfactorily.

*REG. U.S. PAT. OFF. T. M. 438,006

Compare these features

- * Facilities to 12 element prongs.
- * Filament voltages from 3/4 to 117 V.
- * Tests Noval 9 pins; 5 and 7 pin acorns; double-capped H.F. amplifiers; low power transmitting tubes, etc., regardless of filament or any other element pin positions.
- * Isolates each tube element regardless of multiple pin positions.
- * Dual Hi-Lo short check sensitivity for special purpose tube selection.
- * Simplified, High Speed, 12 element Short-Check system, uses consecutive push-button switching.
- * Battery Tests under dynamic load conditions.
- * 4 1/2" Full Vision Meter.
- * Built-in Dual-Window, high speed, geared roller chart.
- * Free Replacement Roll Charts & supplementary tube test data service.

MODEL 10-12-P (illustrated): in sloping, portable hardwood case with tool compartment and hinged removable cover.

Sizes 13 3/4" x 17 1/4" x 6 3/4".....\$107.50

MODEL 10-12-C (Counter Type) \$112.25

MODEL 10-12-PM (Panel Mount) \$112.25

See the "Precision" Master "Electronamic" Tube Testers at leading Radio Equipment Distributors. Write for new, 1953 "Precision" catalog.



PRECISION APPARATUS CO., INC.

92-27 Horace Harding Boulevard, Elmhurst 9, New York

Export Division: 458 Broadway, New York 13, U.S.A. • Cables—Morhanex

In Canada: Atlas Radio Corp., Ltd., 560 King Street, W., Toronto 2B

Convenient "PRECISION" Purchase Terms can be arranged with your local and favorite authorized "PRECISION" Distributor.

AM • FM • TV •

AM • FM • TV

more
and more
replacement
problems
are being
solved
this way

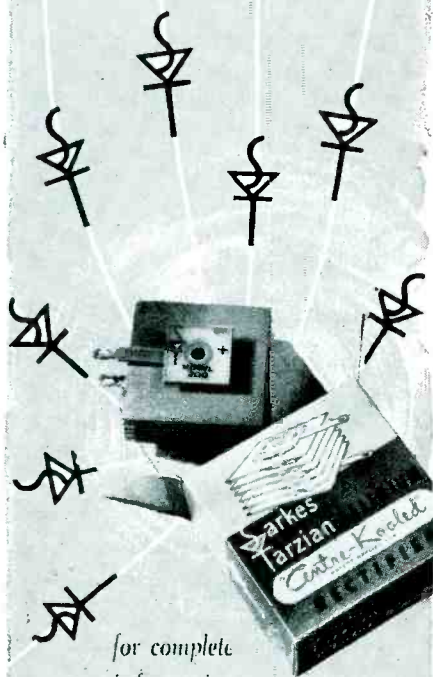

for complete
information
write-

SARKES TARZIAN, INC.
RECTIFIER DIVISION

415 N. COLLEGE AVE., BLOOMINGTON, INDIANA

IN CANADA: 50 ST. CLAIR AVENUE W., TORONTO

Send 25¢ for your new and complete
Replacement Guide for Selenium
Rectifiers or see your distributor.

Servicing Helps

(Continued from page 66)

make the difference between good and unsatisfactory performance.

'53 Pontiac Output Transformers

ON SOME '53 Pontiacs, *noisy-when-jarred* complaints have been frequent. On the output transformer the secondary coil lead connected to ground is welded to the output transformer frame. The ground connection to the chassis relies on the transformer's mounting soldered to the chassis to give a good ground. If the transformer is allowed to shake slightly, the solder connection might give. A poor ground at this point could produce *pops* in the speaker. This failure can be checked in the car by removing the cover and wiggling the output transformer to see if there is a poor ground connection. To repair, the ears should be bent over more firmly and resoldered to the chassis.

12-Volt Buffer Capacitor Replacement

THE BUFFER capacitors across the secondary of 12-v power transformers are very carefully matched. Even a slight deviation in the value of the buffer capacitor can be harmful to vibrator, OZ4 and electrolytic. It is important, therefore, that a .008-mfd capacitor never be used to replace a .007-mfd type, or vice versa. One must always replace the buffer capacitor with the exact value originally used.

Relay in Signal Seekers

SOMETIMES an automatic *signal-seeking* tuner stops at the low end of the band after the solenoid return, requiring the station selector bar to be depressed to start the tuner seeking again. It is not abnormal for a *signal-seeking* radio to stop at the low end of the dial on the solenoid return, if the sensitivity control is in the maximum sensitivity position and if the radio is in an area where there are extremely strong signals or an extremely high noise level.

When one encounters a set that stops at the low end of the band after each sweep, the antenna should be disconnected and tuner seeking started. If the tuner does not stop with the antenna removed, then the chances are that the set is operating normally, and the relay is deenergizing on a very strong signal during the solenoid return. You will find that this stopping condition can be eliminated by merely turning the sensitivity control to a lower position; it would be wise to advise the customer accordingly if the

condition occurs when the radio is mounted in the car.

However, if when checking the set on the bench the receiver continues to stop at the low frequency end of the band, even with the antenna disconnected, there is probably a defective 12AU7 or relay.

Lack of Flatness in Sweep-Generator Output

AMPLITUDE MODULATION in a sweep generator output can be caused by faulty tubes, open or otherwise defective bypass capacitors, poor grounding of cable shield braid to case of instrument, faulty terminating resistors at output end of cable, poor bonding of internal shielding of generator, defective attenuator causing a mismatch in the output circuit, or incorrect *dc* distribution in the generator due to faulty resistors, defective power supply, etc.

Amplitude modulation in the output from the generator should not be confused with amplitude modulation developed by improper application of the crystal probe to the output end of the cable. Experience has shown that the safest way to avoid this type of difficulty is to utilize 100-ohm carbon resistors for making such connections, instead of wire leads. The use of resistor connections attenuates the signal somewhat, but also serves to absorb effectively standing waves which may be generated at high frequencies when wire leads are incorrectly used for the purpose.

Hum Distortion in Square-Wave Check

WHEN A VIDEO amplifier is checked with *hf* square waves, the distortion which appears in the top and bottom of the display at low frequencies becomes modified, and one sees the hum distortion in the *hf* square wave as a thickening of the top and bottom of the waveform. This thickening is due to the rapidity of the distorting motion; it is so rapid that the motion cannot be followed by the eye, and the blurring which takes place appears as a thickening of the horizontal portions of the reproduced waveform.

Checking Video Amplifiers

LOW-FREQUENCY square-wave checks of video-amplifier performance should be conducted at 50 cps, rather than at 60 cps, since the hum distortion (which is usually present to some extent) becomes obscured and is subject to misinterpretation at 60 cycles. When a 60-cycle square wave is used in such tests, the 60-cycle hum *stands still* in the scope display, and one is

often misled into believing that the hum distortion is being caused by frequency or phase distortion. On the other hand, when a test is made with a 50-cycle square wave, the difference beat between 50 cps and 60 cps (10 cps) is clearly apparent as a *wiggling* or writhing of the display. In this manner, the amount of hum distortion in the pattern becomes clearly apparent to the operator.

Safety Glass-Picture Tube Precaution

DISTURBANCE OF THE charge distribution over the fluorescent screen of the picture tube can result when the face of the picture tube touches the safety glass, and as a result the middle portion of the picture may appear abnormally dim. The face of the tube should be spaced a short distance from the safety glass to correct the trouble.

Static on VTVM Face Plate

WHEN THE face plate of a *vtvm* is wiped clean, it may be found that the pointer then sticks to the glass, due to the accumulation of static charge on the glass caused by friction. To release the pointer, one should breathe lightly against the glass surface.

Tube Check Suggestion

IF A TUBE is mounted upside down, or on its side in the receiver, the tube tester should be turned accordingly, or an adapter with a flexible cable should be devised. It will be found on occasion that the tube checks differently on the shorts and leakage test, in particular, when mounted in non-standard positions.

Checking Flatness of Sweep-Generator Video Output

THE FLATNESS of the video output signal from a sweep generator can be checked by sweeping the video amplifier of the receiver in two different ways, and comparing the curves obtained by the two methods. In the first method, the video sweep from the sweep generator is applied to the input circuit of the first video-amplifier stage through a series resistor having approximately the same resistance as the picture-detector tube: 3,000 ohms is usually close enough. The picture-detector tube should be removed during test. The shape of the video response curve should be noted. Next, the picture-detector tube must be replaced, and an *ij* sweep signal applied to the input electrode of the picture-detector tube; a *cv* signal is also mixed with

(Continued on page 102)



Not Just Claims But Unquestioned Proof Of

- **PERFORMANCE** — an engineering accomplishment providing an outstanding antenna designed for increased sensitivity and higher gain in both primary and fringe areas.
- **ACCEPTANCE** — a phenomenal customer acceptance resulting from WW's superb performance characteristics — thousands in use throughout the U.S.
- **SALES** — performance, design, workmanship . . . outstanding selling points to create unprecedented sales demand. Get your share now!

Specifically engineered and designed for true and complete all-channel VHF reception.

Performance charts for the W-W Clipper

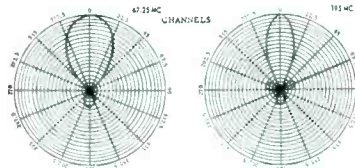
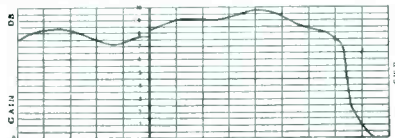

CHECK THESE FEATURES

High Uniform Gain — One Major Forward Lobe — Narrow Beam Reduces Ghosts and Noise Pickup — High Signal to Noise Ratio — Good Front-to-Back Ratio Eliminates Co-Channel Interference — Perfect 300 Ohm Match — Light, Rigid, Quickly and Easily Installed to All Heights — Low Wind Resistance.

ALSO MANUFACTURERS OF

Models 10 and 20 UHF Fans — Models 30 & 40 Colinear Fans — Model UH 6 element UHF Yagi — Model HT High Band VHF Antenna — K series Original Hairpin, Combination Yagi Antenna.

Wells and Winegard
television accessory mfgs.
DEPT. 5 BURLINGTON, IOWA

Service Engineering

field and shop notes

THE PHOTOELECTRIC CELL, today, is the key element in numerous electronic controls. Not only does one find the cell used in sorting, fluid-control and other similar devices, but in complex systems involving gas-fired boiler control.¹ Its use here affords a solid safety factor, practically impossible to achieve with old mechanical means. No matter what goes wrong with the unit, the control assures an immediate and safe shutdown of all fire, gas-flow, or other things which could conceivably cause either explosion or release of unburned fuel.

In this system a photoelectric cell is mounted in a housing on the fire-door of the furnace, so that it can see into the combustion chamber. Here also

*Based on notes prepared by Jack Darr.

are the terminals of an electric igniter and pilot light. The photocell itself is mounted at the end of a metal tube, about 12" long, provided with a lens of heatproof glass at the inside end, and a condenser lens near the cell, to focus light on its surface. This registers not only the main burner, but also the pilot light; if the pilot light fails to ignite, the photocell circuit refuses to allow the main fuel solenoid to open.

Timer Clock System

Included in the main chassis is a timer-clock system, consisting of a four-deck rotary switch, driven by a small sync motor. The shaft of this motor drives four cams, which open and close various contact points, simi-

lar to relay points in structure. Two relays, an *ac* relay or *master relay*, and the plate relay of the photocell circuit, known as the *flame relay*, control the various functions of the programming circuit. A safety-lockout relay, furnished with a heater unit, is in the primary supply voltage circuit, and opens this circuit if the mechanism fails to function properly.

In operation, when the limit switch is closed, thermostat contacts close, or the knob of the timer motor is started manually, the timer-motor starts, and the operating cycle begins. The master relay is energized, through the limit switch, contacts of the rotary switch and contact 1 of the flame relay which is open. Contacts 1, 3, and 4 of the master relay close, and the flame relay contact opens. The timer motor then starts through a contact on the master relay and cam. The main blower motor then starts via a contact on the master relay. This blower purges the combustion chamber of any unburned gases before any fresh fuel is admitted: this purge period lasts for thirty seconds. At the end of the first seven seconds, another cam closes and another opens. The circuit to the

(Continued on page 72)

¹A system of this type, known as *Fireeye* is manufactured by Combustion Control Corp., Boston.

Fig. 1. Schematic of photocell and amplifier used in gas-fired boiler control system. Note: Winding shown at right lower side is secondary of power transformer; primary winding is not shown.

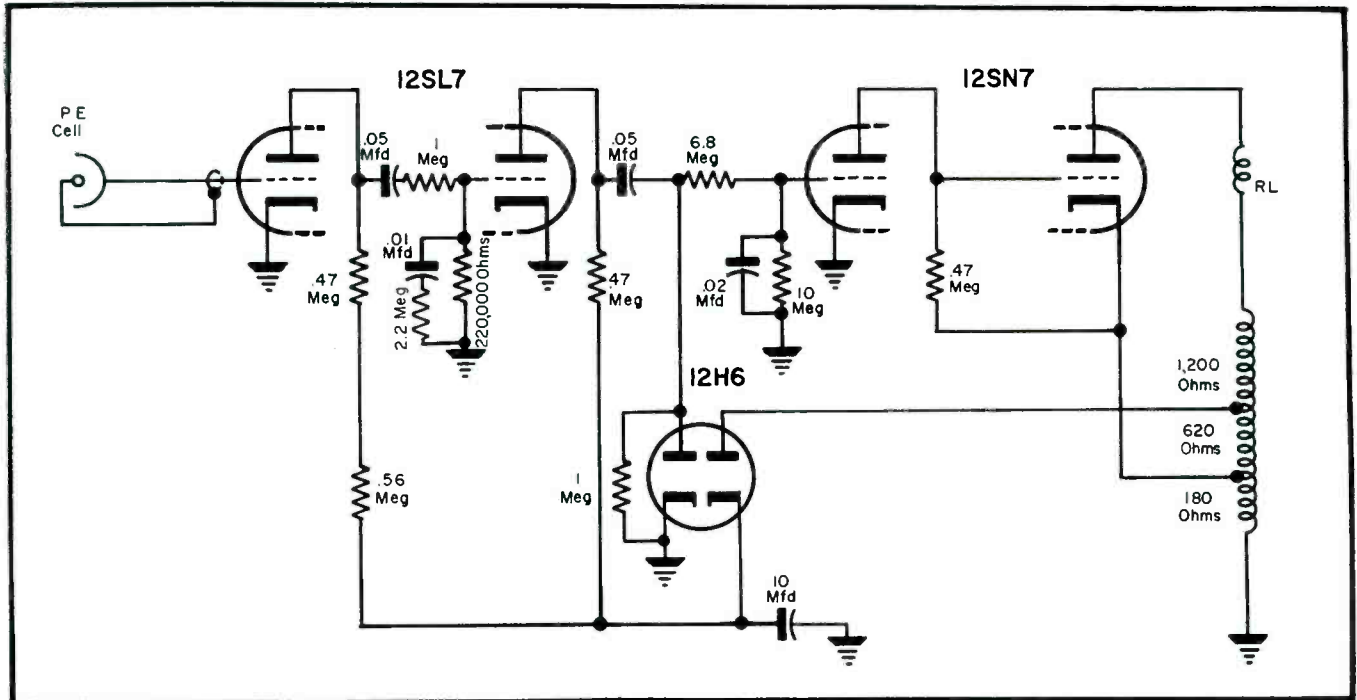

1 CONTROLS

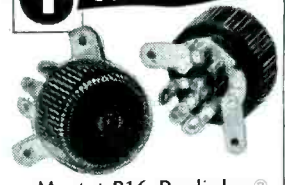

Model B16 Radiohm®
Miniature



Twin and dual concentric Radiohms



Model B Blue Shaft Radiohms



Type AB Adashaft® Radiohms

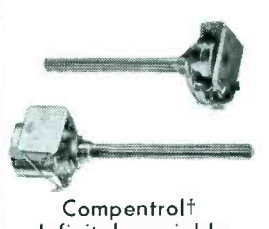

Compentrolt
Infinitely variable loudness control

2 SWITCHES



PA-2000 Miniature Rotary, Steatite Insulation

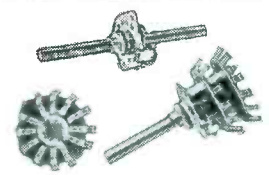

2500 Series Standard Rotary, Steatite Insulation

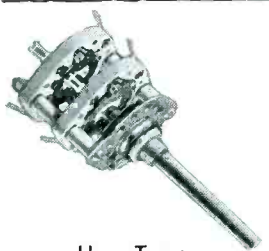

Ham Type

FOR SALE!

These and 100,001 other Centralab quality electronic components

HERE'S a perfect check list to determine your electronic needs. And there are hundreds of variations available to you. Whether you need a few items or dozens — no other single manufacturer can offer you such a wide choice of standard fastest-for-servicing parts. That's why Centralab is the industry's No. 1 electronic component source . . . and keeps your distributor supplied with the latest develop-

ments in the fast-changing electronics field.

You know CRL parts are your best value because each is backed by a written guarantee. That means they're safest for servicing. And you'll agree that's mighty important for building consistent customer satisfaction.

So when you need parts, look for the familiar blue and white CRL package — the product inside is the result of more than 30 years of electronic experience. This experience has pioneered many profit-building "firsts" for you! For complete performance data and engineering specifications mail coupon.

† Trademark P.E.C.—Printed Electronic Circuits

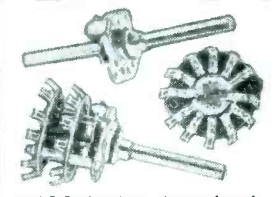

1400 Series, Standard Rotary, Phenolic Insulation

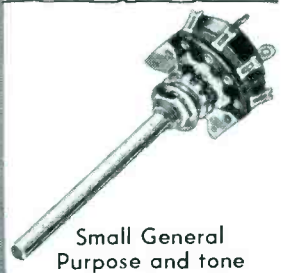

Small General Purpose and tone



Complete Switch Kits

3 CAPACITORS

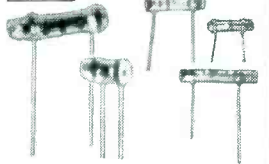

BC Tubular TC Tubular

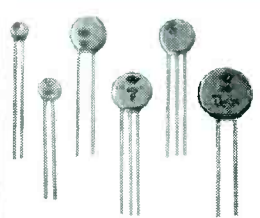

BC Discs



TV HI-VO-KAPS®

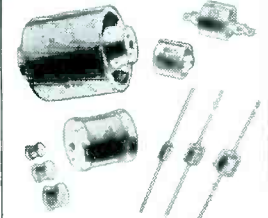

Transmitting Capacitors

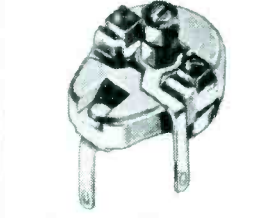

Ceramic Trimmers

4 P.E.C.



Miniature Resistor and Resistor-Capacitor Units

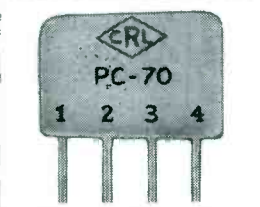

Standard Triode Couplate®

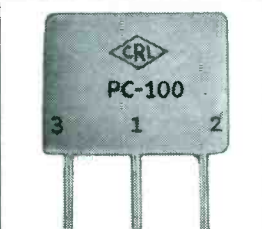

Vertical Integrator

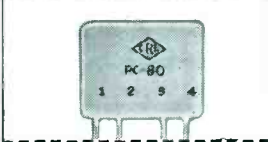

PC-80



PC-90

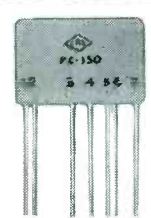

Audet® Audio-detector plate

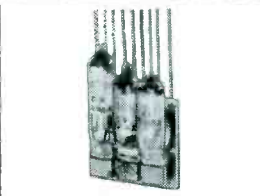

Ampec® standard and miniature 3-stage amplifiers



P. E. C. Kits

Centralab

A Division of Globe-Union Inc.
908-K E. Keefe Ave., Milwaukee 1, Wis.
804 Mt. Pleasant Road, Toronto 12, Ontario
Please send me Catalog 28 with information on Centralab products.

Name.....
Title.....
Company.....
Address.....
City..... Zone..... State.....

Only ROHN TOWERS

ARE PROVED IN CONSTRUCTION,
DESIGN, USE & SALES

3 standard self-supporting ROHN steel towers
for your every need!

Famous ROHN FOLD-OVER TOWER (Pat. Pending)

Fold-Over Tower uses standard tower sections plus an inexpensive easy-to-use "fold-over" kit. The perfect answer to this type tower requirement.

ROHN TELESCOPING MASTS

Come in 20, 30, 40 and 50 ft. sizes. Easily erected, heavy-duty seamless steel tubing throughout.

PLUS A COMPLETE LINE
OF ACCESSORIES:

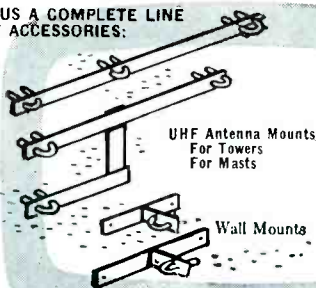

Also House brackets, guy brackets, etc., all Rohn designed!

Contact your ROHN distributor for
FREE catalog and Prices or write:

ROHN
MANUFACTURING
COMPANY

DEPT. S
116 LIMESTONE
BELLEVUE,
PEORIA,
ILLINOIS



safety-lockout relay, preventing it from opening the switch.

After ten seconds of this *priming* period, the timer closes a series of cam contacts and opens another sequence. One of the contacts in this group is in shunt with an *electronic latch*, as the photocell circuit is referred to; this places control of the flame entirely with the photocell circuit. The main gas supply valve is now opened, the blower motor starts again, and the valve is held open through the flame relay and cam contacts. From this point on, the blower is in full operation. If the flame should go out, the photocell circuit will shut off the gas supply, and the timer will go into cycle again, *purging* the unburned gas from the fuel combustion chamber.

This system, as can be seen, is absolutely *fail-safe*. It makes no difference what happens; unless everything is in the proper condition for operation, the burner will not start! The primary supply circuits to the photocell amplifier, relays and other circuits are made through limit switches, high and low gas valves, and the upper and lower water limit switches. Unless every one of these are in their correct condition, no operation can be obtained. Therefore, when servicing this equipment, it is important to check the position and condition of each and every piece of this *outside* equipment, before checking anything inside the programmer chassis. All breakers, relays, and other devices must be reset before even attempting to start the programmer.

If all other devices check out good, the relays should be tested for defective contacts; especially the flame relay, which holds the relay itself closed, another contact which shorts out the heater of the safety relay, and still another, which keeps the timer circuit closed after the cam opens. If the timer is running, and the contacts on it appear to be in good shape, the contacts of the master relay should be checked; this relay is *ac*-operated and receives its supply voltage through all of the various contacts mentioned, limit switches, etc. If this relay will not close other devices should be checked, and the coil checked for continuity.

To gain access to the contacts of the timer, one Phillips screw at the top of the plate must be removed; then the knob can be removed (this unscrews from its shaft in a counter-clockwise direction). The plate can be removed, and the contacts checked. It is a very good idea to *paper* these contacts each time the unit is checked. (Draw a piece of fairly smooth paper between each pair of contacts, for

Service Engineering

(Continued from page 70)

master relay is now held through a thermo-snap heater on a safety-relay. If the mechanism fails to start the flame during the proper time, this heater causes a bimetal blade to operate, breaking the input circuit to the master relay, preventing the admission of any fuel to the boiler.

After 30 seconds, a cam closes, completing the circuit to the igniter, and the pilot valve, a solenoid. During this

time the electron tubes in the photocell amplifier, 12SN7GT, 12SL7GT and 12H6, have reached operating temperature. If the pilot light ignites, the photocell *sees* the flame, and the circuit closes the flame relay, the plate relay of the 12SN7 amplifier tube. Then one contact on the flame relay opens and supplementary contacts close. One of these contacts is in its own coil circuit, and the relay holds itself closed, as long as there is any excitation of the photocell. Another contact shorts out the heater of the

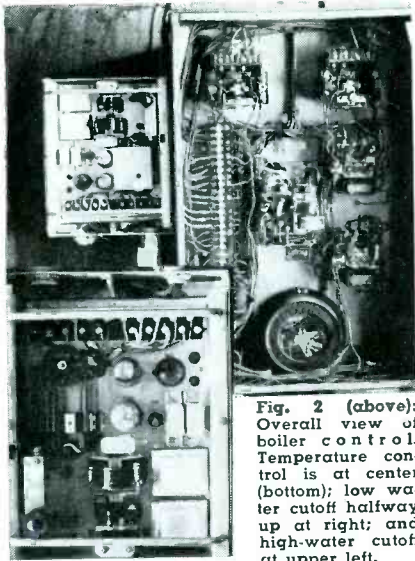

Fig. 2 (above): Overall view of boiler control. Temperature control is at center (bottom); low water cutoff halfway up at right; and high-water cutoff at upper left.

Fig. 3 (left): Closeup of electronic chassis. Lower relay is flame relay; just above it is the main relay. Test jacks visible at upper right corner of chassis, near 12H6. Cover of timer removed to show contacts.

cleaning. Never use emery cloth or very coarse sandpaper on relay contacts.) The timer may be rotated manually to check opening and closing of the contacts.

Tubes may be checked for emission, shorts, etc. The 12H6 serves as a rectifier for the power supply feeding the two amplifiers. The presence of *dc* voltage across this *power-supply* is indicated by the firing of the neon lamp, NE-1.

To start the unit cycling for test, after checking all other devices for closure, the timer knob should be turned a bit clockwise, until the motor starts; it will be held in by the contact on the switch. When the timer reaches 1, at the end of 30 seconds, the pilot light should ignite, and the photocell *see* a flame. These figures are visible through a small round hole in the cover plate just above the timer knob.

Presence of flame will be indicated by the closing of the *flame-relay*. Incidentally, when the unit is started, the main relay should immediately close and stay closed. The flame relay will not close unless there is flame in the combustion chamber. Failure of the master relay to close is usually due to open circuits in devices outside the programmer chassis; failure of the flame relay to close may be due to no flame, defective tubes, or the most likely possibility, dirty contacts on the master relay or the timer. The photocell circuit can be checked by removing the photocell housing and holding a small flashlight against it. The relay should close when this is done.

For a voltage test, a 0-100 *v dc* voltmeter should be connected to the
(Continued on page 89)



JONTZ

TV INSTALLATION ACCESSORIES

**SAFE... LONG LASTING
... EASY TO INSTALL**

Jontz TV Installation Accessories give you extra quality, greater economy.

All Jontz products are heavily zinc-plated with an additional chromate coating... six times more weather protection than ordinary zinc-plating.

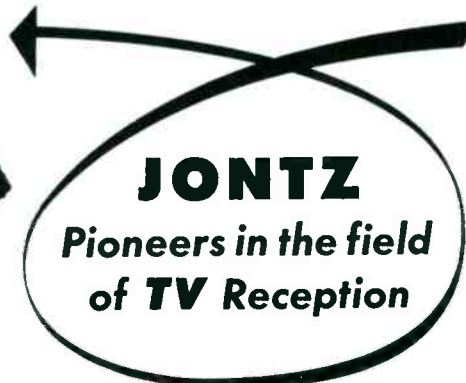

MODEL 200 "SUPER" KWICK CLIMB TOWER*

Finest self-supporting 50-ft. tower available. Withstands wind loads up to 100 m.p.h. . . . assures maximum safety with no guy wires. Approved by one of the world's leading liability insurance companies, when properly installed according to specifications. Constructed of highest quality rust-resistant 1-in., 14 gauge tubular steel . . . easy to erect, easy to climb. Available in 10-ft. sections . . . shipped complete with foundation mounting. Additional height up to 150 feet if required.

*Twelve men in photograph represent 2018 pounds!

Your inquiries will receive prompt attention.
Don't delay . . . write us today!



QUALITY CONSTRUCTION
Jontz masts are made of highest quality electric weld steel tubing, with heavy zinc galvanized coating . . . your assurance of tubular strength and durability.

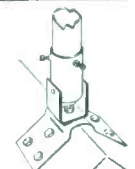

APEX MOUNT, MODEL A-5
4-way swivel mount for any type of installation. Fully adaptable to flat surface, peak roof, or corner mounting.

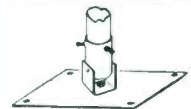

ROTARY MOUNT, MODEL 5
4-way rotary base mount. Fits along roof peak for safe, easy installation.

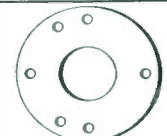

GUY RINGS BY JONTZ
The answer to your guy ring needs. Handy Jontz guy rings may be used with either 3 or 4 guy wires... your choice of 5 I. D.'s.



QUALITY  ECONOMY

MANUFACTURED BY

JONTZ MANUFACTURING CO.

1101 East McKinley, Mishawaka, Indiana, Mishawaka 5-5178



AUTOMATIC VOLTROL

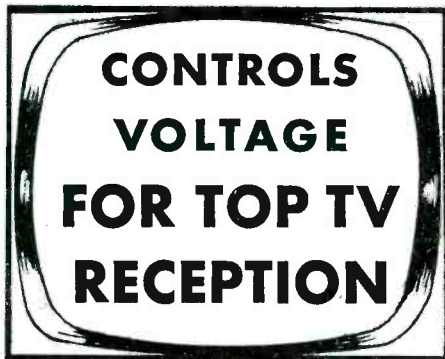
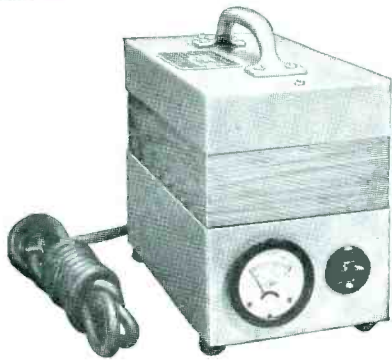

With the Acme Electric Automatic Voltrol, good television reception can be obtained where variation of voltage causes dimness, flickering, shrinkage, fluttering and other peculiar picture disturbances. The Acme Electric Automatic Voltrol is COMPLETELY AUTOMATIC, requires no adjustment, steps up voltage or steps down voltage, correcting fluctuation over a range from 90 to 130 volts to a regulated, normal output of 115 volts.

Automatic Voltrol is compact, portable, only 5½" high, 5" wide. Rated at 300 VA, single phase, 60 cycle, 115 volts. Supplied with primary cord and plug which is connected to convenient electrical outlet, television or appliance cord is connected to secondary receptacle mounted on unit. Primary circuit is automatically disconnected under no-load condition. Indicating voltmeter shows secondary voltage at all times. Write for Bulletin AV-189.

MANUALLY CONTROLLED VOLTAGE ADJUSTOR A SERVICE MAN'S TOOL

With the T-8394 Voltage Adjustor, incoming line voltage can be instantly determined. Voltage can be reduced below normal to simulate night time low voltage condition, thus reproduce "poor performance" of TV set. Determine component aging by permitting adjusting of controls at normal line voltage. The T-8394 Voltage Adjustor is a low cost voltage regulator that can be readily adjusted, manually, to provide the exact voltage needed for normal performance of TV sets. Regulation is adjustable over a range from 95 to 125 volts. Small, compact. Supplied with primary cord and secondary receptacle. Write for Bulletin VVA-190.

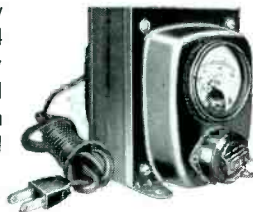

ACME ELECTRIC CORPORATION
MAIN PLANT: 4711 WATER ST., CUBA, NEW YORK
 West Coast Engineering Laboratories: 1375 W. Jefferson Blvd. • Los Angeles, Calif.
 In Canada: ACME ELECTRIC CORP. LTD. • 50 North Line Rd. • Toronto, Ontario



SERVICE INSTRUMENTS BIAS POWER SUPPLY

A power unit, *Align-O-Pak*, designed to replace bias batteries when aligning TV receivers, is now available from Service Instruments Co., 422 S. Dearborn St., Chicago 5, Ill.

Output is variable from 0 to 10 volts *dc*. To provide a fixed *agc* bias for any TV receiver, output leads are isolated from the metal case and power line.

Unit is said to be handy for diagnosing *agc* troubles. When the bias leads are connected to the *agc* buss and the output varied, the appearance of a stable picture indicates that *agc* is faulty.

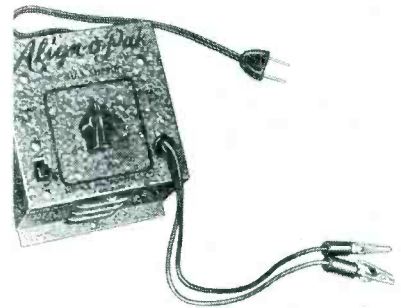

Service Instruments TV Bias Supply

* * *

PHILCO-MOTOROLA STANCOR FLYBACKS

Four replacement flyback transformers, for use in 96 models of the Philco line ('52 and '53 production), are now available from the Chicago Standard Transformer Corp., Standard Division, Addison and Elston, Chicago 18, Ill.

A-8220 replaces Philco part 32-8565; *AA-8221* replaces 32-8555; *A-8222* replaces 32-8533, and 32-8534; and *A-8223* is for part 32-8572. A special mounting tap arrangement on *A-8220-1-2* is said to permit reuse of the expensive base plate of the replaced flyback. Units include the choke coils, resistors, and capacitors already wired to the terminal boards.

Three replacement flyback transformers, covering 91 Motorola models of '52 chassis, are also available. Each unit has a horizontal centering pot, variable gap width control and a socket for a 1B3 rectifier, as well as an additional corona ring which is said to improve the original design.

Stancor part *A-8224* replaces Motorola flybacks 24C711265, 24C711265-A and 24C721290 in 56 models. *A-8225* replaces 24K712193, and *A-8226* replaces 24K721-301C and 24K721517C.

TV Parts . . . Accessories

IMPERIAL ALUMINUM GUY WIRE

Guy wire, constructed of seven strands of 18 gauge aluminum, has been introduced by Imperial Radar and Wire Corp., 820 E. 233 St., New York 66, N. Y.

Wire, which is recommended for installations up to 30', is claimed to withstand rust and deterioration, and have a breaking strength of 285 pounds test. Available in 100' coils or 1,000' spools.

XCELITE STANDOFF INSULATOR PLIER

A standoff insulator plier, 64, that is said to simplify opening and closing of standoff insulators, has been announced by Xcelite, Inc., Orchard Park, N. Y.

Plier features drop-forged rib joints and jaws; a groove on the lower jaw, and recess on the upper provide non-slip gripping action.

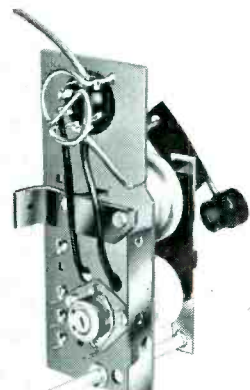

ARROW GUN TACKER

A grooved blade, which is said to act as a guide by insuring accurate positioning of wire for proper staple envelopment, has been added to the T-50 gun tacker of the Arrow Fastener Co., Inc., 1 Junius St., Brooklyn 12, N. Y.

Blade also serves as a safety device because it is said to eliminate the possibility of piercing wire with staple and causing a short circuit.

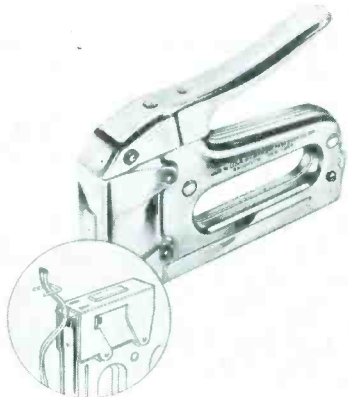

Arrow Gun Tacker

* * *

PRECISE 8 1/2-INCH 'SCOPE

An 8 1/2" 'scope, 308, in kit or wired form, has been introduced by the Precise Development Corp., 999 Long Beach Rd., Oceanside, N. Y.

Uses an 8CP1 crt. Instrument incorporates a low-normal, high-frequency synchronization circuit.

* * *

TELONIC UHF SWEEP GENERATOR

A uhf sweep generator, covering a range of 420-930 mc with a sweep width of 0-50 mc, has been developed by Telonic Industries, 444 South Rural St., Indianapolis, Ind. Available in two models: S, sweep oscillator only; SM, sweep oscillator and marker oscillator.

In the sweep oscillator, a vibration capacitor driven by a voice coil mechanism causes an inductively tuned oscillator to sweep more than 50 mc. Sweep width is variable. Compensated horizontal output is provided. Inductively tuned marker oscillator operates at the fundamental frequency. Voltage is mixed internally with the sweep output and produces a *birdy* on the 'scope. Each oscillator is said to have an accuracy of $\pm 5\%$.

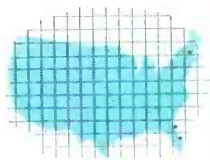

GENERAL INSTRUMENT*

all channel UHF converter

FIRST...in side-by-side tests!

miami

In one of the largest service organizations in the area, the GENERAL INSTRUMENT outperformed the converter formerly regarded as the best on the market!

worcester,
mass.

Test pattern of WBRE-TV Channel 28 (Wilkes-Barre, Pa.) received at Worcester, Mass.--a distance of 225 miles. Written verification of report by famous authority in electronics, available on request.

w. palm beach

In a test in West Palm Beach, Fla., the GENERAL INSTRUMENT pulled in a signal from Ft. Lauderdale in a dealer's store. Previously, no other converter had produced a signal from Ft. Lauderdale.

for the finest UHF converter...
the GENERAL INSTRUMENT!

Jobbers.—some choice territories
still remain open.
Write for
details.



General Instrument & Appliance

CORPORATION

Subsidiary of

GENERAL INSTRUMENT CORPORATION

825 Newark Avenue • Elizabeth 3, N. J.

VIDAIRE FIL-TEST

A wavetrap meter, Fil-Test 100, that is said to determine the type of filter or wavetrap needed to curb interference, has been introduced by Vidaire Electronics Manufacturing Co., Lynbrook, N. Y.

By use of switching arrangements, unit may be incorporated into respective circuits simultaneously, through the ac line or antenna.

Device can be used to check up on recurrent interference troubles, during field operations or on bench.

(Right)

Vidaire Fil-Test



A set is no better than
its Tuning Mechanism!
...and, there's
no better tuner than the
TARZIAN TUNER

It's no happen-so that so many of the nation's leading set manufacturers—the makers of the best-known receivers—use the TARZIAN TUNER in their products.

No other commercial unit possesses so many desirable features found in the TARZIAN TUNER. It's a small, precision-built instrument, expertly designed to provide unsurpassed selectivity and improved reception in ALL areas.

And, the practical, full band—all-channel approach to UHF (another first for Tarzian)—is making the TARZIAN TUNER more popular than ever. It's popular with the manufacturer as well as the ultimate consumer who wants "everything" on the television set he buys.

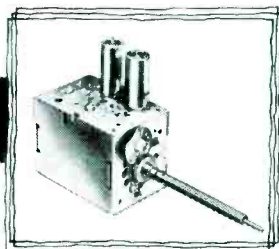
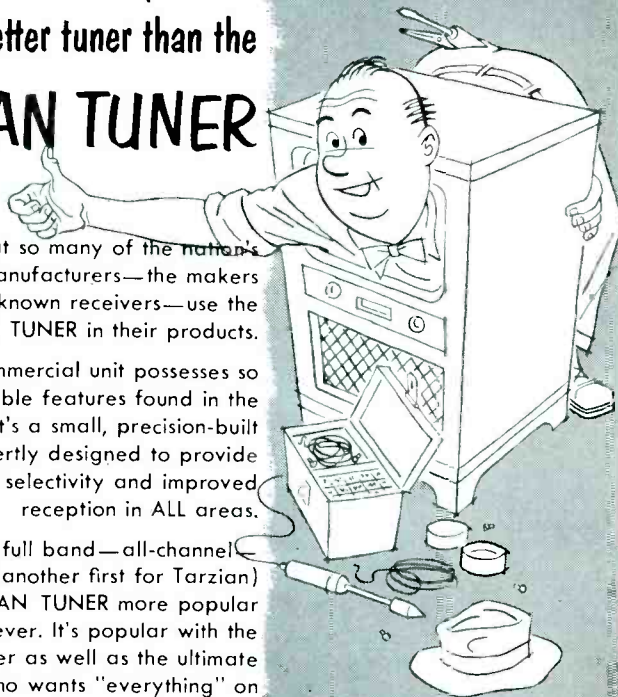

**SARKES
TARZIAN, Inc.**

**Tuner Division
Bloomington, Indiana**

STANDARD VARIABLE ISOLATION TRANSFORMER

A variable-metered isolation transformer, *LR Adjust-A-Volt*, that can be used for applications involving the use of a variable transformer or an isolation transformer, since it combines the features of both, is now available from the Standard Electrical Products Co., 2240 E. Third St., Dayton, Ohio.

Designed for radio and TV, unit has an isolated primary winding that is said to permit servicing of *ac-dc* sets without the chance of a *bite*. Electrostatically shielded, it can be used to check intermittent operating radio and TV sets by dropping the line voltage to 105 or lower to detect a faulty oscillator.

Right: LR Adjust-A-Volt



**Tools . . .
Instruments
Parts . . .**

SMITHGUILD TUBE TESTER

A tube tester, for testing continuity of filaments in tubes in TV sets, radios, automatic washers, electric blankets, and other electronic devices in the home, has been developed by Smithguld, Inc., 360 W. Eighth St., Erie, Pa.

Tester is 4" x 6", self-contained, and requires no external batteries or other accessory equipment. Sockets provided on the face are designed to accommodate any electronic tube now manufactured for use in household appliances. Indicates whether a tube is good or defective. Dial is activated by an integral battery.



Smithguld Tube Tester

INSULINE ALUMINUM MESH GRILLS

Aluminum mesh grills, designed to protect the loudspeakers of custom-built radio and TV receivers, *pa* systems, phonos, and hi-fi sound installations, are now available from the Insuline Corporation of America, Long Island City 1, N. Y.

Finished in non-tarnishing gold color, grills are available in three sheet sizes: 3947, 12" x 18"; 3948, 18" x 24"; 3919, 24" x 36". Material can be cut with a pair of ordinary tinners' snips.

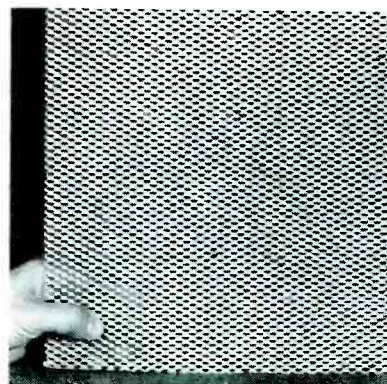

Insuline Aluminum Mesh Grill

G-C WIRE STRIPPER AND TEST LIGHT

A wire stripper, 766, that incorporates a delayed return action to prevent the crushing of fine wires, has been announced by the General Cement Manufacturing Co., Rockford, Ill.

Stripper has interchangeable hardened steel blades for use with various types of wires.

A neon test light, *Dandylite*, for checking fuses and circuits, has also been introduced. May be used from 60 volts ac to 55 volts ac-dc.

* * *

ERIE ROTARY SELECTOR-LEVER SWITCHES

A line of rotary selector and lever switches, in single or multiple sections, shorting and non-shorting types, has been announced by the Erie Resistor Corp., Erie, Pa.

Switches feature flat rivets which fasten the contact to the stator and prevent loosening or rotating due to soldering heat; and rotor assembly combined with the solid stator providing a construction in which the rotor blades do not support the assembly.

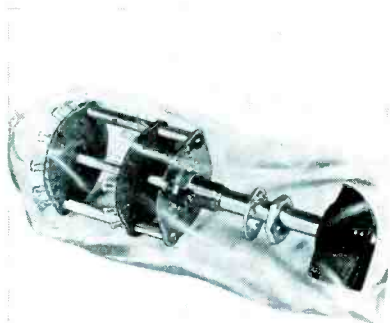

Erie Selector and Lever Switches

* * *

GRAYHILL TEST BOARD

A test board, 2-2, with modified panel-mount test clips designed to simplify testing of resistors, capacitors, germanium diodes, and the use of general test leads, has been introduced by Grayhill, 561 Hillgrove Ave., La Grange, Ill.

Unit is available with banana plugs on 3/4" centers; body is molded of a general purpose phenolic. Plugs and clips are plated. Highly tensioned spring clips are used.

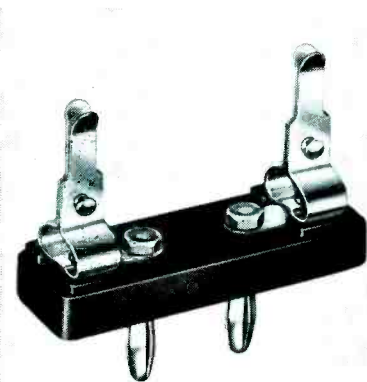

Tim Alexander
of **Motorola** says:

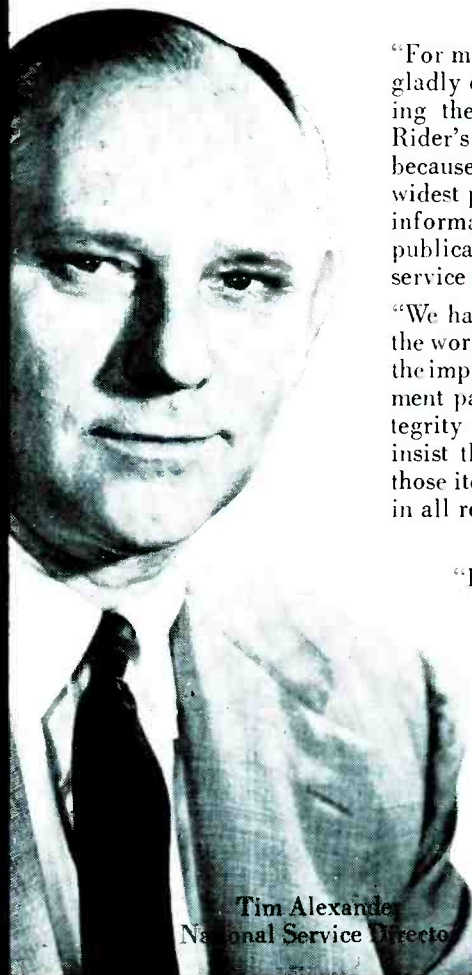

Tim Alexander
National Service Director

"For many years, we at Motorola have gladly cooperated with you in providing the data which you publish in Rider's Manuals. We have done this because we sincerely believe in the widest possible distribution of service information and we know that your publication has wide acceptance in the service section of our industry.

"We have also followed with interest, the work you are doing in emphasizing the importance of using 'exact' replacement parts, and we appreciate the integrity which you display when you insist that your listings include only those items which are like the original in all respects.

"Keep up the good work."

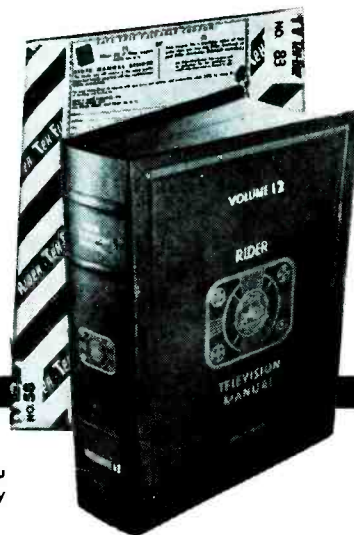

Service Shop Owners:

Your integrity, reputation... the "good will" you establish... can only be built or maintained by servicing your customers with the best!

And now TEK-FILE... ONLY \$1.50 per pack

Dependable replacement parts listings
beginning with TV 10 and TEK-FILE pack 57

For easier radio servicing... use Rider's 22 AM-FM Radio Manuals

JOHN F. RIDER

PUBLISHER, INC.
480 Canal Street, New York 13, N. Y.

Export Agent:
Roburn Agencies, Inc.
39 Warren Street
New York 7, New York

In Canada:
Charles W. Peinton
1926 Gerrard Street, East
Toronto, Ontario

West Coast Office:
4216-20 W. Jefferson Blvd.
Los Angeles, California

Cable Address:
Roburnage N. Y.

TV Voltage Trouble?

TeleVolt AUTOMATICALLY Provides Constant Voltage For Proper TV PERFORMANCE and SET PROTECTION



Bad voltage from overloaded lines shifts TV tube operating points and often causes distortion, fuzzy pictures and jitters; high voltages damage components. The SOLA "TeleVolt" Constant Voltage Transformer automatically stabilizes voltage within $\pm 3\%$. It automatically protects costly components against high voltage surges while it enables any TV set to deliver peak performance. It is an automatic voltage stabilizer... not a voltage booster.

Actual line voltage may vary $\pm 15\%$ or more over nominal value

The Sola TeleVolt automatically stabilizes voltage within $\pm 3\%$

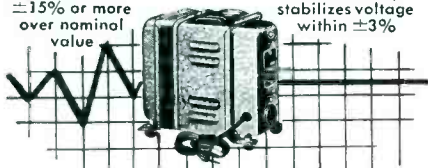

Write today for Bulletin AD-CV-175 or see your electronic distributor

SOLA Tele Volt
Automatic Constant Voltage TRANSFORMERS

SOLA ELECTRIC CO.
4633 W. 16th St. Chicago 50, Ill.

EVEREADY SPOT-FLOOD LIGHT

A Eveready flashlight, 7253 Spot-Flood, which can throw either a concentrated spotlight beam for long range use or a diffused floodlight beam for close range, all with a single flick of the switch, has been announced by National Carbon Co., 30 East 42nd St., New York 17, N. Y.

Flashlight makes use of double-filament lamp which is similar in principle to that used in auto headlamps. Lamp also provides an extra margin of safety in that if one of the two filaments burns out, the other is always available for immediate use in any emergency. Other features include unbreakable polyethylene lens-guard, special ring-hanger, and heavy-gauge seamless brass case, chrome-plated on nickel for lasting finish.



Eveready Flashlight

JAVEX LIQUID PLASTIC

A liquid plastic, *Javabond*, that is said to have practically zero shrinkage, and afford excellent adhesion to metals, ceramics and other materials, is now available from Javex, P.O. Box 646, Redlands, Calif.

Plastic sets to a hard consistency, and may be extended or colored with fillers.

PHILLIPS SOLDER GUN

An instant-heat soldering gun, 250 *Versa-Tool*, that is said to prevent tips from freezing in the barrel, has been announced by Phillips Manufacturing Co., Inc., Dept. KP-1, 2816 Aldrich Ave., Minneapolis 8, Minn.

Other features include a reinforced plastic housing; one-piece phenolic molded trigger pivot arm assembly; barrel assembly which can be removed without disassembling the housing; and fast-heating, long-life carbon element. Unit is rated at 250 watts, 115 volts ac (also available for 200-volt operation) and is said to reach soldering temperatures in less than four seconds.

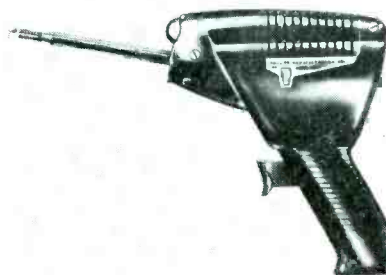

Phillips Solder Gun

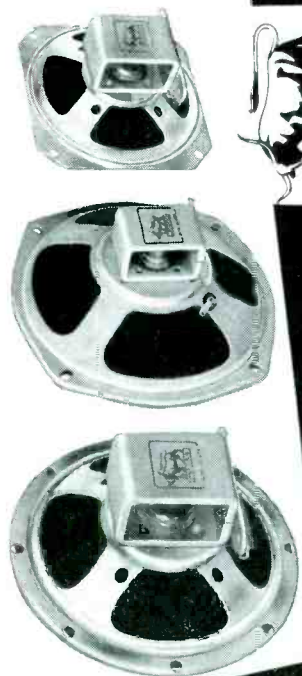

Used by more manufacturers for original equipment than any other brand

3911 South Michigan Avenue, Chicago 15, Illinois

ORDER OXFORD

World's Largest Producer of Speakers

OXFORD ELECTRIC CORP.

If You Want SPEAKERS



SMITH TIP WRENCH

A hand tool, *Tip Wrench*, designed to hold nuts, bolts and screws and tighten or loosen them in hard-to-get-at places, is now available from the Smith Heat Treating Co., 5865 Wilmington Ave., Los Angeles, Calif. It is an adjustable socket pocket-wrench that is a combination self-adjusting socket wrench and screw driver.

Wrench is said to grip, start, tighten (or loosen) with one setting. Knurled-hardened steel jaws slide in form-fitting barrel which take the pressure when tool is in use. Available in three sizes: *model 1*, capacity 2 to 8 nut or screw, 8½" long; *model 2*, capacity 6 to 12 nut or screw, 8¾" long; and *model 3*, capacity 6 to 12 nut or screw, 4½" long.

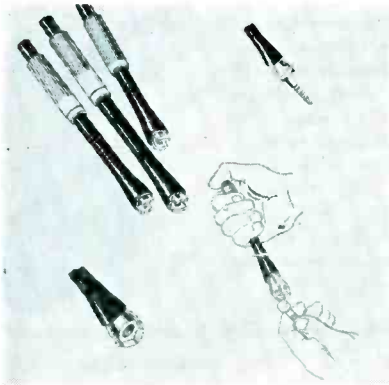

Smith Tip Wrench

INSULINE JACKS AND PHONE TIPS

Locking-type tip jacks, 432, and solderless phone tips, 752, to fit them, have been announced by the Insuline Corporation of America, 3602-35th Ave., Long Island City 1, N. Y.

SPRAGUE CAPACITOR TESTER

An instrument for testing capacitors. *Kwik-Test*, without unsoldering them from the circuit, has been announced by the Sprague Products Co., 61 Marshall St., North Adams, Mass.

Unit is said to determine whether any bypass, coupling, or filter capacitor within the range of 30 mmfd to 2000 mfd is open, shorted, or intermittent, even when it is parallel with a resistance as low as 60 ohms; capacitors between .1 and 2000 mfd may be tested for shorts and intermittent shorts even though in parallel with a resistance as low as 2 ohms. Available in two models: *KT-1* for 115 v 60-cycle operation and *KT-1X* for 115-230/25-60 cycle operation.

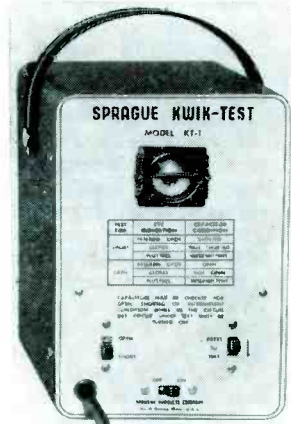

Sprague Kwik-Test

MEET - Telechief!

SANGAMO'S NEW PREMIUM TUBULAR CAPACITOR — designed to give

better TV performance!



EXTRA VALUE
at NO EXTRA COST!

Sangamo combines an amazing new molding compound with a new impregnant to bring you a completely new paper tubular capacitor — developed by request to meet rigid specifications so tough that no previously existing paper tubular could approach them.

Thousands of Telechiefs have been tested under actual service conditions... have proved their ability to outlast and outperform all other tubulars.

The new molding compound, Sangamo Humiditite, greatly

lengthens capacitor life. It has been proved, by severe tests, to give the best seal against moisture of any molding compound in the industry.

The new Sangamo impregnant holds rated capacity under all conditions and makes the Telechief really rugged.

Because we know that service men want only the *best* replacement parts—the new Telechief has been released to the service trade. Get in touch with your Jobber.

Those who know... choose Sangamo



SANGAMO ELECTRIC CO. MARION ILLINOIS

VEMALINE SOLDERING UNIT

An instant-heat soldering unit, *J-4*, with an adjustable heat control, has been announced by Vemaline Products Co., P.O. Box 222, Hawthorne, N. J.

Resistance-type soldering tool heats up to 1600° F. An interval timer is available for this unit, as well as a groundplate attachment on which jigs or fixtures can be mounted.



(Right)

Vemaline Instant-Heat Soldering Unit

NEW! the book that **SAVES TV SERVICE TIME**

VOL. 4

HOWARD W. SAMS' "TELEVISION TUBE LOCATION GUIDE"

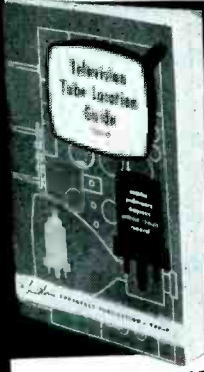

Latest addition to an invaluable series of Tube Location Guides

FIND THE TROUBLE—REPLACE TUBES WITHOUT REMOVING THE CHASSIS

You've asked for more—and here it is—the fourth volume that brings you right up-to-date! It's the only book that shows the *position and function* of all tubes in hundreds of TV sets. Helps save your servicing time. Often an operational check in the customer's home—looking at the picture and listening to the sound—gives you the clue to the trouble. Most often, a tube failure is the cause. This invaluable Guide makes trouble diagnosis and tube replacement quick and easy, *without removing the chassis!* Each TV model has its own clear, accurate diagram. Fully indexed for quick reference. All new diagrams covering 1951-1952 TV models. Handy pocket size, 192 pages, 5½ x 8½". Pays for itself on the first job!

ORDER TGL-4. Only **\$2.00**

Own the Complete Library

VOL. 3. Used daily by thousands of TV Service Technicians. Shows location and function of all tubes in hundreds of 1950-1951 TV sets. 192 pages. 5½ x 8½".

ORDER TGL-3. Only **\$2.00**

VOL. 2. Gives tube positions and functions in hundreds of 1949-1950 TV sets. Helps solve tube failure troubles in minutes. 208 pages, 5½ x 8½".

ORDER TGL-2. Only **\$2.00**

VOL. 1. Covers hundreds of 1948-1949 TV sets made by 56 mfrs. Not duplicated in other volumes. 208 pages, 5½ x 8½".

ORDER TGL-1. Only **\$1.50**

Carry Them ALL in Your Tube Caddy

HOWARD W. SAMS & CO., INC.

Order from your Parts Jobber today, or write to HOWARD W. SAMS & CO., INC. 2207 E. 46th St., Indianapolis 5, Ind.

My (check) (money order) for \$..... enclosed. Send the following books:

- TGL-4 (\$2.00) TGL-2 (\$2.00)
 TGL-3 (\$2.00) TGL-1 (\$1.50)

Name.....

Address.....

City.....State.....

Systematic Servicing

(Continued from page 33)

capacitor leakage or tube malperformance is not affecting the operation of these circuits. It is also well to make measurements both with and without received signal to insure normal generation of *agc* voltage with signal, and to detect oscillation or other malfunction causing unwanted *agc* voltage without signal.

(7) Determine the origin of, and correct malperformance: *A*—General area of fault should be determined with signal tracing techniques. *B*—If trouble cannot be isolated to a small area a thorough wave-shape analysis should be made. *C*—Voltages should be checked systematically throughout suspected areas. *D*—A systematic resistance check should be made of every part in stages where voltages and wave-shapes are abnormal. Parts should be isolated where necessary; do not skip hard to measure parts, but *suspect every part*.

(8) Check general performance: (*A*) Tuner local-oscillator frequencies should be adjusted and sound and picture checked on all channels. (*B*) Picture adjustments (height, width, drive, etc.) should be made before replacing chassis in cabinet. One should be sure that there is an available margin in all picture adjustments. (*C*) Picture sync should be checked at low signal levels by inserting a resistance attenuator in the antenna lead. (*A* properly operating receiver should hold sync on a signal so weak and noisy as to be of little entertainment value.) (*D*) Each tube and the chassis should be tapped gently to detect microphonics and intermittents.

(9) Prepare cabinet for reinstallation of chassis: (*A*) Cabinet should be dusted, using brush attachment on vacuum cleaner. (*B*) Window should be cleaned inside and out with water and soft cloth. (If the cabinet is not brought in with the chassis this operation will of course have to be done in the customer's home.)

(10) Check operation of receiver when installed in cabinet: (*A*) Picture should be adjusted (height, width, centering). (*B*) Sound and picture should be checked on each channel. (Operation *A* and *B* should be repeated after receiver is returned to customer.) (*C*) Assembled receiver should be operated for at least one-half hour to insure proper operation. (If cabinet is not available the receiver should be operated out of the cabinet for a half an hour.)

One item not included in the foregoing list, but which warrants consideration, is the matter of checking

MORE QUIETROLE
TRADE MARK REG. U.S. PAT. OFF.
 is purchased by
MORE USERS
 than ever before...

Because it does more for the user than any other product of its kind. It is the original non-conductive, non-flammable liquid that works magic on noisy TV and radio controls and switches. The choice of those who want the best, the standard since 1947. Keeps customers happy, puts money in your pocket.



Carried by leading jobbers everywhere!



manufactured by

QUIETROLE COMPANY
 Spartanburg, South Carolina

overall-receiver sensitivity. Input sensitivity is a basic indication of receiver performance. However, it has not been common practice to make actual sensitivity measurements as a part of broadcast receiver servicing. This basic check on receiver performance has not been necessary because, at the frequencies and bandwidths involved in broadcast receivers, the replacement of tubes which test *low* in an emission-type tube tester will keep the receiver close enough to design sensitivity; particularly since radio broadcasting is based on high-level signal strength.

In communication receivers which operate in the *vhf* range and at very low signal levels, sensitivity measurement with a signal generator with an accurately-calibrated output control has become recognized as essential for effective servicing. This test provides a simple positive check on receiver performance which must be kept near design peak to provide full-system coverage. Furthermore, it has been found that little reliance can be placed on tube tester measurements on tubes used in the *rf* and *if* stages of these receivers. TV receivers operating in the *vhf* and *uhf* ranges, at relatively low signal levels (particularly in fringe areas), would seem to have more in common with *vhf* communication receivers, than with low-frequency broadcast receivers.

[To Be Continued]

On Book Row

TELEVISION TUBE LOCATION GUIDE . . .
TGL-4: A continuation of a series, covering TV receivers made in 1952 and 1953, and including a combined index of all receivers referred to in the three preceding guides. Guide features tube location, tube function, major component placement, fuse location, fused circuit designation, indicator showing tube socket orientation, tube complement variations used in different production runs, and a tube failure check chart.—192 pages, 5½ x 8½" paper bound, priced at \$2.00; Howard W. Sams and Co., Inc., 2201 E. 46th St., Indianapolis 5, Ind.

*

HOW TO USE SIGNAL AND SWEEP GENERATORS . . . BY J. RICHARD JOHNSON: First of a *How to Use* series devoted entirely to all types of signal generators. Book explains the equipment as well as the applications of AM signal generators, FM signal generators, test oscillators, marker and sweep generators, and calibrators. Discussed are problems involved in using equipment, and how to overcome them. Typical test setups are shown for use in AM, FM radio and TV servicing, as well as signal-generator maintenance and tests.—144 pages, 5½" x 8½", paper bound, priced at \$2.10; John F. Rider, Publisher, Inc., 480 Canal St., New York 13, N. Y.

*

SERV-U-FACT BINDER: A loose-leaf type book, with hard covers enabling it to be self supporting on shop bench. Contains circuit diagrams, alignment data, tube types and locations, waveforms and voltage readings for Capehart TV chassis up through the CX-37. Charts covering models from '53 to January 1, '55, will be made available to all those purchasing this binder.—11" x 17", priced at \$3.00; Capehart-Farnsworth Corp., 3702 E. Pontiac St., Fort Wayne 1, Ind.

*

WEST-COAST TUBE-PLANT GROUND-BREAKING CEREMONY



At ground-breaking ceremonies for Sylvania Electric's 51,000 square-foot TV picture tube plant, Fullerton, Calif., which is expected to be ready for occupancy next Spring. Left to right: W. G. Pat Patterson, Sylvania west coast regional sales manager, radio and TV renewal tube sales; Norb Dean, manager of Fred S. Dean Co., Long Beach, Sylvania tube distributor in California; Glen Logan, managing director, Electric League of Los Angeles; Fred S. Dean; Phil Gough, president, Gough Industries, Inc.; Eleanor Rothaermel (Miss Hospitality at ceremonies); Garlam Morse, Sylvania's Pacific coast director of sales; F. E. Gilbert, Jr., Sylvania district manager for equipment and electronic sales; William J. Quinn; William R. Sears, Sylvania public relations; Tommy Bell, vice-president, Gough Industries; Ed Grisby, western sales manager, Altec Lansing Corp., and president, WCEMA.

INTERNATIONAL RECTIFIER CORPORATION

EL SEGUNDO
CALIFORNIA

DIRECT
REPLACEMENT
RADIO Selenium TV Rectifiers

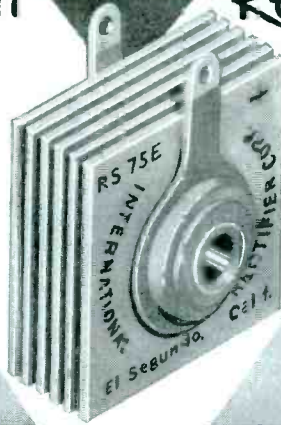

UNIVERSAL
MOUNTING

WIDER
RANGE

Write for
Bulletin JRP-1

INTERNATIONAL RECTIFIER

C O R P O R A T I O N

1521 E. Grand Ave., El Segundo, Calif • Phone: ORegon 8-6281
 CHICAGO: 205 W. Wacker Drive • Phone: Franklin 2-3889
 NEW YORK: 501 Madison Avenue • Phone: Plaza 5-8665

NEW! ... at a glance

Identify TV Interference

Diathermy interference

FM interference

Ignition interference

TELEMATIC

TVI Analyzer Model WT 606

Works like magic! Enables you to put your finger on trouble easily, quickly, accurately . . . every time.

No more guesswork! No more time-consuming testing! This full-range interference analyzer indicates clearly where the trouble lies.

EXCLUSIVE FEATURES:

- Calibrated wave trap section
- Hi-pass and ignition filters
- Variable air condenser tuning
- Cross-indexed scale for spotting frequency causing interference
- Wave traps and filters operate singly or in combinations

The Analyzer's calibrated condenser tuning makes it possible to identify interfering frequencies immediately, so that the service man can apply the filter or wave trap needed without delay.



Write for complete catalog.

3 Joralemon Street
Brooklyn 1, New York

Available Through Parts Distributors From Coast To Coast.

ASSOCIATIONS



Slide used by WNBT during its campaign saluting ARTSNY members. (See National Scene, this issue, for complete report.)

CHICAGO, convention city of the midwest, once again played host to the three-day annual convention of NATESA, its fourth convlave, a few weeks ago. This year, exhibitions and displays, offered by thirty-two manufacturers, highlighted the affair. Presented for the first time was a color TV dynamic demonstrator, which was not only described, but placed in operation by *Dan R. C reato*, vice prexy of RCA Service Co., and *E. R. Klingman*, technical specialist of RCA Service Co.

Also included in the program was a talk by *Lloyd Austin*, Simpson Electric Co., on meter design and application; a business promotion seminar by *Sylvania*; an address on consumer relations by *Frederick Fisher*, Chicago BBB; a discussion of competitive problems by *J. H. Hazlehurst*, Chicago business consultant; an analysis of business promotion techniques by *Gordon F. Burns*, General Electric, and a report on the replacement market in phono accessories by *Karl Jensen*. In addition, there were talks on *uhf* and *vhf* antennas and simplified methods available for TV servicing by *John Spack*, of Amphenol, and *Bill Ashby* of Raytheon. Featured too were two films on selling presented by DuMont and Capehart-Farnsworth.

At a luncheon, on Sunday, *ye editor* spoke on the vital role of the independent Service Man in his community and in industry.¹

C. E. Walters, RCA Service Co., followed with a talk on *transistors*, and *Howard W. Sams* and *William Renner*, Howard W. Sams & Co., Inc., reviewed the import of technical data.

At the end of the show prize drawings and a grand prize drawing were held, through the courtesy of Chicago area parts distributors, who contributed equipment and accessories.

The convention brought delegates from thirty-eight states and Canada; registration was about 700.

At a business meeting all present officers of NATESA were reelected for '54, and one additional office was filled. Officers reelected included *Frank J. Moch*, Chicago, president; *John Hemak*, Minneapolis, treasurer; *J. B. McDowell*, Kansas City, Kansas, secretary-general; *Bertram Lewis*, Rochester, New York, eastern vice president; *Fred Colton*, Columbus, east central vice president; *Harold Rhodes*, Paterson, N. J., eastern secretary; *Francis Fingado*, Denver, western vice president; *Vincent Lutz*, St. Louis, west central vice president and *W. A. Rosenberg*, Wichita, Kansas, west central secretary. *C. N. Burns*, Memphis, was elected east central secretary.

It was also announced at the meeting that NATESA will introduce an integrated public relations and customer relations program in cooperation with the regional and local affiliates, which will include promotional and advertising material; an expansion program; and a manufacturer relations plan. The

¹ See *Views and News*, this issue, p. 29.



Frank Moch, NATESA prexy; *ye editor*, and *John Ceach*, chairman of the fourth annual convention of NATESA, at recent session in the Hotel Morrison, Chicago, where *ye editor* delivered an address on the independent Service Man.



At first Fall meeting of the Long Island Television and Radio Technicians Guild which featured talks by (left to right): Ye Editor, Clint Walter, Jack Wheaton, association proxy, and Henry Wawryck, executive secretary of the group.

latter, it was noted, will feature a speakers' bureau, lectures, films and training sessions in cooperation with manufacturers.

New affiliates of NATESA were also announced at the Convention; the Utah Association of Radio and Television Servicemen; the Rhode Island Radiomen's Business Association; the Radio and Television Service Association of Western New York, and the Associated Television Service Companies of Cincinnati.

Two companies were nominated for the NATESA *Friends of Service Management Award*; RCA and Howard W. Sams & Co., Inc. Two others were given continuing awards; G. E. and Sylvania. Formal awards to RCA and Sams will be made in these companies' plants at a later date.

Next year, the NATESA convention will also be held in Chicago in mid-September.

LITRTG

IN WILLISTON PARK, the Long Island Television and Radio Technicians Guild also heard Clint Walter of RCA Service demonstrate and discuss transistors. This talk, offered a few weeks prior to the Chicago session of NATESA, was a feature of the first meeting of the Fall season of the group.

Many intriguing operational exhibits were introduced by Walter. He demonstrated a transistorized phono amp, audio oscillator, mike amp, and toy organ.

Those who attended also received a 311-page edition of the first volume on nine TV clinic lectures prepared by RCA Service Company.

TEN YEARS AGO

FM receivers, totaling around 12,500,000 sets, and depending on 500 FM stations, would be one of the postwar market bonanzas, predicted *W. R. David*, G.E. executive. He also believed that at least 100 TV stations would be on the air 5 years after the war's end, and that receivers would eventually cost about \$200. . . . *Wartime Servicing of IF Transformers* was described by *Alfred A. Ghirardi*. . . . Front-cover story featured an analysis of the input and modulation circuit of a 12-tube, 4-band AM/FM receiver, which included automatic tuning. . . . Sun Radio changed its name to Sun Radio and Electronics Co. . . . *Durwood D. Allen*, secretary of Universal Microphone Co., predicted that postwar microphones would not show so many changes in technical design as they would in style of casings, stands and accessories. . . . As a result of a successful bond campaign, a bomber bearing the name *Ken-Rad* was added to the Air Force, it was reported by *Larry O'Brien*, director of sales for the Ken Rad Tube and Lamp Corp., Owensboro, Ky. . . . *Carl Stone* was named chairman of the program and meetings committee at a meeting of The Reys in Long Beach, Calif. Others named to head committees included: *George S. Treve*, chairman of the code of ethics; *Lou Brittain*, chairman of membership, and *Don C. Wallace*, chairman of the press committee. . . . *John Ross*, former president of Detroitla, was named head of Aviola Corp., Glenside, Pa. . . . *Fred Goat Co.*, Brooklyn maker of tube parts, observed its 50th anniversary. . . . *H. A. Crossland* was appointed sales manager of G.E.'s receiver division. . . . *E. H. Fritschel* and *H. J. Mandernach* were named sales managers of the G.E. tube division. . . . *J. E. McKinley* was named rep for Solar Capacitors Sales Corp. . . . *S. D. Camper* was appointed Crosley's southeastern regional manager. . . . *Fred H. Pinkerton* was named Reeves' director of public relations. . . . *Dudley E. Foster* and *Arthur W. Ercese* were named vice presidents of Majestic Radio and Television Corp.

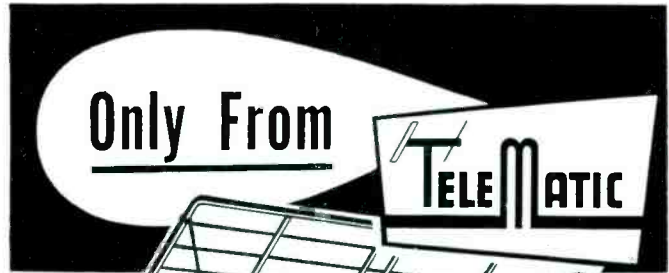

Model No. 715

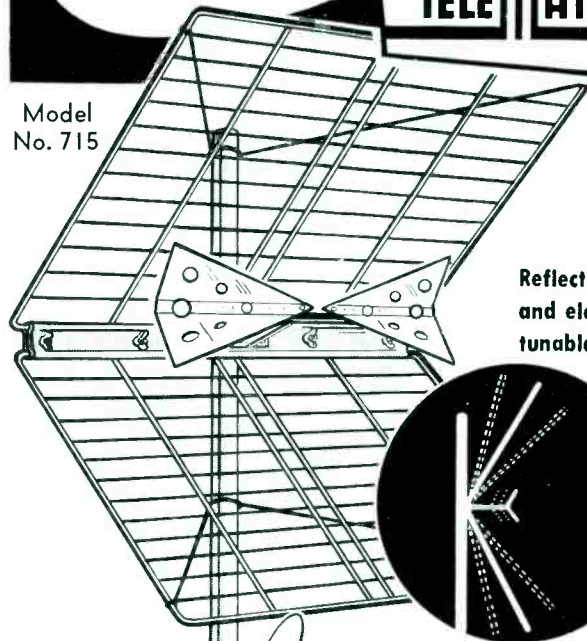

Reflector and element tunable

UHF

Corner Reflector

"Tunable" for

Peak Reception

- Completely pre-assembled
- Adjustable for maximum reception
- Makes the difference between fair and excellent picture quality.

TeleMatic, pioneer antenna manufacturer, produces a complete line of UHF and VHF antennas for every area.

Also, manufacturer of filters, couplers, switches, detents, etc.

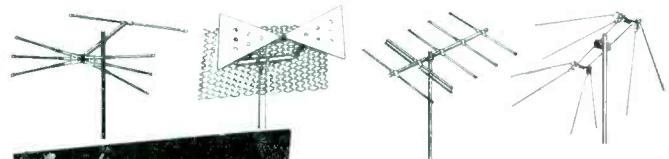

Write for complete catalog.

1 Joralemon Street
Brooklyn 1, New York

Available Through Parts Distributors From Coast To Coast.

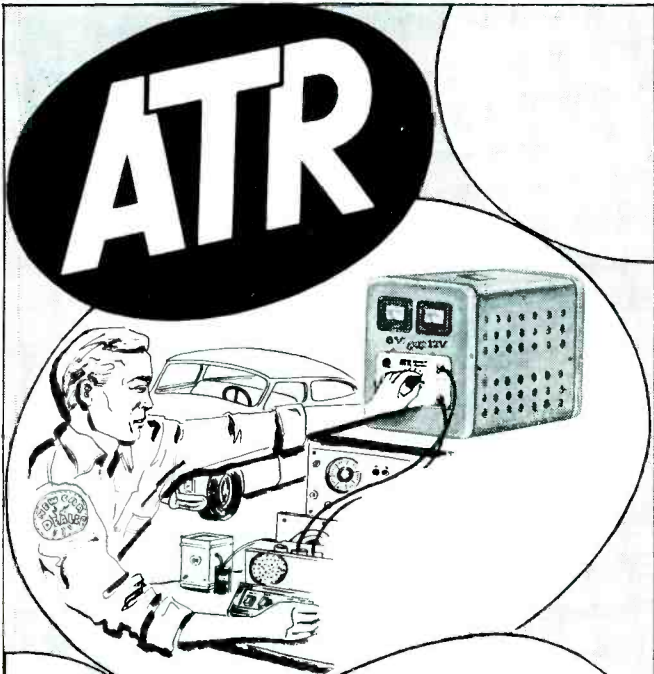

"A" BATTERY ELIMINATORS
Makes it easy to...

for Demonstrating and Testing Auto Radios

6 VOLT OR 12 VOLT!
 6 or 12 volt D. C. combination output available by means of simple toggle switching arrangement, properly safeguarded to prevent accidental switching.

New Models... Designed for testing D. C. Electrical Apparatus on Regular A. C. lines. Equipped with Full-Wave Dry Disc Type Rectifier, Assuring Noise-less, Interference-Free Operation and Extreme Long Life and Reliability.

TYPE	INPUT A. C. Volts 60 Cycles	D. C. OUTPUT			SHIPPING WEIGHT	USER PRICE
		VOLTS	AMPERES Cont.	AMPERES Int.		
610-ELIC	110 volts	6	10	20	22 lbs.	\$29.70
610C-ELIC	110	6 or 12	10 or 6	20 or 12	22	33.50
620C-ELIQ	110	6 or 12	20 or 10	40 or 20	33	46.95

\$29⁷⁰
 and up
 User Price

See your solder or write factory ✓ NEW MODELS ✓ NEW DESIGNS ✓ NEW LITERATURE
 "A" Battery Eliminators, DC-AC Inverters, Auto Radio Vibrators

ATR AMERICAN TELEVISION & RADIO CO.
Quality Products Since 1931
 SAINT PAUL 1, MINNESOTA—U. S. A.

Color TV Tube News

(Continued from page 51)

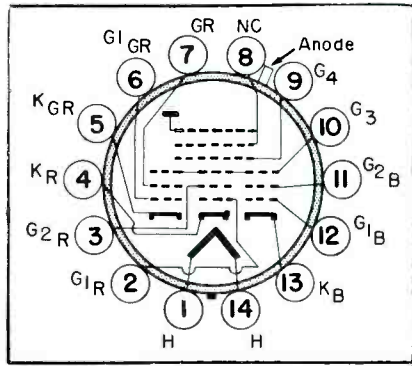

Fig. 3. Basing diagram of color picture tube: Pins 1—heater; 2—grid 1 of red gun; 3—grid 2 of red gun; 4—cathode of red gun; 5—cathode of green gun; 6—grid 1 of green gun; 7—grid 2 of green gun; 8—no connection; 9—grid 4; 10—grid 3; 11—grid 2 of blue gun; 12—grid 1 of blue gun; 13—cathode of blue gun, and 14—heater.

magnetic coils. These coils function in pairs, each coil of a pair located diametrically opposite the other. Since this deflection yoke acts simultaneously on three beams, the electromagnetic field requirements are more stringent than those in the black-and-white tubes. In particular, a more uniform field is required for deflection in the tricolor tube.

Tentative Specifications

Tentative specifications for the deflection yoke are: effective field length, not exceeding $2\frac{3}{4}$ " ; center of deflection, approximately $1\frac{15}{32}$ " from the reference line of the tube; and an inside diameter of not less than $2\frac{3}{4}$ " to facilitate yoke adjustment. To permit adjustment for color purity, the deflection yoke must have an axial movement of $\frac{1}{2}$ " when placed against the glass funnel. Typical inductance values for this deflection yoke are: 15 millihenries for the horizontal winding and 70 millihenries for the vertical winding.

Grid 1 Drive Characteristics and Requirements

The three electron guns have similar transfer characteristics. Due to the difference in phosphor luminescence efficiencies, however, the cutoff voltage of each gun must be adjusted to produce equal phosphor brightness or color balance. If color balance is not maintained when the tube is reproducing black-and-white pictures, for instance, color tinting of the gray scale will result. It is recommended that individual grid-No. 2 voltage controls and grid-No. 1 drive controls be provided. The grid-No. 2 controls must allow adjustment from 100 to 450.



Tube, 6BQ7A, said to be ideally suited to grounded-grid balanced amplifiers service for frequencies up to 300 mc. Tube type is another of the vhf cascode amplifier tube series with higher gain than its prototype, the 6BQ7. This tube has a gm of 6400 umhos and an amplification factor of 38 with 150 volts applied to the plate. It can be used as a replacement for the 6BQ7 with slight realignment of the tuned circuits. (Sylvania Electric)

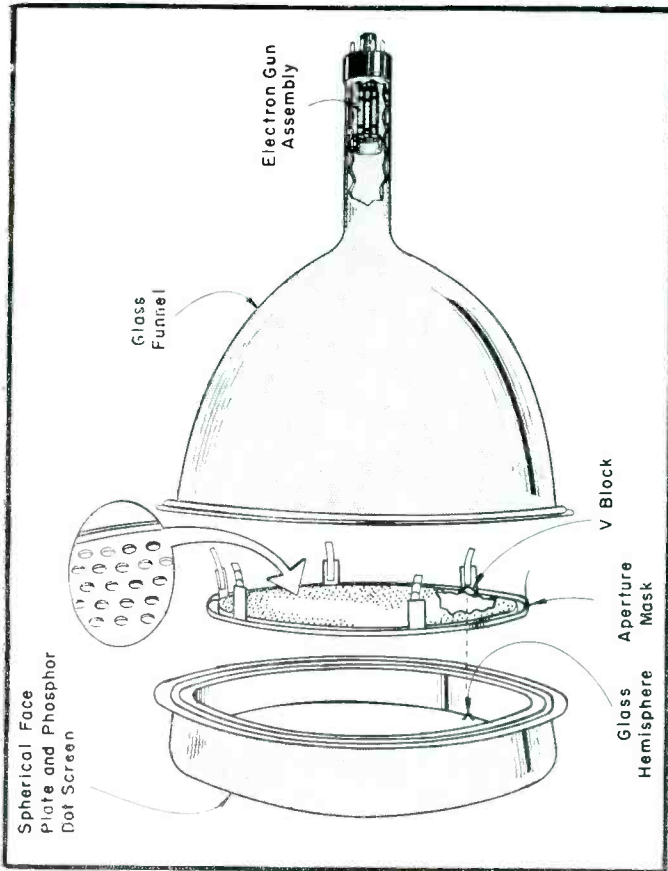

(Above)

Fig. 4. View of mask-assembly which consists of a curved mask with spring clips to hold it in place.

(Below)

Fig. 5. Conditions which exist when beams in color tube are deflected toward edge of screen. Since the convergence point and aperture mask are not quite coincident, the convergence point must be varied in accordance with the position of the beams so that they can scan the phosphor screen; this is known as dynamic convergence.

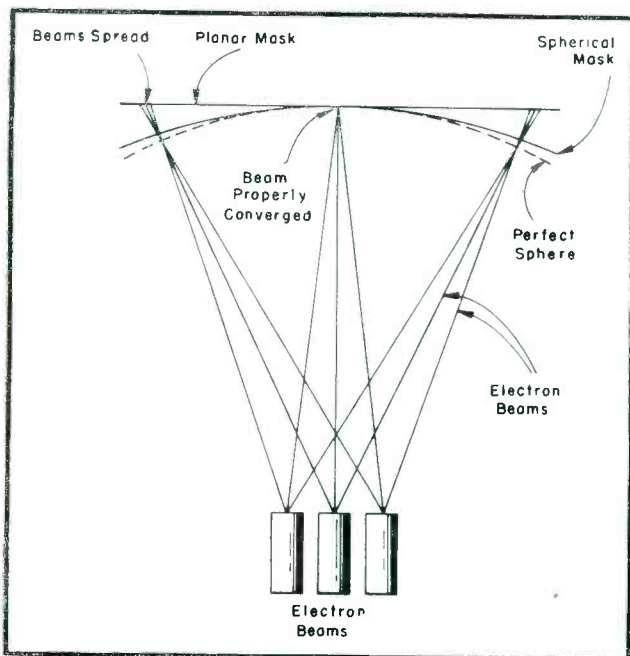

Compare... prove EMC superiority

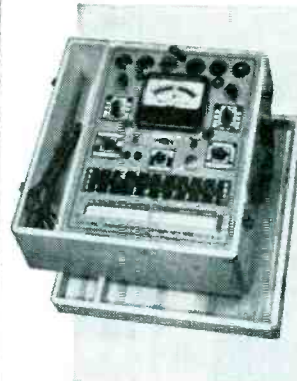

model 206 MUTUAL CONDUCTANCE TUBE TESTER

- Checks mutual conductance on calibrated microhmo scale • Checks tubes for gas content • Detects both shorted and open elements • Tests all tubes from .75V to 117 filament volts • Tests all local, octal and miniature tubes • Checks individual sections of multi-purpose tubes • Built-in roll chart • Uses lever type switches.

MODEL 206P—With hand-rubbed oak carrying case (illustrated)

\$83.50

MODEL 206C—Sloping counter case
\$79.50

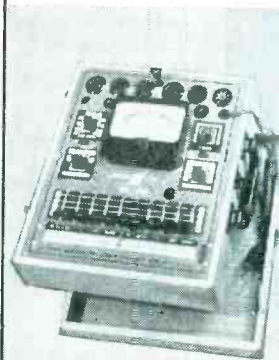

model 205 TUBE TESTER

- Tests all tubes including Noval and sub-miniatures • Completely flexible lever type switching arrangement • Tests all tubes from .75 volts to 117 filament volts by standard emission test • Tests all cold cathode, magic eye, voltage regulator and ballast tubes • Has pilot light indicator • Line voltage control compensates for line variations between 105 and 135 volts • Checks for shorts and leakages • Three-color hammer tone panel.

MODEL 205P—with hand-rubbed oak carrying case (illustrated)

\$47.50

MODEL 205C—Sloping counter case
\$46.50

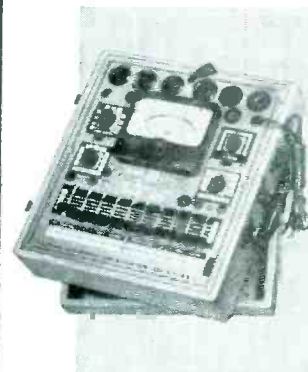

model 204 TUBE-BATTERY-OHM CAPACITY TESTER

- Tests all tubes including Noval and sub-miniature • Tests all batteries under rated load • Emission testing method gives easy, direct readings • Tests resistance to 4 megohms • Tests condensers from .01 to 1 mfd • Uses four-position lever type switches • Checks condenser leakage.

MODEL 204P—Portable oak case, removable cover (illustrated)

\$55.90

MODEL 204C—Sloping counter case
\$54.90

— See them at your Jobbers —

EMC

Write Dept. S-11
for free complete
catalogue of these
and other instru-
ments.

ELECTRONIC MEASUREMENTS CORPORATION
280 LAFAYETTE STREET • NEW YORK 12, N. Y.

EXPORT DEPARTMENT 136 LIBERTY STREET, N. Y. C. 6, N. Y.



So compact they fit anywhere. So many listings (over ten dozen) that you can meet any capacitance, voltage and combination requirement. Yes, singles, duals, triples and quads.

Multiple-section units have stranded wire leads and safety sleeves. Hi-purity aluminum construction minimizes corrosion. Vented for excessive gas pressures.

If ever there was a Jack-of-all-trades electrolytic, this is it—Aerovox Type PRS Dandee.

Ask your Aerovox distributor for Aerovox Dandees. Ask for latest catalog—or write us.



FOR RADIO-ELECTRONIC & INDUSTRIAL APPLICATIONS
AEROVOX CORPORATION
NEW BEDFORD, MASS., U.S.A.

In Canada: AEROVOX CANADA LTD., Hamilton, Ont.
 Export: 41 E. 42nd St., New York 17, N. Y.

PERSONNEL

DR. RAYMOND A. HEISING has retired from the Bell Telephone Laboratories, after serving with the company since July, 1914.

Dr. Heising is the inventor of the constant current system of modulation which was used in the development of radio-telephone equipment for World War I. He was one of the four engineers comprising the initial radio research division at Bell. He is planning to continue his activities as an independent consulting engineer and as a patent agent.



Dr. R. A. Heising



John E. Martin

JOHN E. MARTIN has been named director of research for The Gabriel Co., and will headquarter in the Needham Heights, Mass., plant.

ALLEN N. WHITE, formerly ad manager of the Bendix TV and broadcast receiver division, has been appointed sales promotion manager of the Westinghouse Radio-TV division, Metuchen, N. J. White succeeds Fred McCarthy, who has resigned. . . . HENRY D. CLARK has been appointed sales training manager of the division.

ROBERT C. SPRAGUE, chairman of the board of the Sprague Electric Co., has been appointed by the Senate Armed Forces Subcommittee on Preparedness to direct a full-scale study of hydrogen and atomic bomb defense. . . . DR. ADAIR MORRISON, formerly with Arthur D. Little, Inc., has been named head of the research section of Sprague.

JACK COLVIN, formerly chief engineer and plant manager of the Commercial Radio Co. and chief audio engineer of ABC, has been appointed director of engineering of the Gates Radio Co., Quincy, Ill.



Jack Colvin



R. J. Mueller

ROBERT J. MUELLER is now sales manager of Walsco Electronics Corp., Los Angeles, Calif.

RUSS GAWNE has replaced Charles P. Cushman as vice president and general manager of Crescent Industries, Inc., Chicago, Ill.

STOP

Volume Control Noise!



"NO NOISE"

Contains the amazing new

PERMA-FILM

- ★ **CLEANS!**
Gets rid of dirt and oxidation immediately on contact.
 - ★ **LUBRICATES!**
One drop eliminates scratch, hum and noise.
 - ★ **PROTECTS!**
Perma-Film assures continued top performance.
- The PERFECT Contact Restorer**
 Cleans and restores volume controls, band switches, push button assemblies, electrical contacts.
- **NOT A CARBON TET SOLUTION**
NO NOISE is a scientific formula especially compounded for contacts!

Available in 8 oz. bottle, quart cans and 6 oz. spray can. 2 oz. Bottle. Net to Servicemen **\$1.00**

Nearest Distributor—Or Order Direct
ELECTRONIC CHEMICAL CORP.
 813 Communipaw Ave., Jersey City 4, N. J.

HICKOK
Model 215

LATEST DESIGN

LARGE 5" METER SCALE

VTVM

RANGES

- 5" meter readable from 0.2 ohms to 1000 megohms.
- 0-3200 volts peak-to-peak
- 0-1200 volts AC-DC.
- Zero-Center DC scale.
- Includes AC-DC single-unit probe.
- Write for technical details . . .

THE HICKOK ELECTRICAL INSTRUMENT CO.
 10521 DUPONT AVE. CLEVELAND 8, O.

MERTON W. WHITNEY has been added to the sales staff of the Simpson Electric Co., Chicago, Ill. Whitney was formerly with Cook Electric Co.

* * *

VIRGIL M. GRAHAM, director of technical relations of Sylvania Electric Products, Inc., has been elected a vice president and member of the executive committee of the U.S. National Committee of the International Electrotechnical Commission. . . . DR. O. G. HAYWOOD, JR., has been appointed manager of engineering planning of Sylvania.

* * *

JACK D. HUGHES has been promoted to the position of vice president and operations general manager for Littelfuse, Inc., Des Plaines, Ill.



Jack D. Hughes



A. N. Strickland

A. N. STRICKLAND, formerly on the engineering staff of the Naval Ordnance Plant, has been named chief engineer of Videon Electronic Corp., Indianapolis, Ind.

* * *

EDWARD J. DAVENPORT has been appointed chief of the cathode-ray tube commercial engineering division of National Union Radio Corp.

* * *

WILLIAM H. KELLEY, who has resigned as vice president of Motorola, has been appointed vice president in charge of marketing of Allen B. DuMont Labs., Inc.

* * *

KENNETH R. HESSE has been named chief engineer of the Tel-O-Tube Corp. of America, East Paterson, N. J.

* * *

CHARLES C. KAYHART has been appointed service training director of Magnavox, Fort Wayne, Ind.

* * *

MAJOR WILLIAM J. SCHOENBERGER, recently released from Air Force active duty, has been named assistant to Samuel J. Spector, president of Insuline Corp. of America, Long Island City, N. Y. He will be in charge of the contracts division.



W. J. Schoenberger



W. J. Slawson

WILLIAM J. SLAWSON, formerly jobber sales manager of Federal, has been appointed assistant sales manager, jobber division, of the Pyramid Electric Co., North Bergen, N. J.

* * *

DAVID GNESSIN has been designated education director of Transvision, Inc., New Rochelle, N. Y.



TECH-MASTER

Custom-Built TV CHASSIS

Are A Credit to Your Skill...

when you do a job on a custom installation

When you've been commissioned to do your best . . . when you're being paid for the finest . . . that's the time to remember that TECH-MASTER backs your skill with the finest line of custom-built TV chassis in the field.

- The custom installation field offers a vast potential for expansion and profit!
- One satisfactory installation is a valuable recommendation for another and another!
- TECH-MASTER TV CHASSIS are specifically designed and built for custom installations!
- The finest components and the finest craftsmanship assure years of fine performance!

SO — when your customer wants custom installation — give him custom quality with

TECH-MASTER GOLD MEDAL SERIES

Quality TV Chassis for Custom Installation

MODEL 2430: Latest, improved 630 type circuit; for picture tubes up to 24". Audio connection for optional use of external amplifier.
Net Price (Less Kine) **\$189.50**

MODEL 2431: Same as 2430, but with true fidelity, Push-Pull audio amplifier.
Net Price (Less Kine) **\$199.50**

MODEL 2439: For new 90° kinescopes, (24" rectangular, 27" and 30").
Net Price (Less Kine) **\$262.50**

At All Leading Radio Parts Distributors

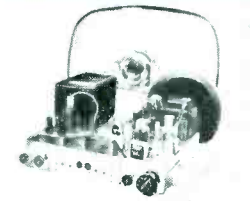
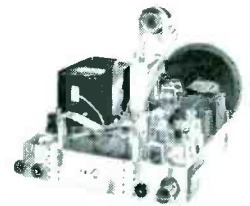

TECH-MASTER PRODUCTS CO.
445 BROADWAY, NEW YORK 13, N. Y.

MAKERS OF CUSTOM-BUILT TV CHASSIS, QUALITY TV KITS AND HIGH FIDELITY AUDIO EQUIPMENT

Write for Detailed Data



Harry E. Allen



P. B. Williams



L. W. Selsor



A. E. Hylas

HARRY E. ALLEN has been promoted from senior engineer to government products manager of the Jensen Manufacturing Co., Chicago, Ill. . . . PHILIP B. WILLIAMS has been named chief engineer of Jensen. . . . LOUIS W. SELSOR is now handling distributor sales for Jensen.

ALBERT E. HYLAS, formerly with the research division of DuMont, has been named chief development engineer of Industrial Television, Inc., Clifton, N. J.

* * *

BEA JONES has been appointed assistant advertising manager for the Regency division of I. D. E. A.

Here's how to GET MORE WORK OUT OF YOUR Oscilloscope!



**A complete,
easily understood guide to
using the handiest, most profit-
able service instrument of all
MODERN OSCILLOSCOPES
AND THEIR USES**

By Jacob H. Ruiter, Jr.

of Allen B. Du Mont Laboratories, Inc.
326 pages, 370 illustrations. Price \$6.

Oscilloscopes are gold mines for servicemen who learn to use them fast, fully and accurately on all types of work—and here at last is a book that really shows you how.

In clear, easily understood terms, it teaches you when, where and exactly how to use the oscilloscope . . . how to interpret patterns . . . how to use your 'scope to handle tough jobs easier, faster, and better.

It contains no involved mathematics—no complicated discussions. Instead, it gets right down to "brass tacks" in explaining how oscilloscopes operate. Then you learn exactly how to use them in lab work and on all types of AM, FM and television service—from locating troubles to handling tough realignment jobs.

Each operation is clearly explained step by step. You learn to determine just where and how to use the 'scope on a specific job; how to make connections and adjust the circuit components; how to set the controls; and HOW TO ANALYZE OSCILLOSCOPE PATTERNS. 370 illustrations including dozens of pattern photos make things doubly clear.

No other type of specific service training can mean so much to you in boosting your efficiency and earning power! Send coupon NOW for 10-day FREE examination!



'SCOPE EXPERTS
get better jobs
. . . bigger pay!

**PRACTICE
10-DAYS
FREE!**

Dept. S-113
RINEHART BOOKS, Inc., Technical Division
232 Madison Ave., New York 16, N. Y.

Send MODERN OSCILLOSCOPES AND THEIR USES for 10-DAY FREE EXAMINATION. If book is satisfactory, I will then send you \$6.00 promptly in full payment. If not, I will return book postpaid in good condition and owe you nothing.

NAME

ADDRESS

CITY, ZONE, STATE

OUTSIDE U.S.A. \$6.50, cash only. Money back if you return book within 10 days.

Rep Talk

JULES BRESSLER, who recently moved his offices to the Professional Building, 4808 Bergenline Ave., Union City, N. J., has been elected president of the New York Chapter of The Reps. Others elected include: *Barret Border*, first vice president; *Mel Levison*, second vice president, and *Wally Shulan*, reelected secretary-treasurer. *James Pickett*, former president, was elected to the Board of Governors for five years. . . . *Adolph Gross* was elected a senior member of the chapter; associate members elected include *E. A. Strato*, *A. W. Pleasonton*, *H. H. Salween*, *W. E. Habig*, *T. A. Marchiano* and *R. H. Cushman*. . . . *Perlmuth-Colman and Associates* have moved to larger quarters at 2419 S. Grand Ave., Los Angeles 7, Calif. . . . *Sam Wiley*, formerly midwest salesman for Snyder Manufacturing Co., has formed *Samuel J. Wiley Co.*, with headquarters at 1737 W. Howard St., Chicago 26, Ill. . . . *Frank R. Hill* has joined the staff of *David H. Ross Co.*, San Carlos, Calif. . . . *Richard R. Brainard*, previously with Pioneer Electronic Supply Corp., has been added to the staff of the *Royal J. Higgins Co.*, 10105 S. Western Ave., Chicago, Ill. *Brainard* will headquarter in Cleveland. . . . *Marvin E. Nulsen*, president of the Hoosier chapter of The Reps, died suddenly in New York recently. . . . *Robert E. Steinwedel* has been added to the Baltimore office of *Ken Randall Co.*, 121 N. Broad St., Philadelphia 7, Pa. . . . *Henry Ginsberg*, formerly sales manager with Imperial Radar and Wire Corp., has joined the staff of *Ben Joseph*, 509 Fifth Ave., New York City. . . . *Tim Coakley* has moved his offices from downtown Boston to 148 Needham St., Newton Highland 61, Mass. . . . *Hagerty-Scott Co.* have moved their offices to 10116 Puritan, Detroit 38, Mich. . . . *John I. Crockett* and *Lloyd S. Lund* have moved their offices to 2204 Griffin St., Dallas 1, Texas. . . . *W. M. Hicks* and *J. A. Keeneth* are now located at 42 Third Ave., Mineola, N. Y. . . . *Henry J. Behrends* has been appointed manager of the Cincinnati office of the *George L. Herrick Co.* Behrends will cover sales operations of *Phalo Plastics Corp.* in southwestern Ohio, Kentucky and West Virginia. . . . *W. B. Gollither*, 1003 Grandview Ave., Boulder, Colo. (New Mexico, Colorado, Utah, Wyoming); *The Bramm Co.*, 123 Manufacturing St., Dallas, Tex. (Texas, Oklahoma, Louisiana, Arkansas); *Arthur Hess*, 62-07 68th Ave., Brooklyn 27, N. Y. (upper New York state), and *Sam Karns Co.*, 36 Oak Ave., Tuckahoe, N. Y. (metropolitan New York City, northern New Jersey), have been named reps for *Rohm Manufacturing Co.* . . . *D. B. Buchanan*, 5130 Powers Ferry, N. W., Atlanta, Ga. (Georgia, Alabama, Florida, Mississippi, North and South Carolina and Tennessee), and *A. L. Perkins*, P. O. Box 488, Mt. Kisco, N. Y., have been named jobber reps for the *Tru-Ohm* Division of *Model Engineering and Manufacturing, Inc. Kaerber and Mack*, 1270 Broadway, New York City, will serve industrials in metropolitan New York City. . . . *Irvin I. Aaron and Associates, Inc.*, 829 N. Marshall St., Milwaukee, Wis. (Minnesota, North and South Dakota, Wisconsin), and *James C. Halliday Co.*, 193A W. Hillsdale Blvd.,

ILLINOIS CAPACITORS HAVE BEEN SERVING SERVICEMEN FOR OVER 19 YEARS



TYPE IHT

The complete dependability of ILLINOIS electrolytic capacitors has made them a favorite with servicemen everywhere!

For over 19 years, ILLINOIS CONDENSER COMPANY has been producing quality capacitors—and during this time has been responsible for many important advancements in electrolytic capacitor construction. Millions of ILLINOIS capacitors, now in service, are proving their absolute dependability.

Used as original equipment by leading TV and radio manufacturers, ILLINOIS electrolytics are "first choice" of servicemen for all replacements!

Write for new catalog!



ILLINOIS CONDENSER CO.
1616 NORTH THROOP STREET • CHICAGO 22, ILL.

For YOUR FRINGE AREA and DIFFICULT INSTALLATIONS use the VHF ALL-CHANNEL DAVIS SUPER-VISION TELEVISION ANTENNA

"BUILT BY AMERICA'S FASTEST GROWING
TELEVISION ANTENNA MANUFACTURER"

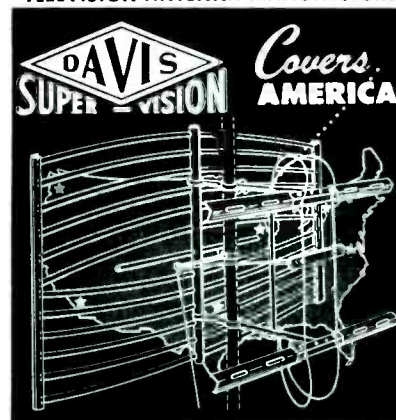

"The Original Antenna Sold With A
Money-Back Guarantee"

DAVIS ELECTRONICS S-2A
BOX 1247, Burbank, California

SIRS: RUSH INFORMATION TO ME AS CHECKED:
 Send Complete Information and Technical Data on New SUPER-VISION ANTENNA.

Send Name and Address of NEAREST JOBBER.

Name _____
Street _____
City _____ State _____



Jules Bressler

San Mateo, Calif. (California and Nevada), are now reps for South River Metal Products Co. . . . *McLoud and Raymond Co.*, 5528 E. Colfax Ave., Denver, Colo., have been named reps for Triad Transformer Corp., in Wyoming, Colorado, Utah, New Mexico, eastern Montana and Idaho, and Scotts Bluff, Nebraska. . . . *Dick Anderson*, Beaverton, Ore., has been appointed by *Adolph L. Gross Associates* as rep in the northwest. *Ernest Schaefer*, Kansas City, Mo., will cover the Missouri area; *Arthur Perkins*, Mt. Kisco, N. Y., will handle the New York state-Poughkeepsie-up area, and *W. F. Souch*, Winnipeg, Manitoba, will act as sales rep in the Manitoba, Port Arthur, Fort Williams and Saskatchewan areas. . . . *Joseph B. Rembaum* and *Nelson W. Wells* have been added to the staff of the *Arthur E. Akeroyd Co.*, Boston 16, Mass. . . . *V Sales Co.*, 1195 Sherman Ave., Bronx, N. Y. (metropolitan New York City, northern New Jersey); *Fred H. Haight Co.*, 3212 Eastlake Ave., Seattle, Wash. (northwestern states); *Don C. and William H. Wallace*, 1206 Maple Ave., Los Angeles, Calif. (adding Mexico to present area); *Atlas Radio Corp., Ltd.*, 560 King St., Toronto, Canada (Canada); *Gassner and Clark Co.*, 6349 N. Clark St., Chicago, Ill. (northern Illinois and southern Wisconsin), and *Larry Zaffina*, 14611 Alma Ave., Detroit, Mich. (Michigan and Toledo, O.), have been named reps for Javex. . . . *Morris F. Taylor Co.* has moved to larger quarters at 9431 Georgia Ave., Silver Spring, Md. . . . *Sydney Jurin* has been appointed factory sales rep for the Brach Manufacturing Corp., in southern California, southern Nevada and Arizona. . . . *Passner Co.*, 1223 Venice Blvd., Los Angeles, Calif., has been named rep for Perma-Power Co., in Los Angeles and all of southern California.

Service Engineering

(Continued from page 73)

red and black test-jacks on the programmer chassis, next to the neon lamp socket. When the photocell circuit is actuated, this meter should read from 85-100 volts, depending on line voltage. If this voltage is too low, approximately 50 volts, there is a possibility of trouble in the power supply, or a partial short in one of the amplifier tubes.

One might have trouble starting the boiler, due to gas-pressure failure, too low water, or any other cause; in such cases the safety-lockout heater will become so overheated that it will cause lockout before its normal time, causing shut-down of the boiler. This heater is intended to hold for 30 sec-

designed for High Fidelity



V-M 935HF Record Changer 936HF on metal pan "all the music is all you hear"



triomatic® 935HF

HIGH FIDELITY RECORD CHANGER

V-M makes high fidelity easier to sell, with such features as:



Exclusive aluminum die cast tone arm. Balanced, resonance-free!



Two plug-in tone arm heads of die cast aluminum. Adaptable to these cartridges*: GE "turn about" RPX050, GE RPX040, GE RPX041, Pickering single-play and turnover, and Clarkstan.



Exclusive laminated turntable with precision-formed concentricity for smooth operation.



Exclusive 4-pole, 4-COIL motor assures constant-speed, wow-free performance.



Muting switch for silent change cycle.

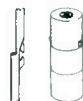

Gentle tri-o-matic spindle lowers records to spindle shelf, holds them flat for silent, air-cushion drop.

V-M automatic 45 Spindle included.

*Pre-amplification stage required.

SEND FOR COMPLETE DETAILS!

MAIL COUPON TODAY!

V-M Corporation, Benton Harbor 5, Michigan

Please send me all data and illustrated literature on the new V-M 935HF high fidelity record changer.

Name _____

Address _____

City _____ State _____

onds minimum, and to open the thermostat in about one minute. If it is not allowed to cool down, after several unsuccessful attempts, it may retain so much heat that the switch will kick out. If protracted tests must be made, a short length of wire may be clipped across the terminals of the heater itself, as they are readily accessible. One must be certain that this jumper is removed at the conclusion of the tests. Operating personnel must be instructed carefully in the operation of this unit; this can avoid many unnecessary callbacks.

RETMA TRADE SCHOOL OPENING



At opening night of the RETMA-sponsored course for TV Service Man training at the New York Trade School. Left to right: H. J. Schulman, chairman of the RETMA service committee and service manager of the Allen B. DuMont Labs; G. E. McLaughlin, superintendent of the school, and John F. Rider, chairman of the local Industry Advisory Committee to the school.

POSITIVE CURES

for TV TROUBLES!

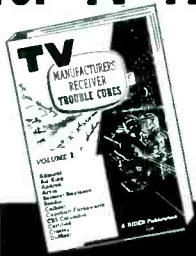

TV MANUFACTURERS' RECEIVER TROUBLE CURES

A brand new series of practical books. Gives you exact directions for correcting TV receiver performance "bugs". Each cure is official, factory-authorized, direct from the receiver's manufacturer. It is positive! Listings by manufacturer and model or chassis number. Helps correct the most difficult faults—picture jitter, hum, instability, buzz, tearing, etc.

1 VOLUME 1

Covers 12 prominent brands — ADMIRAL, AIR-KING, ANDREA, ARVIN, BELMONT-RAYTHEON, BENDIX, CALBEST, CAPEHART-FARNSWORTH, CBS-COLUMBIA, CERTIFIED, CROSLLEY, DUMONT. Over 120 pages (5¼ x 8¼"), illus. \$1.80

2 VOLUME 2

Covers — EMERSON, FADA, FIRESTONE, FREED, GAMBLE, SKOGMO, GENERAL ELECTRIC, HALL-CRAFTERS, HOFFMAN, INDUSTRIAL, INTERNATIONAL, JACKSON. Over 120 pages (5¼ x 8¼"), illus. \$1.80

3 VOLUME 3

Covers — KAYE-HALBERT, KENT, MAGNAVOX, MAJESTIC, MECK, MERCURY, MIDWEST, MONTGOMERY WARD, MOTOROLA, MUNTZ, NATIONAL, NORTH AMERICAN PHILIPS, OLYMPIC, PACIFIC-MERCURY, PACKARD-BELL, PHILCO. Over 120 pages (5½ x 8½"), illus. \$1.80

4 VOLUME 4

Covers — PHILHARMONIC, PILOT, RADIO & TELEVISION (BRUNSWICK), RCA VICTOR, REMINGTON (REMBRANDT), SCOTT, SEARS-ROEBUCK, SENTINEL, SETCHELL-CARLSON, SHAW TV. Over 120 pages (5¼ x 8¼"), illus. \$1.80

VOLUME 5

Coming soon! Covers prominent manufacturers not included in first four volumes.

One service job will more than pay the cost of this series of books!

Write for complete Rider catalog.

Buy these books now from your jobber . . . bookstore . . . If not available from these sources, write to:

JOHN RIDER PUBLISHER INC.
Dept. 10 S 480 Canal Street, New York 13, N. Y.

CATALOGS, BULLETINS ETC.



SARKES TARZIAN, INC., Rectifier Division, 415 N. College Ave., Bloomington, Ind., has released a 12-page *Selenium Rectifier Replacement Guide*, containing a list of radio and TV manufacturers' models, part number and selenium rectifier replacement model numbers. Circuits and dimensional diagrams of single-phase full-wave rectifier stacks are included along with a chart of all types available.

* * *

CENTRALAB, 900 E. Keefe Ave., Dept. J-17, Milwaukee 1, Wis., has prepared a catalog, 42-164, covering its model 1 sub-miniature and 2 (standard 15/16") variable resistors. Five revised catalog sheets, covering bc disc capacitors, ceramic trimmers, tubular trimmers, feed-through capacitors and high-accuracy capacitors, are also available.

* * *

RADIO MERCHANDISE SALES, 2016 Bronxdale Ave., New York 60, N. Y., has published a 6-page bulletin, *UHF-53*, describing TV antennas and accessories for *wif* installations. . . . A brochure, *Get the Rabbit Habit*, describing all indoor antennas manufactured by the company, has also been released. . . . A bulletin, *H953* detailing a line of insulators and stand-offs, is also available. Includes a description of a new type universal grommet.

* * *

DAVIS ELECTRONICS, Box 1247 Burbank, Calif., has released a 4-page catalog-technical data folder, *SV-7*, on their *Super-Vision* TV antenna. Included are highlights of a performance characteristic report as gathered by an independent antenna research lab.

* * *

SPRAGUE PRODUCTS Co., 61 Marshall St., North Adams, Mass., has prepared a 48-page sixth edition of its *TV Replacement Capacitor Manual and Printed Circuit Guide*. Reference book now includes 3,224 models of 671 sets under 85 brand names, covering all TV models up to August '53. Manufacturers are listed alphabetically, and complete data are listed for the replacement capacitors in each model, cross-referenced with the original manufacturer's part number.



SERVICE MEN
KNOW THERE IS
JUST ONE

EVER-QUIET



Since 1949

the Original Volume Control & Contact Restorer

EVER-QUIET is a free-flowing liquid that leaves no powder residue.

- Does Not Arc or Affect Inductance, Capacitance or Resistance.
- Harmless to Metals, Insulation and other Fine Finishes.
- Contains No Carbon "Tet," Gums or other Adhesive Chemicals.

2-Ounce Bottle with Handy Dispenser—Only 59¢ Reg. U.S. Pat. Off.

EVER-QUIET is made by the manufacturers of HUSH—The TV-Tuner Cleaner that Sprays On.

EVER-KLEER—The TV Tube Cleaner in the Plastic Spray Bottle.

All products liability protected by one of America's largest underwriters.

Ask your local distributor for EVER-QUIET or write:

CHEMICAL ELECTRONIC ENGINEERING, INC.
283 Main St. Matawan, N. J.



PERFECTION ION TRAPS

- Simplest to Install
- No Wobble
- Now Standard Equipment on All Leading TV Sets

Order today from your supplier!

PERFECTION ELECTRIC COMPANY
2635 South Wabash Ave., Chicago 16, Illinois

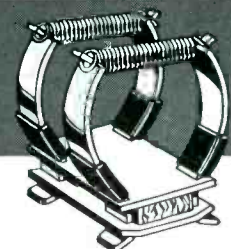



Manual describing How To Install Master TV Systems with complete instructions and diagrams covering every phase of planning and installation, released by Blonder-Tongue, 526 N. Ave., Westfield, N. J. Explained and illustrated are choice of transmission lines, signal amplification and distribution to TV sets. Simplified charts show how to calculate transmission line losses, change decibels to voltage gain and make up all types of attenuation pads.

PYRAMID ELECTRIC Co., 1445 Hudson Blvd., North Bergen, N. J., has published a catalog, *DE*, containing a listing of almost 300 dry electrolytics which have been added to the line. Also contains information on a hermetically-sealed dry electrolytic, *TDL*, in a tubular metal can with an outer cardboard tube and 6" insulated wire leads.

* * *

COLUMBIA WIRE AND SUPPLY Co., 2850 Irving Park Rd., Chicago 18, Ill., has announced publication of a house organ, *Columbia News*, which will be mailed to distributors monthly. In addition to news items, publication will print a list of items carried in stock at the plant.

* * *

JENSEN INDUSTRIES, INC., 329 South Wood, Chicago, Ill., has issued a pocket-sized booklet on the care of records, needles, pickups and cartridges. Booklet, designed as a consumer publication available for dealer distribution, illustrates needle wear comparison, and contains information on caring for phonos and a needle replacement chart.

* * *

CHICAGO STANDARD TRANSFORMER CORP., Standard Division, Addison and Elston, Chicago 18, Ill., has released a bulletin, *469, TV Replacement Transformer Popularity Tables*, which lists the number of TV models that use each Stancor replacement transformer. There are separate tables for each of the 55 major setmakers.

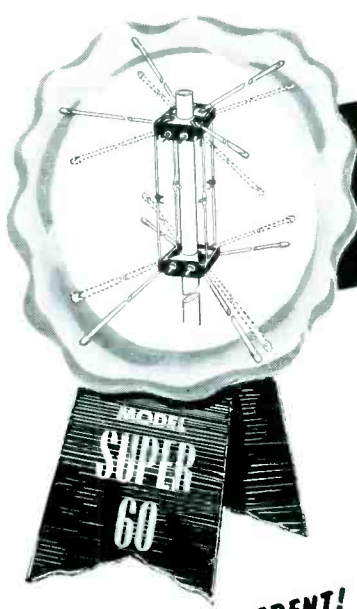
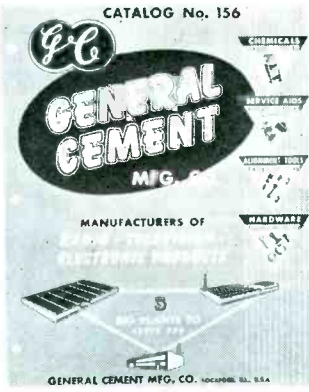

GUARANTEED PERFORMANCE

MONEY BACK GUARANTEED TO RECEIVE All UHF and All VHF STATIONS IN All DIRECTIONS FOR 60 MILES WITHOUT A ROTORMOTOR OF ANY KIND!!

SO NEW! SO DIFFERENT! IT'S PATENTED!

2,585,670
 # 2,609,503
 # 2,625,655
 # 2,644,091
 OTHERS PENDING

WORLD'S MOST POWERFUL UHF - VHF TELEVISION ANTENNA

While antenna reception is guaranteed for 60 miles, perfect pictures have been consistently received as far as 160 miles from stations.

NEW POLYMICALENE 4 CONDUCTOR TRANSMISSION LINE

- Low Loss External - Air Dielectric
- Matched Impedance
- Eliminates End Sealing
- Eliminates Condensation
- Up to 50% Less Loss Than Tubular When Wet
- Easily Spiraled
- No Breaking or Shorting
- Patents Pending - T. M. Reg.

All NEW DESIGN FOR '54

- LOW-LOSS SWITCH
- LOW-LOSS PHENOLIC INSULATORS
- USES NEW 4-CONDUCTOR MATCHED IMPEDANCE LINE
- ONLY 10 INCH SPACING BETWEEN ANTENNA BAYS

LIST PRICE
\$3675
SEE YOUR LOCAL JOBBER.

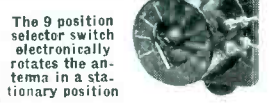

PRICE INCLUDES Complete stacked array • 4 stacking bars • 9 position switch • Switch-to-set coupler • 2 - 7 1/2" stand offs • Individually boxed in available carton

Money Back Guarantee IN EVERY AREA

WITH STATIONS IN ALL DIRECTIONS

The new All Channel Model Super 60 is guaranteed to bring in, immediately on installation, every UHF and every VHF station within 60 miles in any direction, giving clearer and sharper pictures than any antenne or combination of antennas with or without rotor motors.

If, immediately on installation, it fails to do this, we agree to refund to the jobber to whom we sold and shipped it, his full purchase price.

ALL CHANNEL ANTENNA CORP.

70-07 Queens Blvd., Woodside 77, N. Y. Hickory 6-2304

(Left)

A 64-page catalog offering descriptions, specifications and prices of the complete line of G-C radio, TV and electronic products. All products are listed by types in index. More than 3000 items in over 150 different classifications are included. (No. 156 catalog, General Cement Mfg. Co., 904 Taylor St., Rockford, Ill.)

(Right)

Envelope stuffer on three uhf television antennas published by Snyder Manufacturing Co., Philadelphia. Data included covers the Snyder UHF-5 (bow-tie with reflector, channels 14 to 83), UHF-6 (bow-tie with corner reflector), and UHF-3 (broad band yagi in 3 models), for channels 14 to 48, 27 to 62 and channels 47 to 83.)



GRANCO UHF

for superior performance

the only complete
all-channel
UHF converter line



"STAR"

MODEL LCU—Proven all-channel performance everywhere. Coaxial tuning at a new low price!



ALL-NEW "SUPER"

MODEL MTU — Coaxial tuning for unmatched performance . . . especially in difficult reception areas.



"HIDEAWAY"

MODEL HT-5—At last, a front-end tuner that answers the problem of concealed installation for all-channel reception. Coaxial tuned!

Sold by leading
jobbers everywhere!

Write today for free
bulletin to Dept. S

GRANCO PRODUCTS, INC.

36-17 20th Avenue
Long Island City 5, N. Y.



CBS-HYTRON QUALITY SERVICE PLAN CONTEST

A certified quality service plan to improve industry public relations has been announced by CBS-Hytron, Danvers, Mass.

Plan hinges around a *service tag* attached to each set repaired. On the back of tag is space to list all parts used in servicing the set, as well as the individual charges made for them. On the face of tag, there is space for entering total charges for parts and labor, sales tax, and grand total charge. Statement at the top of tag declares: *This certifies that parts used in servicing this set are new and of standard make and quality. All charges are made in accordance with industry standards.* Tag itself carries an imprint of Service Man's name and address. Tag serves an additional purpose, because part of it functions as a claim check, too. On the perforated bottom section of the tag, the claim check, appears the further important statement of the certifying dealer: *Your set is being serviced by technically trained men using the latest equipment so necessary for Quality radio and TV service.*

A contest for Service Men, and distributor salesmen and countermen, has also been launched by CBS-Hytron in connection with the certified quality service merchandising plan. First prize is a Ford panel truck; second prize is a \$1,000 Savings Bond, with \$600 in bonds as the third prize, and seven other Savings Bond prizes ranging down to \$25.

Contestants must fill out entry blanks supplied by distributors, completing in 25 words or less the sentence: *I like the CBS-Hytron Certified Quality Service plan because. . .* An impartial board of judges will decide the winners. Every eligible dealer who is a contestant will be sent free a CBS-Hytron soldering aid.

Contest closes at midnight, December 15. Winners' names will be announced about six weeks later. Only Service Men using the CBS-Hytron certified quality service promotion kit, including tags, decalcomania, window streamer, and easel display blow-up, are eligible.

buy and use
*Christmas
Seals*
Greetings
1953

fight
tuberculosis

ATLAS RADIALS

FOR
CHURCHES



FOR
FACTORIES

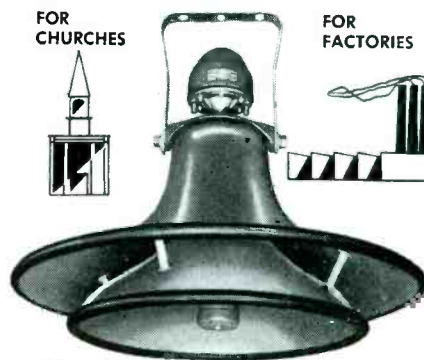

FOR
TERMINALS



FOR CARNIVALS

With uniform 360° coverage, non-resonant construction, and 100% storm-proofing, ATLAS Radial Driver Unit Projectors often solve the most difficult sound problems—are excellent for reproduction of speech, chimes and music. For complete details on Radials and the famous ATLAS line of Public Address and Microphone Stand Equipment . . .

WRITE NOW for FREE Catalog 553



ATLAS SOUND CORP.

1442 39th St., Brooklyn 18, N. Y.
In Canada: Atlas Radio Corp., Ltd., Toronto, Ont.

KENCO KATE SAYS
**"NO
INSTALLATION
PROBLEMS
when you use
KENCO
MOUNTS"**

Kenco
Minute
Mount

One
Piece
Chimney
Mount

Model 5C-SS

Fastest, easiest chimney mount to install. Bearing feet top and bottom prevent rocking on irregular chimneys. Snap-in feature holds mast while applying hardware. Carriage bolts for easy one hand lockup. One piece welded construction. Heavy gauge steel—hot dipped galvanized. 12 ft. stainless steel band and stainless steel seals. 3 Easy-slide corner guards for uniform tightening and protection of bands.

KENWOOD ENGINEERING CO., INC.
Kenilworth, New Jersey

SPRAGUE JUMBO CARTON REMINDER

Jumbo dummy capacitor cartons, designed as a purchase reminder for Service Men, are now being distributed by Sprague.

Designed for use in windows, above shelves, or suspended from the ceiling, the carton measures 25" by 7 13/16" by 7 13/16", and is printed in orange and blue.



* * *

CEE TV TUBE-GLASS CLEANER REFILL

A 3 3/4" plastic refillable spray bottle to hold *Ever-Kleer* TV tube and glass cleaner has been announced by Chemical Electronic Engineering, Inc., 283 Main St., Mattawan, N. J. Eight-ounce cleaner refill bottles are also available.



* * *

PYRAMID TO EXPAND

A new plant, consisting of 160,000 square feet of floor space, and located in Gastonia, N. C., is being readied for occupancy as part of the expansion program of the Pyramid Electric Company, 1445 Hudson Blvd., North Bergen, N. J.

Plant is currently being fitted with machinery and equipment and manufacturing operations are expected to begin around January 1. Paper capacitors as well as motor starting and ceramic capacitors will be manufactured at the new plant.

* * *

G. E. RECORD-KEEPING SYSTEM

A simplified record-keeping system has been announced by the tube department of General Electric Co., Schenectady, N. Y.

Inventory control record comes in a 10" x 12" leatherette binder and includes sections for a one-year inventory, service report forms, data and prices on all tubes, a sheet describing G.E. tube manuals, and an interchangeability data section.

Besides inventory control record, system also includes a tube life record-keeping system for large industrial tube users, service engineers, broadcasters and telecasters.

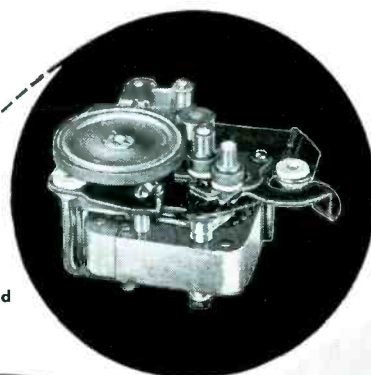

Turret-type 3-speed record-changer phonomotor

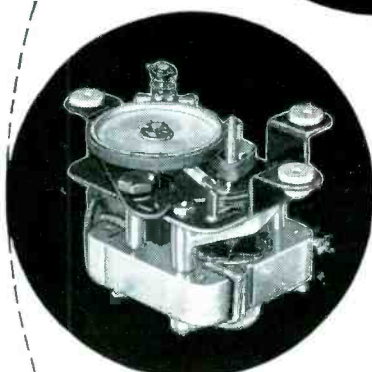

Single belt-type 3-speed record-changer phonomotor

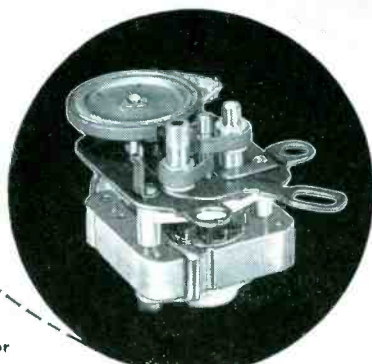

Double belt-type 3-speed record-changer phonomotor

AMERICA'S LEADING RECORD-CHANGER MANUFACTURERS USE GENERAL INDUSTRIES' 3-SPEED PHONOMOTORS

Each of the above 3-speed record-changer phonomotors was designed and engineered by General Industries to meet the specific requirements of a leading national manufacturer. These and countless companion GI phonomotors of all types and sizes—are the evidence on which General Industries bases its claim of phonomotor leadership.



THE GENERAL INDUSTRIES CO.
DEPARTMENT MF • ELYRIA, OHIO

ERIE DEVELOPS PC METHOD

Development of a new method of producing copper foil printed circuits, for which a patent application has been filed, has been announced by *Jerome D. Heibel*, vice president in charge of research and engineering for Erie Resistor Corp., Erie, Pa.

Process involves embossing copper foil in laminated bakelite sheets with the depressed portions representing the wiring form desired. After this operation, which is performed during the curing process of the bakelite, unwanted part of the copper foil is removed mechanically.

PRECISE EXPANDS

Expansion of manufacturing facilities, through the acquisition of an additional building at 980 Long Beach Rd., has been announced by Precise Development Corp., Oceanside, N. Y.

Irving Becker will be in charge of the new division of the plant.

* * *

RAY-TRONIC SALES MOVES

Ray-Tronic Sales Co., distributor of multi-tron picture tubes, have moved to 4628 Washington Blvd., Chicago 44, Ill.

Company, which sells picture tubes directly to Service Men, is headed by *C. Richard Booras*, *Louis Psaltis* and *Samuel G. Booras*.

I've switched to
ERIE SWITCHES
They're in the BAG!

The new, full line of ERIE rotary selector and lever switches includes twenty-five item numbers. They are made in four styles, in single or multiple sections, shorting and non-shorting types. ERIE switches meet existing R.E.T.M.A. requirements. For protection against the corrosion of heavy silver plated contacts, each switch is sealed in a durable plastic bag and then boxed for convenient stocking.

Descriptive literature is available at your distributors, or write Dept. A for your copy.

ERIE components are stocked by leading electronic distributors everywhere.

ERIE RESISTOR CORP.
 ELECTRONICS DISTRIBUTOR DIVISION
ERIE RESISTOR CORPORATION
 Main Offices: ERIE, PA.
 Factories: ERIE, PA. • LONDON, ENGLAND • TORONTO, CANADA

FINCO BILLBOARDS IN OHIO AND INDIANA

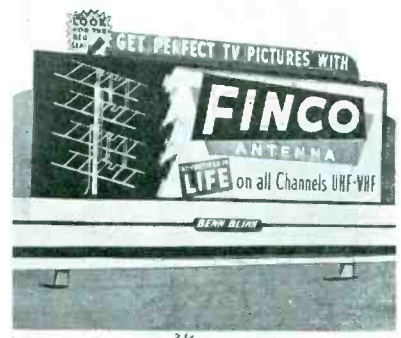

Billboards illustrating Finco 400-A antenna, in luminescent outline, located throughout Ohio and Indiana on heavily traveled U. S. and state routes.

NEW OHMITE PLANT

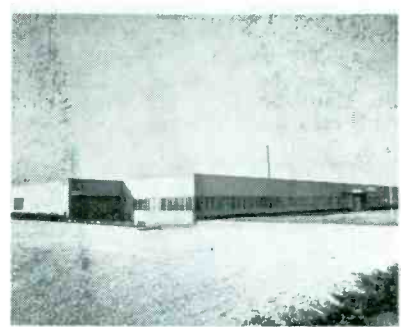

Recently completed single-story plant of Ohmite at 3601 Howard St., Skokie, Ill., with a floor area of 128,000 square feet. Ohmite's former plant was located at 4835 W. Flournoy St., Chicago, where some products will continue to be manufactured.

FIRST RCP EASTON PLANT P-P VTVM



First RCP 655 Do-All peak-to-peak vtvm to come off company's production line at Easton, Pa., being presented to Burt U. Levy, sales manager, by Walter Jonas (right), vice president in charge of production, while prexy Milton Reiner (left) looks on, in RCP general offices at 152 W. 25 St., New York.

KESTER

Since the most important single step in Radio-Television Servicing is soldering . . . it's just plain good sense to use the best — KESTER SOLDER . . . Key Name in Solder for More Than 50 Years.

KESTER SOLDER COMPANY
 4348 Wrightwood Avenue • Chicago 39, Illinois
 Newark 5, New Jersey • Brantford, Canada

SOLDER

AN IDEAL SETTING

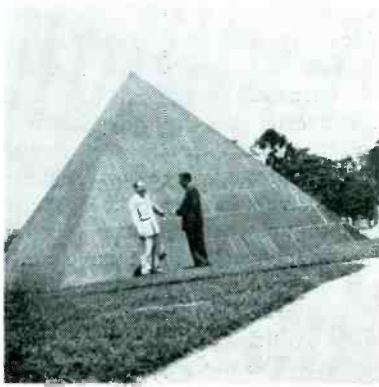

Jack Poff, distributor sales manager, and Jack Berman, rep, both with Pyramid Electric Company, before a true Pyramid they discovered in Los Angeles.

WALDOM TO EXPAND



Architect's drawing of one-level structure, centered on a 34,000 square foot plot with railroad siding facilities and parking accommodations for employees and visitors, being built for Waldom Electronics, Inc., 4621-4645 West 53rd St., Chicago.

REGENCY UHF TECHNICAL FORUM



At uhf technical forum staged by J. Gordon Dougherty, field rep for the Regency division of I.D.E.A., Indianapolis, in the ballroom of the Monticello Hotel, Norfolk, Va. Left to right (front row): John J. Triplett, Jr., purchasing agent, Radio Supply Co., Inc., Norfolk; Sam Schluskel, field and development engineer, Channell Master Corp.; Dorothy Bailey, Virginia's representative in the Miss Universe contest; J. G. Dougherty; and Harold Rieth, engineer, Regency division. Left to right (back row): W. L. Turner, purchasing agent, Radio Parts Distributing Co., Norfolk; W. S. Shumate, owner, General Supply Co., Newport News, and Richard Hyer, sales engineer, FTR.

**THE NEW
1954**



**BOOSTER
CONVERTER**



*Technically
Visually*

... the NEW Sutton VHF Booster-UHF Converter (combination unit) is the same as the metal cabinet model, which thousands of users and service men acclaim to be so outstanding.

... the new model is matchless in modern beauty. The sturdy marble-walnut plastic cabinet with gold panel is distinctive, yet blends well with any television set cabinet.

ONE UNIT DOES THE WORK OF TWO

Both VHF Booster and UHF Converter in one compact cabinet. It has proved outstandingly satisfactory in all present UHF operating areas. Gives any TV set ALL UHF channels and all VHF channels remain open. Takes an easy five minutes to install. Your customers like the neater installation, easier operation and better performance!

SUTTON ELECTRONIC CO., LEXINGTON, KY.

"SLICE-AWAY" TRANSISTOR BATTERY ASSEMBLIES

Two types of RCA alkaline battery assemblies which can be sliced into numerous combinations of cells to provide different voltage requirements for transistors. Battery assemblies are intended specifically for equipment designers and experimenters. Both battery assemblies (VS087 and VS088 . . . for current drains of 2 to 10 milliamps) are 21-volt special-purpose types. Each contains 15 individual 1.4-volt crown-type alkaline dry cells encased in a plastic sleeve.

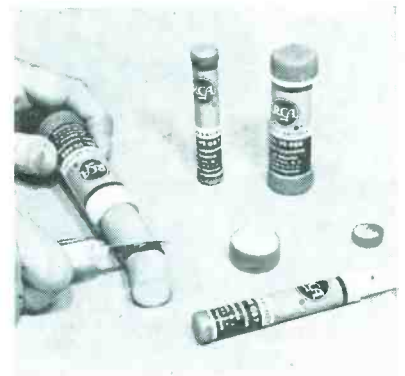



PHALO



Making The Best T. V. Service Easier To Give!

Get and keep the jump on service competition . . . do it with superior quality Phalo wires, cables and cord assemblies like the handy jumper cord shown here.

Ask the men who know — they'll tell you the Phalo trademark is complete assurance of dependable product service.

Remember, Phalo wires, cables and cord assemblies are made to help you make more money . . . introduce yourself to new profits through quality Phalo products.

Ask Your Dealer For:

PHALOTEL
Wires and Cables

PHALOCORD
Cord and Cord
Set Assemblies

PHALO SALES REPRESENTATIVES ARE LOCATED IN THE FOLLOWING CITIES:

New York, N. Y.
Rochester, N. Y.
Philadelphia, Pa.
Greensboro, N. C.

Wichita, Kansas
Natick, Mass.
Cleveland, Ohio
Houston, Texas
Phoenix, Arizona

Chicago, Ill.
Detroit, Mich.
Los Angeles, Cal.
San Francisco, Cal.

PHALO PLASTICS CORPORATION

25-3 FOSTER STREET, WORCESTER, MASSACHUSETTS

Insulated Wires, Cables and Cord Set Assemblies

UHF Booster

(Continued from page 30)

of *vhf* over *uhf* receiver systems available today. Essentially, a *uhf* converter consists of a *uhf* section and a *vhf* booster as shown in Fig. 7 (p. 31). In a converter the *uhf* preselector and crystal mixer introduce a minimum loss of approximately 10 db. Since good *vhf* receivers have essentially the same noise figures as present *vhf* boosters, the *uhf* converter must have at least a 10 db poorer noise figure. Actually noise is introduced by the crystal mixer which degrades performance further. The use of pentode *if* amplifiers in some converters has been found to provide even poorer noise figure performance.

The *uhf* continuous-tuned booster, shown on the cover and in Fig. 1, pre-amplifies the signal before it reaches the converter or tuner. Since the booster has sufficient gain to minimize the noise contribution of the following stages, the overall performance is determined by the noise generated in the triode at *uhf*. The available gain also serves to overcome the gain deficiencies of the converter or the receiver.

Selectivity

Present *vhf* tuner design is virtually limited to a *rf* amplifier, vacuum tube mixer, and a local oscillator working on fundamentals. In *uhf* tuners and converters, where selectivity requirements are more severe because of the relatively close spacing of signal and image frequencies, many different arrangements have been used.

In their allocation plan, the FCC took note of the severe selectivity requirements and chose geographic locations in such a manner as to ease the image rejection requirements of *uhf* tuners, and to protect against local oscillator radiation from these units. Since it would be impossible to provide plans to provide protection for all arrangements, the Commission chose the *uhf* tuner with the oscillator above the signal by 40 mc as the unit which should be considered in the allocation. Only fundamental oscillator operation was considered and no consideration was given to intermediate frequencies other than 40 mc.

Double-Conversion Problems

For units using double conversion, as must be the case for all converters, there are several frequencies which can cause interference in the form of

Heathkit TEST EQUIPMENT

NEW MULTIMETER KIT \$26.50

SIGNAL TRACER KIT \$23.50

NEW SCOPE KIT \$59.50

CONDENSER CHECKER KIT \$19.50

VACUUM TUBE VOLTMETER KIT \$24.50

TUBE CHECKER KIT \$29.50

SIGNAL GEN. KIT \$19.50

GRID DIP METER KIT \$19.50

HEATH COMPANY
BENTON HARBOR 11,
MICHIGAN

BUILD YOUR OWN — INCREASE KNOWLEDGE — SAVE MONEY — BUY DIRECT FROM MANUFACTURER . . . Top quality instruments in kit form featuring latest design and circuit developments. Completely detailed step-by-step construction manual — clear pictorials — complete schematics. All sheet metal work punched, formed and finished. Low kit prices include tubes, chassis, cabinet and all necessary constructional components.

Kits for the school — service shop — industrial laboratory — hobbyist, etc.

Write for free catalog for further information.

spurious responses. Of these the most troublesome are:

(1) The image frequency, a frequency above the local oscillator by twice the *if* of the converter; (2) the intermediate frequency of the converter, and (3) the image corresponding to this first *if*.

When harmonic operation of the local oscillator is used, as in some *uhf* strips, the spurious responses are multiplied, since there is a signal and image frequency for each oscillator harmonic to which the receiver would normally respond, except for the attenuation afforded by the tuned circuits. In strips using the third, fourth and fifth harmonics of the local oscillator for *uhf* coverage, there are at least ten frequencies which can cause interference. Since there is no allocation plan protection for the spurious response frequencies there can be, and have been, many cases of field interference from amateur and commercial services. Many more cases of interference will appear as additional TV stations begin telecasting.

The use of additional tuned circuit selectivity, together with an increase in signal level, can often eliminate or reduce the interference. The use of a *uhf* booster has been found helpful, even in strong signal areas, when interference is a problem.

Intermodulation

In areas where a weak signal is being received and a local station has an extremely large signal, it is sometimes possible for the stronger station to modulate the carrier of the weaker station in the receiving equipment. In severe cases the second modulation will appear on the screen moving from side to side, much like a windshield wiper on an automobile. In less severe cases the picture becomes excessively noisy.

Since intermodulation takes place only in non-linear circuits it is particularly important that *uhf* tuners or converters have a high degree of preselection before the mixer stage. Some minimum-design converters have only a single-tuned circuit, and this is often too little to prevent this type of interference. The addition of another stage of preselection and preamplification can make the difference between an interference-free picture and one having questionable entertainment value.

Line Losses

The loss of TV transmission lines is a function of frequency with losses

increasing at the higher frequencies. Also capacity effects, which can be introduced by placing the transmission line close to metal, are approximately ten times as detrimental on the *uhf* band as on channels 2 to 6.

The receiving-system noise figure of most importance is that which is obtained directly at the antenna terminals. This figure can be calculated by adding the noise figures of the TV receiver or converter in db, to the line loss in db. For example, a 20-db converter, when used with a line length presenting a 10-db loss, results in a

30-db noise figure directly at the antenna.

A large degree of improvement can be affected by mounting a booster as close to the antenna as possible as to minimize line loss. In cases of long runs and noisy converters, or receivers, a booster at the antenna and another at the receiver will result in even greater improvement.

For mounting at the antenna, in single channel areas, the *uhf* booster can be housed in a weatherproof enclosure. It has been found that weather
(Continued on page 98)

One body with 6 interchangeable terminals for the widest mounting combinations.

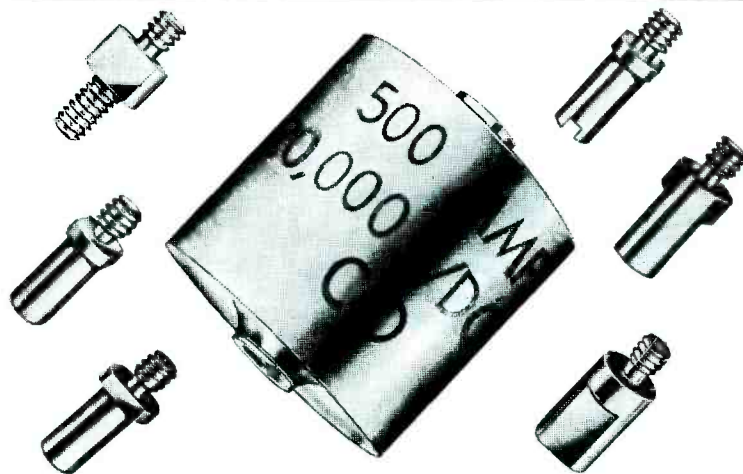

C-D's NEW

Mity Mike[®]

(Type MMU)

CERAMIC CAPACITORS

- Interchangeable terminals take less room in your parts kit — let you do the job right
- Just attach the needed terminals to fit the job...
- Always the right ceramic unit handy — and without tying up money in a big stock
- With the improved construction and processing at point where corona-effects attack
- Rugged — stable — durable
- Use it at Full Rated Voltage
- Precision manufactured with extra-large safety margin — greater dependability
- Now at your C-D Jobber. For his name and address see your Classified Telephone Directory. Catalog on request, Dept. S 113, Cornell-Dubilier Electric Corp., So. Plainfield, N. J.



CONSISTENTLY DEPENDABLE
CORNELL-DUBILIER

There are more C-D capacitors in use today than any other make.

PLANTS IN SOUTH PLAINFIELD, NEW JERSEY; NEW BEDFORD, WORCESTER AND CAMBRIDGE, MASSACHUSETTS; PROVIDENCE AND HOPE VALLEY, RHODE ISLAND; INDIANAPOLIS, INDIANA; SANFORD AND FUGUAT SPRINGS, NORTH CAROLINA. SUBSIDIARY RADIART CORPORATION, CLEVELAND, OHIO

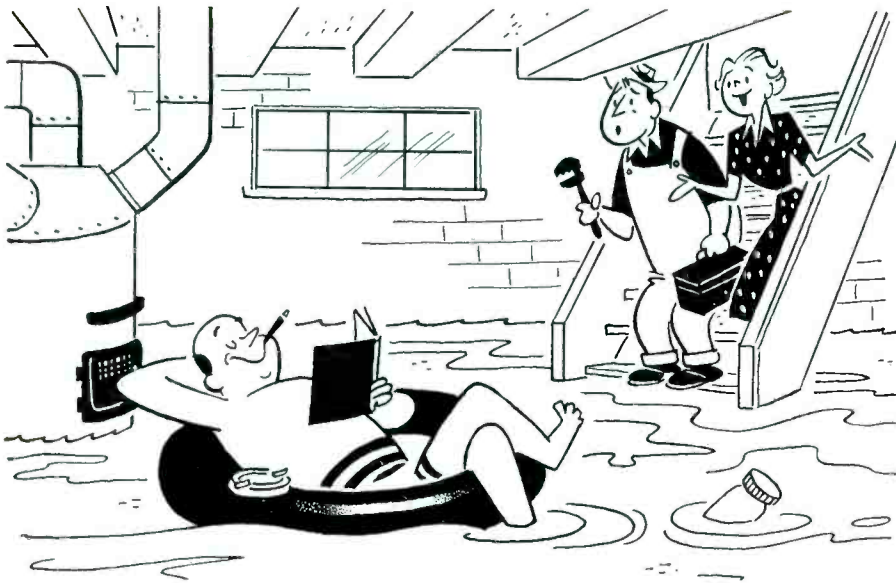

"You can't worry Ed since he's switched to G-E radio dial lamps"

You'll have a vacation from at least one worry when you use General Electric radio dial lamps in your repair work. G-E lamps can't cause annoying static. Hundreds of laboratory tests assure top lamp quality, long life, fewer early burnouts. Be sure you give your customers the best. Replace old dial lamps with General Electric.

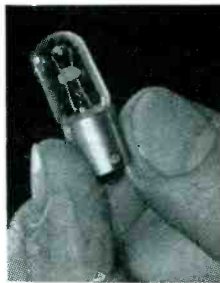

GENERAL  ELECTRIC

THE NEW MODEL TV-11

TUBE TESTER



- Uses the new self-cleaning Lever Action Switches for individual element testing.
- Because all elements are numbered according to pin number in the RMA base numbering system, the user can instantly identify which element is under test. Tubes having tapped filaments and tubes with filaments terminating in more than one pin are truly tested with the Model TV-11 as any of the pins may be placed in the neutral position when necessary.
- Uses no combination type sockets. Instead individual sockets are used for each type of tube. Thus it is impossible to damage a tube by inserting it in the wrong socket.
- Free-moving, built-in roll chart provides complete data for all tubes.
- Phono jack on front panel for plugging in either phones or external amplifier detects microphonic tubes or noise due to faulty elements and loose external connections.

EXTRA SERVICE—The Model TV-11 may be used as an extremely sensitive Condenser Leakage Checker. A relaxation type oscillator incorporated in this model will detect leakages even when the frequency is one per minute.

Operates on 105-130 Volt 60 Cycles A.C. Hand rubbed oak cabinet complete with portable cover.....

\$47.50

**SHIPPED ON APPROVAL
NO MONEY WITH ORDER — NO C. O. D.**

Try it for 10 days before you buy. If completely satisfied send \$11.50 and pay balance at rate of \$6.00 per month for 6 months.—No Interest or Carrying Charges Added. If not completely satisfied, return to us, no explanation necessary.

MOSS ELECTRONIC DISTRIBUTING CO.
Dept. D-3, 38 Murray St., New York 7, N. Y.

Please rush one Model TV-11. I agree to pay \$11.50 within 10 days after receipt and \$6.00 per month thereafter.

NAME
ADDRESS
CITY ZONE STATE

UHF Booster

(Continued from page 97)

conditions will not cause a sufficient thermal drift to affect picture performance, even under extreme conditions. In multiple-channel areas more than one unit can be used with stubs being used to combine the outputs into a single transmission line.

Multiple Receiver Operations

The *uhf* booster has been effective as a preamp for multiple-receiver use. The *uhf* receivers can be decoupled by resistors, or hybrid-ring couplers can be used, but in either case the amplifier can serve to overcome the loss of the decoupling network, and that due to power division. More than one booster can be used by using stub or filter arrangements, and *vhf-uhf* distribution systems can be arranged using crossover networks.

Lob Applications

The *uhf* booster can also be used to amplify the output of *uhf* signal generators, or as a variable attenuator by detuning of the amplifier. Or it can be used to increase the sensitivity of *uhf* field-strength meters, tuned detectors, receivers and the like.

In addition, the amplifier can be used in conjunction with a *vhf* oscillator and a crystal multiplier to generate *uhf* signals. In this application, the booster can be employed to select and amplify the desired harmonic, as shown in Fig. 8 (p. 31). Since some *vhf* oscillators have crystal check points at even .25-mc points, the output at *uhf* can be checked at about 1 mc and even closer by the proper choice of harmonics.

If a detector and meter are connected to the *uhf* booster output, the unit can be used as a sensitive wavemeter. A small probe antenna can be coupled to the input so that the source of oscillation can be located.

Another Wavemeter Setup

If a *uhf* sweeper and a 'scope are available another wavemeter arrangement can be used as shown in Fig. 9 (p. 31). The sweep generator and amplifier are tuned and the location of the oscillator can be determined by locating the *birdie* corresponding to this signal. This method is especially useful when more than one oscillation is present, or where experimental work is being done on a tunable oscillator.

Audio

(Continued from page 44)

by separate voice coils. An electrical filter consisting of a 4-mfd capacitor and the inductance of the low-frequency voice coil delivers the low frequencies to the large outer cone and the high frequencies to the small inner cone.

The filter (or crossover network) reduces the response of the *lf* unit above 1,600 cycles and that of the *hf* unit below 1,600 cycles. To provide enough inductance for effective filtering, the *lf* voice coil is wound with four layers of wire.

The speaker can be mounted in an enclosure with a volume of not less than 5½ cubic feet with a reflex opening of 50 square inches.

Locating Distortion in Amplifiers*

DIFFERENT KINDS of distortion have their own characteristic effect on reproduced sound. Conversely the effect can be used to help recognize the kind of distortion producing it.

Knocking

If reproduction sounds as if the voice coil is knocking against something, the first thing to do, of course, is to check the loudspeaker. There are several varieties of distortion that can cause a similar effect on the reproduced sound.

The sound of actual knocking is caused by the sudden stopping of the voice coil's travel. Any distortion which abruptly stops the signal voltage rising, squaring off the waveform, will produce a similar sound. The most obvious fault responsible for this is insufficient grid bias on one of the tubes; excursions of applied grid voltage running positive of zero for part of the waveform. At this point the tube grid starts to draw current from the grid circuit, and the high impedance of the preceding stage, combined with this grid current, effectively prevents the signal voltage at the grid from running positive, as would be required to maintain waveform.

Now, how can grid-bias voltage become low? In power stages where the self-bias resistor in the cathode is running near its maximum dissipation rating, and is of the composition type, this resistor may fall in value as it ages, causing the bias voltage developed across it to drop.

Another, and more common, cause is slight leakage through a coupling capacitor; Fig. 5. Let us assume that the grid-return resistor is 100,000 ohms and the normal bias 6 v. Then

LOOKING for the RIGHT TV REPLACEMENT TRANSFORMER?



you'll find it in

STANCOR'S NEW TV REPLACEMENT GUIDE

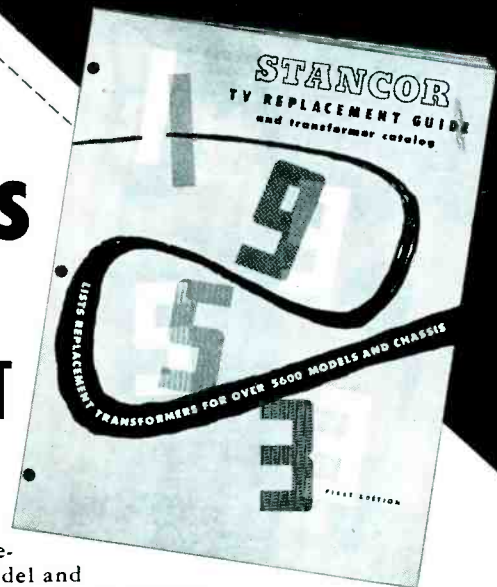

Easier to use . . . lists replacements by manufacturer's model and chassis number and also by original part number.

Up-to-date . . . over 5600 models and chassis are covered, including virtually all sets built prior to 1953 as well as most 1953 models.

You'll save time and trouble when you use this valuable Stancor reference. Get it now from your Stancor distributor, or write us directly for your free copy.

FIVE NEW STANCOR EXACT REPLACEMENT FLYBACKS

Many of these units are the result of recommendations of the Stancor Servicemen Advisory board, composed of the top TV servicemen throughout the country.

PLUS A-8126, Universal vertical blocking-oscillator transformer for all Philco sets, including 1953 models.

Stancor Part No.	Exact Replacement For	No. of Models Using Flyback
A-8137	Hoffman #5035	29
A-8220	Philco #32-8555	24
A-8221	Philco #32-8565	18
A-8222	Philco #32-8533 & #32-8534	38
A-8223	Philco #32-8572	15



CHICAGO STANDARD TRANSFORMER CORPORATION

3588 ELSTON AVENUE • CHICAGO 18, ILLINOIS

EXPORT SALES—Roburn Agencies, Inc., 39 Warren St., New York 7, N. Y.

a 2-v error in bias could cause serious distortion of this kind, since 2 v across 100,000 ohms represents a leakage current of 20 microamps. If there is a dc potential of 100 v across the coupling capacitor, this leakage current represents a leakage of 5 megohms. If the grid resistor were 1 megohm instead of 100,000 ohms, the leakage necessary to produce a 2-v rise in grid potential would be 50 megohms instead of 5 megohms. Thus, the use of lower value grid resistors will mini-

(Continued on page 100)

Fig. 5. Schematic of section of audio amp illustrating how a small coupling capacitor can cause insufficient grid bias.

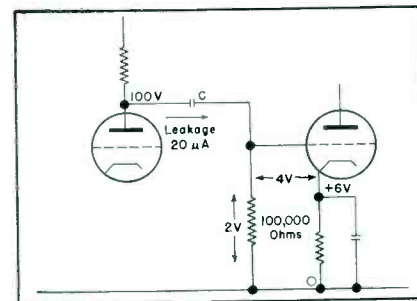

TV SERVICE ESSENTIALS



No. MA-4 Pocket Size Bar Generator
Provides actual bar pattern on TV receiver screen, portable and lightweight for on the spot linearly adjustments. Can be used when no stations are on the air to produce adjustable number of horizontal or vertical lines. Plugs on picture tube.
\$18.25 List Price

No. MA-4-AC Deluxe Bar Generator
Completely self-powered pocket size Bar Generator. Obtains operating power from wall outlet. Usable on all TV sets provides servicemen with a foolproof pocket sized Bar Generator that produces an adjustable number of horizontal or vertical lines. Plug-in unit.
\$24.80 List Price

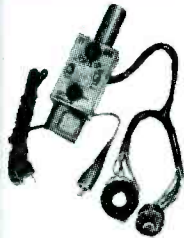

Picture Tube Rejuvenators

Renews brightness of low emission CRT. 488 for magnetic or electrostatic CRT; parallel filaments.

\$2.75 List Price

49C For standard focus CRT, parallel filaments.

\$2.50 List Price

50D For magnetic or electrostatic focus, series filaments.

\$3.40 List Price

51E Isolation rejuvenator for weak CRT having inter-element leakage. For any CRT using parallel filaments.

\$3.60 List Price



No. LVB-117 Line Voltage Booster
Corrects for low or high line voltage. 350-watts, for line voltages from 90 to 135 volts. Multi-tap selector and neon indicator for exact voltage boost. Fused to protect against unsafe voltage increases.
\$17.95 List Price
No. 3021 LVB Jr. (not shown) Budget Priced 350 watts, for 10 volt boost or straight through line. Priced for economy. **\$6.75 List**



No. 200K Variable Inductance, Universal Substitution Kit

For video, IF circuits; 8 variable coils cover range from 1 to 590 μ h; Q Max impregnation. Data enclosed on L, min, L max, Q, R, C dis., Res. Freq. Individual calibration charts permit adjustment without test equipment.
\$7.95 List Price

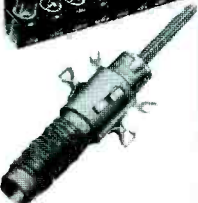

No. 10A Multi-Channel Converter
Pre-tuned for single channel application. Adjustable over 15 channel range without use of instruments. Double tuned, silver plated, high Q pre-selector. Single switch for on-off, VHF-UHF. Model 10A obtains its power from receiver through octal adapter plug. Model 10B complete as above but with 7 Pin adaptor plug.
\$22.50 List Price



CREST

84-11 Blvd.
Rockaway Beach, N. Y.

write for complete literature

Audio

(Continued from page 99)

mize the effect of any coupling capacitor leakage.

Often, however, a coupling capacitor can be wrongly blamed. In this instance, a check of voltage across the cathode resistor should show bias to be normal, or maybe slightly higher than normal, but the output waveform suggests that the grid has insufficient bias. So the coupling capacitor is suspected. A test shows its leakage to be low enough, and a replacement by a component known to be good does not eliminate the effect. This trouble has been found to be *rf* oscillation in the stage. The oscillation is not strong enough to block *af*, and natural filtering prevents it reaching the output at appreciable level, but the stage gently oscillates and builds up until the working g_m prevents it going further. When the audio signal comes along, the *rf* on top of it produces grid current before it would in the absence of the *rf* rider. This damps the *rf* oscillation suddenly, and the change appears in the output as a *knocking* sound, although the *rf* itself does not show up in the output.

Sometimes a knocking effect appears when all grid voltages are apparently

STATEMENT REQUIRED BY THE ACT OF AUGUST 24, 1912, AS AMENDED BY THE ACTS OF MARCH 3, 1933, AND JULY 2, 1946 (Title 39, United States Code, Section 233) SHOWING THE OWNERSHIP, MANAGEMENT, AND CIRCULATION OF SERVICE, published monthly at New York, N. Y., for October 1, 1953.

1. The names and addresses of the publisher, editor, managing editor, and business managers are:

Publisher: Bryan Davis Publishing Co., Inc., 52 Vanderbilt Ave., N. Y. C. 17; Editor: Lewis Winner, 245 W. 107th St., N. Y. C. 25; Managing Editor: None; Business Manager: R. S. Davis, Ghent, N. Y.

2. The owner is: (If owned by a corporation, its name and address must be stated and also immediately thereunder the names and addresses of stockholders owning or holding 1 percent or more of total amount of stock. If not owned by a corporation, the names and addresses of the individual owners must be given. If owned by a partnership or other unincorporated firm, its name and address, as well as that of each individual member, must be given.)

Bryan Davis Publishing Co., Inc., 52 Vanderbilt Ave., N. Y. C. 17; R. S. Davis, Ghent, N. Y.; M. T. Davis, Ghent, N. Y.; J. C. Munn, Cleveland 6, Ohio; P. S. Weil, Great Neck, L. I., N. Y.; G. E. Weil, Great Neck, L. I., N. Y.; F. Walen, Teaneck, N. J.; L. Winner, New York 25, N. Y.

3. The known bondholders, mortgagees, and other security holders owning or holding 1 percent or more of total amount of bonds, mortgages, or other securities are: (If there are none, so state.)—None.

4. Paragraphs 2 and 3 include, in cases where the stockholder or security holder appears upon the books of the company as trustee or in any other fiduciary relation, the name of the person or corporation for whom such trustee is acting; also the statements in the two paragraphs show the affiant's full knowledge and belief as to the circumstances and conditions under which stockholders and security holders who do not appear upon the books of the company as trustees, hold stock and securities in a capacity other than that of a bona fide owner.

(Signed) LEWIS WINNER, Editor

Sworn to and subscribed before me this 29th day of September, 1953.

(Seal) Catherine C. Pons, Notary Public

RADELCO

INDOOR ANTENNA

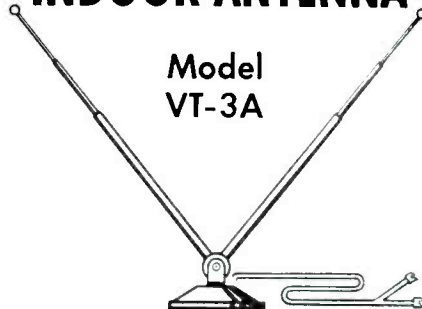

Model
VT-3A

... A high quality antenna, attractively designed and finished in mahogany lacquer to harmonize with all room furnishings. Three section, brass tubing masts with lustrous plate finish extend to 45" for fine reception. Heavily weighted base. Lead and terminals included. A real value!

ORDER FROM YOUR
NEAREST PARTS JOBBER

LIST PRICE
\$3.45

XCELITE Hand Tools
PREFERRED BY THE EXPERTS

4 NEW

"GOOD RIGHT HANDS"
FOR YOU!



- 10" TV STANDOFF INSULATOR PLIER, also a heavy-duty all-purpose plier, has grooved lower jaw, recessed upper jaw for non-slip grip to open or close standoff insulators (illustrated above).
- 6" XCELITE DIAGONAL PLIERS, drop-forged, with keen, hand-honed blades, like all XCELITE cutters.
- 7" DIAGONALS—these and the above added to our regular line by popular request.
- 8" SIDE CUTTER, a rugged "right hand" for you on 1001 jobs.

XCELITE INC.

Ask your supplier
or Write us today!

(Formerly Park Metalware Co., Inc.)
Dept. V
Orchard Park, N. Y.

For Originality
LOOK TO **XCELITE**

correct, and plate voltages and currents also check. How can this happen? This can only be explained by referring to tube characteristics.

Let us take a presentation of tube characteristics that plots plate current and voltage for a series of fixed values of grid potential. Fig. 6 shows a set of such curves for a pentode or beam tetrode. These curves simply mean that for each value of grid voltage the combination of plate current and voltage must lie somewhere on the curve for that value of grid voltage, the exact position of the curve depending on what is connected in the plate circuit. The kind of coupling that gives the trouble now being discussed is transformer or choke, in which the *dc* resistance in the plate feed is low, but the dynamic load coupled in the circuit may be high.

Waveform Flattening

Let us suppose *A* is the plate supply voltage when the tube draws no current. The tube is biased to point *B*, *AB* being the resistance drop in the transformer or coupling choke winding; *CD* is a normal load line due to the dynamic impedance coupled into the plate circuit. Proportionate changes of grid voltage produce proportionate changes of plate voltage and current, as indicated by the fact that the load line crosses the various grid voltage characteristics with reasonably uniform spacing between them. *EF* is a load line representing too high a dynamic load impedance. It will be noticed that at its top end the curves representing the two most positive voltages run together; thus there will be no change in plate voltage and current for this region of grid voltage chain. This will cause flattening of the waveform exactly like that due to grid current with insufficient bias, and will result in reproduction characterized by the knocking sound.

High Dynamic Load Causes

Now why should the dynamic load get too high? Well, a 15-ohm unit might be connected to an output transformer designed to feed a 2 or 3-ohm unit.

Sometimes, however, the nominal impedance of the voice coil may be satisfactory, but its dynamic impedance in the vicinity of the low-frequency resonance of the diaphragm can rise sufficiently to produce the effect in this restricted frequency range only. The

MORE SERVICEMEN ARE USING FENWIRE THAN EVER BEFORE!

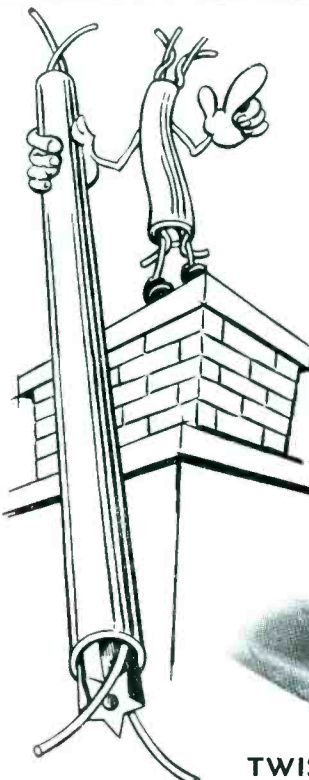

Sold through qualified jobbers only



TWISTUBE*
300-ohm Round Transposed Semi-Airspaced Tubular Line.
Besides being airspaced it is the *only* transposed transmission line created to reduce interference pickup.



FENTUBE AIRSPACED*
300-ohm Oval Tubular Line.
Better because NO dielectric between conductors nor contact between conductors and wall. Performance not affected by outside atmospheric changes.

*U.S. and British Patents Pending

Frequency—MC	50	100	500	700	900
Attenuation —db/100					
FENTUBE—AIRSPACED	.72	1.06	2.6	3.2	3.8
TWISTUBE	.74	1.16	2.68	3.29	3.93



Tuf-Guy *Toughest, most durable guy wire on the market.

FENTON COMPANY
15 MOORE STREET • NEW YORK 4, N. Y.
Tel. Bowling Green 9-3445-6

Write Dept. S-11 for literature on complete FENWIRE line.

effect will be as if knocking occurs at the low-frequency resonance of the speaker unit. A judicious use of negative feedback will overcome this, by reducing the grid swing in the vicinity of resonance. From the loudspeaker's viewpoint, this may be regarded as reducing the plate resistance of the tube, and improving the damping on this resonance. Thus the travel is cut down and the overall effect is precisely the same as if excessive travel at resonance were actually causing voice coil knocking at this one frequency.

Fig. 6. Plot of tube (pentode or tetrode) characteristics showing how too high a plate load can cause knocking distortion: *A*=plate-supply voltage; *B*=point at which tube is biased; *AB*=resistance drop in transformer or coupling choke winding; *CD*=normal load line; *EF*=load line representing too high a dynamic load impedance.

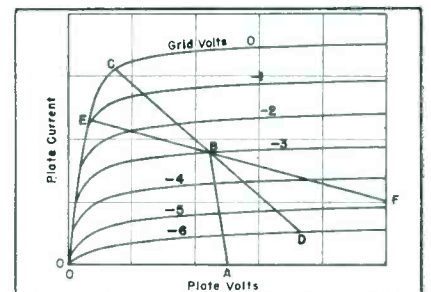

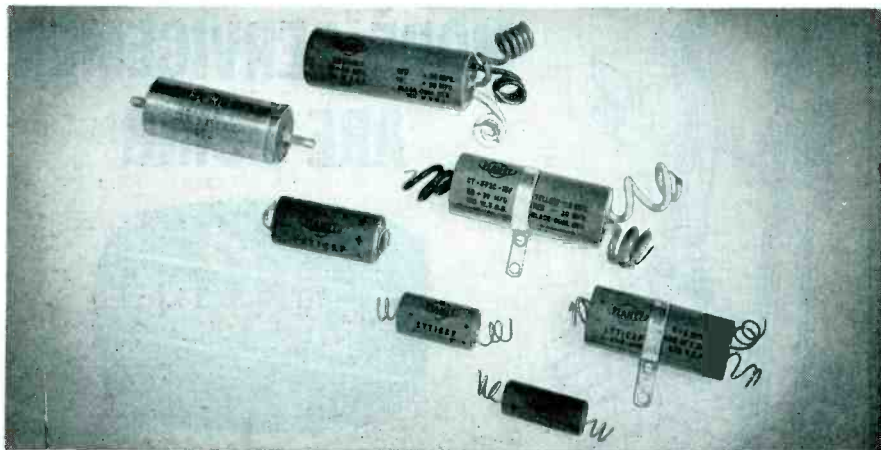

Planet Capacitors "Engineered for Quality"

1 year service guarantee

Custom engineered to your specifications or supplied from stock, Planet capacitors meet the highest standards of the industry. Every capacitor is tested mechanically and electrically throughout its manufacture.

This rigid system of quality control makes our unconditional one-year guarantee possible. But making Planet capacitors right from the start means reasonable prices too!

PLANET MANUFACTURING CORPORATION

225 BELLEVILLE AVENUE
BLOOMFIELD, N. J.



WRITE for Catalog 206-B, listing specifications on stock items.

Coming Event

Radio Engineering Show . . .
Kingsbridge Armory, Bronx, N.Y.C.
March 22, 23, 24 and 25, 1954



the answer to
every serviceman's prayer

Vidaire FIL-TEST

New WAVE TRAP METER Accurately
Determines Type of Line Filter or Antenna
Wave Trap Within Seconds.

- Eliminates installing individual filters or wave traps
- Simple switching arrangement
- Eliminates hours of trouble shooting TVI
- Reduces serviceman's inventory of filters and traps
- Each component in the FIL-TEST matches stock filters and traps

See your local VIDAIRE Distributor Now!



model
FT-100



ELECTRONICS
MFG. CO.,
LYNBROOK, N. Y.

Vidaire

NAT'L SALES OFFICE: 6 E. 39TH ST., NEW YORK 16, N. Y.
LEXINGTON 2-7372

FREE! GET THIS BOOKLET—
NOTHING TO BUY

VIDAIRE ELECTRONICS MFG. CO.,
6 E. 39th ST., NEW YORK 16, N. Y.

SEND ME YOUR FREE BOOKLET "TV INTERFERENCE
AND ITS REMEDIES," WITHOUT OBLIGATION.

NAME _____

ADDRESS _____

CITY _____ STATE _____

Servicing Helps

(Continued from page 69)

the sweep signal at the input electrode. The shape of the resulting video response curve should then be compared with the first curve. If a difference in shape is noted, it may be concluded that the sweep generator is operating incorrectly, although further tests will then be required to pinpoint the difficulty.

Slow Recovery Time in 'Scope

SOME 'SCOPES have a much quicker recovery time than others, due to the use of *dc* coupling networks instead of *ac* coupling. An easy check of recovery time can be made by turning quickly a centering control to determine whether the beam immediately follows the adjustment, or whether there is a time lag in beam response. In the case of *dc* coupling it may appear that no time lag is present in the beam response.

Removing Tweets in the UHF Spectrum‡

TWEETS appearing in the *uhf* band are a result of the incoming signal beating against the set's local oscillator. The resulting frequencies fall in and around the video *if* frequency spectrum. When this is amplified and reproduced on the picture tube, the picture detail becomes slightly distorted with what appears to be *rf* lines throughout the picture.

A simple solution in the field is to readjust the 130-mc slug in the tuner. This slug on Columbia chassis is located on the front of the tuner and sticks out much further than the adjustment slugs for the *vhf* adjustments.

This adjustment can be made while looking at the picture. It will be noted that in making this adjustment, the slug will have to be rotated a few turns before any noticeable change in the picture is achieved.

Line-Frequency Inaccuracy

IT IS SOMETIMES considered that the 60-cycle power-line frequency is extremely accurate for audio-oscillator calibration purposes, etc., because electric clocks keep very good time. It must be observed that electric clocks keep good time *on the average*, but that appreciable short-time inaccuracies may be encountered. Hence, the Service Man should choose a certain period (mid-afternoon, or late evening) to make use of the 60-cycle power-line frequency as a standard. A telephone call to the local utility will serve further to determine what order of accuracy may be reasonably anticipated at the time.

‡ From CBS-Columbia service notes.



ARE YOU GETTING A GOOD PICTURE HERE?

AND LOSING IT BEFORE IT GETS HERE?



WRITE FOR FREE CIRCULAR

R. J. BUCHAN CO.

BRICELYN 3 MINN.

GET CLEAR SHARP RECEPTION

WITH THE NEW LL300

OPEN WIRE LINE



300 OHMS IMPEDANCE

This results in maximum signal transfer from antenna to set.

EXTREMELY LOW LOSS

Air dielectric plus clear polystyrene spacers results in the lowest possible loss of signal.

LESS NOISE PICKUP

Close spacing plus perfect impedance match results in lowest possible noise pickup.

EASILY INSTALLED

Conventional hardware for 300 ohm ribbon lines are perfect for LL300 open wire line.

LONG LIFE

Copperweld conductors, polystyrene spacers, plus light weight and low wind resistance result in virtually indefinite life.

EASY TO USE SPOOLS

Packaged on 100, 150, 200, 250' convenient, easy to use spools.

If not available through your regular Jobber, order direct, immediate shipment via parcel post. Dealer cost \$4.95 per 100 feet.

PERFECT FOR VHF - UHF INSTALLATIONS

Hi-Fi Tuner Maintenance

(Continued from page 54)

10 mmfd. The compensating capacitor is placed next to the oscillator coil physically, so that it will be subject to the same heat environment as the coil. Some commercial designs use the compensating capacitor in series with the oscillator trimmer rather than in parallel with it, but the effect is the same.

This method cannot be used to compensate for drift in the downward direction on the dial.

Weak, Distorted, or Noisy FM Signal

Weak and distorted FM reception, accompanied by increased background noise, is very often the result of insufficient signal going into the limiter or ratio detector circuits. The operation of a tuning eye can be used to confirm this diagnosis; when the eye is affected little or not at all by the station carrier the trouble is probably a case of insufficient carrier voltage. It then becomes necessary to find out just where the signal strength is being lost.

Normal functioning of the antenna is the first thing to be checked. Broken leads, broken or bent antenna elements, misorientation of the antenna, especially in critical signal areas, and bad connections at the tuner terminals can all contribute to faulty reception. In strong signal-strength locations the temporary substitution of an indoor antenna made up of 300-ohm twinlead can reveal whether the antenna is responsible for the trouble.

The tubes must be checked next, preferably by substituting for each tube in turn, leaving the replacement tube in the set if performance is improved. It must be remembered that changing the oscillator or converter tube will probably require retuning of the receiver.

Another source of poor reception is misalignment of the FM circuits. Here a knowledge of the history of the receiver trouble, combined with common sense, can indicate whether it is worth tampering with the alignment adjustments. If the set has been functioning normally and then suddenly fails, for example, misalignment can be eliminated as a likely source of trouble. On the other hand, if the set has been getting worse over a very long period, has recently been subject to rough handling in moving, or has been through the hands of an amateur

(Continued on page 104)

Save TV Alignment Time
with the **EAZY** to use **Align-O-Pak**
TV alignment Bias Battery Eliminator



★ **Quickly determines AGC troubles**

Think of the time wasted connecting batteries in series - - - The **Align-O-Pak** provides all the voltages recommended by these leading TV manufacturers:

- ADMIRAL 1½-4½v
- MOTOROLA 3v • PHILCO 7½v
- RCA 1v • ZENITH 2v Variable.

- ★ Forget messy Bias Batteries
- ★ Fix only TWO AGC troubles and your Align-O-Pak is paid for
- ★ Just Plug it in - - -
- ★ Provides from 0 to 10 Volts BIAS Instantly
- ★ Completely isolated from Power Line and Case

Only \$7.85 DEALER NET

INSTRUCTIONS

FOR ALIGNMENT: Plug Align-O-Pak in and turn unit on. Connect black lead to the Receiver AGC buss and red lead to B minus (usually chassis). Set Align-O-Pak knob to voltage recommended by TV manufacturer.

FOR AGC TROUBLE SHOOTING: With Align-O-Pak connected as described above, turn control knob slowly from 0 to 10. If normal picture appears, AGC is defective.

Carried by leading jobbers!

SI SERVICE INSTRUMENTS COMPANY
422 South Dearborn Street, Chicago 5, Illinois

WHEN YOU CHANGE YOUR ADDRESS

Be sure to notify the Subscription Department of SERVICE at 52 Vanderbilt Avenue, New York 17, N. Y., giving the old as well as the new address, and do this at least four weeks in advance. The Post Office Department does not forward magazines unless you pay additional postage, and we cannot duplicate copies mailed to the old address. We ask your cooperation.

Windsor TUBES

RADIO & TV RECEIVING

TESTED and
GUARANTEED
for **PEAK**
PERFORMANCE

TO MERIT YOUR CONFIDENCE—to insure your satisfaction—Every tube we ship has been tested in a radio or TV set for **PEAK PERFORMANCE**. Each tube is attractively packaged in individual carton—and, **EACH WINDSOR Tube you buy carries the full RTMA GUARANTEE!**

Type	Each	Type	Each	Type	Each	Type	Each	Type	Each	Type	Each
1A7GT	.567	1U4	.61	6AT6	.42	6E5	.72	6x4	.37		
1B3GT	.69	1U5	.51	6AU5GT	.85	6F5GT	.54	6X5GT	.36		
1C6	1.06	1X2A	.74	6AU6	.47	6J5GT	.44	6Y6G	.64		
1E7GT	1.09	2A7	.74	6AV6	.41	6J6	.68	7A4/XXL	.57		
1H5GT	.51	2X2	1.43	6AX4	.72	6J7	.70	7A5	.70		
1H6	.93	3L4	.76	6B8G	.93	6K6GT	.45	7A6	.57		
1J6	.93	3Q4	.66	6BA6	.50	6K7	.70	7A7	.58		
1L4	.63	3Q5GT	.72	6BA7	.66	6L6G	.88	7B8	.56		
1L6	.66	3S4	.61	6BC5	.58	6L6GA	.88	7AD7	1.05		
1LA4	.82	3V4	.62	6BD5GT	.98	6Q7GT	.55	7AF7	.63		
1LA6	.89	5R4GY	1.00	6BD6	.54	6S4	.51	7AG7	.65		
1LB4	.82	5U4G	.44	6BE6	.51	6S8GT	.75	7AH7	.65		
1LC5	.80	5V4G	.83	6BF5	.66	6SA7GT	.57	7AJ7	.70		
1LC6	.80	5Y3G	.37	6BF6	.43	6SC7	.63	7B4	.54		
1LD5	.80	5Y3GT	.32	6BG6G	1.47	6SD7	.55	7B5	.51		
1LE3	.80	5Y4C	.43	6BH6	.63	6SF5GT	.66	7B6	.52		
1LG5	.80	6A8GT	.68	6BJ6	.53	6SH7GT	.52	7B7	.58		
1LH4	.80	6AB4	.51	6BK5	.52	6SJ7GT	.52	7C4	1.05		
1LN5	.80	6AC5GT	.82	6BK7	.97	6SK7GT	.55	7C5	.56		
1N5GT	.63	6AG5	.59	6BL7GT	.94	6SL7GT	.68	7C6	.50		
1P5	.76	6AH4	.68	6BN6	.98	6SN7GT	.59	7C7	.58		
1Q5	.72	6AK5	1.05	6BQ6GT	.98	6SQ7GT	.46	7E5	.85		
1R4	.85	6AL5	.44	6BQ7	.92	6T8	.85	7E6	.65		
1R5	.62	6AQ5	.51	6BZ7	1.09	6U8	.86	7E7	.85		
1S4	.67	6AQ6	.47	6C4	.41	6V3	1.09	7F7	.69		
1S5	.52	6AQ7	.75	6CB6	.58	6V6GT	.51	7F8	.97		
1T4	.62	6AR5	.42	6CD6G	2.04	6W4GT	.50	7G7	.85		
1T5GT	.78	6AS5	.55	6D6	.63	6W6GT	.63	7H7	.61		
								7J7	.85		
								7K7	.85		
								7L7	.85		
								7N7	.62		
								7Q7	.62		
								7R7	.70		
								7S7	.90		
								7V7	.92		
								7X6	.62		
								7Y4	.45		
								7Z4	.50		
								12AT6	.53		
								12AT7	.75		
								12AU6	.47		
								12AU7	.58		
								12AV6	.41		
								12AV7	.87		
								12AX4	.72		
								12AX7	.67		
								12AY7	2.15		
								117Z3	.43		



FREE! WINDSOR TUBE CADDY



The most practical Service-Aid ever designed for the radio and tv repairman. This ideal television carry-all now offered free with every purchase of \$160.00 or accumulated purchases totalling \$160.00 within 90 days. (You get caddy credit memo with each purchase.)

- Carries approximately 125 tubes including meters and tools.
- 16 1/4 inches long x 8 1/4 inches wide x 1 3/4 inches high.
- Weighs only nine pounds.
- Ruggedly constructed with heavy leatherette covering, strong plastic handle, nickel plated hardware, and reinforced with metal clamps.

Windsor Tube Caddy may also be purchased outright for **\$14.95**

Don't Miss This Sensational Offer!

Windsor ELECTRONIC TUBE CO.
1515-S SHEEPSHEAD BAY ROAD, BROOKLYN 35, N. Y.

Hi-Fi Tuner Maintenance

(Continued from page 103)

expert, an alignment check is indicated.

There are two simplified procedures that can be used to check and correct temporarily FM set alignment with a minimum of equipment. A more complete alignment, with a 'scope and sweep generator, can be performed in the shop when necessary.

The first procedure requires a standard AM signal generator, tuned to the intermediate frequency of the FM receiver (almost always 10.7 mc), and set to amplitude-modulated rf output. The test signal usually may be injected directly at the antenna terminals (enough of the if gets through the rf preselector circuits to work with) but the standard procedure of applying the signal to the various grids in turn can also be followed.

The FM detector will probably be sufficiently out of perfect alignment to respond to some amplitude-modulated input, and the result will be a 400-cycle tone (the standard signal generator modulation frequency) in the speaker. At this point it is possible to really get off the beam. Before an adjustment screw is touched it is absolutely necessary to be sure that the signal in the speaker is an if signal and no other heterodyned product. The presence of the if signal will be indicated by the fact that turning the main receiver tuning capacitor back and forth has absolutely no effect on the received sound. The oscillator plates of the tuning capacitor can be shorted out with a screwdriver as a precaution against using the wrong signal.

Normal adjustment procedure is to align the if's, limiters, and detector primary first, and the detector secondary last. In this case, however, the alignment is partly in the nature of a diagnostic test; we are not sure that the set needs alignment. When the main symptom is noise and distortion, but the signal appears loud, it is quite possible that only the secondary winding of the discriminator or ratio detector, the most critical of the tunable circuits, is out. In such a case the wisest course to follow is to tune the signal generator according to loudest receiver dial calibration (observing the precaution just noted about the if signal), adjust only the detector secondary screw for minimum signal, and then remove the signal generator and see if the receiver has been repaired.

The detector secondary adjustment should be made for minimum or zero signal because a properly functioning

Fig. 5. Setup for FM alignment procedure, using an AM signal generator set to 10.7 mc, modulated for rf.

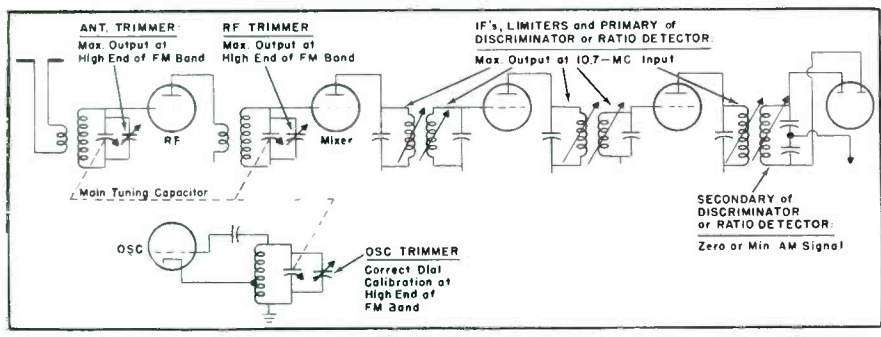

NEW Multi-Purpose Flyback Transformer

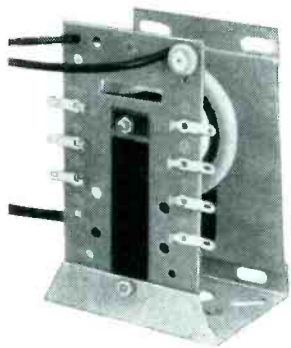

Halldorson FB410

NOW—Replace All these Mounting Types

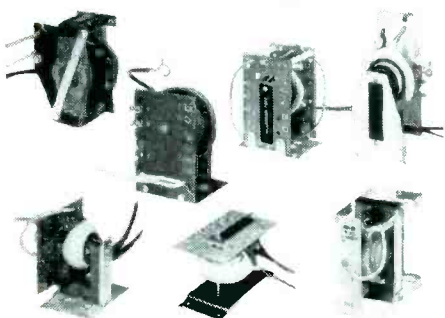

...without Drilling a Single Hole!

Here is a flyback so versatile that it is a "complete stock assortment in itself"! Works with *original* circuit components. Accommodates both low and high MH width controls. Matches 8 to 25 MH yokes. Generates from 10 to 15 KV for 10" to 21" picture tubes. Has separate winding for AGC/horizontal phase detection. Equipped with exclusive universal mounting brackets. *Standardize* with Halldorson FB410, only \$5.97 Dealer Net.

WRITE OR ASK YOUR DISTRIBUTOR FOR—

BULLETIN NO. 113—Illustrates versatile features of FB410 Flyback Transformer.

BULLETIN NO. 114—Contains circuit diagrams and technical application data.

HALLDORSON TRANSFORMER CO.
4500 Ravenswood Avenue
Chicago 40, Illinois



FM detector responds only to frequency modulation, not amplitude modulation. There should be a clearly defined null point, with sound on both sides.

To align the detector primary, *if* stages, and limiters by the foregoing method, the detector secondary must be somewhat out of alignment to pass AM. If it is not sufficiently out, a few turns must be given to the screw until the AM signal comes through. The cans are then adjusted for maximum signal, using as weak a test input as possible. After this procedure has been completed the detector should be adjusted, as described for minimum signal.

The oscillator, *rf*, and antenna circuit trimmers must be adjusted according to the same principles followed in AM receivers. The oscillator parallel trimmer controls correct dial calibration at the upper end of the band; the oscillator series padder (used when the variable capacitor does not have a cut section, but rare nowadays), controls dial calibration at the bottom of the band. The *rf* and antenna circuit trimmers should be adjusted for maximum signal, with the receiver tuned to a test signal or station at the high end of the band. A particular mid-band station can be favored, however, by making the last two adjustments with the desired station tuned in.

FM receivers can also be aligned without any test equipment at all. This is not a recommended procedure, but an emergency measure which may serve to improve performance considerably until better test facilities are available.

The emergency adjustment of the detector secondary can be made under the following conditions: 1—Volume control high; 2—Treble control all the way up; and 3—Station tuned in very carefully, if possible with the aid of a tuning eye, otherwise for minimum background noise. The ideal moment to make this adjustment is during a period of program silence, such as may occur just before or just after an announcement. In general, it is easier to make the adjustment on speech rather than music, since music tends to mask the high pitched hiss that we are trying to eliminate. Alignment should be for a definite null point of silence, with hiss on both sides, and maximum clarity of reception in the middle.

The tuning of the detector primary, limiters, and *if*'s for maximum volume on program material is extremely difficult, and tends to be inaccurate unless

(Continued on page 106)



**FREE!
NEW '54
EDITION**

**SIMPLIFIES
TV ANTENNA
INSTALLATIONS
AND SALES**



TV ANTENNA TIPS



**INCLUDES
LATEST UHF/VHF
DATA & EXCLUSIVE
"ANTENNA SELECTOR"**

Completely revised by TV authorities Matt Mandl and Ed Noll, this essential pocket size manual includes the exclusive "Antenna Selector", Directronic Antennas, Dimension Guide, Channel Frequencies, Proper Feed Methods, Helpful Hints... everything about every type of TV antenna.

**FREE To TV Servicemen,
Service Dealers,
Dealers, Distributors, Hams,
Salesmen, Manufacturers**

Publication Price \$1.
Yours free if you write at once.
—MAIL THIS COUPON TODAY—

SNYDER MFG. CO., Dept. A
22nd & Ontario Sts., Phila. 40, Pa.
Please send free copy of TV ANTENNA TIPS

Name _____
Address _____
City _____ Zone _____ State _____



**New 1954 TV CONSULTANT
TV Serviceman's Silent Partner**



New, easy-to-use way to solve toughest TV troubles. UHF sect. includes conversions, installations and servicing. Modern alignment methods shown by pictures, diagrams and simple directions, tell exactly what to do and how to do it. Practical pointers on use of all TV Test Instruments. Over 300 pix, raster and sound symptoms. Detailed directions tell where and how to find faulty parts. Over 135 RAPID CHECKS, many using pix tube as trouble locator. 125 illustr. of scope wave forms, diagrams, station patterns, show various defects—take mystery out of TV servicing. **NO THEORY—NO MATH—NO FORMULAS**—just practical service info. covering all types of TV sets.

Only...\$2

**NEW! Trouble Shooting PIX GUIDE
incl. TV TERMS Explained**

Sec. 1 is a fully illustrated GUIDE to oft-recurring pix faults. Causes and cures explained. Copyrighted Trouble Indicating illustrated chart tells where troubles start in typical TV set—illustrations show resulting faulty TV pictures. Sec. 2 explains hundreds of TV terms in non-technical language. SPEEDS UP TV SERVICING—HELPS YOU DO A BETTER JOB FASTER!



Only...\$1

NEW! TV TUBE LOCATOR



Money-making Time Saver tells which tubes to replace to cure every type of tube trouble. Over 155 such TV troubles listed with clear charts for quickly locating the faulty tubes. Copyrighted TROUBLE INDICATING TUBE LOCATION GUIDES for over 3000 most popular models from Admiral to Zenith, 1947 to 1953 models. A storehouse of valuable TV servicing info. priced very low for large volume sales.

Only...\$1

NEW! TV TROUBLE TRACER

70 Common TV troubles traced to source and cured. Copyrighted trouble indicating tube location guides covering over 500 most popular TV models. Many models differ from those shown in TV TUBE LOCATOR. Contains over 70 illustrations and tube location guides. Forty most common picture troubles illustrated, with symptoms described, causes given and remedies prescribed.

Only...50¢



H. G. CISIN, PUBLISHER

Order from your Jobber today, or if not stocked, write to

Harry G. Cisin, Dept. S-17

200 Clinton St., Brooklyn 1, N. Y.

Enclosed find \$_____ Send

- TV Consultant TV Locator
 TV Pix Guide TV Tracer

NAME _____

ADDRESS _____

CITY _____ ZONE _____ STATE _____

Hi-Fi Tuner Maintenance

(Continued from page 105)

the receiver has a tuning eye. As with the detector adjustment, extreme care must be used in tuning in the station.

Improper operation of FM receivers that do not possess tuning eyes or *afc* can also result from a lack of understanding on the part of the user rather than from defects in the receiver itself. FM stations are not tuned for maximum volume, but for a null point in the background hiss, plus maximum clarity. Advancing the volume and treble controls during tuning, as described, facilitates correct adjustment. Some receivers exhibit more than one tuning point per station; the correct one has least noise and gives the clearest signal.

A further source of distortion in FM receivers appears in the faulty performance of limiter circuits. Tube characteristics may have changed (a change which may very well not be apparent on a tube checker) or circuit voltages may have altered. Since a change of plate or screen voltage can affect proper limiting action, these voltages should be measured and compared to their rated values.

Another tuner difficulty which tends to show up on high-fidelity systems with good bass response is hum originating in the *rf* circuits, called modulation or tunable hum. This disturbance, together with other types of hum, will be discussed next month.



"I've had no trouble keeping him at home now that I've had a JENSEN NEEDLE installed."

Every issue of SERVICE features top technical coverage on every phase of radio, TV and electronic servicing... vital information for Service Men every month!

Brand New Set Mfr's SURPLUS TUBES STANDARD BRAND WARRANTY

Bulk Packed in Original Mfr's Neatly Cartons or Individually Boxed
Every tube meter and chassis tested for top quality... BRANDED

1B3GT54	6AC771	6BH649	6SN7GT49	19BG6G119
11450	6AH664	6BJ649	6T861	19T861
1R549	6AK579	6BL7GT79	6V6GT41	25BQ6GT82
1S455	6AL537	6BQ779	6W4GT41	25L6GT41
1S541	6AQ541	6BQ6GT79	6W6GT31	35B549
1T449	6AG519	6BK771	6X5GT34	35C549
1U449	6AT634	6C431	12AT634	35L6GT15
1U541	6AU637	6C544	12A760	35W432
1X2A55	6AV634	6C645	12AU637	35Z536
3Q5GT58	6B4G82	6CD6G111	12AU749	50B549
3S449	6RA636	611641	12BA641	50C549
3V149	6BC549	6J5GT37	12BE641	50L6GT15
5U4G37	6BE641	6J651	12BH756	
5Y3GT31	6BG6G119	6K6GT37	12SN7GT49	

More than 400 types in stock. Include all your needs when ordering.

Orders less than \$10.00—add \$1.00 service charge. Terms: 25% with order, balance C. O. D. Please include postage. All prices subject to change without notice. F.O.B. New York City. Mail order division.

TRANSAMERICA ELECTRONICS CORP.

120 LIBERTY ST., NEW YORK 6, N. Y. • COrtlandt 7-4307



24 HOUR
DELIVERY
FROM STOCK!

RELAYS

Our stock of more than a million relays — in over a thousand different types — is the world's largest. Don't delay your production for want of large or small quantities of relays of any type.

Telephone, wire or write for quotations.

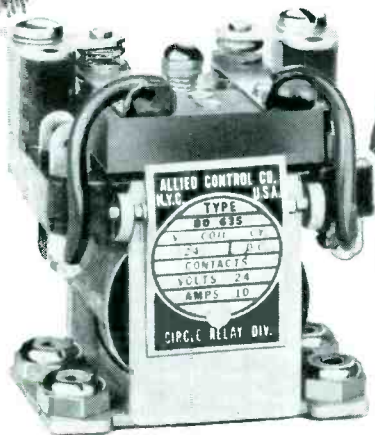

NEW AND MORE
COMPREHENSIVE

1954
RELAY SALES
CATALOG No. C5
NOW READY

Be sure to send
for your copy



4721 W. MADISON
DEPT. 15, CHICAGO 44, ILL.

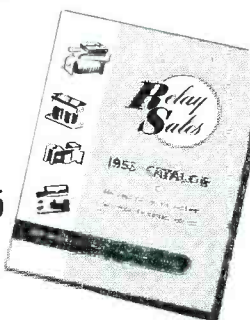

Telephone
SEeley 8-4146

Ser-Cuits

(Continued from page 58)

then be removed from the assembly by compressing the two spring tabs on the top tuning core securing clip.

In the electronic late-model changes the horizontal output tube was changed from 25AV5 to 25BQ6; the 25AV5 tube was used in first production models.

The diode load resistor was changed from 3,900 ohms to 3,000 ohms.

In the third and fourth production models the horizontal output transformer and yoke were also changed. Receivers using these revised sweep components bear a label on the *hv* compartment rear door which indicates the catalog numbers of the horizontal output transformer and yoke contained therein. (Models 17C125 and 20C107 use horizontal output transformer RTO-130; 21 models use RTO-129. The yoke to be used with either of these transformers is RLD-050.) The new components should not be used in those receivers which used the *early* type transformer and yoke, unless a *late* transformer and a *late* yoke are simultaneously installed. These receivers using late sweep components are rubber-stamped with *No. 430* and include changes of *No. 420*.

Late production receivers also incorporate a *delayed agc* system which prevents the application of negative *agc* bias to the *rf* tuner unit on all signals below a predetermined signal level. Thus on weak signals the *rf* amplifier operates at maximum gain and hence improves the signal-to-noise ratio. The *if* stages, however, receive the normal nondelayed *agc* voltage from the clipper circuit, or from the crystal diode.

In operation the *agc* voltage, which originates from the clipper grid circuit is fed through a 680,000-ohm resistor (R_{203}) and thence to the *rf* tuner through a decoupling filter consisting of a 470,000-ohm resistor and a .5-mfd capacitor (R_{180} and C_{151}). A 6.8-meg-ohm resistor (R_{202}) feeds a small positive *dc* voltage into the junction of R_{203} and a bypass capacitor (.1-mfd, C_{151}). The diode of $\frac{1}{2}$ of a 6T8 is tied between this point and ground, the purpose of which is to prevent the voltage at this point from going positive in the absence of signal or in the presence of weak signals. Hence, the voltage appearing on the *rf* tuner *agc* will theoretically remain at zero volts *dc* until a sufficiently strong signal is received which will develop enough negative *agc* bias voltage to overcome the small applied positive delay volt-

(Continued on page 109)

Eliminate
major mechanical
changes



with TRIAD TRANSFORMERS

Triad doesn't expect a serviceman to reconstruct or re-engineer a television chassis to accommodate a replacement part.

For that reason every Triad television component is circuit tested.

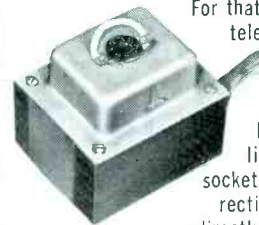

As an example, Triad's R-BS Series Power Transformers, listed below, are tube socket types for use where rectifier tube is mounted directly on the transformer.

They are made for under-chassis or top-chassis mounting and are exact replacements for many popular chassis.

Type No.	Plate Supply		Filaments—Volts and Amperes	
	AC Volts	DC Ma.		
R-47BS*	725 V.C.T.	225	5V.—3A.	6.3V.—10A. 6.3V.—2.7A.
Tube socket type, wired for 5U4G and designed to deliver 360 V. into 80 m.f.d. condenser, low capacity damper tube winding.				
R-48BS*	750 V.C.T.	180	5V.—3A.	6.3V.—9A. 6.3V.—2.7A.
Tube socket type, wired for 5U4G and designed to deliver 375 V. into 80 m.f.d. condenser, low capacity damper tube winding.				
R-49BS*	650 V.C.T.	240	5V.—3A.	6.3V.—9A. 6.3V.—9A. 6.3V.—1.2A.
Tube socket type, wired for 5U4G and designed to deliver 325 V. into 80 m.f.d. condenser, low capacity damper tube winding.				

*B means Horizontal Mount; S, Socket Type

Triad Television Components will simplify and speed your service work. See your jobber for Triad Television Components, catalogs and replacements guides, or

Write for Catalogs TR-53C and TV-53C



! NOW VIKING SELLS DIRECT !

"THERE'S NO SALE LIKE WHOLESALE"

70% TO 90% OFF LIST

VEE BOXED—BRANDED—TUBES FULLY GUARANTEED

1B3	\$.63	6BA6	\$.45	12AT6	\$.43
1R5	.56	6BC5	.53	12AT7	.68
1S4	.61	6BE6	.46	12AU6	.43
1S5	.47	6BG6	1.34	12AU7	.53
1T4	.56	6BJ6	.48	12AV6	.37
1U4	.55	6BK7	.88	12AV7	.79
1U5	.46	6BQ6	.89	12BA6	.45
1X2	.67	6BQ7	.98	12BE6	.47
3Q4	.60	6C4	.37	12BH7	.63
3Q5	.65	6CB6	.53	12SA7	.52
3S4	.55	6CD6	1.85	12SK7	.50
3V4	.56	6J5	.40	12SN7	.54
5V4	.40	6J6	.62	12SQ7	.42
5V4	.73	6K6	.41	19BQ6	1.39
5Y3	.29	6S4	.46	25BQ6	.89
6AB4	.46	6SA7	.52	25L6	.48
6AC7	.75	6SK7	.50	25W4	.48
6AG5	.54	6SN7	.54	25Z6	.42
6AK5	.95	6SQ7	.42	35L6	.47
6AL5	.40	6T8	.77	35W4	.30
6AQ5	.45	6V6	.46	35Z3	.18
6AT6	.38	6W4	.45	35Z5	.30
6AU5	.78	6W6	.57	50B5	.47
6AU6	.43	6X4	.34	50C5	.47
6AV5	.78	6X5	.33	50L6	.47
6AV6	.37			117Z3	.39

All Orders sent C.O.D. plus Postage.
Quantities limited. Minimum order \$5.
Prices subject to change.

ORDERS SHIPPED PREPAID
IF CHECK IS ENCLOSED.



VIKING ELECTRONICS CORP

112-07 FRANCIS LEWIS BOULEVARD, DEPT. S-11
QUEENS VILLAGE 29, N. Y.

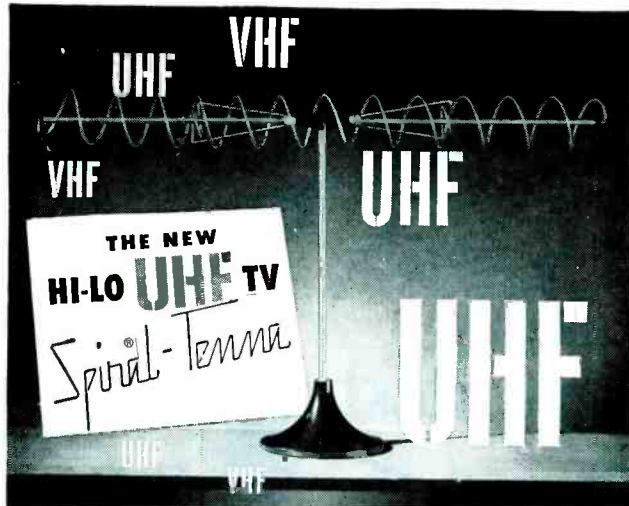

Peak Performance for Indoor UHF and VHF Television Reception

Model
202 U-V

Now — the nationally advertised, consumer accepted HI-LO TV Indoor Spiral-Tenna is applicable for both VHF and UHF with our exclusive UHF antenna adapter from channels 2-83. But, you still get the volume by selling at the same low, low price.

The Hi-Lo UHF antenna adapter is available separately for all previous HI-LO antennas.
List Price \$2.00.

Sold by recognized jobbers

at the same
low list price!

U. S. Patent No. 2,495,579 Canadian patents 1951 — other patents pending
ORDER HI-LO UHF-VHF TV Spiral-Tenna TODAY!

Hi-Lo TV ANTENNA CORP.
3540 N. Ravenswood • Chicago 13, Illinois

\$9.95
LIST PRICE

Color TV Tests

(Continued from page 37)

were transmitted to the DuMont experimental transmitter and broadcast by *uhf* to the Waldorf-Astoria. At the Waldorf the *uhf* signal was converted to channel 6 and distributed to the receivers.

DuMont Power

During this portion of the demonstration the DuMont transmitter oper-

ated with a visual power of 300 watts and an aural power of 150 watts, on 708-714 mc.

Early FCC Approval Seen

The tests were described by FCC spokesmen as very satisfactory. It was felt that certainly within the next 60 days or so, compatible color standards will be officially approved.

SIMPSON ELECTRIC HONORS 12 EMPLOYEES

Five and ten-year service pins were awarded to twelve employees of Simpson Electric Company of Chicago recently.

Ten-year service pins went to *Norbert Brennan*, tabulating; *Helen Mullen*, dc meter line; *Phyllis Poppo*, pivot; *Caroline Anderson*, dc meter line; *Frances Behne*, armature; *Carol Miller*, dc meter line; *Veronica Schlinkert*, armature, and *Frank Skamulis*, foreman, molding department, Lac du Flambeau plant in Wisconsin. Four employees were granted five-year pins: *Christine Balok*, ac meter; *Esther Prince*, radio; *Evy Rona Drake*, radio, and *Geraldine Wagner*, switchboard.

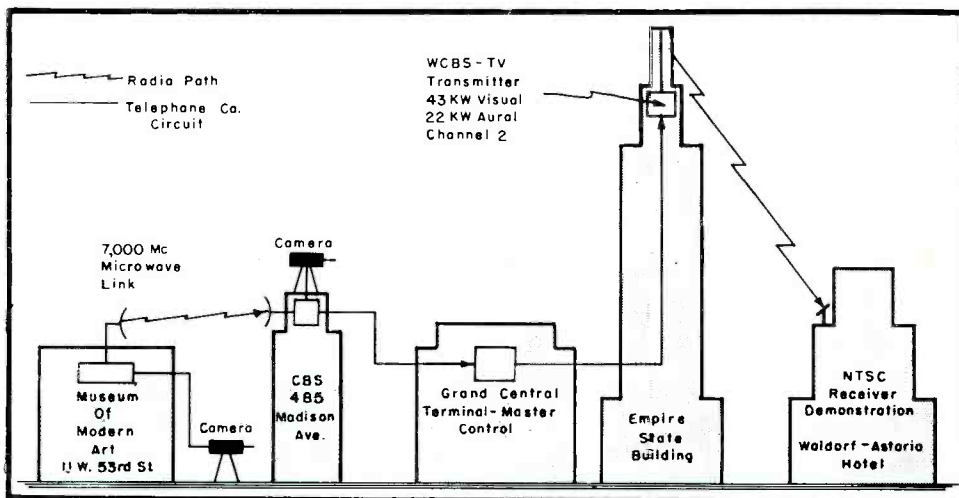
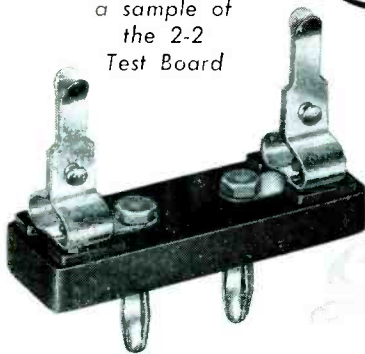

Fig. 4. Link used by CBS in color test for outdoor motion transmission.

NEW
GRAYHILL
2-2 TEST BOARD
further simplifies
your testing!

TEST YOUR
RESISTORS, CAPACITORS,
GERMANIUM DIODES,
GENERAL TEST LEADS, ETC.,
IN A SPLIT SECOND.
TIGHT-GRIP CLIPS GUARANTEE
PERFECT CONTACT. BODY IS
MOLDED OF GENERAL PURPOSE
PHENOLIC. AVAILABLE WITH BANANA
PLUGS ON 3/4" CENTERS. BANANA
PLUGS AND CLIPS PLATED.
LOOK FOR THE NAME
GRAYHILL—
IT'S A STANDARD

Ask for
a sample of
the 2-2
Test Board



533 Hillgrove Avenue
LaGrange, Illinois
Phone: LaGrange 8000

ARROW GUN TACKER

AUTOMATICALLY

Replaces
Hammer & Nails
at Trigger-Rate
Speed!



FOR TACKING—Wires • Cables • Built-in antennas
Speaker grill cloths • Small parts envelopes • and
MANY OTHER USES.

Write for Literature and Jobber Set Up

ARROW FASTENER CO., INC.

1 Junius Street

Dent. SE

Brooklyn 12, N. Y.

Ser-Cuits

(Continued from page 107)

age. In actual practice, however, the zero signal or weak signal *rf* tuner bias voltage is never at absolute zero volts, since a small amount of contact potential is developed by the delay diode and by the second *rf* amplifier. This voltage will usually measure from $-\frac{1}{2}$ to $-1\frac{1}{2}$ volts.

Delayed *agc* incorporated in third and fourth production models, may be identified by the rear apron compensator control which is a two-position switch. (Local-Fringe Stabilizer),

rather than a switch and potentiometer combination, used in earlier receivers.

The original potentiometer and switch was known as a *Picture Stabilizer* or *Signal Strength Compensator*.

A new video amplifier circuit using a 6BK7A instead of 12BH7 tube has also been included in the late production receivers.

This new circuit has been incorporated to increase the overall receiver bandwidth and to improve the video transit response. Since this circuit change was incorporated after the de-

Servicemen

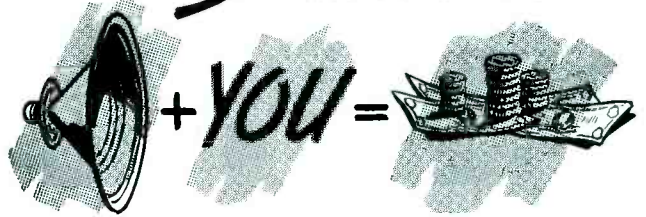

This should interest you

Reconing is Preferred...

WHEN exact replacement speakers are not available, reconing immediately solves mounting problems.

WHEN greater profits for you and greater savings for customers are desired.

WHEN you want quality and fidelity of performance.

Prove this to yourself!

Write to us for location of Reconing Station in your area.

WALDOM
ELECTRONICS INC.

909 N. Larrabee Street
Chicago 10, Illinois

STOP BLACK BORDERS ON TV PICTURE

use a
"B" Plus Booster
Model 5TV4 Replaces 5U4G

Anytime! Pulling a Tube beats
Pulling a Chassis

WHEN YOU NEED • More Height • More Width
• More Gain • Better Overall Performance

Built-in Time Delay to Protect TV Set
Write for free information



THE
5TV4
GETS RESULTS

- SUPPLIES EXTRA 30-40 VOLTS TO LOW VOLTAGE SUPPLY
- GIVES FULL SIZE PICTURE WHEN LOW LINE VOLTAGE OR WEAK TUBES CUT PICTURE SIZE.
- GIVES EXTRA GAIN NEEDED IN FRINGE AREA

STANDARD R.T.M.A. GUARANTEE
PAT. APPLIED FOR.

WORKMAN



TEANECK, NEW JERSEY



Money Back Guarantee
(Cost of Mds. Only) \$5
Min. Order FOB N Y C.
Add Shpg. Charges of
25% Dep. Tubes Gtd.
via R-Exp. only. Prices
Subject to Change. Ph.
Rector 2-6245.

MONTHLY SPECIALS

Carbon-TET C.P. grade 12 oz./65¢; 40 oz.	\$1.65
AC/DC Phono & 3 speed motor portable.	10.98
Muzak Triode 10 watt amplifier.	10.98
GE-ST4A, 5A & 2A TEST EQ. SPEC.	798.00
CARBIDE "TV" Masonary drills 1/4", 3/8", 3/4", 1" for	3.89
K. MILLER wire stripper #100 & cutter.89
Clock Radio 5 tube famous Make.	19.98
TV 300 ohm line 100 FT \$1.39; 1000 FT.	11.95
TV mast Hvy Plated 5 FT/CRIMPED 85¢; 10 for	7.50
TV combo ant/2 poles/100 ft. Twi-nex/mtg. accs.	5.69
EVEREADY type flash light, seamless, HI-Polish	.49
Soldering iron 60 watt gtd special.	1.20

ELECTRIC DRILL

1/4" Model 200J

HI-torque (Powerful) UL appvd. 2400 RPM./115 VOLT/AC/DC Motor. Jacobs Chuck & key. Self aligning—oilless—Ball thrust bearings. Here is a workhorse drill, priced Right. A

"TAB" December Special \$14.75
Model 400J 1/2" Electric drill 425 RPM with JACOBS GEARED HEAD CHUCK & KEY & 9 DRILLS \$29.95

DRILL KIT

200JK workshop, 55 pcs set. A must for the SERVICEMAN. Includes 1/4" 200J drill, drill bits accessories for grinding, polishing, buffing, sanding. Paint Stirrer & many other uses. 55 pieces in all. Special \$19.25



TUBES

90 DAY "TAB" GUARANTEED

0B3 .96	6AX4 .74	6SG7 .64	12BA6 .59
0C3 .92	6BA6 .51	6SH7 .61	12BA7 .94
0D3 .92	6BA7 .70	6SK7 .58	12BD6 .59
1B3 .80	6BC7 1.28	6SK7 .58	12BE6 .59
1R5 .59	6BE6 .54	6SL7 .64	12BH7 1.29
1U4 .52	6BG6 1.58	6SN7 .68	12BY7 1.35
1U5 .54	6BH6 .63	6SQ7 .62	12SA7 .68
1X2A .98	6BJ6 .69	6T8 .96	12SF5 .54
5U4G .55	6BK7 1.58	6U8 .98	12SG7 .80
5Y3 .43	6BL7 1.19	6V6 .59	12SH7 .63
6AC7 .80	6BN6 1.19	6W4 .52	12S17 .54
6AF4 1.29	6BQ6 1.20	6X4 .49	12SK7 .66
6AG5 .71	6BQ7 1.65	6X5 .54	12SL7 .62
6AL5 .48	6BZ7 1.49	12AL5 .51	12SN7 .68
6AN5 2.90	6C4 .52	12AT6 .54	12SQ7 .54
6AQ5 .52	6BC6 .59	12AT7 .89	25BQ6 .93
6AQ6 .81	6BD6 1.00	12AU6 .72	35W4 .49
6AT6 .54	6J6 .58	12AU7 .69	12Z5 .54
6AU6 .56	6K6 .54	12AV6 .52	50B5 .54
6AV6 .49	6L6G 1.08	12AY7 1.69	50L6 .62
6AW6 1.09	6SA7 .66	12AZ7 1.49	80 .58

PRECISE & EICO TEST EQUIPMENT

Stock No.	Type	Kit Price	Built Price
425K—Scope 5" Push Pull		\$44.95	\$79.95
308K—Lab Scope 3 1/2"		129.50	229.50
300K—Oscilloscope 7 1/2"		94.95	189.50
099K—VTVM 21 Ranges		25.98	44.98
630K—RF-AP-Marker Gen		33.95	53.95
315K—Sig Gen 75 KC to 150 MC		39.95	59.95
360K—SWP Gen TV-FM		34.95	49.95
377K—Audio Gen 200 to 2000 KC		31.95	49.95
625K—Tube Tester Checks Latest Tubes		34.95	49.95
566K—VOM Multimeter 38 Ranges		14.90	18.95
635K—Audio-Sq-Pulse Gen 20-2000 KC		33.50	52.50

KITS AND COMPONENTS

Oil Condensers Assorted	5 for	\$1.25
Electrolytics Assorted	5 for	1.25
Silver & Mica Condensers	15 for	1.25
Controls, Popular Values	5 for	1.25
Resistors, 1/2 & 1W	100 for	1.25
Vitreous W W Resistors	8 for	1.25
Sockets, Assorted 8, 7, 5, 4P	12 for	1.25
Iron Core Slug & Screw	50 for	1.25
Knobs, Assid. w/Insert.	10 for	1.25

"TAB"

YOU PICK 'EM \$1.00

Special Lots of 5

SPECIAL — SPECIAL — SPECIAL
You Pick Them. Lots of 10 at 39c each

Cracked base or broken key electrically perfect. TESTED & 90 DAY GUARANTEED.
5U4G—6SN7—25L6GT—35Z5
5Y3GT—6K6GT—12SA7GT—6H6
6V6GT—6BQ6—6W4GT—12SG7



YOU PICK THEM

39c ea Lots of 10

WHILE THEY LAST

ELECTROLYTIC CONDENSERS

20MFD/25VDC	2X15MFD/350VDC
20MFD/450VDC	2X20MFD/25V, 30MFD/450V
25MFD/300VDC	40MFD/250V, 20MFD/25V
50MFD/350VDC	3X100MFD/25VDC
100MFD/25VDC	30/15/10MFD/250VDC

ALL SIZES & TYPES NEW STOCK

REBUILT TV PICTURE TUBES

Standard One Year Guarantee

Duds must be shipped in advance prepaid. We then ship new tubes from our stock. All types available.
F.O.B. N. Y. C. \$3.00 PER INCH
Add 10¢ per inch for metal or Electrostatic Types
New York City RADIO & TV Servicemen: 2
FREE SUBWAY TOKENS WITH A \$5.00 Purchase from our Store.

"TAB"

Dept. 125
111 Liberty St.
New York 6, N. Y., U. S. A.
Rector 2-6245

Ser-Cuits

(Continued from page 109)

voltage should read approximately 12. If zero or near zero volts are measured at this point the primary leads should be reversed. For identification, receivers incorporating this circuit change were rubber-stamped with No. 1140. These receivers include a 3,000-ohm diode load resistor and delayed agc.

Late production 20C107 receivers were equipped with a 20DP4A picture tube instead of 20CP4A as used in the earlier production. Receivers using a 20CP4A tube require two flat washers on each support rod as a spacing medium between the flux shield and the fibre yoke support.

Receivers using a 20DP4 picture tube require a T spacer and one flat washer on each support rod as is also required for the 21-inch models.

First, second and third production receivers incorporate a video detector assembly in which the value of C₁₀₂ is 5 mmfd. The video detector of the fourth run production receivers incorporate a 9-mmfd capacitor, C₁₀₂. This change appears in all receivers which incorporate the 6BK7A type video amplifier.

* * *

TAUBER SHEET-BINDING KIT

A three- and four-punch sheet-binding kit, which may be used to bind service data into loose-leaf form, has been introduced by Tauber Plastics, Inc., 200 Hudson St., New York 13, N. Y.

Kit, which utilizes plastic tubes in diameters of 3/16" up to 1", features a punch which can go through approximately 15 sheets of paper, depending on the thickness.

* * *

NEW BUILDING FOR SAMS

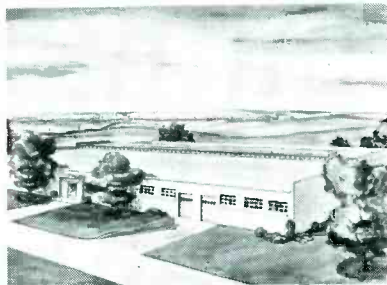

Sketch of 38,000 square foot building to be erected on a six-acre tract of land at 33rd Street and Sutherland Avenue, Indianapolis, by Howard Sams and Co., Inc. Building will house the printing, warehousing and shipping operations. Company's administration, sales, engineering and analytical work will continue at main plant, 2201 E. 46th St. Operations in the new building are expected to begin April 1, 1954.

NEW

Mueller

INSULATOR



for "60 Series" ALLIGATOR CLIPS!

No. 62

Flexible Vinylite Insulator in

Red and Black

Specially designed to fit Mueller Alligator Clips Nos. 60S, 60-CS and 60

AVAILABLE NOW!

Here for the first time is an insulator which will completely cover and insulate the popular Mueller Alligator Clip, leaving only the nose of the jaw exposed.

SEND FOR SAMPLES & CATALOG #10
CLIP SPECIALISTS SINCE 1908

Mueller Electric Co.

1565 E. 31st St., Cleveland 14, Ohio

\$495

Ppd. or C.O.D. + Chgs.



THE NEW TV DYNATRACER

- Traces TV Signals and Voltages
- Locates Defective Components
- Requires No Additional Equipment

This sensationally new piece of test equipment is ideal for troubleshooting television sets in the home or in the shop. The "DYNATRACER" will outperform more expensive testers and should pay for itself on first repair.

A Must For Every TV Technician
SPECIFICATIONS: The "DYNATRACER" is a self-powered quality test instrument designed to trace TV signals through any Video, Sound, Sync, AFC, Horizontal or Vertical Sweep Circuit—will isolate trouble to a stage or component.

ADDED FEATURE: The "DYNATRACER" will also trace voltages (50/500 V. AC/DC) and instantly locate open, shorted, intermittent or leaky (up to 20 megohms) condensers, resistors, coils, transformers, etc.

Instruction and Trouble-Shooting Book Enclosed

10-DAY MONEY-BACK GUARANTEE

Cut out ad, attach name and address, with \$3 bill, check or money order, and mail to

Century ELECTRONICS CO.

8509-21st Ave., Dept. 303, Brooklyn 14, N. Y.



YOU SHOULD OWN A MICRO CIRCLE CUTTER

A well built tool for those odd size holes. Cuts through 1/2" of steel. Has MICROMATIC SIZE ADJUSTOR. Comes complete with tool steel cutting bit for extra long service. . . . Specify round (7/16") or square shank. See your local distributor or write us.

PRECISE MEASUREMENTS CO.
942 Kings Highway, Bklyn. 23, N. Y.

LIGHTNING ARRESTER PATENT TO JFD

Two patents, 2,654,857 and 159,330 (design) covering design and construction of lightning arresters with saw-tooth contact washers originated by Julius Finkel, president of the JFD Manufacturing Co., Inc., have been granted to JFD.

JOTS AND FLASHES

WITHIN THREE TO FOUR YEARS some 50 million television sets will be in use in the U. S., and the overwhelming majority of them will be black-and-white. So prophesized Abraham Blumenkrantz, chairman of the board of General Instrument Corp., recently. Although the engineering difficulties of color TV have been overcome, he said, the art of mass production of color sets and picture tubes has not been fully mastered. Noting that color tube production for early next year was estimated at only between 2,000 and 4,000 a month, he pointed out that even if these estimates were doubled, there can be no more than a maximum of 100,000 color sets produced in '54, and all beyond the reach of the average purse. . . . *H. Brown*, president of Technical Appliance Corporation, Sherburne, N. Y., announced recently that the scholarship committee has selected *Rex Sawyer*, a science student of the Sherburne Central School, as this year's winner of the Taco Scholarship Award. . . . A 25,000-square-foot Western regional tube warehouse of G. E. was opened recently at 11840 Olympic Blvd., Los Angeles. . . . Increased manufacturing facilities at G. E.'s receiving tube plant at Tell City, Ind., will be housed in a newly-completed 44,000-square-foot plant addition. . . . *Robert D. Hallock* is now plant manager of American Microphone Company, Pasadena, Calif. Prior to joining American Microphone, Hallock was with Bardwell

& McAlister, Inc., Solar, Standard Coil, and Airesearch. . . . *Nat Welch* has been named sales manager of Orradio Industries, Inc., Opelika, Alabama. Orradio manufactures Irish Brand magnetic tape for tape sound recorders. . . . A 400% increase in the sale of diamond styli during the first nine months of '53 as compared with a like period in '52 was disclosed recently by *T. J. Nicholson*, G.E. parts sales manager. . . . *E. Allen Autrey*, formerly with the Office of Naval Research, has been appointed manager of the patent department of Penta Laboratories, Inc., Santa Barbara, Calif. . . . More than 50 representatives from all over the country attended the '53 sales conference of the Simpson Electric Company recently at Lac du Flambeau, Wisconsin, site of one of the company's four major plants. Highlighting the event was the awarding by Simpson president *Wallace E. Carroll* of a 15-year pin to *John M. Forshay*, New York rep. . . . A huge repair center for the upkeep of microphones has been set up in the plant of American Microphone Co., Pasadena, Calif.



A. Blumenkrantz,
G.I.C. board chairman



By WALTER V. TYMINSKI

AN EVALUATION OF PASSIVE TELEVISION RECEIVER COUPLERS

Parts one to three contained a discussion of the general characteristics of resistance decouplers and transmission line arrangements for multiple operation of up to four television receivers.

PART IV

In the concluding article of this series the latest advance in passive multiple receiver couplers will be discussed.

The IT-132A *AutoCoupler*, an exclusive ITI product, is an efficient four-set VHF coupler with excellent electrical characteristics. Four unique wide-band RF transformers are used with the balanced output connections brought out to the terminal strip for use with 75 ohm unbalanced and/or 300 ohm balanced receivers. The transformer coupling also provides AC isolation between the receivers, eliminating the need for coupling capacitors.

The operating characteristics for the IT-132A are:

- Loss Ant.-to-Set — 6.0 db (P/4)
- Loss Set-to-Set — 15.6 db (P/36)
- Directivity — 9.6 db (9)
- Freq. Range — VHF

If decreased oscillator suppression can be tolerated, as is the case for receivers using 40mc I.F., up to eight receivers can be connected to the IT-132A VHF *AutoCoupler*.

I.T.I. accessories together with dealer prices are:

IT-117A Two-Set Coupler	\$2.37
IT-118A Four-Set Coupler	2.97
New IT-126A VHF-UHF Tenna Coupler	2.97
New IT-131A Two-Set VHF Coupler	2.97
New IT-132A Four-Set VHF Coupler	4.17
New IT-135A Two-Set UHF Coupler	2.37
Tenna Clips30

In many installations signal amplification is found desirable. I.T.I. boosters especially designed for this application are:

IT-90AB Cascade VHF <i>AutoBooster</i>	\$41.95
IT-102A Super VHF <i>AutoBooster</i>	23.95
New IT-133A UHF <i>AutoBooster</i>	29.95

UHF signals can be simulated for demonstration of VHF-UHF receivers by the use of a TV generator. In all installations signal strength can be measured at each outlet with a field strength meter. I.T.I. products for these applications are:

IT-105RB UHF-VHF Field Strength Meter	\$114.95
New IT-130R UHF TV Generator	149.50

Industrial Television, Inc.
369 LEXINGTON AVENUE CLIFTON, N. J.
Gregory 3-0900

ADVERTISERS IN SERVICE NOVEMBER, 1953

Acme Electric Corp.	74	Ohmite Mfg. Co.	65
Admiral Corp.	8	Oxford Electric Corp.	78
Aerovox Corp.	86	Perfection Electric Co.	90
All Channel Antenna Corp.	91	Phalo Plastics Corp.	96
Alliance Mfg. Co.	16	Philco Corp.	10
American Microphone Co.	64	Planet Mfg. Corp.	102
American Phenolic Corp.	14	Precise Measurements Co.	110
American Television & Radio Co.	84	Precision Apparatus Co., Inc.	67
Arrow Fastener Co., Inc.	109	Pyramid Electric Co.	19
Astron Corp.	1	Quietrol Co.	80
Atlas Sound Corp.	92	Rad-El-Co. Mfg. Co.	100
R. J. Buchen Co.	103	The Radiart Corp.	Inside Front Cover
Bussmann Mfg. Co.	15	Radio Corporation of America	17, Back Cover
CBS-Hytron	13	Radio Merchandise Sales, Inc.	12
Centralab Div., Globe-Union, Inc.	71	The Radion Corp.	21
Century Electronics Co.	110	The Rauland Corp.	63
Channel Master Corp.	42, 43	Raytheon Mfg. Co.	28
Chemical Electronic Engineering Co.	90	Relay Sales	107
Chicago Standard Transformer Corp.	99	John F. Rider Publisher, Inc.	77, 90
H. G. Cisin	106	Rinehart Books, Inc.	88
Clarostat Mfg. Co., Inc.	53	Rohn Mfg. Co.	72
Cornell-Dubilier Electric Corp.	97	Howard W. Sams & Co., Inc.	80
Crest Laboratories, Inc.	100	Sangamo Electric Co.	79
Davis Electronics	88	Service Instruments Co.	103
Electro Products Laboratories	3	Simpson Electric Co.	26, 27
Electro-Voice, Inc.	61	Snyder Mfg. Co.	105
Electronic Chemical Corp.	86	Sola Electric Co.	78
Electronic Measurements Corp.	85	South River Metal Products Co., Inc.	112
Erie Resistor Corp.	94	Sprague Products Co.	11
Federal Telephone & Radio Corp.	22, 23	Sutton Electronic Co.	95
Fenton Co.	101	Sylvania Electric Products, Inc.	18
General Cement Mfg. Co.	64	TV Products Co.	49
General Electric Co.	20	TAB	110
General Electric Lamp Dept.	98	Sarkes Tarzian, Inc. Tuner Div.	76
The General Industries Co.	93	Sarkes Tarzian, Inc. Rectifier Div.	68
General Instrument Appliance Corp.	75	Tech Master Products, Inc.	87
Granco Products, Inc.	92	Telematic, Inc.	82, 83
Grayhill	109	Telrex, Inc.	55
Halldorson Co.	105	Transamerica Electronics Corp.	106
The Heath Co.	96	Triad Transformer Mfg. Co.	107
Hickok Electrical Instrument Co.	86	Trio Mfg. Co.	4, 5
Hi-Lo TV Antenna Corp.	108	Triplet Electrical Equipment Co.	6
Illinois Condenser Corp.	88	Tung-Sol Electric, Inc.	9
Industrial Television, Inc.	25, 111	U. S. Treasury Dept.	24
International Rectifier Co.	81	V-M Corporation	89
JFD Mfg. Co., Inc.	2	Vidaire, Inc.	102
Jensen Industries, Inc.	106	Viking Electronics	108
Jontz Mfg. Co.	73	Waldem Electronics, Inc.	109
Kenwood Engineering Co., Inc.	92	The Ward Products Corp. Div., The Gabriel Co.	46
Kester Solder Co.	94	Wells & Winegard	69
Leader Electronics, Inc.	7	Windsor Electronic Tube Co.	104
P. R. Mallory & Co., Inc. Inside Back Cover		Workman TV, Inc.	109
Moss Electronic Distributing Co., Inc.	98	Xcelite, Inc.	100
Mueller Electric Co.	110		

NEW

Model RM-15 ROOF MOUNT

AGAIN South River has the serviceman in mind! With the new South River Roof Mount Model RM-15 his job is a quick, easy, efficient operation. A unique "walk-up drop-lock" feature permits ONE MAN roof-mounting for single mast installations. This mount allows fast, simple installation from a horizontal position. After the antenna and mast are "walked-up" to the vertical position, the mast holder DROPS into a special notch and LOCKS securely. The serviceman is then free to guy the mast.

Made of heavy-gauge metal, heavily plated for rust resistance and embossed at all critical points for extra strength and rigidity, the 5 1/2" long mast socket accommodates masts measuring up to 1 1/2" O. D.

The mast is secured in the mounting socket with 2 rugged hex screws, eliminating the danger of the installation vibrating loose. Two "in line" holes in mounting base permit bolting directly into heavy roof cross member.

FROM *South River*

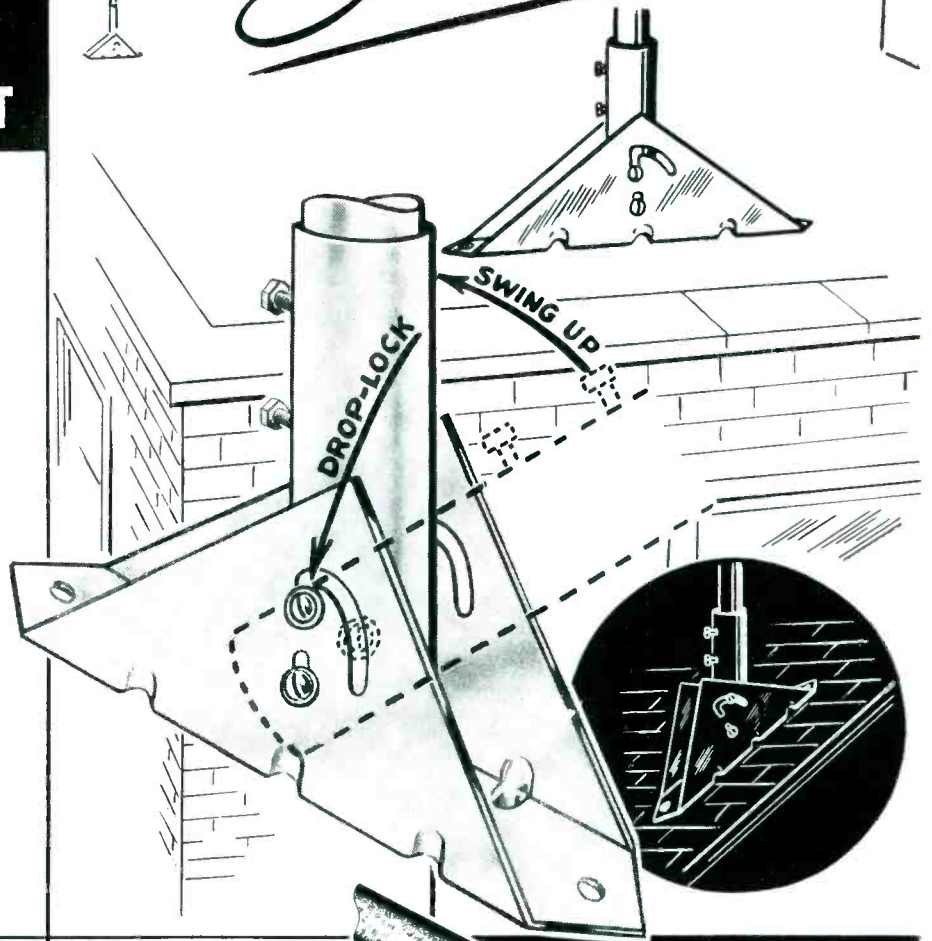

Rust-Proof

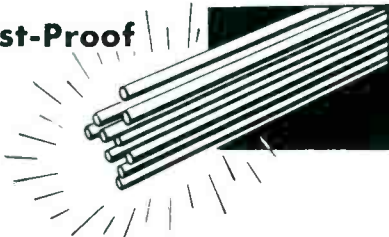

ALUMINUM TUBING

Only South River is able to offer the industry this super-strength product extruded especially for us. The new aluminum tubing is fabricated of 63S-T6, a special structural alloy designed for maximum strength. Aluminum itself is bright and non-rusting, affording a lasting finish. Made with a .054 wall by 1 1/4" dia., in 10' lengths, the tubing is supplied 25 to a bundle.

Stronger, Tight-Twist GUY WIRE

Do the best installation job... use South River's new hot-dip galvanized guy wire, carefully drawn with a tighter, stronger twist for extra durability under stress—providing tensile strength up to 70,000 lbs. per square inch. Produced in either 18 gauge or GENUINE 20 gauge, both available in either 4 or 6 strands, this vital product comes to you in 1,000' lengths on metal spool, or in continuous loops of 50' and 100' lengths.



Exclusive STEEL TUBING

Hot-Dip Galvanized Inside and Outside!

South River presents another FIRST in the industry... 18 gauge steel tubing, hot-dip galvanized INSIDE AND OUTSIDE... affording maximum utility and long life because of complete, all-over protection. It greatly increases the resistance of steel to the extreme atmospheric corrosion of shore and industrial areas. Hot-dip galvanizing is the only experience-proven rust resistant finish known. The tubing is available in 5' and 10' lengths, 10 to a bundle, is 1-1/4" dia., and is supplied with either plain or swaged end for mast extension.

South River's INSIDE AND OUTSIDE hot-dip galvanized steel tubing is another step forward in combating rust and corrosion. Your use of this product will prove that you keep abreast of important, new developments, for increased customer satisfaction.

South River
METAL PRODUCTS CO., INC., South River, New Jersey

Write for
Complete Catalog

PIONEER MANUFACTURER AND OUTSTANDING PRODUCER OF THE FINEST LINE OF ANTENNA MOUNTINGS

In Canada—A.T.R. Armstrong Co., Toronto

Depend on Mallory
for
Approved Precision Quality

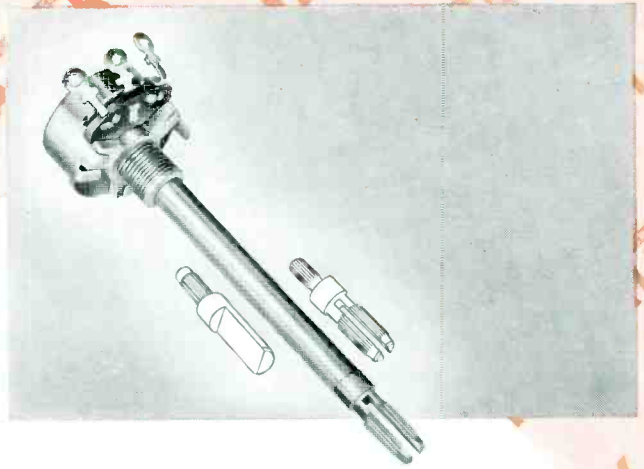

"WE'LL HAVE IT BACK TOMORROW"



Mallory Dual Control Kits

Three kits of controls and switches, selected to meet varying requirements in different parts of the country, will serve 50 different models of radio and television sets. You pay only for the controls and switches; attractive 3-drawer metal cabinet is free of extra cost. Get details from your Mallory Distributor.

Fast turnover . . . more jobs done per day . . . that's the answer to greater profits for any service shop. Every minute saved is time available for turning out more work.

That's why Mallory Midgetrols® were designed for fast, easy installation in any set . . . TV or radio.

Round tubular shafts can be cut accurately and quickly . . . fit split-knurl or flatted-type knobs.

AC switches can be attached instantly without disassembling the control.

Unique design simplifies inventory problems . . . makes them quickly available from your distributor.

Midgetrols are engineered to match the electrical characteristics of the original equipment of any TV or radio set. They will give equal, and often better, performance and life than the original control.

For all your service work, use Mallory Midgetrols. They are the answer to fast installation . . . precision quality on every job.

This will save you time, too. Ask your Mallory Distributor for a copy of the Mallory Control Guide. It is a complete cross reference between set manufacturers' part numbers and the equivalent Mallory control.

P. R. MALLORY & CO. Inc.
MALLORY

CAPACITORS • CONTROLS • VIBRATORS • SWITCHES • RESISTORS
RECTIFIERS • POWER SUPPLIES • FILTERS • MERCURY BATTERIES
APPROVED PRECISION PRODUCTS

P. R. MALLORY & CO., Inc., INDIANAPOLIS 6, INDIANA

Have you hung up

your shingle?

IT PAYS TO KEEP GOOD COMPANY . . . and it's good business to advertise the good company you keep.

Thousands of dealers and servicemen are using the sales-magic in the RCA name to instill confidence in their customers. Identifying *your* name with RCA pays off in dollars and cents.

And it's so easy to do . . . because RCA's new Dealer Identification Program provides you with a handsome "shingle" with your name on it, that you'll be proud to display in your shop. When a customer sees this Dealer Identification Plaque he *knows* you are using the best tube products available.

So, we ask . . . "Have you hung up *your* shingle yet?" If not, be sure to see your **RCA Tube Distributor** today and learn how *you* can qualify for a Registered Dealer Plaque at no extra cost.

Unlock the door to bigger profits

Here's *your* key to better business . . . RCA's dynamic Dealer Identification Program. Ask your *RCA Tube Distributor* for your copy of the colorful, 16-page booklet "A Magic Pass-Key to Customer Confidence." It tells you how—for the first time—you can become a Registered Dealer . . . and get *extra* sales benefits.

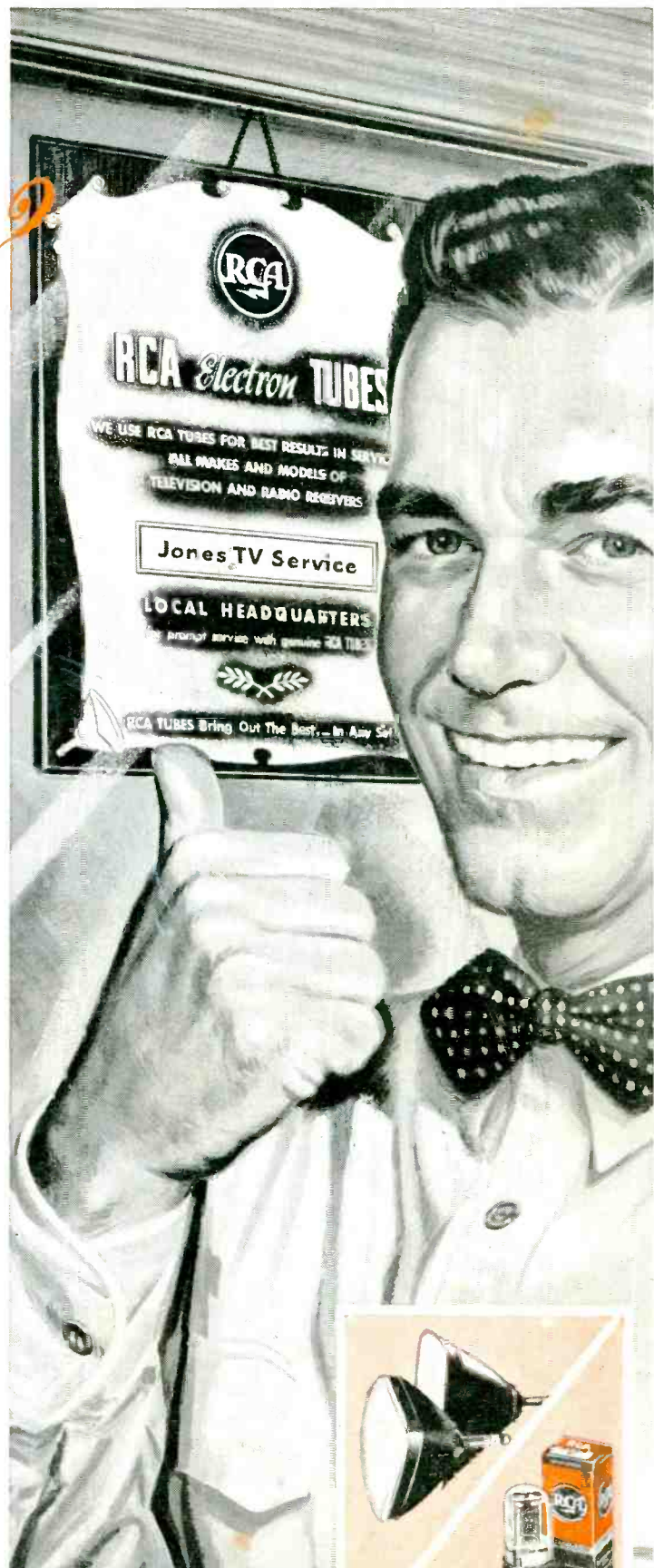

RADIO CORPORATION of AMERICA
ELECTRON TUBES

HARRISON, N. J.