

SERVICE

VOL. 22

THE TECHNICAL JOURNAL OF THE TELEVISION-RADIO TRADE

JUNE
1953

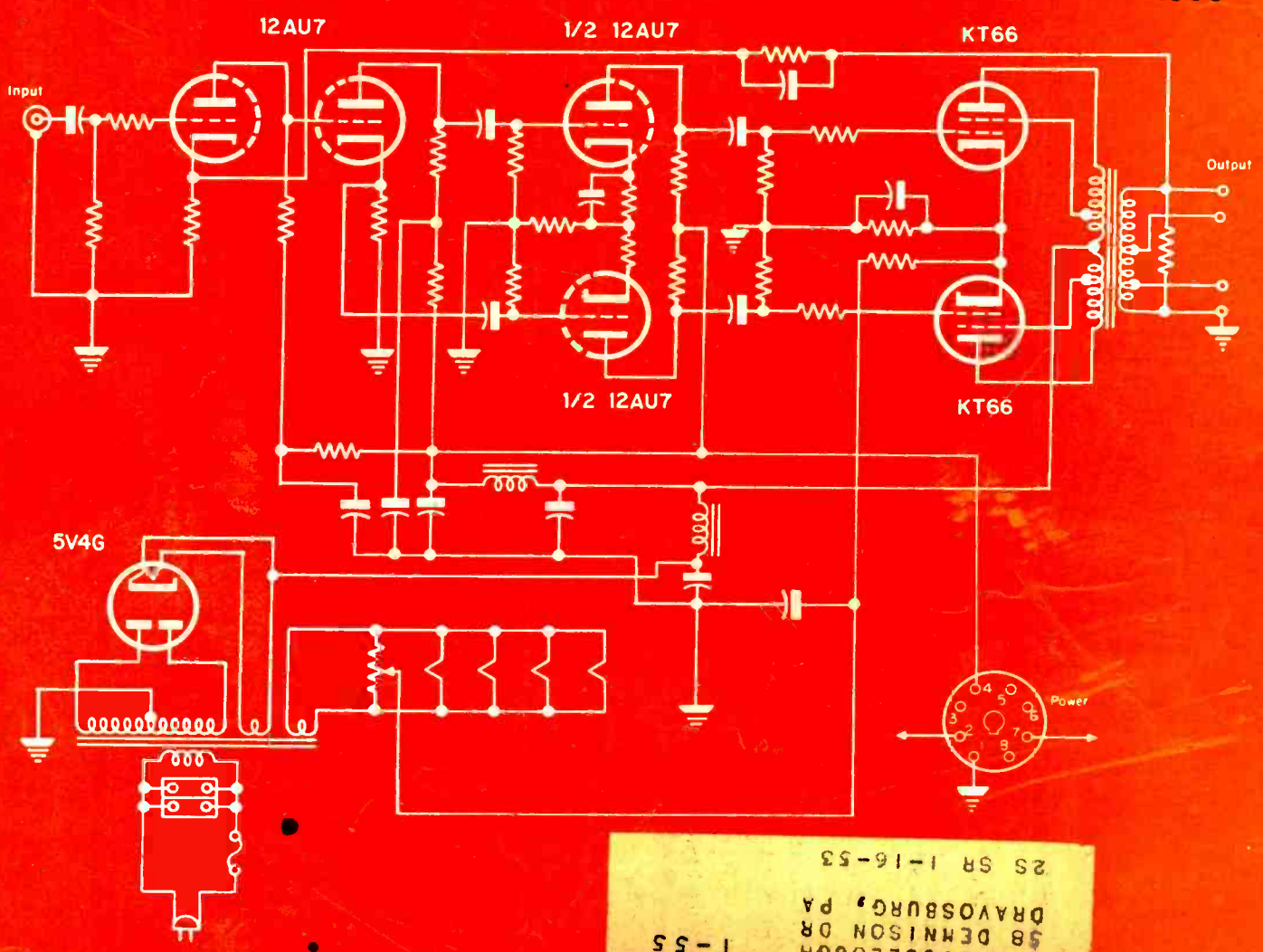

C F McCULLOUGH
 58 DENNISON DR
 DRAYSBURG, PA
 1-55
 2S SR 1-16-53

Power amplifier featuring ultra-modification of Williamson circuit.
 [See circuit analysis, this issue]

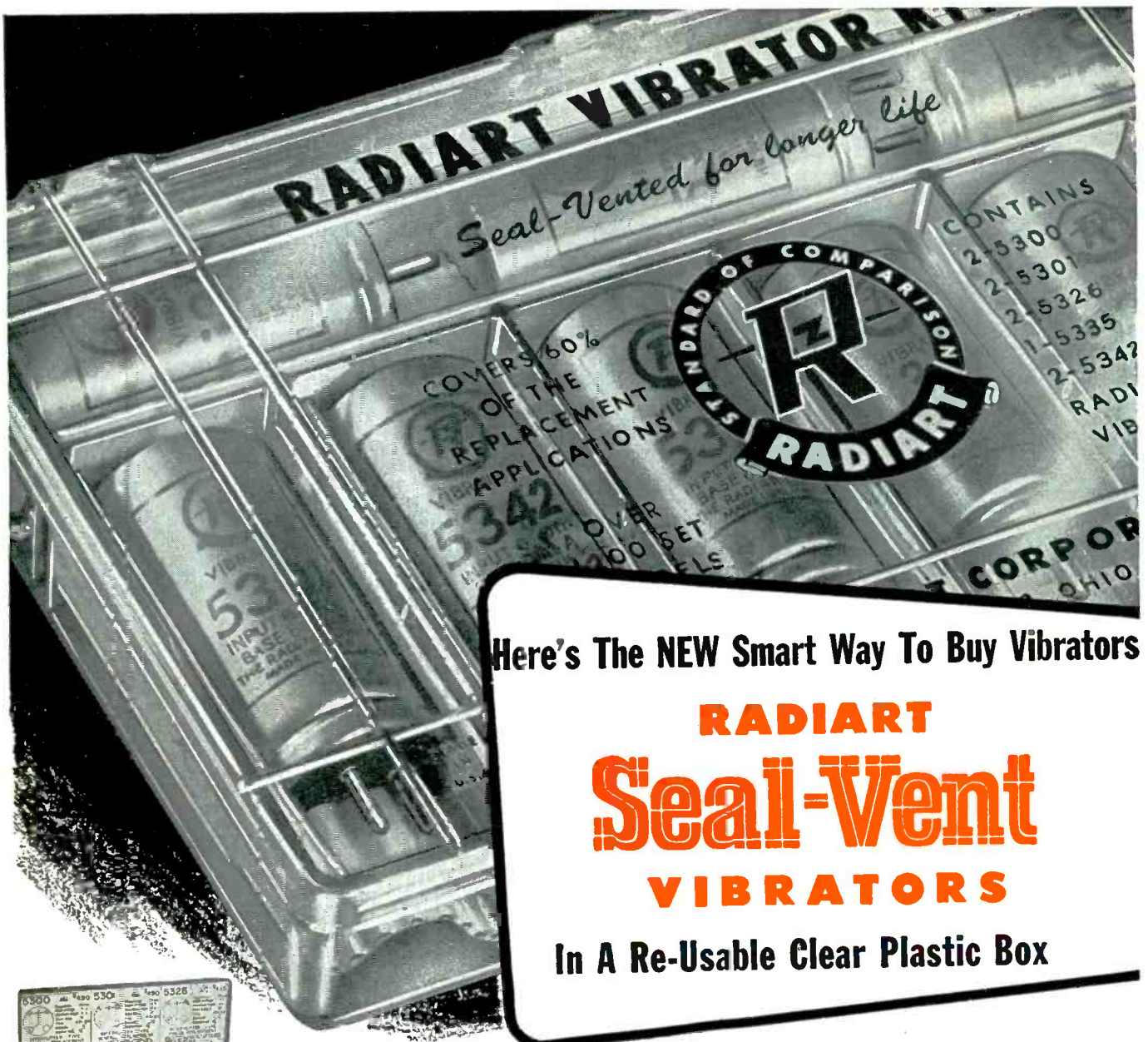

Here's The NEW Smart Way To Buy Vibrators

RADIART
Seal-Vent
VIBRATORS

In A Re-Usable Clear Plastic Box

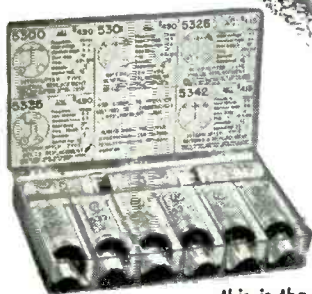

this is the way it looks fully packed



here is the re-usable box with dividers for a hundred uses at home or work

★ The BEST Vibrator Money Can Buy

★ A "BCNUS" for You in the Re-Usable Plastic Box

★ Save Time — Buy the ONE KIT that Gives You the Five Types that Serve 60% of the Replacement Requirements

Here's another PLUS for you from Radiart — the RADIART VIBRATOR KIT! In this handsome plastic box with sturdy dividers and a hinged cover are these 9 vibrators . . . all yours for the price of the vibrators alone! You get these 5 basic types that serve 60% of replacement applications . . . 2-5300 . . . 2-5301 . . . 2-5326 . . . 2-5342 and 1-5335. These are all the famous quality . . . with the sensational SEAL VENT. Original quantities are limited . . . so make sure of yours by seeing your RADIART jobber NOW!



THE RADIART CORPORATION CLEVELAND 13, OHIO
 VIBRATORS • AUTO AERIALS • TV ANTENNAS • ROTATORS • POWER SUPPLIES



Regency

makers of VHF Boosters, FM Boosters, UHF Converters,
Professional High Fidelity Equipment

TV Technicians—

Show your Skill

Let your customers SEE that GOOD service is your business. Your skill is your most precious asset. Dress it up with the right tools to make sure it's appreciated.



NEW
De Luxe
tube caddy

Carries TOOLS and TUBES, Saves TIME, MONEY
PAYS for ITSELF

Technicians who carry the Tube Caddy make the right impression. Handy top tray for tools, soldering gun, or meter. Regimented drawers give tube inventory at a glance. Slip-apart hinges on cover, with clips inside for price list or mirror.

Its efficiency saves time, its neatness inspires confidence—builds business. Can pay for itself in three weeks time. Size 18 x 14½ x 9¼ in. Ask your Parts Jobber or write.

*Net to Dealer. Higher on West Coast.
Other Models \$13.50 and \$7.75.

Craftsmanship in Cabinets
Argos
PRODUCTS COMPANY
310 MAIN STREET • GENOA, ILLINOIS

Vol. 22, No. 6

RADIO • TELEVISION • ELECTRONIC

SERVICE

June, 1953

LEWIS WINNER
Editor

B. BLOCK
F. WALEN
Assistant Editors

Including SERVICE—A Monthly Digest of Radio and Allied Maintenance; RADIO MERCHANDISING, and TELEVISION MERCHANDISING. Registered U. S. Patent Office.

Association News	75
Audio Installation and Service (Tape and Disc System Standards). By Kenneth Stewart	40
Engineering Small Hall Audio Systems (Use of Sound Augmentation Techniques). By Donald Phillips	30
In the Field (Interpretation of Waveforms)	51
'Scope Modifications (For Service Engineering). By Ronald L. Ives	63
Ser-Cuits (PC TV IF Amplifiers). By M. W. Percy	52
Service Engineering Field and Shop Notes (2-Way FM Systems). By Thomas K. Beamer	56
Service . . . The National Scene	47
Servicing Helps (Picture-Tube Voltage Checks . . . UHF Mixer Crystals). By M. A. Marwell	36
Small Shop Sound Systems (Fixed-Mobile AC/DC Amp Setups). By Jack Darr	26
Ten Years Ago	76
Testing and Measuring Audio Equipment. By Mark Vino	28
The Hi-Fi Market. By C. K. Sterling	62
Tube News (Oscillator and AF Transistors). By L. M. Allen	44
TV Antenna Digest (850-Mc Reception Test Report). By Ralph G. Peters	58
UHF Alignment (Reflection Coefficients and VSWR . . . Delay Lines . . . IF Alignment). By Henry R. Hesse	35
Ultra-Linear Williamson Circuit Amplifier (Cover). By Wyn Martin	32
Views and News. By Lewis Winner	25

AUDIO INSTALLATION AND SERVICE

Crystal-Element Components	41
45 Record-Change Tripping Adjustments	41
Hi-Fi Audio Products	40
New Standards for Tape and Disc Systems	40
Record-Change Turntable Replacement	41

CIRCUITS

Brociner UL-1 Ultra-Linear Williamson Amplifier (Cover)	32
Dual-Channel Amplifier to Drive Hearing Aids and Broadcast Loop	30
Jack Box With Compensating Resistor and Volume Control	31
Junction-Transistor Circuitry	44
Point-Contact Transistor Circuitry	44
Printed-Circuit Component TV IF Amplifier	52
RCA CMV-3E1 30-50 Mc Two-Way FM	57
Speaker-Phasing Check System	31
Stromberg-Carlson Dual-Target Tuning-Eye Schematic for Picture-Tube V Checks	37
Test-Record Frequency-Response Layout	28
Truetone 4C11 6-V Audio-Radio With PC Audio Coupler	53

COVER

Ultra-Linear Williamson-Circuit Amplifier (Brociner UL-1)	32
---	----

SERVICE ENGINEERING FIELD AND SHOP NOTES

Two-Way FM System Design	56
--------------------------	----

SERVICING HELPS

Contrast-Control Modifications	36
Decreasing Minimum Brightness Levels	39
Dual-Target Tuning Eyes for Picture-Tube Voltage Checks	36
Improving Horizontal Stability	38
Positioning of UHF Mixer Crystals	37

Index to Advertisers

	82
--	----

Manufacturers

Catalogs and Bulletins	68
Jots and Flashes	82
News	69
New Parts . . . Tools . . . Instruments	72
On Book Row	67
Personnel	64
Rep Talk	66
TV Parts . . . Antennas . . . Accessories	74



Entire contents Copyright 1953, Bryan Davis Publishing Co., Inc.
Published monthly by Bryan Davis Publishing Co., Inc.

52 Vanderbilt Avenue, New York 17, N. Y.

Telephone MUrray Hill 4-0170

Bryan S. Davis, Pres. Paul S. Weil Vice-President F. Walen, Sec. A. Goebel, Cir. Prom. Mgr.
Mid-West Representative: Stuart J. Oston, 333 N. Michigan Ave., Chicago 1, Ill. Telephone: D Earborn 2-3507
East-Central Representative: James C. Munn, 2253 Delaware Dr., Cleveland 6, Ohio. Telephone: Erievuew 1-1726
Pacific Coast Representative: Brand & Brand, 1052 W. Sixth St., Los Angeles 14, Calif. Telephone: Michigan 1732
Metropolitan District Manager: Donald C. Weil, 52 Vanderbilt Ave., New York 17, N. Y.

Entered as second-class matter June 14, 1932 at the Post Office at New York, N. Y., under the Act of March 3, 1879. Subscription price: \$2.00 per year in the United States of America and Canada; 25 cents per copy. \$3.00 per year in foreign countries; 35 cents per copy.

ALL-CHANNEL **UHF** CONVERTER

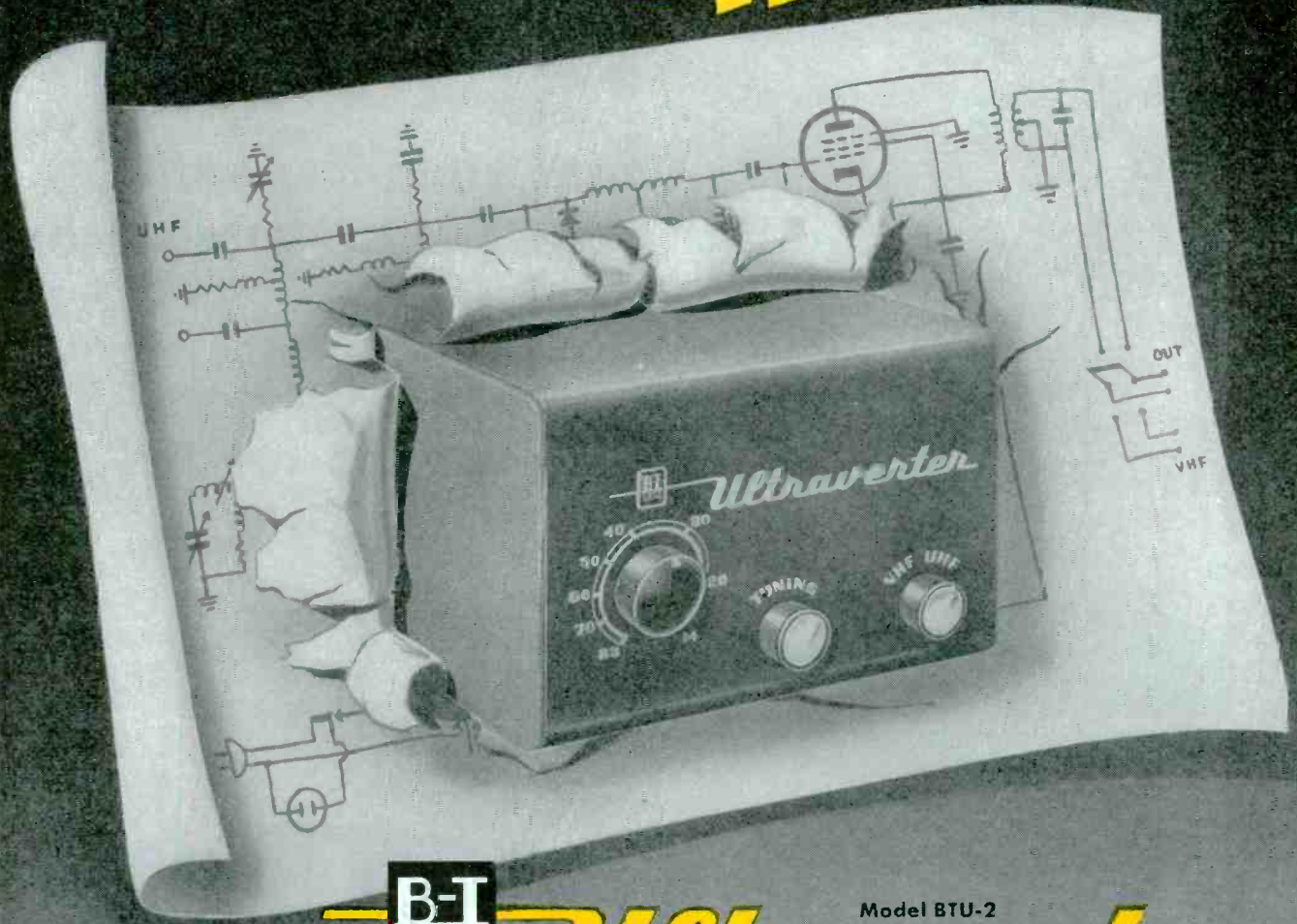

**B-T
LABS**

Model BTU-2

Ultraverter

Ultra POWERFUL
Ultra DEPENDABLE

Employing the newly developed B-T Ultratuner, the B-T Ultraverter, Model BTU-2, provides for reception of all UHF channels on any TV set with quality unmatched by any converter, regardless of price. 'On/off' operation is automatically controlled by the power switch on the TV receiver. Terminals are provided for both VHF and UHF antennas.

MORE
POWER

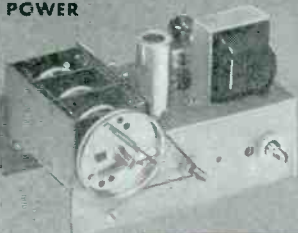

Advanced circuit design assures high gain, high stability, and lowest noise performance. A high ratio vernier knob permits easy, accurate tuning on UHF channels from 14 through 83. Tube complement includes 6T4/6AF4, 6AB4, and Germanium Diode, 1N72.

GREATER
STABILITY
EASIER
TUNING

**B-T
LABS**

BLONDER-TONGUE LABORATORIES

WESTFIELD, N. J.

Manufacturers of TELEVISION AMPLIFIERS, UHF CONVERTERS, MIXERS, DISTRIBUTION UNITS and TV ACCESSORIES

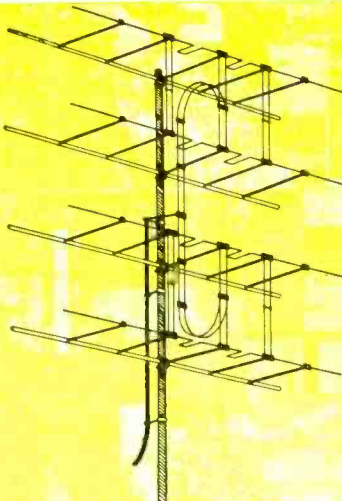

have confidence

... THAT YOUR FRINGE AREA INSTALLATIONS ARE TOPS!

Suggest and Use the remarkable new Double CO-Lateral

FINCO 400-A

ALL CHANNEL

FINCO IS A NAME YOUR CUSTOMERS KNOW BECAUSE OF THIS POWERFUL NATIONAL ADVERTISING PROGRAM!

UHF and VHF

EXCELLENT RECEPTION
120 to 150 MILES
FROM STATIONS

FINCO is acknowledged as the First and Foremost fringe area antenna

Fringe area buyers more and more ask for the FINCO by name. Let them know you handle the best — advertise the low cost way with Finco co-op ad mats — tie-in with LIFE — watch your sales soar! Get the complete story from your jobber or write direct

FARM MAGAZINES RADIO LOCAL NEWSPAPERS TELEVISION LIFE

The Finney Co.
Dept. S-26
4612 St. Clair Ave.
Cleveland 3, Ohio

R U S H

- information on the new 400-A and UHF Conversion Kit No. 12.
- FREE LIFE merchandising display material.
- Co-op newspaper ad mat brochure.

YOUR NAME

COMPANY NAME

ADDRESS

CITY ZONE STATE

YOUR JOBBER

The FINNEY Compa

Dept. S-26, 4612 St. Clair Ave., Cleveland 3, Ohio

How to make PICTURE-TUBE SUBSTITUTIONS EASILY



New CBS-Hytron Substitution Chart for Television Picture Tubes helps you pick logical substitutions easily, quickly. It's a cinch to use this complete, up-to-date Chart. An Index of types leads you to proper Substitution Group listing all readily interchangeable types. You pick an available type . . . with the least number of necessary service adjustments. That's it. No other references required. You save time . . . money. You need this indispensable CBS-Hytron TV Substitution Chart. Get it from your CBS-Hytron distributor. Or write direct today.

WHAT'S IN IT

1. General Introduction outlines scope and purpose.
2. Introductory Notes give details on tabulation.
3. Typical Substitution shows how to use Chart.
4. Index indicates Substitution Group for each type.
5. Substitution Groups narrow choice to logical substitutions.
6. Basing and Outline Drawings give basing and dimensional data.

FEATURES

- All necessary data given for all electromagnetically deflected types, regardless of make.
- Directly interchangeable types indicated.
- Other popular substitutes and required service changes high-lighted and explained.
- Substitution, not conversion, emphasized.

GOT THESE HELPFUL GUIDES?

All are complete. Include all types, regardless of make. Give all pertinent data. Are free. Get yours today.



Miniature Guide includes 250 types, 111 basing diagrams. Indicates similar larger prototypes.



Crystal Diode Guide describes 92 types, 19 basing diagrams. Indicates typical application for each type.



TV Picture-Tube Guide lists 164 types, 19 basing diagrams for all magnetically deflected picture tubes.

NOW 3

CBS-HYTRON TEST ADAPTERS



7-Pin Min.,
\$1.45 Net

8-Pin Octal,
\$2.25 Net

9-Pin Min.,
\$1.75 Net

BY POPULAR DEMAND. You can now buy CBS-Hytron Test Adapters in all three popular sizes: 7-pin miniature, 8-pin octal, 9-pin miniature.

You can now test *all* sockets dynamically . . . "topside." Without wrestling with heavy chassis. Without disturbing wiring or parts. Just plug tubes into Test Adapters and Adapters into sockets. Presto, socket connections are topside . . . ready for your test prod. You check voltage, resistance, gain, intermittents, oscillation. Trace signals, etc. All the e-a-s-y topside way. Order *all three* Test Adapters from your CBS-Hytron distributor today.

New . . . Free DECAL

Not just an identification. But a colorful decal that sells for you! *Sells* your magic ability to recapture new-set sparkle. Let this decal pull customers to you. Get it today from your CBS-Hytron distributor.

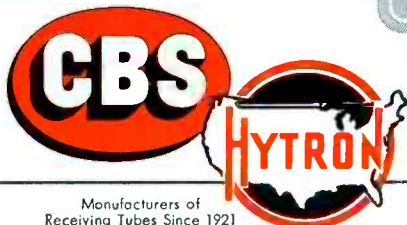

Manufacturers of
Receiving Tubes Since 1921

CBS-HYTRON Main Office: Danvers, Massachusetts

A Division of Columbia Broadcasting System, Inc.

RECEIVING . . . TRANSMITTING . . . SPECIAL-PURPOSE AND TV PICTURE TUBES • GERMANIUM DIODES AND TRANSISTORS

SERVICE, JUNE, 1953 • 5

Your **Basic Buy** for trouble shooting and alignment of VHF and UHF receivers

THE PROTECTION of your investment in TV test equipment is an important point to consider before you buy. Eventually you will be called upon to service both VHF and UHF television receivers . . . so it is sensible to choose equipment that will serve for years as the *basic foundation* of your TV servicing set-up.

The RCA WR-39C Television Calibrator and the RCA WR-59C Television Sweep Generator incorporate the facilities you need

now, and in the future, for trouble shooting and alignment of VHF receivers and of if systems of UHF sets . . . single or double conversion. In addition, these instruments provide usable harmonics in the UHF region.

Before selecting TV test equipment for your special needs, be sure to get the full details on the WR-39C and WR-59C from your **RCA Test Equipment Distributor** . . . or write RCA, Commercial Engineering, Section 56 FX, Harrison, New Jersey.



RCA WR-39C
TELEVISION CALIBRATOR
\$242.50 Suggested User Price

RCA WR-59C
TELEVISION SWEEP GENERATOR
\$274.50 Suggested User Price



RADIO CORPORATION of AMERICA
TEST EQUIPMENT

HARRISON, N. J.

PREDICTION

THE VEE-D-X ROTATOR WILL SOON BE THE NATION'S BEST SELLER!

Seeing is Believing!

Study this cutaway view. See for yourself why it is truly the finest of all rotators.

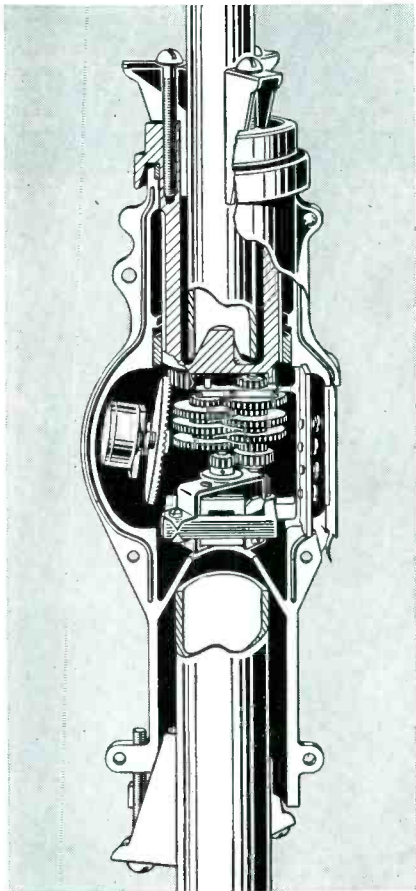

THE MAGNIFICENT DECORATOR STYLED CONTROL CONSOLE

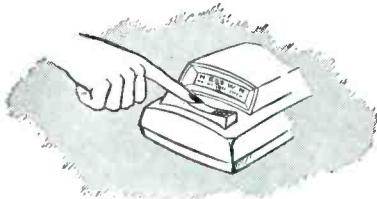

VEE-D-X

This forecast is not given lightly — nor do we expect it to be accepted lightly. It is backed by sound business reasoning and the awareness that VEE-D-X engineering, in collaboration with other world famous manufacturers, have jointly produced the finest of all rotators. It is so far in advance of anything on the market that a comparison with existing rotators will only serve to substantiate these (not lightly given) claims.

Many months of research, planning and testing were spent on the VEE-D-X Rotator. Its many exclusive and precision incorporated features assure pin-point accuracy and complete dependability under all weather conditions. The VEE-D-X Rotator is precision made for precision performance — designed to provide TV reception at its very best.

VEE-D-X OFFERS YOU RIGHT NOW ALL THE FEATURES YOU'VE DREAMED OF IN A FINE ROTATOR

PRECISION-BUILT—The VEE-D-X Antenna Rotator is built with the same precision with which it was engineered. Nothing has been spared in quality construction to provide the utmost in dependability and long trouble-free operation.

ADVANCED STYLING — Streamlined case design — better looking, less wind resistance.

FINEST GEARING OF ANY ROTATOR — Unique. Compact. Efficient. The self-contained, flanged spur gear train of the VEE-D-X Rotator puts it in a class by itself. Flanged reinforced gear teeth cannot be stripped. Designed and developed in cooperation with world famous small gear specialists. It provides most dependable performance under all conditions.

BALANCED MOUNTING — In-line (axial) mounting. Relieves strain on mast and guy wires. Equalized load distribution—no cumbersome offset—improved rooftop appearance.

WEATHER-RESISTANT FINISH—Entire unit is completely finished with new weather-resistant Luster-On #15 that meets rigid Army Signal Corps specifications. Stays bright—will not corrode.

FINEST MAST CLAMPS OF ANY ROTATOR — The positive three jaw chuck-type mast clamp is a VEE-D-X feature that provides simplest installation and the largest clamping surface of any rotator.

POSITIVE MAST ALIGNMENT — Is assured with built-in, self-centering mast guides both top and bottom.

FAST, EASY LINE CONNECTIONS—Accommodate four wire line. Exclusive snap-in cover, slides into place—no screws to drop when installing.

FULL 365 DEGREE TRAVERSE — Eliminates necessity of reversing rotation at critical points at end of normal 360 degree traverse.

POSITIVE ANTENNA BRAKE—No over travel, assures pin-point accuracy the moment control actuator is released.

EXTREMELY POWERFUL — Will support a load of over 200 pounds—thereby eliminating any need for the extra expense of an auxiliary thrust bearing.

GUYED AT TOP—Three guy ring lugs are cast as an integral part of the case for maximum strength. Spaced 120 degrees apart—permits three or four wire guying.

DECORATOR STYLED CONTROL CONSOLE — Smaller, more compact, more beautiful than any other. Unique control actuator. Dial gives both compass and numerical reference points. Plastic case in choice of beautiful decorator colors—Heather Green or Cordovan Mahogany.

ACCURATE COMPASS INDICATION AT ALL TIMES—No screw driver adjustment required to compensate for voltage fluctuation.

FACTORY TESTED AND GUARANTEED—Every Rotator and Control Console is thoroughly tested electrically and mechanically and fully guaranteed.

Write For Literature!

LaPointe Electronics Inc.
Rockville, Connecticut

Mail copies of Rotator literature.

Name

Street

City Zone State



MAKE IT EASY FOR YOURSELF

...Better for your Customers

BY USING THE **NEW**

South River CHIMNEY UNI-MOUNT

Here's a combination every service man will find unbeatable. The new South River Chimney Uni-Mount offers you every advantage—quicker, easier installation—because of the convenience of a one-piece mount. The snap-in feature makes inserting the mast a simple, quick operation. And, the unique, sure, banding closure—the exclusive South River Kwik-Klip—enables you to speedily tighten the banding to complete a perfect installation.

Your customers will appreciate the solidity, extra rigidity and permanence of the Uni-Mount, with heavy-gauge, stainless-steel strap. You can point with pride to another South River installation that has made money for you and has enhanced your reputation as a first-rate service man.

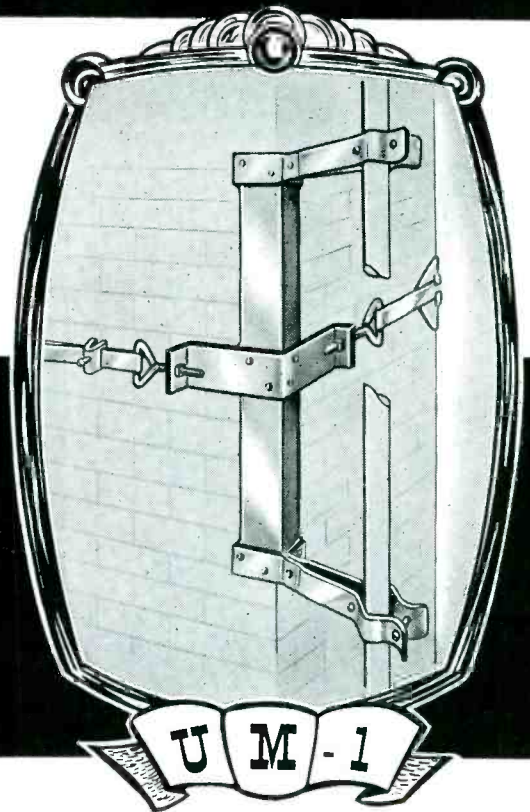

SOUTH RIVER CHIMNEY UNI-MOUNT MODEL UM-1

is constructed of heavy-gauge steel, riveted for extra strength. It is hot-dip galvanized for lasting weather-proof coating and features the snap-in mast holders with flared lips. Generous 18" spacing between mast holders provides firm support. This model is available with one heavy-gauge, stainless-steel strap, the Kwik-Klip Banding Closure and clever new Chimney Corner Guards.

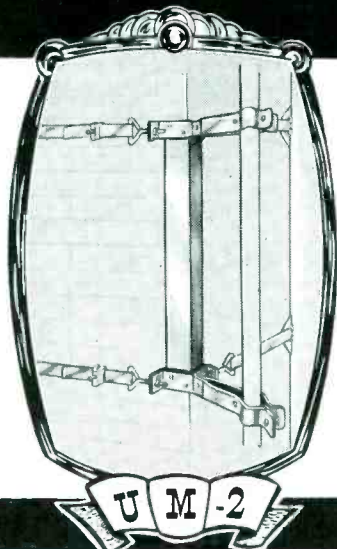

MODEL UM-2

with two heavy-gauge, stainless-steel straps, is complete with all of the other features listed above.

Sold by leading parts jobbers from coast to coast.

Write for your copy of
South River's complete 1953 catalog.

South River

METAL PRODUCTS CO., INC.

South River, New Jersey

PIONEER AND OUTSTANDING PRODUCER OF THE FINEST LINE OF ANTENNA MOUNTS

SERVICEMAN'S DIARY..as told to Ben Grim, **SPRAGUE PRODUCTS COMPANY**



ALL'S ANGELIC ON THE HOME FRONT..

...UNTIL THE TV REPAIRMAN ARRIVES!

BIG NEWS about **CERAMIC CAPACITORS**

Now you can get anything you need in ceramic capacitors from Sprague, the big name in ceramic capacitors!

GA Types from 1.5 mmf, 3,000 WVDC to 5,000 mmf, 500 WVDC, as well as dozens of in-between ratings at 400, 1,000, 2,000, 5,000, 7,500 WVDC. NPO Types from 10 mmf to 270 mmf, 500 WVDC. High-K Types in single units at .001 mf to .03 mf, 500 WVDC, and 4,000 mmf to 10,000 mmf at 1,000 and 2,000 WVDC; dual units at 2 x .001 mf to 2 x .02 mf, 500 WVDC. Doorknobs at 500 mmf, 20,000 WVDC. Bulplate ceramics from 1.0 mmf, 500 WVDC to 10,000 mmf, 2,000 WVDC. Multiple ceramics at 500 WVDC, 1,000 test voltage d-c Buttons from 10 mmf to 1,500 mmf, 500 WVDC. 6 Printed Circuits at 450 WVDC, one at 100 WVDC. Precision tubular ceramics at 500, 1,000, 1,500 WVDC for all standard temperature coefficients from P100 to N750. Precision Ceramic Trimmers from 4 mmf (min.) - 18 mmf (max.) to 10 mmf (min.) - 110 mmf (max.).

There's a Sprague ceramic capacitor to meet every need, either in original equipment, or as an exact replacement.

See your distributor, or write to Sprague Products Co., 61 Marshall St., North Adams, Mass. for the complete new Sprague listings in Bulletin C650. Remember Sprague can fill all your ceramic needs.

*Don't Be Vague
Ask For Sprague*

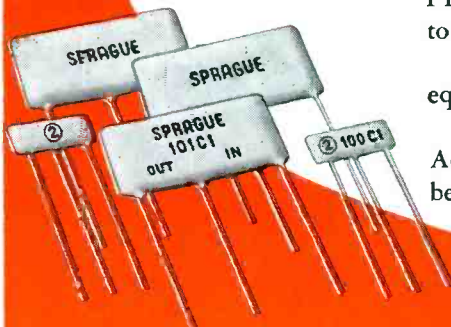

SPRAGUE WORLD'S LARGEST CAPACITOR MANUFACTURER

R_x for UHF^s fringe areas!

CHANNEL MASTER'S all-UHF TWIN CORNER REFLECTOR

the most sensitive fringe area antenna ever developed for UHF!

- Two dipoles—actually two antennas in one.
- Provides twice the gain of any standard-type UHF Corner Reflector.
- Instantly installed in just three steps.
- Furnishes far better picture quality — at far greater distances.
- Eliminates UHF's TWIN TERRORS. Features vibration-proof construction; and "free-space" terminals.



up to
16 DB gain!

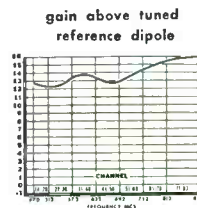

horizontal polar pattern (relative voltage)

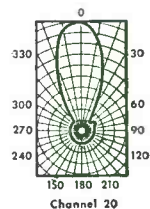

practically
no
assembly
necessary

CHANNEL MASTER'S 10-ELEMENT DELTA-WELD YAGI

custom-designed for your specific area!



**CHANNEL MASTER
engineering
pays off on UHF!**

- Elements permanently WELDED IN POSITION on crossarm.
- Custom construction — designed for almost any UHF area.
- Delta-matched dipole for excellent impedance match.
- Brilliant performance. Average gain: over 11 DB, single bay; over 14 DB, stacked. Even higher on some models.
- Eliminates UHF's TWIN TERRORS.



CHANNEL MASTER CORP.
ELLENVILLE, N. Y.

Write for complete technical literature.

At Last! a YAGI for the ENTIRE LOW BAND!

CHANNEL MASTER'S Newest *futuramic*

Completely covers every low band channel—2 through 6

Now the extraordinary high gain of a Yagi . . . the razor-sharp directivity of a Yagi . . . Not on just one channel — but clear across the entire Low Band!

Designed for service TODAY and TOMORROW in these 3 booming VHF markets:

Areas in which present VHF stations are changing channels (on the Low Band).

The Futuramic Yagi provides better reception than conventional Yagis on the present channels — and when the shift occurs this superior reception will continue on the new channel WITHOUT INTERRUPTION. And you can make your change-over installations NOW.

Areas in which a new VHF station is being added to the present one (on the Low Band).

The great number of single channel Yagis now in use will not bring in the new channel. If an additional Yagi is installed it will have to be tied into the present installation with separate leads and a switching system. However, one Futuramic will do the job of BOTH antennas — at lower cost — with better results on BOTH channels.

Areas served at present by two or more VHF stations on the Low Band.

You no longer have to compromise between conventional broad band antennas, and separate Yagis for each channel. The Futuramic gives you the full advantages of both. It combines highest gain and sharpest directivity with simple, economical installation.

horizontal polar pattern (relative voltage)



gain above tuned reference dipole

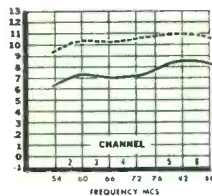

model no. 1126

A high-low Futuramic combination is the most sensitive array ever designed for all-channel VHF reception. Just combine models 1173 and 1126.

Now — 6 great Futuramic models, designed for every reception area:

model no.	channels covered	list price
1173	7 — 13	\$20 ⁸³
1124	2, 3, and 4	
1125	2, 3, 4, and 5	
1136	3, 4, 5, and 6	\$40 ⁹⁷
1146	4, 5, and 6	
1126	2, 3, 4, 5, and 6	

CHANNEL MASTER engineering pays off on VHF!



CHANNEL MASTER CORP. ELLENVILLE, N. Y.



Sylvania's New 1954 Calendar

for Service Dealers.... sells all through the Year!

They'll read your super-service story every month!

Billed with ideas and recipes your prospects will want to keep

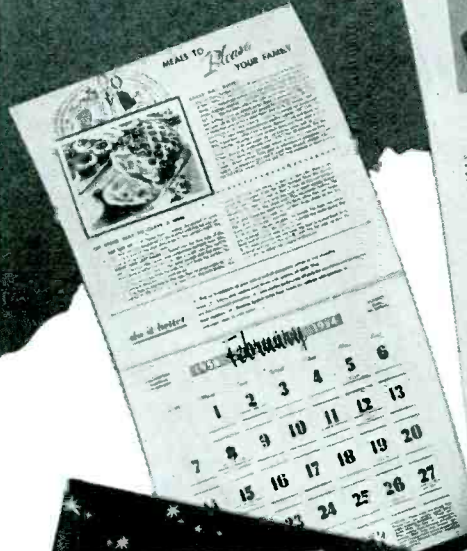

Only 1½¢
PER MONTH PER PROSPECT...
YOUR GREATEST
ADVERTISING BUY!



Don't miss this Dramatically Different Business Builder!

It's your personal Christmas greeting, too

Here's the hardest-selling, custom-made Home Calendar ever offered to Radio-TV Service Dealers! It's tailor-made just for you! Features an appealing illustration painted exclusively for Sylvania by a famous cover artist. Reproduced in full color and imprinted with your name and address.

Your prospects simply can't overlook this calendar. It's filled with timely hints and valuable household suggestions they'll want to keep handy. And, every time they turn the page they'll be reminded of your dependable service, skill, and experience.

Order now . . . supply limited! At only 1½¢ per customer per month (in lots of one hundred or more), this calendar

is truly the smartest advertising buy ever offered. But don't delay, the supply is limited! Order a couple of hundred from your regular Sylvania distributor . . . **TODAY!** If he is out of stock, write to: Sylvania Electric Products Inc., Dept. 3R-2406, 1740 Broadway, N. Y. 19, N. Y.

SYLVANIA



RADIO TUBES; TELEVISION PICTURE TUBES; ELECTRONIC PRODUCTS; ELECTRONIC TEST EQUIPMENT; FLUORESCENT TUBES, FIXTURES, SIGN TUBING, WIRING DEVICES; LIGHT BULBS; PHOTOLAMPS; TELEVISION SETS

NO OTHER UHF ANTENNA COMBINES ALL

- 1 Extra high gain
- 2 All channel reception
- 3 Sharp vertical and horizontal directivity

3

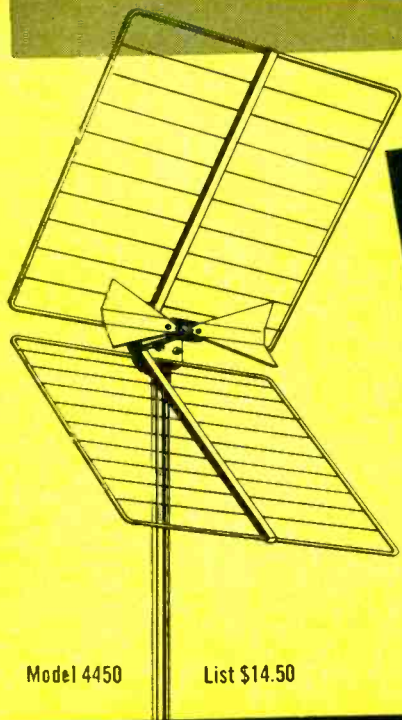

Model 4450

List \$14.50

WALSCO

CORNER REFLECTOR

Not 1... Not 2... but all 3 combined
for amazing picture clarity

NOTHING . . . *absolutely nothing* compares with Walsco's Corner Reflector. It's the only UHF antenna that offers a 3-way *combination* that produces sharper, clearer TV pictures. Truly a masterpiece in precision electronic engineering.

WALSCO *A Model to Fit Every Installation*

Walter L. Schott Co.
3225 Exposition Place
Los Angeles 18, California

COMPARISON CHART

	High Gain	All channel Performance	Sharp Directivity
WALSCO CORNER REFLECTOR	YES	YES	YES
ANTENNA B	NO	YES	NO
ANTENNA C	NO	YES	NO
ANTENNA D	YES	NO	YES

Overseas Representative: Ad Auriema, Inc., 89 Broad St., New York 4, New York

*Quality
conscious dealers
want the
Nepco Line*

Experience is a great teacher.
And experience has taught more
and more TV installers and service
men they can't afford to risk their
reputations on inferior materials.

That's why so many demand the
NEPCO LINE—television's "Master
of the Elements." They've found
that National Electric's complete
line of TV Antennas, Mounting
Accessories, and Wire provides
built-in ruggedness . . . meets the
test of time and weather—and
*assures their reputation in both
the new and replacement markets.*



EXAMINE THE NEPCO LINE—

**Quality materials
with the strength to
stay on the job . . .**

- * Extra heavy zinc galvanizing on all parts.
- * Baked on "Shera-solution" for *extra* corrosion protection.
- * Rigid heavy gauge steel used in all mounts (1 $\frac{3}{4}$ "x1 $\frac{1}{8}$ ").
- * Two 15' *stainless steel* chimney bands, $\frac{5}{16}$ " eye bolts, and 4 heavy gauge banding clips with patented imbedding screws available with each chimney mount.
- * All hardware corrosion-protected in the same complete manner as the mounts.

* Every item in the NEPCO Line is engineered, tested and field proved to assure long service on the job.

**Plus features
for fast, easy installation
and handling**

- * Unique adjustable mast clamp with one bolt mounting.
- * Exclusive antenna mast clamp with positive alignment in all planes.
- * Patented imbedding type screw for positive electrical and mechanical locking.
- * Versatile mounts that accommodate all types of installations.

National

ANTENNAS—UHF

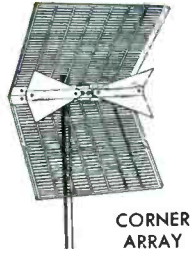

CORNER ARRAY

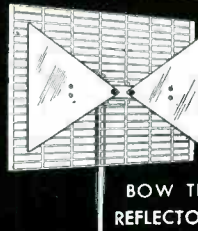

BOW TIE REFLECTOR

- DOUBLE DIPOLE REFLECTOR
- STACKED DIPOLE REFLECTOR
- YAGI TYPE
- BOW TIE
- CONICAL TYPE

ANTENNAS—VHF

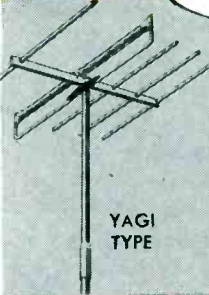

YAGI TYPE

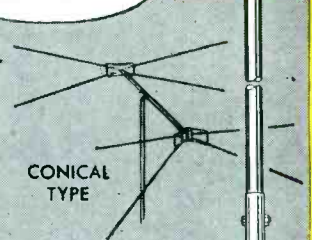

CONICAL TYPE

THE COMPLETE LINE
FOR A FAST
PERMANENT INSTALLATION

MASTING

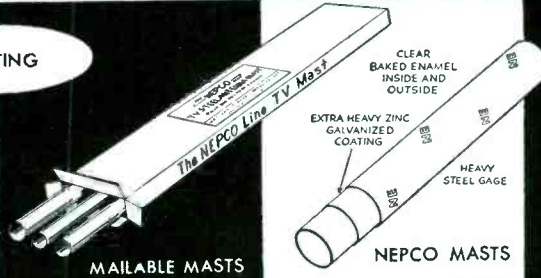

MAILABLE MASTS

CLEAR BAKED ENAMEL INSIDE AND OUTSIDE

EXTRA HEAVY ZINC GALVANIZED COATING

HEAVY STEEL GAGE

NEPCO MASTS

TELESCOPING MASTS

MOUNTS

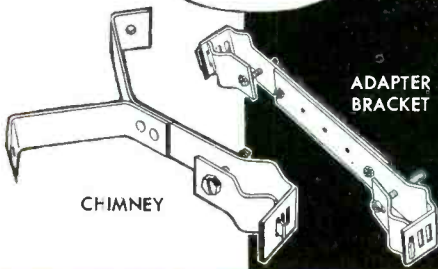

CHIMNEY

ADAPTER BRACKET

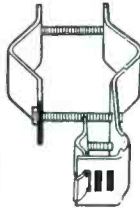

VENT

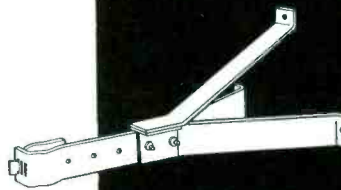

ADJUSTABLE WALL

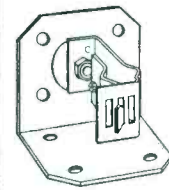

ROOF

WIRES

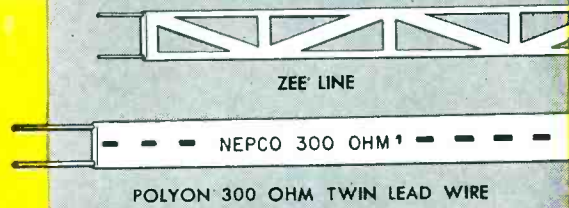

ZEE' LINE

NEPCO 300 OHM 1'

POLYON 300 OHM TWIN LEAD WIRE

YOU'LL FIND...

- * A line designed with your handling problems in mind . . . strong compact boxes easy to move and stack.
- * Large easy-to-read illustrated package labels.

In addition . . .

Brand recognition has been gained for the NEPCO Line through superior service on the job, and a national advertising and promotional program has created acceptance for this quality line.

The NEPCO Line is priced right for your customers.

Write, wire or phone for the name of your nearest representative today

Plus

- Wall Brackets
- Guy Rings
- Chimney Banding
- Banding and Mast Clamps

THE
NEPCO
LINE

Electric Products

Radio & Television Department, Pittsburgh, Pa.

Field Engineers

FOR INSTALLATION AND MAINTENANCE OF LINK ELECTRONIC JET TRAINING EQUIPMENT

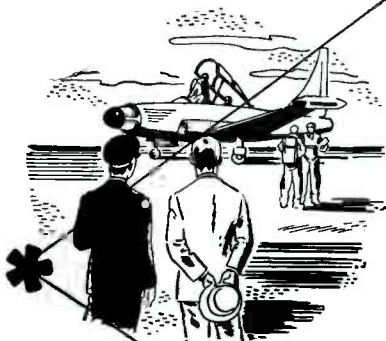

Here is an unparalleled opportunity for men with a College or Technical Institute Training and a sound background in electronic engineering. The training and experience provided will open up increasing opportunities for earnings and advancement in the fast approaching age of jet air transportation.

You will work in close contact with key personnel of the U.S. Air Force and Naval Aviation. Your responsibilities will include supervising the installation and long range maintenance of highly specialized Link Electronic Jet Training Equipment. After three months' special training at the Binghamton, N. Y. plant of Link Aviation, you will be assigned to a U.S. Air Force or Navy jet training base in the U.S., Europe or the Far East!

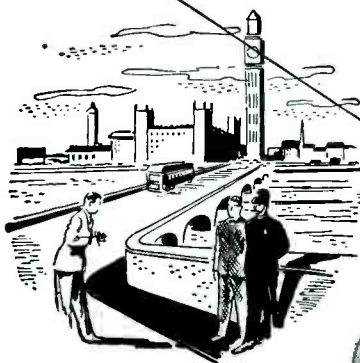

In addition to excellent base pay and unusual company benefits, you will be placed on a liberal expense account and receive a 20% bonus if you receive an overseas assignment.

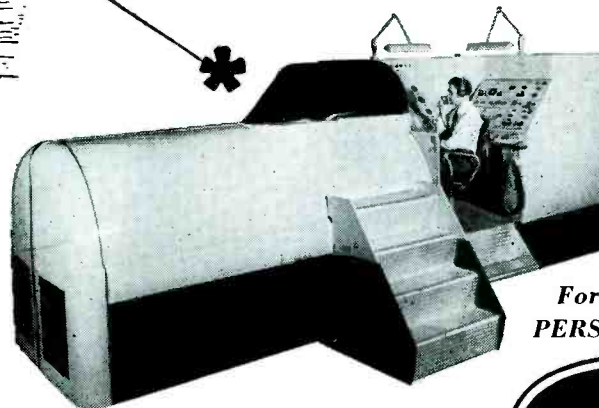

Immediate Openings
are available
ACT NOW—
for a career
with a future!

For Interview write to
PERSONNEL MANAGER

the connecting link between ground and sky

Manufacturers of the famous World War II LINK TRAINER,
now producing Electronic Jet Training Equipment
in quantity for the U.S. Armed Services



HERE'S **WHY** IRC EXACT DUPLICATES ARE DOUBLE-MONEY-BACK **GUARANTEED**

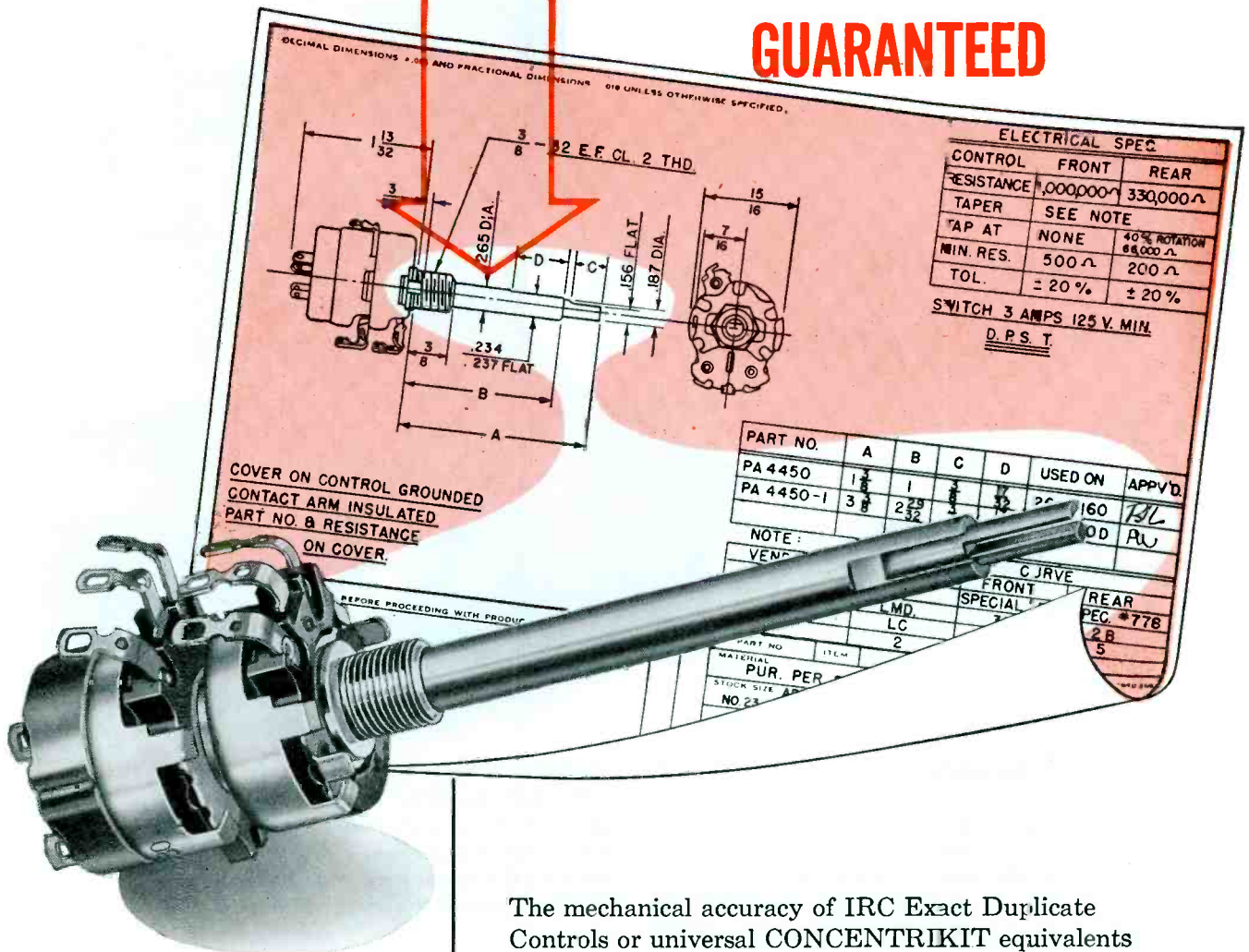

**ONLY IRC GUARANTEES
SATISFACTORY MECHANICAL FIT
AND ELECTRICAL OPERATION,
OR DOUBLE-YOUR-MONEY-BACK**

The typical manufacturer's specifications shown here are exactly duplicated by IRC QJ-180 control. CONCENTRIKIT assembly includes P1-229 and R1-312 shafts with B11-137 and B18-132X Base Elements, and 76-2 Switch.



Wherever the Circuit Says ~~~

The mechanical accuracy of IRC Exact Duplicate Controls or universal CONCENTRIKIT equivalents is based on set manufacturers' procurement prints. Specifications on those prints are closely followed.

Shaft lengths are *never less* than the set manufacturer's nominal length—*never more* than $\frac{3}{32}$ " longer.

Shaft ends are precisely tooled for solid fit.

Inner shaft protrusion is accurately duplicated for perfect knob fit.

Alterations are never needed.

For Exact Duplicate Controls, specify IRC. Most Service Technicians do.

INTERNATIONAL RESISTANCE CO.

402 N. Broad Street, Philadelphia 8, Pa.

In Canada: International Resistance Co., Ltd., Toronto, Licensee

*“... opportunity
is freely given...”*

PAUL M. HAHN
President, The American Tobacco Co.

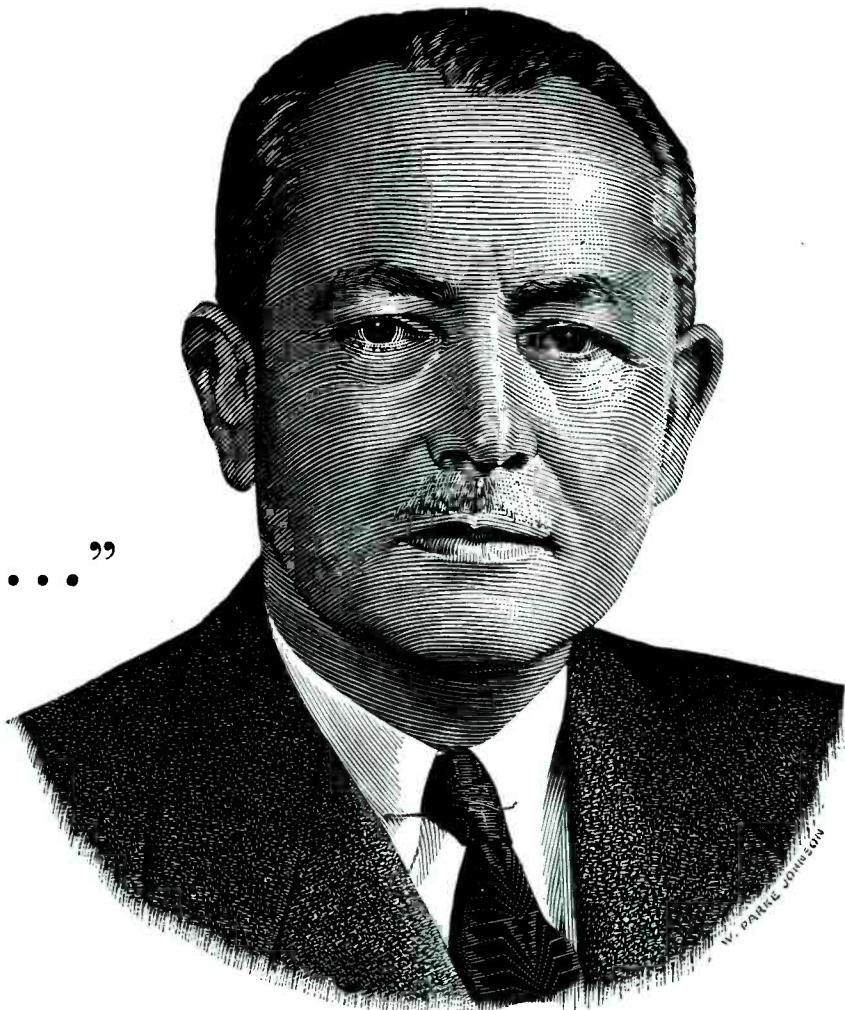

“Our nation has grown great largely because opportunity is freely given. Only very few people actually make their own ‘breaks.’ Today, millions of Americans are providing for their personal financial security and at the same time helping in the building of our national defenses. The opportunity to do so is given by business management which affords employees the means of practicing systematic thrift through the Payroll Savings Plan for the purchase of U. S. Defense Bonds.”

Nearly seven million employees of industry are “providing for their personal security and at the same time helping in the building of our national defenses.”

- they are the men and women who availed themselves of the opportunity referred to by Mr. Hahn—the opportunity to enroll in the Payroll Savings Plan for the systematic purchase of U.S. Defense Bonds.
- they represent a high percentage of their companies’ employees—in plant after plant, the averages are climbing to 60%, 70%, 80%—even higher.
- their investment in Defense Bonds—and America—add up to \$140 million per month.
- they constitute a large block of the men and women who on December 31, 1951, held Series E Bonds

amounting to \$34,727,000,000—\$4.8 billions more than the cash value of Series E’s outstanding in August, 1945.

Not far from you is a State Director of the Savings Bond Division. He will be glad to tell you how easy it is to give your employees a Payroll Savings Plan. Or, if you already offer the Plan to your people, he will show you how to conduct a simple person-to-person canvass of your plant—a canvass intended to do only one thing—to put a Payroll Savings Application Blank in the hands of every man and woman on your payroll. Your employees will do the rest.

Phone or write to Savings Bond Division, U.S. Treasury Department, Suite 700, Washington Building, Washington, D. C.

The U. S. Government does not pay for this advertising. The Treasury Department thanks, for their patriotic donation, the Advertising Council and

SERVICE



Save by Standardizing
YOUR ELECTRICAL PROTECTION

with the Complete Line
of **BUSS FUSES**

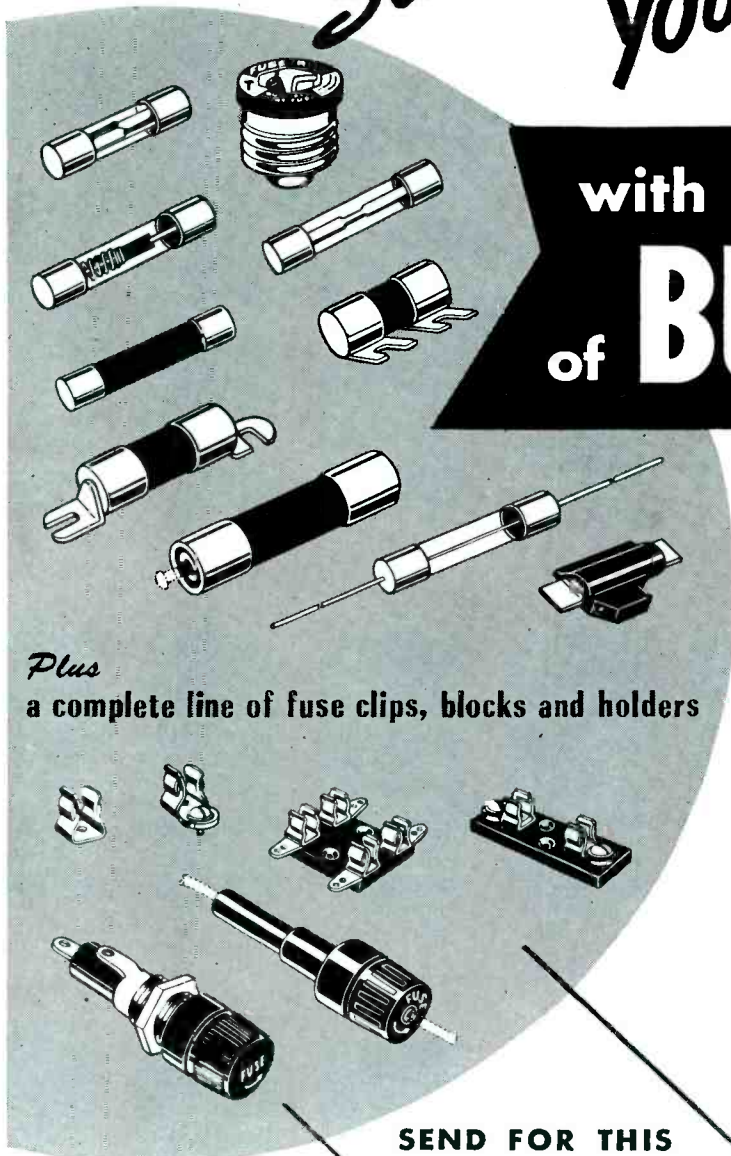

Plus
a complete line of fuse clips, blocks and holders

for Television • Radio • Radar •
Instruments • Controls • Avionics

You'll save time and trouble when all your fuse needs are supplied by one, dependable source. The complete BUSS line makes it easy for you to select the fuse to do the job right.

Behind every BUSS fuse is the world's largest fuse research laboratory and fuse production capacity. To assure and maintain top quality, each individual BUSS fuse is tested in a highly sensitive electronic device. Any fuse that is not correctly calibrated, properly soldered or the right dimensions, is automatically rejected.

Start now to simplify your fuse selection and save by standardizing on the complete BUSS line.

SEND FOR THIS
HELPFUL
INFORMATION

IT'S GOOD BUSINESS to stock and use BUSS fuses. Your customers know the name BUSS . . . famous for protection in homes, on farms and in industry for 39 years. When you use BUSS, they know you've used the finest fuses available.

BUSSMANN Mfg. CO., Division of McGraw Electric Co.
University at Jefferson, St. Louis 7, Missouri

BUSSMANN Mfg. Co. (Division of McGraw Electric Co.)
University at Jefferson, St. Louis 7, Mo.
 Please send me bulletin SFB containing facts on
BUSS small dimension fuses and fuse holders.
 Name _____
 Title _____
 Company _____
 Address _____
 City & Zone _____ State _____ S-653

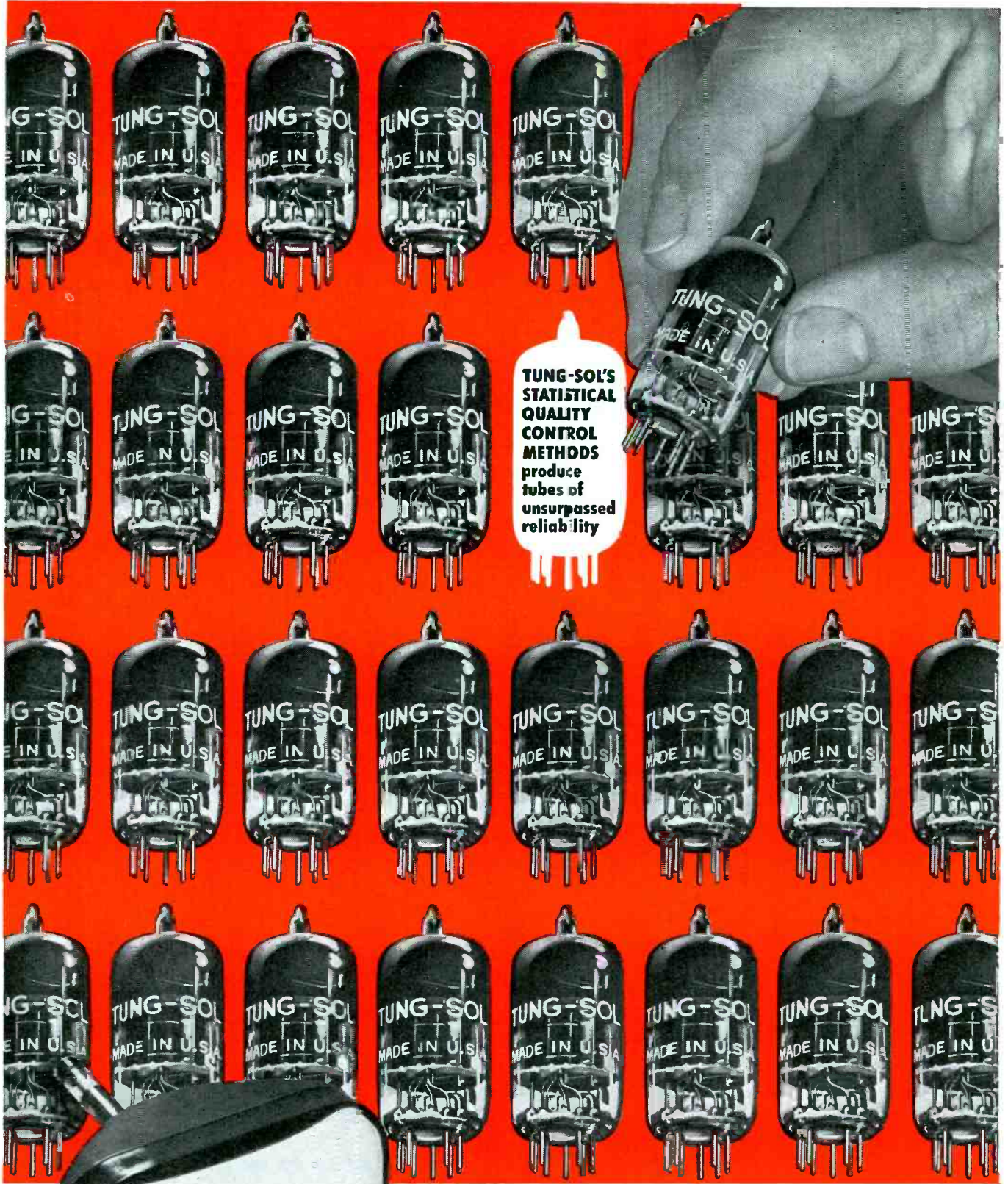

TUNG-SOL'S
STATISTICAL
QUALITY
CONTROL
METHODS
produce
tubes of
unsurpassed
reliability

TUNG-SOL makes All-Glass Sealed Beam Lamps, Miniature-Lamps, Signal Flashers, Picture Tubes, Radio, TV and Special Purpose Electron Tubes and Semiconductor Products.

TUNG-SOL ELECTRIC INC.
Newark 4, N. J.

Sales Offices Atlanta, Chicago, Culver City (Los Angeles), Dallas, Denver, Detroit, Newark, Seattle

The First and Only

VHF to UHF Signal

Generator Adapter

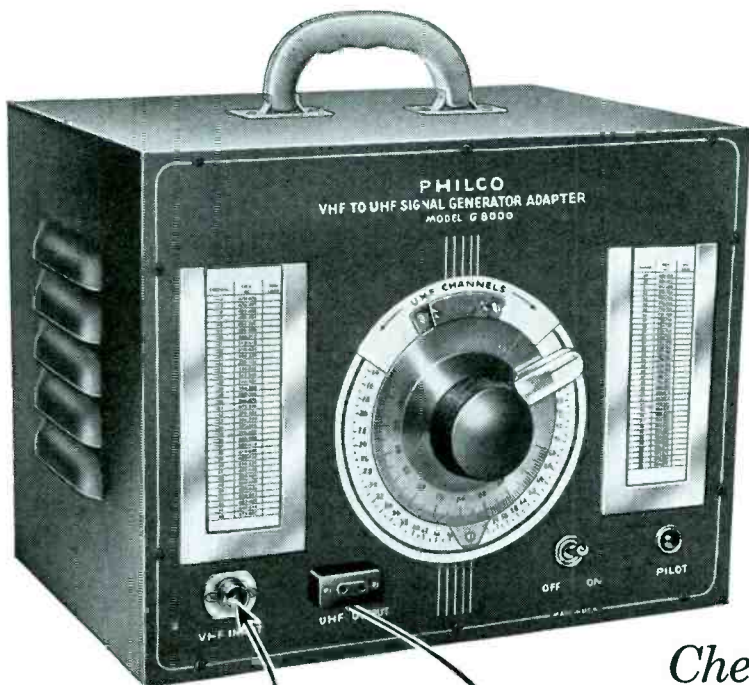

Here from
PHILCO

Now at a mere fraction of the usual cost, you can produce UHF signals for TV receiver tests. As the output from any VHF signal generator at 60 MC is fed into this Model G8000 Adapter, the VHF sweep or marker signal beats against the UHF oscillator of the unit, producing UHF signals having the same characteristics as the VHF input signal. The most economical system ever . . . and only Philco has it!

Check These Philco Features

1. No expensive attenuator required—the VHF signal generator output attenuator controls the UHF output signal level.
2. Precision Vernier Dial for accurate re-set ability.
3. Can function as an external UHF

converter by connecting UHF antenna transmission line to generator's output terminal and connecting lead to TV receiver tuned to 60 MC (Channel 3).

4. High UHF levels, excellent stability, no drift.

VHF INPUT
60 MC

UHF OUTPUT
SIGNAL



5" Wide Band TV Oscilloscope
Model 7021. Finest at the price! Provides extremely wide video response for accurately viewing complex TV wave forms. Celebrated input attenuator and gain control for peak voltage readings.

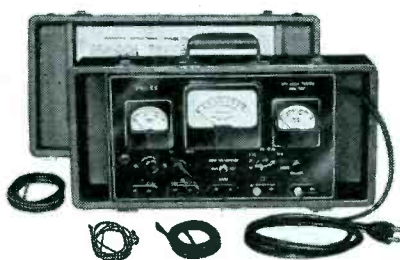

Philco Appliance Tester

Model 5007. In one compact, portable unit—everything you need to make range, refrigerator, freezer and air conditioner temperature and power measurements quickly and easily.

YOURS ON NEW SPECIAL PAYMENT PLAN

Fill Out and Mail Coupon or See
Your Philco Distributor Now!

PHILCO CORPORATION, Accessory Division
Allegheny & "A" St.,
Philadelphia, Pa.

I am interested in the Philco Test Equipment shown here. Please send me details of your SPECIAL PURCHASE PLAN for obtaining these units.

Please send FREE copy of your new booklet on Philco Test Equipment.

NAME.....

ADDRESS.....

CITY.....STATE.....



PHILCO Test Equipment
SPECIFICALLY Designed for the Serviceman

TIGHT SEAL

... BONDED BLUE-POINT

TOUGH SHELL

... MOLDED PLASTIC TUBULAR

... a
in

BONDED SEAL

Positive, heat resistant, non-inflammable bond seals leads and shell, locks out humidity.

DRY ASSEMBLED

Ensures uniform high quality and uncontaminated capacitors.

ATTRACTIVE YELLOW MOLDED PLASTIC SHELL

Non-inflammable. Will not burn or melt under soldering iron or flame.

BONDED SEAL

Positive, heat resistant, non-inflammable bond seals leads and shell, locks out humidity.

FIRMLY SECURED LEAD

Can't be pulled out, even under soldering iron heat.

MINERAL OIL IMPREGNATED*

Extremely stable over wide operating temperature range.



PATENT
PENDING

New

ASTRON

BLUE-POINT

BONDED

Capacitors

**INDIVIDUALLY
TESTED AND
GUARANTEED**

To insure *still greater* dependability in the field, *each* and *every* Astron Blue-Point Capacitor is subjected to an exhaustive series of physical and electrical tests prior to final shipment. As a result, Astron proudly *guarantees* the excellence of *every* Blue-Point Capacitor you buy.

†Trade Mark

Export Division: Rocke International Corp., 13 E. 40th St., N.Y.C.
In Canada: Charles W. Pointon, 1926 Gerrard St., East, Toronto.

ASTRON

Major Achievement

Molded Capacitor

Construction and

Performance

Engineered and Produced Exclusively by ASTRON



PATENT
PENDING

Now—Heat and Moisture PROTECTION To a Degree Never Before Possible!

Outstanding Performance in Hot and Humid Climates!
Here at last is a capacitor that affords *absolute protection* under every condition—a capacitor you can rely on completely—ASTRON BLUE-POINT, the *bonded* capacitor.

This capacitor is produced by an exclusive new design and manufacturing process (patent pending) developed by Astron engineers.

The all-important *blue point* which distinguishes this new capacitor actually *bonds* itself to the tough, heat-resistant outer shell and leads—forming the *tightest seal against moisture* ever produced!

The Blue-Point *dry-assembly* process—as used in hermetically sealed metal encased capacitors—prevents contamination, provides still further protection against moisture, and assures uniform *quality and dependability* for every Blue-Point.

The Blue-Point is mineral oil impregnated* for continuous operation at 85°C. The blue point seal

itself makes ingenious use of a special thermo-setting, heat-resistant, non-inflammable *bonding agent* as a positive protection against moisture.

With the Astron Blue-Point, you may solder leads as close to the capacitor as you like. Leads will not pull out, nor will the heat of the soldering iron damage the lead or the connection.

Further, every Blue-Point is clearly marked with rated voltage and capacitance, and is imprinted with outside foil identification.

The Astron Blue-Point Capacitor gives you greater protection against heat and moisture at every stage—assuring long life and dependable performance from *every unit*—to a degree never before possible with molded plastic capacitors.

From now on, look for the Blue-Point—ask for exclusive Astron Blue-Point Capacitors by name . . . more than ever before, *depend on, insist on* . . . ASTRON!

*For bulletin AB-20A, with complete engineering data and listings, write: Astron Corporation, 255 Grant Avenue, East Newark, N.J.

Astron manufactures a complete line of dry electrolytic capacitors, metalized paper capacitors, plastic molded capacitors, standard and subminiature paper capacitors and RF interference filters for every radio, television and electronic use.

DEPEND ON—INSIST ON



CORPORATION

255 Grant Avenue

East Newark, New Jersey

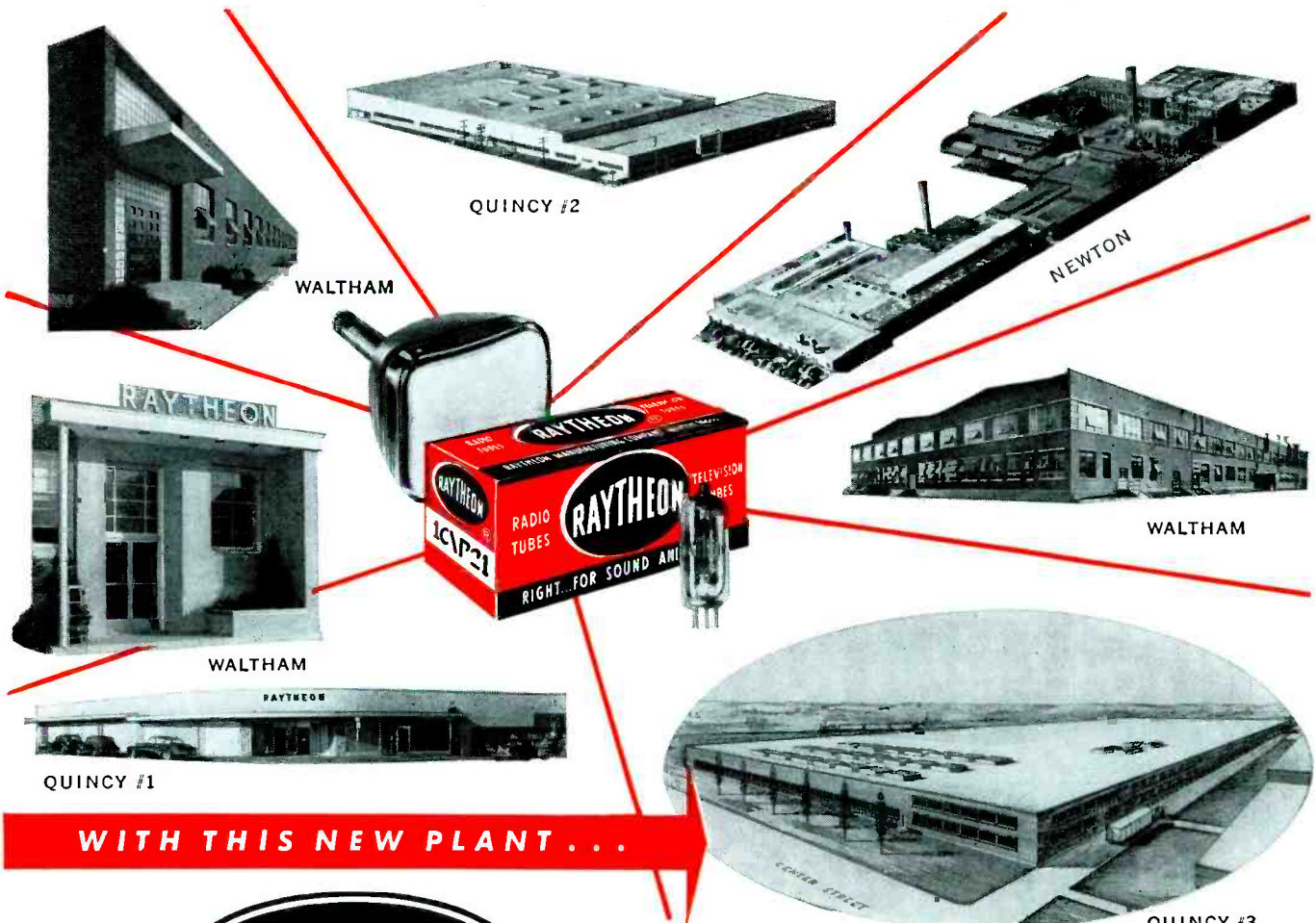

WITH THIS NEW PLANT . . .

the **RAYTHEON** resources

DEVOTED EXCLUSIVELY TO ELECTRON TUBES

- consist of • **more than 1,000,000 sq. ft. of manufacturing area**
- **more than 10,000 skilled tube craftsmen**
- **backed by 30 years of tube engineering, development and production experience**

Raytheon's newest plant at Quincy, Massachusetts is expressly designed to economically manufacture 24 inch and larger Raytheon Picture Tubes. It will employ the very last word in modern engineering and manufacturing techniques. It will be devoted exclusively to the making of tubes worthy of the Raytheon reputation for quality and dependability. With *Raytheon* Radio and Television Tubes you are *Right . . . for Sound and Sight.*



RAYTHEON MANUFACTURING COMPANY

Receiving Tube Division
 Newton, Mass., Chicago, Ill., Atlanta, Ga., Los Angeles, Calif.

Excellence in Electronics

RAYTHEON MAKES ALL THESE:
 RECEIVING AND PICTURE TUBES • RELIABLE SUBMINIATURE AND MINIATURE TUBES • GERMANIUM DIODES AND TRANSISTORS • NUCLEONIC TUBES • MICROWAVE TUBES

RADIO • TELEVISION • ELECTRONIC
SERVICE

The Audio Bandwagon

AUDIO, majestic pacemaker in industry for over a score of years, whose enviable record of progress has been a boon to Service Men, is now streaking ahead to even greater triumphs, which will bring beaming ledgers to more and more in the servicing business. Whereas a comparatively short time ago, audio concerned only a few, today, thanks to a spectacular surge of development, it has captured the interest of millions whose goal is better, and still better listening pleasure.

Accent on Audio

Enthusiasm has even spread to the camps of many setmakers, who have directed their research and development staffs to concentrate on audio . . . design packaged hi-fi systems, and even seen to it that improved audio is a feature of portables and TV, too. One chassis manufacturer has just reported that his exhaustive research efforts have resulted in the evolution of a new type of speaker for his small radios, an inverted type, which he describes as . . . "the first significant change in speaker design in 25 years." Developed in collaboration with a speaker maker, the new unit has the magnet built into the cone, thus eliminating the bulk from the rear of the speaker.

Still another radio-TV chassis maker has come up with an acoustical-dome speaker that, it is believed, will contribute to an extraordinary sense of realism. Others have made similarly striking improvements in amplifiers, changers, cartridges and enclosures, and are striving to increase further the value and usefulness of these items.

Return of AF Transformer

Even component manufacturers have begun to probe deeper and deeper into the requirements of better audio, and their campaign has produced significant results. The program has been highlighted by the return of the *af* transformer as a vital component in the audio system*. For years, because of the lack of materials and a general

apathy toward the component, *af* transformers had actually become museum pieces. However, the advent of new core materials and sealing techniques in particular, sparked a new interest on the development front. It was found that the philosophy that transformers had to be big to be good, which incidentally was only ever true for the *lf* end of the range, could be discarded, because the new core materials made it possible to handle low frequencies with transformers only the fraction of the size of the older prototypes. Continued research has revealed too, that the view that *af* transformers inherently cause distortion is out of line. While it is true that when a transformer is operated under conditions that saturate its core at low frequencies, considerable distortion can obtain, there are other forms of distortion not truly the fault of the transformer. This can be well illustrated by a comparison with resistance-coupled circuit operation: If a triode type tube, designed to work with a plate-load resistance of 6000 ohms, is connected instead to a 600-ohm resistor, the tube will distort the signal. Similarly, a pentode or tetrode does not like working into a load much higher than its recommended value. Actually, no one would seriously suggest that the 600-ohm resistor was distorting the signal; the distortion is due to the use of the wrong value of resistance for the tube. Even if the 600-ohm resistor was coupled into the plate circuit by a 1:1 transformer, the plate would still be working into a 600-ohm load instead of the required 6000-ohm load. Many might conclude that, after testing this setup, the transformer was responsible for distortion. Once again, though, the distortion is still due to an improper plate load.

Trend to Exact Specs

Further studies in transformer design have emphasized the fact that

*With apologies to N. H. Crowhurst, author of *The Use of AF Transformers*.

often transformer circuits can produce distortion because the plate load goes wrong at either high or low frequencies. The substitution of the correct load has been found to solve the problem. Manufacturers have found that it is important to specify the exact impedances required for both sides of the transformer to insure effective operation. A 3:1 interstage transformer must not have its impedances listed as just 10,000 and 90,000 ohms; 10,000 ohms indicating the plate impedance which will automatically be transformed to 90,000 ohms in the grid circuit, as indicated by the turns-square rule. Instead, it has been found necessary to state which circuit must be connected to the secondary for satisfactory operation; just the grid with no resistor, or perhaps with a 220,000-ohm unit.

New Concept of Tube Values

Tube characteristics have also been carefully scrutinized by amplifier designers, and with unique results. For instance, many early prejudices against certain types of tubes have now been shelved. In the early days, tetrodes and pentodes were severely criticized because of the distortion they produced; actually much of the distortion was due to operation under incorrect conditions. These useful tubes, capable of giving much more gain than the older triodes, have now become universally accepted for a variety of audio applications.

The Concerted Drive

Yes, it seems as if everyone has joined the spirited improvement parade, so that all can enjoy smoother, truer listening; a glowing tribute to the growing stature of audio . . . a stature we're proud to hail in this, our *annual audio issue*, featuring a host of reports on the latest advancements in the art which have brought such fame to audio.—L.W.

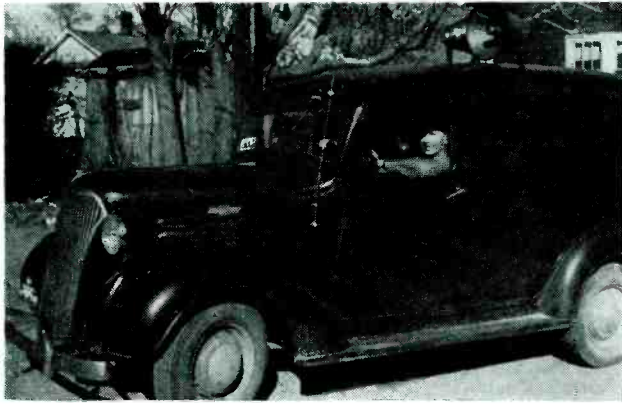

Small Shop

(Left)

Typical audio truck, using boom-type mike for driver. Small candlestick mike mounted on a lavalier-type strap can also be used here.

Design of Intergrated Fixed-Mobile Facilities, Featuring Use of 20-Watt AC Amp, 6-V 10-Watt DC Amp (For Truck) and Combination 20-25 Watt Unit Which Can Operate from 6-V DC or off the 110-V Line

COMMERCIAL AUDIO SYSTEMS, available for mobile and fixed rentals or sales, plus service, are rapidly becoming one of the most popular features of Service shops. For it has been found that such systems are not only useful during special seasonal occasions, but for a variety of community activities all year round.

The equipment required must be durable, capable of rugged performance, and flexible, too. Each unit of the entire system should be instantly interchangeable with any similar unit.

In typical setups, three amplifiers are used; an *ac*-operated unit with about 20 watts output, a 6-volt *dc* amp providing about ten watts output (for a sound truck), and a combination 6 *v* *dc*/110 *v* *ac* 20-25-watt amp.

PA Truck Requirements

One of the most frequently-used items in the audio system is the sound truck. Often the shop's delivery truck is used for this purpose.

To meet our *pa*-truck needs, a special amp was built, using a pair of 6V6GTs in the output, driven by a 6SC7 phase-inverter-driver; a 6SC7 was included in a mike input amplifier. Two reentrant speakers were permanently mounted on top of the auto body. Remote control facilities were included; relays, controlling plate voltages, were mounted on the amplifier chassis. The control wiring for these were brought out to an octal plug, on the front apron. The remote-control box was mounted above the windshield; it contains a red pilot light and toggle switch. Two bat-handle toggle switches were included on the ampli-

fier chassis for manual switching of plate and filament voltages. Red and green pilot lights indicate when these are in use.

HV Source

High-voltage (200 *v* at 100 *ma*) is derived from a *Vibrapak*,[‡] mounted on the truck floor, beneath the amplifier. Input wiring was run directly to the battery, both ground and hot wires, to eliminate voltage drop. Heavy aircraft (No. 6 stranded *glass-insulated*) primary cable was used for this. The loads were brought to a small home-made terminal block, just below the amplifier, and fastened with heavy wing-nuts.

Plug-In Approach

For ease in servicing, the plug-in idea was used throughout the amp. An octal socket was placed in the remote control, a 4-prong in the power supply; the *Vibrapak* was connected to a 5-prong plug, and the speakers connected to a 6-prong plug. The amplifier, built on a small standard chassis, with cover, was mounted on a metal base-plate fastened to the metal shelf on the side of the truck body, using two large wingnuts. The whole amplifier can be removed in less than one minute.

Boom For Mike

The microphone input connector was mounted on the front apron of the chassis, just forward of the gain con-

trol, and is within easy reach of the driver. In the initial installation, a small bullet-dynamic mike was mounted on a boom bolted above the windshield, and could be moved into any position. A snap and fabric strap held the boom and microphone out of the way when not in use. Half of a small rubber sponge was cemented to the body, and the microphone rested against this when traveling, to eliminate vibrations.

Lavalier Strap

This boom arrangement was replaced by one of the small *candlestick* type crystal microphones, mounted on a home-made *third-hand*, worn around the operator's neck. This arrangement was adopted because of the mike's lightweight and small size. The holder is nothing more than a converted wire coat-hanger, with a chassis type microphone connector¹ soldered to it; the connector fits the threads in the bottom of the microphone. *Lapel-microphone* type cable was installed; it can be draped across the operator's lap and back to the amplifier.

Dynamics Preferred

For other field and fixed applications, dynamics have been found very satisfactory. Crystal mikes have not been used in our audio work, because of heat problems. When these mikes remain in the truck, or if they should be out on an *unattended* rental job,

[‡]Mallory. ¹Amphenol.

SOUND SYSTEMS

by JACK DARR

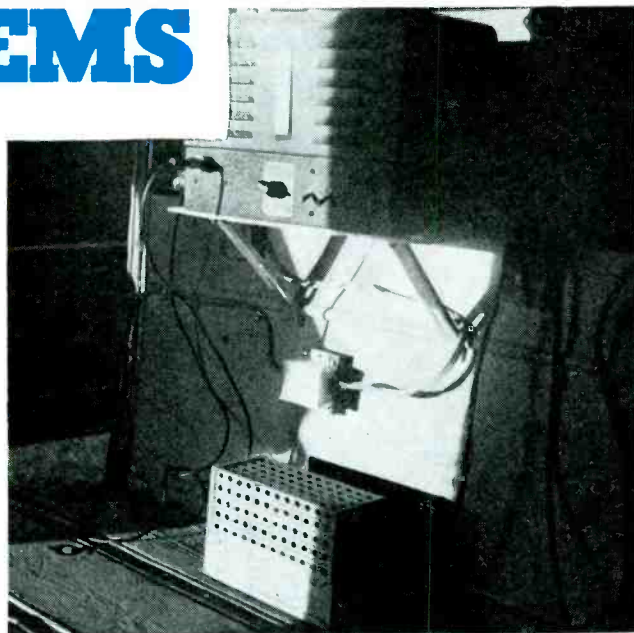

(Right)
Interior of truck, showing amplifier, power supply and A supply terminal panel.

and the afternoon Summer sun beats down, the ambient temperature can easily go well above the safe temperature for the crystal cartridge, resulting in damage. This problem has also been encountered in *phono-top* systems, using crystal cartridges.

A 78 changer, together with one of the two *ac* amplifiers, and a cone-type 12-inch speaker in a wooden baffle, has been found ideal for rental to small social groups for dances; it is cheaper than a *juke-box*. For the rapidly multiplying square-dance clubs, a microphone may be furnished with the system, for use by the *caller*. The little candlestick, in the neck-yoke, is ideal for this use.

Conversion of Stock Units

The interchangeability of parts, mentioned earlier, facilitates installation and service. A 6 or 8-terminal strip, mounted on the back of each amplifier, with various output taps brought out, can be a life-saver. If the occasion arises when some extra speaker must be connected in a hurry; it is only necessary to cut off the plug and fasten the wires to the appropriate terminals. This is also handy when some helpful soul drives a car over a speaker plug, at the last minute! Standard 6-prong plugs can be used on all speakers: any desired plug may be used, as long as all are alike.

Mike Plug Flexibility

The same types of microphone plugs can be used on all microphones and

cables. In one case a microphone had an attached 6' cable; this was removed and a male connector installed on the microphone itself; it was fastened into the base of the microphone with a set-screw. This permits packing and carrying of microphones and no long unhandy cables are in the way.

The chassis-mounted type of microphone connector can be utilized to make an emergency microphone stand. For this purpose a small piece of pipe can be used. The connector can be fitted into the end, and the other end screwed into a *floor-flange* and fastened to a piece of wood or a table. The occasion for this may never arise, but it will come in very handy, in an emergency.

One important addition that should be made to an *ac* amplifier chassis is a fuse-holder, installed in the primary circuit. Special 4AG fuses, in 5-ampere size, are good for protection. They will blow on a genuine overload, yet provide plenty of margin for line surges, etc. An ordinary 3AG fuse, such as used in cars, will not fit into these large holders; therefore, there is not much chance of a 20-ampere auto-fuse being substituted if the original blows. By the way, the 6-volt amp jobs are protected by standard auto-radio type fuse holders inserted in the hot lead. (This should be one of the SFE-type, which will not accept an incorrect size fuse.)

The combination 6 *v dc*/110 *v ac* amplifiers use special, multi-conductor plugs for their power inputs. These plugs, often with as many as 24 con-

tacts, by using jumpers on the sockets, are used as automatic switches when changing the amplifiers from 110 *ac* operation to 6 *v dc* operation. The plugs are usually delicate, and easily damaged, and thus require extreme caution in handling. Never let a customer tamper with these plugs: connect them yourself, when making the rental, and warn the user against moving them. The writer remembers one embarrassing experience, when a prominent politician and a large crowd waited rather impatiently for almost half an hour, during a Fair while he struggled with a very intermittent amplifier, only to find that a boy, who had used the system the previous afternoon, had damaged the plug and failed to report it! To prevent such incidents, *never* rent out a system without first testing it, and be sure that the lessee hears the unit in operation. This will avoid the claim that: "It never did work! We don't owe you nothin'!"

Business opportunities for commercial audio work are many, even in the smaller towns. The audio truck can pick up many a dollar, on Saturday afternoons, by making one or two trips up and down the main streets advertising dances, sales, movies, auctions, and numerous other items. Elections always need sound. Rentals for dances, either with turntables providing the music, or for amplification for small orchestras, are also profitable.

You should display large *sound-system for rent* signs in your shop. Your truck should also carry a prominently displayed sign advertising *sound systems: sales, service and rental*.

Determining Frequency Response with Test Records
. . . Critical Listening Test Techniques . . . Transient
Response Testing . . . Distortion Tests

Testing and Measuring

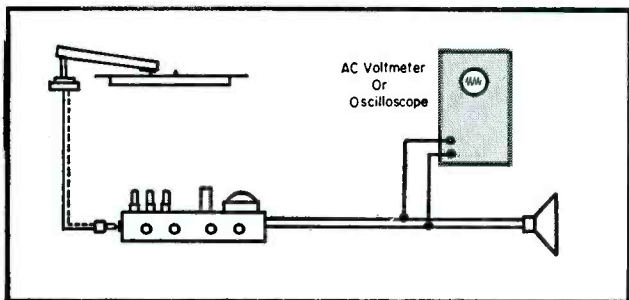

Fig. 1. Method of checking frequency response of an audio system with test record.

THE FINAL and all-important test of an audio system is the way it sounds; how close the music seems to that heard in the concert hall. But a listener can be fooled easily, especially when there is no standard with which to compare, and certain undesirable qualities in the reproducing apparatus may not become noticeable until after prolonged listening. *Listening fatigue*, a term used to describe a vague displeasure with reproduced music after it has been on for a while, is not caused by any mysterious quality of reproducing equipment, but by the same distortion, noise, ragged frequency response, and other factors that have been previously discussed; defects that may not have been apparent when the system was first turned on.

It is therefore desirable, during various stages of the assembly of an

audio system, to test performance results. Audio testing in a well-equipped lab involves the use of specialized and expensive apparatus involving harmonic analyzers, intermodulation analyzers, calibrated microphones, anechoic chambers or alternative facilities for open-air testing of loudspeakers, etc. However, it is possible to conduct many tests, with a minimum of specialized equipment, with excellent results.

Testing of Frequency Response Test Records

There are several test records on the market that make testing of the frequency response of an audio system (up to but not including the loudspeaker) relatively easy. These frequency test records include the *steady-tone* and the *sweep-frequency* type. Both have a certain advantage over a signal generator for overall system

checking, as the stylus, pickup, pre-amplifier and even the turntable can be checked along with the amplifier. Fig. 1 illustrates the use of a frequency test record.

It is very important to know that the test signals have been recorded with approximately the same recording characteristics¹ as those for which the preamplifier has been compensated. The bass-turnover frequency and the treble preemphasis characteristic will normally be indicated on the record label. In any case, if adjustment of the amplifier tone controls makes possible good test results, then good frequency response in reproducing musical records of similar characteristics will also be possible.

The steady-tone record furnishes a signal with a progressively rising pitch, usually with voice breaks that announce the frequency at periodic intervals. The signal voltage produced at the speaker voice coil can be read on a low-scale *ac* voltmeter or on a 'scope, and a curve of voltage versus frequency plotted for the frequency range covered by the record. This curve might look something like the graph of Fig. 2. At a glance Fig. 2 may seem to represent poor response because of its unevenness, but the appearance is deceiving. We are used to seeing frequency response curves where the vertical scale is plotted in *db*; logarithmic units of ratio. The variations that appear in Fig. 2 will not seem as bad when the voltage scale is converted to *db*, and a graph in *db* is more truly representative of the way we actually hear sound. A simple chart which can be used for converting voltage ratios to *db* appears in Fig. 3. It will be seen that after the *db* conversion is made, our original, uneven curve can be read as representing a frequency response from 60 to 11,000 cycles, $\pm 2\frac{1}{2}$ *db*. This may be considered excellent for the overall system up to the speaker.

A word of caution must be noted with regard to the steady-tone record. The use of such a record in a listening test is almost or entirely useless

¹Vino, Mark, *Pickup Compensators and Preamps*, SERVICE; January, 1953.

Fig. 2. Frequency-response curve, in volts, which might be plotted from a steady-tone test record. The crosses indicate points at which voltage readings were taken.

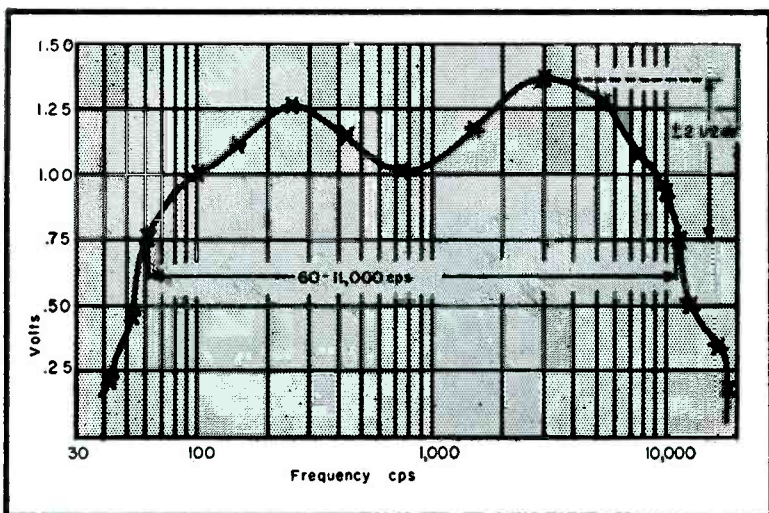

by MARK VINO

AUDIO Equipment

for checking the frequency response of an audio system. It has been shown that the Fletcher-Munson effect dulls hearing sensitivity at the frequency extremes of high and low tones, and makes sounds in the three or four-thousand-cycle region appear exceptionally loud. This effect may cause the apparent intensity of sound, at the same acoustical level, to vary more than 20 db from one frequency range to another. In addition, reflections and standing-wave resonances in the room may cause the sound intensity to go through large changes; an effect that cannot be influenced by the design of the audio system except as regards speaker placement. Fortunately, the electrical meter or 'scope does not obey the laws of either psychology or acoustics, and can be trusted to present an accurate measurement of the signal fed to the loudspeaker.

Importance of 'Scope

The sweep-frequency type of record can only be used when the measuring instrument is a 'scope, as noted in Fig. 1. However, this record does not require frequency runs or graph plotting, since it creates a screen pattern which is an instantaneous and complete picture of the voltage frequency response of the system. The synchronization controls of the 'scope must be adjusted to produce a stationary pattern, as in Figs. 4a and b. Variations in the height of the pattern represent the voltage response variations at differ-

Fig. 3. Voltage-db conversion table.

Voltage Ratio	Approximate Difference in db	Voltage Ratio
1:10	20	1: .1
1: 5.6	15	1: .18
1: 3.2	10	1: .32
1: 2	6	1: .5
1: 1.8	5	1: .56
1: 1.6	4	1: .63
1: 1.4	3	1: .71
1: 1.26	2	1: .79
1: 1.1	1	1: .89
1: 1.0	0	1: 1.0

ent frequencies, and the frequency scale is indicated by marker *pips* at major points. These voltage variations, like those of the steady-tone graph, must be converted to db for proper reading. If, for example, the height of the pattern above the center line starts out at ten screen divisions, goes up to fourteen (forming a ratio to the original of 1.4:1) and down to seven (forming a ratio of 1:7) the variation may be read as approximately ± 3 db. When the reference height of the pattern is cut in half, voltage response is down 6 db. A signal which is reduced in amplitude by 6 db is still able to make a significant contribution to the music.

An interesting feature of the pattern of the sweep-frequency record is that the effect of tone-control adjustments at the amplifier, or of record equalizer adjustments at the preamp is immediately observable on the 'scope screen. The effectiveness of these tone adjustments for a given recording characteristic can thus be checked without laborious charts or graphs, and the operation of tone control circuits can be checked visually.

The high-frequency response of the reproducing system will appear to be reduced as the pickup moves in toward the center of the record. This is a normal effect called *transition loss*.

Testing Frequency Response: Listening Test

The qualities that may be evident in the sound output of a system with poor frequency response are:

(1) Accentuated bass, giving the music a thumpy, heavy quality.

(2) Weak bass, giving the music a thin quality, and causing the sound of supporting instruments like the bass viol to disappear, either partly or entirely.

(3) A combination of weak bass at the extremely low notes and accentuated bass in the higher bass range.

(4) Shrillness, usually created by increased amplitude in the *low-highs* between 1,000 and 4,000 cycles.

(5) Weak upper treble creating muffled reproduction, softening the

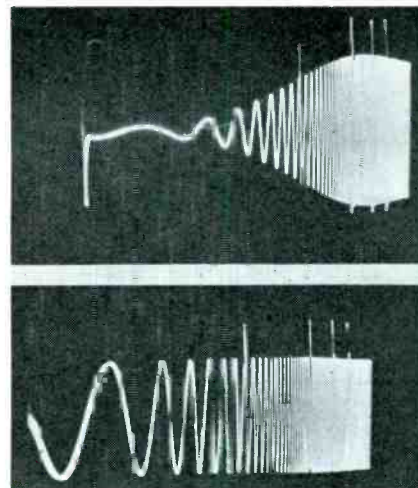

Fig. 4 a and b. In a appears a 'scope pattern produced by a sweep-frequency test record. In this case the low and high frequencies are both attenuated. Sweep-frequency response pattern, shown in b, illustrates flat-frequency response with bass equalization. (Courtesy Pacific Transducer Corp.)

natural metallic sound of cymbals and brass, destroying the *gitty* quality of strings, and either partly or completely hiding the sound of the triangle or the drummer's brush.

(6) A combination of shrillness in the low-high range and muffled reproduction in the upper-high range.

Transient Response Testing

A sweep-frequency record can be used to test high-frequency transient response, as illustrated in Fig. 5. When the audio system exhibits *hf*

(Continued on page 77)

Fig. 5a and b. An expanded pattern of sweep-frequency record, indicating high-frequency ringing in first low-frequency signal cycle is shown in a. Pattern in b, is same as a, but with high-frequency transient response good. (Courtesy Pacific Transducer Corp.)

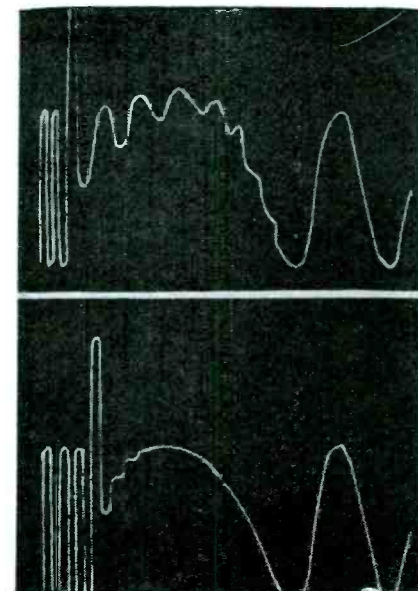

Engineering Small Hall

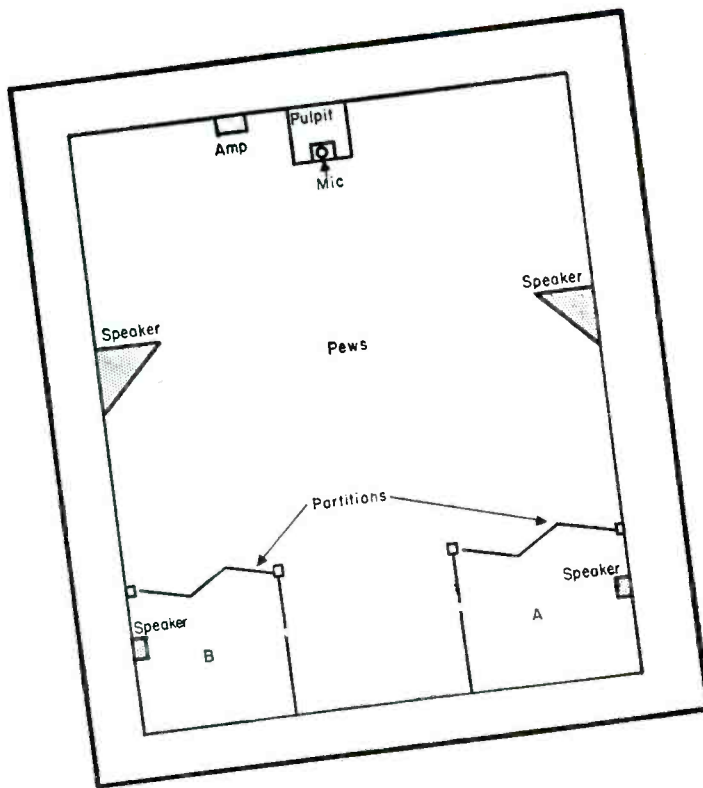

Application of Sound Augmentation to Insure Uniform Coverage, Through Use of Carefully-Selected and Properly-Installed Amplifier, Speaker Assemblies and Feeds*

(Left)

Fig. 1. Layout for audio system in typical auditorium of small church, with speakers set up in pews and end rooms (A and B) to provide sound for overflow audience.

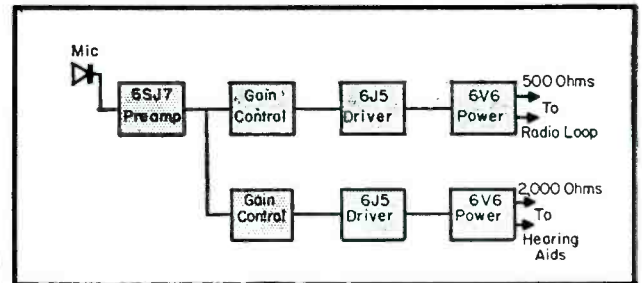

Fig. 2. Block diagram of dual-channel amplifier used to drive string of hearing aids, and also a radio loop for special broadcasts.

IN THE LAYOUT and installation of smaller audio systems, as used in churches or community auditoriums, an engineering approach is particularly effective. In this type of application one must consider *sound-augmentation*, rather than *sound amplification*. These structures are usually of an *intimate* design and size in which normal conversation or speeches, are easily audible over the hall; however, because of the normal tendency of speakers, home-talent play actors, and the like, to *lower* their voices when appearing on a stage, instead of raising them, as professionals do, their voices must be amplified. Therefore, the audio system need not be one which blankets the whole area, but merely large enough to render sub-normal speech audible in all parts of the building.

Lately, there have appeared a number of *hi-fi* speaker systems, using several small speakers, instead of one or two large, high-powered horns, which are ideal for the small audio sound systems. Because such speaker assemblies are not too costly, it becomes possible to bring a system within budget limitations of the smaller users; insuring a sale which heretofore would have been impossible to consummate.

In the average church auditorium the room is about 50' long (front to

back), and 40' wide, with a 20' ceiling. At the back several areas are usually partitioned off by sliding doors, for Sunday school use; this area is also used as seating space when the crowd overflows the main seating area. Let's assume that, much to the minister's gratification, much larger crowds than usual have been attending, and thus it is necessary to use these rooms for seating parishioners every Sunday. Because of the rooms' location, and the bad acoustics of the auditorium, many complain that they cannot hear the sermons. Here we have a typical need for a *sound-augmentation* system.

For an average commercial audio job, an amplifier of 18-20 watts is usually specified. However, in this instance, it is not necessary to use so large an amplifier, as that amount of power would be much too high for any possible use. Excessive volume levels are not needed here, and in fact, not wanted. Any amplifier of good design, which will provide a maximum of ten watts undistorted power output, will easily do the job.

In probing the power required to saturate any small auditorium, you will find that considerably less than ten watts are required. More than this cannot be used because of the prob-

lem of acoustic feedback. Of course, speaker phasing and placement will control feedback; speakers correctly installed and phased will carry a much higher level without feeding back.

For this type of installation, a small speaker could be installed in each of the back rooms. One more speaker might be installed on each side of the auditorium, roughly halfway back from the pulpit; all mounted on flat, inexpensive wall-baffles, the back room speakers flat on the wall, and the front speakers mounted at an angle. For the best angle they should be mounted so that the direct *beam* of sound from each strikes directly at the back corner of the room; Fig. 1. Audio power distribution in these speakers may be equalized; assuming a ten-watt system, each speaker can be connected for 2.5-watt outputs. This can be done by equalizing all voice-coil impedances and connecting all speakers in parallel. The sound level should then be very uniform over the entire seating area. If it is not, the level of sound in the speakers should be adjusted to obtain even coverage.

Speaker Phasing

The speakers must be correctly phased; each voice coil should travel in the same direction, at any given in-

*Based on notes prepared by Jack Davr.

AUDIO SYSTEMS

by DONALD PHILLIPS

stant. Phasing can be tested by checking each speaker with a small flashlight battery; the connection which makes the cone go inward can be marked positive, and negative. Then, each *positive* terminal can be connected together, when wiring in, and they will all be in phase. If this precaution is not observed, *dead spots* and distortion will be observed at some places in the auditorium.

Jackboxes

For church use, the system might be augmented by a set of hearing aids, output being fed from the amplifier, which can be located inside of the lectern itself, or at any convenient spot. This wiring can terminate in *jackboxes*, mounted on the backs of the desired pews; hearing aids or lorgnette-type phones can be plugged into these. This will add somewhat to the power requirements of the system. For instance, if a total of ten hearing-aids are to be used, it will be necessary to add about five watts to the power output of the amplifier, as each phone can use about .5 watt of audio power.

The jackboxes may be simple, with merely a phone jack, or elaborate. In the latter instance, individual volume controls (a 10,000-ohm potentiometer) can be connected across each phone, and equalizing resistors, equal to the impedance of the phones, used with 'circuit-breaking' jacks, so that the impedance of the system will remain constant at all times.

In one *custom-built* amplifier system designed for a local church, not only were the foregoing features included, but a separate radio-broadcast audio channel, was also added to permit the church to broadcast their services over the local station; Fig. 2.

Fig. 3. Circuitry of jackbox, with compensating resistor and volume control. Volume control may be from 30 to 50 ohms, connected in series with phone, or from 50,000 ohms up, connected in shunt.

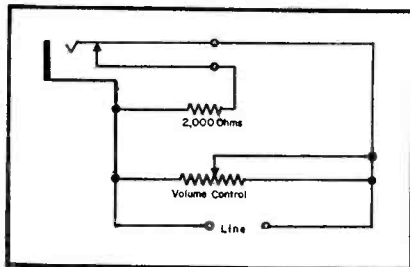

A small velocity type mike was used (for low visibility) on a *pulpit stand*, and the amplifier itself installed on the bottom shelf of the lectern. The switch, together with a pilot light, were mounted on the lower apron of the top of the lectern, so as to be easily accessible. The pilot light is visible only from above. The pilot was originally one of the large 110-volt type, with a 1" red jewel. It was removed, and a smaller one substituted, because the larger lamp cast a rather pronounced red glow upon the minister's face, as he stood on the pulpit, prompting him to say: "I'm going to preach about the Devil, but I certainly don't want to *look* like him." Hence, the smaller pilot light!

The amplifier, built on a chassis measuring about 12" square, and about 3" high, has one preamp stage, using a 6SJ7, which drives two separate outputs, each with a 6J5 driving a 6V6GT. Separate gain controls are provided for each channel acting independently of each other. A small amount of negative feedback is used in each side, the feedback loop being around the power and driver stages. The radio output terminates in a standard 500-ohm transformer, which is connected to a telephone terminal block below the lectern. The other channel is used mainly to feed a string of hearing aids, installed in the first five rows of pews, and terminates in a transformer having a 2,000-ohm output impedance.

By the way, the wiring for the hearing aids is 300-ohm twinlead, run from the lectern down and out into the aisle, where it continues underneath the aisle carpet, tapped for each pew. All phones are in parallel. This chan-

†SERVICE; February, 1948.
‡Power Distribution in Loudspeaker Systems; Jensen monograph.

Fig. 4. Speaker layout, illustrating power required for small auditorium.

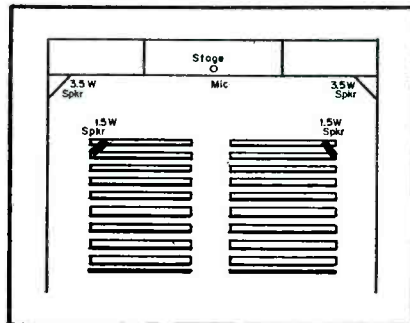

nel can also feed extra speakers, if needed. All output, power and switch connections are brought out to a ten-terminal strip on one apron of the amplifier chassis. Thus, all connections may be removed and the chassis taken out for servicing.

Small Auditorium Sound Systems

Many a town has a medium-sized auditorium or hall, used for home-talent plays or public-service programs, which would benefit mightily from sound augmentation. A system for such an application, described earlier,[‡] should afford a division of audio power to give uniform coverage; see Fig. 4. In the installation, for which this setup was designed, bleacher seats on one side, the stage on the other, and a large floor space between, made uneven distribution necessary. It was found necessary to use four speakers; two were mounted in the front corners, and two more high and back, to feed the bleacher area. The final sound distribution was about 60-40, with the front horns using 60% of the total. The division was accomplished by using the correct output transformers.¹

The speakers also must be correctly phased. If they are, the sound distribution will be so even all over the area that the average listener will not be conscious of the sound system, and usually will refuse to believe that it is even working, until it is turned off, for proof! In the ideal case the sound should appear to be coming from the stage, and not from the speakers themselves. If too high a level is used, the speakers at once become apparent as the source of sound, and the illusion is destroyed. This ideal condition, in

(Continued on page 54)

Fig. 5. Method used to check phasing of speakers. Red and black wires should be soldered to flashlight cell, and then connected one way and then reversed to speaker voice coil, and watch for pull-in of cone. The connection that causes pull-in can be marked positive, and identified with a dot of red nail polish. When installing speakers, using color-coded wires, all red terminals should be connected together; thus all speakers will be in phase.

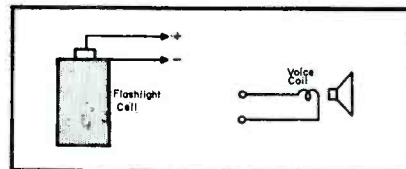

Ultra-Linear

[See Front Cover]

Williamson-Circuit Amplifier

b y W Y N M A R T I N

RECENT ADVANCEMENTS in loudspeakers, phono pickups and in the art of recording providing extended bass and treble range have placed more stringent demands upon the amplifier. For this span of frequencies requires lower distortion, better transient response, and faster recovery time.

To meet these requirements, many types of amplifier systems have been developed. On the cover and in Fig. 1 appears the circuit of one such amplifier, an *ultra-linear* modification of the Williamson circuit¹, which it is said more than doubles the power output, with no increase in input power.

A basic power amplifier providing 20 watts from 30 to 20,000 cps, 12 watts are available from 15 to 50,000 cps.

Gain is said to be .4 volt input for 1 watt output average level in 16 ohms and 1.8 volts input for 20 watts output average level in 16 ohms.

Amplifier's hum and noise level is noted as being 80 db below 20 watts; feedback, 20 db.

The input impedance is 1 megohm, isolated for *dc*.

Designers of the amplifier state that a wide-frequency range and maximum stability is available regardless of the nature of the load into which the amplifier works. This is an important factor when amplifiers use large amounts of negative feedback, since loudspeakers are very complex reactive loads, and long connecting cables themselves are essentially transmission lines at high frequencies. Recovery time of the amplifier is said to be very short; the behavior of the amplifier immediately after a sudden burst of signal has been applied to it, which occurs frequently in reproduction of music. Fast recovery time has been found to contribute to clean reproduction of a sudden crescendo.

Two auxiliary 110-volt outlets are provided to permit simultaneous on-off control of the amplifier and auxiliary equipment. A power take-off socket supplies filtered plate voltage and filament power for use where required for preamps.

Fig. 1. Schematic of 20-watt amplifier, featuring *ultra-linear* modification of Williamson circuit.

¹Brociner model UL-1.

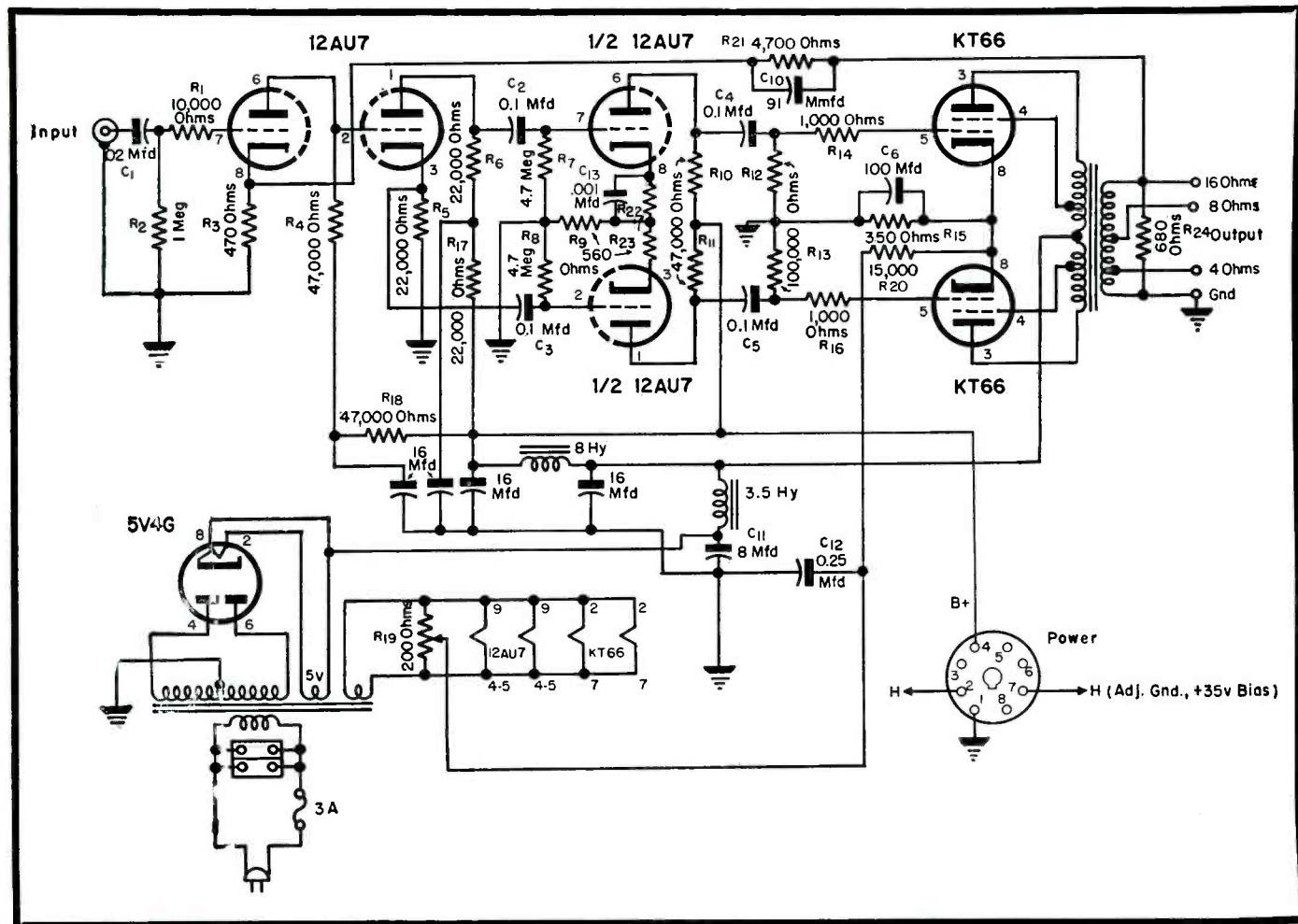

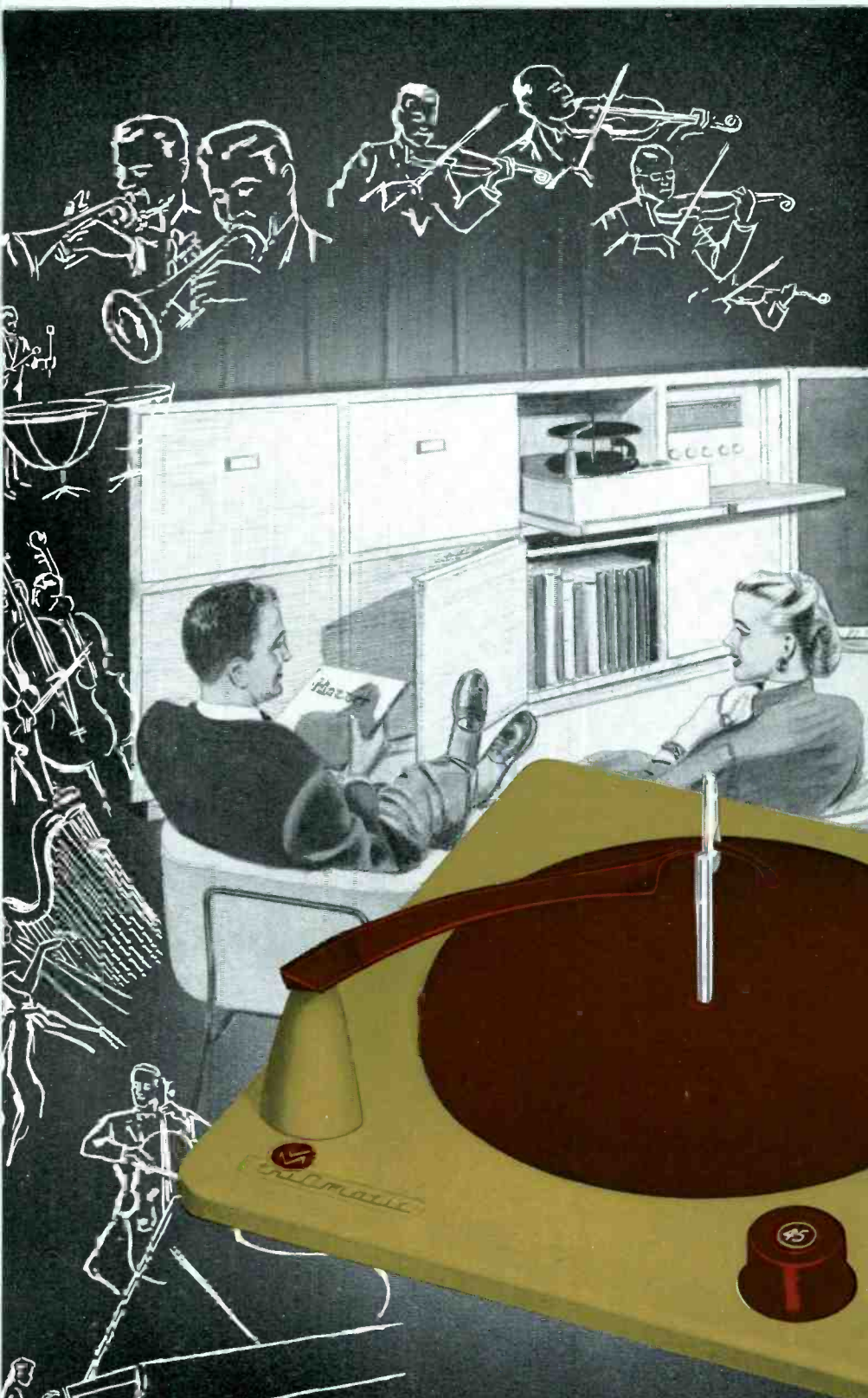

Presents
 the World's FIRST
 Completely NEW
 High Fidelity
 Record Changer!

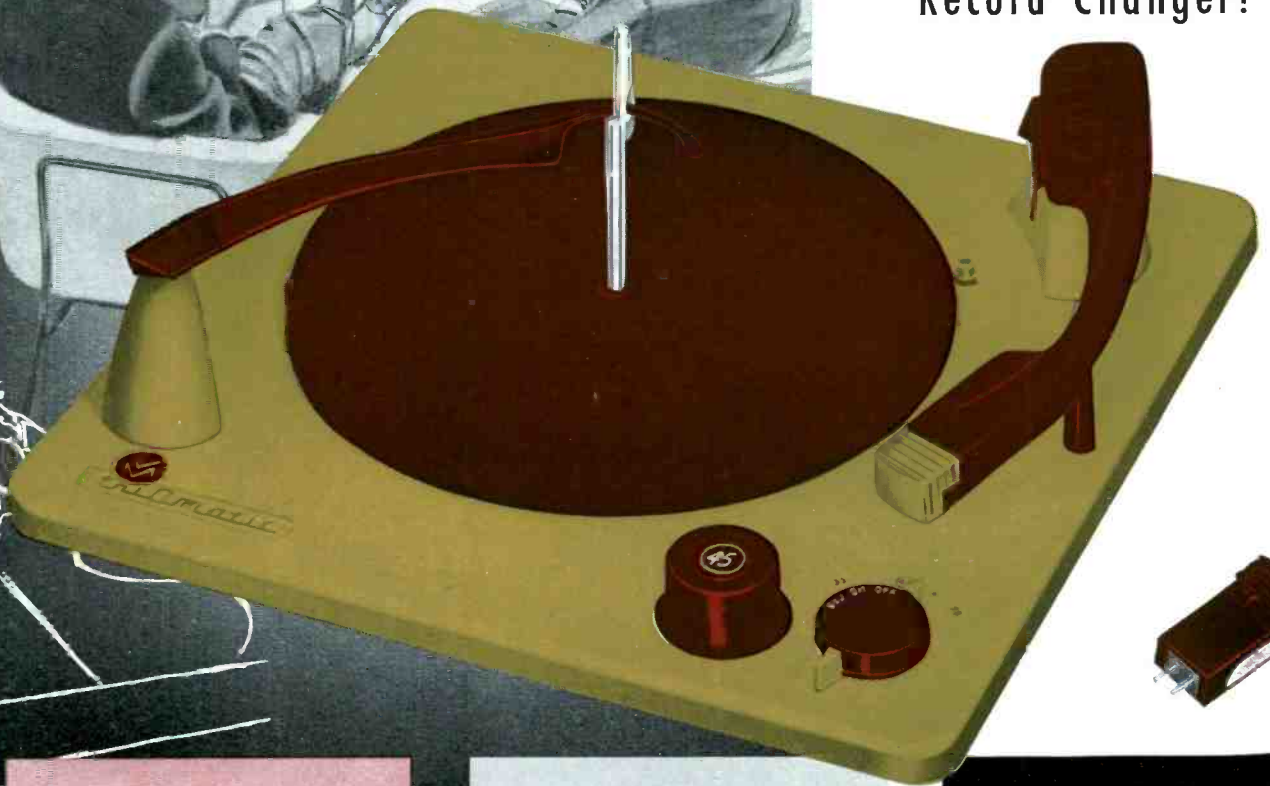

specifically designed
 to meet the
 exacting standards
 of
 Hi-Fi enthusiasts!



trioMatic®
935HF
 record changer

OFFERS
 more Exclusive
 Hi-Fi Features...
 more Record
 Protecting Features...
 more Convenient Record
 Handling Features...
THAN ANY COMPETITIVE CHANGER!

All New



triomatic® 935HF record changer

**"CUSTOM-PRECISION" QUALITY FOR THE
DISCRIMINATING BUYER**

The V-M 935HF is a top quality high fidelity record changer throughout! Its many exclusive features will have tremendous appeal to ALL of your customers interested in life-like reproduction of recorded music.

Manual Operation—Allow changer to shut off automatically, place record on turntable and set speed, turn Control Knob to "ON" and place needle in lead-in groove.

1. Laminated Turntable with Precision-Formed Concentricity, (exclusive in this price range) is weighted and balanced to assure constant-speed operation. New motor mount and close-tolerance drive completely eliminate wow. Extra heavy flocking silences and cushions record drop. Turntable is mounted on a selected three-ball thrust bearing, with mirror-finished surfaces, for silent rumble-free performance.

2. Gentle tri-o-matic Spindle protects records, eliminates record holders that grip the grooves. Records are moved at the center (point of perfect control) . . . are lowered, NOT dropped, to spindle shelf and flat, air-cushion dropped to turntable.

3. Two Plug-In Tone Arm Heads (1 gold, 1 red, less cartridges) are included. Precision-fitted cast aluminum construction. Adaptable to: GE "turn-about" RPX050, GE RPX040, GE RPX041, Pickering single-play and turnover, and Clarkstan cartridges.*

4. Die Cast Tone Arm of aluminum, is rigid and resonance-free! Is balanced for easy, exact adjustment to needle pressures specified by needle or cartridge manufacturers.

5. A Minimum of Lateral Pressure is required to track and trip the friction-free V-M 935HF changer. Cartridges requiring down to 5 grams needle pressure can be used with excellent results.

6. Muting Switch for absolute quiet during change cycle.

7. V-M 45 Spindle is included. Permits automatic play of up to fourteen large center-hole records.

8. Exclusive Four-Pole, Four-Coil Motor with surplus power for silent, constant-speed service, eliminates the source of electronic hum and rumble.

Additional Features: Gold base plate, burgundy accessories; complete, automatic shut-off; plays all speed, size records automatically; completely jamproof mechanism.

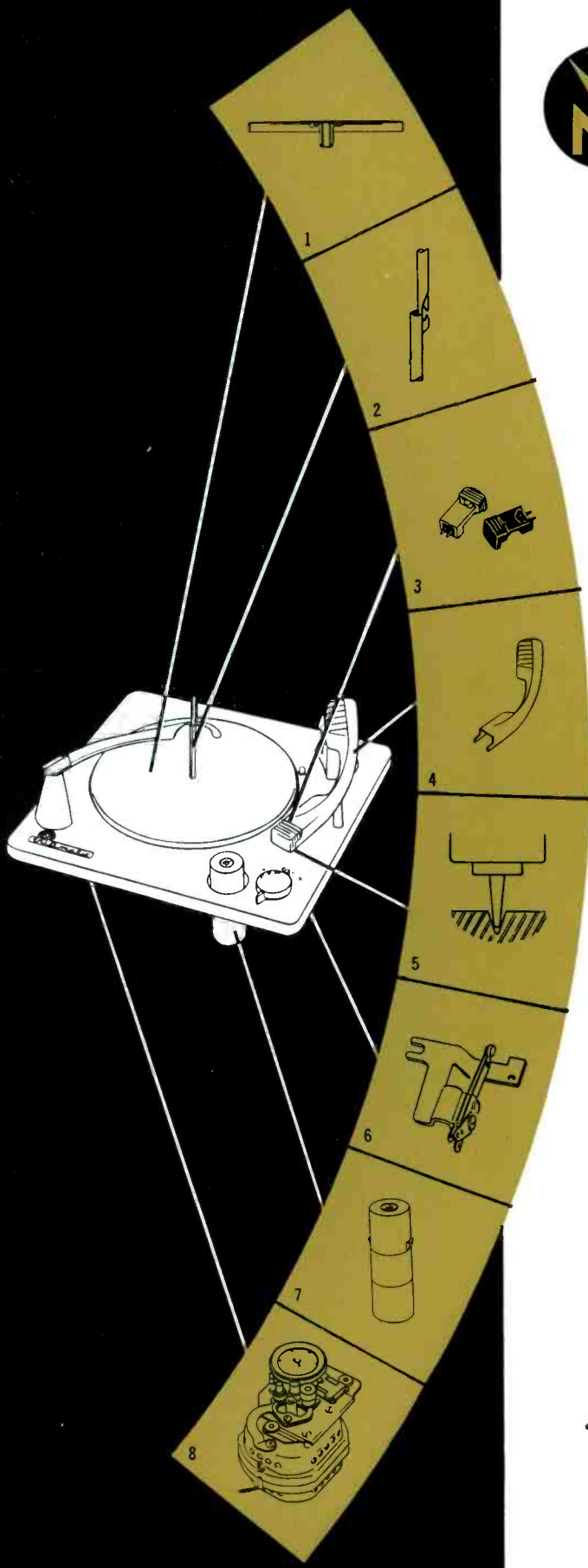

**V-M 935
Mounting Board**
Pre-cut. Measures
 $\frac{3}{8}$ " x $16\frac{13}{16}$ " x $17\frac{1}{8}$ "

*Pre-amplification
stage required.

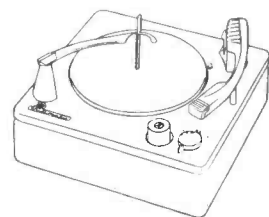

**V-M 936HF
Changer
Attachment**

On metal pan. Has 6' cord, 4' phono cord
with plugs. Underwriters approved.



CORPORATION
BENTON HARBOR, MICHIGAN

**WORLD'S LARGEST
MANUFACTURER OF
PHONOGRAPHS AND
RECORD CHANGERS
EXCLUSIVELY**

UHF Alignment

(Below)
Fig. 1. Graph of v_{swr} obtained from a reflection-coefficient test.

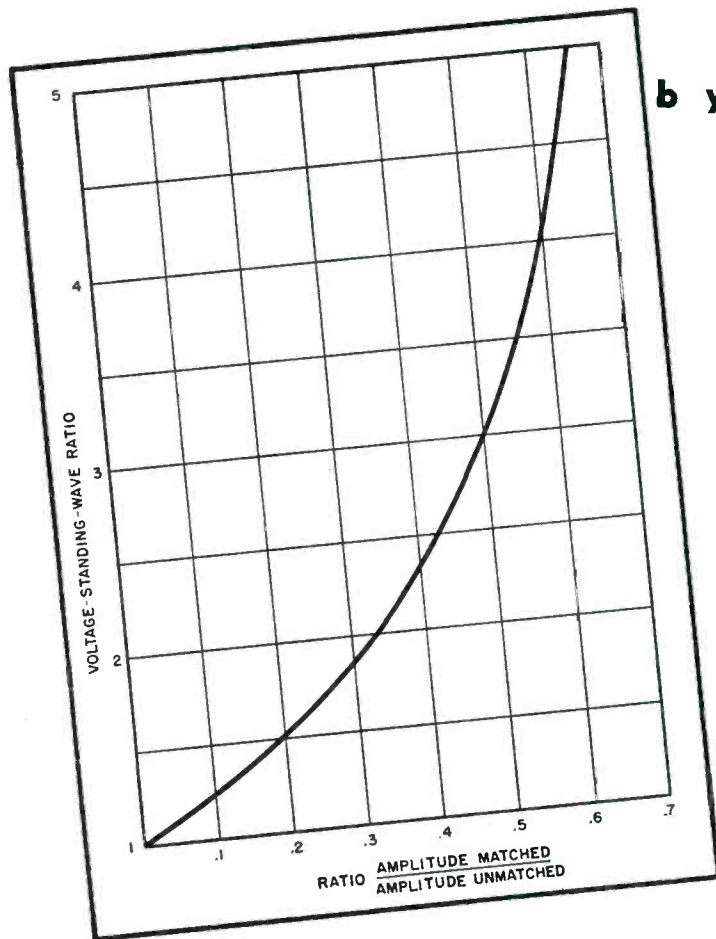

by HENRY R. HESSE

Senior Engineer, TV Receiver Division
Allen B. DuMont Labs.

Concluding Installment: Reflection Coefficients and VSWR at UHF... Use of Delay Lines... IF Alignment Through UHF Input.

AT THE ULTRAHIGHS, swr is a particularly important factor. This is effectively illustrated in Fig. 1, a graph, which shows the standing-wave ratio for any ratio of matched amplitude to unmatched amplitude. As an example, each of the waveform photos have a matched amplitude of 2 divisions, and an unmatched amplitude of 20 divisions on the screen; thus the reflection coefficient is $2/20$ or $.1$ and the v_{swr} is 1.22 . In Fig. 2a the reflection-coefficient corresponds to the resonance curve of Fig. 3a; likewise Fig. 2b corresponds to the response of Fig. 3b, and Fig. 2c corresponds to 3c.

Fig. 2. 'Scope patterns showing various degrees of input match using reflection-coefficient technique; a (left); b (center); c (right).

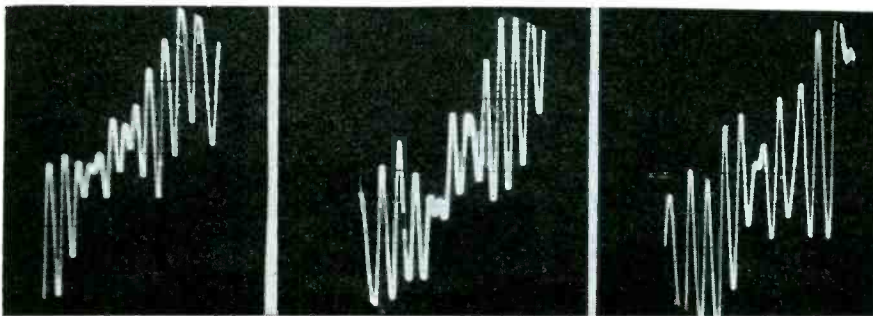
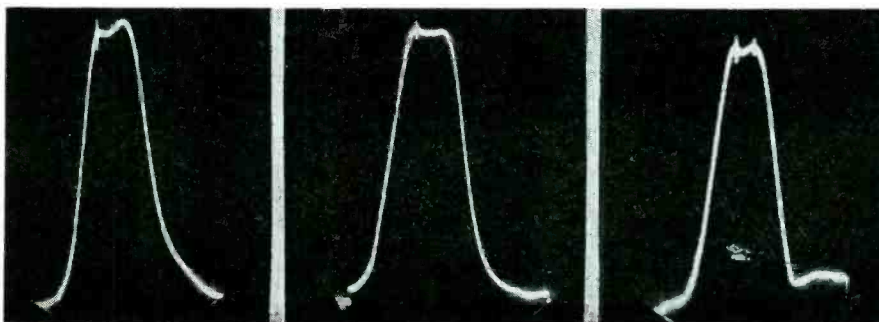

Fig. 3. UHF response curves: At left, response of converter at channels 50-51; center, channels 60 to 61; right, channels 70 to 71.



Let us now observe the resonance curve at the mixer crystal through a delay line. The 'scope views in Fig. 4a, b and c (p. 81) show a response curve using the mixer crystal as a detector, but interposing a delay line between the sweep generator and the tuner. In this case the response curve has added jagged mountain peaks. In this case, for the best match, the jagged peaks must be minimized as much as possible. It will be found that when a double-tuned preselector circuit is tuned correctly, the side slopes of the response curve will appear symmetrical, with the notches having the same amplitude and position on both sides of the curve. This method of matching is not recommended to those who are not too familiar with this technique; but to be used in conjunction with the first procedure, until the interpretation is thoroughly understood in relation to the first step.

IF Alignment Through the UHF Input

In the final test the *if* circuit between the mixer crystal and the *if*
(Continued on page 81)

Servicing Helps

Dual-Target Tuning Eyes for Picture-Tube Voltage Checks . . . Positioning of UHF Mixer Crystals . . . Improving Horizontal Stability . . . Decreasing Minimum Brightness Levels . . . Contrast Control Modifications

by **M. A. MARWELL**

A DUAL-TARGET TUNING EYE, such as the 6AF6, can be used to check the voltages on the picture-tube socket. According to Stromberg-Carlson the tube can be wired in on their chassis, as shown in Fig. 2.

When the tuning eye has been connected to the picture-tube socket, glowing filament in the tuning eye will indicate that there is voltage at the socket. A bright green target will disclose that the first anode voltage is correct. One-half of the dual target will have sharp edges, as in Fig. 3b. Turning the brightness control should result in a variation in the size of the shadow

area, thereby indicating that the brightness control is functioning normally. The other half of the dual target will have poorly defined edges, as in Fig. 3a. Varying the contrast control should cause the size of the shadow area to increase or diminish, indicating that the contrast control is operating properly.

The results indicated in the last two steps will not be observed as indicated when the tuning eye is used on S-C models 119, 24 or 317 series receivers. On the 119 and 24 receivers, the eye will overlap, but otherwise the action

of the brightness and contrast controls can be checked.

On the 317 series receivers, the brightness control is fed to the same element in the picture tube as the video. Consequently, the action of the brightness and contrast controls will both be observed on one-half of the dual target.

Sentinel Service Notes

In the SM1002 circuit diagram of Sentinel models 454, 455, 456 and 457, terminal connections 4, 5 and 6 of the horizontal output transformer were in-

Fig. 1. Circuit changes in Sentinel models 454, 456 and 457, affording improved contrast range and better control of vertical size of picture.

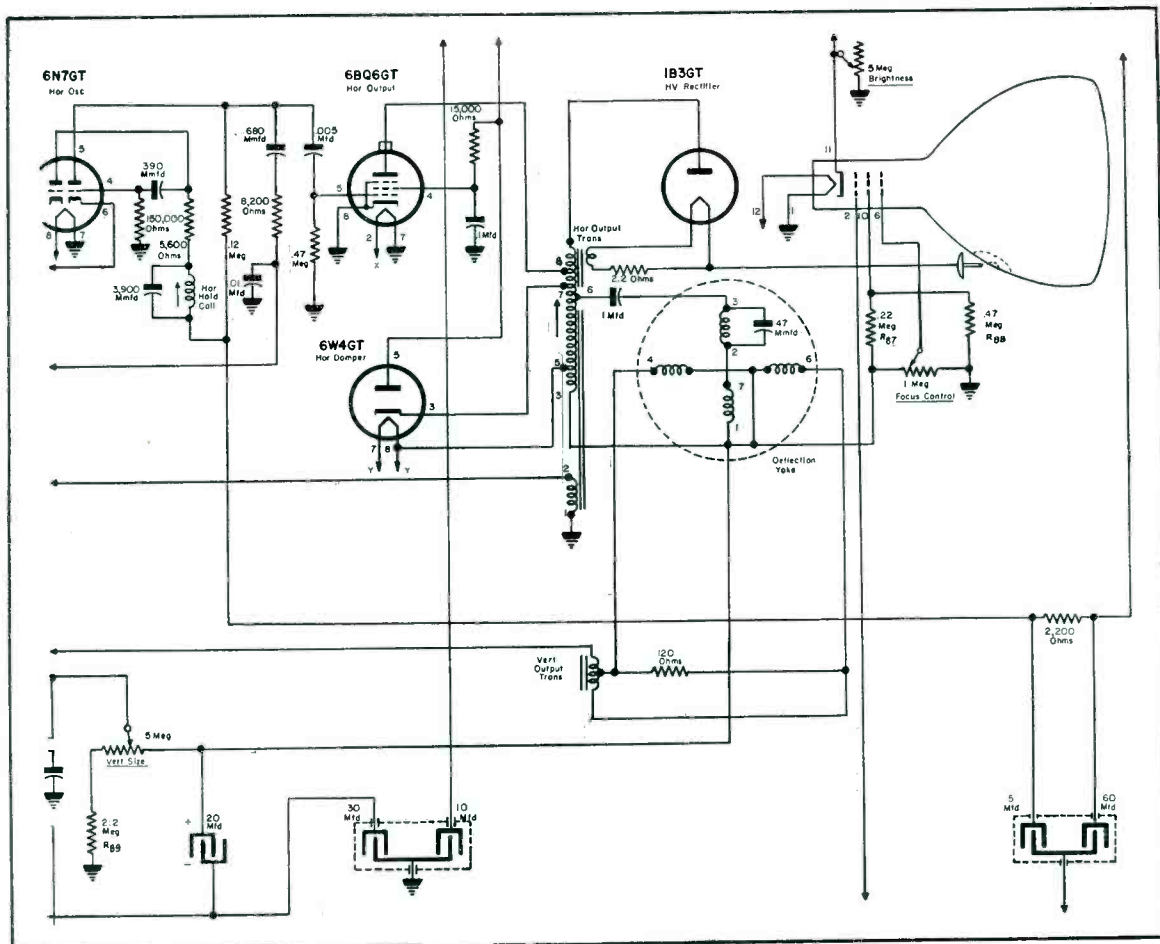

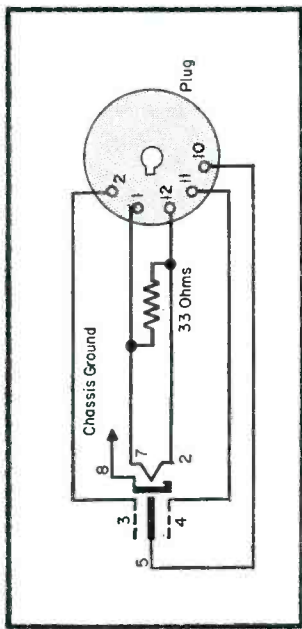

Fig. 2. Schematic of dual-target tuning-eye (6AF6) system used to check voltages at the picture-tube socket of Stromberg-Carlson TV receivers.

correctly numbered. Fig. 1 indicates the correct terminal connections; no connections are to be made on terminal 4.

To improve the contrast range in these models, 220,000 and 470,000-ohm resistors, R_{87} and R_{88} , have been added to the *B* boost line to lower the first anode voltage of the picture tube. Between the junction of the first anode of the picture tube and the 220,000-ohm resistor and ground, a 470,000-ohm $\frac{1}{2}$ -watt resistor, R_{88} , has been inserted.

To permit greater variations of vertical size of picture in these Sentinel models, a 2.2-megohm $\frac{1}{2}$ -watt resistor, R_{89} , should be inserted between the open terminal of the vertical size control and ground.

UHF Mixer Crystals

The position of the *uhf* mixer crystal in Motorola *uhf* converters^{1,2} is very important in determining the sensitiv-

(Continued on page 38)

Fig. 3a and b. Dual-target tuning-eye patterns produced when connected to picture-tube socket: *b* serves as brightness check, and *a* indicates effectiveness of contrast-control.

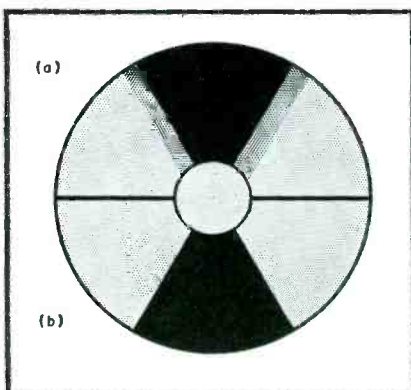

my Radio
and **T.V.**

REPAIR SECRET?

OHMITE®
DEPENDABLE REPLACEMENTS

Little Devil® COMPOSITION RESISTORS



Tiny, yes . . . but what dependability, ruggedness, and stability! And they provide an *extra* margin of safety—being rated at 70C rather than 40C. Completely sealed and insulated by molded plastic, they meet all JAN-R-11 requirements . . . are available in $\frac{1}{2}$, 1, and 2-watt sizes in all RTMA values.

TYPE AB NOISE-FREE POTENTIOMETERS

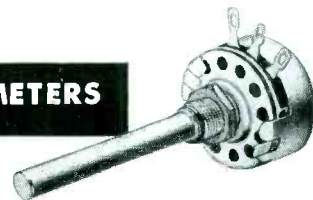

Because the resistance material in these units is solid-molded—not sprayed or painted on—continued use has practically no effect on the resistance. Often, the noise-level *decreases* with use . . . and they provide exceptionally long, trouble-free service. Rated at 2 watts, with a good safety factor.

BROWN DEVIL® AND DIVIDOHM® RESISTORS

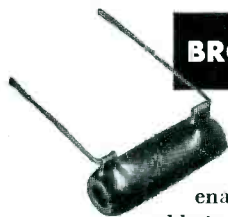

BROWN DEVIL fixed resistors and DIVIDOHM adjustable resistors are favorite vitreous-enameled units! DIVIDOHM resistors are available in 10 to 200-watt sizes; BROWN DEVILS in 5, 10, and 20-watt sizes.



WRITE FOR
STOCK
CATALOG



OHMITE MFG. CO.
4879 Flornoy St.
Chicago 44, Ill.

Be Right With . . .
OHMITE

RHEOSTATS • RESISTORS • TAP SWITCHES

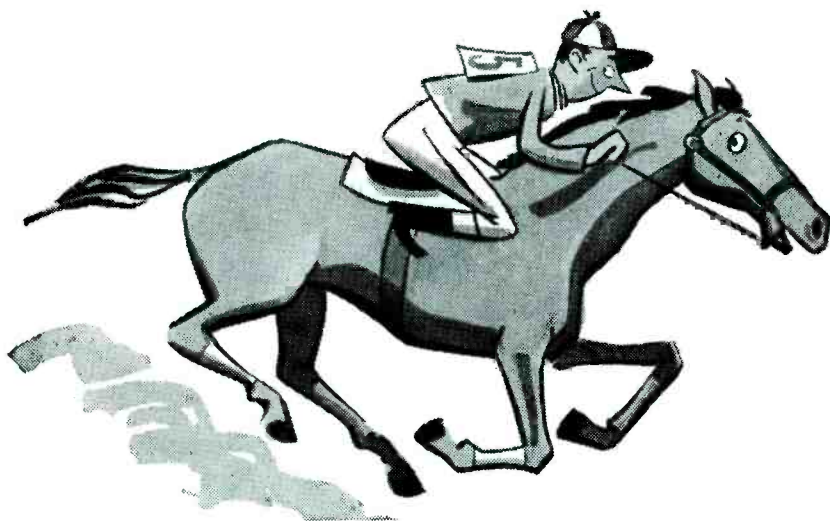

C-D's Tiny Mike

the Ceramic with the Million Dollar Body!

- Even the ceramic body is made by C-D, in the industry's newest, most modern ceramic body plant.
- You get a more uniform, more dependable capacitor—a real thoroughbred!
- Leads withstand 5 lb. direct pull and over 10 lbs. sideways pull.

See your Cornell-Dubilier
jobber today for details.

CORNELL-DUBILIER ELECTRIC CORPORATION
South Plainfield, New Jersey

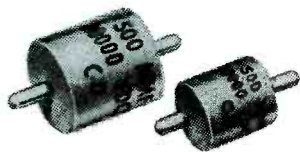

CONSISTENTLY DEPENDABLE
CORNELL-DUBILIER
CAPACITORS

SUBSIDIARY

Plants in So. Plainfield, N. J. • New Bedford, Worcester and Cambridge, Mass. • Providence, R. I.
Indianapolis, Ind. • Fuquay Springs and Sanford, N. C. • Subsidiary, Radiart Corp., Cleveland, Ohio

Servicing Helps

(Continued from page 37)

ity of the unit. Moving the crystal, within its lead length, can result in very good or very poor reception; in some instances, there may even be a complete loss of picture due to crystal dressing. There is no particular position into which the crystal can be placed for maximum sensitivity. If the crystal has to be moved for sensitivity-peaking purposes, an insulated alignment tool should be inserted through

the opening which is exposed by removing the plug button directly over the crystal location. Indiscriminate moving of the crystal should be avoided once the maximum response has been attained.

When the *uhf* mixer crystal is changed, the *uhf* converter must be completely realigned.

Sometimes improved sensitivity can be realized by dressing the crystal takeoff lead (buss wire between the

¹Converters TT-19A, 27MA, 28MA, 31MA, 35MA, 50MA, 52MA, 57MA, 58MA, 60MA, and VTT-28MA and VTT-60MA. ²Ser-Cuits, SERVICE; April, 1953.

crystal and the antenna transmission-line assembly) for maximum performance.

If fluctuations are noticed in the picture, the white lead (C_4 to junction of L_3 , C_5) should be checked to see if it is dressed close to and cemented to the chassis. The converter sensitivity is also affected by the dressing of this lead.

Maximum oscillator efficiency can be obtained if: (a)—The blue lead from the oscillator plate coil to R_{11} is dressed close to the chassis and away from the oscillator pipe; (b)—The injector capacitor, C_3 , leads are kept as short and straight as possible; (c)—The 18,000-ohm resistor, R_8 , is dressed about $\frac{3}{8}$ " away from and parallel to the oscillator pipe; (d)—The clear space on the oscillator pipe (between grid and plate sections) is kept free of rosin and other foreign matter. Rosin or foreign matter in this clear space will cause a leakage, especially in humid areas.

Horizontal Stability Improvement

The horizontal stability of the Admiral 19 series chassis has been improved with the use of a new vertical sync integrator couplate.* The circuit used in this couplate is similar to earlier types** used in chassis stamped *run* 6 or lower, except that resistor R_{407} (22,000 ohms) is not contained in this new couplate. Instead, the resistor is now connected externally from terminal 3 of the couplate to pin 1 of the

'SCOPE PRODUCTION



At DuMont's new instrument division plant, in Clifton, N. J., with 118,000 square feet of space used for the development and manufacture of 'scopes. View below shows quality control group, in new plant, examining quality of finished instruments as well as components. In foreground is a test unit for subjecting metal parts to salt spray, to be sure that they do not corrode even under most adverse conditions.

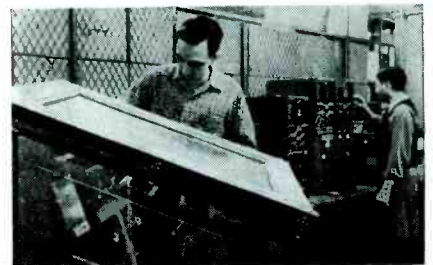

12AU7 sync clipper. This change has improved the horizontal sync stability by increasing the amplitude and *squaring up* the horizontal sync pulses.

This change represents a further improvement over that obtained with the *run 4* production change, which consisted of adding a 8,200-ohm resistor between terminal 3 of the couplate and pin 1 of the 12AU7.

To replace the old couplate, R_{448} , the 8,200-ohm resistor (added at *run 4*) should be omitted.

Decreasing Minimum Brightness Level

The minimum brightness level that could be obtained in the first production of Admiral 22P2 chassis was in some cases objectionably great, even with full counter-clockwise rotation of the brightness control. To decrease the minimum brightness level, R_{324} should be changed from 680,000 to 270,000 ohms and R_{325} changed from 560,000 ohms to 1 megohm. These resistors are both in the cathode circuit of the picture tube.

A cathode-to-heater short in the 6AU6 second sound *if* tube, V_{201} , in the Admiral 22 series chassis will cause a loud 60-cycle hum when there is a signal being received. If hum is encountered the antenna should be disconnected, and if the hum level decreases, it is likely that the 6AU6 may be defective.

*63B6-11. **63B6-2.

REPLACEMENT BATTERY DRIVE



Aids designed for replacement-battery spring-summer ad and sales promotion campaign. Hub of the program is a battery tester, which tests portable radio batteries under load conditions. It has a selector switch on the front panel, with nine prefixed testing positions for readings of batteries in the range of 1½ to 90 volts. Operating condition of battery under test is indicated as *good, usable, or replace* on a 4½-inch meter. The tester measures 9½" h, 6" w, and 1½" deep. Additional in-store display material includes a wire floor stand for the mass display of RCA batteries, a three-tier counter merchandiser, window display unit featuring sign which spotlights the dealer as local headquarters for battery replacements, and a variety of pennants for wall, counter, or window display.

BEST ALL-AROUND TESTER ON THE MARKET

USE IT FOR:

- TV SETS
- RADIOS
- TRANSMITTERS
- BROADCASTING EQUIPMENT
- HOME APPLIANCE
- TWO-WAY RADIO COMMUNICATIONS SYSTEMS
- PHONE LINES
- AIR CONDITIONING SYSTEMS
- STARTER CONTROLS
- AUTO IGNITIONS, GENERATORS, BATTERIES
- MOVIE EQUIPMENT
- PANEL INSTRUMENTS
- TV CAMERAS
- AUTO LIGHTING SYSTEMS
- GENERATORS
- VOLTAGE SOURCES
- "HAM" RADIO EQUIPMENT
- CABLES
- CONNECTORS
- AUDIO FREQUENCY SOUND CURRENTS

... and write for your complimentary copy of "1001" Uses for the Simpson Model 260"

RANGES:

20,000 OHMS PER VOLT DC
 1,000 OHMS PER VOLT AC
 VOLTS, AC AND DC: 2.5, 10, 50, 250, 1,000, 5,000
 OUTPUT: 2.5, 10, 50, 250, 1,300
 MILLIAMPERES, DC: 10, 100, 500
 MICROAMPERES, DC: 100
 AMPERES, DC: 10
 DECIBELS (5 RANGES): -12 TO +55 DB
 OHMS: 0-2000 (12 OHMS CENTER), 0-200,000 (1,200 OHMS CENTER), 0-20 MEGOHMS (120,000 OHMS CENTER)

SIMPSON ELECTRIC COMPANY

5200 W. Kinzie St., Chicago 44 • ESTebrook 9-1121

In Canada: Bach-Simpson, Ltd., London, Ont.



Simpson
Model 260
 VOLT-OHM-MILLIAMMETER

Burton Browne Advertising

AUTO ANTENNA PROMOTION



(Left)

Promotional material designed to stimulate replacement sales of auto antennas. *How You Can Sell More Auto Antennas*, the theme of the promotion, is explained in an eight-page booklet which outlines complete campaigns, and describes newspaper mat, radio announcement, counter display and streamer, postcard, invoice stuffers, and new catalog material offered. (Ward)

Next Month

THE CONCLUDING installment of the picture-tube fault analysis by J. C. Geist will be published in the July issue of SERVICE. It will feature a tabulation of data covering possible faults in picture-tube circuits and corrections evolved to facilitate troubleshooting.

AUDIO installation and service

Phono-Tape-Wire-PA-Amplifiers-Speakers

by KENNETH STEWART

New Standards for Tape and Disc Systems . . . 45 Record-Changer Tripping Adjustments . . . Turntable Replacements . . . Operation of Crystals in Turnover Cartridges, Microphones, Headphones and Record Cutters . . . Highlights of New Audio Products for Hi-Fi

THE SUCCESSFUL DESIGN, operation and installation of any equipment not only involves a comprehension of circuitry, but the specific function of each of the elements and their performance values. Such data, appearing in standard terms and definitions, normally serves as a basis of approach in the development of a piece of equipment.

In audio, standards have always played a key role; with the trend to extended range reproduction on both magnetic and disc systems such standards have become even more important.

New Definitions

Recently, one group of audio specialists* prepared a new series of defini-

Steel support channels designed for the installation of speakers in suspended ceilings. Channels available for 24" and 48" spans. May be used in either new or existing ceilings. In new ceilings, the support channels are secured between supports at desired locations for protective back speaker enclosures before ceiling material is applied. Where the ceiling has already been installed, a hole can be cut for slip fit of protective enclosures, or a ceiling panel can be removed for size of hole. (Lowell Manufacturing Co., 3030 Laclede Station Rd., St. Louis, Mo.)

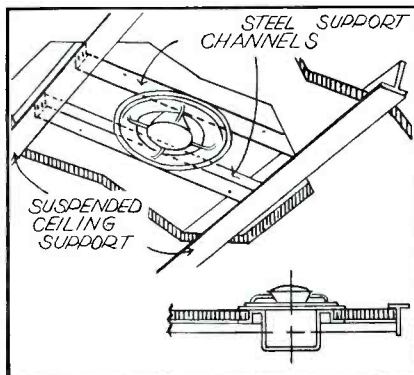

itions covering the latest developments in the art, which are expected to become a basic addition to audiology.

Technique and Test Standards

Terms defined include hot and cold-cutting styli, constant-velocity recorders or reproducers, echoes, and feedback cutters. Also appearing in the new standards are methods of meas-

*Recording and reproducing standards committee of the National Association of Radio and Television Broadcasters.

Bass reflex loudspeaker enclosure with a throat port, which can be used for 12" and 15" loudspeakers. Interiors are said to be insulated to absorb internal standing waves and sound reflections. Models available for wall and corner applications. (Tannoy Westminster and Parliament models; Beam Instrument Corp.)

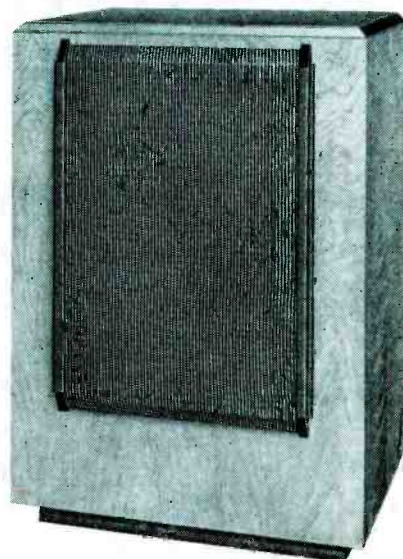

urements, and signal-to-noise ratios and standard reference levels for tape.

A cold cutting stylus was defined as one having its cutting edge burnished at a plane substantially different from the cutting face, for the purpose of cutting and polishing the groove in an acetate disc at normal room temperature. Hot cutting styli differed in that their cutting edges were only slightly burnished at a plane different from the cutting face, heated while cutting a groove.

Constant velocity recorders or reproducers were said to include turntables rotating in such a manner that constant velocity will be effected at the recording or reproducer stylus irrespective of diameter. Echoes were described as the effects caused by over-

Cable hanger which enables mike cable to be coiled and looped over the hook when moving, storing or transporting mike and stand. Can be clamped to any diameter tubing. (CH-1; Atlas Sound.)

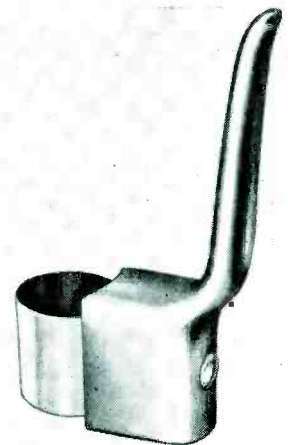

modulation in mechanical recording, where the side wall of an adjacent groove conforms slightly to the over-modulation.

A feedback cutter was cited as an electromechanical transducer which performs the same as a *cutter*, except that it is equipped with an auxiliary feedback coil in the magnetic field. Signals exciting the *cutter* are induced into the feedback coil, which in turn is fed back to the input of the cutter amplifier resulting in a substantially uniform frequency response.

Stroboscope Disc Standards

Disc measurements, it was said, shall be made by means of a stroboscopic disc illuminated by a neon lamp or equivalent operated from the same power source as the turntable. The stroboscopic disc for 33 $\frac{1}{3}$ speed measurement shall have 216 spots in 360°; for 45 speed it shall have 160 spots in 360°; and for 78.26 speed, it shall have 92 spots in 360°.

At either 33 $\frac{1}{3}$, 45 or 78.26, not more than 21 dots per minute in either direction may pass or *drift* by a reference point.

The signal-to-noise ratio of tape recording systems, the experts said, shall be at least 55 db referred to the standard reference level. All frequencies between 50 and 15,000 cycles should be included in the measurement of the noise. (The standard reference level for signal-to-noise measurements shall be that output level obtained by reproducing tape, produced by a recording system operating under normal conditions, at which two per cent

¹From RCA phono notes.

Lavalier-type (4" x 1") dynamic microphone for chest, desk or hand use. Frequency response is said to be peak-free 60-13,000 cps, specially compensated for chest resonance. Output level is -57 db. Polar pattern is omnidirectional, becoming slightly directional at extremely high frequencies. Acoustically treated grille is claimed to minimize wind and breath blasts, and prevent *pop*. Cable runs through center bottom. Has a rubberized 3-pin plug and strain relief on cable. Available in a choice of low or hi-Z. (Model 647; Electro-Voice, Inc.)

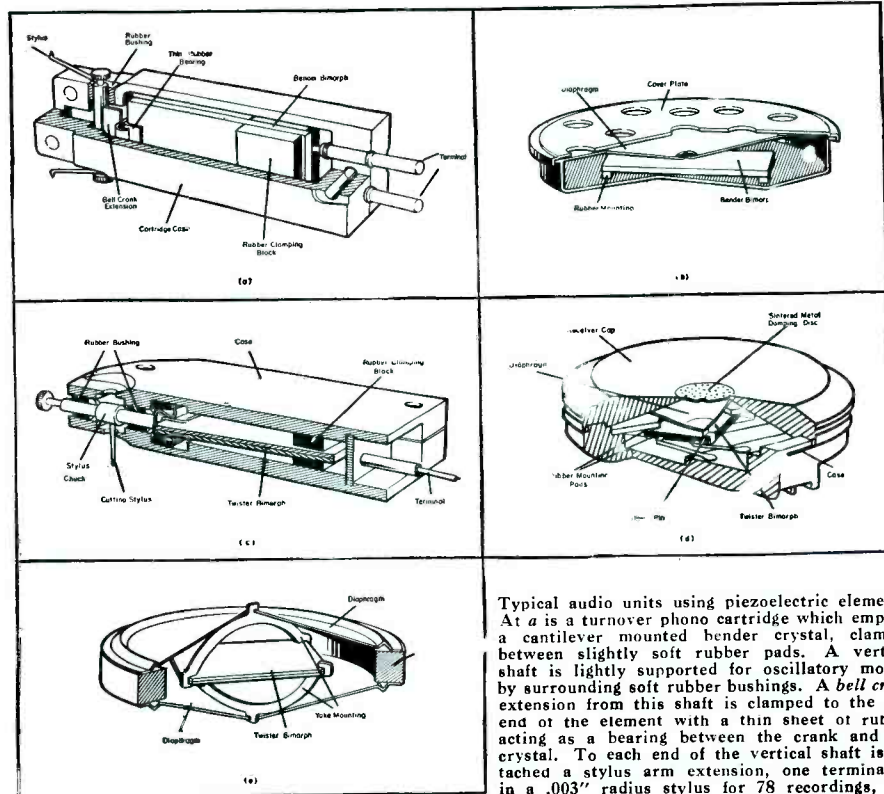
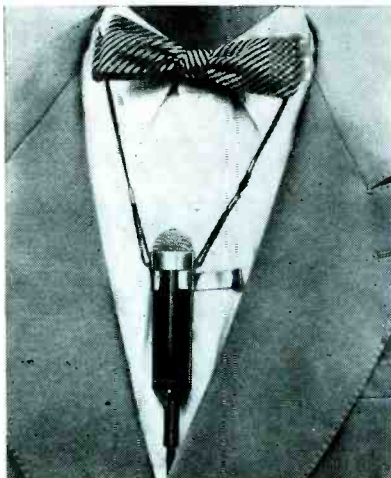

Typical audio units using piezoelectric elements. At *a* is a turnover phono cartridge which employs a cantilever mounted bender crystal, clamped between slightly soft rubber pads. A vertical shaft is lightly supported for oscillatory motion by surrounding soft rubber bushings. A *bell crank* extension from this shaft is clamped to the *free* end of the element with a thin sheet of rubber acting as a bearing between the crank and the crystal. To each end of the vertical shaft is attached a stylus arm extension, one terminating in a .003" radius stylus for 78 recordings, and the other terminating in a .001" radius stylus for microgroove recordings. The undulations in the grooves of the recording swing the engaging stylus back and forth, causing corresponding oscillatory motion of the vertical shaft, which in turn is transmitted to the element as a bending action by the bell crank extension. Thus, *ac* voltages are generated corresponding to the stylus oscillations. At *b* is a microphone cartridge, also with a bender element cemented at both ends to rubber mounting pads and driven at the center by a diaphragm. Sound pressures cause a reciprocating motion to be set up in the diaphragm which is transmitted as a reciprocating force to the center of the crystal to generate *ac* voltages corresponding to the sound waves. Record cutter shown at *c* employs a torsionally mounted twister element, which is clamped at one end between rather hard rubber pads; other end is forced between stiff spring-like jaws of a clamp which terminates the stylus chuck. This chuck is supported for oscillatory motion by two soft rubber bushings. Thus, torsional oscillations of the element, in response to an applied *ac* voltage, impart oscillatory motions to the cutting stylus, which cuts a modulated groove when in engagement with a recording blank. At *d* is a headphone receiver with a three-corner mounted twister crystal, which is clamped at the three corners between rubber mounting pads. The fourth corner of the crystal is coupled to the metal diaphragm by a drive pin. The motion of the unmounted corner of the crystal in response to an applied *ac* voltage produces a reciprocating motion of the diaphragm. Microphone at *e* employs a twister crystal in a novel yoke-type mounting. Here the crystal is held at alternate diagonal corners by opposing yoke-type holders. These holders not only support the crystal but, since they are coupled to metal diaphragms, also serve as drivers for the crystal. Sound pressures cause reciprocating motion to be set up in both diaphragms, towards and away from each other, producing the desired flexure in the twister crystal. Crystals used in these devices are usually made from rochelle salt, ammonium dihydrogen phosphate (ADP), and piezoelectric ceramic materials, with rochelle salt most commonly used because of its high sensitivity. Ammonium dihydrogen phosphate and piezoelectric ceramic materials are used in some special applications because they will withstand higher temperatures than rochelle salt. (Based on copyrighted report appearing in *Piezotronic Technical Data*, published by Brush Electronics Co.)

total harmonic distortion of a recorded 400-cycle tone occurs.)

45 Record Changer Tripping Adjustments¹

Before making an adjustment on 45 changers, the mechanism must be cycled and tested to determine if it is operating normally. To measure the tripping distance conveniently, the back of a stroboscope disc can be marked off at 1 $\frac{1}{2}$ " from the center hole, or a 4 $\frac{1}{8}$ " diameter circle can be inscribed about the center hole.

Record Changer Turntable Replacement²

Often, Service Men replace turntable hub gears because they are

(Continued on page 42)

²From Admiral service notes for RC600 changers.

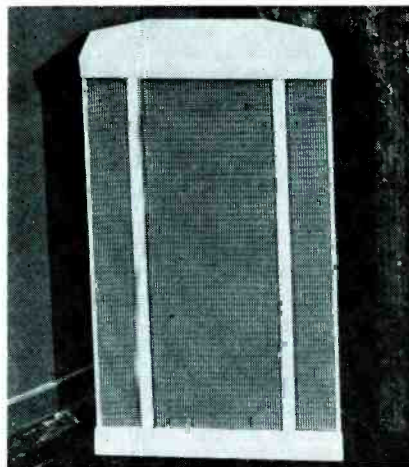

(Left)

Klipsch corner horn enclosure designed for 12" and 15" speakers. Built-in removable panel is said to allow for a variety of speaker combinations; two mid-range types, or tweeter-woofer combination. (Klipsch Rebel IV; G. and H. Wood Products Co.)

new

MANUALLY-OPERATED

Three-Speed Phonomotors by General Industries

MODEL SS (2-pole motor)

Very compact 3-speed phonomotor incorporating vertical idler shifting principle. Idler wheel drives the turntable directly from appropriate step on motor shaft. Moving shift lever to "OFF" position automatically disengages idler wheel from motor shaft during non-operating periods.

Features include ribbed mounting plate, oilless bearing and dynamically-balanced rotor. Turntable shaft revolves with turntable and is grooved for turntable clip. Furnished with 8" turntable.

Dimension: Length: 5"; Width: 4²³/₃₂"; Depth: 2¹⁵/₃₂" below mounting plate.

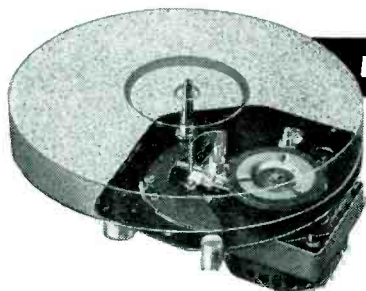
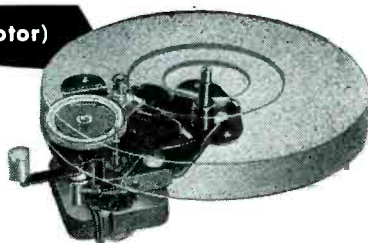

MODEL DSS (4-pole motor)

For applications in which compactness is secondary to need for absolute minimum of stray field radiation. Ideally suited for magnetic pickups.

Speed change is accomplished by vertical movement of idler wheel to appropriate diameter of motor shaft for desired turntable speed. Moving shift lever to "OFF" position automatically disengages idler wheel from motor shaft, and cuts off the current to the motor.

Features include precision construction throughout, oilless motor and turntable bearings, dynamically-balanced rotor. Furnished with 10" turntable.

Dimensions: Length: 6⁵/₈"; Width: 6¹/₁₆"; Depth: 2²¹/₃₂" below mounting plate.

Both models available for immediate delivery. Write for quantity price quotations on these and other G.I. phonomotors.



THE GENERAL INDUSTRIES CO.
DEPARTMENT MF • ELYRIA, OHIO

Audio

(Continued from page 41)

chewed-up or stripped. Unfortunately, seldom do the boys determine and correct the cause of the gear damage. Actually, the turntable hub gear is practically never defective in itself, but results from other faulty, damaged, or incorrectly assembled parts.

Most frequently, the gear becomes damaged when it does not mesh properly with the drive gear, because either the trip motion arm, gear engagement pawl, or trip pivot hub may be dimensionally out of tolerance or damaged.

If the distance between the axis of the gear engagement pawl and the end of the pawl that engages the lug on the turntable hub is incorrect for any reason, the drive gear will not mesh properly with the turntable hub gear, and the turntable hub gear will become damaged.

It is difficult to visually determine any fault with the trip assembly parts. For this reason, and in the interest of preventing call-backs, it is always wise to replace the trip motion arm, gear engagement pawl, and trip pivot hub when replacing the turntable.

[Additional new-product news on page 54]

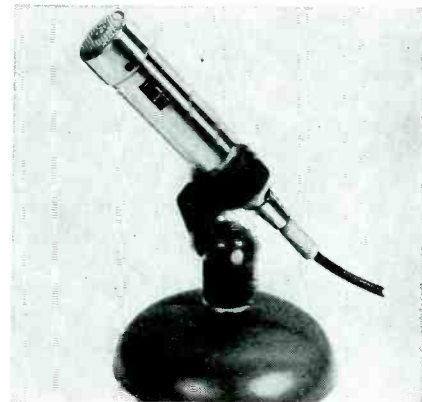

Six-ounce high-impedance microphone, with sealed crystal element, which is 4¹/₂" long and has a 1" diameter. Can be used on desk stand, as illustrated above, floor stand, or with lavalier, as shown below. (Slim-7 727; Shure Brothers.)

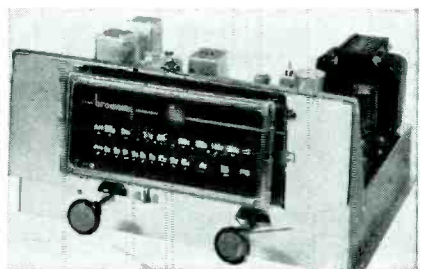

FM-AM tuner, with FM section featuring 20 db quieting for 3 microvolts signal input. Armstrong FM receiving method is employed, with dual cascade limiters and discriminator. AM section is a superhet type using triple-tuned *if*, and said to provide useable output for 1 or 2 microvolts input. Sharply tuned 10-ke whistle filter is claimed to remove interchannel beats. Audio output is fed through cathode-follower stage providing low impedance output to amplifiers. (RJ-42; Browning Labs.)

View of demonstration room in audio salon of Washington, D. C., distributor specializing in hi-fi. (Courtesy Electronic Wholesalers, Inc.)





A hi-fi package, which includes a 12" dual coax speaker, transcription tone arm (shown mounted on a three speed manual play turntable), a 10-watt power amplifier, and remote control pre-amp (at top) which incorporates a record compensator. Preamp control is self-powered and has adjustable record compensation with five positions, three input jacks to take record player, AM-FM tuner, tape recorder or television, bass and treble controls, loudness control, loudness-volume switch and level set control. Amplifier is of push-pull variety with a screw-driver adjustment which regulates hum balance. Coaxial speaker features two separate cone type units, one a 12" woofer, the other a 2 3/4" tweeter. Also incorporates a *wave front shaper*: Center plug attached to the pole piece in the tweeter is claimed to smooth out high frequencies and reduce distortion to a minimum. Ball bearings are used in the tone arm for both lateral and vertical motion. Two parallel aluminum shafts extend from the post to the cartridge housing. This housing is hinged in such a manner that it can be tilted upward at a 90° angle for stylus inspection. A scale, calibrated in grams, with a sliding weight, is attached to the side of the head parallel to the supporting shafts. This weight makes stylus pressure adjustable from 0 to 10 grams. (General Electric.)

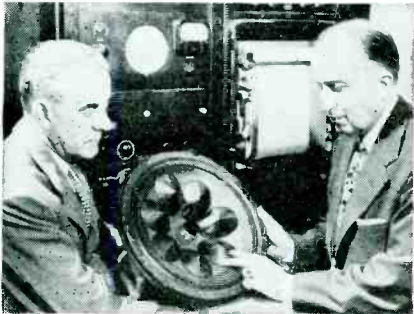

(Above)

Seven acoustical domes, indicated by Dr. H. F. Olson, director of acoustical research laboratory of RCA's David Sarnoff Research Center at Princeton, N. J., featured in improved model of duo-cone speaker. Irregular spaced inverted cones are claimed to detour sound waves, eliminating interference normally caused by symmetry of conventional loudspeaker design. With Dr. Olson is John Preston, codeveloper of new design. Speaker incorporating this innovation is part of line of hi-fi audio system components, unveiled at Chicago Parts show.

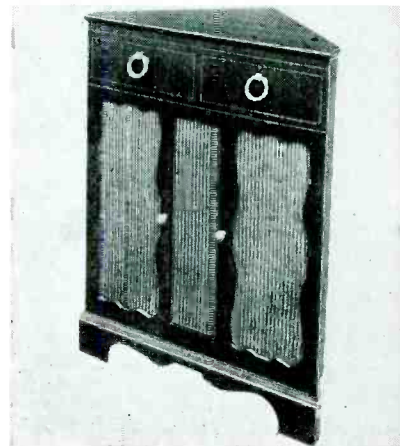

(Left)

Hi-fi corner enclosure for 12" speakers. Internal horn arrangement in cabinet, together with the floor and walls of the room, form an extended horn thereby loading rear wave. Efficiency, however, is said to be maintained by funneling horn loaded rear wave energy through a port which further serves to operate the enclosure as a bass reflex device. Enclosure dimensions are: height, 37", width 28", depth 15". (University Loudspeakers, Inc.)

(Right)

Coax speaker, employing 7 1/2-pound Alnico V magnet in a round pot structure. Has an aluminum die-cast frame. (Model 2064X; Stephens Manufacturing Corp.)

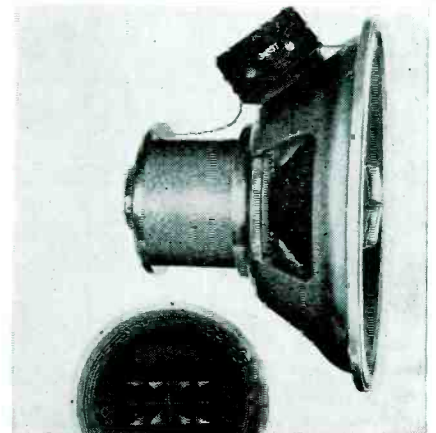

Simpson

marks what?



burton browne advertising

SEE IT AT YOUR PARTS JOBBER.

TUBE

Junction and point-contact transistors.

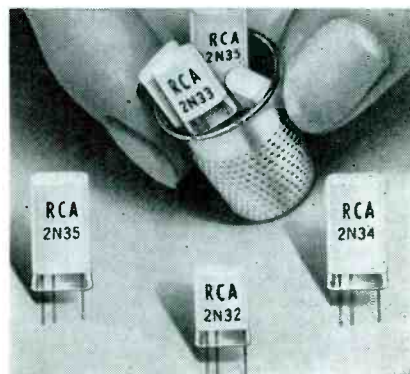

News _____ by L. M. ALLEN

Design and Application of Point-Contact and Junction Transistors, Developed for Oscillator (Up to 50-Mc) and Low-Power AF Use[†]

TRANSISTORS, essentially low-impedance devices, operating under current changes rather than voltage changes, have been found practical for many special applications within certain frequency ranges. Currently, it has been found possible to employ the point-contact type, which has a current amplification factor *greater* than unit, in *rf* and *if* amplifier, and *rf* oscillator circuitry. The junction-type transistor, which has a current amplification factor *approaching* unit, found to contribute to stability even under short-circuit conditions, has a high operating power gain and can operate with extremely low values of input power. These features are useful in oscillator

and amplifier applications in the *af* and low-frequency ranges.

For these applications, several types of point-contact and junction transistors have been developed.

Oscillator Designs

For oscillator service at frequencies up to 50 mc, one tube-maker has produced a point-contact type.¹ And for low-power *af* use, junction transistors of the *p-n-p* and *n-p-n* types,² have been processed. These transistors operate at extremely low voltages.

Each of the types has a base with

three small pins in line and spaced to provide mechanical indexing for socket insertion.

The structure of the point-contact transistor, and its related circuitry is illustrated in Fig. 1. It will be noted that this type consists of a crystal of *n*-type germanium having three electrical contacts. Two of these are point contacts and are known as the emitter and collector. A third, the base, makes area contact with the germanium crystal.

The input circuit on the left, in Fig. 1, is completed through the battery, the emitter, and the germanium

[†]Based on data in copyrighted booklet on transistors prepared by RCA tube department.
¹RCA 2N33. ²RCA 2N34 and 2N35.

(Continued on page 80)

Fig. 1. Sketch showing structural arrangement of point-contact transistors with associated circuit. (Courtesy RCA)

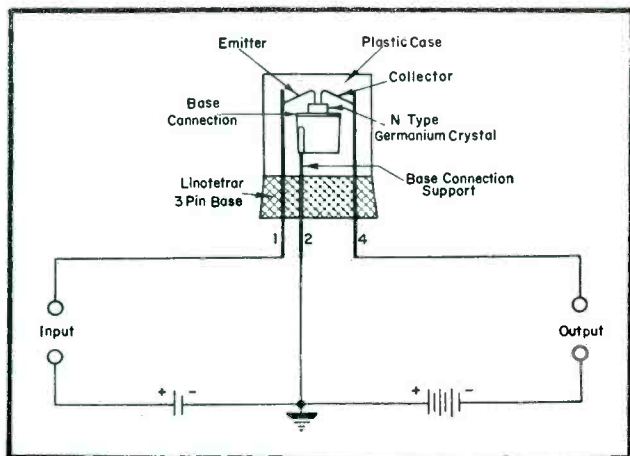
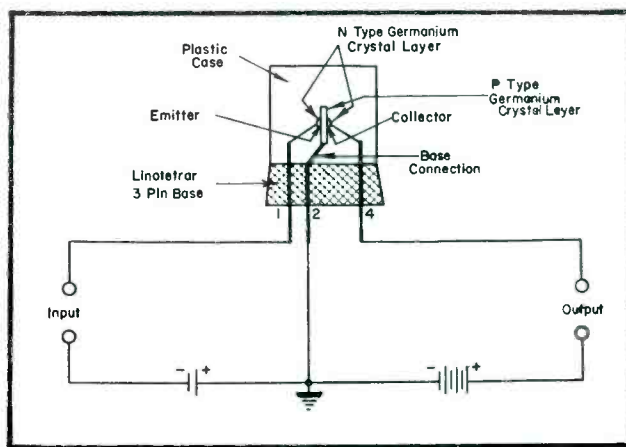

Fig. 2. Structural arrangement of junction transistor with associated circuit. For illustration purposes the crystal assembly has been rotated 90° within its plastic case. (Courtesy RCA)



Concord presents the most spectacular service values of the year!



Linearity Adjustments...vest pocket version with the CREST TV BAR GENERATOR

Provides actual bar pattern on TV receiver screen

- Can be used when no stations are on the air.
- Produces horizontal or vertical bars.
- Adjustable number of vertical and horizontal bars.
- Simple self-powered plug-in unit...fits picture tube no tools required for this 10-second installation.
- Vest pocket size...stow conveniently in tool box.

\$10⁹⁵

IMPOSSIBLE BUT TRUE!

SINGLE CHANNEL 5 ELEMENT DELTA-MATCH

YAGIS
ONLY
\$200
each
LOTS OF 5

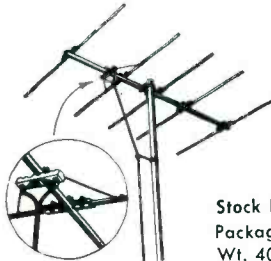

Stock No. YDM5
Packages of 5 Yagis.
Wt. 40 lbs. ...Net \$10.00

We know it's hard to believe, and we hardly believe it ourselves — but here it is, so make the most of it! These beautifully fabricated Yagis usually sell for 3 to 5 times our price!

Delta-Match principle insures flat response over entire channel bandwidth, providing maximum fidelity in both picture and audio portion of TV signal. These Yagis available for channels 2, 3, 4, 5 and 6, together with detailed instructions for cutting to channels 7, 8, 9, 10, 11, 12 or 13. Sorry, no less than 5 antennas of one channel. SPECIFY CHANNEL WHEN ORDERING.

Free with each order of 5 antennas 1 all-purpose hack-saw with blade and complete instructions for simple conversion of lower frequency Yagis to high frequency Yagis.

Spectacular

KIT VALUES!



1000 RESISTORS

1/2 watt, 1 watt, 2 watt, 5 watt. All new. 5 and 10% tolerance. Well assorted, popular values. Specially low priced! 1000 resistors.....

\$795

KIT OF 100..... **98¢**

CONDENSER TREASURE CHEST



Surprise value! 75 paper, bypass, mica, electrolytic, "FP", oil-filled ceramic, TV and bathtub condensers. Plastic Utility box. Wt. 10 lbs. No. CTC75 Kit of 75 condensers.....

\$795

15 MICA CONDENSERS

Popular sizes, receiving type micas. 600 to 1000 volt test. Silver micas included. In plastic utility box. Wt. 1 1/2 lbs.

98¢

No. MCK15 15 Micas
Same as above, 75 Micas.....\$3.50



25 CERAMICONS



Fresh, new, popular assortment, worth twice the price! In sturdy plastic utility box, wt. 1 lb. No. CCK25

\$149

25 Ceramicons

ALL STANDARD BRANDS!

60% OFF LIST

"Miniature" KIT
12A7, 12BA6, 12BE6,
35W4, 50B5 **\$3.15**

"Portable" KIT
1R5, 354, 1T4, 155
or more **\$2.95**

FREE

TOOL STEEL Tube
Pin Straightener

For 7-pin Miniatures,
FREE with each order
of 25 Tubes
or more.
Worth \$3.95!



Tube No.	Net Each	Tube No.	Net Each	Tube No.	Net Each	Tube No.	Net Each	Tube No.	Net Each
024	.66	6AL5	.72	6BQ7A	1.50	6SN7GT	.88	12SK7GT	.74
1A7GT	.88	6AL7GT	1.16	6BZ7	1.50	6S07	.60	12SL7GT	1.00
1B3GT	1.02	6AQ5	.80	6C4	.58	6S07GT	.60	12SN7GT	.92
1H5GT	.68	6AQ6	.76	6C86	.88	6T8	1.16	12SQ7GT	.64
1L4	.84	6AQ7	1.06	6CD6	3.95	6V6GT	.80	198C6G	2.40
1L6	1.06	6AR5	.66	6D6	.88	6W4GT	.74	19CS	1.28
1NSGT	.84	6AS5	.84	6F8	.88	6W6GT	.88	25B06GT	1.36
155	.76	6AS7G	3.95	6F6GT	.68	6X4	.62	25L6GT	.68
1T4	.84	6AT6	.62	6F8G	1.34	6X5GT	.62	25Z5	.66
1TSGT	1.04	6AU6	.72	6H6	.66	6Y6GT	1.00	25Z6G	.54
1W4	1.06	6AU7	.88	6H6GT	.74	7N7	.88	35A5	.72
1W5	.88	6AV6	.62	6J5	.80	12AT6	.62	35B5	.80
1X2A	1.06	6B4G	1.28	6J5GT	.80	12A7	1.16	35C5	.80
3Q5GT	1.00	6BA6	.76	6J6	1.00	12A7	.72	35L6GT	.68
354	.80	6BA7	1.00	6K6GT	.84	12A7	.96	35W4	.50
3V4	.80	6BC5	.80	6K7	.74	12AV6	.62	35W5	.52
5U4	.60	6BE6	.76	6L6G	1.25	12AX7	1.16	35Y4	.72
5V4C	.98	6BF5	.94	6L6GA	1.42	12AX7	1.00	50B5	.80
5Y3G	.54	6BG6G	1.92	6S4	.68	12BA6	.76	50C5	.80
5Y3GT	.44	6BH6	.84	6SA7	.70	12B7	1.00	50C6G	1.16
6AB4	.80	6BJ6	.84	6SA7GT	.74	12B6	.76	50L6GT	.68
6AC7	1.16	6BK6	.60	6SJ7	.66	12B7	1.20	80	.52
6AG5	.90	6BK7	1.28	6SK7	.86	12A7	.70	117L7	1.56
6AK5	1.66	6BL7	1.16	6SK7GT	.74	12SA7GT	.74	117Z3	.62
6AK6	.94	6BQ6GT	1.36	6SL7GT	.98	12SJ7	.70	117Z6GT	1.00

5% ADDITIONAL DISCOUNT ON LOTS OF 100 OR MORE ASSTD.

"All-American"
TUBE KIT
12SA7, 12SK7, 12SQ7,
35Z5, 50L6 **\$2.99**

*All Tubes Guaranteed for 90 days,
excepting only burnouts and breakages.

STOP BLACK BORDERS ON TV PICTURE

use a
"B" Plus Booster

Model 5TV4 Replaces 5U4G

- SUPPLIES EXTRA 30-40 VOLTS TO LOW VOLTAGE SUPPLY
- GIVES FULL SIZE PICTURE WHEN LOW LINE VOLTAGE OR WEAK TUBES CUT PICTURE SIZE
- GIVES EXTRA GAIN NEEDED IN FRINGE AREA
- BUILT-IN TIME DELAY TO PROTECT TV SET
- RTMA GUARANTEE



\$395
NET

Manufactured by
WORKMAN TV, INC., Teaneck, N. J.

Please include 25% deposit
with order, balance C.O.D.
FOB NYC. Minimum order \$5.

Concord Radio

52 Vesey Street, New York 7, N. Y.
Phone Digby 9-1132



THEY'VE GOTTA BE IN **UHF-VHF** PICTURES!

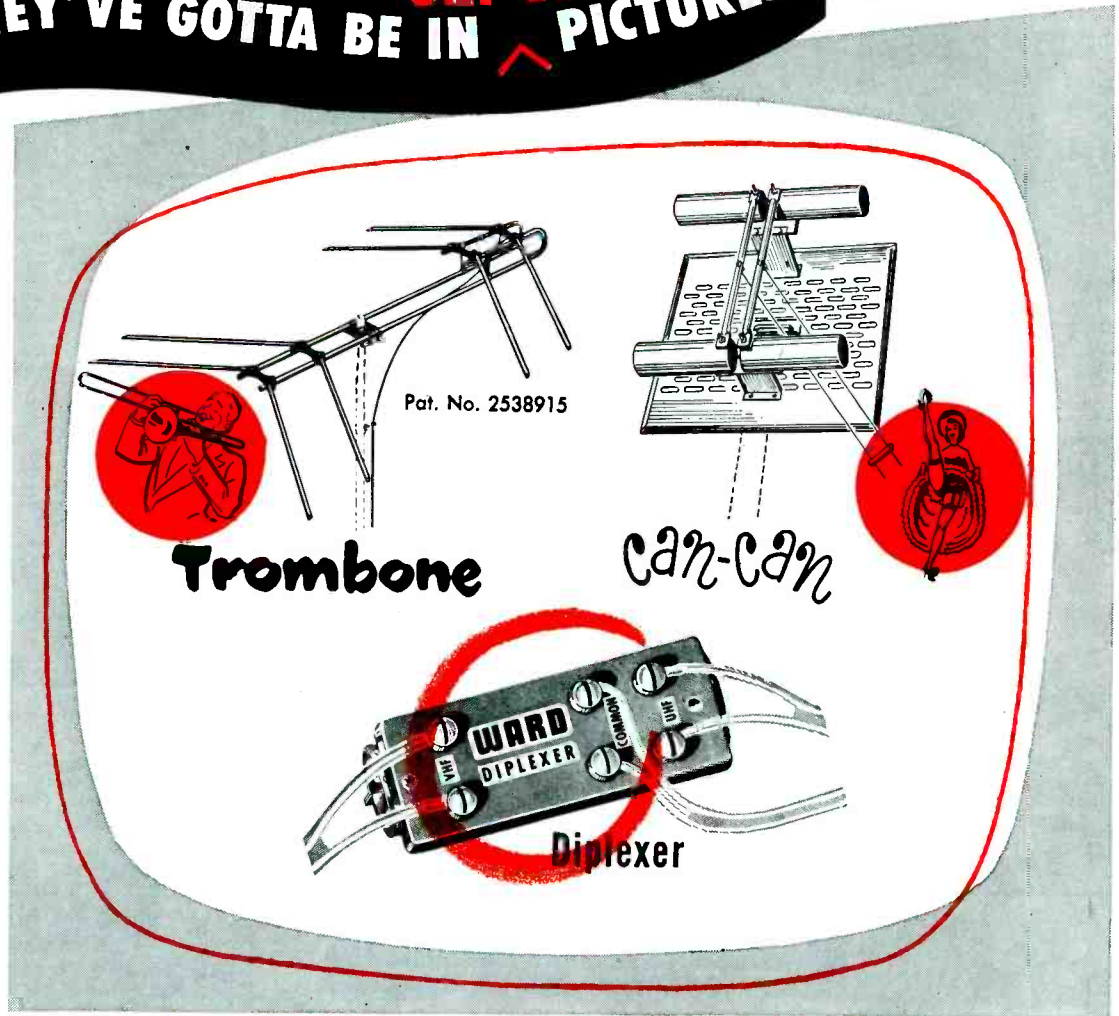

FOR

NEW INSTALLATIONS

Nothing compares with the radically new WARD all-channel "TROMBONE" Antenna. It gets the best in VHF and UHF . . . now and in the future. Protects your customers against channel changes and new stations . . . Delivers high gain — up to 16 db — on all channels — 2 to 83.

WARD'S "TROMBONE" is The Antenna for every new installation.

OLD INSTALLATIONS

WARD'S "CAN-CAN" auxiliary Antenna is the answer to the demand for UHF through the medium of an already-existing VHF Antenna. Simply add the "CAN-CAN" to the mast of the present antenna and you have complete UHF-VHF reception. Small, lightweight, streamlined, "CAN-CAN" gives high gain on all UHF channels. Also can be used for a new UHF installation.

DOUBLE ANTENNAS

WARD'S ingenious "DIPLEXER" is the complete solution of the problem of two lead-in lines, where two Antennas are used. Just connect the lead-in lines to the "DIPLEXER" and extend one single line to the receiving set. It solves the entire matter just that easily.

THE **WARD** PRODUCTS CORP.



DIVISION OF THE GABRIEL COMPANY

IN CANADA: ATLAS RADIO CORP., LTD., TORONTO, ONT.

1148 EUCLID AVENUE • CLEVELAND 15, OHIO

SERVICE... *The National Scene*

HI-FI, TV ANTENNAS AND ACCESSORIES HEADLINE AT PARTS SHOW--Industry's sparkling duo--hi-fi and TV--dominated the huge May parts show in Chicago, with a striking display of new developments. The largest collection of wide-range audio gear, and antennas and accessories, ever assembled, were seen by a record throng of nearly 12,000. Particularly outstanding were the displays of packaged hi-fi, with ingenious design innovations in speakers, amplifiers, tone arms and changers. . . . One speaker, a 21-pound model, featured a series of acoustical domes placed on the inside of the speaker's cone which, it was said, serves to break up unit symmetry and thus eliminate interference normally characteristic of a symmetrical shape, without compromising the unit's ability to reproduce highs and lows effectively. . . . Another speaker development disclosed the use of a tweeter unit mounted on a slotted baffle plate, which was described as serving as a tweeter baffle to reduce interference between tweeter and woofer units. To eliminate cavity effects, the designers of this speaker included a pressure equalizer at the apex of the tweeter cone. . . . Complementing the slotted baffle-plate speaker was a 10-watt amplifier which featured a 15-db inverse feedback loop and a split-load triode phase inverter driving a pair of 6V6GTs in push-pull. . . . Also available for this hi-fi system are two types of tone arms, to be used with 12" or 16" diameter discs, with provision for cartridge-pressure adjustment and direct stylus-pressure measurement in grams. . . . Every conceivable type of enclosure, to accommodate from one to three or four speakers, were also displayed and demonstrated. . . . Microphones, smaller and slimmer, and yet more efficient than ever, were also set up for viewing and testing. . . . Along TV row, many brilliant advancements in antenna and accessory design were in the spotlight. Visitors saw new types of helicals, conicals and tubulars for the ultrahighs, as well as a host of modified bow ties, yagis and Vs, plus diplexers and triplexers for multiple antenna installations, streamlined rotators (some with clock timers), and lines of tubular, lossless leadins, developed especially for the higher frequencies. . . . Antenna hardware (mounts, brackets, guys, stays, standoffs, towers), designed to facilitate installation and insure sturdiness, were featured items, too. . . . Many of these unusual developments are illustrated and detailed in this issue in the Audio and TV Antenna Digest sections. Many more will be described in detail next month. Watch for these reports.

DEPARTMENT STORE ADOPTS COOPERATIVE INDEPENDENT SHOP PLAN--When some months ago it became apparent that the service department of one of the largest department stores in New York City could no longer handle the growing demand for widespread service, and store-controlled depots were found to be too costly and inefficient, management decided to investigate the capabilities of independent service shops who might lend a hand. The survey disclosed that such a move would be very practical, and accordingly, a novel independent-Service Man call plan was initiated. Independent service companies were selected on their past record of serving appliance and department stores or chains, as well as their specific ability to render prompt, reliable and thorough service. Inspections were made of their facilities and stock of parts. The personnel of every shop were carefully interviewed. Spot checks on service rendered in the home were made during surprise visits by department store officials. . . . The independent Service Men are called in when the department store finds itself overloaded with calls, or if a call originates in a zone beyond routes covered by the store's service trucks. . . . Payment is made directly to the department store at a rate of \$5.75 an hour for home calls and \$15 an hour for shop work, provided no contract is in force. . . . The names of the approved independent service shops appear on an elaborate display hung in the radio-TV section of the department store. The specific areas which each service shop can cover are noted on a huge map. . . . According to the department store's director of service, the program has proved so successful that a plan to add many more independents in outlying areas to the call system is now being considered.

SERVICE... The National Scene

PICTURE TUBE CALLED KEY TO COLOR SET PRODUCTION--Notwithstanding the spirited debates revolving about who will petition the Commission first for new color standards--NTSC or industry--there is one basic item that will really determine when we will have color . . . the picture tube. So declared the color-system committee chairman at a distributor meeting in Chicago recently. While a number of proposals have been advanced for all-electronic, tri-color picture tubes, he said, only one of these has produced fully satisfactory pictures. And, he stressed, it will be type of tube employed that will determine the designs of color chassis. In an analysis of this particularly important factor, it was revealed that tubes using a single electronic beam, with a change in beam direction at the front of the tube to provide color selection, are simple and economical to produce, but they require a complicated chassis and a greater degree of circuit precision to insure color fidelity. In addition, it was said, the beam-bending operation makes it necessary to use an appreciable amount of power at high frequency, which raises the problem of interference radiation. The other type of color tube available uses three separate electron beams, whose possible paths are restricted physically, so that the green gun can only reproduce green, etc. This is the tube employed in models demonstrated on many occasions before the Commission and many industry groups. The use of these tubes, it was said, permits a reduction in chassis and circuit precision complication, but the tube complexity and cost is higher. However, since no beam bending power is required, no radiation problem exists. . . . Industry will thus have to decide, the distributors were told, which procedure will be most practical: Shall a precision structure be included in the tube, thus permitting the use of a simpler chassis circuit, with the assurance that no radiation will obtain and all colors will be reproduced properly since they are controlled by tube design; or shall precision be built into the chassis and a lower-cost tube be employed, a step that will introduce the hazard of radiation and place more of the color-control responsibility in the hands of the consumer. . . . The picture tube holds, it was emphasized, not only the key as to how the chassis is to be designed, but also the cost of the finished end-product . . . the complete color-TV set . . . which may vary from \$750 to \$1000 for a 21" model.

WASHINGTON BLASTS TV CONSUMER SHORT-CUT REPAIR BOOK--A scathing cease and desist order, issued by the Federal Trade Commission, has branded the claims made by a publisher of a TV setowners operation and repair book as false and misleading. The FTC declared that it objected to the repeated statements noting that inexperienced persons could repair their TV sets without any danger, if they followed the guide. The Commission also hit at the ads which pointed out that consumers without the aid of any special test equipment, by using the guide, could trace each trouble to its source, locate and replace wornout parts, and without any prior technical knowledge prevent major breakdowns, save up to \$100 a year on service, and even convert sets for color reception. . . . Huzzas to the Commission for issuing this very-welcome ruling!

IN THE MAILBAG--From our friends overseas, and way up North, we've received letters of which we are particularly proud. . . . Commenting on the association news and technical reports carried in SERVICE, the secretary of the Radio-Electronic Technicians Association in Vancouver, Canada, declared that . . . "I can assure you that for myself, and a number of our boys, SERVICE is really a service to the radio-technician." . . . And, according to Leonard E. Geisler, in Tokyo, Japan . . . "SERVICE . . . in our opinion . . . is a must for anyone who intends to render the latest up-to-date service to his customers." . . . Many thanks gentlemen for these heartening comments.--L. W.

FREE!

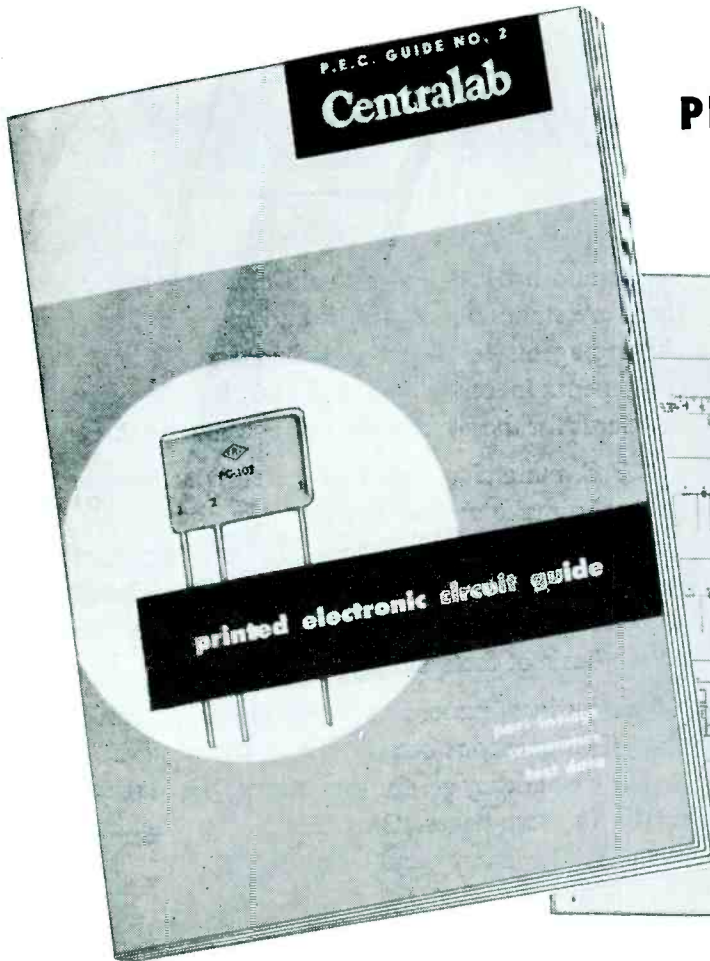

PRINTED ELECTRONIC CIRCUIT GUIDE NO. 2

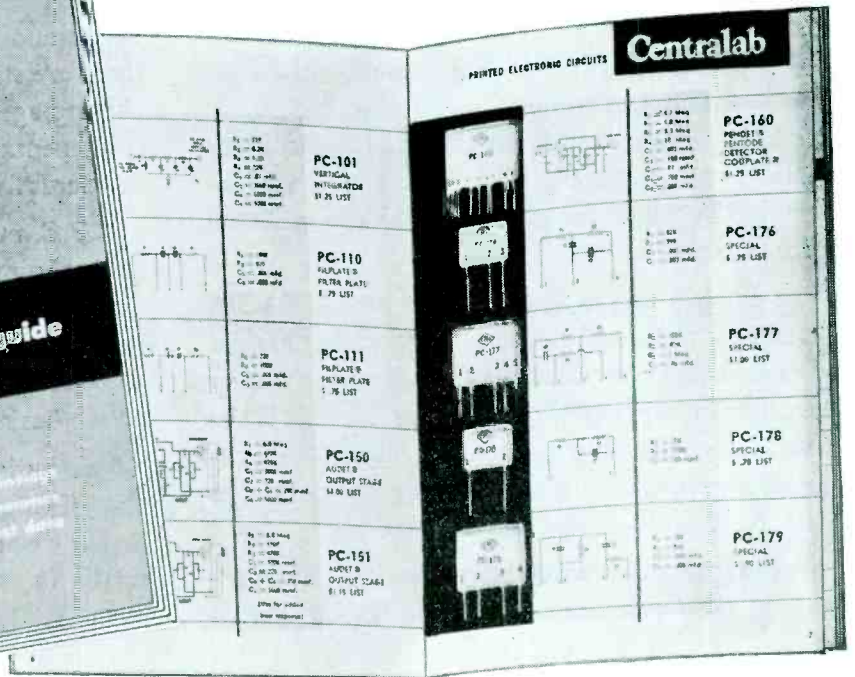

1953 CENTRALAB PEC GUIDE BIGGER — EVEN MORE COMPLETE

includes 445 PEC applications — 21 stock parts covering
25,000,000 PEC's now in use — lists 119 set manufacturers

HERE'S the only practical PEC service guide. It's a must for every service shop. And it's yours absolutely free.

Original equipment manufacturers have marveled at the extremely low failure percentage of PEC units as compared to individual standard components. But there are many millions of older sets in use that were produced prior to the use of PEC. Standard components in these sets can be replaced quickly and inexpensively by a single Printed Electronic Circuit Plate. If trouble is located in a certain section of a circuit, for instance, the vertical integrator in a TV set, or the Audio Detector in a radio set, instead of taking costly time to locate the exact component failure, replace the entire section with a vertical integrator or audio detector PEC plate.

Printed Electronic Circuits, originated and developed by Centralab, are in use on 60% of today's radio and television sets. Be sure you have the new 1953 guide for fast, positive information — where and when you need it.

Centralab

A Division of GLOBE-UNION INC., Milwaukee 1, Wisconsin
In Canada, 635 Queen Street East, Toronto, Ontario

Your parts distributor has this guide — ask him for a copy. If he can't supply you — use the coupon.

FOR FREE GUIDE, CLIP THIS COUPON AND MAIL TODAY

CENTRALAB, Division of Globe-Union Inc.
908F E. Keefe Avenue, Milwaukee 1, Wisconsin
Please send me without delay, a copy of Centralab's Printed Electronic Circuit Guide No. 2.

Jobber's Name.....
Jobber's Address.....
Name.....
Firm.....
Address.....
City..... Zone..... State.....

Before Any Other Consideration

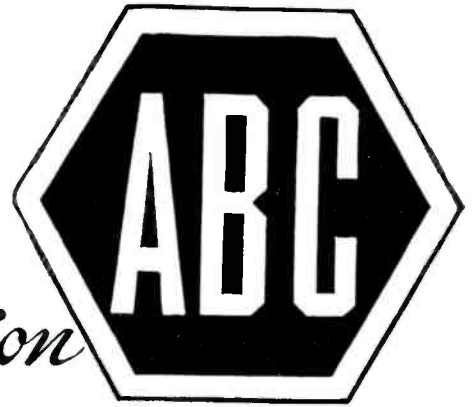

Integrity of Circulation

OF THE several factors that enter into the use of published media, the distribution of the advertisers' sales messages, as governed by the selection of media, can of itself decide the success or failure of the advertising investment. That is why integrity of circulation is the first consideration with experienced space buyers.

The emblem shown above stands for the FACTS that make it possible for advertisers to select the right media and to know what they get for their money when they invest in publication advertising. It is the emblem of membership in the Audit Bureau of Circulations, a cooperative and nonprofit association of 3300 advertisers, agencies and publishers.

Working together, these buyers and sellers of advertising have established standards for circulation

values and a definition for paid circulation, just as there are standards of weight and measure for purchasing agents to use in selecting merchandise and equipment. In other words, A.B.C. is a bureau of standards for the advertising and publishing industry.

A.B.C. maintains a staff of specially trained auditors who make annual audits of the circulations of the publisher members. Information thus obtained is issued in A.B.C. reports for use in buying and selling space. All advertising in printed media should be bought on the basis of facts in these reports.

This business paper is a member of the Audit Bureau of Circulations because we want our advertisers to know what they get for their money when they advertise in these pages. Our A.B.C. report gives the facts. Ask for a copy and then study it.

SOME OF THE AUDITED INFORMATION IN A.B.C. BUSINESS PAPER REPORTS

SEND THE RIGHT MESSAGE TO THE RIGHT PEOPLE

Paid subscriptions and renewals, as defined by A.B.C. standards, indicate a reader audience that has responded to a publication's editorial appeal. With the interests of readers thus identified, it becomes possible to reach specialized groups effectively with specialized advertising appeals.

- How much paid circulation.
- How much unpaid circulation.
- Prices paid by subscribers.
- How the circulation was obtained.
- Whether or not premiums were used as circulation inducements.
- Where the circulation goes.
- A breakdown of subscribers by occupation or business.
- How many subscribers renewed.
- How many are in arrears.

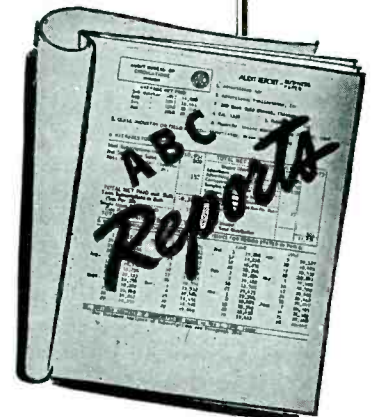

SERVICE

A.B.C. REPORTS — FACTS AS THE BASIC MEASURE OF ADVERTISING VALUE

In The Field[‡]

Interpretation of Waveforms . . . Relationship of 'Scope Patterns to Receiver Troubles

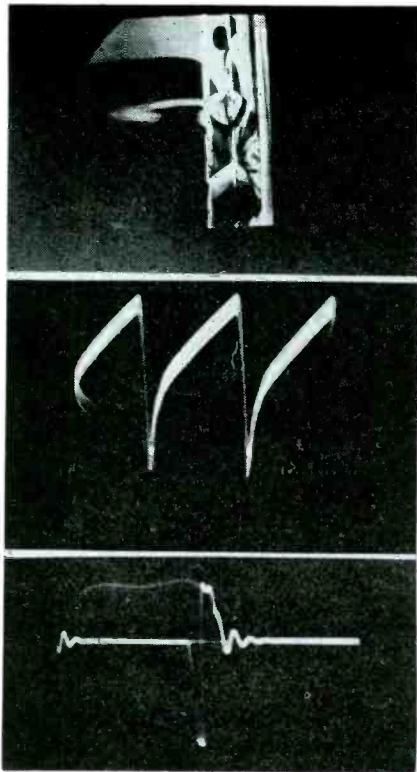

(Above)

Fig. 1. Top *a* illustrates a booster defect, which in this case produces a visible symptom of trouble in the picture. If the high voltage is more seriously affected, the picture symptom becomes invisible. In *b* (center), the booster trouble is apparent in the sawtooth of current deflection through the horizontal coils, as would be expected. At bottom, *c*, we see that the trouble is also reflected in the ripple waveform in the high-voltage supply. It must be remembered that the booster circuit, the deflection circuit, and the high-voltage supply are *interlocked circuits*.

(Below)

Fig. 2. Pattern illustrating point that the undershoot following the vertical trigger pulse is not caused by kickback from the vertical blocking oscillator; in this case, the vertical blocking oscillator tube has been removed. The undershoot is caused by the relative time constant of the network utilized in the receiver, compared with the width of the trigger pulse.

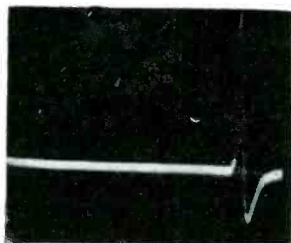

[‡]Based on questions posed during meetings conducted by R. G. Middleton, senior engineer at Precision Apparatus Co., Inc., and author of *TV Troubleshooting and Repair Guide Book*, published by John F. Rider.

IN TROUBLESHOOTING, often it is necessary to trace trouble without the aid of a picture on the screen to analyze. It is necessary to rely on waveform analysis. Will meaningful waveform variations be found throughout the receiver, or only at one point?

The extent to which the waveform variations are *spread out* through the receiver circuits depends upon the nature of the circuits and of the trouble, as illustrated in Fig. 1, at *a* and *b*. In *a* we have a defect which happens to be apparent on the picture tube; this defect is caused by a faulty input booster capacitor. To show the wide-spread nature of the trouble, it will be noted at *b*, that the sawtooth current through the horizontal deflection coils is badly distorted; likewise the ripple waveform on the high-voltage supply reflects the trouble, as shown in *c*.

IN CHECKING integrating circuits with a 'scope, with the vertical-oscillator tube removed, patterns often seem to indicate that a small kickback from the vertical oscillator is present. Why?

This is actually an undershoot of the pulse waveform which results from the relative time-constant of the circuit to the pulse width; Fig. 2.

IF THE SWEEP generator has insufficient sweep width to display the complete response curve, can a harmonic be used to get increased sweep width?

Yes, but it is usually preferable to use a zero-volt reference line from the sweep generator, as shown in Fig. 3.

DOES THE sweep generator show the *Q* of a trap?

Yes. A medium-*Q* trap is shown in Fig. 4. A high-*Q* trap is shown in Fig. 5.

CAN the air gap of deflection yoke cause foldover if the spacing is incorrect?

Vertical foldover will be encountered if the air gap in the deflection yoke is too wide. Normal spacing is 1/32".

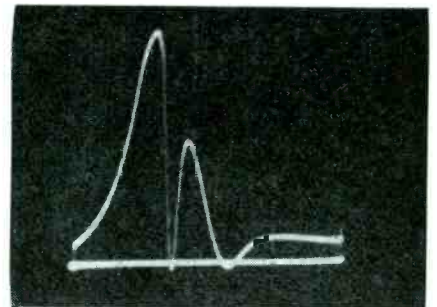

(Above)

Fig. 3. Sweep width of sweep-frequency oscillator inadequate to display complete curve. If sweep width cannot be increased, the use of a zero-volt reference line, as shown, will serve to provide a better display of the partial response.

(Below)

Fig. 4. Waveform which reveals how a medium-*Q* trap can cut notch in response curve, but notch need not extend all the way down to the base line.

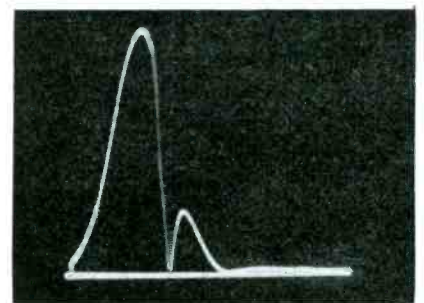

(Below)

Fig. 5. Response illustrating fact that a high-*Q* trap cuts a notch in the response curve, which extends all the way down to the base line.

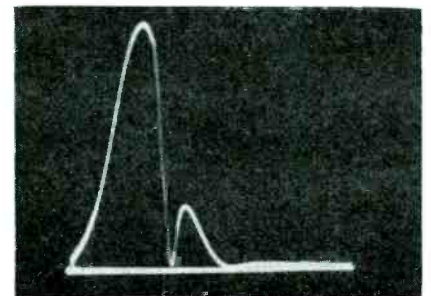

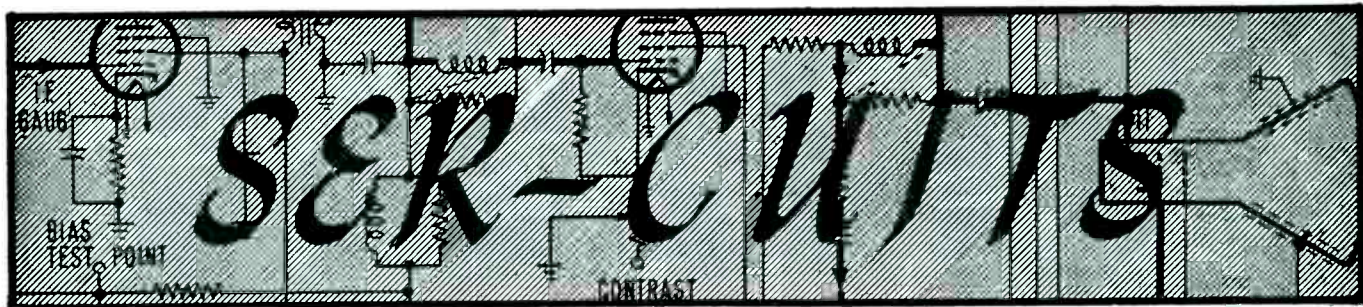

by M. W. PERCY

Features of TV IF Amplifier Circuitry Using PC IFs and Traps . . . Auto Radios With PC Audio-Coupling Assemblies

PRINTED CIRCUITRY which has become increasingly popular among set and special component assembly producers, is now being used in the processing of 40-mc *ifs*, a line of coils and traps.¹

In the new approach inductances are provided by flat inductors having rectangular windings which are photographically printed on copper-clad plastic strips.[‡]

Components are housed within metal shield cans $\frac{7}{8}$ " square and $2\frac{1}{4}$ " high. Alignment adjustments are furnished by special screw discs accessible from one side of each component. This arrangement enables one to make all alignment adjustments from the top of the chassis.

Production of a *pc* component begins with a photograph of the pattern

[‡]Based on copyrighted notes prepared by tube department of RCA.

of the required circuit. A contact print of the negative is then made on a copper-clad plastic strip which has been coated with a light-sensitive material. Following this operation, the strip is developed and placed in an etching solution. The unexposed parts of the copper are eaten away, leaving sharply defined reproduction of the desired copper circuit. After the strip has undergone additional processing, it is inserted in a metal case.

The new *if* components, designed for TV sets utilizing intercarrier-sound and incorporating picture *if* and sound *if* carriers of 45.75 and 41.25 mc, respectively, include: first picture *if* grid-circuit coil and trap²;

first picture *if* plate-circuit coil³; second picture *if* grid-circuit coil⁴; first and second picture *if* filter traps⁵; second picture *if* transformer⁶; and third picture *if* transformer⁷.

These *pc* components are said to provide an overall sensitivity of 70 microvolts* at 44 mc in a typical *if* amplifier circuit of the type shown in Fig. 1. Designed for use in double-tuned circuits, the *pc* parts achieve a bandwidth of 4 mc.

The first picture-*if* tuned grid-circuit coil is transformer-coupled to a tuned absorption trap. The grid-circuit coil is used in conjunction with a twisted-pair conductor, approximately 5" in length, for coupling

¹RCA.
²RCA-209K1. ³210K1. ⁴211K1. ⁵212K1.
⁶213K1. ⁷214K1.

*Measured at the grid of the converter tube. Seventy microvolts at this point will produce a dc output of 1 volt across the load resistor of the second detector with zero external bias.

Fig. 1. Typical *if* amplifier using printed-circuit components. L_1 has ten turns of No. 30 enameled wire wound on a varnished paper coil form having $\frac{1}{4}$ " outside diameter. Turns are spaced to fill 1" and then covered with three layers of electrical scotch tape. L_2 has one turn of enameled wire wound over scotch tape, and positioned over center of L_1 . T_1 is a converter transformer with a powdered-iron core, and a center frequency of 43.5 mc. All resistors in this circuit are of the non-inductive type.

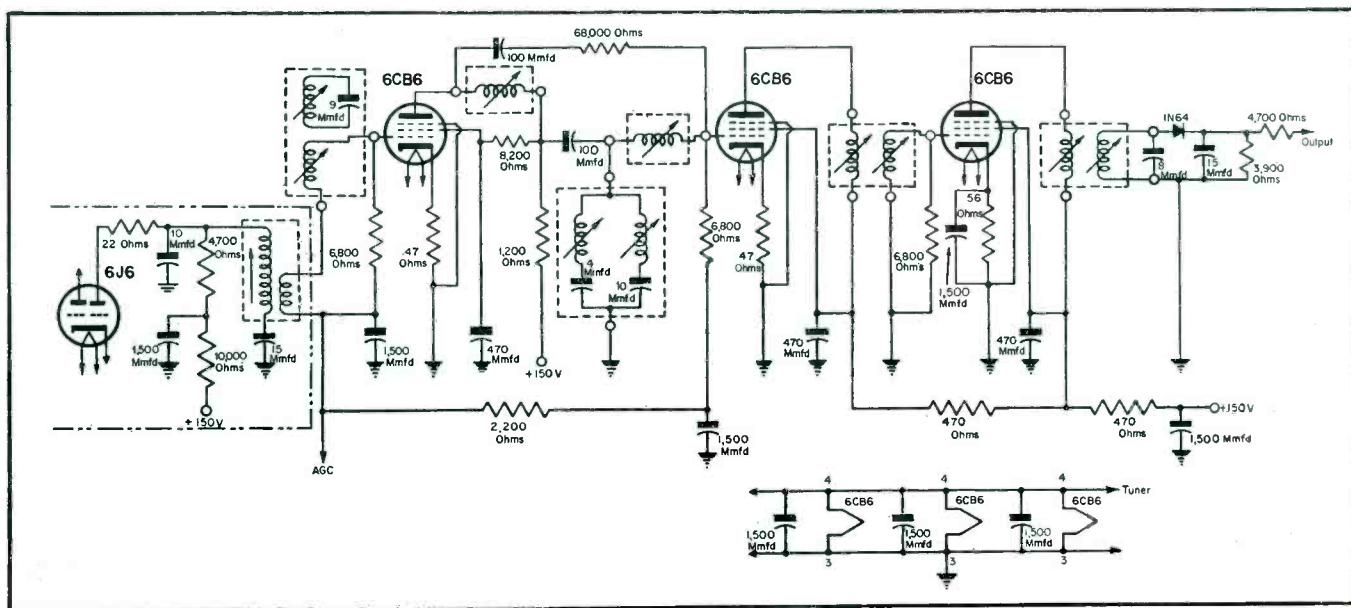



Comparing a printed-circuit *if* transformer and printed electronic circuit components. (Courtesy RCA)

to the converter transformer of a tuner to form a double-tuned circuit. The absorption trap is designed for attenuation of the adjacent picture-carrier signal.

Inductance Adjustments

Shunted by tube and stray capacitances, the inductance of the grid-circuit coil is adjusted by means of an upper screw disc accessible from the side of the shield can. This adjustment centers the overall response

curve at 43.5 mc. The absorption trap is tuned to 39.75 mc by means of the lower screw disc accessible from the side of the shield can. The inductance of this trap is shunted by a fixed capacitor.

Picture IF Coils

The *pc* tuned first picture-*if* coil, incorporated in the plate circuit of a 6CB6 amplifier, has been designed for use with a *pc* second picture-*if* grid-circuit coil and first and second picture-*if* filter traps to form a double-tuned, double-cutoff, M-derived filter section between the two 6CB6 amplifiers. The characteristics of this filter section are said to provide efficient coupling between first and second *if* stages, essentially flat-bandpass response, and proper attenuation of the accompanying sound and the adjacent-channel sound signals.

A tuned second picture-*if* coil employed in the grid circuit of a 6CB6 amplifier, is also used to form a double-tuned, double-cutoff, M-derived filter section between the two 6CB6s.

The first and second picture-*if* plate-circuit coils have a center frequency of 43 mc, and their inductance

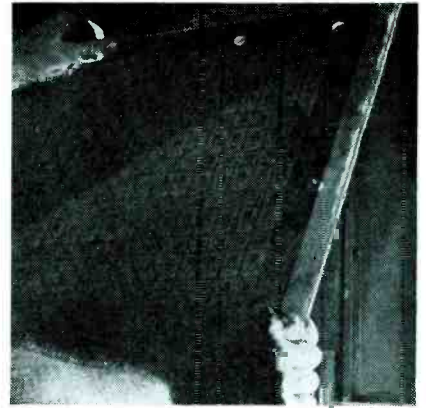

Giant glass negative used in production of printed circuit components. (Courtesy RCA)

is shunted by tube and stray capacitances.

Two separately-tuned *pc* first and second picture-*if* traps, also connected between the 6CB6s, tune to 41.25 and 47.25 mc to provide proper attenuation of the accompanying sound and the adjacent-channel sound signals, respectively.

Each trap coil of this *pc* component is connected in series with a fixed capacitor.

The *pc* double-tuned mutually-coupled second picture-*if* transformer, used between two 6CB6s, has a tuned primary and a tuned secondary wind-

(Continued on page 54)

Fig. 2. A 6-volt auto-radio circuit, using a *pc* audio coupling unit, and self-rectifying vibrator; Truetone 4C11.

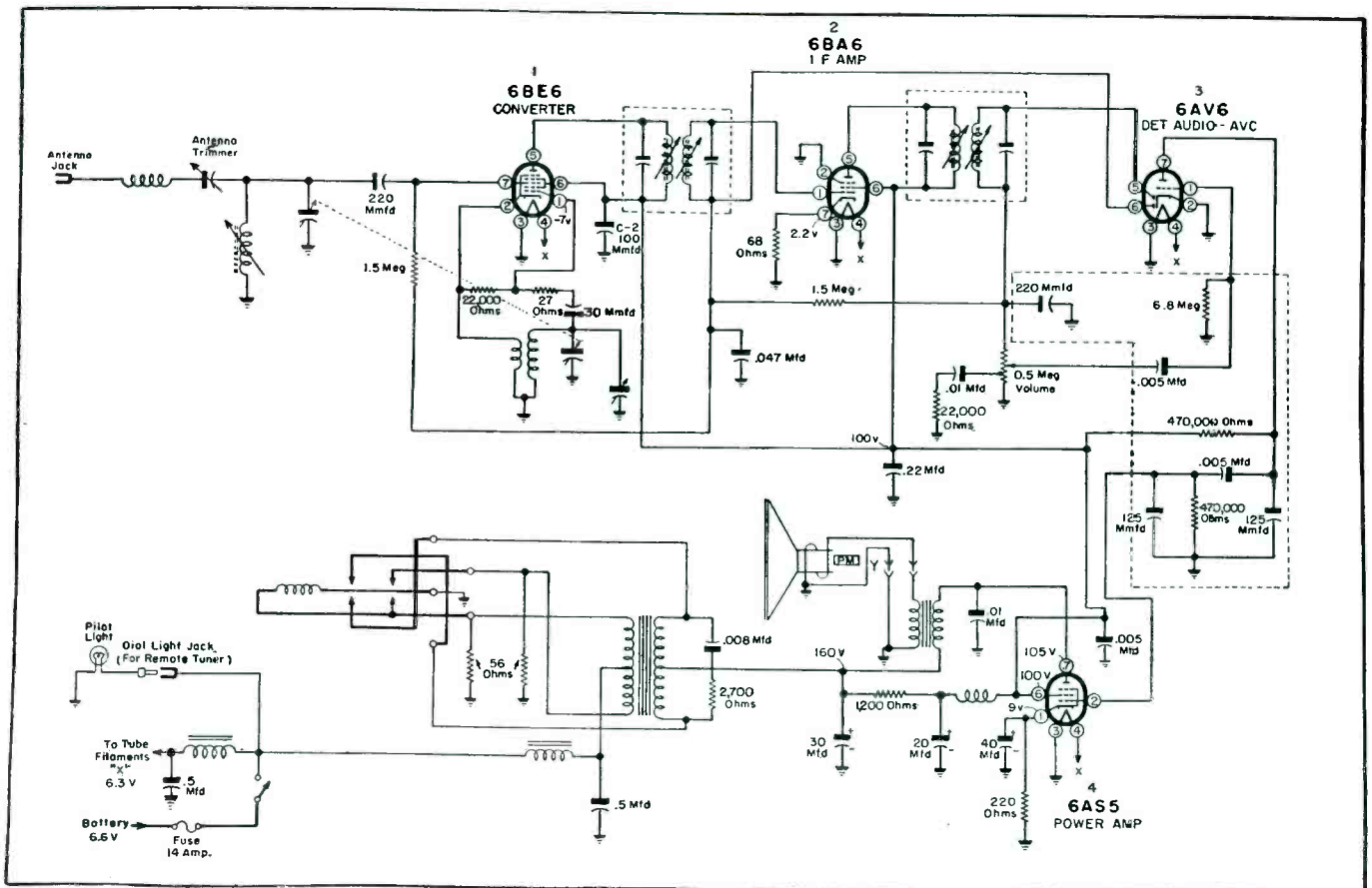

SPACE RESERVED!

for RCP TV "DO-ALL" Model 740A

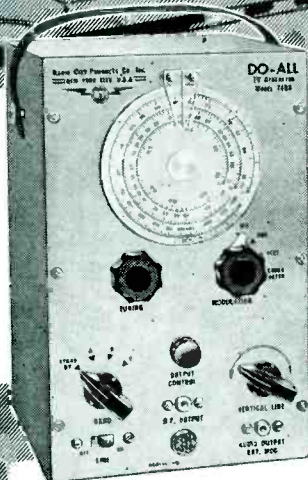
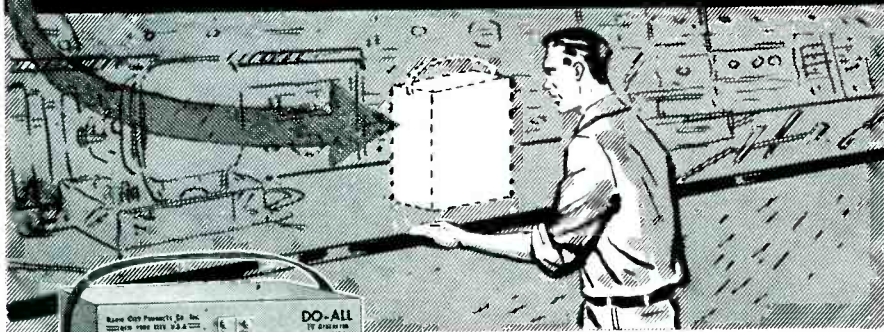

Because the Radio City Products Model 740A Fills the Need for a Fine TV Signal, Marker, Pattern "Do-All" Generator . . .

Within one test unit you have the servicing capacity of three. You need buy only the RCP Model 740A TV Generator to meet your TV and FM receiver servicing requirements. It's three times Better—because it's three instruments in one.

SIGNAL GENERATOR—Generates a modulated or unmodulated carrier signal covering every channel (VHF) and every IF band on any TV or FM receiver—ALL ON FUNDAMENTALS. 9 meg-220 meg. UHF Frequencies covered on harmonics. It will supply a 540 cycle audio signal at the audio output.

MARKER GENERATOR—Accurate to within 1/10 of 1% on 9-11 megacycle band, and better than 1/2 of 1% over-all. Perfect for alignment.

PATTERN GENERATOR—Produces

either horizontal or vertical bars or cross hatch.

Lightweight among Heavyweights . . . When the Model 740A last weighed in, it stood at 8 lbs.—fully knobbed. Designed for portable servicing functions . . . yet provides for the complete test and alignment of: front ends, IF's, horizontal and vertical linearity, syncs, sweeps, size, position, focus coil, deflection coil, ion trap. Smartly finished with brushed aluminum etched panel and dial, the Model 740A is 10" x 6" x 6". Complete, ready to operate. **\$6950** Net

Understand why so many servicemen agree that RCP is The Best For Test. Ask your local distributor for a copy of the latest Radio City Products Catalogue or write to us in care of Dept. S-6.

RADIO CITY PRODUCTS CO., INC.

152 WEST 25th STREET • NEW YORK 1, N. Y.



Ser-Cuits

(Continued from page 53)

ing. Windings are designed to center the response characteristics at 43.5 mc. Inductances of the primary and secondary windings are shunted by tube and stray capacitances and adjusted by screw discs.

Final Picture IF Transformer

Between the 6CB6 and 1N64 type crystal-diode detector, another double-

tuned, mutually-coupled picture-*if* transformer is used. The primary and secondary windings of this transformer are also separately tuned, and have a center frequency of 43.5 mc. Secondary inductance is shunted by a fixed capacitor and stray capacitances. The crystal-diode detector is usually shielded to minimize feedback.

PCs in Auto Radios

Auto radio designers have found *pc* coupling units excellent items, not only because they simplify layout and

wiring, but improve efficiency, too. A typical model using a *pc* couplate is illustrated in Fig. 2 (p. 53); Truetone 4C11. This is a 4-tube affair which features the use of a self-rectifying vibrator and a printed-circuit unit as an audio-coupling element.

Small Hall Audio

(Continued from page 31)

our belief, can most easily be obtained by the use of multiple speakers, properly phased, driven at a moderate level.

In some applications, it may be necessary to use a directional or cardioid microphone. This might be avoided by careful placement of speakers, and selection of operating levels. However, acoustical conditions of some buildings may compel the use of this type of mike.

Profit in Planning

The careful study of each job, and the application of correct engineering principles will insure a much better performing system, a much lower cost to the user, and more profit to the audio Service Man. It must be remembered, that once the basic system is installed, there is always the possibility of additional sales; the addition of more features to the system such as extension speakers, hearing aids, etc. These can be sold after the first cost of the system has been paid.

Audio

(Continued from page 43)



Dynamic microphone, said to have a 70 to 10,000 cps response; output level, 58 db below one volt/dyne/sq cm. Standard 3/8"-27 coupler swings microphone in 60° arc. Choice of 50, 200, 500 ohms or high impedance. Various switching arrangements available. (Model AD-4 95D; Turner Co.)

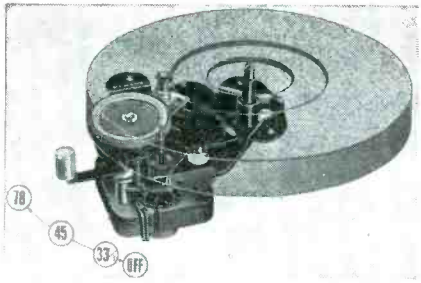

Above and below: Manually-operated three-speed phonomotors. Model above is 2-pole motor incorporating vertical idler shifting principle. Idler wheel drives the turntable directly from appropriate step on motor shaft. Moving shift lever to off position automatically disengages idler wheel from motor shaft during non-operating periods. Features include ribbed mounting plate, oilless bearing and dynamically-balanced rotor. Turntable shaft revolves with turntable and is grooved for turntable clip. Furnished with 8" turntable. Below is 4-pole motor type designed for hi-fi applications. Speed change is accomplished by vertical movement of idler wheel to appropriate diameter of motor shaft for desired turntable speed. Features include oilless motor and turntable bearings, and dynamically-balanced rotor. Furnished with 10" turntable. (Models SS and DSS; General Industries.)

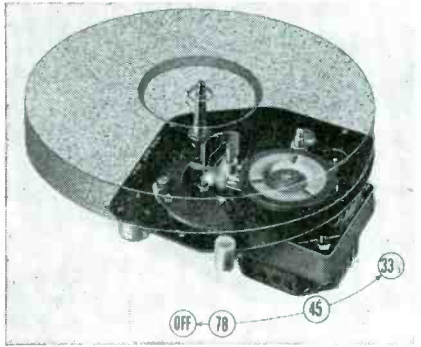

(Below)

A 2 1/2-ton electromagnet designed especially for magnetizing 10 1/2-pound pieces of Alnico V that serve as the permanent magnet in 15-inch hi-fi loudspeakers. Also serves to magnetize smaller units. The magnetizing unit consists of a steel yoke, supporting the two pole pieces, each one foot in diameter. Each of the pole pieces is wound with three coils, and each coil contains 1,450 turns of No. 12 cotton-enamel copper wire. There are approximately 700 pounds of copper in the coils. The complete assembly weighs slightly over 5,000 pounds. Special supports had to be built into the plant floor before it could be installed. Electromagnet is activated by a self-excited generator which supplies 50 amperes, at 300 volts to the coils. Activation of the electromagnet's coils is controlled by a photoelectric relay device. Electric eye is so placed that a loudspeaker passing through the magnet's gap interrupts the beam of light as the speaker approaches the center of the gap. That switches current into the coils. A time switch, which can be adjusted to different intervals, cuts the power off. Several tungsten bulbs and two heating coils have been wired into the circuit, in parallel with the magnet's coils, to absorb power surges and to bleed off residual current. (Stromberg-Carlson)

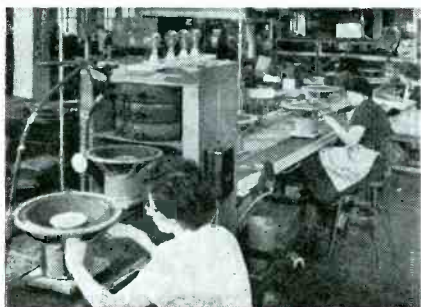

ATR

Makes it easy to
DEMONSTRATE and TEST
 D. C. apparatus from A. C. lines
 with "A" BATTERY
ELIMINATORS



for
**Demonstrating
 and Testing
 Auto
 Radios**

6 volt or
 12 volt!

See your jobber
 or write factory

New Models . . . Designed for testing
 D.C. Electrical Apparatus on Regular A.C. lines.
 Equipped with Full-Wave Dry Disc Type Rectifier,
 Assuring Noise-less, Interference-Free Oper-
 ation and Extreme Long Life and Reliability.
 ✓ NEW MODELS ✓ NEW DESIGNS ✓ NEW LITERATURE
 "A" Battery Eliminators, DC-AC
 Inverters, Auto Radio Vibrators



AMERICAN TELEVISION & RADIO Co.
 Quality Products Since 1931
 SAINT PAUL 1, MINNESOTA—U. S. A.

Service Engineering

field and shop notes

by THOMAS K. BEAMER

Two-Way FM Systems: Circuitry Used in Receiver and Transmitter Sections ... Plate-Voltage Supply Design Features

THE INSTALLATION, service and maintenance of two-way communication systems are particularly important items on a service-engineering schedule, in view of the continuous reliable performance the equipment must provide. A variety of special services, involving public safety, industrial operations, and emergency control depend on the operation of this gear; thus it must never falter.

Two-ways feature transmitter-receiver facilities, frequency-modulated. In one system,¹ providing for the use of any preselected frequency in the 30-50-mc band, adjacent-channel operation is available in a standard 40-kc channel. The transmitter has a 55-60 watt output, depending upon the frequency. The 60 watts from this transmitter are supplied by two 807s operated in parallel.

Transmitter Circuit

The transmitter employs a crystal oscillator stage, followed by two tripler stages, a doubler-driver, and a *pa* stage. An audio amplifier, limiter, and modulator are contained in the modulation circuits.

A crystal, ranging in frequency from 1.67 to 2.78 mc, is used in a Pierce oscillator circuit, the frequency of which may be varied $\pm .005\%$ by a 4-30 mmfd trimmer, C_{201} . This arrangement permits the stage to be set exactly on frequency. Output from a 6AK5 oscillator is used to drive two tripler stages, with a 6BH6 and 6AQ5. A 5763 doubler-driver and

power amplifier complete the *rf* stages of the transmitter. Frequency output of the power amplifier (the assigned frequency) is equal to 18 times the crystal fundamental.

A .25-megohm drive-control resistor, R_{210} , in the screen-grid circuit of the second tripler provides a means for adjusting the gain of this stage and, hence, the drive, through the 5763 double driver on the *pa* stage. Inductive coupling, between L_{207} and L_{208} , links the doubler-driver to the *pa* stage.

Modulation Circuits

Modulation circuits include a 6C4 audio amplifier, and 12AU7 limiter. Audio signals from the microphone are

applied through a preemphasis network, consisting of a 56-mmfd capacitor and 8.2-megohm resistor, to the grid of the audio amplifier. After amplification the signal is fed to grid 7 of the limiter tube. This tube functions as an instantaneous-acting positive-negative limiter, due to the use of a 1000-ohm common cathode resistor, in each of the triode sections. Section 1-2-3 of the limiter limits the output signal due to positive grid-voltage excursion on grid 7, while the other section, 6-7-8, limits the output signal due to negative grid-voltage changes. The limiting action is, therefore, accomplished on both the positive and negative halves of the cycle.

Deemphasis Network

The output from the limiter tube is fed through a deemphasis network, consisting of .022-mfd and .033-mfd capacitors, and a 250,000-ohm resistor, which, together with the preceding preemphasis, insures flat response over the operating range.

Action of the limiter restricts the range of the applied voltage to the phase modulator, preventing the modulation frequency swing from exceeding the specified 15-kc deviation at any audio modulating frequency. A pot, .25-megohm, in the output of the limiter stage, provides a means for

(Continued on page 80)

Impulse generator for *uhf* recommended for use as a calibrating standard on noise and field-intensity meters, or as a signal source for broad band distributed amplifiers. May also be used for bandwidth determinations, receiver alignment, noise figure measurement, transient response studies, and rapid gain checks on TV tuners (both *uhf* and *vhf*). Unit has a frequency spectrum of .01-1000 mc. (Model IC-115; Empire Devices Products Corp.)



(Right)
Fig. 1. Schematic of RCA CMV-3E1 30-50 mc two-way, with power output of 60 watts.

¹RCA Fleetfone, CMV-3E1.

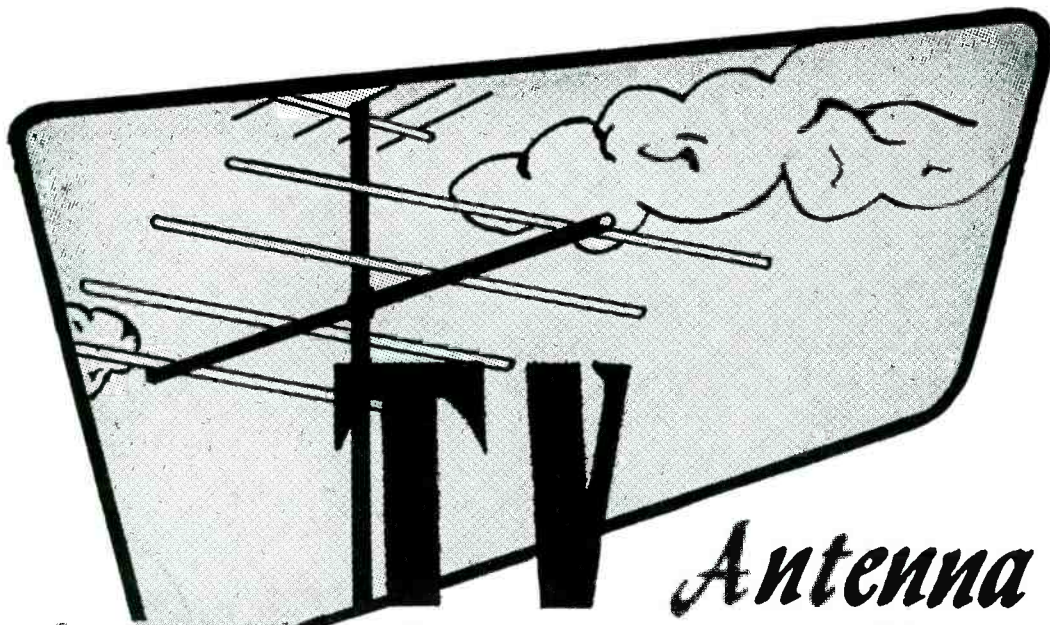

Antenna Digest

design.. application.. installation.. service

by RALPH G. PETERS

Highlights of Report on 850-Mc Reception Tests ... New Products for UHF and VHF: Antennas, Tuners Converters and Hardware Accessories

ON THE ULTRAHIGHS, many unusual terrain and atmospheric factors can affect the reliability of reception. It has been found for instance, that surface roughness plays a key role. Hills and valleys, buildings and trees, and even grass, farm crops and waves, can all control signals. Atmospheric complications, which include scattering, ducting and super-refraction, can vary field strengths.

To evaluate these problems and evolve solutions, two of the country's leading propagation experts, Jess Epstein and Donald W. Peterson,¹ initiated a series of exhaustive tests on 850-mc, about a year ago, using the 760-foot tower of WOR-TV located on the Palisades, just west of New

York City, as the transmitting point.

Reporting on their results,[‡] during a recent IRE meeting, they said four horizontally-polarized uni-directional antenna arrays designated as levels 1, 2, 3 and 4, were evenly spaced along the height of the tower. The transmitters were 10-watt, self-excited oscillators remotely controlled and mounted at the antennas to eliminate costly and lossy transmission lines. Because of the narrow vertical patterns of the antennas, it was noted, they were tilted vertically to enable measurement on pattern maxima. This was also done

Bowtie-flector antenna, with a wire-frame screen reflector. Features Bronzidite military-specified plating that is said to prevent rust and corrosion in non-aluminum parts. Provided in stacked models with balun matching transformers. (Model UHF611; JFD.)

by remote control, with selsyns to convey accurate angular position to the operator.

Field observations were made in a car in radio communication with the station operator. This mobile test van was equipped with a motor-driven, telescoping, 35' mast installed periscope fashion in the roof. The mast could be raised in 30 seconds, so that field strength versus height observations could be easily and quickly made.

The experts revealed that an interesting example of seasonal change of field distribution, from a third order

¹RCA Labs, RCA. [‡]From a paper on an experimental study of wave propagation at 850 mc, presented before the IRE Professional Group on Broadcast Transmission Systems, at the March, '53 meeting.

Broad-band yagi, said to cover the entire low band; channels 2 through 6. Model is a 10-element twin dipole design. Gain said to range from 7 to 8½ db single bay; and from 10 to 11 db for stacked array. Incorporates a Z-match impedance matching system. Antenna is boom-braced. Can be combined with high-band yagi (Model 1126; Channel Master.)

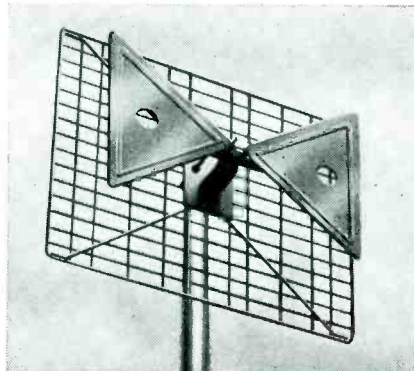
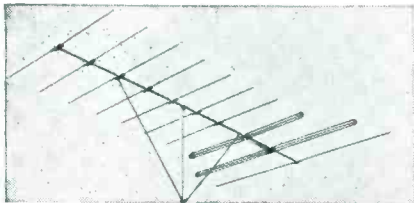

Bow-tie and reflector. Insulation is bakelite. Antenna measures 17" by 7"; reflector 20" by 11". Unit mounts on standard pipe with a single U clamp. (Single-element Tri-Fan (6688) and stacked array (two units and a phasing stub, 6689); Insuline.)

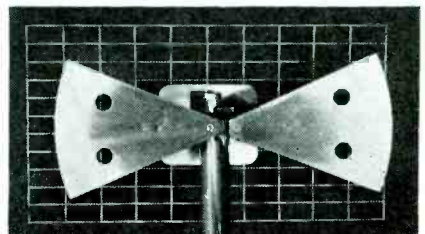

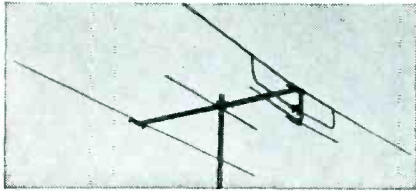

(Above): VHF antenna which features a forward resonator section, mid-band parasitic resonator and narrow beamwidth. (Below): UHF bowtie. (Models 904 and BT-178; Spiraling Products.)

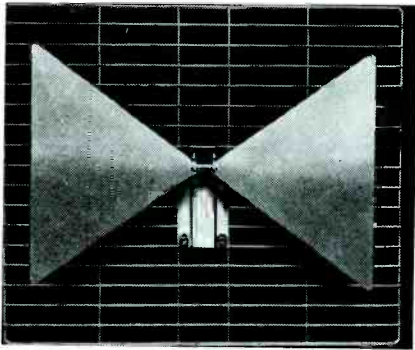

roughness effect, was found adjoining a corn field. The field strength versus height relations before and after harvesting the corn provided a significant pattern: Using a 26' antenna height, the field-strength intensity increased substantially after the corn was cut.

Two quite distinct reflection effects from objects beyond the receiving site are important, it was said. By far the most common is reflected signal from nearby buildings. This kind of reflected signal is almost always prominent in residential areas. It was pointed out that TV picture observations in residential areas confirm the fact that such reflected signals usually involve short enough path differences as to not seriously impair the picture. These reflected signals are usually quite constant with time, although seasonal variations of signal strength

(Continued on page 60)

Corner reflector which uses fiberglas booms said to permit the use of small diameter solid aluminum rod to prevent icing. Swing-open design. (Model Cor-U; Vee-D-X.)

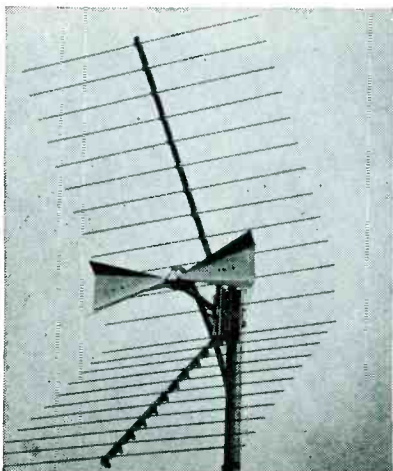

Here's the new **SHURE** **SLIM-X**

ALL-PURPOSE CRYSTAL MICROPHONE

Its Versatility and
"Hand-a-Bility" make
it an ideal low-
cost all-purpose
microphone!



MODEL 777
List Price \$18.95
MODEL 777s
(with switch)
List Price \$20.95
(Price includes cradle for mounting on stand)

LIGHT! The new "777" Slim-X Microphones are rugged little microphones weighing only 6 ounces! They are designed for good-quality voice and music reproduction. Their versatility and "hand-a-bility" make them ideal for use by lecturers, announcers, instructors, and Hams; for audience participation shows; carnivals; panel and quiz shows; and use with home-recorders. When mounted on either cradle or swivel, the "777" can be removed in a flash (no tools necessary)—simply by lifting it out of the holder. This makes it an ideal "walk-around" hand-held microphone.

TECHNICAL INFORMATION: Smooth frequency response—60 to 10,000 c.p.s.; special-sealed crystal element—for long operating life; high impedance; 7' single-conductor cable, disconnect type. Dimensions: (Microphone only) Length, 4½"; Diameter 1". *Finish:* Rich satin chrome overall.

NOTE: Lavalier cord for suspension of Microphone around neck is available (optional).

ACCESSORIES FOR "777"

MODEL 538 STAND is a heavy die-cast base. Includes metal screw machine stud for connecting microphone adaptor to stand base.

List Price: \$3.00

MODEL A25 SWIVEL ADAPTOR features a long-life, high-quality swivel connector. Is lined with a long-life nylon sleeve—for noise-free and scratch-free insertion and removal of microphone.

List Price: \$5.00

On 538 Desk Stand (With A25 Swivel)



On Floor Stand



On 538 Desk Stand



With Lavalier

SHURE

SHURE BROTHERS, Inc. ★ MANUFACTURERS of MICROPHONES and ACOUSTIC DEVICES

225 West Huron Street, Chicago 10, Illinois

• Cable Address: SHUREMICRO

SERVICE, JUNE, 1953 • 59



The SMART, NEW way to buy your C-D Seal-Vent Vibrators in the RE-USABLE Plastic Vibrator Kit

You get the re-usable plastic box FREE with the nine vibrators *

You get the best vibrator's money can buy *

You get in one purchase the 5 types that serve over 60% of the popular replacement requirements

Save time . . . with the convenient C-D VIBRATOR KIT that gives you 9 vibrators in 5 types PLUS a sturdy transparent plastic box with a hinged cover and dividers that has dozens of uses around the shop and at home. The assortment includes two 5300; two 5301; two 5326; two 5342 and one 5335 — all with the remarkable SEAL VENT that allows the vibrator to remain sealed until used and then vents itself automatically for "breathing" when put into use for even greater performance.

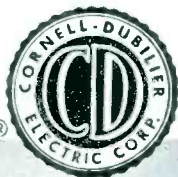

CONSISTENTLY DEPENDABLE

CORNELL-DUBILIER
SOUTH PLAINFIELD, NEW JERSEY



• CAPACITORS • ANTENNAS
• ROTORS • VIBRATORS • CONVERTERS

TV Antennas

(Continued from page 59)

may result from nearby reflections if foliage is involved as either reflector or obstacle. Standing-wave patterns from nearby reflecting objects can often be recognized. Reflected signals from hills beyond the receiving site also occur. Such reflected signals were observed where direct signals were very low because of shadowing loss. There were, it was noted, quite rapid variations with time and considerable vertical polarization, although

the signal source was horizontally polarized. The hills involved in the tests were wooded. Field strength recording along the radial line, in the presence of this kind of reflected signal, showed no standing wave where the average magnitude of reflected signal equalled the direct.

Analyzing the propagation of horizontally-polarized uhf waves, the specialists said that they are reflected by smooth earth. The reflection was likened to that which would be produced by a perfectly conducting surface. The

(Continued on page 79)

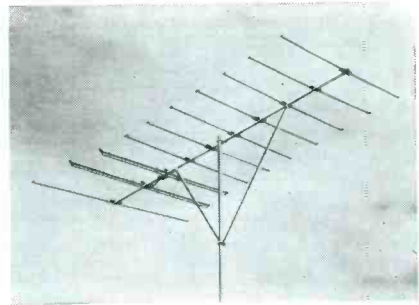

A 10-element cascade balun multi-channel yagi, which features two folded dipoles, a Y support that is said to make rigid connection between the mast and the cross-bar for extra resistance to vibration, and a set of matching transformers for stacking. Model weighs 12½ pounds, and is preassembled. (Model 10B26; JFD.)

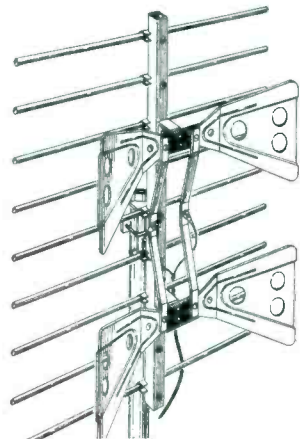

Stacked bow tie with screen reflector for uhf channels 14 to 83. Model provides completely pre-assembled, unitary array comprising two vertically stacked bow tie conical-V-beam dipoles with stacking bars, and a single screen reflector assembly. (Model 755; Telrex.)

Signal generator, which operates on fundamental frequencies, needing no harmonics to cover range of 54-950 mc. Covers 54-330 mc in first band and 300-950 mc in the second band. Generator is provided with a calibrated frequency dial, power output meter, calibrated output attenuator (waveguide beyond cut-off) and regulated power supply. Dial for the two rf ranges is calibrated in mc with accuracy claimed to be $\pm 2\%$. The rf output voltage is continuously variable over the range of 10 to 100,000 microvolts. Attenuator, which is calibrated in microvolts, is a capacitive waveguide beyond cut-off type, which is logarithmic. The output is said to be constant to ± 3 db of the graduated output reading. Band of 54-330 mc is covered in approximately 28 turns of the tuning control; 300-950 mc in approximately 11 turns. (Connecticut Telephone and Electric Corp.)

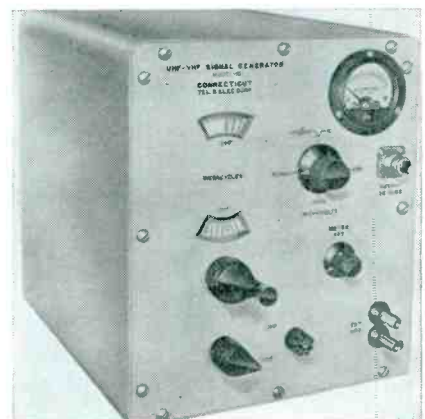

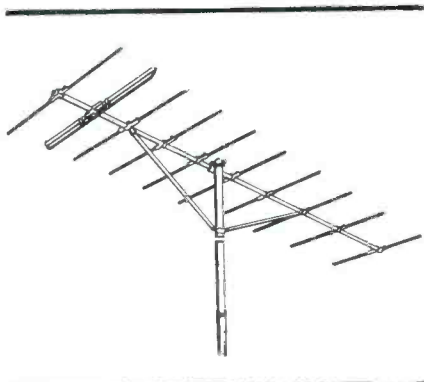

Pre-assembled, all-aluminum 10-element yagi for channels 2 through 6; in two section units, boom-braced. Unit for channels 7 to 13 designed as one-piece. Available stacked with 1/2-wave stacking kits. (RockeTenna; TV Products.)

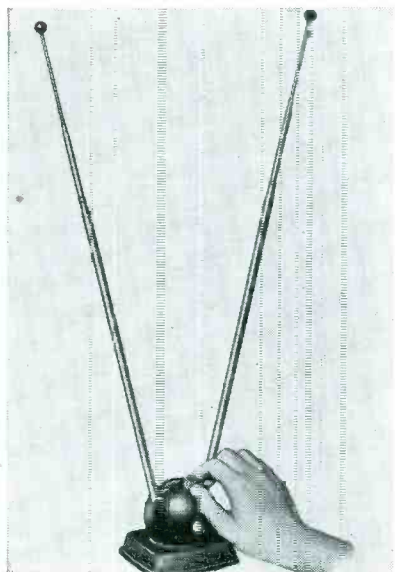

Tunable indoor TV antenna, featuring single knob tuning. Has 3-section telescoping elements. Said to include continuous tuned circuit designed to resonate at desired channel. Plastic ball at bottom recessed into a low symmetrical heavy base. Design is claimed to lower the unit's center of gravity so that it is stable against tipping. (Model SV-T3; RMS.)

Lead-in wall plate socket. Mounts flush on wall or baseboard. Available in brown or ivory molded polystyrene and supplied with mounting wood screws. (F-2; Mosley Electronics, Inc.)



FIRST...
FOR MORE THAN FIFTY
YEARS WITH AMERICA'S
BEST SERVICEMEN...

American Beauty

ELECTRIC SOLDERING IRONS

Since 1894, longer than any other make, American Beauty Soldering Irons have been giving servicemen TOP SOLDERING PERFORMANCE . . . because of these features . . .

- Nickel-coated, corrosion-resistant tips, easily and quickly replaced
- Super-flexible cord, American Beauty made, resists wear due to flexing
- Heating element of chrome-nickel ribbon resistance wire
- Insulated with pure mica
- Built-in adapter for ground wire



*Build Better with Solder—
 Solder Better with
 AMERICAN BEAUTY
 Soldering Irons*

A-101 Write For Free Literature

AMERICAN ELECTRICAL HEATER COMPANY
DETROIT 2, MICHIGAN

see

the **UHF VHF**
AMPHENOL
television
antenna story

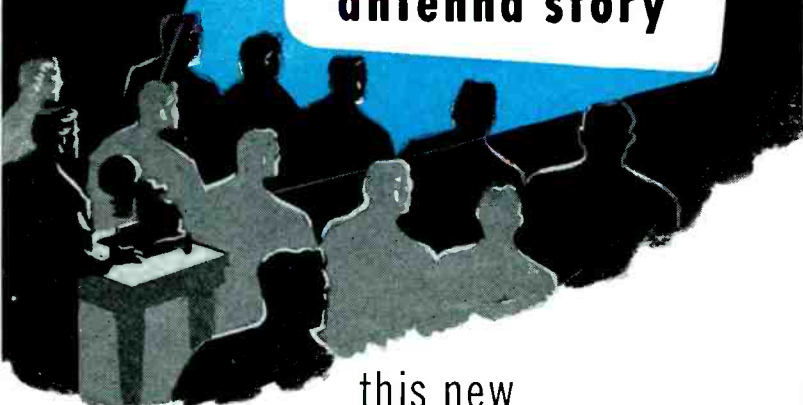

this new
AMPHENOL FILM presentation

Previewed by your distributors at the May Electronics Parts Show in Chicago, a new AMPHENOL film, "The UHF-VHF Television Antenna Story," will soon be available for showing to servicemen and dealers. Your jobbers thought it so good (they found its information on UHF particularly helpful) that AMPHENOL is making it available for wider distribution. Besides reviewing VHF transmission and antenna characteristics, the film clears up a great deal of the current confusion on UHF; answers questions that will be asked of you. Given special attention in this factual presentation are the many different UHF antenna types: Rhombic, Yagi, Corner Reflector, Bo-TY and Stacked-V. The sometimes puzzling behavior of UHF signals is illustrated and discussed.

★ For complete information on UHF as well as VHF be sure and contact your distributor and arrange to see "The UHF-VHF Television Antenna Story." ★



★ AMERICAN PHENOLIC CORPORATION
chicago 50, illinois ★

The Hi-Fi Market*

by C. K. STERLING

THE PAST FEW YEARS have seen a rapid growth in the number of people who have become more conscious of the striking quality of wide-range reproduction. As a result, they have become extremely critical in their listening habits, seeking only those audio systems which can insure truly sound-dimensional results; an interest which has created a spectacular upsurge in the *hi-fi* industry.

Service Men have found that they can play a major role in this growing market, serving prospects everywhere . . . among those who have heard about *hi-fi*, as well as the many who have to be sold on the new idea in reproduction . . . through demonstrations.

Such demonstrations are most effective in rooms which simulate the home atmosphere, and feature the necessary acoustical treatment through placement of speakers, furniture, drapes, rugs, and other accessories.

Customers who bring in old sets for repairs will be found particularly vulnerable to this new mode in reception. They can be invited to sit in the salon audio room and listen to reproduction from the old radio model and new *hi-fi* equipment. They will hear highs and lows, that will fascinate and intrigue them.

Many will ask for a complete packaged assembly, tailor-made for the layout of the home, an ideal assignment for the Service Man. Not only can he arrange to install the system but maintain the equipment to assure the high standard of performance for which it was originally designed.

The wide awake Service Man will find unlimited potential in this new field. The average set owner will be found very receptive to the idea of better reception, through the use of *hi-fi* equipment, which includes specially-designed tuners, and amplifiers.

To provide such quality performance, one series of tuners¹ have been provided with temperature compensated oscillators for minimum station drift, and equalizers for correcting variations in recording characteristics. For fringe area reception, an *afc* control has been located on the front panel, for in and out switching, at will. A handsome bronze-finished front plate, also included, lends itself to a wide variety of custom installations; the front portion can be readily dismounted and replaced as an escutcheon on the cabinet.

Hi-fi amplifiers² in this line follow the famous Williamson circuit.

In *hi-fi* audio the Service Man has an outstanding business-builder, for sales, service and maintenance, too.

*Based on notes prepared by James I. Benjamin, Pilot Radio sales manager. ¹Models AF-723 and AF-723 Pilot-tuners. ²Model AA-901 Pilotone amplifier.



'Scope Modifications †

by RONALD L. IVES

To ELIMINATE HUM in 'scope work, shielding is helpful, if the correct amount is used and in the right place.

Placement of shields in 'scope is usually determined by experiment. A conveniently-sized piece of sheet iron, with a good electrical ground, should be moved around the 'scope interior until a location is found where the hum is at a minimum. Then a permanent shield can be installed, care being taken that the mechanical mounting is rigid, and that it is effectively grounded.

Leads can be effectively shielded by use of short lengths of spring curtain rod, slipped over the wire and insulated at the ends. These shields should be grounded in only one place to eliminate ground loops and reduce circulating currents.

When a magnetic field impinges upon the *crt*, rather typical distortions of the patterns occur, usually indicating the source of the field. The best cure for this trouble is a high-permeability *crt* shield. Although good *crt* shields are somewhat expensive, they are very effective trouble eliminators. The magnetic shield should be effectively grounded somewhere near the base of the tube, and electrically insulated from all other metal in the 'scope.

In rare instances, with modern 'scopes, hum may be introduced by a vibrating transformer or choke core or winding. If tightening of the core bolts does not eliminate the hum, a new transformer or choke is the cheapest remedy. Transformers and chokes can be very effectively silenced by soaking them for 24 hours in diluted *glyptal* and then drying them at a temperature of about 140° for a fairly long period, such as 60 hours. All interior *glyptal* must be dried hard before any *ac* is applied to the windings, if this cure is to be effective.

A 'scope, to be a useful field instrument, must work in the field. If it fails on the job, the profit from that job is probably wiped out. And few industrial users of electronic equipment will place much confidence in a Service Man who can't keep his own test equipment working.

To minimize 'scope failures in the field, a definite program of preventive maintenance is in order, but this program need not be either complex or time-consuming. A routine check of the instrument before going on the job is desirable. Replacement of all minor components and accessories that show signs of wear should be made promptly. It is wise, for instance, not to wait until the test leads break before ordering a new set.

Checking of all tubes every 100 hours of operation, or after each 1,000 miles of travel, and replacements of any tubes that are weak, gassy, or loose in their bases, even though they still work after a fashion, is good practice. Some Service Men find that use of *premium** tubes, is good insurance against on-the-job instrument failures, despite their higher cost.

'Scope modifications should be made cautiously, and should be made only when there is a definite and continuing need for the added function or refinement. Desired additions or refinements should be tested on a breadboard before their incorporation into the instrument, and great care should be taken in the final installation, so that the new work does not produce overall instability, and does not impair any standard function of the instrument.

†Concluding installment.

*RCA Rey type; G. E. Arine.

starred in

AMPHENOL

the **UHF VHF**
AMPHENOL
television
antenna story

AMPHENOL UHF antennas featured in AMPHENOL'S film, shown at the May Parts Show, were these:

BO-TY (with reflector) An efficient performer on all channels, 14 to 83. Signal gains of 5½ to 8 DB. An excellent major-area antenna for locations troubled with reflections.

YAGI Best for extremely high gain over a specific group of channels. Single forward lobe and high efficiency make it ideal for fringe areas. Gives high gain of 10 DB.

CORNER REFLECTOR Designed for high gain over all UHF channels. Ascending signal gain of 7.8 DB to 13 DB across UHF channels makes it especially desirable for low signal areas.

RHOMBIC Provides narrow horizontal directivity over all UHF channels. Excellent for areas of medium signal intensity because of good signal gain from 6.2 DB to 13.8 DB.

STACKED-V For all channels, VHF or UHF, 2 to 83. Seamless aluminum tubing elements can be adjusted to different angles for VHF signals, UHF signals, or both.

and shown also,
the dependable VHF performer

INLINE* Leading the field for over four years! Unique **INLINE** design assures constant fine reception. Maximum broadband gain over all channels and excellent impedance match.

*Reissue Pat. No. 23,273

AMPHENOL Antennas = best reception for UHF or VHF

AMPHENOL

AMERICAN PHENOLIC CORPORATION
chicago 50, illinois

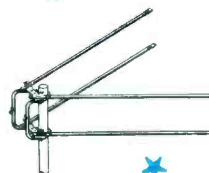
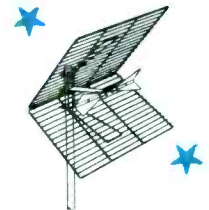
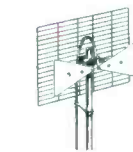

—INLINE—



Thousands depend on PHOTOFACT! THEY TELL YOU WHY

Unsolicited letters tell what the world's finest TV and Radio Data means to Service Technicians



R. W. Fairbanks
Radio-TV Service
64 W. Colorado St.
Pasadena, Calif.

"I find your manuals are 'right on the button' and are the best I have been able to get hold of yet . . . Needless to say, I couldn't do without your time-saving PHOTOFACTS, Manuals and Tube Guides."



W. W. Bryan
810-24th St.
Vienna, W. Va.

"I think that the PHOTOFACT system is the greatest help to service men that has ever been on the market. I want to have every set that comes out."



William J. Levy
Radio & TV Service
3935 N. Eighth St.
Philadelphia, Pa.

"I wouldn't think of servicing a radio or television receiver without one of your PHOTOFACT Folders. Your Folders are the most detailed servicing data on the market. I am a steady user of PHOTOFACT and intend to remain so."

NOW! GET THE PROOF FOR YOURSELF!

FREE

We'll send you a Free Photofact Folder on any receiver covered in Sets No. 101 and following

Learn for yourself—at our expense—how PHOTOFACT pays for itself by earning bigger profits for you! Select any Folder appearing in PHOTOFACT Sets Nos. 101 and following, from the PF Index. (If you haven't a copy, see your distributor.) When you write for your Free Folder, be sure to state Photofact Set and Folder Number as shown in the Index (offer limited to Folders in sets subsequent to No. 101). Get your Free Folder now. Examine, use, compare—see why PHOTOFACT belongs in your shop!

HOWARD W. SAMS & CO., INC.
2207 E. 46th St., Indianapolis 5, Ind.

HOWARD W. SAMS & CO., INC.

PERSONNEL



LEO G. SANDS, who recently resigned as president of Bougue Railway Equipment division, has been appointed sales manager of the Langevin Manufacturing Corp., 37 W. 65th St., New York 23, N. Y. Sands was formerly with Bendix.



Leo G. Sands



Jerry Kirschbaum

JERRY KIRSCHBAUM, vice president of Precision Apparatus Corp., has been elected president of the eastern division of the Sales Managers Club. Others elected include: BOB FERREE, distributor sales manager at IRC, vice president; WALTER JABLON, vice president at Bogen, secretary-treasurer; B. L. CAHN, Insuline vice president, director to executive board-show, and VIN UHLRICH, National Union renewable tube sales manager, to the executive board of the show group.

* * *

JACOB RUITER, JR., DuMont ad manager, has been elected president of Industrial Marketers of N. J., a chapter of the National Industrial Advertisers Association.



Jacob Ruiter



Dr. C. S. Szegho

DR. C. S. SZEGHO has been appointed vice president in charge of research for The Rauland Corp., 4245 N. Knox Ave., Chicago 41, Ill.

* * *

WALLACE E. ST. VRAIN, formerly chief engineer for KXLW, has been appointed chief engineer of Mosley Electronics, Inc., 8622 St. Charles Rock Rd., St. Louis 14, Mo.

* * *

DONALD H. KUNSMAN has been elected a vice president of the RCA Service Co., Camden, N. J. Kunsman will be in charge of the consumer products service division.

* * *

JOHN J. MUCHE, chairman of the board of Clarostat Manufacturing Co., died recently. . . . EDWIN I. GUTHMAN, head of Edwin I. Guthman Co., coil manufacturers, has passed away. . . . VICE ADMIRAL CARL F. HOLDEN (USN Ret.), president of the Federal Telecommunication Labs, Inc., died recently.

* * *

GARRARD MOUNTJOY is now with American Radio-Television, Inc., Little Rock, Ark., as assistant to the vice president.

a Drop of Magic



Silencer

An Amazing Permanent Protective Film

which will

- Instantly clean and remove rust from controls, bandswitches, tuner assemblies, etc
- Lubricate and Silence all moving parts
- Leave a protective coating which will last indefinitely

Silencer is not an oil that gums controls or changes capacity. As a cleaner it is 100 times more effective than carbon tetrachloride.

3 Full Oz.
(not 2 oz.)



Available in Quart and Gallon sizes.

Tell your Distributor you want Silencer

Illinois

RESEARCH LABORATORIES

22 W. Madison St.
Chicago 2, Illinois

RADELCO

INDOOR ANTENNA

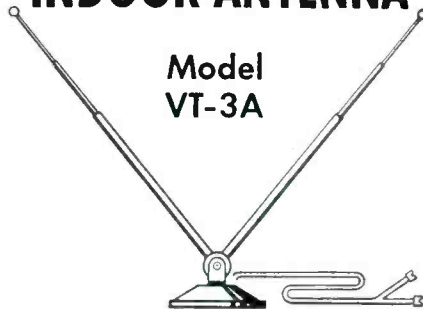

Model
VT-3A

. . . A high quality antenna, attractively designed and finished in mahogany lacquer to harmonize with all room furnishings. Three section, brass tubing masts with lustrous plate finish extend to 45" for fine reception. Heavily weighted base. Lead and terminals included. A real value!

ORDER FROM YOUR
NEAREST PARTS JOBBER

LIST PRICE

\$375

DON G. MITCHELL has been elected chairman of the board of directors, and H. WARD ZIMMER president, of Sylvania Electric Products, Inc. WALTER R. SEIBERT has been elected treasurer, and LEON C. GUEST, JR., controller. . . . D. W. GUNN has been appointed assistant general sales manager, radio tube and TV picture-tube sales.



Don G. Mitchell



Ward Zimmer

WALTER J. BROCK has been named mid-west sales manager for CBS-Hytron, Danvers, Mass.



W. J. Brock



Al Friedman

AL FRIEDMAN, vice-president in charge of sales, has been elected a director of Olympic Radio & Television, Inc. Friedman joined Olympic in April, '47, as sales manager.

* * *

HARRY SILVERSTEIN has been elected president of Vaco Products Co., filling the vacancy left by the death of C. D. Pettingell, co-founder of the Chicago concern. . . . ALVIN E. SHUGARMAN, former vice president, has been named executive vice president, and JAMES T. PETTINGELL has been elected vice president.



Harry Silverstein



D. B. Tolins, Jr.

DAVID B. TOLINS, JR., formerly with Rocke International Corp., has been named publicity director of the JFD Manufacturing Co., Inc., Brooklyn, N. Y.

* * *

WALTER J. JONAS has been elected vice president in charge of production of Radio City Products Co. of Pennsylvania. . . . MURRAY MICALOWSKY, formerly with Sperry Gyroscope Co., has been named development engineer, and WILLIAM Ziegler, recently associated with DeMornay Budd Inc., has been appointed junior engineer.

* * *

JOHN MACKEY, reported in the April issue to have been named general manager of Alprodeco, Inc., Mineral Wells, Texas, was appointed general manager of Alprodeco, Inc., Kempton, Ind.

here's a versatile **NEW**

WEBSTER ELECTRIC® Featheride

2-needle Replacement Cartridge

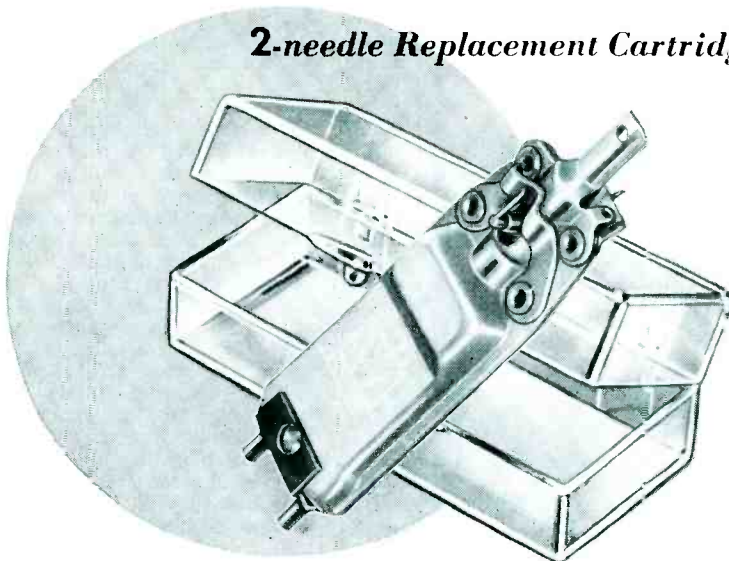

Model FX for twist mechanisms
high or low output

The new Model FX Featheride is a lightweight, two-needle crystal cartridge especially designed for replacement installation in WEBSTER ELECTRIC and other twist mechanisms. Although furnished as a high-output cartridge, each Model FX is provided with a shunting capacitor for adaptation to low-output applications. Model FX—complete with needles, capacitor, spacers and installation instructions—comes packed in a handsome, useful clear-plastic box for protection during shipping and handling.

application:

specifications and data

a two-needle model for 33 1/3, 45 and 78 RPM records.

output (1000 CPS):

without capacitor, 4.4 volts at 78 RPM, 2.6 volts at 33 1/3 RPM; with capacitor, 1.2 volts at 78 RPM, 0.6 volt at 33 1/3 RPM.

tracking pressure:

12 grams.

cut-off frequency:

3500 CPS.

needles:

one 1-mil osmium, one 3-mil osmium, furnished. Push-in needles are held in friction-type chucks.

SEND FOR NEW REPLACEMENT CHART

Our new Featheride Replacement Chart YF-2 gives full information on how just five Featheride models fill virtually every cartridge-replacement need. Mail coupon for your copy.

Webster Electric Co., Dept. 5-6, Racine, Wisconsin

Without obligation, send Featheride Replacement Chart YF-2

Name _____

Address _____

City _____ Zone _____ State _____

WEBSTER ELECTRIC
RACINE WISCONSIN

"Where Quality is a Responsibility and Fair Dealing an Obligation"

WEBSTER ELECTRIC COMPANY, RACINE, WISCONSIN • EST. 1909

Columbia

The Improved Deluxe TELEVISION Service Light!



HANDIER THAN A FLASHLIGHT!

Now . . . with complete swivel for better lighting and easier servicing!

EVERY SERVICEMAN, experimenter, model-maker, needs this handy item. No need to work in the dark . . . ample light is provided by a 7½ watt, 110 volt bulb that remains cool at all times.

Scientifically-designed, unbreakable aluminum reflector directs maximum light to point of work . . . A REAL TIME AND LABOR SAVER.

CARRIED BY LEADING JOBBERS!

Have you seen our other TV service aids . . . "TV Service Cord" and "TV Picture Tube Extension Cable"?

We manufacture cord sets and cables to government and civilian specifications.

Columbia

WIRE & SUPPLY CO.

2850 Irving Park Road • Chicago 18, Ill.

"National distributors and warehouse for ANACONDA denshath television and radio wires and cables"

Rep Talk

FRANK B. KOESSLER, formerly in charge of the sound equipment division of Neely Enterprises, has established the Koessler Sales Co., specializing in hi-fi audio, and will cover California, Arizona and Nevada. Koessler plans to take over all audio accounts formerly handled by Neely Enterprises, including American Elite, Inc., American Microphone Co., James B. Lansing Sound, Inc., McIntosh Laboratory, Inc., Magnecord, Inc., Minifon Corp. of America, Reeves Soundcraft Corp., Thorens Co. and Weathers Industries. Neely will hereafter devote his complete facilities to electronic instrumentation and industrial control activities. . . . *G. S. Marshall Co.*, Pasadena, Calif., has announced the formation of an instrument division with *Dr. Walter East* in charge. Company has been appointed rep for Radiation, Inc. . . . *D. R. Bittan Co.*, 53 Park Place, New York 7, N. Y., has been named rep for Middletown Manufacturing Co., in metropolitan New York. . . . *Frank A. Emmet Co.*, 2837 W. Pico Blvd., Los Angeles, Calif., has re-occupied all of its own building which formerly was used for manufacturing. *John Giltner Twist*, formerly general sales manager of Sangamo Electric Co., has been appointed a sales rep for Radell Corp. in Wisconsin and Illinois. . . . *Max Goldfinger*, Rutherford, N. J., has been named a company sales rep for South River Metal Products Co., Inc., in New York City, Long Island, southern New York State and northern New Jersey. *Martin L. Roth*, who formerly covered this territory, is now responsible for all sales promotional activities of the company. . . . *Sam L. Spraggins*, 373 South Robertson Blvd., Beverly Hills, Calif., has been appointed West Coast sales rep for the National Union Radio Corp., and will handle industrial and initial equipment accounts. Spraggins was formerly vice president and member of the board of directors of the Hoffman Radio Corp. . . . *J. E. Joyner, Jr.*, P. O. Box 341, Station A, Atlanta, Ga. (Alabama, Georgia, Tennessee, North and South Carolina and Mississippi), and *Dick Hyde Co.*, 3250 S. Dexter St., Denver 20, Colo. (Colorado, Utah, Wyoming, New Mexico, Montana and Idaho), have been appointed reps for The National Co. . . . *Neal Bear Corp.*, West Richfield, O., has been appointed Ohio rep for Littelfuse, Inc.

(Continued on page 67)



Frank B. Koessler
J. G. Twist



Norm Neely
Max Goldfinger



Introducing The New HUSH Jr. KIT SERVICER

The Amazing, New TV-Tuner Cleaner That Sprays On!

The new, "handy" size for TV and Radio Service Men to pack right along in their tube kits. So convenient on home service calls.

HUSH Jr. KIT SERVICER—\$1.25
2-ounce bottle, complete with 24 karat gold plate spray attachment.
8-ounce refill bottle only \$1.95

HUSH is made by the manufacturers of EVER QUIET—for volume controls—contact restorer.

EVER KLEER—for cleaning and keeping TV tubes clean.

Ask your local distributor for HUSH or write:

CHEMICAL ELECTRONIC ENGINEERING, INC.
283 Main St. Matawan, N. J.

HICKOK

Model 650

VIDEO GENERATOR

Does in minutes many TV Service Jobs that normally take hours by usual methods.

Ask for a demonstration at your nearest Jobbers' . . . or write today for descriptive literature.

THE HICKOK ELECTRICAL INSTRUMENT CO.
10521 Dupont Avenue, Cleveland 8, Ohio

On Book Row

TV SERVICING SHORT CUTS . . . BY MILTON S. KIVER: Actual case histories, based on experiences of service groups and the author, appear in this book (paper-bound) to help the TV service man sharpen his servicing techniques. Symptoms or clues are presented, conclusions that can be drawn are noted, and the manner in which the defect can be tracked down are provided. Many models of various manufacturers are covered.—95 pages priced at \$1.50; Howard W. Sams and Co., Inc., 2207 E. 46th St., Indianapolis 5, Ind.

* * *

SOUND REPRODUCTION (REVISED) . . . BY G. A. BRIGGS: In this, the third edition, the behavior of sound as influenced by loudspeakers, cabinets and room conditions, are introduced. Author covers such subjects as: high-fidelity; room acoustics; cone resonance; resonators; vented enclosures; transient response; response curves by 'scope; the ear; interference; magnetic recording; recording technique; pickups; and home recording. A question and answer section is also included.—368 pages; Available from British Industries Corp., 164 Duane St., New York 13, N. Y.

* * *

TV MANUFACTURERS' RECEIVER TROUBLE CURES . . . VOLUME 3 . . . EDITED BY MILTON S. SNITZER: Specific receiver troubles and their cures are covered in this new edition. The following manufacturers are represented: Kaye-Halbert; Kent; Magnavox; Majestic; Meck; Mercury; Midwest; Montgomery Ward; Motorola; Muntz; National; North American Philips; Olympic; Pacific Mercury; Packard-Bell, and Philco.—Paper bound, 119 pages, priced at \$1.80; John F. Rider Publisher, Inc., 480 Canal St., New York 13, N. Y.

* * *

UHF ANTENNAS, CONVERTERS AND TUNERS . . . BY MILTON S. KIVER: A comprehensive study of *uhf* design and application. In five sections, the author analyzes *uhf* antennas, transmission lines and matching networks, *uhf* installation practices, and *uhf* converters and tuners.—134 pages, priced at \$1.50; Howard W. Sams and Co., Inc.

* * *

WIRELESS AND ELECTRICAL TRADER YEAR BOOK . . . 1953 EDITION: A valuable year book, which features condensed specifications of current British commercial TV receivers, including facts on tubes used, *if* values, etc., and information on tube and picture-tube base connections with over 200 tube-base diagrams. Also listed are sources of supply in Great Britain.—264 pages; Trader Publishing Co., Ltd., Dorset House Stamford St., London SE 1, England.

Rep Talk

(Continued from page 66)

. . . Milton R. Benjamin, 1740 E. 47th St., Brooklyn, N. Y. (New England states and New York, except Westchester county and metropolitan New York City), and Lawrence-Elliott Co., 2011 Fairmount Blvd., Cleveland, O. (Ohio, Kentucky, Michigan and Indiana), have been named reps for the Continental Electronics Corp. . . . Ellinger Sales Co., 6540 Northwest

Highway, Chicago 31, Ill. (Illinois and Wisconsin); Joe Clancy and Co., Wilder Rd., Angulo, Ind. (Indiana and Kentucky); Merrill Franklin Co., 338 E. Franklin Ave., Minneapolis 4, Minn. (North and South Dakota and Minneapolis proper), have been appointed reps for the Oxford Electric Co. V. E. Wolland has been named manager of distributor and export sales for Oxford. . . . Sydney Wimble, Rockbar Corp., and Lee Roche, Newhope Corp., were accepted as senior members in the New York chapter of The Reps. George B. Brown and Louis Rabitaille were accepted as assistant members. . . . Richard Parker has been named distributor salesman for upper New York state for CBS-Hytron. . . . Among the reps to visit the Dover, New Hampshire, Clarostat factory re-

cently have been Leon Adelman, New York City; Leonard D. Allen, Syracuse, N. Y.; J. M. Cartwright, Tennessee; Bruce Cumming, Chicago, Ill.; Harry Gawler, New Jersey; John Olsen, Cleveland, Ohio; Clarence Henderson, Upper Darby, Penna.; James N. Dietrich, Pittsburgh, Penna.; Marvin Nulsen, Indianapolis, Ind.; Jack Perlmutz, Los Angeles, Calif.; W. L. Roth, New York City; Henry Sarkis, Chicago, Ill.; Henry Segal, Boston, Mass.; Samuel Stroum, Seattle, Washington; and A. J. Warner, Minneapolis, Minn. . . . G-F Sales Co., headed by Harry Goldman and William Feder, 120-88 Queens Blvd., N. Y., will represent Hudson Electronics Corp., 110 E. Third Street, Mt. Vernon, in the five boroughs of New York and Westchester County.

STOP BLACK BORDERS ON TV PICTURE

use a
"B" Plus Booster
Model 5TV4 Replaces 5U4G



NO SIDE BORDER



NO TOP-BOTTOM BORDER



NO ALL 'ROUND BORDER

Anytime!

**Pulling a Tube beats
Pulling a Chassis**

WHEN YOU NEED • More Height • More Width
• More Gain • Better Overall Performance

Built-in Time Delay to Protect TV Set

**Sold Through Authorized Distributors
Only. List Price \$6.60.**

**THE
5TV4
GETS RESULTS**

- SUPPLIES EXTRA 30-40 VOLTS TO LOW VOLTAGE SUPPLY
- GIVES FULL SIZE PICTURE WHEN LOW LINE VOLTAGE OR WEAK TUBES CUT PICTURE SIZE.
- GIVES EXTRA GAIN NEEDED IN FRINGE AREA



STANDARD R.T.M.A. GUARANTEE
PAT. APPLIED FOR

**WORKMAN
TV**

TEANECK, NEW JERSEY

are you
**BURNED
UP?**



**TRIAD
DEFLECTION
YOKES**
will cool
you off



If you are tired of blasting cooked yokes off of picture tubes—then switch to Triad Deflection Yokes. They have a molded high-temperature plastic insulation between vertical and horizontal coils, reducing chances of cooking and simplifying servicing. Triad's new 1953 Catalog features 18 new items which have been added to an extensive line of TV replacements—every item designed for long trouble-free service, and to ease and speed the serviceman's job.

Write for Catalogs TR-53C and TV-53C



CATALOGS, BULLETINS ETC.



Mosley Electronics, Inc., 8622 St. Charles Rock Rd., St. Louis 14, Mo., has prepared a catalog, 53-54, describing a line of TV installation accessories for both uhf and vhf.

* * *

P. R. Mallory and Co., 3029 E. Washington St., Indianapolis 6, Ind., has published a 50-page edition of *Vibrator Guide*. Containing nine sections, guide includes references to Mallory replacement number, original equipment number, vibrator type and application and manufacturer's replacement number. Also included are vibrator specifications and base diagrams, installation notes and circuit diagrams, buffer capacitor reference circuits and auto battery ground chart, and auto-radio service notes. Priced at \$.15. . . A 12-page catalog, 5-27, covering rectifier power supplies and replacement stacks, is also available.

* * *

Heath Co., Benton Harbor, Mich., has released a 4-page bulletin, *Spring Flyer*, describing instrument kits including a bar generator kit, which provides a series of horizontal or vertical bars on the TV screen for linearity checks.

* * *

Sprague Products Co., 61 Marshall St., North Adams, Mass., has made available a catalog, C-650, listing a line of ceramic capacitors. Catalog covers more than 375 ratings of ceramic subminiatures to molded plastic types, in 11 voltages from 300 to 20,000 vdc.

* * *

Cornell-Dubilier Electric Corp., South Plainfield, N. J., has prepared a 12-page catalog, NB-148, describing a line of Quietone rf attenuation filters.

* * *

Astron Corp., 255 Grant Ave., East Newark, N. J., has released a bulletin, AB-18, containing performance characteristics and test specifications on Meteor high-temperature subminiature paper capacitors.

* * *

The Insuline Corporation of America, 3602 35th Ave., Long Island City 1, N. Y., has released a 16-page brochure describing facilities for the production of electronic components and assemblies for both civilian and military purposes.

* * *

Merit Coil & Transformer Corp. have issued a revised edition of their *Repl Guide, No. 406*, expanded to 40 pages. Features the addition of if-rf coil and width-linearity coil listings. Also contains information on new TV flybacks, yokes and power transformers.

* * *

The Commercial Engineering Division of National Union Radio Corp., Hatboro, Pa., has prepared an interchangeability chart (No. 1003) for germanium-type diode crystals to aid in determining what diode types may be used as replacements or as substitutions in various television and electronic equipment. Chart shows outlines of the various styles of diodes to scale, and gives the electrical characteristics for nineteen point-contact N. U. germanium diodes.

**BRIGHTEN
YOUR
SALES
PICTURE** With The New
KINE-LITE
Pat. Pending
Picture Tube
Brightener & Rejuvenator

Only VIDAIRE'S Kine-Lite operates on ANY cathode ray picture tube of 10" and larger, including electrostatic focus.



VIDAIRE's Kine-Lite brings new brightness to TV picture tubes having low emission—permanent installation—can be re-used—simple instructions with each unit.

- ★ Renews brilliance and contrast of picture
- ★ Prolongs life of old picture tubes
- ★ Easy to install ★ No soldering necessary
- ★ For all standard tubes using duo-decal bases
- ★ No limit to tube size—10" to 30"
- ★ Standard Warranty ★ Two connecting plugs
- ★ Compact, attractive package
- ★ QUICK SELLER — EXCEPTIONAL PROFITS

Sold only through VIDAIRE distributors
Write for Catalog C

Vidaire Electronics Mfg. Co.



Mfrs. of TV color equipment,
phono & TV amplifiers
6 E. 39th St., N. Y. 16, N. Y.
LExington 2-7372

CARBON-TET

Finest Cleaner for Electrical Parts



1. Quickly removes oil, grease, tar and other soils from electrical parts!
 2. Safe, Won't burn! Won't explode!
 3. Won't harm finest surface or finish!
 4. Dries instantly—no odor or residue!
 5. Economical for cleaning sliding contacts, condenser plates and chassis. Also as a wash for carbon deposits.
- In gal. cans, qt. cans, 8-oz. bottles.
Order from your jobber.

THE KERDEN CHEMICAL CO.

5717 WALWORTH AVENUE • CLEVELAND 2, OHIO

WHEN YOU CHANGE YOUR ADDRESS

Be sure to notify the Subscription Department of SERVICE at 52 Vanderbilt Avenue, New York 17, N. Y., giving the old as well as the new address, and do this at least four weeks in advance. The Post Office Department does not forward magazines unless you pay additional postage, and we cannot duplicate copies mailed to the old address. We ask your cooperation.

ROSEN FORMS VISULITE CO.

Formation of the Visulite Company, to handle Keystone products to service jobbers and distributors, nationally, has been announced by Irving Rosen, president of Keystone Electronics, 423 Broome St., New York, N. Y.

* * *

IRC OPENS SYRACUSE SALES OFFICE

Opening of a Syracuse sales office, located at 112 Montgomery St., Syracuse 2, has been announced by the International Resistance Corp., 401 N. Broad St., Philadelphia 8, Pa.

Branch office will function as general liaison between IRC and its New York state area customers, with the exception of New York City, in promoting and selling the IRC line, processing orders and issuing quotes. *James G. Perkins, Jr.* has been appointed general manager, *Richard Johnson*, assistant manager, and *Anne Florek*, customer service correspondent.



J. Perkins and R. Johnson

* * *

EBERT EXPANDS FACILITIES

Ebert Electronics Co. has moved their plant to a new location at 212-26 Jamaica Ave., Queens Village 28, N. Y. Company manufactures mercury relays and special components.

* * *

HYTRON CHANGES NAME TO CBS-HYTRON

Hytron Radio and Electronics Co., division of the Columbia Broadcasting System, Inc., has changed its company name to CBS-Hytron.

* * *

ERIE TO BUILD PLANT IN MISS.

Plans for the construction of a plant for the manufacture of electronic and plastic products at Holly Springs, Miss., 40 miles south of Memphis, Tenn., has been announced by the Erie Resistor Corp., Erie, Pa.

Program calls for a one-story, brick-face building, providing approximately 60,000 square feet on a 25-acre tract. Production is expected to reach a maximum within two years.

* * *

OLYMPIC TV NAMES REGIONAL DISTRIBUTORS

Distributors for the Colorado, East Central Florida, Central Illinois and Cleveland marketing areas have been named by Olympic Radio and Television, Inc.: Eagle Distributors, Inc., 4303 Brighton Blvd., Denver, Colo.; Russell Distributing Co., Inc., 1963 Fourth Ave. S., St. Petersburg, Fla.; Mid-American Auto Parts, Inc., 821 Main St., Peoria, Ill.; and Milmar, Inc., 1805 East 40th St., Cleveland, O.

Latest TV Data!

JUST OUT

RIDER'S TV II

with
**dependable
replacement parts
listings**

THE standard reference
for TV service technicians

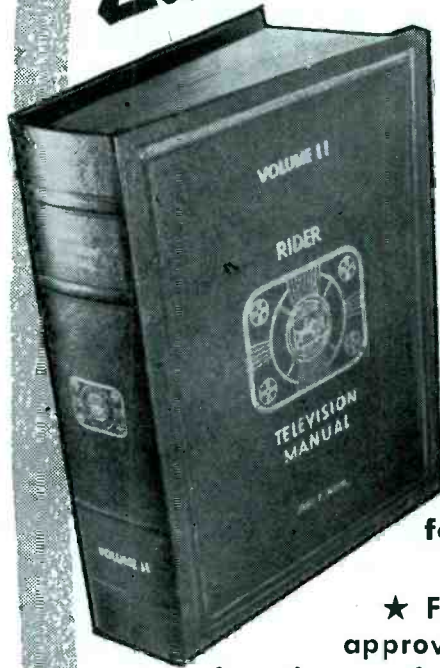

★ Factory-authorized! Factory-approved! ★ Servicing data - direct from the manufacturer! ★ Now sectionalized for most up-to-date coverage! ★ Schematics . . . wave-forms . . . chassis views . . . circuit changes . . . different production runs! ★ Cumulative replacement parts listings include cross-reference by chassis and models! ★ Over 2,200 (8½ x 11") pages in a (12 x 15") durable binder! Only \$24.00!

Order from your jobber today!

TEK-FILE

TAILOR-MADE FOR EASY TV SERVICING

TV service information in 83 individual packs . . . the same data as in Rider TV Manuals . . . about 3000 models . . . new packs monthly . . . try a TEK-FILE Pack at \$2 each. Money refunded within 7 days if you're not completely satisfied.

★ Dependable replacement parts listings beginning with Pack 57

For easier radio servicing . . . use Rider's 22 AM-FM Radio Manuals

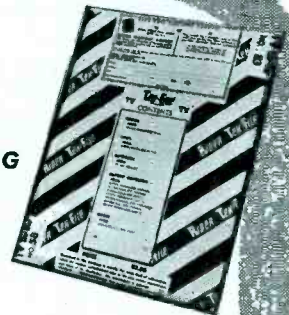

JOHN F. RIDER

PUBLISHER, INC.
480 Canal Street, New York 13, N. Y.

West Coast Office:
4216-20 W. Jefferson Blvd.
Los Angeles, California

Export Agent:
Roburn Agencies, Inc.
39 Warren Street
New York 7, New York

In Canada:
Charles W. Pointon
1926 Gerrard Street, East
Toronto, Ontario

Cable Address:
Roburnage N. Y.

PERFORMANCE

Guaranteed

TO LAST A LIFETIME!

UNIVERSITY COBREFLEX-2 WIDE-ANGLE TRUMPET

Lifetime Performance has been built-into each Cobreflex-2. Nothing yet produced compares in construction and design efficiency. Once installed, the Cobreflex-2 can be forgotten. The Cobreflex-2 is Breakdown-Proof... truly performance guaranteed to last a lifetime.

Compared! Tested! Proven Superior!

Write for
technical
literature



When used with University Driver Units

Frequency Response
Power Capacity
Impedance Requirement
Mounting
Application



Model T-0 Driver Unit
Cont. Power: 20 Watts over 250 CPS
Response: 250-15,000 CPS
Impedance: 8 Ohms



Model SA-HF Driver Unit
Cont. Power: 25 Watts
Response: 90-10,000 CPS
Impedance: 16 Ohms



Model MA-25 Driver Unit
Cont. Power: 25 Watts
Response: 90-6000 CPS
Impedance: 16 Ohms



Model PA-30 Driver Unit
Cont. Power: 30 Watts
Response: 80-10,000 CPS
Impedance: 15/25/50/100/2000 ohms
Power Taps (70V):
30/20/15/5/2.5 Watts



Model SA-30 Driver Unit
Cont. Power: 30 Watts
Response: 90-10,000 CPS
Impedance: 16/8/5/165/250/500/1000/2000 ohms
Power Taps (70V):
30/20/10/5/2.5 Watts

UNIVERSITY LOUDSPEAKERS • INC. 80 SOUTH KENSICO AVENUE, WHITE PLAINS, N. Y.

Audio Lovers... AS YOU LIKE IT!

THE *New* PENTRON TAPE RECORDER

PROFESSIONAL QUALITY TAPE RECORDING AT LOW COST!

Now get the high fidelity and flexibility of operation formerly possible only with far costlier equipment.

Ready to Use 2 Ways: 1—Tape Mechanism and Pre-Amp for custom installation with your own amplifier and speaker. 2—Self-Contained Portable Unit for use anywhere. Just plug into any existing audio amplifier, radio, TV set or combination.

Model 9T-3M Tape Mechanism. 2 speeds: 3.75" and 7.5" ps. 2 hours, record-playback time. Fastest rewind-forward speeds—1200' in 40 sec. Separate record-erase heads—removable pole pieces, dual track, (single track available). Flutter: —0.3% at 7.5"; —0.5 at 3.75"

Model PRE-7 Pre-Amp. Push-pull supersonic bias-erase. Magic eye record level indicator. Exclusive oscillator circuit. Frequency response: +3 db. 50 to 11,500 cps at 7.5"—3 db. 50 to 6500 cps at 3.75. Outputs: amplifier and headphones. Inputs: radio, phono and mike.

Model PMC Portable. Includes above units in handsome carrying case. Reel of tape and take-up reel included.

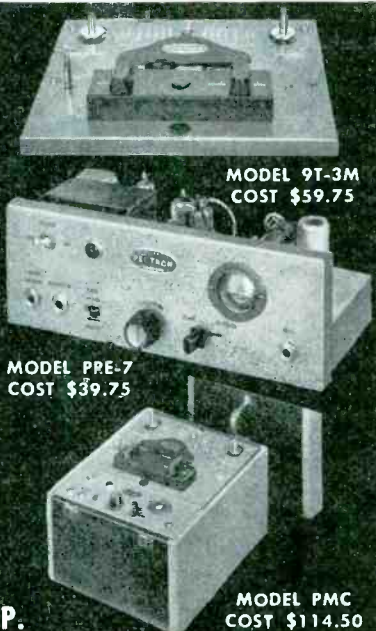

MODEL 9T-3M
COST \$59.75

MODEL PRE-7
COST \$39.75

MODEL PMC
COST \$114.50

ELECTRONIC
PENTRON
EQUIPMENT

THE PENTRON CORP.

844-Sp North Michigan Blvd., Chicago 11, Illinois
Canada: Atlas Radio Ltd., Toronto

Send for **FREE Bulletin**

BURGESS ENGINEER RECEIVES PATENT

A patent for the manufacture of multi-cell, dry-cell batteries, has been issued to Roy D. Arbogast, development engineer of Burgess Battery Co., Freeport, Ill.

Patented process permits the production of square, wafer-shaped cells in one operation before they are assembled into the finished battery. Individual cells are sealed in a strip envelope of waterproof, non-conductive thermoplastic material, making a chain or ribbon of sealed cells, which it is said can be stored for a length of time before assembly.

RAYTHEON COSPONSORS UHF LECTURE IN ATLANTA

Another *How to Interpret What You See in UHF* lecture was presented recently to 300 Service Men in Atlanta, Ga., under the cosponsorship of Southeastern Radio Parts Co., Raytheon tube distributor and Hopkins Equipment Co., Raytheon TV set distributor.

Main speaker of the evening was *William Ashby*, of Raytheon, who spoke on the best methods known today to localize service problems by using the information on the face of the picture tube. Uhf antennas, installation techniques, feedlines, high speed service and all methods and means of *uhf* tuning were covered in detail.

SPRAGUE OFFERS THERMOMETER DISPLAY TO SERVICE MEN

A thermometer, *D-114*, designed to attract the attention of customers of radio and TV Service Men, is now available from parts distributors of the Sprague Products Co., 61 Marshall St., North Adams, Mass.

Measuring 12" in diameter, thermometer's face is finished in orange and blue, and is weather-sealed in an aluminum case for outdoor as well as indoor use. Priced at \$3.00.

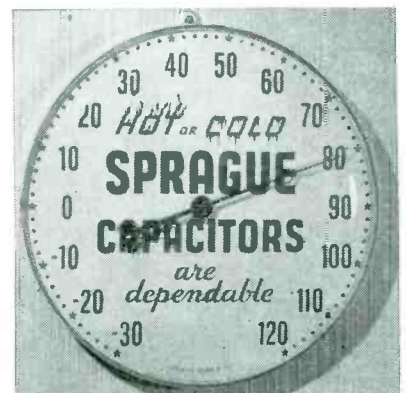

VARI-L COMPANY FORMED

Formation of a company to manufacture variable inductors has been announced by Vari-L Company, Inc., P.O. Box 1433, Stamford, Conn.

Headed by *James L. Kiser*, firm is now constructing a plant on Fairfield Ave. Variable inductor, a manually-variable, high-frequency saturable-core reactor, will be produced under license from CGS Laboratories.

STATE LABS MOVES

State Labs, Inc., has moved their offices and warehouse to 649 Broadway, New York City.

PORTABLE BATTERY CAMPAIGN



Point-of-purchase sales aids for batteries: Counter card showing all the latest makes and models of portable radios and Burgess batteries they use, and a 3-dimensional, electric flasher sign for window or counter display.

* * *

RMS FLORIDA FORUMS

Two forums, under the direction of Martin Bettan, conducted under the sponsorship of local distributors and Radio Merchandise Sales, 2016 Bronxdale Ave., New York 60, N. Y., were held recently in Florida.

At St. Petersburg, Fla., cosponsored by Tampa distributor, Radio Accessories Co., the subject of the new *uhf* station due in the city was discussed, with emphasis on the types of antennas that would be needed to receive the present *vhf* station (Jacksonville) and the new *uhf* channel.

During the second forum, held at the Alcazar Hotel in Miami, and sponsored by East Coast Radio and TV, a discussion on the merits of various types of *uhf* and *vhf* antennas was presented. In addition, the particular circumstances of Miami reception (WTJV) and for channel 23 (Ft. Lauderdale) were also highlighted.

* * *

CASH AWARD G.E. SERVICE CONTEST

A nation-wide sales contest, *Write Your Own Ticket*, designed to build business for radio and TV Service Men, providing for cash awards totaling \$7,125, has been announced by the G. E. Tube Dept., Schenectady, N. Y.

Top prize of \$2500 will be presented to the contestant who makes the best 50-words-or-less explanation of how he would spend \$2,500 to improve his service business. A total of 140 prizes will be awarded, including the \$2,500 first prize; four \$500, 10 \$50, 25 \$25 and 100 \$15 prizes.

Contest opens June 15 and closes August 31. One entry blank will be distributed with each purchase of a G. E. picture tube or 25 receiving tubes.

(Rights)

Managers of four RCA Service Company television branches who received *President's Cup* trophies in behalf of TV service branch employees for outstanding achievement in providing prompt, conclusive service to TV set owners during an intensive campaign designed to promote maximum efficiency and customer satisfaction. Left to right: E. C. Cahill, president of the RCA Service Co.; Ernest A. Steinkraus, Auburn, N. Y., branch; Francis X. Diamond, Baltimore branch; W. L. Rothenberger, New York regional manager for RCA; Frank M. Folsom, RCA prexy; R. N. Baggs, general sales manager, RCA Service Co.; Robert C. Scully, Bridgeton, N. J., branch; Orrin Dunlap, Jr., vice-president in charge of advertising and publicity for RCA; and Stanley T. Burek, Kalamazoo, Mich., branch.

STANCOR Exact REPLACEMENT

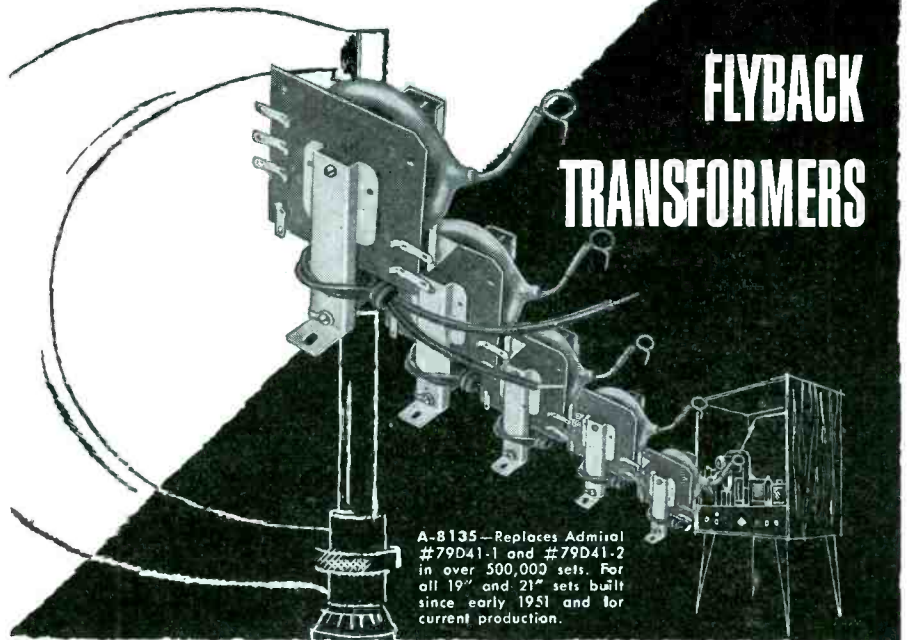

FLYBACK TRANSFORMERS

A-8135—Replaces Admiral #79D41-1 and #79D41-2 in over 500,000 sets. For all 19" and 21" sets built since early 1951 and for current production.

Ask your distributor for Stancor bulletins 461 and 465, listing replacement applications of these transformers—or write directly to Stancor for your free copy.

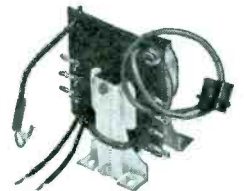

A-8132—Replaces Muntz #TO-0031; used in 1951 and 1952 production. Covers approximately 300,000 Muntz sets.

A-8136—Replaces Philharmonic #80-263, #80-265-2 and #80-265. Used in all sets built since early 1951 including AMC, Pathe, Silvertone, and other "private label" sets.

Stancor Transformers are listed in Howard W. Sams' Photofact Folders, John W. Rider's Tek-Files, and the Howard Company's Counterfacts.

STANDARD TRANSFORMER CORPORATION



3588 ELSTON AVENUE • CHICAGO 18, ILL.
EXPORT SALES—
Roburn Agencies, Inc., 39 Warren St., New York 7, N.Y.

OUTSTANDING SERVICE PERFORMANCE WINNERS



KESTER

Since the most important single step in Radio-Television Servicing is soldering . . . it's just plain good sense to use the best — KESTER SOLDER . . . Key Name in Solder for More Than 50 Years.

KESTER SOLDER COMPANY
4248 Wrightwood Avenue • Chicago 39, Illinois
Newark 5, New Jersey • Brantford, Canada

SOLDER

HERE IT IS!

ERIE
QUALITY
ELECTRONIC COMPONENTS
ERIE RESISTOR CORPORATION
ERIE, PENNSYLVANIA

Ready for YOU

Complete, up-to-date listings, illustrations, and descriptions of ERIE Electronic components are contained in the new ERIE CATALOG D-53.

This catalog assembles all the new items introduced since publication of our last catalog together with the long-time standard numbers.

Ask for it at your Distributors, or write Dept. A for your copy.

ERIE
RESISTOR CORP.

ERIE RESISTOR CORPORATION . . . ELECTRONICS DIVISION
Main Offices: **ERIE, PA.**
Sales Offices: Cliffside, N.J. • Philadelphia, Pa. • Buffalo, N.Y. • Chicago, Ill.
Detroit, Mich. • Cincinnati, Ohio • Los Angeles, Calif.
Factories: **ERIE, PA.** • LONDON, ENGLAND • TORONTO, CANADA

Tools . . . Instruments Parts . . .

MALLORY BENCH POWER SUPPLIES

Three bench power-supply units, *Rectopower*, designed to test, service and demonstrate electronic and communications equipment, have been announced by the P. R. Mallory & Co., Inc., 3029 E. Washington St., Indianapolis 6, Ind.

Two of the models, *12RS14D* and *28RS15D*, are dual-range types, the former handling 6 and 12-volt equipment, the latter designed to service equipment operating on 14 or 28 volts. Third unit, *6RS25-1*, is for servicing 6-volt equipment.

All three models are equipped with automatic voltage regulating systems which are said to maintain the output voltage constant as the load changes from no load to full rating. Voltage-regulating system, which uses no relays, is of particular value in testing transceivers and two-way radiotelephones in which the input fluctuates rapidly between transmit and receive.

* * *

SANGAMO MOLDED TUBULAR CAPACITOR

A premium molded-paper tubular capacitor, *Telechief*, for TV applications, has been announced by Sangamo Electric Co., Marion, Ill.

Uses *Humiditite*, a new molding compound, said to have high moisture-resistance characteristics, and a stable impregnant. Capacitors, it is claimed, will meet the minimum moisture resistance requirements of MIL-C-91A (proposed).



Sangamo Telechief

* * *

EVEREADY FLASHLIGHT BATTERY

A flashlight battery, *Eveready 950*, that is claimed to have a longer service life than other standard cells, has been announced by the National Carbon Co., 30 E. 42nd St., New York 17, N. Y.

Due to its longer shelf life, it is said, battery does not require dating. Packing carton may be used as battery display.

* * *

REGO CORD SET

An all-purpose cord set, consisting of a lead line 6' long with a double socket on the end, and a 3' cheater cord and 3' cheater can cord, has been introduced by Rego Insulated Wire Co., Inc., 830 Monroe St., Hoboken, N. J.

QUAM

QUAM
FOCALIZER
UNIT TRADE MARK

Tru-Match
**OUTPUT
TRANSFORMERS**

QUAM
ION TRAPS

Adjust-a-Cone **SPEAKERS**

ELECTRO-DYNAMIC SPEAKERS
PERMANENT MAGNET SPEAKERS
HIGH FIDELITY SPEAKERS
OUTDOOR THEATRE SPEAKERS
REAR SEAT AUTO SPEAKERS
TELEVISION SPEAKERS
INTER-COM SPEAKERS
CO-AXIAL SPEAKERS

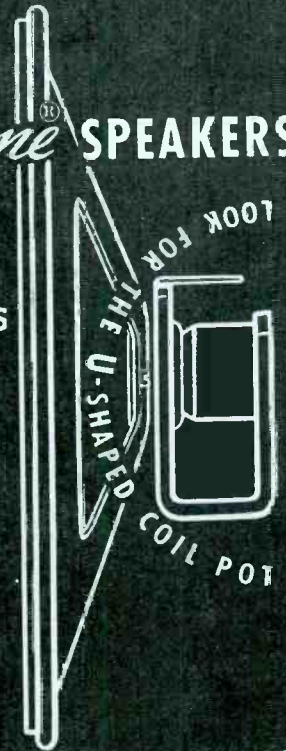

QUAM-NICHOLS CO. 33rd Place and Cottage Grove, Chicago 16, Ill.

MUELLER ALLIGATOR-CLIP INSULATOR

A flexible vinylite insulator, 62, designed to fit alligator-type clips, 60S, 60-CS and 60, has been introduced by the Mueller Electric Co., 1565 S. 31st St., Cleveland 14, Ohio.

Insulator, available in red and black, completely covers and insulates clip, leaving only the nose of the jaw exposed.

* * *

SEP VARIABLE TRANSFORMER

A variable transformer, 3000B *Adjust-A-Volt*, that features variable output voltage from 0-135, 30 amperes maximum, has been developed by the Standard Electrical Products Co., 2240 E. Third St., Dayton 3, Ohio.

Transformer is said to afford smooth control of voltage; has a new type of brush construction. Available in stacked assemblies for series-parallel or 3-phase operation. Maximum rating is 4000 *va.*



BUILD YOUR OWN Heathkit TEST EQUIPMENT

Heathkits are completely engineered instruments supplied unassembled. Every kit goes together smoothly and easily. All drilling, punching, and painting has already been done for you. All parts are furnished and are of highest quality.

Detailed construction manual shows clearly where each wire and part goes and tells exactly how to build the kit. Write for free catalog.



AUDIO GEN. KIT
\$29.50



R. F. SIGNAL GEN. KIT
\$19.50



5" SCOPE KIT
\$43.50



T.V. ALIGN. GEN. KIT
\$39.50



SIGNAL TRACER KIT
\$22.50



VACUUM TUBE VOLTMETER KIT
\$24.50



BATTERY ELIMINATOR KIT
\$24.50



IMPEDANCE BRIDGE KIT
\$69.50



TUBE CHECKER KIT
\$29.50



G.E.D. DIP. METER KIT
\$19.50



CONDENSER CHECKER KIT
\$19.50

HEATH COMPANY

BENTON HARBOR 11, MICHIGAN

EXPORT AGENT
ROCKE INTERNATIONAL CO. P.
18 East 40th Street
NEW YORK CITY (16)

It's Here! It's New!

ELECTROX BATTERY ELIMINATOR

For Servicing Both
6 and 12 VOLT AUTO RADIOS

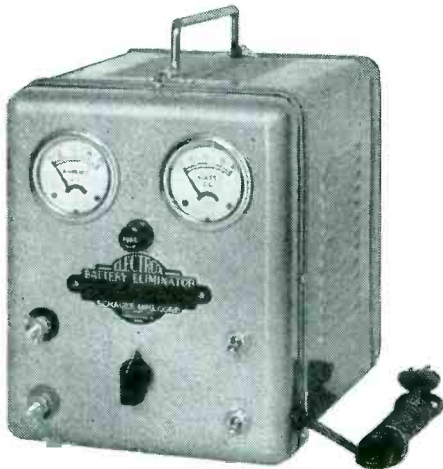

MODEL AR 56-12

Quality Built Throughout
Outstanding Value at \$52.50

Service both 6 and 12 Volt auto radios with this one, dependable power source. Electrox Model AR 56-12 provides amply filtered, adjustable D.C. that will operate any type and size auto radio, either push-button or manually tuned.

OUTPUT: Low range: 7½ volts at 12 amps., continuous; 20 amps., intermittent. High range: 15 volts at 6 amps., continuous; 11 amps., intermittent. High and low range controlled by selector switch.

Built of quality components throughout. Selenium rectifiers. Equipped with accurate 0-20 V. and 0-20 A. meters.

ALSO AVAILABLE: Model AR 46-12, only \$41.50. Built to same quality standards as AR 56-12. Output not adjustable. Equipped with high-low switch to change from nominal 6-volt to nominal 12-volt power.

SEE YOUR ELECTROX JOBBER OR
WRITE FOR FULL DETAILS

Rectifier Division

SCHAUER MANUFACTURING CORP.
4512 Alpine Ave. Cincinnati 36, Ohio

TV Parts... Accessories

HALLDORSON PHILCO TV MODEL FLYBACK ASSEMBLIES

Flyback transformers, FB407-8-9, designed as specific replacements in over 135 Philco TV models for '51, '52 and '53, are now available from the Halldorson Transformer Co., 4500 Ravenswood Ave., Chicago 40, Ill.

Models FB407 and FB408 are tailor-made coil assemblies designed to fit the core pieces, terminal panels, and mounting brackets of original Philco parts which are adaptable to quick coil changing. Model FB409 is a complete unit designed to replace both electrically and mechanically Philco flybacks of unconventional construction. New *hv* filament wires and instructions are provided with all units.

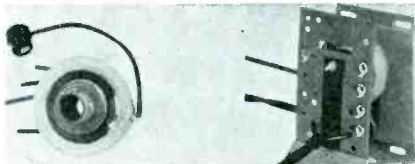

Halldorson Philco Flybacks

PHILCO VHF-TO-UHF SIGNAL- GENERATOR ADAPTER

A *vhf*-to-*uhf* signal-generator adapter, G8000, designed to prevent obsolescence of *vhf* signal generators, has been introduced by the Philco Corp., Philadelphia, Pa.

Adaptation is achieved as the output from *vhf* signal generator at 60 mc is fed into the adapter, where a *vhf* sweep or marker signal beats against *uhf* oscillator of the unit producing *uhf* signals having the same characteristics as the *vhf* input signal.

Features incorporated into the model include vernier dial for resetability; setup as an external *uhf* converter by connecting *uhf* antenna transmission line to generator's output terminal and connecting lead to TV receiver tuned to 60 mc; use of *vhf* signal generator output attenuator to control the *uhf* output signal level. Levels at *uhf*, it is said, are stable.

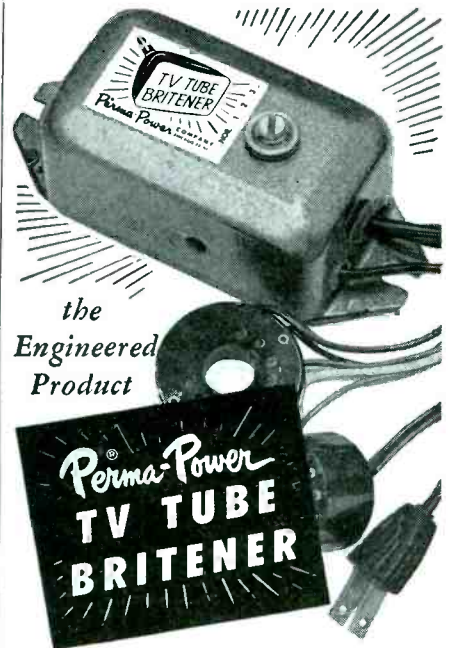

the
Engineered
Product

Perma-Power
TV TUBE
BRITENER

**extends useful life
of older TV tubes!**

manufactured by

Perma-Power COMPANY

Chicago 25, Illinois

Manufacturers of Electronic Equipment Since 1928

C-E JR. KIT SERVICER

A smaller version of the Hush TV-tuner cleaner spray, Jr. Kit Servicer, that consists of a 2-ounce bottle complete with a 24-karat gold-plated spray attachment has been introduced by the Chemical Electronic Engineering, Inc., Dept. H, 283 Main St., Matawan, N. J.

Smaller size was developed for TV and radio Service Men to pack along in their tube kits on home service calls. Cleaner sprays on, leaving a protective film which is said not to react to heat, cold, oil or corrosive solution.

* * *

B-T ALL-CHANNEL UHF CONVERTER

An all-channel continuous-tuning *uhf* converter, Ultravertier BTU-2, that is said to provide a 12-mc output for either channel 5 or 6, has been announced by Blonder-Tongue Laboratories, Inc., 526-536 North Ave., Westfield, N. J.

Unit employs double-tuned preselector circuits, a 6AF4 oscillator section, a 1N72 germanium diode and a 6AB4 triode for *if* amplification. A *uhf*-*vhf* selector switch is used to provide *vhf* reception for tuning the TV set in the usual manner. Converter has separate 300-ohm input terminals for *vhf* and *uhf* antennas, and a 300-ohm output to the TV set.

* * *

RAM FLYBACK TRANSFORMER

A horizontal-deflection and *hv*-output transformer, X074, designed for use in Arvin, Hallicrafters, Kaye-Halbert, Packard-Bell, RCA, Silvertone, Techmaster and many other TV receivers, has been introduced by Ram Electronics Sales Co., Irvington-on-Hudson, N. Y.

MOSLEY 3-WAY TV ANTENNA SWITCH

for Multiple

UHF and VHF ANTENNA INSTALLATIONS

- Install anywhere. Extension rod supplied for back of set mounting.
- Constant impedance—Low loss—Solderless.
- Sturdy rotary switch making silver-to-silver contact.
- In brown or ivory polystyrene case.
- Also available in Flush Wall Plate style.

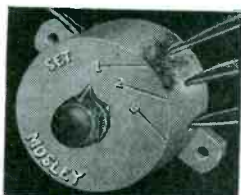
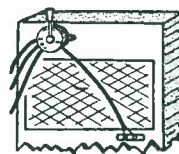

Cat. No. F-20 MOSLEY 3-Way
TV Antenna Switch
List Price..... \$3.75

At Radio Parts Jobbers

MOSLEY Electronics, Inc.

8622 St. Charles Rock Road
St. Louis 14, Missouri

Associations

RTS, New Jersey

HENRY A. WILLIAMS, publisher of the *Paterson Morning Call*, received the first annual award of the Radio and Television Servicemen of New Jersey, Inc., recently for his efforts to promote the pulse acceptance of reliable television service.

The award was made at the association's second annual dinner-dance, held in the Suburban Restaurant, Paramus, N. J. Over 150 members and guests attended the conclave.

In making the presentation, *H. B. Rhodes*, president of the group, pointed out that the *Morning Call* had run for almost two years a weekly column, *Video Views*, provided by the association; had cooperated completely with the association in efforts to raise the standards of TV service advertising; had publicized the activities of the association and exposed evils in the service industry.

Accepting the award, Williams said: "It is your association that deserves all the honor, for in organizing for the mutual protection of yourselves you have at the same time been a pioneer in our state and in the nation in providing invaluable protection to the public, whom you so usefully and honorably serve."

NETSDA

DELEGATES OF THE NATIONAL ELECTRONIC Technician and Service Dealers Association at a recent meeting in Paterson, N. J., set up committees for an expansion program. Credentials . . . *Max Leibowitz*, N. Y., *Edward Lukas*, Pa., and *W. H. Lockey*, Philadelphia; membership . . . *Samuel Brenner*, Philadelphia, *Harold McFarland*, N. Y., and *Gordon Delancey*, N. Y.; publicity . . . *Leon Helk*, Pa., *Dave Krantz*, Pa., and *O. Capitelli*, N. Y.; steering committee . . . *Bert Bregenzer*, Pa., *Milan Krupa*, Pa., and *Max Leibowitz*, N. Y.

Steps were also taken to obtain a charter of incorporation.

RTA, Long Beach, Calif.

JOSEPH MARTIN has been elected president of the Long Beach Chapter of the Radio Technicians Association, in California. Others named for '53 posts were *Fred Abrams, Jr.*, vice president; *Merlyn Cochems*, secretary; *Clarence Spencer*, treasurer; *Lee Johnson*, assistant treasurer; *Harry Ward*, public relations; *Richard Harding*, newsletter editor; and *Walt Rundquist*, membership chairman.

MOST of the BETTER sets use the TARZIAN TUNER

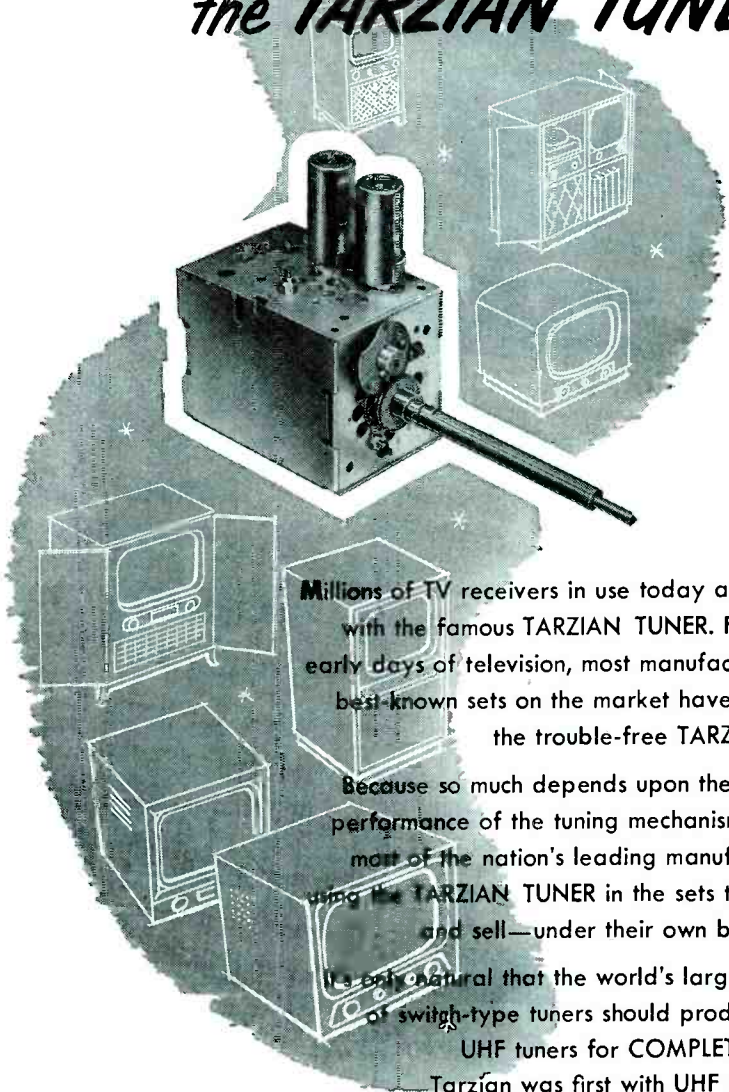

Millions of TV receivers in use today are equipped with the famous TARZIAN TUNER. For, since the early days of television, most manufacturers of the best-known sets on the market have relied upon the trouble-free TARZIAN TUNER.

Because so much depends upon the satisfactory performance of the tuning mechanism, you'll find most of the nation's leading manufacturers are using the TARZIAN TUNER in the sets they make—and sell—under their own brand names.

It's only natural that the world's largest producer of switch-type tuners should produce the best UHF tuners for COMPLETE coverage. Tarzian was first with UHF adaptability engineered into VHF tuners.

 **SARKES TARZIAN, Inc.**
Tuner Division • Bloomington, Indiana



Neal Hunter of Sprague receiving NATESA plaque awarded to Sprague Products for their . . . "outstanding service in creating customer relations" . . . at the association's national convention recently held in Kansas City, from *Frank Moch*, proxy of the National Association of Television and Electronic Service Association.

Latest Books for TV "KNOW-HOW"!



TV MANUFACTURERS' RECEIVER TROUBLE CURES, VOL. 1, VOL. 2 and VOL. 3

Positive cures for TV troubles! Gives you exact directions for correcting TV receiver performance "bugs". Each cure is official, factory-authorized, direct from the receiver's manufacturer. Listings by manufacturer and model or chassis number. Helps correct the most difficult faults — picture jitter, hum, instability, buzz, tearing, etc.

- Vol. 1, 115 pages (5 1/4 x 8 1/4").....\$1.80
Covers 12 brands, Admiral through Dumont.
- Vol. 2, 117 pages (5 1/4 x 8 1/4").....\$1.80
Covers 11 brands, Emerson through Jackson
- Vol. 3, 119 pages (5 1/4 x 8 1/4").....\$1.80
Covers 16 brands, Kaye-Halbert through Philco

VOLUMES 4 and 5 coming soon!
Prominent manufacturers not in first 3 volumes
ONE SERVICE JOB WILL MORE THAN PAY THE COST OF THIS SERIES OF BOOKS!

OBTAINING AND INTERPRETING TEST SCOPE TRACES

by J. F. Rider

Over 500 actual photographs of test scope traces. Shows how to use scopes and what the traces mean.

Valuable for servicing TV receivers, FM and AM radio receivers, audio systems and test equipment. Specific test equipment set-ups shown with each application. No other book like it!

Over 140 pages.....Only \$2.40

HOW TO USE METERS

by J. F. Rider

Panel type, volt-ohm-milliammeters, vacuum tube voltmeters for servicing radio and TV receivers, audio amplifiers, power supplies, for use and repair of ham transmitters. Written for the service technician, the TV and Radio student and hams.

Over 140 pages.....Only \$2.40

TV SWEEP ALIGNMENT TECHNIQUES

by Art Liebscher, Test Equipment Specialist

Never before has there been a book such as this on TV sweep alignment! An expert gives you accurate time-saving methods — and tells you how they work. Introduces the new Supermark method. Chock-full of sweep curve pictures. Valuable for servicing in UHF signal areas.

123 (5 1/2 x 8 1/2") pp., illus.....\$2.10

TV TROUBLESHOOTING AND REPAIR GUIDE BOOK

by R. G. Middleton

The finest practical book to make your TV servicing easy. Spot TV receiver troubles rapidly. Includes receiver wave forms, visual alignment, test equipment kinks, etc.

204 (8 1/2 x 11") pages.....\$3.90

ENCYCLOPEDIA ON CATHODE-RAY OSCILLOSCOPES AND THEIR USES

by Rider and Usion

Covers practically every scope manufactured during the past 10 years — and applications. 992 (8 1/2 x 11") pages. 3,000 illus. Cloth cover.....\$9.00

Write for information on all RIDER books.

Buy these books now from your jobber... bookstore... if not available from these sources, write to Dept. S-6.

JOHN F. RIDER

Publisher, Inc.

Dept. 6S 480 Canal Street, New York 13, N. Y.

FRSAP

THE PENNSYLVANIA State Federation met recently with Bert Bregenzer serving as acting chairman. Delegates attending represented affiliated chapters in Philadelphia, Chester, Williamsport, York, Pittsburgh, Altoona, Hollidaysburg, Scranton, Wilkes-Barre and Harrisburg. Chapter reports were given and a panel discussion was held on the proposed Pennsylvania licensing bills, HB-838 and HB-839. The Federation endorsed both bills as a step toward correcting part of the ills in the servicing profession.

A program of *Public Education in TV* has been instituted over WHUM-TV, Reading. Subject of one program will be *Your Local Service Man Is Your Best Friend*.

RETA, Fraser Valley, Canada

W. GUENTHER has been elected president of the Fraser Valley chapter of Radio Electronic Technicians Association. Other officers elected included: James Fraser, vice president; Dalton Newberry, secretary; and Jack Unruh, treasurer.

WILF MUNTON, Dominion chairman of RETA, was guest speaker at the first annual dinner meeting, and spoke to the group on the association's history since its formation 25 years ago. A feature of the dinner was a life-membership certificate award to Cliff Mathews.

R-TTG, Miami, Florida

NEW EXECUTIVE officers of the Radio and Television Technicians Guild, Miami, Florida, are S. Kessler, C. R. Gunn, S. DesJardins and A.E. Stevens. Now serving on the board are T. Rand, R. Lewis, C. Minter, J. Gilbert and J. Petruff.

TEN YEARS AGO

AN ANALYSIS of the state of the industry was offered by Victor Mucher, Clarostat; Harry Kalker, Sprague Products Corp.; Jack Berman, Shure Brothers; Charley Golenpaul, Aerovox Corp.; R. P. Almy, Sylvania; L. W. Teegarden, RCA and Sylvan A. Wolin, Solar Capacitor Sales Corp. . . . S. J. Thompson, service manager, Belmont Radio Corp. reviewed AM and FM receiver design. . . . A beat-frequency oscillator, with Dow electron-coupled fixed and variable low-frequency oscillators, was the front-cover feature. Unit was described as having a low distortion factor over a frequency range of from 20 to 17,000 cycles. . . . Oden F. Jester, Austin Ellmore and Remy Hudson were elected vice presidents of Utah Radio Products Co. . . . Leslie G. Thomas was elected vice president in charge of production at IRC. . . . Capt. William Sparks, former head of Sparton Radio, was reported killed in action. . . . Lt. Alexander Norden, Jr., vice president of L. S. Brach Manufacturing Corp., was appointed executive officer of a squadron in the Civil Air Patrol. . . . George Barbey was reelected head of NEDA. . . . Frederick S. Rowe was appointed tube production manager at the Westinghouse Lamp division. . . . Lou Shappe and Jesse Wilkes joined forces to form the advertising firm of Shappe-Wilkes. . . . Paul Galvin was reelected president of RMA.

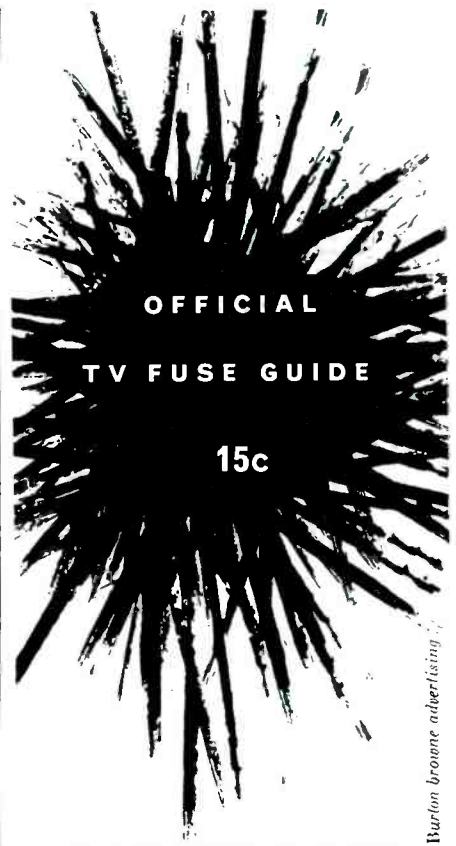

LITTELFUSE

Des Plaines, Ill.



"I'm not complaining. Just wanted to compliment you on the quality of the music since you got the JENSEN NEEDLE!"

RADELCO

LIGHTNING ARRESTOR

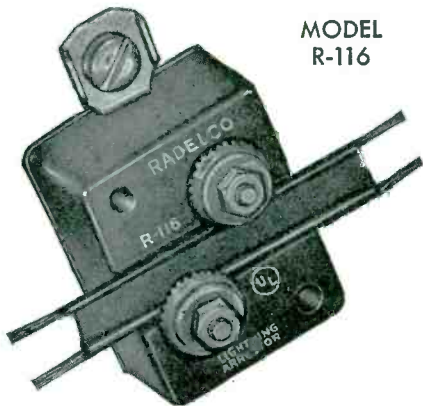

MODEL R-116

IT'S THE LOWEST PRICE UNDERWRITERS' LISTED ARRESTOR ON THE MARKET

ORDER FROM YOUR NEAREST PARTS JOBBER

LIST PRICE **90¢**



double purpose for double sales!

JFD Lightning Arrestor AT103 protects UHF and VHF signals

For use with UHF or VHF tubular twin lead, the AT103 is the perfect tie-in for every antenna sale. And the exclusive JFD strain-relief lips that prevent contact washers from ripping the twin lead apart give you yet another sales-making feature. Write for bulletin #139. *No. AT103 \$2.25, list.

*Complete with stainless steel strap and aluminum ground wire.

JFD Manufacturing Co., Inc., Brooklyn 4, N. Y.
World's largest manufacturer of television antennas and accessories

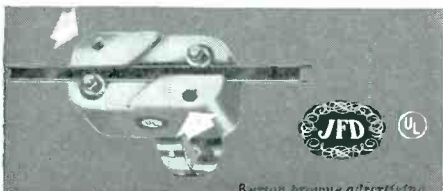

TV Antennas

(Continued from page 60)

field strength at any receiving point is thus a combination of two vector quantities; the field from a direct ray added to the field from an earth reflected ray. At 850 mc, this results in a field strength which varies from 0 to 20 miles, in which field strength is calculated for a receiving antenna height of 30'.

The tests accentuated the fact that field-strength prediction for *uhf* TV broadcasting can hardly be either a precise science or fine art, but it can be greatly refined as experience is accumulated. Theoretical methods evolved for point-to-point communication can sometimes be used for first-order roughness effects. Useful experience factors can be procured for second-order roughness effects. In some cases, it was emphasized, reflection coefficient measurements may be desirable to determine the magnitude of third-order roughness effects, where examination of terrain indicates possible important earth reflection.



(Above)

All-channel *vhf* TV booster, said to be automatically self-tuned to all *vhf* channels. Circuit has three tubes in broadband balanced stages, including a power multiplier stage. Built-in *hi-lo* gain switch claimed to permit reducing gain, if desired, when local station is tuned in. (Tunc-O-Matic, model 3002-A; Electro-Voice.)

(Below)

Battery-operated portable field-strength meter. Continuous one-knob tuning for channels 2 to 83; direct reading in microvolts of either the video or audio portion; sensitivity said to range from 5-50,000 *mv* on *vhf* and 50-100,000 *mv* on *uhf*. Powered by standard A and B dry cells; battery condition is shown on dial. (Model SM-5000-Pat. Pending; Radion.)

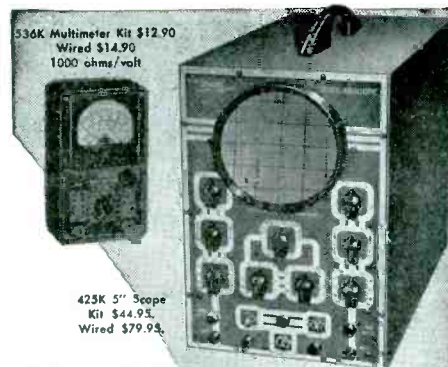

YOU BUILD EICO

KITS IN ONE EVENING-

but they last a lifetime... and you save 50%!

22 Kits and 24 Instruments — the industry's most complete line of **MATCHED TEST INSTRUMENTS!**

Over 1/4-million EICO Instruments are now in use the world over! That's the proof of EICO's leadership in **Value to the Serviceman!**

For latest precision engineering, finest components, smart professional appearance, lifetime performance and rock-bottom economy — see and **compare** the EICO line at your jobber's today **before you buy any higher priced equipment!** You'll agree with over 100,000 others that only EICO Kits and Instruments — no other — give you the industry's greatest values at lowest cost.

Write NOW for **FREE** latest Catalog S-6.

536K Multimeter Kit \$12.90
Wired \$14.90
1000 ohms/volt

425K 5" Scope Kit \$44.95
Wired \$79.95

221K VTVM Kit \$25.95
Wired \$49.95

565K Multimeter Kit \$24.95
Wired \$29.95
20,000 ohms/volt

320K Sig. Gen. Kit \$19.95. Wired \$29.95

360K Sweep Gen. Kit \$34.95. Wired \$49.95

1040K Battery Elim. Kit \$25.95. Wired \$34.95

525K Tube Tester Kit \$34.95. Wired \$49.95

EICO Reg. U.S. Pat. Off.

1952 **INSTRUMENTS & KITS**
ELECTRONIC INSTRUMENT CO., Inc.
84 Withers Street, Brooklyn 11, N. Y.

Laboratory Precision at Lowest Cost
Prices 5% higher on West Coast.

Engineered for the Purpose...

Copperweld GUY STRAND

provides REAL GUYING CONFIDENCE

Copperweld doesn't STRETCH

Soft wire guys frequently stretch badly in service and go slack. This means a wobbly antenna and poor reception. Copperweld Guy Strand is hard drawn—has the strength to stay taut—holds the antenna firmly in place—improves reception. And, it's easy to install.

Copperweld combats RUST

A guy weakened by rust may go unnoticed until a storm brings down the antenna, causing damage many times the cost of the guy. Copperweld Guy Strand is protected against rust by a molten-welded layer of pure copper on each wire. Its strength is lasting.

Write today for further details.

COPPERWELD STEEL COMPANY • Glassport, Pa.

Copperweld GUY STRAND
ANTENNA WIRE • GROUNDING WIRE
GROUND RODS AND CLAMPS . .

SOLD BY RECOGNIZED PARTS DISTRIBUTORS

LEADING UTILITIES rely on Copperweld Strand for guying poles and towers

NOW! SEE THE

Scala

VOLTAGE DOUBLER PROBE (BZ-4)

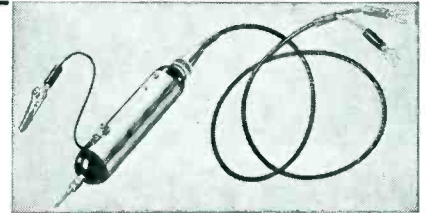

No probe marketed in this price field offers a range anywhere near the range of the BZ-4. \$10.75

Check with your distributor about the BZ-4 and other Scala Probes:
 BZ-1 Signal Tracing Probe . . . \$9.75
 BZ-2 Low Capacity Probe . . . \$9.75
 BZ-3 100:1 Voltage Divider . . . \$9.75

SCALA RADIO CO. 2814 19th St., San Francisco 10

!!SAVE \$\$\$. . . SAVE TIME! . . . EVERYONE CAN DO IT!!

REPAIRING YOUR OWN SPEAKERS!!

Use LEOTONE precision-engineered REPLACEMENT CONE & VOICE COIL ASSEMBLIES. Made with the skill of a QUARTER CENTURY'S "Know-How" and of the same high quality supplied to ALTEC, BELL LABS., ZENITH, etc. READY TO INSTALL, complete with spider, Leads & Instructions. Please give all dimensions (including depth) or send sample.

Any 4" assembly . . .	\$.72	Any 10" assembly . . .	\$1.62
" 5" "90	" 12" " . . .	1.89
" 6" " . . .	1.08	" 15" " . . .	2.58
" 7" or 7 1/2" " . . .	1.20	" 4"x8" " . . .	1.08
" 8" " . . .	1.32	" 5"x7" " . . .	1.28
" 9" " . . .	1.47	" 6"x9" " . . .	1.47

(Above prices based on minimum order of \$10.00. On smaller orders add 25%)



SPECIAL SERVICERS' DEAL !! . . . "UNIVERSAL" 4" TO 12" REPLACEMENT CONE & VOICE COIL ASSEMBLY ASSORTMENT . . . A specially selected kit of 23 complete assemblies, to fit over 100 different popular speakers. Consists of: 3, each—4", 4"x6", 5", 6" and 7" sizes. Plus 2 each—8", 9", 10" and 12" sizes. ALL FOR ONLY . . . \$24.95

DIRECT FACTORY SPEAKER REPAIRS SINCE 1927 . . . SPECIALISTS ON ALL TYPES OF "HIGH FIDELITY" UNITS

LEOTONE

LEOTONE RADIO CORP., 65 Dey Street • New York 7, N. Y.

Send for your free "Speaker Replacement Parts Manual" Minimum Order \$3.00 . . . 20% Deposit required on all orders. Please add sufficient postage . . . excess refunded.

Tube News

(Continued from page 44)

crystal to the base connection. When a positive voltage is applied to the emitter, electrons will be drawn from the crystal into the emitter and thus leave holes in the crystal structure. Under the influence of the negative field of the collector, these holes flow to the collector and thereby increase the collector current appreciably. Or as is sometimes stated, the emitter electrode injects holes into the germanium crystal. Holes near the collector allow electrons to pass into the crystal. Some of these electrons neutralize the holes; others flow to the base connection and thus complete the circuit.

If the assumption is made that every unit of the hole current which leaves the emitter reaches the collector, it follows that a small change in emitter current will result in an equivalent change in collector current, and consequently produce a current amplification factor of one. The current amplification factor or *alpha* of a transistor is defined as the ratio of change in collector current to a change in emitter current, when the collector voltage is maintained constant. In point-contact transistors *alpha* is greater than unity; in junction-type

units, it is less than but approaches unity.

If the germanium crystal employed in Fig. 1 is of the *p*-type, a negative voltage is applied to the emitter and holes will be drawn from the crystal into the emitter and thus leave an excess of electrons in the crystal structure. Under the influence of the positive field of the collector, these electrons flow through the crystal to the collector. In general, the *p*-type germanium crystal has characteristics similar to the *n*-type except that in operation all battery polarities are reversed.

Fig. 2 shows the structure of a junction transistor of the *n-p-n* type. It is composed of a wafer of *p*-type germanium between two smaller layers of *n*-type germanium. Low-resistance connections are made to the *n*-layers, one of which serves as the emitter and the other as the collector.

[To Be Continued]

Correction

IN THE DISCUSSION of record players by Mark Vino, which appeared in May SERVICE, the *ac*-operated light used with a stroboscope should have been described as . . . "blinking bright and dull at twice the frequency of the power line, or 120 times a second" for a 60-cycle line. And, the disc pattern will return . . . "to its original configuration every 1/120 of a second."

Service Engineering

(Continued from page 56)

accurately adjusting the amount of frequency deviation.

Two transmitting frequencies may be employed in this equipment. Shown dotted on the overall schematic diagram, Fig. 1, this auxiliary crystal circuit is energized by operating a switch in the control unit. A frequency-change relay, *K*₃₀₁, enables the desired crystal to be selected. No change in transmitter tuning is required for a second output frequency, the only limitation being that the auxiliary frequency must not differ from the first frequency by more than 120 kc.

Plate voltage for the transmitter is derived from two sources; a dynamotor and vibrator.

Receiver Circuits

A double-superhet circuit is utilized for the receiver. Employing an *rf* stage, one stage of high *if*, two low-*if* stages, two limiters, and two *af* stages, the receiver incorporates a squelch circuit to silence the receiver during non-signal periods. Double and triple-tuned networks are used in the receiver for increased sensitivity.

[To Be Continued]



Phenolic Cartridge Type



DIAMETER: From 1/8" to 1"
 LENGTH: From 1/2" to 12"
 CURRENT, half-wave: 1.5 ma to 60 ma
 VOLTAGE, DC output: 20 volts to 10,000 volts

SEND FOR BULLETIN H-1

INTERNATIONAL RECTIFIER CORPORATION

1521 E. Grand Ave., El Segundo, Calif. Phone: Oregon 8-3778
 CHICAGO: 205 W. Wacker Drive. Phone: Franklin 2-3889
 NEW YORK: 501 Madison Avenue. Phone: Plaza E-8665



The NEW JSC Tubular Twin Lead...

The best low loss, low cost 300 ohm lead-in for UHF and VHF television.

Rain, snow, dirt or salt deposits do not materially affect impedance and electrical efficiency.

JSC tubular construction contains and protects the concentrated field of energy and reduces to a minimum high ratio signal losses.



Manufactured under license of Amphenol Pat. 2543696

UHF Alignment

(Continued from page 35)

amplifier should be aligned. This can be done by using a crystal detector coupled to the interstage circuit of a cascode amplifier, or a detector coupled to the plate circuit of the first *if* stage to observe the *if* response curve as the *uhf* sweep generator is used to sweep over any portion of the *uhf* band, to which the tuner is adjusted. The *if* markers will assist in making the correct alignment of the *if* transformer. The response curve at *if* will be much narrower than the *uhf* response curve

for reasons previously mentioned. It is advisable to reduce the *uhf* sweep bandwidth, when making this test, so that the *if* response curve appears in

the same height-to-width proportions you have been accustomed to viewing, so that the response will appear normal.

Fig. 4. Ultrahigh-response waveforms resulting from tests made with a delay line.

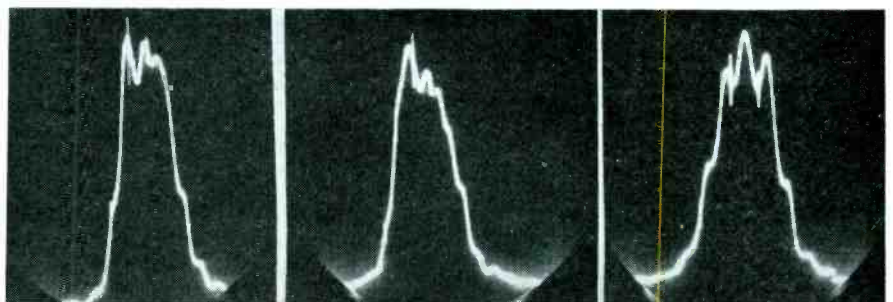

Yes . . . of course Radio Receptor Co. is producing . . .

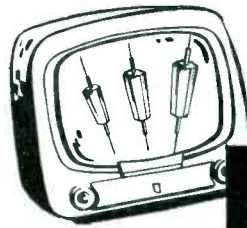

MIXER DIODES For U.H.F. — TV Tuners

The taper of the diode case allows polarity identification at a glance or at a touch thus speeding up assembly and reducing the possibility of error in connecting the diode into the circuit.

Featuring polarity at a glance!

current flow ↑

- 1N72 Germanium** Noise figure as a mixer better than 15DB @ 750 MC with 43.5 MC-IF circuit having a noise bandwidth of 3 MC and a noise figure of 4 DB.
- 1N82 Silicon** Noise figure as a mixer better than 12DB @ 750 MC with 43.5 MC-IF circuit having a noise bandwidth of 3 MC and a noise figure of 4 DB.
- 1N110 Germanium** Noise figure as a mixer better than 12DB @ 750 MC with 43.5 MC-IF circuit having a noise bandwidth of 3 MC and a noise figure of 4 DB.

Radio Receptor Co. is one of the major producers of Standard Germanium Diodes, Germanium Transistors and Seletron Selenium Rectifiers for radio, TV and other electronic circuits. Write for information!

SELETRON & GERMANIUM DIVISION

RADIO RECEPTOR COMPANY, Inc.

Since 1922 in Radio and Electronics

SALES DEPARTMENT: 251 WEST 19TH STREET • NEW YORK 11, N. Y.
 FACTORY: 84 NORTH 9TH STREET • BROOKLYN 11, N. Y.

Your One Complete Speaker Source

UTAH REPLACEMENT SPEAKERS

Export Dept. Rocks International Corporation, N. Y. C.

utah RADIO PRODUCTS CO., INC.

HUNTINGTON, INDIANA

A WHOLLY OWNED SUBSIDIARY OF NEWPORT STEEL CORPORATION

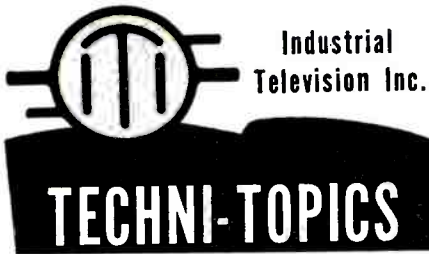

Industrial
Television Inc.

TECHNI-TOPICS

By W. TYMINSKI

NEW UHF AUTOBOOSTER EXTENDS UHF-TV RECEPTION

The IT-124A UHF Channel* *AutoBooster* is a high gain low noise amplifier, factory pre-tuned to any one channel in the UHF band (channels 14 to 83).

Up to now the only means of fringe area performance improvement available in UHF areas was the use of a VHF booster between the UHF converter and the VHF receiver. The VHF amplifier can effect an improvement in overall performance only in the cases where the converter has insufficient gain to overcome the noise contribution of a high noise factor VHF receiver, but, since the noise generated in the UHF portion of the converter is unaffected, only a limited noise figure improvement can be obtained.

The IT-124A *AutoBooster* uses the low noise 6AJ4 grounded grid triode for pre-amplification of UHF signals. Two stages are cascaded to virtually eliminate the noise contribution of the UHF converter and the VHF receiver, or the UHF tuner, and to overcome any gain deficiencies in these units. The unique design features of the UHF *AutoBooster* permit the realization of gain and noise factors approaching the theoretical limits for the 6AJ4 RF amplifier.

The UHF *AutoBooster* is designed for use with any UHF or VHF-UHF receiving arrangement, and offers the advantages of improved performance in terms of lower noise figure, higher usable gain, increased selectivity, improved input match, and reduced local oscillator radiation. The automatic power control of previous *AutoBoosters* is retained by use of a magnetic relay.

The input and output impedance of the UHF *AutoBooster* is 300 ohms balanced, but can be converted to 75 ohms unbalanced through the use of the IT-125A *AutoMatch* UHF Transformer.

In the VHF-UHF areas the IT-126A Tenna-Coupler is recommended to split a single antenna input into separate VHF and UHF outputs, in order to by-pass the VHF around the IT-124A UHF *AutoBooster*, and where necessary, to combine separate VHF and UHF signals into a common receiver input. In areas receiving more than one UHF channel individual UHF *AutoBoosters* can be used by means of switching or combining networks.

*Specify channel desired when ordering.

Industrial Television, Inc.

369 LEXINGTON AVENUE CLIFTON, N. J.
GRegory 3-0900

JOTS AND FLASHES

THE WORLD is rapidly entering a period when almost every phase of human endeavor is vitally affected by electronics, declared *Dr. Allen B. DuMont* recently during the opening of a 'scope plant in Clifton, N. J. And, he continued, the 'scope is actually providing the important key to what can be termed *The Electronic Age*. . . . Record sales of better than \$30 million for '52 were reported recently by General Instrument Corp. . . . *Governor Christian A. Herter* of Massachusetts delivered a brief address during the recent laying of the cornerstone of Raytheon's new TV picture-tube plant on Centre St., Quincy, Mass. New building will enclose 100,000 square feet, and will bring to a total more than 200,000 square feet of plant space occupied in Quincy, Brockton, and vicinity. . . . Flexibly-mounted circuits, consisting of thin layers of copper, in the desired configuration, attached to a woven cloth by a thermosetting adhesive, were described recently by *E. R. Bowerman* and *R. F. Walton* of Sylvania Electric Products, Inc., Bayside, N. Y., during a Dayton IRE section meeting. Production consists in silk screening an insulating lacquer in a suitable pattern, onto a stainless steel plate, copper plating the exposed areas of the steel, and stripping the plated copper and the insulating lacquer from the steel surface by an adhesive tape. The plated copper and lacquer are stripped from the steel plate by pressing firmly and evenly an adhesive tape of suitable area over the circuit and then giving it a rapid, continuous pull. . . . Orders booked for 'scopes by the instrument division of DuMont rose 19% during the first four periods of the company's fiscal year, compared to the same periods last year, according to *Emil G. Nichols*, technical sales manager of DuMont. . . . A custom-built, 630-type TV chassis, model 2430-9, designed for 27" and 30" picture tubes, as well as the new 24" rectangular tube, has been announced by *Tech-Master Products Co.*, 443 Broadway, New York 31, N. Y. . . . *John F. Rider* was a guest speaker during a recent meeting of the N. Y. chapter of the National Electronics Distributors Association. . . . *John C. McDevitt* has been appointed regional manager for Admiral for the Kansas City area. *Elmer B. Freeman* has been named New England regional manager. . . . *Edward L. Nung*, formerly manager of the Long Island City parts division for Sylvania, has been named manager of the tuner division of P. R. Mallory.

ADVERTISERS IN SERVICE

JUNE, 1953

American Electrical Heater Co.	61
American Phenolic Corp.	62, 63
American Television & Radio Co.	55
Argos Products Co., Inc.	2
Astron Corp.	22, 23
Audit Bureau of Circulations	50
Blonder-Tongue Laboratories, Inc.	3
Bussmann Manufacturing Co.	19
CBS-Hytron (Div. Columbia Broadcasting System)	5
Centralab—Div. Globe-Union, Inc.	49
Channel Master Corp.	10, 11
Chemical Electronic Engineering Co.	66
Columbia Wire & Supply Co.	66
Concord Radio	45
Copperweld Steel Co.	80
Cornell-Dubilier—Radiart	60
Cornell-Dubilier Electric Corp.	38
Crest Laboratories, Inc.	45
Davis Electronics	77
Electronic Instrument Co., Inc.	79
Erie Resistor Corp.	72
The Finney Co.	4
The General Industries Co.	42
The Heath Co.	73
Hickok Electrical Instrument Co.	66
Illinois Research Labs.	64
Industrial Television, Inc.	82
International Rectifier Co.	81
International Resistance Co.	17
JFD Manufacturing Co., Inc.	79
Jensen Industries, Inc.	76
Jersey Specialty Co.	81
Kerden Chemical Co.	68
Kester Solder Co.	72
LaPointe Electronics, Inc. (VEE-D-X)	7
Lee Electronic Laboratories, Inc.	78
Leotone Radio Corp.	80
Link Aviation, Inc.	16
Littlefuse, Inc.	76
P. R. Mallory & Co., Inc.	Inside Back Cover
Mosley Electronics, Inc.	74
National Electric Products	14, 15
Ohmite Mfg. Co.	37
Pertron Corp., The	70
Perma-Power Co.	74
Philco Corp.	21
Quam-Nichols Co.	73
Rad-El-Co Manufacturing Co.	64, 79
The Radiart Corp.	Inside Front Cover
Radio City Products Co., Inc.	54
Radio Corporation of America	6, Back Cover
Radio Receptor Co., Inc.	81
Raytheon Manufacturing Co.	24
Regency Division I.D.E.A., Inc.	1
John F. Rider Publisher, Inc.	69, 76
Howard W. Sams & Co., Inc.	64
Scala Radio Co.	80
Schauer Manufacturing Corp.	74
Walter L. Schott Co.	13
Shure Brothers, Inc.	59
Simpson Electric Co.	39, 43
Skyline Manufacturing Co.	78
South River Metal Products Co., Inc.	8
Sprague Products Co.	9
Standard Transformer Corp.	71
Sylvania Electric Products, Inc.	12
Tallen Co., Inc.	78
Sarkes Tarzian, Inc. Tuner Div.	75
Triad Transformer Corp.	68
Tung-Sol Electric, Inc.	20
U. S. Treasury Dept.	18
University Loudspeakers, Inc.	70
Utah Radio Products Co., Inc.	81
V-M Corporation	33, 34
Vidaire, Inc.	68
Waldom Electronics, Inc.	78
The Ward Products Corp. Div.	
The Gabriel Co.	46
Webster Electric Co.	65
Workman TV, Inc.	67

GOOD FOR
A
LONG
TIME

Mallory Vibrators

are your answer for long, dependable service... that you can be sure of. Their precision quality and uniformity means longer life... satisfied customers... an end to the call-back problem.

There are other advantages, too. The patented, tuned mechanism in Mallory Vibrators gives you these exclusive performance features:

- ← Less wear... because of slow contact make
- ← Low resistance... because of high contact pressure
- ← Reduced arcing... because of fast clean break

These are reasons why 5 out of 6 service men prefer Mallory Vibrators for all their service work... and why more are used as original equipment than all other makes combined.

Order Mallory the next time you call your distributor. The line is complete and meets original equipment specifications. You'll get better vibrators that cost no more. Every job you turn out will be right the first time.



P. R. MALLORY & CO. Inc.
MALLORY

CAPACITORS • CONTROLS • VIBRATORS • SWITCHES • RESISTORS
RECTIFIERS • POWER SUPPLIES • FILTERS • MERCURY BATTERIES
APPROVED PRECISION PRODUCTS

P. R. MALLORY & CO., Inc., INDIANAPOLIS 6, INDIANA

*Depend on Mallory
for
Approved Precision Quality*

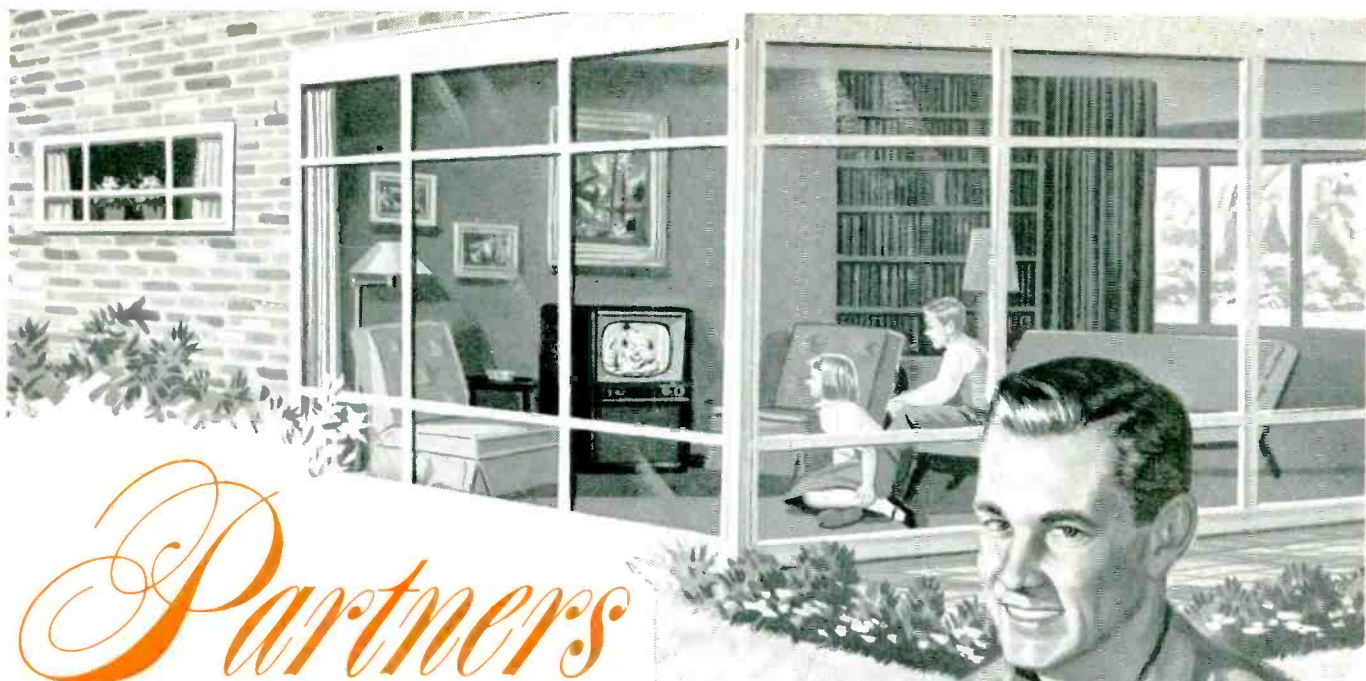

Partners

... for extra profit

EVERY successful service call automatically results in *extra profit* . . . in *dollars and cents* . . . and in increased "*customer confidence*." You can insure *both* kinds of profit by coupling your good name in partnership with another . . . *RCA*.

Wherever you go, the familiar RCA emblem serves as your silent partner, helping you to sell your service and build repeat business. And the superior quality of RCA Receiving Tubes and Kinescopes protects your profit by cutting those costly call-backs caused by premature tube failures.

Helping you to safeguard your reputation is a vital, everyday service of RCA Tubes. And that protection is yours at no extra cost.



"Sign up" for Success

Identify yourself with RCA! Ask your *RCA Tube Distributor* today how *you* can qualify for a Dealer Identification Plaque displaying your name. He'll give you full details on the big RCA Sales Promotion Program.

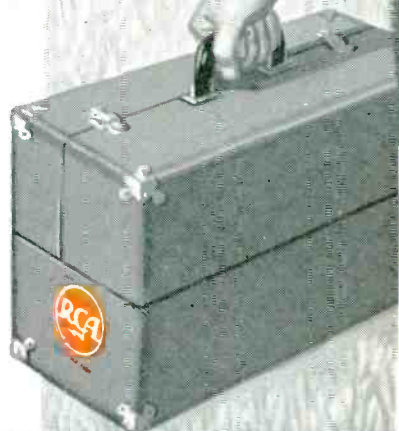

RADIO CORPORATION of AMERICA
ELECTRON TUBES

HARRISON, N. J.