

# SERVICE

JANUARY  
1952

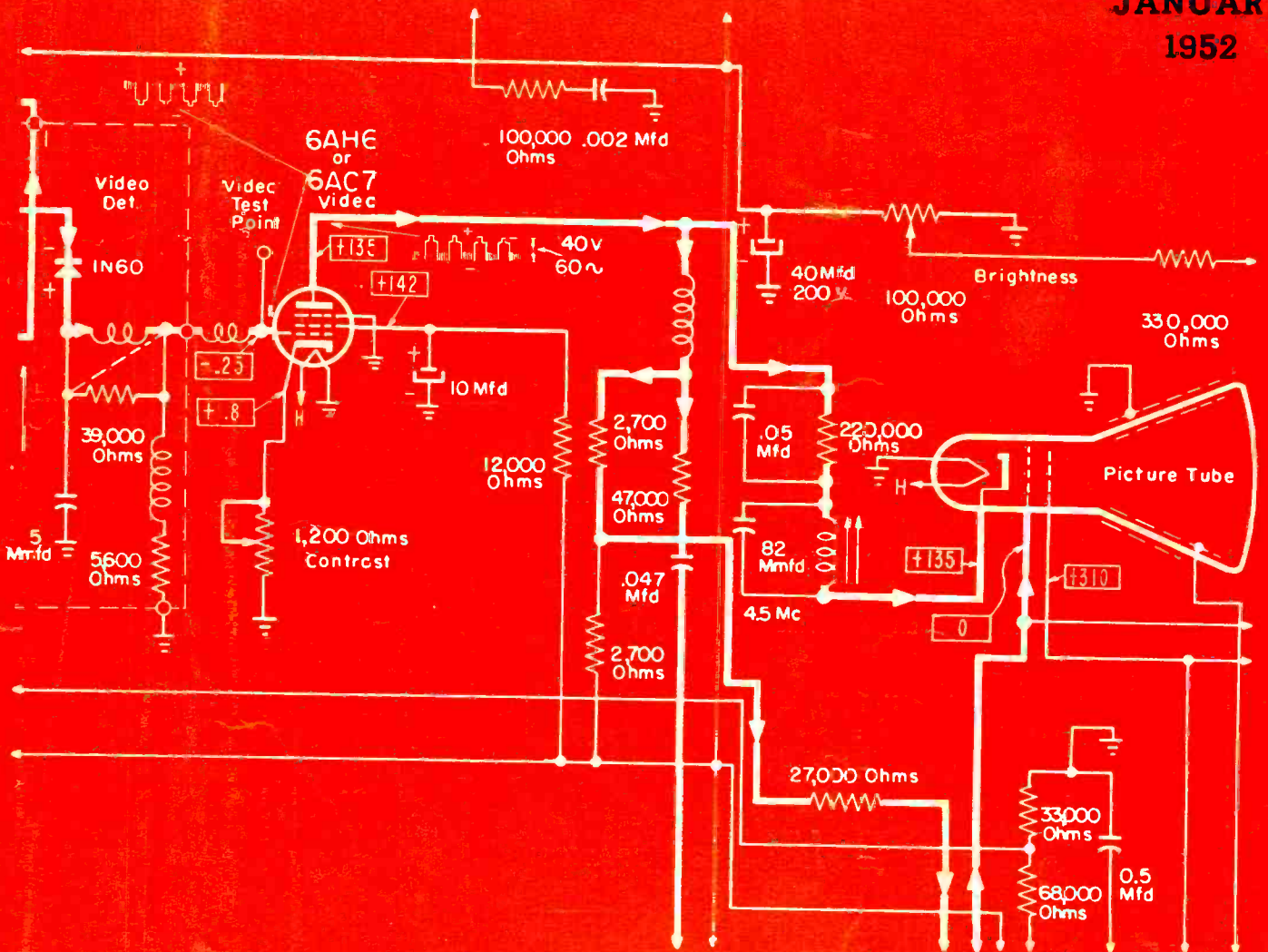

Keyed-a-gc system in which 6AH6 video-amplifier plate is dc coupled to picture-tube cathode through a 4.5-mc trap and 220,000-ohm resistor.

[See page 2]



the MOST

# POWERFUL

## TV ROTATOR

on the market



# TELE-ROTOR



Power When And Where You Need It...To Turn Any TV Antenna Array Under All Weather Conditions

When your customers want an antenna-turning device, it is YOUR RESPONSIBILITY to sell them one that will do the job best day in and day out... night in and night out! This covers considerable ground... but the TELE-ROTOR fills the bill!! STURDY enough to hold any array... POWERFUL enough to rotate it under all weather conditions... DEPENDABLE because it offers long-lasting, uninterrupted service! Give them the best... they'll thank you for your recommendation!

**MODEL TR-2**... complete rotator with "COMPASS CONTROL" cabinet having illuminated "perfect pattern" dial... (uses 8 wire cable) . . . . . \$49.95

### TELE-ROTOR

**CUB**

Second Only In Power To The Heavy Duty TELE-ROTOR

Featuring the same powerful motor that has helped to make the 'heavy duty' TELE-ROTOR so famous, the "CUB" incorporates a sensitive meter for utmost accuracy in tuning.

**MODEL 502B**... complete rotator with indicating meter control cabinet for "hairline" tuning... (uses 5 wire cable) . . . \$44.95

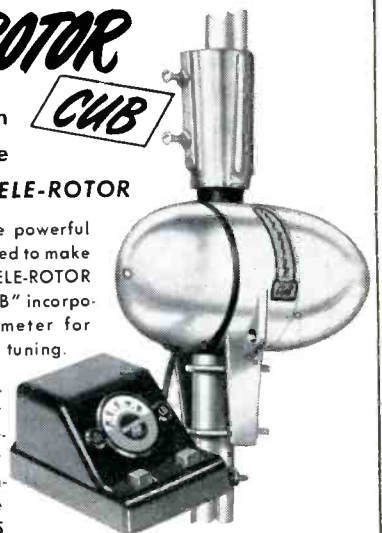

THE **RADIART** CORPORATION  
CLEVELAND 2, OHIO



**CORNELL-DUBILIER**  
SOUTH PLAINFIELD, N.J.

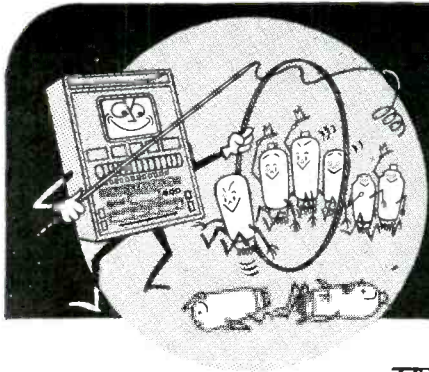

# THE INSTRUMENT THAT DEMANDS **OVERALL PERFORMANCE** FROM THE TUBE UNDER TEST!

*-PRECISION-* SERIES 10-12

## *Electronamic*\* Tube PERFORMANCE Tester

with 12 element free-point Master Lever Selector System

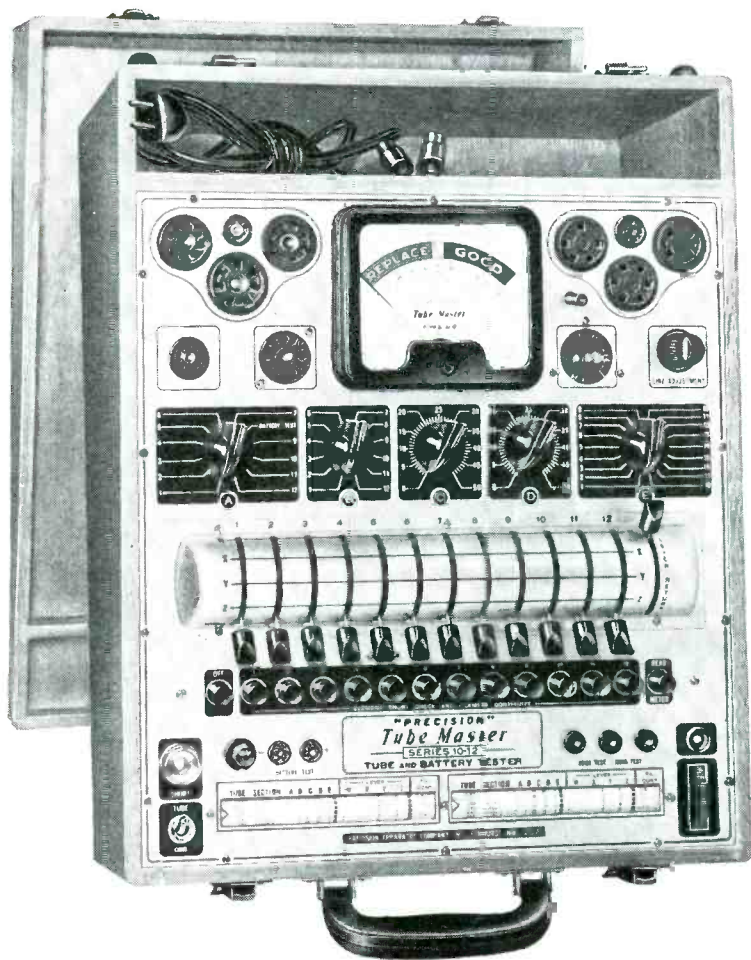

To test modern tubes for only one characteristic will not necessarily reveal **OVERALL PERFORMANCE CAPABILITIES**. Modern tube circuits look for more than just mutual conductance or other single factor.

It has been conclusively proven that even though a tube may work well in one circuit, it might fail to work in another—simply because different circuits demand different relative performance characteristics, such as amplification factor, plate resistance, power output, emissive capability, etc.

In the PRECISION "ELECTRONAMIC" Circuit, the tube under test is made to *perform* under appropriately phased and selected individual element potentials, encompassing a wide range of plate family characteristic curves. This COMPLETE PATH OF OPERATION is electronically integrated by the indicating meter circuit in the positive performance terms of Replace-Weak-Good.

The efficiency of this "Electronamic" test results from encompassing several fundamental tube characteristics, NOT JUST ONE. Accordingly, when a tube passes this demanding OVERALL PERFORMANCE test, it can be relied upon, to a very high degree, to work satisfactorily.

\*REG. U.S. PAT. OFF. T.M. 438,006

### Compare these features

- ★ Facilities to 12 element prongs.
- ★ Filament voltages from 3/4 to 117 V.
- ★ Tests Noval 9 pins; 5 and 7 pin acorns; double-capped H.F. amplifiers; low power transmitting tubes, etc., regardless of filament or any other element pin positions.
- ★ Isolates each tube element regardless of multiple pin positions.
- ★ Dual Hi-Lo short check sensitivity for special purpose tube selection.
- ★ Simplified, High Speed, 12 element Short-Check system, uses consecutive push-button switching.
- ★ Battery Tests under dynamic load conditions.
- ★ 4 1/2" Full Vision Meter.
- ★ Built-in Dual-Window, high speed, geared roller chart.
- ★ Free Replacement Roll Charts & supplementary tube test data service.

MODEL 10-12-P (illustrated): in sloping, portable hardwood case with tool compartment and hinged removable cover. Sizes 13 3/4" x 17 1/4" x 6 3/4".....\$101.75  
MODEL 10-12-C (Counter Type) \$106.50  
MODEL 10-12-PM (Panel Mount) \$106.50

See the "Precision" Master "Electronamic" Tube Testers at leading Radio Equipment Distributors. Write for new, 1952 "Precision" catalog.



## PRECISION APPARATUS CO., INC.

92-27 Horace Harding Boulevard, Elmhurst 6, New York  
Export Division: 458 Broadway, New York 13, U.S.A. • Cables—Morhanex  
In Canada: Atlas Radio Corp., Ltd., 560 King Street, W., Toronto 2B

Convenient "PRECISION" Purchase Terms can be arranged with your local and favorite authorized "PRECISION" Distributor.

AM • FM • TV •

AM • FM • TV

# SURE CURE FOR BATTERY HEADACHES

NO FUSS, NO MUSS WITH



## BATTERY ELIMINATORS

SAVE TIME, MONEY...

Servicing DC Equipment From AC Lines!

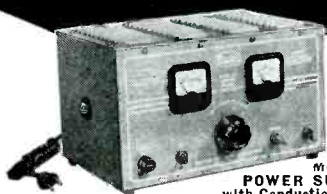

Model "B"  
POWER SUPPLY  
with Conduction Ceiling

### DEMONSTRATE and TEST CAR, AIR, MARINE RADIOS

... also relays, 'phone circuits, instruments, other low voltage devices. End costly storage battery failures with Electro's dependable power supply. New exclusive conduction cooling assures lowest cost per ampere output and silent long-life performance. Operates two radios with push-button solenoids simultaneously. 6 volts, 20 amperes.

New Low Cost "BJ" JUNIOR DC POWER SUPPLY, 6 Volts, 12.5 Amperes



OVER 2 MILLION Battery Radios Offer Huge PROFIT Market!



New Model "S"  
BATTERY ELIMINATOR  
with Selenium Rectifier

### CONVERT BATTERY RADIOS TO ALL-ELECTRIC

Now is the time your customers want dependable all-electric hum-free performance... tap this big timely market now! Operates any 1.4 volt 4 to 6 tube battery radio from 115 volt 50/60 cycle source. Uses less than 1/4 the power of the cheapest AC radio. Guaranteed 3 years.

#### SEND COUPON NOW!

ELECTRO PRODUCTS LABORATORIES  
4501-Sbs Ravenswood Ave., Chicago 40, Ill.

Send literature, name of nearest jobber.

Name.....

Address.....

City.....Zone.....State.....

In Canada: Atlas Radio Corp., Limited, Toronto

Vol. 21, No. 1



January, 1952

LEWIS WINNER  
Editor

F. WALEN  
Assistant Editor

Registered U. S. Patent Office  
Including Radio Merchandising and Television Merchandising

AFC Sync Circuit Servicing. By Solomon Heller and Peter Orne.....	36
Association News.....	54
Audio Installation and Service (Magnetic Recording). By Kenneth Stewart.....	20
Auto Radio Tests.....	29
Business Aids (Direct Mail Promotion).....	28
Fast-Acting AGC Systems (Keyed AGC-Circuitry Analysis: Cover). By Charles E. Bowers.....	14
Intercom Systems. By Jack Darr.....	34
Ser-Cuits (Instruments). By M. W. Percy.....	40
Service... The National Scene.....	11
Servicing Helps. By M. A. Marwell.....	24
Ten Years Ago in Associations.....	54
The Service Man and His Income Tax. By Wyn Martin.....	18
Tube News (Cures for Anode-Cap Troubles). By L. M. Allen.....	32
Views and News. By Lewis Winner.....	9
Wavemeter for AM Chassis Oscillator Tests. By Leonard J. Eisner.....	16

#### AUDIO INSTALLATION AND SERVICE

Magnetic Recording:	
Features of Tape Systems.....	41
Principles of Recording.....	20
Webster-Chicago 210 Tape Recorder-Playback Circuitry.....	42

#### CIRCUITS

Input Circuit of Auto Radio Chassis With Antenna Compensators.....	24
Keyed AGC Circuit With Single Video Stage and Cathode Drive.....	15
Keyed AGC System With 6AH6 Video Amplifier Plate DC Coupled to Picture-Tube Plate (Cover).....	14
Video Amplifier With Two Video Stages.....	15
Wells-Gardner Original and Revised Circuit Providing Improved Signal-to-Noise Ratios.....	24

#### COVER

Keyed AGC System, With 6AH6 Video Amplifier Plate DC Coupled to Picture Tube.....	14
---	----

#### SERVICING HELPS

Anode-Lead Breakdown Protection Method.....	26
Auto-Radio Compensator Adjustments.....	27
Cures for Inoperative Battery/AC Portables.....	26
Fogged Dial Crystal Cures.....	24
Remedies for Poor Focus or Dark Picture Tubes.....	24
Replacement Precautions for 5642 Tubes.....	24

#### Index to Advertisers

.....	56
-------	----

#### Manufacturers

Jots and Flashes.....	56
News.....	46
New Parts... Tools... Instruments.....	50
Rep Talk.....	55
TV Parts... Antennas... Accessories.....	52



Entire contents Copyright 1952, Bryan Davis Publishing Co., Inc.

Published monthly by Bryan Davis Publishing Co., Inc.

52 Vanderbilt Avenue, New York 17, N. Y.

Telephone MUrray Hill 4-0170

Bryan S. Davis, Pres. Paul S. Weil, Vice-Pres., Gen. Mgr. F. Walen, Sec. A. Goebel, Cir. Mgr.  
Mid-West Representative: Stuart J. Oster, 333 N. Michigan Ave., Chicago 1, Ill. Telephone: DEarborn 2-3507  
East-Central Representative: James C. Munn, 2253 Delaware Dr., Cleveland 6, Ohio. Telephone: ERview 1-1726  
Pacific Coast Representative: Brand & Brand, 1052 W. Sixth St., Los Angeles 14, Calif. Tel.: Michigan 1732  
Suite 1204, Russ Building, San Francisco 4, Calif. Telephone: SUtter 1-2251

Entered as second-class matter June 14, 1932, at the Post Office at New York, N. Y., under the Act of March 3, 1879. Subscription price: \$2.00 per year in the United States of America and Canada; 25 cents per copy. \$3.00 per year in foreign countries; 35 cents per copy.

Life-like window displays and counter cards!



Bright exciting streamers!



Personalized postal cards. Giant mailers! Radio announcements and reminder stickers!

# STOP! DON'T PASS THIS PAGE

...until you've read about SYLVANIA'S power-packed Service-Dealer Campaign

Talk about an exciting, sales-building Radio-TV Service Dealer campaign! Mister, this is it!

Featuring personal endorsements of some of the most glamorous and newsworthy people in the entire country, this campaign ties you in with big-space ads in *Life*, *The Saturday Evening Post*, *Collier's* and *Better Homes and Gardens*.

Just see what you get: . . . brilliant life-like cut-outs of the celebrated stars . . . counter cards, streamers, appealing mailers . . . also radio spot announcements, and reminder stickers. You pay only two cents per prospect per month for the mailers. The rest is FREE. Don't delay! Call your Sylvania distributor or mail coupon N-O-W!

SEND COUPON NOW FOR DETAILS ON THIS BIG CAMPAIGN



Sylvania Electric Products Inc.  
Dept. R-3101, Emporium, Pa.

I'd like full details about Sylvania's big 1952 Campaign for Service Dealers.

Name \_\_\_\_\_

Street \_\_\_\_\_

City \_\_\_\_\_ Zone \_\_\_\_\_ State \_\_\_\_\_

# SYLVANIA

RADIO TUBES; TELEVISION PICTURE TUBES; ELECTRONIC PRODUCTS; ELECTRONIC TEST EQUIPMENT; FLUORESCENT TUBES, FIXTURES, SIGN TUBING, WIRING DEVICES; LIGHT BULBS; PHOTOLAMPS; TELEVISION SETS



Frank J. Moch says—

“there is no other **OSCILLOSCOPE**  
like the **NEW Simpson MODEL 476**  
**MIRROSCOPE”**

FRANK J. MOCH,  
president of the  
National Alliance of Television and  
Electronics Service Associations.

**Simpson's** new and completely advanced type of oscilloscope—Model 476 **MIRROSCOPE**—is designed to eliminate certain inherent disadvantages found in the conventional type of oscilloscope by use of the “Mirroscope principle.” In this kind of construction the 5-inch cathode ray tube is mounted in a vertical position, thus reducing bench space requirements to an area of only 9" x 8" thereby permitting better concentration of associated equipment for any type of test procedure. The cathode ray image is reflected from an optical type front surfaced mirror mounted in the adjustable cover at the top of the cabinet bringing the viewing surface of instrument near eye level when instrument is used on benches of normal height. The mirror angle is quickly and easily adjusted to any position of the operator. The cover with integral side wings forms an effective shield against external light sources or may be closed down for protection of the tube and mirror when the instrument is not in use. The upright construction permits location of controls and connections for maximum convenience and allows for internal cathode ray tube connections at the front of the panel instead of the rear.

**SENSITIVITY:**

Vertical direct.....12 volts rms per in.  
Vertical amplifier.20 millivolts rms per in.  
Horizontal direct.....14 volts rms per in.  
Horizontal amplifier.....38 millivolts rms per in.

**INPUT IMPEDANCE:**

Vertical direct.....10 megohms, 15 mmf.  
Horizontal direct...10 megohms, 15 mmf.  
Vertical amplifier.300,000 ohms, 30 mmf.  
Horizontal amplifier.....500,000 ohms, 15 mmf.

Horizontal trace expansion is over 4 times tube diameter. This makes it possible to examine minute portions of a response pattern for finer detail.

Linear Sweep frequency is continuously adjustable in five overlapping ranges from 15 cycles to 60,000 cycles. Internal, external or line frequency synchronization with variable amplitude is available.

Means for intensity or “Z axis” modulation is provided. Approximately 14 volts peak will blank a trace of normal intensity.

The vertical amplifier frequency response is within 3 DB from 20 cycles to over 300,000 cycles and is usable to well over three megacycles. Square wave slant and over-shoot is held to less than 5 per cent of amplitude. This response will be found adequate for all phases of television receiver service including observation and diagnosis of Sync. signals.

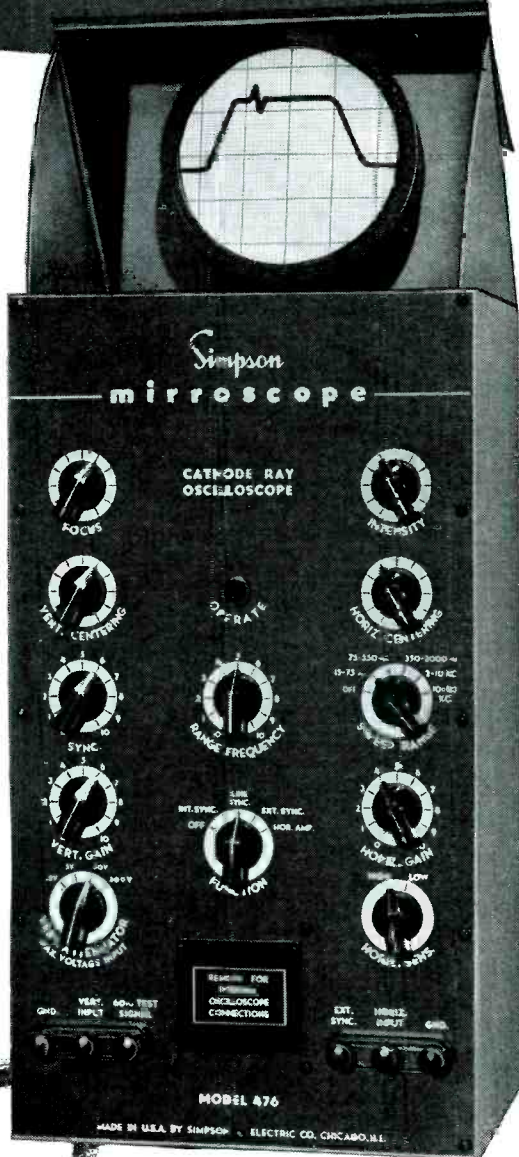

**TUBE COMPLEMENT:**

- 5UP4 Cathode Ray Tube.
- 4-6J6 Horizontal and Vertical Amplifiers.
- 1-12AU7 Vertical pre-amplifier.
- 1-6J6 Linear Sweep oscillator and Sync. injector.
- 2-6X4 High voltage rectifiers.

LINE VOLTAGE: 105-125 volts, 50-60 cycles.

SIZE: Height 16 1/4"; Width 9 1/8"; Depth 8" over all

WEIGHT: 25 lbs.; Shipping weight 30 lbs.  
High Frequency Crystal Probe...\$7.50

DEALERS NET PRICE including operators manual .....\$179.50



**SIMPSON ELECTRIC COMPANY**  
5200 W. Kinzie St., Chicago 44, Ill.  
Phone Columbus 1-1221  
In Canada:  
Bach-Simpson Ltd., London, Ontario

BURTON BROWNE ADVERTISING

# Rauland—the Original

## LOW FOCUS VOLTAGE ELECTROSTATIC TUBE

**Perfected in Rauland Electronics Laboratories,  
this tube that gives edge-to-edge sharpness of focus  
without coils and magnets is proved and ready  
as the materials pinch becomes painful**

**BETTER** in all ways! Gives better over-all focus—hair-line sharpness from edge-to-edge—with NO critical materials for focusing . . . and **STAYS SHARP** under considerable variation in line voltages.

**REQUIRES NO** re-engineering of present television chassis . . . NO added high voltage focus circuit . . . NO added receiver tubes . . . NO additional components except an inexpensive potentiometer or resistor.

**FOCUSES** by using D.C. voltage already available in the receiver.

**ELIMINATES** focusing coils and magnets . . . saves critically scarce copper and cobalt.

• • •

*This new Rauland development is now available in substantial quantities in 17 and 20 inch rectangular tubes. For further information, address . . .*

**THE RAULAND CORPORATION**



*Perfection Through Research*

4245 N. KNOX AVENUE • CHICAGO 41, ILLINOIS



# New 1952 HEATHKITS

Heathkit  
TELEVISION  
GEN. KIT \$39.50

Heathkit  
ELECTRONIC  
SWITCH KIT \$19.50

Heathkit  
AUDIO GEN.  
KIT \$34.50

Heathkit  
CONDENSER  
CHECKER KIT \$19.50

Heathkit  
R. F. SIGNAL  
GEN. KIT \$19.50

Heathkit  
A.C. VOLTMETER  
KIT \$29.50

Heathkit  
SQUARE WAVE  
GEN. KIT \$29.50

Heathkit  
INTERMODULATION  
ANALYZER KIT \$39.50

Heathkit  
AUDIO FREQ.  
METER KIT \$34.50

## Heathkit 5" OSCILLOSCOPE KIT

- New "spot shape" control for spot adjustment — to give really sharp focusing.
- A total of ten tubes including CR tube and five miniatures.
- Cascaded vertical amplifiers followed by phase splitter and balanced push-pull deflection amplifiers.
- Greatly reduced retrace time.
- Step attenuated — frequency compensated — cathode follower vertical input.
- Low impedance vertical gain control for minimum distortion.
- New mounting of phase splitter and deflection amplifier tubes near CR tube base.
- Greatly simplified wiring layout.
- Increased frequency response — useful to 5 MC.
- Tremendous sensitivity .03 RMS per inch Vertical .6V RMS per inch Hor.
- Dual control in vernier sweep frequency circuit — smoother acting.
- Positive or negative peak internal synchronization.
- Multivibrator type Wide Range Sweep Generator.

A brand new 1952 Heathkit Oscilloscope Kit with a multitude of outstanding features and really excellent performance. A scope you'll truly like and certainly want to own.

The kit is complete with all parts including all tubes, power transformer, punched and formed chassis, etc. Detailed instruction manual makes assembly simple and clear — contains step-by-step instructions, pictorials, diagrams, schematic, circuit description and uses of scope. A truly outstanding value.

MODEL 0-7

SHIPPING WT. 24 LBS.

**\$43.50**



## Heathkit VACUUM TUBE VOLTMETER KIT

- New styling — formed case for beauty.
- New truly compact size — Cabinet 4 1/8" deep x 4-1/16" wide x 7 3/8" high.
- Quality Simpson 200 microamp meter.
- New ohms battery holding clamp and spring clip — assurance of good electrical contact.
- Highest quality precision resistors in multiplier circuit.
- Calibrates on both AC and DC for maximum accuracy.
- Terrific coverage — Reads from 1/2V to 1000V AC, 1/2V to 1000V DC, and .1 to over 1 billion ohms resistance.
- Large, clearly marked meter scales indicate ohms, AC Volts, DC Volts, and DB — has zero set mark for FM alignment.
- New styling presents attractive and professional appearance.

The 1952 Model Heathkit Vacuum Tube Voltmeter! Newly designed cabinet combines style and beauty with compactness. Greatly reduced size to occupy a minimum of space on your work-bench. Covers a tremendous range of measurements and is easy to use. Uses only quality components including 1% precision resistors in multiplier circuit for greatest accuracy. Simpson 200 microamp meter with easy to read scales for fast and sure readings.

All parts come right with kit, and complete instruction manual makes assembly a cinch.

MODEL V-5

SHIPPING WT. 5 LBS.



**\$24.50**

YOU SAVE BY ORDERING DIRECT FROM MANUFACTURER

EXPORT AGENTS  
ROCKE-INTERNATIONAL CORP.  
3 E. 40th ST.  
NEW YORK CITY (10)  
CIRCLE 47-248-N.Y.C.

The **HEATH COMPANY**

... BENTON HARBOR 11, MICHIGAN



Tel-a-Ray's

BIG

FOUR

of TV reception

For television that's  
bright and clear  
Wherever you are . . .  
far or near



TRADE MARK

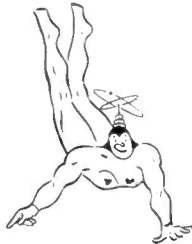

**Good reception up to 200 miles or more!**

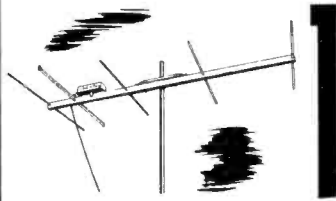

Models T and TD Antennas . . . famous for providing clear, stable, interference-free reception at almost unbelievable distances. With the Pre-Amplifier, they give up to an amazing 300 times gain over dipole. Rugged, weatherproof construction.

**Signal amplification without noise!**

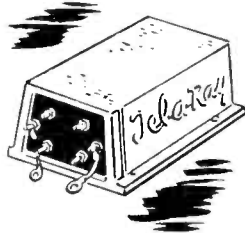

The unique, research-perfected Pre-Amplifier . . . the only device of its kind . . . an antenna- or mast-mounted installation that dramatically multiplies the signal gain while keeping noise at a minimum. Eliminates snow and makes signals strong and stable. Sold as a weather-sealed unit and guaranteed against weather damage.

**Middle-distance champions!**

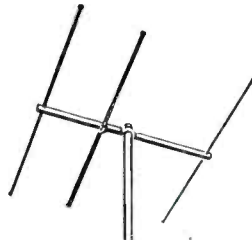

Models R and RD Antennas . . . designed to give the finest TV reception to the outer service areas at low cost . . . America's champion middle-distance performers. Same quality construction features as Models T and TD.

**Now, primary area reception benefits from Tel-a-Ray Antenna know-how!**

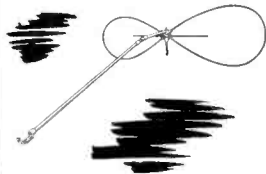

Butterfly Swivel-Positioned TV Antenna . . . low cost, high gain . . . easy to adjust for best primary area reception . . . self-mounted on three-way bracket for quick installation almost anywhere . . . an all-channel antenna designed and priced for the mass market.

**HOW TO MAKE MORE MONEY WITHOUT CALL-BACKS**

With the aid of Tel-a-Ray's "Big Four," you can give your customers brilliant, stable television reception almost anywhere . . . beyond the fringe areas, in outer service areas, in the primary areas. Reception problems are solved in a jiffy. Installation is amazingly easy and fast. Call-backs are reduced to a minimum. The quality of these Tel-a-Ray products shows in their appearance . . . in their rugged construction of the finest corrosionproof materials . . . in their unconditional guarantee against wind and weather damage.

Use them to sell television beyond the fringe areas . . . to make more money out of the replacement market in the established TV areas . . . to give your customers the finest TV reception at low cost. Send the coupon for full information.

*Tel-a-Ray*, America's most progressive antenna manufacturer, has applied to the FCC to operate a UHF television station on Channel 50 . . . Tel-a-Ray's research engineers, keeping pace with America's fastest-growing industry, have developed an effective UHF antenna. Such progress assures you finer television.

**MAKE MORE MONEY WITH  
LESS WORK AND TROUBLE**

*Send the coupon now*

*Tel-a-Ray* ENTERPRISES, INC., P.O. Box 3325, Henderson, Kentucky

Yes . . . I'd like descriptive literature on the Tel-a-Ray line, and the name of my nearest Tel-a-Ray Distributor.

NAME.....

COMPANY.....

ADDRESS.....



**A SERVICE DEALER  
IS ONLY AS GOOD AS  
HIS WORK**

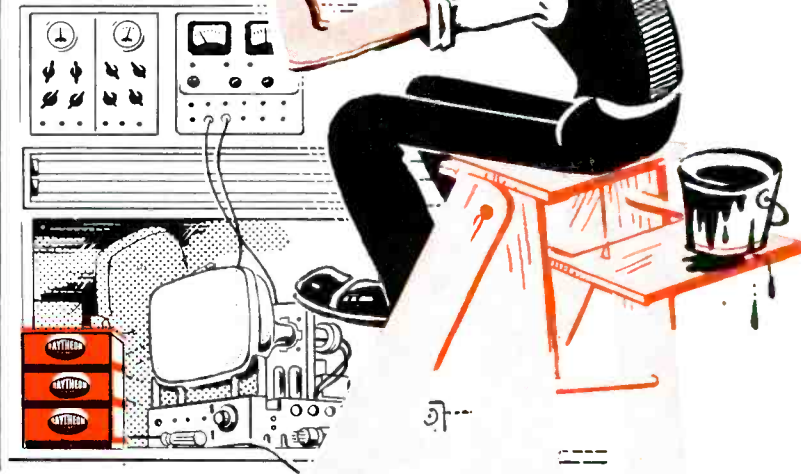

**T**oday's wary customers are more interested in the *business ethics* of a Television and Radio Service Dealer than they are in his *technical ability*.

They look for a Service Dealer who will treat them fairly, a Service Dealer whose guarantee is sound, and then take it for granted that the results will be satisfactory.

The RAYTHEON *Bonded* Electronic Technician Pro-

gram gives customers just what they are looking for. If you can qualify as a Raytheon *Bonded* Electronic Technician your 90-day guarantee on service and parts is cash-protected by a *bond* issued by the American Mutual Liability Insurance Company. You are presented with a Registered Bond Certificate, Creed Displays and Identification Cards all featuring an 8-point Code of Ethics that will convince the most skeptical customers of your integrity and ability.

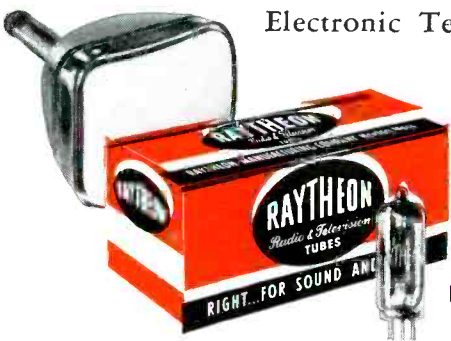

Back up your business with the Raytheon *Bond*. Ask your Raytheon Tube Distributor if you qualify for this exclusive business asset. It's yours *at no cost*, if you can.

RIGHT... FOR SOUND AND SIGHT®

**RAYTHEON MANUFACTURING COMPANY**

Receiving Tube Division  
Newton, Mass., Chicago, Ill., Atlanta, Ga., Los Angeles, Calif.



*Excellence in Electronics*

RECEIVING AND PICTURE TUBES • RELIABLE SUBMINIATURE AND MINIATURE TUBES • GERMANIUM DIODES AND TRANSISTORS • RADIAC TUBES • MICROWAVE TUBES



### Nettled Consumers

SINCE THE EARLY DAYS of servicing, the industry has been beset by many raging storms of consumer gripes. Fortunately, it has been nearly always possible to calm the tempest with discreet investigations of the causes of the fury and with immediate corrective steps. As intimated, the score has never been perfect because of the few who seem to delight in erring, prompting the hurling of the critical blasts. Nevertheless, the collective efforts of the majority have always impressed the general public.

With the advent of TV, there was general fear that an era of heartaches and headaches were ahead. For quite awhile the problem was quite acute. Endless production changes, lack of adequate instrument techniques, and general unfamiliarity with circuitry, brought about a distasteful state of confusion. It wasn't too long, however, before some stabilization in production appeared, thoroughly field-tested checking systems were evolved with foolproof troubleshooting gear, and the boys began acquiring real circuit know-how. Manufacturers introduced clinics, during which their chassis were thoroughly reviewed, and complete servicing assists were provided by company specialists. Comprehensive reports on clinic information, published in *SERVICE*, were sought by the resourceful Service Man, who realized that these data were invaluable to him. As a net result, most of the boys soon found that TV servicing could be quite a bright business, if the necessary tools and the proper knowledge were at hand. The scene sparkled, even though there still were a few black sheep in the pastures.

As production roared ahead, and chassis poured into the homes, installation and service potentialities zoomed. The servicing fraternity grew and grew; certainly this was evidence of a healthy situation. But, as in the early 360-meter days, the expansion seemed to attract many *get-rich-quick-Wallingford* characters, who felt that they could set up, reap and go, fast. Unfortunately, they did set up, and reap, but they lingered

and caused endless trouble. Regretfully, these folks are still causing headaches. Unwilling to attend clinics or join associations, or become acquainted with the complexities of the art through serious study, they have become a thorny problem and aroused the fury of many. Those who have been unfortunate enough to have these sad specimens service their chassis have been riled, and justifiably so. Often, on these occasions, customer requests for specific details on promised service are completely shunned. And assurances of reliable performance that should result after repairs are made are never offered. There appears to be only a goal for these men—a lot for as little service as possible.

### Trouble Spots

Oddly enough, most of the difficulties have cropped up in small communities, where everyone knows that even a few complaints can ruin a business. Manufacturers and distributors have found it necessary to send emergency crews into these zones to repair the damage; not too pleasant a sight to view in a small town, and an open admission that the shop on the corner has failed to serve his community.

It may be difficult to believe that such inexcusable conditions exist today, but they do; the practice is widespread and must be destroyed and eliminated from the scene quickly, very quickly. There are too many competent, reputable boys around town who can effect repair of chassis to the complete satisfaction of the consumer. They must not be made to suffer because of the malpractices of the belligerent few.

Service Men should seek out these errant members of the business, and set them straight on the facts of life in servicing, particularly TV servicing. It's a big, time-consuming job, but well worth the effort.

The consumer should be a friend of every Service Man, not a nettled, disgruntled critic. The campaign to affect a rout of these undesirables should begin immediately!

### Smiling Ledgers

AS THE YEAR BEGINS, and the auditing days begin to hover over the shop, there are many who will have to fret over the bleak 12-month record that the books may show for '51; but there are those who will be quite gleeful of what the records will show.

The latter represent those who were careful in not only the technical conduct of their business, but the economic planning, with perhaps a well-conceived budget program. The former were careless with their time and their training, and made no attempt to evaluate their financial status every month.

Too many Service Men still insist that budgets and accounts should not concern them. Perhaps the subject is not engrossing as a circuit diagram analysis, but it is an important item and just can't be discounted.

### Budgets and Accounts

A few years ago, during one of the Town meetings, Charles Towe, an accountant, offered wise counsel on the subject of budgets and accounts. He pointed out that every service shop must be realistic and face facts. It is important to have a score board or a financial statement, he declared, to permit the calling of proper plays at the right time. The shop must budget its profit, the boys were told, if it is to determine a practical chargeable rate for productive time.

Service shop operators must consider the relationship of their overhead to their charges. For instance, a shop should yield a gross profit on charges for labor at least equal to its entire overhead, with a ratio of about 150 per cent as the goal. Unfortunately, many Service Men refuse to accept this premise, or even consider it, and as a result find themselves steeped in trouble.

The employment of a sound accounting and budgeting program, the operation of which can be guided by a professional accountant, can provide the insurance, which as Charles Towe stated. . . "will go a long way toward surviving any economic storm which may occur in the future."—L. W.

For accurate  
flexible and  
quick tube  
testing at  
low cost...  
model 3413-A

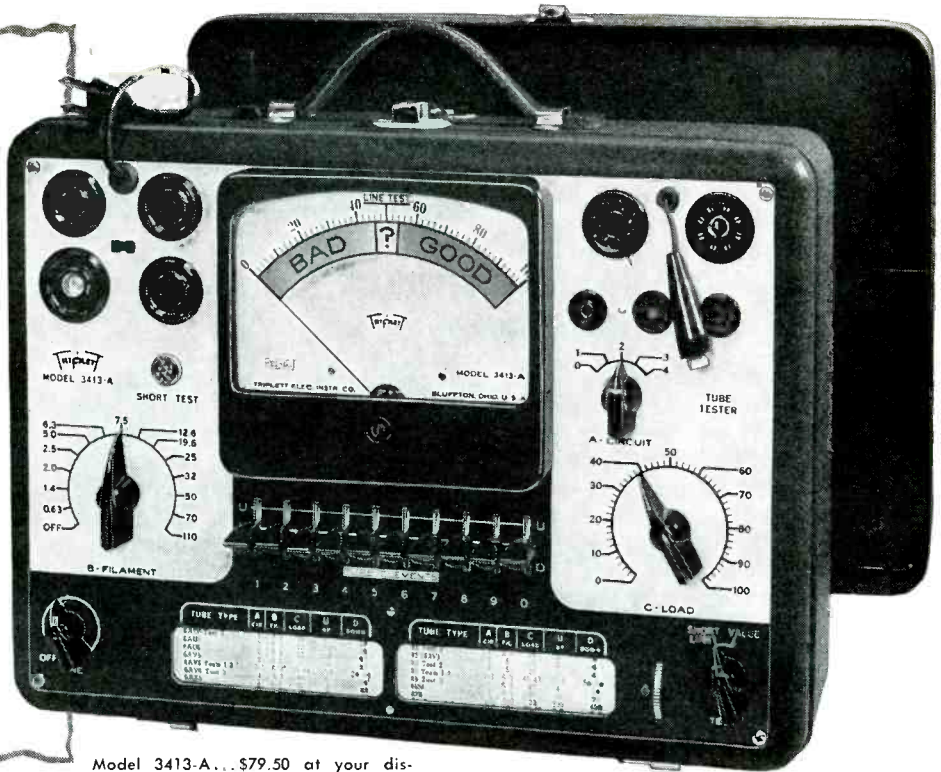

Model 3413-A...\$79.50 at your distributor. (Price subject to change.) BV Adapter, \$7.90 Add'l.

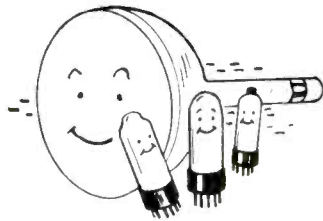

1. YOU CAN TEST MORE TYPES of tubes, also appliances for shorts and open circuits.

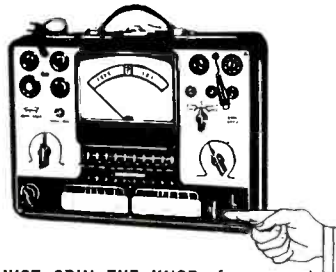

2. JUST SPIN THE KNOB—for correct, last-minute data, on the speed roll chart. Lists 700 tubes.

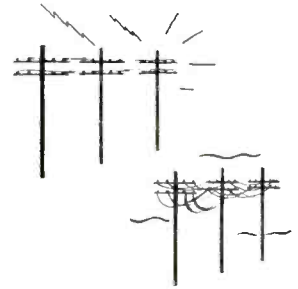

3. YOU CAN COMPENSATE for line voltage—just throw snap-action switch.

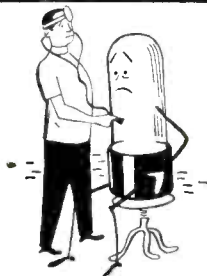

4. YOU CAN TEST EACH ELEMENT in each tube—by a simple flip of the switch.



5. YOU CAN TEST THE NEW TUBES—including those with low cathode current.



6. YOU GET NEW TUBE DATA—immediately, while it is still news. No waiting.

*Nearly Half a Century of Service to the Service Man*

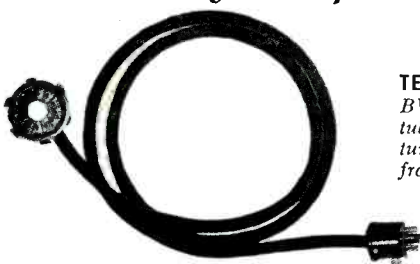

TESTS PICTURE TUBES, TOO! With this BV Adapter, Model 3413-A tests every tube in a TV receiver, including the Picture Tube—without even removing tube from receiver or carton! Saves time!

FOR THE MAN WHO TAKES PRIDE IN HIS WORK

**Triplet**

TRIPLET ELECTRICAL INSTRUMENT CO., BLUFFTON, OHIO, U. S. A.

# *SERVICE...The National Scene*

LICENSING PROPOSALS SCORED BY INDUSTRY GROUPS--A concerted effort to war against licensing laws and restrictive ordinances may soon be underway, if a resolution offered by the sponsors of the annual electronic parts show in Chicago is accepted by five co-sponsors, which includes RTMA, NEDA, AEPFM, SMCEG and WCEMA. Should these associations say aye to the fight plan, a Service Man-dealer advisory committee will be set up, and a task force appointed to conduct a program informing the public on the pitfalls of legislation. The plan has been criticized by several servicing groups who are currently seeking passage of an assortment of measures. In New York City, where a bill has been pending for nearly a year, the proposed resolution was harshly censured. Said the prexy of the New York City servicing association, who is also head of a national group: "Notwithstanding all objections to the servicing bill, which recently was approved by the city council, the measure will pass and become law very soon." Licensing, as offered in the metropolitan New York measure, was emphasized as being the only answer to the mountain of complaints and criticism heaped on Service Men.

THREE POLICING MEASURES OFFERED BY NEW YORK STATE LEGISLATORS--Ordinances to control antenna installation and repair practices, introduced and pigeonholed in '51, received another airing, as the sessions of the '52 state legislative body in New York convened. In one instance, an assemblyman from Manhattan offered a bill which would authorize cities to provide for the licensing, bonding and regulation of persons servicing TV sets. Another measure, introduced by an assemblyman from Brooklyn, stipulated that monies paid under contract for the servicing of TV sets should constitute a trust fund held in separate account under regulation. In a third proposal, also introduced by an assemblyman from Manhattan, there appeared the recommendation that landlords should permit tenants to use rooftops for TV or radio antennas, if this had been the practice in the past, provided a \$2.00-a-month charge was assessed for the privilege of using the roof for the installation. All three bills have been severely criticized, but the proponents have indicated that it should be possible to override all protests.

ULTRAHIGH BOOM VIEWED AS A POSSIBILITY IN '52--With assurances from Washington that the freeze will definitely be lifted in the early part of '52, and that we will undoubtedly see the addition of many new TV stations, not only on the present bands but in the new uhf zone, or bands 14-83, an unusually lively era appears to be ahead. Comparatively small communities are scheduled to be favored in the program, which may involve the installation of perhaps a score of stations before the year is over. Manufacturers are expected to be ready for the event, not only with combination receivers, but with chassis which will accept uhf tuners or converters. The introduction of this new element on the TV scene will increase the responsibilities of Service Men. It will be more necessary than ever before for the boys to study the parade of developments carefully and become thoroughly familiar with the vagaries of the art. SERVICE will lend a hand with the publication of a continuing series of authoritative product reports and circuit analyses.

COMMUNITY ANTENNA RULING IN OFFING--The year-long survey of community-antenna system operation, and its legality in relation to the present Communications Act, is expected to be completed soon, resulting in an official opinion on the future of this unique service. The FCC will be obliged to decide whether the community-antenna system might be classified as a broadcasting or common-carrier system. It will also have to determine whether the technique represents an interstate or intrastate operation. It is believed that the Commission will indicate that it has jurisdiction over some types of systems which might parallel telephone facility services.

# SERVICE... *The National Scene*

NEW HIGHS IN PERFORMANCE PROMISED FOR '52 CHASSIS--The chassis scheduled to come off the line in early '52 will contain an assortment of circuitry innovations, which it is claimed will increase not only the sensitivity of the sets, but provide more stable signals and improved sound. According to one manufacturer, there'll be a series of chassis available with builtin boosters, specially designed for weak-signal area use. A cascode turret-type tuner, which it is expected will reduce snow in the picture, will also be featured in this line. In another series of chassis, there'll be a tru-lock tuner along with an automatic retrace-line suppression system. A static eraser, included in an inverse-feedback circuit, will be used in another chassis series to screen out picture interference. Picture tubes in the new lines will feature special face coatings to insure increased white-to-black ratios in reproduction. In several instances, picture tubes will feature antiglare focus and tip-tilted safety-glass mounting systems for reflection-free pictures. Up to 2½ watts of distortion-free sound are predicted for some of the chassis. The tube sizes in these new models will range from 17- to 24-inches. Analyses of the circuits employed in these chassis will begin appearing in the next issue of SERVICE. Watch for them.

LP 78-RPM SYSTEM INVENTED--A unique phono development, which has made it possible to minigroove a 78-rpm record and produce a disc less than 7 inches in diameter, providing up to five minutes of playing time, has appeared on the scene. Conceived by one of the largest radio manufacturers in Europe, the technique features the use of a half-ounce pickup with a sapphire needle, and is adaptable to normal 78-rpm phonos. Complete details on the system will appear soon in SERVICE.

TV SERVICING COURSES OFFERED TO ELECTRICAL ENGINEERS--In the belief that electrical engineers should be familiar with the procedures involved in the servicing of TV chassis, the communications division (New York section) of the AIEE has decided to inaugurate a 6-course lecture series. Scheduled have been talks on general circuits in TV receivers, antenna and front ends, video amplifiers, sync and sweep circuits and troubleshooting. Representatives of G. E., Emerson, Olympic, RCA, DuMont and John F. Rider, have been selected to do the talking.

SUPERMARKET-TYPE SERVICE STATION NOW IN OPERATION--In Mineola, Long Island, there has appeared an unusual type of service station, featuring supermarket service practices. Long repair benches have been set up, to permit the customers to view not only repairs being made on their chassis, but the subsequent tests that might be required to assure continuing service.

PICTURE-TUBE FACE COVER PROTECTOR PRODUCED--On occasion it is necessary to remove a picture tube from a chassis and either place it aside or take it back to the shop for examination. In transit or on the service bench, the tube face may become scratched or nicked. To prevent this possibility, there has been produced a cover made of quilted rayon, with the inside surfaced with polyethylene to prevent scratches on the face surface of the tube. Covers are available for round or rectangular models for all popular sizes from 14 to 20 inches.

TV INDUSTRY SPECIALISTS COAUTHOR SERVICING GUIDE--The extremely important subjects of rf-if and tuner alignment, general troubleshooting and circuit analyses, have been covered in a extremely well-prepared 48-page booklet, coauthored by two of TV's foremost authorities; John R. Meagher and Art Liebscher. Among the topics discussed are troubles and cures in the horizontal deflection, agc, vertical-oscillator and vertical-deflection circuits. Detailed, too, are the procedures which should be followed to prevent horizontal pulling, audible hum and buzz or microphonics. Here is a lively package of servicing information which every Service Man should have in the shop and in the field. --L. W.

A LEADING PUBLISHER'S  
SURVEY SHOWS . . .

servicemen prefer

# Jensen

## NEEDLES

# 2 to 1



The "Jenselector" is Free  
See Your Distributor

#### PICK THE RIGHT NEEDLE

The "Jenselector" will give you the exact needle replacement number for any record player without knowing the model or cartridge number.

#### No. 32 DEALER PACK

Contains a balanced assortment of 32 needles of the best proven sellers. Needles are available either on cards or in plastic boxes. Complete instructions with each needle.

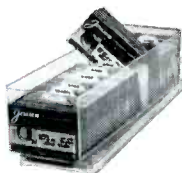

## Here's Why!

- ★ MORE VOLUME
- ★ EASIER TO SELL
- ★ A NEEDLE TO FIT ANY PLAYER
- ★ SIMPLE SELECTION OF CORRECT NEEDLE
- ★ COMPLETE CUSTOMER SATISFACTION

JENSEN—The Oldest Name In Sound Engineering

# Jensen

**INDUSTRIES, INC.**, 331 South Wood Street, Chicago 12, Illinois  
Canadian Branch: Duplate Canada Ltd., 50 St. Claire Ave., West, Toronto 5, Canada  
Export Sales: Scheel International, Inc., 4237 Lincoln Ave., Chicago 18, Ill. Cable: Harscheel

**Detailed Analysis of Basic and Modified Keyed AGC Systems Now in Use, With Data on the Theoretical and Practical Aspects of Circuitry Involved.**

# Fast-Acting AGC SYSTEMS

by CHARLES E. BOWERS

Staff Engineer, Bendix Radio

[See Front Cover]

IN THE CONSTANT SEARCH to provide better and more foolproof television receivers, automatic gain control has been found to be quite a boon, when used in the picture *if* and the *rf* amplifiers to prevent overloading and many types of fading.

Practically all of the '49 chassis featured some *agc* system. Most of the circuits were designed to operate on the same principle as the *avc* systems found in every standard broadcast receiver. That is, a portion of the *if* signal is rectified and filtered in such a manner that a negative *dc* voltage is obtained. This voltage varies in amplitude as the *if* signal varies, and therefore, when a very strong signal is received, a larger negative voltage results. The grid returns of several *if* and *rf* stages are connected to this bias voltage. Thus, a very strong signal generates a more negative bias which, in turn, reduces the gain of the stages connected to it.

This type of *agc* has been found to be fairly satisfactory when all stations can be received with a minimum of sustained noise, and changes in signal strength are relatively slow. The filter networks in TV receivers which smooth out the rectified *if* signal, to produce the desired *dc* bias, must have

a long enough time constant to filter out the 60-cycle sync pulses. Thus, when the change in signal strength occurs in about 1/60 of a second, the bias voltage will not be changed at all. Herein, lies one of the major drawbacks of the standard control system, when fading is due to reflected signals from airplanes or other fast moving objects.

### Noise

Another drawback has appeared when the noise level of a signal is very high; the noise itself will produce a more negative bias and thus reduce the gain of the *rf* and *if* stages. This, in turn, means less amplification for the desired signal and a lower signal-to-noise ratio.

In areas where a weak station is accompanied by noise riding in, there is a tendency to suppress the signal altogether, since the noise pulses can produce a bias voltage so large that the already weak signal does not receive sufficient amplification.

Two main types of noise can mar television pictures: man-made noise and so-called *static* noise.

Man-made noise originates in any of the great variety of electrical appliances, such as vacuum cleaners, refrigerators, pumps, automobile ignition, electrical machines of all sorts, and the many mechanical devices which create electricity through friction or electrostatic action. In general, man-made noise is distinguished by some regularity in its appearance.

*Static* noise is considered to be caused by different natural forces, such as the action of the sun, weather conditions, static charges resulting in lightning and thunder, and the influence of cosmic rays. Actually, it is found that the so-called *static* noise level is often highest in locations having large industrial establishments. In such areas it is hard to determine which is nature's and which is man's contribution to the noise picked up by the antenna. It is true, however, that the noise grows less and less as the antenna is mounted higher and higher. One drawback in high antenna locations is the long lead in required, since the lead itself tends to pick up noise.

In studying the appearance of the noise waveforms it has been found

Fig. 1. Diagram of assumed condition for calculating maximum airplane flutter rate.

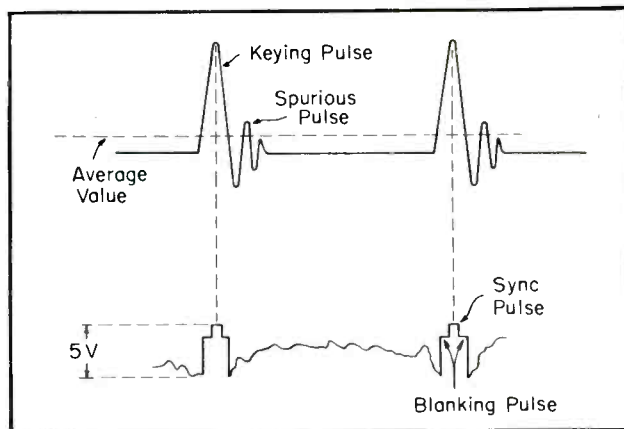
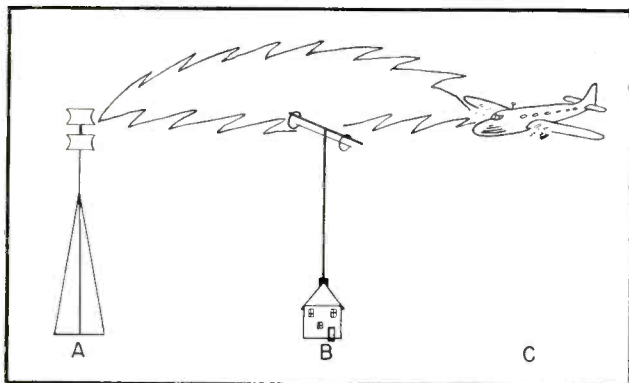

Fig. 2. Time relation between the sync and keying pulse. Sync pulse has been drawn larger than it actually is in relation to the flyback pulse (about 1/50 the height of the flyback pulse), to present a clearer illustration. Duration of both pulses in relation to rest of the individual line has also been exaggerated to show their appearance.



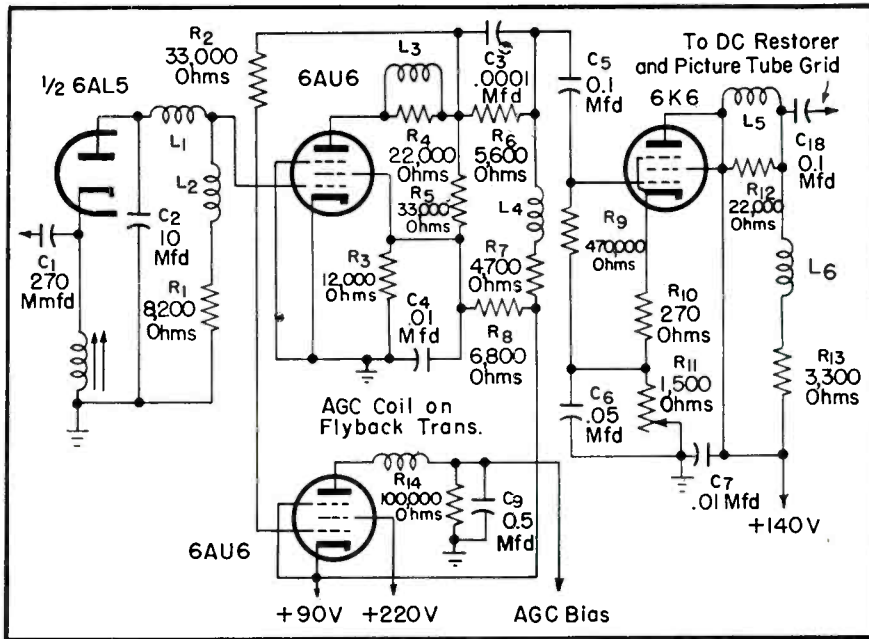

Fig. 3. Video amplifier with two video stages, in which a direct connection is made from the second detector to the grid of the first video amplifier to preserve the *dc* component.

that practically all types of noise consist of sharp pulses of very short duration. It is the average *dc* voltage obtained from the rectification and filtering of constantly recurring noise pulses that determines the bias on the amplifier tubes. A single noise pulse alone will not upset the bias at all, but where noise is continuous and strong enough to appear in the television picture it will also have an effect on the bias.

When a TV signal is reflected and reaches the receiving antenna exactly in phase with the direct signal, it will increase the amplitude of the total signal received. If the reflected signal is out of phase with the direct signal, by about 180°, it will reduce the total signal received. When a radio wave is reflected from a moving object, the phase of the reflected signal changes

as the object moves. This is called the *Doppler* effect and is used in certain types of radar where the speed of a plane is found by the phase or frequency difference of radio waves reflected by it.

A concrete example is the case of an airplane flying at 300 mph away from the receiving antenna, as illustrated in Fig. 1. For simplicity in calculating, let us assume that the transmitter, the airplane and the receiving antenna are all of the same height. Obviously two different signals can be received at *B*: one directly from the transmitter at *A*, and one reflected from the plane at *C*. If it is assumed that the station broadcasts at 200 mc, the wavelength of this signal is 1.5 meters. The speed of the airplane, translated into the metric system, would then be 135 meters per

second:  $135/1.5 = 90$  cps. This, then, is the difference frequency created by the motion of the plane. As far as the receiving antenna is concerned, however, the difference frequency is twice 90 or 180 cps, because the plane moves away, not only from the transmitter, but also from the receiver. This flutter frequency is the frequency at which the signal strength of the total received signal varies between the sum and different of the two. Naturally, any *agc* system, which is required to filter out variations occurring in 1/60 of a second, cannot compensate for variations every 1/180 of a second.

Actual field tests have shown that the higher flutter frequencies encountered are about 100 cps, due to the fact that the receiving antenna is never as high as the transmitter or an airplane and because of other practical considerations. Thus, an *agc* system, which could compensate for signal strength variations occurring in about 1/100 of a second and which would not be activated to any great extent by random noise pulses, constitutes another receiver improvement.

To provide this result a keyed *agc* system was evolved. In operation, the picture signal with the *dc* component present is fed to the grid of a pentode, usually a 6AU6, in such a manner that the sync pulses drive the grid more positive. The cathode of this *agc* tube is about 90 to 145 volts, positive, with the plate at *dc* ground potential. A portion of the horizontal flyback pulse is applied to the plate through a coupling network from the flyback transformer. During the peak period of this pulse, the tube conducts since the plate is then made sufficiently positive with respect to the cathode. A voltage divider maintains the grid a few volts negative with respect to the cathode, biased closely to cutoff.

[To Be Continued in Feb. SERVICE]

Fig. 4. Illustration of noise pulses, where *D* = *agc* tube cutoff and *O* = video tube cutoff. The  $E_g I_p$  curve is for the first video stage.

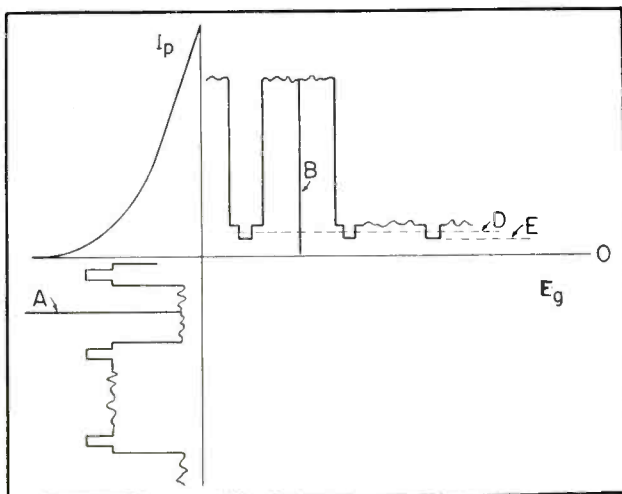
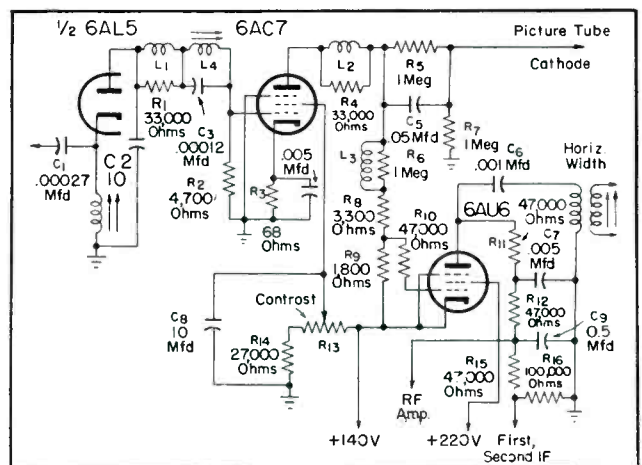
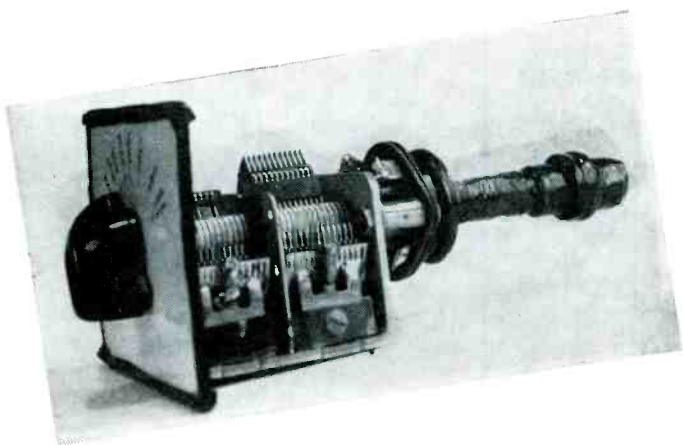

Fig. 5. Keyed *agc* circuit with single stage of video where cathode of picture tube is driven with picture signal. A 33,000-ohm resistor is used to reduce effect of peaking.





**How to Build Instrument Which Has Been Found to be Excellent for Testing and Alignment of Oscillators in Standard Type Broadcast Receivers.**

Left: Complete wavemeter.

# WAVEMETER For AM Chassis Oscillator Tests

by **LEONARD J. EISNER**

*Teacher, Radio Mechanics*

*Chelsea Vocational High School, N.Y.C.*

OSCILLATORS that do not operate at the correct frequency present quite a problem to Service Men. In a superhet receiver, oscillators off frequency can not only cause squealing or double spot tuning, but limited tuning with only a few stations being received at either the higher or low end of the dial. It may be assumed that the trouble lies in alignment, but alignment will not correct the trouble. It is the frequency of the oscillator that is usually at fault and must be checked and corrected.

Present practice, in determining if the oscillator is working, involves measurement of the bias across the grid-leak resistor. To measure oscillator bias a high resistance 20,000-ohms-per-volt or *vvm* must be used; the probe of the *vvm* goes to the oscillator control grid. Zero bias indicates an inoperative oscillator, whereas -4 to -15 volts indicates that the oscillator is working. A shorted oscillator tuning capacitor, an open oscillator

coil or a defective oscillator section of a converter tube can cause an oscillator in a superhet to stop oscillating. Sometimes an oscillator will stop functioning at one end of the dial, because of a weak tube or shorted plates in the oscillator tuning capacitor. Therefore, it is wise to tune through the broadcast band, while measuring the bias. Usually you will find the oscillator bias increases slightly as you tune to the high frequency end of the dial.

Oscillator bias serves as a check on oscillator operation, because oscillators produce their own bias only when operating. Thus, if an oscillator is working, the signal will drive the control grid alternately positive and negative causing grid current to flow through the grid-leak resistor, which in turn produces the bias voltage.

\*Meissner 14-4034. \*\*Eby.

When the oscillator is not working there is no signal, and the result is no grid current and thus no bias. The *vvm* can only disclose whether the oscillator is working; it cannot indicate at what frequency the oscillator is working.

The frequency of an oscillator is determined mainly by the inductance and capacitance of the tuned circuit; if an oscillator has changed frequency something must have happened to the elements of the tuned circuit. Should an oscillator coil develop shorted turns, which might even be caused by soldering iron burns, there would result a change in inductance and thus a change in frequency. If an oscillator coil were replaced with another one, the replacement coil could be checked by a wavemeter.

## Component Requirements

A wavemeter is simply a tuned circuit (coil and tuning capacitor) that

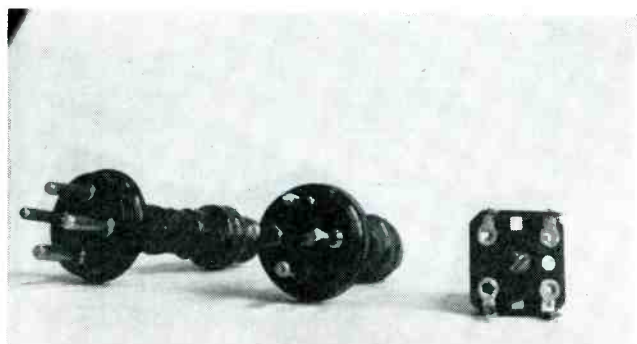
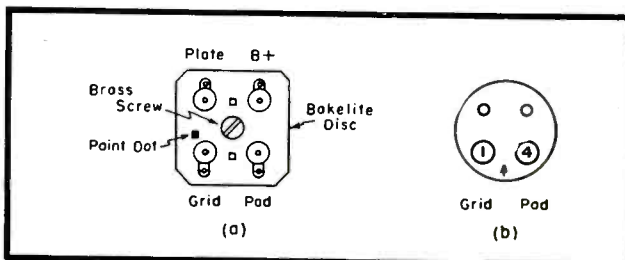
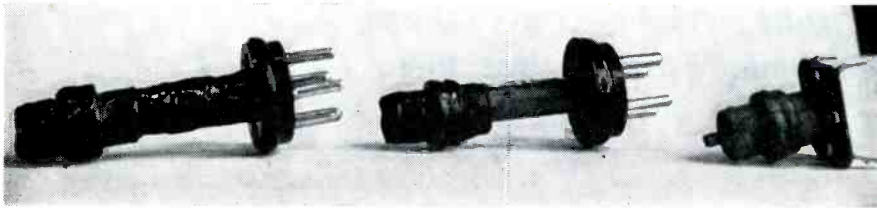

Fig. 2. View of coil bases and socket used in wavemeter.

(Below)

Fig. 1. Layout of coil and plug used in wavemeter.





Left: Wavemeter coils.

has been calibrated. To construct such a unit standard components can be used: Unshielded oscillator coil\*; two gang (420-120 mfd) superhet counter clockwise (close left) variable; four prong wafer socket; and a four prong plug.\*\*

To permit use of the wavemeter to reach in tight spots, the coil can be extended with a section of a dowel between the coil and four prong socket. A hole should be drilled through  $1\frac{1}{4}$ " length of dowel to receive a  $6/32-1\frac{1}{2}$ " machine screw. Any tubing can be used such as an old test prod; this would eliminate drilling of the hole. The plate and B+ leads of the tickler coil can be cut since this winding is not used; Fig. 1. The padder and grid leads should be unsoldered from the lugs on the oscillator coil and extended the length of the dowel. Then the brass screw should be taken out and the bakelite disc removed. Now, the coil, dowel, and 4-prong plug should be joined with the  $6/32-1\frac{1}{2}$ " machine screw. Next, the two leads should be soldered to the two flat prongs of the plug; the grid lead to pin 1 and the padder lead to pin 4. Scotch electrical tape should be used to protect the coil, stretching while taping the complete coil.

The four-prong socket must be mounted on the back of the tuning capacitor to receive the coil. You will probably find that no holes need be drilled to mount the socket. There are usually two holes perfectly spaced for the socket on the frame of the gang variable. To mount the socket two  $\frac{5}{16}$ " lengths of tubing, made of any substantial material such as metal, wood or bakelite, should be used. A solder lug should be placed next to pin 4 on the socket and pin 4 wired to the solder lug. Next, the stator of the oscillator section of the tuning capacitor should be wired to pin 1 of the four-prong socket. Plugging the coil into the socket will place the coil right across the oscillator tuning capacitor.

#### Dial Plate Construction

To complete the construction of the wavemeter, a piece of  $2\frac{1}{2}$ " x 3" sheet-metal, aluminum, or bakelite should be secured for the dial. This plate should be attached with two flat-head ma-

chine screws and nuts to the front frame of the tuning capacitor. Rubber cement should be used to paste a piece of paper on the plate for the dial. Lastly, a knob should be placed on the shaft that has a pointer.

To calibrate the wavemeter the coil should be plugged into the socket to complete the tuned circuit. The wavemeter need only be calibrated at both ends of the broadcast band; if the oscillator is working at the correct frequency at the low frequency end of the dial and at the high frequency end of the dial, then it must be able to work over the middle portion of the dial. To calibrate, a superhet whose *if*'s have both been accurately aligned to 455 kc, can be used. A *vtvm* should be connected across the oscillator grid-leak resistor. The receiver should be tuned to a station at the low end of the band (570 kc, if possible). The coil of the wavemeter should then be coupled to the receiver's oscillator coil and the wavemeter tuned at the low frequency end of the dial, for the greatest dip on the *vtvm*. The wavemeter must not be coupled too closely to the oscillator coil in the set; it should be just close enough to obtain a small dip. This point should be marked on the dial of the wavemeter; identity can be in the form of a number, frequency or station call. Since any oscillator in a superhet on the broadcast band always operates higher than the incoming signal by the amount of the *if*, the wavemeter at this point will be tuned to  $570 + 455$  or 1,025 kc. Next, the receiver should be tuned to a station at the high end of the band (about 1,600 kc). The wavemeter should be coupled to the receiver oscillator coil and the wavemeter tuned at the high frequency end of the dial for the greatest dip on the *vtvm*. This point should also be noted on the wavemeter. Now, the wavemeter is really tuned to the incoming signal plus the *if* or  $1,600 + 455$  or 2,055 kc. This may be repeated for as many stations as you desire, although the two ends of the broadcast band would be sufficient.

#### 455-260 Kc IF Uses

The wavemeter is useful for checking the frequency range of oscillators in superhets with 455 kc *if*'s. Since

the majority of receivers use a 455 kc *if*, this coil will fill the bill. If desired another coil can be calibrated for a 260 kc *if*; this will allow checking of the oscillator in nearly every superhet receiver.

#### Applying Wavemeter

To use this wavemeter the receiver under test should be tuned to approximately 570 kc. A *vtvm* should be connected across the grid-leak resistor, and the wavemeter coupled. An indication should be obtained when the wavemeter points close to the low point on the dial. Next, the dial of the receiver should be tuned to 1,600 kc, and the wavemeter coupled. A dip should be obtained close to this high point on the dial of the wavemeter. If the low frequency end of the dial cannot be received, insufficient inductance or capacitance will be the trouble. If the high-frequency end of the dial cannot be received, too much inductance or too much capacitance will then be the problem. These troubles may be caused by improper alignment, wrong size oscillator coil or incorrect padder. If, it is found, that the low or high-frequency end of the band cannot be received, alignment can be tried using the wavemeter.

#### Alignment Procedure

To align the oscillator of the superhet receiver with a wavemeter, the dial of the set should be tuned to 570 kc and the wavemeter adjusted to the low dial point. The *vtvm* should be connected across the oscillator grid-leak resistor. The wavemeter should then be coupled and the padder adjusted for maximum dip on the *vtvm*. If the oscillator has cut plates, there will be no padder and alignment will only be necessary at the high-frequency end of the dial. The dial of the receiver should be set at 1,600 kc and the wavemeter set to the high point on the dial. The oscillator trimmer on the tuning capacitor should be adjusted for maximum dip on the *vtvm*. Once the oscillator has been aligned, the *rf* trimmer and the *if*'s can be touched up on a weak station for greatest output.

**Revealing Review of Deductions Which Service Shop Operators Can Take and Methods Which It Has Been Found Can Simplify Form Preparation.**

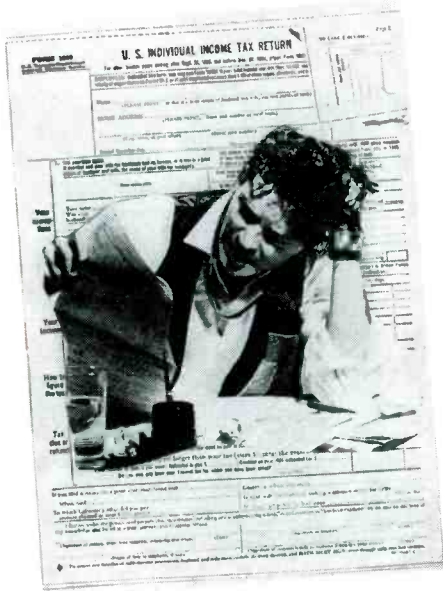

# The Service Man and His INCOME TAX

by WYN MARTIN

No need for fretting on or before March 15, if the suggestions offered in this interesting article are followed.  
(Photo Courtesy Markstein News Service)

THE INNUMERABLE COMPLEXITIES of income tax have always plagued everyone. In servicing, there has been one phase of the tax problem which has completely puzzled the boys; *legitimate deductions*.

## Deductible Expenses

There are many items that are deductible. For instance, all parts bought during the year represent a business expense, and a deductible item. Also, all service charges paid, such as postage, freight, express, telephone and telegraph fees, rent, light and heat. One item often overlooked is bad debts. They are all deductible from your tax, and thus a careful record should be kept of them. If one of these bills should be unexpectedly paid at a later date, the income becomes taxable during the year the bill was paid. If legal talent is required for bill collecting, all fees incurred are an allowable deduction.

## Taxes; State and Federal

The cost of your automobile license, occupation tax, if any, driver's license, and in some cases, state gasoline tax, are also all deductible expenses. Losses from fire or theft, and damages from collision, if not covered by insurance, are also fully deductible. By the way, insurance carried on your shop,

truck or equipment is also fully deductible.

## Other Expenses

If a truck or car is used entirely for shop work, all of its operating expenses, gas, oil, tires and repairs, are deductible. If the car is partially used for business and for pleasure, or let us say fifty per cent of the time for each, half of the upkeep is deductible. Traveling expenses incurred while attending service meetings or business trips are also deductible. Stationery, letterheads, advertising and other services are also fully deductible.

## Depreciation

Each piece of your test equipment which represents quite an investment has deductible aspects, too, deductions being made in periods; proportionate percentages each year until the whole cost has been deducted. For instance, a tube-tester costing \$100 may be considered by you to have a useful life of five years. Thus, \$20.00 per year may be deducted on this instrument. If the unit lasts six or seven years, no more deductions may be taken. All test equipment, trucks, or other shop equipment that would fall in the same category, may be treated in the same way. Hand tools lost, strayed or stolen dur-

ing the year are also deductible expenses.

## Keeping Records

There is no royal road to learning, neither is there any paved road for preparing easily an income tax return! It all depends on how faithfully you have kept up your records during the previous year. Quick, accurate totals for each and every item of deductible expense must be available, if you don't want to spend a hard week trying to figure out how much you owe Uncle Sam!

There is an easy way to get all these figures, however. A small ledger or day-book is sufficient. One should be purchased at the beginning of the year. Pages should be set aside and titled *Automobile Expenses, Parts, Lights, Heat, Rent, Office Supplies, Salaries*, etc. Each and every time money is spent or a bill is paid, you must remember *not* to close that drawer until that amount is entered in the appropriate page of the ledger. At the end of the year you can then pick up the little book, sit down with an adding machine, and your whole totals will be available in less than a half hour. Your gross income can be figured just as quickly from your daybook, or from your sales-tax returns, if you have to make them. There you have all the figures necessary for making out your own return, if you want to try it; if not, an income tax man may be called in to help. These men can be found

(Continued on page 30)

\*Based, in part, on data prepared by Jack Darr.

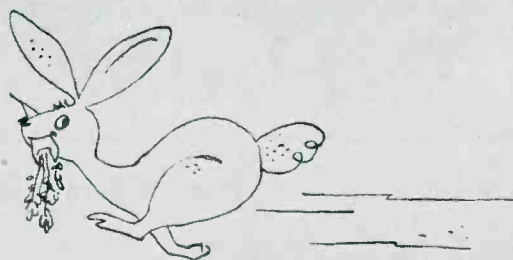

# FAST

## KESTER "RESIN-FIVE" CORE SOLDER

**FAST** . . . On Every Soldering Job

Kester has two Solders for you . . . Kester "Resin-Five" Core Solder, the newest development, and Kester Plastic Rosin-Core Solder, the old reliable.



- Diameters of 1/16 inch and smaller available, besides the 3/32 inch.

Either product, but especially "Resin-Five," does the work fast, enables you to get the job out quickly and make room for more of that profitable servicing.

With Kester "Resin-Five" Core Solder, the flux being of the activated Resin-type, you can solder anything and everything . . . even those badly oxidized parts! Yet, "Resin-Five" Flux is absolutely non-corrosive and non-conductive.

Your Jobber has Kester! Be sure to ask for "Resin-Five" or "Plastic Rosin" . . . they are the genuine Kester products.

**KESTER SOLDER COMPANY**

4248 Wrightwood Ave., Chicago 39  
Newark 5, New Jersey • Brantford, Canada



# AUDIO installation and service

## Phono-Tape-Wire-PA-Amplifiers-Speakers

by KENNETH STEWART

MAGNETIC RECORDING, which has become one of the liveliest members of the audio circle, is expected to rise to striking heights of popularity during the new year.

Whereas only a short time ago, but a few companies were involved in magnetic-recording activities, today there are over a score in the field engaged in developing and producing a wide assortment of models for every possible application in the home and for the professional world.

Fundamentally, the art of magnetic recording is old, dating back from the last century. But then, no one seemed to know how to apply the principle in a practical way. Since '45, there have appeared a host of ingenious solutions to the problems which so stumped the early experts, resulting in simplified gear, capable of exceptional results.

Magnetic recordings can be made in any type of material which permits a varying degree of permanent magnetization and which is mechanically

### Magnetic Recording\*: Principles of Recording . . . Features of Tape Systems . . . Highlights of New Audio Products: Radial Reentrant Speakers . . . Hi-Fi and Coax Speakers

stable and physically formed in a fashion permitting it to be handled in a reeling and scanning mechanism. The process of making a magnetic recording is basically one of moving the recording material at a fixed rate of speed through a station, which functions to impress upon the material the desired magnetic state. In the reproducing process, the requirement is to move the material at the same rate of

speed as in the recording process through the reproducing station, whose function is to derive from the magnetic state of the material a signal voltage which can be amplified in the electronic section of the recorder to produce a usable audio power.

Magnetic recording also lends itself to a further basic operation, which provides a unique advantage over almost any other type of recording. This is the erasing principle. Since a mag-

(Continued on page 41)

\*Based on copyrighted data appearing in the Brush service manual on the Soundmirror.



Hi-fidelity speaker, one of a group in which are included an 8" model with a 6.8-ounce magnet and 1" voice coil diameter and 10" model, also with a 6.8-ounce magnet, and 1" voice coil diameter. Both can handle 10 watt outputs. There are also two 12" models with 6.8-ounce magnets and 10-power handling watts. Also available is a 12" speaker with a 14-ounce magnet, and 1 1/2" voice coil diameter. Model has 25-watt output capability. Each of the speakers has a voice coil impedance of 8 ohms. (Oxford Electric Corp., 3911 S. Michigan Ave., Chicago 15, Ill.)

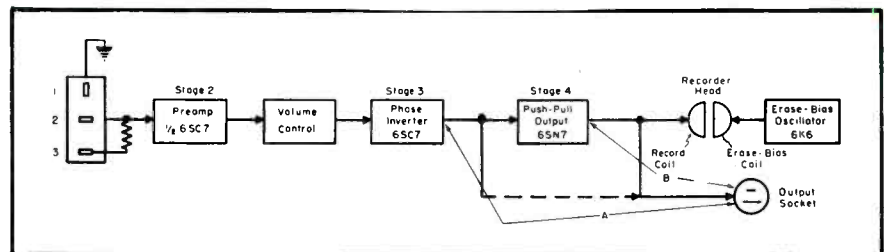
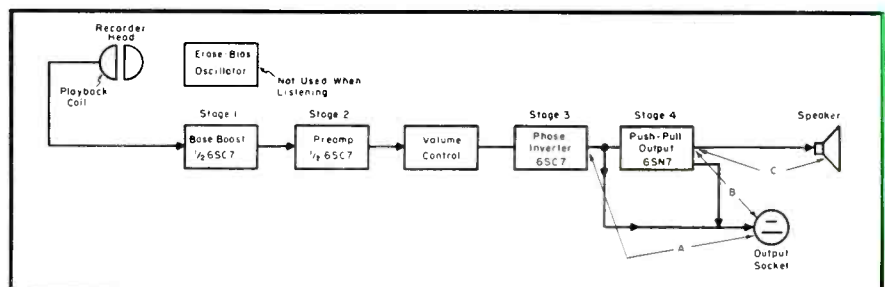

Fig. 1. Block diagram illustrating path of signal when recording on magnetic system. *A* represents high-impedance position 3 of the output selector switch in the Webster-Chicago 210 tape unit, while *B* is the 500-ohm position 2 of the output switch.

Fig. 2. Block diagram illustrating path of signal when playing back on a tape unit of the type shown in Fig. 1. Here *A* is also the high-impedance position 3 of the output-selector switch, while *B* represents 500 ohms and 2-watts of audio at position 2 of the switch. Diagrams shown in Figs. 1 and 2 can be used as guides to localize defects that might be present in system.



THEIR CHOICE IS

Regency

WALLACE E. CARROLL  
PRESIDENT SIMPSON ELECTRIC COMPANY  
RAY SIMPSON  
CHAIRMAN OF THE BOARD  
PHOTOGRAPHED IN MR. CARROLL'S HOME

LARGEST SELLING BOOSTER AT ANY PRICE

CURTOM BROWNE ADVERTISING

# No fuss



## When you use Centralab's Exact Replacement Controls



Why waste time "tinkering" with kits . . .



when you can get exact, quickest-for-servicing,  
custom replacement controls for TV - AM - FM . . .

**There's a Centralab Custom Control — or Standard *Blue Shaft* Unit that's Quickest for Service.**

Service Engineers! Centralab's famous Blue Shaft and Custom Controls are exclusive service items. You'll find Blue Shafts available in a complete line of plain and switch types with resistance ranges from 500 ohms to 10 megs. in a wide variety of tapers and

tapped units! All Centralab controls are packaged singly. Blue Shafts are also available in handy plastic boxes of 12 and in a special metal cabinet containing 22 controls. NO EXTRA charge for the cabinet.

Check These LOW PRICES on Popular Blue Shaft Controls!

Cat. No.	Ohms Max. Resistance	Taper	Circuit Location	List Price
B-60	500,000	C-2 (audio)	Volume or Tone	\$1.00
B-60-S*	500,000	C-2 (audio)	Volume or Tone	\$1.50
B-70	1 megohm	C-2 (audio)	Volume or Tone	\$1.00
B-70-S*	1 megohm	C-2 (audio)	Volume or Tone	\$1.50

\*Switch Type

Ask your jobber or write direct for Bulletin 42-106 on Blue Shaft Controls. Send 25c for Centralab's TV and Custom Control Guide.

# Centralab

Division of GLOBE-UNION Inc.

908 E. Keefe Ave. • Milwaukee 1, Wisconsin



# No CUSS

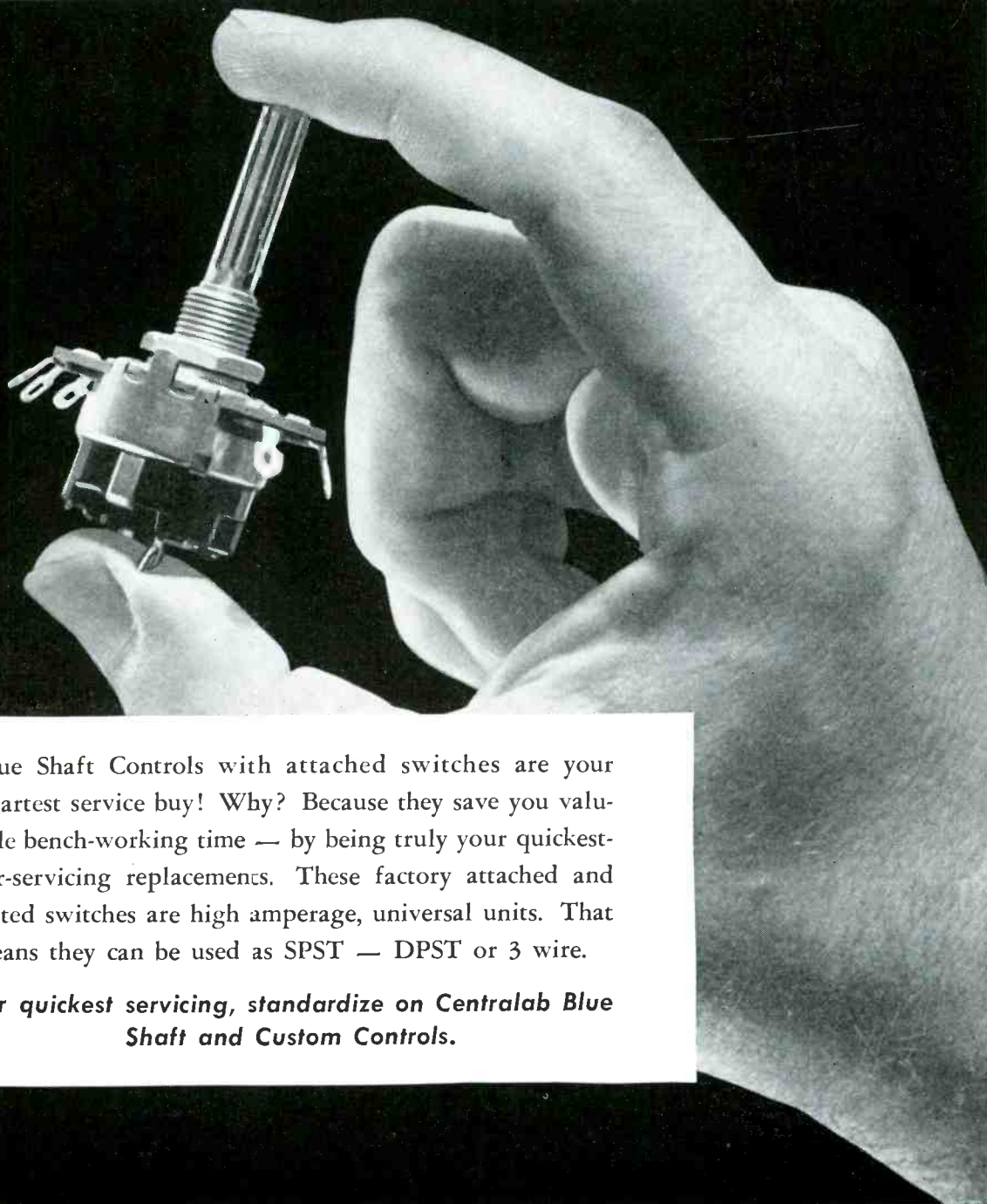

Blue Shaft Controls with attached switches are your smartest service buy! Why? Because they save you valuable bench-working time — by being truly your quickest-for-servicing replacements. These factory attached and tested switches are high amperage, universal units. That means they can be used as SPST — DPST or 3 wire.

***For quickest servicing, standardize on Centralab Blue Shaft and Custom Controls.***

**Remedies for Poor Focus or Dark Pictures . . .  
 Replacement Precautions for 5642s . . . Auto Radio  
 Antenna Compensator Adjustment . . . Fogged Dial  
 Crystal Cures . . . Anode-Lead Breakdown Protection  
 . . . Improving Vertical Hold and Vertical Bending**

# Servicing Helps

WHEN POOR FOCUS or a very dark picture is observed on Sylvania 1-168 chassis (CB19 and up) it may be due to little or no voltage being supplied to the screen grid (pin 10) of the picture tube. Additional symptoms of this condition are that the ion trap magnet adjusts to a position far out of normal and the brightness and contrast controls must be turned full on. To cure,  $C_{20}$  (.00015-mfd 1,000-v mica) and  $V_{20}$  (6X4 picture tube screen-supply rectifier tube) should be checked.

### Replacement of 5642 Tubes\*

When replacing 5642s, special care must be taken to center the tube be-

by **M. A. MARWELL**

tween the terminal lugs so that the lead length between the tube and lug is equal for all three leads. This will decrease the risk of soldering too close to the glass which may otherwise cause a defective tube. All solder joints on the tube leads or anywhere in the *hv* section should be formed with a well rounded ball of solder. Sharp point

edges will cause corona and must be removed.

### Fogged Dial Crystals

Fogging of the dial crystal on Admiral table models 5J21, 5J22 and 5J23 has been reported and found due to chemical reaction of the plastic crystal to the plastic used in the dial pointer.

To eliminate this condition the manufacturer has substituted a pointer using a different plastic and a shorter hub ( $\frac{3}{16}$ " instead of  $\frac{5}{16}$ ").

When replacing the dial crystal (23D82), it will also be necessary to

(Continued on page 26)

\*From Sylvania service notes.

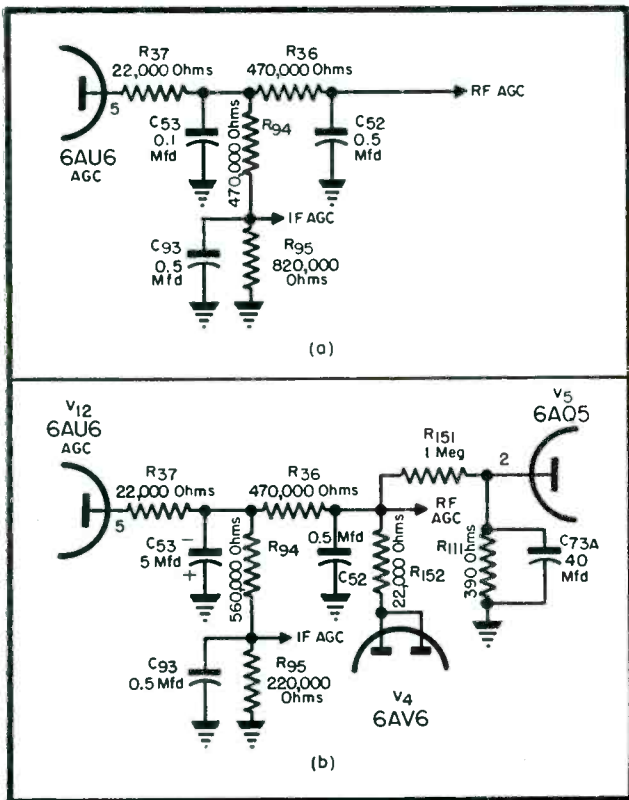
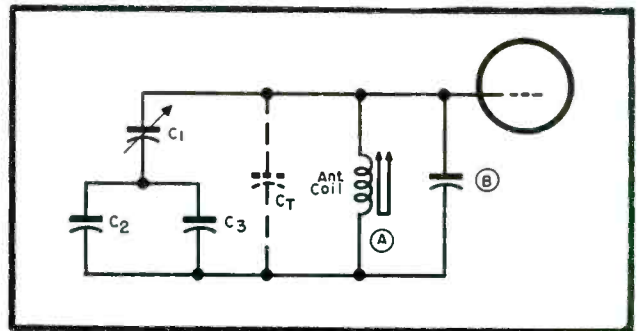
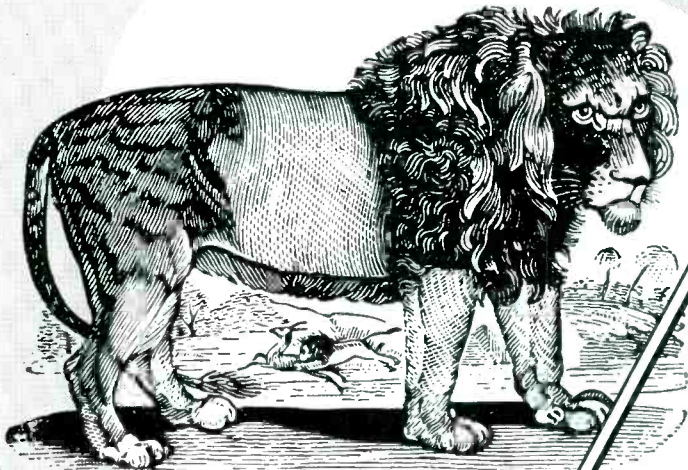

Fig. 1. Standard (a) and revised (b) circuitry of Wells-Gardner TV chassis (Ward, Western Auto, Gamble-Skogmo and department store models), corrected to provide improved signal-to-noise ratios in fringe areas. Changes include new values for  $R_{94}$ ,  $R_{95}$  and  $C_{53}$ ; 560,000 and 220,000 ohms and 5-mfd dry electrolytic. Two additional resistors are also involved:  $R_{151}$  and  $R_{152}$ , with values of 1 megohm and 22,000 ohms.

Fig. 2. Circuit illustrating how auto-radio antenna compensators are adjusted.  $C_1$  is the antenna compensator,  $C_2$  the antenna-to-ground capacity, and  $C_3$  antenna cable capacity.  $C_T$  represents the total effective capacity of the antenna system and compensator as it appears across the tuning circuit, where  $C_T = C_1 (C_2 + C_3) / C_1 + (C_2 + C_3)$ .  $B$  represents coil capacitance, input capacitance of tube, distributed wiring capacitance, and fixed padder, if used.





## ELIMINATES ONE MAN!

The RADION "Metropolitan" outdoes our Friend Leo above . . . RADION eliminates one installer in many cases in areas where most TV set sales are made . . . but RADION saves you the valuable services of this eliminated installer to handle different installations or profitable repair work or even selling on the floor. Your RADION installations are fast, and economical and they save your customer a pretty penny on installation . . . in many cases saving the sale for you! Over 2,000,000 RADION installations prove RADION'S ability to deliver the goods while selling the goods for you. Write today!

# Radion

The Radion Corp., 1130 Wisconsin Ave.  
Dept. E-1, Chicago 14, Ill.

Send me free "8 ways to profit with Radion"

Name \_\_\_\_\_

Firm \_\_\_\_\_

Address \_\_\_\_\_

Columbia

# New TV Service Light—

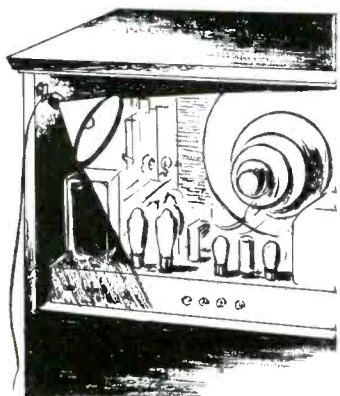

Every Serviceman needs this television service light!



**Includes:**

- 7 watt—110 V bulb
- Non-breakable reflector for good illumination
- 6 foot cord with plug
- Rubber suction cup which holds firmly to any flat surface—ideal for servicing
- Takes very little room inside TV cabinet. Throws light just where you want it. Keeps both hands free to work.

INDIVIDUALLY BOXED. Each service light is packaged in light-weight durable box, easy to carry on service calls.

Have YOU seen our NEW Television SERVICE CORD?

"Columbia" Products are carried by leading Jobbers!

Write for our Plant-Facility Brochure.

Columbia

**WIRE & SUPPLY CO.**

2850 Irving Park Road • Chicago 18, Ill.

"National distributors and warehouse for ANACONDA denseath television and radio-wires and cables"

## Servicing Helps

(Continued from page 24)

replace the pointer (25A31-1, -2 or -3) with a new pointer (25A31-5, -6 or -7).

The defective parts can be identified by a *sour milk* odor when scraped with a knife. The new pointers have no appreciable odor.

### Stromberg-Carlson Note

**Anode Lead Breakdown Protection (Model 317 Series):** To reduce the possibility of breakdown between the high voltage anode lead and chassis, a grommet has been inserted in the chassis at the point where the anode lead leaves the high-voltage case.

### Improved Vertical Hold

The vertical hold action of Stewart-Warner 19-tube chassis can be improved by adding a 10-megohm ½-watt resistor from pin 4 of the 6SN7GT sync amplifier tube to 140 *v B+*.

Model 9202 receivers which contain the letter *G* in the series coding, 9203 receivers which contain the letter *D* in the series coding and 9204 receivers which contain the letter *E* in the series coding incorporate this modification.

### Vertical Bending

In moderate or strong-signal areas, vertical bending may be encountered on Stewart-Warner 9202 series of receivers, which include the letter *F* in the series coding. In that particular series of receiver, the 27,000-ohm isolating resistor (219) was removed from the plate circuit of the 12AU7 phase-splitter tube. That action was taken to further improve sync stability in weak signal areas, but vertical bending may then be encountered on those receivers located in medium or strong signal areas. To overcome this bending action, the resistor should be reinserted.

### Inoperative Battery/AC Portable Cures

Often battery/ac portables have been found to be inoperative on *ac*.

In the Sentinel 312, this has been found to be due to low line voltages (less than 112 volts) which cause the 1R5 oscillator tube to stop oscillating. To remedy, the 1R5 and the selenium rectifier should be replaced. With a good 1R5 and a good selenium rectifier the set should function when operating at 105 volts.

Sets that operates on the shop bench correctly may not operate in the customer's home because of low line voltage. This is especially true in rural

## ASTRON CAPACITORS



No shelf-warmers; no comebacks—for smooth, sweet SERVICE all the way, use ASTRON capacitors on your next job—they DO MORE!

Have YOU sent for our new Catalog AC-3 with its wealth of educational data? Write for this helpful material today.

**ASTRON CORPORATION**  
255 Grant Ave. East Newark, N. J.

## PERFORMANCE Not Size IS WHAT COUNTS

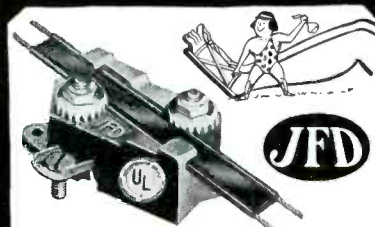

## "LITTLE GIANT" LIGHTNING ARRESTER

PROTECTS Against Lightning Hazards

No. AT 105

For ribbon-type and oval jumbo twin lead.

\$125 LIST

ONLY JFD Lightning Arresters offer you these exclusive patented features . . .

1. Strain-relief Retaining Lip prevents pulling or straining of lead against contact points.
2. You actually see positive contact made with lead-in wire.
3. No wire stripping or cutting.

Write for Form No. 84 showing the damage lightning can do to a Television Installation.

**JFD MANUFACTURING CO., Inc.**  
6109-A 14th AVENUE, BROOKLYN 4, N. Y.  
FIRST in Television Antennas and Accessories

areas. Because of this possibility every *ac/dc* battery set employing 1.5-volt tubes should be checked on low line voltage. A *variac* or other line reducing equipment should be used for this purpose.

**Auto-Radio Antenna Compensator Adjustment†**

In preparing for the adjustment of auto-radio antenna stages it is important to remember that the circuitry and performance of this input section are affected by the antenna and lead-in. In designing the front end of auto chassis, the capacitance of the antenna, the antenna-to-car body, and the lead to braid ground are taken into consideration as part of the tuning capacitance. These factors are as much a part of the antenna tuning circuit as the coil and fixed padder, and probably of more importance than such items as tube input capacity and wiring capacity.

The antenna compensator plays a key role since its purpose is to equalize the capacitive effects of the antenna system of a particular car to the proper value necessary to make a given receiver track properly. This value of external capacitance will vary from car to car, as will the value needed by the radio's antenna system, due to variations in coil capacity, tube-input capacity, distributed wire capacity, etc. When the set is engineered, a set of average or center line values are established. The antenna tuning circuit is designed with less capacity than is necessary for the circuit to tune. The remaining capacity is made up of three constants, as illustrated in Fig. 2 (p. 24);  $C_1$ ,  $C_2$  and  $C_3$ . The midpoint value of  $C_1$  is chosen so that it, added to the average values of  $C_2$  and  $C_3$ , in various installations, will make up the remaining necessary capacitance. Since all values were chosen with reference to the midpoint value of  $C_1$ ,  $C_1$  can be adjusted to compensate for variations of individual radios and installations.

Therefore, if the set is to operate at maximum efficiency, the final antenna stage adjustment must be made with the set installed in the car, the antenna lead-in connected, and the antenna fully extended. This adjustment should be performed by using a weak station at or near 1,400 kc; tuning the antenna compensator for maximum.

If this adjustment is not made, even though the receiver has been carefully aligned on the bench, the set may not track properly, may suffer great loss of sensitivity and selectivity, and may be noticeably poor on image rejection.

†Based on Philco service notes.



**YEARS AHEAD**



**360° ELECTRONICALLY SWITCHED BEAM**

**GIVES SAME CLEAR PIX AS MOTOR DRIVEN AERIALS AT 1/3 THE COST**

**SIMPLE FLICK OF SWITCH CLEARS PICTURE INSTANTLY NO WAITING**

**OPENS BIGGEST REPLACEMENT MARKET IN TV HISTORY**

**MAIL THIS COUPON TO-DAY!**

**SNYDER MFG. CO.**  
22nd & Ontario Sts., Phila. 40, Pa.

Please send me free copy of authoritative booklet **TENNA TIPS** on Directronic and all other types of aerials, plus catalogs.

NAME \_\_\_\_\_  
ADDRESS \_\_\_\_\_  
CITY \_\_\_\_\_ ZONE \_\_\_\_\_ STATE \_\_\_\_\_



**NO MOTORS OR MOVING PARTS**



**NO ROOF ORIENTATION**



**NO ELECTRIC POWER**



**NO GHOSTS**

**FREE**



**TENNA TIPS**

PRICE 50c

## PHOTOFACT Users Write Our Best ADS!

Hundreds of unsolicited letters tell what the world's finest Radio & TV Data means to Service Technicians

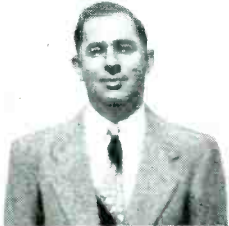

V. J. Major  
815 Westboro Ave.  
Alhambra, Calif.

"I find the way PHOTOFACTS are laid out most convenient to use. Best of all, easy on the pocketbook."



Henry E. Sims  
12A Belleview Ave.  
Oceanside, L.I., N.Y.

"I would like to express my thanks to you for the PHOTOFACT Folder Sets. I have never seen such a complete source of servicing information for such a small cost. PHOTOFACT Folder Sets enable me to maintain a service reference library of only sets I come in contact with, without having to purchase expensive volumes containing information on sets I'd never use. Thanks again for a wonderful job."



Milton A. Sizer  
641 N. Harvey  
Oak Park, Ill.

"I like your service very much and appreciate especially your simple alignment methods."

### NOW! GET THE PROOF FOR YOURSELF!

**FREE**

We'll send you a Free Photofact Folder on any receiver listed in "PF Index & Technical Digest."

Learn for yourself—at our expense—how PHOTOFACT pays for itself by earning bigger repair profits for you! Select any Folder from the PF Index (if you haven't an Index, get a free copy from your distributor). When you write us for your Free Folder, be sure to state Photofact Set and Folder Number as shown in the Index. Get your Free Folder now. Examine, use, compare—see why you can't afford to be without PHOTOFACT!

**HOWARD W. SAMS & CO., INC.**  
2201 East 46th Street • Indianapolis 5, Indiana

## Business Aids . . .

[In response to many requests, arrangements have been made to feature every month in SERVICE a column devoted to a discussion of Business Aids for the Service Shop, based on queries submitted by readers of SERVICE. Topics to be reviewed will include advertising, bookkeeping, customer relationship, filing systems, displays, direct mail, etc. These columns are being conducted by a veteran Service Man with over a quarter of a century experience in the field, who is currently operator of a large Service Shop, and is also extremely active in association affairs. If you have a business-aid problem, send it to ye editor, and every effort will be made to publish a solution in an early edition of SERVICE.]

Dear Editor:

Being in business for myself for the past year, I find now that I'd like to do some advertising directed to my old accounts and to new prospects. I can't afford to carry on a large and extensive program, but I can spend a limited amount of money each week. Do you have any suggestions? Incidentally, we have two local newspapers, two AM and two FM stations in this city of about 200,000 population.—P. K.

Dear P. K.:

With your small and limited funds and your desire to contact your past customers and new accounts, the most practical approach would be a direct-mail campaign. This would permit you to spend your weekly advertising appropriation to the best advantage.

Direct-mail items which can be used to advantage include:

(1) A series of promotional postal cards which are available from most tube and some set producers. These cards are both colorful and carry an attractive message on your behalf. If ordered in considerable quantities, the companies will imprint your name on the card in the space provided, for a small fee. In most cases these cards are available gratis, other than cost of the postage.

(2) Your own postal cards. With the use of a postal-card mimeographing machine, your own message, tailor-made to suit your purpose, can be imprinted. The machines cost around \$15 at stationary supply shops.

(3) A series of form letters and envelope stuffers which are also available from some manufacturers.

(4) A two-faced postal card, which is also a desirable item to use if you wish to solicit direct answers, or to make a survey.

The foregoing ideas will produce best results if a substantial mailing list is available. In addition to your customer file, you can use local telephone books, voters registration lists, or a special telephone street directory available for a monthly rental charge. The best time for mailing is before special events, such as elections, football classics, and baseball series, or in the very late summer or

(Continued on page 31)

## DRAKE PeeWee

the mighty mite with  
a PROFITABLE future



Yes sir! PeeWee in your kit means saved time—extra profits. A full 35 watts, with 3/16" tip, the Drake PeeWee gets right into those tight corners—has baffle plates to keep handle cool. Order from your distributor now.

**DRAKE ELECTRIC WORKS, INC.**  
3656 LINCOLN AVE. CHICAGO 13

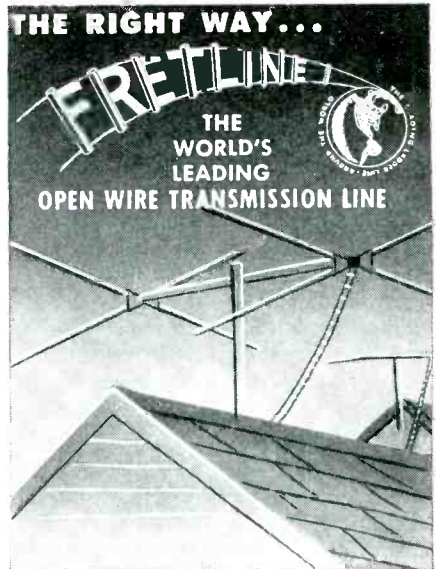

- 1/10 THE LOSS
- LONGER LIFE
- MORE PROFITS
- BETTER PICTURES

Fretline is the best in transmission line because of its low loss and its ability to withstand atmospheric conditions permanently. In remote signal areas Fretline has been the answer to installation problems. Ask anyone using Fretline.

Immediate Delivery from Your Jobber  
or Write for information Dept. S-2

**FRETSCO**

TELEVISION CO., INC.  
1041 Forbes Street  
Pittsburgh 19, Penna.

## Auto-Radio Tests

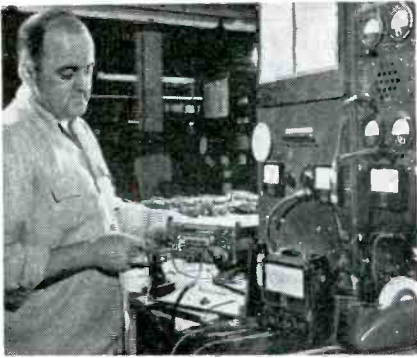

Testing auto radios, produced for Plymouth and DeSoto cars, at Motorola. Test equipment, made by Simpson Electric, provides check on voltages and resistance values in chassis. Instrument illustrated above, a 260, provides *dc* readings as low as 2 microamperes and up to 10 amperes. Resistance readings can be made up to 20 meg-ohms and as low as 1/5 ohm. The unit can be used to measure *afc* diode balancing circuits, grid currents of oscillator and power tubes, bias of power detectors, *avc* diode currents, high-mu triode plate voltages, etc. View below shows two operations at Motorola plant. In the background is one of the booths used for screening out electrical disturbances, one of the quality-control steps which follow final assembly. A Simpson signal generator (model 340) is used in the test. This instrument has a range of 75 kc to 120 mc, fundamentals to 30 mc. Unit uses an electron-coupled circuit, with 3 tubes serving as full wave rectifier, modulator and oscillator, and standard 30% modulation at 400 cycles. *RF* coils provide ranges of 75-220, 200-600 and 550-1700 kc, and 1.5-4.5, 4.2-14, 9-30 and 36-120 mc. In the foreground is an operator using both the 260 and the 340 for analysis of rejects which have not passed their final tests. The radio is checked here and the cause of the objection is corrected. Then, the unit again goes through the procedure of phasing (shown in view at top) and screening and final examination.



Below: Section of auto-radio assembly line at Motorola.



# HERE'S THE "SECRET!"

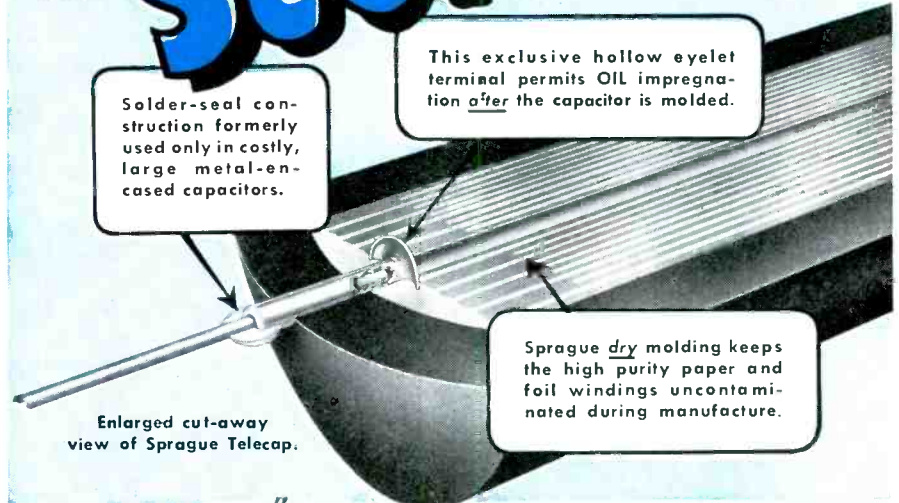

Solder-seal construction formerly used only in costly, large metal-encased capacitors.

This exclusive hollow eyelet terminal permits OIL impregnation after the capacitor is molded.

Sprague *dry* molding keeps the high purity paper and foil windings uncontaminated during manufacture.

Enlarged cut-away view of Sprague Telecap.

..... that makes  
**SPRAGUE TELECAPS®**  
 outperform and outlast  
 other molded tubulars

Actual, on-the-job performance *proves* the superiority of Sprague "Black Beauties" beyond question. To find the secret that explains just why they're so much better, however, you've got to see inside of a Telecap itself.

The big feature is that every Sprague Telecap is molded into its sturdy Bakelite phenolic shell while its windings are still *dry*. Any chance of contamination by moisture or dust during manufacture is avoided. *After* molding, the capacitor is vacuum-impregnated with mineral oil through a tiny eyelet. The lead is then inserted, the terminal is solder-sealed—and you have a capacitor that has maximum resistance to heat and moisture... extra high insulation resistance and superior capacitance stability. *In short, a capacitor that brings you premium quality at no extra cost!*

... And that's the secret behind the fact that Sprague Telecaps are more widely used by leading television set makers... and why they're first choice of service technicians who value their reputations for good work!

*Write for "Telecap" Bulletin. It's free!*



SPRAGUE PRODUCTS CO.  
 61 Marshall Street  
 NORTH ADAMS MASSACHUSETTS

BLACK BEAUTY  
**TELECAPS®**

TELEVISION'S MOST WIDELY USED  
 MOLDED TUBULARS

FOR THOSE

**HOT SPOTS**

**AEROVOX AFH  
ELECTROLYTICS**



Especially for elevated temperatures and high ripple currents, particularly in TV applications.

Light weight. High capacitance. Compact container. And of course the handy twist-prong mounting and easily-wired terminals.

Single-, dual-, triple- and quadruple-section units. Connections clearly indicated on rear label. Expanded listings provide outstanding selection of voltages, capacitances, combinations.

Ask your distributor for Aerovox AFH electrolytics. Consult the Aerovox expanded listings.



**FOR RADIO-ELECTRONIC  
INDUSTRIAL APPLICATIONS  
AEROVOX CORPORATION  
NEW BEDFORD, MASS., U. S. A.**

In Canada: AEROVOX CANADA LTD., Hamilton, Ont.  
Export: 41 E. 42nd St., New York 17, N. Y.

## Income Tax

(Continued from page 18)

at the local post office, or the office of the Internal Revenue Department, if you have one in your city.

### Examples

To illustrate the procedure that might be used to prepare an income tax return, let us take a typical case, involving the Bill Jones Radio-Television Service; Fig. 1. In this instance, the total inventory value of all parts on hand, at the beginning of the year, was \$300. This represents a cost, not list price value. During the year, \$4,000 worth of parts were bought. The year-end inventory showed that \$500 worth of parts were on hand. Thus we have a total of \$4,300 to consider. Subtracting the \$500 worth of parts on hand, the sum of \$3,800 is obtained. This represents the total parts-cost for the year, and is entered as an item of expense. The difference of \$200.00 gain in the value of the inventory (\$500 — \$300) is entered as a profit, since an increase in value is the same as income.

In the next step, all the deductible expenses are totaled; Fig. 2.

Now, it is necessary to add up all of the moneys received during the year, for sales of parts, service, etc. This total should be added to the \$200.00 gain in inventory. This figure represents the total gross income. Then, it is necessary to subtract from this, all deductible expenses, parts cost, depreciation, operating expenses, etc.; the result will be the total net income. This is the amount that must be entered on line 5 of Form 1040.

Effective on the first of January, '51, self-employed Service Men became eligible for coverage under the Social Security Act, requiring the filling out of another tax return. Although coverage became effective last year, it is not necessary to make out a tax return until 1952. This can be made out at the same time the income tax return is prepared, as both are sent to the same place; the Collector of Internal Revenue.

In the SS setup, the tax rate is 2 1/4% of your net earnings, up to \$3600 per year. If less than \$400 per year is earned, no return is required. To become eligible for this protection, you must have a Social Security number. If you do not have one, you should go to your local Social Security office and one will be issued to you, free of charge. If you worked as a civilian for a defense plant or the Government during the last war, you already have one. If you've lost your

# PLYMOUTH

TV and FM

Antenna Channel Transfer

## SWITCH



For use with 300 ohm Twin Lead Transmission Line. The practical answer to better reception with easy cabinet installation. Positive action, minimum leakage contact.

Write today for free illustrated literature and price list.

**PLYMOUTH**   
*electronic corp.*

50 KINGSBURY STREET  
WORCESTER 10, MASS.



Ask for the  
**SMITH**

**Roof Mount**

FOR TV MASTS  
Made of Sturdy  
Cast Aluminum

Pat. App. For

JUST WHAT TELEVISION INSTALLERS  
HAVE BEEN LOOKING FOR.

- 1—ALL ALUMINUM CASTINGS WITH PLATED STEEL BOLTS.
- 2—TESTED TO WITHSTAND ANY NORMAL LOAD UP TO 1500 LBS.
- 3—WILL TAKE TUBING O D 1/4" TO 2".
- 4—THE ORIGINAL SADDLE MOUNT FOR ROOF RIDGE.
- 5—CAN BE USED ANY PLACE ON ROOF.
- 6—IDEAL MOUNT FOR TALL MAST.
- 7—HOLDS BASE OF PIPE AT FIXED POSITION FOR RAISING OR LOWERING.

Thousands in use. Ask your Jobber—or write for Circular

**SMITH ELECTRIC MFG. CO.**  
Ashland, Ohio



Inventory value at beginning of year .....	\$300.00
Parts purchased during year ...	4,000.00
<b>Total .....</b>	<b>\$4,300.00</b>
Net value of closing inventory .....	500.00
<b>Total parts sold during year ...</b>	<b>\$3,800.00</b>
Total sales of parts and services .....	\$8,000.00
Cost of parts .....	3,800.00
<b>Gross profit .....</b>	<b>\$4,200.00</b>
Operating expenses .....	1,087.03
	\$3,112.97
<b>Net profit, plus a \$200.00 gain in inventory .....</b>	<b>\$3,312.97</b>

Fig. 1. Example of a typical total balance statement for a radio shop

old card, a new one can be secured from the National Security Administration, Washington, D. C.

While making your income tax return, your SS tax return should be prepared, too. All the figures you'll need are available, at your finger tips. For instance, if a total of \$3,500 were earned in '51, your tax would be 2 1/4% of this, or \$78.75.

Income tax time may not be a gay one, but if you'll have kept a set of simple, legible records faithfully, all through the year, you will be a much happier man, when income tax time does roll around, and that's on March 15.

Rent .....	\$300.00
Lights .....	49.43
Heating shop .....	20.00
Insurance .....	21.00
Occupation tax .....	15.00
Advertising .....	69.19
Repairs to delivery truck .....	160.16
Gas, oil, for delivery truck .....	110.00
Wages .....	87.29
Telephone, freight charges .....	73.75
Depreciation on equipment .....	181.21
	\$1,087.03

Fig. 2. Itemized operating expenses

## Business Aids

(Continued from page 28)

early part of the fall and spring. When using any list which has been borrowed or rented, it is advisable to make a master list for future mailings, which should be followed up as soon as possible after the first mailing. You can purchase these items in small amounts, doing your own addressing, a few minutes each day.

In one shop in Philadelphia, recently, a mailing of postal cards in surrounding areas involved 8,000 cards within one month. A 2 per cent or better response has been effected, with many phoning or appearing personally at the shop to talk about service problems. A continuous mailing should improve this percentage greatly.

Sincerely,  
Don Kay

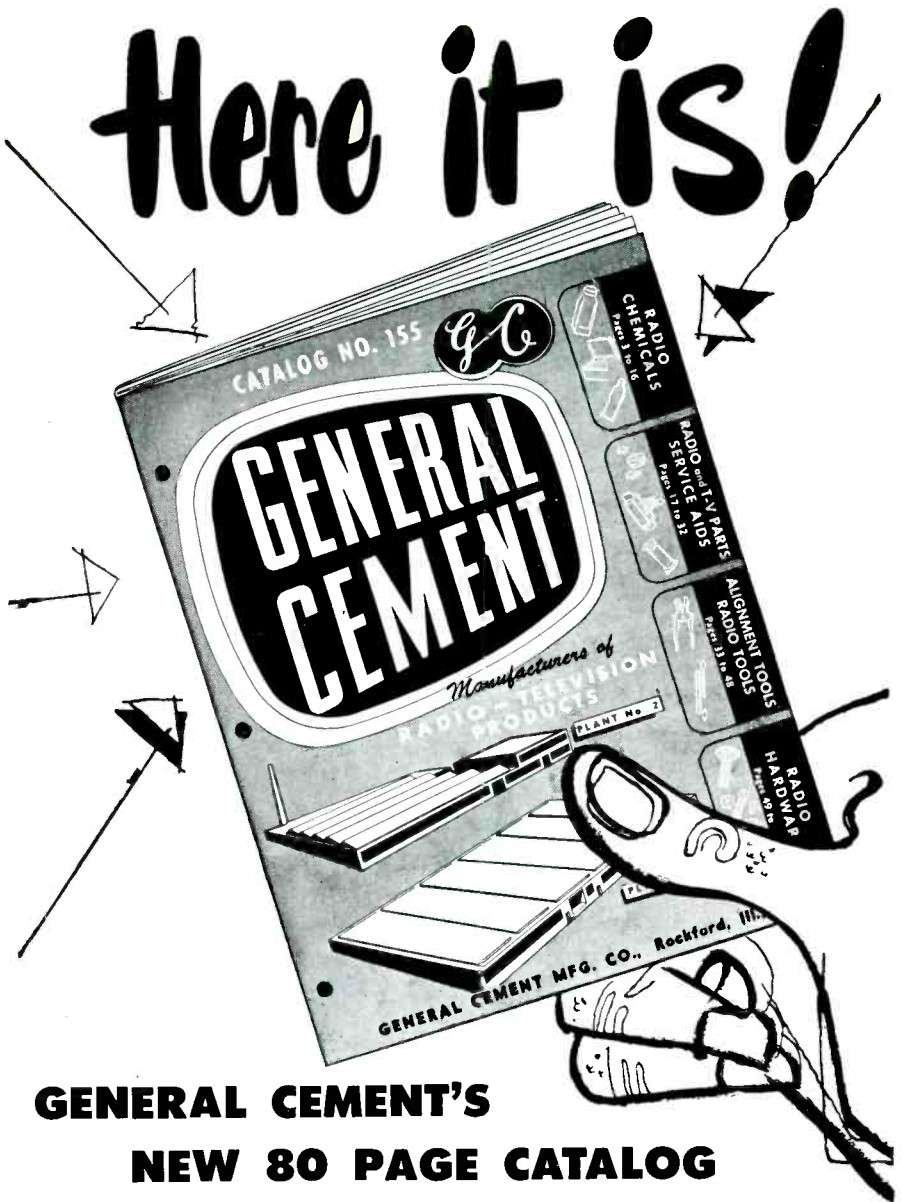

## GENERAL CEMENT'S NEW 80 PAGE CATALOG OF TV AND RADIO SERVICE NEEDS

80 pages crammed with everything the serviceman needs in the way of radio and TV chemicals, service aids, tools, hardware, antennas, and parts. See your distributor for a free copy or write direct to company.



### SPEEDEX AUTOMATIC WIRE STRIPPER MODEL 744-I

A heavy duty wire stripper that features a delayed action release which prevents wires from being crushed or bent.



### TELEVISION TUBE KOAT No. 49-2

For recoating peeling or scratched picture tubes. Coat inside of TV cabinets to prevent high voltage leaks.

# FREE

Please rush me your new 80 page catalog of TV and Radio Service Needs

Company Name \_\_\_\_\_

Street Address \_\_\_\_\_

City \_\_\_\_\_ Zone \_\_\_\_\_ State \_\_\_\_\_



**GENERAL CEMENT  
MANUFACTURING  
COMPANY**

901 Taylor Avenue  
Rockford, Illinois

# Tube News

by L. M. ALLEN

## Safety ALL WAYS

with **AMPHENOL**

### INLINE ANTENNA

Because your TV antenna is continually being exposed to the rigors of Mother Nature—wind, ice and storm—choosing an antenna that is structurally strong is very important. The Amphenol Inline Antenna is engineered to repeatedly withstand winds of 70 miles per hour and one-half inch annular ice loadings. It is clean in design and presents no surface unduly exposed to wind. Its aluminum construction is strong and light in weight. In addition, the aluminum is rust and corrosion resistant and is especially suited for use in sea coast areas and other places where salt or other corrosive conditions are encountered.

### LIGHTNING ARRESTOR

The National Electric Code states that every unshielded outdoor antenna lead-in should have an approved lightning arrester. The Amphenol Lightning Arrester is approved for this purpose and also carries the Underwriters' Laboratories seal of approval. It eliminates the danger of lightning causing damage to your TV set or home and also carries off the minor static discharges that interfere with good picture reception.

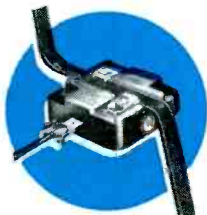

**AMERICAN PHENOLIC CORPORATION**  
1830 SOUTH 54th AVENUE • CHICAGO, ILLINOIS

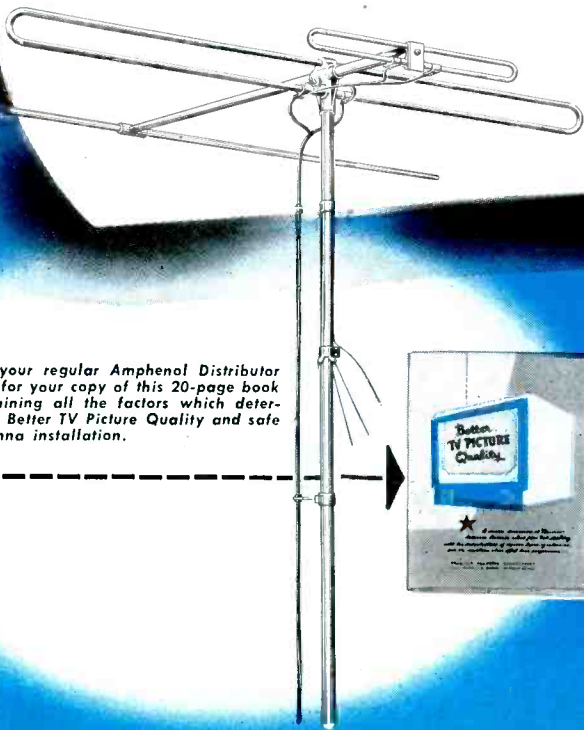

See your regular Amphenol Distributor now for your copy of this 20-page book containing all the factors which determine Better TV Picture Quality and safe antenna installation.



THE USE OF low-grade rubber anode caps on some picture tubes has introduced a serious problem, involving surface contamination, which has led some Service Men to believe that the picture tube itself was defective. Under the relatively high electrostatic stress present at the anode button, these caps gradually become conductive, due to a chemical decomposition of the rubber. This leads to a reduction in the leakage path across the insulated area of the glass around the anode button, often resulting in corona or arcing problems. Ordinarily wiping or cleaning of the glass under the rubber cap will not remove the surface contamination that results from the breaking down of the rubber.

A suggested cure is to remove the rubber cap and replace it with one of plastic or synthetic rubber, not containing lamp black (carbon) as a vulcanizing agent. If such a cap is not available, the complete elimination of the cap can be eliminated with no harmful results. Some manufacturers are already leaving the cap off on new production, since it is no longer required by Underwriters Laboratories.

Picture tubes can be cleaned if ordinary water and a scouring compound are used with a little bit of *elbow grease*. The area around the anode button should be cleaned and then thoroughly dried and polished with a clean, dry cloth so that no residue remains.‡

### Subminiatures

Last month, in a review of several types of new subminiatures, it was noted that many of the tiny models have been found to be excellent substitutes for their larger counterparts.

Now available is a CK6150\* subminiature pentode, similar to the CK6148, with the addition of sufficient control in the suppressor grid to permit its use in dual-control circuits such as *rf* mixers or gated amplifiers. The basic design and static characteristic curves of the tube duplicate the miniature 6AS6 and the subminiature CK5784\*. The tube has microphonic characteristics superior to the CK5784.

There has also been developed a high- $\mu$  subminiature triode, the CK6151\*, similar to types CK619CX or CK5744\*. The most typical service for this type is in resistance-coupled audio-amplifier circuits where the  $\mu$  of 70 can produce a voltage gain of 50.

\*Raytheon. ‡Based on data prepared by Hytron.

Zero-voltage electrostatic tubes developed by G. E.: 21-inch 21FP4A, and 20-inch 20HP4A/20LP4.





*Announcing*

**The new RCA WV-87A *Master* VoltOhmyst\***

\$112.50 Suggested User Price

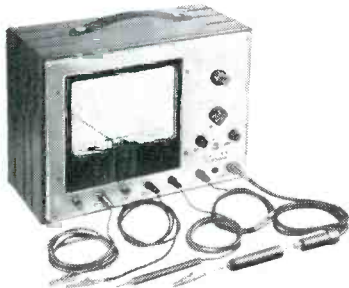

**Measures... (Full-scale ranges)**

- DC VOLTAGE: 0 to 1.5, 5, 15, 50, 150, 500, 1500 volts
- PEAK-TO-PEAK VOLTAGE: 0 to 4, 14, 42, 140, 420, 1400, 4200 volts
- RMS VOLTAGE: 0 to 1.5, 5, 15, 50, 150, 500, 1500 volts
- RESISTANCE: 0 to 1000 megohms in seven overlapping ranges
- DC CURRENT: 0 to 0.5, 1.5, 5, 15, 50, 150, 500 milliamperes; 0 to 1.5, 15 amperes

**Sold Complete — with the following Probes and Cables**

- Direct Probe and Cable
- DC Probe
- Ohms Cable and Probe
- + Current Cable (Red)
- - Current Cable (Black)
- Ground (Case) Cable

**Accessory Probes Available on Separate Order**

- ✓ WG-264 Crystal-Diode Probe for measuring ac voltages at frequencies up to 250 Mc.
- ✓ WG-289 High-Voltage Probe, with WG-206 Multiplier Resistor, for increasing dc-voltage range to 50,000 volts and input resistance to 1100 megohms.

FEATURING an 8½" meter, the new WV-87A Master VoltOhmyst is really the master of every testing application. Its peak-to-peak scales are particularly useful for television, radar, and other types of pulse work.

The WV-87A measures dc voltages accurately in high-impedance circuits, even with ac present. It also reads rms values of sine waves and the peak-to-peak values of complex waves or recurrent pulses, even in the presence of dc.

Like all RCA VoltOhmysts, the WV-87A features ±1% multiplier and shunt resistors, a ±2% meter movement, high-input resistance, zero-center scale adjustment for discriminator alignment, dc polarity-reversing switch, and a sturdy metal case for good rf shielding.

On direct-current measurements, extremely low-

meter resistance gives an average voltage drop of only 0.3 volt for full-scale readings on all ranges. Nine overlapping ranges provide dc readings from 10 microamperes to 15 amperes.

An outstanding feature is its usefulness as a television signal tracer... made possible by its high ac input resistance, wide frequency range, and direct reading of peak-to-peak voltages.

The RCA WV-87A Master VoltOhmyst has the accuracy and stability for laboratory work. Its large, easy-to-read meter also makes it especially desirable as a permanently mounted instrument in the factory and repair shop.

For complete information on the WV-87A, see your RCA Test Equipment Distributor or write RCA, Commercial Engineering, Section AX56, Harrison, New Jersey.

\*Reg. U. S. Pat. Off.

Get complete details today from your RCA Test Equipment Distributor.



**RADIO CORPORATION of AMERICA**  
TEST EQUIPMENT  
HARRISON, N. J.

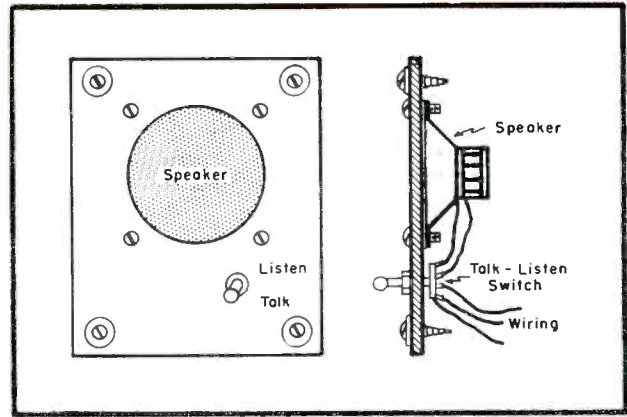
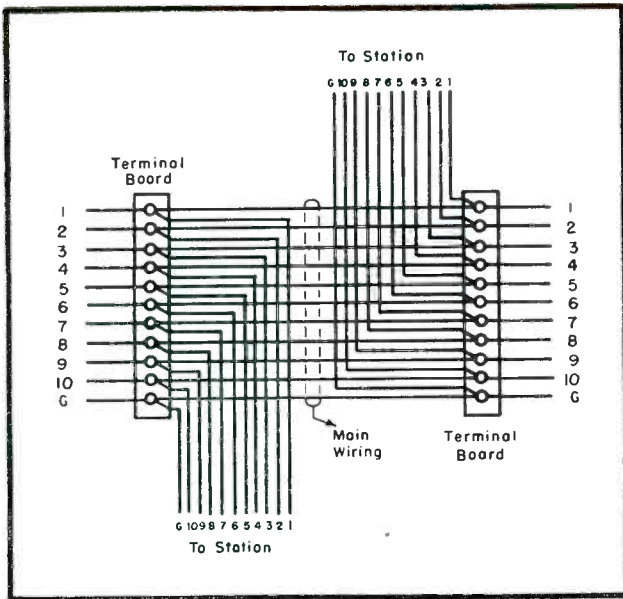

Fig. 1 (left). Recommended wiring system for all-master installation. Main line carries all wires from station to station; individual stations are connected to terminal boards.

Fig. 2. Remote station for intercom which can be mounted in the wall, or on a surface by adding four sides deep enough to clear speaker.

# INTERCOM Systems

by JACK DARR

Ouachita Radio Service

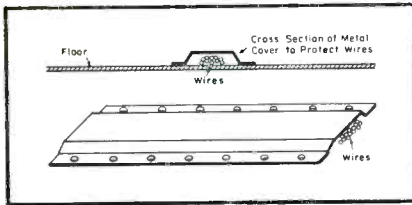

## Part II . . . Features of All-Master Systems and Remote Units. Estimating Procedures . . . Wiring Techniques for Simple and Complex Layouts.

INTERCOM layout and wiring, as noted earlier, represents an extremely important item in the wired communications system.

The heart of the wiring system is identification; unless easy identification of any lead is possible, the whole job becomes hopeless. This must be taken care of before any wiring. It is only necessary to make up sets of numbers typed on white paper, (1-1-1-1, 2-2-2-2, G-G-G-G, CALL-CALL-CALL-CALL, etc.), and cut them out and fasten them to the wires, at a point about ten inches or so from the ends.

### Estimating

As in all service and installation projects, estimating is quite an essential factor. Before beginning to estimate an intercom job, a rough floor plan of the building must be prepared. Distances and directions, should be marked on this plan as a guide in computing the number of feet of wire needed. If it is possible, plans should provide for the running of all wiring in the attic; this makes

direct runs from station to station feasible, and will save much time and material. Although shielded wire is recommended, it is possible to effect a saving by using unshielded wire, if the wires are separated far enough to eliminate cross-talk; feedback from one wire to another. Whenever wires are to be run in a cable, or close together, shielded wire must be used.

Let us assume that a ten-station installation is to be made. This will require twelve conductors; ten station wires, the master call-wire, and the ground. As indicated the call-wire should be shielded, the shield serving as a ground. For convenience a terminal board should be constructed out of masonite. Holes should be drilled about an inch apart and 1½" bolts inserted. Two nuts on each bolt will make an excellent terminal strip. Figures from an old calendar page may be cut out and glued to the board for identification. This may be fastened across rafters in the attic, pro-

viding a handy place to make up the connections. Now, a cable of shielded wires should be made up and numbered, and run from this terminal board to the master station. This may be run inside the wall, if possible, or on the surface in a corner, so as to be as inconspicuous as possible, and tied in to the master. From the upstairs terminal strip, all wires may be run. For tests, they may be easily disconnected if necessary.

First, the ground and call wires should be run to all stations. This doesn't have to be continuous; branches may be where necessary, to conserve wire. It is important to be very sure that the ground is spliced firmly and soldered to prevent pickup of hum. Next, the station wires should be run. Incidentally, there is no need to be particularly neat in this instance. The wires can be strung any way, as long as they are electrically continuous. They should be separated as far as possible to avoid crosstalk.

Some systems use all-master units; thus, any station may call any other

(Above, left)

Fig. 3. Sheet-metal cover to protect intercom wiring when laid on floor.

(Continued on page 44)

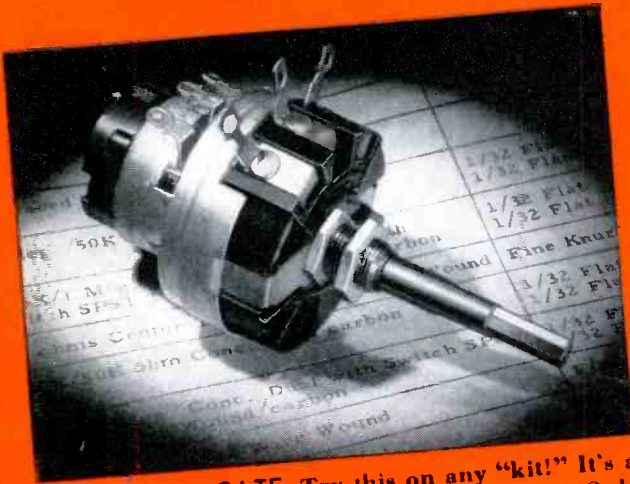

**EXACT DUPLICATE:** Try this on any "kit!" It's a wire-wound, carbon and switch combination. Only the Clarostat RTV (Exact Duplicate) number will do.

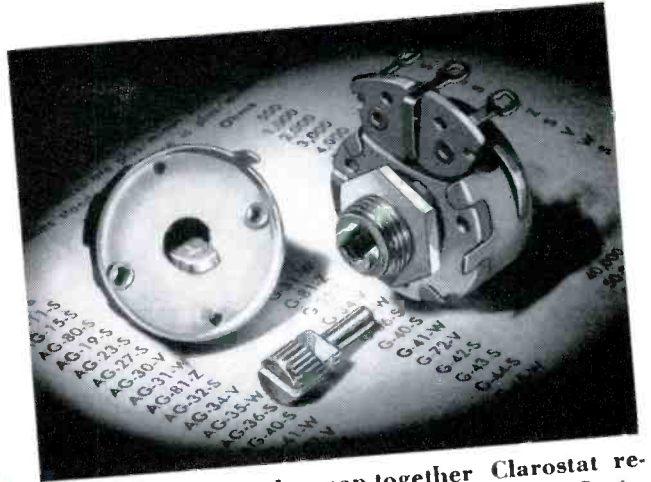

**STANDARD:** Simple snap-together Clarostat replacement—Series AG "15/16" control with Series SWB Ad-A-Switch and Series FKS-1/4 fine knurled slotted Pick-A-Shaft.

# Exact Duplicate OR Standard Type

**EITHER WAY**  
you can stand pat with

# CLAROSTAT *Controls*

Which? Well, some replacement jobs call for exact duplicates. No standard controls will do. Especially so with those concentric-shaft duals. And you just can't afford to lose time, patience, money and even reputation trying to assemble tricky combinations from old-fashioned "kits." Your best bet is Clarostat's RTV program—Exact-Duplicate numbers—almost 300 types—covering 2700 TV models of approximately 100 set manufacturers.

In the many applications where standard controls will do, Clarostat offers you the outstanding selection of 1 1/8" and 15/16" sizes. More than that, you can have Ad-A-Switches and Pick-A-Shafts to assemble simple combinations.

Best of all, your Clarostat distributor stocks them! Ask him about it.



The Clarostat TV Control Replacement Manual (and supplements) tells you what control to use. Ask your distributor for it!



Clarostat's latest catalog No. 51 lists the greatest choice yet of controls and resistors. Ask your distributor for your copy!

## Controls and

CLAROSTAT MFG. CO., INC.,  
DOVER, NEW HAMPSHIRE



## Resistors

In Canada:  
Canadian Marconi Co., Ltd.,  
Toronto, Ontario

# AFC SYNC Circuit Servicing

by

SOLOMON HELLER\*

and PETER ORNE

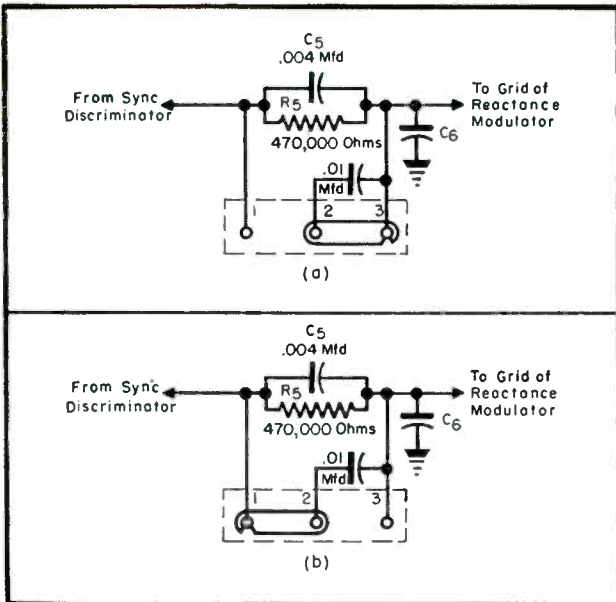

## Part IV... Time Constants ... Instruments to be Used for Tracing Defects.

REVIEWING THE operation of the *afc* link in a 630 chassis last month, it was noted that when the link is in the *afc* system, it is used to provide two different time constants in the grid circuit of the reactance modulator. One is relatively short, while the other is relatively long.

Why, one might ask, is a choice of time constants made available?

Well, when the link is in position 1 (normal) the time constant of  $C_5$  and  $R_5$  is relatively short, compared to the time constant of  $C_5$ ,  $C_7$  and  $R_5$  when the link is in position 2; Fig. 1.

The reactance present between circuit points *A* and *B* is relatively high (since the capacitance is relatively small) with the link in position 1. Noise pulses will be greatly attenuated across the relatively large reactance of  $C_5$  and  $R_5$  in parallel (large in comparison to the reactance of  $C_6$ ). The noise rejection characteristic of the circuit will therefore be good. This position (1) is the normal setting of the link.

At a few transmitters (their number is growing less all the time) the sync pulse is apt to vary in phase, due to instability of the transmitter sync generator. These rapid changes in phase must produce equally rapid changes in the bias of the reactance modulator, to keep the receiver horizontal oscillator

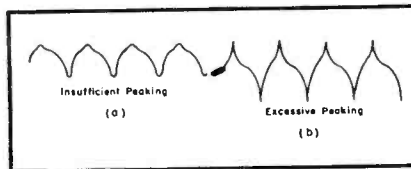

Fig. 2. Incorrect peaking in the CIR circuit of Fig. 1 appears above. At *A* we have insufficient peaking, while at *B* there is excessive peaking.

locked in phase with the transmitter horizontal oscillator, and prevent a loss of sync.

If the reactance between points *A* and *B* is small (link position 2), the small voltage variation that appears at the output of the sync discriminator, when the phase of the sync pulse varies (this voltage variation is equivalent to an *ac* signal), will not be attenuated too much when it reaches the grid of the reactance modulator. Correction will therefore be made for the change in sync phase, and synchronization will not be disturbed.

If the reactance between points *A* and *B* is large, however (link position 1), the small *ac* voltage variations produced by changes in the phase of the incoming sync pulse will be greatly attenuated, and will not charge  $C_6$  enough to produce the right amount of correction voltage. A loss in synchronization will therefore occur.

Although the use of link position 2 will compensate for changes in the phase of the transmitted sync signal, it will also reduce the noise immunity of

the circuit, since noise pulses will more readily affect the bias of the reactance modulator when the reactance between points *A* and *B* has been decreased. A compromise regarding the use of link setting 2 may therefore have to be made.

In such a compromise the following suggestion may be used. If, when the link is in position 1 (normal setting), horizontal tearing is observed on one or two channels, and if, with the link in position 2, reception on these channels is improved, while it is not impaired on other channels, position 2 may be used.

Trouble in the *afc* circuit should be looked for when loss of horizontal synchronization is present, and symptoms cannot be eliminated by adjustment of the various controls, as previously described. In troubleshooting it is necessary to locate the defective stage and the defective component.

This brings up the question of what instruments and test procedures to use.

Theoretically, a scope should be valuable in troubleshooting the circuit. In practice it will be found, however, that the scope will not provide all the answers in localizing trouble to the stage at fault. This situation has been found to prevail because the interaction of the stages in the *afc* system may result in improper waveshapes in all the stages, instead of only in the one at fault.

Now, the *afc* circuit operation depends upon a feedback loop. That is, signal voltage from the oscillator, is

(Continued on page 38)

Above: Fig. 1. Link at the rear of the 630 chassis which may provide a choice of two *afc* settings. The units shown are in the input to the reactance modulator. In *A* the normal link position, 2-3, is shown. Where the sync is unstable, position 1-2 is used as illustrated in *B*. This arrangement will serve to prevent phase modulation from pulling out picture.

\*Instructor at American Radio Institute; co-author of "Television Servicing."

# REMEMBER THESE CBS-HYTRON TV FIRSTS?

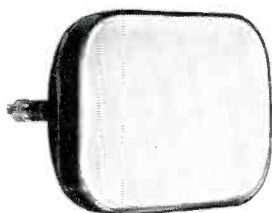

**16RP4**  
original *studio-matched*  
rectangular picture tube.



**12BH7**  
twin-triode sweep  
amplifier with  
superior efficiency.



**1X2A**  
compact, high-  
voltage TV rectifier.



**6BQ6GT**  
**25BQ6GT**  
extra-performance  
deflection amplifiers.



← **NEW 12BY7**  
Very - high - gain miniature  
pentode amplifier. Gives gains  
— within its power capabil-  
ities — equal to those of  
6AG7. As video amplifier,  
provides better contrast in  
high-quality TV receivers.  
And in low-cost receivers,  
adequate amplification at low  
plate voltages.



← **NEW 12BZ7**  
High-mu, 9-pin miniature  
dual triode. Especially de-  
signed for sync. separators  
and sync. amplifiers, high-  
gain audio amplifiers, and  
gating circuits.

Meet 4 more  
**CBS-HYTRON**  
TV Firsts!

**NEW 12A4** →

High-efficiency, medium-mu,  
9-pin miniature triode. Used  
as vertical amplifier, class C  
oscillator, or low-distortion  
audio output amplifier in  
push-pull.



**NEW 12B4** →

High-efficiency, low-mu triode  
with 6/12 volt heater. De-  
signed for vertical ampli-  
fiers with limited B supply  
voltages. Gives more sweep  
than 6W6GT. In proper cir-  
cuit, sweeps any 70° rec-  
tangular.



**YOU'LL BE SEEING THEM . . . BUYING THEM SOON**

Because these tubes are specifically designed for high-performance, low-cost TV for the mass market. Watch for them in new models of famous TV sets. When you buy these CBS-Hytron TV firsts, follow leading set manufacturers. Buy the original. Buy CBS-Hytron!



MAIN OFFICE: SALEM, MASSACHUSETTS

**NOW AVAILABLE!**

**C-D**



**DUAL CERAMICS**

**guaranteed  
minimum  
capacities:**

CAPACITIES:	PART NUMBER:
2x100 mmf. +50, -20 %	6TM5DT1E Tol. +50, -20 %
2x1000 mmf.	6TM5DD1B
2x1500 mmf.	6TM5DD15C
2x2000 mmf.	6TM5DD2C
2x2500 mmf.	6TM5DD25C
2x3000 mmf.	8TM5DD3C
2x4000 mmf.	8TM5DD4C
2x10,000 mmf.	8TM5DS1C

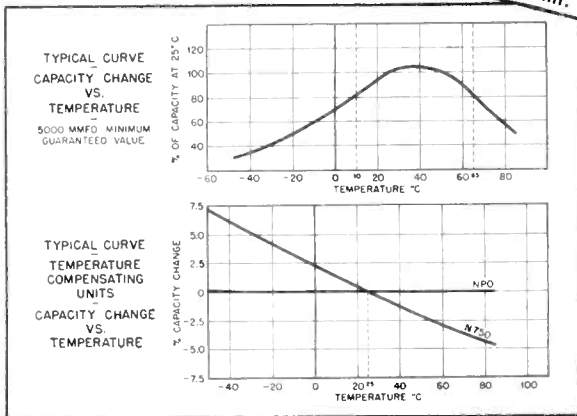

- Small • Space-saving
- Lightweight • Ideal capacitor construction
- Low inductance • Stable, dependable performance • Fully insulated • Capacity clearly stamped in mmf. for capacities under 1000 mmf., and in mfd. for capacities of 1000 mmf. (.001 mfd.) and over.

Order C-D Dual Ceramics from your Cornell-Dubilier jobber today. Write for catalog. CORNELL-DUBILIER ELECTRIC CORPORATION, South Plainfield, New Jersey.

OTHER PLANTS IN New Bedford, Cambridge and Worcester, Mass.; Providence, R. I.; Indianapolis, Ind., and subsidiary, The Radiart Corp., Cleveland, Ohio.



## AFC Sync Circuits

(Continued from page 36)

fed back through the correction system, to the oscillator. Therefore, trouble in the oscillator will produce an incorrect waveshape not only in the oscillator, but in the diode circuit as well, since part of the oscillator signal is fed back to the diode.

Similarly, waveshapes on the elements of the control tube are radically changed when the *afc* circuit goes out of adjustment. Under normal conditions, the grid voltage of the control tube is steady, since it is possible to

compensate for any tendency to drift. When the circuit is not operating normally, however (when synchronization is absent), the control tube will try to pull the oscillator into sync, fail, try again, fail, etc., causing a sawtooth waveshape to appear on its grid.

If a waveshape of this sort is seen in the reactance modulator circuit, it does not necessarily mean that the control tube itself is at fault; it could, for instance, be due to the fact that the oscillator tank circuit is way off its correct frequency of operation.

Summarizing, we find that waveshapes seen on the 'scope in different

stages of the *afc* may not be of much help in localizing the trouble to a particular stage.

Another reason 'scope waveshapes may prove difficult to interpret lies in the waveshape changes that the 'scope itself may introduce. The capacitance of the 'scope's hot lead, or the input impedance of the 'scope, is apt to affect the *afc* circuit to which the 'scope is connected, and thus result in improper waveshapes being seen.

Isolation of the 'scope from the *afc* circuit will eliminate or minimize this undesired effect. Such isolation may be achieved in some cases by inserting a 1-megohm resistor in series with the 'scope's hot lead, or probe. Insertion of this resistor may not permit a large enough waveform to be seen, or it may necessitate turning up the contrast control to the point where the circuit operates improperly, or it may change the shape of the signal in spite of the isolation.

A thoroughly experienced Service Man can use his 'scope to great advantage on a set which he has serviced before, if he remembers, or keeps a record of, waveforms produced by different troubles in the *afc* circuit on his particular 'scope.

Two other test procedures that deserve a discussion are *dc* voltage measurements and resistance checks. Resistance readings are generally easier to interpret than *dc* voltage measurements. This is true, because voltages in one stage affect those in the others. It may therefore be difficult to decide whether the source of the incorrect voltage lies in the stage being checked, or some other stage. In the case of resistance readings, however, an incorrect reading can readily be interpreted by further readings, with components disconnected.

Other troubleshooting methods are conventional, and merit no special comment: tube substitution, which is, of course, the first check that should generally be made; capacitor bridging tests, etc.

### Further Hints on Troubleshooting

If the correct frequency can be reached (as evidenced by one picture being seen in the horizontal direction) but the picture does not remain locked in horizontally, trouble may be present in the diode (6AL5), the sync coupling capacitor ( $C_2$ ), or the coupling to the control tube. It is assumed, in the case just cited, that the correct frequency can be reached merely by hold control rotation, without readjustment of the lock control.

If the picture remains locked in horizontally, but the horizontal blanking



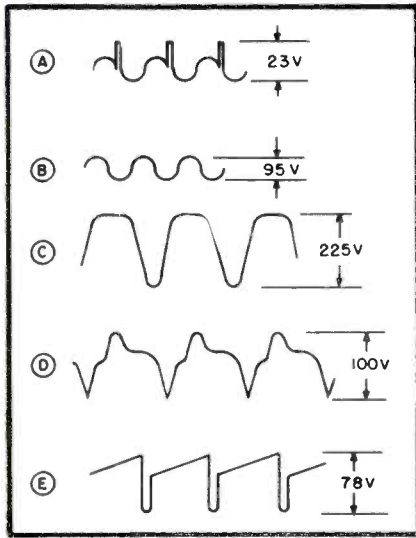

Fig. 3. Signal waveshapes and their amplitudes at different test points in the 630 afc sync circuit. Normal operation is assumed. At A appears the waveshape of the signal at the plates of 6AL5; at B, the waveshape of signal at grid of 6K6; at C the waveshape of the signal at plate of 6K6; at D, waveshape of signal at grid of discharge tube or  $\frac{1}{2}$  of the 6SN7; and at E, waveshape at plate of the discharged tube.

bar is seen, trouble may be present in the diode side of the transformer, or the shaping network ( $C_1 R_1$ ) in the plate circuit of the oscillator may be defective.

The latter trouble can be readily detected with a 'scope, by comparing the existing waveshape, with the waveshape that should be present. If insufficient peaking is present (Fig. 2A)  $R_1$  may have increased in value, or  $C_1$  may be too large, due to an incorrect replacement. If too much peaking is present (Fig. 2B),  $R_1$  or  $C_1$  may have decreased in value.

If the correct oscillator frequency cannot be reached at all (as evidenced by the fact that no recognizable picture can be seen, or several pictures in the horizontal direction are observed), the trouble probably lies in the oscillator tube, or the frequency-determining components in the oscillator circuit:  $L_2$ ,  $C_5$ ,  $R_6$ , the hold control, or the reactance modulator.

It should be remembered that the afc circuit used in the 630 is extremely stable, and that the components are not too critical. This means that even slight defects in horizontal holding action will indicate severe troubles; that is, radical changes in component values. Such marked defects should be relatively easy to track down.

Some of the normal waveshapes to be expected at different points, when troubleshooting the circuit with a 'scope, are illustrated in Fig. 3.

# AVOID RESISTOR BREAKDOWNS

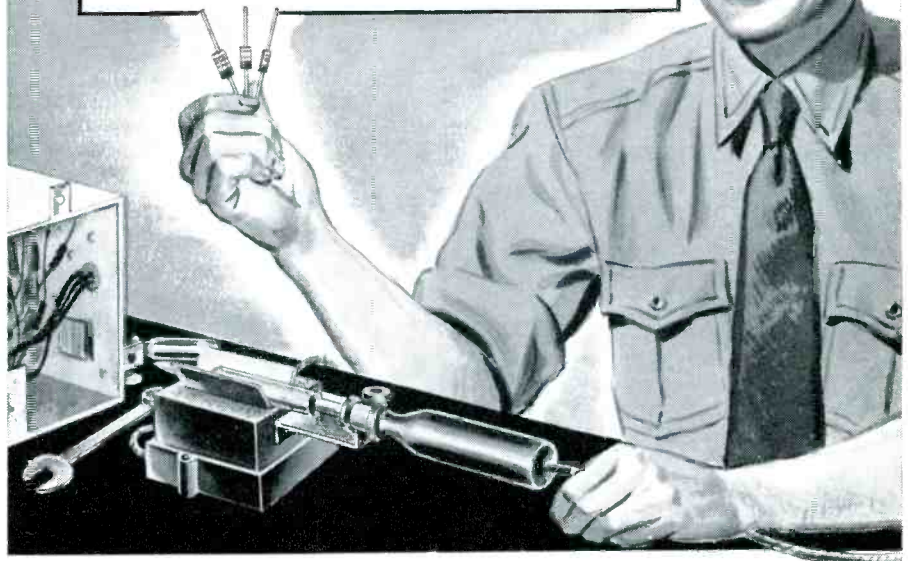

## OHMITE Little Devil Resistors Provide EXTRA MARGIN of SAFETY

Although they are tiny in size, Ohmite Little Devil molded composition resistors have unusual ruggedness, stability, and current-carrying capacity. For example, they are rated at 70C instead of the usual 40C. They meet all test requirements of JAN-R-11, including salt water immersion and high humidity tests without wax impregnation. In addition to conventional color coding, the resistance value and wattage are clearly marked on each unit.

Available in  $\frac{1}{2}$ , 1, and 2-watt sizes with  $\pm 5\%$  or  $\pm 10\%$  tolerance, in standard RTMA values—10 ohms to 22 megohms. The 1-watt size,  $\pm 10\%$  tolerance, comes in values as low as 2.7 ohms.

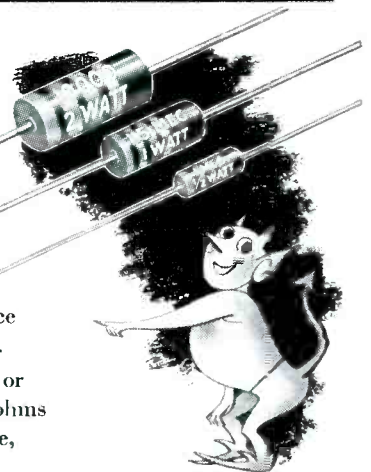

Available Only  
From Your  
Distributor

OHMITE MANUFACTURING CO.  
4877 Flourney St., Chicago 44, Ill.

Be Right with **OHMITE**  
RHEOSTATS • RESISTORS • TAP SWITCHES

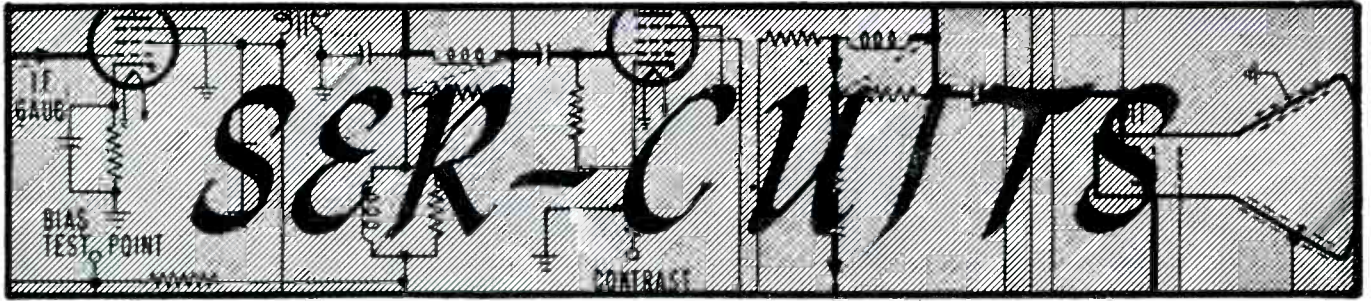

by M. W. PERCY

**Features of Instruments Used for TV Servicing: Sweep Generator . . . Marker Generator . . . Signal Generator . . . VTVM . . . Multiplier . . . Crystal Calibrator . . . Travelling Detector . . . Standard and High-Resolution Scopes.**

IN ANY TYPE of servicing, a carefully selected assortment of instruments is extremely important. In checking standard broadcast or FM-type chassis, where only audio-output problems must be considered, test-equipment requirements are, of course, not as extensive as those necessary for the TV chassis, where the viewing situation must be kept in line.

In addition to the normal service shop equipment (tube tester, capacity meter, analyzer, 20,000 ohm-per-volt voltmeter), a service shop should have the following specialized test equipment for TV service: sweep generator for *rf* and *if* alignment; marker generator; signal generator; *vtvm*; multiplier and 'scope.

The marker generator permits the accurate location of various frequency points on the alignment curve. The signal generator, with provisions for modulated (400 or 1000 cps) or unmodulated output, may also be used as an alternate marker generator, although the markers will not be independent of the pass-band. It can also be used for trap adjustment, local oscillator adjustment and for rapid signal tracing in the *rf*, *if* and video channels. When used with a sweep

generator, the signal generator can be used to check the overall frequency response of the video detector and amplifier circuits.

A *vtvm* serves to measure both *ac* and *dc* voltages in high-impedance circuits.

The multiplier, for use with a 20,000 ohm-per-volt meter, provides for the measuring of voltages up to at least 20,000 v. If projection receivers are to be checked, this range will have to be extended to 30 kv.

Equipment that is desirable, but not absolutely necessary, include a crystal calibrator; field-strength meter; variac; isolation transformer; composite video signal generator; and a travelling detector.

The crystal calibrator unit can be used for checking the calibration of the signal generator or marker generator. A completely shielded portable TV receiver with a meter in the video detector circuit has been found ideal for checking relative field strength, antenna surveys and in noting the effect of antenna orientation on reflected signals.

The composite video signal gener-

\*Based on copyrighted TV service notes prepared by G.E.

ator can provide a standard video signal with both vertical and horizontal sync pulses, equalizing pulses and horizontal and vertical blanking pulses. Also some sort of modulating signal should be available to produce a grating pattern on the raster for checking horizontal and vertical linearity. The travelling detector is an interesting device. It consists of a crystal detector probe which permits a 'scope to be connected to the tuned circuits anywhere in the video *if* or sound *if* channels. Occasionally, it is desirable to check the response of individual tuned circuits rather than the overall response. This also permits the use of a 'scope having a limited high-frequency response to check the frequency response of video amplifiers.

**'Scopes\*\***

Since the only practical way to align or check the alignment of the wideband circuits in a TV receiver is to use the visual method of alignment, a 'scope is essential. Also, a 'scope is one of the most useful tools for checking the operation of those circuits peculiar to TV, such as the clipper, sync separating and deflection circuits.

One of the most important uses for a 'scope in TV service work is for the checking of the ratio of sync to blanking levels to determine if the amplifiers in the set are working correctly.

A high-resolution model\*\*\* was recently developed for this purpose. It employs a 6J6 as a horizontal oscillator, 12AX7 as a horizontal amplifier, 1V2 as a *hv* rectifier, 6X as a low-voltage rectifier, 12AU7 as a vertical input, a

\*\*Based, in part, on copyrighted notes prepared by Philco. \*\*\*Philco model 7020.

Setup for 'scope and sweep generator which can be used to align and also check FM chassis. [In the February issue of SERVICE there will appear a detailed analysis of the application possibilities of this technique.]

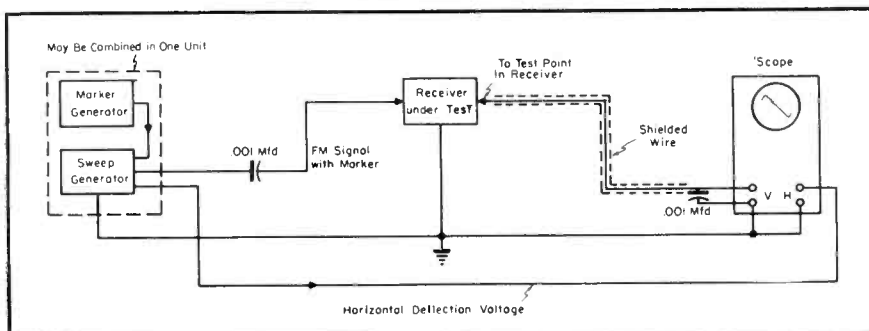

pair of 12AT7s as vertical amplifiers and a 3RP1 as the picture tube.

The 'scope, by virtue of a *dc*-coupled vertical amplifier, may be used to observe the *ac* component of a complex wave in relation to its *dc* component. That is, there is no elimination of *dc* level indication such as is encountered in *ac*-coupled 'scopes. An application of this feature appears in the observation of per cent ripple on *B+* supplies.

Very frequently it is helpful to know certain *dc* values of any other wave form. Pulse generating and shaping circuits particularly require such observation. However, any circuit which operates over a portion of a cycle, creates an average *dc* voltage other than zero. The ratio of *ac* component to *dc* component is necessary for evaluation of these types of circuits.

The peak-to-peak voltage reading of an input signal can also be measured with this model. The signal to be measured is fed into the vertical amplifier, and by means of a *calibrate* position, 60-cycle *ac* is fed into the vertical amplifier and compared against the signal deflection. The reading of the *calibrate* volts is multiplied by the original setting of a *v all* switch, resulting in peak-to-peak value of the input voltage.

[To be concluded in the February issue, in which a full-page diagram of the Philco 7020 'scope will also be published.]

## Audio

(Continued from page 20)

netic recording consists of a varying degree of magnetization in some form of a carrier, it is possible to conceive of the idea of erasing a magnetic recording by subjecting the material to some operation which will demagnetize the material.

### Recording

In magnetic recording an intense magnetic field penetrates the wire or tape causing an unoriented condition of magnetic particles to be changed to a more or less oriented condition. The amount of orientation is controlled, of course, by the amount of current flowing instantaneously in the recording magnet. More energy is required to produce complete orientation of the magnetic particles than to obtain partial orientation. Thus, if the current through the recording head increases slowly, more and more orientation is established in the material until finally

(Continued on page 42)

## IT'S CARTRIDGE

# Check-up TIME!

REPLACE INEFFICIENT  
PHONO-CARTRIDGES NOW  
with Modern, Lightweight, Compliant  
**E-V CARTRIDGES**

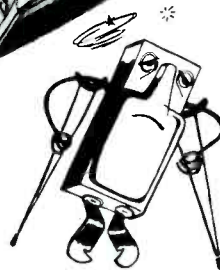
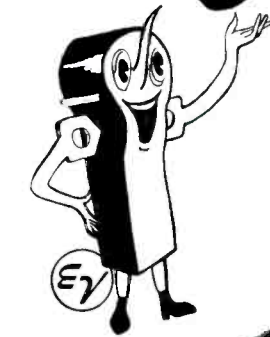

DETERIORATED

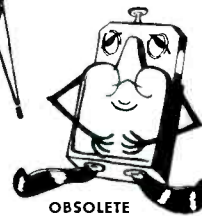

OBSOLETE

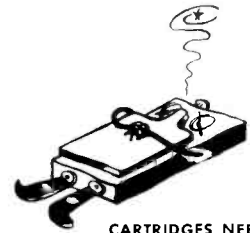

CARTRIDGES NEED NOT BE COMPLETELY DEAD TO NEED REPLACEMENT



WORN OUT

This is a good time to contact record-player owners and check the condition of their phono-cartridge. If it is not reproducing properly or is causing excess record and needle wear, chances are the cartridge has deteriorated or is obsolete—and should be replaced. You'll make new replacement sales, and open the way to other service business, too! A modern, lightweight, compliant E-V cartridge will give fullest record enjoyment and longer record life. You can demonstrate the difference. Remember, you can make most replacements with fewer E-V models!

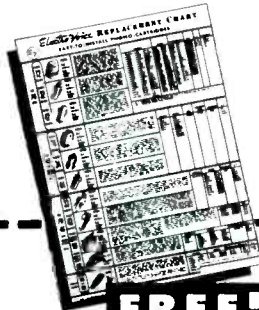
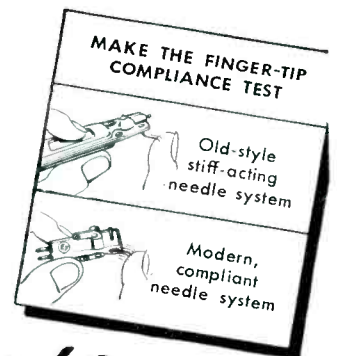

**FREE!**

**REPLACEMENT CHART**  
Large, Complete Replacement Chart. Gives handy cross-reference and valuable data. Tells when to replace a phono-cartridge. Ask your E-V Distributor or send for it now.

## Electro-Voice INC.

411 CARROLL STREET • BUCHANAN, MICHIGAN  
Export 13 East 40th St., New York 16, U.S.A. Cables: Arlab  
TV BOOSTERS • MICROPHONES • HI-FI SPEAKERS • PHONO-PICKUPS

Electro-Voice, Inc., Dept. S1-2  
411 Carroll St., Buchanan, Michigan  
Send FREE Cartridge Replacement Chart.

Name .....  
(PLEASE PRINT)  
Address .....  
City ..... Zone ..... State .....  
 Service-Technician  Dealer  Record Fan

# RECORDS SHOW THERE'S NO BOOSTER

# LIKE... *SEC* BOOSTER

\* Actual records show less than one return for every 1,000 SEC Boosters shipped

The extremely high efficiency of SEC's newly designed tuned circuits eliminates the usual loss of gain on high channels, provides the ultimate gain and picture clarity on both high and low channels. SEC's superior design and rigid inspection by qualified engineers assure you the highest performance.

Available at your favorite distributor; however, if you are in one of the few areas not yet represented, send orders direct.



LIST PRICE  
\$34.95

(Usual trade discounts apply)

### SPECIFICATIONS

Tube complement:  
Single 6J6  
Coverage:  
Channels 2-13 Incl.  
In-put: 75-300 ohms  
Output: 75-300 ohms  
Current:  
110-120V 60 cycles  
Size: Height, 4 1/4"  
Width, 6", Depth, 4"

## Audio

(Continued from page 41)

Radial reentrant projector supplied with air column lengths of 5' (RC-8) and 4' (RC-6). Cutoff of the 5' model is 110 cycles; 4' model, 140 cycles. Bell diameter of 5' type is 28 1/4"; 4' unit, 24 3/4". (RC models; Atlas Sound Corp., 1449 39th Street, Brooklyn 18, N. Y.)



all of the particles are completely oriented and this represents a maximum energy which can be stored in the material. The condition of completely unoriented particles corresponds to the noise level of the material; the condition of saturation, when all of the particles are oriented corresponds to the maximum signal which can be recorded on the material. The ratio between these two figures represents the maximum dynamic range of the material.

Unfortunately, the remaining magnetization of the recording material is not quite proportional to the recording magnetic field, particularly at small recording currents, and this can result in a distorted magnetic pattern after the material leaves the recording pole-pieces. To guard against this occurrence, there is superimposed upon the

A 12" coax speaker, which is said to have a frequency range of 65 to 15,000 cps; power rating 10 to 12 watts. Input impedance is 8 ohms; Woofer is 12" with a 6.8-ounce Alnico V magnet. Tweeter is a 3" unit with a 1.47-ounce Alnico V magnet. (Model CO12JB; Oxford Electric Corp.)

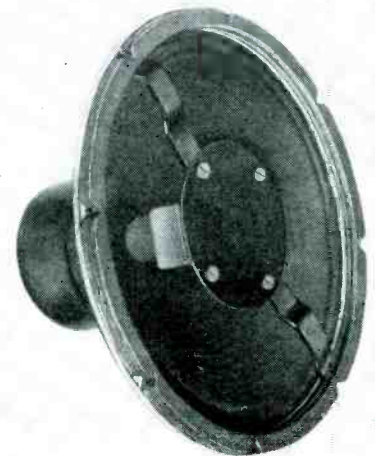

# STANLEY SALES

600 WEST THIRD

NATIONAL DISTRIBUTORS

OWENSBORO, KENTUCKY

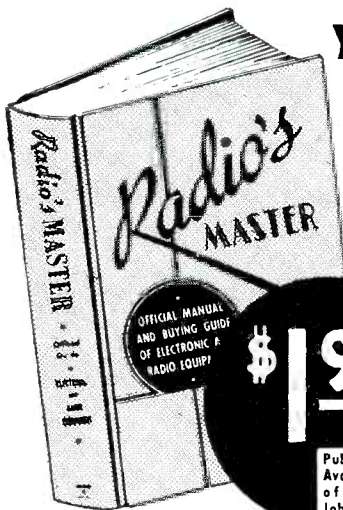

You'll find it

# FASTER

in the  
**MASTER**

No More  
Files of  
Small  
Catalogs and  
Loose  
Literature

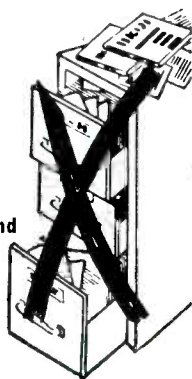

**\$1.95**

Publisher's price \$6.50.  
Available at special price of \$1.95 thru Parts Jobbers who absorb part of cost for privilege of printing ad on cover.

Industry's OFFICIAL Buying Guide of Radio-Electronic-Television parts and equipment.

When you **BUY--SELL--SPECIFY** you must have the **MASTER**

This single volume replaces all other small catalogs

Over 90% of the products manufactured in the Radio-Electronic-Television Parts and Equipment Industry are catalogued in this BIG 1100 page MASTER Buying Guide. Complete descriptions, with specifications and illustrations are written and compiled by each manufacturer covering such products as: tubes, instruments, TV parts, transformers, capacitors, resistors, test equipment, relays, coils and antenna equipment. Also, recording and PA systems, intercoms, tools, hardware, switches and thousands of associated products. IT'S YOUR "RADIO BIBLE"—SAVES YOU TIME AND MONEY.

**BE MASTER-Minded—GET your copy NOW**

**UNITED CATALOG PUBLISHERS, INC.**  
110 Lafayette St., New York 13, N. Y.

**NEW — 16th Edition available from local Parts Distributor at the special \$1.95 price.**



Push-out pillbox type individual containers designed to house pickup cartridges. Container provides an individual box with the cartridge mounted on a platform which contains the accessories inside it. Model and stock numbers are printed on the end of the box, which can be pushed out for inspection, without disturbing contents. (Shure Brothers, Inc.)

current in the coil corresponding to the signal, a second current of relatively high amplitude, but of such a high frequency that it cannot be heard in the reproducing process. This *hf* current is known as the *bias current*.

#### Webster-Chicago 210 Tape Recorder

In Figs. 1 and 2 (p. 20) appear the block diagrams of a tape recording and playback system which features the use of a 6K6 as an oscillator, while the first triode section of a 6SC7 is used only during playback as a bass-boost amplifier.

This model uses three coils in each record-playback head. One coil is in the bias-erase circuit, one is a low-impedance 500-ohm record coil and the third is a high-impedance playback coil.

In recording, the signal to be recorded is fed into the second triode section of a 6SC7 input tube. The signal is amplified and passed on to a phase inverter, first passing through the volume control. After again being amplified in the 6SN7 push-pull stage, the signal is introduced into the record coil of the head through the 500-ohm secondary tap of the output transformer. A rotary head switch shifts the signal to the proper head when actuated by a tape direction control.

The 6K6 operates as an oscillator to generate the erase and bias voltage which is the heart of the recorder. This *ac* voltage is at a frequency of approximately 40 kc. The circuit normally provides 3½ to 4 volts of bias at .7 to .9 amp *rf* to the erase-bias coil of the heads. When the 6K6 is oscillating, a negative-grid voltage of about -35 *v* will be measured at pin 5 of the tube socket.

# "CONICAL-V-BEAMS"\*

\*REGISTERED TRADE MARK

**-first CHOICE everywhere!**

*-for* SUPERIOR PICTURE QUALITY  
... FULL RANGE AUDIO AND VIDEO  
... ALL-WEATHER CONSTRUCTION

— 90% of all Television Antennas being produced today are genuine TELREX "Conical-V-Beams" or imitations thereof!

Because TELREX TV antennas are designed, engineered and field-tested by experts to produce results! You can depend on famous "Conical-V-Beams" for cleaner, sharper pictures, finer sound reception and rugged, weather-durable fabrication that means a lasting antenna installation! Check on the famous TELREX line, today!

**THE ULTIMATE IN HIGH GAIN ALL CHANNEL TV ANTENNAS**

The TELREX 8X-TV illustrated is the 4 bay stacked array that outperforms all others at remote-from-transmitter locations. "IF THE 8X-TV DOES NOT PROVIDE A USABLE SIGNAL, RECEPTION IS IMPRACTICAL."

**— WILL OUTPERFORM ANY OTHER ANTENNA OR COMBINATION THEREOF!**

MODEL 8X-TV

"CONICAL-V-BEAMS" are produced under Re-issue Patent No. 23,346  
CANADIAN AND FOREIGN PATENTS PENDING

**THE SKILL TO DESIGN...  
THE FACILITIES TO PRODUCE...  
THE ABILITY TO DELIVER**

*telrex* INC. AMERICA'S STANDARD OF COMPARISON  
**CONICAL-V-BEAMS** ASBURY PARK 4, NEW JERSEY

When playing back a recording, the high-impedance playback coil of the head is connected to the first triode section of a 6SC7 input tube, where bass boost is effected by means of the compensating network in the plate circuit. The signal is then fed to the second section of the tube and on through the same circuit as when recording, until the output transformer is reached. The signal is now fed to the speaker from a 3.2-ohm secondary tap of the output transformer.

[To Be Continued in February]

Wallet needle carrier which holds a dozen individually-carded needles. Available with needles for 78, 33½ and 45 rpm uses. (M. A. Miller Manufacturing Co., 1165-1169 E. 43d St., Chicago 15, Ill.)

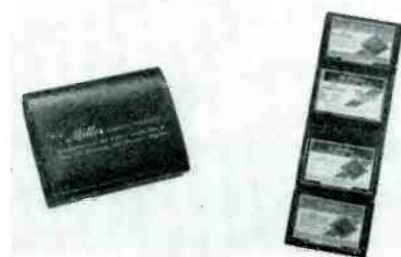

# For Replacements

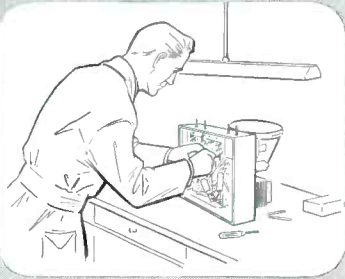

Get the **CORRECT**  
Temperature Compensating  
Ceramic Capacitor . . .

use **ERIE**

In addition to the standard replacement line of ERIE Ceramicon, a complete line of temperature compensating ceramic capacitors is available in the following ranges.

Temp. Coeff.	Range	Temp. Coeff.	Range
P100	1 MMF-212 MMF	N220	1 MMF-600 MMF
P030	1 MMF-226 MMF	N330	1 MMF-665 MMF
NP0	1 MMF-400 MMF	N470	1 MMF-800 MMF
N030	1 MMF-420 MMF	N750	1 MMF-1100 MMF
N080	1 MMF-480 MMF	N1400	1 MMF-1380 MMF
N150	1 MMF-545 MMF	Hi-K	100 MMF-.016 MFD

Be sure . . . order **CORRECT** parts when replacements are necessary. Erie Temperature Compensating Ceramic Capacitors have wide application for Front End, IF, Oscillator and other Critical Circuits.

Your local distributor can order all the above capacitors for you from one source . . . ERIE.

Electronics Division  
**ERIE RESISTOR CORP., ERIE, PA.**  
LONDON, ENGLAND . . . TORONTO, CANADA



# Intercom Systems

(Continued from page 34)

station in the whole system. The wiring for this type is quite a bit more complicated than the others, but not too difficult, if properly identified. The wiring system shown in Fig. 1 has been found to be ideal for this type of system. Again it will be necessary to prepare a rough floor-plan to estimate footage of wire. For the best results, this whole system had best be installed with shielded wire. If not, crosstalk will surely result.

## Terminal Sequence

If the system involves all-masters, only one more wire than the number of stations will be needed. Thus, for a ten-station setup, eleven wires will be needed; one for each station's call wire and the ground wire. Numbers can be assigned to the stations; regardless of their final designation, these numbers should be used when working with the wiring to simplify matters. Thus, when connecting such a system, station 1 would have its terminal board connected as follows (top numbers refer to the number of the pushbutton on the station; bottom row are your wire-numbers):

No. 1 2 3 4 5 6 7 8 9 10 CALL GND  
2 3 4 5 6 7 8 9 10 1 GND

The station 2 hook up would follow this pattern:

No. 1 2 3 4 5 6 7 8 9 10 CALL GND  
1 3 4 5 6 7 8 9 10 2 GND

Thus, the wires are hooked up in arithmetical order, using the wire corresponding to the station being connected as the *call-wire* for that station, and leaving it out of the wires on the terminal board. When calling from the front of the box, to locate any given number, simply count off from the left, omitting the number of the station where you are. If you are at station 4, to call 6, you would press button 5.

It is best to install a terminal board at each station in the attic, or on an outside wall, if the building happens to be a temporary structure, such as a hangar, etc. The wiring will run to this terminal board, connect to the bolts, then run out on to the next station. The wires from the station will come up to the terminal board and connect to their corresponding numbers. Although this sounds rather complicated, in practice it works out as much simpler than any other system. It was applied successfully while setting up a 24-station system at an Army air base. If your system is such that constant uninterrupted communication is imperative, a final touch

# VIS-U-ALL TUBE and TOOL CASE

® TRADE MARK REGISTERED

Holds 107 Tubes  
and All Tools for  
TV Home Service

## EVERYTHING IN FULL VIEW WHEN CASE OPEN

No hidden tubes. Easy to find the tubes you want, *when you want them*. Saves time. Holds tubes snugly and protects them against breakage. Tool compartment, 15½ by 3 by 2½ inches in size; accommodates all tools ordinarily needed for home service calls. Case is made of strong plywood with durable leatherette covering. Sturdy clasp fasteners and convenient luggage-type handle. Handiest case you ever saw, and a real boon to busy service men. Order yours *now!* If not satisfied, return within ten days and your money will be refunded.

Only 16 x 13½ x 7½ in.,  
closed. Weighs only 7½  
lbs. (21 lbs. when full)

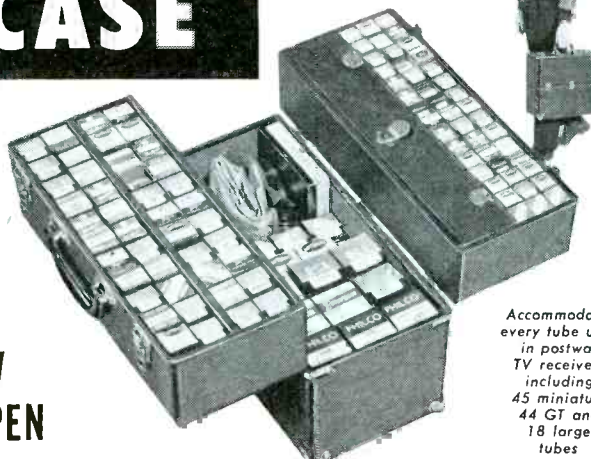

Accommodates  
every tube used  
in postwar  
TV receivers  
including  
45 miniature  
44 GT and  
18 large  
tubes

NET PRICE

**\$14.95**  
Case Only

Send check or money  
order. We will ship  
day order is received.

# TELEVISION ENGINEERS, INC.

1539 W. Harrison Street • Chicago 7, Illinois

© Copyright, January 1, 1952

of retnement can be added by installing a twelve-contact plug on each station, with the socket on the wires. Then, if a station breaks down, another may be substituted by plugging it in.

If the wiring cannot be installed in the attic, an alternate must be found. If the building is equipped with warm-air heating, or air-conditioning, you can try threading the wires through the ducts. It will be necessary to watch out for sharp corners on the sheet-metal which might chafe wiring.

If the system is being installed in a new building, every effort should be made to get the wiring in place before the walls are completed. This type of installation will require very careful testing, because the wires will be quite inaccessible after the walls are completed. It is important to be very careful when bringing the wires out of the walls; the point of egress must be protected to avoid damage to wires from moving furniture, etc. If wires must go across the floor, to reach a desk, they should be covered with a metal strip.

For school systems, or others where first, cost is a primary consideration, an economical remote station may be constructed from a piece of hardboard or Masonite, speaker, and a suitable switch. This may be a pushbutton or a rotary type; Fig. 2. These are mounted in the wall, in a small hole cut out of the plaster or wallboard. This type cannot be used on tile walls unless a small box is built for them. Wiring is all concealed, and the units are not likely to be damaged by children, which is a primary consideration for school systems. The units should be fastened to the wall with four self-tapping screws and cup-washers. In a plastered or plasterboard wall, a 1½" self-tapping screw will hold the panel very securely.

If remote stations are to be installed in other separate buildings, garages, shops, etc., some outdoor wiring will be necessary. The most convenient point on the floor-plan should be located and the inside wiring brought there. This must provide a satisfactory anchorage for the cable. If this run of outdoor cable is over 25', the use of a messenger cable will be necessary. This may be solid steel wire, or ordinary stranded steel clothesline. It should be run across to carry the load, and the intercom wires fastened to it with friction or plastic tape. At least three turns should be applied around the cable, spaced every foot. Rubber tape should not be used, since sunlight will deteriorate it and cause it to fail.

The intercom cable must, of course, be weatherproof. Plastic insulated

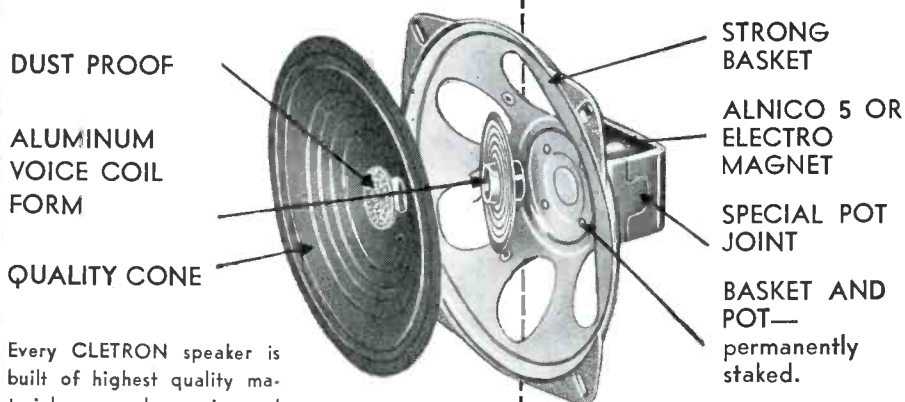
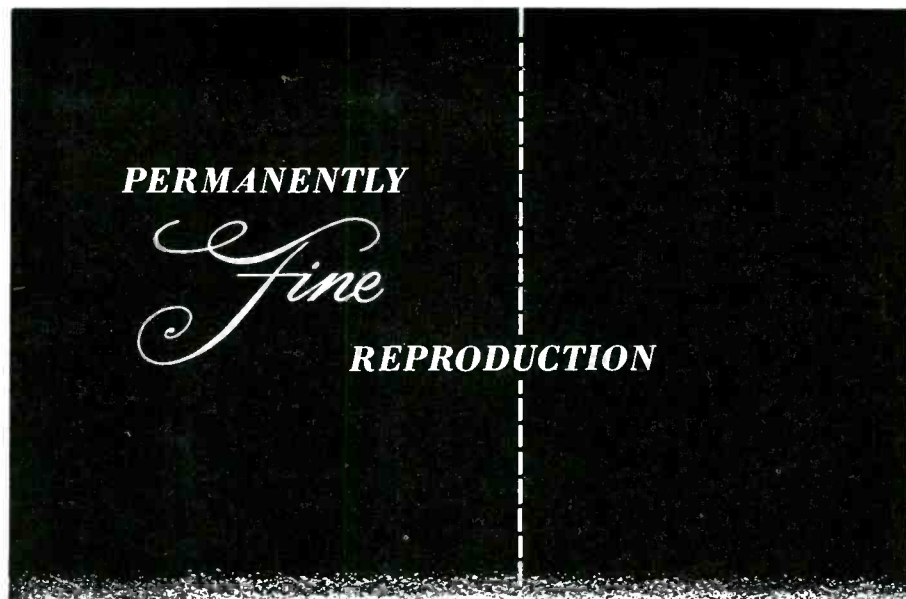

Every CLETRON speaker is built of highest quality materials properly engineered and assembled to a strong permanently sealed unit to withstand all climatic conditions and deliver a wide range tonal response.

Aluminum voice coil form handles greater power without distortion, warping or buckling because it dissipates heat more rapidly.

CLETRON 4", 5" and 6" speakers include a universal mounting bracket. Recommend CLETRON for: Radio, TV and Waterproof Speakers, TV Deflection Yokes and TV Lightning Arresters. Write for complete information today.

## RADIO • TV SPEAKERS

CLEVELAND ELECTRONICS, INC.  
6618 Euclid Ave. • Cleveland 3, Ohio  
Morhan Exporting Corp., 458 Bway., NY, NY.



wires, in an outer jacket of vinylite or neoprene, are recommended.

### General Hints

It is imperative that you do not underestimate the time needed to install a system of this type. As a rough rule-of-thumb, you can figure about two hours per station. This will take care of the time needed to run wires, connect and test each station. Each piece of equipment should be carefully checked at your shop before taking them to the job; this will eliminate much trouble in determining just

where a fault lies. If care is taken to do a good job on the wiring, the whole system should work perfectly the first time it is turned on. Any troubles may be quickly localized, if terminal boards have been used in the installation.

An intercom job is just like any other job . . . you'll get just as much out of it as you put into it! Careful work when making installations will return big dividends in good service from the job and in an enhanced reputation for yourself! This can be very profitable work, and there is hardly ever a shortage of prospects for such systems.

# TEK-FILE

THE BEST  
IN  
SERVICE  
DATA

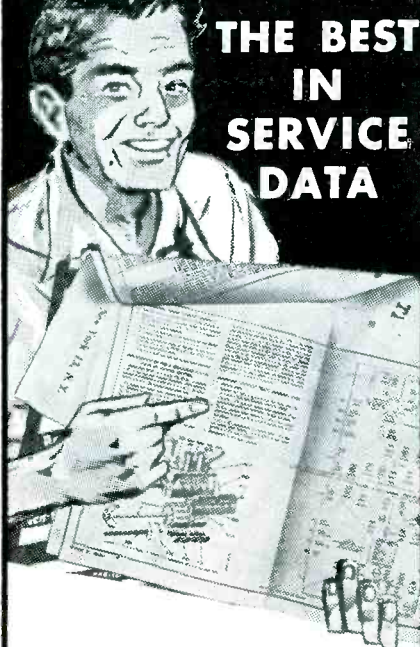

Only Rider Tek-File gives you so much for so little. You buy just the data you want, to match the set you're working on...and it's complete, unabridged factory-authorized data, including record changer data for ALL phono combination sets.



**FREE  
BINDER  
OFFER—**

A TEK-FILE binder is yours free with every 15 TEK-FILE packs you buy. See page 8 of the TEK-FILE Index for full details—at your jobbers now!

THE MAN WHO USES  
RIOER TEK-FILE — MANUALS  
MAKES MORE MONEY.



**JOHN F. RIDER**  
PUBLISHER, INC.

480 Canal Street, New York 13, N. Y.

# NEWS

## HINES APPOINTED WORKSHOP ASSOCIATES ENGINEERING DIRECTOR

Paul Hines has been appointed director of engineering for The Workshop Associates, Division of The Gabriel Company, Cleveland, Ohio.

Hines, formerly head of the antenna group at Raytheon, will be in direct charge of the Workshop laboratory now being built in Natick, Mass.



Paul Hines



Robert L. Wolff

## WOLFF NAMED CENTRALAB PRODUCTS ENGINEERING DIRECTOR

Robert L. Wolff has been named director of products engineering for Centralab. Wolff was formerly chief radio-electrical engineer.

\* \* \*

## RALPH SHIELDS WINS SYLVANIA PROMOTION

Ralph R. Shields, formerly engineer for test equipment merchandising, has been appointed merchandising supervisor for the television picture tube division of Sylvania Electric. He will headquarter at Seneca Falls, N. Y.



Ralph Shields



Jack C. Keith

## KEITH ELECTED SAMS VP

Jack C. Keith has been elected vice president in charge of sales of Howard W. Sams and Co., Inc., Indianapolis, Ind.

# for dependable sound, INDUSTRY relies on ATLAS



DR Double-Reentrant Projectors

## DEPENDABLE QUALITY:

The latest electro-acoustic research and engineering—and over 20 years of manufacturing know-how—are behind every ATLAS product.

## DEPENDABLE SERVICE:

Coast-to-coast and around the world today—in every Industrial, Marine, Railroad, Military, Educational, Civic, U.S. and Foreign Government application—under every kind of climate and noise condition—ATLAS sound equipment is famous for highest efficiency and durability. That's the proof of ATLAS performance dependability.

## DEPENDABLE DELIVERY:

Yes, ATLAS gives our Government highest priority. And yes, we too feel the pinch of material shortages. But our customers will continue to get our usual dependable delivery—because we believe in equitable and dependable distribution to all ATLAS users.

## DEPENDABLE PROFITS:

Completeness of line, excellence of product, dependable delivery, right prices—that's the ATLAS combination that means high, steady Industrial Sound profits for You!

JUDGE for yourself, COMPARE ATLAS at your local Jobber today. See why ATLAS is the preferred line for utmost dependability. Write NOW for FREE latest Catalog 551.



Paging & Talk-Back Speakers



ALNICO-V-PLUS Driver Units



Dual Speakers



FULL-GRIP, VELVET-ACTION Mike Stands



**ATLAS  
SOUND CORP.**

1442-39th Street, Brooklyn 18, N. Y.

In Canada: Atlas Radio Corp., Ltd., Toronto, Ont.

## TV INSTALLERS! SAVE TIME—INCREASE PROFITS with MOSLEY PLUGS and SOCKETS

Time is money to TV installers! Today, installers are speeding up their work and eliminating the cause of possible future call-backs by using MOSLEY Low Loss TV Plugs and Sockets.

Available for every installation need, MOSLEY Plugs and Sockets are, in most cases, installed without solder. They are made of low loss acrylic plastic, have phosphor bronze contacts, and will maintain exact line impedances. They can be depended upon to provide the very best electrical and mechanical connections.

Illustrated, are the popular MOSLEY 300 ohm Transmission Line Plug and mating Line Socket, and the handy MOSLEY 4-Con-

ductor Polarized Rotator Cable Plug and Base Socket Combination.

Get these and other MOSLEY products from your favorite jobber and ask him for MOSLEY Bulletin 51-51, a complete listing and description of the most popular MOSLEY products for the installer.

Use MOSLEY Plugs and Sockets on every job. You'll save time, you'll save money—and, your customers will appreciate it!

**MOSLEY ELECTRONICS**

2125 Lackland Road  
Overland, Missouri



CAT. NO. 301



CAT. NO. 311



CAT. NO. C-124



**GEORGE DETERS APPOINTED HYTRON SALES MANAGER**

George Deters has been appointed sales manager in the midwest section of Hytron Radio and Electronics Co., Salem, Mass.



George Deters



M. P. Fieldman

**FIELDMAN APPOINTED HALLDORSON GENERAL SALES MANAGER**

Maurice P. Fieldman, formerly with Standard Transformer Corp., has been appointed general sales manager of the Halldorson Co., 4500 North Ravenswood Ave., Chicago 40, Ill.

\* \* \*

**SIMPSON EXPANDS WISCONSIN FACTORY**

A new wing, which will adjoin the main factory building, has been added to the Lac du Flambeau, Wisconsin branch of Simpson Electric Co., Chicago, Ill.

Building will provide more assembly lines for test equipment and panel meters and will also give employment to the remainder of the Chippewa Indians who live on the nearby reservation and are now 75% employed by Simpson.



\* \* \*

**CENTRALAB COLOR-CODING CHART**

A 36" x 30" color chart that includes all the color-coding requirements of the entire electronic industry, has been prepared by Centralab.

Printed in eleven colors with over 3,300 color dots or marks, the color-code chart covers transformers, battery cables, antennas and ground leads, telephone switchboard cable, RTMA and JAN mica, paper and ceramic capacitor values, standard values of fixed composition resistors, miscellaneous capacitors and resistors, electrodynamic speakers, and radio and TV chassis.

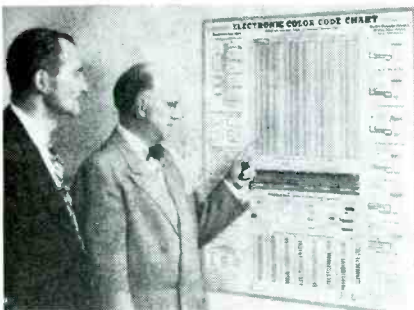

Centralab color chart being inspected by W. S. Parsons, vice president (right) in charge of the Centralab division of Globe-Union, Inc., and Angus B. Morse, ad manager.

**MORE TV OUTLETS PER DOLLAR!**

**AMPLIFIED, ALL-CHANNEL MASTER ANTENNA SYSTEMS FOR 2 TO 2000 TV SETS**

**NO** Special connectors  
**NO** Matching transformers  
**NO** Engineers  
**NO** Individual channel equipment

BLONDER-TONGUE systems are based on the use of "no loss" Distribution Amplifiers which split the signal from the antenna into the desired number of outlets... all having the same signal level and picture quality as though each TV set used the antenna alone.

The B-T Automatic, All-Channel systems, using three basic units in any desired number and combination, can be easily installed by any TV service man.

**INSTALLED WITH THE TURN OF A SCREW**



**DISTRIBUTION AMPLIFIER, MODEL DA8-1-M**  
8 TV Outlets  
Amplified and Isolated  
List Price \$87.50

Combine these B-T units to serve up to 2,000 sets from 1 antenna.



Model #CA-1-M  
Commercial Antensifier  
(30 Times Gain)

Use As Pre-Amplifier, Line Amplifier or de-luxe Booster  
List Price \$77.50



MODEL #DA2-1-M  
Distribution Amplifier  
2 TV Set Outlets  
List Price \$39.50

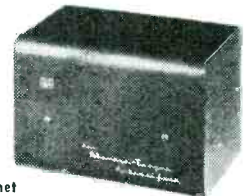

**B-T HOME ANTENSIFIER MODEL HA-2-M**

Finest All-Channel TV Booster. Fully Automatic, 16 Times Gain. In Metal Cabinet  
List Price \$57.50

**FREE INSTRUCTION BROCHURE ON MASTER ANTENNA SYSTEMS..Write Today. Dept. H-2**

**Blonder-Tongue Labs., Inc. Mt. Vernon, N. Y.**

**STANCOR OUTPUT TRANSFORMER CHART**

An output transformer chart, 375, which lists 129 of the most frequently used output transformers and the tubes with which they should be used, has been released by the Standard Transformer Corp., Chicago, Ill.

Guide simplifies the selection of the proper transformer for use as replacement in receivers or in the construction of audio amplifiers. Application, class and operating characteristics of the tube and transformer are also shown in reference form.

Chart also lists tubes, use, class, watts, load resistance in ohms and the correct Stancor output transformer to be used with each tube.

**C-D REPLACEMENT CAPACITOR CATALOG**

A 28-page catalog, 200C, describing service replacement capacitors, has been published by Cornell-Dubilier Electric Corp., jobber division, South Plainfield, N. J.

Among the items covered are: *Tiny Chief*, moulded plastic capacitors; *Pups*, *Sealpups* and *Metapups*, self-healing metallized paper capacitors; *Tiny Mike*, miniature ceramic disc capacitors; *Mity Mike*, high-voltage TV ceramic capacitors; *ZNW*, tiny paper capacitors for small electronic assemblies; *TWC*, high-temperature sub-miniature oil capacitors; *3WP*, *5WP*, *1WP*, high-voltage postage stamp midget micas for TV applications; and *Silver Mike*, (type 22R) miniature micas.

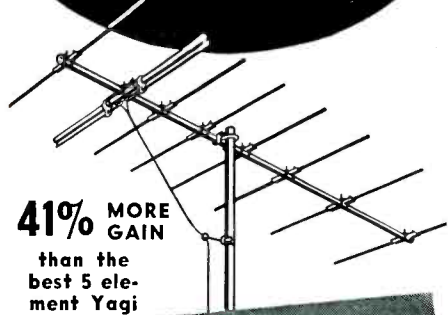

**41% MORE GAIN**  
than the  
best 5 ele-  
ment Yagi

**GIVES EQUAL GAIN TO  
A DOUBLE-STACKED  
5 ELEMENT YAGI ARRAY**

*at lower cost!*

MODEL LJ **\$12.50** LIST  
for Channels 7-13

**COMPARE THESE TIME  
AND MONEY SAVING FEATURES**

- Faster, easier to install than stacked arrays
- Better roof-top appearance
- Higher front-to-back ratio eliminates co-channel interference
- Full 6 megacycle band width
- Rugged pre-assembled construction
- Low channels (2-6) have 1 1/4" reinforced boom of highest quality aluminum tubing and extra rugged VEE-type clamp (CL-10) which allows use of mast up to 2" diameter

*Another Great Product by* **VEE-D-X**

**Originators of the World's  
Most Powerful TV Antenna Systems**

THE LaPOINTE-PLASCOMOLD CORPORATION  
Windsor Locks, Connecticut

Gentlemen:  
Send me complete information on Long John

Name .....

Street .....

City..... Zone.....

State .....

Check here if technician

**RCA TUBE DEPT NAMES D. Y. SMITH  
SALES OPERATIONS MANAGER**

Douglas Y. Smith has been promoted to manager of sales operations for the RCA tube department. Earl M. Wood, for the past 10 years manager of manufacturing at the tube department's Lancaster, Pa., plant, succeeds Smith as plant manager at Lancaster.

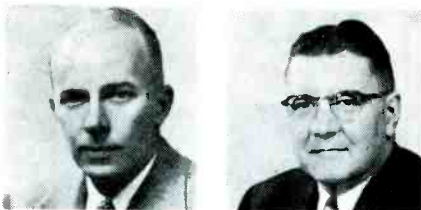

Douglas Y. Smith

Charles Griffith

\* \* \*

**CHARLES GRIFFITH NAMED IRC  
GENERAL SALES MANAGER**

Charles H. Griffith, manager of the radio sales division, has been appointed general sales manager of the International Resistance Co., 401 N. Broad St., Philadelphia, Pa. He will continue as radio sales division manager.

\* \* \*

**G. E. TV SERVICE GUIDE**

An 80-page television service guide has been published by G.E.

Designed for on-the-bench reference, with each page dirt and fingerprint-resistant, opening flat, the guide contains schematic diagrams with circuit symbol numbers, tube locations, top and bottom chassis views and cabling diagrams on combination sets, detailed information on 102 G.E. chassis, plus 10 rf tuners used in 86 TV chassis. A picture section identifies every postwar G.E. television set made from '45 through present production models, including a 24-inch chassis, plus color code charts for resistors and capacitors.

Priced at \$1.00.



G.E. TV service guide in use.

\* \* \*

**CISIN TV TERMINOLOGY GUIDE**

A 24-page book, *TV Terms Simply Explained Including TV Troubleshooting Picture Guide*, has been published by Harry G. Cisin, 200 Clinton St., Brooklyn 2, N. Y.

Book features a compilation of technical terms used in TV. A troubleshooting picture guide, also presented, and alphabetically arranged, not only shows the symptoms of each fault, but lists probable trouble causes and remedies. Priced at \$1.00.

\* \* \*

**O'DONNELL NOW HEAD OF  
WALSCO CHICAGO BRANCH**

J. E. O'Donnell has become manager of the Walter L. Schott warehouse in Chicago. Plans are afoot to expand the facilities of this mid-west depot.

**Presenting  
THE NEW  
Mueller  
NEEDLE CLIP**



Actual Size

**PIERCES INSULATION  
TO MAKE QUICK  
CONTACT**

Solid bronze, non-corroding. Wire centers itself in notched jaw. Teeth on sides of jaw allow use for many other applications.

— USED IN —

- Electric and radio service shops
- Telephone and power company testing and maintenance
- Laboratory test work
- Hooking up truck trailer lights
- Field telephone and signal work

SEND FOR FREE SAMPLE AND CATALOG 810



1565 East 31st Street, Cleveland 14, Ohio

**IT'S A SALES NATURAL  
Because It's**

**TIP-PROOF**



**Tip-Proof**

Model No. TA 135

**INDOOR TV  
ANTENNA**

Complete with  
twin lead.

Closes TV set sales  
on-the-spot. One reason  
why over 1,000,000 have  
already been sold!

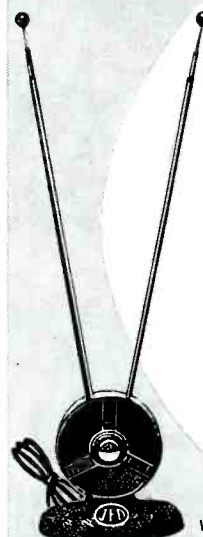

See Your Jobber or  
Write for Brochure No. 164



**MANUFACTURING CO., INC.**

6129 16th Ave. Brooklyn 4, New York

FIRST In Television Antennas and Accessories

**ASTRON CATALOG**

A 24-page catalog, AC-3, with information on performance data and test characteristics of capacitors and filters has been published by Astron Corporation, 255 Grant Avenue, East Newark, N. J.

Listed and illustrated are a line of dry electrolytics, along with applicable engineering data. A *Metalite* section, covering metallized paper capacitors, features a history of the use of metallized paper in capacitors, advantages of their self-healing property, subminiature size and light-weight, and engineering performance data, curves and test procedures.

Recently developed type AQ capacitors, for operation at 125°C without derating, are also covered. *RF* interference filters are also listed and illustrated, with drawings, attenuation charts and other design aids.

\* \* \*

**RCA NAMES ROTHENBERGER EASTERN REGION MANAGER**

W. L. Rothenberger has been appointed manager of the eastern region for the RCA Victor Division, RCA.

R. M. Macrae, formerly assistant regional manager in New York, has been appointed manager of the newly formed northeastern region.



W. L. Rothenberger, recently named eastern region manager, (second from right), receiving congratulations from L. W. Teegarden, vice president in charge of RCA technical products, on his completion of 30 years of continuous service with RCA. Looking on: R. T. Orth (extreme left), vice president in charge of the RCA tube department, and L. S. Thees (extreme right), general sales manager of the tube department.

\* \* \*

**SCHAUER EXPANDS**

The Schauer Manufacturing Corp. has moved its offices and production facilities into a new 30,000 square-foot plant at 4500 Alpine Ave. in Rossmoyne, a suburb of Cincinnati, Ohio.



\* \* \*

**OHMITE TO EXPAND**

Plans for a 125,000 square-foot manufacturing plant, at 3601 Howard St., Skokie, Ill., have been announced by Ohmite Manufacturing Co., Chicago.

It is hoped that construction will begin early next year, and that the structure will be completed by late summer or early fall.

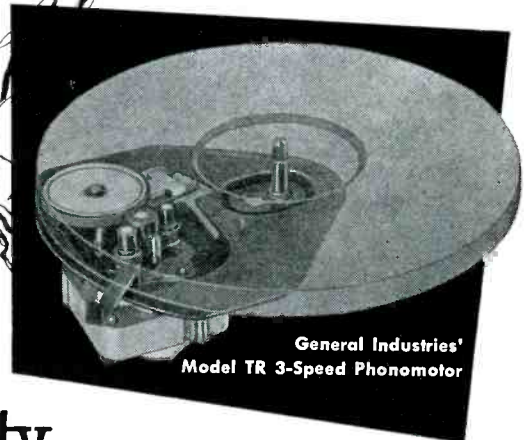

**Dependability...**

**an important reason why leading manufacturers prefer General Industries' 3-Speed Phonomotors**

Year after year, General Industries' *Smooth Power* Phonomotors provide trouble-free performance—backing up fine radio, television and record-changer engineering with highest quality motor design and construction.

Write for complete information, including specifications, design features and dimensions. Quantity price quotations available on request.



**THE GENERAL INDUSTRIES CO.**  
DEPARTMENT MF • ELYRIA, OHIO

**SARKES-TARZIAN SELENIUM-RECTIFIER BOOK**

An 80-page book featuring data on the application of selenium rectifiers in radio and TV, has been published by Sarkes-Tarzian Inc., Bloomington, Indiana.

Included are complete circuits, schematic data and a replacement parts section. Priced at \$50.

\* \* \*

**DURALUMINUM LADDER FOLDER**

A folder, illustrating safety features of aluminum ladders, has been issued by Duraluminum Manufacturing Co., 110 W. 34th St., New York 1, N. Y.

Detailed are rung construction, side-rail, and lock and shoes information.

**NATIONAL VIDEO COPPER SAVING PICTURE-TUBE**



Edgar W. Morse, left, and C. V. Fogelberg, right, co-inventors of National Video Corp. picture tube which permits focusing without use of focus coil, that it is said will save about 4½ thousand tons of copper a year, discussing new tube with Asher J. Cole, center, National Video prexy.

# CENTER TV PICTURES in 3 seconds

with the **NEW**

## BeamaJuster

This efficient and easily installed Perfection centering device makes possible the centering of TV pictures in 3 seconds instead of 20 to 30 minutes. The BeamaJuster eliminates costly and complicated centering controls of the resistor type.

It also replaces mechanical centering controls which tilt the focus coil to center the picture and require numerous springs, wing

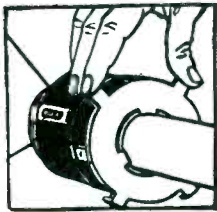

nuts and special brackets. No drifting of picture. Perfect for conversions from small to large size tubes. Easily installed.

1. Snap BeamaJuster on back cover of tube yoke. (Fits any size tube.)
2. Rotate BeamaJuster as shown here for approximate centering of picture.
3. Make final adjustment by sliding outer plate of BeamaJuster vertically or horizontally.

*Order today from your supplier!*

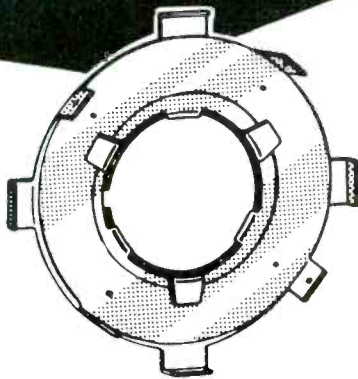

**PERFECTION ELECTRIC COMPANY**  
2637 South Wabash Avenue, Chicago 16, Illinois  
MAKERS OF PERFECTION SPEAKERS AND TELEVISION COMPONENTS



# RADELCO

## LIGHTNING ARRESTOR

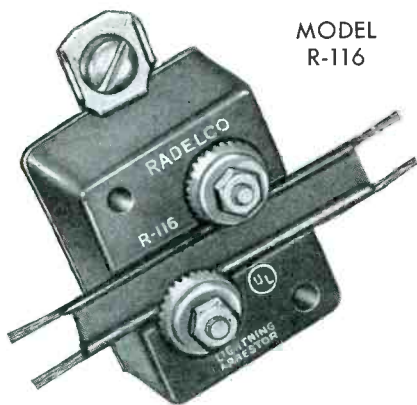

MODEL  
R-116

IT'S THE LOWEST PRICE  
UNDERWRITERS' LISTED  
ARRESTOR ON THE MARKET

ORDER FROM  
YOUR NEAREST  
PARTS JOBBER

LIST PRICE  
**90¢**

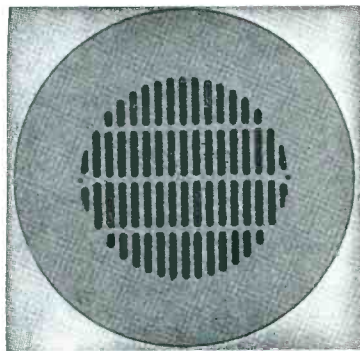

Model 10-P Grille

Tests have proven that the NP-832 and NP-8680 8-inch Speakers will give practically the same results when used with the 10-P Flush Mounting Grille, where the whole wall or ceiling is used as a baffle, as a 12-inch speaker with the same magnet strength.

*Write for literature*

**WRIGHT Inc.**

2237 University Ave., St. Paul 4, Minn.

# Tools . . . Instruments Parts . . .

## WEN SOLDERING GUN

A soldering gun that features a transformer-type soldering device, has been announced by Wen Products Co., 5806 Northwest Highway, Chicago 31, Ill. Gun has a built-in spot light that illuminates work, and a long tip that reaches spots otherwise inaccessible.

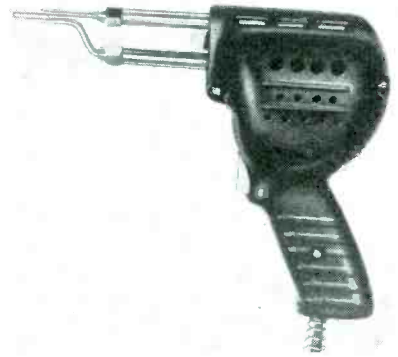

\* \* \*

## PRECISE RF PROBE

An *rf* probe, 912, that is housed in a non-porous case and uses a germanium crystal rectifier for measurements up through 250 mc, has been introduced by Precise Development Corp., Oceanside, N. Y.

Provides a frequency range of low audio frequencies through 250 mc that is said to be practically flat through 100 mc. Reads *rms* value of a sine wave, .707 peak. Also affords maximum *ac* reading; linear readings up through 20-volt peak. *DC* blocking is said to permit measurements of *rf* voltage present in circuits using up to a peak of 600 volts. Approximate input capacity is 3 mmfd, while the input resistance is 200,000 ohms at 1 mc, 150,000 ohms at 10 mc and 25,000 ohms at 100 mc.

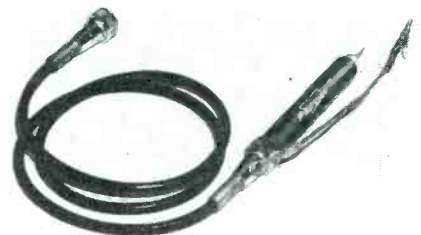

\* \* \*

## IDEAL CONTINUITY TESTER

A pocket-size continuity tester that is said to permit the testing of circuits without the need of live-wire connections, has been introduced by Ideal Industries, Inc., 4025 Park Ave., Sycamore, Ill.

Tester provides own power from batteries, and uses a signal light indicator. Equipped with a 4' cord and alligator clip.

### ENCO PORTABLE MAGNETIC BASE LIGHT

A portable magnetic base light, the *Miti-Mite* No. 250, has been announced by Enco Manufacturing Co., 4524 W. Fullerton Ave., Chicago 39, Ill.

Unit holds up to a 100 watt standard incandescent bulb and is said to attach securely with approximately a 100 pound pull to curved or flat surfaces. Flexible ball and socket bracket construction permits illumination of work wherever needed. Includes an aluminum light shield, 6' of cord, and base is 1 1/4" x 4" x 1 5/8".

\* \* \*

### TRU-OHM RHEOSTAT

A rheostat, featuring all ceramic-metal construction, has been announced by Tru-Ohm Products, 2800 Milwaukee Ave., Chicago 18, Ill.

Rheostat has a deep core on which resistance wire is toroidally wound. Resistance values, either uniformly or taper wound, are available. Standard resistance tolerance is 10%, with 5% tolerance available.

Featured are *off* positions and screw-driver control.

\* \* \*

### INSULINE LONG-HANDLED TEST LEADS

A pair of long handled test leads 8" long and made of polished hard rubber, 329, has been introduced by the Insuline Corporation of America, 3602 35 Ave., Long Island City 1, N. Y.

Handles are fitted with short, sharp-pointed tips. Flexible leads are of kinkless wire 48" long. Have standard phone tips on their ends, and can be used with most test instruments.

\* \* \*

### HUNTER SCREW HOLDING SCREWDRIVER

A screwholding screwdriver, *M8*, developed to drive small screws in tight, hard-to-get at places, has been announced by R. N. Hunter Sales, 3499 E. 14th St., Los Angeles 23, Calif. Has a long, thin shape and shockproof, tenite 2 plastic handle. To securely fasten the screw to the blade tip requires a slight push against the screw slot. This action rotates a hardened steel locking pin in the center of the blade which locks the blade tip in the screw slot. The steel locking pin extends through the full length of the blade. The blade tip can be ground fine or blunt.

Overall length is 8" with a 5" blade made of chromoly steel and attached to 3" x 7/16" handle. Blade width is 3/16" and tip width is .030" to fit No. 3 to No. 7 screws.

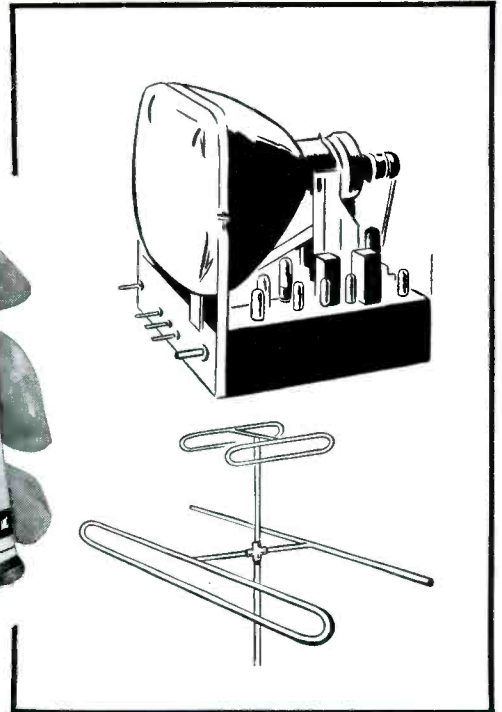
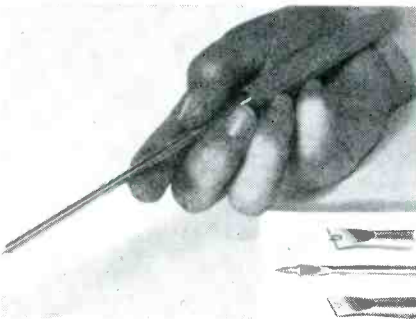

# PREVENT CORONA

in high voltage circuits with



ACRYLIC SPRAY

Advertised in  
The SATURDAY  
EVENING POST

### Spray on antenna and lead-in terminals, too; Krylon prevents corrosion and pitting

Krylon is an acrylic spray — not a vinyl plastic. Spray it, right from the 12 oz. aerosol can, on the high voltage coil and insulation... in the socket of the high voltage rectifier... on component parts of the high voltage rectifier circuit. Krylon dries in a few minutes to form a permanent protective coating of high dielectric strength.

Both inside the set and on the antenna, Krylon seals and protects... makes TV sets perform better, longer... cuts down service calls... builds customer good will. Two types — clear (list \$1.95) and nonconducting aluminum (list \$2.25). Also in gallons for application by brushing or dipping. See your jobber, or write direct.

**KRYLON, Inc. Dept. 612**  
2601 North Broad St. Philadelphia 32, Pa.

### W-S AUTOMATIC WIRE STRIPPER

A automatic wire stripper, *Speedex Automatic 766-I*, which features a delayed action release that is said to prevent wires from being crushed or bent, has been introduced by Wood Specialty Manufacturing Co., 915 Taylor Ave., Rockford, Ill.

Cutting blade strips solid as well as stranded wire from 8 to 22 gauge, and by changing blades, it can be used to strip parallel wire, 300-ohm TV and FM twin-transmission wire.

### KAPNER PORTABLE SPRAY GUN

A portable sprayer, *Payswell Spray-pak*, with a spray gun system including a dual piston type built in compressor, self-lubricating 10,000 rpm motor, mixing head and gun, *all built into one unit*, is now available from Kapner Hardware, Inc., 2248 Second Ave., New York 29, N. Y. Any liquid that is sprayable can be used and is rated to spray at 1 quart in 4 minutes at 50 pounds air pressure.

System is supplied with carrying case and spare aluminum cannisters, covers, gaskets, 3 interchangeable nozzles, strainers, respirator with refills, brush, and oil.

# FIRST AID FOR TV SETS!

## H. G. CISIN'S "TV DOCTOR"

Shows you how to fix TV sets RAPIDLY!



Save money—do a better job faster. Here's a really practical TV book. An amazing, quick, copyrighted method of fixing TV troubles. Written by a noted inventor and educator, H. G. Cisin, in language you can understand.

### MAKES TV SERVICING EASY!

**TUBES CAUSE 80% OF TV TROUBLES!** TV DOCTOR shows how to quickly locate all defective tubes.

**WITHOUT EXPERIENCE—PICTURES & TEXT SHOW YOU THE QUICK EASY WAY TO FIX FAULTY TV SETS**

Reveals many closely guarded TRADE SECRETS. Lists over 123 trouble conditions. Method applies to all TV sets from oldest to newest.

**11 money-making, fact-cramped, detailed, illustrated chapters include:** practical ways to combat interference and ghosts, how to appraise TV sets, valuable information on antennas, lead-ins, color, practical—not theoretical—pointers on TV sets, ion traps, tubes used in TV, addresses of manufacturers—a veritable encyclopedia.

**Only \$1—you'll say it's worth hundreds.**

## FREE SPECIAL OFFER

Get a new, full-size, profusely illustrated, \$1 book —"TV TROUBLE PICTURE GUIDE INCLUDING TV TERMS SIMPLY EXPLAINED" as a **FREE GIFT**, by ordering the "TV DOCTOR" and H. G. Cisin's famous "TV TROUBLE SHOOTING METHOD" which trains you to be a TV Diagnostician, selling for \$1. Think of it—all 3 TV books postpaid for only \$2—you save \$1.

**\$1** Post-paid

H. G. CISIN, Consulting Engineer (Dept. S-8)  
200 Clinton Street, Brooklyn 2, N. Y.

- Enclosed find \$2. full payment for "TV DOCTOR" & "TV TROUBLE SHOOTING METHOD" PLUS my FREE copy of "TV TROUBLE PICTURE GUIDE." Rush all three books postpaid.
- Enclosed find \$1. full payment for "TV DOCTOR." Rush copy postpaid.

Name.....  
Address.....  
City..... Zone..... State.....

# 1/6 the LOSS With Permanent OPEN LINE by T.V. Wire Products

Guarantees lowest loss . . . holds the signal stronger on short or long runs (1/2-mile to mile with minimum loss) . . . resists disastrous atmospheric conditions indefinitely!

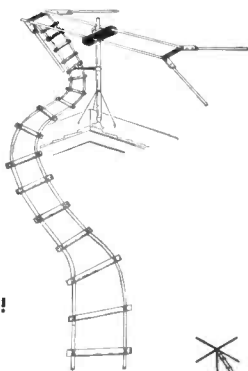

NOW AT A NEW LOW PRICE!

Through Your Distributor — or Write

## T. V. WIRE PRODUCTS

THE PERFECT FINAL TOUCH TO QUALITY INSTALLATIONS

102 Prospect Ave., Burbank, Calif.  
ROckwell 9-2562

# TV Parts . . . Accessories

## TACOPLEX TV COUPLER FOR NEW-CONSTRUCTION USE

A master TV-antenna-system coupler, 1582, for use in conduit installations in new-construction work, is now available from Technical Appliance Corp., Sherburne, N. Y. Coupler is designed to fill the need for a tap-off device along the main transmission lines housed in conduits.

As a tap-off device, it is said to provide the necessary isolation between receivers and at the same time provide proper attenuation to maintain a constant level of signal strength throughout the system. By means of three resistors wired in parallel, the proper attenuation is obtained by clipping out one or two of the resistors.

Coupler is designed to be housed in a standard electrical outlet box. Connection to the receiver is made by means of a polarized plug that is supplied with each unit. A standard-size flush cover plate is available, 1581, which identifies the outlet as a TV signal source.

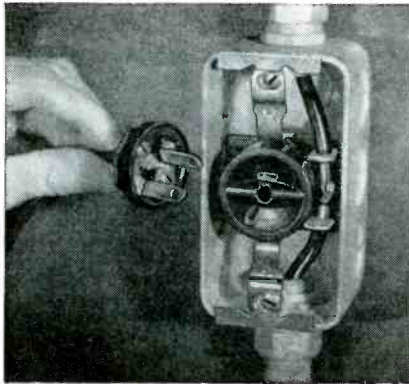

\* \* \*

## TELEMATIC TV COUPLER

A TV coupler, *Add-A-Set*, that is said to permit the operation of two sets from one antenna, has been announced by Telematic Industries Inc., 1 Joralemon St., Brooklyn, N. Y.

Coupler provides an impedance match of 300-ohm antenna to two 300-ohm receivers; shielding that is said to minimize losses from interline mutual coupling; and interwinding capacitance combined with bifilar inductance for high-pass filter action.

## DUMONT TELE-LEAD

A TV servicing aid, the *Tele-lead*, is now being offered to Service Men through distributors by the picture tube division of the Allen B. DuMont Laboratories, Inc., Clifton, N. J.

Lead serves as a jumper from the ac power outlet to the TV chassis when the protective back of the receiver is opened and the safety switch is broken, and also serves as a trouble light of convenient size. Provides a 6' lead from the standard Edison plug to a molded-rubber T junction. From this T, an additional 3' length of wire supplies power to the safety interlocking switch receptacle of the receiver. Another three-foot length of wire from the T terminates in a standard midget-base receptacle accommodating standard midget-base 110-volt bulb.

Available as a free premium with the purchase of every DuMont Teletron, between January 1 and February 29, 1952.

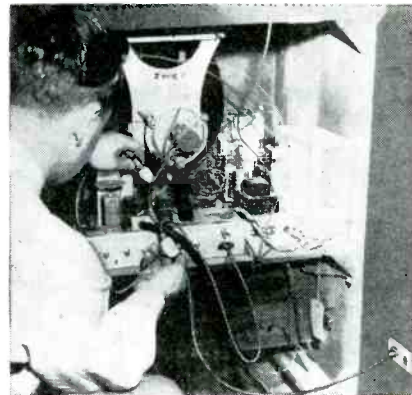

\* \* \*

## REMOTE THERMAL SWITCH

A thermal switch, model *SW-T-1* for remote on-off control of auxiliary electrical circuits, such as those used with TV boosters, has been produced by the La-Pointe Plascomold Corp., Windsor Locks, Conn.

Switch is said to have fast self-recycling, pure silver-to-silver contact and mechanical stability. Maximum load is 50 watts, actuating load minimum is 100 watts at 117 v and actuating load maximum is 500 watts at 117 v. Available in a range of actuating voltages and current loads for specific applications.

Speakers Need Repairing?

# Recone with a WALDOM CONE



Speakers are hard to obtain. Recone with Waldom cones.

Send for your FREE WALDOM Replacement Cone Manual Catalog!

FREE, 24-page manual is yours without obligation. Data on over 750 TV, FM, AM speakers. WRITE TODAY!

• WALDOM CONES

... maximum efficiency, R.M.A. warranty, true low frequency response, unconditionally guaranteed.

WALDOM ELECTRONICS, INC. 911 N. Larrabee St., Chicago 10, Ill.

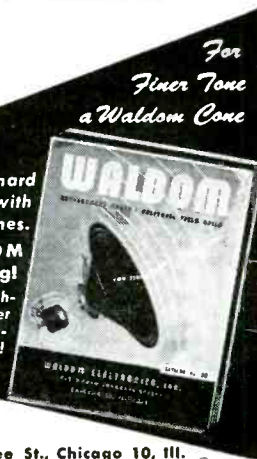

For Finer Tone a Waldom Cone

for **SERVICEMEN** . . .

From the earliest  
days of Radio . . .  
to the present  
era of Television . . .

The symbol of  
**QUALITY and  
PERFORMANCE**



**WIRES**

are preferred  
for their

**ABSOLUTE  
UNIFORMITY**

**SUPERIOR  
QUALITIES**

and

**ULTIMATE  
ECONOMY**

**CORNISH WIRE CO., Inc.**  
50 Church St., N. Y. C. 7

**TRICRAFT INDOOR ANTENNA**

An indoor TV antenna, covered in two-tone leatherette that is provided with a concealed lead-in wire, has been introduced by Tricraft Products Co., 1535 N. Ashland Ave., Chicago 22, Ill.

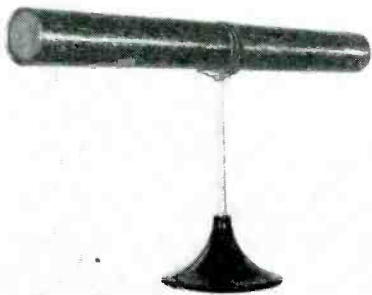

**COLUMBIA WIRE TV SERVICE LIGHT**

A television service light with a 7-watt 110-v bulb, non-breakable reflector, 6' cord with plug and a rubber suction cup which holds firmly to any flat surface, has been announced by Columbia Wire and Supply Co., 2850 W. Irving Park Road, Chicago 18, Ill.

Light comes individually boxed in a lightweight container.



**TEL-A-RAY ANTENNA-SWITCHING BOOSTER**

An antenna-switching booster, which receives signals from four antennas and can be switched from one to another, has been produced by Tel-A-Ray Enterprises, Inc., Henderson, Ky.

Booster is equipped with four input terminals for four separate antennas, any of which may be switched from the front. Four sets of terminals, supplying 6 to 7 volts ac for operation of up to four antenna-mounted preamps, are mounted adjacent to the four input terminals and automatically switched as the antennas are switched.

A 6J6 preamp, serving as the integral part of the switching booster, is said to increase the strength of the signal as it arrives from the antenna. When the signal is naturally high, the preamp may be bypassed.

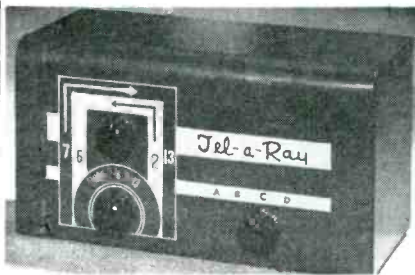

**INSULINE TWIN-LEAD CONNECTOR**

A connector, 6172, that is said to provide rapid connecting and disconnecting of flat twin-lead television wire, has been introduced by the Insuline Corp. of America, 3602 35th Ave., Long Island City 1, N. Y. Made of low-loss transparent plastic, the connector consists of two separable sections each an inch square and 1/4" thick, with solderless-screw type terminals on the plug and jack members.

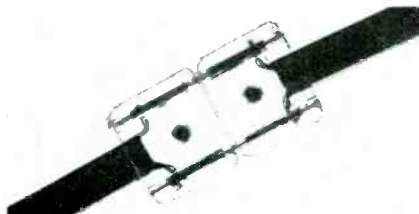

**FAST**

**TELEVISION**

**Tuner Alignment**

**to Crystal Accuracy**

**HICKOK**



MODEL 680

**R. F. MARKER and  
CRYSTAL CALIBRATOR**

EXCLUSIVE — Contains Magic Eye circuit for calibrating and crystal accuracy.

**FEATURES**

- Provides accurate alignment of RF and overall sections of a TV receiver. 53-89 MC and 173-217 MC on fundamentals.
- Harmonic output on UHF and VHF.
- Will calibrate any other generator to crystal accuracy by means of a built-in magic eye zero-beat indicator.
- 2.5 MC crystal supplied — 2 other crystal holders provided.
- Permits adjustment of frequency of TV local oscillators to crystal accuracy.
- Moderately priced — the 680 will prove to be a valuable investment in modern TV equipment.

See the 680 at your jobber's today, or write for full details.

**THE HICKOK ELECTRICAL INSTRUMENT CO.**  
10521 Dupont Ave. • Cleveland 8, Ohio

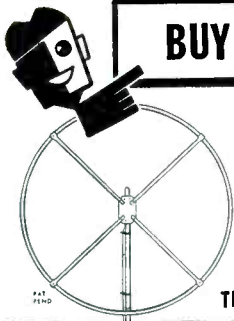

## BUY A BETTER ANTENNA

It's Circle-X for clear, sharp pictures on all channels, compare it and note the superiority . . .

Buy Circle-X chimney mounts, twin lead, guy wire, ground rods, wrenches, etc.

TRY A CIRCLE-X ON YOUR NEXT INSTALLATION

Air express or parcel post, special delivery direct from factory to you through your distributor.

**CIRCLE-X ANTENNA CORP.**  
511 MARKET ST., PERTH AMBOY, N. J.



## SOLAR MODEL CF Exam-eter

PRICE  
**\$69.95**  
F.O.B.  
N.Y.  
Ready to operate.  
20% deposit with  
order. Balance  
C.O.D.  
JOBBER: WRITE  
FOR DISCOUNTS

The most complete of all capacitor analyzers. Solar's famous Model CF is a sturdily constructed, reliable instrument designed to simplify electronic servicing.

- Has exclusive patented Quick-Check circuit for qualitative tests and intermittent checks without unsoldering capacitors
- Capacitance bridge — 10 mmf to 2000 mf in 4 ranges
- Power factor—0 to 50 percent
- Insulation resistance—3 to 10,000 megohms
- Electrolytic leakage current reads directly on 4 1/2" motor
- Built-in D-C power supply continuously adjustable from 0-550 volts for electrolytic tests under rated voltage
- 100 ohms to 7.0 megohm A-C resistance bridge
- 0-600 volt D-C vacuum-tube voltmeter
- 10-50 volt A-C vacuum-tube voltmeter
- Quality Components for Long, Trouble-free Service, 115 V., 50-60 cycles
- Complete with test leads & instruction manual

**ARCEE ELECTRONICS CO., Dept. P**  
96 WARREN STREET, NEW YORK 7, NEW YORK

# ASSOCIATIONS



### RTA, Long Beach, Calif.

THE LONG BEACH Radio Technicians Association, Inc., in California, have presented to the city of Long Beach, Councilman Ed Davenport of Los Angeles, Sheriff Biscaluiz of the county of Los Angeles and to the state legislature, a licensing law, which it is felt would be of benefit to the trade.

One of the features of the licensing measure is apprenticeship training which RTA reveals it has always believed was a must requirement. According to Harry E. Ward, RTA is probably the grandfather of such operations, now entering their fifteenth year of training programs, and working in coordination with the adult education group of the Long Beach City College and the AFL union.

Currently Ward is not only in charge of public relations at RTA, but general secretary of the Joint Executive Apprenticeship Committee of the

Long Beach and Harbor Area. Included on this committee are representatives of the automobile repair trades, electric motor repairmen, etc.

In the November, 1951, issue of SERVICE, in the *Ten Years Ago* column, Norman Neeley was described as having been in Los Angeles appearing before the RTA. Neeley was actually in Long Beach, at Miller's Cafeteria, presenting a talk before members of the association.

### FRSAP

DAVE KRANTZ has been reelected chairman, for the fourth time of the Federation Radio Servicemen's Associations of Pennsylvania. Others elected were: Milan Krupa, vice chairman; Leon Helk, secretary; and F. J. Schmidt, treasurer.

Speaker programs have been scheduled for the first quarter of '52. Included in the programs are John Rider, Capehart-Farnsworth, Howard Sams, etc.

### TEN YEARS AGO From the Association News Page

DURING a Jamestown chapter business meeting of RSA, held at the Hotel Jamestown, technicolor sound movies were shown. . . . At an open meeting of the Lehigh Valley chapter, John Rider spoke on the formation and subsequent dissolution of various Service Men's associations because of inadequate support. Detailed discussion of the *Reader's Digest* story and its benefits to legitimate Service Men followed. The parts shortage, future outlooks, etc., danger of utilities competition and the procedure being used in New York City to offset this threat, were also discussed. . . . Harold Sheets, service manager of the C. R. Rogers Co., Philco distributor, addressed the Pittsburgh chapter, providing latest information on the correct servicing of the new Philco record changers. . . . The year-end meeting of the LaPorte chapter was held at the Soldiers Memorial Park. Regular business included the distribution of rubber stamps and code charts, for use in chassis markings, to all members. RSA pins were also given to all members. . . . During the last meeting of the year, Interstate chapter's regular course of study was conducted by Dr. Harvalik at St. Ambrose College. All chapter officers were reelected: Edwin H. Gordon, president; L. H. Moorhead, vice president; and Oscar W. Olson, secretary-treasurer. . . . President F. E. Smith of RTA, Long Beach, Calif., was called to the colors for service in the Navy. Vice president Duane Davis and past president Harry E. Ward, Jr., were selected to carry on. The association unanimously and voluntarily joined the Voluntary Defense Bureau for repair work on radio, communications, etc. Plans were also laid for central service of all radio repairing.

At presentation of the National Alliance of Television and Electronic Service Associations' first annual *Friends of Service Management* industry award to Sylvania . . . "for the greatest service rendered by any industry manufacturer" . . . to the cause of the Service Man in 1951. In ceremony at Sylvania's executive headquarters, Frank J. Moch, left, president of the Alliance, tendered plaque symbolizing the award to Don G. Mitchell, Sylvania president. Looking on, from left to right: B. K. Wickstrum, vice president and director of sales for Sylvania; Terry P. Cunningham, Sylvania director of advertising and sales promotion; and Russell G. Cummings, eastern vice president of the association.





# Finest TV Reception

**The Hi-Lo TV Spiral Indoor ANTENNA**

Model 101

U. S. Patent No. 2,495,579  
Canadian patents 1951

**\$9.95** LIST PRICE

Available at leading jobbers!

**Hi-Lo TV ANTENNA CORP.**  
3540 N. Ravenswood Chicago 13

**THREE TYPES OF TWIN LINE CONNECTORS GIVE YOU A CHOICE FOR ANY INSTALLATION PROBLEM!**

**No. 14-0**  
A general purpose polarized connector.

**No. 14-1**  
Attaches directly to receiver screw terminals. Eliminates cutting line to install a connector.

**No. 14-2**  
A baseboard connector; serves as junction for antenna lead-in and inside lead to set. Mount them in parallel to accommodate the receiver in various locations.

**Grayhill**

GET DETAILS—Write for the Grayhill Catalog NOW

4532 W. Madison Street Chicago 24, Illinois

## Rep Talk

CHARLES W. POINTON, Toronto, Canada, has been appointed rep for Thomas Electronics, in Canada. Organization is managed by Charles G. Pointon. . . . *Gerald Wilson*, 403 Second St., Jackson, Michigan, has been appointed rep for James B. Lansing Sound, Inc., in Michigan, and Toledo, Ohio. . . . *J. T. Hill Sales Co.*, Los Angeles, has been named rep for Electronics Lab, in California, Arizona and Nevada. . . . *W. Bert Knight Co.*, 10373 W. Pico Blvd., Los Angeles, is now rep for Quam-Nichols Co., in California south of Port San Luis and Ryan, and Arizona. . . . *L. F. Waelterman Co.*, 8543 McKenzie Rd., St. Louis, Mo., have become reps for Jensen Industries, in Missouri, Kansas and Nebraska. . . . *J. M. Cartwright and Son* has been appointed rep for The Workshop Associates, in Tennessee and Mississippi. . . . *Paul A. Rothschild* has joined Oren H. Smith Co., sales reps, 221 W. Huron St., Chicago, Ill., as director of sales engineering. . . . *John B. Tubergen Co.*, Los Angeles, has been appointed southern California rep for Mandex Manufacturing Co., Chicago. . . . *Lee C. Van Hooser* has joined the Hollywood staff of Gerald B. Miller Co., engineering reps, to head the electronic component sales division. . . . *Jules J. Bressler* has been appointed by LaPointe Plascomold as manufacturer's rep for Vee-D-X products. He will cover the Metropolitan New York territory. . . .



Bert Knight



Jules J. Bressler



Charles W. Pointon



Charles G. Pointon

At '52 Electronic Parts Show space drawing, held at Hotel New Yorker, N. Y. City. Rear, left, group of show directors: Hy Ruble, NEDA; Lew Howard, WCEMA; John H. Cashman, EP&EM and Walter W. Jablon, SMCEG. Back of the floor plan is George Wedemeyer, NEDA, checking plan with Sam Baraf, SMCEG. At far right, Jules Bressler, New York rep, conversing with Aaron Lippman, NEDA. In front row: B. N. Zachariah, NEDA; Sam Spector, Insuline Corporation of America and Dick Mitchell, Regency Co. Center, with microphone, Kenneth C. Prince, show manager.



## JOTS AND FLASHES

STANDARD BROADCAST MODELS, as well as TV chassis, were quite prominent in new-receiver announcements which appeared as the new year rolled in. Clocks, in a variety of shapes and styles, highlighted the AM and FM table models, while improved indoor antennas and higher-gain inputs were spotlight features of TV sets. In one indoor-antenna news release, there appeared the report that an under-the-rug *V* system would be used. Manufacturers also reported that their sets would employ area-selector switches to provide best pickup in either local, suburban or fringe areas. Audio also received a nod from the designers in the new sets, with one chassis maker announcing an *accoustinator variable tone control*. Detailed analyses of these new developments will appear in the next issue of SERVICE. . . .

LaPointe Plascomold Corp. has initiated an increased advertising and sales promotion program for '52. . . . Herman S. Sacks has been appointed assistant general sales manager for Bendix TV and Radio. . . . Milton R. Benjamin has been named general sales manager of Jewel Radio Corp. . . . Tel-O-Tube Corp. of America has purchased the entire equipment and inventory of Video Industry Products Co., Paterson, N. J. The new facilities will be housed in Tel-O-Tube's recently renovated 10,000-square foot plant at 159-161 Marshall St., Paterson, N. J. . . . A Spanish edition of the Vec-D-X catalog, *La Linea de Antenas de Television mas completa y Potente del mundo*, has been issued by the LaPointe Plascomold Corp. . . . Van Sickle Radio Supply Co., 102 S. Pennsylvania St., Indianapolis, Ind., has had a name change. It will be known hereafter as Graham Electronics Supply Inc. Thornton Graham is president. . . . Warren E. Albright, who joined RCA Victor in '30 as an inspector in the Camden plant, has been appointed general plant manager of the home instrument department. . . . JFD Manufacturing Co. Inc., Brooklyn, N. Y., has introduced a package design for its AT105 *little giant* lightning arrester, the *handi-pak*; it holds six smaller boxes, each containing one arrester with hardware and installation instructions. . . . A jobber-dealer booklet, *How to Sell Brach Products*, has been released by the Brach Manufacturing Corp., 200 Central Ave., Newark, N. J. . . . Electronic Instrument Co., Inc., has purchased a 6-story plant at 84-86 Withers St., Brooklyn 11, N. Y. Plant will house factory and offices, adding more than 30,000 square feet to existing facilities.

## ADVERTISERS IN THIS ISSUE

### SERVICE INDEX—JANUARY, 1952

AEROVOX CORPORATION	30
Agency: Austin C. Lescarboursa & Staff	
AMERICAN PHENOLIC CORP.	32
Agency: Burton Browne, Advertising	
AMERICAN TELEVISION & RADIO CO.	56
Agency: Firestone-Goodman Adv. Agency	
ARCEE ELECTRIC CO.	54
Agency: Gelles Adv. Agency, Inc.	
ASTRON CORP.	26
Agency: Lehman Advertising	
ATLAS SOUND CORP.	46
Agency: H. W. Hauptman Co.	
BLONDER-TONGUE LABS.	47
Agency: Lester Harrison, Inc.	
CENTRALAB DIV. GLOBE-UNION, INC.	26
Agency: Klau-Yan Pietersen-Dunlop Associates, Inc.	
CIRCLE ANTENNA CORP.	54
Agency: Homer Harding	
H. G. CISIN	52
Agency: Jaman Advertising, Inc.	
CLAROSTAT MFG. CO., INC.	35
Agency: Austin C. Lescarboursa & Staff	
CLEVELAND ELECTRONICS, INC.	45
Agency: Hart White Adv. Co.	
COLUMBIA WIRE & SUPPLY CO.	26
Agency: Sander Rodkin Adv. Agency, Ltd.	
CORNELL-DUBILIER ELECTRIC CORP.	38
Agency: Reiss Advertising	
CORNISH WIRE CO., INC.	53
Agency: Hart Lehman Advertising	
DRAKE ELECTRIC WORKS, INC.	28
Agency: Sunders MacKenzie & Co., Inc.	
ELECTRO PRODUCTS LABORATORIES, INC.	2
Agency: Clarence M. Gotsch Associates	
ELECTRO-VOICE, INC.	41
Agency: Henry H. Teplitz, Advertising	
ERIE RESISTOR CORP.	44
Agency: W. J. Hill Co.	
FRESCO TELEVISION CO., INC.	28
Agency: Adrian E. Clark, Jr.	
GENERAL CEMENT MFG. CO.	31
Agency: Paul J. Steffen Co.	
THE GENERAL INDUSTRIES CO.	49
Agency: Meldrum & Fewsmith, Inc.	
GRAYHILL	55
Agency: Advertising Advertisers, Inc.	
HEATH COMPANY	6
Agency: G. Dean Arend, Advertising	
HICKOK ELECTRICAL INSTRUMENT CO.	53
Agency: The White Adv. Co.	
HI-LO TV ANTENNA CORP.	55
Agency: Sander Rodkin Adv. Agency	
HYTRON RADIO & ELECTRONICS CO.	37
Agency: Bennett, Walther & Menadier, Inc.	
JFD MFG. CO., INC.	26, 48
Agency: Shappe-Wilkes, Inc.	
JENSEN INDUSTRIES, INC.	13
Agency: Paul J. Steffen Co.	
KESTER SOLDER CO.	19
Agency: Paul J. Steffen Co.	
KRYLON, INC.	51
Agency: Gray & Rogers	
LA POINTE-PLASCOMOLD CORP. (VEE-D-X)	48
Agency: The F. W. Prella Co.	
P. R. MALLORY & CO., INC.	Inside Back Cover
Agency: The Witkin-Kynoit Co.	
MOSLEY ELECTRONICS	46
Agency: Rudolph Bartz, Advertising	
MUELLER ELECTRIC CO.	48
Agency: The Penholt Co.	
OHMITE MFG. CO.	39
Agency: The Penholt Co.	
PEERLESS PRODUCTS INDUSTRIES	48
Agency: Howard H. Clark	
PERFECTION ELECTRIC CO.	50
Agency: Seantlin & Co.	
PLYMOUTH ELECTRONIC CORP.	30
Agency: Howard-Wesson Co.	
PRECISION APPARATUS CO., INC.	1
Agency: Shappe-Wilkes, Inc.	
RAD-EL CO., MFG. CO.	50
Agency: Lehman Wood	
RADIART CORP.	Inside Front Cover
Agency: Stern & Warren	
RADIO CORPORATION OF AMERICA	33, Back Cover
Agency: J. Walter Thompson Co.	
THE RADION CORPORATION	25
Agency: Calkins & Holden, Carlock, McClinton & Smith, Inc.	
REGENCY DIV. I.D.E.A., INC.	21
Agency: Burton Browne, Advertising	
THE RAULAND CORPORATION	5
Agency: MacFarland, Aveyard & Co.	
RAYTHEON MFG. CO.	8
Agency: Walter B. Snow & Staff	
JOHN F. RIDER PUBLISHER, INC.	46
Agency: Conti Adv. Agency, Inc.	
HOWARD W. SAMS & CO., INC.	28
Agency: George Brodsky, Advertising	
SIMPSON ELECTRIC CO.	4
Agency: Burton Browne, Advertising	
SMITH ELECTRIC MFG. CO.	30
Agency: Brooks & London	
SNYDER MFG. CO.	27
Agency: Sprague Products Co.	
SPRAGUE PRODUCTS CO.	29
Agency: The Harry P. Bridge Co.	
STANLEY SALES	42
Agency: C. D. Advertising Agency	
SYLVANIA ELECTRIC PRODUCTS, INC.	3
Agency: Cecil & Preshrey, Inc.	
T.V. WIRE PRODUCTS	52
Agency: A. James Rouse Co.	
TEL-A-RAY ENTERPRISES, INC.	7
Agency: Erlen-Crescent Co.	
TELREX, INC.	43
Agency: George Homer Martin Associates	
TELEVISION ENGINEERS, INC.	44
Agency: E. H. Brown Adv. Agency	
TRIPLETT ELECTRICAL INSTRUMENT CO.	10
Agency: Western Adv. Agency, Inc.	
UNITED CATALOG PUBLISHERS	42
Agency: Burton Browne, Advertising	
WALDOM ELECTRONICS, INC.	52
Agency: Turner Adv. Agency	
WRIGHT, INC.	50
Agency: Kay Advertising, Inc.	

# ATR

## AUTO RADIO VIBRATORS

have Ceramic Stack Spacers

Free VIBRATOR MANUAL

### A COMPLETE LINE OF VIBRATORS . . .

Designed for Use in Standard Vibrator-Operated Auto Radio Receivers. Built with Precision Construction, featuring Ceramic Stack Spacers for Longer Lasting Life. Backed by more than 20 years of experience in Vibrator Design, Development, and Manufacturing.

NEW MODELS  
NEW DESIGNS  
NEW LITERATURE

"A" Battery Eliminators, DC-AC Inverters  
Auto Radio Vibrators

See your jobber or write factory

**AMERICAN TELEVISION & RADIO CO.**  
Quality Products Since 1931  
SAINT PAUL 1, MINNESOTA—U.S.A.



Preferred by Servicemen everywhere . . .

## MALLORY VIBRATORS

There are three big reasons why servicemen prefer Mallory vibrators over all other brands combined. They count on Mallory vibrators for long dependable service because they give . . .

- 1— Slow contact impact for minimum wear
- 2— High contact pressure for low resistance
- 3— Fast contact break for reduced arcing, pitting

That combination—available only from Mallory, with its patented, tuned mechanism—means real performance for you and your customers. That's why more Mallory vibrators are used as original equipment than all other makes combined. Put these features to work for you. When you order vibrators . . .



### Service 47 Radio Makes With ONE of Mallory's Special Vibrator Deals

Ask your distributor about these Mallory specials. They help keep your inventory down. You can service 47 radio makes with the 6 Mallory vibrators in one of these deals. And you get a handy parts cabinet at no additional cost when you buy *at your regular discount price*. Call your distributor today for details.

## Make Sure! Make it Mallory!

P. R. MALLORY & CO. INC.  
**MALLORY**

CAPACITORS • CONTROLS • VIBRATORS • SWITCHES • RESISTORS  
• RECTIFIERS • VIBRAPACK\* POWER SUPPLIES • FILTERS

\*Reg. U. S. Pat. Off.

**APPROVED PRECISION PRODUCTS**

**P. R. MALLORY & CO., Inc., INDIANAPOLIS 6, INDIANA**

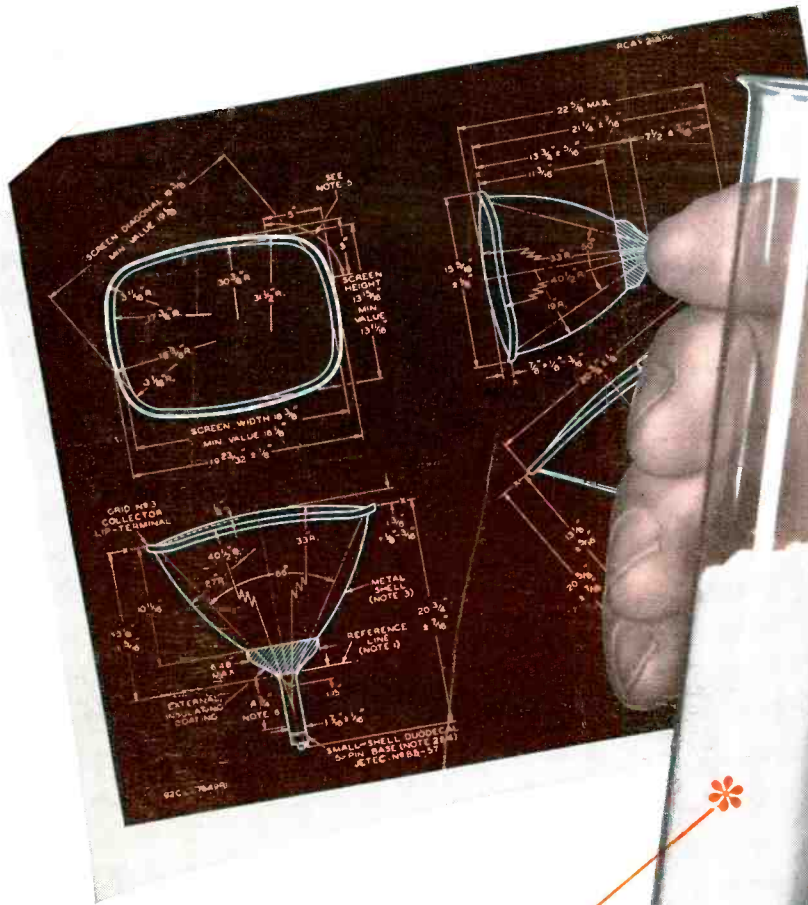

**99<sup>99</sup>/<sub>100</sub>%**

**pure phosphor . . .  
yet we threw it away**

PURE by most standards, this batch of phosphor was discarded because it contained more than our prescribed limits of 2 parts in one million of copper salts . . . sufficient, in our experience, to impair the performance of the fluorescent screen of a picture tube.

To avoid any such occurrence, every process in the manufacture of RCA picture tubes is closely guarded . . . from the control of raw materials to the final

evacuation and sealing operations. By exercising rigid control over every step in production, RCA has achieved the exceptional quality for which RCA picture tubes are noted . . . a quality that is unmatched for reliability and uniformity.

In RCA picture tubes, the difference is TOP-QUALITY CONTROL. That's why —dollar for dollar—RCA picture tubes have no equal.



With RCA Receiving Tubes, as well as RCA kinescopes, TOP-QUALITY CONTROL makes the difference.



**RADIO CORPORATION of AMERICA**  
ELECTRON TUBES  
HARRISON, N. J.