

# SERVICE

October  
1950

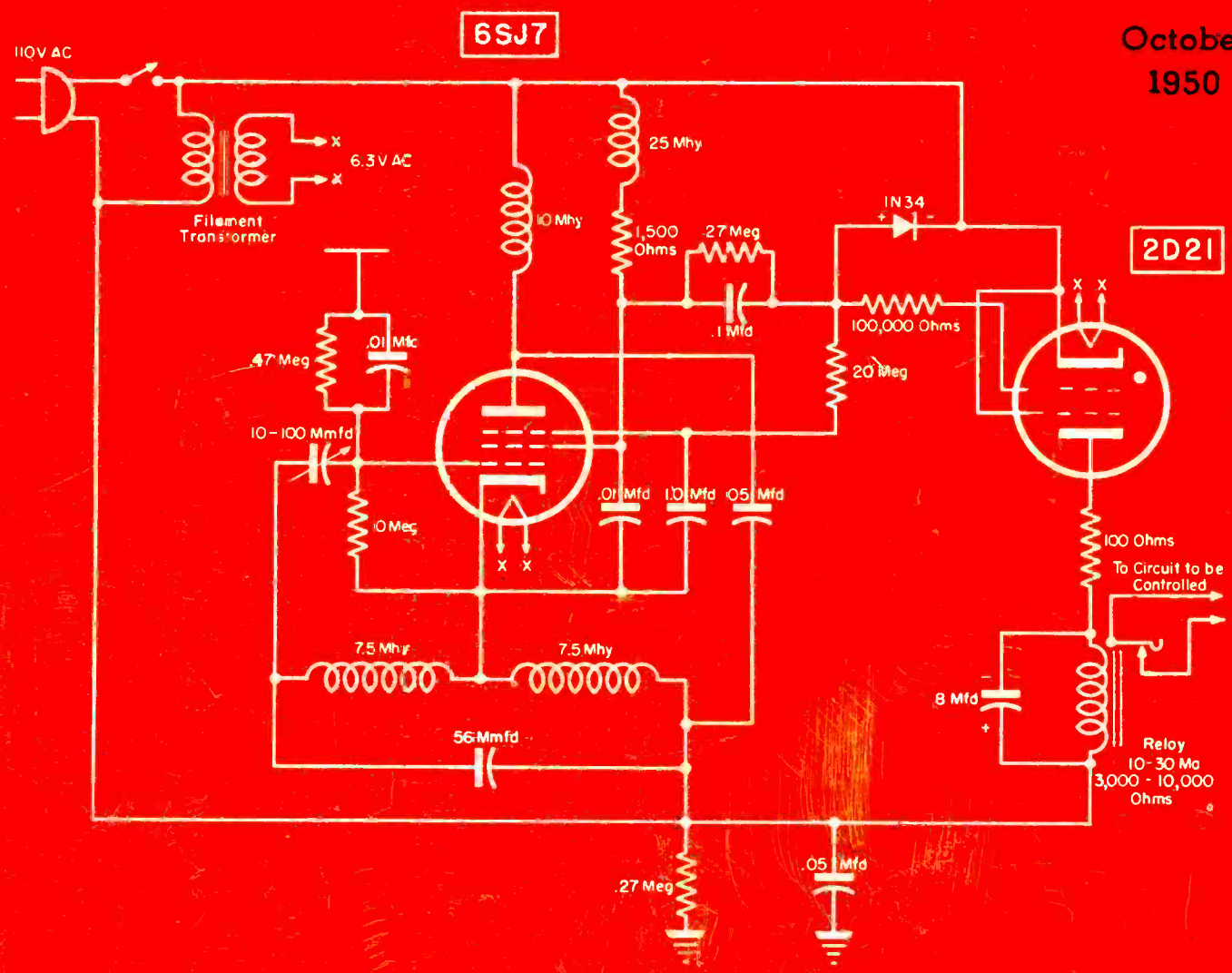

Circuit of self-compensating capacity-operated presence-detector system.

[See page 2]



# C-D

the only electrolytic  
with built-in extras



# blue beavers\*

**Now smaller, yet better than ever!**

they  
eliminate  
comebacks

When a set comes into your shop, the chances are that the original characteristics have been changed—either by previous servicing, aging of components, or by climatic conditions. That's why it's smart to use "Blue Beavers," designed and built exclusively for servicemen.

"Blue Beaver" Electrolytics have that extra "safety factor" that makes allowance for changes that may have taken place in the set after it left the factory.

That's why servicemen like to "play it safe" by using C-D "Blue Beavers" — Proved Best by Field Test.

"Blue Beaver" Electrolytics are available in all the popular capacity and voltage ratings required by servicemen. For further details, see your jobber or write for Catalog 200B. CORNELL-DUBILIER ELECTRIC CORPORATION, Dept. S100, South Plainfield, New Jersey. Other plants in New Bedford, Brookline and Worcester, Mass.; Providence, R. I.; Indianapolis, Ind., and subsidiary, The Radiart Corp., Cleveland, Ohio.

See your local Classified Telephone Directory for nearest C-D jobber.



CONSISTENTLY DEPENDABLE

## CORNELL-DUBILIER

CAPACITORS • VIBRATORS • ANTENNAS • CONVERTERS



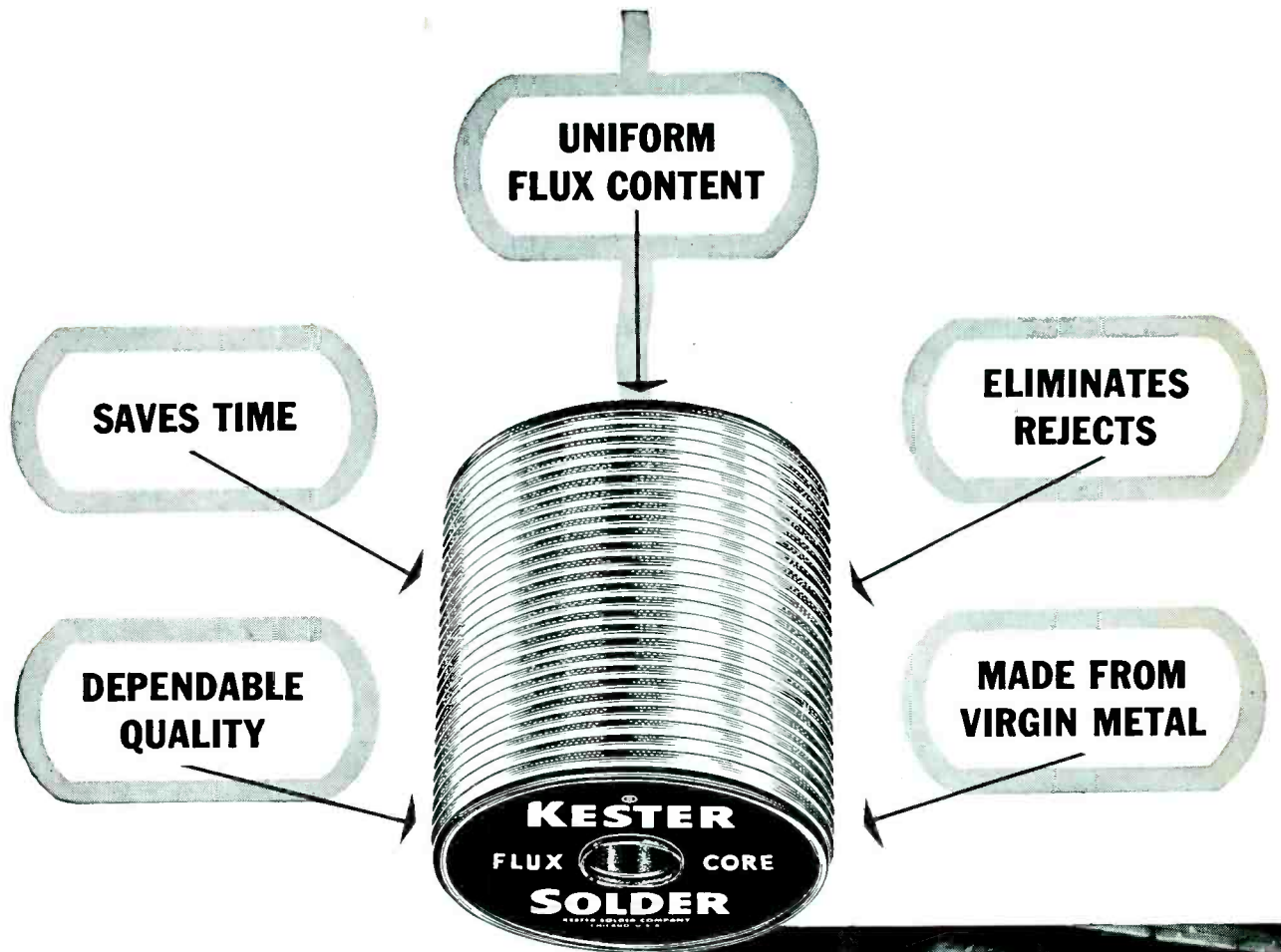

**KESTER**

the Solder

*that gets Speed  
into  
TV Production*



Using Kester Flux-Core Solders, Plastic Rosin or "Resin-Five" Core Solders—the same solder selected for original manufacture of TV sets and components—will enable you to do your finest work. Kester flows better—handles easier—faster to use. Kester Solders are made only from newly mined grade A tin and virgin lead.

**KESTER SOLDER COMPANY** • 4201 WRIGHTWOOD AVE.  
CHICAGO 39, ILL. • NEWARK, N. J. • BRANTFORD, CANADA

**KESTER  
SOLDER**





**LEWIS WINNER**  
Editorial Director

**F. WALEN**  
Assistant Editor

**ALFRED A. GHIRARDI**  
Advisory Editor

Including *Radio Merchandising and Television Merchandising.*  
Registered U. S. Patent Office

	Page
Association News	36
Auto Radio Automatic Tuners. By Jack Darr	18
Capacitive-Operated Presence Detector (Cover). By Alan Smolen	30
Dry Batteries (Constructual Features . . . Testing and Repair Techniques)	16
Phono Installation and Servicing. By Kenneth Stewart	28
Ser-Cuits (RCA 12½", 16" and 19" TV Chassis)	22
Servicing Helps. By M. A. Marwell	34
Servicing TV Flyback HV Systems. By Cyrus Glickstein	14
Ten Years Ago in Associations	36
Tube News (Classification Charts for TV and General Purpose Types). By L. M. Allen	20
TVI . . . Causes and Remedies (Part II). By Ira Kamen	32
Views and News. By Lewis Winner	13

**CIRCUITS**

Cam-Lever Mechanical Automatic Tuning System	18
Capacitive-Operated Presence Detector (Cover)	30
Coupling Signal Generator to TV Mixer Tuner	35
Electric Turret Tuning System	18
Hartley Oscillator Basic Circuitry	30
Kickback High-Voltage Supply Circuit	14
Motorola TV Chassis Modifications	34
RCA TV Chassis Vertical Oscillator	23
RCA TV Chassis Sync Separator and Amplifier	23
RCA TV Chassis Horizontal Oscillator	23
RCA TV Chassis Second Detector and Video Amplifier System (12½" Tube)	24
RCA TV Chassis Horizontal Output	48
TVI Filter Systems to Prevent Radiation in Ham Bands	32
TVI Filters in Ham Transmitter Inputs	32
TVI High-Pass Filters for 72 and 300-Ohm Inputs	32
Westinghouse Sound Takeoff Modifications	35

**COVER**

Capacitive-Operated Presence Detector	30
---------------------------------------	----

**PHONO INSTALLATION AND SERVICING**

Duo-Cone Speakers	56
L P Crystal Cartridge Design	58
Properties of Response	28
Remote-Controlled Amplifier	57
Sixty-Watt Bi-Power Amplifier	58
Three-Speed Phonos	58

**SERVICING HELPS**

Features of Five Basic TV Test Instruments	35
Motorola TV Chassis Modifications:	
Elimination of Vertical Collapse	34
Improving Picture Quality	34
Improvement of Vertical Sync Stabilization	34
Reduction of Horizontal Radiation	34
Westinghouse Chassis Alterations:	
Improving Horizontal Linearity Control	35
Securing More Filament Voltage for 1X2A	35
TV Tube Substitutions	35

**Index to Advertisers**

Manufacturers	64
Jots and Flashes	64
News	61
New Parts . . . Tools . . . Instruments	43
Rep Talk	63
TV Parts . . . Antennas . . . Accessories	42

Entire contents Copyright 1950, Bryan Davis Publishing Co., Inc.



Published monthly by Bryan Davis Publishing Co., Inc.  
52 Vanderbilt Avenue, New York 17, N. Y. Telephone MURray Hill 4-0170

Bryan S. Davis, President      Paul S. Weil, Vice-Pres., Gen. Mgr.      F. Walen, Secretary      A. Goebel, Circulation Manager

Mid-West Representative: Stuart J. Osten, 333 N. Michigan Ave., Chicago 1, Ill. Telephone: Dearborn 2-3507  
East-Central Representative: James C. Munn, 2253 Delaware Dr., Cleveland 6, Ohio. Telephone: ERIevlew 1-1726  
Pacific Coast Representative: Brand & Brand, 1052 W. Sixth St., Los Angeles 14, Calif. Telephone: Michigan 1732  
Suite 1204, Russ Building, San Francisco 4, Calif. Telephone: SUTter 1-2251

Entered as second-class matter June 14, 1932, at the Post Office at New York, N. Y., under the Act of March 3, 1879. Subscription price: \$2.00 per year in the United States of America and Canada; 25 cents per copy. \$3.00 per year in foreign countries; 35 cents per copy.

# Set a new mark in TV Set Service



...with this new  
**SYLVANIA  
Marker  
Generator**  
Type 501

**FOR THE BEST IN TEST EQUIPMENT  
...SEE SYLVANIA**

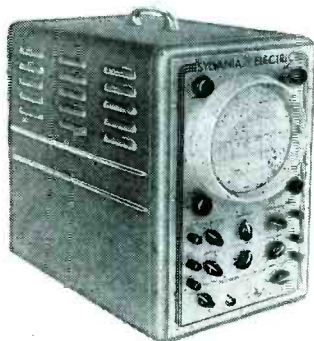

**Sylvania TV  
Oscilloscope**  
(Type 400)

This new, high-gain, wide-band instrument accurately displays any TV pulse, wave-shape, or signal. Sensitivity: 0.01 volts/inch. Band width useful to 4.0 mc. Frequency compensated attenuator.

**Sylvania TV Sweep  
Signal Generator**  
(Type 500)

A compact, efficient instrument equipped with electronically controlled sweep circuits to eliminate the complexities found in mechanical sweeps. Ideal companion instrument for Type 501 Marker Generator.



**I**t's here at last! The new Sylvania TV Marker Generator we promised you.

Now you can offer better TV service than ever before. This new Sylvania instrument provides *two* separate signals for marking an oscilloscope trace of response curves, accurate adjustment of traps, frequency spotting, measuring band width, and correct adjustment of the popular 4.5 mc. intercarrier sound circuits.

Single switch provides continuously variable and crystal-controlled signals *separately* or *simultaneously*, or standby operation. VFO covers 15 to 240 mc. range. Second oscillator furnishes crystal-controlled signals without tuning, when standard makes of crystals are inserted in a panel socket.

*Mail the coupon for full information or see your Sylvania distributor today!*

Sylvania Electric Products Inc.  
Department R-1710  
Emporium, Pa.

*Please send me illustrated folders describing the full line of Sylvania Test Equipment.*

Name \_\_\_\_\_

Company \_\_\_\_\_

Street \_\_\_\_\_

City \_\_\_\_\_ Zone \_\_\_\_\_ State \_\_\_\_\_

# SYLVANIA ELECTRIC

RADIO TUBES; TELEVISION PICTURE TUBES; ELECTRONIC PRODUCTS; ELECTRONIC TEST EQUIPMENT; FLUORESCENT TUBES, FIXTURES, SIGN TUBING, WIRING DEVICES; LIGHT BULBS; PHOTOLAMPS; TELEVISION SETS;



# HERE IS YOUR BASIC TELEVISION and FM SERVICE LAB

- ★ APPLICATION ENGINEERED for TV, FM and other modern electronic requirements. Every necessary feature BUILT-IN without costly and cumbersome duplication of instruments you already own.
- ★ PERFORMANCE DESIGNED for practical operational simplicity and ruggedness, insuring long-lived, trouble-free service.

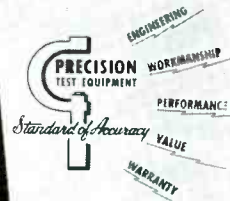

- PLUS -



## Series E-400

### WIDE RANGE SWEEP SIGNAL GENERATOR

Complete with test cables, quartz marker crystals and Technical Manual. Size 10 1/2 x 12 x 6."

Net Price **\$134<sup>50</sup>** Convenient Terms Available See your PRECISION Distributor

- ★ Direct Frequency Reading 2 to 480 Mc. 5 ranges to 240 MC. 280-480 MC bands harmonically calibrated. 3 color, 6 1/2" diam. etched tuning dial, high ratio rim driven. Zero back-lash.
- ★ 1500 Point Vernier Scale. Engraved lucite hair-line indicator. Positive readings free from parallax.
- ★ High Output and Accuracy via use of selected and true VHF components and circuits. Voltage regulated oscillators. Crystal calibrated plus crystal control.
- ★ Narrow and Wide Band Sweep. 0-1MC and 0-15MC
- ★ Wide Range Phasing Control.
- ★ Multiple Crystal Marker-Calibrator Oscillator built-in. 4 rotary selected crystal sockets. 10.7MC and 2MC crystals furnished as standard equipment.
- ★ Terminated RG/U Coaxial Output Cable and dual R. F. attenuators, triple shielded, stepless, quiet.
- ★ Simultaneous A.M. and F.M. test facilities.
- ★ Double-Pi Line Filter plus multi-section, copper-plate shielding of entire instrument.
- ★ Tube Complement: 3 each 6J6 & 6C4. 1 each VR-105 & 6X5.
- ★ Fully Licensed under W.E., AT&T and Remco patents
- ★ PLUS many other "Precision" engineering refinements too lengthy to list.

YOU MUST SEE the Series E-400!

## SUMMARY OF IMPORTANT FEATURES

- ★ Extended Range Vertical Amplifier. Response to 1 Megacycle. 2 Megohm input resistance with exceptionally high stability.
- ★ 20 Millivolt Vertical Sensitivity. Such high sensitivity required for diversified TV, FM and AM circuit analyses.
- ★ Vertical Input Step Attenuator. x1, x10, x100. Additional continuous vernier control. Cathode follower input circuit.
- ★ Extended Range Horizontal Amplifier. Response to .5MC. 1/2 megohm input resistance.
- ★ Linear Multi-Vibrator Sweep Circuit. 10 cycles to 30 KC. Improved circuits assure unusual linearity thruout range.
- ★ Amplitude Controlled Synch Selection.
- ★ "Z" Axis Modulation terminals for blanking, timing, etc.
- ★ Phasing Control for line sweep operations.
- ★ Audio Monitoring phone jacks provided at rear of cabinet plus direct access to H and V deflection plates.
- ★ Light Shield and Calibrating Screen removable and rotatable for varied applications and light conditions.
- ★ Tube Complement: 1 each type 6J5, 6AG5, 7N7, 6X5, 2X2, 7AD7, 7W7. 5CPI/A CR tube.
- ★ Fully Licensed under patents of Western Electric and A.T.&T. companies.
- ★ PLUS a lengthy list of "Precision" refinements and facilities that must be seen to be appreciated.

Order Now from your nearest authorized "Precision" distributor to assure earliest possible delivery.

AM • FM • TV



## PRECISION APPARATUS CO., INC.

92-27 Horace Harding Boulevard, Elmhurst 1, New York

Export Division: 458 Broadway, New York, U.S.A. • Cables—Morhanex  
In Canada: Atlas Radio Corp., Ltd., Toronto, Ontario

Ask to view the inside of any instrument and know why "Precision" is the Standard of Workmanship, Performance and Accuracy.

AM • FM • TV

# NEW INDICATOR ION TRAP

Now in all  
**Rauland  
Tubes**



The response to Rauland's new Indicator Ion Trap, after its introduction in the 12LP4-A, has been so enthusiastic that this feature has now been incorporated in all Rauland tubes—as a standard feature of the new Rauland Tilted Offset Gun.

In the field or on the assembly line, this new Indicator Ion Trap reduces Ion Trap Magnet adjustment time to a matter of seconds, eliminates mirrors and guesswork, and assures accuracy of magnet adjustment. It can increase profits for every service man and service dealer—and at the same time assure better customer satisfaction.

A bright green glow on the anode of the picture tube signals when adjustment is incorrect. Correct adjustment is made instantly, by moving the magnet until the glow is extinguished or reduced to minimum.

Only Rauland offers this advanced feature—one of a half-dozen important post-war developments from Rauland.

## **RAULAND**

The first to introduce commercially these popular features:

Tilted Offset Gun

Indicator Ion Trap

Luxide (Black) Screen

Reflection-Proof Screen

Aluminized Tube

## **THE RAULAND CORPORATION**



*Perfection Through Research*

4245 N. KNOX AVENUE • CHICAGO 41, ILLINOIS





# SETS NEW RECORDS

*... in Performance and Popularity*

**THE VEE-D-X**

## COLINEAR ARRAY

is fast replacing other types  
of antennas in all areas where

**POWERFUL MULTI-CHANNEL  
RECEPTION**  
is required

The preassembly features made so popular by the VEE-D-X single channel Yagi series are now incorporated in an all-channel antenna . . . the sensational new VEE-D-X Colinear Array. In spite of this big extra, the powerful, high gain Colinear Array is still the lowest price 4 bay array ever manufactured. That is why its popularity is sweeping the country. Send for new catalog showing the Colinear and complete VEE-D-X Single Source line.

**Here Are The Features That Are Making The  
VEE-D-X "Colinear" a byword in The World of Television**

- Powerful, high gain, all-channel performance.
- Completely preassembled for immediate installation.
- Compact in size. Light in weight . . . only 4¼ lbs.
- Equipped with attached phasing harness.
- The lowest price 4 bay array ever manufactured.

THE La POINTE-PLASCOMOLD CORPORATION, UNIONVILLE, CONN.

# VEE-D-X

**BUILDERS OF THE WORLD'S MOST POWERFUL ANTENNAS**



**ONLY**  
**23<sup>75</sup>**  
**LIST**  
Less Mast

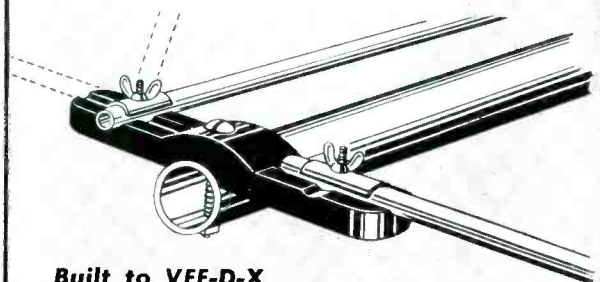

**Built to VEE-D-X  
Standards of High Quality**

The use of the best materials throughout, combined with rugged construction give the Colinear life-time sturdiness. (Note — extra heavy duty insulator blocks). Wing-nut type construction permits all elements to be easily swung into place. No separate bolts or screws . . . a real timesaver for installation men.



# The RCA "TV Duo"...

## Designed for the Professional Television Technician



**The new WR-59B Television Sweep Generator for all TV channels and having continuous IF and video coverage from 0.3 to 50 Mc.**

**The new WR-39B Television Calibrator is a Marker and Linearity Pattern Generator.**

Matched in design...unmatched anywhere for their advanced engineering features...these new companion units furnish *all basic signals* essential for the rapid, precision servicing and production testing of television receivers. Flexibility, versatility, and accuracy are outstanding characteristics of each unit individually and in combination.

**The RCA WR-59B Television Sweep Generator** covers all broadcast television channels on preset selector-switch positions, and in addition features a continuous tuning range from 0.3 to 50 Mc, to accommodate current and future intermediate frequencies. The rf signal is frequency-modulated at the fundamental frequency by a precision-type vibrating capacitor of advanced design. The signal is free from spurious responses and other frequency components often found in harmonic generators and beat-frequency oscillators.

An additional feature of the WR-59B is the inclusion of a blanking circuit which produces a zero-reference line on the cathode-ray tube. This base line aids in determining the amplitude of the signal. The base line is also very useful in aligning FM discriminator circuits, or in checking the exact slope of the frequency-response curve of any circuit.

**The RCA-39B Television Calibrator** features crystal calibrated markers for all TV frequencies and is useful in making linearity adjustments. Included in this one instrument is a crystal-calibrated variable-frequency oscillator, two crystal-controlled oscillator stages with three crystals supplied, a wide-band modulator stage for internally modulating the output at audio and radio frequencies, and an audio amplifier with speaker. The instrument provides a crystal-controlled 4.5-Mc output for alignment of TV sets employing inter-carrier sound...crystal-controlled markers

4.5 megacycles removed from the main marker, for television rf and if alignment...and crystal-controlled markers 250 kilocycles removed from the main marker, for sound discriminator alignment.

Additional features are—provision for injection of external marker...internal audio and rf modulation of variable-frequency oscillator...and crystal-calibrated heterodyne frequency meter.

For a complete and modern television alignment setup, your best buy is the WR-39B Television Calibrator combined with the WR-59B Television Sweep Generator and the new, revolutionary WO-57A Oscilloscope matching unit. This "TV Trio" is also available in the WS-17A 3-unit rack.

For complete details on the WR-39B and WR-59B, see your RCA Test Equipment Distributor, or write RCA, Commercial Engineering, Section J56X, Harrison, N. J.

Available from your RCA Test Equipment Distributor



**RADIO CORPORATION of AMERICA**  
TEST EQUIPMENT  
HARRISON, N. J.

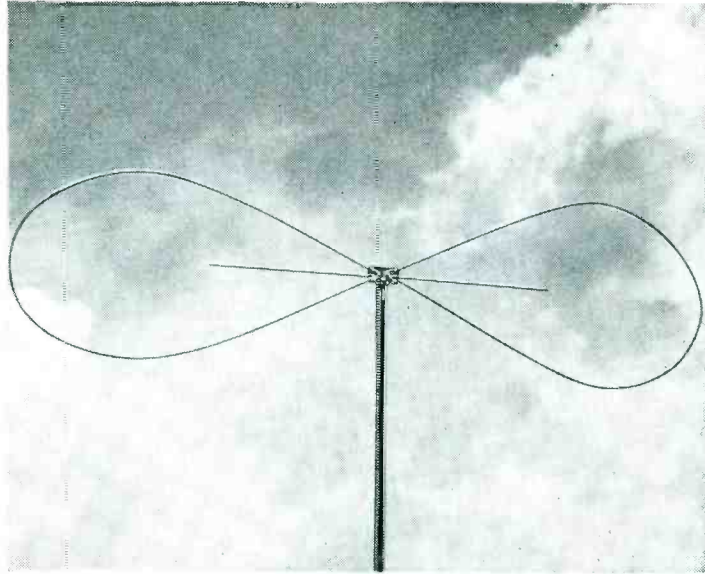

**THE ANSWER  
TO INSTALLATION  
PROBLEMS**

**Just unpack this antenna and mount to  
the mast . . . THE ECON-A-RAY *Butterfly***

and it sells for **\$2<sup>95</sup>** Suggested List

**T**HE FIRST antenna built with the problems of the serviceman in mind — the Econ-a-Ray Butterfly — for lightning fast installations at low cost.

There is nothing to assemble with the Butterfly. Just take it out of the box and mount it to the mast — for fine television.

The Butterfly will save you time and money — not only in installations — but by eliminating call-backs. Constructed from Dural, with stainless steel fittings, the Butterfly withstands winds up to 75 mph, is unaffected by any weather conditions, and cannot corrode.

This is a quality antenna — even though the price is low. It receives all 12 TV channels and FM radio, eliminates ghost images, and brings in a strong, sharp signal. It is designed for high signal areas, only.

The Econ-a-Ray Butterfly comes individually wrapped, 12 to a carton. Order yours today from your distributor.

TEL-A-RAY manufactures a complete line of TV and FM antennas including the Model T Reception Master which brings television to homes 200 miles away from the nearest station. All are guaranteed against weather and wind damage. We will be glad to send you our catalog.

**“FIRST—because they LAST”**

*Write Today for Information and Distributor's Name*

***Tel-a-Ray* ENTERPRISES, INC.**

P. O. BOX 3325

HENDERSON, KENTUCKY



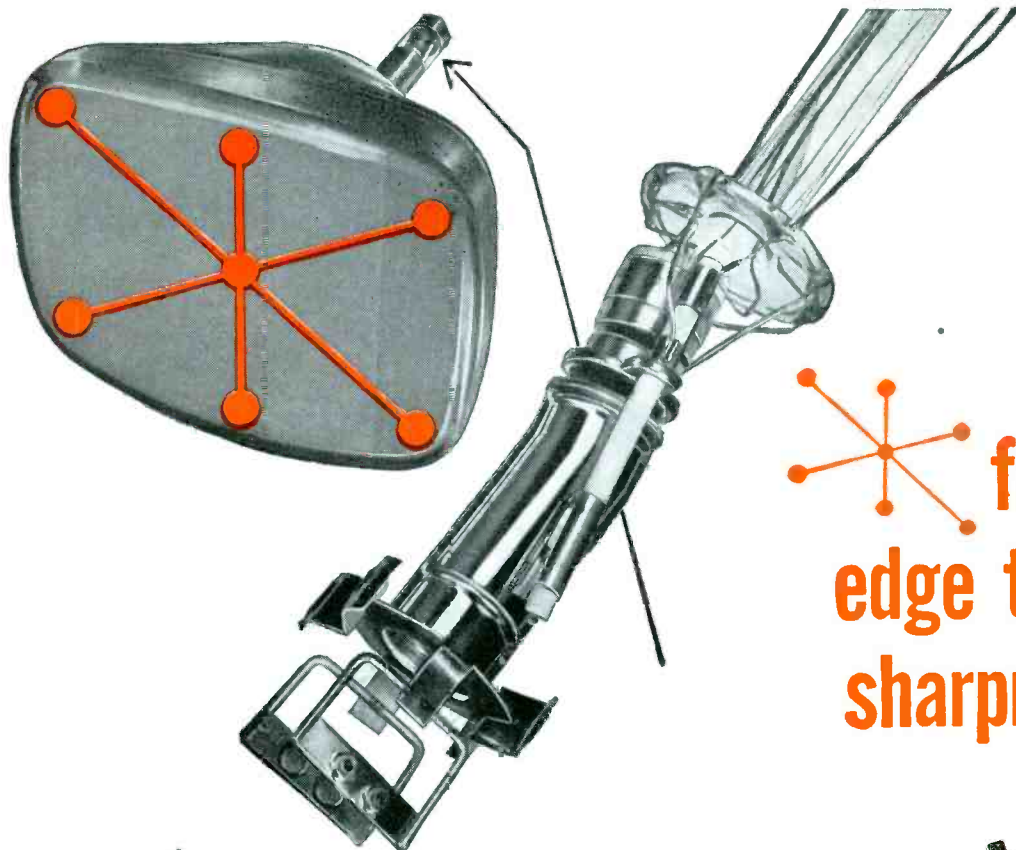

**for  
edge to edge  
sharpness...**

# the **New** Du Mont Bent-Gun

**U**niform sharpness of trace to the very edges of the screen distinguishes the new Du Mont Bent-Gun.

A higher degree of pre-focusing passes a smaller-diameter beam through the deflection field. Spot distortion is reduced and a uniform overall focus results. Other design changes are: Improved bulb spacer insures proper anode contact and electron gun centering; rounded corners on pertinent gun parts eliminates stray emission at higher anode voltages; new grid-cathode assembly allows a longer G-2 (second grid) without increasing overall length.

This new Du Mont Bent-Gun is now being incorporated in ALL Du Mont Teletrons. Therefore, whether planning a new TV receiver or modifying an old one, be sure to include the Du Mont Teletron for the best in TV pictures. Simply specify DU MONT.

FIRST WITH THE FINEST IN **T-V** TUBES

**DU MONT**

*Teletrons*<sup>\*</sup>

ALLEN B. DU MONT LABORATORIES, INC.,  
Tube Division, Clifton, N. J.

\*Trade-mark.



**WIDE RANGE 5-INCH  
OSCILLOSCOPE  
MODEL 3440**

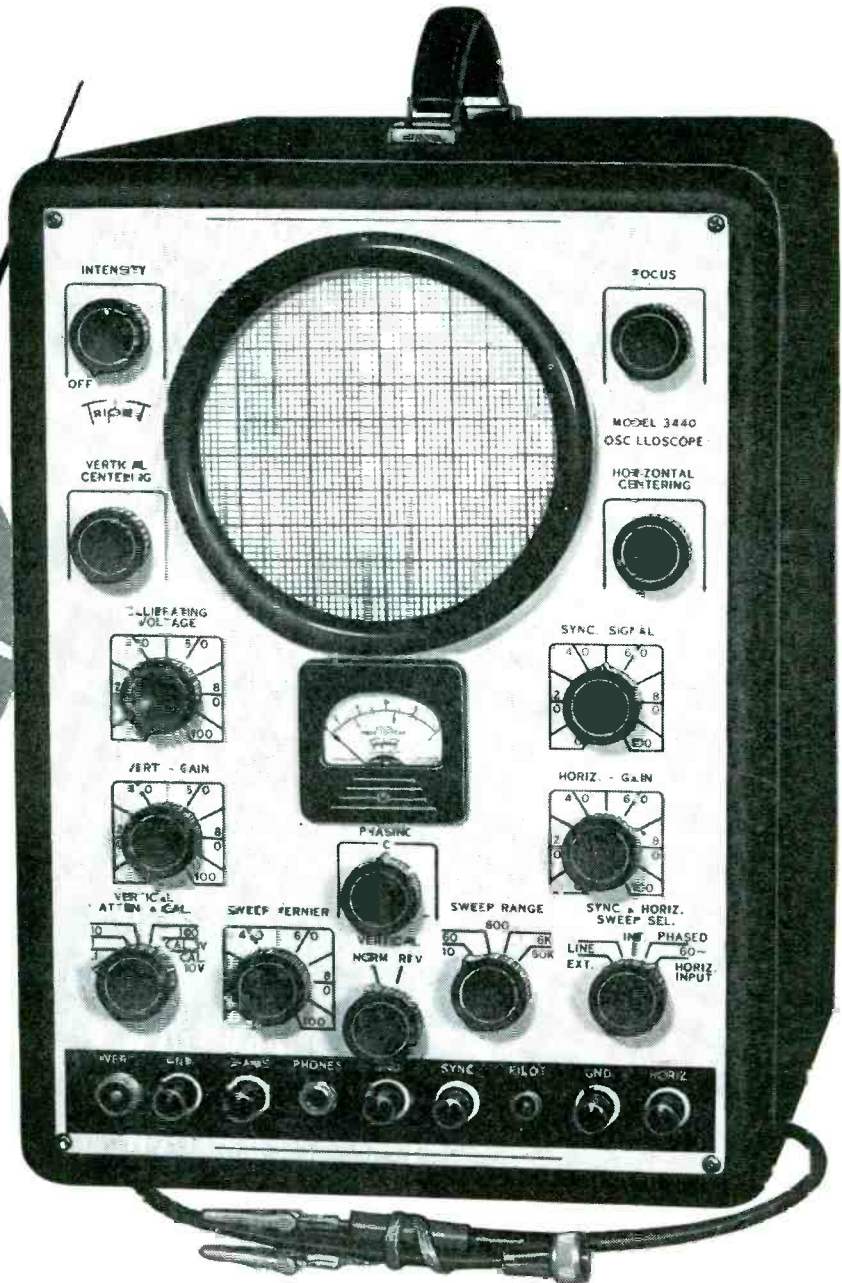

- \* ● Provision for changing polarity—wave form shows in conventional manner.
- \* ● Calibration Meter—to measure voltage of complex wave forms in TV receivers.
- \* ● Vertical deflection sensitivity—.009 RMS volts/inch.
- Wide frequency range—20 cycles to 1 MC on Vertical—Services both TV & FM.
- Return trace eliminator.
- Internal phase controlled horizontal sweep.
- Internal sweep oscillator—10 to 60 KC linear.
- Z-axis input for intensity modulation.
- Copper plated feet for improved grounding.

\* EXCLUSIVE AT THIS PRICE LEVEL

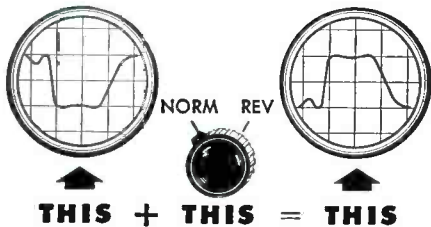

The first oscilloscope which permits changing polarity, thus keeping wave form showing in a conventional manner.

**ONLY \$189.50 AT YOUR DISTRIBUTORS**







**GET YOUR SHARE** with

# Webster-Chicago *Diskchangers*

**MODEL 100**

Install in radio or T/ combinations, to replace old single and dual speed changers.

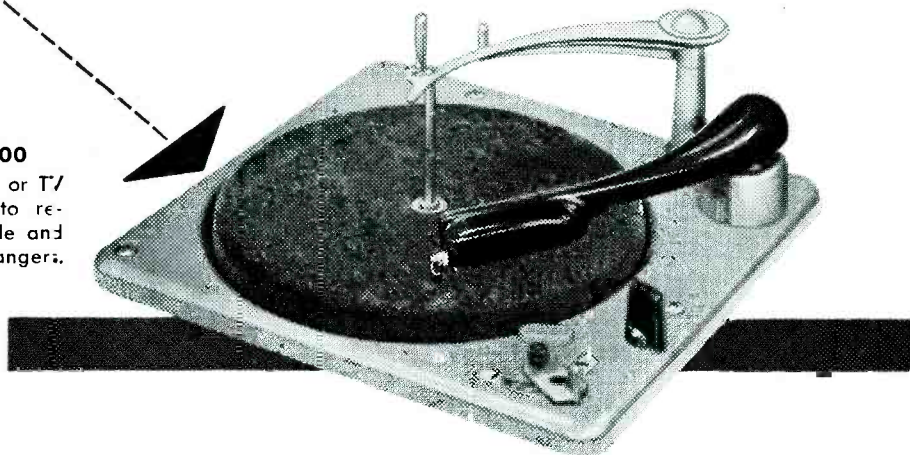

**Leads in customer acceptance**

When there's a chance to cash in on a market as big as this record changer replacement market, it makes "dollar sense" to sell the leader! And that's just what you do when you sell these sensational Diskchangers, one of the newest additions to Webster-Chicago's famous line of record-changing equipment. Here's a record-changing mechanism you can endorse for sturdiness, quality and fool-proof performance. Sensibly priced to spell value to any prospect! Don't compromise—sell the best—sell Webster-Chicago.

**Ask your distributor about Webster-Chicago's big dealer cooperative advertising program.**



**WEBSTER-CHICAGO**

**...far ahead in features, too!**



**BALANCED TONE ARM**  
Gives perfect record touch on all size and all speed records.



**VELOCITY TRIP**  
New mechanism gives all records increased quality playing life.



**CUSHION DROP**  
New spindle gently lowers records; heavy flock turntable cushions drop.

- Automatically plays 12-inch, 10-inch or 7-inch records at 33½, 45 or 78 rpm without any special adjustments.
- Pick-up arm comes to rest position after last record is played.
- Fewer working parts for longer life of carefree operation.
- New automatic manual position plays home recordings or "inside-out" records without special adjustment.

**CHICAGO 39, ILLINOIS**



Sell an

# ANCHOR BOOSTER

for fast profits

and complete customer satisfaction...



**\$1800** PROFIT ON NEW TWO-STAGE BOOSTER

**\$1320** PROFIT ON NEW SINGLE-STAGE BOOSTER

## ON EVERY FRINGE INSTALLATION

Why High Towers,



Hazardous Installations



for your men as well as your customers? WHY spend so

many hours



on one installation when you CAN

make 3 or 4 calls



and more profits



per

installation in one afternoon?

You, the Service Dealers, are recognized as experts in your community. Your advice is often asked and usually followed. Your men are the *one group* in the electronics field who actually get into the home... right at the point of sale. It stands to reason then that an installation of one of the many fine simple-to-install antennas, plus an ANCHOR Single or Two-Stage Booster would make a faster and more profitable installation for YOU as well as a completely satisfied customer. REMEMBER, returned calls due to dis-satisfaction are costly.

**The New ANCHOR BOOSTERS Are Available. Order from your jobber Now.**

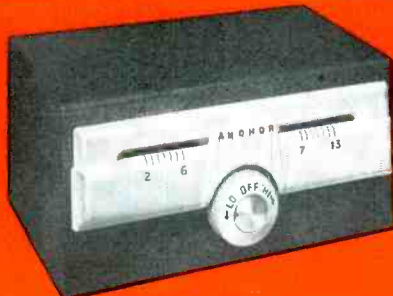

ANCHOR'S NEW SINGLE-STAGE BOOSTER, ARC-101-75, especially recommended for low signal areas in or near cities where there may be any number of interference problems. Assures consistently good reception up to 75 miles.

BE SURE YOU KNOW ALL THESE FACTS

Only ANCHOR can provide your customers with ALL of the most Ultra-Modern advantages for consistent, top-notch, long-range TV reception. Here's why!

- ANCHOR has the highest gain of any TWO-STAGE BOOSTER.
- ANCHOR has the highest Signal to Noise Ratio.
- ANCHOR is the only non-regenerative unit available. The unit that is not returned.
- ANCHOR'S Single Knob Construction is so convenient for Booster is turned on and can be switched and tuned all on the same knob.
- ANCHOR'S New and Revolutionary method of construction of the RF Stage (Fat. Lead.) is the only real engineering advance in Boosters in recent years.
- ANCHOR'S TWO-STAGE BOOSTER is modernly styled with streamlined plastic escutchion, soft mahogany leatherette finish.
- IMPORTANT ANCHOR'S TWO-STAGE BOOSTER is often the answer to installation difficulties well within the normal TV areas where their New Single Stage Model fails to give complete satisfaction.

ANCHOR'S NEW TWO-STAGE BOOSTER, ARC-101-100, increases original TV signal strength more than 5 times and assures consistently good reception over 100 miles.



# ANCHOR RADIO CORP.

ANCHOR ENGINEERING ALWAYS A YEAR AHEAD

2215 SOUTH ST. LOUIS AVENUE

CHICAGO 23, ILLINOIS





### **The Color Wheel**

WITH THE MECHANICAL REE, BLUE AND GREEN DISC ERA NOW WITH US, WITH THE blessing of the august body of Commissioners in Washington, and late November scheduled for the inauguration of colorcasting, at least in New York City, the months ahead are destined to be as exasperating to many as the early days of TV. Unfortunately, the headlines of many dailies have, as in the past, contributed to the confusion. With banner heads exclaiming that complete obsolescence lies ahead and black and white programs are doomed, Mr. and Mrs. Consumer have been whirlpoiled into a sea of bewilderment. Actually, there will be black and white telecasts for years and years, and years. No black and white sets now in use, or to be purchased, will become obsolete at any time, regardless of the permanence of the FCC ruling, or possible adoption of any other system in the future.

#### **Black and White Conversion**

Receivers, according to the current plan, can be modified to pick up the green signal of the colorcasts, which will provide a so-called black and white picture. Since the Columbia method is based on the use of 405 lines, the resultant monochrome picture will not be as detailed and effective as the 525-line pictures now being sent out by standard TV stations. Technically speaking, the CBS picture consists of 29,160 lines in 144 fields. It is the circuitry required to provide pickup of this type of a signal that seemed to stump most of the manufacturers and prompted them to report that they could not possibly meet the production deadline set by the Commission. To make the new and old models scan at the higher line and field frequencies, the manufacturers declared that it would be necessary in most instances to effect a complete redesign, not only of the scanning circuit, but perhaps of some of the yoke systems, too. Washington stipulated that sets should have a manual or automatic switch providing selection of the 405 or 525-line signals and the resultant pictures should be of equivalent size, geo-

metrical linearity and brightness on each of the two switch positions. Most manufacturers said that such a result could not be achieved easily; it would take months and months to provide a solution. In the opinion of one chassis maker, the middle of '51 might be a plausible date for the production of a receiver with the 405-525 switching mechanism.

#### **Color Pickup**

Converters and adapters are required to provide color pickup, that is, pickup of the three signals of red, green and blue. But here again, there are the time and economic problems to consider, although some in industry have announced that such equipment would be available very soon. According to a leading set maker, it was not believed that many would want to convert their sets until color broadcasts offered a real added service and that may be many years in the future.

#### **Receiver Costs**

Explaining the problems of producing combination color and black and white receivers as a unit, this manufacturer stated that at present, it was not known how this could be accomplished, particularly within reasonable commercial cost limits. It was his belief that such a set could not be put into production in less than a year, and that perhaps eighteen months to two years would be a more realistic estimate, even assuming that the added materials and components could be made available in the face of increasing demand for these same materials by the military for vital electronic equipment. Reviewing the economic aspects of the situation, this manufacturer declared that no actual cost estimates for this combination type of receiver are available now, for the very simple reason that such sets have not as yet been designed or developed. It has been assumed that such sets might cost from 50 to 100% more than the present models for equal-sized pictures.

Many have queried the picture sizes possible with the new system. At pres-

ent, CBS color pictures are limited to a basic 10-inch size and can only be increased by a magnifier lens. The disc required for a 10-inch picture is 24" in diameter and for a 12½-inch picture it is 28" in diameter. Should a 16-inch picture be desired, the disc required would have to be three feet in diameter. Of course, as the size increases, a larger and larger motor is required for operation of the wheel.

In a bulletin to distributors, another manufacturer emphasized the longevity of black and white sets by declaring that . . . "It is clear that you can continue to offer our TV sets to the public with complete confidence that your customers will be buying . . . sets from which they will get years of satisfactory service and entertainment." This manufacturer then went on to explain that the present outstanding program service in black and white television will be continued, expanded and improved for years to come.

The possibilities of electronic color were also reviewed in this bulletin, with the comment that the development of all-electronic color TV will continue and demonstrations will be offered to prove . . . "that the sound future of color television can be built and will be built on bedrock principles."

Color is at present and will be for quite awhile, a supplementary service. Explaining this view in a dealer bulletin, a Pacific coast set maker said that color cannot be described as a replacement service.

#### **Status of Color Today**

In retrospect, we find, therefore, that color is at present a metropolitan, New York City factor and a very limited one, since only one or two hours of colorcasting are planned; plans for expansion in huecasting in other cities are vague; switch-circuit concepts for black and white pickups are still in the experimental stage, and only small-size picture tube reproduction will be possible with whatever converters or adapters may become available.

Color has come into our fold, but in a miniature hobby-like way.—L.W.

Fig. 1. Kickback high-voltage supply circuitry.  $T_1$  is a kickback transformer.

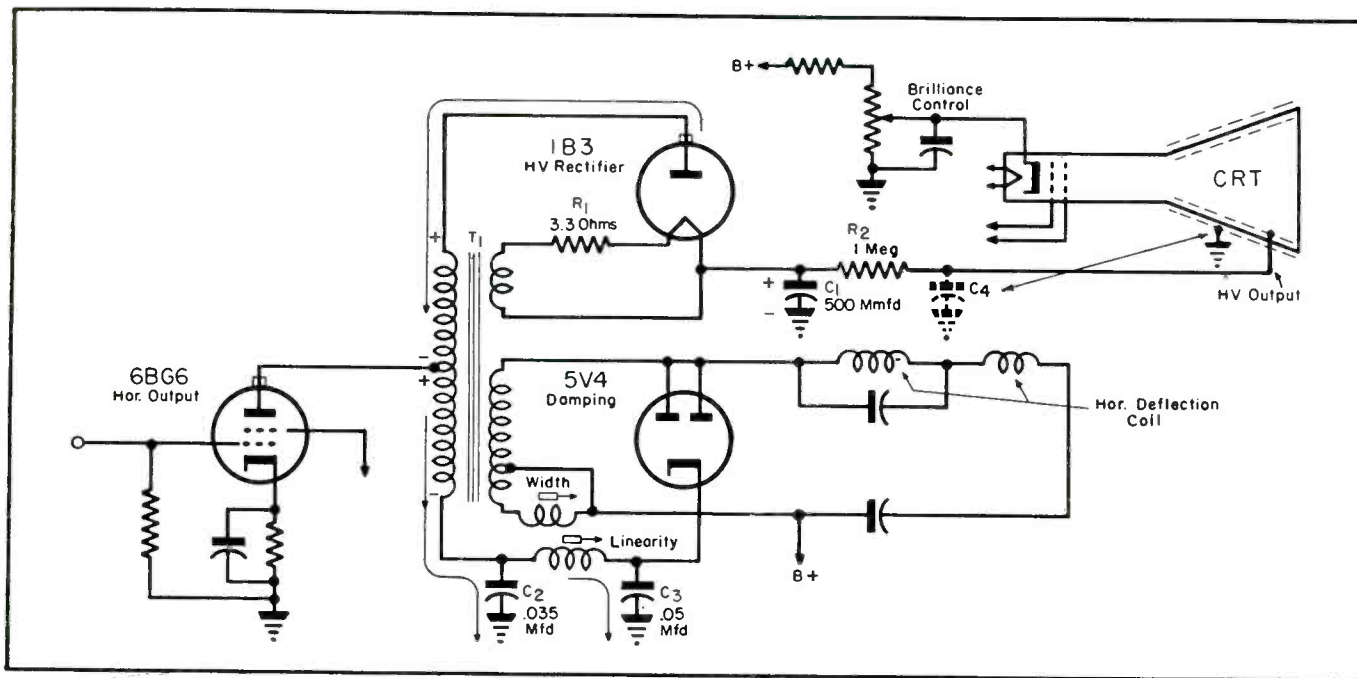

## Determining Requirements for Picture-Tube Visibility . . . Brilliance Factors . . . Detailed Steps Which Can be Taken to Locate Defects in Picture-Tube Circuitry . . . Indications and Probable Causes of Trouble in Kickback High-Voltage Supplies.

THE FUNCTION OF HIGH VOLTAGE in TV receivers is to pull the invisible beam of electrons, emitted from the picture-tube cathode, and propel the beam with enough force against the screen to provide a bright glow and good visibility.

Considerable voltage is necessary to accelerate electrons enough to accomplish this feat; from 2.5 to 25 kilovolts or more depending on the type of picture tube. The most popular method of generating such high voltage in 10" sets and larger has been through the use of the flyback or kickback system. This method makes use of the horizontal sawtooth to generate the high voltage, or more specifically, of the fast collapse of the lines of force during the retrace period.

The horizontal sawtooth voltage comes to the grid of the horizontal output tube, 6BG6, and current through the tube increases gradually during the trace. During the retrace part of the signal, current through the tube

drops suddenly to cutoff. The lines of force around the primary of the kickback transformer collapse suddenly. A high voltage is induced in the bottom section of the primary; about 6,000 v. Across the whole primary, the voltage is even greater because of the stepup due to autotransformer action; 9,000 v or more, depending on the type of transformer. This voltage is rectified by a 1B3 and a high-voltage capacitor charges up. The current path is from ground through a 500-mmfd capacitor ( $C_1$ ), 1B3, down the primary through .035-mfd ( $C_2$ ) and .05-mfd capacitors ( $C_3$ ) to ground.

A 3.3-megohm unit ( $R_1$ ) serves as a current limiting resistor, so that the filament of the 1B3 will not be overloaded and damaged on surges of current. A 1-megohm resistor,  $R_2$ , acts both as a filter and as a safety device to reduce shock if the high voltage is accidentally touched, by limiting the amount of current flow. The 500-mmfd capacitor serves as an input fil-

ter to filter out the ripple and increase high-voltage output. The low value of capacity that can be used because of the high ripple frequency is also a safety factor, since not much of a charge can accumulate. The output filter ( $C_4$ ) usually represents the capacity between the inner and outer aquadag coating of the picture tube itself, with the glass acting as the dielectric.

The kickback transformer has a double function. It not only acts as an output transformer to pass along the sawtooth current to the horizontal deflection coil, but also acts as a high-voltage transformer and provides filament voltage for the rectifier.

### Requirements for Picture-Tube Visibility

In reviewing the requirements for visibility in a picture tube, we find that high voltage represents but one factor. The picture tube is like any other vacuum tube in its requirements for nor-



# TV FLYBACK HV SYSTEMS

by **CYRUS GLICKSTEIN**

American Radio Institute

mal plate-current flow, and it must be remembered that unless there is a current flow there can be no electrons hitting the screen and we'll have a blank screen.

The picture tube needs:

(a) Plate voltage; high voltage on the inner aquadag coating.

(b) Filament voltage, which must be sufficient.

(c) No biasing to cutoff of grid; correct voltage on other electrodes, if any.

(d) No open filament or shorts between elements, etc.

There is one additional requirement in most magnetically deflected picture tubes; an ion trap magnet over the neck of the tube. If the magnet is not in the correct position, either the electrons will not reach the screen even if everything else is correct, or else the picture will have dark areas around one or more of the corners.

Low brilliance or none at all can be indications of low or no high voltage. But as we have seen, these indications can also arise from various other causes. Assuming the sound is normal, problems can originate in three places. Rearranging the foregoing data, these trouble areas can be:

(1) High-voltage system. (High-voltage section of kickback transformer, 1B3, filter, etc.)

(2) Horizontal deflection circuit, which provides the input voltage for the high voltage system. (Horizontal oscillator and output stages, damping tube, output section of kickback transformer, horizontal deflection coil, etc.)

(3) Picture-tube circuit. (Picture-tube filament voltage or bias, picture tube itself, ion trap, focus coil, etc.)

In probing for no brilliance, each of these possibilities would have to be checked in turn. In cases of low brilliance, a further clue may be available right on the screen. Naturally, it is assumed the brilliance control has been rotated to maximum and the brilliance is still low.

For example, a low, but not too low, amplitude of horizontal sawtooth will, of course, give lower than normal  $B+$  and therefore low brilliance. (Amplitude that is too low will result in a  $B+$  that is too low for any visibility.) Since the horizontal sawtooth is not as

Indication	Probable Cause
Picture enlarges and gets dark as brightness control is turned up	Gassy 1B3 Defective 1-megohm filter Gassy picture tube
Flashing streaks or lines across picture or picture tears up as brightness control is turned up	Arcing 1-megohm filter
Buzz as brightness control is turned up	
No control over brightness	Metal ground clips not touching outer aquadag coating of picture tube Gassy picture tube or shorted capacitor across brightness potentiometer
Intermittent raster; sound satisfactory	Arc-over or corona discharge in high-voltage power supply should be checked
Shadows on corner of picture when the ion trap is adjusted for maximum brightness	Deflection yoke, which should be adjusted until as far forward as possible. Also, picture should be centered with focus coil further to rear or further forward as necessary. (Never adjust ion trap so that brightness is sacrificed)

Table 1  
Table of indications and probable causes of trouble in kickback high-voltage supplies

large as it should be, width will probably be less than usual. And since  $B+$  is low, *height will be greater*. That is, the vertical sawtooth, being of normal amplitude, will have greater deflecting power on the beam when the  $B+$  is low and the acceleration of the electrons in the beam is not as great.

In other words, low brilliance, normal or less than normal width and greater than normal height, point to trouble in the horizontal deflection system; a horizontal sawtooth of less than normal amplitude. This may and usually will be accompanied either by horizontal non-linearity or foldover or one or more bright vertical lines, depending on whether the horizontal sawtooth is distorted as well as small.

Suppose we now take a case of low brilliance originating in the high voltage system, where the 1-megohm filter resistor ( $R_2$ ) has increased considerably in value. Brilliance will be less than normal, because the  $B+$  is lower. The load current through the larger filter provides a greater voltage drop and the output of the power supply is now less than before. The only other effect is that the picture is larger than usual, both vertically and horizontally. That is, with less  $B+$ , and both sawtooth currents normal, the deflecting ability of the two is greater and size increases in both directions.

The third possibility of low brilliance, the picture-tube circuit itself, can be caused by a worn screen, misadjustment of the ion trap, too much bias, etc. In this case, while the picture would be dim, it should be normal in size since the amplitude of the saw-

tooth currents would not be affected and  $B+$  is as usual.

All the foregoing conditions were predicated on normal sound. If sound is lower than normal, with low brilliance, the low voltage  $B+$  system would be a logical place to start an investigation, since it is common to both audio and the horizontal sawtooth sections in most designs.

To sum up, in all cases of low brilliance and normal sound, the screen should be checked more closely and . . .

(1) Where width is normal or less, and possibly non-linear, while height is greater, the trouble most likely is in the horizontal deflection system;

(2) Where width and height are both greater, the defect is probably originating in the high-voltage system;

(3) With width and height normal, the first circuit to check would be the picture-tube circuit.

Obviously, if either size control or the horizontal drive control, etc., have been readjusted prior to analyzing the information on the screen, the foregoing rules may not be of much use. However, while there may be occasional exceptions, the foregoing suggestions are generally time-saving in indicating the circuits to check first. Further checks can then be made to verify the assumption and to find the defective component.

## Brilliance Factors

Brilliance depends on two factors: the number of electrons hitting the

(Continued on page 38)

# Dry BATTERIES\*

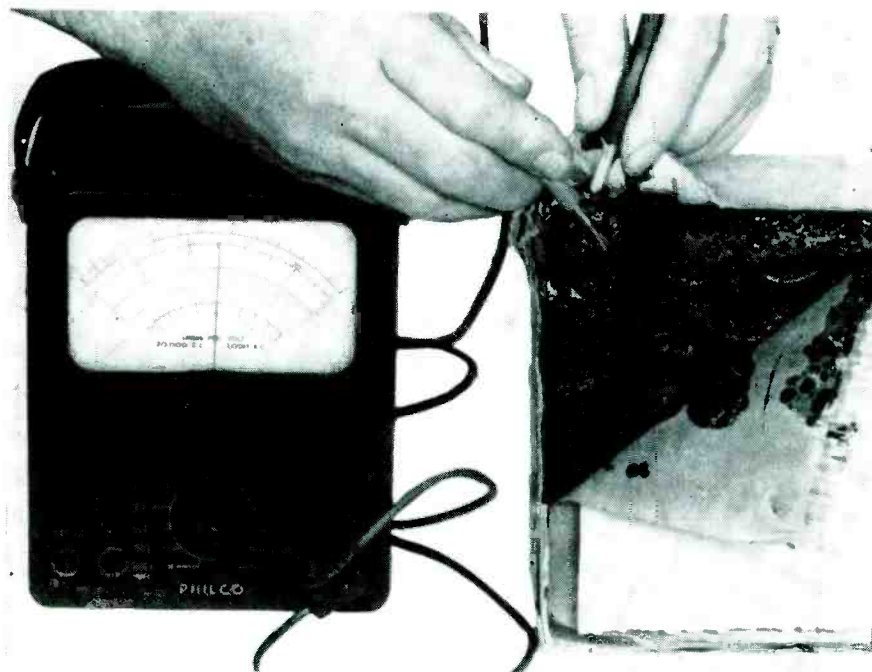

(Left)

Checking a battery with a voltmeter, with the prod on the end positive cell to provide key information as to the overall service the battery can afford.

*\*From a talk by Bob Sidnell, delivered at the annual service meeting of Philco.*

---

## Constructional Features of Modern Batteries . . . Farm Pack Designs . . . Evaluating Battery Adjustments . . . Testing for Battery Efficiency . . . Battery Repair Techniques.

---

THE DRY BATTERY, which with the advent of the *ac* receiver, became a collector's item, has within the past few years routed its museum mustiness and become even more popular than in the hectic days of the 20s. With the sales of portables, farm equipment, hearing aids, pack sets, handtalkies, etc., racing up the chart, batteries are now and will be for a long while quite a factor, a factor of concern to every Service Man.

Unfortunately not too many Service Men have displayed an active interest in the structure or application possibilities of these packaged power houses. And little interest has been exhibited in the means which can be used to check the batteries, so that they can provide the effective service of which they are capable.

Batteries normally feature novel structural features which have been found to contribute to their immediate and long-term usefulness. For instance, extruded seamless zinc cans are

used in some lines, to insure, as the manufacturers state, uniform wall thickness and thus avoid thin spots which might be *eaten through* early in the chemical reaction which causes voltage. This would allow leakage of electrolyte and perhaps cause ruin of the adjacent cells in the battery.

Porous separators are another feature. Just as in storage batteries, the negative element (zinc can) in dry batteries must be separated physically and electrically, but not chemically from the positive element (the mix). In one line of batteries, this separator is a piece of Kraft paper coated with flour paste. It is tough, yet thin. It has to be tough to withstand shocks and jars of shipment without rupture. It is thin to allow more room for life-giving mix. The mix also comes in for special attention. The manganese dioxide, besides being very finely ground, is chemically treated to give longer service life without impairing shelf life.

Each cell in a *AB* pack is individually and hermetically sealed. The top rim of the cell is curled so that when sealing compound is poured in, it flows under and over the curl. As gas rises through the mix and seeks an exit from the cell, it tends to push the sealing compound upward. But the sealing wax locks under the curl tighter and tighter as the gas pressure increases. Finally, the pressure is relieved by the escape of gas through tiny pores in the sealing compound. Meanwhile, the individual cells are tightly sealed against drying out. In other words, a dry battery that's dry, is dead. Moisture must be present internally to have any chemical reaction and voltage.

### Farm Packs

Farm packs have become particularly popular, replacing the large block *A* and *B* units for many reasons. For instance, the farm packs eliminate any chance of misconnection; their terminals fit only one way, the correct connection of *A* and *B* voltage to the receiver. In addition, the unit pack is more convenient than several separate block batteries. They are more efficient because they have been engineered to do a particular job of supplying power. *A* and *B* sections run

*(Continued on page 45)*





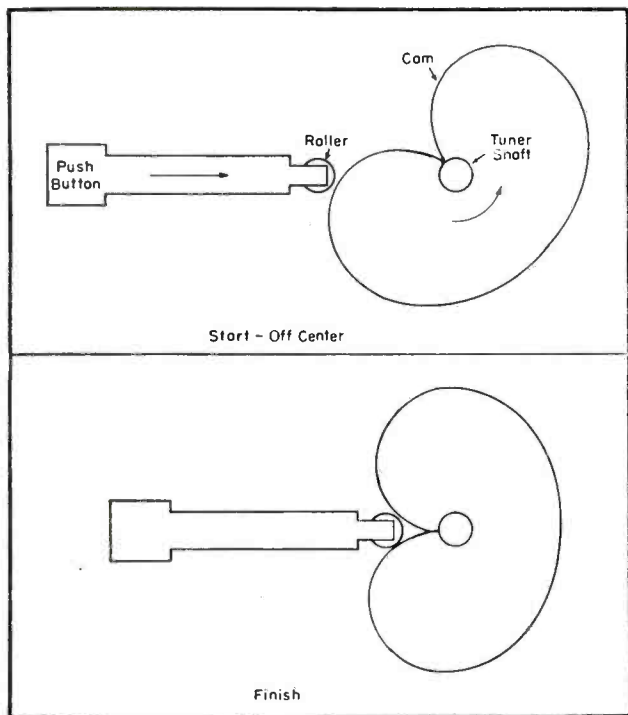

Fig. 1. The cam-lever mechanical auto-tuner, which features use of a cardioid type cam on the tuner shaft.

AUTOMATIC TUNING SYSTEMS, which have been featured in most car receivers, possess many unique mechanical and electrical setups, ranging from the simple cam and lever to the elaborate motor-driven solenoid-driven or electric tuners. While the greatest part of this equipment is well built and well designed, the gear does find itself showered with dust and dirt, and subjected to vibration, jolts and jars. Consequently, all types of troubles are often encountered. Some of the mechanisms have been found in such bad condition that it has been found necessary to replace or just disconnect and employ some makeshift direct-drive arrangement. The procedure depends, of course, on the customer. If automatic tuning is used regularly, a repair or replacement will be imperative. And before proceeding, it is wise to analyze the problem for the auto-set

owner, explaining the pricing situation in detail.

#### Types of Automatic Tuning

In auto-radio servicing, the term *tuner* is normally applied to the mechanism that actually tunes the receiver, whether it is a gang-capacitor or a permeability tuner, using iron-cored coils. The operational aspects are the same in either case; tuner must cause the tuning mechanism to assume a pre-determined position, upon the actuating of a tuning mechanism. In auto-radio work, the term *pushed* is often used in place of *depressed*, when referring to pushbuttons. Almost all of the tuners are actuated by pushbuttons. There may be only one, as is the *sequence* tuners, or there may be indi-

vidual buttons for each station. But, they're all *pushbuttons*.

About the simplest form of auto-tuning is the direct-driven kind, in which an arm with a small roller on the end contacts a *cardioid* cam on the tuner shaft. When pushed, the roller forces the cam to turn, until it reaches the lowest place. One of these cams is used for each station position. They are all mounted on the tuner shaft and are usually locked by a nut on the end of the whole assembly. To set up, the locknut is loosened, and a station tuned in, manually. One pushbutton is then held all the way down, while holding the dial stationary with the knob. The pushbutton is then released and another set up. This operation is continued until all are set. The locknut is then tightened and the job is done.

The cam tuners are about the simplest of all the tuning mechanisms to adjust and service. They are entirely mechanical in action, and as long as the parts are all in proper alignment and free to work, no trouble will prevail. When servicing, all old hardened grease and dirt should be cleaned off by washing with carbon-tet or a similar solvent. This step should be followed by relubricating sparingly with *Lubriplate* or just a bit of powdered graphite. All the rods should be straight, the bearings turning freely. In addition, it will be necessary to see that the pushbuttons do not bind on the plastic escutcheon plate.

There are several variations of the cam tuners, although fundamentally

# Auto

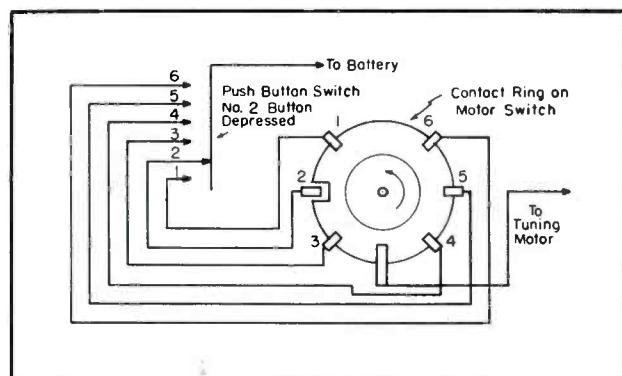

Fig. 2. Diagram of the electric automatic tuner system, illustrating how the wafer switch provides required contact for pushbuttons.

## Design and Operational Features of Mechanical and Electric Automatic Tuning Systems, Employing Direct-Driven Cams, Electric Turrets, Electric Pushbuttons, etc. How to Replace Coils and Slugs . . . Motor Adjustments . . . Cleaning Techniques.



# Radio Automatic Tuners

by JACK DARR

Ouachita Radio Service

they're all the same. For instance, some tuners use a solenoid to set the eccentric to a pre-determined position which is normally performed by an actuating arm or lever.

Motorola and Chevrolet auto models use an *electric* tuner which is rather novel. A *turret* carrying six screws, each with an adjustable *dog* or stop on it, is mounted with the tuner. These are ordinarily permeability-tuned or *slug* tuners. The slugs are mounted on a sliding carriage. On the front of the carriage is a rotatable stop-arm, and on the back, a solenoid plunger. The stop-arm is connected to a ratchet mechanism so that when the solenoid is pulled all the way in, it is turned 60° (1/6 turn). Then, when it is released, it is pulled back by a spring, until it strikes one of the stops. The next time the button is pushed to start the cycle, the stop-arm turns another 1/6 turn, and is stopped by the next dog, in a clockwise direction. There is a *dash-pot* action in the solenoid form and plunger, which regulates the speed of the action. An adjustable air-escape is provided at the back end of the solenoid housing. If the action is too fast, the tuner may not work properly.

Some of these are *one-shot* affairs, in which the tuner moves one step and then stops until the button is pressed again. Such an arrangement appears in the Fords. Others are electrically operated, using five pushbuttons and one manual position, which will run continuously until the correct position is reached. This is accomplished by a selector switch, in a pushbutton gang, which supplies the operating current to the solenoid. On the end of the turret assembly, connected to the ratchet, is a wafer switch. When any pushbutton is depressed, current flows through the wafer switch to the solenoid, starting it. It is energized and pulls in. As the end of its travel is reached, the slider of the wafer switch is turned. This has a complete circle contact,

with one gap. The contacts of the wafer are connected to the various pushbutton switches. If the switch is not turned to the gap when it stops, current is again applied to the solenoid, and it pulls in again, moving the switch and stop-arm another 60°. This action continues until the wafer switch has reached the gap in the contact, breaking the circuit.

The *manual* tuning lead-screw in these tuners can be distinguished from the others (five) by its different pitch, having a much steeper pitch to its threads. The manual screw is operated by the tuning knob, when the stop-arm on the tuner is in such a position that it is engaged.

When servicing these tuners, the procedures employed for the mechanical systems can be followed. All parts should work freely, and be properly lubricated with the right grease. Guide-rods, ratchet parts, etc., should be *washed* with carbon-tet and a very thin coat of *Lubriplate* or similar grease applied to them. By the way, don't over-lubricate! Too much grease will only serve to provide a base for more dust, and these segments don't need that kind of an assist. They'll catch enough dust without this *help*. Dragging parts should be watched for, especially on the tuner carriage. To check, the return spring should be disconnected and first one end of the chassis should be held up, and then the other. The carriage should be loose enough to slide freely from one end to the other, under only the force of gravity. Proper engagement of the manual tuning gear should be checked, cleaning and adjusting, if necessary.

The speed of the action of these tuners is regulated by a dash-pot, formed by the solenoid plunger and its form. Proper speed must be checked, adjusting the air-escape, at the back end of the solenoid, if the action is too slow or too fast. If the electrical type

operates too fast, it may run continuously, due to the switch overshooting the stopping-break in the wafer switch. If the action is slow and draggy, after the tuner has been cleaned, the air escape must be checked. Slow action on the pull-in of the solenoid may be caused by low battery voltage, also. Voltage at the input of the set should be not less than 5.5 volts, and not less than 4.5, with the solenoid energized.

## Coil and Slug Replacements

Basically, the coils of this type of tuner are wound on a thin-walled form of insulating-paper or plastic, the inductance of these being varied by sliding in or out a round core made of *rf* iron. This iron is powdered and held together by binders. On the ends of these coils are long thin screws, on which the cores or slugs are mounted to a carriage or bracket, so that they may be moved in and out of the coils together. The screws are used to adjust the core position, with respect to the others in the gang, for tracking.

Some coils are enclosed in shield-cans, and some will be found out in the open. Most of them are held in place by a soft rubber grommet, the *back* end being pushed away from the cores into the grommet and cemented. The leads to these coils are customarily made of fine wires, and sometimes open from vibration or electrolysis. If the open is close to the end of the lead, it may be resoldered without trouble. If there will not be sufficient slack in the lead, the whole lead should be replaced. The same extremely flexible wire used for connecting voice coils of small speakers has been found excellent for this purpose. Enough slack should be left in the lead to allow for a slight movement of the coil, as the tuner is operated.

In removing the coils from automatic tuners, the single coil on top,  
(Continued on page 50)

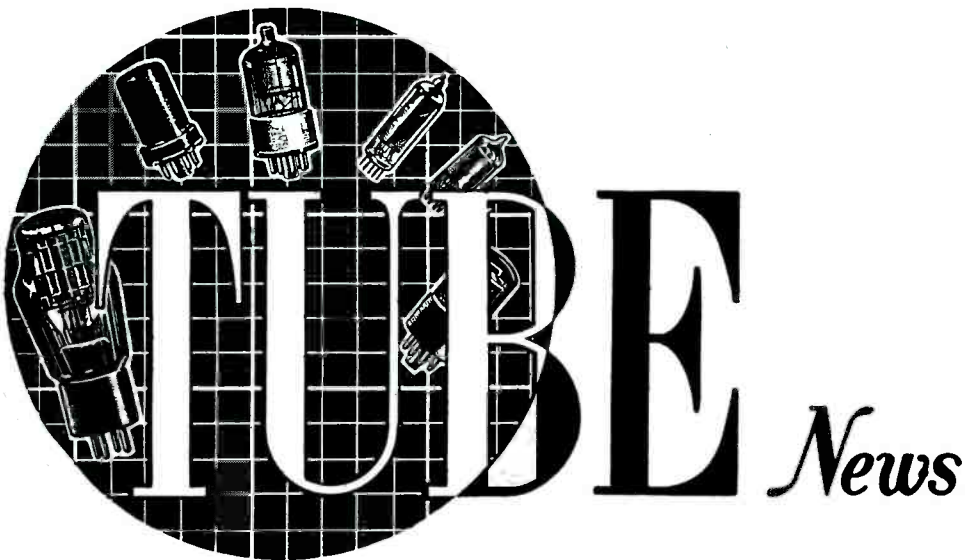

# TUBE News

by L. M. ALLEN

THE VARIETY OF TUBE TYPES now available for standard and TV *rf*, *if*, *af* and power amplification, special multi-function purposes, converter applications, rectification, control, etc., has introduced many puzzling problems in the Service shop, the boys often wondering about the exact duties of each of the tubes. In an effort

to clarify the situation, the tube data have been carefully screened and organized into a series of tables,<sup>1</sup> which we are privileged to present in this section this month. These tables ap-

pear in Figs. 1 and 2 below and at right.

### TV Miniatures

Two miniature tubes, the 6S4 and 6AH6, have been announced by G.E. The 6S4 is a high perveance medium-mu triode designed primarily for

<sup>1</sup>Offered through the courtesy of the Electronic Tube Division of the Tung-Sol Lamp Works, Inc. (Copyright, 1950, by Tung-Sol.)

APPLICATION		HEATER VOLTAGES									150 MILLI-AMPERE HEATER CURRENT	300 MILLI-AMPERE HEATER CURRENT		
		1.4	2.0	2.5	5.0	6.3	12.6	18.9	25	35			50	
POWER AMPLIFIERS	GENERAL PURPOSE	TRIODES		1H4G 30 31	2A3 45	01A 12A 71A 183	6A3 501 6A5G 6AC5GT 6B4G 6C4				25AC5GT		25AC5GT	
		DOUBLE TRIODES	1G6GT 3C6/XXB	1J6G 19	53 3C6/ XXB#		6A6 6Y7G 6AS7G 6Z7G 6E6 79 6N7 6N7GT						6Z7G	
		TETRODES		49	46		6AL6G							
		PENTODES	1A5GT 3LE4 1AC5 3LF4 1C5GT 3V4 1L4A 3C5GT 1L4B 3Q4 1S4 3S4 1V5* 1W4 3A4 3D6	1F4 1F5G 1G5G 1J5G 33 950	2A5 3A4# 3C5GT# 3LE4# 3O4 3S4# 3V4# 47 59	257	6A4/LA 6R6G 6AG7 7B5 6AK6 38 6AN5 41 6AR5 42 6F6 89 6F6G 6F6GT 6G6G 6K6GT	12A5		25A6 25A6GT 25B6G 43			6AK6 6G6G	6A4/LA 12A5 25B6 25A6GT 25B6G 38 43
		BEAM PENTODES	1Q5G 1Q5GT 1T5GT 3B5GT 3LF4 3Q5GT		3B5GT# 3LF4# 3Q5GT#		6AH5G 6V5GT 6AQ5 6V6 6AR6 6V6GT 6AS5 6W6GT 6L6 6L6G 7A5 6L6GA 7C5 6U6GT	12A6 12A6GT 14A5 14C5 1625		25C6G 25L6 25L6GT	35L6GT 35A5 35B5 35C5	50A5 50B5 50C5 50C6G 50L6GT	12A6 50L6GT 12A6GT 14A5 35A5 35C5 35C6GT 50B5 50C5 50C6G	25C6G 25L6 25L6GT
		DOUBLE PENTODES		1E7G				12L8GT					12L8GT	
		DIRECT COUPLED					6AB6G 6B5 6AC6GT 6N6G			25B5 25N6GT				25B5 25N6G
TELEVISION	HORIZONTAL DEFLECTION	BEAM PENTODES				6AUSGT 6BQ6GT 6AV5GT 6CD6G 6BG6G		19BG6G	25BQ6GT				19BG6G 25BQ6GT	
	VERTICAL DEFLECTION	TRIODES OR TRIODE CONNECTED PENTODES				6AR5 6K6GT 6S4 6SN7GT 6W6GT 12AU7	12AU7 12SN7GT					12AU7	12AU7 12SN7GT	

\* 1.25 V    # 2.8 V    † 7.5 V

Fig. 1. Classification chart for general purpose and TV power amplifiers.



# Tube Classification Charts for RF, IF, AF and Power Amplifiers and Indicators for TV and General Purpose Applications.

APPLICATION	HEATER VOLTAGES						150 MILLIAMPERE HEATER CURRENT	300 MILLIAMPERE HEATER CURRENT		
	1.4	2.0	2.5	5.0	6.3	12.6				
RF - IF AMPLIFIERS GENERAL PURPOSE	TRIODES	26 957* 958*	1H4G 30	27 56 485††		6AD4 7A4 6C4 37 6J4 76 6K4 955 6N4 9002	14A4	6AD4 6C4 955 9002	7A4 37 76	
	DOUBLE TRIODES	3B7/1291		3B7/1291#		6AH7GT 7F8 6J6 7AF7 7F7	12AH7GT 19J6## 12AT7 14AF7/XXD 14F7	12AH7GT 19J6 12AT7 14AF7/XXD 14F7	6AH7GT 12AT7 7AF7 7F7 7F8	
	TETRODES		1A4T 1D5GT 1E5GT 32	24 35		36				36
	PENTODES	1AB5** 1AD4 1AD5 1L4 1LC5 1LN5 1NSGT 1P5G 1P5GT 1SA6GT 1T4 1U4 1W5* 3E6 959*	1A4P 1B4P 1D5GP 1E5GP 15 34	3E6## 57 58		6AG5 6K7 6U7G 954 6AH6 6K7G 6W7G 956 6AK5 6K7GT 7A7 9001 6AU6 6S7 7AB7 9003 6BA5 6S7G 7AD7 6BA6 6SD7GT 7AG7 6BC5 6SG7 7AJ7 6BD6 6SG7GT 7B7 6BH6 6SH7 7C7 6BJ6 6SH7GT 7G7 6C6 6S7 7H7 6CB6 6S7GT 7L7 6D6 6SK7 7V7 6E7 6SK7GT 39/44 6J7 6SS7 77 6J7G 6SS7GT 78	12AU6 14H7 12AW6 12BA6 12B6 12B7 12J7GT 12K7GT 12L7GT 12M7GT 12N7GT 12P7GT 12Q7GT 12R7GT 12S7GT 12T7GT 12U7GT 12V7GT 12W7GT 12X7GT 12Y7GT 12Z7GT 14A7/12B7 14C7	6BA5 12S7G 6BH6 12SH7 6BJ6 12SH7GT 6S7 12S7 6S7G 12S7GT 6SS7 12SK7 6SS7GT 12SK7GT 6W7G 14A7/12B7 7AB7 14C7 7B7 14H7 7C7 954 12AU6 956 12AW6 9001 12B7 9003 12BA6 12BD6 12J7GT 12K7GT	6AU6 6SH7GT 6BA6 6S7 6BD6 6S7GT 6C6 6SK7 6D6 6SK7GT 6E7 6U7G 6J7 7A7 6J7G 7AG7 6J7GT 7AJ7 6K7 7H7 6K7G 7L7 6K7GT 39/44 6SD7GT 77 6S7G 78 6SG7GT 6SH7	
	TRIODES					6AB4		6AB4		
	DOUBLE TRIODES					6J6 12AT7	12AT7 19J6##	12AT7 19J6	12AT7	
	PENTODES					6AB7 6AK5 6BH6 6AC7 6AU6 6CB6 6AG5 6BC5	12AU6	6BH6 12AU6	6AG5 6AU6 6BC5 6CB6	
	AF AMPLIFIERS	TRIODES	1C3 1E4G 1G4GT 1LE3 26	1H4G 30	27 56 485††	01A	6AE5GT 6J5 7A4 6AD5G 6J5GT 7B4 6AF5G 6K5G 37 6C5 6K5GT 56 6C5GT 6L5G 75S 6F5 6P5GT 76 6F5G 6S5 6F5GT 6SF5GT	12E5GT 12F5GT 12J5GT 12S5 12SF5 12SF5GT 14A4	6L5G 12E5GT 12F5GT 12J5GT 12S5 12SF5 12SF5GT 14A4	6AE5GT 6F5GT 6SF5GT 6AF5G 6J5 7A4 6AD5G 6J5GT 7B4 6C5 6K5G 37 6C5GT 6K5GT 56 6F5 6P5GT 76 6F5G 6S5 6F5GT 6SF5GT
		DOUBLE TRIODES			53		6A6 6SL7GT 6AE7GT 6SN7GT 6C8G 6V7G 6F8G 6Z7G 6N7 7AF7 6N7G 7F7 6SC7 12AU7 6SC7GT 12AX7 12AV7 79	12AU7 14F7 12AX7 12AY7 12SC7 12SL7GT 12SN7GT 14AF7	12AU7 12AX7 12AY7 12SC7 12SL7GT 12SN7GT 14AF7 14F7	6C8G 12AY7 6SC7 12SN7GT 6SL7GT 6Z7G 7F7 12AU7 12AX7
		TETRODES		32	24		36			36
PENTODES		1L4 1LG5 1U4 959*	1B4P 1E5GP 15	57		6AU6 6SH7 7E5 6BA5 6SH7GT 7G7 6BH6 6S7 7L7 6C6 6S7GT 7T7 6J7 6W6GT 7V7 6J7G 6W7G 7W7 6J7GT 7AB7 77 6R6G 7AG7 717A 6SG7 7AH7 954 6SG7GT 7C7 956 9001 9003	12AU6 12J7GT 12SH7 12SH7GT 12S7 12S7GT 14C7 14V7	6BH6 12S7GT 6W7G 14C7 7AG7 954 7AH7 956 7C7 9001 7E5 9003 12AU6 12J7GT 12SH7 12SH7GT 12S7	6AU6 7L7 6C6 7T7 6J7 7W7 6J7G 77 6R6G 6SG7 6SG7GT 6SH7 6SH7GT 6S7 6S7GT	
INDICATORS	TUNING INDICATORS			2E5 2G5		6A15/6N5 6AD6G 6AF6G 6AL7GT 6E5 6G5 6T5 6U5/6G5		6AL7GT	6E5 6G5 6T5 6U5/6G5	
	INDICATOR CONTROL					6AE6G		6AE6G		

Fig. 2. Chart of tubes used in rf-if, af and indicator applications.

use as a vertical-deflection amplifier in TV receivers which employ picture tubes having a deflection angle up to 70° and operating at anode voltages up to 14,000 volts. Ratings include a dc plate voltage of 500; peak positive

surge plate voltage of 2000; and a plate dissipation of 7.5 watts.

The 6AH6 is a sharp-cutoff amplifier pentode, with a high transconductance and low input and output capacitances, which adapt it to use as a wide-

band amplifier and as a reactance tube for television receivers. Under typical operating conditions it has a transconductance of 9,000 micromhos and plate current of 10 millamperes.

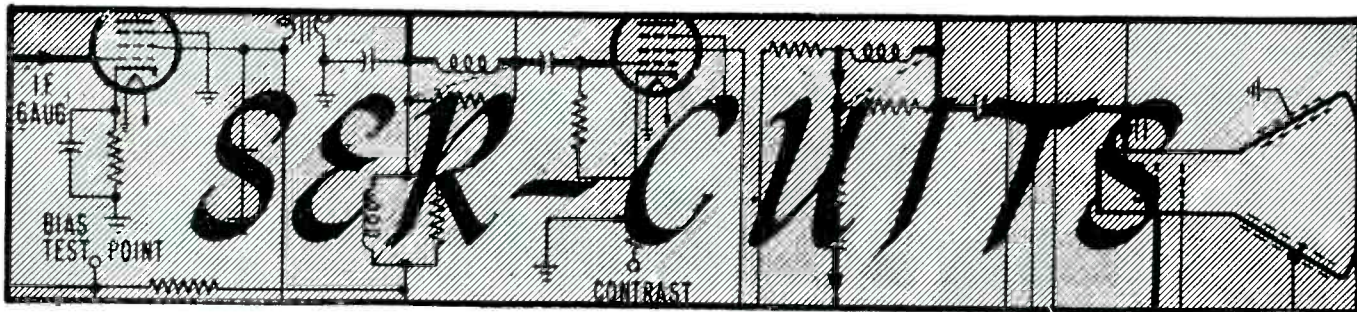

## Review\* of the Circuitry of the RCA 12 $\frac{1}{2}$ , 16 and 19-Inch TV Chassis, with Highlights of the AGC, Bias Clamp, AGC Switching, Picture IF Amplifier, Sound Channel, Picture Second Detector, Video Amplifier, DC Restoration, Sync and Horizontal Sweep Output Systems.

THE TREND TO THE USE of fewer tubes, but larger and larger picture tubes, in circuits of unusual simplicity, cited in past issues of *SERVICE*, appears to have become the TV pattern of the year, adopted by most of the set builders.

The new runs of chassis reveal a host of the streamlined features. In the latest RCA models, employing 12 $\frac{1}{2}$ , 16 and 19-inch tubes, for instance, there are a variety of simplified design innovations. In the *rf* units employed in the 12 $\frac{1}{2}$ -inch chassis, there's a 6CB6 as an *rf* amplifier and a 6J6 as an oscillator and mixer tube. The new set also has an antenna input circuit which has been shielded. Appearing in this circuit is an antenna elevator transformer, and a high-pass filtering section. This shielding was found to provide a great degree of freedom from stray pickup. Another feature included has been a parallel-tuned FM (90 to 100 mc) trap, adjustable from the top of the *rf* chassis.

The 6CB6 was selected as an *rf* amplifier because it is a low input conductance pentode with good low noise factor characteristics and low plate to grid capacitance. This low capacitance has been found to help minimize oscillator feed-thru which *minimizes oscillator radiation*.

The oscillator circuit and the mixer were combined in one envelope of the 6J6 dual triode. This oscillator circuit differs from previous *rf* units in that only one triode section of the 6J6 tube has been used. Stability has been obtained by using a low *L/C* ratio to tune the oscillator, which helps to reduce microphonics. In addition, microphonics were also reduced by selecting the plate which does not support the getter. This is the plate or pin 1 of the tube.

Inductances have been mounted on a

switch wafer for tuning channels 2 to 12. All adjustments for oscillator inductances have been made accessible from the front of the cabinet by removing the escutcheon plate. These adjustments can be made by means of brass screw studs in the inductances. A tracking inductance for all channels has also been included.

For the  $\frac{1}{2}$ " models a new vertical oscillator circuit was developed. It differs from that formerly used in that it does not use the usual transformer-coupled feedback type of blocking oscillator. Feedback has been accomplished by coupling the output from the vertical sweep output circuit back into the oscillator input. In operation, a .047-mfd capacitor charges up through the *B* supply circuit and a 1,500-ohm resistor. During the positive excursion of the oscillator tube, this capacitor is discharged rapidly through the sweep oscillator tube, and a 12,000-ohm resistor.

When the capacitor discharges, the current through the 12,000-ohm unit causes a voltage to appear across it, so that the capacitor never discharges to zero. At the instant the grid of the sweep oscillator goes negative and cuts off the discharge of the capacitor tube, the grid of the vertical sweep output jumps from zero to some positive value due to the termination of the voltage drop across the 12,000 ohms. This suddenly raises the grid of the vertical sweep output tube from near zero at the end of the discharge cycle, to a positive value determined by the charge remaining on the capacitor. A .0047-mfd capacitor, a 470,000-ohm fixed unit and a 1-megohm vertical hold control determine the recovery

time of the sweep oscillator. During the positive portion of the cycle on the grid of the sweep oscillator, the capacitor acquires a negative charge which leaks off through the resistances. The rate of this discharge determines the rate at which the sweep oscillator recovers and will again be ready to fire.

The use of this type of circuit was found to eliminate the need for a vertical blocking transformer, thus simplifying servicing.

### AGC

The automatic gain control circuit employed is quite interesting, too. In this series, *agc* controls the gain of the *rf* amplifier and the first, second, and the third picture *if* stages by application of a negative bias to their grids which is a function of signal strength. The end result of the *agc* circuit is to provide an almost constant output at the second detector over a wide range of input signals to the receiver.

The peak sync signal from the fourth picture *if* amplifier is coupled by a 100-mmfd capacitor to the diode of a 6AL5 (pins 2 and 5).

The voltage input to the *agc* circuit is three times the signal input to the 6AL5 detector (pins 1 and 7).

The return of the *agc* signal from a 150,000-ohm resistor to the *dc* restorer grid improves sync separation on strong signals and also slightly increases the *agc* voltage on strong signals at high contrast settings.

A bias clamp is used in these receivers. In this circuit the *rf* amplifier bias voltage is divided down and delayed by 2.2 megohm and 33,000-ohm resistors. *B-plus* voltage applied to the 2.2-megohm unit would bias the

\*From special copyrighted lecture notes prepared by the commercial service section of the RCA Service Co., Inc.



grids with a positive voltage if the diodes of a 6AV6 first *af* were not present. The diode effectively places the *rf* bias bus to a fraction of a volt above ground. Contact potential of about  $-0.5$  volt would be present without the  $B+$  voltage on the 2.2-megohm resistor. The net result of the small positive voltage due to this resistor and the contact potential further reduces the residual clamped bias to about  $.1$  volt negative.

This grid bias level on the *rf* amplifier is clamped by the 6AV6 ( $V_{109}$ ) until sufficient *agc* signal voltage is developed to overcome the clamped bias level and apply bias to the *rf* amplifier tube on stronger signal levels.

This delayed action improves the sensitivity of the *rf* amplifier for weak signal levels, reduces the sensitivity for high signal levels, and prevents overloading the picture *if* amplifier and the *rf* input unit.

### AGC Switch

To compensate for operation in weak signal and noise condition areas, a 3-position *agc* switch is installed on the rear of the chassis. This switch allows adjustments for a particular fringe signal area or noise condition.

In normal installations the switch is set in position 1. This adjustment is in the extreme counter-clockwise position. If impulse type of interference is experienced, switch position 2 must be used.

In very weak signal areas, in which impulse interference is experienced, the switch is turned to position 3. In this position *agc* is removed and the receiver may overload if the input signal exceeds 200 microvolts.

### Picture IF Amplifier

The picture *if* amplifier channel is conventional in most respects and consists of a double-tuned overcoupled circuit in the mixer plate, followed by four stagger-tuned circuits tuned, however, to new *if* picture frequencies. These *if* frequencies differ from those used in previous RCA TV models. All the picture *if* transformers and traps are now tuned at  $.25$  mc lower in frequency. This change was made to eliminate interference due to picture *if* harmonics.

The cathodes on the *agc*-controlled tubes, (6AU6 first and third picture *if* and 6CB6 second picture *if*) have been over compensated to cause the picture carrier to rise slightly on the overall selectivity curve as the signal input is decreased. This has been found to improve the signal-to-noise

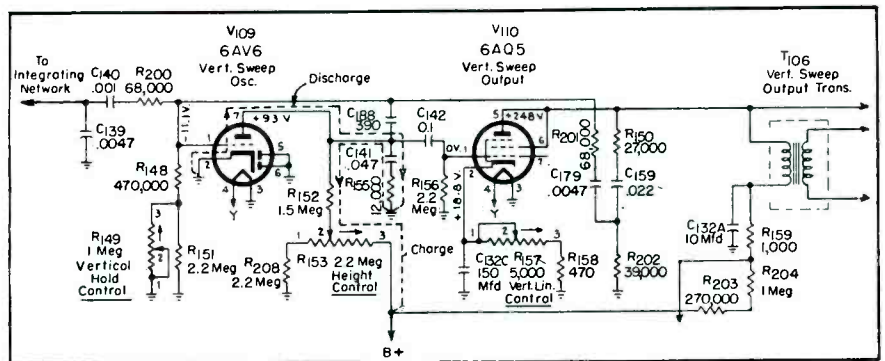

(Above)

Fig. 1. Vertical sweep oscillator and output circuit of the new RCA TV chassis.

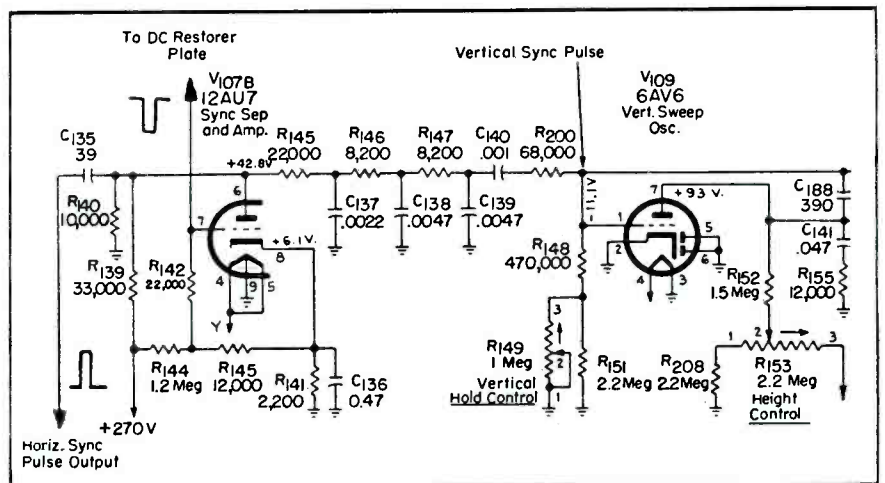

(Above)

Fig. 2. The sync separator and amplifier of the RCA models.

(Below)

Fig. 3. Circuitry of the horizontal oscillator and control of the RCA sets.

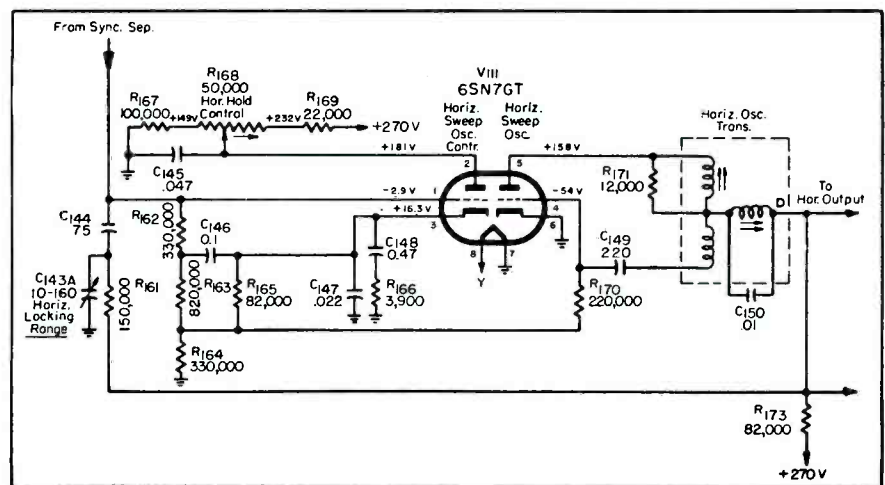

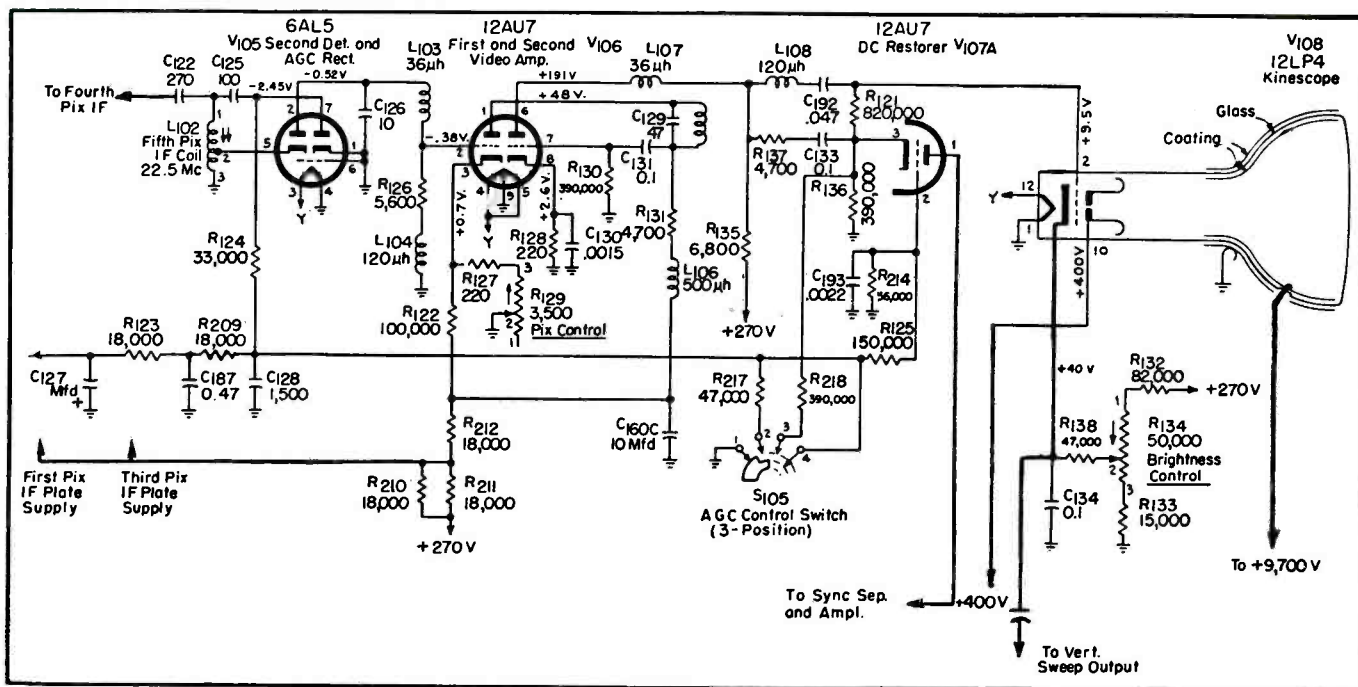

Fig. 4. The second detector and video amplifier system used in the 12½-inch TV chassis of the new RCA line.

ratio on weak signals and offer some increase in resolution on strong signals.

Incidentally, polystyrene was selected for the *if* coil forms to provide less *rf* losses, and more gain in the *if* transformers. Higher attenuation or selectivity of the *if* trap circuits was also obtained by use of the polystyrene coil forms. This improved performance served to eliminate one *if* trap circuit.

#### Picture Second Detector

In the picture second detector, the 6AL5 second detector has been tapped across the fifth picture *if* coil (22.5 mc) to reduce loading and provide the correct level to the video amplifiers, while providing three times this level to the *agc* rectifier for bias control of the picture *if* stages.

The picture second detector does not return to the high negative bus as in earlier sets using *dc* coupled video amplifiers. By operating this tube at lower cathode to filament potentials, the possibility of breakdown between elements has been reduced.

#### Sound Channel

In the sound channel in the new line the *ifs* have been lowered .25 mc., making the second *if* 21 mc.

In the 12½-inch models a 6AQ5 output tube is used, while a single 6K6GT output tube is used in most of the 16 and 19-inch models.

The output transformers are mounted on the speaker so that the screen

supply to the tube can be routed through the speaker plug where a jumper is provided to open the screen voltage when the speaker is unplugged. This has been done to protect the tube from being damaged by high screen current, in case the speaker is unplugged while the receiver is operating.

In addition to the usual switch which connects phono into the audio channel, the phono switch also breaks the *B+* to the vertical and horizontal deflection output tubes and second sound *if* stages, on the 12½-inch models, thus cutting down the *B* drain by about 100 milliamperes, when playing records.

#### Video Amplifier

The peak-to-peak video signal developed at the first video grid varies over a range of approximately 2:1. To clip any noise impulses at the first video grid, it is highly desirable that the tips of sync be close to the cutoff of that tube. This is accomplished by varying the first video plate voltage in accordance with the signal level. To provide this plate voltage control, the first and third picture *if* plate voltage is supplied through a dropping resistor. The voltage drop across this resistor is a function of the current being drawn through it. This, in turn, is controlled by the *agc* voltage which is controlled by the incoming picture signal, the drop being greatest for weak signals. This voltage drop, through the first and third

video *if* plate-dropping resistor, varies in accordance with the incoming signal strength. After adequate filtering this voltage is applied to the plate of the first video stage to control noise clipping. The plate voltage on the first video will then rise with increased signal input to the receiver and drop as the signal is reduced. It varies from 60 to 140 volts. This tends to clip any noise present in the signal and provides better sync operation. *AC* coupling is used between the video stages to simplify *B*-voltage requirements and the *dc* video component is lost. A *dc* restorer is used to reinsert the *dc* component at the picture tube grid. In the 12½-inch receivers a positive pulse from the vertical sweep circuit drives the picture-tube cathode positive during retrace. This positive pulse of voltage applied to the cathode results in a voltage difference between the picture-tube grid and cathode, which exceeds its cutoff characteristics and extinguishes the beam during retrace time. The peak voltage from the plate of the vertical sweep output is on the order of 600-700 volts and is subject to about 100:1 reduction through a capacity-driver circuit, which has been found sufficient to blank the tube out during retrace time.

#### DC Restoration

*DC* restoration, or *dc* insertion, as it is sometimes termed, must be applied to the video signal at the picture-

(Continued on page 48)



  
**Regency**  
Division, I.D.E.A., INC.  
55 N. New Jersey St., Indianapolis 4, Indiana



**Regency**

THE DB 400

LIST \$32.50

IN BLONDE FINISH AT \$37.50

**TV IS THE LARGEST SELLING  
SIGNAL BOOSTER!**

**BECAUSE . . .** Regency wins all performance tests in nationally-known laboratories . . . Regency is the lowest priced QUALITY Television Signal Booster . . . Regency offers such features as simplified tuning control; easy installation; full coverage on all 12 channels . . . and Regency is UNDERWRITERS'  APPROVED.

**REGENCY** Division, I.D.E.A. INC. • 55 New Jersey Street, Indianapolis 4, Indiana



# AT LAST! PRINTED NOW AVAILABLE TO

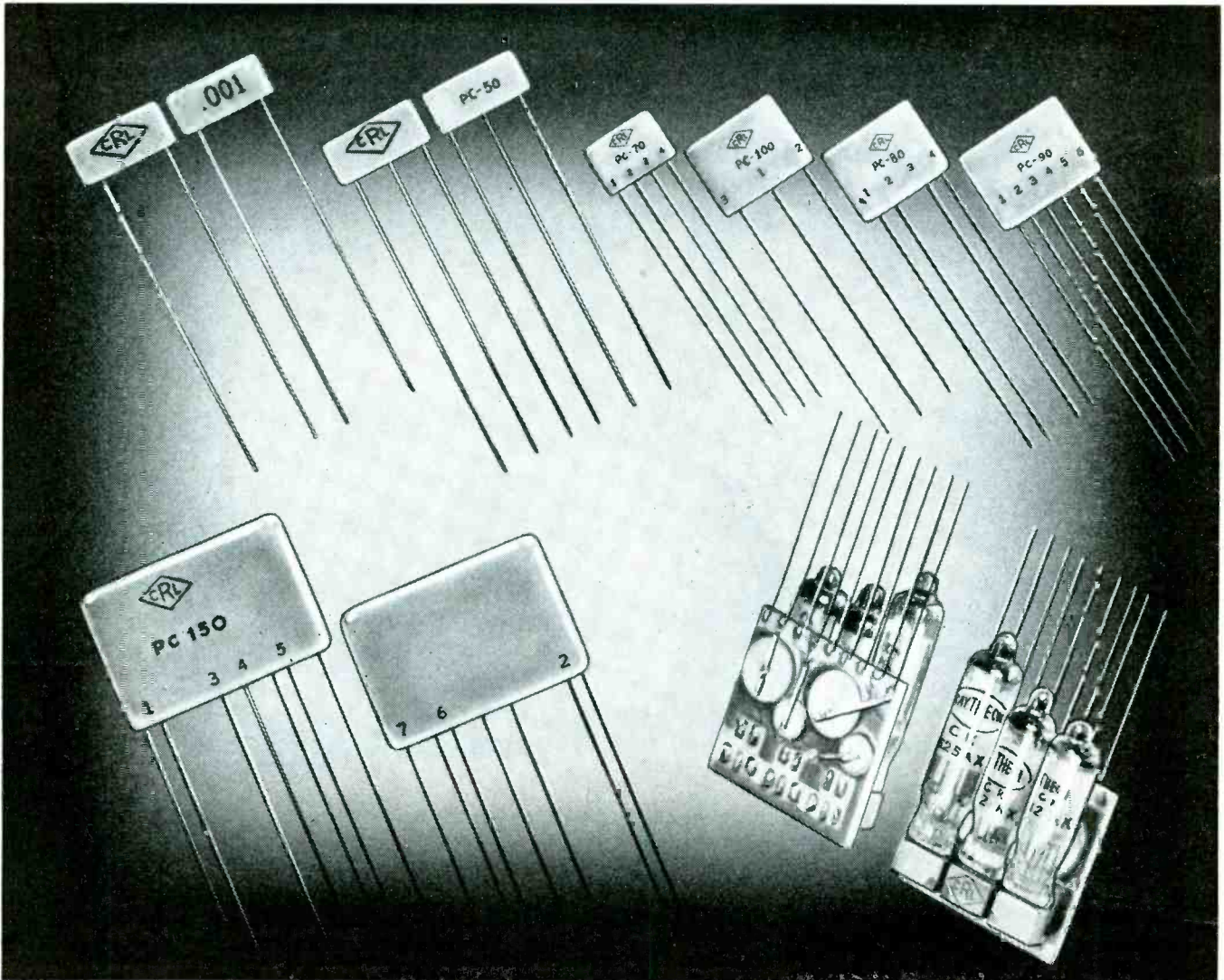

## TYPICAL SCHEMATICS OF CENTRALAB PRINTED

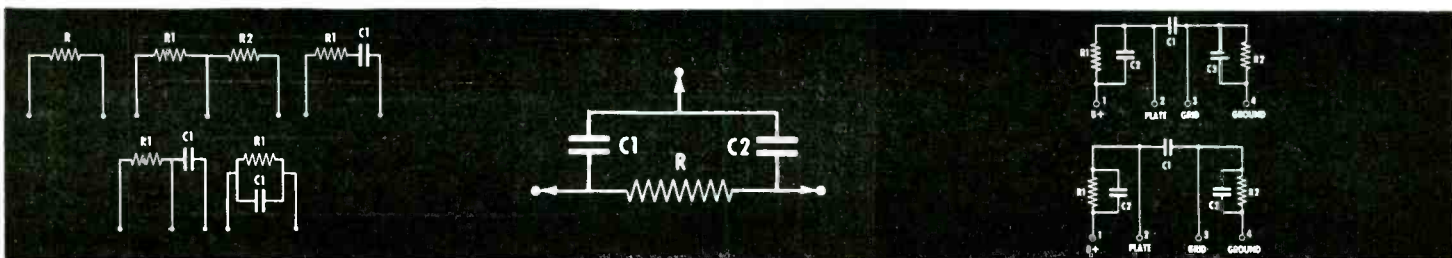

The resistor-capacitor units diagrammed here are only  $1\frac{1}{32}$ " x  $\frac{1}{32}$ " x  $\frac{3}{64}$ " thick maximum. These tiny units are ideal where small size is essential in low-voltage applications.

The Centralab FILPEC diagrammed here is one of the smallest multi-value components available to the industry. Specially designed for use as balanced diode filter but adaptable to variety of circuits.

Centralab TRIODE Couplers are combinations of 3 capacitors and two resistors. Easily replaces 4 separate components normally used in audio circuits. Size —  $1\frac{3}{16}$ " x  $1\frac{1}{32}$ " x  $\frac{3}{64}$ " thick.



# ELECTRONIC CIRCUITS SERVICE ENGINEERS

*The most amazing component development in years — Centralab's famous PRINTED ELECTRONIC CIRCUITS provide simpler, REALLY FAST guaranteed servicing*

YOU'VE heard about them for years — maybe you've seen them in sets you've repaired — now you can get them right through your Centralab jobber . . . PRINTED ELECTRONIC CIRCUITS!

Pioneered and made by Centralab, the first name in electronic ceramics, you'll find that Printed Electronic Circuits save you time, space and weight, save you "customer grief" . . . save you soldering.

What are they? They're resistor-capacitor combinations, complete circuits, parts of circuits — actually printed and fired to tiny ceramic wafers and brought

out to convenient external leads.

You'll find they can save you up to 75% of your usual soldered connections — and provide unsurpassed electronic performance . . . plus the kind of permanence that enables you to *confidently guarantee* your work.

Get your Centralab's P.E.C. replacement data (by part numbers) at once . . . see your jobber or use the coupon below. And remember—if it isn't a Centralab it isn't an original printed electronic circuit.

## Centralab

CENTRALAB DIVISION OF GLOBE-UNION INC., 908 East Keefe Avenue, Milwaukee 1, Wisconsin

- Enclosed — 25 cents for TV Control Guide including Replacement data on Printed Circuits.
- Send Free Centralab Catalog No. 27.

Name.....  
 Company Name.....  
 Address.....  
 City..... Zone..... State.....

**Please!**

Your Distributor's Name.....  
 Address.....  
 City..... Zone..... State.....

## ELECTRONIC CIRCUITS NOW AVAILABLE TO YOU

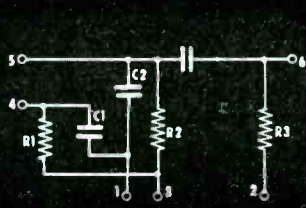

Pentode couplers can easily replace 6 components normally found in audio circuits. Think of it only 6 soldered connections instead of 12!

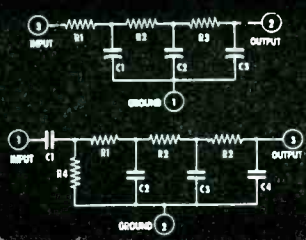

P.E.C. Vertical Integrator plates — widely used in television vertical integrator networks. They are a "must" for the up-to-the-minute TV Service Engineer.

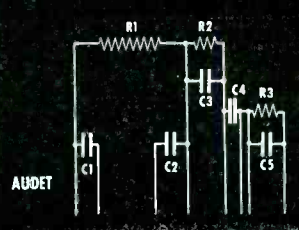

Audet — Furnishes values of all components generally comprising output stage of AC-DC receivers. If there's trouble — replace the entire old audio-detector stage with an AUDET!

# PHONO *installation and service*

by **KENNETH STEWART**



Ann Blyth, motion-picture star, using the American D-33 dynamic microphone.<sup>8</sup> Microphone has omnidirectional pickup. No pre-amplifier required. Can be mounted for stand or suspension use. Weighs seven ounces. Available in all popular impedances and equipped with Cannon latch-lock plug and 25' 2-conductor shielded cable.

RCA 15" duo-zone loudspeaker (See p. 56 for details.)

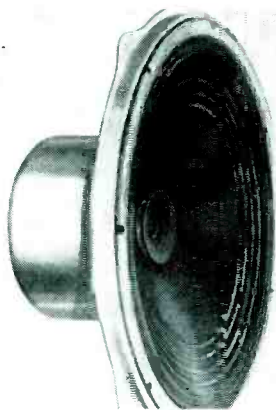

Rauland-Borg 60-watt amplifier (See p. 58 for details.)

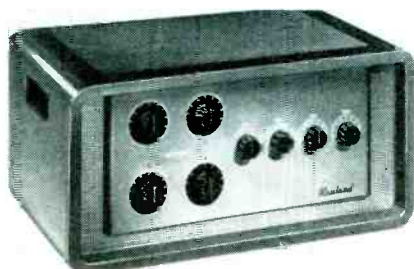

## Properties of Response . . . Features of New Developments: Duo-Cone Speaker, Remote-Controlled Amplifiers, Three-Speed Phonos, 60-Watt Biased-Power Amplifiers, Slow-Speed Crystal Cartridges.

IN THE AUDIO SYSTEM, response characteristics have been generally used as a means of gauging performance. However, since response depends on both frequency and intensity, sounds of the same intensity and intensity level may not sound equally loud to the ear if their frequencies are different. Accordingly, the net results on the receiving end can be replete with variables.

Discussing this unique situation in a recent issue of the *Westinghouse Engineer*, S. Bennon, a Westinghouse sound engineer, pointed out that a 40-cycle note having an intensity level of 72 db is identical in loudness level to a 1,000-cycle note of 30 db or a 4,000-cycle note of 27 db. In addition, two sounds of 70-db intensity level, one of 28 cycles and the other of 1,000 cycles, have loudness levels of 10 and 70, respectively.

Since sound intensities along a certain contour are of equal loudness they can be identified as to loudness level by a common unit; the *phon*. The intensity of a 1,000-cycle frequency has been arbitrarily selected as the reference. Explaining the relation between loudness levels and intensity levels, Bennon cited that the loudness level of a pure tone (in phons) equals the intensity level (in db) of a 1,000-cycle tone that sounds equally loud. Consequently, he said, the 72-db, 40-cycle note, the 30-db, 1,000-cycle note, and the 27-db, 4,000-cycle note all have a loudness level of 30 phons.

Actually, therefore, the phon simply defines sounds of equal loudness levels. However, although the phon is useful

in this respect, it does not really indicate the proportionate effect of these levels on the ear. For instance, a sound of 60-phon loudness level is not twice as loud to the ear as a sound of 30 phons nor three times as loud as a sound of 20 phons.

Loudness units have been found to be directly proportional to the response of the ear to pure tones. In other words, a sound of 100 units appears to the ear to be twice as loud as one of 50 units and ten times as loud as one of 10 units. The loudness unit has been defined as the loudness sensation corresponding to a loudness level of zero phons or 0 db at 1,000 cps.

In determining the loudness sensation of the ear to a pure tone of given frequency, it has been found that a pure 8,000-cycle tone of 82-db intensity level has a loudness level of 70 phons and causes an ear response of 7,800 loudness units. However, another pure 8,000-cycle note, but of half the intensity level (41 db) will have a loudness level of 30 phons and cause an ear response of 360 loudness units. To the ear this response appears to be less than one twentieth as loud as the 82-db note.

If the components of a complex sound are widely separated in frequency, then, according to Bennon, the ear response is proportional to the sum of the loudness units of the components. Generally, however, a phenomenon known as masking is encountered to some degree. Masking, explained Bennon, is the reduction of the

(Continued on page 56)



**IT'S HERE!**

**The New HIR**

a fully automatic

**ANTENNA  
ROTATOR**

*by*

**ALLIANCE**

*with the most  
accurate indicator  
on the market!*

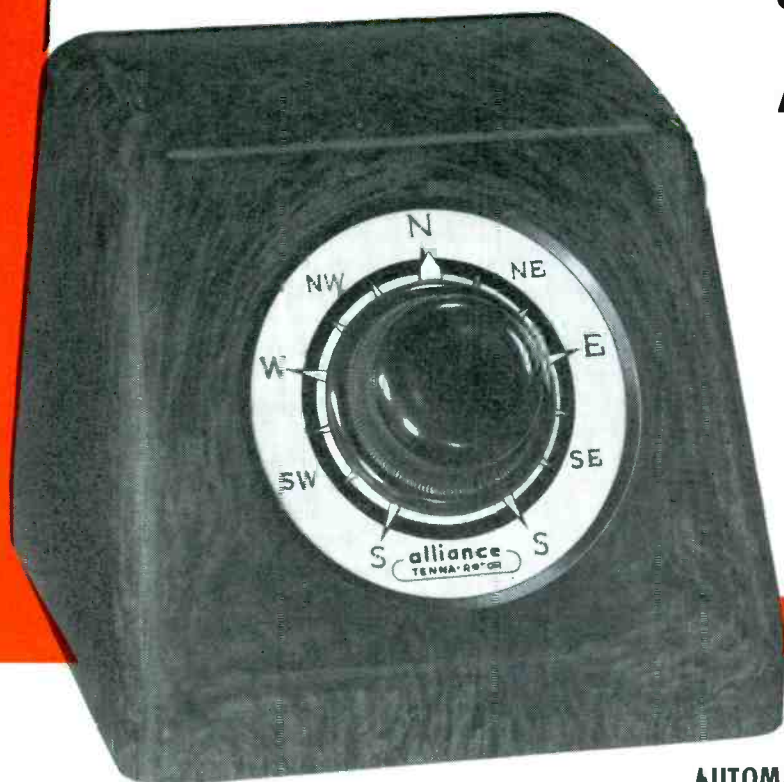

**Just set the pointer and forget it!**

*Works in any weather  
Guaranteed for one year*

The famous Model DIR also available with handy—North—South—East—West indicator. Approved by Underwriters' Laboratories—guaranteed for one year!

*And Remember—*

Only Alliance delivers a national TV campaign to five million viewers around 60 stations.

*It pays to stock and sell  
Alliance Tenna-Rotor!*

**AUTOMATIC**—the new deluxe model HIR Alliance Tenna-Rotor is fully automatic. Turn the indicator knob and the antenna turns to any setting on the dial and stops.

**FASTER INSTALLATION** — Easily accessible connections. Uses special "Zip" feature 4-conductor cable. No expensive callbacks necessary.

**NEVER OUT OF DATE**—mark the best antenna position for each station right on the dial with removable stickers. New channels can be added at any time by customer.

**MYSTIC LIGHT** — light moves along the dial, shows position while antenna turns. Pointer indicates antenna position at all times. Dial shows North—East—South—West directions.

**Alliance Manufacturing Co.**  
**Alliance, Ohio**

Export Department: 401 Broadway, New York, N. Y., U. S. A.

**alliance**  
**TENNA · ROTOR**

(TV ANTENNA ROTATOR)

# Capacitive-Operated PRESENCE DETECTOR

by ALAN SMOLEN

IN THE SHOP, there is often a need for a door announcer, a device which will ring a chime or bell whenever a person enters.

Several types of systems have been employed for this purpose, some featuring a photoelectric cell and others a capacitive arrangement. The cell-relay system has been found ineffective in those areas where there are beams of stray light about. Shielding does help, but often the shielding can be quite an expensive factor. The capacitive idea has been found to be very practical, requiring only a circuit which utilizes the presence of body capacity to detune and stop oscillation.

On the cover, this month, appears the circuit of a detector using the capacitive theme, which has been found to be very effective, not only as door announcer, but as a burglar alarm, door opener and display operator.

A 6SJ7 is used as an oscillator that operates in the conventional manner. The cathode of the tube is at an *rf* potential and develops a negative *dc* voltage through rectification by the crystal. This negative bias is used to keep the grid of the thyatron at cutoff, and prevent the operation of the plate relay. For sudden changes in the antenna to ground capacity, the voltage fed back to the grid will suddenly decrease and the oscillation will cease. When oscillations fail the bias drops, and the thyatron conducts, operating the plate relay. When oscillations start again (due to the removal of the capacity change), the bias is quickly built up again, and the grid of the thyatron will again gain control, because since *ac* is applied to the plate at some portion of the cycle, the plate voltage will go negative and conduction will cease. The plate relay is operated by pulsating *dc* and therefore requires an electrolytic across it to prevent chattering.

To adjust the relay, it is only necessary to use an insulated screwdriver, adjusting  $C_1$  till the relay just closes, and then increasing  $C_1$  a small amount.

[See Front Cover]

Bringing your hand near the antenna will operate the relay.

The circuit actually employs a Hartley oscillator, which maintains oscillation by virtue of the feedback from plate to grid. The amount of voltage fed back is a function of the ratio of the inductances  $L_1$  and  $L_2$ , the ratio of  $C_1$  and  $C_2$ , the gain of the tube, and the  $Q$  of the oscillator coil. For a given tube and oscillator coil,  $C_1$  can be adjusted to provide sufficient feedback to maintain oscillations. If, when this adjustment is made,  $C_2$  is suddenly increased, the fed-back voltage decreases, and oscillation will cease. It will be noted that if the gain of the tube could be increased, oscillation still may be maintained even with the increased capacity,  $C_2$ .

For a capacity-operated relay to be sensitive and stable, it must be reliable under conditions of large changes in line voltage, aging of tubes, and drift in capacity resulting from temperature and humidity changes. The circuit must be self compensating for all these slow changes, and still maintain maximum sensitivity. If this condition is not met, slow changes of the type mentioned will cause false operation of the relay.

To avoid such operational problems, the rectified negative voltage is applied to the suppressor of the oscillator tube, as well as the grid of the thyatron.

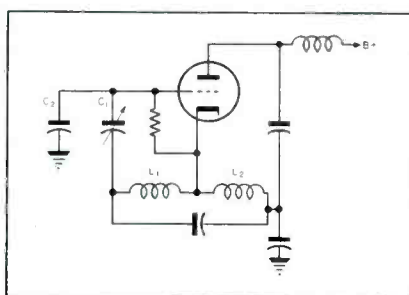

Fig. 1. Basic circuit of the Hartley oscillator used in the presence detector.

When the gain of the tube decreases due to tube aging or low line voltage, the amplitude of oscillations start to decrease. The rectified voltage will also decrease. The decrease in the suppressor negative voltage will increase the gain of the tube and still maintain oscillations.

Let us suppose that the antenna capacity is increased slowly, due to a humidity change. Since the fed-back voltage is a function of this capacity, the reduction in feedback will cause the oscillation amplitude to decrease, and the change will be compensated for by the decrease in suppressor voltage.

The suppressor voltage is taken from the junction of a 20-megohm resistor and a 1-mfd capacitor. This results in a 20-second time constant. This self-compensating feature is only present for slow changes and does not prevent sudden changes from operating the relay circuit in the desired manner. The circuit has been found satisfactory with line voltage changes from 70 to 130 volts.

Thus, for slow changes, the suppressor voltage will compensate and maintain maximum sensitivity and prevent false-relay operation.

The system has been used as a burglar alarm for a nursery window. The antenna was connected to the window screen, and since the screen was a large surface the sensitivity was high. With the circuit elements shown the frequency was approximately 150 kc, which should cause no concern regarding radiation in the broadcast band.

Another application has been as a window display. A small metal disc was attached to the inside of the window at a convenient height and the antenna connected to it with a very fine wire. A small sign suggested that passersby bring their hands near the disc, which when done operated display lights, etc.

The antenna capacity should be kept to a minimum for maximum sensitivity. For large antenna surfaces or long leads, it may be necessary to increase the value of  $C_1$ .



The Service  
Managers of  
*Admiral*  
**ZENITH**  
Hallicrafters  
*Motorola*  
all recommend the

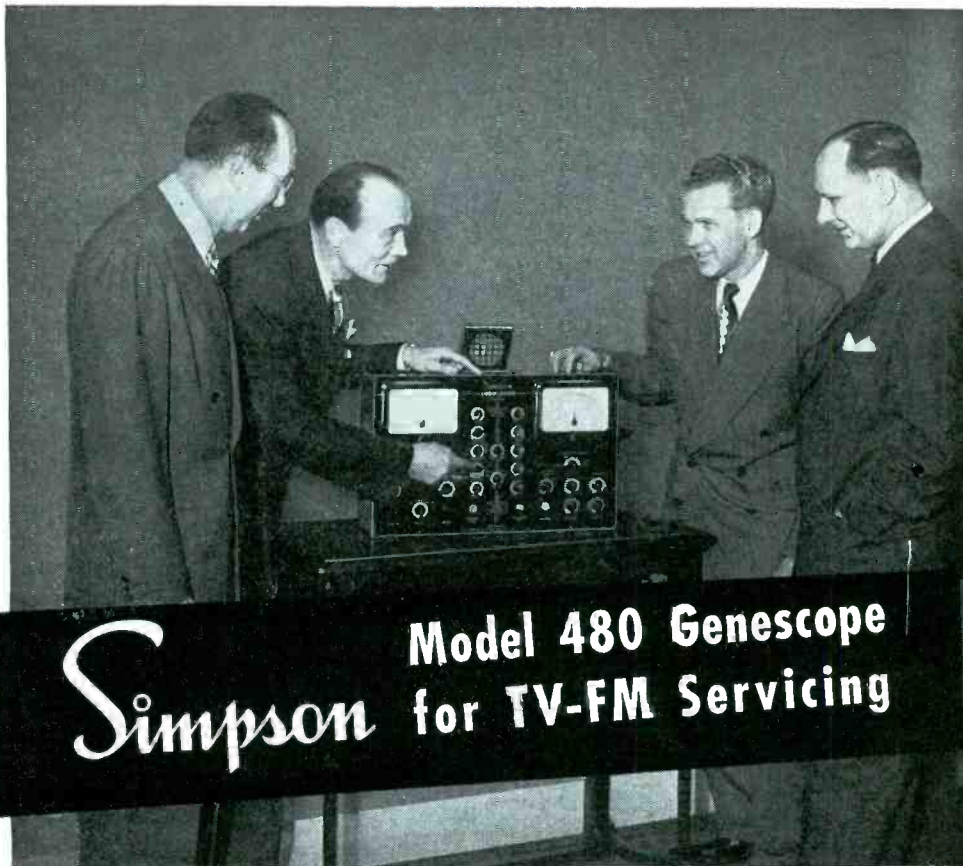

**Simpson** Model 480 Genescope  
for TV-FM Servicing

Max Schinke—ADMIRAL Frank Smolek—ZENITH Ed Croxen—HALLICRAFTERS Tim Alexander—MOTOROLA

• These four well known general service managers prefer the Simpson Model 480 Genescope for their FM and TV servicing.

For proper testing, servicing, and alignment of all TV and FM receivers, the Simpson Model 480 Genescope is the ideal instrument, leading general service managers agree.

These service managers know that modern FM and TV development and servicing demands test equipment made to the most exacting standards. They prefer the Simpson Model 480 Genescope because it is the most accurate, flexible, and convenient instrument available.

The Genescope is ruggedly built to give many years of trouble-free, accurate service.

In addition to providing all necessary signal sources, the new Simpson Genescope includes a high sensitivity oscilloscope of unique advanced design, complete in every detail. Equipped with a high frequency crystal probe for signal tracing. AM and FM oscillator sections provided with large, easy to read dials with 20:1 vernier control and 1000 division logging scales. *Revolutionary, ingenious, exclusive* output termination provides for various receiver impedances, either direct or through an isolating condenser. Step attenuator for control of output. Size 22" x 14" x 7 1/2". Weight 45 lbs. Shipping Weight 54 lbs.

DEALER'S NET PRICE complete with Test Leads and Operator's Manual \$375.00

**THESE RANGES SHOW HOW MUCH THE SIMPSON GENESCOPE CAN DO FOR YOU**

**FREQUENCY MODULATED OSCILLATOR**

- Band A: 2-120 megacycles
- Band B: 140-260 megacycles
- Sweep width variable from zero to 15 megacycles
- Sweep rate 60 cycles per second
- Specially designed frequency sweep motor
- Continuously variable attenuator
- Crystal calibrator: 5 megacycles  $\pm$  .05%
- Audio Oscillator 400 cycles
- Output Impedance 75 ohms
- Step attenuator for control of output

**AMPLITUDE MODULATED OSCILLATOR**

- Band A: 3.3-15.6 megacycles
- Band B: 15-75 megacycles
- Band C: 75-250 megacycles
- 30% modulation at 400 cycles or unmodulated
- Continuously variable attenuator
- Visual method of beat frequency indication

**OSCILLOSCOPE**

- Vertical sensitivity: 35 mv per inch
- Horizontal sensitivity: 70 mv per inch
- Linear sweep frequency: 3 cycles to 60 kilocycles
- 60 cycle sine sweep
- Frequency essentially flat to 200 KC. usable to over 3 megacycles

**THE SIMPSON MODEL 479 TV-FM SIGNAL GENERATOR**

Exactly the same circuits, ranges and functions as the Model 480, described above, with the exception of the oscilloscope. Size 17" x 14" x 7 1/2". Weight 34 lbs. Shipping Weight 40 lbs.

DEALER'S NET PRICE with Test Leads and Operator's Manual . . . \$245.00



**SIMPSON ELECTRIC COMPANY**  
5200 WEST KINZIE STREET • CHICAGO 44, ILLINOIS  
In Canada: Bach-Simpson, Ltd., London, Ont.  
Phone: COLUMBUS 1221

# TVI... Causes and Remedies

by IRA KAMEN

TV Consultant

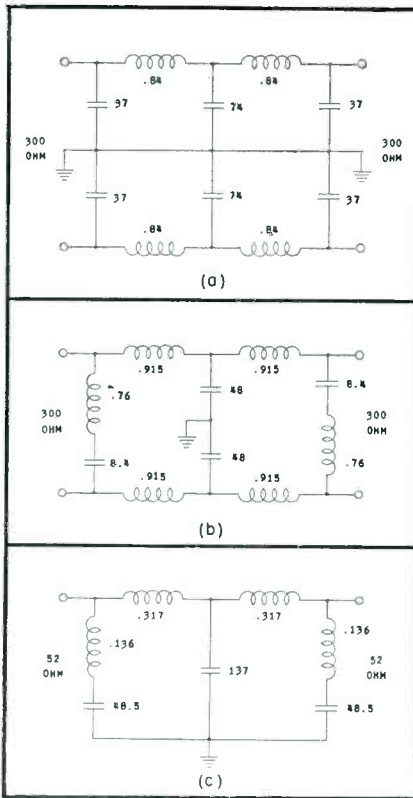

Fig. 1. Circuitry of typical filter systems employed by hams to prevent radiation in the TV bands. (Courtesy R. L. Drake Co.)

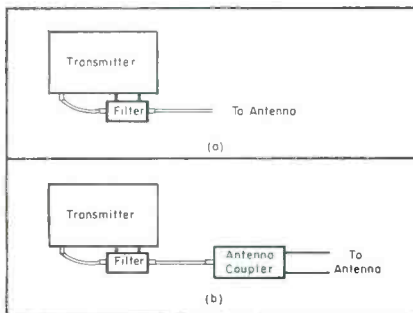
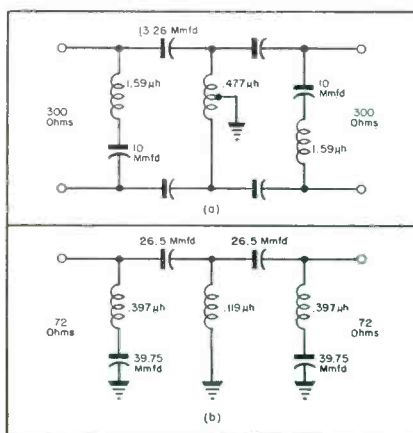

Fig. 2. Typical installment arrangements of filters connected in antenna circuits of ham setups. (Courtesy R. L. Drake Co.)

Fig. 3. Circuits of high-pass filters designed to work with 75 and 300-ohm input and output impedances. (Courtesy R. L. Drake Co.)



**Part II... Conclusion of Report on Current Status of Nine Sources of Interference (Second Harmonic of FM Stations; FM Receiver Radiation on Channels 5 and 6; Local Oscillators of TV Sets; FM Stations, Due to Lack of Image Rejection in TV Chassis; Hams; Prewar Diathermy Equipment; Electromedical and Industrial Apparatus; Ignition Systems; and TV Receiver Sweep and Video Circuit Radiation) and New Methods Which Have Been Evolved to Eliminate the Problems.**

ON THE TVI SCENE, there have been many significant changes, for the better, during the past year. As cited in the August issue installment, it has become possible to classify five of the nine types of TV interference as improving: ham, prewar diathermy, electromedical and industrial equipment, pulse-type or ignition systems and the second harmonic of FM stations. The latter was reviewed in the initial presentation of this series.

Let us now take up the case of the ham situation. Many effective filter systems have been developed to curb this type of interference.

In Fig. 1 are illustrated three types of low pass filters which are now available to prevent a ham's antenna from radiating any rf signals in the TV band. Fig. 2 shows these filters in their installed position.

It may be said that amateurs generally have placed their own house in order. Most of the TVI complaints now being registered against hams are

really due to reradiation from neighboring TV chassis.

## Prewar Diathermy Equipment

Most of the prewar diathermy units were low powered transmitters in the if TV band. While many doctors have discontinued use of their prewar models, there are still a fair number of the units in operation. In addition, there are the home diathermy operators who have a considerable number of these non-standard units installed in various locations. Fortunately the fundamental interference from these units is filtered at the TV receiver input. Fig. 3 shows a typical filter system which has been found very effective. Here we have two high-pass filters, one designed for 300-ohm input and the other for 75-ohm coax cable input. These filters reject all signals which are below 50 mc, which precludes the possibility of if signals entering the TV receiver via the antenna circuit. These

(Continued on page 52)



# FOLLOW THE LEADERS

BUY WISE...

BUY THE ORIGINALS...

BUY **HYTRON** TV FIRSTS



Emerson



Magnavox



Westinghouse

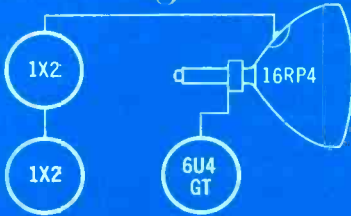

Admiral

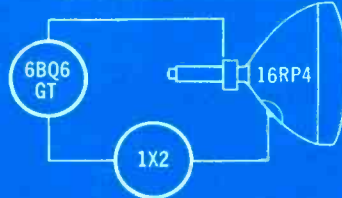

OLYMPIC

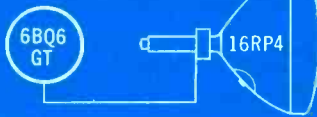

BENDIX

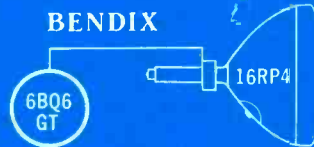

Sentinel



CROSLY

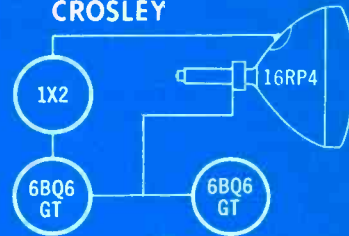

TRAV-LER

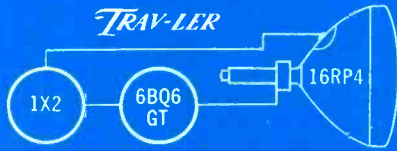

PHILCO



STROMBERG-CARLSON

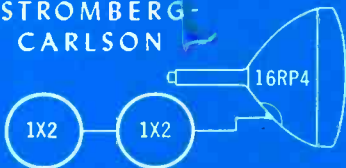

hallicrafters



Packard-Bell



Hoffman

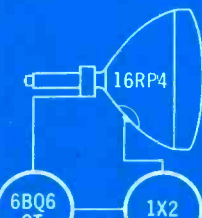
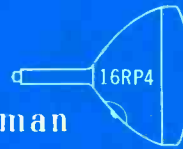

Spartan

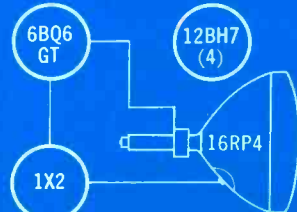

air-O-king



National

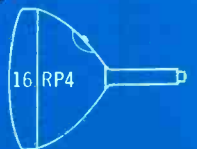

Motorola

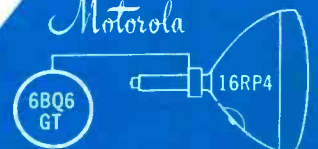

Ask for the original Hytron TV firsts: Hytron 1X2 compact, high-voltage TV rectifier. Hytron 6BQ6GT, 25BQ6GT extra-performance deflection amplifiers. Hytron 6U4GT high-perveance damping diode. Hytron 12BH7 twin-triode sweep amplifier with superior efficiency. Hytron 16RP4 original rectangular TV picture tube.

MAIN OFFICE: SALEM, MASSACHUSETTS



# Servicing Helps

by M. A. MARWELL

PICTURE QUALITY can be improved in Motorola chassis\* with a change in compensating coils; Fig. 1a.  $L_{17}$  should be changed from a red-dot coil to a yellow dot coil and  $L_{19}$  changed from a green-black dot coil to a green dot coil. This provides a change in compensation with the RC network on the tapped contrast control,  $R_{31A}$ , being eliminated.

**Video Amplifier-Tube Alternate:** In some models, a 6CB6 will be found as the video amplifier ( $V_7$ ) instead of a 6AH6. In this case, the screen dropping resistor,  $R_{30}$ , must be changed from 33,000 to 22,000 ohms; Fig. 1b.

**Vertical Sync Stabilization:** An RC network,  $C_{92}$  (100 mmfd) and  $R_{100}$  (470,000 ohms), which has a short time constant, has been added in the grid input circuit of the first clipper. This short time constant has been found to keep noise pulses, most of which have a much longer time duration, from reaching the clipper, result-

ing in more stable syncing of the vertical oscillator. The grid resistor,  $R_{61}$ , should be changed from a 1-megohm value to a 2.2-megohm value; Fig. 1c. It will be found advisable to add this network in chassis situated in noisy areas.

**Vertical Output Tube Alternate:** In some sets, 6AS5s are now being used in the vertical output ( $V_{14}$ ) instead of 6W6s. No component changes are required, except the substitution of a miniature tube socket. The connections for the 6AS5 miniature socket are shown in Fig. 1d.

**Elimination of Vertical Collapse:** The addition of a 100-ohm screen isolation resistor,  $R_{101}$ , in the vertical output stage,  $V_{14}$ , has been found to prevent a tendency of some tubes to break into momentary oscillation; Fig. 1e. Where a momentary collapsing of the raster is troublesome, this resistor may be added in existing sets.

**Speaker Revision:** As the AM-FM chassis in the combination model re-

quire *pm* speakers, a filter choke has been mounted on the speaker frame to serve the TV chassis. Fig. 1f illustrates the speaker wiring.

**Horizontal Radiation Reduction:** A 10,000-mmfd ceramic disc-type capacitor has been added from each side of the ac line to chassis to reduce horizontal radiation. These capacitors are installed right on the power input receptacle. A paper-backed foil shield, to cover the upper half of the picture tube, has also been added. These changes help to minimize horizontal oscillator interference in broadcast receivers and may be added to existing sets where this condition is troublesome.

## TV Tube Substitutions

In the Westinghouse vertical multi-vibrator circuitry, it has been found possible to use either a 12AU7 or a 12BH7 interchangeably. The multi-vibrator circuit remains the same regardless of which tube is used.

Either a 6AU6 or a 6BJ6 may be used as a keyed *agc* tube. Although the pin connections for these tubes are different, they may be used interchangeably because the pin connections that are different (pins 2 and 7) are connected together externally.

Some Westinghouse chassis use a 6AL5 and a 12AV6, as a ratio detector and *af* amplifier, in place of a 6T8.

## Westinghouse Circuit Revisions

In late production Westinghouse chassis, a 5600-ohm resistor ( $R_{400}$ ) was added in parallel with the horizontal linearity control ( $L_{402}$ ). This resistor has been found to suppress the appearance of faint light and dark vertical lines at the left of the raster by damping out ringing in the control.

Due to variations between 6K6GT vertical output tubes, it was found desirable in later production to provide increased control over the picture height. Accordingly the circuit was altered, with the 39,000-ohm resistor ( $R_{414}$ ) in the vertical output grid circuit removed, and the arm of the 1,000-ohm height-control pot going to a

\*Motorola TS-89/TS-94/TS95.

Fig. 1. Motorola circuit changes: (a), compensation change to provide improvement in picture; (b), video-amplifier tube alternate circuitry; (c), vertical sync stabilization via modification of the time-constant circuit; (d), vertical output-tube alternate arrangement; (e), addition of 100-ohm screen isolation resistor to eliminate vertical collapse; (f), speaker wiring for a *pm* model on AM/FM chassis.

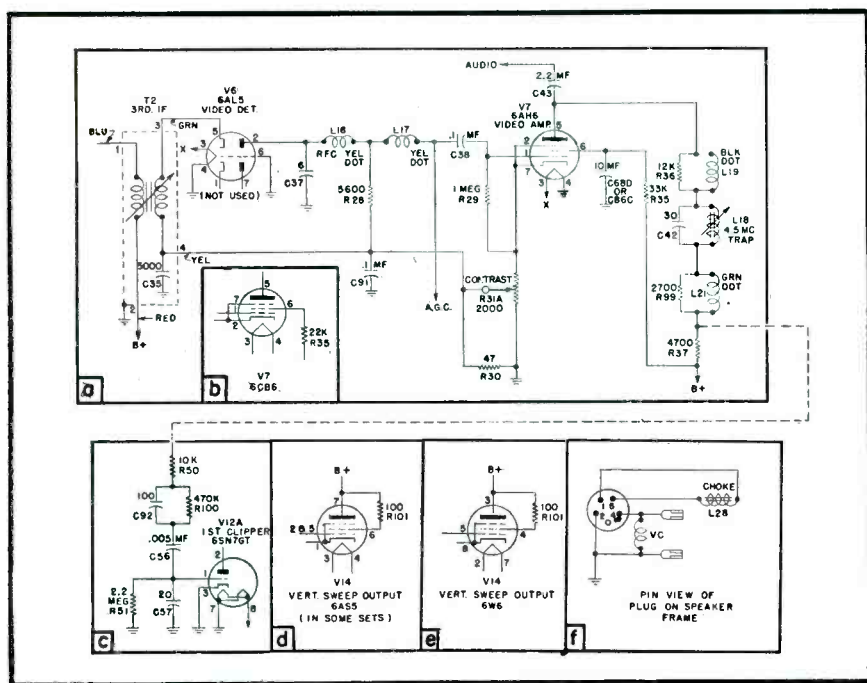



# Modifications in Motorola TV Chassis Which Provide Improved Picture Quality, Vertical Sync Stabilization, Elimination of Vertical Collapse, Reduction of Horizontal Radiation . . . TV Tube Substitutions in Westinghouse Models . . . Circuit Revisions in Westinghouse Receivers to Improve Horizontal Linearity Control Action and Secure More Filament Voltage for 1X2A for Increased Picture Brightness . . . Required Features of Five Basic TV Test Instruments.

.1-mfd capacitor in the vertical output grid.

The reactor ( $L_{408}$ ) in the filament circuit of the 1X2A high voltage rectifier has been omitted in later production. As a result of variations between tubes, the filament voltage for the 1X2A was found to be too low in some instances with  $L_{408}$  in the circuit. Insufficient filament voltage at the *hw* rectifier resulted in a loss of brightness along with excessive height and width.

## TV Test Equipment

In a study of the test equipment which should be used for TV chassis servicing, the Westinghouse service department found that five instruments are particularly important:

(1) An *rf* sweep generator, capable of producing a 10-mc sweep at a center frequency of 44 mc. The output should be adjustable from at least 100,000 microvolts down to a very low minimum, and the output must be flat at all positions of the attenuator.

(2) A 'scope, preferably one with a wide-band vertical deflection amplifier, a low-capacitance input probe, and good low-frequency response characteristics.

(3) Signal generator or generators

capable of producing an accurate unmodulated signal at 4.5, 41.25, 42.25, 43, 44, 45 and 45.75 mc. Accuracy at these frequencies is very important. If the signal generator does not include a crystal calibrator, a heterodyne frequency meter equipped with a crystal calibrator should be used to insure accuracy. The output level must be adjustable from at least 100,000 microvolts down to a very low minimum.

(4) A *vvm* equipped with a high-voltage multiplier probe for measurements up to 15,000 volts, and an *rf* probe for measuring *rf* voltages.

(5) Signal generator or generators capable of providing output at various frequencies between 455 kc and 108.5 mc. The *rf* output level should be adjustable with at least 100,000 microvolts maximum and a very low minimum. Amplitude modulation is required on the frequencies between 455 and 1615 kc.

The chassis and the test equipment should be bonded together by short lengths of heavy braided copper ribbon, and all interconnecting leads should be shielded and as short as possible, consistent with ease in making connections. The effectiveness of the bonding can be checked during align-

ment by placing the hand on the chassis or test equipment case. If the response curve or meter reading changes, the bonding must be improved before the circuits are aligned.

It is important that the coax cable used to couple the sweep generator output to the receiver be terminated at its output end in the characteristic impedance of the sweep-generator output circuit. To accomplish this, the appropriate value of resistance should be connected across the output leads at the open end of the cable.

## Alignment Tools

To adjust the slugs in the common *if* and 4.5-mc *if* transformers in Westinghouse chassis, a special tool<sup>2</sup> is required. This tool must fit into the .035" x .093" slot in the slug. An incorrectly designed tool will cause chipping of the slug.

## Common IF Alignment

The common *if* system uses over-coupled *if* transformers to obtain the required bandwidth. In the alignment of this type system, the visual method of stage-by-stage alignment should be used. A sweep generator is used to

(Continued on page 55)

Fig. 2. How to couple a signal generator to the TV mixer tuner during alignment.

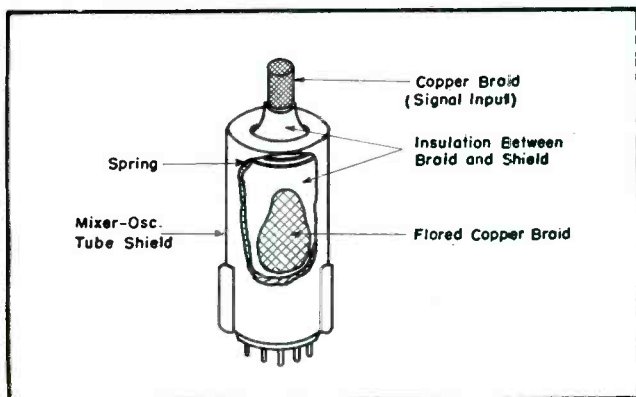
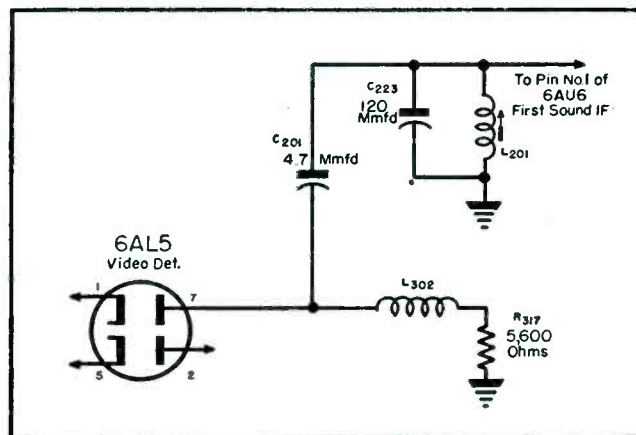

Fig. 3. Revised Westinghouse circuit providing for new sound takeoff and input to sound *if* amplifier.



# ASSOCIATIONS



## ETG, Philadelphia, Pa.

A NEW ORGANIZATION, The Electronic Technicians' Guild of Pennsylvania, was formed recently in Philadelphia, according to a memo from James T. Daly of the guild's publicity committee.

According to the preamble of the guild's constitution, the new association was set up . . . "for the purpose of aiding its members in improving and uplifting their social, professional and economic status in life through cooperation, registration and informative advertisements." The guild proposes to provide . . . "for an enlightened educational program; the classification of employees according to their skills, talents and qualifications; encouragement of the adoption of fair-trade competition; settlement of disputes between guild members and the public or between guild members and external organizations." There will also be provided a means of . . . "securing compliance with statutory federal, state and local laws and regulations as they pertain to labor, business and health and fire underwriting policies." Provided, too, will be legal-aid services and other benefits, programs or policies that might be helpful to the individual and collective interests of the membership.

Paul Lau was named president of the new guild; Karl Vogelsang, vice president; John Zagury, corresponding secretary; Stan Myers, secretary-treasurer, and Frank Gerhard, recording secretary.

## PR SMA

THE SECOND ANNUAL SHOW AND EXHIBIT of the Philadelphia Radio Servicemen's Association, held in the Broadwood Hotel, Philadelphia, recently, featured a series of lectures and demonstrations by outstanding members of industry, including Charles C. Dwyer of Webster-Chicago; Jack Karlan, Sheldon Electric Co.; Fred Edwards, Standard Coil Products Co.; Ralph Shields, Sylvania Electric; Caywood Cooley, Philco; Lee Sigmund, Olympic Radio; John F. Rider, and Charles J. Hirsch of Hazeltine Electronics.

## TEN YEARS AGO

From the Association News Page of SERVICE, October-November, 1940

WALTER R. JONES, director of commercial engineering of Hygrade Sylvania Corp., delivered a lecture on *Oscillators and Their Applications* before members of the Lucerne County Radio Servicemen's Association at Wilkes-Barre, Pennsylvania. Jones was assisted by George Isham, New York and Pennsylvania Sylvania sales rep. . . . A dinner-meeting of the Dallas Radio Service Association was held at the Dallas Power and Light Auditorium. Among those at the meeting were the members of the board, which included: Gene Taylor, Howard Smith, Colvin Bee, Roy Allen, J. D. Ellis, Lloyd Williams, Louis Stone, Bill Inman, Porter Bennett, Harold Grow, B. A. Blanton, and Egon Pflughaupt.

Topics discussed included test-equipment selection, TV front-end installations, picture-tube conversions with 14" tubes, record changers and color television.

In the color-television talk, which was moderated by ye editor, a unique demonstration of color techniques was offered. Charles Hirsch, who is chief engineer of the Hazeltine research division, described the principles of mixed highs, used in the transmission of color signals. Hirsch pointed out

that this principle has eliminated the necessity of transmitting 100% of the detail in color, as well as black and white, since it has been psychologically and physiologically established that the human eye is incapable of distinguishing color in fine detail. The bandwidth signal advantages of the system were also explained. In the demonstrations, during which two projectors and two screens were used, there were shown color pictures obtained on a 12-mc bandwidth, which is the ultimate, and pictures obtained on 4.2-mc bandwidths, in which mixed highs were used.

A standing-room-only audience attended this highly entertaining and informative talk, the first of its kind ever presented in the country.

## LRTA

THE LACKAWANNA RADIO TECHNICIANS ASSOCIATION was quite active during the PRSMA meeting in a drive to secure new members.

On view at the LRTA booth was a proposed code of ethics, declaring that members would not charge more than current prices for parts installed in a repaired receiver and would . . . "test customers' receiving tubes as accurately and reliably as possible; keep charges for labor in such repair work at a fair and reasonable level; perform only such repair work as necessary or authorized; use only parts of authorized quality in such repair work; maintain and use service equipment essential to good receiving set repair work; supply an itemized statement on all parts and labor used in the repair work of a customers set; and return all old parts replaced to the customer."

## ARTSNY

AT THE FIRST FALL MEETING of the Associated Radio-Television Servicemen of New York, Inc., John F. Rider appeared as guest speaker.

The meeting featured the offering of application tests for ARTSNY membership, as well as entry examinations for the TV courses conducted by the Board of Education for members of the association.

## RCA BATTERY CONTEST WINNERS



Winners of Ford custom sedans in the \$10,000 RCA battery "Get the Facts" contest: Verne Larson (left), Warren Radio Supply, Sioux Falls, S. D., winning distributor salesman, and Raymond J. Becker (third from left), Leite's Supply, Volga, S. D., first prize-winning dealer. Admiring on-lookers are: Cliff Leite (second from left) and G. Erickson.



12 Improvements IN NEW 1951

MODEL O-6

PUSH-PULL

# Heathkit OSCILLOSCOPE KIT

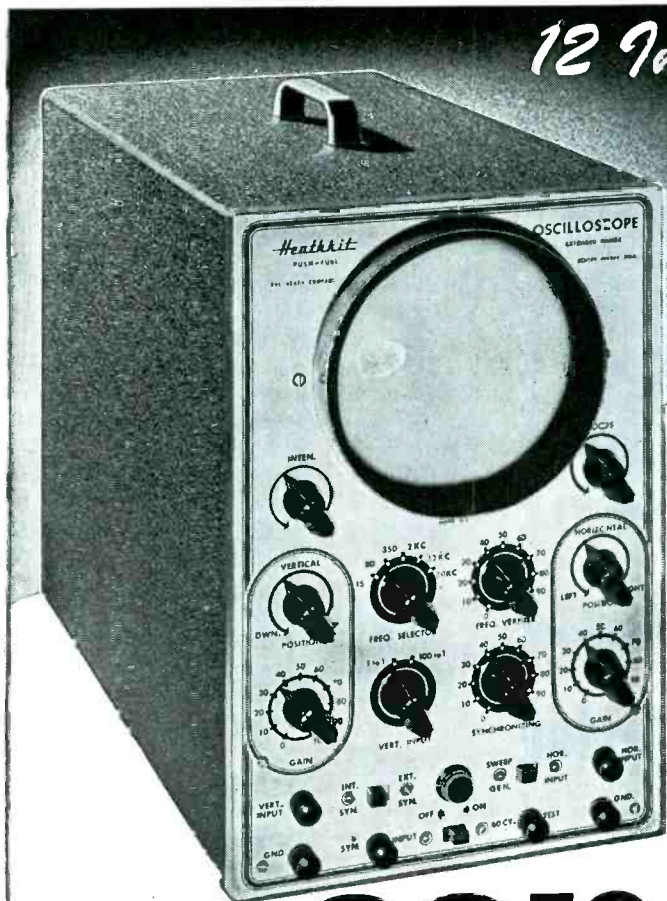

Only **\$39.50**

- ★ New AC and DC push-pull amplifier.
- ★ New step attenuator frequency compensated input.
- ★ New non frequency discriminating input control.
- ★ New heavy duty power transformer has 68% less magnetic field.
- ★ New filter condenser has separate vertical and horizontal sections.
- ★ New intensity circuit gives greater brilliance.
- ★ Improved amplifiers for better response useful to 2 megacycles.
- ★ High gain amplifiers .04 Volts RMS per inch deflection.
- ★ Improved Allegheny Ludlum magnetic metal CR tube shield.
- ★ New synchronization circuit works with either positive or negative peaks of signal.
- ★ New extended range sweep circuit 15 cycles to over 100,000 cycles.
- ★ Both vertical and horizontal amplifier use push-pull pentodes for maximum gain.

## New INEXPENSIVE MODEL S-2 ELECTRONIC SWITCH KIT

Twice as much fun with your oscilloscope — observe two traces at once — see both the input and output traces of an amplifier, and amazingly you can control the size and position of each trace separately — superimpose them for comparison or separate for observation — no connections inside scope. All operation electronic, nothing mechanical — ideal for classroom demonstrations — checking for intermittents, etc. Distortion, phase shift and other defects show up instantly. Can be used with any type or make of oscilloscope. So inexpensive you can't afford to be without one.

Has individual gain controls, positioning control and coarse and fine switching rate controls — can also be used as square wave generator over limited range. 110 Volt transformer operated comes complete with tubes, cabinet and all parts. Occupies very little space beside the scope. Better get one. You'll enjoy it immensely. Model S-2. Shipping Wt., 11 lbs.

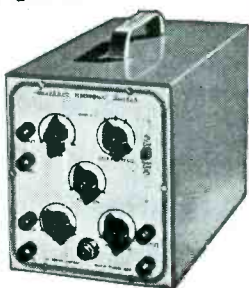

Only **\$19.50**

The new 1951 Heathkit Push-Pull Oscilloscope Kit is again the best buy. No other kit offers half the features — check them. Measure either AC or DC on this new scope — the first oscilloscope under \$100.00 with a DC amplifier.

The vertical amplifier has frequency compensated step attenuator input into a cathode follower stage. The gain control is of the non frequency discriminating type — accurate response at any setting. A push-pull pentode stage feeds the C.R. tube. New type positioning control has wide range for observing any portion of the trace.

The horizontal amplifiers are direct coupled to the C.R. tube and may be used as either AC or DC amplifiers. Separate binding posts are provided for AC or DC.

The multivibrator type sweep generator has new frequency compensation for the high range it covers; 15 cycles to cover 100,000 cycles. The new model O-6 Scope uses 10 tubes in all — several more than any other. Only Heathkit Scopes have all the features.

New husky heavy duty power transformer has 50% more laminations. It runs cool and has the lowest possible magnetic field. A complete electrostatic shield covers primary and other necessary windings and has lead brought out for proper grounding.

The new filter condenser has separate filters for the vertical and horizontal screen grids and prevents interaction between them.

An improved intensity circuit provides almost double previous brilliance and better intensity modulation.

A new synchronization circuit allows the trace to be synchronized with either the positive or negative pulse, an important feature in observing the complex pulses encountered in television servicing.

The magnetic alloy shield supplied for the C.R. tube is of new design and uses a special metal developed by Allegheny Ludlum for such applications.

The Heathkit scope cabinet is of aluminum alloy for lightness of portability.

The kit is complete, all tubes, cabinet, transformer, controls, grid screen, tube shield, etc. The instruction manual has complete step-by-step assembly and pictorials of every section. Compare it with all others and you will buy a Heathkit. Model O-6. Shipping Wt., 30 lbs.

EXPORT DEPT.  
13 East 40th St.  
NEW YORK CITY (16)  
CABLE: ARLAB-N.Y.

The **HEATH COMPANY**

... BENTON HARBOR 11, MICHIGAN

## Flyback HV Systems

(Continued from page 15)

screen and the speed. The amount of high voltage controls the speed. The bias controls the number. Under normal operation, the picture gets brighter and at the same time blooms (gets larger) to some extent as the brilliance control is turned completely up. The reason is interesting. When the brilliance control is rotated to maximum, the bias is reduced. Less bias means more current through the picture tube and more electrons hit the screen, resulting in greater brightness. However, more current through the *R* filter, means a reduction in high voltage output because of the greater voltage drop across the 1-megohm resistor. In view of the reduced high voltage, the picture gets bigger in both directions. While this normally should mean a somewhat dimmer picture, the increased number of electrons hitting the screen over-balance the effect of the reduced *B+*.

Suppose, now, we have a blank screen and normal sound. Just as with a dim picture, we have the same three possible locations of trouble: (1) High voltage system; (2) horizontal deflection circuit; and (3) picture-tube circuit.

In a quick check for the presence of high-voltage *B+* we can turn the set off and take off the high-voltage rubber cap connection from the picture tube. The cap should be held in one hand and the set turned on again. Then the cap should be brought close to its connection point. When about  $\frac{3}{8}$ " away, a thin blue spark should jump across. If the cap has to be brought closer before the spark jumps, the *B+* can be considered low. If there is no arc, even when practically touching, there is no *B+*. Obviously, it may take a little practice and experimentation to judge a normal arc in various receivers.

If the *B+* is satisfactory, both the high-voltage system and the horizontal-sawtooth circuit must be ruled out as the source of trouble. Further checks should therefore be made in the picture-tube circuit. The picture tube should be checked to see if the tube's filament is lit. (Generally, this should be the first check to determine if the filament is good and if filament voltage is being applied.) If the ion trap (if any) is approximately in the correct position, the picture tube socket can be removed and voltage readings taken around the socket. For most picture tubes, approximately —50 v (grid-to-cathode) is required for cut-

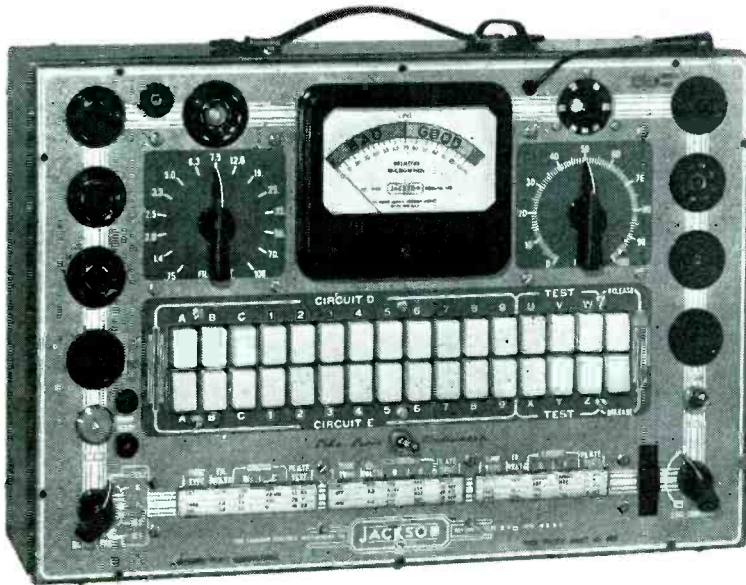

Dependable—Simple—and, "Service-Engineered"

# JACKSON "Dynamic" \* Tube Tester

Here is the tube tester used and recommended by manufacturers, laboratories and smart service organizations. Uses the "Dynamic" principle, pioneered by Jackson. Here are just a few of its major features.



**Sequence Switching**—no obsolescence with this amazing switch. Simple to use. Tube elements not connected to each other. Each element gets the right load or the right voltage.



### Complete Shorts and Noise Tests

You test every element for shorts. Because tube elements are tested separately, you get a true picture of tube operation. Switch position shows which element is shorted—helps you locate source of circuit trouble.



### Life-Line Indicator

Reduces normal heater or filament voltage. Tells you if tube is approaching the end of its life. Helps avoid troublesome call-backs. Insures more satisfied customers.

There are many more advantages to this fine Jackson tube tester—big, 4" meter—sockets for every type of tube, including sub-miniatures, blanks for future types—built-in roll chart. For the complete story, fill in and mail coupon today.

Available in bench, counter, or portable styles. Prices as low as

**\$94.50**

# JACKSON

"Service-Engineered"  
Test Equipment  
Dayton 1, Ohio

Tube Testers—Television Generators—  
Oscilloscopes—AM-FM Generators—  
Audio Oscillators—Condenser Checkers—Vacuum Tube Voltmeters.

\*TM REGISTERED U. S. PATENT OFFICE

Jackson Electrical Instrument Company  
Department 48  
16-18 S. Patterson Blvd.  
Dayton 1, Ohio

Gentlemen:

Please send information on:

- Model 648 Tube Tester     Complete Jackson Line  
 Low Cost Challenger Line     TV Instruments

NAME \_\_\_\_\_

ADDRESS \_\_\_\_\_

CITY \_\_\_\_\_ ZONE \_\_\_\_\_ STATE \_\_\_\_\_

MY DISTRIBUTOR IS \_\_\_\_\_



off. If the socket voltages are all correct, and the brilliance control varies the bias properly, as indicated in the manufacturer's schematic or service manual, the ion trap should be rotated and moved back and forth. If this move doesn't help, a defective picture tube is indicated.

On the other hand, if the B+ spark is not there on the first test, it will then be necessary to isolate the trouble either to the high-voltage section or the horizontal-deflection circuit. The high-voltage cage should be opened. A screwdriver with a heavy wooden or plastic handle should be held in one hand and the end brought close to the 1B3. If the high-voltage ac input to the plate is normal, a long thin spark will jump across from plate to screwdriver, when they are about  $\frac{3}{8}$ " apart. If the spark is smaller, the ac input can be judged as being low. If there is no spark, even when the screwdriver touches the plate and is moved slowly away, there is no input.

If there is a good spark at this point and none at the high-voltage rubber cap, where the first check was made, the main possibilities of trouble would be an open filament winding on the kickback transformer, bad 1B3, open filament resistor or one which has greatly increased in value, shorted high-voltage capacitor, or open filter resistor. A tube change and a resistance check should show up the trouble.

If there is no spark at the plate of the 1B3, the assumption can be that there is no input to the rectifier and a check would then be made at the plate of the horizontal output tube, 6BG6, to see if high-voltage ac is present. As noted before, because of the fast collapse of the lines of force in the bottom section of the primary, there is a 6,000-v pulse at this point. An arc test can be made at this point. The blade of the screwdriver should be brought close to the plate of the 6BG6. The spark naturally will not be as big here as on the plate of the 1B3 under normal operation, but it should be drawn off when about  $\frac{1}{4}$ " away. If there is a spark here, and none at the plate of the 1B3, the trouble is between these two points—the top part of the primary winding of the transformer. If there is no spark, the grid of the 6BG6 would be checked for sawtooth input and further checks made in the horizontal sweep circuit, if necessary.

It might be noted that if there is normal sawtooth input to the 6BG6 and little or no output at the plate, the trouble does not necessarily have to be directly in the 6BG6 circuit. A defective damping tube, which is in the

(Continued on page 44)



REVOLUTIONARY GIVES YOU

**maximum replacement**

WITH A **minimum of cartridges!**

**THIS MEANS MONEY TO YOU!**



**ORTHOGONAL SERIES 32, 33 and 34**

This TORQUE DRIVE\* vertical-type crystal cartridge is being used more and more in original equipment and for replacement. The 32 series greatly improves 78 rpm reproduction—saves record wear. The 34 series for 33 $\frac{1}{3}$  and 45 rpm beautifully plays the new wide-range, high fidelity recordings—tracks perfectly at 5 grams pressure. The 33 series handles all three speeds, with remarkable efficiency. All specially moisture protected for extra long life. Has  $\frac{1}{2}$ " and  $\frac{3}{8}$ " hole spacing. Color coded. Simple to install. Replaceable osmium-tip or sapphire-tip needles.

\*E-V Pat. Pend. Licensed under Brush patents.

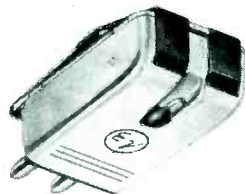

**SERIES 12 and 14**

The Series 12 TORQUE DRIVE crystal cartridge replaces over 150 types in general use for 78 rpm. Saves time and work—speeds servicing. Gives better reproduction and longer record life. Series 14 for 33 $\frac{1}{3}$  and 45 rpm is performing brilliantly in thousands of record changers. Tracks perfectly at 5 grams pressure. Color coded. Replaceable osmium-tip or sapphire-tip needle.



**SERIES 16 TWILT FOR ALL 3 SPEEDS**

Superbly plays 33 $\frac{1}{3}$ , 45 and 78 rpm records with a single twin-tip replaceable needle without weight change, with tracking pressure of only 6 grams, and does it with TORQUE DRIVE efficiency. You merely tilt the Twilt and select the 1-mil or 3-mil needle tip for fast or slow speed records. Setdown is accurate. Mounts easily in most any standard pickup arm, with nothing more required than reducing needle pressure. Also available without tilting mechanism.



**SERIES 60 REPLACES OVER 20**

New Econo-Cartridge for economical replacement of over 20 conventional Bimorph crystal types. Frequency response to 6000 cps. Output is 3.5 volts with compliant needle, and 4.5-5 volts with straight shank needle. Has exclusive E-V needle stop which prevents chuck from rotating excessively and damaging crystal.



INCORPORATED

411 CARROLL STREET • BUCHANAN, MICHIGAN

Export: 13 East 40th Street, New York 16, N.Y., U.S.A. Cable: Arlab

Research-Engineered Phono Pickups, Microphones, High-Fidelity Speakers

ASK YOUR E-V  
DISTRIBUTOR OR  
WRITE FOR  
FREE BULLETINS

# Covers the Entire TV Rotator Field!

There's A Correct *TELE-ROTOR* For Every Application

C-D and RADIART  
**TELE-ROTOR**  
U. S. DEVICES MODELS



Here is the new standard TELE-ROTOR for all average installations! Featuring the ALL IN LINE design . . . with true in-line thrust between antenna and mast — the 3/4" STEEL shaft rotates on a case hardened steel ball. In-line reamed oilless bearings keep the shaft in perfect alignment and offer smooth trouble-free rotation and performance.

NOW — Powered by the same husky motor that has proven its superiority in the heavy duty TELE-ROTOR . . . You can depend on this easily installed unit to perform accurately and dependably.

**Model 501-A** rotator with control cabinet having end of rotation light. Light flashes every 7.2° showing antenna is turning. (Uses 5 wire cable) **\$34.95**

**Model 502-A** rotator with control cabinet having indicating meter for "hairline" tuning (Uses 5 wire cable) . . . . **\$44.95**  
ATX-10 . . . 5-wire cable, 6 1/2 c ft.

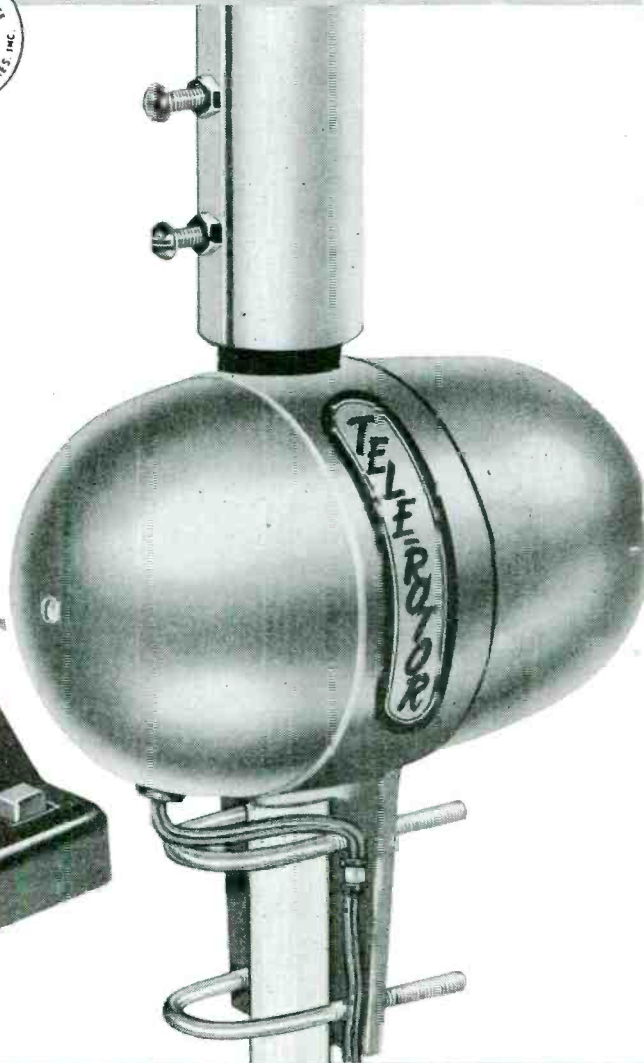
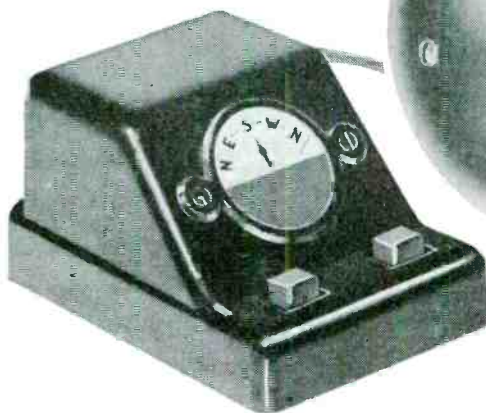

**CORNELL-DUBILIER SOUTH PLAINFIELD, N. J.**

**THE RADIART CORPORATION CLEVELAND 2, OHIO**





# TELE-ROTOR

C-D and RADIART  
**TELE-ROTOR**  
HEAVY DUTY MODELS



Tested... proven... and accepted as the outstanding rotator... this heavy duty TELE-ROTOR has no match! Powerful beyond any normal requirement... sturdy enough to hold and turn any TV antenna array under *any* weather conditions. Servicemen and dealers everywhere are recommending the heavy duty TELE-ROTOR with assurance of dependable TROUBLE-FREE performance! Complete with handsome control cabinet that indicates antenna position instantly.

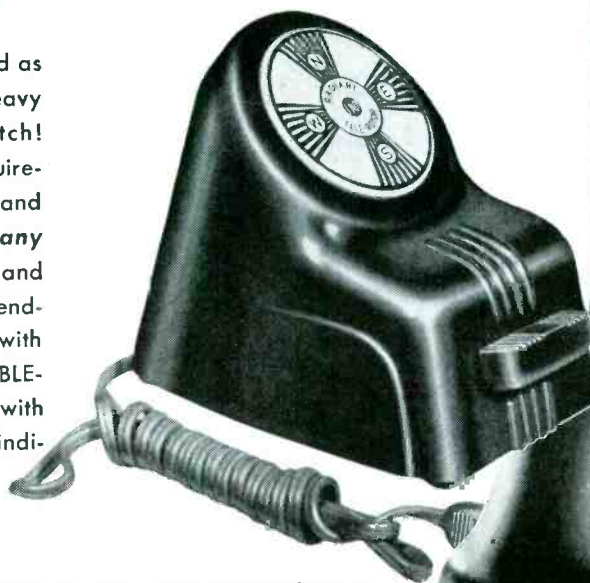

**Model TR-2** . . . . rotator with "Compass Control" cabinet having illuminated "perfect pattern" dial . . . . (Uses 8 wire cable) . . . . . **\$44.95**

**Model TR-1** . . . . rotator and control cabinet with end of rotation light . . . . (Uses 4 wire cable) . . . . **\$39.95**  
ATX-8 . . . 8-wire color-coded cable, 10c ft.

**PRE-SOLD TO YOUR CUSTOMERS**  
**Through A National TV Spot Campaign**  
**In Major TV Markets**

# New TV Parts . . . Accessories

## G.E. TV SERVICE PARTS

A new line of TV receiver parts, applicable to G.E. and to many other receiver makes, has been announced by the parts section of G.E., receiver division, Electronics Park, Syracuse, N. Y.

Line includes 70° deflection yokes for magnetic deflection circuits; horizontal sweep output and high voltage transformers, and other components such as *cm-pm* focus coils, width and linearity controls, ion trap magnets, etc.



\* \* \*

## PHILIPS 30" x 40" or 21" x 28" REMOTE-CONTROLLED SYSTEMS

Two TV systems, one producing a picture 30" high and 40" wide, and the other a 21"x28" picture, have been developed by North American Philips Company, Inc. Both can be controlled from distances up to 150 feet by a remote tuner measuring 8"x16"x10½".

Available now as Norelco Jumbo-Vue, model 1200 (1200 square inch picture), and model 588 (588 square inch picture).

Four controls—sound, station, picture and focus—are provided by the remote tuner. The receiver has 26 tubes, 4 rectifiers, picture tube and 2 diodes. Has a *protect-a-matic* relay which is said to assure long picture tube life.

\* \* \*

## VEE D-X LIGHTNING ARRESTER

A 4-wire lightning arrester, RW-204, featuring the use of double phenolic, has been announced by the La-Pointe-Plascomold Corp., Unionville, Conn. Material is said to meet requirements of the National Electric Code and is also approved by Underwriters' Laboratories. Arrester accommodates 4-wire rotator line as well as regular 300-ohm transmission line.

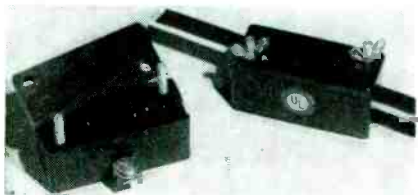

## TACO 5-ELEMENT YAGI

A 5-element yagi antenna tuned for any one of the low-band (2-6) or high-band (7-13) channels has been announced by Technical Appliance Corp., Sherburne, N. Y.

Antenna has three directors, antenna element and reflector. High front-to-back ratio and pinpoint directivity inherent in the yagi design is said to minimize ghost effects caused by reflected signals. Delivers 11 db gain, by actual field measurement.

Models are of all-aluminum construction. Physical shape is said to offer low wind resistance. Both are available in several types for varying needs, stacked or single, depending upon signal strength available. Stacking lines are supplied with stacked assemblies, or may be obtained for addition of antenna to existing array.

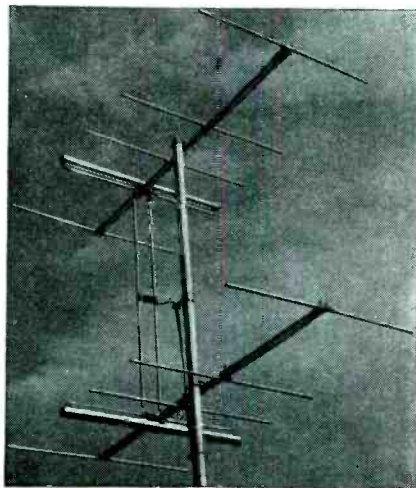

\* \* \*

## HAYDU ROTATOR

An antenna rotator which can be operated from chairside through a remote-control cabinet connected to a motor unit by a three-conductor cable, rotation being accomplished by pressing either of two buttons, for turning either right or left, has been announced by Haydu Brothers, Plainfield, N. J. Releasing the button is said to stop *instantly* rotation without coasting, and *lock* reception in that position. A signal light is included in the circuit hookup and glows to indicate the completion of each revolution.

Other features of the rotator include a cast aluminum housing that is said to be permanently weather-sealed. Antenna, after being rotated, is gear-locked into position, and cannot coast or be turned by the wind.

A self-protecting feature is said to prevent accidental damage to the unit through improper operation.

Universal fittings take any installation. Operates on 25 volts from 110-volt, ac. Rotator will withstand antenna weight up to 150 pounds. Barber-Coleman gears are used throughout.

[Additional TV product news on page 59.]

## TELREX MONARCH ANTENNAS

A new *Monarch* series of TV antennas, designed to give all-channel performance as a standard *Conical-V-Beam* or to permit selective channel emphasis when operated as a modified *Conical-V-Beam* has been announced by Telrex, Inc., Asbury Park, N. J.

Monarch series will be available in single, double and four bay models designated as K2X-TV, K4X-TV and K8X-TV. All models will be furnished with dowelled, heat treated dural tubular elements or optionally, with solid dural rods.

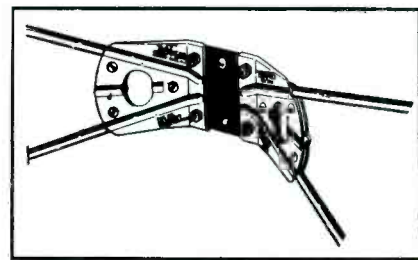

\* \* \*

## JFD WAVE TRAPS

A series of wave traps designed to filter out FM image and amateur harmonic interference have been announced by the JFD Manufacturing Co., Inc., 6101 Sixteenth Ave., Brooklyn 4, N. Y. Four models are available: No. BR106-10-30 to trap out amateur harmonic interference (14 and 28 mc bands); No. BR106-80-110 to trap out FM image interference; No. BR106-30-60 to trap out amateur harmonic interference (30 to 60 mc); and No. BR106-60-90 to trap out diathermy interference (60 to 90 mc).

\* \* \*

## SUPER SONIC TV/FM AMPLIFIER

A TV/FM amplifier, Super Sonic, model IT 5, is now available from the Sonic Industries, Inc., 221 West 17th Street, New York City. Has one continuous tuning control and one off-on switch, without verniers and *hi-lo* switching. High ratio tuning, 6 turns from channel 2 to 13.

Unit employs pure silver inductances and *rf* circuit contacts, minimum shunt grid and plate circuit capacities, short input and output link wiring, optimum input and output link circuit coupling, copper plated chassis and heavy power supply filtering. Balanced input and output circuits; 72 and 300 ohms. Housed in a walnut bakelite cabinet. U/L approved.





# New Parts . . . Tools . . . Instruments

## HEATH 'SCOPE KIT

A 'scope kit, model 0-6, for TV work has been developed by the Heath Co., Benton Harbor, Mich.

Unit features a sync circuit which operates on either positive or negative peaks of the input signal to lock in TV signals as they appear in the various stages of a television receiver.

Has a multivibrator type sweep circuit with a range from 15 to over 100,000 cycles. Vertical and horizontal deflection plates are operated in push-pull by high-gain pentodes. A step-attenuated frequency-compensated vertical input amplifier circuit permits examination of non-sinusoidal and high harmonic content input signals.

Other features include a *dc* amplifier arrangement, power transformer which is said to have reduced external electromagnetic field, and an Allegheny Ludlum metal 'scope tube shield.

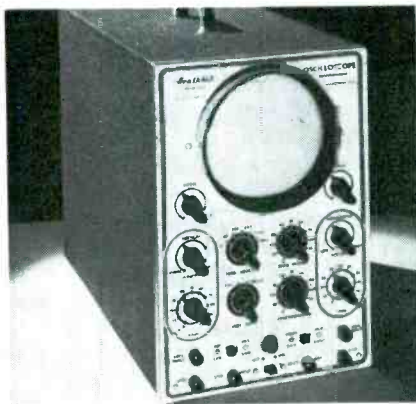

\* \* \*

## CRL DISC CAPACITORS

A new line of ceramic disc capacitors, which includes single, dual and shielded dual capacitors with very high capacities in relation to size, some as small as  $\frac{1}{4}$ " diameter, has been announced by Centralab. Can be used as bypass coupling capacitors in high frequency circuits. Shielded dual discs are available for bypassing in multiple stages.

Ceramic discs use No. 22 tinned soft copper wire radial leads which permit close coupled connections and eliminate tricky bending and fitting. All of the capacitors are rated at 600 working volts *dc* and are flash tested at 1000 volts. Discs are packaged 5 of one value per envelope and the shielded dual discs are packaged one per envelope.

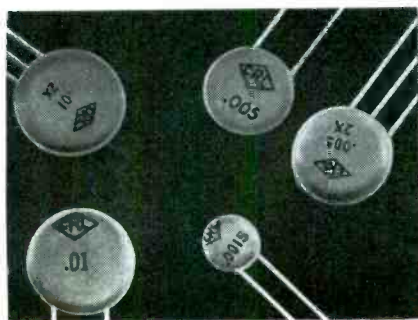

## WALSCO LUBRICATOR

A plastic Lubricator, No. 998, designed to reach cramped and inaccessible points in radio and television chassis and record changers, has been announced by Walter L. Schott Co., Beverly Hills, Calif.

Tool can be used with light greases and solvents for cleaning and lubricating TV tuners and record changers. Hypodermic syringe-type construction allows release of the desired amount of lubricant. Long plastic tip is flexible and may be bent to any position for efficient lubrication.



\* \* \*

## IDEAL INDUSTRIES' WIRE STRIPPER

The *E-Z Wire Stripper*, formerly produced by the Pyramid Products Co., Chicago, is now being marketed by Ideal Industries, Inc., 4025 Park Avenue, Sycamore, Ill. Tool works like pliers and provides for removal of insulation from wire.

\* \* \*

## SERVICE PART SYSTEM BINS

Two service shop bins have been announced by Service Parts Systems, 4607 St. Aubin Street, Detroit.

One, model 700, is a wall unit with 100 separate compartments. All are tilted forward to meet the eye and are built on the *cash drawer* principle with rounded bottoms. Each compartment carries a bin tag holder for labels of part number, price, and specification.

Unit is 56" high, 44" wide, and 12" thick at the base.

Another, type 320, is an island unit with compartments on both sides of the stand. It provides 320 separate compartments in a unit 65" high, 44" wide, and 20" thick at the base.

All the compartments of both units lift from the rack for stock rotation and clearing. Shelves at the top and bottom of the wall unit provide extra space for storage of packaged stocks.

Both bins are built of 18 and 20 gauge steel and are painted in buff and maroon.



## PHILLIPS CABLE TACKER

A cable tacker, especially designed for those in radio, sound and juke box work, has been announced by the Phillips Manufacturing Co., Minneapolis, Minn.

Featuring concave center guides that center both small and large cables, the tacker is said to anchor cables without damage to insulation. Tacker handles staples in three different lengths:  $\frac{3}{8}$ ",  $\frac{1}{2}$ " and  $\frac{9}{16}$ ". Amount of pressure applied to the tacker governs the depth to which the staples are driven. The tacker will handle from single conductor cables up to 30-wire multi-conductor cables of half inch *od*.

The tacker itself is a Bostitch stapler fabricated by Phillips engineers to their own specifications.

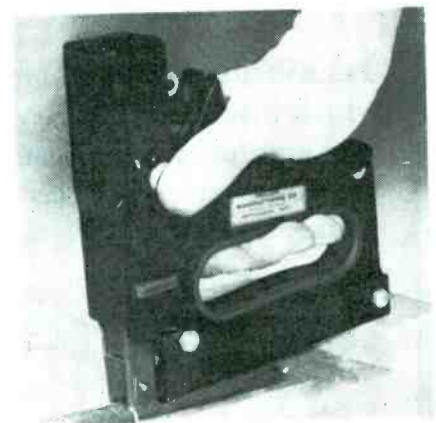

\* \* \*

## CLAROSTAT DUAL-CONCENTRIC ASSEMBLY WIRE-WOUND AND CARBON CONTROL

A combination wire-wound and carbon control has been announced by the Clarostat Mfg. Co., Inc., Dover, N. H. The front control in assembly is of the wire-wound type used for focusing circuits and other higher electrical value circuits. The rear control is the carbon control and may be had in practically any value for various circuit controls using this type. The concentric shafts are said to have been so designed as to facilitate independent control in either circuit.

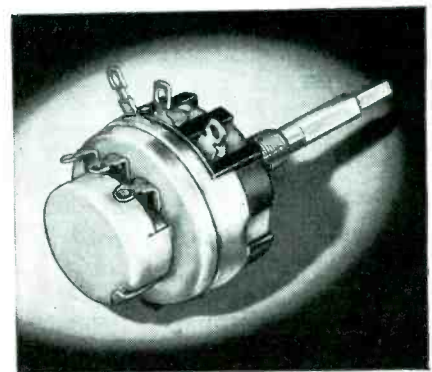

[Additional new product news on page 60]

... if you are commercially or professionally interested in TV, you must read

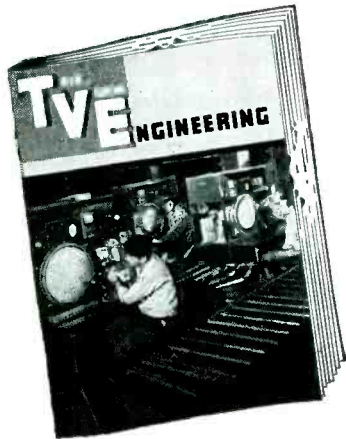

## TELEVISION ENGINEERING every month!

*Devoted exclusively to TV Research . . . Design . . . Production . . . Operation . . . Instrumentation*

**TELEVISION ENGINEERING** is the *only* trade publication which directs its *entire* editorial content to executives and engineers who design, manufacture, operate and maintain television receiving and transmitting equipment—both commercial and educational.

*Every issue is chock full of timely and thorough TV articles, authored by outstanding specialists. You'll find practical, carefully prepared reports and papers on such vital subjects as . . .*

*Color TV Systems . . . Ultrahigh Receiver-Transmitter Design Problems . . . Tube Production-Line Techniques . . . TV Broadcast Equipment . . . Camera Tube Research . . . Glass, Plastics and Metal in TV . . . TV Test Equipment in the Plant . . . Film Recording . . . Flying Spot Scanners . . . Tone Amplifiers for TV Films . . . Compact Motors for TV . . . TV Component Design . . . Mechanical Design Factors in Antennas . . . Quality Control Charting . . . Microwave Relays . . . Receiver and Transmitter Servicing . . . Production Aids . . . Instrument Activities . . . TV Sound Systems . . . Studio Lighting.*

**Enter your subscription NOW . . . Fill out the coupon below**  
*(Not sold on newsstands)*

**TeleVision Engineering**  
52 Vanderbilt Ave., New York 17, N. Y.

Here is my remittance for my subscription to **TeleVision Engineering** at the

**SPECIAL RATE . . . 3 years (36 issues) only \$5.**

*(1 year subscription \$3.)*

NAME .....

ADDRESS .....

CITY..... ZONE..... STATE.....

For our confidential records, open only to the Audit Bureau of Circulation, please supply the following information:

Occupation..... Title.....

Department in which employed

Operation

Production

Research

Employed by .....

Nature of Business.....

*(State if TV Manufacturer, TV Broadcast Station, etc.)*

## Flyback TV Systems

*(Continued from page 39)*

plate supply path for the 6BG6, will knock out its operation. Tube substitutions and voltage checks around the circuit should clarify the trouble.

While the most common indications of a defect in the high-voltage system are low brilliance or none, other indications of trouble in this circuit are intermittent black streaks across the screen, and possibly noise in the sound simultaneously. This can be caused by arcing; whether from a high-voltage point to  $B-$ , between high and low-potential points, or internally inside tubes, resistors or capacitors in high-voltage circuits. External arcing can be observed. The components usually subject to internal arcing are the high-voltage filter resistor and capacitor.

### Other HV Servicing Techniques

A few other techniques are useful in servicing high-voltage systems. A resistive or capacitive voltage divider has been found helpful. This can be set up with several resistors or capacitors in series. The divider can then be placed across the high-voltage  $B+$  or across the high-voltage  $ac$  input. Voltages can be measured or waveforms studied from a point on the divider close to ground, where the voltage is not very high. In this way, checks can be made for correct voltage, filtering action, proper waveforms, hash due to arcing, etc., even though the instruments cannot take the full voltage. Where the set has its own voltage divider across  $B+$ , the same principle holds true. The meter or scope can be placed on the first resistor from the ground end and the full voltage can be computed easily. As in any series circuit, the voltage across one resistor has the same relation to the total voltage as that resistor has to the total resistance.

High-voltage multiplier probes are available for *vtvm*'s, so that the full high voltage can be measured directly on most sets, if desired, when the spark method is not conclusive. There are also several meters now available that can measure high voltage directly when necessary.

As far as safety factors are concerned, most sets are designed so that shocks on accidental contact with high voltage  $B+$  will not be fatal to normally healthy persons. However, the usual reactions from shock can result in serious accidents and normal caution is suggested in servicing high-voltage systems.



## Dry Batteries

(Continued from page 16)

down together, but it's been found a good practice to *over A*; that is, put extra power in the *A* section to keep the oscillator tube oscillating and thus secure all the power out of the *B* section before the oscillator stops. This is very important to the users, who always want long life and noise-free reception.

### Battery Adjustments

Battery adjustments, handled correctly, can be fair, economical, and a source of good will. Poorly handled, they can backfire seriously. As a rule, adjustments run somewhat under 2%. Some adjustments must be expected, because no product or person is 100% perfect.

Batteries normally considered for adjustment, may have any or several of the following defects:

- (1) Died on shelf while in guarantee.
- (2) Seal making terminals inoperative.
- (3) Low voltage.
- (4) High resistance.
- (5) Poorly soldered connections.
- (6) Incorrectly wired.
- (7) Leakage prior to use.
- (8) Incorrectly shipped.
- (9) Defective terminals.
- (10) Open circuited.
- (11) Incorrectly designated.
- (12) Recorded short service life.
- (13) Internally short circuited.

Batteries cannot be considered for adjustment, include those that are:

- (1) Past shelf life guarantee.
- (2) Satisfactory.
- (3) Exhausted in normal service.
- (4) Partially exhausted but not defective.
- (5) Leaking subsequent to use.
- (6) Have been abused.
- (7) Have leads pulled out of seal.
- (8) Scuffed labels.
- (9) Modified after leaving factory.

When a defective battery that has given partial service is encountered and a partial adjustment is in order, the procedure to be followed is simple. Let us assume we have a farm pack to adjust. By checking voltage of the end positive cell in the *B* section, it is possible to determine how much of 100% service was given. In very, very rare instances, the end positive cell will be found to be the defective one that caused the battery's breakdown; about 1 in 50,000. (*End positive* is that cell in the *B* section whose positive (carbon) terminal is connected to the battery's outside positive 90-volt terminal

(Continued on page 46)

# Terrific FOR TELE-CIRCUITS!

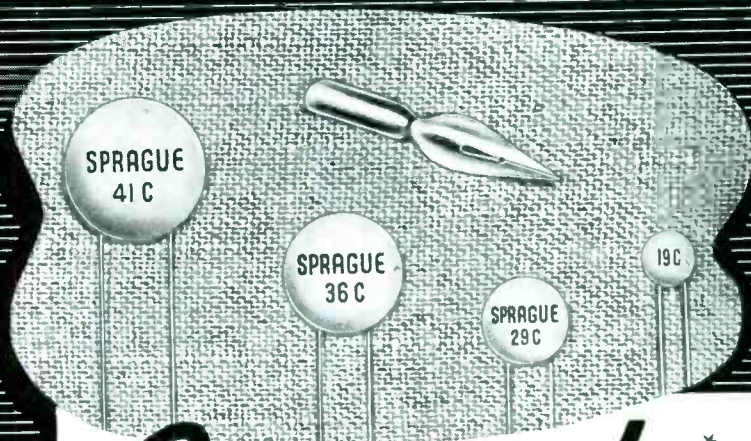

## Cera-mite<sup>\*</sup> CAPACITORS

### THE *First* COMPLETE DISC CERAMIC LINE

DEVELOPED especially for the television industry, Sprague Cera-mite Capacitors fill the bill for the alert service technician!

Temperature-compensating, general-purpose and high-k bypass types fit every type of circuit application. The low self-inductance feature of the flat plate design with uni-directional leads gives better high frequency performance than the older tubular ceramics which they replace. And they're ideal as mica capacitor replacements, too!

Tiny and dependable, every Cera-mite is rated at 1000 volts test, 500 wvdc, and for operation at 185°F. (85°C.).

Cera-mites are clearly stamped with capacitance—no confusing color coding.

Stock up on Cera-mites at your Sprague distributor without delay!

Write for Bulletin M-454A-61 today!

<sup>\*</sup> Trademark

# SPRAGUE<sup>®</sup>

SPRAGUE PRODUCTS COMPANY  
North Adams Massachusetts

PIONEERS

IN ELECTRIC AND ELECTRONIC DEVELOPMENT

# PHOTOFACT Users Write Our Best ADS!

Hundreds of unsolicited letters tell what the world's finest Radio & TV Data means to Service Technicians



A. Haraczak  
201 16th Street  
New Kensington  
Pennsylvania

"Thank you for making radio work easier for us . . . setting up a method for the radio industry with the new schematics and pictorials . . . doing equally as much for us in Television."



Zed Z. Smith  
P. O. Box 364  
Naples, Texas

"I would not try to work without PHOTOFACT Folders . . . hope they are put in the hands of many others for whom they will save as much time as they have for me."



Lonnie Mills  
238 S. La Brea  
Inglewood  
California

"I am another proud owner of PHOTOFACT. My gratitude to the Sams organization for all the success and enjoyment I have had in using PHOTOFACT Folders. Keep up the good work."

## NOW! GET THE PROOF FOR YOURSELF!

**FREE**

We'll Send You a FREE Photo-fact Folder on any postwar set

Learn for yourself—at our expense—how PHOTOFACT pays for itself by earning bigger repair profits for you! Ask for a FREE Folder covering any postwar AM, FM or TV receiver listed in the PHOTOFACT Cumulative Index. Examine it. Put it to work at your bench—then judge for yourself!

WRITE FOR FREE FOLDER TODAY!

**HOWARD W. SAMS & CO., INC.**  
2201 East 46th Street • Indianapolis 5, Indiana

## Dry Batteries

(Continued from page 45)

and whose negative wire is soldered to the next lower cell.) The end positive cell is a good indicator because only one side of it is inside the battery. All other cells except the end negative have both positive and negative inside. But, the end negative is not considered a good indicator because its positive side is subject to action by all cells above it in the series string.

To check the end positive, the battery should be opened and the B+ lead traced from outside terminal to the end cell. Any good voltmeter with a zero to 2.5 or 5-volt range can be used. The positive prod is placed on carbon of end positive cell, and pushed through the seal until it stops on top of the carbon cap of that cell. The negative prod is then placed on the carbon of the next lower cell or on the zinc can of the end positive cell itself. The reading on meter should then be noted.

The voltage reading of this end positive cell should be multiplied by 60, the number of cells, in this instance, in the B section. If the answer is more than the total test voltage you noted when you first tested the B section, you have a defective battery on your hands. For example, let us say that the end positive cell read 1.35 volts, with the total B section reading 42; thus,  $60 \times 1.35 = 73.7$  volts. From this we can allow a tolerance of + or - 2 volts.

### Voltages and Percentage of Life

A cell can be considered useful from its initial voltage of 1.50 down to 1.00 volt, or *cutoff*. At or near cutoff, the cell or battery often becomes noisy and its increased internal resistance causes distortion. When, therefore, a cell reaches 1.00 volt, or a B section reaches 60 volts, there is theoretically no more service life available. Thus, the useful life is  $\frac{1}{2}$  volt per cell.

The discharge curve is not linear; that is, voltage of  $\frac{1}{4}$  down from 1.50 does not mean the cell is  $\frac{1}{4}$  used nor does voltage halfway down (1.25) to cutoff mean the cell is  $\frac{1}{2}$  used.

Now, if we refer back to our example, we find that the battery delivered 40% of normal life up to the time of failure. We also see that the customer got only 40% of what he paid for. Therefore, the customer is entitled to a new battery, not free, but at a price of 40% of list price. In this way he gets what he pays for and you deliver what

## Presenting THE NEW

# Mueller NEEDLE CLIP



Actual Size

### PIERCES INSULATION TO MAKE QUICK CONTACT

Solid bronze, non-corroding. Wire centers itself in notched jaw. Teeth on sides of jaw allow use for many other applications.

#### — USED IN —

Electric and radio service shops  
Telephone and power company  
testing and maintenance  
Laboratory test work  
Hooking up truck trailer lights  
Field telephone and signal work

SEND FOR FREE SAMPLE AND CATALOG 810

**Mueller Electric Co.**  
1565 E. 31st St., Cleveland 14, Ohio

"HAVE YOU HEARD  
THE SOUND OF QUALITY?"



### NEWCOMB SOUND IS BETTER

Manufacturers of public address, mobile, phonograph, musical instrument and wired music amplifiers • Portable systems • Portable phonographs and radios • Transcription players • Rack and panel equipment.  
Write today! Circle items of interest and indicate whether you are a Dealer, Parts Jobber or Sound Specialist.

**NEWCOMB AUDIO PRODUCTS CO.**  
DEPT. E, 6824 LEXINGTON AVE.  
HOLLYWOOD 38, CALIFORNIA



you agreed to in so many service hours for so much money.

It is often more expedient and less expensive to repair a battery than to send it back for adjustment. Sometimes internal, or cell to cell soldered connections become open in transit. In such cases, the battery can be opened and the broken connection located. A hot soldering iron should be applied, holding the wire in place with a screwdriver or wooden lead pencil until the solder sets. There's usually enough solder present to make the connection with only a hot iron. Then the battery can be tested with a voltmeter and reassembled.

- 1.42 volts per cell indicates roughly 20% exhaustion.
- 1.35 volts per cell indicates roughly 40% exhaustion.
- 1.27 volts per cell indicates roughly 60% exhaustion.
- 1.20 volts per cell indicates roughly 80% exhaustion.
- 1.00 volt per cell indicates roughly 100% exhaustion.

Reference table of voltage versus exhaustion.

#### G. E. SERVICE SHOP EXHIBIT



Above: Shop setup, developed by the Tube Division of G. E., and exhibited at the NEDA show in Cleveland. On view were assortment of illuminated signs, window cards, decals, and product displays which can be used in a typical shop. Another feature of the exhibit were demonstrations of TV, AM and FM test equipment. Explaining the exhibit to visiting distributors at the show, at left, John T. Thompson, G. E. manager of replacement sales; center, George Wedemeyer of Electronics Supply Co., Ann Arbor, Mich., and at right, Hoyt Crabtree of Crabtree Wholesale Radio, Dallas, Texas. Below: Roland Kempton of the G. E. Tube Divisions, in the NEDA exhibit shop, demonstrating how defects in TV receivers can be spotted by using G. E. *Tele-Clues*, a pictorial feature of G. E.'s bi-monthly publication, *Techni-talk*. The *Tele-Clues* enable the technician to spot the defect in a receiver by observing the pattern on the picture tube. At left, John T. Thompson, and next to him, Arthur Stallman, newly elected NEDA president.



The little **SHURE** cartridges

that fill the Big need

for High Fidelity

Phonograph Reproduction . .



## THE NEW SHURE "VERTICAL DRIVE"

### CRYSTAL PICKUP CARTRIDGES

Big things often come in little packages . . . So it is with the superlative new Shure "Vertical Drive" Crystal Cartridges. They reproduce *all* the recorded music on the new fine-groove recordings—a reproduction that meets the strict requirements of high compliance and full fidelity. The "Vertical Drive" cartridges are requisite for the critical listener—the lover of fine music. They are especially recommended for those applications where *true fidelity* is essential.

#### SINGLE MODELS:

W 23 A for standard width-groove records.  
W 21 A for fine-groove records.

#### TURNOVER MODELS:

W 22 A and W 22 B for both standard and fine-groove recordings.

Unusually highly compliant, these "Vertical Drive" Cartridges will faithfully track standard records with a force of only 6 grams—micro-groove records with a force of only 5 grams (an added protection for treasured recordings). Will fit standard or special mountings. Have more than adequate output for the average audio stage.

See Your Shure Distributor for NEW Cartridge Replacement Guide with Handy Numerical Listing.

**SHURE**

**SHURE BROTHERS, INC.**

Microphones and Acoustic Devices

225 WEST HURON STREET, CHICAGO 10, ILL. • CABLE ADDRESS: SHUREMICRO

SERVICE, OCTOBER, 1950 • 47

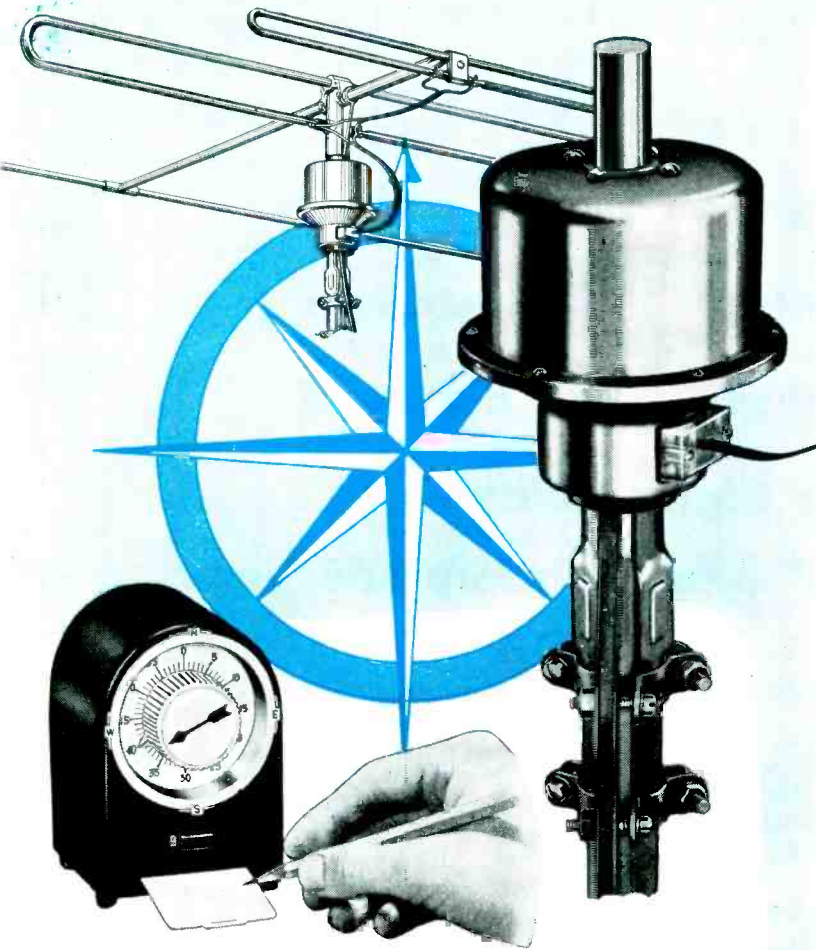

## "AUTO-DIAL" TV ANTENNA ROTATOR

With *Automatic* TRAVEL ACTION

AMPHENOL takes pride in announcing the new "Auto-Dial" TV Antenna Rotator. It features an entirely new and different principle of rotator control called "automatic travel action," and represents the greatest single advance in antenna rotators.

There are no tiresome buttons or switches to hold while the antenna is turning. An effortless turn of the knob to the correct setting and "Auto-Dial" takes over. Automatically—just like magic—the antenna follows to point directly at the TV station—then stops!

So accurately does it perform that even a child can "log" antenna positions, accurately returning to them time after time. Rotation is in steps of 6 degrees, accurately calibrated on the indicator. Because of this important feature, servicemen can now determine whether an antenna is functioning properly, whether it has the required front-to-back ratio and whether it is properly located for the best possible picture.

### FEATURES

- Completely Automatic—no tiresome buttons or switches to hold while antenna turns!
- Antenna Rotates Rapidly—one revolution every 22 seconds!
- Heavy-Duty Motor, Sturdy Construction—easily handles stacked arrays!
- Housing of cold-rolled steel, copper flashed and with attractive baked-on enamel finish!
- Neoprene Sealed at Factory Against Dirt and Moisture!
- Accommodates Mast Sizes from 3/4" to 2" Diameter!

See It At Your Jobber Or Write For Illustrated Folder  
Another AMPHENOL Development For Your Greater TV Enjoyment

# AMPHENOL

AMERICAN PHENOLIC CORPORATION  
1830 SO. 54TH AVENUE • CHICAGO 50, ILLINOIS

## SER-CUITS

(Continued from page 24)

tube grid to reset the background level. This *dc* value is lost from the signal in passing through an *ac*-coupled amplifier.

The video signal at the output of the second video amplifier finds a level which is an average of the *ac* component of the signal.

By rectifying a portion of the video and sync component, it is possible to reinsert the *dc* level into the picture information at the picture-tube grid, by the amount of the rectified voltage between the negative tip of sync and the *ac* zero axis of the composite signal. The negative sync pulse applied to the *dc* restorer through the cathode capacitor is rectified, thus charging the capacitor by an amount equal to the difference between the picture background and sync tip.

After the sync pulse, the capacitor maintains this *dc* level. The *ac* video content of the picture fluctuates above and below this level to produce the light and dark picture elements. Each successive sync pulse resets this *dc* level on the capacitor, so that the picture-tube grid always maintains the same definite voltage relation to the sync tip for a given brightness of background. An additional adjustment is provided in the brightness control which allows some control over the picture-tube grid bias to brighten or darken the background as the viewer may desire.

In the 12½-inch chassis, the *ac* signal is applied to the picture-tube grid through a .047-mfd capacitor ( $C_{192}$ ) and a 820,000-ohm resistor ( $R_{121}$ ), and the *dc* component is developed across a .1-mfd capacitor ( $C_{138}$ ) by current flowing during tips of sync. The time constant of the .1-mfd capacitor and 390,000-ohm resistor ( $R_{138}$ ) were so chosen that the capacitor will maintain most of its charge over one line. The capacitor is recharged by the succeeding sync pulse,

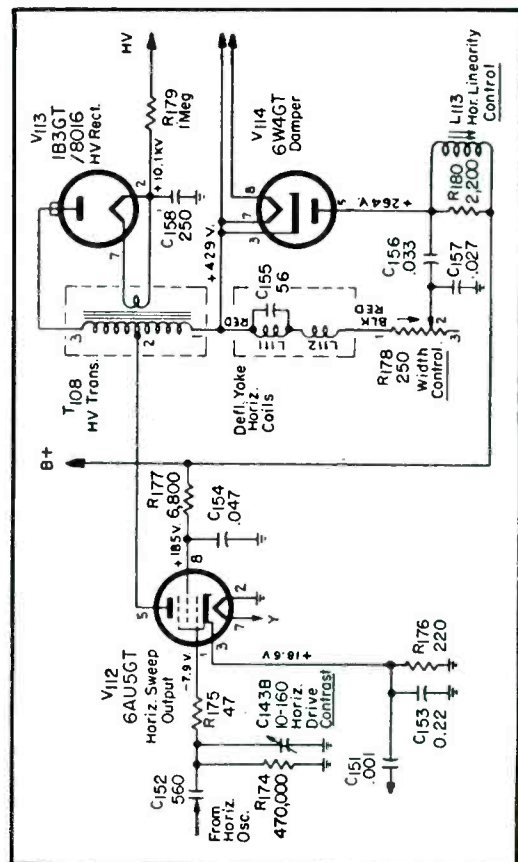

Fig. 5. Horizontal output circuit of the RCA TV chassis.



to maintain the background at its proper point with reference to the sync and background information supplied.

Except for a slight difference in the way in which the *dc* restorer is coupled to the video output circuit, the 16 and 19-inch receivers are similar to the 12½-inch receivers in the video output, picture-tube input and *dc* restoration circuits.

The receiver is held in sync by the oscillator control tube in the following manner: The oscillator control tube is cathode biased almost to cutoff so that plate current flows only during the positive peak of the waveform applied to the grid of the control tube. The waveform applied to the control grid is a complex wave consisting of the incoming sync pulse which is derived from the sync separator stage, and a portion of the sawtooth generated by the horizontal blocking oscillator. Depending upon the phasing of the sync signal and the oscillator sawtooth, more or less conduction will take place in the oscillator control tube, which will vary the amount of charge which a pair of capacitors (.022 and .47-mfd; C<sub>147</sub> and C<sub>148</sub>) will attain. This voltage is applied to the grid of the blocking oscillator through 82,000 and 170-ohm resistors, R<sub>166</sub> and R<sub>170</sub>.

The capacitors, in series with a 3900-ohm resistor, R<sub>168</sub>, also filter the control voltage applied to the blocking oscillator. In series with the plate supply is the familiar tuned circuit which provides for stabilization of the blocking oscillator. The purpose of this network is to sharpen the approach of the grid as it recovers from cutoff, and thus stabilize the circuit.

#### Horizontal Sweep Output

The signal from the horizontal sweep oscillator is then fed to the horizontal sweep output. The output of the horizontal sweep oscillator is fed across a capacity divider (560 and 10-160 mmfd; C<sub>120</sub> and C<sub>148B</sub>) and by means of adjusting the 10 to 160-mmfd horizontal-drive control the amount of conduction of the horizontal sweep output can be set, thus varying the drive. The horizontal sweep output is similar to that encountered in previous models, with the output being of the direct drive type, and a pulse of kickback energy being fed to the high voltage rectifier, thereby supplying the necessary high voltage.

The horizontal sweep output in the 12½-inch models, is slightly different from that encountered in the 16 and 19-inch models, in that a 6AU5 is used as the horizontal sweep output, rather than a 6BG6.



The PROFIT-WISE  
Serviceman Specifies . . .

### New STANCOR PRODUCTS



8400  
POWER  
SERIES

A comprehensive line of 35 part numbers designed for replacement and new construction. Wide range of applications based on a thorough study of today's power transformer needs. Most ratings available in a choice of vertical or horizontal mountings.



OUTDOOR LINE  
TO VOICE  
COIL

Two new units designed to fit most needed outdoor applications. Primary impedances of 3,000/2,000/1,500/1,000/500 ohms; secondary impedances of 16/8/4 ohms. Part Number A-3333 rated at 14 watts. A-3334 rated at 25 watts.

## STANCOR TRANSFORMERS

Using Stancor replacement transformers for your radio, TV and sound service jobs is the sure way to fatten your bank account. Here's why —

- Quality comes first with Stancor. Ability to "take it" cuts down call-backs—keeps your customers happy with a good job.
- Stancor has the largest line in the industry. A choice of 450 part numbers, in some 30 mounting and terminal styles, enables you to get exactly the right unit for almost any application.
- Easy-to-read instruction sheets and clearly marked terminals make your job quicker and easier. Saves valuable shop time.

New Stancor units are coming out all the time. Keep posted. Ask your Stancor distributor for our latest catalogs.



Most Complete Line in the Industry

STANDARD TRANSFORMER CORPORATION 3588 ELSTON AVE., CHICAGO 18, ILL.

#### SYLVANIA PICTURE-TUBE BOOKLET

A 12-page booklet, in which characteristics of 194 cathode-ray tubes for TV receivers, scope and radar applications are tabulated, has been published by Sylvania Electric Products, Inc.

The *crt* described include 103 designed for magnetic deflection and 91 electrostatic types with screen sizes ranging from two to twenty-two inches.

The publication, 8½" x 11", also includes table of phosphor characteristics, fifty basing diagrams and suggestions for the physical handling and high voltage circuit adjustment practice. Copies may be obtained on request from the advertising department, Sylvania Electric Products Inc., Emporium, Pennsylvania.

#### SPRAGUE SERVICE WALL CHART

A revised edition of the *Tell-U-How* wall chart for Service Men is now available from distributors of Sprague capacitors.

The chart, 22" x 28", includes service application data on capacitors, as well as descriptions of common circuit troubles and their remedies; complete color codes on all types of capacitors; transformer color codes; resistor color codes; electrical formulas, and other useful and related service information.

Chart, Sprague form M-453, may be obtained free from all Sprague distributors or by writing the Sprague Products Co., North Adams, Mass., enclosing 10 cents to cover postage and handling costs.

# TRAP INTERFERENCE

## Effectively

### with DON GOOD TRAPS

TELEPASS\*—TELETRAPS\* (FM & DIA.)  
... T.V.I. TRAPS



**DON GOOD TRAPS**, known as "DARN GOOD TRAPS," do their job—they do eliminate unwanted interference. That's why they're so well liked—and used.

**POPULARLY PRICED—ALL AT \$3.95 LIST**  
... ALL NEW ITEMS

**New DON GOOD TELEPASS\***. Here's a TV HIGH PASS FILTER that eliminates or greatly reduces interference which may be picked up by I. F. Amplifier or TV Receiver and interference which may arise from strong, local low-frequency fields radiated from Amateur Radio Stations, Diathermy and X-Ray Equipment, Industrial Induction Heaters, Appliances, Neon Signs, etc. . . . Pre-tuned at factory—no adjustments required. Easily installed at receiver antenna terminal. In compact, low-loss Polystyrene case—2 3/4" x 1 1/4" x 4 1/2". . . NO. 300—for 300 Ohm Line. . . NO. 72—for 72 Ohm Line.

**LIST PRICE—either—\$3.95.**

**DON GOOD VARIABLE TELETRAPS\***

**NO. R-301 FM—88 MC to 110 MC.** This effectively eliminates interference from F. M. Stations operating within its tuning range.

**NO. R-302—DA—26 MC to 32 MC.** This effectively eliminates interference from DIATHERMY and AMATEUR SIGNALS within its tuning range.

**EITHER TELETRAP\* ABOVE—LIST PRICE: \$3.95.** For quick, simple installation at TV receiver antenna terminals.

**New DON GOOD VARIABLE T.V.I. TRAPS\***  
**NO. T-301 LB—LOW BAND.** Reduces or effectively eliminates harmonic interference on TELEVISION CHANNELS—2 through 6—within its tuning range—50 MC to 90 MC.

**New T-302 HB—HIGH BAND.** Reduces or effectively eliminates harmonic interference on TELEVISION CHANNELS—7 through 13—within its tuning range—170 MC to 220 MC.

**EITHER T.V.I. TRAP\* ABOVE—LIST PRICE: \$3.95.** . . . For tunable, quick, easy installation on antenna feedlines of AMATEUR TRANSMITTERS.

**New DON GOOD ADJACENT CHANNEL TELETRAPS\***

These effectively trap adjacent channel signals with respect to any desired channel. **NO. R-103—LB—LOW BAND.** Tunable to trap any single channel—2 through 6. . . . **NO. R-104—HB—HIGH BAND.** Tunable to trap any single channel—7 through 13. . . . Easily installed on TV receiver antenna terminals. . . .

**LIST PRICE—\$3.95**

**NOTE: All above TELETRAPS\* and T.V.I. TRAPS\* are tunable and are enclosed in a round, compact, low-loss Polystyrene case: 3 3/4" diameter x 1 1/2" thick.**

\*PATENT PENDING

\*TRADE MARK

**ASK YOUR JOBBER OR WRITE.**

*Don Good, INC.*

**ALSO MANUFACTURERS OF  
GOODLINE AIRLEAD\***

1014 Fair Oaks Ave., South Pasadena, Cal.  
Phone: SYcamore 9-1194

## Auto Radio Tuners

(Continued from page 19)

normally present, should be removed. This can be done without taking the whole tuner mechanism out. A rough sketch of the coil connections should be made, the leads unsoldered, the tuner run to the high end (where the cores are as far out of the coils as possible), and finally the core unscrewed until it clears the coil-form. The coil may then be gently worked loose from the cement and removed. It is important to be very careful when pulling the coil loose, as the walls of the form are very thin and may be crushed if too much pressure is exerted.

If the coil is entirely open, and no replacement is at hand, it may be rewound. Normally, the coils are small, consisting of not too many turns. Of course, the wire must be an exact duplicate of the original, and there must be the same number of turns. In other words, you should rewind only if an exact duplicate of the original can be made. The whole coil should be coated with *Q-dope*, making sure that none of the coating finds its way inside the form.

Broken cores may be replaced in the same fashion. The tuner must be run until the cores are out as far as possible and then the broken core can be unscrewed. The replacement should be an exact duplicate of the original. Then the set can be realigned. Alignment instructions in service manuals provide the proper distance for core setting. This can be at 1600 kc, or wherever the high end of the band is, on the particular receiver being serviced.

The old familiar *electric-pushbutton* type of tuning, featured in household chassis for several years, is still being used in some auto models. Basically,

## THE SIMPLEST WAY To Center TV Pictures

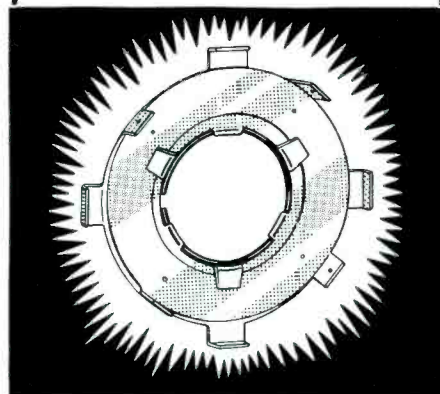

## —Install a BeamaJuster!

No mechanical or electrical centering devices are needed when the picture is centered with a Perfection BeamaJuster. You can center the picture in 3 seconds (not 20 to 30 minutes).

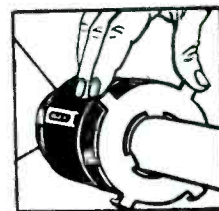

1. Snap the BeamaJuster on back cover of tube yoke. (Fits any standard yoke and any size tube.)
2. Rotate for approximate centering of picture.
3. Slide outer plate vertically or horizontally for final adjustment.

Ask your supplier for BeamaJusters today!

**PERFECTION ELECTRIC COMPANY**  
2641 S. WABASH AVE., CHICAGO 18, ILL.

Makers of Perfection  
Alnico 5 Speakers  
and Ion Traps



## HOW LONG WILL A CONDENSER LAST?

Frankly we don't know. Not because ours never go "west"—they occasionally do—but rather because the life of a condenser depends so much upon the type of service in which it is used, the quality of its associated components, whether it is being used conservatively or made to operate at maximum load, and things like that.

We have been making electrolytic capacitors for 16 years—literally millions of condensers have left ILLINOIS CONDENSER's modern plant to go into electronic applications of all types. Every one of these condensers has one common characteristic—DEPENDABILITY.

This is the result of top-flight engineering, skilled, careful workmanship and the earnest desire on our part to make the finest, most reliable capacitors to be found.

Every capacitor made by ILLINOIS CONDENSER COMPANY is Unconditionally Guaranteed For One Full Year From Date Of Purchase.

There is a Guaranteed ILLINOIS CONDENSER for practically every electronic application. Write for new expanded catalog.



**ILLINOIS CONDENSER CO.**  
1616 NORTH THROOP STREET • CHICAGO 22, ILL.





in these setups each pushbutton is a switch, which disconnects the adjustable tuning mechanism from the circuit, and replaces it with a fixed capacitor and coil combination, for the oscillator and *rf* or antenna stages. These, of course, are actually not fixed, but adjustable, so that they may be tuned to the desired stations. Some sets use fixed coils and tune both by trimmers; in some chassis the oscillator is tuned with a slug-tuned coil, and the antenna by a trimmer.

Some models use a row of pushbutton switches for this type of tuner, while others used a rotary switch. In the '39-'49 Ford sets, this switch was rotated by hand, one set of contacts serving to connect the gang capacitor in the circuit, for manual tuning. In some other receivers (Philco AR-5, AR-55-75) the same type of rotary switch was driven by a flexible shaft, from the control head. In still others, the switch was driven by a small electric *ratchet-motor* to the desired position. This motor performs like the selector-system used in the turret-tuners. When contact is made by the pushbutton switch, the motor runs until it reaches a break in the switch contact.

Adjustment of the motors and cleaning of the switch points are the major service problems in these systems. The switches must be watched closely for bad points, bent contacts, etc. Here, as in the other systems, it will be found wise to underlubricate, than over-lubricate.

If the tuning motor runs continuously and will not stop, the switch should be checked for shorts. If that check doesn't help, then the wiring should be probed. Multi-conductor plugs, used in this type of equipment, often will short out on the back side of the plug, where the wires are soldered to the contacts. The cables should be searched for breaks, cuts, and shorts, especially close to the plug, where the greatest flexing and strain is encountered. When reinstalling, you should be sure that the plugs are firmly seated, and the shells grounded. Otherwise, they will tend to pick up ignition noise, and feed it into the set.

Most of these tuners may be installed on the front of the set. In other words, the owner may set or reset stations himself, at any time. In the GM models (United Motors), the pushbuttons can be set up by moving the pushbutton a little to the right or left, and then pulling it off to expose the adjusting screws. On some Pontiac sets, the pushbuttons must be pulled to one side. Then the station can be tuned in manually, after which the button is pushed in all the way

# Beyond Compare-The Antenna that created New Horizons in Television Reception



## Telrex de luxe

# CONICAL-V-BEAMS

REGISTERED TRADE MARK

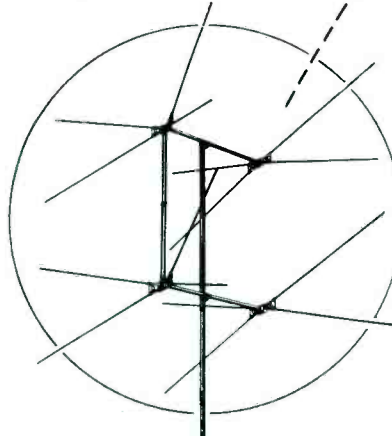

NEW! DOWELLED DURAL ELEMENTS  
ADD STRENGTH AND DAMPEN VIBRATION — EXTRA-HEAVY DUTY CONSTRUCTION THROUGHOUT

THE FINEST TELEVISION ANTENNA EVER MADE!

Manufactured by Telrex and selected Telrex licensees under Pat. No. 2518297

The original Conical-V-Beam that reached beyond the accepted limits of usable reception and produced satisfactory pictures in areas where reception was considered impossible. For maximum TV profits install the antenna that increases your selling area by producing excellent pictures where others fail. Telrex De Luxe is your one best bet for every TV installation near or far. It outperforms, outsells any other antenna at any price! For complete information, contact your local Telrex distributor or write direct for details and new catalog.

For best reception, insist on the genuine! Look for the Telrex trademark. It's your assurance of reliable factory ratings and long lasting, weather-durable construction.



CONICAL-V-BEAMS



AMERICA'S STANDARD OF COMPARISON

ASBURY PARK 4, N. J.

THE SKILL TO DESIGN  
THE FACILITIES TO PRODUCE  
THE ABILITY TO DELIVER

in and released. To relock, it is pushed back to the opposite side.

Cars, with automatic tuning, operating in very dusty country, such as a rural mail route, require special attention. For instance, it may be necessary to seal most of the upper ventilating holes in the cabinet to prevent excessive dust and dirt collection. This is quite a problem on the older cars, with cowling ventilators, which served admirably to gather up the dust and throw it directly into the radio! The holes can be covered with Scotch or surgical tape. Only the holes on the

bottom and a few on the sides need be left open for ventilation. It's better to let the equipment get a bit too warm than have to clean up every few weeks.

For cleaning and lubricating, it will be necessary to have a kit of a fair-sized bottle of carbon-tetrachloride, a can of lighter-fluid, a can of light or penetrating oil, a tube of *Lubriplate*, *Walsco Gear-Lub* or similar compound, and for the hard cases, a small tube of *Dow-Corning DC-4*. The latter is a light grease, which has a silicone base, and will not harden,  
(Continued on page 52)



**gives you Laboratory Precision at  
Lowest Cost!**



**...with a complete line**

Over 50,000 servicemen have bought one or more EICO Kits and Instruments. That's the proof of EICO's leadership in value to the serviceman!

For latest precision engineering, finest components, smart professional appearance, lifetime performance and rock-bottom economy—see and compare the EICO line at your jobber's today before you buy any higher-priced equipment! You'll agree, with over 50,000 others, that only EICO Kits and Instruments—no other—give you the industry's greatest values for the industry's lowest costs!

Read the full story on the complete EICO line. Write today for your free latest Catalog S.



**VACUUM TUBE VOLTMETER**  
Model 221-K, Kit, only \$23.95  
Model 221, factory wired, \$45.95

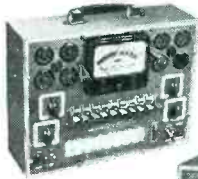

**TUBE TESTER**  
Model 625-K, Kit, only \$29.95  
Model 625, factory wired, \$44.95



**SIGNAL GENERATOR**  
Model 320-K, Kit, only \$19.95  
Model 320, factory wired, \$29.95



**SIGNAL TRACER**  
Model 145-K, Kit, only \$18.95  
Model 145, factory wired, \$28.95



**5 PUSH-PULL OSCILLOSCOPE**  
Model 425-K, Kit, only \$39.95  
Model 425, factory wired, \$69.95



**DELUXE SIGNAL GENERATOR**  
Model 315-K, Kit, only \$39.95  
Model 315, factory wired, \$59.95



**HIGH VOLTAGE PROBE**  
Model HVP-1, wired, only \$6.95



**BATTERY ELIMINATOR & CHARGER**  
Model 1040-K, Kit, only \$22.95  
Model 1040, factory wired, \$29.95  
Prices 5% higher on West Coast



**VOLT-OHM-MILLIAMMETER**  
Model 511-K, Kit, only \$14.95  
Model 511, factory wired, \$17.95

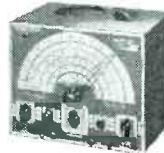

**SWEEP GENERATOR**  
Model 360-K, Kit, only \$20.95  
Model 360, factory wired, \$29.95

**C-5 5 MC Crystal, \$3.95**



**RF PROBE**  
Model P-75K, Kit, for VTVM,  
P-76K for Scope, ea. \$3.75  
Model P-75 or P-76, factory wired, ea. \$7.50

**ELECTRONIC INSTRUMENT CO., Inc.**  
276 NEWPORT STREET, BROOKLYN 12, N. Y.

## Auto Radio Tuners

(Continued from page 51)

evaporate or wash off even under extremely bad conditions.

For cleaning tools, you can use a couple of packages of pipe cleaners, a small water-color brush, some old toothbrushes, and a few round toothpicks. The latter will be mighty handy in picking out hardened bits of grease, etc.

Occasionally you'll find sets with pushbuttons or escutcheon plates, made out of plastic, which have swelled until the buttons jam or drag. The offending button should be pulled off and the hole trimmed carefully with a sharp knife until the button is freed.

Summing up, while automatic tuners do appear quite complicated, a careful study of their operating principles will reveal that they are fairly simple. In servicing, extreme pains should be taken to make sure that the parts are actually operating as they should, and they are clean and properly adjusted. If this is done, the mechanism will operate as its designer intended it to, and as it did when the set was new. If it worked then, you can make it work now!

## TVI

(Continued from page 32)

filters can be installed with boosters, as shown in Fig. 4. The filter should be installed ahead of the booster amplifier input to prevent the interference from over-loading the booster. Sometimes, under conditions of strong interference it may be necessary to install two filters; one at the input to the booster and a second at the output of the booster. Most boosters are actually high-pass filters and seriously attenuate if interference signals.

The high-pass filter will not, of course, eliminate interference from the harmonics of diathermy equipment radiating on the TV channel frequencies. This type of interference must be suppressed at the source. Lining

Fig. 4. Installing a high-pass filter to attenuate if interference signals.





# 2-way Protection... only with this new

## RMS all-weather Arrestor



**TAKES REGULAR OR  
JUMBO TWIN LEAD  
UL APPROVED FOR  
INDOOR-OUTDOOR USE**

LIST PRICE **\$1.75**  
See your jobber



**RADIO MERCHANDISE SALES INC. 1165 SOUTHERN BLVD.  
NEW YORK 59, NEW YORK**

Because of the double protection features of neon gas discharge and air gap, you can be dead sure of the new RMS LA-2 Lightning Arrestor. In its positive protection against lightning and static, infinite resistance is maintained before and immediately after discharge — input impedance is constant. It's waterproof and no wire stripping is necessary . . . mounting to walls, sills, and masts is quick. Here is protection at the lowest possible cost!



the inside of the diathermy cabinet with simple tinfoil will provide a considerable reduction in radiation from the diathermy oscillator. In some instances, lining the diathermy cabinet with tinfoil affects the operation of the diathermy oscillator, which in many cases can be readjusted. Moving the tinfoil over near the tank coils is often all that is necessary to restore the diathermy equipment to its operating frequencies.

Another method of filtering interference in the diathermy and amateur band is illustrated in Fig. 6; the application of a tunable stub. This tunable stub can be adjusted to trap out interfering signals in the 26 to 32-mc band.

#### Electromedical and Industrial Apparatus TVI

The installation of traps, of the absorption type (designed to absorb *if* frequencies), the high-pass type and the tunable stubs, can all successfully attenuate this type of interference (26.96 to 27.28 mc). There are times, however, when this interference is so strong that it enters the *if* circuits in the TV receiver by direct induction. Under these conditions lining the back and top of the TV receiver cabinet with tinfoil (providing clearance for ventilation holes) and installing a tinfoil bottom plate provides an additive solution to the problem.

Harmonic radiation from the FCC approved type of electromedical and industrial equipment has never proved to be an actual problem.

#### TVI from Ignition Systems, Power Lines, Etc.

In an investigation, to determine what, if any, interference with television reception could be traced to power lines, it was found that power lines caused little or no interference under normal operating conditions, even with the TV antenna only 20 to 30 feet from the lines.

The principal cause of TV interference, it was found, were automobile ignition systems, followed by old-type diathermy equipment, old-type tungsten

\*Electric Auto-Lite.

Fig. 5. Recently developed high-pass filter designed to match 300-ohm input and output impedances.



new

Permoflux

ROYAL EIGHT™

compares with  
any 12" speaker!

This averaged laboratory response curve of the Permoflux 8T8-1 proves that it compares with the finest speakers regardless of size or price.

**It's Your "Springboard" to Extra Sales with Customers who want 12" performance but don't want to pay a 40% higher price.**

From the resonant boom of jungle drums to the light warble of the flute, this new 8" speaker reproduces sound with superior sensitivity and fidelity. The tonal qualities of this magnificent speaker can only add to the excellence of any audio equipment.

Special processing provides extra-strong cone; allows cone to be soft-suspended from basket and held at coil-end by extra-large spider. Permits more faithful reproduction at lower frequencies. Deeper, curvilinear cone greatly extends high-frequency response.

Permoflux Royal Eight™ (Model 8T8-1) is ruggedly-built, and simple to install. Provides big speaker performance in a small frame—uses smaller, more economical baffle. List Price \$15.00.

Send for Catalog No. J201—Dept. SE

PERMOFLUX CORPORATION  
4900 W. GRAND AVE., CHICAGO 39, ILL. • 236 S. VERDUGO RD., GLENDALE 5, CALIF.

filament lamps and other less common electrical equipment.

Old models of some automobiles were found to be particularly bad offenders causing pictures which had broken, horizontal lines of irregular pattern.

While ordinary distributor-type suppressors materially reduce the interference, resistor-type spark plugs\* have been found to eliminate practically all TVI and simultaneously improve gasoline-engine performance, especially in smoother idling in high-compression motors.

The resistor plug is a specially-

designed heavy duty type spark plug with a 10,000-ohm resistor built in to the insulator. The resistor eliminates that part of the spark discharge which causes interference and most of that part of the spark discharge which causes heavy electrode erosion. It does not affect that characteristic of the spark which ignites the mixture. A resistor at the spark plug will eliminate the unwanted portion of the spark without affecting the useful part.

The resistor used in the resistor plug is not an organically-bonded carbon resistor. That is, it is not a mix-

*(Continued on page 54)*

- ✓ Bayonet type fitting provides rigid, rapid assembly.
- ✓ High quality corrosion resistant aluminum.
- ✓ High frequency type steatite for superior electrical connection.
- ✓ Circular design — rugged construction — no loose ends.

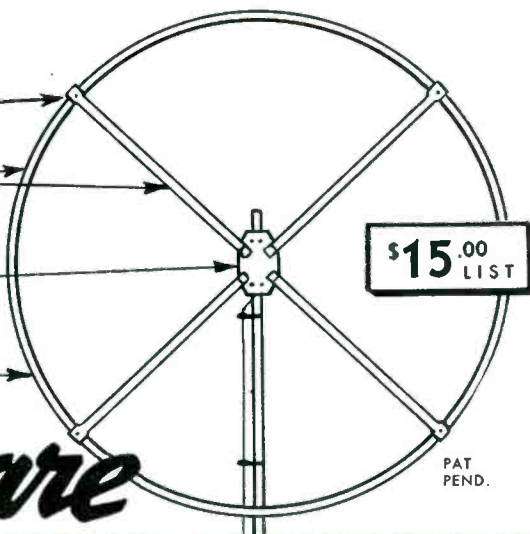

# Compare

## CIRCLE-X TO ANY OTHER TV ANTENNA

- One type antenna for all jobs.
- One wire lead-in.
- Clear, sharp pictures on all channels.
- Eliminates ghosts.
- Weighs only 1 1/2 lbs.

The mechanical and electrical construction of Circle-X is unsurpassed. No other antenna combines all the features that are engineered into the Circle-X. It is perfectly matched to 72, 150 and 300 ohm receiver input circuits.



DEALERS: Air Express or Parcel Post Special Delivery direct from factory to you through your jobber, if he cannot supply you with the Circle-X from his stock.

CIRCLE-X ANTENNA CORP.  
503 MARKET ST., PERTH AMBOY, N. J.

# 8 Ways Better

## Polyken®

### No. 163 ELECTRICAL TAPE

First improvement in 70 years over sticky, old-fashioned friction tape... and costs less than most! Eight outstanding advantages include quicker, firmer "stick," greater dielectric strength, less bulk, no fraying, easier unwinding. And it's much cleaner. Doesn't pick up dirt or soil hands. See your dealer today!

3 Convenient Packs AVAILABLE NOW from Your Electrical Dealer

60-ft.

82 1/2-ft.

Job Pack  
Ten 60-ft.  
Rolls

Polyken®

DEPARTMENT OF  
**BAUER & BLACK**

DIVISION OF THE KENDALL COMPANY  
**222 W. ADAMS ST., CHICAGO 6**

INDUSTRIAL TAPE

## TVI

(Continued from page 52)

ture of carbon and a shellac or lacquer. It is an inorganically-bonded resistor and the carbon present is chemically combined with a ceramic bond. No carbon as such is present. To make it stable and retain its ohmic value, the resistor is impregnated with a silicone.

### TVI from TV Receiver Video Circuits

TV receiver video circuits must reproduce currents varying from 60 cps to 4.5 mc. In the frequency range of 60 cycles to 4.5 mc, we have the broadcast band which is .54 to 1.5 mc. It is therefore obvious that if the TV receiver video circuits or components were to radiate, they would induce interference signals into broadcast receivers in the neighboring area.

This video interference manifests itself in two ways:

(A) Background noise of variable signal strength which rides along behind broadcast stations. When the broadcast signals are weak, this background interference may be severe enough to mask the station program.

(B) Beeps of variable intensity which ride all over the broadcast band. These beeps are a result of the video signals beating with the steady broadcast station frequencies.

When making custom installations, care should be taken in shielding the video cable which connects the video amplifier output to the picture tube. Failure to shield this cable can result in high level induction fields which can radiate interference in a mile radius.

### TVI from TV Receiver Sweep Circuits

The TV receiver sweep circuits have saw-tooth wave forms which are rich in harmonics. The horizontal sweep frequency of 15,750-cps harmonics produce beeps in the broadcast band when they beat with the broadcast station carriers.

The old type large picture tubes with their large sweep yokes have been the worst offenders. In some dealer establishments where the AM broadcast signals are weak, the beeps from the TV receivers make AM reception impossible on loop-operated receivers.

In addition to shielding, serious consideration must be given to locating the TV receiver, as far as possible from the AM receiver picking up the interference. A shielded external AM antenna will raise the AM signal to beep



ratio, so that the *beeps* will be lost in the background.

Radiation from the sweep circuits which couple into the antenna circuits and reradiate from the TV receiving antenna, can be reduced considerably by the installation of high-pass filters at the antenna terminals of the TV receiver. The high-pass filter works in both directions and therefore will stop the harmonics of the 15.75 kc oscillator from climbing into the transmission line and broadcasting *birdie* type beats which appear every 15.75 kc on the broadcast receiver.

Generally it may be said that the TV industry, as a whole, has been working diligently on TVI problems and next year's report should disclose substantial progress on all fronts.



Fig. 6. Adjusting tunable stub to eliminate *if* interference in the 26 to 32-mc band.

## Servicing Helps

(Continued from page 35)

develop the *if* response curve on the scope, and an unmodulated signal generator (marker) is used to provide spot-frequency indications on the curve.

With some of the *if* transformers, peaks may be obtained at two positions of the adjustment slugs. If a transformer is badly out of adjustment, it is advisable to turn the slug out (counterclockwise) as far as possible before beginning alignment. Then the slug should be turned clockwise until the first peak is reached. This procedure is recommended to obtain the correct peak, rather than an undesired second peak which is sometimes obtained when the slug is turned farther clockwise.

In the common *if* alignment step, the sweep generator should be coupled to the 6J6 mixer-oscillator tube, using coupling device shown in Fig. 2; p. 35. This system has been found to provide adequate signal injection and at the same time provide shielding which prevents radiation of the signal. The device can be constructed by flaring a piece of tubular copper braid over the top of the 6J6 and wrapping gummed tape over the braid to serve as insula-

# Follow-Through

## AN IMPORTANT TUNG-SOL CHARACTERISTIC



The sweep of a pitcher's arm after the ball is released — the arc of a golf club after the impact — that's the follow-through that makes for winning games and low scores. TUNG-SOL follow-through is equally important to you in making the most of radio and TV service opportunities in your neighborhood. TUNG-SOL follow-through is merchandising help.

Strong selling punch and quality mark all of TUNG-SOL's sales promotion material. Stationery, direct mail campaigns, displays, window valances, tool kits, shop coats, calendars, etc. — all are skillfully designed by nationally known merchandising experts to promote you — to build your business. Your name — your service gets top billing everytime on TUNG-SOL promotion material.

It costs no more to use the finest sales helps available. Some promotion items are free. Others are available to you at only a fraction of their cost. For example, the popular TUNG-SOL calendar with your imprint is the most economical calendar buy in the country.

If you are not aware of the sales helps to which you are entitled as a TUNG-SOL dealer, we suggest that you ask your TUNG-SOL distributor right away.

TUNG-SOL LAMP WORKS INC., Newark 4, N. J. Sales Offices: Atlanta, Chicago, Dallas, Denver, Detroit, Los Angeles, Newark.

## TUNG-SOL SALES-AIDS FOR SUCCESSFUL SELLING



tion. The tube shield is then replaced over the tube with the braid protruding through the hole in the top of the shield. The braid must not contact the chassis nor the tube shield at any point. The tube shield should be locked securely to its mounting base. The high side of the sweep-generator output cable should then be connected to the copper braid, and the ground side connected to the nearest point on the chassis.

### Westinghouse Schematic Correction

The 4.5-mc sound take-off point and

the input circuit to the first sound *if* amplifier were incorrectly shown on the schematic diagram in the original Westinghouse service notes. The 4.7-mmfd capacitor ( $C_{200}$ ) should be deleted from between pin 7 of the 6AL5 video detector and ground. The 4.5-mc sound takeoff point should be pin 7 of the 6AL5 video detector, rather than pin 1 of the 6AH6 video amplifier. The sound take-off capacitor ( $C_{223}$ ) should be added in parallel with  $L_{201}$  in the grid circuit of the first sound *if* amplifier. These corrections are indicated in Fig. 3 on page 35.

# NEW

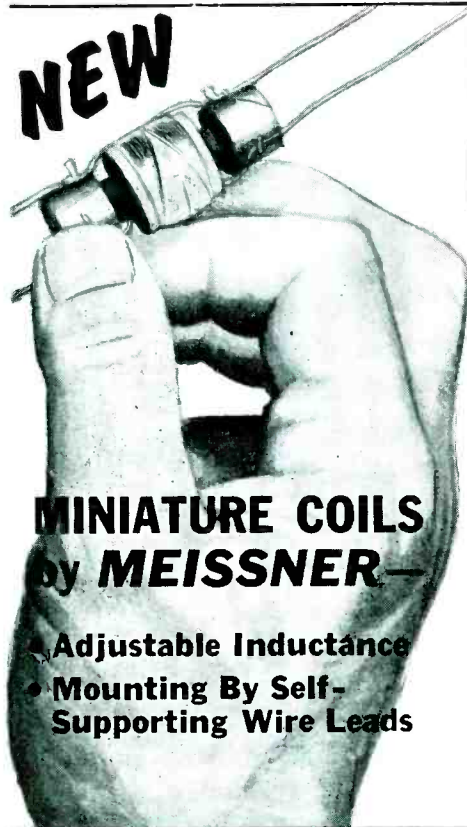

## MINIATURE COILS by MEISSNER

- Adjustable Inductance
- Mounting By Self-Supporting Wire Leads

DESIGNED WITH THE NEEDS OF THE SERVICEMAN IN MIND, THESE HIGH QUALITY COILS ARE UNEXCELLED FOR REPLACEMENT APPLICATIONS.

### MINIATURE ADJUSTABLE BROADCAST OSCILLATOR COIL (Iron Core)

14-1073 has 100 uuf capacity interwinding. For use with 6SA7, 12SA7, 6BE6, 12BE6, 7Q7 and 14Q7 tubes in receivers having 455 Kc I. F. and with effective gang condenser capacities of 108 to 180 uuf. in unpadding circuits, and 365 to 420 uuf. in padded circuits.

14-1074 for Battery and 3-way Portables. Small size, 1" x 3/8". Its wide inductance adjustment range allows its use with gang condenser capacities of 108 to 180 uuf. and accurate adjustment of inductance for proper calibration and tracking.

### MINIATURE BROADCAST ANTENNA AND R. F. COILS (Iron Core)

Small size, 1-1/2" x 1/2", plus adjustable inductance makes these coils ideal for replacement in compact circuits or where mounting or original coil is hard to duplicate. For broadcast band with gang condensers having effective capacities of 280 to 420 uuf. Antenna 14-1071 R. F. 14-1072.

### VIDEO PEAKING COILS (Iron Core)

This series of adjustable inductance video peaking coils permits accurate screw driver adjustment of frequency response in video amplifier stages. 19-1920, 65 to 115 uh; 19-1921, 115 to 195 uh; 19-1922, 195 to 325 uh.

### OTHER MEISSNER COILS

In addition to the new miniature coils listed above, MEISSNER manufactures a complete line of Antenna, R. F. and Oscillator coils for every application. Write today for Meissner catalog 50A that describes them in detail.

## MEISSNER for Magnificent Reception!

MEISSNER MANUFACTURING DIVISION

MAGUIRE INDUSTRIES, INC., MT. CARMEL, ILLINOIS

## Phono

(Continued from page 28)

ear's ability to distinguish one frequency in the presence of another. The magnitude of the effect, which depends on loudness level, frequency, and frequency separation of components, is unfortunately quite complex and normally not introduced into commercial testing equipment. Consequently, if masking is to be considered, the reading of sound-level instruments must be corrected to account for the effect of masking in reducing ear response. Bennon explained that this correction has been accomplished by multiplying the loudness units of each component by a masking coefficient, equal to or less than unity. The corrected loudness units are then added to obtain the total, which is, of course, less than if masking is neglected. This masking correction is ordinarily used only in the lab.

There are three excellent texts available, covering in detail the various aspects of the foregoing problems, which every Service Man should have in his library. These are *Noise Primer*, Fletcher's *Speech and Hearing*, and Olson's *Elements of Acoustical Engineering*, published by General Radio and Van Nostrand, respectively.

### New Developments

**15" Duo-Cone Speaker:** A speaker featuring a duo-cone, with two voice coils operating in two separate air gaps excited by a single, 2-pound Alnico V magnet has been announced. The duo-cone is constructed with a large woofer cone and small tweeter cone, each so mounted in its individual housing, that the large cone is effectively a continuation of the small cone. The large cone is driven by a 2" voice coil to produce the low frequencies, and the small cone is driven by a 3/4" voice coil to produce the high frequencies.

The small cone does not vibrate at the lower audio frequencies because of

Astatic long-play record crystal cartridge.  
(See p. 58 for details.)

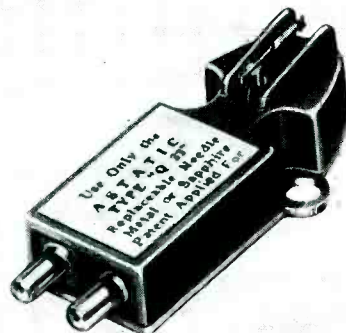

## FREE

To Radio Servicemen

The Miller Manual  
**MILLER REPLACEMENT NEEDLES**  
For Use In  
Phonograph Pick-Ups

48 pages  
Of Valuable Information  
Installation Instructions  
On All Replacement Needles

Now the complete "know-how" of the replacement needle business can be yours for just the asking. The M. A. Miller Manual on "Miller replacement needles for use in phonograph pick-ups" is packed full of all the valuable information required for this highly profitable business. Complete installation instructions and needle styles required to fit all cartridges. Don't miss this generous offer.

Write for Yours Today!

**M. A. MILLER MFG. CO.**  
1169 E. 43rd St., Chicago 15, Illinois

At no extra expense to me please send me a Miller Manual of Phonograph Needles.

Name \_\_\_\_\_  
Address \_\_\_\_\_  
City \_\_\_\_\_ State \_\_\_\_\_

LIST YOUR WHOLESALE JOBBER

Name \_\_\_\_\_  
Address \_\_\_\_\_  
City \_\_\_\_\_ State \_\_\_\_\_

## TWIN LEAD, TELEVISION LIGHTNING ARRESTER

No. AT102  
U. S. Patent No. D-4664  
completely waterproof

APPROVED for OUTDOOR-INDOOR Use \$ **2.25**  
Protects Television Sets  
Against Lightning and Static  
Charges

## SAFE TV GUARD

Simple to install everywhere and anywhere  
...no stripping, cutting or spreading of  
wires. More than 300,000 in use today!

SEE YOUR JOBBER OR WRITE TO

**JFD MANUFACTURING CO., Inc.**  
6127 16th Avenue, Brooklyn 4, N. Y.  
First in Television Antennas & Accessories



the high reactance of the coupling capacitor at these frequencies. This design is said to eliminate the need for the usual multi-element cross-over electrical network. Only the coupling capacitor is required to prevent excessive low frequency power from damaging the high-frequency voice coil.

The speaker utilizes a single 2-pound Alnico-V magnet arranged with the pole pieces and yoke so that the magnetic paths form a bridge network to provide each air gap with equal flux density. Both air gaps are excited by the single Alnico-V magnet.

Speaker is flange-mounted with the front edge of the large cone-section flush with the front of the baffle. Recommended baffle for the new speaker is an enclosure made of 3/4" plywood lined with a 1" thickness of sound-absorbent material. The recommended inside volume of the enclosure is approximately 5 to 10 cubic feet with a port-hole opening of approximately 30 to 100 square inches placed below the speaker mounting hole. The speaker is also designed for standard RTMA rim mounting and can be used as a direct replacement for existing 15" rim-mounted speakers. The speaker can also be mounted in a flat baffle.

Two output transformers have been designed especially for use with the duo-cone; for operation from line-to-voice coil,<sup>2</sup> and for operation from tube-to-voice coil.<sup>3</sup> Both transformers are multi-tapped for matching to several input impedances.

**Remote-Controlled Amplifier:** A 30-watt all-triode amplifier<sup>4</sup> is now available with a remote-control unit which has a selector that not only permits switching to and from phono and radio (or television), but is also said to permit selection of the correct equalization for all types of domestic and foreign recordings. In addition, there is one volume control, compensated for low level listening, plus one bass and one treble control that is said to have a flat center position, with boost and attenuation. Unit is equipped with a 5-foot cable on remote unit, but can be extended to 25 feet with the addition of an accessory 20-foot extension cable.

Inputs, outputs, and power source all connect to the amplifier chassis instead of to the remote control unit. There are six inputs: 3 phono, 1 high impedance microphone, and 2 radio. The amplifier also has a master gain control, ac switch, and provision for remote ac switch.

Frequency response is said to be within  $\pm 25$  db from 20 to 30,000 cycles; hum and noise level is 80 db below rated output. Output impedances are 4, 8, and 16 ohms. Total

(Continued on page 58)

# Announcing a NEW Jackson 5-inch Oscilloscope

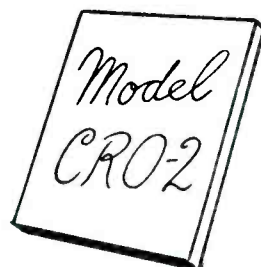

## What's New...

Input Calibration Voltage—provides a standard for measuring unknown voltages. Vertical polarity switch allows you to reverse the polarity of vertical deflection voltage. New return trace blanking—all electronic—provides clearer, sharper image. New styling—helps you locate controls more quickly, matches Jackson Television Generator.

## Plus All These Important Features...

Dual purpose vertical amplifier. Wide band, flat within 1.5 db, 20 cycles through 4.5 megacycles. Vertical deflection sensitivity .018 rms volts-per-inch. Saw tooth sweep, 20 cycles to 50 kilocycles. Intensity modulation, either 60 cycle or from external source. Direct connection through capacitors to deflection plates. Removable calibration screen. Many more important features.

See your distributor, or write

# JACKSON ELECTRICAL INSTRUMENT CO.

DAYTON 2, OHIO

Represented in Canada by: The Canadian Marconi Co.

<sup>2</sup>RCA-51552.

<sup>3</sup>RCA-213T1. <sup>4</sup>RCA-214T1.

<sup>5</sup>Model 2145; Bell Sound Systems.

<sup>6</sup>Model RC-12; Newcomb Audio Products

(Right)

British 10" speaker designed by G. A. Briggs for medium to small rooms. Has a center diaphragm which reacts to highs while larger paper cone handles the low. Cone, suspended by cloth, is said to eliminate carry-overs. Impedance is 12/15 ohms.

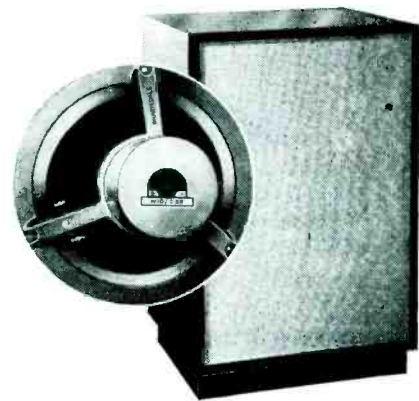

[Speaker (Wharfedale W101CSB) is now being distributed by Sun Radio & Electronics Co., 122-124 Duane Street, New York City.]

# GOLDEN WAND

INDOOR Television ANTENNA

**SALES ARE CLIMBING**

**BECAUSE THEY'RE BETTER MADE**

**Check THESE 5 EXCLUSIVE FEATURES POINT BY POINT!**

1. Phosphor bronze shims at all telescoping joints for better electrical contact. Constant tension; jamless telescopic action.
2. Admiralty brass dipoles for better electrical conductivity. Stronger; will not rust or corrode.
3. Polystyrene base for better insulation. Terminals completely housed to prevent lead breakage.
4. Terminals completely housed. No strain on terminals, hence breakage of wires impossible.
5. Polystyrene insulators for better insulation.

## TWO POPULAR MODELS

Full Channel Coverage TV plus FM

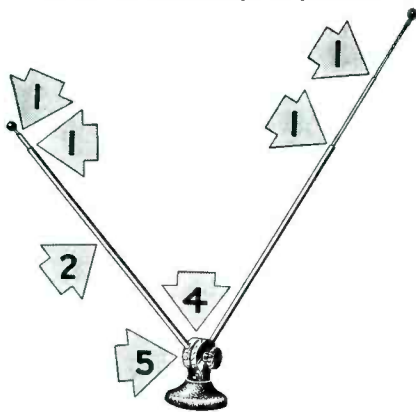

**MODEL G84TV**—3-section polished finish dipoles. Adjustable friction holds dipoles at any angle. Heavily weighted, felt padded base, gold finished. Harmonizes with any set or room. Supplied with 300-ohm lead-in.  
**List Price \$6.95**

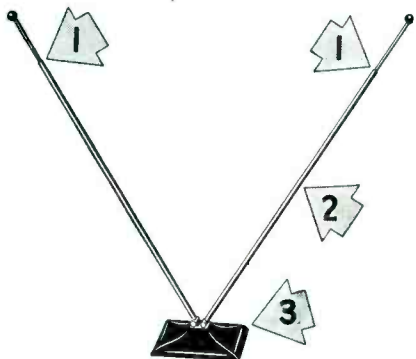

**MODEL 50TV**—2-section satin finished dipoles. Automatic friction holds dipoles at any angle. Walnut-mahogany polystyrene base, felt padded, heavily weighted. Will not tip when fully extended. Slot in base for mounting on wall, window frame or ceiling. Harmonizes with any set or furnishings.  
**List Price \$6.95**

Order from your Radio Parts Wholesaler

**PEERLESS PRODUCTS INDUSTRIES**

818 North Puloski Road, Chicago 51, Illinois

## Phono

(Continued from page 57)

distortion at 20 watts is said to be less than 2% with a maximum power output of 30 watts.

A total of 12 tubes are utilized in the power amplifier and remote control unit. The high gain tubes are shock mounted.

The remote control unit is 3½" deep, 10" wide, and 4½" high. Weighs 3½ pounds.

**Three-Speed Phono:** A 3-speed portable phono<sup>5</sup> with a changer that plays 33⅓, 45 and 78-rpm records, up to 12" diameter, has been announced. The phono has a 5-watt, ac amplifier which incorporates an inverse-feedback circuit. Has a 6" x 9" oval Alnico V pm dynamic speaker and a featherweight crystal pickup. Operating panel has tone control, volume control and pilot light.

**60-Watt Bi-Power Amplifier:** A bi-power (biased power) amplifier<sup>6</sup> with a rated output at 60 watts at 5%, or less, total harmonic distortion (measured at 100, 400 and 5,000 cycles) has been produced.

Features include: 4 microphone inputs (each convertible for use with a low-impedance mike by means of a plug-in transformer); 2 phono inputs with dual fader; electronic mixing and fading on 6 inputs; separate bass and treble tone controls; provision for adding 60-watt booster amplifiers. Frequency response is said to be ± 1 db, 40 to 15,000 cps. Output impedances are 4, 8, 80 (70 volts), 250, 500 ohms. Tubes: 5-6SQ7, 2-6SC7, 2-6SN7GTA, 2-6L6, 2-5U4G, 2-5Y3GT.

**LP Crystal Cartridge:** A crystal cartridge<sup>7</sup> has been designed for use on slow-speed platters of the 33⅓ and 45-rpm type. Cartridge is said to be internally equalized to follow the Columbia Records ideal-frequency response for the recording characteristics of lp records (30 to 11,000 cycles).

The cartridge has a small, lightweight aluminum housing with standard ½" mounting holes to fit most tone arms. It is furnished with an adapter plate to permit mounting in 45 rpm record changers. Has a sapphire-tipped needle.

Output is listed at approximately .6 volt at 1,000 cps per second on the Columbia No. 103 test record and 1 volt on the RCA 12-5-31-V test record.

<sup>5</sup>Model 1960; Rauland-Borg Corp.

<sup>7</sup>CAC-J; Astatic Corp. Model CAC-78-J available with three-mil needle tip radius for 78 rpm records.

<sup>6</sup>American Microphone Co.

## ELECTRONICS TECHNICIANS WANTED

The RCA Service Company, Inc., a Radio Corporation of America subsidiary, needs qualified electronics technicians for U. S. and overseas assignments. Candidates must be of good character and qualified in the installation or maintenance of RADAR or COMMUNICATIONS equipment or TELEVISION receivers. No age limits, but must have at least three years of practical experience.

RCA Service Company offers comprehensive Company-paid hospitalization, accident and life insurance programs; paid vacations and holidays; periodic review for salary increases; and opportunity to obtain permanent position in our national and international service organization, engaged in the installation and maintenance of AM, FM and TV transmitters, electronic inspection devices, electron microscopes, theatre and home television, r-f heating equipment, mobile and microwave communications systems, and similar electronic equipment.

Base pay, overseas bonus, payments for actual living and other expenses, and benefits mentioned above add up to \$7,000 per year to start for overseas assignments, with periodic review of base salary thereafter. Openings also available at proportionately higher salaries for specially qualified technicians with supervisory ability.

Qualified technicians seeking an advantageous connection with a well-established company, having a broad-based, permanent peacetime and wartime service program, write to:

**Mr. G. H. Metz, Personnel Manager**  
**RCA Service Company, Inc.**  
**Camden 2, New Jersey**

## C-D BUYS U. S. DEVICES

The Cornell-Dubilier Electric Corp. and its subsidiary, the Radiart Corp., have purchased the assets of the U. S. Devices Corp., South Plainfield, N. J.

The U. S. Devices rotator has been added to the Tele-Rotor line and will be called the Standard Tele-Rotor, U. S. Devices models 501A and 502A. Model 501A features a flickering light indicating antenna rotation and end stop position. Model 502A has a meter dial on the control cabinet.

## AT NEDA CONVENTION

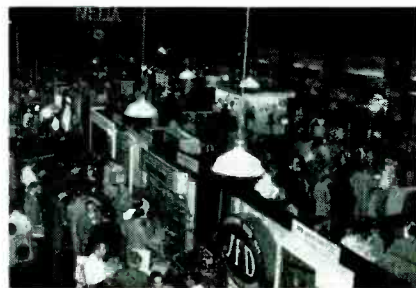

View of the exhibit floor at the recent NEDA convention and show in Cleveland, Ohio.



# FOR TOP QUALITY PICTURES



## -USE PERFECTION ION TRAPS

- Simplest to Install
- Stay Put—No Wobble
- Standard on All Leading TV Sets Including

AIR KING	MUNTZ
AMERICAN	OLYMPIC
BENDIX	PHILCO
DEWALD	RCA VICTOR
DU MONT	SENTINEL
EMERSON	STEWART
GENERAL ELECTRIC	WARNER
JACKSON	TELEKING
MECK	TELEPHONE
	WESTINGHOUSE

Order today from your supplier!

### PERFECTION ELECTRIC COMPANY

2641 South Wabash Ave., Chicago 16, Ill.

Makers of Perfection Speakers and BeamaJuster TV Centering Controls

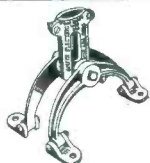

#### UNIVERSAL ROOF MOUNT

Just What TV Installers Have Been Looking For

- 1—All-aluminum castings with plated steel bolts.
- 2—Tested to withstand any normal load up to 1500 lbs.
- 3—Will take tubing O.D. 3/4" to 2".

Ask your jobber—or send for circular and prices.  
**SMITH ELECTRIC MFG. CO.**  
 ASHLAND, OHIO

#### MASCO TV BOOSTER

A TV booster, housed in a baked mahogany metal cabinet with a sloped dial panel, and with one tuning control that tunes from channel 2 to 13, has been produced by the Mark Simpson Mfg. Co., Inc., Long Island City 3, N. Y. It turns itself on and off with the TV receiver. Model is U/L approved.



\* \* \*

#### SYLVANIA MARKER GENERATOR

A TV marker generator, type 501, designed particularly for use with TV sweep-signal generators, has been announced by the radio tube division, Sylvania Electric Products, Inc., 1740 Broadway, New York 19.

Generator is said to provide a means of accurately marking frequencies on the scope trace of response curves while testing a TV receiver. Through the use of the marker generator, accurate measurements of bandwidth and evaluation of dynamic response at any spot frequency may be made.

Crystal controlled signals are provided by an entirely separate self-contained crystal oscillator which may be operated at any frequency fixed by a plug-in crystal without tuning. It provides checkpoints at fundamental frequencies ranging from 2 to 20 mc and has useful harmonics up to at least the sixth. The crystal oscillator may be operated at the same time as the variable oscillator to provide two simultaneous markers on a scope screen.

Two marker pips may be used to set video and if circuits and traps. Variable marker may be brought into coincidence with the crystal marker to check dial reading with crystal frequency or crystal frequency harmonic.

The tuned oscillator in the marker generator provides frequencies ranging from 15 to 240 mc, in four bands: 15-30; 30-60; 60-120; and 120-240 mc. With an appropriate crystal inserted in the panel socket, oscillator will operate at any frequency between 2 to 20 mc.



# more than 65,000

R.C.P.

## AC-DC MULTITESTERS

MODEL 447B and their prototypes

### in use ALL OVER THE WORLD



### \$15.95

**SUCH POPULARITY MUST BE DESERVED!**

The exceptional value of the 447B Model is made possible by the tremendous quantities produced. The resulting very low price is responsible for its great popularity. These units are in a class with other makes of testers that sell for considerably more.

A 3" square D'Arsonval meter is used, having an accuracy of 2%. Accuracy of AC voltage measurements is improved by use of a new gold plated copper oxide rectifier.

#### RANGES

DC Voltmeter: 0-5-50-250-500-2500 Volts.  
 AC Voltmeter: 0-10-100-500-1000 Volts.  
 Output Voltmeter: 0-10-100-500-1000 Volts.  
 DC Milliammeter: 0-1-10-100-1000 M.A.  
 DC Ammeter: 0-1-10 Amperes.  
 Ohmmeter: 0-10,000 Ohms—1 Megohm—10 Megohms Ext.

Decibel Meters—8 to +55 decibels.  
 Model 447B—Open face, oak case. Size 5"x8 1/2"x3". Weight 21 oz. Complete with batteries.

Net Price **\$15.95**

Model 447BP—Portable, oak case with carrying handle, cover and test leads. Size 6 1/2"x8 1/2"x4 1/2". Weight 24 oz. Complete with batteries.

Net Price **\$19.95**

Now you can get in KIT FORM the best professional test equipment made by RCP—precision equipment at the lowest prices ever. Each KIT contains simple step by step instructions.

Model 447BK—Open face, same as 447B but in kit form **\$12.75**

Model 447BPK—Portable, same as 447BP but in kit form **\$15.95**

BUY FROM YOUR JOBBER

INSIST ON R.C.P. INSTRUMENTS

Write for Catalog 10S

**RADIO CITY PRODUCTS CO., INC.**

152 West 25th St.  New York 1, N. Y.

# You Can't Afford to be Without It! TV and OTHER RECEIVING ANTENNAS

(Theory and Practice)  
by Arnold B. Bailey

No other book discusses antennas— theory and practical aspects—so fully. It is a book which will teach; a book which every person interested in antennas, especially TV antennas, will use every day because of the facts and figures it contains. All men whose livelihood depends on getting the most out of antenna systems cannot afford to be without this unique text. Well planned and precisely written, it is practical in every sense of the word. Mathematics is made easy to understand through the use of graphs, charts and tables. The radio and television industry—electronics schools—antenna design engineers—all personnel interested in antennas will agree this is the most helpful source book of its kind ever projected. It embraces world knowledge concerning antennas.

12 Chapters, 480 Pages, including Bibliography and Index.....\$6.00

Shows you how to get the MOST out of your oscilloscope . . .

## Encyclopedia On Cathode-Ray Oscilloscopes and Their Uses

by Rider and Uslan

This is a book of a thousand-and-one uses. It teaches you how to use an oscilloscope properly. It tells what is inside the scope and how to get the most out of it. The book shows what can and cannot be done with an oscilloscope. When planning to buy equipment, this text helps you avoid costly mistakes in selecting the type of instrument best suited to your needs. The book begins with basic theory of cathode-ray tube operation, and then proceeds through application in 'scopes and TV receivers. There are full and clear explanations for uses in every field and research activity which employs a cathode-ray oscilloscope. All 'scopes produced during the past 10 years, more than 70 different models, are described—with schematic wiring diagrams. Almost 500,000 words and about 3,000 illustrations are incorporated in the 992 pages. Invaluable for engineers, servicemen, teachers, students, Armed Forces, radio amateurs, research laboratories, etc. There is no other book like it!

992 Pages, 22 Chapters, 8 1/2" x 11" ..\$9.00

### 10-DAY FREE TRIAL

Send for these books today. Keep them for 10 days . . . if you are not completely satisfied, return them. **SAVE POSTAGE.** If you enclose check or money order WITH coupon, we will prepay postage charges. Money back if you return books within 10 days.

### RUSH THIS COUPON TODAY

**JOHN F. RIDER PUBLISHER, Inc.**  
480 Canal Street, New York 13, N. Y.

Please send me the following books on your 10-Day FREE TRIAL Offer:

TV AND OTHER RECEIVING ANTENNAS (Theory and Practice).....\$.....  
ENCYCLOPEDIA ON CATHODE-RAY OSCILLOSCOPES AND THEIR USES.....\$.....

NAME.....  
ADDRESS.....  
CITY..... ZONE..... STATE.....  
Check for \$..... Money-Order for \$.....  
Enclosed. 6

### BELNORD AUTO RADIO ANTENNA

A quick-mount type of auto radio antenna, which can be mounted from the top, on cowl or fender, has been announced by Belnord & Co., 474 Sterling Place, Brooklyn, N. Y.

Antenna is constructed entirely of brass and chromium. Length: closed, 20"; open, 60". Leads are 48" long. Antenna is patented under U. S. Pat. No. 2509563; other patents pending.

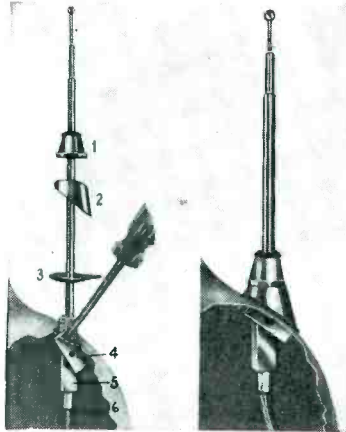

### BURGESS FINELITE BATTERY CELLS

Slim No. 7 cells are now employed in a line of pencil-type flashlights, the *Fine-light* type, developed by the Burgess Battery Co., Freeport, Ill. The light is styled in heavy chromium plate.

Has a clip-action switch which is said to assure automatic fool-proof action. Cells and bulb can be easily replaced.

Lights are being packaged twelve to display card or individually gift-boxed with two Burgess 7 cells in silver carton for the holiday season.



### WELLER DUAL SPOTLIGHT SOLDERING GUN

A light-duty soldering gun with a dual spotlight, model WD-135, has been announced by Weller Electric Corp., Easton, Pa.

Gun provides dual heat (100/135 watts) for light and delicate soldering. Has 5-second heating, trigger-switch control, and a chisel-shaped tip.



# The World's Finest LIGHTNING ARRESTERS

### MODEL RW-204



The first and only lightning arrester that will accommodate 4-wire line for antenna rotator in-stallation as well as regular 2-wire transmission line.

Only \$1.50 List



### MODEL RW-300

For use with 2-wire standard antenna ribbon type transmission line for TV or FM. An air gap plus resistors provide double protection.

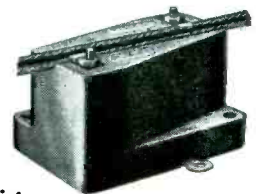

Only \$2.00 List

# VEE-D-X

LaPointe-Plascomold Corp., Unionville, Conn.

# NOW! SPEED UP ALL SOLDERING WITH UNGAR FEATHER-LIGHT SOLDERING PENCILS WITH HI-HEAT TIPS



Stop wrestling with big irons. New HI-HEAT TIPS in your Ungar Electric Soldering Pencil produce a really versatile tool that'll perform on a par with the big, bulky 100-150 watt irons. If you can't get immediate delivery, please be patient, for production hasn't yet caught up with demand. Ask your supplier for No. 1236 Pyramid or No. 1239 Chisel. List price, \$1.25 each.

# Ungar

ELECTRIC TOOL CO., Inc.  
LOS ANGELES 54, CALIFORNIA



## SHOOTS TROUBLE FASTER!

Makes more money for you on job or at service bench!



PRICE \$9.95

at distributor or post paid, direct. No COD's please. Ok please add 3% State Sales Tax.

## Signalette

### MULTI-FREQUENCY GENERATOR

In radio service work, time means money. Locate trouble faster, handle a much greater volume of work with the SIGNALLETTE. As a trouble shooting tool, SIGNALLETTE has no equal. Merely plug in any 110V. AC-DC line, start at speaker end of circuit and trace back, stage by stage, listening in set's speaker. Generates RF, IF and AUDIO Frequencies, 2500 cycles to 20 Megacycles. Also used for checks on Sensitivity, Gain, Peaking, Shielding Tube Testing. Wt. 13 oz. Fits pocket or tool kit. Satisfaction, or money back! See at your distributor or order direct.

**Clippard** INSTRUMENT LABORATORY Inc.

DEPT. C, 1125 BANK STREET  
CINCINNATI 14, OHIO  
QUALIFIED JOBBERS WRITE,  
WIRE FOR DETAILS.

FREE! SEND FOR IT NOW!

## ALLIED'S NEW 1951 CATALOG

212 PAGES—  
EVERYTHING IN  
RADIO, TV AND  
ELECTRONICS

Radio's Leading  
Buying Guide



Service Technicians and Engineers: ALLIED'S complete 1951 Catalog brings you all the latest equipment and money-saving values—from the world's largest stocks of test instruments, amplifiers, P.A. systems and equipment, tubes, parts, tools, books and accessories—ready for instant expert shipment. Send today for your FREE 212-page ALLIED Catalog.

## ALLIED RADIO

ALLIED RADIO CORP., Dept. 23-K-O  
833 W. Jackson Blvd., Chicago 7, Ill.

Send FREE Catalog

Name.....

Address.....

City..... State.....

### DOONER JOINS BRACH

John Lester Dooner is now with the Brach Manufacturing Corp., 200 Central Ave., Newark, N. J., as an antenna research engineer. Dooner was formerly with the antenna laboratories of Amy, Aceves and King. During the war he served as a professional radio engineer with the Navy. Dooner will initiate a new research program for Brach in uhf and color TV antenna design.



J. L. Dooner

\*\*\*

### SCANALYST WINNING NAME FOR NEW RCA TV SCOPE

Mrs. Elizabeth French, Washington, D. C., who with her husband own and operate French's Radio Service Shop in that city, was the first prize winner in the RCA Tube Department's *You Name It* contest, which was designed to find a name for RCA's WO-57A TV 'scope, the name being *Scanalyst*.

Second prize was awarded to James S. Bennett, Newington, Conn. Third prize went to Paul Silverman, Brooklyn, N. Y.

\*\*\*

### PETER L. JENSEN KNIGHTED BY KING OF DENMARK

Peter L. Jensen, president of Jensen Industries, Inc., 329 South Wood St., Chicago 12, Ill., received the Order of Knight of the Flag from King Frederick on his recent trip to Denmark. Jensen was recognized for his contribution to the field of radio.

Jensen founded the Magnavox and the Jensen manufacturing companies.

A book entitled *Jensen, Inventor of the Loudspeaker*, based on an autobiography, has been published in Denmark.



Peter Jensen

\*\*\*

### HOWARD E. ANTHONY HONORED BY HOLLYWOOD UNIVERSITY

The board of trustees of the University of Hollywood has awarded an honorary Doctorate degree of Doctor of Science in electronics to Howard E. Anthony, president of the Heath Manufacturing Co. of Benton Harbor, Mich.

This honor and recognition was conferred in recognition of his valuable contributions to the industrial electronics field.



H. E. Anthony

# NEW!

# HICKOK

## TELEVISION

### Circuit

## ANALYZER

MODEL 630

**Multiplies Usefulness of Your Present Scope**

### NEW HICKOK MODEL 630

Specifically designed in answer to the urgent need of TV technicians for quick, accurate checking of troublesome TV receiver circuits.

With the 630 you can measure single or multiple stage-gain from Video Detector through Video Amplifier stages to Cathode Deflection amplifiers on thru Deflecting Circuits of the picture tube. This is in addition to gain measurements from the Sound Detector thru all Sound Amplifiers to the speaker. Makes easy work of tough problems with SYNC, CLIPPER, DIFFERENTIATING, SEPARATING and AGC circuits. ALSO: The 630 is a Square Wave Generator at 420 cycles. Permits tests on amplifiers from 40 to 4000 cycles.

IN ADDITION: The 630 is an accurate Peak-to-Peak Voltage Calibrator.

See the Model 630 at your jobber's, or write a card for full information Today!

### THE HICKOK ELECTRICAL INSTRUMENT COMPANY

10521 Dupont Ave., Cleveland 8, O.

Choice of the Experts for 40 years

# SAFE AT THE PLATE!

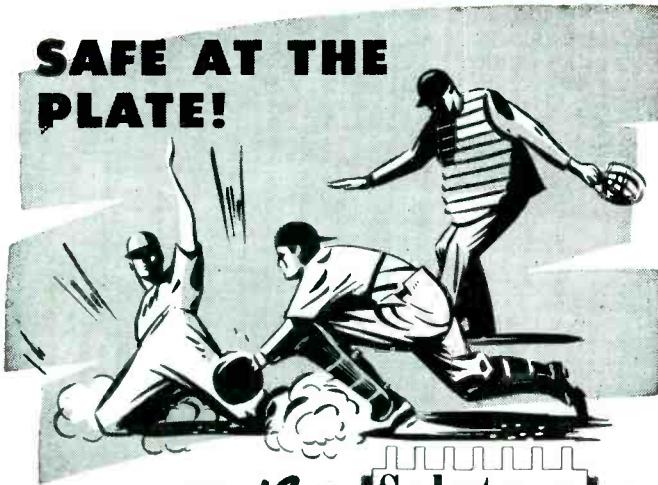

## AND SO IS SELETRON

SELETRON "Safe Center" plates in miniature rectifiers eliminate the danger of arc-over, short circuits and excessive heating due to high leakage current at the center contact point. Assembly pressure, or pressure applied in mounting the rectifier cannot affect its performance. This SELETRON feature is accomplished by deactivating the area of the plate under the contact washer.

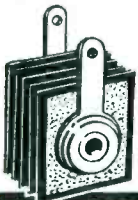

There are millions of SELETRON Selenium Rectifiers in service in radio and TV; millions more in other electronic circuits. That is why you can specify SELETRON and be safe!

Look for Howard W. Sam's Red Book Supplement listing SELETRON replacements . . . and write for your copy of our new Bulletin No. SE-4..

**SELETRON DIVISION**  
**RADIO RECEPTOR COMPANY, INC.**  
 Since 1922 in Radio and Electronics  
 Factory: 84 North 9th St., Brooklyn 11, N. Y. • Sales Department: 251 West 19th St., New York 11, N. Y.

# SERVICE

Edited exclusively for professional independent servicemen, service organizations and the service departments of established dealers.

Readership represents 100% buying power for manufacturers of tubes, test equipment, components, accessories, sound and intercom equipment, TV antennas, tuners, boosters, etc.

Advertising in **SERVICE** pays dividends

## WHEN YOU CHANGE YOUR ADDRESS

Be sure to notify the Subscription Department of **SERVICE** at 52 Vanderbilt Avenue, New York 17, N. Y., giving the old as well as the new address, and do this at least four weeks in advance. The Post Office Department does not forward magazines unless you pay additional postage, and we cannot duplicate copies mailed to the old address. We ask your cooperation.

### A NEW INVENTION!

## SYNCHRO-SWEEP\*

Provides Saw Tooth and Sync Pulses for  
 • SYNC • SWEEP • HI VOLTAGE  
 CIRCUITS  
**TELEVISION SERVICING**  
**"ON-THE-SPOT"**  
 With or Without Test Pattern, "Scope, or  
 Bench Equipment!

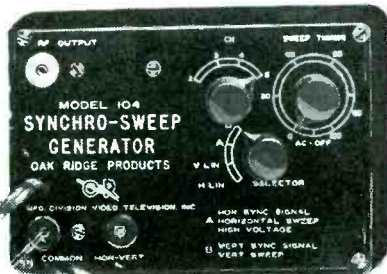

**OAK RIDGE "MINIATURE" MODEL 104**  
**in BAKELITE CASE 5 3/4 x 4 x 2 1/4"**  
 Synchro-sweep\* is the FIRST to date the ONLY TV Test Instrument to provide its own sync and sweep signals for fast trouble-shooting of sync, sweep, and high voltage circuits. It supplies:  
 1. Direct or Transmitted Vertical & Horizontal Sync Pulse.  
 2. Vertical & Horizontal Saw Tooth Signals.  
 3. Transmitted Vertical & Horizontal Linearity Pattern Bars (Cross Hatch).  
 This marvelously compact new instrument is acclaimed by leading Servicing Organizations, Parts Jobbers, Technical Schools, as a much needed invention for ON-THE-SPOT Television Servicing!  
 Model 104 Synchro-Sweep. . . Dealers' Net \$44.50  
 See this and other amazing Oak Ridge "Miniature" Television Testing Equipment at your Jobber's or Write for complete information to:

**OAK RIDGE PRODUCTS**  
 (Mfg. Div. of Video Television Inc.)  
 37-01-S Vernon Blvd.  
 Long Island City 1, N. Y.  
 \*T.M. Reg. App. For. Pat. App. For

### VEE-D-X EXPANDS

The LaPointe-Plascomold Corp., has purchased an entire new plant in Windsor Locks, Conn.  
 Plant is 344 feet long with a production area of 105,000 square feet. It is located in the center of Windsor Locks, two miles from Bradley Airfield.

\* \* \*

### LITTELFUSE SNAP-ON TV FUSE HOLDER COUNTER CARD

A counter display card for snap-on TV fuse holders has been announced by Littelfuse, Chicago, Ill. Card can also be hung on the wall. There are 24 fuse holders on the card and a picture which shows how to use the holder for repairing pig tail fuses.

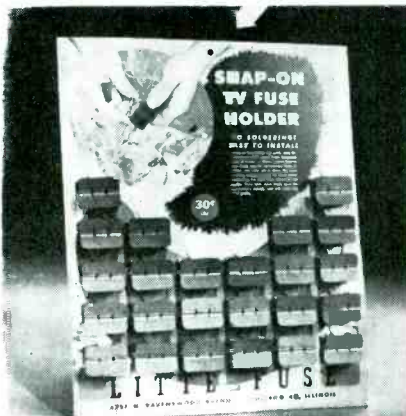

## YOU NEED THIS NEW "W-J" CATALOG

Thousands of Television, Radio and Electronic Items at Your Finger-Tips!



- Fast, Easy Selection
- 
- Saves Time
- 
- Saves Trouble
- 
- Simplifies Parts Procurement

Complete buying guide for servicemen, dealers. New TV accessories, TV installation equipment, TV test instruments, tubes, radio accessories and other electronic supplies. Thousands of repair parts cross-indexed for quick, easy selection. Standard brands. Exact duplicate replacements. Fast, same-day shipment. Profit Guide sent only to those entitled to wholesale prices.

Send Coupon for Your Free Copy Now

**WALKER-JIMIESON, INC.** 482  
 311 S. Western Ave., Chicago 12, Illinois  
 Please Send Your Free 1950 Profit Guide.  
 Name .....  
 Company .....  
 Address .....  
 City ..... Zone ..... State .....



# PHOENIX



**SPEED-MOUNTS and  
HARDWARE  
WILL  
REDUCE**

**.... HIGH COSTS  
.... INSTALLATION  
TIME  
... CALLBACKS**

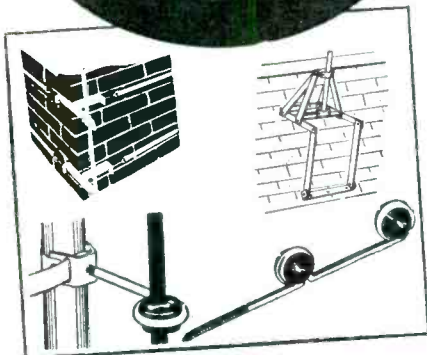

**PHOENIX ELECTRONICS  
INC.  
LAWRENCE, MASS.**

## RPEES OFFICERS FOR '51



The '51 officers for the Radio Parts and Electronic Equipment Shows, left to right: Jerome J. Kahn, Standard Transformer Corp., Chicago, president; Lew W. Howard, Triad Transformer Manufacturing Co., Los Angeles, secretary; Samuel J. Spector, Insuline Corporation of America, New York, vice president; and Charles A. Hansen, Jensen Mfg. Co., Chicago, treasurer.

# Rep Talk

ED DE NIKE, formerly distributor sales manager for the National Union Radio Corp., is now a sales rep of the Flush Wall Radio Co., in the state of Florida. In addition to covering the state for Flush Wall, he also represents Roto Beam air circulators. His address is P. O. Box 612, Winter Park. . . . Dr. Ralph L. Power has succeeded Lewis E. Sperry as executive secretary-treasurer of the Los Angeles chapter of The Reps. Power was publicity director for the mid-September 6th annual Pacific Electronic Exhibit. He has been public relations counsel for the past six years for the Los Angeles WCEMA Council and three years for the state-wide group. . . . Robert Boniface, business manager of Neely Enterprises, electronics reps, has been called to the colors. . . . Harry Appleton, 315 W. Pico Blvd., Los Angeles, has been elected to membership in the Los Angeles chapter of The Reps. . . . T. Robinson-Cox has joined the J. Alan Biggs Co., Overbrook Drive, Stamford, Conn. He will specialize in industrial sales representation and cover jobber sales in some territories. Cox was formerly general manager of Engineering Products Division of R. C. A. International. . . . Milton Baum has joined the sales staff of Jules J. Bressler, 1780 Broadway, N. Y. 19. . . . Charles E. Pheasant, Indianapolis, Ind., is now representing JFD in the territories of Indiana and Western Kentucky. . . . Holliday-Hathaway, with headquarters at Cambridge, Mass., and district offices at Canaan, Conn.; Rochester, New York, and New York City, have been appointed sales reps for Radio City Products, as well as Reiner Electronics. Coverage will be in New England and New York State with the exception of the metropolitan New York City area. . . . Oak Ridge Products, 37-01 Vernon Boulevard, Long Island City, N. Y., have announced the appointment of two reps: Selco Sales Co., for Southern New Jersey, Philadelphia, Eastern Pa., Baltimore and Washington, and Edward F. Aymond Co. for Texas, Arkansas and Louisiana. . . . Nine reps are now handling the Brach TV line nationally: Burlingame Associates, New York, N. Y. (N. Y. and N. J.); Holiday & Rothleder, Evanston, Illinois (Wis., Minn., Iowa, Upper Mich. Peninsula); Verner Jensen Co., Seattle, Washington (Wash., Ore., Idaho, Mont., British Columbia, Alaska); Carl A. Lewis Co., Atlanta, Georgia (N. and S. Carolina, Ala., Fla., Tenn., Ga.); J. W. Marsh Co., Los Angeles, Calif. (Calif., Ariz., Nev.); Midwest Sales Co., Cleveland, Ohio (W. Va., Ohio, Ky., Mich., Ind., Western Penn.); W. F. Pray Sales, Wellesley Hills, Mass. (Me., Mass., R. Is., Vt., N. H., Conn.); W. S. Trinkle, Philadelphia, Pa. (Md., Del., D. C., South Jersey, Eastern Penn.); and G. G. Willison Co., Houston, Tex. (Tex., Ark., Okla., La.). . . . Joe Sprung has been elected president of the New York Chapter of the Representatives. Jim Pickett has been named vice president; Frank X. Brennan has been reelected secretary-treasurer. . . . Cornish Wire Co., Inc., 15 Park Row, New York City 7, has appointed Herman C. Gerdtz, 415 Lexington Ave., New York City, to serve as a rep.

# Two rugged wirewounds



## OHMITE

### BROWN DEVIL

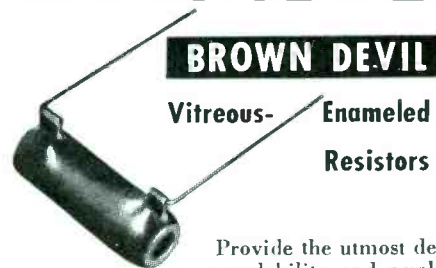

Vitreous-Enameled Resistors

Provide the utmost dependability and small size. Easily mounted by 1½" tinned wire leads. Three sizes: 5, 10, and 20 watts. Tolerance ± 10%.

### DIVIDOHM

Adjustable Resistors

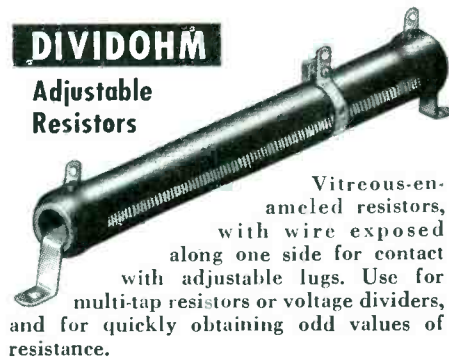

Vitreous-enameled resistors, with wire exposed along one side for contact with adjustable lugs. Use for multi-tap resistors or voltage dividers, and for quickly obtaining odd values of resistance.

## NEW OHM'S LAW CALCULATOR

Quickly solves Ohm's Law problems—including parallel resistance. Also has standard slide rule.



25¢

OHMITE MANUFACTURING CO.  
4878 Flournoy St. Chicago 44, Illinois

Be Right with  
**OHMITE**

Reg. U. S. Pat. Off.

RHEOSTATS • RESISTORS • TAP SWITCHES

# RADIO SERVICEMEN GET YOUR NEW RADIO'S MASTER FREE!

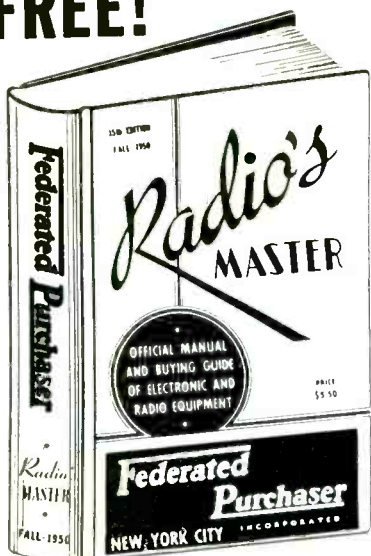

RADIO'S ONLY COMPLETE  
**REFERENCE BOOK AND BUYING GUIDE**  
 FOR RADIO AND ELECTRONIC PARTS AND EQUIPMENT  
 FIFTEENTH EDITION NOW READY  
 OVER 1,200 PAGES  
 THOUSANDS OF ILLUSTRATIONS  
 SPECIFICATIONS AND PRICES  
 CROSS-INDEXED FOR EASY HANDLING  
 PERMANENTLY BOUND WITH HARD COVER  
 PUBLISHER'S PRICE \$5.50

HERE'S HOW TO GET IT  
**FREE = FROM FEDERATED =**

We will send RADIO'S MASTER free of charge upon request with your order for Electronic Merchandise.

OR USE THIS COUPON

FEDERATED PURCHASER INCORPORATED  
 66 DEY ST., NEW YORK 7, N. Y.

Send a copy of RADIO'S MASTER, post-paid. Check for \$1.65 enclosed, which will be refunded with our initial order for Electronic Merchandise.

NAME \_\_\_\_\_  
 COMPANY \_\_\_\_\_  
 ADDRESS \_\_\_\_\_

**Federated Purchaser**  
 INCORPORATED  
 • 66 DEY ST., NEW YORK 7, N. Y. •  
 Digi 9-3050

NEWARK, N. J.  
 ALLENTOWN, PA.  
 EASTON, PA.

114 Hudson St.  
 1115 Hamilton St.  
 701 Northampton St.

## JOTS AND FLASHES

THE RECTANGULAR PICTURE TUBE, which at the beginning of the year was in the meek, wallflower stage, is now on its way to becoming one of the most popular members of the picture-tube family. In a report issued by RTMA, nearly half of the production in the summer months was devoted to rectangular picture tubes. Incidentally, 84% of the picture-tube summer sales involved tubes 16" and larger. The 10" tube seems to have become a museum piece. . . . Edward Fishbein is now head of the Parts Sales and Service Division of Emerson Radio. Harold Bernstein had been named to assist Fishbein as a technical adviser. . . . The Sylvania Electric TV show *Beat the Clock* is now being telecast over the CBS network in 25 cities. . . . The Braid Electric Co., recently moved into a new building at 1100 Demonbreun Viaduct, Nashville, Tenn. Ben S. Gambill is president of the company. . . . Miniature tubes will soon be made in a new RCA plant in Cincinnati, Ohio. The plant, formerly occupied by the Rich Ladder and Manufacturing Co., covers approximately 180,000 square feet of floor space. . . . Charles M. Odorizzi has been elected operating vice president of the RCA Victor Division. Odorizzi, since July '49 vice president in charge of service, will continue as chairman of the board of the RCA Service Co. . . . The Audio-Master Co. is now located at 341 Madison Ave., New York 17, N. Y. . . . Walter R. Jones, associate professor of electrical engineering at Cornell University, has been retained as a member of the editorial staff of Howard W. Sams & Co., Inc. . . . A 172-page catalog has been issued by the Radio Shack Corp., 167 Washington St., Boston 8, Mass. . . . Broadcasting's 30th birthday will be celebrated during National Radio and Television Week from October 29th to November 4th. . . . Perfection Electric Co. is now located at new quarters at 2641 S. Wabash Ave., Chicago 16. The new plant provides about two and one-half times the production capacity of the previous facilities. . . . John C. Merman has become president of a new electronics manufacturing company, Electronic Contractors, Inc., 1508 Sansom St., Philadelphia. Merman, a TV service contractor, has as his associates Albert M. Haas, vice president; Samuel A. Whittingham, vice president; Jack Phillips, secretary, and Angelo Brunetti, treasurer. All are TV Service Men. . . . Arthur H. Tracy has been named credit manager of Quam-Nichols Co., Chicago, Ill. . . . Brooks & London have been named advertising agents for National Union Radio Corp. Appointment was made by V. K. Ulrich, manager of the N. U. renewal sales division. . . . Rockwell M. Gray of the Rauland-Borg Corp., Chicago, was recently elected chairman of the Association of Electronic Parts and Equipment Manufacturers. John H. Cashman, Radio Craftsmen, Inc., was named vice chairman and Helen Staniland Quam was re-elected treasurer, for her fifteenth annual term. . . . The *Encyclopedia on Cathode-Ray Oscilloscopes and Their Uses* has been published by John F. Rider Publisher, Inc., 480 Canal St., New York 13, N. Y. The text, co-authored by John F. Rider and Seymour D. Uslan, contains 992 pages and about 3,000 illustrations, and is priced at \$9.00.

## ADVERTISERS IN THIS ISSUE SERVICE INDEX—OCTOBER, 1950

ALLIANCE MANUFACTURING CO.	29
Agency: Foster & Davies, Inc.	
ALLIED RADIO CORPORATION	61
Agency: George Brodsky, Advertising	
AMERICAN PHENOLIC CORPORATION	48
Agency: Burton Browne, Advertising	
ANCHOR RADIO CORPORATION	12
Agency: Symonds, MacKenzie & Co.	
BAUER & BLACK DIV., THE KENDALL CO.	54
Agency: Leo Burnett Company, Inc.	
CENTRALAB DIV., GLOBE-UNION, INC.	26, 27
Agency: Klau-Van Pletersom-Dunlop Assoc., Inc.	
CIRCLE-X ANTENNA CORPORATION	54
Agency: Homer Harlowe, Advertising	
CLIPPARD INSTRUMENT LABORATORY	61
Agency: The S. C. Haer Co.	
CORNELL-DUBILIER	40, 41
Agency: Stern and Warren	
CORNELL-DUBILIER ELECTRIC CORP.	Inside Front Cover
Agency: Reiss Advertising	
ALLEN B. DUMONT LABORATORIES, INC.	9
Agency: Austin C. Lescarbours & Staff	
ELECTRONIC INSTRUMENT COMPANY, INC.	52
Agency: H. W. Hauptman Co.	
ELECTRO-VOICE, INC.	39
Agency: Henry H. Tepitz, Advertising	
FEDERATED PURCHASER, INC.	64
Agency: Mort Junger, Advertising	
DON GOOD, INC.	50
Agency: Clark Collard Advertising Agency	
HEATH COMPANY	37
Agency: G. Dean Arend, Advertising	
HICKOK ELECTRICAL INSTRUMENT CO.	61
Agency: White Advertising Co.	
HYTRON RADIO & ELECTRONICS CORP.	33
Agency: Bennett, Walther & Menadier, Inc.	
ILLINOIS CONDENSER CORPORATION	50
Agency: Rudolph Bartz, Advertising	
J. F. D. MFG. CO., INC.	56
Agency: Shappe-Wilkes, Inc.	
JACKSON ELECTRICAL INSTRUMENT CO.	38, 57
Agency: The Parker Advertising Co.	
KESTER SOLDER COMPANY	1
Agency: Frank C. Nahser, Inc.	
LAPOINTE-PLASCOMOLD CORPORATION	6, 60
Agency: F. W. Prella Co.	
P. R. MALLORY & CO., INC.	Inside Back Cover
Agency: The Altkin-Kynett Co.	
MEISNER MFG. DIV., MAGUIRE INDUSTRIES	56
Agency: Rudolph Bartz, Advertising	
M. A. MILLER MANUFACTURING CO.	56
Agency: Irving J. Rosenbloom Agency	
MUELLER ELECTRIC COMPANY	46
NEWCOMB AUDIO PRODUCTS COMPANY	46
Agency: Stuart Stevens, Advertising	
OAK RIDGE PRODUCTS	62
OHMITE MANUFACTURING COMPANY	63
Agency: The Fensholt Co.	
PEERLESS PRODUCTS INDUSTRIES	58
Agency: Bayard H. Clark	
PERFECTION ELECTRIC COMPANY	50, 59
Agency: Scantlin & Company	
PERMOFLUX CORPORATION	53
Agency: Symonds, MacKenzie & Co.	
PHOENIX ELECTRONICS, INC.	63
Agency: Milton Ilchards Adv. Co.	
PRECISION APPARATUS CO., INC.	4
Agency: Shappe-Wilkes, Inc.	
RCA SERVICE COMPANY, INC.	58
Agency: J. Walter Thompson Co.	
RADIART CORPORATION	40, 41
Agency: Stern and Warren	
RADIO CITY PRODUCTS COMPANY	59
Agency: Jaman Advertising, Inc.	
RADIO CORPORATION OF AMERICA	7, Back Cover
Agency: J. Walter Thompson Co.	
RADIO MERCHANDISE SALES, INC.	52
Agency: Reid Associates	
RADIO RECEPTOR COMPANY	62
Agency: Walter J. Zimmerman & Associates	
RAULAND CORPORATION	5
Agency: MacFarland, Ayrsvard & Co.	
REGENCY DIVISION, I.D.E.A., INC.	25
Agency: Burton Browne, Advertising	
JOHN F. RIDER PUBLISHER, INC.	60
Agency: Shappe-Wilkes, Inc.	
HOWARD W. SAMS & COMPANY, INC.	46
Agency: George Brodsky, Advertising	
SHURE BROTHERS, INC.	47
Agency: Casler, Hempstead & Hanford, Inc.	
SIMPSON ELECTRIC COMPANY	31
Agency: Burton Browne, Advertising	
SMITH ELECTRIC MANUFACTURING CO.	59
SNYDER MANUFACTURING COMPANY	17
Agency: Brooks and London	
SPRAGUE PRODUCTS COMPANY	45
Agency: The Harry D. Bridge Co.	
STANDARD TRANSFORMER CORPORATION	49
Agency: Burnet-Kuhn Advertising Co.	
SYLVANIA ELECTRIC PRODUCTS, INC.	3
Agency: Ceill & Presbrey, Inc.	
TEL-A-RAY ENTERPRISES, INC.	8
Agency: Keller Crescent Co.	
TELEX, INC.	51
Agency: George Homer Martin Associates	
TRIPLETT ELECTRICAL INSTRUMENT CO.	10
Agency: Western Advertising Agency, Inc.	
TUNG-SOL LAMP WORKS, INC.	55
Agency: E. M. Frevstadt Associates, Inc.	
UNGAR ELECTRIC TOOL COMPANY, INC.	60
Agency: A. James Rouse Co.	
WALKER-JIMIESON, INC.	62
Agency: Edward C. Kennedy	
WEBSTER-CHICAGO CORPORATION	11
Agency: Fuller & Smith & Ross, Inc.	



# A Controlled Curve For Better Performance!

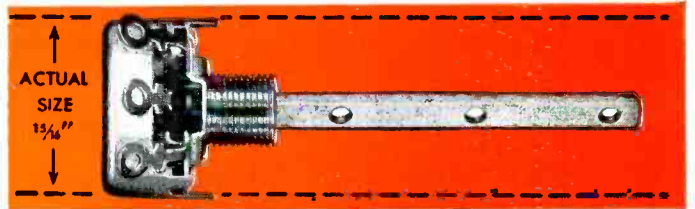
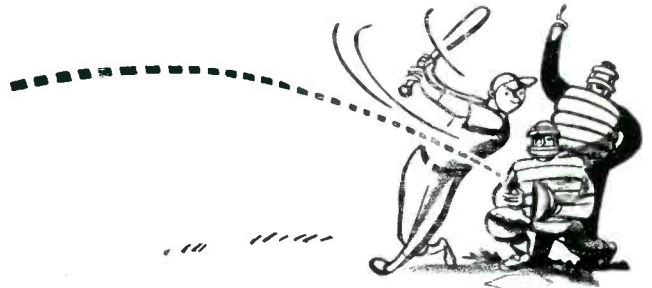

## The Mallory Midgetrol

The resistance taper of the Mallory Midgetrol makes a smooth, controlled curve. No sharp breaks . . . perfect attenuation. An exclusive Mallory engineered machine automatically forms the taper . . . removes all chance of human error. Each Mallory Midgetrol element is a duplicate of every other element of the same rating. And each element gives you accurate over-all resistance and ample current-carrying ability.

The Mallory Midgetrol is the answer to your control problems. A  $\frac{15}{16}$ " diameter control with electrical characteristics superior to  $1\frac{1}{8}$ " controls, it lets you standardize on *one* control for all of your replacements!

### WIDER APPLICATION

The small size allows you to service portables, auto radios and small AC-DC receivers requiring  $\frac{15}{16}$ " controls.

### LESS INVENTORY

Electrical characteristics allow you to use the Mallory Midgetrol to replace large as well as small controls. No special shafts required. You carry fewer controls in stock.

### SIMPLER INSTALLATION

The new and unique flat shaft design of the Mallory Midgetrol saves installation time with all types of knobs.

See your Mallory distributor for this new standard in carbon controls!

P. R. MALLORY & CO. Inc.  
**MALLORY**

CAPACITORS . . . CONTROLS . . . VIBRATORS . . .  
SWITCHES . . . RESISTORS . . . RECTIFIERS . . .  
VIBRAPACK\* POWER SUPPLIES . . . FILTERS  
\*Reg. U. S. Pat. Off.

**APPROVED PRECISION PRODUCTS**

P. R. MALLORY & CO., Inc., INDIANAPOLIS 6, INDIANA

# Now... the new RC-16

## RCA RECEIVING TUBE MANUAL

- ✓ Up-to-the-minute
- ✓ Over 300 pages
- ✓ Latest TV tube data
- ✓ Over 460 tube types
- ✓ "Lie-flat" binding
- ✓ Expanded circuit section



... you should have these other "RCA firsts" in authoritative technical literature

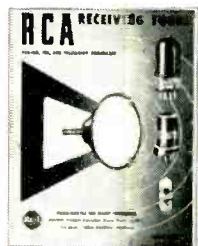

**Receiving Tubes for AM, FM, and Television Broadcast.**  
Bulletin 1275-E.  
Characteristics and base diagrams on over 450 RCA receiving types. 24 pages. Price 10 cents.



**New RCA Triple PindeX at your fingertips...** any 3 base diagrams out of over 600 receiving tubes and kinescopes. Price 75 cents.

**RCA Television Pict-O-Guides.** For quick and accurate TV trouble shooting by picture analysis. (See your RCA Tube Distributor for details.)

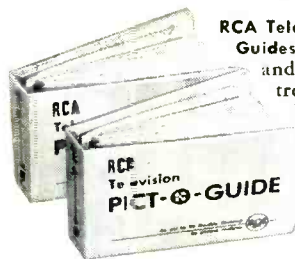

Months of planning and preparation went into the new RC-16 Receiving Tube Manual to produce what is unquestionably the most complete and authoritative reference guide to receiving-type tubes ever published.

Patterned after the famous RC-15—of which over 600,000 copies were sold—and retaining its proved features, the new and larger RC-16 contains over 300 pages of detailed information on more than 460 RCA receiving tubes and kinescopes.

### Features include

... tube and circuit theory with formulas and examples for calculating power output, load resistance, and distortion for several classes of amplifiers—plus new information on cathode follower design.

... new information on kinescope installation and handling.

... a classification chart which groups types having similar characteristics and the same filament or heater voltages. Also shows miniature types and their GT equivalents.

... expanded circuit section, including many new audio amplifier and receiver designs.

... design data and charts for resistance-coupled amplifiers.

A textbook in itself, the new RC-16 is the most valuable day-to-day tube reference guide in the field... yet it costs only 50 cents! **Get your copy today from your local RCA Tube Distributor.**

For quick action—

----- Mail this coupon to your **RCA TUBE DISTRIBUTOR** \*

Mr. RCA Tube Distributor:  
Please rush RCA Technical Literature checked below for which remittance is enclosed—

Name \_\_\_\_\_

Address \_\_\_\_\_

City \_\_\_\_\_ Zone \_\_\_\_\_ State \_\_\_\_\_

- RC-16 RCA Receiving Tube Manual (50 cents)       Receiving Tubes for AM, FM, and TV (10 cents)
- RCA Triple PindeX, New Edition (75 cents)      Tell me how I can obtain Volume I  Volume II  of the RCA Pict-O-Guide



**RADIO CORPORATION  
of AMERICA**

ELECTRON TUBES      HARRISON, N. J.

\*If you do not know your RCA Tube Distributor, orders may be sent to RCA, Commercial Engineering, Section J56U, Harrison, N. J.