

SERVICE

May
1950

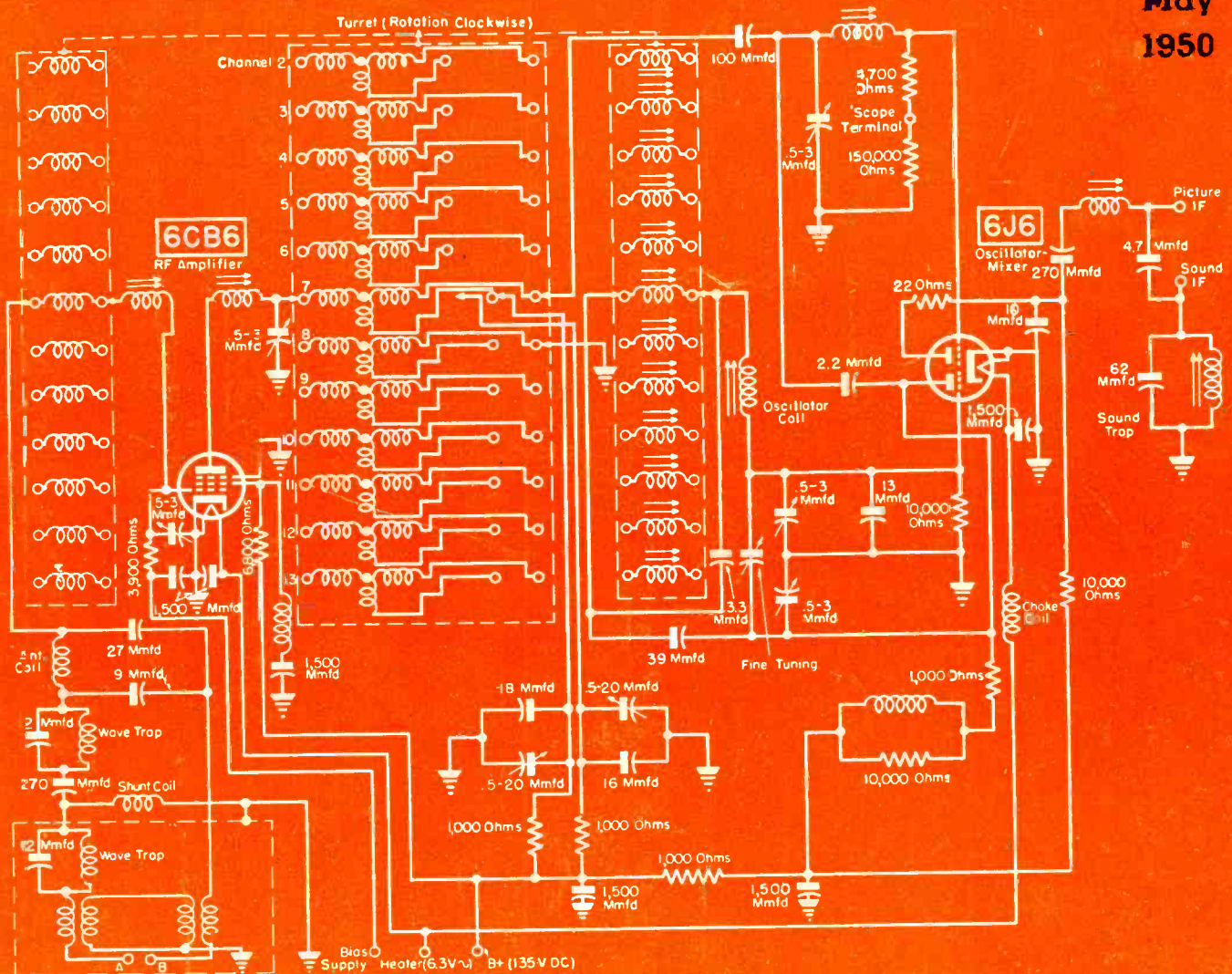

Twelve-channel cylindrical turret-type printed-circuit tuner featuring a pair of elevator transformers in input which serve to match to 300-ohm line and attenuate noise which may be induced in line.

[See page 2]

THE GREATEST

DEVELOPMENT IN TUBULAR

CAPACITORS IN 25 YEARS



WELDED LEADS

another

C-D first!

now available in "BLUE CUB"*

paper tubular capacitors

Only C-D moulded tubulars have welded leads!

- Sturdy welded joints between wire leads and foil of capacitor section results in permanent connections; no intermittents; no open-circuit defects!
- Permanent bond between lead wire and foil electrodes will withstand soldering temperatures, shock, vibration and rough handling.

That's why "Blue Cubs"* have become the fastest selling moulded tubular on the market today. In addition to "Leadweld"* terminals you get all these plus features:

STYRICAST* MOULDED—

The only tubular cast in plastic after Vikane* impregnation. No heat or pressure to pinch, distort or injure unit.

FIXEDRESIN* CASE—

Will withstand temperatures up to 300° F. without softening.

VIKANE* IMPREGNATION—

Only C-D tubular capacitors are Vikane* impregnated. This superior impregnant provides high stability of all electrical characteristics during long service life with exceptionally high insulation resistance, low power factor, and great durability under voltage stress.

For fewer servicing headaches, more satisfied customers and greater profits—insist on C-D "Blue Cubs"! Best by Field Test!

CORNELL-DUBILIER ELECTRIC CORPORATION, Dept. S50, South Plainfield, New Jersey. Other plants in New Bedford, Brookline and Worcester, Mass.; Providence, R. I.; Indianapolis, Ind., and subsidiary, The Radiart Corp., Cleveland, Ohio.

For nearest C-D jobber see your local Classified Telephone Directory.



*® 1910-1950

CONSISTENTLY DEPENDABLE

CORNELL-DUBILIER

CAPACITORS • VIBRATORS • ANTENNAS • CONVERTERS



SUBSIDIARY

BERKS ELECTRONIC SERVICE
 COMMUNICATIONS - AERONAUTICAL - INDUSTRIAL
 423 BUTTONWOOD STREET
 PHONE 56239 READING, PA.

**CONFIDENCE
 STARTS HERE!**



**DO YOU HAVE THESE G-E
 SALES BUILDERS?**

- NEW 4-way plan for more business
- NEW electric window sign
- NEW outdoor metal sign
- NEW luminescent window card
- NEW decalcomania
- NEW tube storage-display cabinet
- NEW newspaper ad mats
- NEW postcard promotion mailers
- Convenient G-E pocket office
- Handy G-E tube puller
- Techni-talk Magazine
- TV service course
- Distinctive shop garments
- Wall plaque
- Giant tube cartons
- Imprinted stationery and business cards
- Repair and tube-test stickers
- Job-tickets and shipping labels

"It's the 'G-E' on my store window that brings in customers. And 'G-E' on the tube cartons on my shelves leads them to buy!" Radio-TV servicemen unite in this statement, for their sales have proved the *pull* of the General Electric trademark.

Also . . . more business comes to G-E tube dealers because *all* their needs are met with a complete line of TV-picture, metal, glass, and miniature types, as well as germanium diodes and selenium rectifiers. Profits are bigger by reason of General Electric's sensational group of plus-powered promotion helps (the list at the left shows how many *new* items there are to give your 1950 sales a jet take-off).

Phone or write your G-E tube distributor . . . today. He'll show you how to make real money from an active local market you can dominate with G-E tubes to install and sell, G-E promotions to help you sell! *Electronics Department, General Electric Company, Schenectady 5, N. Y.*

You can put your confidence in—

GENERAL  ELECTRIC

181-JA4

SERVICE, MAY, 1950 • 1



LEWIS WINNER
Editorial Director

F. WALEN
Assistant Editor

ALFRED A. GHIRARDI
Advisory Editor

	Page
Association News	36
Auto Radio Noise Cures. By Jack Darr	22
Experimental UHF TV Tuner and Converter. By E. I. Jeffrey	20
Phono Installation and Service. By Kenneth Stewart	56
Printed Circuit TV Tuner (Cover)	48
Ser-Cuits (Motorola TV Chassis)	38
Servicing Helps. By M. A. Marwell	28
Ten Years Ago in Associations	36
Tube News (Auto, PA and TV Types) By L. M. Allen	34
TV Electronic Magnifier Conversion Installations. By B. W. Marwyn	46
TV Receiver Production Changes. By Donald Phillips	52
TV Sync and Inter-Sync Systems. By Edward M. Noll	74
Views and News. By Lewis Winner	19
CIRCUITS	
Dry-Disc Voltage Doublers	28
Electronic Magnifier Circuit for Air King, Ansley, Base, Crosley, DeWald, Hoffman, International Television, Nielsen, Philmore, RCA, and Starret Chassis	46
Electronic Magnifier Circuit for Federal Television, Olympic, Philharmonic, Teletone, U. S. Television and Western Auto Supply Chassis	46
Electronic Magnifier Circuit for Artone, Gamble-Skogmo, Hallicrafters, United Motors and Video Corp. of America Chassis	46
Electronic Magnifier Circuit for Midwest and Scott Chassis	47
Electronic Magnifier Circuit for Sears Roebuck Chassis	47
Emerson 634B	58
Experimental UHF Converter	20
Experimental UHF Tuner and Power Supply	21
G.E. 802 Contrast Control Circuit	31
Motorola TS-16/TS-30 Chassis	39
Raytheon Built-In Antenna	44
Raytheon 12AX22 TV Chassis	53
RCA 206E3 Printed Circuit Tuner (Cover)	48
Westinghouse Electronic Magnifier Circuitry	44
COVER	
Printed Circuit TV Tuner (RCA 206E3)	48
PHONO INSTALLATION and SERVICE	
Emerson Receiver Three-Speed Automatic Record Changers	56
Changer-Amplifier Design Highlights	62
G.E. Three-Speed Dual-Style Changer Features	58
Velocity-Trip Mechanism Operation	59
Westinghouse Receiver Three-Speed Changers	59
SERVICING HELPS	
G.E. 801, 802, 803 TV Modifications Involving Insufficient High Voltage, Picture-Width Circuitry, Linearity and Contrast Control	30
Cabinet Repair Suggestions	32
Dry-Disc Rectifier Circuit Trouble Shooting	28
Westinghouse H-196, H-207, H-210, H-211, H-217 and H-188 Revisions to Prolong Tube Life; Improve Vertical Hold; Eliminate Audio Hum, Cabinet Buzz and Dial Pointer Rattle	32
TV RECEIVER PRODUCTION CHANGES	
Cures for Severe Horizontal Shift in Raytheon 12½" Models	52
Eliminating Squegging in Horizontal AFC Circuit in Raytheon Chassis	52
Raytheon 12AX22 Chassis Modifications	79
Securing Better Picture Centering, Increasing Range of Vertical Hold Control, Improving High-Voltage Supply Dressing, Providing 6V6 Tube Protection and Eliminating Folding in Raytheon Receivers	77
Westinghouse V-2150-176 Chassis Changes	79
Index to Advertisers	
Manufacturers	
Jots and Flashes	80
News	51
New Parts . . . Instruments . . . Accessories	54
TV Parts . . . Antennas . . . Accessories	55

Entire contents Copyright 1950, Bryan Davis Publishing Co., Inc.



Published monthly by Bryan Davis Publishing Co., Inc.
52 Vanderbilt Avenue, New York 17, N. Y. Telephone MUrray Hill 4-0170



Bryan S. Davis, President Paul S. Weil, Vice-Pres., Gen. Mgr. F. Walen, Secretary A. Goebel, Circulation Manager

East-Central Representative: James C. Munn, 2253 Delaware Dr., Cleveland 6, Ohio. Telephone: ERview 1-1726

Pacific Coast Representative: Brand & Brand, 1052 W. Sixth St., Los Angeles 14, Calif. Telephone: Michigan 1732

Suite 1204, Russ Building, San Francisco 4, Calif. Telephone: SUTter 1-2251

Entered as second-class matter June 14, 1932, at the Post Office at New York, N. Y., under the Act of March 3, 1879. Subscription price: \$2.00 per year in the United States of America and Canada; 25 cents per copy. \$3.00 per year in foreign countries; 35 cents per copy.

"Leave it to Sylvania!"



SYLVANIA ANNOUNCES...



"Another Sylvania advance!"

Two Outstanding New

"That's great news for TV Service men!"



TV Test Instruments!

Sylvania's early pioneering in radio testing devices naturally places this company in a position to step ahead in the field of television testing equipment.

So again Sylvania comes through! This time for service dealers everywhere, with a splendid new line of TV Test Equipment. Here are the first two instruments in this line. A new TV Marker Generator will be announced soon. Mail coupon for prices and latest specification sheets.

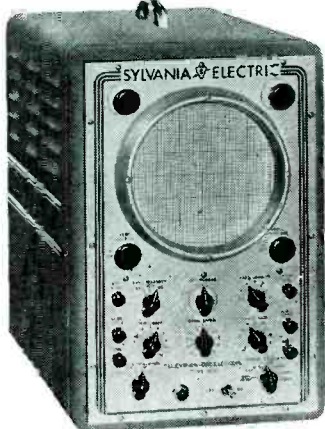

Type 400

Sylvania TV Oscilloscope

Here's an entirely new high gain, wide band oscilloscope especially designed for television. Accurately displays any TV pulse, wave-shape or signal on a large 7-inch screen. Has excellent tilt, rise-time, and overshoot characteristics. Features include: 3-position frequency-compensated attenuator; vernier gain control; low internal hum level. Mail coupon for full details.

Sylvania TV Sweep Signal Generator

This compact instrument is equipped with electronically controlled sweep circuits to eliminate the complexities inherent in mechanical type sweeps.

The smooth attenuator gives continuous control of the output from 300 microvolts to the maximum of .1 volt. Voltage-regulated power supply insures good frequency stability. Double shielded to prevent unwanted signal leakage.

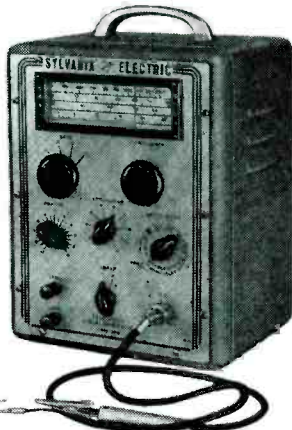

Type 500

RADIO TUBES; TELEVISION PICTURE TUBES; ELECTRONIC PRODUCTS; ELECTRONIC TEST EQUIPMENT; FLUORESCENT LAMPS, FIXTURES, SIGN TUBING, WIRING DEVICES; LIGHT BULBS; PHOTOLAMPS; TELEVISION SETS

SYLVANIA ELECTRIC

Sylvania Electric Products Inc.
Advertising Dept. R-1705
Emporium, Pa.
Please send me full details about Sylvania's new TV Test Equipment.
Name _____
Street _____
City _____ Zone _____ State _____

**KESTER
SOLDER**

Give top quality TV service with Kester "Resin-Five" Core Solder

**MADE ONLY FROM NEWLY MINED
GRADE A TIN AND VIRGIN LEAD**

TV—the nation's fastest growing business demands the nation's number 1 solder. Kester "Resin-Five" Core Solder, formulated especially for TV, will out perform any solder of the rosin-core type. It easily solders such metals as brass, zinc, nickel-plate, copper, and ferrous alloys.

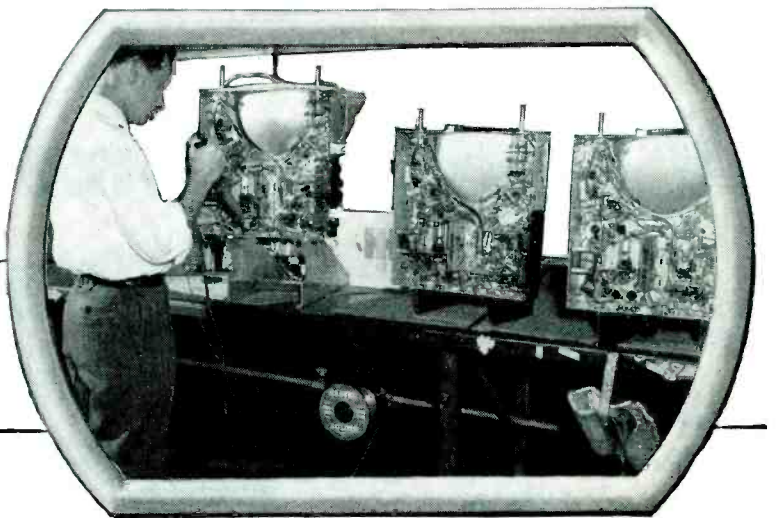
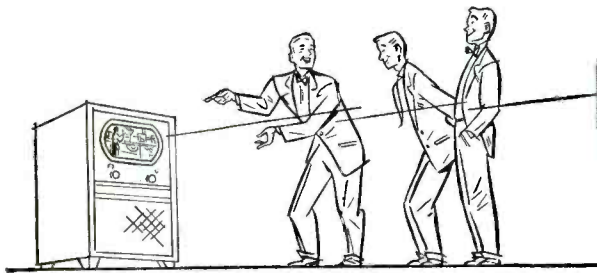

'Resin-Five' Core Solder

non-corrosive . . . non-conductive

Kester... Standard for the TV and Radio Fields

SEE US AT BOOTH 111, STEVENS HOTEL
MAY 22-25

"Resin-Five" flux is more active and stable than any other rosin-type flux. Yet it is absolutely non-corrosive and non-conductive.

FREE SOLDERING BOOKLET—Send for Your
Copy of — *Soldering Simplified*

Kester Solder Company
4248 Wrightwood Avenue • Chicago 39, Illinois
Newark, New Jersey • Brantford, Canada



THESE LEADING SET MAKERS

Emerson

Motorola
airOking

Admiral
Hallicrafters

Spartan

Sentinel

PHILCO

BENDIX RADIO
REG. U.S. PAT. OFF.

STROMBERG-CARLSON

Westinghouse

Majestic

SETCHELL-CARLSON, INC.
CROSLEY

Seen these Hytron firsts in popular new TV sets? The prominent TV set makers shown are using them. And the list is growing.

DuMont, for example, now uses the 1X2 and 6BQ6GT. You'll see many more of these famous tubes. And many more new Hytron types designed for low-cost TV for the mass market. When you buy these Hytron firsts, follow the leading set manufacturers. Buy the original. Buy Hytron!

choose one or more of
THESE HYTRON TV FIRSTS

HYTRON
TV FIRST

1X2
compact,
high-voltage
TV rectifier.



HYTRON
TV FIRST

6U4GT
high-
performance
damping
diode.



HYTRON
TV FIRST

1CRP4
original rectangular
TV picture tube.

HYTRON
TV FIRST

6BQ6GT,
25BQ6GT
extra-
performance
deflection
amplifiers.



HYTRON
TV FIRST

12BH7
twin-triode
sweep amplifier
with superior
efficiency.



Relax! LET HYTRON TOOLS
EASE YOUR WORK

SOLDERING AID 49c net

TUBE LIFTER 15c net

TUBE TAPPER 5c net

BY THE MAKERS OF
HYTRON TUBES

FREE

New Hytron Tool Catalogue. Describes all the famous Hytron Service Shop tools to date: Soldering Aid, Tube Lifter, 7-Pin and 9-Pin Straighteners, Tube Tapper, and Auto Tool. Find out how these Hytron Tools can ease your work. Learn how you can save money. Send for your free copy today!

OLDEST MANUFACTURER OF RECEIVING TUBES
HYTRON
RADIO AND ELECTRONICS CORP.



MAIN OFFICE: SALEM, MASSACHUSETTS

SERVICE, MAY, 1950 • 5

NOW! Convert 10"-12½"

Quickly, Profitably, Easily with

NEW! NORELCO DUO-VUE
world's first dual-purpose TV offers
3' x 4' picture — \$199.50 list*

NEW! PROTELGRAM "CONVERSION PACKAGE"
makes possible huge 234 sq. in.
picture for trade-in buyers



This 2½" 3NP4 is smallest projection tube on market, is lowest in cost (\$19.50 retail), produces largest home picture (3'x4').



PROTELGRAM

North American Philips has really BIG PROFIT NEWS for you—and BIGGER, BETTER PROTELGRAM TV pictures for your customers, up to 3' x 4' in the sensational NORELCO DUO-VUE now making its world premiere at \$199.50 — more television picture for less money than ever before offered!

What is there in it for you? PROFITS from PROTELGRAM'S Four-Way Plan described on the right.

Philips makes it easy and profitable for you to—

1. Sell PROTELGRAM to set builders interested in bigger pictures — 13½" x 18".

2. Sell PROTELGRAM for custom-built, large-screen installation, up to 3' x 4' for homes, clubs, bars, hotels, etc.

3. Sell NORELCO DUO-VUE, television's newest, finest and biggest picture used with the customer's direct-view table set to produce 3' x 4' pictures on a home-movie screen. A flip of a switch selects either picture, and you can connect DUO-VUE to almost any table-model receiver in less than an hour.

4. Sell PROTELGRAM in a conversion cabinet to customers wanting to convert their 10 or 12½" direct-view receivers to a picture larger than a 20" tube gives. And you can make the conversion in less than one hour following the simple, straightforward instructions provided.

Right NOW is the time to make extra profits with PROTELGRAM. Read every word of this ad. Then get in touch with your distributor or send the coupon now for all the facts.

*Prices slightly higher west of Rockies. Connection charges extra.

NORTH AMERICAN PHILIPS COMPANY, INC.

100 E. 42nd Street, New York 17, N. Y.

16" Sets to BIG PICTURE TV PROTELGRAM

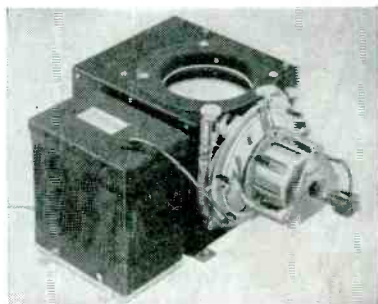

PROTELGRAM UNIT

Projection box measures only 8½" x 9" x 13", contains optical system and alignment assembly, is designed for quick easy service and adjustment. The 2½" 3NP4 projection tube is long-lived, extremely low in cost. Compact 25KV high-voltage unit is only 8½" x 4½" x 7".

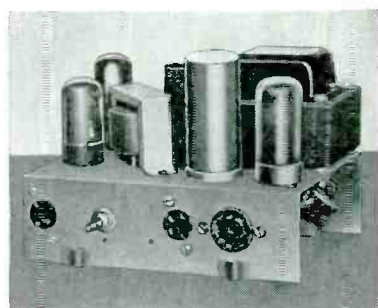

AUXILIARY CHASSIS

New auxiliary chassis fills additional electrical requirements essential to adaption of TV chassis to PROTELGRAM; makes change-over quick and easy. Measures only 8" x 12" x 4".



CONVERSION CABINET

Console cabinet measuring 22" x 27¼" x 46½" provides space for installation of customer's 630 Type TV chassis, comes equipped with complete PROTELGRAM system, auxiliary chassis, cabinet mirror and viewing screen.



NORELCO DUO-VUE

Beautiful cabinet contains PROTELGRAM unit. Only 23½" high. 20" x 26" top holds most any 10" or larger direct-view table model. Concealed ball-bearing casters make it easy to pull out from wall for 3' x 4' viewing on external screen. Offers customers choice of two picture sizes for small and large group viewing.

FOUR-WAY Profit Plan

1 Sell PROTELGRAM to the man who builds his own!

Thousands of TV kits have been sold to the man who likes to build his own equipment. These handymen are ripe for PROTELGRAM, because they can combine it with a TV chassis, get life-size TV at a reasonable cost.

2 Sell PROTELGRAM to custom set buyers

Clients who want built-in installations in walls or cabinets are perfect prospects for PROTELGRAM. Huge picture size, plus compactness and flexibility, makes it the answer for this type of user.

3 Sell PROTELGRAM to trade-in customers

PROTELGRAM sells itself to customers who want bigger pictures, but are reluctant to take a trade-in loss. You can now use their present TV chassis, connect it with PROTELGRAM in a cabinet such as shown at (3) left. They get a 234 square-inch picture, 13½" x 18"

4 Sell NORELCO DUO-VUE for largest home-TV pictures

Only with NORELCO DUO-VUE can you offer both direct-view and 3' x 4' movie-size TV... and at a reasonable price. This is the newest thing in television for your customers who want the best. Lots of sales opportunities in bars, clubs, institutions and hospitals, too.

CONTACT YOUR DISTRIBUTOR OR SEND COUPON TODAY

NORTH AMERICAN PHILIPS COMPANY, INC.
Dept. PL-5, 100 East 42nd Street, New York 17, N. Y.

Gentlemen: Please send full information as checked

- PROTELGRAM SYSTEM NORELCO DUO-VUE unit
 PROTELGRAM SYSTEM PROTELGRAM SYSTEM
with auxiliary chassis for conversion console

NAME..... POSITION.....

FIRM NAME.....

ADDRESS.....

CITY..... STATE.....

- Check here for Dealer Information on
 Norelco Electric Shaver Lady Norelco Electric Razor

Hiawatha was a PIKER!



"Go out into the world," said Pops*
"and don't come back 'till you're proved tops!"



The water test he passed with ease,
Earning a feather was just a breeze...



Heat was applied to test his worth
In "hot spots" he then won a berth...



The life test took a long, long time
Though others quit — he kept his prime...



His leads proved strong—his casing tough
It did no harm to treat him rough!

His Pops was pleased when he came through
We know you'll like the Redskin, too!

Sangamo's New Molded Paper Tubular Capacitor gives LONG LIFE under severe conditions!

The REDSKIN is easy to work with—on production line or on the bench—because the especially designed flexible leads resist breakage and can't pull out! It offers greater mechanical strength because of its plastic construction. It is molded under *low* pressure, assuring elements undamaged in fabrication, longer life and greater dependability. It is an 85° C tubular which offers assurance of long life under television and other severe operating conditions.

A trial of these *better* molded tubulars will convince you. See your jobber—if he can't supply you, write us.

*Big Chief Sangamo



SANGAMO ELECTRIC COMPANY
SPRINGFIELD, ILLINOIS

In Canada: Sangamo Electric Company Limited, Leaside, Ont.



850-1

There's Real SALES PULL in these Facts about... GENERAL ELECTRIC SPEAKERS!

IT PLAYS UNDER WATER! Submerged in water, the G-E speaker continues to deliver sound reproduction day in and day out. Do you know of any other speaker that will take a similar beating? The answer is in G.E.'s waterproof Voice Coil...the hottest selling feature in any speaker today!



WHEN you're out to corral new business (and what smart dealer or serviceman isn't?) give yourself a head start by selling the line that's booming along today at a dollar volume 40% higher than last year's record...

General Electric speakers—from the 4" replacement unit to the famous 12" high fidelity champion—are packed with features that assure your customer superb performance and build his confidence in your workmanship. You'll make no mistake when you stock, talk, and sell General Electric speakers!

GREATER MAGNETIC POWER. The stronger the magnet the more sensitive the speaker. Iron filing clusters indicate comparative magnetic strengths...the Alnico 5 alloy used in G-E units is 2½ times as powerful as the standard material previously employed in magnet construction.

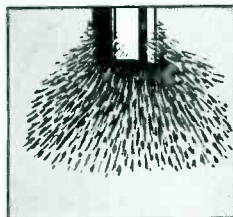
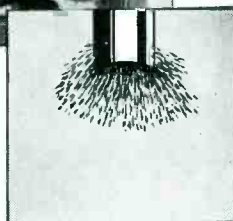

ALL WELD CONSTRUCTION. Rigid enough to support a man's weight, the G-E speaker housing is treated with bright-finish zinc plating...this enables the speaker to resist corrosion long after untreated models have begun to rust.

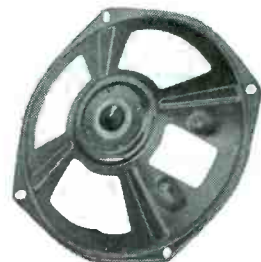

GENERAL ELECTRIC

GET THESE SALES AIDS

Start now to expand your speaker sales. G-E promotion kits help attract new business in home radios, portables, custom installations, drive-in theatres, P.A. systems... Send coupon for full information.



FREE BOOKLET!

General Electric Company, Section 350
Electronics Park, Syracuse, New York

I'm interested in G-E Speakers. Send me new folder illustrated here.

NAME _____

ADDRESS _____

CITY _____ STATE _____

★ **Build Your Service-Sales Future on a Firm Foundation With.....**

PRECISION
TEST EQUIPMENT
Standard of Accuracy...

These 5 "Precision" Instruments Provide a Complete, Modern Service Lab... for TV-FM-AM ...at only moderate cost.

NO. 2 OF A SERIES OF MATCHED COMBINATIONS

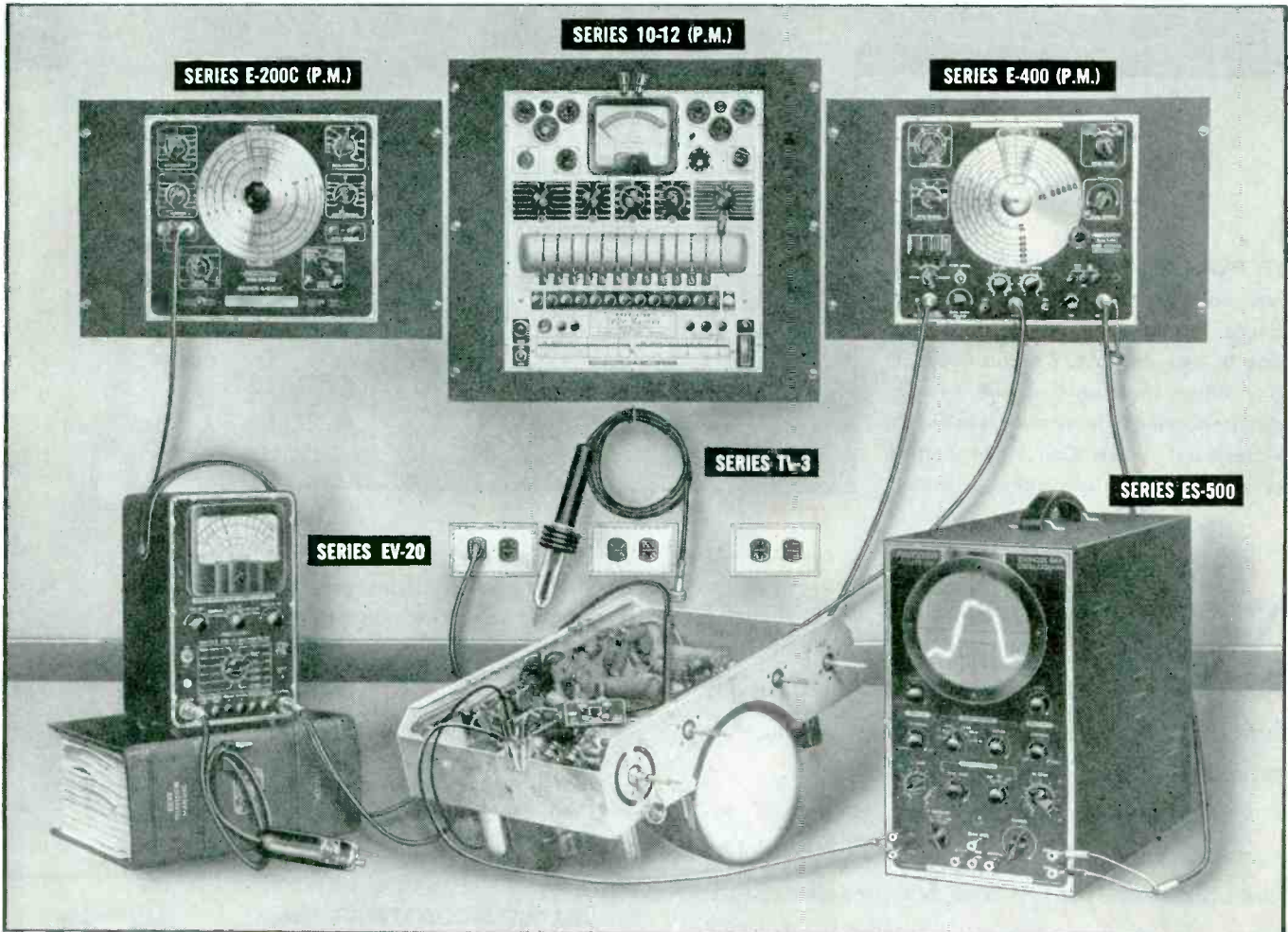

**SERIES E-200C (P.M.)
SIGNAL AND MARKER GENERATOR**

Exceptional Accuracy and Stability • Direct reading • 88 KC to 120 MC. • 1000 pt. vernier calibrating scale • 0-100% Modulation • A.V.C.-A.G.C. Substitution network • Complete with output cable and technical manual. In standard panel 19 x 12 1/4".
Net Price: \$69.70

**SERIES E-400 (P.M.)
SWEEP SIGNAL GENERATOR**

Narrow and Wide Band Sweep for F.M. and TV • Direct Freq. reading 2 to 480 MC. • Multiple Crystal Marker • 8 tubes including V.R. and rectifier • RG/62U Coaxial Terminated Output • Complete with 2 crystals. In standard panel 19 x 12 1/4".
Net Price: \$127.55

**SERIES ES-500
5" OSCILLOSCOPE**
Wide Range
High Sensitivity

V. Amp. Response to 1 MC. • Low C, High R input Step Attenuator • 2 axis modulation terminals • 9 tubes incl. V.R. and 2 rectifiers • Complete with light shield and mask • Heavy gauge steel case. 8 1/4 x 14 1/2 x 18".
Net Price: \$149.50

**SERIES EV-20
True Zero Center VTVM
& Multi-range Test Set**

48 ranges to 1200 V., 2000 megs., 63 DB, 12 amps. • Voltage Regulated Bridge Type Circuit • 13 1/3 Megs. D.C. Input resistance • Direct reading high freq. scales • Optional RF-10-A High Freq. Probe • Heavy gauge steel case 6 1/4 x 5 x 10 1/2".
Net Price: \$64.75

**SERIES 10-12 (P.M.)
Electronamic*
TUBE MASTER**

Employs famous "PRECISION" Electronamic tube performance testing circuit plus dynamic Battery Tester • 12 element, anti-obsolete-free-point lever system • Roller-chart • Dual short-check • Noise tests • In standard panel 19" x 17 1/2".
Net Price: \$99.40

SERIES TV-3 SUPER HIGH VOLTAGE SAFETY TEST PROBE. Extends range of Series EV-20 to 30 KV direct reading. Series TV probes available to match most VTVM's and 20,000 ohms per volt test sets. (NOTE: For deluxe Series EV-10 VTVM, with extra-large 7" meter, order Series TV-1 probe.)
Net Price: \$15.45

*Reg. U.S. Pat. Off.

BUY PERFORMANCE—NOT SPECIFICATIONS!—BUY "PRECISION"

"PRECISION" PERFORMANCE, ACCURACY, WORKMANSHIP and VALUE have been setting a standard of comparison for over 15 years. **DO NOT BE MISLED...** It is not "PRECISION" test equipment unless it is manufactured by Precision Apparatus Co., Inc., Elmhurst, L.I., N.Y.

OTHER MATCHED COMBINATIONS

The instruments shown above illustrate one of many possible **MATCHED COMBINATIONS** of diversified "PRECISION" Test Equipment for TV-FM-AM. Each combination provides a selected and basic, modern, efficient Laboratory at moderate cost.

"Precision" Instruments are on display at leading radio equipment distributors.



PRECISION APPARATUS CO., INC.

92-27 Horace Harding Boulevard, Elmhurst 6, New York

Export Division: 456 Broadway, New York, U.S.A. • Cables—Morhanex
In Canada: Atlas Radio Corp., Ltd., Toronto, Ontario

Convenient Purchase Terms can be arranged with your favorite Precision Distributor.

• TV • FM • AM

AM • FM • TV •

Are You KEEPING Your TV Installation PROFITS

**... Or paying them back
in "FREE" Service Calls?**

IT'S expensive... following up nuisance calls and "complaints" during guarantee periods... wasteful in truck operation, traveling time and labor. You can reduce your costs to a new low — with the high quality, all-around ruggedness and dependable performance of Federal lead-in cables!

Where noise level is low — Use Federal K-1046 ... with distinctive Federal-developed "silver" polyethylene insulation ... providing 30 per cent more service life than ordinary polyethylene. K-1046 repels sunlight ... fights heat ... doesn't dry out, crack, buckle or leave conductors exposed. It holds its original characteristics longer ... retains its impedance values. In Weatherometer tests, K-1046 surpassed all competitive types.

Where noise level is high — Use Federal K-111 ... shielded lead-in ... another exclusive FTR development. K-111 is a top item in TV because it minimizes noise, snow and ghosts due to transmission line pick-up. Pictures are clearer, brighter and steadier ... all the time. Actually, Federal's K-111 permits TV installations in many noisy areas where good, clear reception was impossible before!

See your distributor now for data and prices on Federal's K-1046 and K-111 ... for that next new installation or lead-in replacement. You can depend on these highly efficient 300-ohm lead-ins to keep service calls down ... to keep profits UP. Insist on Federal ... it pays to start with the best!

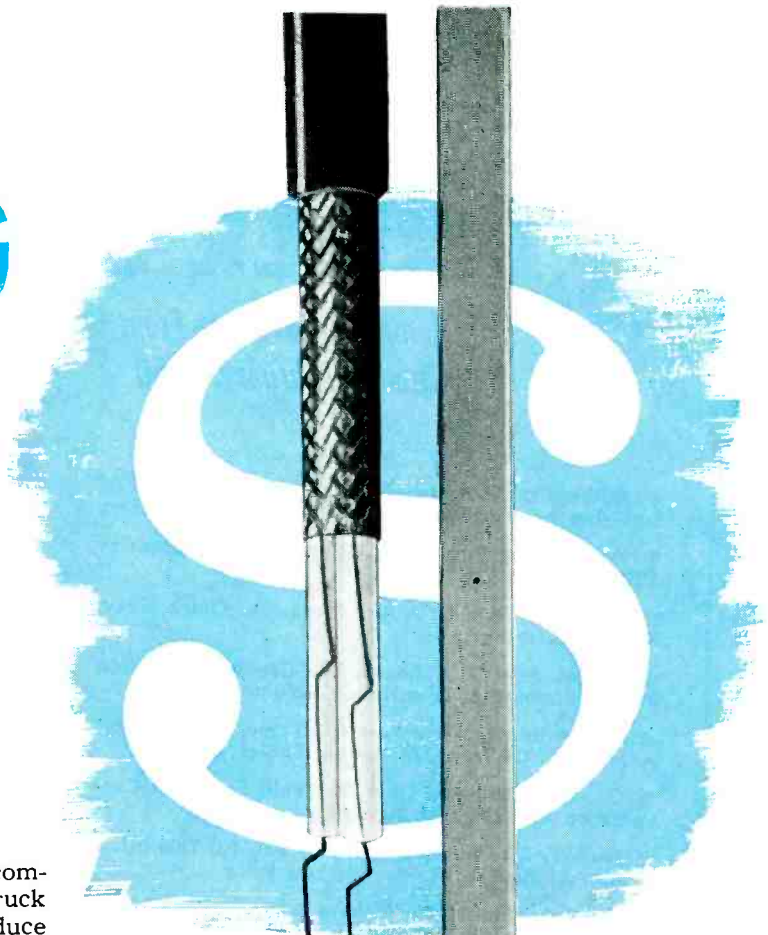

K-111
300-Ohm
Shielded
Lead-in for
HIGH
Noise Level
Areas

K-1046
300-Ohm
"Silver"
Polyethylene
Lead-in for
LOW
Noise Level
Areas

These **2**
**Federal TV Lead-ins Protect
Your Profits in
HIGH and LOW
Noise Level Areas**

America's largest producer of solid dielectric high-frequency cables



Federal Telephone and Radio Corporation



SELENIUM and INTELIN DIVISION, 100 Kingsland Road, Clifton, New Jersey

In Canada: Federal Electric Manufacturing Company, Ltd., Montreal, P. Q.
Export Distributors: International Standard Electric Corp., 67 Broad St., N. Y.

The Greatest TV Servicing Manual Ever Published!

more data than ever before! ...at the same low price!

NEW

RIDER TV MANUAL VOL. 4

Complete Coverage From October, 1949 through February, 1950

- Authentic, Accurate, FACTORY-AUTHORIZED TV Servicing Information Direct From 73 Manufacturers
- New, Larger Page Size, 12" x 15", Equivalent of 2296 Pages (8½ x 11)
- All Pages Filed in Proper Place, For Quick, Easy, Efficient Reference.
- 494 Models. 235 Chassis. The Greatest Collection Ever Assembled In One Handy Volume
- Test Patterns, Wave Forms, Schematics, Voltages, Adjustment Of Traps, Alignment Tables, Etc.
- Giant Pages Have Only One Fold For Extra Convenience And Greater Durability
- Nobody Else But RIDER Brings You All This Information At Such An Amazingly Low Price
- Get Yours Right Now Without Delay. Volume 3 Sold Out in A Few Weeks. Volume 4 should Do the Same

ONLY \$21⁰⁰

Including Cumulative Index Volumes 1, 2, 3 and 4... PLUS the One and Only RIDER "How It Works" Book.

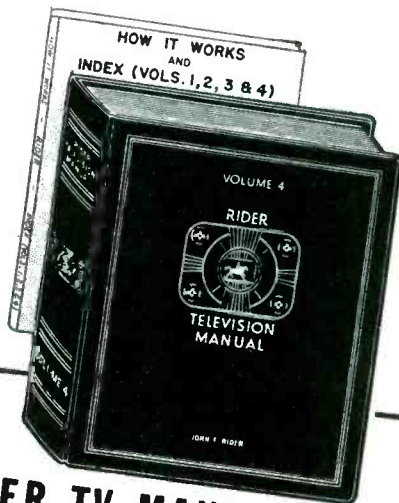

RIDER TV MANUAL VOL. 3

74 Television manufacturers. 441 models. 243 chassis. Larger page size, 12" x 15". All pages filed in their proper place. Equivalent of 2032 Pages (8½" x 11") Plus Cumulative Index Volumes 1, 2 and 3, plus the famous RIDER "HOW IT WORKS" Book. \$21.00

RIDER TV MANUAL VOL. 2

Complete factory-authorized coverage up to January 1949. 67 manufacturers. June delivery—in new, larger page size, 12" x 15". Contains all of the data formerly presented in the 8½" x 11" page size manual. PLUS the RIDER "HOW IT WORKS" Book, and Cumulative Index Volumes 1 and 2 \$21.00

RIDER TV MANUAL VOL. 1

Complete factory-authorized coverage up to early 1948. 34 manufacturers. Equivalent of 2000 pages. (8½" x 11") PLUS Index and the RIDER "HOW IT WORKS" Book. \$18.00

RIDER MANUALS

Television Manual Volume 4 (Plus "How It Works" Book and Index).....	\$21.00	Volume XX.....	\$18.00
Television Manual Volume 3 (Plus "How It Works" Book and Index).....	\$21.00	Volume XIX.....	\$19.80
Television Manual Volume 2 June delivery—in new, larger page size, 12" x 15". (Plus "How It Works" Book and Index).....	\$21.00	Volume XVIII.....	\$19.80
Television Manual Volume 1 (Plus "How It Works" Book and Index).....	\$18.00	Volume XVII.....	\$16.50
PA Equipment Manual, Vol. I.....	\$18.00	Volume XVI.....	\$ 8.40
		Volume XV.....	\$19.80
		Volume XIV to VII (each vol.)	\$16.50
		Volume VI.....	\$12.50
		Abridged Manuals I to V (one volume).....	\$19.80
		Master Index, Covering Manuals, Vols. I to XV.....	\$ 1.50

NOTE: Are you receiving your copy of "Successful Servicing"? It's Rider's own publication of interest to every Serviceman. Write for it...it's FREE!

NOTE: The Mallory TV Service Encyclopedia, 1st TV Edition, makes reference to only one source of TV receiver schematics—Rider TV Manuals.

NOTE: The Mallory Radio Service Encyclopedia, 6th Edition, makes reference to only one source of radio receiver schematics—Rider Manuals.

NOTE: The C-D Capacitor Manual for Radio Servicing, 1948 Edition No. 4, makes reference to only one source of receiver schematics—Rider Manuals.

Another Great RIDER Servicing "Must!"

RIDER MANUAL Vol. XX



Do a better, more satisfactory job... insure repeat business... make a larger net profit. Get RIDER MANUAL Volume XX. Complete coverage up to November, 1949—AM-FM, Radio, Auto Receivers, Record Changers. Products of 74 manufacturers. All pages and double spreads filed in proper positions.

1776 Pages... Plus Separate "How It Works" Book, and Cumulative Index, Volumes XVI to XX. ONLY \$18⁰⁰

JOHN F. RIDER PUBLISHER, Inc., 480 Canal Street, New York 13, N. Y. • Export Agent: Rocke International Corp., 13 East 40th St., N. Y. C., Cable, ARLAB.

RIDER MANUALS mean SUCCESSFUL SERVICING



Losing time and money on too many TV service call-backs?

ATV 225 and all ANACONDA ribbon type and coaxial lines are distributed by Columbia Wire and Supply Company, 2850 West Irving Park Road, Chicago 18, Ill., and sold through recognized jobbers everywhere.

Visit the Columbia-Anaconda Display at the Radio Show, May 22-25, Hotel Stevens, Chicago.

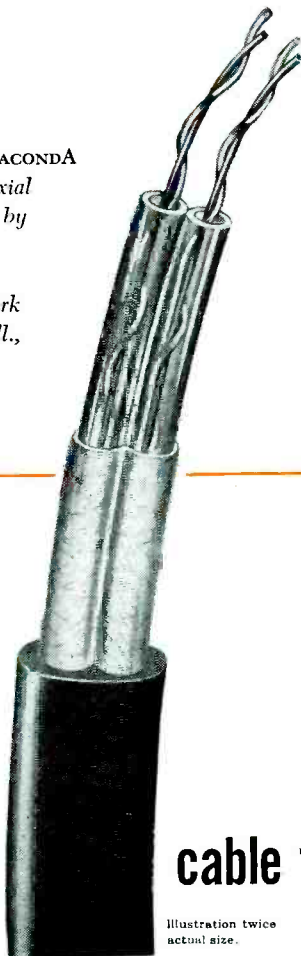

Illustration twice actual size.

Install ATV 225 Shielded Lead-In Lines and cut down time and money lost in servicing.

ATV 225* Shielded Lead-In Lines show as high as 85% noise suppression over unshielded lines.

Pictures are steadier, clearer and more vivid in detail, where external "noise" is a factor.

why? . . .

BECAUSE ATV 225 Shielded Lead-In Lines offer:
HIGH SIGNAL-TO-NOISE RATIO — will not pick up electrical noise . . .

HIGH IMPEDANCE — broad band response over all channels .

and . . .

ATV 225 operates in the open or in conduit without change in electrical characteristics . . . *resists moisture and corrosion* . . . is flame-retarding. Install it with complete confidence. Anaconda Wire & Cable Company, 25 Broadway, New York 4, New York.

50333

*Reg. U. S. Pat. Off.

the right

cable for the job

ANACONDA[®]

WIRE AND CABLE

SERVICE, MAY, 1950 • 13

**ANOTHER TACO
REQUIREMENT-DESIGNED
TYPE ALL-CHANNEL**



TRI-X

● For 16 years Taco has been providing the serviceman with the antenna best suited to his particular needs. For each TV area with its own specific conditions as to channels operating, directivity and signal strength, Taco has provided the best design.

For areas where additional gain is desired on channels 11, 12, and 13, the new Taco Tri-X is now offered. Designed as an alternate for the Lazy X, this new Taco antenna incorporates all the latest developments of the unparalleled Taco Engineering and Research facilities.

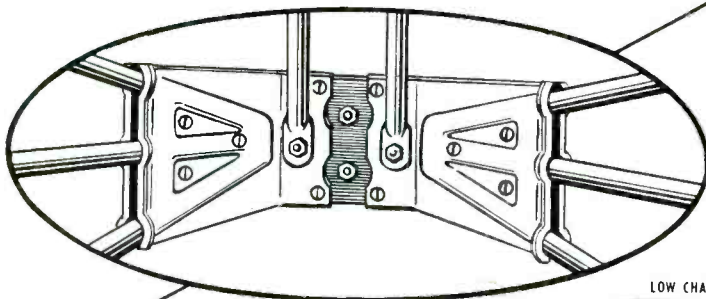
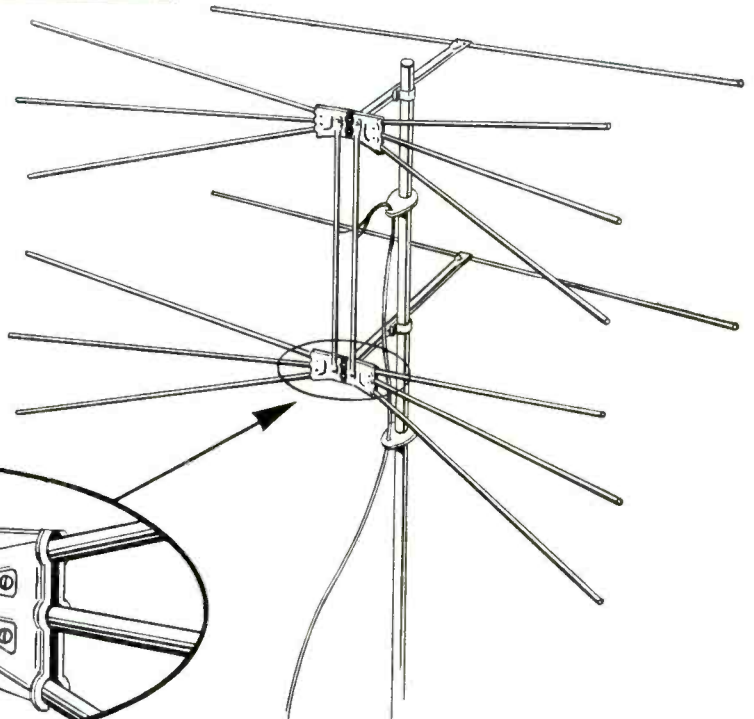

The new apex design used in the Taco Tri-X eliminates the inherent weak point of X type antennas. Heavy aluminum fans, ribbed for extra strength, are bell-mouthed on ends of grooves thus leaving no sharp edges in contact with element rods. Special Taco noise-snubber eliminates bothersome wind-whistle effect. Jiffy-Rig construction provides the fastest, most practical assembly.

SEE YOUR JOBBER FOR PRICE AND DETAIL

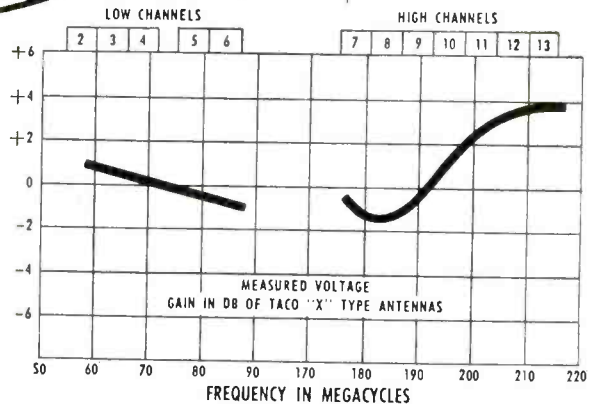

Graphic illustration showing gain of Tri-X compared to Lazy X. Through low-band difference is negligible. In high-band operation the Tri-X shows considerable gain over the Lazy X on channels 11, 12, and 13.

MR. TV SERVICEMAN:

Don't risk your reputation or lose TV receiver sales by gambling with unproven antenna equipment. Taco equipment has proven itself for the past 16 years. Avoid those costly call-backs due to electrical or mechanical failures in antennas.

RADIO AND ELECTRONIC EQUIPMENT



TECHNICAL APPLIANCE CORP.

SHERBURNE, N. Y. • IN CANADA: STROMBERG-CARLSON CO. LTD. TORONTO 4, ONTARIO

SNAP-ON TV FUSE HOLDER!

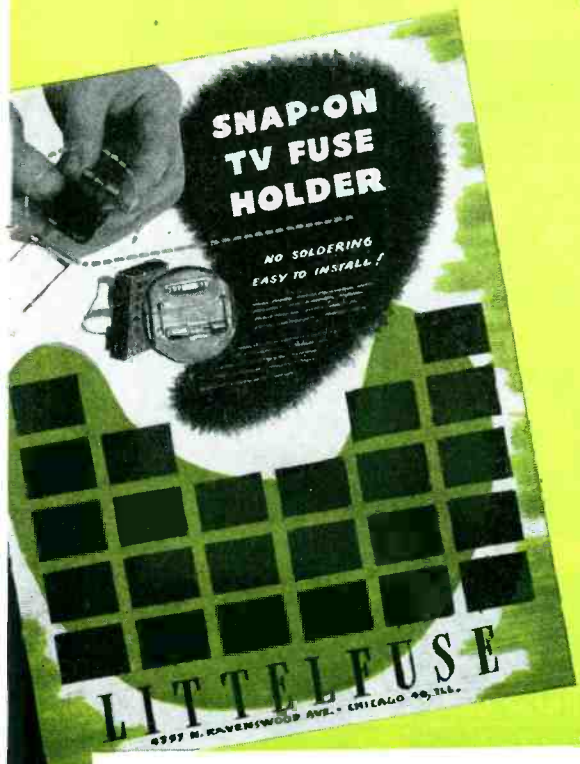

DEAL NUMBER 1

Snap-on fuse holder for quick, easy replacement of TV pigtail fuses. Snap one side of holder on blown pigtail fuse in set. Snap regular replacement fuses in other side—the job is done. No more cutting out the pigtail. No more messy soldering. No more fuses blown by hot irons. Save time, save work, save the customer's money, and still make big TV profits. Service dealer cost, 15c each.

LITTELFUSE INC.

4757 N. RAVENSWOOD AVE., CHICAGO 40, ILLINOIS

2 TV PROFIT DEALS!

DEAL NUMBER 2









TV fuse kit—10 assorted fuses that service all TV receivers—Admiral, Philco, RCA, Zenith, Emerson, Hallicrafters, etc., etc., etc. The serviceman needs the right fuse in his box—it is in this kit when he needs it. Saves time, saves profit. Service dealer cost, 98c each.

LITTELFUSE INC.

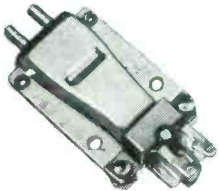
4757 N. RAVENSWOOD AVE., CHICAGO 40, ILLINOIS

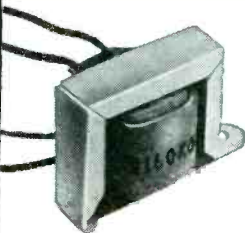

TV FUSE KIT

<p>➔</p> <p>Ganged Tuning Capacitors for all RCA Victor radio receivers.</p>		<p>Volume and Tone Controls with exact taper and compensation for each receiver model.</p> <p>➔</p>		<p>Vitreous Wire-Wound Resistors for B-supply voltage dividers.</p> <p>↓</p>
	<p>←</p> <p>Crystal Cartridges for RCA Victor 45-rpm record players.</p>		<p>←</p> <p>Ceramic Capacitors for RCA Victor television receivers.</p>	
<p>➔</p> <p>Detent and Fibre-Shaft Assemblies for RCA Victor television receivers.</p>		<p>➔</p> <p>Plastic Cabinets each an exact replacement.</p>		<p>Output Transformers. Exact duplicates for every receiver model.</p> <p>↓</p>
	<p>←</p> <p>Dual IF Transformers for RCA Victor AM-FM models.</p>		<p>←</p> <p>"A" Band Oscillator Coils with correct inductance values.</p>	

Always use *Genuine* RCA Service Parts . . . for RCA Victor Radios, Television Receivers, and Record Changers

Customers count on you to return their RCA Victor instruments to their *original* high performance standards . . . by using *genuine* RCA service parts in your work.

Fortunately, that's easy . . . because RCA stocks over 40,000 *different parts* in order that you may repair RCA Victor instruments—old or new—with the least amount of effort and with the assurance that original performance standards will be duplicated.

Genuine RCA service parts are readily available from your local RCA Distributor.

NOW . . . Volume IV, RCA Victor Service Data

This latest volume of RCA Victor Service Data contains an enlarged television section, and provides you with complete service data on 1947-1948 models of RCA Victor Radios, Television Receivers and Record Changers *to be found nowhere else . . .* including complete lists of replacement parts. Get your copy today! Only \$6.00 at your RCA Distributor.

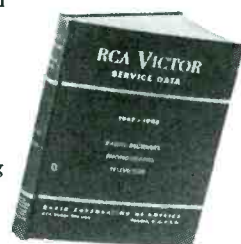

RADIO CORPORATION of AMERICA
ELECTRONIC COMPONENTS **HARRISON, N. J.**

NOW!

2 to 16 Equally Brilliant
Pictures from 1 Antenna* at
AMAZINGLY LOW COST!

BRACH
MUL-TEL
TELEVISION DISTRIBUTING SYSTEM

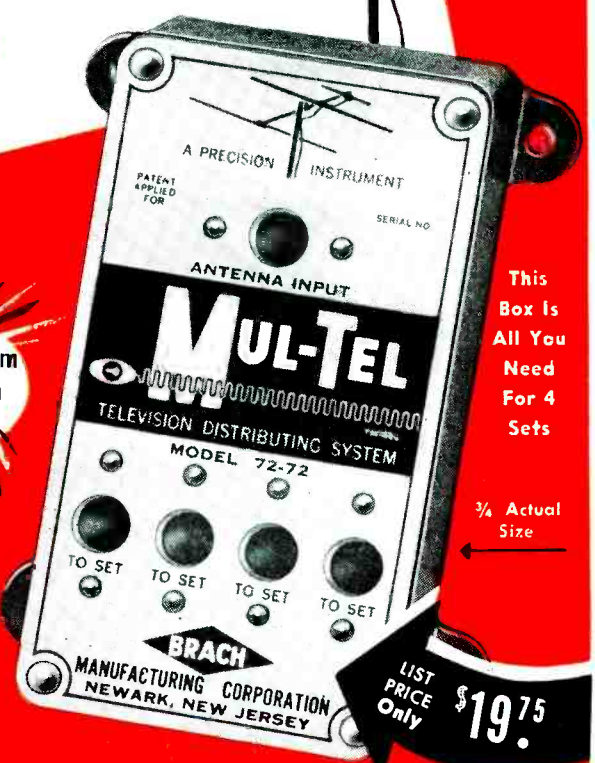

This Box Is All You Need For 4 Sets

3/4 Actual Size

LIST PRICE ONLY **\$19.75**

Features the **BERGER EFFECT**
A New Application of Electronics

Operates Equally Well On All TV & FM Channels

Matches 300 or 72-ohm Transmission Line

INSTALLED IN MINUTES

WORKS WITH ANY GOOD ANTENNA

NO BOOSTER AMPLIFIERS. NO PLUG-IN TO HOUSE-CURRENT

No Switching
No Moving Parts
No Maintenance
No Tubes

YOUR LEADING JOBBER HAS IT!

Produced by Oldest & Largest Manufacturers of Antennas & Accessories

SEE US AT THE RADIO PARTS SHOW
ROOMS 652A, 653A

*Electronically possible through the new BERGER EFFECT which allows a balanced type of TV signal distribution and stops re-radiation.

A TYPICAL HOME-OWNER NOW WATCHES TV IN PEACE. HIS CHILDREN SEE TV IN ANOTHER ROOM.

A TOP-RATED MANUFACTURER URGES INSTALLATION OF MUL-TEL FOR BETTER DEMONSTRATION OF HIS TELEVISION SETS.

A FRINGE-AREA DEALER INCREASED TV SET SALES BY FEATURING MUL-TEL. GARDEN APARTMENT DWELLERS BECAME HOT PROSPECTS OVERNIGHT.

A PROMINENT JOBBER CAN'T SUPPLY MUL-TEL TO HIS DEALERS FAST ENOUGH.

A NEW JERSEY LANDLORD HAS BECOME A HERO TO HIS TENANTS. NOW THEY CAN INSTALL TV. HE INSTALLED MUL-TEL.

BRACH MFG. CORP.
200 CENTRAL AVE., NEWARK 4, N. J.

Gentlemen:

Kindly send me literature on the following:

Mul-Tel TV Antennas TV Accessories

Name.....

Address.....

City..... State.....

Dealer Jobber

If Dealer, Give Jobber's Name and Address

.....

.....

BVC

BRACH MANUFACTURING CORP., 200 Central Ave., Newark 4, N. J. (Division of General Bronze Corp.)

ANCHOR

Ahead Again



**New 2-Stage Pre-Amplifier
Increases Original TV Signal
Strength 5 TIMES**

LIST PRICE
\$44.95

You'll be Ahead Too . . . With Greater Profits Than Ever!

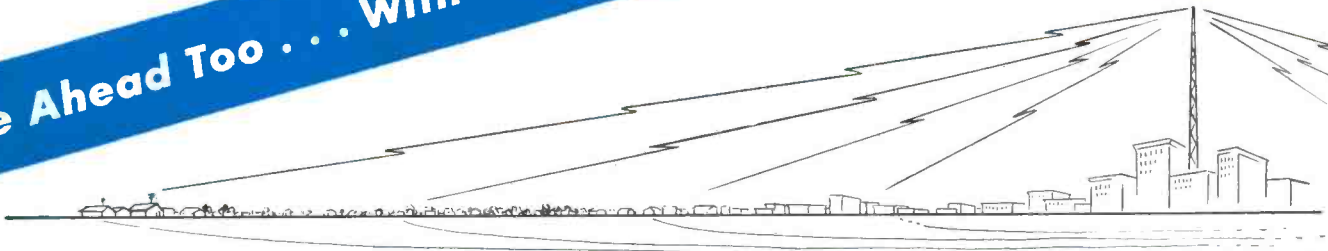

ANCHOR'S NEW 2-STAGE BOOSTER NOW Enlarges Your TV Market for Sales to Thousands of New Suburban and Fringe Area Residents

In 1949 the ANCHOR Single Stage BOOSTER improved television reception for 1 out of every 4 TV Set Owners. Thousands of apartment dwellers, suburban and fringe area residents the nation over demonstrated their preference by making ANCHOR the Number One BOOSTER in sets sold. ANCHOR developed this recognition only through its own top-notch performance by being able to deliver sharp snow-free pictures in most difficult conditions. Now ANCHOR has added the new Two Stage BOOSTER to their line to bring television, and the finest television reception, to everyone. The New ANCHOR Pre-Amplifier Will Out-perform Any Two Stage BOOSTER on the market.

ANCHOR'S performance curves have never been challenged. Undisputed laboratory tests prove that the ANCHOR Two Stage BOOSTER increases the original TV signal strength 5 TIMES.

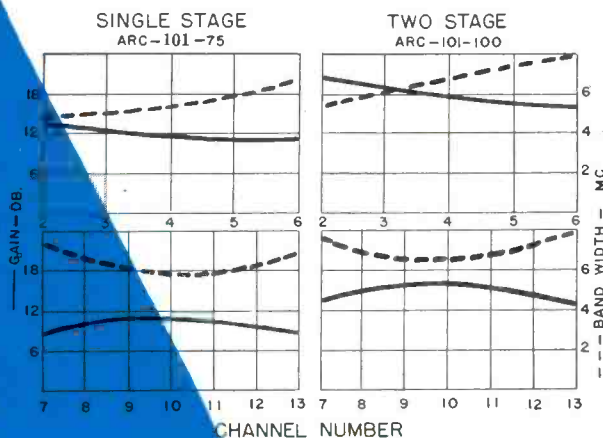

- Single Knob Construction allows switching and tuning with a flick of the wrist.
- Radically new switching of tube and circuit components.
- Modernly styled with streamlined plastic es-cutcheon. Soft mahogany leatherette finish.
- Most stable non-regenerative unit available. The unit that is not returned.

**ANCHOR
ENGINEERING
ALWAYS A
YEAR AHEAD!**

ANCHOR RADIO CORP.
2215 SOUTH ST. LOUIS AVENUE
CHICAGO 23, ILLINOIS



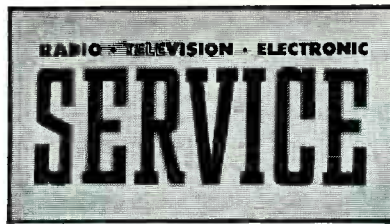

Ultrahighs Begin To Sparkle

THE 500 TO 600-MC band, once considered as a purely experimental playground for the researchist, with any practical possibilities completely removed from the scene, has suddenly bounced into reality, and with a resounding zoom. The reason . . . those revealing tests conducted at Bridgeport, Connecticut, by RCA and NBC, the results of which have just become available, disclosing that the ultrahighs can provide quite a signal for a fairly wide area, up to twenty miles in some instances, although most reliable reception was found to be in the five- to ten-mile runs.

For the Service Man, these tests indicate that the *uhf* bands will have to be considered as a vital receiving horizon for TV reception . . . a horizon that will come closer as the months go by, as these and other scheduled tests go on, and the FCC finds that it can now proceed with a high-band allocation plan, the plan over which they have been debating for over a year. From statements made by FCC headman Wayne Coy, his fellow Commissioners and others formerly with the Commission, there is no doubt that before the year is out, there will be a schedule of upstairs frequencies, and on a national basis. Of course, that does not mean that *uhf* stations will spring right into existence. But it does mean that the groundwork will have been laid and it won't be long before the high-band frequencies will be with us. Probably in a year from now, we'll have full-fledged ultrahigh service in many cities. And, as it looks now, these telecasters will be located in those areas not presently served by a veryhigh-frequency type of 2 to 13-channel station. During this twelve-month period, the Service Man can strike up his building and planning program, too. Using the final allocation chart as a map of operations, the Service Man can determine just where he can be of maximum usefulness, and what to do to provide that service. That will mean a critical evaluation of both the types of receiving equipment which will be used, and what will be used for pickup purposes. It now appears as if tun-

ers and converters will be employed in the bulk of the initial installations, and the types that will be used will be very similar to those described in this issue on pages 20 and 21. The antennas may take several forms and include stacked rhombics, stacked vees, parabolas, stacked fans and rhombics. In the Bridgeport survey, the parabola was found to be the best but, because of its weight, difficulty of mounting and general unavailability, it was supplanted by the stacked vee, which provided excellent reception, in most instances.

Antenna heights have been found to be extremely important factors in establishing improved *uhf* pickup. During the tests, the heights were varied from 25' to 70' and, in some instances, these heights were supported by additional elevation of the local terrain. In one case, for instance, a stacked vee mounted on a forty-foot tower, which was located on a point 380' above sea level, was found to provide a perfect picture. The lengths of the coax cable, which incidentally was found to be the only type of feed line which could be used, varied from 20' to 90'. The shorter lead lengths were found to offer a more effective transfer of energy. The cables used were of the standard 59/U type. NBC reported that this cable, normally only installed for low-channel work, had to be used because it was the only bulk type of wire available at the time of the tests. High-frequency types of coax are now being tested and it is felt that the results will certainly be even better. An indication of this anticipated improvement became evident during the use of a round-type of coax (280°), where with a run of 125' and a stacked vee mounted atop a 55' pole, located about twelve miles from the transmitter, the results were excellent, according to the official report.

The next few months will see an accelerated testing program, not only in the east, but in the middle west and particularly on the Pacific coast, where many striking ultrahigh developments are being completed. Some manufacturers, aware of this forthcoming wave of ultrahigh activity, have included provisions for ultrahigh inputs in their

receivers. In this issue on page 38, in the Ser-Cuits section, appears a detailed analysis of one such type of receiver. There'll be many more chassis which will include this input feature coming off the production lines.

The ultrahighs are coming along and at a mighty fast clip. Developments on this new frontier will be covered completely in SERVICE in a special series of articles. Watch for them!

Coordination

TV SERVICE AND INSTALLATION, prior to the sudden surge of sales which has been witnessed during the past few months, could be handled on a fairly simple scheduling basis, provided, of course, carefully-planned procedure and technical administrative policies were in force. However, with receivers now being sold at a snappy pace, all normal formats of operation have begun to require complete revision and, in many instances, substitution by radically new streamlined practices.

The problem has been recognized by many, and as a result several novel systems have been inaugurated. In Chicago, for instance, in an attempt to standardize and accelerate service to all parts of the metropolitan areas, four sectional service companies pooled their resources and formed a city-wide unit.

A central office has been set up in downtown Chicago, with a day and night switchboard routing calls to other members of this group. This unusual approach has been found to be very effective, providing a consistency of service and installation follow-through, heretofore impossible. Although the four companies are operating as a unit, each is under separate management and is self-sustaining, following incidentally a set of standard procedures set up by the local TV association, TISA¹.

Here is an unusual example of coordination and cooperation, among service groups, which merits a solid round of applause.—L. W.

¹See *Association News* (p. 36) for an interesting report on this association's activities.

Experimental UHF TV

WITH THE RESULTS of the recently inaugurated 529-535 mc ultrahigh service from Bridgeport, Connecticut, reported as extremely satisfactory, there has been quite an accelerated interest in the tuners and converters which have been providing this reception.

The models, classified as purely experimental by RCA Labs who designed them, feature extremely novel circuitry.

In the tuner, illustrated in Fig. 2, there is an input high-pass filter cutting off at 500 mc, an *rf* amplifier, first mixer-oscillator, 132-138-mc first *if* amplifier, and second fixed-tuned mixer-oscillator, the output of which is at 21-27 mc and low impedance. The *uhf* amplifier and oscillator tuning elements were designed to cover the 500 to 700-mc range.

A high-enough first *if* was chosen to provide satisfactory image rejection with two *uhf* tuned circuits, but low enough so that reasonable *if* gain and noise factor could be realized with conventional amplifier tubes.

The high-pass input filter reduces spurious responses, most of which are

at frequencies below 500 mc, since in a double-superhet receiver the first local oscillator is below the signal frequency. This filter is a *printed* circuit, the *printing* being accomplished by photoengraving a 1.5-mil copper sheet bonded to a paper-base bakelite sheet.¹ The filter and *rf* amplifier were designed to operate with a 75-ohm coax antenna transmission line.

A 6J4 triode serves as a grounded-grid amplifier, a single 6J6 being used for the first oscillator-mixer, with cathode injection of the oscillator voltage.

In the 132-138-mc first *if* amplifier are two stages of 6AG5s with three double-tuned circuits. Two stages are necessary to isolate the first and second oscillators sufficiently. Automatic gain control was not used because of the marked effect of varying tube transconductance on the band shape.

Another 6J6 is used as the second oscillator-mixer to heterodyne the 132-138-mc signal to 21-27 mc. The out-

put from the tuner can be link-coupled to the first picture *if* amplifier of a standard television receiver through a low-impedance line; 110-ohm shielded twin line was used in this tuner.

Switching between the *uhf* tuner and the conventional *vhf* tuner (which is normally an integral part of the television receiver) is made in the low-impedance link circuit. In some television receivers it may be necessary to modify either this switching arrangement, or the 21-27-mc *if* amplifier, since the link may alter the band-pass characteristics of the amplifier.

Tuning Element Features

The tuning elements used in the *rf* and oscillator circuits consist of strips of copper foil mounted on natural paper-base bakelite tubing with low-loss cement. Tapered copper foil has been used to obtain a desirable tuning curve and proper tracking of the *rf* and oscillator circuits. The oscillator element consists of a bifilar winding

¹See *Printed-Circuit TV Tuner*, this issue.

Fig. 1. The experimental *uhf* converter, designed to extend the frequency range of a *vhf* type receiver to include the 500 to 700-mc band. The converter *if* amplifier has a bandwidth of 12 mc, from 204 to 216 mc. Accordingly, either channel 12 or 13 of the *vhf* receiver may be used for ultrahigh reception. A high *if* has been used to improve the image and spurious responses, and to reduce the oscillator radiation.

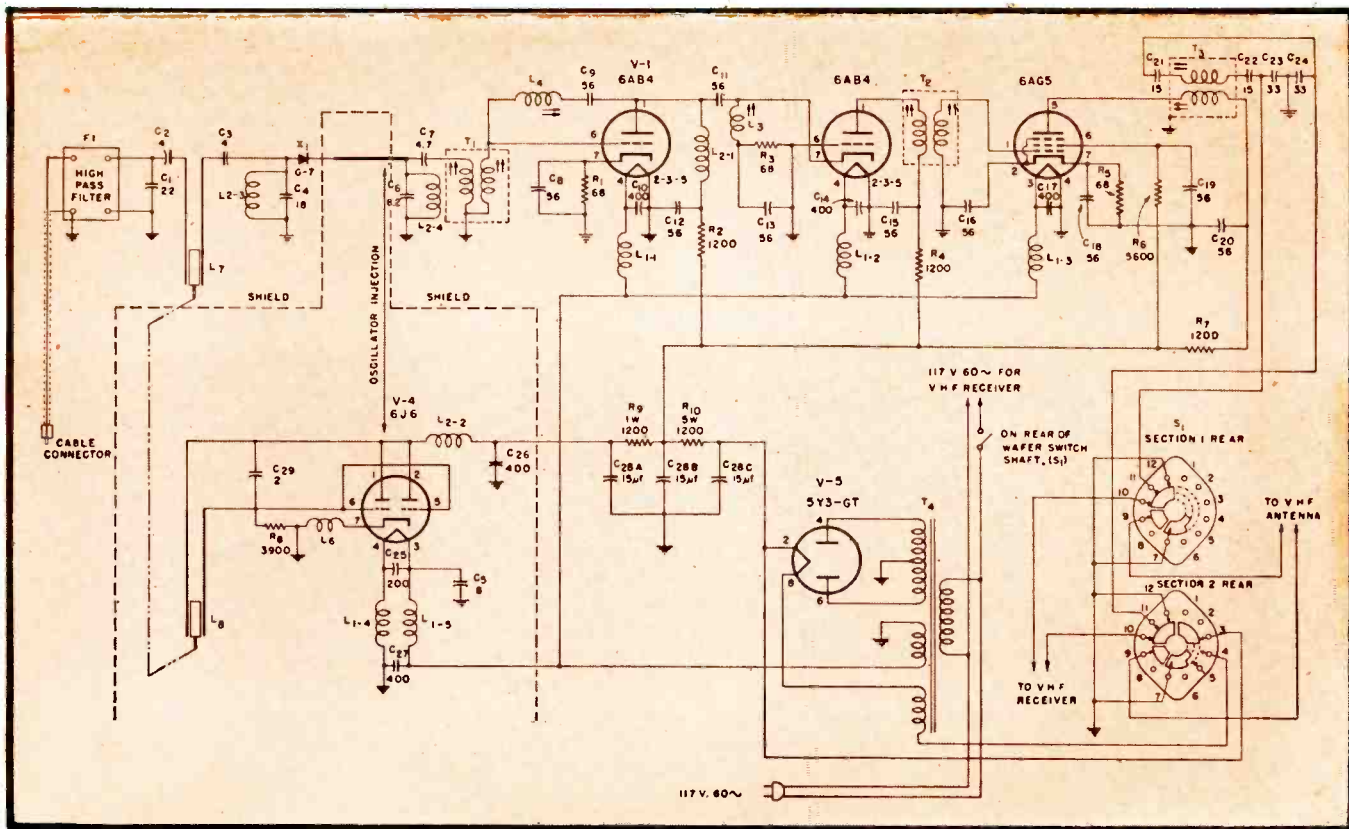

Tuner and Converter

Electrical and Mechanical Properties of Ultrahigh Tuner and Converter Recently Developed for Pick Up of 529-535 Mc Signals from the NBC Station in Bridgeport, Conn.

by E. I. JEFFREY

terminating in a split-capacitor section. All three elements are tuned by means of copper or brass cores inside a bakelite tubing. A 500 to 700-mc tuning range is covered with a core movement of approximately $1\frac{3}{8}$ ".

In tests it was found that the image responses were more than 66 db down and the *if* response more than 80 db down from the main responses, when the high-pass filter was used in the input circuit.

Application of Decoupling

To attain this degree of freedom from spurious responses, it is necessary to decouple the fixed oscillator from the *uhf* circuit. In addition to mechanical shielding attained by careful placement of components, it was found necessary to decouple thoroughly the B+ and heater-supply leads.

Tests revealed that there was a spurious response caused by the fourth harmonic of the fixed oscillator (158

mc) feeding back to the input circuit at 632 mc. A 6.8 mmfd capacitor in the B+ supply line and the 1 to 3-mmfd trimmer in the low side of the primary winding of the first 132-138-mc transformer were inserted to suppress this 632-mc harmonic. The amount of the harmonic signal entering the tuner input was found to depend on the position of the antenna-input coax cable and the leads from the power supply. It was also found that this response could be further reduced with a 632-mc trap circuit magnetically coupled to the fixed oscillator.

Tuner Power System

The tuner operates with the filaments on at all times. Regulation of the plate voltage for the *uhf* oscillator is necessary to prevent frequency change due to variations in supply

voltage. The oscillator drift at 500 mc with preheated filaments was found to be 150 kc measured $\frac{1}{2}$ minute from the time B+ is turned on. All of the drift has been found to occur in less than $2\frac{1}{2}$ minutes, the oscillator stabilizing after that time. At 600 and 700 mc the drift characteristics are very similar to those at 500 mc.

High-Pass Filter Design

The input high-pass filter can be made of lumped constants. The coils then consist of $1\frac{1}{2}$ turns of No. 16 wire, $\frac{1}{4}$ " inside diameter, and the capacitors of $\frac{1}{2}$ to 3-mmfd trimmers. The capacitors are adjusted until best band-pass characteristics are obtained.

The *uhf* tuning cores are mounted on kovar wire which is broken in several places with glass bead supports. The use of kovar wire was found to minimize oscillator drift due to thermal expansion. It was found neces-

(Continued on page 63)

Fig. 2. Circuit of the *uhf* tuner and special power supply.

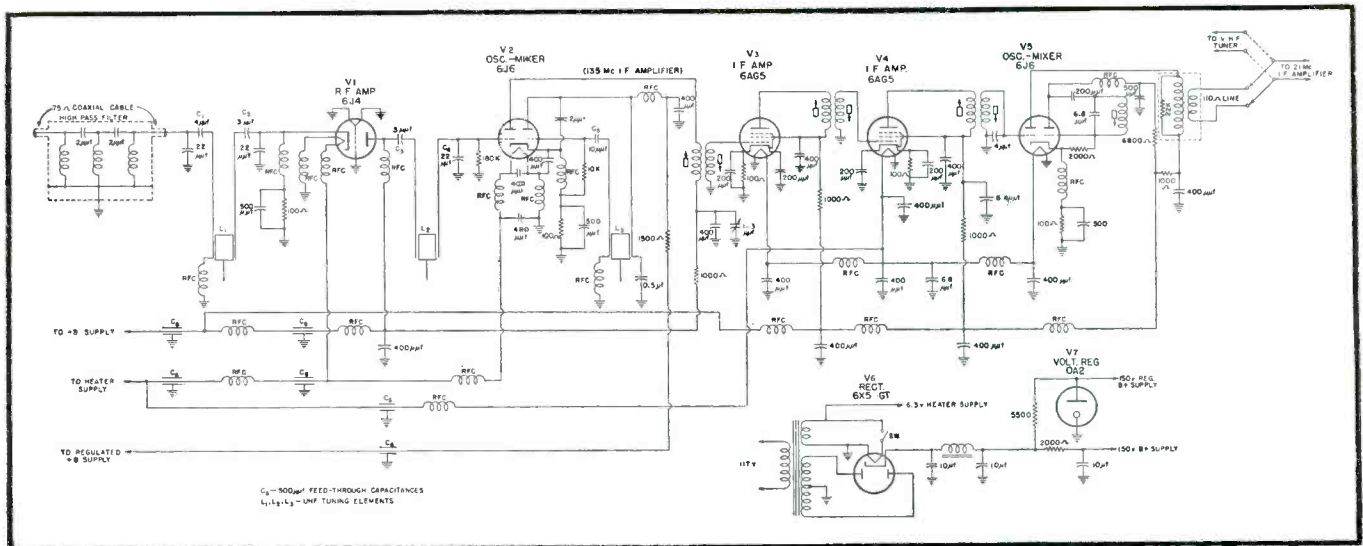

Auto Radio

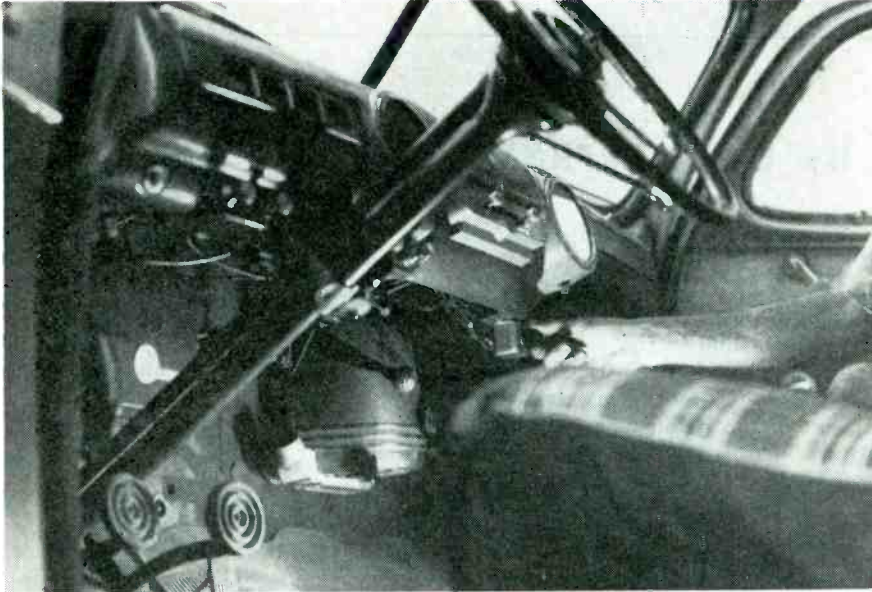

Underdash view of typical installation. Note receiver mounted on firewall and remote control head mounted in center of instrument panel. Hand is on rear-seat speaker selector switch.

(All photo illustrations by Anthony Grove)

Typical auto-receiver installation in a 1950 Studebaker car. (Courtesy Motorola)

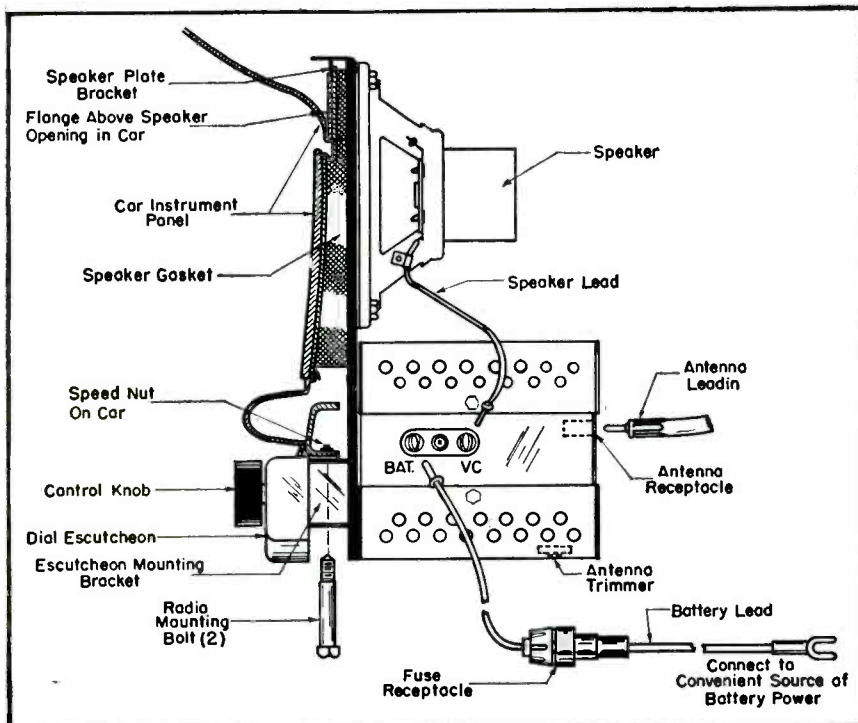

ONE OF MOST PROVOKING problems in auto installation and servicing is *noise*. With popping of spark-plugs, howling of the generator, scratching noise from the front wheels, and the myriad other pops and bangs, originating everywhere in the car's electrical system and body to check, the situation can be quite exasperating.

Every effort is made today to provide a chassis and allied accessories which will resist the pickup of noise. However, noise can seep through, if installation and service precautions are not applied. For instance, there are numerous small screws used to hold the lids of the chassis shield securely. These screws aren't there for mechanical strength, but to insure perfect grounding of the lids. When servicing, it is therefore imperative that all screws taken out be replaced and if possible, any that turn up missing should be replaced, too.

The battery supply lead, antenna connection, external speaker and volume control leads, pilot light leads, and the flexible shafts used for tuning, volume control, etc., are also possible paths for the entry of interference into the case.

Battery Lead Filters

To minimize this noise-feed possibility, the battery supply lead is normally filtered with small metal plates, riveted to the chassis, insulated with mica *sparkplates* and by *rf* chokes composed of 20-25 turns of heavy self-supporting wire.

Antenna Shielding

Antenna connections are usually arranged to permit the use of a shielded cable, with a positive ground for the shield. Noise impulses, picked up by the shielding braid, are thus drained off to the grounded chassis, without affecting the leadin itself.

To further eliminate noise, speaker leads are usually filtered with small

NOISE CURES

Comprehensive Analysis of Cures Which Can Be Applied to Eliminate Spark-Plug, Generator, Front-Wheel and Intermittent Noises.

by JACK DARR

Ouachita Radio Service

mica capacitors, at the point where they leave the case. This approach is also used in the pilot light and speaker-field supply leads.

Volume-Control Lead Shields

Volume controls which are mounted in the remote control head itself must be connected by a shielded cable to the set. The grounds at each end of this circuit *must* be very good, to avoid the pickup of audio hum, due to unbalanced noise fields in the shield-braid.

Flexible-Shaft Grounds

While the flexible shafts used for tuning and volume controls are metal-

lic and usually pretty well grounded, care must be taken to see that the clamps, set-screws, gland-nuts, etc., are actually clean and tight. Numerous cases have been encountered where noise has been picked up by these shafts and fed into the set through a poorly-grounded cable.

Chassis Installation

The set chassis also requires careful installation attention. All mounting bolts should be tight. All paint must be cleaned from under the nuts to insure a good ground connection.

Plug-Noise Problems

The loud-popping noise, which

changes in frequency with the engine speed, is often identified as *plug-noise*. Actually, this noise probably has as much of its origin at the distributor or coil, as at the plugs themselves. Let us see what might cause this trouble by reviewing the operation of an ignition system. We find that the distributor points close the primary circuit of the ignition coil, which is just a step-up transformer with a very high turns-ratio. When the points break, therefore, the secondary of this coil furnishes a pulse of high-voltage current back to the rotary switch, which is part of the distributor mechanism. This rotor and the plug wiring *distribute* the impulses to the proper plug, which

Bypass capacitor installed on ignition coil (foreground) and generator (background).

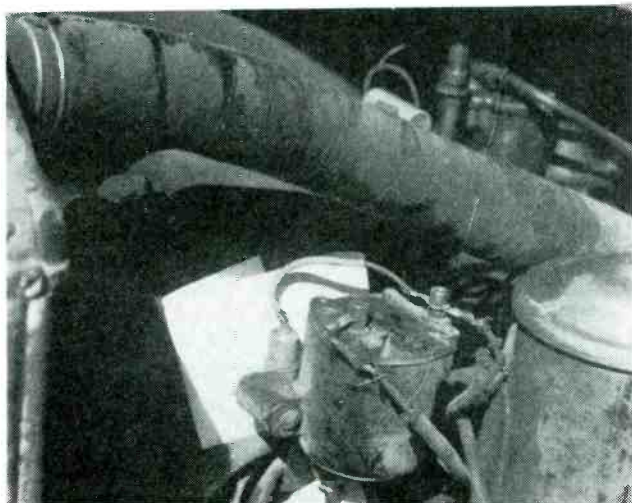

Installing noise suppression grounding springs in front wheels.





Cutting antenna mounting hole with circle cutter.



Top-cowl mounted antenna. Note flexible strap bonding hood to body just below antenna, also hood grounding spring just below hood.

breaks down and arcs, firing the gasoline mixture in the cylinder. The amplitude of this pulse of secondary voltage, in the average ignition system, is around 25,000 volts. Transit characteristics of the pulse resemble those of the old-time *spark* transmitters, with components of practically every frequency in the book.

The Damping Effect

Interference from this pulse can be reduced by *damping*. This is accomplished by inserting a 10,000-ohm carbon resistor, in series with the center lead of the distributor, to the high-voltage terminal of the coil. This places it close to the arc which might be created when the high-voltage jumps the gap between the rotor and the various plug wires. The resistor tends to reduce radiation of the noise pulses by damping, holding the maximum amplitude of the pulses down, and thus cutting the decay time and shortening the period of the pulses. So far as the efficiency of the spark is concerned, it suffers little from the presence of this resistor, as the plug will function satisfactorily if sufficient voltage is impressed to break down the gap at the points and fire the charge. In cases of very severe plug-noise, additional resistors or *suppressors* may have to be connected at each individual plug, or a set of the *resistor-type* plugs¹ substituted. These plugs, which have the resistor or suppressor built into the body of the plug itself, have been found to be very effective. If you happen to run into an auto-radio which features a 19 or 25-meter short-wave band, the use of these resistor

plugs is almost a necessity. With these plugs installed, the set will become so quiet that you'll be able to hear ignition noise of other cars which might be almost a quarter of a mile away.

Generator Noise

Noise from the generator brushes originates at the many tiny arcs, caused by the movement of the commutator past the brushes. This noise takes the form of a continuous stream of *rf* pulses, of random frequencies, carried by the battery wiring over the entire electrical system. Reduction or elimination of this noise is fairly simple, though. A .5-mfd capacitor from the *armature* connection of the generator to ground will bypass satisfactorily most of this disturbance. The connection must be made at the generator itself. In extremely bad cases you may have to use another bypass at the voltage regulator, from the *batt* terminal to ground. Incidentally, bypass capacitors should never be connected to anything except the *batt* terminal of the voltage regulator or the *armature* connection of the generator. No connection should be made to the field terminal of the generator, as this will upset the action of the voltage regulator. Also, it will actually increase the noise, instead of lessening it.

Bypass Requirements

Bypass capacitors used for this type of service should be metal-cased units of about 200 working volts. A metal lug is mounted on the case to serve

¹Electric Auto-Lite type.

as a mounting for the capacitor and a ground terminal. The other connection is a flexible pigtail, terminated in a spade lug. The metal case and heavy sealing are necessary to enable the capacitor to withstand the attacks of oil, grease, heat, water and the many abuses it will be subjected to, in its exposed position in the engine compartment.

While the two villains mentioned constitute the main sources of noise in a car, there are several other sources which may give trouble before a job is completed.

Importance of Grounds

The antenna lead, for instance, must be perfectly grounded at *both* ends; at the set, and where it emerges from the car body. Failure to make perfect grounds at either end will result in pickup of noise by the leadin itself, which will be fed into the antenna input of the set. Testing for this pickup is quite simple. The antenna plug is pulled out of its socket while the set is on and the engine running. If the noise disappears you can be sure that it was being picked up by the leadin or the antenna rod itself, outside the body. This can be checked by reinserting the leadin, then grounding the antenna rod to the body with a screwdriver. If the noise disappears when the rod is grounded, the noise is being picked up on the rod itself. This is often due to noise leakage from the hood, due to poor grounding. This can be checked by inserting a wide-blade screwdriver into the crack, at the rear of the hood, and twisting until the blade cuts through the paint and

HOT-X

Quicker Installation

Lower Cost

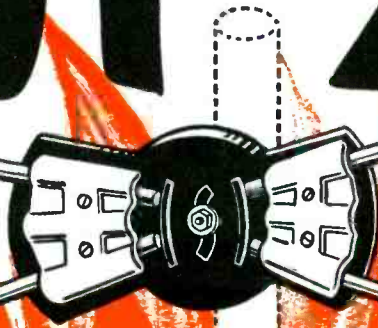

Snyder
PHILADELPHIA

\$2⁹⁵
LIST



HEAD-LINE

TV

CONICAL XA-1

SERVICEMEN'S KIT

Includes Array and Universal Mast Clamp with
4 Hi-Tensil 3/8" Aluminum Alloy Elements



SNYDER MFG. CO.

ONTARIO RESEARCH CORP.

ANTENNA-GINEERS®

PHILADELPHIA

Export: ROBURN AGENCIES, INC., N.Y.

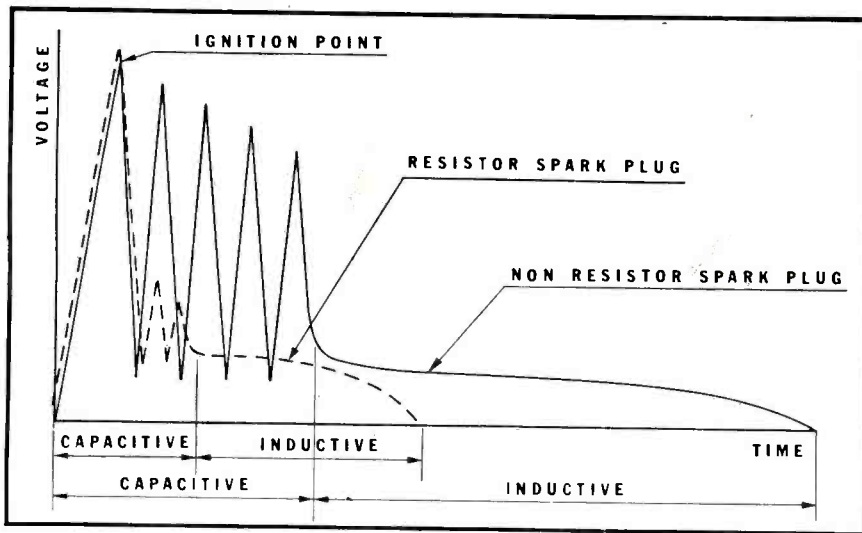

Plot illustrating how capacitive and inductive charge time is reduced when a resistor spark plug is used: Any ignition system in good condition will operate satisfactorily with resistor plugs using wide gap settings. Also, resistor plugs with a given gap setting require no more voltage than non-resistor plugs with the same gap setting. This is so because the portion of the spark discharge that causes ignition does not pass through the resistor, when the plug gap breaks down, but is stored ahead of the resistor, as a capacitive charge, in the interval of time between the opening of the distributor points and the ionization of the spark plug gap.

grounds the hood to the body. If any improvement results, it will then be necessary to install either grounding springs, small C-shaped brass springs, or bonding the hood to the body with short strips of $\frac{1}{2}$ " shielding braid, fastening with small metal screws. The paint must be cleaned from under the screws, and a flat washer used on top of the braid. It often helps to flatten the end of the braid and run some solder through it, especially if you want to drill a hole in the braid. By the way, the hood should always be closed and latched when making any noise tests. If the hood is open or even loose, the noise will leak out

and be picked up by the antenna, thus nullifying the tests.

Problem of Leakage

If you're working on an old antenna, already installed, and the noise refuses to clear up, the antenna insulators should be checked for leakage. Some of the older insulators were decidedly hygroscopic, absorbing moisture readily. In one case, insulators showed a resistance of about 50,000 ohms to ground, and the noise persisted until these were replaced.

A *ripping* or *tearing* noise, encountered only when the engine is raced,

or the car is in motion, may sometimes be found in the fuel gauge; in the indicator unit on Chrysler, Plymouth or Dodge cars and in the tank unit on '37-'41 Fords. To check for this, the ignition switch should be turned on, but the engine shouldn't be started. The instrument panel should then be jarred with the side of your fist, especially around the suspected instrument. If the noise is heard, either a bypass or a *fuel-gauge* filter should be installed. The filter consists of a capacitor and a small choke, mounted on an insulating board, with eyelet terminals to fit on the back of the fuel gauge. For the Ford models, this test should be repeated, with one more step added. You'll have to jar the rear bumper. If this causes a loud noise, the trunk will have to be opened and the small plate, visible in the center of the floor, taken up. This will allow access to the *transmitter* unit in the top of the fuel tank. Scraping away about three pounds of dust will disclose a small round unit, with one wire running to an insulated terminal in the center. To this center terminal the capacitor should be attached, grounding the case under one of the screws around the rim, which hold the unit. Too much force should not be exerted on the center screw, as the insulators are easily broken, and then you'll have to replace the unit!

Other Plug Noise Remedies

Some of the remaining plug-noise may be removed by connecting a bypass at the battery side of the ignition coil. This unit should not be installed on the distributor side, as this will cause trouble in the ignition system. The Chevrolet cars and some others have a bracket on the coil, especially installed for this purpose. Older models of Dodge or Plymouth often have the battery lead to the coil running through a metal guide with the high tension lead. It is sometimes helpful to remove and reroute this lead, to avoid transfer of noise into the low-voltage wiring.

The Ammeter-Capacitor

An *ammeter-capacitor*, which is usually a .5 mfd, but in a paper case, with two pigtail leads, is often helpful in removing both plug and generator noise. This is installed at the point where the hot lead from the set

(Continued on page 64)

Detailed drawing illustrating how a side cowl antenna and cable connector are mounted in position. (Courtesy Radelco)

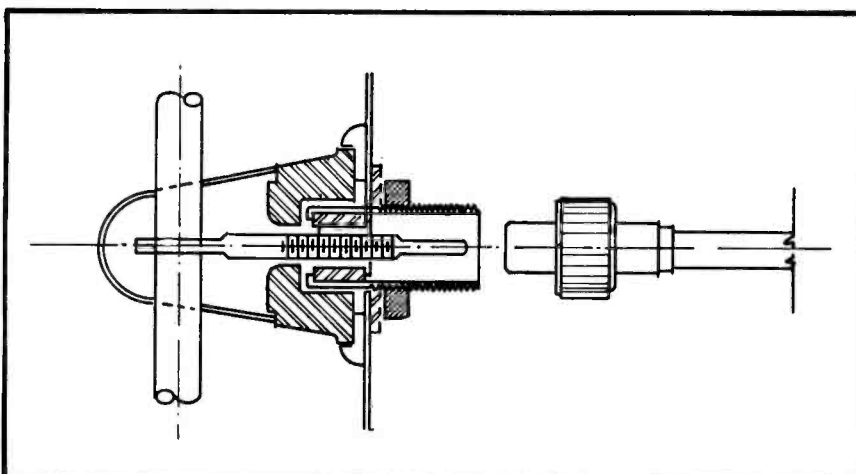

For Clear Sharp Pictures and
Powerful Trouble-Free Performance

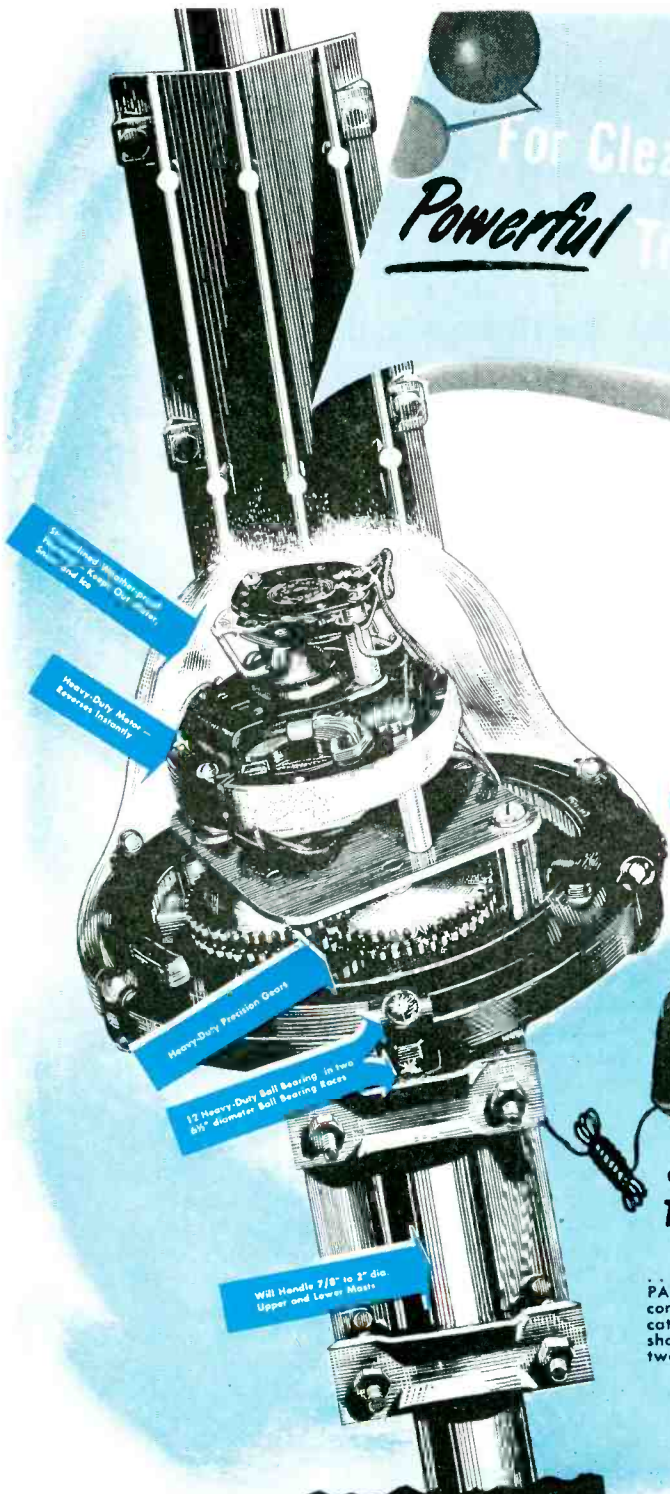

THE  SKY HAWK

TELE-ROTOR

 CHECK THESE FEATURES

- Will Handle 7/8" to 2" diameter Upper and Lower Masts
- Heavy-Duty Motor — Reverses Instantly
- Mast, Tower or Platform Mounting
- Four Heavy-Duty Guy-Wire Lugs
- Completely Weather-Sealed ... Factory Lubricated For Life
- Handles Heavier Loads With Ease ... As Much As 150 Pounds
- Streamlined Weather-proof Design ... Durable Sturdy Construction
- 12 Heavy-Duty Ball Bearings in two 6 1/2" diameter Ball Bearing Races
- Heavily Reinforced Die-Cast Housing
- Heavy-Duty Precision Gears
- Positive Stop at End of Rotation



C-D SKY HAWK
TELE-ROTOR
 CONTROL

... with the PERFECT PATTERN dial... fingertip control with instant indication of antenna position shown on the illuminated two-tone face.

Available in the Following Models:

- TR-1... rotator with control box \$37.45
- TR-2... compass control rotator with "Perfect Pattern" dial..... \$44.95

A Combination You Can't Beat . . .
 It's a C-D Sky Hawk Antenna with a
 C-D Sky Hawk Tele-Rotor

CONSISTENTLY DEPENDABLE

CORNELL-DUBILIER

SOUTH PLAINFIELD, NEW JERSEY



- CAPACITORS
- ANTENNAS
- ROTATORS
- VIBRATORS
- CONVERTERS

Servicing Helps

Trouble Shooting Dry-Disc Rectifier Circuits . . . Modifications in G. E. 801, 802 and 803 TV Models, Involving Insufficient High Voltage, Picture Width Circuitry, Linearity, and Contrast Control . . . Westinghouse H-196, H-207, H-210, H-211, H-217 and H-188 Circuit Revisions To Prolong Tube Life, Improve Vertical Hold, Eliminate Audio Hum, Cabinet Buzz, and Dial-Pointer Rattle . . . Cabinet Repair Suggestions.

Trouble-Shooting Dry-Disc Rectifiers*

by M. A. MARWELL

G.E. 801/802/803

To TROUBLE-SHOOT receivers using dry-disc rectifiers, it is necessary to localize the trouble to either the dry-disc rectifier or the associated circuit. Since the dry disc cannot be easily removed and placed in a tester, it has been found necessary to apply a check-in-the-set type of approach. In one method using this technique, with the receiver inoperative, the resistance between B+ and B- must be measured right at the output of the dry-disc rectifier. If the resistance is 5,000 ohms or more, it is safe to apply power to the receiver. (It should be noted that this resistance measurement is not a quality check of the filters, but only a preliminary check to determine whether it is safe to apply power to the receiver without causing further damage.)

With power applied, voltage measurements may be made to determine whether trouble is in the decoupling networks, other sections, or in the rectifier itself.

If the over-all voltage of the power supply is low and there are no indications of overload, the input-filter capacitor may be open and should be checked first. It may be checked by simply shunting a good capacitor across the input filter and noting whether the voltage indication rises to the normal value.

Where a voltage-doubling system is

used, a voltage measurement should be taken across the doubling capacitor(s), as indicated in Fig. 1. No voltage or low voltage across the doubling capacitor(s) indicates that they have lost capacitance or are leaky.

Only after it has been determined that the associated circuits are normal, should the dry-disc rectifier be replaced.

*Based on notes prepared by Philco.

Fig. 1. Dry-disc voltage-doubler circuitry which requires a check-in-the-set type of approach during trouble shooting. Capacitors at A are doubling type.

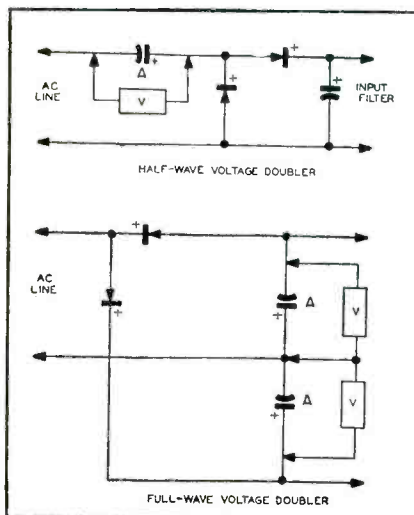

Insufficient High Voltage: (1) This can be probed in three steps: The setting of the horizontal linearity control must be checked first. Over its range, it will change the high voltage output by approximately 2 kv. At the position of best linearity, this *hw* produced is usually at its highest value. *The effect of the linearity control must always be checked* before assuming that any modifications made in the chassis may be faulty. (2) On the late production model 801 and all production models 802 and 803, a 5Y3GT rectifier was used. In cases of low picture-tube anode voltage, a 5V4G can be substituted for the 5Y3G to raise the anode voltage considerably. (3) Instead of connecting the ground return of the 500-mmfd capacitor, C₀₀₅, in the 801 or C₁₁₈ in the 802 and 803, to ground, reconnecting this capacitor to tap 4 of the sweep output transformer, will increase the high voltage by approximately 1,000 volts. The ground side of this capacitor must be insulated by a suitable bracket to provide this circuit revision.

To Change Picture Width Beyond Range of Size Control: By changing the value of the series capacitors (two 1,000-mmfd capacitors) which might be, due to a late conversion, connected between terminals 6 and 8 of the sweep transformer, the sweep width may be altered as follows: The value of the

(Continued on page 30)

Here's Our Investment In Your Future...



THIS IS TO CERTIFY THAT
 FRANKS RADIO & TELEVISION SERVICE
 has met the requirements of
RAYTHEON
 FOR
BONDED ELECTRONIC TECHNICIANS
 A Surety Bond Has Been Issued by the AMERICAN MUTUAL LIABILITY INSURANCE COMPANY

Expiring the 31st day of December, 1950, covering this firm respecting its Agreement with Raytheon Manufacturing Company to

1. GUARANTEE FOR RADIO AND TELEVISION REPAIR WORK FOR NINETY (90) DAYS FROM DATE PERFORMED AND REPLACEMENT PARTS PURCHASED FROM RAYTHEON.
2. Use only parts of recognized quality in such repair work.
3. No charge more than the price for parts installed in such repair work.
4. Test customer tubes as accurately and reliably as possible.
5. Keep charge for labor in such repair work as a fair and reasonable level.
6. Perform only such repair work as is necessary or authorized.

7. Maintain and use service equipment essential to such repair work and replace the same.
8. Maintain in such repair work the high quality service indicated by the agreement required of all Bonded Electronic Technicians.

Signed
 AMERICAN MUTUAL LIABILITY INSURANCE COMPANY

The amount of coverage with respect to the above deals under this Surety Bond is limited to the sum of Four Hundred and No. 00 (\$400.00) Dollars in the aggregate and is further limited to the sum of Two Hundred and No. 00 (\$200.00) Dollars for any claims involving any single customer.



No. A

Now it covers Television, too!

THE RAYTHEON BONDED ELECTRONIC TECHNICIAN PROGRAM

Raytheon considers the tremendous amount of money invested in the Raytheon Bonded Electronic Technician Program exceedingly well spent because it is an investment in your future. And your success is tightly tied up with ours.

RAYTHEON Bonded Electronic Technicians can offer their customers a cash protected guarantee on all radio and television repair work and parts for 90 days. Think what this guarantee, backed by almost \$100,000,000.00 resources of American Mutual Liability Insurance Company, can do to create customer confidence and good will and to stimulate sales. And yet this big business builder costs you *not one cent*.

Even before it covered *Television*, the Raytheon Bond lifted hundreds of Service Dealers head and shoulders above the crowd. Now that it covers *Television*, too, it's the most covered key to better business in the industry.

You'll be building a firmer foundation for your business when you ask your *Raytheon Tube Distributor* to help you become a Raytheon Bonded Electronic Technician.

RIGHT... For Sound and Sight
RAYTHEON RADIO and TELEVISION TUBES

RAYTHEON

RAYTHEON MANUFACTURING COMPANY

Radio Receiving Tube Division

Newton, Mass., Chicago, Ill., Atlanta, Ga., Los Angeles, Calif.

Excellence in Electronics

RADIO AND TELEVISION RECEIVING TUBES, CATHODE RAY TUBES, SPECIAL PURPOSE TUBES, SUBMINIATURE TUBES, MICROWAVE TUBES

"I'm interested in selling you more than a TV set—I want to sell you picture quality. To accomplish that you must have an outdoor antenna that reaches into the air, capturing and delivering strong, clear TV signals to your set. We recommend an Amph-enol **INLINE** Antenna because it will bring out the best picture quality in any of these sets."

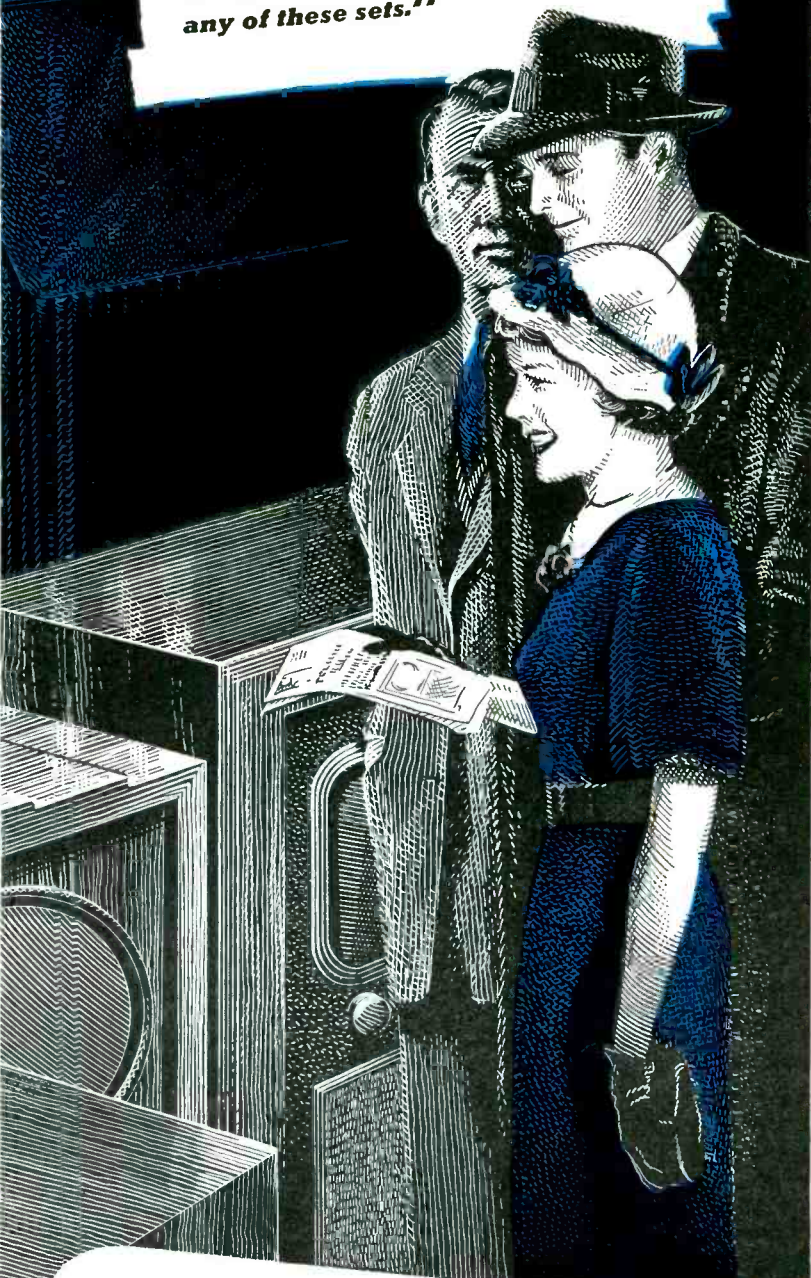

Servicing Helps

(Continued from page 28)

capacitors can be increased to increase the sweep width. This change in capacitor value will also influence the high voltage output to the picture tube, as the higher the value of capacity shunted between terminals 6 and 8, the lower will be the high voltage output to the picture tube.

Linearity: On some receivers, so that the horizontal linearity control can reach optimum linearity, it may be necessary to add a 68-ohm, 2-watt carbon resistor in series with the 300-ohm cathode resistor, R_{60} , in the 801 or R_{125} in the 802 or 803 of the damper tube.

Contrast Control Change: In a few early production model 802 receivers, the voltage for the contrast control operation was obtained from the grid circuit of the 6AS7G damper tube. This bias source has not proved satisfactory when a universal horizontal sweep-output transformer¹ is substituted, as in many cases the bias is too low or may even be positive, dependent upon tube characteristic and voltage variations between receivers. It has been found that a germanium diode can be added to rectify the 6.3 volt ac filament voltage, connected as shown in Fig. 2. To make this conversion, the following steps should be followed:

(1) It is necessary first to disconnect the 1-megohm resistor, R_{134} , which connects between the grid of the 6AS7G and the contrast control, and discard it. In addition, it is necessary to remove the .05-mfd capacitor (C_{20}) from the same circuit.

(2) Then the high side of the contrast control, R_{108A} , must be reconnected to the positive terminal of a 1N48, 1N64, or 1N65 germanium diode. Then the other side of the diode should be connected to pin 7 of the 6SN7GT horizontal multivibrator tube.

(3) In the final step a 1-mfd capacitor is connected across the contrast control as shown.

G.E. 810/811/835

Linearity Problem: On models 810, 811, or 835, there will probably be two settings of horizontal linearity control which will be found to give good linearity. The proper setting is the one available when the slug is withdrawn from the center of the coil, or minimum inductance. The other position may cause some *squaring* of the outside circle of a test pattern.

Westinghouse H-196A, H-207A, H-207B, H-225

Antenna Input Circuit: In the DX type tuner assemblies transformer coupling between the antenna and the rf stage provides the correct impedance match for either a balanced 300-ohm or an unbalanced 72-ohm transmission line. When a balanced 300-ohm line is used, it should be connected to the antenna terminals in the conventional manner; however, if the transmission line is a 72-ohm coaxial cable, the center conductor of the cable should be connected to one of the antenna terminals, the outer shield should be connected to the other terminal, and then the terminal to which the outer shield is connected should be grounded to the chassis.

The DX type tuner assemblies now use a 6AG5 rf amplifier tube in conjunction with a tuned input circuit to provide increased gain, and full agc voltage is applied to the grid of the rf tube. In addition, provisions have been made for adjusting the hf oscillator coils.

¹G.E. RTO-071.

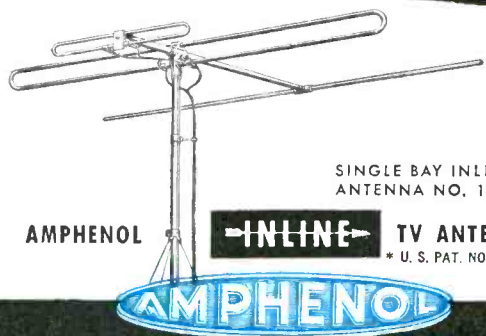

SINGLE BAY INLINE TV ANTENNA NO. 114-005

AMPHENOL

—**INLINE**—

TV ANTENNAS

* U. S. PAT. NO. 2,474,480

AMPHENOL

AMERICAN PHENOLIC CORPORATION
1130 SO. 54TH AVENUE CHICAGO 50, ILLINOIS

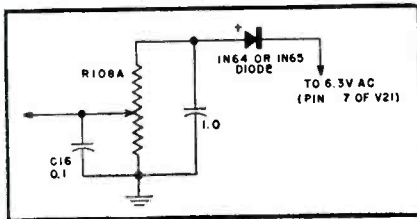

Fig. 2. Revised contrast circuit of G.E. 802.

Audio Section: In later production of the *DX* chassis, *avc* was removed from the first audio *if* stage to increase the audio *if* sensitivity. Sufficient control is provided by the *rf* and first video *if* amplifiers to handle the *avc* requirements for the audio section.

An inductance (L_{207}) has been placed in series with the ratio detector load resistors and pin 2 of the 6T8 to eliminate channel-6 interference caused by the fourth harmonic of the audio *if* (21.6 mc).

Westinghouse H-196

Prolonging Tube Life: Early chassis used a 5Z4 as a low-voltage rectifier. In later production a 5V4G, which has a higher current rating, was used in place of the 5Z4. To prolong tube life in the early chassis, the 5Z4 low-voltage rectifier should be replaced (a direct substitution, no wiring change required) by a 5V4G. This change is not of sufficient importance to warrant a special service call, but it should be made when other service is performed on the set.

Poor Vertical Hold: In weak signal areas the sync may be improved by replacing the 12AU7 sync amplifier tube (used in early chassis only) with a 12AT7. The 12AT7 is a medium- μ tube and will provide greater sync amplitude than will the 12AU7, which is a low- μ type. This change is a direct substitution, and no wiring changes are required.

Insufficient Picture Width: Under very low-line voltage conditions, the picture width may not be sufficient, even though the width control is at maximum. If this is the case, check the code number of the deflection yoke; this number is located under the *V* number on the yoke. If the number is 98, 108, or 118, yoke should be replaced with one carrying any other code. The

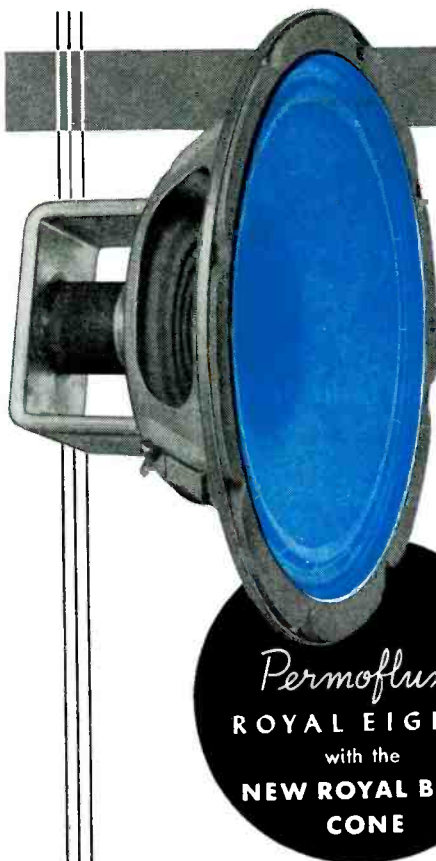

new

PermoFlux ROYAL EIGHT" compares with any 12" speaker!

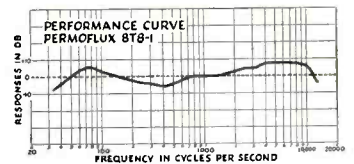

This averaged laboratory response curve of the PermoFlux 8T8-1 proves that it compares with the finest speakers regardless of size or price.

It's Your "Springboard" to Extra Sales with Customers who want 12" performance but don't want to pay a 40% higher price.

From the resonant boom of jungle drums to the light warble of the flute, this new 8" speaker reproduces sound with superior sensitivity and fidelity. The tonal qualities of this magnificent speaker can only add to the excellence of any audio equipment.

Special processing provides extra-strong cone; allows cone to be soft-suspended from basket and held at coil-end by extra-large spider. Permits more faithful reproduction at lower frequencies. Deeper, curvilinear cone greatly extends high-frequency response.

PermoFlux Royal Eight" (Model 8T8-1) is ruggedly-built, and simple to install. Provides big speaker performance in a small frame—uses smaller, more economical baffle. List Price \$15.00.

Send for Catalog No. J 201—Dept. SE



old yoke will perform satisfactorily with normal line voltage.

Westinghouse H-196 and 207

Audio Hum: Hum in the audio section may be reduced by adding a 30-mfd capacitor across C_{60} which is connected between the screen of the 6AQ5 audio output tube and ground. This change has been incorporated in later production.

Westinghouse H-196, H-207 and H-217

Sensitivity Control: There has been considerable confusion in the past as

to the correct method of setting the sensitivity control. The correct methods are: If the chassis is *on the bench*, the control should be set for .6 volt on the picture *if agc* line with no signal input. If the set is in the customer's home, the channel selector should be set to a dead *channel*, the contrast turned to maximum, and the sensitivity control turned fully counterclockwise, for maximum sensitivity. The screen should then be well filled with *snow*. The sensitivity control should then be turned clockwise slowly until the

(Continued on page 32)

In 1950 TUNG-SOL will supply electron tubes to 8 of the 10 top producers of television sets.

In 1950 TUNG-SOL will build more electron tubes than at any time in the history of the company.

TUNG-SOL tubes are precision built for uniform performance. 77 tests assure highest standards of quality. TUNG-SOL tubes back up your service work and safeguard your profit. Build your radio and tv service business by using dependable TUNG-SOL tubes.



TUNG-SOL LAMP WORKS Inc., Newark 4, N. J. Sales Offices: Atlanta
Chicago • Dallas • Denver • Detroit • Los Angeles • Newark

Servicing Helps

(Continued from page 31)

amount of snow just begins to decrease. The screen should still be saturated with snow and the control should be locked at this position.

The slot in the control will be approximately horizontal. If the control is set below the correct point, the full sensitivity of the set will not be realized in weak signal areas. If the control is set above the correct point, the

receiver will overload in strong signal areas.

Fuse: The ½-ampere fuse must never be replaced by a jumper of heavy wire. This fuse protects the horizontal output transformer. If the fuse is not in place and the 6BG6G tube becomes defective, the transformer is apt to be damaged. A blown fuse is usually indicative of a gassy 6BG6G, and

unless the cause is located elsewhere the 6BG6G should be replaced.

Westinghouse H-210 and H-211

Cabinet Buzz: Cabinet buzz in these models may be caused by warpage of the plastic due to temperature changes, etc. To correct this, the two chassis mounting screws should be loosened, the cabinet sides should be squeezed until they are parallel, and the screws then tightened. This will hold the back cover more firmly against the sides and stop the vibration.

Sticking Dial Pointers: If the dial pointer has a tendency to bind, the two dial pulleys should be lubricated with record changer lubricant and the dial cord tension spring moved to another hole in the drum to increase the tension.

Dial Pointer Rattle: Dial pointer rattle can be cured by gluing a piece of bumper material (cork and rubber composition) ⅛" thick and about ½" square between the right hand pulley rivet on the dial background and the front of the chassis.

All-Wood Cabinet Repair**

Stripped Wood Screw Holes: A good remedy for stripped wood-screw holes is to slip a piece of small-diameter rosin-core solder into the hole and replace the original screw. This will, in most cases, hold more securely than in the original hole and eliminate the possibility of splitting the wood with a larger screw.

Philco 50-T701/T702

Dim Picture: A dim picture may result from leaky dc blocking capacitors to the deflection plates of the picture tube or by faulty high-voltage filters. Whenever a dim picture is encountered, capacitors should be checked for leakage.

Philco 50-T1630

Replacing Picture-Tube Insulating Cone*:** A replaced picture-tube insulating cone may be prevented from riding up on the tube bell by taping the leading edge of the cone to the rim of the tube before the insulating ring is installed. Any type of cellophane tape, such as scotch tape, is satisfactory for this purpose.

Philco 50-T1104; 50-T1105; 50-T1106

Connecting Television Booster**:** In the above models, the cathode and filament circuits of the 6V6GT audio-output tube are 130 volts above ground. Therefore, the octal-power adapter for TV booster is not applicable to these models. A special 3-prong socket is

**From Westinghouse Service Department.
***Philco Part No. 54-7791.

incorporated into the top of the chassis, near the speaker, to supply booster power. A plug and cable assembly***** must be used to connect the booster to this socket.

General Notes on Philco Models

Failure of Brightness Control to Reduce Picture Brilliance: A leaky *dc* blocking capacitor between the video-output stage and the picture-tube grid or between the video-output stage and the *dc* restorer will cause an extremely bright picture that is not affected by the setting of the *brightness* control.

Whenever the *brightness* control fails to reduce the brilliance of a picture, these capacitors should be checked for leakage.

****Philco TB2. *****Philco 41-3942.

G. E. TUBE-SPEAKER CAMPAIGNS



Above: Reviewing new identification signs designed for Service shops and dealers by the G.E. tube division, left to right: J. L. Robinson, of G.E. tube divisions' sales promotion section; J. W. Duffield, N. Y. district rep., and M. J. Strehle, assistant manager, replacement sales tube division. Below: E. A. Malling, G. E. parts sales manager with a recently-prepared three-piece promotion package for G.E. speakers. Streamers and wall chart provide complete information on each of the speakers in the line.

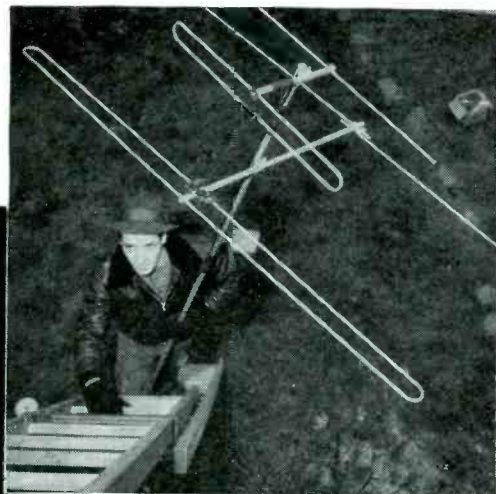

You can get

STRONG, LIGHT ALCOA ALUMINUM

**For better masts and antennas
from your nearby Alcoa Distributor**

Better for masts—Alcoa Aluminum masts are strong, light in weight and easy to install. Aluminum's lighter weight (one-half as much as steel pipe) makes it easier to handle on the ladder and roof. Will never streak houses with unsightly rust because it's corrosion-resistant *all the way through*.
Better for elements—So much so it's standard in the industry. Because it gives you light weight with strength,

but is ductile enough to form easily into the most intricate dipole designs. **Get fast service** on Alcoa Aluminum—call your nearby Alcoa Distributor listed below. He stocks Alcoa Aluminum masts and element tubing, can give you overnight delivery in most cases. Cutting and slitting also, at nominal charges. ALUMINUM COMPANY OF AMERICA, 1960E Gulf Building, Pittsburgh 19, Pennsylvania.

For best results, always fasten aluminum with Alcoa Aluminum Fasteners, also available from your Alcoa Distributor

**BUY ALCOA ALUMINUM MASTS AND ELEMENT TUBING
LOCALLY from these distributors**

- Atlanta, Georgia
- J. M. Tull Metal & Sup. Co., Inc.
- Baltimore, Maryland
- Whitehead Metal Prod. Co., Inc.
- Boston (Cambridge), Mass.
- Whitehead Metal Prod. Co., Inc.
- Buffalo, New York
- Braco-Mueller-Huntley, Inc.
- Whitehead Metal Prod. Co., Inc.
- Charlotte, North Carolina
- Edgcomb Steel Company
- Chicago, Illinois
- Central Steel & Wire Company
- Steel Sales Corporation
- Cincinnati, Ohio
- Williams & Company, Inc.
- Cleveland, Ohio
- Williams & Company, Inc.
- Columbus, Ohio
- Williams & Company, Inc.
- Dallas, Texas
- Metal Goods Corporation

- Detroit, Michigan
- Steel Sales Corporation
- Houston, Texas
- Metal Goods Corporation
- Kansas City, North, Missouri
- Metal Goods Corporation
- Los Angeles, California
- Ducommun Metals and Sup. Co.
- Pacific Metals Company, Ltd.
- Milford, Conn.
- Edgcomb Steel of New Eng., Inc.
- Newark, New Jersey
- Whitehead Metal Prod. Co., Inc.
- New Orleans, Louisiana
- Metal Goods Corporation
- New York, New York
- Whitehead Metal Prod. Co., Inc.
- Philadelphia, Pennsylvania
- Edgcomb Steel Company
- Whitehead Metal Prod. Co., Inc.

- Pittsburgh, Pennsylvania
- Williams & Company, Inc.
- Portland, Oregon
- Pacific Metal Company
- Rochester, New York
- Braco-Mueller-Huntley, Inc.
- San Francisco, California
- Pacific Metals Company, Ltd.
- Seattle, Washington
- Metal Goods Corporation
- St. Louis, Missouri
- Metal Goods Corporation
- Syracuse, New York
- Braco-Mueller-Huntley, Inc.
- Whitehead Metal Prod. Co., Inc.
- Toledo, Ohio
- Williams & Company, Inc.
- Tulsa, Oklahoma
- Metal Goods Corporation

ALCOA ALUMINUM MASTS AND TUBING



INGOT • SHEET & PLATE • SHAPES, ROLLED & EXTRUDED • WIRE • ROD • BAR • TUBING • PIPE • SAND, DIE & PERMANENT-MOLD CASTINGS
FORGINGS • IMPACT EXTRUSIONS • ELECTRICAL CONDUCTORS • SCREW MACHINE PRODUCTS • FABRICATED PRODUCTS • FASTENERS • FOIL
ALUMINUM PIGMENTS • MAGNESIUM PRODUCTS

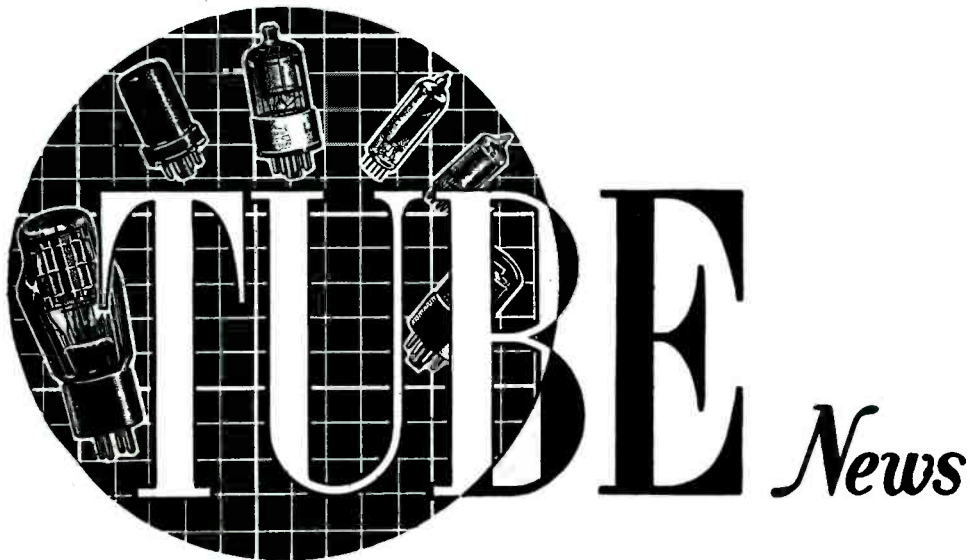

TUBE News

TWO NEW types of tubes for auto and sound-system applications have been developed.

Full-Wave Rectifier

One of the tubes is a full-wave vacuum rectifier¹ developed to facilitate the design of auto receivers having high power output.

Wide Plate-Cathode Spacing

The tube features a unipotential cathode having a 6.3-volt heater and a relatively wide plate-cathode spacing chosen to minimize sputter and yet provide good regulation. The heater can be operated from the same transformer winding that supplies other 6.3-volt heater types in the receiver.

Use of LV Electrolytics

Since the tube has the same heating time as other heater-cathode types in the receiver, the voltage appearing across the filter capacitors is limited during the warm-up period. Consequently, electrolytic filter capacitors having lower peak voltage ratings than required for a filament-type rectifier tube can be used.

Sharp-Cutoff Pentode

The second tube² is a sharp-cutoff pentode of the 9-pin miniature type intended for use as an audio amplifier

in applications requiring reduced audio noise.

Short Single-Ended Structure

Utilizes a single-ended structure which is relatively short and rigidly mounted to minimize microphonics, a controlled getter deposit to minimize internal leakage, and a double-helical-coil heater to minimize hum.

Pin Connections

The base pins of the 5879 fit the noval 9-pin socket. The socket may be mounted to hold the tube in any position.

It is recommended that pins No. 2 and 6 be grounded in all applications. Grounding of these pins will effectively shield grid No. 1 and plate from heater and help to reduce hum level when an *ac* heater supply is used.

DuMont Bent-Gun Rectangular Picture Tube

A rectangular picture tube,³ featuring a bent-gun has been announced.

The bent-gun design is said to afford a sharper spot focus and also provide protection from ion spot blemishes. The tube also features a gray filter faceplate which is said to

improve contrast in the presence of ambient light.

Picture Size Available

Tube makes possible a picture 14 $\frac{7}{8}$ " wide including all the scanning area of the transmitted signal. Overall width dimension is 16 $\frac{1}{8}$ ", and overall length 18 $\frac{1}{8}$ ".

Sylvania TV Tubes

Five tube types for TV applications have been developed by Sylvania.

One is a T6 $\frac{1}{2}$ miniature, type 19C8, which contains three high perveance diode sections and a high- μ triode section. The tube is similar to type 19T8 but provides a high amplification factor and operates at lower plate voltages. It also affords diode matching with fixed current rating between each diode section.

Heater is rated at 18.9 volts, 0.15 ampere.

Damping Diode

The second type is a half-wave rectifier designed for use as a damping diode in television receiver deflection circuits.

Heater-Cathode Ratings

The tube, 6U4GT, features a high peak heater-cathode rating of 3,850 volts when the heater is negative with respect to the cathode. High peak heater-cathode rating is said to eliminate the need of low capacitance

¹RCA 6AX5GT.

²RCA 5879.

³DuMont 16TP4.

Design and Application Features of Auto and PA Tubes, Rectangular Bent-Gun Picture Tubes, Miniatures With Three Diode and High-Mu Triode Sections, Damping Diode Rectifiers, Double Triode Subminiatures, Miniature Video IF Amplifiers and 14" Rectangular and 19" Metal Picture Tubes.

by L. M. ALLEN

heater isolation transformers in television circuits, where a high impedance yoke with direct coupling is used.

Fullwave Applications

Output current rating is 125 milliamperes *dc*. Two tubes of this type may be also applied in fullwave rectifier applications.

The 6BF7

A double-triode subminiature is the third Sylvania development.

The subminiature, available with pigtail leads as type 6BF7, and with short pins for socketing as type 6BG7, is supplied in a T-3 bulb measuring 0.400" in diameter and 1½" long.

Use of Separate Cathodes

Tubes are supplied with separate cathodes for each triode section so that each section may be operated independently.

Video IF Amplifier

The fourth Sylvania tube development is a miniature video *if* amplifier, 6CB6, for applications at approximately 40 mc or as an *rf* amplifier at frequencies up to 400 mc.

Tube's Features

A sharp cut-off pentode type, the tube is similar to types 6AG5 and 6BC5, but with the added features of a transconductance of 6,200 micromhos, input capacitance of 6.3 mmfd, output capacitance of 1.9 mfd, and grid-

to-plate capacitance of .02 mmfd, maximum.

Has separate base pins for suppressor grid and cathode.

The 19AP4

A nineteen-inch metal picture tube, 19AP4, represents the fifth new Sylvania tube, which provides a 11¾" x 15¾" image.

Tube is designed for magnetic focus and deflection and utilizes an electron gun with bent structure for use with a single external magnetic field to eliminate ion-spot screen blemish.

G.E. 14" Rectangular Picture Tube

A 14" rectangular picture tube, 14CP4, which provides a viewing area of 99 square inches has been announced by G. E.

Has a neutral density faceplate, and an electron gun designed to be used with an external ion-trap magnet for prevention of ion-spot blemish.

Maximum ratings are: anode voltage, 14,000; grid No. 2, 410 volts; grid No. 1, 125 volts negative and 0 volts positive bias.

Raytheon TV Tubes

Three television tubes, 1V2, 6AU5GT and 6CB6, have been announced by Raytheon.

The 1V2 is a miniature type half-wave rectifier.

The 6AU5GT is a beam power amplifier intended for use as a horizontal deflection amplifier, and the 6CB6 is a miniature type sharp-cutoff pentode. This type will be in general use in receivers as an *if* amplifier replacing, in many circuits, the 6AG5.

Picture-tube conveyor belt line at the Tel-O-Tube plant in Paterson, N. J.

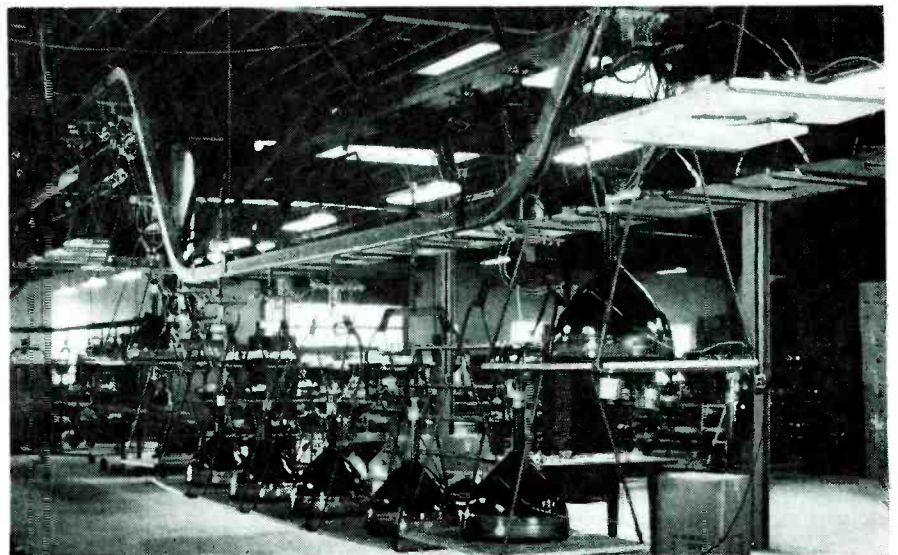

ASSOCIATIONS



TCA

A TELEVISION SERVICE GUIDE BOOK, which would be left at the point of installation by Service Men and also distributed by retailers at the sale of a TV set to help identify the Service Man who might do the installation and service work on the model sold, is now being planned by the Television Contractors Association in Philadelphia.

The book is expected to cover nine subjects: Selecting your television receiver; selecting your television service contractor; how television works; how to get best reception; how to reduce service calls; what to expect from the service contractor; your television service contract; how to avoid unscrupulous service contractors, and the importance of service contractors' insurance coverage.

All members of TCA will soon receive an identification card which will contain a photograph of the Service Man to whom the card is issued, his complete affiliation and signature. It is planned to laminate the card after the photograph and signature have been affixed so that no alteration might be possible. To obtain the card, an employee or applicant for employment must fill out a specially designed application form in duplicate. One copy will be retained by the TCA member, and the duplicate forwarded to TCA headquarters.

Present plans call for the publication of nearly 100,000 copies of the guide books, which it is believed will be available within the next 30 to 60 days.

TISA

IN AN EFFORT to eliminate the rumble of service-practice dissatisfaction now being reported by many, The Television Installation Service Association, Chicago, have made plans to invite manufacturers, distributors, parts manufacturers, broadcasters, parts jobbers, dealer organizations, the press, the Federal Trade Commission and Better Business Bureaus to discuss these problems during the forthcoming Parts Show in Chicago.

In a strong letter outlining the situation, Frank J. Moch, TISA prexy,

disclosed that they have found many . . . "bad practices being permitted and encouraged by some manufacturers." The letter went on to say that . . . "it is the duty and responsibility of the industry to support any association which is endeavoring to maintain the servicing profession on an ethical basis. . . . Failure of the industry to cooperate with such an association . . . is a violation of a trust on the part of the industry. We of TISA are doing our

TEN YEARS AGO

From the Association News Page of SERVICE, May, 1940

THE THIRD ANNUAL CONVENTION of RSA was scheduled for the Stevens Hotel in Chicago. An extension course session was programmed for the convention during which it was planned to present talks on circuits and their maintenance problems. FM was also scheduled to be covered during the conference. . . . SERVICE had received a certificate of honorary membership in the RSA for its cooperative endeavors in behalf of the association. . . . The Cleveland Chapter acquired a G. E. television course. . . . Television instruction was also inaugurated at the Danville Chapter. A campaign to eliminate radio interference was also initiated by the chapter, a local newspaper adding its support to the program. Also cooperating were the local broadcasting station and power company. . . . The Newark Chapter announced plans for taking an active part in the *joint industry promotion campaign* under the *guaranteed service plan*. . . . The newly organized Chippewa Valley Servicemen's Association in Wisconsin prepared an elaborate display campaign, with many of the members of the association devoting their entire windows to the display. Featured in the setup were the various instruments used in servicing and variety of parts required for replacement purposes. A complete list of all the members of the association also appeared as a part of the display arrangement.

utmost to maintain a healthful, clean service profession for the benefit of the entire industry and the set buyers. We cannot achieve full success without each manufacturer's explicit co-operation."

Members of TISA include Fred Levine of West Side Television Service, who is secretary; Irving Kaluzna of Television Engineers, Inc., who is vice president; Martin Reese of Television Technicians, Inc., who is treasurer, and prexy Frank J. Moch, who is with the Aide Sound and Radio Service Corp. Others in the association include Philip Ban, Central Television Service; John Beranich, Emergency Radio; John Cecich, Cheltenham Television Co.; Louis Arnoff, Dealers Radio and Television Service; Walter Kent, Kent Engineering Co., and William B. Wilson, Radio City, all of Chicago, Ill.

ESFETA

AT A RECENT ELECTION MEETING of the Empire State Federation of Electronic Technician Associations, held in Binghamton, N. Y., Max Liebowitz was reelected president. Other reelected officers include Wayne Shaw, who was renamed secretary, and Ben De Young who was renamed treasurer.

Lawrence Ramo was elected vice president and Ed Fiske became sergeant-at-arms.

ARSD

AT A RECENT ELECTION of the Associated Radio Service Dealers, Columbus, Ohio, Malcolm Homsher was elected president; John Potts, vice president; Dana Young, secretary; Clyde Stapf, treasurer.

The qualifications and classes of membership were changed during a meeting of the board of directors, and full membership now applies to firms or individuals *actively engaged* in servicing or the sale of receivers or other similar electronic devices, from *regular established places of business* in Franklin County. Also included now are associate and jobber memberships.

Match where features... furnish all the rapid, precision testing Flexibility, versatility, outstanding character individually and in

The RCA WR-59B Generator covers all channels on preset tions, and in addition f tuning range from 0.3 modate current and f frequencies. The rf sig modulated at the funda. by a precision-type vibrat advanced design. The sign spurious responses and otr components often found i generators and beat-frequency



Av

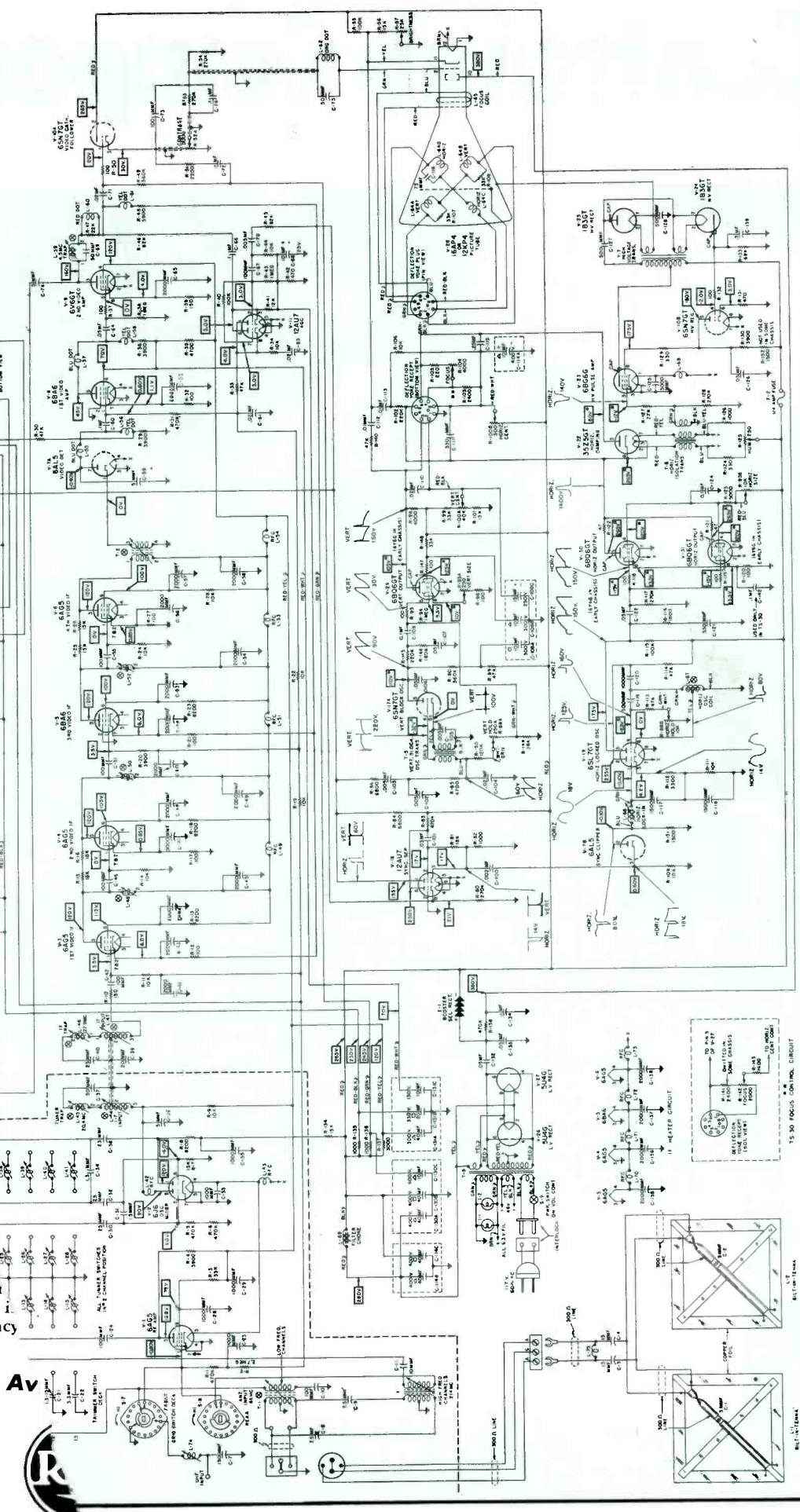

Fig. 1. Circuit of the Motorola TS 16/TS-30 chassis.

Centralab Components

CENTRALAB
CAPACITORS

... More Than Meet Your
Replacement Needs



HI-VO-KAPS
for TV Power Supplies.

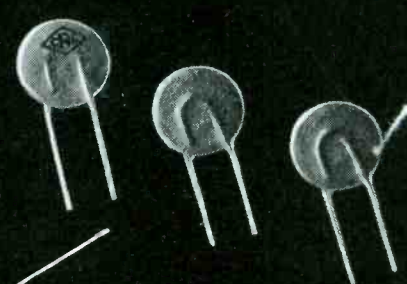

KOLORDISKS
for by-pass and coupling in AF,
RF, VHF, UHF, TV, FM and AM
circuits.



BC HI-KAPS
for by-pass and coupling in RF,
HF, VHF, UHF, TV, FM and AM
circuits.

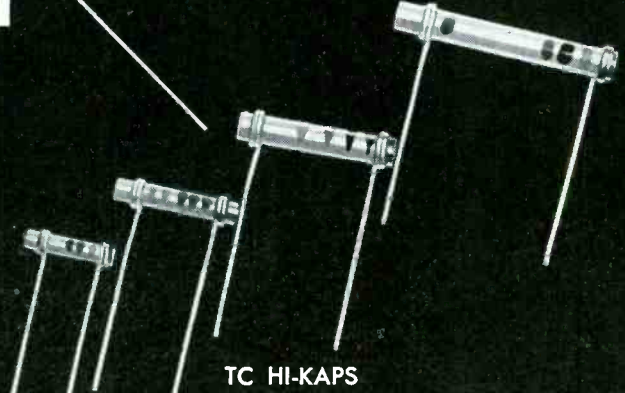

TC HI-KAPS
for temperature compensation
in AF, VHF, UHF, TV, AM and
FM circuits.

CRL CAPACITORS MEAN PROFITS FOR YOU!

WHEN YOU use high quality Centralab replacement capacitors in repairing radio sets, television receivers and other electronic equipment, you can be sure of customer satisfaction. You can be sure of new business. What's more, Centralab capacitors — *Hi-Vo-Kaps*,

Kolorisks, *TC* and *BC Hi-Kaps* — make your job easier, save you time. Here's why. They're simple to install . . . easy to stock. Get all the facts on profit-making CRL replacement capacitors from your nearby Centralab distributor.

— Safest for Servicing

Successful servicemen, like successful engineers don't guess — they know! Here are Four important standards they run their business by: "1) Do the replacement parts I use give my customers trouble-free service? 2) Are these parts designed to help me do a good job quickly? 3) Are they packaged to save shelf space . . . to make accurate selection easy? 4) Am I getting the kind of service I want from my distributor?" If you can answer "Yes" to all these questions, it's very likely you use quality Centralab parts, too. If you can't, we're confident you will find it profitable to ask your nearest Centralab distributor for all the facts. Call him today!

Centralab
Division of GLOBE-UNION INC. • Milwaukee

Ask Your Distributor for These CRL Parts

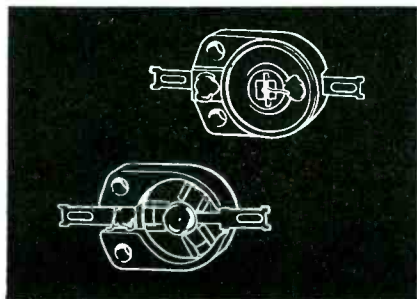

TRIMMERS

CERAMIC TRIMMERS for padder application in RF and HF circuits. These trimmers are noted for their great mechanical strength and electrical stability; low power factor. Hold circuit drift to a minimum. Truly an indispensable "must." Ideal for amateur, experimental and industrial use.

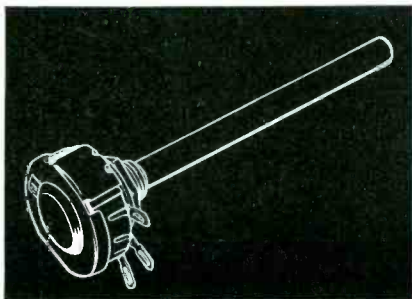

CONTROLS

MODEL "M" for voltage-divider, antenna shunt and "C" bias control, tone control, AF grid control. **MODEL "I"** for all miniature applications; rated at 1/10 watt, actually smaller than a dime. **MODEL "R"**, wire wound, for voltage divider, antenna shunt, "C" bias, AF grid or tone control circuits.

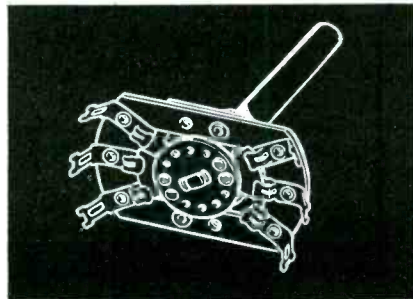

SWITCHES

ROTARY for band change, meter, intercom circuits; made in ceramic and phenolic models. **ROTARY SPRING RETURN** for meter selection, intercom, phono-radio applications. **MEDIUM DUTY** for band changing in low power exciter-transmitters and receivers. **LEVER ACTION** for intercom, speaker, microphone and other applications.

Ser-Cuits

(Continued from page 38)

first trap consists of coil L_{35} , a 50-mmfd capacitor, C_{37} , and several turns of a coil, L_{44} . This trap is tuned to resonance at 20.4 mc, which is the frequency of the upper, adjacent-channel picture carrier. The number of turns of L_{44} used for the trap was chosen for maximum absorption at 20.4 mc. The second trap consists of a coil, L_{46} , a 25-mmfd capacitor, C_{40} , and a part of a coil, L_{47} , and is tuned to resonance at 27.9 mc. A low-pass filter, choke L_{42} , and a 5-mmfd capacitor, C_{34} , is placed in the mixer plate circuit to prevent loading of the tuner by the *if* input, which would cause low sensitivity on the high channels.

Driver-Degenerative IFs

The four *if* tubes are arranged in two pairs, each pair consisting of a driver stage and a degenerative stage. Unlike stagger-tuned systems, the four stages are all tuned to the same frequency, one of which will center the *if* curve at 24.4 mc, and proper bandwidth is achieved by providing degeneration between the plate and grid of the degenerative stage. This degenerative path consists of a pair of 18,000-ohm resistors, R_{15} and R_{16} , and a 100-mmfd capacitor, C_{46} , and a pair of 15,000-ohm resistors, R_{26} and R_{28} , and a 100-mmfd capacitor, C_{55} . The degenerative resistors are split in half and shielded from each other to keep capacity in the loop at a minimum to prevent phase shift.

Use of Fixed Bias

Since the gain of the degenerative stages controls the amount of feedback, and, therefore, the bandwidth, any variation in bias on these stages would result in varying the bandwidth. For this reason, the degenerative stages are operated with fixed bias, and only the driver stages are returned to the *agc* bus.

Because of the high level of signal at the third *if* tube grid, a remote cut-off tube, type 6BA6, is used to minimize gamma or gray-scale distortion. The plate load of each stage except the fourth consists of a tunable coil. The fourth *if* stage plate is coupled to the video detector tube by a unity coupled

transformer. The video detector tube is one-half of a 6AL5. The *if* frequencies are filtered out of the plate circuit of the video detector by a 5-mmfd capacitor, C_{58} .

Video Detector Polarity

The video and sound *if* carriers heterodyne in the detector circuit to produce a 4.5-mc (amplitude and frequency modulated) intercarrier beat, and this voltage, together with the recovered video modulation, appears across a 3900-ohm detector load resistor, R_{29} . The polarity of the video detector is such that sync pulses are produced in the negative direction.

Video Amplifier

The video amplifier consists of two pentodes, 6BA6 and 6V6GT, and a cathode-follower, one-half of a 6SN7GT. The amplifier embodies both high- and low-frequency compensation, *dc* restoration, and high- and low-level noise limiting. It also delivers a 4.5-mc intercarrier beat to the sound system.

Video-Amplifier Input

The 4.5-mc intercarrier beat and the demodulated video signal, with negative-going sync pulses, are applied to the first video-amplifier tube grid. The frequency response of the first video amplifier stage is extended at the high end by series and shunt compensating coils L_{55} and L_{58} in the grid circuit, and by L_{57} and L_{58} in the plate circuit. A 10-mmfd electrolytic, C_{130C} , connected to the screen grid of the 6BA6 first video amplifier tube provides low-frequency compensation.

Frequency Compensation

The amplified signals from the 6BA6, with the sync pulses now positive, are coupled to the grid of the 6V6GT second video amplifier. The second video-amplifier stage is also frequency compensated by series and shunt peaking coils, L_{60} and L_{61} , in the plate circuit, and by cathode degenera-

tion. The 4.5-mc intercarrier beat at the plate of the 6V6GT amplifier does not appear at the grid of the 6SN7GT cathode follower, because of the high impedance offered to this frequency by coil L_{58} and a 50-mmfd capacitor, C_{58} , the 4.5-mc trap circuit. The trap offers a low impedance to the video signal, however, and this signal with the sync pulses negative appears at the grid of the cathode-follower tube.

Cathode-Follower Features

The cathode follower tube serves two purposes: First, it is so biased that the peaks of the negative-going sync pulses are near cut-off; thus, any noise pulses which exceed these peaks will drive the tube to cutoff and be clipped very accurately at the sync pulse level because of the high amplitude of the signal at this point (about 70 v *p* to *p*) producing an effect known as *high-level clipping*. Second, it acts as an amplifier to feed the cathode of the picture tube and as an impedance source to the grid of the picture tube, which is important because stray capacity attenuation of high video frequencies is minimized by using a low impedance source. The contrast control is placed in the cathode circuit of the cathode-follower tube, and it controls the magnitude of the video signal reaching the picture tube grid.

Video Signal Coupling

The video signal to the picture tube grid is fed through a .1-mfd coupling capacitor, C_{74} . The *dc* component is applied through a voltage divider network of resistors R_{58} (270,000 ohms) and R_{154} (82,000 ohms). A trap consisting of a coil, L_{92} , and a 50-mmfd capacitor, C_{75} , is resonated at a frequency slightly higher than 4.5 mc, and it is placed in the grid lead to the picture tube to remove transients caused by the 4.5-mc trap in the preceding stage.

Video Signal Amplification

The video signal is also amplified in the 6SN7GT and is fed to the cathode of the picture tube through a shielded lead. Since the signal on the grid of the picture tube is negative and that on the cathode is positive, a push-pull effect is achieved, allowing the picture tube to be driven hard enough to ob-

tain a good picture contrast ratio. Capacitor C_{146} (.05 mfd) is the coupling capacitor, and the combination of capacitor C_{130} (100 mmfd) and resistor R_{108} (10,000 ohms) provides high-frequency compensation.

Sync Separation and DC Restoration

The entire video signal is fed from the 6SN7GT cathode follower through resistor R_{51} (2,200 ohms) and capacitor C_{72} (.1 mfd) to the cathode, pin 8, of the 12AU7. The signal is taken from the high end of the contrast control so that synchronization is independent of the contrast setting. Since the video signal applied to the 12AU7 cathode contains negative-going sync pulses, and since the grid of the tube is grounded, with respect to *ac*, through a .02-mfd capacitor, C_{148} , this stage will act as a peak detector, conducting only during sync pulses. The resulting positive voltage across resistors R_{80} (270,000 ohms) and R_{157} (120,000 ohms) is the *dc* component of the video signal.

Bias Division

The 270,000-ohm and 120,000-ohm resistors (R_{80} and R_{157}) form a voltage divider to provide the proper bias on the grid of one triode section of the 12AU7. The voltage across the 270,000 ohm resistor biases this triode so that it conducts only on sync pulses. In addition, the total voltage is applied through resistor R_{40} (560,000 ohms) to the grid of the 6SN7GT cathode follower. Capacitor C_{71} (.02 mfd) charges up to a *dc* level equal to the total voltage and keeps the voltage constant between sync pulses. The *dc* voltage level appearing now on the grid of the cathode follower tube appears on the cathode as well, and a portion of this level, along with a portion of the *ac* component of the video signal, is applied to the grid of the picture tube, the amount depending upon the setting of the contrast control.

Sync Separation

Since the *dc* voltage level biases one triode section of the 12AU7 so that it conducts only on sync pulses, blanking and video components of the signal are beyond cutoff, and only negative sync pulses appear in the plate circuit. These pulses are applied to the grid of the second triode section of the 12AU7. The amplitude of the pulses

is such that their peaks drive the tube to cutoff, resulting in positive, square wave sync pulses of constant amplitude in the plate circuit. These positive pulses are fed to the vertical integrator, to the *agc* circuit, and to an *audio squelch circuit*. In addition, negative sync pulses are fed from the 12AU7 cathode to the horizontal locked-oscillator circuit.

AGC Circuit

This receiver employs an *agc* circuit (12AX7) in which the control responds only to carrier amplitude and is independent of picture content. The circuit will respond to rapid, as well as slow, changes in signal strength so that flutter in the picture is eliminated.

AGC Signal Inputs

The *agc* circuit has two signal inputs; a constant amplitude, positive, horizontal sync pulse from the sync-separator tube, and the composite video signal, with negative sync pulses, from the second video amplifier. The pulse from the sync-separator tube is fed to the grids of the two triode sections of the 12AX7 and acts as a keying pulse to allow the triodes to conduct only during the horizontal sync pulse time, which means that the *agc* circuit makes a bias correction only at peak carrier amplitude and is independent of picture content. The composite video signal is applied to the plate of one triode section of the 12AX7 and to the cathode of the other triode section, and the amplitude of the sync pulse of this signal determines the *dc* bias developed in the circuit.

Positive Keying Pulses

The positive keying pulse is applied to the grid of one triode section through a differentiator circuit consisting of a 100-mmfd capacitor, C_{67} , and a 1-megohm resistor, R_{48} , which filters out the vertical sync component. The peak-to-peak amplitude of this pulse is about 7 volts under normal conditions. At the same time, in a given case, the composite video signal, with negative sync pulses, applied to the cathode of the same triode section have a peak-to-peak amplitude of about 9 volts. The grid-cathode bias developed would be about 8 volts, cutting off this portion of the tube. Dur-

ing the sync-pulse interval the grid is driven positive by the keying pulse from the sync-separator tube, and the cathode is driven negative by the sync pulse in the composite signal. The resultant current flow charges capacitor C_{68} (.02 mfd) negatively and develops a voltage (the *agc* voltage) at the plate of this 12AX7 triode section, which is applied to the cathode of the other triode part of the tube. This action is repeated with every sync pulse, and the .02-mfd capacitor continues to charge more and more negatively.

Voltage Provided by AGC

As the plate of one triode section is driven more negative, the triode begins to conduct, producing an *agc* voltage proportional to incoming carrier amplitude. At the same time the cathode of the other triode section is going more negative, bringing this tube closer to conduction, despite the negative composite signal applied to its plate. Eventually, the negative-going *agc* voltage allows the triode section to start conducting plate current, which will tend to discharge C_{68} in opposition to the charging current from the other triode section. For a given signal strength, a stable balanced condition is reached when the current in the latter triode section, trying to charge the .02-mfd capacitor negatively, equals the current in the other triode section which is trying to discharge this capacitor back to ground potential. The *agc* voltage thus obtained is about 4 or 5 volts on an average signal.

Control of Keying Pulses

If the signal strength should suddenly increase, the keying pulses will remain constant in amplitude, but the video signal will increase in amplitude, which means that the cathode of one triode section is driven more negative, giving an increase in plate current, and the plate of the other triode section is also driven more negative, decreasing the plate current. The net result is that .02-mfd capacitor will be charged more negatively by the difference of these currents, and a new balanced condition will exist with a greater negative *agc* voltage, which
(Continued on page 44)

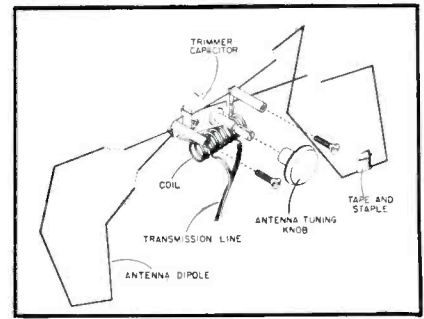
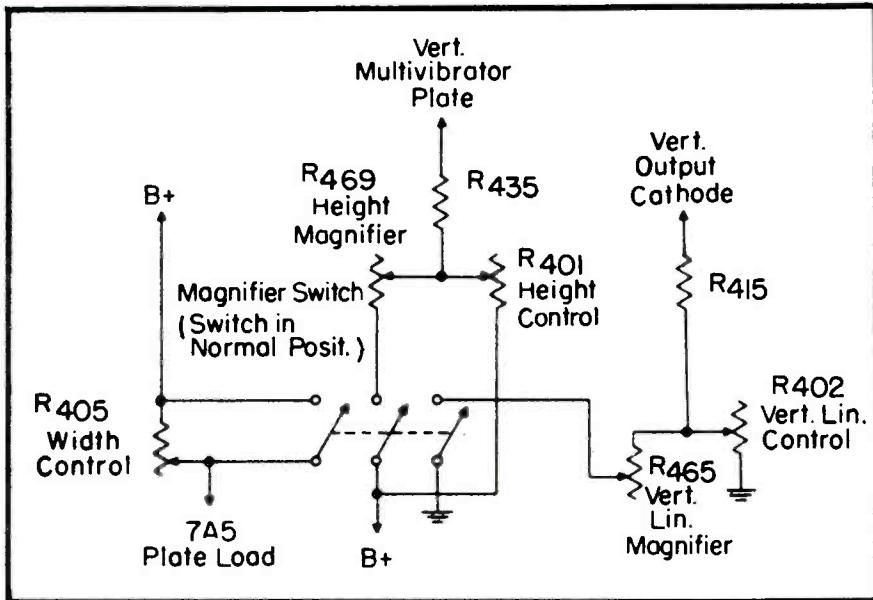

Fig. 3 (above). Raytheon TV built-in antenna setup.

Fig. 2. Westinghouse electronic magnifier circuit.

corrects for the original increase in signal strength.

AGC Voltage Filters

If the signal strength should decrease, the composite signal will have less amplitude, and both the cathode of one triode section and the plate of the other triode section will be driven less negative. In this instance, the latter triode section will conduct more current than the other triode and the .02-mfd capacitor will discharge until a new equilibrium *agc* voltage is reached. The action is very rapid because of the short time constants involved. The *agc* voltage is filtered by resistor R_{38} (47,000 ohms) and capacitor C_{61} (.02 mfd) to keep the voltage constant over a number of horizontal lines and to prevent noise from changing the bias.

AGC Delay System

The *agc* voltage is applied to the grid of the 6AG5 *rf* amplifier and to the grids of the 6AG5 and 6BA6 *if* amplifiers. To keep the *rf* amplifier tube unbiased in weak signal areas, a delay is incorporated in the circuit. Resistor R_{42} (470 ohms) is placed in series with the cathodes of the 6AG5 and 6BA6 *if* amplifiers, and the voltage drop across the resistor, due to cathode current, raises the entire *agc* circuit above ground by about 4 volts positive. Since the cathode of the 6AG5 *rf* amplifier tube is grounded, no negative bias will be applied to this tube under weak signal conditions, but if the *agc* circuit develops more than

4 volts bias, the grid of the *rf* tube will be biased negatively, and thus strong signals cannot block the *rf* stage.

Avoiding Clipping

Overload conditions in the first video amplifier stage would cause clipping of the sync pulses, thus rendering the *agc* system inoperative because of lack of keying pulses and the *if* amplifier tubes would operate at full gain, contributing further to the overload and also developing several volts, negative, across a 3,900-ohm video detector load resistor. This video detector voltage is applied through decoupling resistors R_{30} (47,000 ohms) and R_{158} (1 megohm) to the *agc* line, decreasing the *rf* and *if* gain to a point where overload no longer occurs and allowing the *agc* circuit to operate properly. With normal signals, the voltage applied to the *agc* line from the video detector is considerably lower than the developed *agc* voltage, and, therefore, it has no effect in controlling the gain of the system.

Westinghouse Electronic Magnifier¹

Recent months have seen a wider and wider application of the electronic magnifier type of circuit, an example of which appears in Fig. 2. In this system a four pole single throw switch type, in the counterclockwise (normal) position, serves to open circuit the magnified picture system.

When the switch is in the clockwise

position, all contacts are closed with the following results:

- (1) The width control is shorted out, allowing the picture to expand to maximum width.
- (2) The height magnified control is connected in parallel with the normal height control. This increases the charging rate of the vertical discharge capacitor, as the shunted control presents less resistance in the charging circuit.
- (3) The linearity magnified control is connected in parallel with the normal linearity control. Further control of the vertical linearity is provided without disturbing the normal linearity control.

Built-In TV Antennas

A rather novel type of built-in antenna appears in Fig. 3.

Mounting and Orientation

The antenna is mounted inside the cabinet and is operated by the use of a knob at the top of the back of the cabinet. Since the antenna is fastened to the cabinet it may be necessary to orient the cabinet to obtain the best reception. It has been found that for best reception either the front or the back of the cabinet may have to face the transmitting station.

The antenna tuning knob should be used as a fine tuning control and adjusted until the best picture is obtained.

¹See page 46, this issue, for additional electronic-magnifier data.

**ZOOMING
AHEAD
IN DEMAND!**

**Feature For Feature
Compare it... You can't beat a
RADIART TELE-ROTOR**



HEAVY DUTY MOTOR... most powerful of all TV rotators



Streamlined Weather-Proof Housing, Keeps Out Water, Snow and Ice

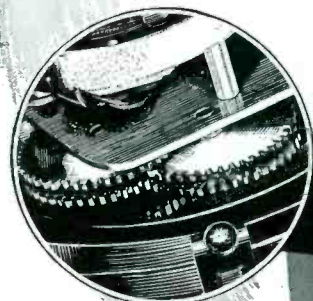

HEAVY DUTY Precision STEEL GEARS



12 Heavy Duty Ball Bearings in 6½" diameter Ball Bearing Races



THE RADIART TELE-ROTOR CONTROL BOX with the PERFECT PATTERN dial... fingertip control with instant indication of Antenna Position shown on the illuminated two-tone face

Available in the following models:

- **TR-1** ... rotator and Control Unit with end of rotation light (uses 4 wire Cable) **\$37.45**
- **TR-2** ... Compass Control Rotator with illuminated "Perfect Pattern" dial (uses 8 wire Cable) **\$44.95**

You Can't Beat a RADIART ANTENNA on a TELE-ROTOR... It's TOPS!



IT'S RIGHT WHEN IT'S RADIART

THE RADIART CORPORATION
CLEVELAND 2, OHIO



- ROTATORS
- VIBRATORS
- AUTO AERIALS
- TV ANTENNAS
- POWER SUPPLIES

TV Electronic

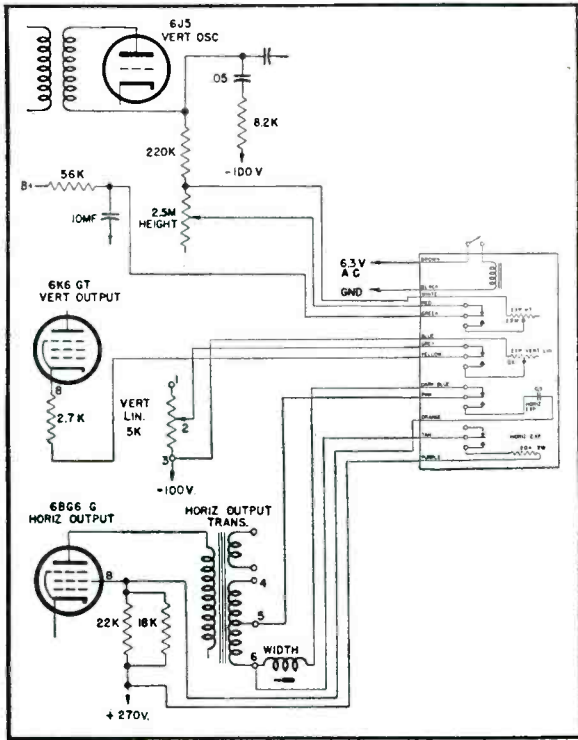

Fig. 1. , Circuit of the Air King, Ansley, Bace, Crosley, DeWald, Hoffman, International Television, Nielsen, Philmore, RCA, Starrett chassis set up for use with the Federal electronic magnifier system.

ELECTRONIC MAGNIFICATION has become quite popular in many new models during the past few months, and as a result Service Men have been asked if the system can be installed in older-type standard type chassis.

Recently a system¹ permitting such installations in a variety of chassis was developed.

Typical Circuit Applications

In Fig. 1 appears a typical circuit which reveals how the system can be applied to chassis used in models made by Air King (A-1000), Ansley (701,

702), Artone (630 type chassis), Crosley (307TA, 307TA-50, 9-408, 9-408(50)), DeWald (CT-101, BT-100, BT-101), Hoffman Radio Corp. (CT-800, CT-801, CT-900, CT-901), International Television (D-16), Mars (1200), Nielsen Television Corp. (1018), Philmore (P30), RCA (630TS, 8TS30 chassis, 8TV41 chassis), Starret TV (all 630 TV chassis), Techmaster (930, 1230, 1530, 1630, 1631, 2031), etc. Figs. 2, 3, 4 and 5

¹Federal Television Corp., model MO-100.
*Based on copyrighted notes prepared by Federal Television Corp.

illustrate other circuits in which the system can be installed.

System Operation

The system affords electronic enlargement of pictures on magnetic deflected type receivers. The enlargement takes place from the center of the picture outward. When a control button is pressed a relay is operated, which causes the picture to become enlarged. This button does not have to be held in the depressed position. When it is desired to return the pic-

Fig. 2. Electronic-magnifier system setup for Federal Television (Model 12 T and 15 commercial), Olympic (TV992, TV928, TV922L, TV944, TV945, TV104, TV105, TV108, TV946, TV947, TV949, TV950), Philharmonic (TV-1049, TV-1249), RCA (621TS, 721TS, 730TV1, 730TV2), Teletone (TV-249 10" and 12" models, all TS chassis), U. S. Television (T10823) and Western Auto Supply (D1991A, D1993A, D1991B, D1993B) chassis.

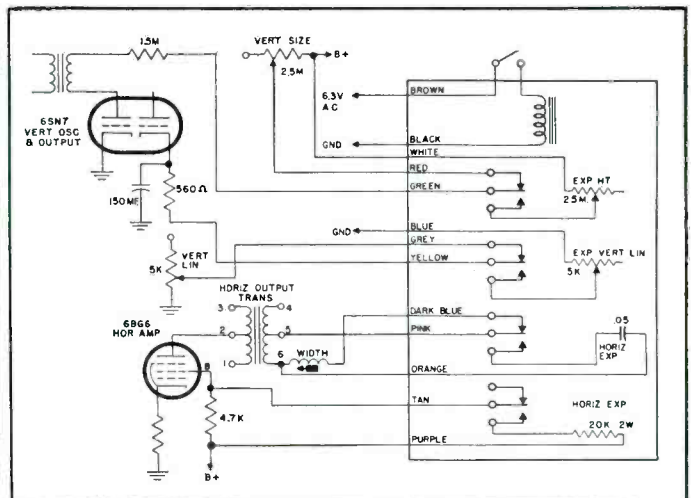
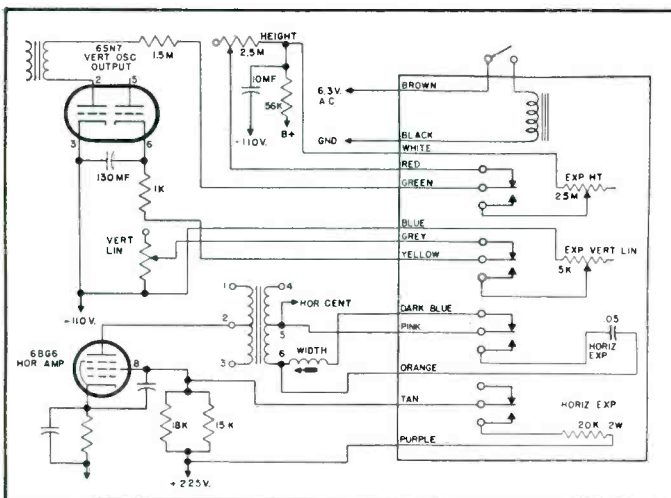

Fig. 3. How the electronic-magnifier system can be used with chassis made by Artone (dual chassis), Gamble-Skogmo (TV 43-8960, 94TV-43, 8970A, 8971A, 8985A, 8986A), Halli-crafter (T64, 509, 510, 515, T61, T67), United Motors (TV101, TV201), Video Corp. of America (VS-120).

MAGNIFIER CONVERSION

Installations

Circuit Changes Required in Most TV Chassis for Electronic Magnifier System Application*

by B. W. MARWYN

ture to normal size, the button is pressed again.

The Installation

A normal installation consists of mounting the magnifier box on the rear or inside of the television cabinet, whichever is more convenient.

Many manufacturers use the same type chassis in different models. Once an installation of the electronic magnifier is made on a particular type chassis, the experience gained can be applied to future installations on similar type chassis.

After the magnifier unit has been wired into the receiver, and the control

button pressed, a click will be heard from the magnifier box, indicating that the relay is operating. The button should then be pressed once again to return the picture to normal size. On sets equipped with a horizontal drive the control should be adjusted for maximum drive. The width coil should then be adjusted so that the picture just barely fills the opening of the picture framing mask.

Securing Brightness

If a noticeable decrease in picture brightness occurs when the magnifier is operated, the ion magnet on the neck of the picture tube must be readjusted for maximum brightness.

In some sets there may be slight

change in focusing between normal picture size and enlarged picture size. The focus control should be set so that a compromise focus is obtained between both types of operation.

Vertical Sync Adjustments

In some receivers the setting of the height control interacts with the setting of the vertical holding control. If trouble occurs with the vertical synchronization, the expanded height control should be adjusted for maximum height consistent with proper vertical synchronization action and the vertical linearity control should be used to expand the picture to the desired amount in the vertical direction.

Fig. 4. Midwest TV (XA12, 932, chassis CA-12), Scott (300), Teletone (12½" and 16" models TH, TJ and TT) chassis arranged for the installation of the electronic-magnifier system.

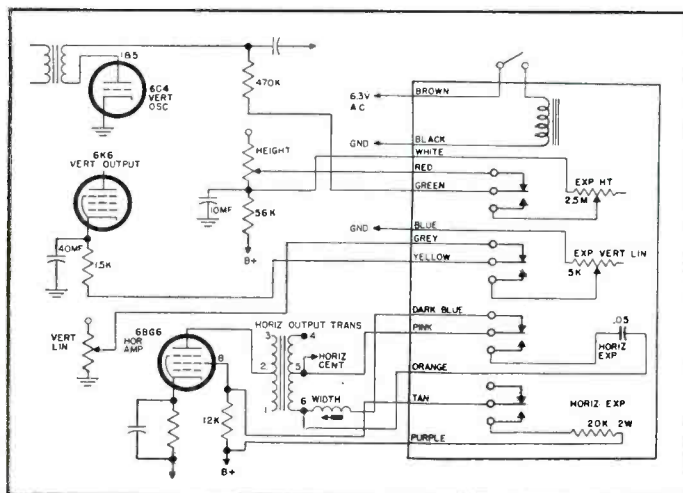
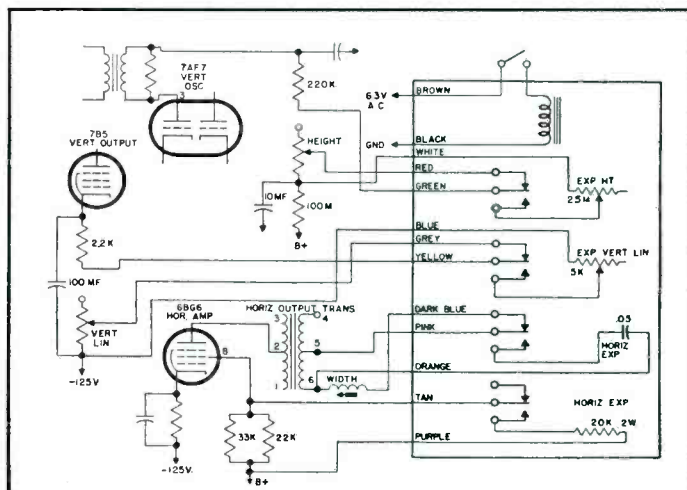

Fig. 5. Sears Roebuck TV models (8132, 9122, 9119, 9120 chassis; 101.854, 101.864, 101.865) adapted for electronic-magnifier use.



PRINTED CIRCUIT TV Tuner

(See Front Cover)

SINCE THE early days of production, the TV receiver has undergone many radical mechanical and electrical revisions, particularly in the front end where several types of switching systems and circuitry innovations have been applied.

A New Approach

Recently, in a new approach, a rotary-turret switch tuner¹ was evolved featuring printed-circuit coils.

For Stagger-Tuned IF

Designed for use with a stagger-tuned picture-*if* system having a carrier of 25.75 mc and a sound-*if* system having a carrier of 21.25 mc, as employed in the 630TS type of television receiver, the tuner for 12-channel coverage is said to provide a voltage gain of between 28.7 and 34.9 db for all channels under typical operating conditions.

Elevator Transformers

The input circuit of the tuner contains a pair of elevator transformers for matching to a balanced 300-ohm transmission line and to attenuate noise which may be induced in the transmission line. This circuit also contains a high-pass filter with cutoff at approximately 47 mc and with maximum attenuation at approximately 23.5 mc for rejection of intermediate frequencies at the grid of the *rf* amplifier. A tuned low-pass pi-network, with a coil for each channel, provides gain and selectivity at the grid of the *rf* amplifier and reduces oscillator voltages at the antenna terminals. The constants and configuration of this pi-network have been chosen to provide a varying impedance transfer to the grid of

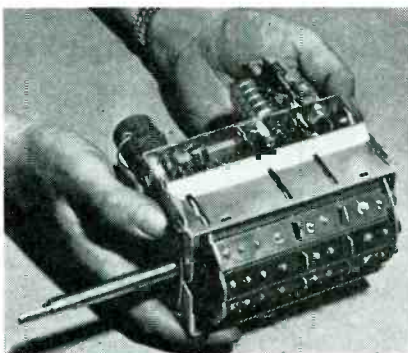

Printed-circuit television tuner. The first segments on which the tuned circuits are printed are shown on the tuner turret.

the *rf* amplifier so that an optimum noise factor is achieved for all channels.

RF Amplifier Design

Controlled negative resistance has been introduced at the grid of the *rf* amplifier to maintain high gain at high signal frequencies and to minimize the effects of cathode inductance. The *rf* amplifier is a 6CB6. The output of the *rf* amplifier contains a double-tuned, M-derived band-pass filter with maximum attenuation at approximately the image frequency of each channel. This filter, with coils for each channel, has been found to provide unusually high image rejection and also attenuate voltages of oscillator frequencies at the plate of the *rf* amplifier. The oscillator, with adjustable coil inductances for each channel, contains a single-ended, temperature-compensated Colpitts circuit to provide oscillator stability.

Low-Pass Filter

The mixer plate circuit contains a tuned low-pass filter section for the

picture-*if* output and a high-*Q* trap for the sound-*if* output. This trap is tuned to 21.25 mc and attenuates sound-*if* frequencies at the picture-*if* output. The low-pass filter section minimizes oscillator frequencies at both sound-*if* and picture-*if* grids. The picture-*if* output frequency is normally 22 mc but may be adjusted for operation between approximately 21.8 and 23 mc so that it may be used with various stagger-tuned *if* combinations.

Mechanical Features

The turret employs 12 removable segments, each containing the coils for one of the twelve channels. Tuning is accomplished by rotating the turret to connect the proper coils to stator contacts of the switch. Adequate bearing surfaces of proper materials have been provided at all points to insure noise-free ground contacts. A special long-life lubricating compound is used on both the bearing and contact surfaces. The stator contact springs are solid hard spring silver; the turret contact rivets are solid coin silver. The tuner has been found capable of withstanding well over 40,000 complete revolutions of the turret.

Printed-Circuit Process

The printed circuits are reproduced by a photo-etch process, which begins with the photographing of a circuit drawing. A contact print is then made from the negative in a copper-clad sheet of phenolic plastic which is coated with a light-sensitive material. The print of plastic sheet is next developed and placed in an etching solution. The solution etches away that part of the copper not covered by the pattern of the circuit, leaving the required copper circuit on the plastic

(Continued on page 67)

¹RCA—206E3.

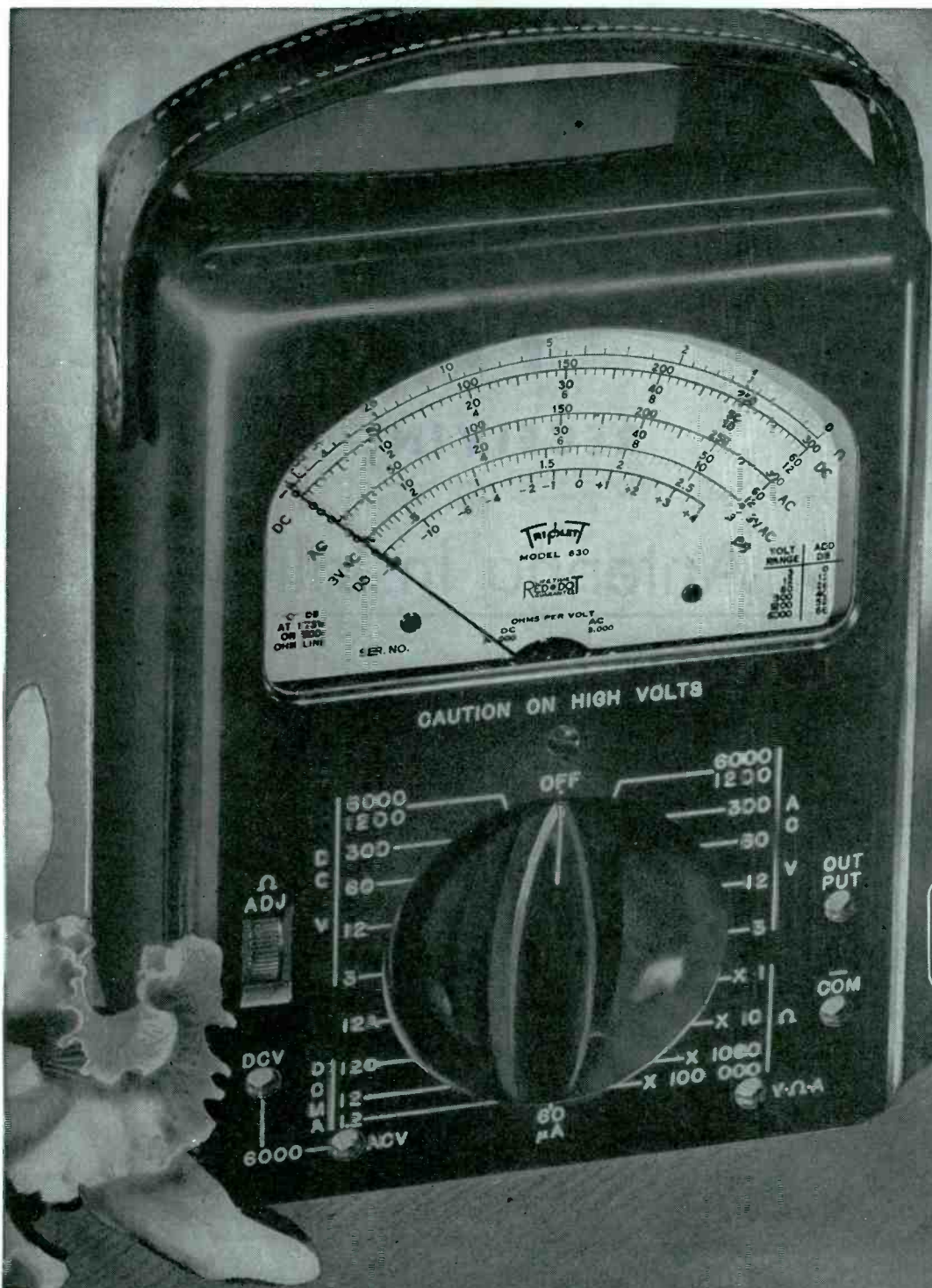

Model
630

*There is no more useful
and dependable instrument made*

FOR THE MAN WHO TAKES PRIDE IN HIS WORK

Triplet

TRIPLET ELECTRICAL INSTRUMENT COMPANY - BLUFFTON, OHIO, U.S.A.

ONLY \$37.50 AT YOUR DISTRIBUTOR



FIELD TESTED

Installation Information on

TV and FM

RECEIVING ANTENNAS

TV...FM Antenna Installation

by IRA KAMEN

Manager, Antenaplex and TV Dept., Commercial Radio Sound Corp.

and LEWIS WINNER

Editorial Director, Bryan Davis Pub. Co., Inc.; Editor, SERVICE and TELEVISION ENGINEERING

The only practical book on the all-important item in TV and FM reception . . . based entirely on actual experiences in the most active TV and FM areas in the country. . . . Over 35,000 words of vital data with over 130 photos and drawings.

TEN CHAPTERS COVERING:

Installation Tools
Antenna Installation Procedures
Securing 12-Channel Coverage
HF Antenna Installations
TV Interference

Fringe Reception
Master Antenna Systems
FM Antennas
Installation Business Practices
Tricks of the Trade

The first book in which you'll find complete design and installation information on every type of TV and FM receiving antenna. . . . Contains detailed illustration and subject index for rapid reference.

VV "The best book on the market at this time dealing with the problem of television antennas and antenna installation . . . If more Service Men would read this book, it would help them considerably in making better installations and providing better television reception for their customers."—*M. J. Shapp, President, Jerrold Electronics Corp.*

VV "Will recommend it to all the Service Men and technical people I meet."—*Charles Cahn, Field Service Engineer, Bendix Radio.*

VV "Well organized and illustrated, very complete and up-to-date, carefully detailed. It will definitely improve the ability of the man who studies it and therefore is mighty useful to a firm like ours."—*Hamilton Hoge, President, United States Television Mfg. Corp.*

VV "Will certainly fill a long-felt need for some practical information . . . sincerest congratulations."—*George P. Adair, Former Chief Engineer, FCC, and now Consultant in Washington, D. C.*

VV "A thorough-going compendium of the installing art . . . Going to recommend it highly to our Service Control Department and our service organizations."—*Ernest A. Marx, General Manager, Television Receiver Sales Div., Allen B. DuMont Laboratories, Inc.*

VV "Informative and extremely well written."—*R. Morris Pierce, Vice President in charge of Engineering, WJR, WGAR, KMPC.*

BRYAN DAVIS PUBLISHING CO., INC., Book Dept.
 52 Vanderbilt Avenue, New York 17, N. Y.

Send me a copy of TV . . . FM Antenna Installation, post-paid, for which I am enclosing \$2.00.

(Please print)

NAME

ADDRESS

CITY AND STATE

AT YOUR JOBBER
 OR ORDER DIRECT



Price \$2 Post Paid

ALLIED RADIO ELECTRONICS DICTIONARY

A 64-page *Dictionary of Electronic Terms* containing over 2,500 terms used in television, radio and industrial electronics, edited by Harry L. Van Velzer, Associate Professor of Electrical Engineering, University of Illinois, has been published by Allied Radio Corporation, 833 West Jackson Blvd., Chicago 7, Ill.

Over 125 illustrations and diagrams of components, equipment, and electronic circuits are included, as well as an appendix section containing useful radio data. Available for twenty-five cents.

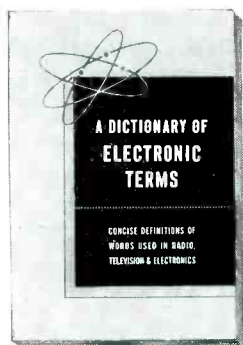

* * *

SYLVANIA GERMANIUM DIODE BOOKLET

A 48-page booklet entitled, *40 Uses for Germanium Diodes*, and containing forty basic germanium diode applications has been published by the electronics division of Sylvania Electric Products Inc., 1740 Broadway, New York 19, N. Y.

Text is grouped in three sections which describe germanium diode applications in radio and TV receivers; transmitters and amplifiers; and instruments and supervisory circuit devices.

The first section on crystal radio receivers and video circuit components contains 10 schematic diagrams with circuit constants. The second section on transmitters includes six schematics. The section treating instrument and gadget uses describes twenty-four devices ranging from a simple sideband generator in which matched diodes are arranged as a ring modulator to a 144-mc tubeless receiver for the remote control of model airplanes and model boats.

The booklet also includes descriptions and circuit diagrams of crystal voltage multipliers, two way relays operating at different *dc* voltages and suitable for temperature, frequency and current variation measurement, or for relay operation of alarm or recording mechanism; frequency triplers; tubeless tone generators; and selective telephone and telegraph circuits.

Booklet may be obtained from Sylvania radio tube distributors, or with remittance of one dollar to the advertising department, Sylvania Electric Products Inc., Emporium, Pa.

INSULINE AUTO ANTENNA DISPLAY

An all-steel display stand for auto antennas is now available from Insuline Corporation of America, 3602-35th Ave., Long Island City 1, N. Y. Display is free with order of six antennas.

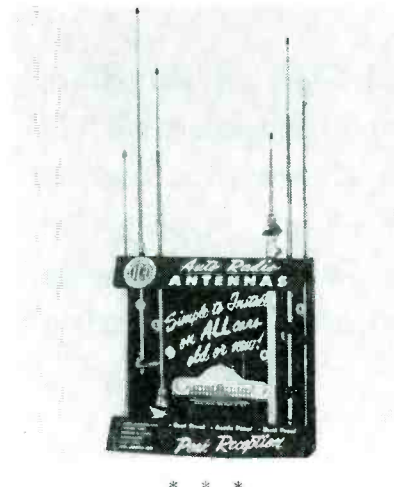

* * *

HYTRON MINIATURE TUBE REFERENCE GUIDE

The fourth edition of a *reference guide* for miniature electron tubes has been announced by Hytron Radio and Electronics Corp., Salem, Mass. Listed are data on 132 miniatures, of which 41 are new types. Illustrated are 70 basing diagrams. Shown, too, are similar larger prototypes.

* * *

TURNER CATALOG

An 8-page catalog describing crystal and dynamic microphones has been published by the Turner Co., Cedar Rapids, Iowa.

Detailed and illustrated, too, are magnetic contact pickups, lapel microphones, stands, and matching transformers.

* * *

RCA BATTERY CONTEST GRAND PRIZE



One of the pair of 1950 custom Fords which will be awarded to a lucky radio battery dealer salesman declared a winner, in the new RCA radio battery "Get the Facts" contest, for which \$10,000 in prizes have been allocated. Another car will go to the battery distributor salesman whose name appears on the winning entry coupon. Purpose of contest is to acquaint radio battery dealers and distributors with the features of RCA radio batteries. Winners will be selected on the basis of an impartial drawing of entry coupons mailed in by battery dealers. Holders of the coupons will then be called person-to-person by phone and, upon correctly answering a question in the official contest booklet, will be awarded the prizes.

Contest closes June 30, and drawings will be made at Camden, N. J., on July 10.

ALLIANCE TENNA-ROTOR SPRING CAMPAIGN

A 1-minute sound-film television campaign, on 60 TV stations in and around 50 cities, promoting the Tenna-Rotor is now being conducted by the Alliance Manufacturing Co., Alliance, Ohio.

Alliance has also produced recently an action counter display which permits prospect to operate the control case at the counter. A miniature antenna, which is part of the display, is attached to a rotator mounted in the rear of display.



* * *

CENTRALAB FIVE-POINT PLAN

A five-point plan, involving lines of new components and new methods of distribution, will be unveiled by Centralab during the Parts Show in Chicago at the Hotel Stevens.

Among the new lines to be displayed will be *blue-shaft* volume controls, printed electronic circuits, and control, switch and capacitor kits offered as merchandising features. An expanded line of ceramic capacitors with values as high as .1 mfd, 600 volts working, will also be shown. Presented, too, will be a plan for handling TV control replacements with *exact-duplicate* controls.

A new TV and radio service catalog, No. 27, will also have its first distribution at the show.

Distributors attending the Parts Show will also learn about a 60-day CRL price-protection policy and a comprehensive method of keeping inventories up-to-date, through an inventory-exchange plan. Also to be announced will be details about Centralab's program of cooperation with Sams' Photofact service, beginning with folders 93, which together with subsequent issues, will carry complete listings of CRL components for replacements.

* * *

WALKER-JIMIESON TV-RADIO-ELECTRONICS CATALOG

A television, radio, and electronics parts catalog No. 158, has been announced by Walker-Jimieson, Inc., 311 S. Western Ave., Chicago 12, Ill.

Listed are television and radio parts, tubes, test equipment, tools, accessories and other electronic supplies.

* * *

[Additional News on page 67]

TV

Receiver Production Changes

Cures for Severe Horizontal Shift in Raytheon 12 $\frac{1}{2}$ " Models . . . Eliminating Squegging (Hunt Oscillation) in Horizontal AFC Circuit of Raytheon Chassis . . . Securing Better Picture Centering, Increasing Range of Vertical Hold Control, Improving High-Voltage Supply Dressing, Providing 6V6 Tube Protection, and Eliminating Folding on Raytheon Receivers . . . Raytheon 12AX22 Chassis Modifications . . . Westinghouse V-2150-176 Chassis Changes.

by **DONALD PHILLIPS**

IMPROPER NEUTRALIZATION of the sync amplifier in the Raytheon models, code 13 and up (also chassis carrying *group numbers*), has been found to result in a severe horizontal shift* of the entire picture with contrast control adjustments, and may also start hunt oscillation (*squegging*) of the horizontal *afc* circuit.

The Squegging Problem

Squegging, evidenced by white lines or streaks running diagonally across the picture, ringing from the speaker,

or singing from the horizontal deflection transformer may cause damage to the 6BQ6, 6W4, 1X2 or the horizontal deflection transformer.

How to Eliminate Trouble

To eliminate these troubles, it will be necessary to adjust the neutralization of the sync amplifier, with the following nine circuit modifications:

(1) Disconnect the antenna.

*A similar picture shift may also be caused by defective age, video overloading, poor sync separation, and a defective picture tube . . . grid (+) leakage to anode or cathode.

- (2) Remove the 6AU6 *if* tube.
 - (3) Rotate the contrast control to its normal operating position.
 - (4) Connect a *vtvm* (± 10 -volt range) across capacitor C_{100} (near pin 4 of 6SN7 horizontal multivibrator).
 - (5) Short pin 5 of 6SL7 to ground.
 - (6) Turn set on.
 - (7) Notice *vtvm* reading. It should be within $\pm 5/10$ of zero volt. If this reading is not obtained, capacitors C_{90} , C_{100} , C_{101} , C_{102} , and resistors R_{82} and R_{87} should be checked.
 - (8) Remove the short at pin at 5 of 6SL7 from ground and note *vtvm* reading.
 - (a) If the voltage goes positive, the two neutralizing capacitors C_{71} and C_{116} should be moved closer together to reduce the voltage to zero, as indicated in Fig. 1. Should this adjustment be insufficient the black and blue leads connected to pins 2 and 4 of the 6SL7 should be spread.
 - (b) If the voltage is negative reverse the (a) step.
- (Continued on page 77)

Fig. 1. Adjustments required in Raytheon models to eliminate horizontal shift or oscillation of horizontal *afc* circuit.

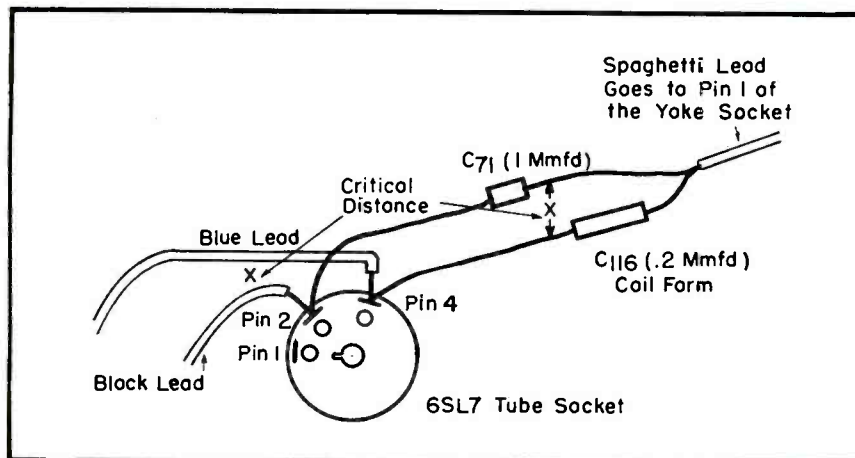

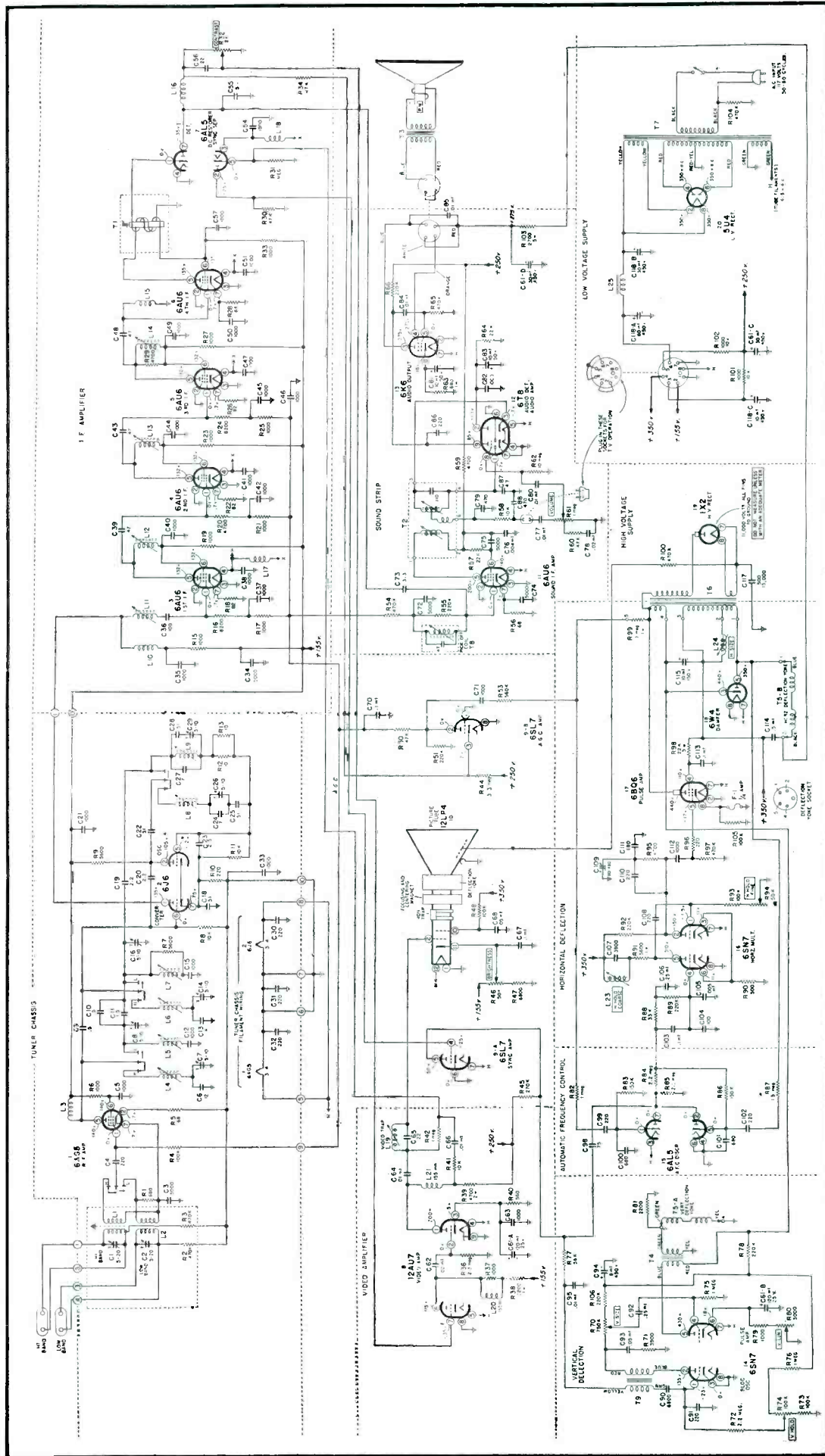

Fig. 2. Raytheon 12AX22 chassis which was modified to include alterations cited in text; the 220,000-ohm resistor (R100) and tuner lug 9 should go to ground instead of *agc*, as shown here.

New Parts . . . Instruments . . . Accessories

AEROVOX MICRO-MINIATURE CAPACITORS

Micro-miniature capacitors, 3/16" diameter by 7/16" long, type P83Z, have been announced by Aerovox Corp., New Bedford, Mass.

Capacitor features use of metallized dielectric. Hyvol K impregnated section is said to be molded in humidity-resistant molded thermoplastic. Operating temperatures range said to be from -15° C to +85° C, without derating; power factor less than 1% when measured at or referred to a frequency of 1000 cps and an ambient temperature of 25° C. Self inductance of capacitor is said to be an absolute minimum, not greater than the equivalent length of wire. Available in 400 *v dc* (.0005 to .003 mfd) and 200 *v dc* (.005 and .01 mfd).

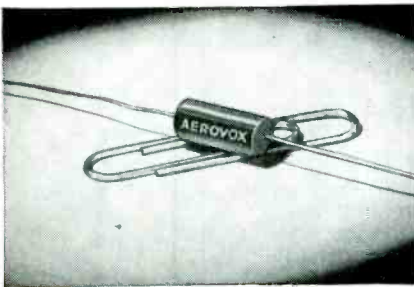

* * *

ELECTRO-PRODUCTS DC POWER SUPPLY

A *dc* source of filtered power, *BJ Junior*, which supplies 1 to 12.5 amps, 6 volts, continuous duty, with an intermittent rating up to 25 amps, has been announced by Electro Products Laboratories, Inc., 4501 N. Ravenswood Ave., Chicago 40, Illinois. Supplies 3 to 9 volts at other ratings, operating from 115 volts.

Designed for demonstrating and testing, from *ac* lines, auto radios, relays, etc. Features of power supply include heavy duty selenium rectifiers, 8-position tap switch, 0-10 voltmeter, 0-20 ammeter, heavy duty transformer and choke, 2000-mfd filter and an accessible fuse.

Size 12" x 7" x 8 1/2"; net weight 21 pounds.



PYRAMID AMPROBE

An Amprobe, A-5-1, (7 1/8" long x 2 9/16" wide x 1 1/8" thick) pocket size voltmeter, has been announced by Pyramid Instrument Co., 49 Howard St., New York 13, N. Y. Has seven ranges: 6.5/13/26/65/130 amperes and 150/600 volts. Has a split-core transformer which will handle conductors up to 1 1/8" in diameter. Transformer core is permanently insulated with a molded plastic cover said to be capable of withstanding 5,000 *v ac*.

Movement is a D'Arsonval jeweled type with alnico magnet. A plastic finger trigger opens the jaws, and the selector switch is operated with a flip of the finger. Meter said to have an accuracy of ±3 per cent of full scale.



* * *

JFD DETENT SWITCH CONTROLS

Four detent switch controls for use as replacements in RCA, Emerson, Admiral, Air King, Capehart, De Wald, Garod, Philmore, Techmaster, Fada, Olympic, Regal, Packard-Bell, Truetone, Coronado, and U. S. Television Receivers have been announced by JFD Manufacturing Co., Inc., 6101 Sixteenth Ave., Brooklyn 4, New York.

Detents (No. DT10 . . . short shaft . . . replaces RCA part No. 71463; No. DT11 . . . long shaft . . . replaces RCA part No. 72743; No. DT12 . . . extra long shaft . . . replaces Admiral part No. 76B14; No. DT13 . . . all-phenolic shaft . . . replaces RCA part No. 73440) are made with brass and phenolic shafts.

Detailed information and complete reference charts listing all television receiver makes according to the respective detent required are available from JFD.



CLAROSTAT ATTACHABLE HIGH-VOLTAGE COUPLER

High-voltage coupler and spacer assemblies, 59-186, with nylon insulator shaft, RN-3", for use in TV, 'scope and other high-voltage circuits, are now available in *pick-a-shaft* type controls, types AM and AT, from Clarostat Mfg. Co., Inc., Dover, N. H.

High-voltage insulator sleeve screws on to the control bushing while its threaded metal-stud end takes the mounting nut. The nylon shaft with standard *pick-a-shaft* keyed end, slips into the control's slot and is tapped to snap it in place for the integral control and shaft combination.

The high-voltage coupler *pick-a-shaft* is said to be rated at 10,000 volts breakdown test.

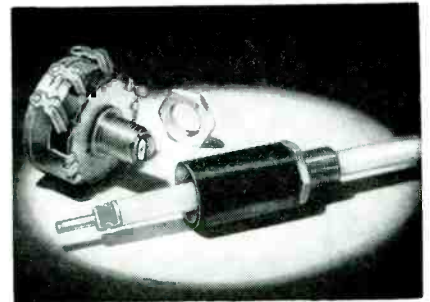

* * *

POLYKEN ELECTRICAL TAPE

Electrical tape, Polyken No. 163, which is said to exceed ASTM friction tape specifications has been announced by Polyken Industrial Tape Department, Bauer and Black, 222 W. Adams Street, Chicago 6, Ill. Manufactured by a calendaring process and thus said not to be a friction tape. Tape's clean black cloth backing is non-sticky and will not collect grime from exposure or handling.

Tape can be purchased in either 60' or 82 1/2' rolls, 3/4" in width, in bulk, individual cartons or a 10-roll *job pack* which contains 600' of tape.

Folder *Test It Yourself* available.



[Additional New Parts data on page 70]

New TV Parts . . . Accessories

TACO TRI-X ANTENNA

A *Tri-X antenna* for areas where the *Lazy X* does not provide sufficient gain for the upper end of the highband has been announced by Technical Appliance Corp., Sherburne, N. Y. The forward angle of the antenna elements has been increased and a third antenna element added in between other antenna elements to provide the conical effect necessary for this type antenna.

Noise-snubbers said to eliminate wind-whistle effects are also used. An apex design which is said to overcome the inherent weak point of X-type antennas has also been included.

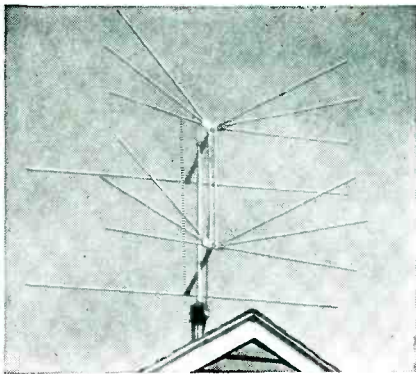

* * *

KOENIG TELE-BEAMER

An antenna rotator, *Tele-Beamer*, which affords antenna rotation by push-button action at a remote control box, has been announced by the Koenig Engineering Co., 735 Southwest Blvd., Kansas City 3, Kansas. A continuous service direction indicator is said to show exact antenna bearing at all times. Designed for masts from $\frac{3}{4}$ " to 2" diameter. Motor works on 24 volts.

All case openings are below mechanism level. Two motors drive lifetime lubricated steel and bakelite gears. Electrical stops turn off the motors when *Tele-Beamer* reaches one full turn; automatic interlock is said to allow operation of one motor work at a time.

Unit is also available without direction indicator.

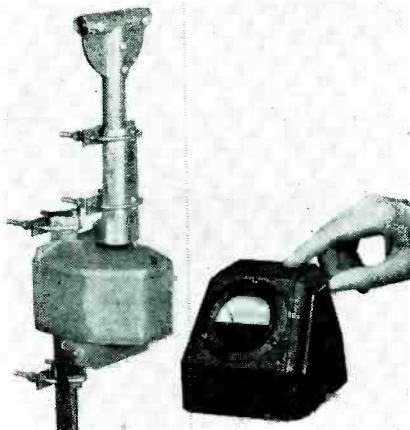

TELREX TV ANTENNAS

Two new types of TV antennas have been developed by Telrex, Inc., Asbury Park, N. J.

One is a *duo-orienting conical-V-beam*, known as the *D-OX*. This model permits orienting of one large section to cover low and high-band stations and turning of other smaller section to pick-up other stations which may not be in the path of the larger unit. The antenna is said to provide cancellation of vertical component and optimum match on all frequencies, minimizing possibilities of hot transmission line acting as an antenna in high-signal areas.

The second model is a closed loop, *conical TV window antenna*, known as the *Superex*.

While especially designed for window mounting in private and multiple dwellings, the antenna is said to be well suited for concealed indoor use, as in closets, behind furniture, etc.

Each antenna is complete with mounting bracket which is said to permit orientation for maximum signals and for reduction of *ghosts*.

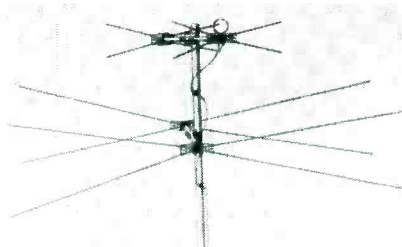

(Above)

Telrex Duo-Orienting Conical-V-Beam

(Below)

Telrex Superex window antenna

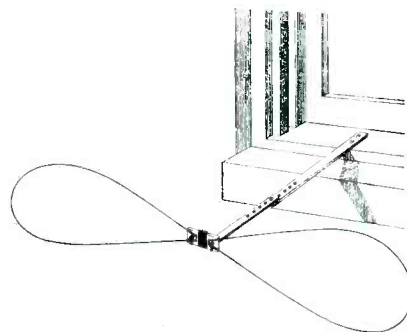

* * *

CIRCLE X QUICK RIG ASSEMBLY ANTENNAS

Circle X antennas made by Circle X Antenna Corp., 500 Market St., Perth Amboy, N. J., are now featuring quick-rig assembly. The *tee* connectors have been eliminated and the circular segments are now manufactured in such a manner as to permit the ends of these segments to telescope together. The straight rods are formed with a curved end to facilitate securing these rods to the outer circle which is done with four screws.

RMS CONICAL CLAMP

Span-a-clamp, model SC, a device which is said to stop breakage and noise, and absorb vibration in conical antennas, has been developed by Radio Merchandise Sales Inc., 1165 Southern Boulevard, New York 59.

Clamps are said to be scientifically paired so as to cancel fundamental and harmonic resonant vibrations; this is accomplished by absorption of the vibration in a *hi-flex* strip. Clamp snaps onto dipoles by means of spring clips. Two sizes are supplied, for $\frac{3}{8}$ " and $\frac{1}{2}$ " dipoles.

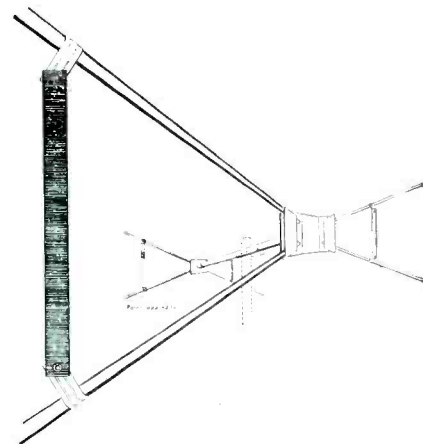

* * *

PHILSON CHIMNEY MOUNT

Chimney mounting brackets, TCM8, consisting of two mounting brackets with adjustable eye bolts on each side of both brackets, are now being made by the Philson Manufacturing Co., Inc., 60-66 Sackett Street, Brooklyn 31, New York. Supplied with $\frac{3}{4}$ " galvanized straps. The units are riveted with $\frac{1}{4}$ " solid rivets. Will fit masts from 1" to $1\frac{3}{8}$ " in diameter.

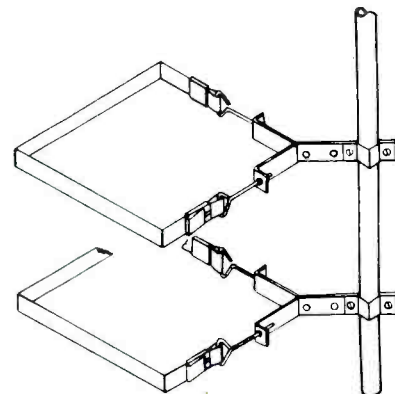

[Additional TV Part data on page 71]

PHONO *installation and service*

Operational Characteristics of Three-Speed Automatic Record Changers Used in Emerson and Westinghouse Receivers . . . G. E. Three-Speed Dual-Stylus Changer Features . . . How the Velocity-Trip Mechanisms Work . . . Changer-Amplifier Design Highlights.

by **KENNETH STEWART**

THE THREE-SPEED AUTOMATIC record changers appear to have outgrown their novelty stage and become a featured item in most standard-brand phono combinations.

Several types are being used in most models, all usually affording automatic playing of the 78, 33 $\frac{1}{3}$ and 45 records, not intermixed.

An interesting example of the foregoing type appears in the Emerson 634B single band superhet, the circuit of which appears in Fig. 1; page 58.

Control-Lever Operation

In this model, the control lever has two functions: To change the idler

Fairchild turret-head pickup.



wheel speed and to change the weight of the tone arm, measured at the point of the stylus. In the 33 and 45 position, a link is in such a position that a spring is lax. In this position, a counterweight is so adjusted on the back of the lift and sweep lever that between 7 and 10 grams of needle pressure are provided. A motor lever of the control linkage actuates an assembly on the motor which drives the idler wheel and in turn the turntable,

thus giving the three speeds 78, 45 and 33 $\frac{1}{3}$. When the control knob of the control linkage is moved to 78, the link pivots the spring lever toward the front of the base plate, placing forward pressure above the pivot point of the tone arm support by means of a spring, increasing the weight of the tone arm. When the control knob is in the 45 and 33 position the spring lever is pivoted toward the back of the changer, thus decreasing the tone arm weight for long play and 45 records.

Change Cycle

When the switch button is moved to the *on* position, power is supplied to the motor, causing the turntable to

Audio oscillator designed for use in conjunction with distortion meters or where an accurate check is to be made of audio systems. Output, 10 volts into 2000 ohms; internal impedance, 100 ohms at full output; frequency range, 14.5 to 145,000 cps in 4 ranges; distortion, $\frac{1}{4}$ of 1% with high impedance loads, 1% with 2000 ohm load; output variation, ± 1 db; hum level, 50 db below signal at any output level; tube complement . . . 1 6SN7, 1 6V6, 1 5Y3. (Type 500, Radex Corp., 2076 Elston Avenue, Chicago 14, Ill.)



Three-speed changer-amplifier featuring a three-tube (including rectifier) amplifier, 4" x 6" speaker, tone and volume controls. (Model 970; V-M Corp.)



rotate. The automatic mechanism is then put into operation by moving the switch plate in the direction indicated by an arrow. By this action a reject lever, which is connected to the switch plate, is pivoted against the trip plate and latch assembly, and in turn lifts a brass pinion. In this position the latch engages the top of the positioning bracket, thus holding the pinion in a raised position. As a result, the finger of an adjustable driving collar, which is fastened to the turntable hub, engages a projection on the brass pinion. This sets a pinion and the cam in rotation. A single revolution of the main cam performs all of the required change cycle function.

The Actuating Lever

As the main cam rotates, the pin of the sweep lever rides up the incline and into the groove of the cam. This action raises the tone arm and swings it out to clear the record. At this point the set-down position of the tone arm is determined. As the cam rotates, a 7" frog of the main cam comes in contact with the flat spring which is fastened to the base plate. This pivots the 7" frog outwardly. Therefore, if the record shelf is in position to play 7" records, the spring tipped end of the 7" actuating lever will be in a raised position, thus leaving the 7" frog in this outward position. This sets the cam track for 7" setdown. However, if 10" or 12" records are being played the spring tipped end of the 7" actuating lever will be in a lowered position, and upon contact the 7" frog will be pivoted inward which sets the cam track for 10" and 12" setdown.

Record Drop Operation

The extended section of teeth of the main cam now engages and rotates a pinion, which in turn rotates the eccentric assembly, thus selecting and dropping a record to the turntable. After the record has been dropped, the wide portion on the cam moves away from the pinion. The eccentric is now aligned with the lower part of the spindle and is held in this position by the detent spring of the positioning bracket.

The 7" Frog Setting

If the 7" frog has been set to play 7" records, the sweep lever pin will

(Continued on page 58)

Walco shows you **how**
to make **money** on phono needles
without stocking them **all!**



THE NEW Walco
C-I* PLAN
***(CONTROLLED INVENTORY)**

for your
Replacement
Needle Stock
on
COLUMBIA
CROSLEY
PHILCO
SHURE BROS.
WEBSTER
ASTATIC
ADMIRAL
ETC.

The advent of 3-speed record-players has created a condition in the merchandising of phono needles that calls for unprecedented action.

The needle dealers' choice is either to do the Herculean job of stocking all the myriad replacement needles and be stuck with slow-moving profit-robbars, or merchandise by the hit-and-miss method from kits, or to keep repeating the suicidal, "Sorry, we don't have it."

The WALCO C.I. PLAN is the solution!

It's simply this; ORDER AS YOU SELL! You can buy as little as ONE NEEDLE, which we send you by return FIRST CLASS OR AIR MAIL. You make a sure sale and a sure profit. We've a complete, comprehensive program. Write for it. Use the coupon.

Remember! You deal with America's leading supplier of sapphire and osmium points to pickup cartridge makers.

ELECTROVOX CO., Inc. • 60 Franklin St., E. Orange, N. J.

See us at the May PARTS TRADE SHOW
BOOTH 107, Exhibition Hall, HOTEL STEVENS, CHICAGO

FREE!

Send coupon for your copy of the WALCO Replacement Chart for easy reference. Gives you the right replacement needle for all phonographs.

ELECTROVOX CO., INC., 60 FRANKLIN ST., E. ORANGE, N. J.

Please send information on the C.I. Plan.

Please send the FREE Replacement Chart.

STORE NAME _____

STREET _____

CITY _____ STATE _____

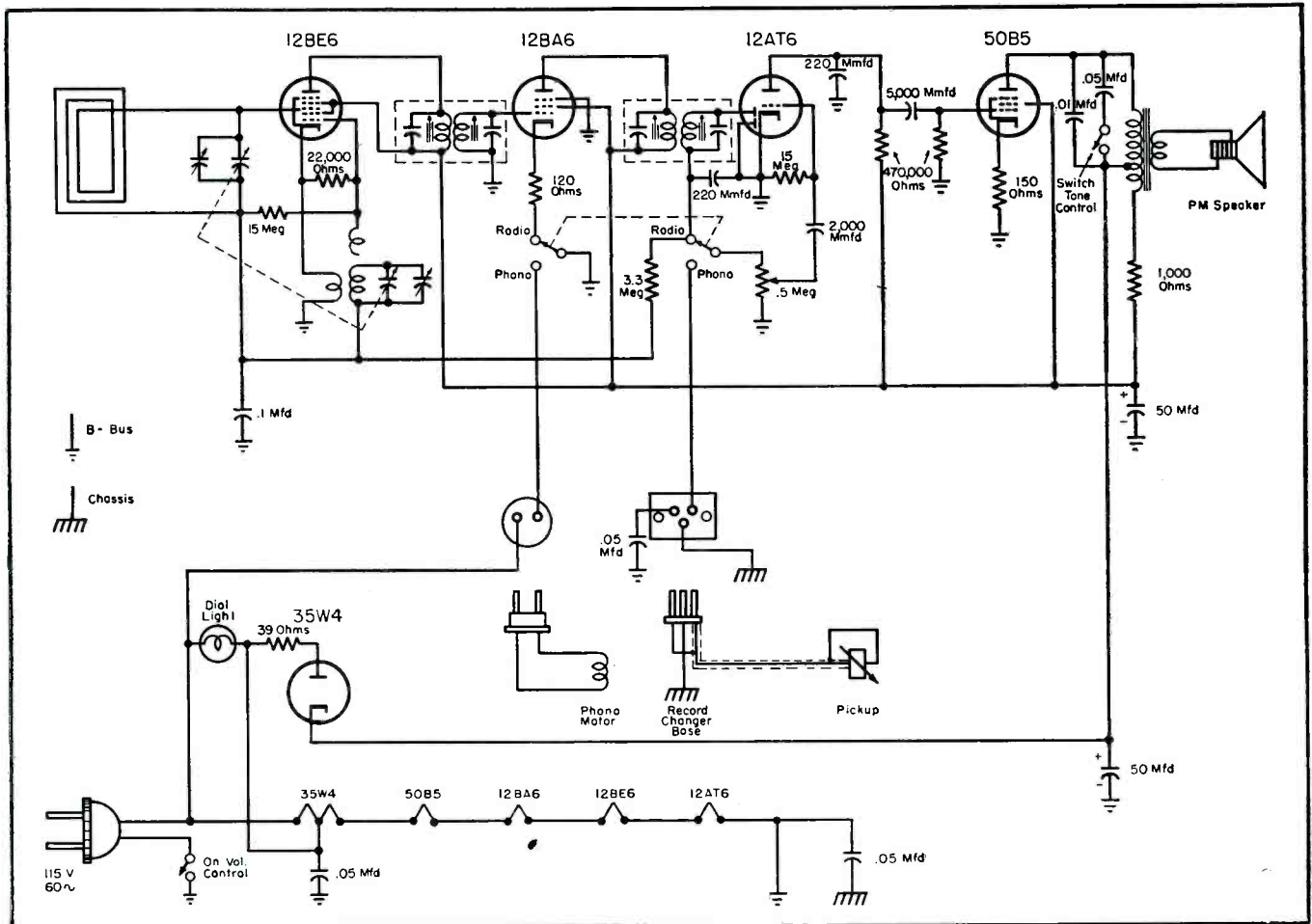

Fig. 1. Emerson 634B which features a 3-speed automatic record changer.

Phono

(Continued from page 57)

now move into the first groove of the cam, thus positioning the tone arm for 7" setdown. However, if the changer has been set for 10" and 12" records, the sweep lever pin will continue in the outer groove of the cam. If the record support is in the 10" position, the spring tipped end of the 10" actuating assembly will be in a lowered position, which, as a result, pivots the selector frog outward upon contact. The sweep lever pin then moves into the inner indexing track, moving the tone arm in and positioning it for 10" setdown. The end of the frog is designed so that when it comes in contact with the sweep lever pin it will be pivoted inward, setting the indexing track for 12" positioning. This operation is repeated in each change cycle; i.e., when the record support is in 10" position. However, when the record support is in the 12" position, the actuating lever is raised above the frog, keeping the frog in position which leads to the 12" track.

The sweep lever pin now rides down the incline of the main cam, low-

ering the tone arm to the record. The latch trip lever, which is mounted on the bottom of the cam strikes the latch of the trip plate and latch assembly allowing the trip plate bumper to drop down to the rim of the cam. As the cam continues to rotate, the trip plate bumper drops into a recess in rim of the main cam, allowing the brass pinion to disengage from the driving collar, and also holding the cam in a locked position. This completes the change cycle.

This model features a permanent type needle, which is used to play the three types of records.

G. E. P15 Record Changers

In a 3-speed model produced by G. E. the record changer is equipped with a dual stylus pickup for playing microgroove and standard groove records. A selector knob control permits setting of the dual assembly, to bring the required stylus into operating position of a corresponding type of record. The knob index indicates the operating position of the styli and is pointed to a 1-mil microgroove stylus with respect to the stylus assem-

bly. To operate the knob control, the knob is first depressed and then turned to the desired position with its arrow index pointed to the end of the tone arm for microgroove records, or pointing to the tone arm rear for standard groove types.

Removing Styli

To remove the styli assembly from cartridge, the knob is pulled off and the spring slightly compressed to release tension upon retaining washer. Retaining washer, spring and flat washer may then be picked off shaft and stylus assembly removed from cartridge. To insure optimum performance from the cartridge,¹ its styli, magnetic pole pieces and gaps should be cleaned periodically of foreign particles accumulated from the record surfaces. A soft bristle brush should be used to clean these parts. These parts are more readily accessible for cleaning if the stylus assembly control knob is depressed and rotated to expose the styli, poles, gaps, and the stylus guide and its recess. The gap

clearance between stylus and each of its pole pieces has been adjusted to be not less than .010".

Westinghouse Automatic Changers

The *velocity-type* trip mechanism is a feature of several types of 3-speed changers. For tripping action, this type of mechanism depends on the rate of forward motion of the pickup arm with respect to the turntable rotation. The changer will trip only when the pickup arm advances more in one revolution of the turntable than the distance between normal grooves in a record. Only records having fast finishing grooves before the eccentric cycling groove will operate the velocity trip.

In models used by Westinghouse (V-9022 and V-9114) the trip pawl is contacted with a wiping action by a small projection on the turntable hub. This repeated action prevents the trip pawl from engaging the projection while the pickup arm moves *slowly* toward the spindle.

A stud on the locator housing contacts the trip link when the pickup arm nears the end of a record. The end of the trip link nearest the spindle contacts the trip lever and turns it as the pickup arm advances. The trip lever, through spring washer tension, turns the trip pawl. Small motions of the trip pawl are not sufficient to cycle the mechanism because, on each revolution of the turntable, the wiping contact by the hub projection moves the trip pawl back to clear the projection.

In the first revolution of the turntable, during which the pickup arm

(Continued on page 60)

G.E. RPX-050.

Multi-cellular tweeter reproducer and high pass filter designed for use with any suitable type of cone-speaker woofer. The horn, of six cell construction, is said to offer a wide-angle distribution pattern. Unit will handle 25 watts of program material above 1,000 cycles. Die cast sectoral horn, flush mounting, 6 3/4" wide, 3 1/2" high, 8" deep. (Type HR-2; Atlas Sound Corp., 1449 39th St., Brooklyn 18, N. Y.)

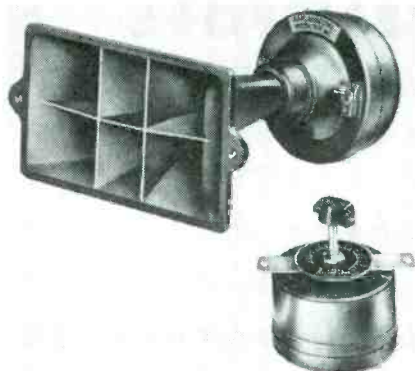

PREFERENCE

for Du Mont Oscillographs is
BASED ON PERFORMANCE

Type 274-A

FASTEST GROWING CHOICE of Television Receiver Manufacturers for I-F circuit alignment



Type 292

is setting a **NEW HIGH** in PERFORMANCE with **PORTABILITY.**

. . . and for both the "service call" and service bench . . .

- ▶ Over five full inches of undistorted deflection.
- ▶ Linear sweeps variable from 8 cps to 30 kc.
- ▶ Type 5BP-A cathode-ray Tube with magnetic shield.
- ▶ Vertical deflection sensitivity of 0.2 rms volt per inch.
- ▶ Frequency response within 50% from 20 cps to 200 kc.
- ▶ Provision for intensity modulation.
- ▶ Sine wave test-signal output.

- ▶ NEW cathode-ray tube, Du Mont Type 3RP-A with magnetic shield.
- ▶ Brilliant, "hair-line" trace.
- ▶ Flat faced cathode-ray tube.
- ▶ Rugged construction.
- ▶ Vertical sensitivity of 0.4 rms volt per inch.
- ▶ Balanced deflection amplifiers.
- ▶ Frequency response from 5 cps to 100 kc, within 30%.
- ▶ Linear sweeps variable from 8 cps to 30 kc.

Television service technicians as well as receiver manufacturers are finding receiver i-f alignment easier and more accurate with this inexpensive, general-purpose instrument which already has become one of the most popular radio-service oscillographs. By applying to the i-f strip a signal which sweeps through the desired band of frequencies at some low rate, and by observing the output at the detector of the receiver, accurate response curves of i-f stages may be obtained on the screen of the Type 274-A. With over five inches of available undistorted deflection, the pass-band response curve may be expanded to full-screen size, providing a legible and detailed indication of peak alignment. Detailed fidelity of this easy-to-read response curve eliminates all guesswork and makes the Type 274-A the economical choice for T-V alignment.

TYPE 274-A—CATALOG No. 1420-A
Cathode-ray Oscillograph for 115
volt operation—PI screen \$136.50

Here is the **one** radio and television service oscillograph which combines extreme portability with the versatile performance which has made the cathode-ray oscillograph an indispensable service tool. Only when you see its operation can you appreciate fully the advancements in 3-inch oscillograph design which it incorporates. Its cathode-ray tube features an **entirely new** concept in electron gun design and provides a finely focused, brilliant trace, free from the distortions usually unavoidable in a short, 3-inch cathode-ray tube. Its amplifiers are push-pull dual triodes, employing cross-coupled feedback, and provide balanced signals to the deflection plates of the cathode-ray tube to minimize astigmatic defocusing of the trace. Moreover, the Type 292 is packaged handsomely in a strong steel cabinet which measures only 10 7/8" high x 8 3/8" wide x 11" deep.

TYPE 292—CATALOG No. 1500-A
Cathode-ray Oscillograph for 115
volt operation—PI screen \$129.50

Please Order by Catalog No.
Address your order directly to

DU MONT for Oscillography

ALLEN B. DU MONT LABORATORIES, INC. • INSTRUMENT DIVISION • CLIFTON, N. J.

FREE WITH PHOTOFACT!



"Bonus" TV Supplements Preliminary Service Data on Hundreds of Television Models for Your IMMEDIATE USE . . . AT NO EXTRA COST!

TV set owners are calling for service within days—even hours—after installation. That's why you, the TV Technician, must have your service data *right now!* And *right now*, PHOTOFACT brings you the "rush" preliminary TV service data you need for *immediate use* to keep you going at full speed. FREE with the purchase of PHOTOFACT Folder Sets No. 91 and No. 93, you receive with each a separate 64-page Supplement containing preliminary data (in *advance* of regular PHOTOFACT coverage) on over 100 popular TV models. Place your standing order for PHOTOFACT today—it's the only way to get *without delay* the TV service data you must have *right now!*

Buy PHOTOFACT Folder Set No. 91 and get **FREE TV SUPPLEMENT NO. 91A:**
Covers 114 important Television Receiver models, produced by 11 leading TV manufacturers.

Buy PHOTOFACT Folder Set No. 93 and get **FREE TV SUPPLEMENT NO. 93A:**
Covers more than 100 leading Television Receiver models, produced by 17 TV manufacturers.

BUY BOTH! GET THE DATA YOU WANT NOW ON HUNDREDS OF TV MODELS

PHOTOFACT Set Nos. 91 and 93 are going fast—order today to avoid disappointment

HOWARD W. SAMS & CO., INC.

Order from your Parts Jobber today or write direct to HOWARD W. SAMS & CO., INC., 2201 East 46th Street, Indianapolis 5, Ind. My (check) (money order) for \$..... enclosed. Send me the following:
 Photofact Set No. 91 and Supp. 91A. \$1.50
 Photofact Set No. 93 and Supp. 93A. \$1.50

Name.....

Address.....

City.....Zone.....State.....

Phono

Continued from page 59)

advances rapidly, the trip pawl is moved far enough for the sharp point at the end to definitely engage the projection on the turntable hub, thereby turning the cam to start the change cycle.

When the changer does not cycle when record has been played in these models, the trouble has been found to be due to either of three faults:

(1) No eccentric trip groove on record. All standard records made today have a finishing groove, but some records made in the past did not have this groove. When records of this type are being played, the control knob must be turned to *rej* at the end of the record.

(2) Needle jumps out of grooves in record.

(a) Trip pressure must be checked. The lateral pressure should not exceed 3 grams. If the pressure is excessive, the pickup should be suspended approximately 2" to 5" above record changer. Using a sensitive scale, the amount of horizontal pull should be measured on the pickup arm, after the arm has become engaged with the locator trip assembly.

(b) The record may be defective. The finishing groove is often too shallow. Check with a record which is known to be good.
(c) The needle point may be damaged or affected by an excessive accumulation of dust, lint, etc. Needle pressure should be checked.

(d) There may be binding in the pickup bearing or locator housing.

(3) Trip pawl binding on cam face.

The trip pawl must be free to move

forward and engage the teeth of the turntable hub when the trip link releases it. It is necessary in this instance, to check for burrs or foreign matter lodged between the pawl and the cam. Oil should not be used, as this might collect dirt and gum up the pawl.

When the changer shuts off prematurely, the trouble might be due to:

(1) Spindle roller spring compressed too far.

(2) Roller spring in spindle too weak. When the bottom record of a stack of ten 12" records is being

The ORIGINAL and Still the BEST LIGHTNING ARRESTER

for all weather conditions

will not absorb moisture

completely waterproof

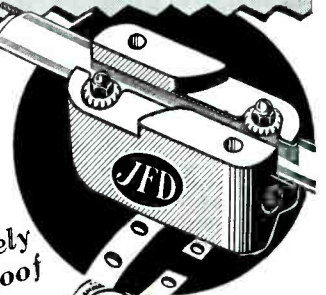

APPROVED for OUTDOOR-Indoor Use!
Protects Television Sets Against Lightning and Static Charges

JFD SAFE TV GUARD

Fits Any Type of Twin Lead

No. AT102 for Regular Twin Lead
No. AT103 for Oval Jumbo Twin Lead
No. AT103 Also for Tubular Twin Lead
BOTH Models Conform With Fire Underwriters and National Electrical Code Requirements for OUTDOOR installations.

\$2.25 EACH

SIMPLE TO INSTALL . . . For maximum efficiency, arrester should be mounted outside window nearest to TV receiver, with ground wire attached to nearest grounded point. No stripping, cutting or spreading of wires necessary. Supplied complete with 4 ft. length of Ductile Aluminum Ground Wire for Wall Mounting, and Strap for Mast or Grounded Pipe Installation.

JFD MANUFACTURING CO., Inc.
6127 16th Avenue, Brooklyn 4, N. Y.
First in Television Antennas & Accessories

For Stability CONTINENTAL "NOBLELOY" RESISTORS



- Engineered Performance
- Metal Film
- Range 1/2 ohm to 30 megohm
- Ratings, 1/2, 1, 2 and 5 Watt
- Tolerance 1/2%, 1% and 5%

The "Nobleloy" type X resistors assure dependable operating characteristics for many critical applications at economical savings.

Write for further details

CONTINENTAL CARBON INC. CLEVELAND 11, OHIO



A three-speed automatic phono, supplied with an amplifier. Record changer plays all sizes records. Up to 12 records at one loading. Size 8 1/4" x 14 1/2" x 16 3/4". (Type Duosonic 97; Sonic Industries, Inc., 221 West 17th St., N. Y. C.)

ejected from the spindle ledge, the roller spring (in the housing) should not compress until just before the roller reaches the top of the cam incline on the lift arm. If the roller spring is compressed under the load of a full stack of records, it may cause premature shut-off. Replace, if necessary.

(3) Record too thick. The changer is designed to play standard records. If an old style 3/8" thick record is used, the changer will shut off instead of dropping the record.

(4) Cutoff rod not being reset. After the shut-off cycle, when the cutoff rod has been turned to throw the switch to the off position, it should be returned to its original position, the next time the machine cycles, by the bent-up end of the cutoff rod contacting the round stud on one leg of the control lever. The flat spring (on the lift arm) acting against the cutoff rod

(Continued on page 62)

A three-speed phono unit which plays all sizes of records up to and including 12". Employs a single, all-purpose needle. Has a 5" Alnico speaker. Motor is constant speed type. Size: 12 1/2" x 10" x 4 3/4". (Type Music Master 148; Tone Products Corp., 225 West 17th St., N. Y. C.)



TWO Sensational New JACKSON Television Instruments

ONE! NEW TV SWEEP GENERATOR



Model TVG-1 Net Price \$220.00

The ONE generator for accurate complete TV servicing. Look at these features:

Built-In Marker Generator. On fundamentals from 4 to 54 Mc. Harmonics readily usable to 216 Mc. Three ranges, accurately calibrated dial.

Crystal Callibrator. Jack provides means for calibrating Marker for any frequency within the range of the instrument.

Complete Sweep Generator. Provides frequencies from 2 Mc. to 216 Mc. in three ranges. Accurately calibrated dial with TV channels and FM band clearly indicated.

Adjustable Sweep width. Easily and quickly adjustable from 100 Kc. to a full 12 Mc. for FM and TV servicing.

400 Cycle Modulation. For use with Marker Generator.

'Scope Timing. Provides a phased sinusoidal voltage for the Horizontal timing axis of the oscilloscope. Built-in phasing control assures a single pattern indication on the 'scope screen.

TWO! NEW 5" OSCILLOSCOPE

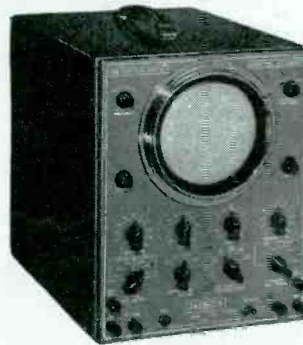

Model CRO-1 Net Price \$195.00
Demodulation Probe .. Net 9.95
(For Signal Tracing)

Thanks to an amazing JACKSON discovery, this fine laboratory-type instrument gives you either wide band or high sensitivity. Check these features against any other oscilloscope.

Wide Band Amplifier. Vertical amplifier flat within plus or minus 1.5 db from 20 cycles to 4 1/2 Mc. Readily usable to full 5 Mc! Such band width is essential for accurate picture of TV sync pulses.

High Sensitivity. Vertical sensitivity .018 RMS volts-per-inch. Ideal for proper analysis of low voltage signals. Band width on High Sensitivity ranges is 20 cycles to 100 Kc.

Sweep Oscillator. Saw tooth wave 20 cycles to 50 kilocycles in 5 steps. Provision for external sweep.

Extra Features. Provision for direct connection of AC voltages. Internal and External Intensity Modulation. Synchronizing Input Control. Removable calibration screen. Height same as TVG-1 (above) for compact service-bench installation.

Get all the facts! Mail the coupon today!

JACKSON

"Service-Engineered"
Radio-Television
Test Equipment

Dayton 1, Ohio

Jackson Electrical Instrument Co.
14-16 S. Patterson Blvd.,
Dayton 1, Ohio

Please rush complete information on the following Jackson instruments:

TVG-1 Television Generator Complete line of Jackson Test Equipment CRO-1 5-Inch Oscilloscope

NAME _____

STREET _____

CITY _____ ZONE _____ STATE _____

MY DISTRIBUTOR IS _____

Anyone
**Can build a
HEATHKIT**

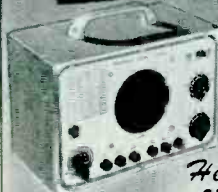
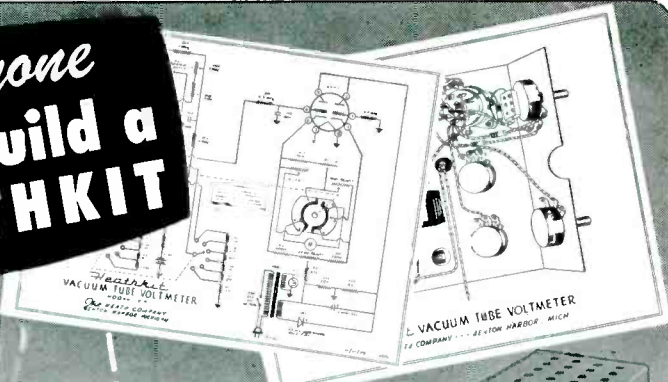

Heathkit
**SIGNAL
TRACER KIT**
\$19.50



Heathkit
TUBE CHECKER KIT
\$29.50



Heathkit
**BATTERY
ELIMINATOR KIT**
\$22.50



Heathkit
**VACUUM TUBE
VOLTMETER KIT**
\$24.50



Heathkit
**CONDENSER
CHECKER KIT** \$19.50

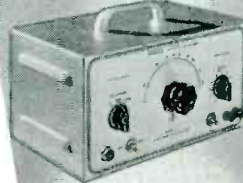

Heathkit
**AUDIO GEN.
KIT \$34.50**

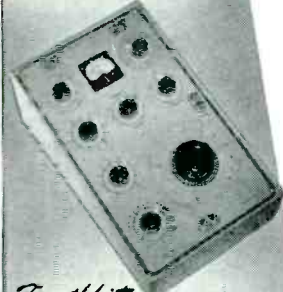

Heathkit
**IMPEDANCE
BRIDGE KIT** \$69.50

Heathkits are beautiful factory engineered quality service instruments supplied unassembled. The builder not only saves the assembly labor cost but learns a great deal about the construction and features of the instrument. This knowledge aids materially in the use and maintenance of the equipment. Heathkits are ideal for and used by leading universities and schools throughout the United States. Each kit is complete with cabinet, 110V 60 cycle transformer (except Handitester), all tubes, coils assembled and calibrated, panel already printed, chassis all punched, formed and plated, every part supplied. Each kit is provided with detailed instruction manual for assembly and use. Heathkits provide the perfect solution to the problem of affording complete service equipment on a limited budget. The basic three instruments — an Oscilloscope, Vacuum Tube Voltmeter, and Signal Generator can be purchased in Heathkits for \$83.50, about the cost of a factory-built VTVM alone. Write for complete catalog.



Heathkit
**ELECTRONIC
SWITCH KIT**
\$34.50

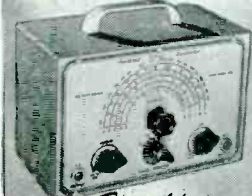

Heathkit
**R. F. SIGNAL
GEN. KIT . . .**
\$19.50

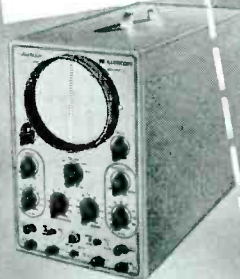

Heathkit
**5" OSCILLOSCOPE
KIT**
\$39.50



Heathkit
**TELEVISION
GEN. KIT . . .**
\$39.50

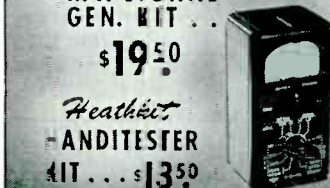

Heathkit
**HANDITESTER
KIT . . . \$13.50**

HEATH COMPANY
BENTON HARBOR 11,
MICHIGAN

EXPORT DEPT., 13 E. 40th ST., NEW YORK 16, N.Y. . . . CABLE ARLAB—N.Y.

Phono

(Continued from page 61)

should throw the rod against its stop on the lift arm and hold it there. If the cutoff rod is not fully turned, the bent-up end next to the spindle may stick up high enough to prematurely contact the shoulder on the pusher housing.

- (a) Check the lever spring (on the lift arm) for tension. Remove and bend slightly to increase tension if necessary.
- (b) Lubricate the cutoff rod bearings, and around the lever spring with Lubriplate or light mineral oil.
- (c) Check the clearance between the end of the cutoff rod which passes under the control lever, and the bottom of the round stud on the control lever. When the cutoff rod is in its normal operating position, it should not clear the bottom of the round stud by more than enough to completely turn the end of the cutoff rod from vertical position back to a horizontal position.

V-M Changer-Amplifier

The 3-speed principle has also been applied to separate units with their own amplifying systems.

In one model, developed by V-M[®] there's a 3-tube (including rectifier) amplifier, 4" x 6" speaker, tone and volume controls and a 3-speed automatic changer.³ The changer will play twelve 7" 33 $\frac{1}{3}$, twelve 7" 45 (using snap-in adaptors), ten 12" either 33 $\frac{1}{3}$ or 78, and twelve 10" 33 $\frac{1}{3}$ or 78 records. Will also play automatically, intermixed, ten 12" and 10" records of the same speed.

²970 Tri-O-Matic. ³V-M 950.



Flame-proof and explosion-proof speaker adaptable for use in mine installations, gasoline cracking plants, gasoline producing plants, and installations where volatile gases exist. (Oxford Electric Corp., 3911 South Michigan Ave., Chicago 5, Ill.)

UHF Converter-Tuner

(Continued from page 21)

sary to break the wire into small segments to decouple the cores from the surrounding metal and avoid spurious suck-outs.

The UHF Converter

In Fig. 1 appears the schematic diagram of the converter circuit. With this system, the *uhf* incoming signal from the *uhf* antenna is first fed to a high-pass filter, having a cut-off frequency at about 475 mc, through a cable connector and short length of 75-ohm low-loss cable. Only an *rf* tuned circuit, with proper impedance transformation networks to maintain high operating circuit *Q*, is employed between the high-pass filter and the crystal mixer. The local-oscillator signal is injected into the crystal mixer in a manner which provides uniform injection for optimum operation of the crystal mixer.

The IF System

The *if* system consists of a low-noise high-gain cascade stage followed by a conventional pentode. The output from the last *if* stage is developed across a balanced 300-ohm load to match the input circuit of *vhf* type receivers.

Power Supply

A power supply is included in this converter. Only antenna connections to the *vhf* receiver are required upon installation. Here, too, the heater of the oscillator tube is left on continually to minimize the warm-up frequency drift. The power consumption during the stand-by period has been found to be about 9 watts.

Converter Housing

The converter has been housed in a wooden cabinet with a 7" x 8" x 2½" chassis. Two knobs are accessible on the cabinet front: a *uhf* tuning knob and a three-position switch knob (power off/*vhf/uhf*). The converter is tuned with a wormdrive mechanism to minimize back lash. A fairly linear dial calibration is read through a cabinet window.

PREMIUM QUALITY at NO EXTRA COST

Sprague Telecap* Tubulars are superior to every other molded paper capacitor because they are made by the same dry assembly process as large metal-encased oil capacitors. They *cannot* be contaminated by dust or moisture during manufacture.

Every Sprague Telecap, from 600 to 12,500 volts, is molded *dry* . . . then mineral-oil impregnated under high vacuum through a small opening . . . and the terminal solder-sealed after the lead is inserted.

Result? Top resistance to heat and moisture . . . extra high insulation resistance . . . superior capacitance stability . . . and a capacitor that is preferred by the nation's leading television manufacturers.

Ask for Telecaps at your jobber's. Or write for bulletin covering details and specifications.

TELECAP* TUBULARS

Hollow eyelet terminal for oil impregnation after molding

Non-flammable, dense bakelite phenolic-molded housing

Uniform windings of high purity paper and aluminum foil

Solder seal as in large metal-encased oil capacitors

CUT-AWAY VIEW

SPRAGUE SPRAGUE PRODUCTS COMPANY
North Adams Mass.

PIONEERS IN ELECTRIC AND ELECTRONIC DEVELOPMENT

★Trade Mark

BAR-X*

**A NEW, DIFFERENT,
DEFINITELY BETTER
CONICAL ANTENNA.**

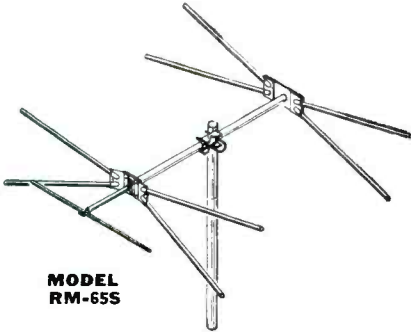

MODEL
RM-65S

BY ADDING A "BAR" TO THE "X", RADELCO IS FIRST TO GIVE YOU A PERFECTED CONICAL AERIAL THAT PROVIDES MARVELOUS RECEPTION ON BOTH UPPER AND LOWER CHANNELS.

THE RADELCO BAR PERFORMS WONDERS!

The ordinary conical antenna has proved highly efficient for low channel reception, but has been inadequate for higher channels. In order to make the conical aerial an all-channel antenna, RADELCO has added a director bar in front of the receiving dipole. The addition of this bar greatly increases the signal strength on upper channels and makes the RADELCO BAR-X the finest all-channel antenna ever offered to the industry.

More for Your Money

Model RM-65 includes mast, two 5 ft. sections of 1/4" gal. steel with 1" gal. steel cross boom, swivel base, guy ring and stand-off insulator. Ends of elements are plugged with dowels to eliminate vibration.

Model RM-65—Complete as per above... List \$10.95

Model RM-65S—5 ft. Mast and Array only. List 8.95

Model RS-751—Stacking Array only. List 7.45

*Trade mark reg.



CLEVELAND 25, OHIO

Auto Noise Cures

(Continued from page 26)

is connected, at the ignition switch or the ammeter.

Electric oil-gauges or temperature-gauges sometimes cause interference to be carried into the set, by feeding it into the body of the car. Bypass capacitors should be installed on these, using the metal-cased types, and placing them on the transmitter units, on the engine itself, not at the dash indicator units.

Wheel Noises

An intermittent, popping or scratching noise, only heard when the car is moving may be traced to the front wheels. The wheel, rotating in the grease of the bearing, will sometimes break electrical contact with the spindle. The rapidly revolving tire will build up a static charge, which discharges the next time the bearings make an electrical contact. This is usually noticeable only on paved roads, as the static charges don't seem to build up on gravel or dirt roads. It may be positively identified by running the car up to about thirty miles per hour, or until the noise appears, and then cutting the ignition, leaving the set on. As the car coasts to a stop, the noise will be slower and slower, finally disappearing entirely when the car comes to a standstill. Another test is to apply the brakes momentarily. The brake-shoes will ground the wheel and stop the noise. Once located, the cure can be affected by supplying a good, constant ground for the offending wheels. This is done by removing the hub-cap and grease-cap from the front wheels and then inserting grounding springs in the grease-caps. These are spiral springs, wound from stiff wire or stamped from sheet brass, with

a small button in the center, which makes contact with the lathe-center or dimple in the end of the spindle. Hub-cap should be replaced, being sure that the button centers in the dimple.

There may be a frying sort of noise heard, which is not relieved by the foregoing treatment, especially on smooth pavement at high speeds. This is tire-static, and requires the blowing of graphite powder into each tire. This powder is supplied in small packets, in sets of five. To apply, the tire must be deflated, the contents of one envelope poured into a special applicator, the powder then being blown through the applicator into the tire, as it is being reinflated.

Old Car Problems

If the car is rather old the motor noise may be difficult to eliminate or

ODEGAARD ORIGINAL NAIL
POLYETHYLENE STANDOFF
JOHN ODEGAARD PAT. PEND.
for Ribbon or Coaxial Cable

Saves more labor, time and money than any other standoff! No drilling—just quick, easy hammer strokes. Easily drives into wood, marmor, iron, aluminum, etc. Excellent most-coupler. "Step"-locked, permanent installation. Cadmium-plated hardened high-carbon steel nail. Specially punched to-loss polyethylene.

SERVICEMEN: For free sample and nearest distributor's name, write today to Dept. S.

PARTS DISTRIBUTORS: Choice protected territories still open. For full details, write today to Dept. S.

COPYRIGHT 1950, JOHN ODEGAARD, BROOKLYN, N. Y.

ODEGAARD MFG. CO.
5416 EIGHTH AVE., BROOKLYN 20, N. Y.

FOR ORIGINALITY

LOOK TO **XCELITE**

Where Else Could You Get
So Many Tools for \$9.95?

- 9 chrome-plated detachable nut driver blades!
- 2 screwdriver sizes in reversible chrome-plated blade!
- Detachable reamer! All fit big, comfortable XCELITE handle!

YOURS in the durable XCELITE "99" roll kit! AVAILABLE in patented metal case at same low price! Ask your supplier or write:

Park Metalware Co., Inc.
Dept. V Orchard Park, N. Y.

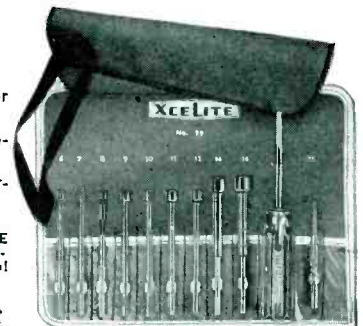

Canadians send orders direct to: Chas. W. Pointon, Canadian Warehouse Distributor, 1926 Gerrard St., E., Toronto, Ont.

even to reduce. All grounding and bonding should be checked and all loose sections of the body tightened, especially around the hood and front fenders. The ignition system should be cleaned up, watching out for old and frayed high-tension wiring. In one job we had, the trouble was cleaned up when it was discovered that the center lead of the distributor had corroded until the wire had disappeared for almost two inches from the end, leaving only the insulation and a bit of green oxide. Corona on old wires should be watched for, too, and intermittent arcs to the block, choke-rods or other parts should be checked. The generator commutator should be cleaned with fine sandpaper. The brushes should be checked for sticking which might cause excessive arcing and noise.

Bonding

Often all the parts of a car's body do not make perfect electrical contact with one another, due to paint, rust or the like. Parts immediately around the hood and engine compartment, such as fender skirts, side-panels of the hood, etc., will give trouble, if they are not well grounded. If a thorough tightening does not stop the noise, short lengths of $\frac{1}{2}$ " or $\frac{3}{4}$ " woven metal braid should be attached from one to the other, fastening under convenient bolts, or drilling holes and mounting with metal screws. It is occasionally necessary to bond the tail-pipe or muffler to the frame, or to bond the engine block to the body or firewall. All metal rods, such as choke or throttle controls, temperature gauge, etc., which pass from the engine compartment into the body should be bonded. A long piece of narrow braid, $\frac{1}{4}$ " or so, should be fastened from one end under a convenient bolt near the point where these rods pass through the firewall. About two inches of each rod should be cleaned off with sandpaper, and at least two turns of the braid should be wrapped on each rod, pulling tightly. Then the braid should be grounded on the other side. This will ground the metal rods to the firewall, and prevent them from carrying noise into the body. On some cars, the battery ground-strap is fastened to the engine block instead of the body. The body is bonded to the engine with another heavy strap, of flexible braid, and these occasionally break, due to excessive bending. If this bond looks ragged or worn, at least one more should be installed from the body to the block. The flat heavy

(Continued on page 66)

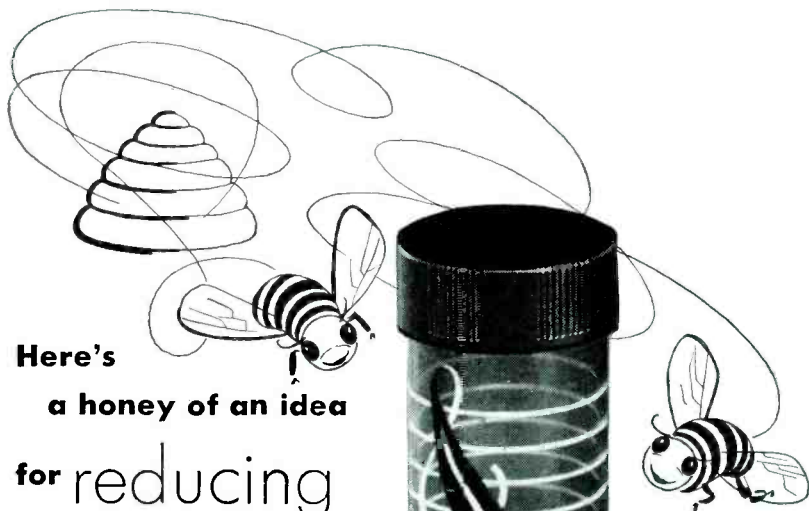

Here's
a honey of an idea
for reducing
inventories

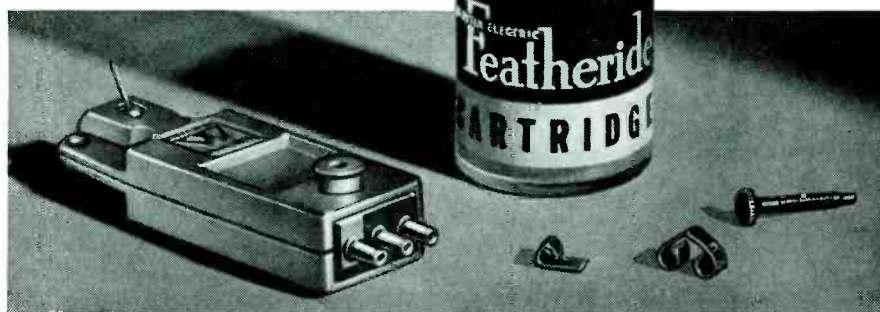

THE "Featheride" REPLACE-ALL MODEL W. S.* CARTRIDGE replaces more than 50 crystal cartridges now in current use

Service men and radio parts jobbers welcome the Featheride Replace-all Model W. S. Cartridge with Dri-Seal, for it replaces the large stocks previously necessary to meet requirements. Here you have one cartridge replacing more than 50 models. You save investment—you don't have to maintain large stocks—you have only one cartridge to order.

The exclusive Dri-pack container assures the greatest protection during shipping, storing and handling.

The "Model W. S." is a honey of an idea—order a supply today.

*Pat. Pending

FEATURES

1. Because of its three-terminal construction, this one cartridge will develop either 1.5 volts or 4.0 volts.
2. Only $\frac{3}{4}$ ounce tracking pressure.
3. May be installed in any $\frac{1}{2}$ " R.M.A. standard tone arm.
4. Crystal protected with Dri-Seal against humidity and moisture. This means longer life.
5. Factory tested, osmium tipped removable needle for 78 r.p.m. records.
6. Packed in Dri-pack container with rest button, terminal clips, extra needle screw, spacers and instructions.
7. List priced only \$5.50 each. See your jobber today for Model W. S. Specification Bulletin.

WEBSTER ELECTRIC



Webster Electric Company, Racine, Wisconsin • Established 1909

"Where Quality is a Responsibility and Fair Dealing an Obligation"

SERVICE, MAY, 1950 • 65

SEE THE *American* EXHIBIT AT THE RADIO PARTS SHOW

CHICAGO, MAY 22 - 25

FULL VISION



NEW!

Dynamic

MICROPHONE

MODEL D33 - Latest addition to America's line of quality microphones. Full vision for artist and audience. Omnidirectional pickup.

Output: -52 db with transformer. Easily detachable from stand or suspension mounting by raising small lever lock. • Weight: seven ounces. • Plug: Cannon "Latch lock." • No pre-amplifier required.

American

MICROPHONE COMPANY

370 SOUTH FAIR OAKS AVENUE
PASADENA 1, CALIFORNIA

Auto Noise Cures

(Continued from page 65)

braided sold for ground straps on battery connections should be used.

Heater Noise Source

On some cars with hot-water heaters the heater hose has been known to carry plug noise into the chassis. This is due to the conductive column of water in the hose passing close enough to a spark plug to pick up noise. To remedy this, the hoses should be moved away as far as possible from the wiring, and small wires laced around the hoses to form a shield, grounding them at both ends. The hoses should be tied to the hood braces or other rigid parts to hold them in place.

Bolt Tightening

Often the car's instrument panel may become ungrounded. The bolts must be tightened as much as possible, cleaning all paint from under them. If necessary, the dash should be bonded to the body at each end.

Speaker Bonding

On those receivers featuring a volume control in the remote control head, mounted beneath the dash, noise may be picked up if the grounding is not perfect. Sometimes this will be noted as a bad hum, which becomes louder as the volume control is turned down. To cure this a good ground, as short and heavy as you can make it, should be connected from the control head itself to the chassis of the set. While it doesn't seem to be too necessary to bond separate speakers to the set, especially in the later model sets, it might be, sometime, so don't overlook the possibility. The older sets which used separate speakers mounted on the firewall do require good grounding of the speaker housings. This is probably due to imperfect filtering in the sets themselves.

Summary Highlights

In summation, most cars will require only a few noise suppression devices, some will require a lot, and now

SHOOTS TROUBLE FASTER!

Makes more money
for you on job or
at service bench!

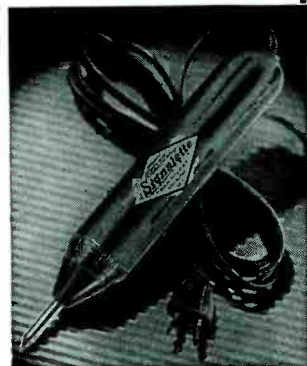

PRICE
\$9.95

at distributor
or postpaid,
direct. No
COD's please.
Ohioans add
5% State Sales
Tax.

Signalette

MULTI-FREQUENCY GENERATOR

In radio service work, time means money. Locate trouble faster, handle a much greater volume of work with the SIGNALLETTE. As a trouble shooting tool, SIGNALLETTE has no equal. Merely plug in any 110V. AC-DC line, start at speaker end of circuit and trace back, stage by stage, listening in set's speaker. Generates R.F. and AUDIO Frequencies, 2500 cycles to 20 Megacycles. Also used for checks on Sensitivity, Gain, Peaking, Shielding, Tube Testing. Wt. 13 oz. Fits pocket or tool kit. Satisfaction, or money back! See at your distributor or order direct.

Clippard INSTRUMENT
LABORATORY
Inc.

DEPT. C, 1125 BANK STREET
CINCINNATI 14, OHIO
QUALIFIED JOBBERS WRITE,
WIRE FOR DETAILS.

Be Sure...
Rely on these
ERIE RESISTOR
components



Be sure, too, that you visit ERIE RESISTOR at the Radio Parts and Electronic Equipment Show, Chicago, May 22-25, Booth 415

Electronics Division
ERIE RESISTOR CORP., ERIE, PA.
LONDON, ENGLAND TORONTO, CANADA

and then you'll find one which will be determined to make noise, no matter what you put on it! It has been found, though, that about 90% of the noise can be removed from the average car. The set's usually excellent selectivity will block out the rest of the noise, giving noise-free reception on even the weak stations. The remaining ten per cent may cause trouble. Our policy has been to explain to the owner the difficulty and expense necessary to make the car absolutely quiet, and then let him make the 90%-100% decision.

The Methodical Approach

A methodical approach, and a thorough working knowledge of the causes and remedies of the various noises encountered, will make the job a whale of a lot easier, and reveal that noise removal can be a paying proposition.

Printed Circuit Tuner

(Continued from page 48)

sheet. The sheet is then placed in a die and cut into separate sections and pierced.

Reproducibility is said to be excellent, with detail and precision of the lines in the circuit approaching photographic accuracy.

News

[See page 51 for other News]

'49 ELECTRONIC ENGINEERING MASTER INDEX AVAILABLE IN JUNE

The Electronic Engineering Master Index for 1949, published by the Electronics Research Publishing Co., Inc., 480 Canal Street, New York 13, N. Y., will be available in June.

The '49 edition, the fourth volume in the series that starts with the '25-'45 issue, will contain an index of 8500 articles from nearly 400 world-wide scientific periodicals, journals, proceedings, technical house-organs, and a listing of 4000 applicable patents granted by the U.S. Patent Office. Index will offer 800 references under television, 1500 under communications, 700 for microwaves, computers, and calculators, 900 for measuring, testing, and maintenance equipment and methods, etc.

Index, cloth bound, 7½" x 10½", will sell for \$17.50.

YOUR NEW STANCOR CATALOGS

are ready!

CATALOG OF TRANSFORMERS FOR RADIO, SOUND AND OTHER ELECTRONIC USES.

Here's a "must" for every user of transformers—serviceman, ham, experimenter, engineer. Detailed listings of more than 400 Stancor part numbers. Includes accurate electrical and physical specs, dimensions, prices, illustrations. Complete and up-to-date. Handy charts and easy-to-use indexes help to make this new Stancor catalog the book you'll want to find the part you need.

TELEVISION CATALOG AND REPLACEMENT GUIDE.

The sixth edition of the popular Stancor TV Replacement Guide (50,000 copies printed to date). Now combined in a big, 30-page book with a complete catalog of all Stancor TV components. Original part numbers, with Stancor replacements, are listed for more than 600 TV receiver and chassis models made by 64 manufacturers. Every Stancor component recommended in the guide is listed in the catalog section with complete specs, dimensions and prices. Gives you one convenient source of information. Makes your job quicker and easier.

And remember, when you buy a Stancor transformer, you get a quality product used by the country's biggest set makers as original equipment. Stancor transformers have to be good!

See your Stancor distributor today for your free copies of these books. If he is out of stock, we'll be glad to send you copies. Write Standard Transformer Corporation, 3588 Elston Avenue, Chicago 18, Illinois.



Most Complete Line in the Industry

NEDA ANNUAL MEETING SCHEDULED FOR CLEVELAND

Members of NEDA's executive committee, who met in Atlantic City, New Jersey, recently, approved recommendations that all special annual and other association meetings be held in Cleveland, Ohio, August 24-28, during the annual convention period.

The meeting was called to order by chairman, W. D. Jenkins. Present were the following members of the committee: R. C. Hall, Harry Stark, William A. Wilson, Max I. Epstein. Officers present were L. W. Hatry, Arthur C. Stallman, A. W. Greeson, Jr., Aaron Lippman, Lealis L. Hale. Present as guests were L. B. Calamaras and Leslie C. Rucker.

DUMONT NAMES DE NIKE TELETRON MANAGER

G. Edward De Nike has been appointed manager of Du Mont Teletron sales.

De Nike was, for sixteen years, with National Union Corporation serving as assistant advertising manager, advertising and sales promotion manager, divisional sales manager, and sales manager. For several years he was vice president of Morris F. Taylor & Co. and recently he served as vice president of the Television Technicians Lecture Bureau conducting professionally prepared lectures to Service Men throughout the country.

[Additional News on page 68]



OHMITE

Little Devil

INSULATED
COMPOSITION RESISTORS

In critical television applications, Little Devil Resistors can be depended on for longer, trouble-free service. These tiny, rugged units give quiet performance and are ideal for sensitive RF circuits. Moreover, they are available in $\pm 5\%$ as well as $\pm 10\%$ tolerances — in $\frac{1}{2}$, 1, and 2-watt sizes; standard RMA values.



'Little Devil'
RESISTOR ASSORTMENT
IN All-Plastic CABINET

CABINET INCLUDED AT COST OF THE RESISTORS ALONE!

Designed for the serviceman!
Three assortments to choose from— $\frac{1}{2}$ -watt, 1-watt, 2-watt sizes. Each includes 125 most frequently used Little Devils, in 40 values, from 10 ohms to 10 megohms. Packed in rugged plastic cabinet—you pay only for the resistors! Prices: $\frac{1}{2}$ -watt, \$12.50; 1-watt, \$18.75; 2-watt, \$25.00.

SEND NOW for Catalog No. 21

OHMITE MFG. CO.
4879 Flournoy St., Chicago 44



Be Right with...



News

[See pages 51 and 67 for other News]

NEAL HUNTER JOINS SPRAGUE PRODUCTS COMPANY

Neal Hunter has been named to the field engineering staff of the Sprague Products Company, North Adams, Mass.

Hunter was formerly on the electronic research staff of the Taylor Instrument Company, Rochester, New York.



Neal Hunter

* * *

BALDERSON NOW WCEMA PREXY

H. P. Balderson, sales manager of the transformer division of the Thermador Electrical Manufacturing Co., Los Angeles, has been elected president of WCEMA. Orrin H. Brown is now vice president, Noel E. Porter, secretary, and Fred W. Falck, Jr., treasurer.



H. P. Balderson

* * *

CENTRALAB WILL OCCUPY FIFTH PLANT

A fifth plant to be used as a completely integrated production unit for wave switches and printed circuit components, was acquired recently by Centralab in Milwaukee.

The company took over buildings formerly occupied by the Eclipse Molded Products Company. The property consists of two buildings with 42,000 square feet of floor space and a total land area of more than two acres.

Centralab now has three plants in the Milwaukee area, and plants in Denville, N. J., and Fort Dodge, Ia.

* * *

SAMS PHOTOFAC BONUS TV SERVICE DATA

A 64-page preliminary data supplement, containing schematic diagrams and other data on over 100 TV models, is being supplied at no additional charge with Photofact set 91 by Howard W. Sams and Co., Inc., 2201 East 46 Street, Indianapolis 5, Ind. At present other such supplements are planned for distribution with sets 93 and 95.

Preliminary data are being released in advance of complete coverage of the equipment by regular Photofact TV folders.

These preliminary data will be listed in the Photofact cumulative index until the same receivers are covered by regular Photofact folders.

Suppress TELEVISION Interference

with Miller FILTERS



NO HERRINGBONE
NO SOUND BARS
NO JITTERS!

This New TV HIGH-PASS FILTER will reduce interference which may be picked up by the i-f. amplifier of your tv. receiver.

The Miller No. 6168 High-Pass Filter diminishes spurious signals which arise from strong, local fields generated by:

1. Amateur radio transmitters.
2. X-ray or medical diathermy equip.
3. Short wave stations.
4. Industrial r.f. heating units.
5. Various electrical appliances.

Filter is designed to attenuate all signals to 40 megacycles. All television channels passed with minimum loss. Installed easily in antenna lead-in. No tuning required. Dim. 1-7/16" by 1-7/8" by 3-1/2" high.



Cat. No. List Price
6168 For 300-ohm line \$5.00
See your Wholesaler or write us for literature

J. W. MILLER COMPANY
5917 S. Main St., Los Angeles, Calif.
BUILDERS OF QUALITY RADIO INDUCTANCES SINCE 1924

WAVE TRAPS

the HOT TV LINE

TV INTERFERENCE ELIMINATED

WAVE TRAPS eliminate FM image interference and amateur harmonic interference.

Easy to install!

List: \$2.75 ea.
Write TODAY for complete data!

THE HOUSE OF TELEVISION INCORPORATED
40 WEST FOURTH STREET
NEW YORK 12, N. Y.

WHEN YOU CHANGE YOUR ADDRESS

Be sure to notify the Subscription Department of SERVICE at 52 Vanderbilt Avenue, New York 17, N. Y., giving the old as well as the new address, and do this at least four weeks in advance. The Post Office Department does not forward magazines unless you pay additional postage, and we cannot duplicate copies mailed to the old address. We ask your cooperation.

TELREX ACQUIRES NEW TESTING SITE

A 3-acre testing site on which will be constructed a fully equipped lab which will be devoted largely to antenna design and development work, to supplement existing facilities, has been acquired by Telrex, Inc., Asbury Park, N. J.

The tract, second highest point on the East Coast, is located in Belmar, N. J., just a stone's throw from the former site of Marconi's historic transatlantic radio transmitter.

* * *

BALCOM NAMED PENNSYLVANIA BOARD CHAIRMAN

Max F. Balcom has been elected chairman of the board of Sylvania Electric Products, Inc., to succeed the late Walter E. Poor. Frank A. Poor, founder of the company, has been named vice chairman.

Three new directors were elected: Edward J. Poor, who resigned as chairman in 1943, Richard L. Bowditch, president of C. H. Sprague & Son Company, and H. Ward Zimmer, vice president in charge of operations.

* * *

VON MAYRHAUSER BECOMES TURNER CO. CHIEF PRODUCTION ENGINEER

Benno Von Mayrhauser has been appointed chief production engineer for the Turner Company, Cedar Rapids, Iowa.



B. Von Mayrhauser

* * *

HARMAN AND ZUCKERMAN NOW BOGEN VICE PRESIDENTS

Sidney Harman has been elected vice president of David Bogen Co., Inc., 663 Broadway, New York City. Harman will continue as sales manager, in charge of sales, advertising and promotion. Alfred Zuckerman has also been elected a vice president at Bogen.

Zuckerman will continue as chief engineer in charge of design and development.



S. Harman



A. Zuckerman

* * *

PHOENIX ELECTRONICS INCREASES PRODUCTION FACILITIES

About 3000 square feet of manufacturing area have been added to the Phoenix Electronics, Inc., plant in Lawrence, Mass.

Phoenix now produces antennas, folded dipoles; in-line antennas; conical and double conicals; chimney, wall, vent pipe, roof and universal mounts; stand-off insulators, and hardware and installation equipment, described and illustrated in a new catalog.

IT'S NEW ...

IT'S DIFFERENT ...

It's GENERAL INDUSTRIES' latest sound reproduction triumph

**MODEL 250
TAPE-DISC Recorder Assembly**

- * Records on tape
- * Records on discs
- * Plays back both
- * Plays any 78 R.P.M. Record

(*) when connected with the proper amplifier.

The GENERAL INDUSTRIES Co.
DEPARTMENT O • ELYRIA, OHIO

EARL OLSON JOINS JENSEN INDUSTRIES

Earl L. Olson is now chief engineer of Jensen Industries, Inc., 329 S. Wood St., Chicago 12, Ill.



Earl Olson

WALTER LEFEBRE NOW PENNSYLVANIA TV ACTING FIELD S. M.

Walter Lefebre has been appointed acting field sales manager for the Sylvania television division of Sylvania Electric Products, Inc.



Walter Lefebre

HIGHEST VALUE

ALL-ALUMINUM CONICALS

At the **LOWEST PRICE** Anywhere!

JFD "COMMANDAIR"
ALL-ALUMINUM TV CONICALS (less mast)

TOP QUALITY CONSTRUCTION!
Elements made of high-strength, aircraft-type aluminum alloy for greater resistance against vibration and corrosion.

HEAVY DUTY ELEMENT BRACKETS!...
Made with extra-long gripping surface for secure anchoring of elements. No wonder that "Commandair" Conicals will stay put in the face of strong winds, under the strain of ice and snow.

UNIQUE BRACKET FLEXIBILITY!...
An important feature of these amazing Conicals is their unique flexibility, which permits easy conversion from a standard Conical to a 6-element front and 2-element reflector type.

ENGINEERED FOR MAXIMUM GAIN...
Improved signal-to-noise ratio produces brighter pictures with minimized fading.

NOTE: The "Commandair" Conical is also offered in a separate, lower-priced "Economy" Line... of partial steel construction... completely assembled... similar to its all-aluminum counterpart in design and performance.

JFD No. C660 — "Commandair" All-Aluminum All-Band Conical. List Price (less mast) **\$9.85**

JFD No. C661 — Same as No. C660 but 1/4 wavelength stacked for extra gain and directivity. List **\$20.70**

Write for **FREE** literature completely describing the JFD "Commandair" Line of All-Aluminum TV Conicals.

JFD MANUFACTURING CO., Inc.
6109 16th AVENUE, BROOKLYN 4, N. Y.
FIRST IN TELEVISION ANTENNAS AND ACCESSORIES

PEAK FOR PERFORMANCE *on your channels* with the new **RMS BOOSTER SP-5**

Here's the only Booster you can peak by simply tuning with an ordinary screw driver — from the outside of the cabinet!

Write for fuller details or See Your Jobber

Has an edge in engineering!

Wide band width
Lowest insertion loss
Greatest signal to noise ratio.

Has an edge in styling and simplicity!

All metal cabinet in mahogany ripple finish — blends with all furniture.

Gear driven for velvet-smooth, 1-knob tuning.

RADIO MERCHANDISE SALES INC. • NEW YORK 59

70 • SERVICE, MAY, 1950

New Parts

(Continued from page 54)

TRIO PRODUCTS CAR RADIO ANTENNA

An auto antenna, patterned after a TV antenna, has been designed by Trio Products, Franklin, Michigan. Antenna, with five feet of pickup surface, is claimed to provide increased efficiency.

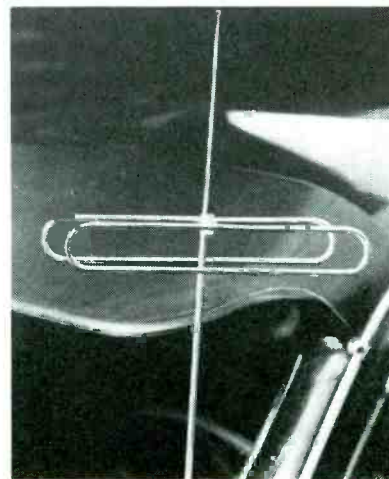

* * *

TELE-MATIC INDUSTRIES DETENT

A replacement part, the *sturdy-tune* detent, designed to fit the 630TS and 721TV chassis, has been announced by Tele-Matic Industries, 32 Wyckoff St., Brooklyn 2, N. Y.



* * *

G. E. TEST UNIT

A test instrument, type EX-1-C, that is said to eliminate the need for separate multimeters, *rf* generators and field-strength meters for in-the-field tests of communication equipment, has been announced by G.E. Unit is designed for use with equipment operating in the 25-50, 72-76 and 148-174 mc bands.

One of the primary purposes of this new unit is to align land-mobile communication receivers. Attenuator on self-contained crystal-controlled oscillator in test set is said to be adjustable down to substantially zero *rf* output.

A crystal diode pickup head, furnished with the unit, permits comparative measurement of antenna power output.

Instrument also contains a full range of current and voltage scales as well as a resistance scale which provides for continuity checks *on the job*.

The complete test unit includes the basic instrument, crystal diode pickup, headphone plug test lead, and *rf* interconnecting lead.

WATERMAN POCKETSCOPE

A wide-band pocketoscope, model S-14-B, which is said to have an amplifier fidelity constant within 2 db from *dc* to above 700 kc without peaking, has been announced by Waterman Products Company, Inc., 2445 Emerald St., Philadelphia 25, Pa. A linearized triggered or repetitive time base is continuously variable from 1/2 cps to 50 kc with either polarity of sync or trigger. Amplifier sensitivity is said to be of the order of 50 mv rms/inch; internal calibration of trace amplitude is provided. Observation of limited wave form areas are said to be facilitated by a trace expansion better than four times screen face. Input attenuators and gain controls are non-frequency discriminating.

* * *

MILLER MAGNETRICK RACK

A *Magnetrick Rack*, which consists of a 10", two pound bar of permanently magnetized Alnico metal that is detachably mounted on 12" x 12" plywood for wall, or counter use, has been announced by the L. B. Miller Company, Stamford, Conn.

Magnetrick can hold chisels, screwdrivers and other tools as well as small parts like screws, washers and springs on magnetized bar.

TV Parts

(Continued from page 55)

VEE-D-X YAGIS

A line of yagi antennas, the *J* series, has been announced by the LaPointe-Plascomold Corp., Unionville, Conn.

The series consist of a 2-bay 3-element (includes phasing rods), and 4- and 5-element types; *JA, JB, JC*. Each antenna incorporates clamp type construction. The use of matching transformers (driven elements) are said to insure a match to a standard 300-ohm transmission line.

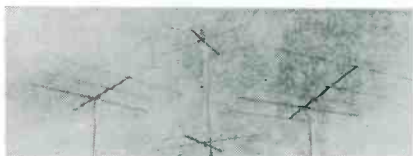

* * *

TRIO TV ANTENNA

A TV *controlled-pattern* antenna system has been developed by Trio Manufacturing Co., Griggsville, Ill.

The antenna is said to operate in the following manner: High voltage from two double dipole yagis is phased via a tunable *phasitron* to provide addition of voltages from the desired direction and cancellation of undesired voltages.

Phasitron is also said to permit tuning for maximum signal regardless of changing vertical wave angle.

Uses two 300-ohm feed lines and two double-folded yagis.

Separate antenna systems available for each 12 channels.

OUTSTANDING

OXFORD Speakers

Constant research and development have made each and every OXFORD SPEAKER the outstanding unit of the industry. This is proved by the fact that over 77 television and radio manufacturers have used millions (yes — millions) of OXFORD SPEAKERS in the last 25 years.

The excellent engineering skill, fine sound reproduction, quality of components and durability of design, are just a few of the many reasons that make OXFORD SPEAKERS worthy of your consideration.

Precision-built for every sound application with the guarantee of unsurpassed performance, truly make Oxford Speakers **OUTSTANDING**.

Write for your free copy of our new catalog today — for the most complete speaker line available.

Leading jobbers carry OXFORD SPEAKERS for TV, FM, AM, AUTO and PA.

See us at the Parts Show, Booth No. 515, Display Room No. 507A, Stevens Hotel

OXFORD ELECTRIC CORPORATION
3911 South Michigan Avenue • Chicago 15, Illinois
EXPORT: ROBURN AGENCIES, NEW YORK CITY

BRACH 6-BAR ANTENNAS

A 6-bar type of TV antenna which features a fan-type arrangement of elements which are said to provide a uniform high impedance with *Vee-beam* alignment for a narrow high-gain lobe, has been announced by Brach Manufacturing Corp., Newark, N. J. The antenna is said to eliminate the high-band drop-off common to the conventional conical types. Antenna also features a *speed rig* design, elements swinging out into position, a few turns on lock nuts mitre-locking them into a set position. Antenna is said to have a low standing-wave-ratio permitting direct coupling to 72-, 150-, or 300-ohm transmission line. Antennas can be stocked, and either horizontal or *X* type reflectors can be used.

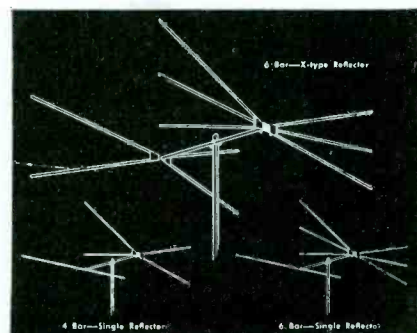

(Above)
Brach bar antennas



See Us
at the
**MAY
SHOW**

and we'll explain how to
**make TV SIGNALS strong
enough to do MOST ANYTHING**

IN ADDITION to our leading role in the production of microphones, pickups, pickup cartridges and related equipment—making weak TV signals strong has become a big business with us. You've heard of the Astatic Model AT-1 Television Booster, of course—the one with such unequalled quality that it holds top sales despite top price. Well, we want to give you the whole story on the AT-1 at the Show, plus a good look inside a real SURPRISE PACKAGE! We will have a brand new model booster to show you . . . not a modified version of our present booster but one that's entirely different, from the inside out!

The newest Astatic cartridges and pickups will be there for your inspection. Never before have we had so much that's new to warrant your interest and enthusiasm!

We're anxious to tell you all you want to know about Astatic products . . . and we're anxious to see you and shake your hand. You'll be more than welcome.



DRAKE *insta-heat*
SOLDERING GUN

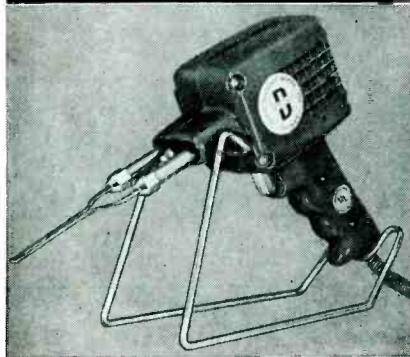

with the *New*
READY STAND

Designed and engineered for you, the perfectly balanced Drake "insta-heat" Soldering Gun features a full 135 watts, easy-removable tip and the ideally located visa-life. Now with the new ready stand—to keep the Drake *insta-heat* Soldering Gun at hand for instant use—it's the gun with all the features you've wanted. See your distributor today.

DRAKE ELECTRIC WORKS, INC.
3656 LINCOLN AVENUE CHICAGO 13

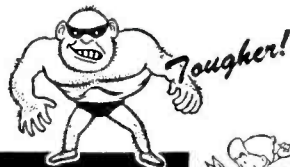

PHOENIX
Speed-Mounts
and
Speed-Tennas

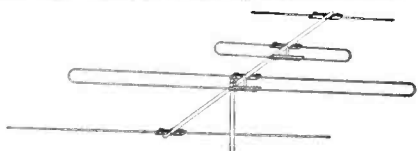

Phoenix IN-LINE SPEED-TENNA PAR-3

High gain consisting of director, high and low folded dipoles and reflector. Speed-rig. **Lo Loss** insulation. Complete with all hardware, less mast.
SEE US AT THE SHOW—BOOTH 618

**PHOENIX
ELECTRONICS, INC.**
Lawrence, Mass.

AT LEADING
JOBBERS
Write for
folder V of
complete line
of television
accessories.

**JFD PORCELAIN LIGHTNING
ARRESTER**

A *safe TV guard* twin-lead lightning arrester has been announced by JFD Manufacturing Co., Inc., 6101 Sixteenth Ave., Brooklyn 4, N. Y.

Made of glazed porcelain the arrester is said to bear the Underwriters' Laboratories seal of approval for both outdoor and indoor use, and comply with fire insurance regulations of the National Board of Fire Underwriters and National Electrical Code for *outdoor* antenna installations.

No wire stripping or cutting is said to be necessary. The twin-lead transmission line is slipped into the slot on top of the arrester and tightened in place. A 4' length of ductile aluminum ground wire is supplied for use when mounting the arrester on walls. Arrester is available in three models: No. AT102 for regular twin lead; No. AT103 for oval jumbo and tubular twin lead; No. AT105 For *any* type twin lead.

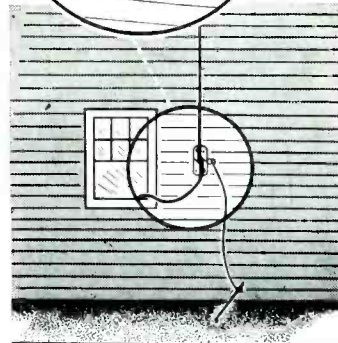

* * *

**INDUSTRIAL PRECISION ANTENNA
HARDWARE**

A line of antenna hardware, including chimney and wall mounts, and all-mast standoffs made with a deep extrusion to accommodate four or more threads, has been announced by Industrial Precision Products Co., 325 N. Hoyne Ave., Chicago 12, Ill.

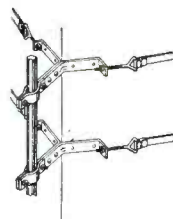

CHIMNEY MOUNT NO. 110



MAST STAND-OFF NO. 123

U. S. DEVICES ANTENNA ROTATOR

An antenna rotator which features an *in-line thrust* from top mounting through the center shaft of the rotator and down to the mast, has been announced by the U. S. Devices Corp., Antenna Rotator Division, Hillside Ave., Oak Tree, South Plainfield, N. J. Also uses a 3/4" solid steel rotating shaft, rotating on a 5/8" case-hardened steel ball bearing, which, in turn, rests upon a stainless steel plate.

Unit is made of aluminum, bronze, brass, and stainless steel. Uses a heavy-duty tandem motor. Rotates 370° clockwise or counter-clockwise, and is said to be instantly reversible from any point. Has an internal magnetic brake which is said to prevent possibility of coasting.

Also has a rubber sealed housing, which is said to make unit waterproof.

Rotator is available with two types of plastic control boxes: model 501, with end of rotation light where center dial lights up to indicate end of rotation and that rotation should be reversed; model 502 with a directional indicator.

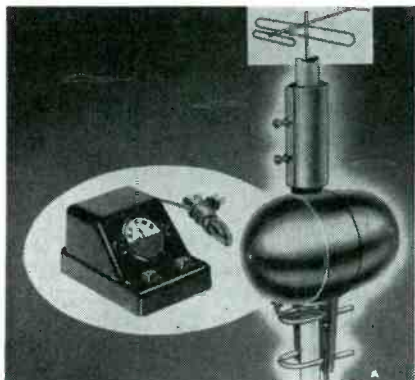

* * *

RMS DRIVE-IN STANDOFFS

A masonry insulator leadin standoff, *Super Nail*, model SN-3, has been announced by Radio Merchandise Sales, Inc., 1165 Southern Boulevard, New York 59, N. Y.

Of hardened steel, the nail is said to go through mortar, cinder block, aluminum, sheet iron and wood. Leadin is supported in a low-loss universal polyethylene insert which takes both twin lead and coaxial cable.

Another application of the standoff is its use as a masonry guy wire anchor, model SN-4.

* * *

WARD INDOOR ANTENNA

A TV antenna, TVH-52, which can be installed in attics, has been developed by Ward Products Corp., Cleveland, Ohio.

Can be suspended from the attic ceiling inside the house or building. Can be suspended upside down with a bracket, C-14.

Model is said to be designed for use in areas where signal from high and low band station transmitters originate from the same general direction.

* * *

RAYTHEON ONE-YEAR PICTURE-TUBE GUARANTEE POLICY

A one-year guarantee policy on picture tubes has been announced by Raytheon.

another RCP television
FIRST!



at a
LOW LOW PRICE!

\$84.50
NET PRICE

MODEL TV-80 SWEEP GENERATOR AND MARKER

THE FIRST OUTSTANDING UNIT OF THIS TYPE GIVING TOP PERFORMANCE AND QUALITY AT AN ECONOMICAL PRICE!

This is the real answer to TV and FM service requirements in a high quality Sweep Generator combined with a TV marker. Sharp, clean-cut patterns with stability and sharp legible marking.

Comprehensive range—continuously variable 5—240 megacycles.

Sweep width—variable 400 KC to 10 MC.

Linearity—as required for band pass checking with an oscilloscope.

High "Q" absorption marker 17 to 48 KC.

Future IF's of higher frequencies provided by direct calibration of marker dial.

Marker calibration—accurate to within 1 per cent.

Planetary Drive.

Provision for use of external marker.

Special design permits retrace to be blanked out independently, regardless of type of oscilloscope used.

Controls for regulating sweep width—sweep amplitude—phasing—marker tuning—Pilot Light—Power Switch.

Handsomely finished steel panel, cabinet and chassis, ready to use—105-125 volts 60 cycle. Size 15 x 9 x 7 inches. Weight 14 lbs. Price—net \$84.50



All Coverage DE LUXE MULTITESTER

The one best multitester covering all requirements (41 ranges) in the TV—FM—AM and general radio and electrical service fields.

HIGH VOLTAGE — 30,000 volts.

LOWEST VOLTAGE SCALE DIVISION—0.05 volts.

HIGH FREQUENCY — 300 megacycles.

DUAL SENSITIVITY—20,000 ohms per volt—3 voltage ranges.

1,000 ohms per volt—7 voltage ranges.

A.C. Measurements of CURRENT—by current transformer method—very low impedance so as not to change normal circuit current.

Shunts and multipliers matched for accuracy within 1%.

OHMMETER—completely self-contained—no soldering for battery replacement. Range—0-3,000-300,000 ohms, 0-30 megohms.

DC Voltmeter 20,000 ohms per volt 0-3-12-60-300-600-1,200-6,000-30,000 volts.

DC Voltmeter 1,000 ohms per volt 0.1-1-10-100-1,000-10,000 volts.

AC Voltmeter 0-3-12-60-300-600-1,200-6,000.

DC Microammeter 0-60-300.

DC Milliammeter 0-3-20-120-600.

DC Ammeter 0-12.

MODEL 488A DL

AC Ammeter 0-3-6-12. Output Voltmeter 0-3-12-60-300-600-1,200. Complete with High Voltage Multiplier Probe and High Frequency Probe—natural finish oak carrying case ready to use. Size 11 1/2 x 9 1/2 x 6 1/2 inches. Weight 10 1/2 lbs. Only \$59.50

RADIO CITY PRODUCTS CO., INC.

152 WEST 25th ST — NEW YORK 1, N. Y.



APPROVED ELECTRONIC SIGNAL GENERATOR

A signal generator, model A-200, featuring non-glare multi-color frequency dial scales and controls in one line (band selector, selector modulation, attenuator and multiplier), has been announced by Approved Electronic Instrument Corp., 142 Liberty St., New York 6, N. Y.

Covers eight rf bands: 100-250 kc; 190-500 kc; 420-1000 kc; 1000-3000 kc; 3-9 mc; 9-25 mc; 18-50 mc and 27-75 mc.

Tubes used: 1—6SN7-rf oscillator; 1—6SH7-af oscillator and modulator; 1—6SH7-cathode follower output stage; 1—7Y4 rectifier.

Unit is housed in a steel cabinet, measuring 8" x 10" x 12".

MALLORY MERCURY BATTERY

A mercury A battery, suitable for applications in miniature radios, hearing aids, meters, instruments and penlights, has been announced by the battery division of P. R. Mallory & Co., Inc., North Tarrytown, N. Y.

Identified as the RM-1C battery, this new addition to the Mallory line of mercury batteries is reported to have an ability to handle higher current drains than heretofore available in any battery of its size. For example, at a current drain of 250 milliamperes, service life is indicated to be approximately 10 hours, depending upon required minimum voltage. Battery is said to have a constant voltage discharge rate, long shelf life and resistance to extremes of temperature, pressure, shock and humidity.

ABSORB TV Interference with the DECIMETER TVI WAVE TRAP

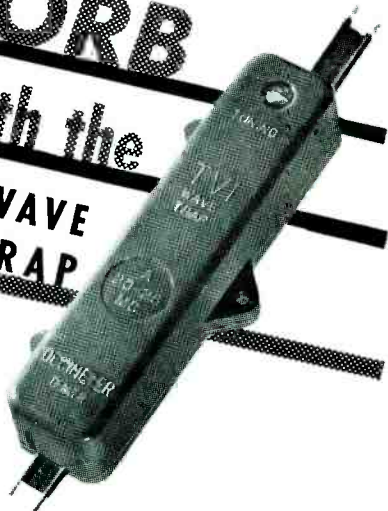

You can make MORE satisfactory TV installations—and quickly—by making use of the simple, fool-proof Decimeter TVI Wave Trap to attenuate interference from DIATHERMY, FM BROADCAST, 10-METER AMATEUR, SPURIOUS IF. The Wave Trap is easy to install. You don't need to cut the lead in—the Wave Trap simply slides over it.

TVI Wave Traps are designed to absorb interference in three frequency ranges: 20 Mc. to 26 Mc.; 25 Mc. to 35 Mc.; 88 Mc. to 108 Mc. They are not intended to eliminate pulse-type interference from ignition, neon signs, etc.

Thousands of TVI Wave Traps are now in use, and users find that they contribute immeasurably to good reception where specific interference needs to be eliminated.

Order today from your jobber—see how efficient the TVI Wave Traps are!

DECIMETER
INCORPORATED
1430 MARKET STREET DENVER 2, COLORADO

TV Sync and Inter-Sync Systems

by **EDWARD M. NOLL***

*Instructor in Television
Temple University*

PROBING vertical retrace intervals in sync systems, we find that the actual vertical retrace interval between fields and between frames is absolutely identical, starting at the same instant for each field or frame and ending at the same instant. Thus, the generating, formation and stabilization of the vertical retrace signals at the transmitter is simplified.

Reviewing horizontal and vertical sync patterns, we find:

(1) During the vertical retrace interval, the horizontal is synchronized by the leading edges of the equalizing and vertical sync pulses.

(2) Between fields, the horizontal is synchronized by the leading edges of the odd-numbered equalizing and vertical pulses. This occurs because the vertical retrace between fields has been assumed to begin at the bottom right and there is a full horizontal line interval between the last horizontal pulse and the first equalizing pulse.

(3) Between individual frames of the picture the horizontal is synchronized by the leading edges of the even-numbered equalizing and vertical sync pulses. This is so because the start of the vertical retrace between frames occurs at the bottom center of the scanning raster and consequently, there is only one-half line interval between the last horizontal sync pulse and the first equalizing pulse.

There is, however, a full line interval between the last horizontal sync pulse and the second equalizing pulse. The insertion of this mid-point equalizing and vertical sync pulse steps up the repetition rate of the equalizing and vertical sync pulses to 31,500.

It is evident that although the series of equalizing and vertical sync pulses occur only every 1/60th of a second at the instant they do occur, the six pulses of each group are occurring at

8 Ways Better!

Polyken® No. 163 ELECTRICAL TAPE



First improvement over old-fashioned friction tape in 70 years!

POLYKEN No. 163 Electrical Tape is the first improvement over sticky, old-fashioned friction tape in 70 years.

POLYKEN No. 163 is 8 ways better than conventional friction tapes. What's more, it comes in three pack sizes for your convenience... 60 ft., 82½ ft. and Job Pack of ten 60-ft. rolls. And POLYKEN No. 163 costs no more than most ASTM Friction Tapes! See your distributor, or write for FREE folder, "Test It Yourself." Address POLYKEN, Dept. 17-5, 222 W. Adams St., Chicago 6.

Check These 8 Extras!

- Higher dielectric strength
- Better moisture barrier
- Less bulk—equal strength
- Higher tack (quick stick)
- Cleaner (doesn't collect dirt)
- Unwinds easily
- Doesn't fray
- Sticks firmly

Polyken®
INDUSTRIAL TAPE

DEPARTMENT OF

BAUER & BLACK

DIVISION OF THE KENDALL COMPANY
222 W. ADAMS ST., CHICAGO 6

*These data, prepared as part of a series of sync articles, which were offered in SERVICE, appear in Noll's book, *Television for Radio-men*, published by The Macmillan Company, New York.

the rate of 31,500 pulses per second. Horizontal synchronization between fields is not affected by the even-numbered pulses, and between frames not affected by the odd-numbered sync pulses. They do not adversely affect the control of the oscillator because they occur at a time when they cannot affect the synchronization or timing of the horizontal oscillator. Thus the arrangement and duration of the vertical retrace and its component pulses are identical from the leading edge of the first equalizing pulse to the trailing edge of the last in spite of the half-line interlace arrangement. Horizontal synchronism is not lost because of the double frequency rate of the equalizing and vertical pulses.

Vertical Sync and Equalizing Pulses

The vertical sweep is being synchronized by the accumulative charge that is built up on the integrating capacitor during the 190-microsecond vertical sync block. Inasmuch as this block is only transmitted once every 1/60th of a second, the vertical is synchronized at 60 cycles per second. The vertical sync pulses are of long duration and very short spacing, and differ in that respect to the horizontal and equalizing pulses which are short duration pulses and long interval spacing. Therefore, the vertical sync pulses during the vertical sync block build up an appreciable charge on the integrating capacitor. Each pulse adds an appreciable charge to the capacitor and although a small percentage is lost during the slot in the vertical, the actual spacing is so small that the accumulative charge builds up until it reaches an amplitude at the fifth or sixth pulse sufficient to trigger the vertical sweep circuit of the receiver.

Equalizing Pulses

It is imperative that the vertical pulses fire at the same instant for each cycle when an interlaced scanning system is used, because if the vertical pulses between frames fired a bit ahead of or after its normal time as compared to the vertical firing between fields, the interlace would be lost. If there is any displacement of time whatsoever, the even-numbered lines will not set exactly midway between the odd-numbered lines, causing pairing of lines and loss of picture resolution. The purpose of the equalizing pulses is to make absolutely certain that the vertical synchronizes at the same time between fields as it does between

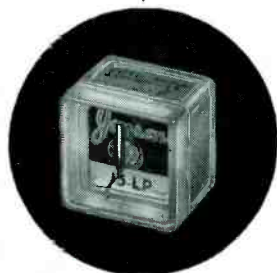

Jensen Needles come to you individually packed in a dust-proof container.



JENSEN — THE OLDEST NAME IN SOUND ENGINEERING

Make Your Service Calls

MORE PROFITABLE

Specify

Jensen NEEDLES
FOR ALL REPLACEMENTS

A Size and Shape to fit any Record Player

It's easy and profitable to recommend a new Jensen Needle when making a service call. What's more, it's still easier to order any needle required from your jobber by number. He can supply you from stock at once. A new needle assures a satisfied customer.

Free Replacement Needle Wall Chart

With this Chart, a quick glance gives you the number of the needle you need. Send for yours today.

Jensen
INDUSTRIES, INC.

331 South Wood Street, Chicago 12, Illinois

frames. We realize that between frames, in our example, the picture ends at the bottom center and between fields at the bottom right. Consequently, at the time it ends between frames at the bottom center there may be present a small residual charge on the integrator capacitor from the previous horizontal sync pulse only a half-line preceding. Thus at the instant the first vertical sync pulse arrives (assuming no equalizing pulses present) there would be already present on the capacitor a small charge and therefore the accumulative charge on the capacitor would build up the

firing level a bit ahead of its normal firing cycle. This is evident when we consider that between fields the charge placed on the integrating capacitor by the last horizontal sync pulse had a full line to discharge before the arrival of the first vertical sync pulse, while between frames capacitor only discharges for a half-line interval. To prevent this unsymmetrical firing and to drain off any residual charge on the integrating capacitor the equalizing pulses have been inserted into the composite television signal. These equalizing

(Continued on page 76)

TV Sync

(Continued from page 75)



new! LOW COST DC SOURCE ELECTRO "BJ" JUNIOR

SUPPLIES 1 to 12.5 AMPS. 6 VOLTS CONTINUOUS DUTY
3 to 9 Volts at Other Ratings

Demonstrate and Test from AC Lines . . . Radios . Relays 'Phone Circuits . Instruments . Other Low Voltage Devices

New Model "BJ" Junior Filtered Power Supply utilizes same exclusive application of selenium rectifiers used in the famous Model "B." This application, using conduction cooling, doubles the rectifier power rating, dissipates over 3 times the heat and provides lower cost per ampere output over other types. Supplies ample power, with a peak instantaneous current rating of 25 amperes (from standard 50/60 cycle 115 volt source). Heavy duty components withstand high over-loads. AC ripple less than 0.4 volts at 6 volts DC 8 amperes.

EXCLUSIVE FEATURES

Voltmeter 0-10 volts 5% accuracy.	8 Heavy-duty power tap adjustments.
Ammeter 0-20 amperes 5% accuracy.	2000 Mfd. filter condenser.
Heavy-duty selenium rectifiers, transformer and choke.	Readily accessible fuse.
	Steel cabinet, blue hammerloid finish.

Send for New Folder on Complete Line of Battery Eliminators



Pioneer Manufacturers



of Battery Eliminators

ELECTRO PRODUCTS LABORATORIES, INC. 4501-BJ Ravenswood Ave., Chicago 40, Ill.

HERE'S LOW-COST SOLUTION FOR your TV Tower Problems

. . . IT'S SIMPLE AS A-B-C!

Now . . . you can slash installation and service costs to a minimum with any one of three famous TV Towers by Camburn. Each can be installed and serviced by one man . . . each can be ground or roof mounted (mounts for Alliance and Crown rotors available) . . . each satisfies the most rigid building codes . . . each will help you make more TV sales and profits! Sturdily built to withstand severe wind loads, these versatile Towers are built in three sizes . . . A, B and C as illustrated. The telescoping Camburn "Jack-Up" Tower (A) has a variable Tower height from 20' to 38' plus 14' of 1 3/8" mast section . . . the next size (B) is 20' high plus 14' of 1 3/8" mast section . . . and the Small Tower (C) has a 20' height. Each is constructed from 16 gauge electric welded steel for utmost rigidity and sturdiness.

Remember . . . for lower installation costs and more profits, specify and buy Camburn TV Towers. Don't settle for less. Investigate Camburn today!

In the "Jack-Up" Tower, top section pulls out and is fastened rigidly with metal clamp to middle section. Jack handle (1) easily lifts middle section and antenna to desired height. Spring-loaded locking ring and auxiliary lock hold middle section securely in position. Lever (2) lowers antenna to any position or brings it all the way down for quick, easy servicing.

Camburn TV Towers are sold only through recognized distributors. A few territories are still available . . . Write today for full information and details.

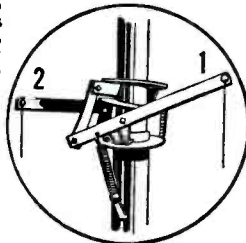

Camburn SALES & MFG. CORPORATION
392 W. Michigan Ave., Battle Creek, Michigan

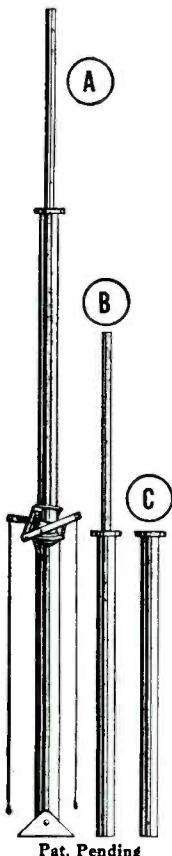

Pat. Pending

pulses are of very short duration and extremely long spacing, permitting a long discharge time and only a very small charge time. Thus, any residual charge present on the integrating capacitor at the start of the vertical retrace interval is slowly drained off during the equalizing pulse block. Therefore, between fields or between frames the charge on the integrating capacitor is zero at the instant the vertical sync pulse arrives and accordingly, the vertical oscillator will be fired at the same instant between fields, as it is between frames. After the firing of the vertical oscillator, the trailing sets of equalizing pulses discharge the integrator capacitor back to zero again before the start of the horizontal scanning intervals.

Field Retracing

In this discussion we have considered the field retrace as starting from bottom right and frame retrace from bottom center. This is true when the vertical oscillator is triggered by an even-numbered vertical sync pulse (generally 4 or 6). However, it is quite possible to have field retrace start from bottom center and frame from bottom if the vertical were to synchronize on one of the odd-numbered vertical sync pulses (3 or 5).

Vertical Sync Characteristics

Summarizing, we find vertical sync with the following characteristics:

- (1) During horizontal line intervals the integrator has time to discharge to zero.
- (2) Vertical sync block made of long-duration short-interval-spacing pulses which build-up accumulative charge to fire vertical oscillator.
- (3) Short-duration long-interval spacing of equalizing pulses which draw any residual charge off capacitor before start of vertical sync block; likewise sync-to-noise ratio is improved because equalizing pulses also drain noise of capacitor.
- (4) Vertical is triggered at same time between fields and frames.

BRAND NEW PROFIT MAKER



**FOR
RADIO
SERVICE
MEN!**

Model AR-3
Electrovox Vibra-
tor Analyzer &
Power Supply

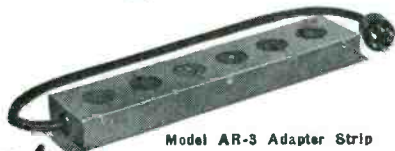

Model AR-3 Adapter Strip

New ELECTROX

VIBRATOR ANALYZER AND POWER SUPPLY

Here's a new Electrovox test unit that's *indispensable* for shops servicing auto radios, 2-way mobile communication systems or other equipment using 6-volt vibrators.

TWO VALUABLE TEST UNITS IN ONE! This instrument combines an adjustable POWER SUPPLY that provides smooth, hum-free direct current in any voltage needed to test auto radios, with a VIBRATOR ANALYZER that *thoroughly tests* practically all synchronous and non-synchronous vibrators found in auto radios today!

TESTS OVER-ALL VIBRATOR PERFORMANCE! Vibrator Analyzer *accurately* determines shorted and otherwise defective vibrators and predicts vibrator failures before they occur. It measures starting voltage, current consumption, output voltage and indicates irregular operation. Subjects vibrator to voltage conditions normally encountered when connected to the electrical system of the car. Over-voltage is available for starting vibrators with oxidized contacts. A standard oscilloscope can be attached for wave form observation.

It's a top quality test instrument—a *must* for every service shop. It safeguards your auto radio repairs—increases your parts sales—steps-up your efficiency and earnings. **ORDER NOW FROM YOUR DISTRIBUTOR.**

Write for Free Bulletin No. 1466, Giving Full Details

Rectifier Division
SCHAUER MANUFACTURING CORP.
2078 Reading Road • Cincinnati 2, Ohio

WALCO CONTROLLED PHONO

NEEDLE INVENTORY PLAN

A *controlled-inventory plan* featuring a simplified system which is said to afford identification of the many replacement needles now in use, or that have been in use for the past few years has been developed by Electrovox, Inc. Electrovox will make available complete up to date data, charts, and samples of needles to facilitate stocking.

Visitors to the Walco booth at the Radio Parts Show will receive complete details of the *inventory plan*.

TV Receiver Changes

(Continued from page 52)

- (9) When the *vtrm* reading is zero the receiver is properly neutralized.

Picture Centering

To provide better centering of the picture in Raytheon 10" and 12" models, two changes have been made:

Replacement of 2700-Ohm Resistor

- (1) Resistor R₁₀₃ (2,700 ohm, 2 watt) was replaced with a 5600 ohm, 2 watt.

Addition of 5600-Ohm Resistor

- (2) A 5600-ohm, 2 watt resistor was added from electrolytic C_{61-D} (bank) to electrolytic C_{118-A} (squat dot-lug).

Vertical Hold Range Increase

To increase range of vertical hold control in the Raytheon chassis, resistor R₇₆ (1 megohm) was replaced with a 560,000 ohm unit, and resistor R₇₃ (68,000 ohms) was replaced with an 18,000 ohm unit.

Dressing in High Voltage Power Supply

Life tests on Raytheon chassis have indicated the need for closer attention to dressing within the high voltage power supply to minimize breakdowns in the field.

Conditions to Watch

In the process of inspection, repairs, changing of tubes, or for any other reason where it is necessary to work within the high voltage power supplies the following conditions should be closely observed and corrected accordingly:

- (1) Terminals on 1X2 sockets must be dressed toward the inside of corona ring, and be free of sharp protrusions.

(Continued on page 78)

MERIT

SINCE 1924—FINE RADIO PARTS

News

FREE!

MERIT TV "REPL" GUIDE

MAY 1950 ISSUE
63 MANUFACTURERS.
575 MODELS. MOST COMPLETE, UP-TO-DATE LISTING

Get this easy-to-use, time-saving guide to exact replacements for all popular television receivers. Simplifies servicing, cuts repair-bench time. Write us today for your free copy.

USE MERIT TV!

ONE SOURCE FOR

TV Tape-Marked Components:
Powers, Blocking Oscillators,
Vertical Outputs, Focus Cells,
Deflection Yokes, Flybacks.

WATCH FOR
Merit's future issues
of the TV "Repl"
Guide

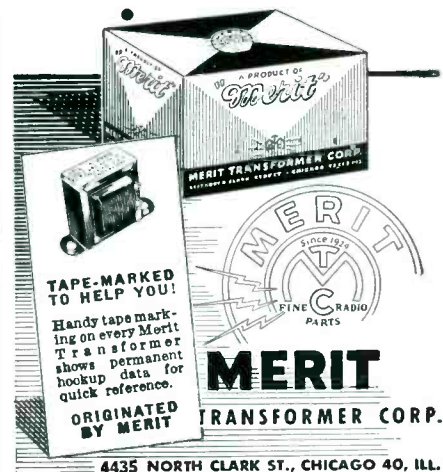

SERVICE, MAY, 1950 • 77

HALF AS LARGE... TWICE AS GOOD!

DUAL & TRIPLE DANDEES
with the **NEW INSULATED-STUD TERMINALS**

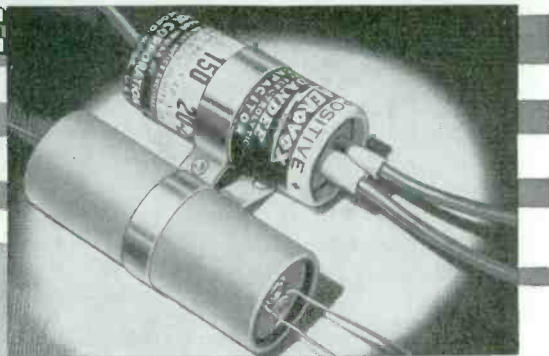

• Smaller — better. That's why the new Aerovox dual and triple midget-can electrolytics are a smash hit with servicemen.

Stud terminals replace usual riveted terminals. Reduce tubular diameter 40%. Advanced electrolytic capacitor art further reduces bulk. Note comparison between usual dual and new Dual Dandee.

To top it all, insulated wire leads in place of bare wires! Also insulating sleeves over stud terminals. No danger of "shorts" even in tight spots.

GO AEROVOX!

For faster, easier, more-money servicing, ask your Aerovox jobber for these Dandees. Ask for latest Aerovox catalog—or write us.

TV Receiver Changes

(Continued from page 77)

- (2) Corona ring must be dressed in such a way as to make its presence useful; that is, properly centered and about 1/8" below socket terminals.
- (3) All leads must be dressed as far away as possible from the transformer winding. Excess lead length should be transferred to the underside of chassis.
- (4) On the race track type transformer assembly, leads must be dressed away from the coil and race track.
- (5) The tube cap clip ends must face away from the sides of shield can.



FOR RADIO-ELECTRONIC AND INDUSTRIAL APPLICATIONS

AEROVOX CORPORATION, NEW BEDFORD, MASS., U. S. A.

SALES OFFICES IN ALL PRINCIPAL CITIES • Export: 13 E. 40th St., NEW YORK 16, N. Y.

Cable: 'ARLAB' • In Canada: AEROVOX CANADA LTD., HAMILTON, ONT.

6V6 Tube Protection

In early production of Raytheon 16AX23—25—26 chassis (16" models), the 6V6 plate supply voltage was connected through the fuse. If the fuse happened to blow, the 6V6 plate supply voltage (350 volts) would be cut off and leave the screen at 240 volts, causing damage to the tube.

The Solution

This problem can be overcome by disconnecting the red lead of the vertical output transformer from the B+ point and reconnecting to pin 5 of the power jumper socket. If the fuse blows after the change is made, the plate will remain at 350 volts and the 6V6 will not be damaged by excessive screen current.

Folding on 12 1/2" Chassis

Folding at the right of the picture tube in Raytheon chassis, evidenced by a loss of horizontal scanning of one-half to four inches and a bright vertical line as the right edge of the picture or raster has been cured by the following changes:

Capacitor Substitution

The .001 mfd capacitor (C₁₁₂) connected to pin 2 of the 6SN7 horizontal

SAVE TIME SAVE MONEY!

BUILD PRECISION INSTRUMENTS WITH EICO KITS

Build it yourself and save the assembly labor cost. The schematic and pictorial diagrams enclosed with each EICO Kit are easy to follow, it's no trick at all to complete the job in one evening!

Ideally suited for TV: EICO VTVM goes to 30,000 volts and over 200 Mc with our accessory probes—EICO Sweep Generator has TV channels marked on panel and crystal marker—new EICO 'scope has high sensitivity and Push-pull.

West Coast prices 5% higher. Write NOW for our new catalog '58.

ELECTRONIC INSTRUMENT CO., INC.
276 Newport Street, Brooklyn 12, N. Y.

320K SIGNAL GENERATOR KIT \$19.95
Wired \$29.95

221K HIGH PRECISION-VACUUM TUBE VOLTMETER KIT \$23.95
Wired \$49.95

145K MULTI-SIGNAL TRACER KIT \$18.95
Wired \$28.95

315 DELUXE SIGNAL GENERATOR \$59.95
Wired only

360K SWEEP SIGNAL GEN'R KIT \$29.95
Wired \$39.95

425K 5" PUSH-PULL SCOPE KIT \$39.95
Wired \$69.95

511K POCKET VOLT-OHM-MILLIAMMETER KIT \$14.95
Wired \$17.95

5 Mc. Crystal \$3.95

HI-VOLTAGE PROBE Wired only \$6.95

HI-FREQ PROBE KIT \$3.75
Wired \$7.50

EASY-TO-FOLLOW SCHEMATIC & PICTORIAL DIAGRAMS WITH EVERY EICO INSTRUMENT KIT.

SAVE TIME & MONEY
CUT DOWN RECALLS!

Replace with

TELE-MATIC

**STURDY-TUNE
DETENTS**

SAVE MONEY

Priced lower than other available detents because you reuse the original locating plate

SAVE TIME

You avoid recalls because the Sturdy-Tune detent is built with a long lasting phosphor bronze spring.

The TELE-MATIC "Sturdy-Tune" detent shafts are designed to fit the RCA tuners as used in the 630 & 721 type chassis made by Air King, Regal, Fada, Emerson, DeWald, Olympic, Garod, etc. Also, available for Admiral, Magnavox and other specials.

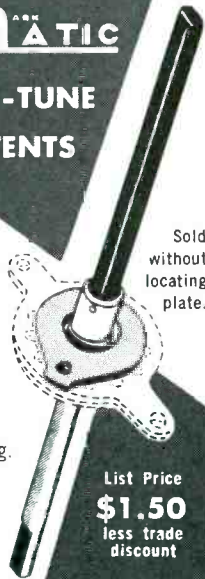

Sold without locating plate.

List Price
\$1.50
less trade discount

Available at all the leading jobbers. For complete details and name of your nearest jobber, write:

TELE-MATIC INDUSTRIES, INC.
ONE ORALEMON ST.
BROOKLYN 2, N. Y.

multivibrator has been replaced with a .02 mfd 600-volt capacitor. If a 3900-ohm, 2-watt resistor (R_{107}) is wired in the chassis, another 3900-ohm 2-watt resistor can be paralleled with R_{107} . The 6BQ6 tube should be replaced if the trouble is not cured.

Raytheon 12AX22 Changes

Chassis stamped with group numbers between 9000 and 12,399 are wired as shown in Fig. 2, with the following exceptions:

- (1) Resistor R_{72} is 2.2 megohms.
- (2) Capacitor C_{65} is .01 mfd.
- (3) Resistor R_{73} is 18,000 ohms.
- (4) Resistor R_{45} is 270,000 ohms.
- (5) Capacitor C_{100} is .25 mfd.
- (6) Resistor R_{120} and capacitor C_{90} are not incorporated.
- (7) A 6,800-mmfd capacitor is connected from pin 1 of the 6SN7 to the green lead of the vertical oscillator transformer (C_{90} on code 15 schematic).
- (8) A 220-mmfd capacitor is connected from pin 1 of the 6SN7 to ground (C_{91} on code 15 schematic).
- (9) The horizontal deflection transformer T_6 is as shown without the -1 part number.

Chassis stamped with group numbers from 14,200 and up were wired as shown in the schematic.

Changes in Westinghouse V-2150-176 Chassis

In later production of the V-2150-176 chassis used in models H-617T12 and H-619T12, the following changes were incorporated:

Horizontal Wobble Reduction

- (1) To reduce horizontal wobble under strong signal conditions and increase the contrast range, R_{427} (5,600 ohms connected between pins 6 and 7 of the 6AU6 *agc* tube) was changed to 3,300 ohms.

Horizontal Linearity Improvement

- (2) To improve horizontal linearity, C_{227} (680-mmfd horizontal discharge capacitor) was replaced by a 330-mmfd unit.



the **EXTRAS**
that make it easy
to sell
WALSCO

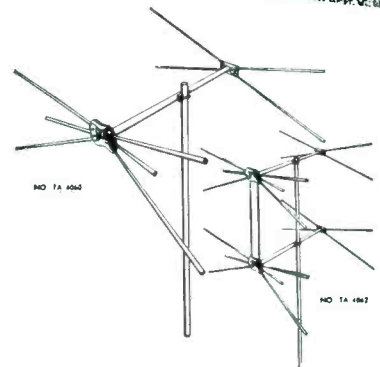

crystal-clear TV reception

Exclusive features available
ONLY in WALSCO T.V. antennas

ONLY WALSCO features a silicone-treated styron molded insulator to assure crystal-clear TV reception.

ONLY WALSCO uses marine type high tensile chromium aluminum alloy for elements... with a "yield point" 94% higher than ordinary aluminum.

ONLY WALSCO uses a butt-seamed tubing for elements to assure the highest elasticity.

These EXTRA features make it easy to sell WALSCO.

WRITE FOR FREE ILLUSTRATED CATALOG 94-D

WALSCO new TV Alignment Tools are used everywhere. Available at your local jobber.

WALTER L. SCHOTT CO.
Beverly Hills, Calif. • Chicago 6, Ill.

1950 PROFIT GUIDE
JUST OFF THE PRESS

W-J
WALKER-JIMIESON CHICAGO, ILL.

THE TELEVISION AND RADIO SERVICE-DEALERS' SUPPLY HOUSE

WALKER-JIMIESON, INC.
21 SOUTH WESTERN AVE. • CHICAGO 12, ILLINOIS • C.A.M. 8-2322

PACKED WITH NEW PROFIT ITEMS

Complete buying guide for service-men, dealers. New TV accessories, TV installation equipment, TV test instruments, tubes, radio accessories and other electronic supplies. Thousands of repair parts cross-indexed for quick, easy selection. Same-day shipment. Catalog sent only to those entitled to wholesale prices.

SEND For Your FREE Copy Now

101
WALKER-JIMIESON, INC.
311 S. Western Ave., Chicago 12, Illinois
 Please send your 1950 Free Profit Guide

Name _____
Address _____
City _____ Zone _____ State _____

American Beauty

dependable

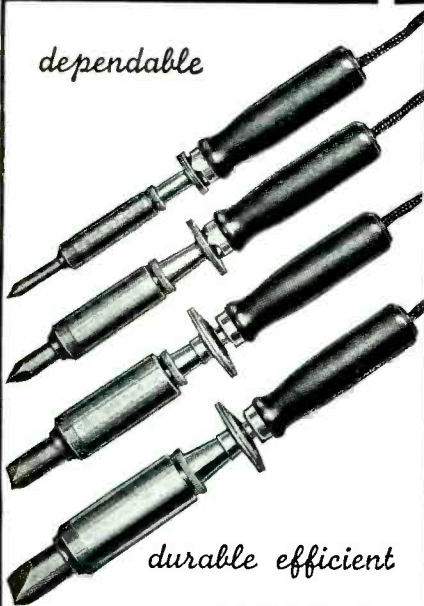

durable efficient

ELECTRIC SOLDERING IRONS

are sturdily built for the hard usage of industrial service. Have plug type tips and are constructed on the unit system with each vital part, such as heating element, easily removable and replaceable. In 5 sizes, from 50 watts to 550 watts.

TEMPERATURE REGULATING STAND

This is a thermostatically controlled device for the regulation of the temperature of an electric soldering iron. When placed on and connected to this stand, iron may be maintained at working temperature or through adjustment on bottom of stand at low or warm temperatures.



For descriptive literature write

111-1

AMERICAN ELECTRICAL HEATER COMPANY
DETROIT 2, MICH., U. S. A.

JOTS AND FLASHES

TV now appears to have gained official acceptance in industry, the long-established RMA having surrendered to the tempo and agreed to be identified hereafter as the Radio-Television Manufacturers Association. The decision to strike a new nameplate was reached at the recent Canadian-U.S. meeting in Canada, where it was also decided to make another important change, this time in management and engage a full-time paid proxy. . . . FCC Chairman Wayne Coy will deliver the principal talk at RMA's 26th annual convention banquet on June 8th at the Stevens Hotel in Chicago. . . . Spellman Television Co., Inc., are now located at 3029 Webster Ave., Bronx, N. Y. . . . Sylvania Electric Products, Inc., have consolidated their New York Offices and are now located at 1740 Broadway, New York 19, New York. . . . Harry Van Rensselaer, sales manager, and Ben French, applications engineer, of the Electronic Parts Division of Allen B. DuMont Laboratories will attend the Radio Parts Show in Chicago. . . . The second in a series of six television-service lectures has been announced by RCA. The clinics, which are sponsored jointly by the home instrument department and the RCA Service Co., and conducted by field engineers of the RCA Service Company, will be devoted to the servicing of the *rf* unit, the picture *if* and the sound channels in television receivers. Test methods and test equipment will also be discussed. . . . Rocke International Corp., 13 E. 40th Street, New York 16, are now the export agency for American Television and Radio Company, 300 E. 4th Street, St. Paul, Minnesota. . . . Eight new distributors have been appointed by North American Philips Co., Inc., to handle the recently announced Duo-Vue system: Louis J. Lerro Co., Inc., Philadelphia, Pa.; Electronic Supply Corp., Long Island City, N. Y.; L & S Radio Supply, Middletown, New York; Century Distributing Co., Los Angeles, Calif.; Westchester Electronic Supply Co., White Plains, N. Y.; Ebinger Radio & Supply Co., St. Louis, Mo.; Mission Radio, Inc., San Antonio, Texas, and Warren Radio, Inc., Erie, Pa. . . . The executive and sales offices of Tele-OTube Sales Corp. are now located at 580 5th Avenue, New York 18. . . . A six-page catalog has been released by Electronic Measurement Corp., 423 Broome Street, New York 13. Described and illustrated are vacuum tube volt-ohm-capacity meters, mutual-conductance tube testers, *rf* signal generators, antenna orienters, etc. . . . Donald E. Steele is now associated with Arthur E. Akeroyd, manufacturer's rep in New England, with offices at 419 Commonwealth Ave., Boston, Mass. . . . The Lyte Parts Co., Plainfield, N. J., have been purchased by a new corporation, The Lyte Products Company. Pat Shlafer is the sales manager of Lyte. . . . The Sheldon Electric Company, 68-98 Coit Street, Irvington 11, N. J., published recently a four-page bulletin titled *Mis-Information*, disclosing pertinent television facts of today. . . . Sylvania picture tubes will hereafter carry a one-year guarantee. All tubes will have a code date stamped on them to determine whether the tube is within the adjustment period. . . . The Triad Transformer Company, 2254 Sepulveda Blvd., Los Angeles 64, Calif., have released a 16-page original-replacement transformer catalog.

ADVERTISERS IN THIS ISSUE SERVICE INDEX—MAY, 1950

AEROVOX CORP.	78
Agency: Austin C. Lescarboursa & Staff	
ALUMINUM COMPANY OF AMERICA	33
Agency: Fuller & Smith & Ross, Inc.	
AMERICAN ELECTRICAL HEATER CO.	80
Agency: Dudgeon Taylor & Bruske, Inc.	
AMERICAN GRAPHONE CO.	66
Agency: Ross, Gardner & White	
AMERICAN PHENOLIC CORP.	30
Agency: Burton Browne, Advertising	
ANACONDA WIRE & CABLE CO.	13
Agency: Kenyon & Eckhardt, Inc.	
ANCHOR RADIO CORP.	18
Agency: Simonds, MacKenzie & Co.	
THE ASTATIC CORPORATION	72
Agency: Wearstler Advertising, Inc.	
BAUER & BLACK DIV. THE KENDALL CO.	74
Agency: Henri, Hurst & McDonald, Inc.	
L. S. BRACH MFG. CORP.	17
Agency: A. W. Lewin Co.	
CANBY SALES & MFG. CO.	76
Agency: Paxson Advertising, Inc.	
CENTRALAB DIV. GLOBE-UNION, INC.	40, 41
Agency: Klau-Van Pietersom-Dunlop Associates, Inc.	
CLIPPARD INSTRUMENT LAB.	66
Agency: The S. C. Baer Co.	
CONTINENTAL CARBON, INC.	60
Agency: William Glazer Adv. Agency	
CORNELL-DUBILIER ELECTRIC CORP.	Inside Front Cover
Agency: Reiss Advertising	
CORNELL-DUBILIER ELECTRIC CO.	27
Agency: Stern and Warren	
DECIMETER, INC.	74
Agency: Wayne C. Weight, Inc.	
DRAKE ELECTRIC WORKS, INC.	72
Agency: William Hoffmann & Assoc.	
ALLEN B. DUMONT LABORATORIES, INC.	59
Agency: Austin C. Lescarboursa & Staff	
ELECTRONIC INSTRUMENT CO., INC.	78
ELECTRO PRODUCTS LABORATORIES, INC.	78
Agency: Gotch and DeVille Advertising	
ELECTRO-TECH, INC.	61
Agency: Henry H. Teplitz, Advertising	
ELECTROVOX, INC.	57
Agency: H. W. Hauptman Co.	
ERIE RESISTOR CORP.	66
Agency: W. S. Hill Co.	
FEDERAL TELEPHONE & RADIO CORP.	11
Agency: Mathes, Inc.	
GENERAL ELECTRIC CO.	1, 9
Agency: Maxon, Inc.	
THE GENERAL INDUSTRIES CO.	69
Agency: Meldrum & Fowsmith, Inc.	
THE HEATH COMPANY	62
Agency: G. Dean Arend, Advertising	
THE HOUSE OF TELEVISION, INC.	68
Agency: A. D. Adams Advertising	
HYTRON RADIO & ELECTRONICS CORP.	5
Agency: Bennett, Walther & Menadier, Inc.	
J. F. D. MFG. CO., INC.	60, 70
Agency: Shappe-Wilkes Inc.	
JENSEN INDUSTRIES, INC.	75
Agency: Frank C. Nahser, Inc.	
KESTER SOLDER CO.	4
Agency: Frank C. Nahser, Inc.	
LITTELFUSE, INC.	15
Agency: Burton Browne, Advertising	
P. R. MALLORY & CO., INC.	Inside Back Cover
Agency: The Atkin-Kynett Co.	
MERIT COIL & TRANSFORMER CORP.	77
Agency: Symonds, MacKenzie & Co.	
J. W. MILLER CO.	68
NORTH AMERICAN PHILIPS CO., INC.	6, 7
Agency: Erwin Wasey & Co.	
ODEGAARD MFG. CO.	64
Agency: H. W. Hauptman Co.	
OHMITE MFG. CO.	68
Agency: The Fensholt Co.	
OXFORD ELECTRIC CORP.	71
Agency: Sander Rodkin Adv. Agency	
PARK METALWARE CO., INC.	64
Agency: Melvin P. Hall Agency	
PERMOFLUX CORP.	31
Agency: Symonds, MacKenzie & Co.	
PHOENIX ELECTRONICS INC.	72
Agency: Milton Richards	
PRECISION APPARATUS CO., INC.	10
Agency: Shappe-Wilkes Inc.	
RADIO CORPORATION OF AMERICA	16, 37, Back Cover
Agency: J. Walter Thompson Co.	
RAD-EL-CO MFG. CO.	64
Agency: Lehman Wood	
RADIART CORP.	45
Agency: Stern and Warren	
RADIO CITY PRODUCTS CO.	73
Agency: Jaman Advertising, Inc.	
RADIO MERCHANDISE SALES, INC.	70
Agency: Nottingham & Phaneuf	
RAYTHEON MFG. CO.	29
Agency: Walter B. Snow & Staff	
JOHN F. RIDER PUBLISHER, INC.	12
Agency: Shappe-Wilkes Inc.	
HOWARD W. SAMS & CO., INC.	60
Agency: George Brodsky, Advertising	
SANGAMO ELECTRIC CO.	8
Agency: Arthur B. Mogge, Inc.	
SCHAUER MFG. CORP.	77
Agency: The Keeler & Stites Co.	
WALTER L. SCHOTT CO.	79
Agency: Tills & Cantz	
SNYDER MFG. CO.	25
Agency: Brooks and London	
SPRAGUE PRODUCTS CO.	63
Agency: The Harry P. Bridge Co.	
STANDARD TRANSFORMER CORP.	67
Agency: Burnet-Kuhn Adv. Agency	
SYLVANIA ELECTRIC PRODUCTS, INC.	3
Agency: Ceell and Presbrey, Inc.	
TECHNICAL APPLIANCE CORP.	14
Agency: Austin C. Lescarboursa & Staff	
TELE-MATIC INDUSTRIES, INC.	68
Agency: Lee-Murray Co., Inc.	
TRIPLET ELECTRICAL INSTRUMENT CO.	49
Agency: Western Adv. Agency, Inc.	
TUNG-SOL LAMP WORKS, INC.	32
Agency: E. M. Freystadt Associates, Inc.	
WALKER-JIMLISON, INC.	79
Agency: Edward C. Kennedy	
WEBSTER ELECTRIC	67
Agency: Hamilton Adv. Agency, Inc.	



This Little Fellow Is Some Performer!

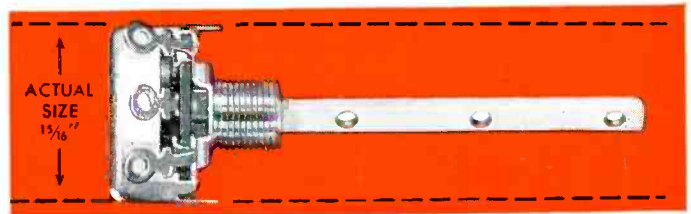

The Mallory Midgetrol

Here's the answer to your control problems... a $15/16$ " diameter precision control with electrical characteristics superior to $1 1/8$ " controls, while physical size meets requirements of auto and personal sets. Now you can standardize on *one* control for all of your replacements... profit by the versatility of the Mallory Midgetrol!

And that's not all! Exclusive precision equipment and scientific inspection assure smooth, uniform tapers. Electrical noise is eliminated, because there is no metal-to-metal contact on moving parts except where conductivity is required. The moisture-proof base prevents warping and provides greater stability.

The Mallory Midgetrol has been designed to meet *your* problems. Your Mallory distributor is ready to serve you.

WIDER APPLICATION

The small size allows you to service portables, auto radios and small AC-DC receivers requiring $15/16$ " controls.

LESS INVENTORY

Electrical characteristics allow you to use the Mallory Midgetrol to replace $1 1/8$ " as well as $15/16$ " controls. Since no special shafts are required, you carry fewer controls in stock.

SIMPLER INSTALLATION

The new and unique flat shaft design of the Mallory Midgetrol saves installation time with all types of knobs.

See your Mallory distributor for this new standard in carbon controls!

P. R. MALLORY & CO. Inc.
MALLORY

CAPACITORS... CONTROLS... VIBRATORS...
SWITCHES... RESISTORS... RECTIFIERS...
VIBRAPACK* POWER SUPPLIES... FILTERS
*Reg. U. S. Pat. Off.

APPROVED PRECISION PRODUCTS

P. R. MALLORY & CO., Inc., INDIANAPOLIS 6, INDIANA

\$10,000 IN PRIZES

FOR RADIO BATTERY RETAILERS and RCA BATTERY DISTRIBUTOR SALESMEN



IN THE RCA BATTERY "GET THE FACTS" CONTEST

YOU CAN WIN
A '50 FORD
... OR OTHER
VALUABLE
PRIZES

FREE ENTRY... here's how

LOOK AT THESE DEALER AWARDS! FIRST PRIZE — 1950 FORD SEDAN

Factory equipped 8-cyl. Tudor Custom Sedan

- 2nd Prize \$700 Drexel Bedroom Suite
- 3rd Prize \$619 Drexel Dining Rm. Suite
- 4th Prize \$450 Deep Freeze Unit, 12 Cu. Ft.
- 5th Prize \$350 Rogers Sterling (Service for 12)
- 6th Prize \$260 Kaufmann Travel Luggage (4 matched pcs.)
- 7th Prize \$233 Kroydon Golf Clubs & Bag
- 8th Prize \$145 Kaufmann Travel Luggage (2 matched pcs.)
- 9th to 15th Prizes—\$100 Longines Wrist Watches
- 16th to 25th Prizes—\$25 U. S. Savings Bonds

**Duplicate Prizes for
RCA Battery Distributor Salesmen**

Purpose of this contest is to encourage Battery Retailers to Get The Facts on why it's best to stock and sell . . .

RCA The battery for the Radio Trade!

Mail coupon today if you DO NOT know the name of your local RCA Battery Distributor.



RCA Battery Sales
Radio Corporation of America, Harrison, N. J.
Sirs: I am a Radio Battery Retailer, but DO NOT know the name of my local RCA Battery Distributor.

Please forward this request to him for my FREE copy of the RCA Battery "Get The Facts" Official Contest Booklet containing the FREE Entry Coupon.

Signed _____
Co. Name _____
Street & No. _____
City & State _____

No purchases required—no sentences to complete! Simply get your FREE copy of the Official RCA "Get The Facts" Contest Booklet . . . from your nearest RCA Battery Distributor. Then, fill out and mail the Free Entry Coupon in the Contest Booklet to the address printed thereon. Contest closes June 30, 1950. All entries must be postmarked on or before that time.

This contest is open to all radio battery retailers within the continental U. S. A. and to full-time personnel whose duties include the selling of radio batteries.

Here's how prizes will be awarded

1. All entry coupons received will be assembled at Contest Headquarters for an impartial drawing to be held July 10, 1950.
2. The retailer whose name appears on the first coupon drawn will be contacted by telephone, person-to-person. He will be asked one of the easy questions about RCA Batteries appearing in the "Get The Facts" Contest Booklet. If this contestant gives the correct answer immediately, he will be awarded first prize.
3. If the contestant fails to give the correct answer immediately, another drawing is held.
4. The above procedure will be followed in awarding all prizes.

DON'T DELAY. Get your Contest Booklet from your nearest RCA Battery Distributor. A magnificent prize can be your reward!

Complete Entry and Prize Award Rules can be found in the Official Contest Booklet.

RADIO BATTERIES



**RADIO CORPORATION
of AMERICA**

HARRISON, N. J.