

# SERVICE

April  
1949

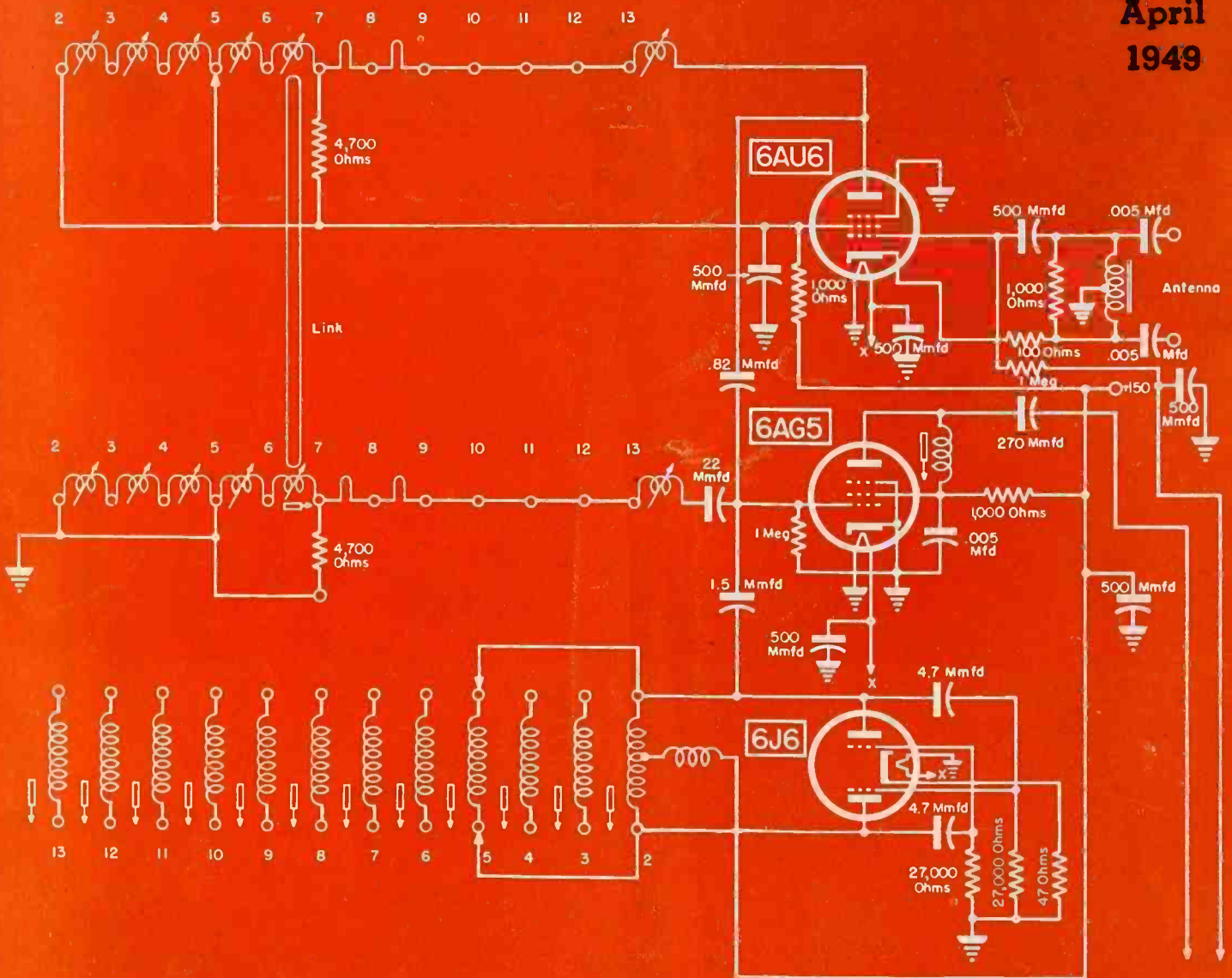

The rf tuner of a 12T4 TV receiver with a 6AU6 rf amplifier employing a double peaked rf response obtained through capacitive coupling on the high and additional inductive coupling on the low channels.

[See page 3]

# THE BOOK OF THE MONTH

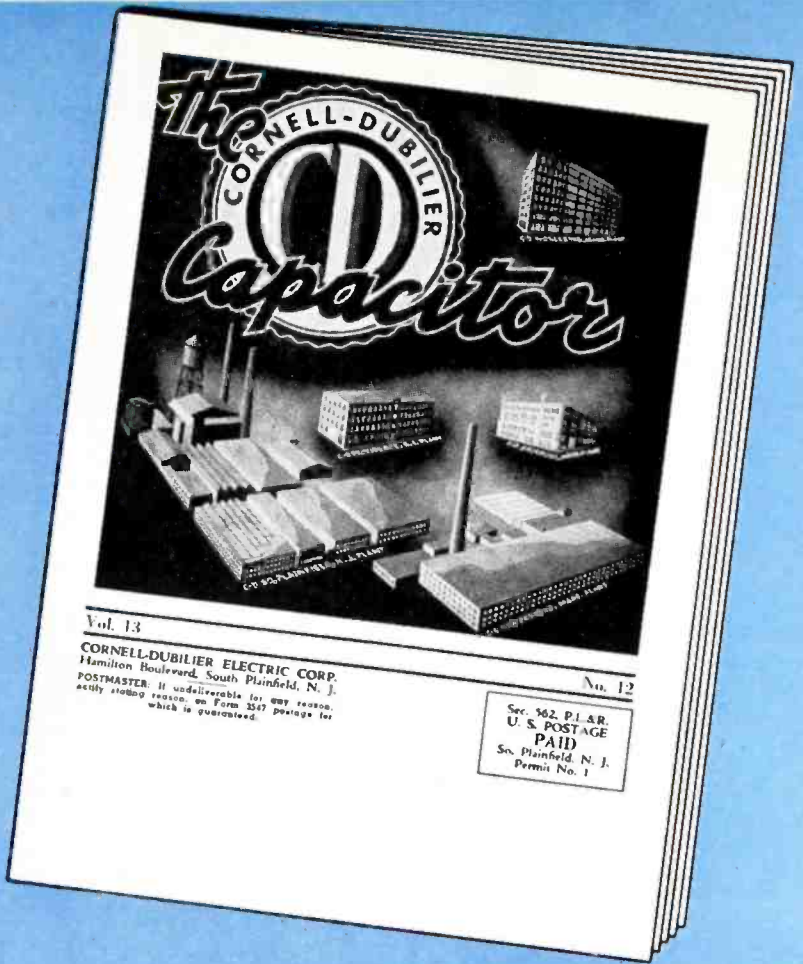

AND IT'S YOURS *Free* ALL YEAR 'ROUND

MAIL COUPON NOW for your FREE monthly subscription to this revealing, up-to-the-minute book. It doesn't miss a trick on the newest developments in your field. Exclusive articles on timely, helpful subjects. Cornell-Dubilier Electric Corporation, South Plainfield, New Jersey. Other large plants in New Bedford, Worcester, and Brookline, Mass.; Indianapolis, Ind., and Providence, R. I.



CORNELL-DUBILIER ELECTRIC CORP., Dept. 549  
South Plainfield, New Jersey

YES, rush my FREE subscription to the "C-D Capacitor" which you will mail to me every month from now on.

Name.....

Shop or Occupation.....

Mail Address..... Zone..... State.....

City.....

**CORNELL-DUBILIER**  
world's leading manufacturer of  
CAPACITORS  
AUTO VIBRATORS • TV and FM ANTENNAS  
POWER CONVERTERS

CLIP COUPON AND MAIL NOW





RADIO AND TELEVISION TUBES

**"THEY SELL FAST  
AND STAY SOLD!"**

**Y**OU have the word of other experienced servicemen for it—Ken-Rad tubes are a fast-turnover line. And they give satisfaction. They make friends for your shop.

By word-of-mouth endorsement alone, Ken-Rad tubes will gain a good name in any locality. They're a quality product, a better tube . . . and such news gets around!

But there's a faster way to bring Ken-Rad dependability to the notice of your customers. *Advertise!* Ken-Rad makes it easy for you. See the counter displays shown on this page.

In a jiffy you can put one, or both, of these attention-getters where people coming into your store are sure to see them. Also, the Ken-Rad wall plaque, decal, and giant tube carton will help identify your premises. There are blotters, postcards, stationery, repair stickers—many other aids to sales that up-and-coming servicemen have found effective. Ken-Rad's new shop coats and uniforms already are a smash hit!

Phone or write your nearby Ken-Rad distributor. He will be glad to show you how Ken-Rad radio-TV tubes—a profitable

line—*can be made more so* by taking full advantage of Ken-Rad's streamlined promotion helps!



**KEN-RAD** *Radio Tubes*

PRODUCT OF GENERAL ELECTRIC COMPANY

Schenectady 5, New York

say servicemen everywhere.



KEN-RAD'S LIVE LINE OF PROMOTION PIECES HELPS TO KEEP SALES HIGH. YOUR CASH REGISTER WILL CHIME APPROVAL OF THESE NEW HIGH-OCTANE COUNTER CARDS.



In full colors, varnished for extra brilliancy, the cards have a fast-getaway that draws the customer's eye. Also, they feature the service you sell, not just the tubes! Supplied with built-in folding easel mounts.

ASK YOUR KEN-RAD DISTRIBUTOR TO DESCRIBE THE MANY OTHER SALES AIDS AVAILABLE!

**The Serviceman's Tube**

102 H43

RADIO · TELEVISION · ELECTRONIC  
**SERVICE**

**LEWIS WINNER**  
Editorial Director

**F. WALEN**  
Assistant Editor

**ALFRED A. GHIRARDI**  
Advisory Editor

	Page
Aligning the TV Receiver for Fringe Area Reception. By J. F. Bigelow	10
Association News	21
Ser-Cuits (TV Receivers and Test Equipment)	16
Servicing Helps. By P. M. Randolph	24
Ten Years Ago in Associations	38
The Harrisburg Preventive Maintenance Campaign	9
Tube News (Ballast Tubes). By L. E. Stewart	14
20-Tube 12½" TV Model (Cover). By Walter H. Buchsbaum	12
TV Receiver Visual Alignment Techniques. By Lester L. Libby	26
TV Receiver Production Changes. By Donald Phillips	27
Views and News. By Lewis Winner	9

**CIRCUITS**

Ballast Tube Circuits	15
G. E. 810, 811 and 814 Video Output Circuits	27
Supreme 660 TV Scope	18
Vision Research 20-20 TV Model (Cover)	13
Westinghouse H196 TV Set	17

**COVER**

20-Tube 12½" TV Model (Vision Research 20-20)	12
---	----

**SERVICING HELPS**

Capacitor Checker	25
TV Installation Hints	24

**TV RECEIVER PRODUCTION CHANGES**

Changes Required Where Stubs Are Used	27
Modifications in G. E. 811, 814, 820, 830 and 835 Models to Curb Audio IF Regeneration	27
Production Changes in G. E. 810, 811 and 814 Receivers to Remove Buzzing Sounds, and Eliminate Wiggle and Vertical Retrace Lines	27

Index to Advertisers	48
----------------------	----

**Manufacturers**

New Parts and Accessories	42
New TV Parts . . . Accessories	40
News	46
Jots and Flashes	48

*Entire contents Copyright 1949, Bryan Davis Publishing Co., Inc.*



Published monthly by Bryan Davis Publishing Co., Inc.  
52 Vanderbilt Avenue, New York 17, N. Y. Telephone MURray Hill 4-0170



Bryan S. Davis, President      Paul S. Weil, Vice-Pres., Gen. Mgr.      F. Walen, Secretary      A. Goebel, Circulation Manager

Cleveland Representative: James C. Munn, 2255 Delaware Dr., Cleveland 6, Ohio. Telephone: ERIEview 1726

Pacific Coast Representative: Brand & Brand, 1052 W. Sixth St., Los Angeles 14, Calif. Telephone: MICHigan 1782  
Suite 1204, Russ Building, San Francisco 4, Calif. Telephone: SUTter 1-2251

Entered as second-class matter June 14, 1932, at the Post Office at New York, N. Y., under the Act of March 3, 1879. Subscription price: \$2.00 per year in the United States of America and Canada; 25 cents per copy. \$3.00 per year in foreign countries; 35 cents per copy.



# PHOTOFACT Publications

## The Books that Help You

SAVE TIME

EARN MORE

SAVE WORK

LEARN MORE

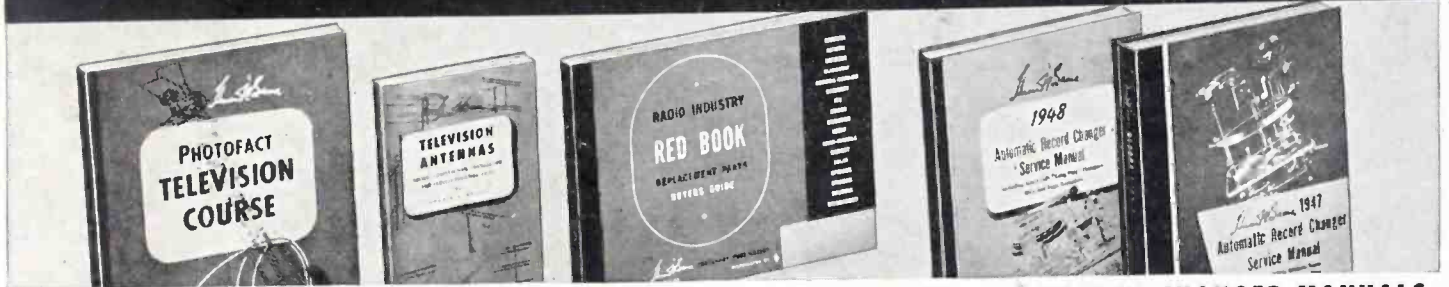

### NEW TELEVISION BOOKS

### THE RED BOOK

### RECORD CHANGER MANUALS

#### TELEVISION COURSE

Gives you a clear, complete understanding of TV principles, operation and practice. Covers: Beam Formation and Control; Beam Deflection Systems; Beam Modulation and Synchronization. Full analysis of the Cathode Ray tube, voltage supplies, control functions, antenna circuits, RF and IF systems, AGC, video amplification, contrast, etc. 216 pages; 8½ x 11"; profusely illustrated; sturdily bound. **\$3.00** Only.

#### TELEVISION ANTENNAS

All you need to know about TV antennas. Written by Donald A. Nelson; based on actual field experience. Shows you how to select antenna, how to install it, how to solve troubles. Many short-cuts help you save time and earn more. Chapters cover: antenna principles; construction; analysis of all types of commercial units; installation data; problems and trouble-shooting. 192 pages; 124 illustrations. **\$1.25** Only.

Tells you in *one* volume all you need to know about replacement parts for 17,000 receivers made from 1938 to 1948. Eliminates wasteful hunting through dozens of incomplete manuals. Includes full, accurate listings of all 9 major replacement components; lists correct replacement parts made by 17 leading manufacturers. Gives original parts numbers, proper replacements and valuable installation notes on: Capacitors, transformers, controls, I.F.'s, speakers, vibrators, phono-cartridges, tube and dial-light data, battery replacement data. 448 pages; 8½ x 11"; sewed binding. **\$3.95** Only.

**Volume 2, 1948.** Covers 45 models made in 1948, including new LP and dual-speed changers, plus leading wire and tape recorders. Complete accurate data—based on actual analysis of the equipment. Gives full change cycle data, adjustment information, needle landing data, hints and kinks, parts lists, exclusive "exploded" diagrams. A time-saving, money-making book. Over 400 pages; 8½ x 11"; deluxe bound. **\$6.75** Only.

**Volume 1, 1947.** Covers over 40 different post-war models up to 1948. Includes full, hard-to-get data on leading wire, ribbon, tape and paper disc recorders. 400 pages; fully illustrated; 8½ x 11"; hard binding. **\$4.95** Only.



### SPECIALIZED SERVICE DATA VOLUMES

### "MUSTS" FOR EVERY SERVICE BENCH

**Post-War Auto Radios.** Covers everything you need to know on over 100 post-war models (practically every auto radio made since 1946); represents the products of 24 different manufacturers. Makes auto radio servicing easy. Over 360 pages; profusely illustrated; each model treated uniformly, completely, accurately—based on actual study of the equipment. Sturdy binding; 8½ x 11". **\$4.95** Only.

**Post-War Audio Amplifiers.** Invaluable data for custom-builders, audio men and sound engineers. Covers a wide variety of well-known audio amplifiers and FM and AM tuners, plus data on important wire and tape recorders. Presents a complete analysis of each unit. A "must" for all sound men and custom installers. 352 pages; 8½ x 11"; sturdy binding. **\$3.95** Only.

**Post-War Communications Receivers.** Complete technical analysis of more than 50 of the most popular communications sets on the market. An invaluable service aid, a perfect buying guide for purchasers of communications receivers. All data is accurate and authoritative, based on actual examination and study of each unit. 264 pages; profusely illustrated; 8½ x 11"; durably bound. **\$3.00** Only.

**Radio Receiver Tube Placement Guide.** Shows you exactly where to replace each tube in 5300 radio models, covering 1938 to 1947 receivers. Clear, accurate diagram for each tube layout. Saves time—eliminates risky hit-or-miss methods, especially where tubes have been removed from the set. Indispensable in the shop or on calls. 192 pages. **\$1.25** Only.

**Dial Cord Stringing Guide.** The book that shows you the *one right way* to string a dial cord. Here, in one handy pocket-sized book, are all available dial cord diagrams covering over 2300 receivers; 1938 through 1946. Makes dial cord restringing jobs quick and easy. Nothing like it. Order copies today for your tool kit and shop bench. **\$1.00** Only.

**NEW PAY-AS-YOU-PROFIT PLAN**  
brings you PHOTOFACT Service Data

NOW—you can easily own the world's finest radio service data—the complete PHOTOFACT Library of volumes, plus continuous PHOTOFACT Folder Set Service! Your Jobber has all the details of an amazing new purchase plan—no interest—no carrying charges to pay! Offer limited—don't miss it . . .

**ASK YOUR JOBBER TODAY**

**COMING SOON!** "Telefile"—a new kind of Television Service Data covering practically every TV set now on the market. Absolutely unbeatable for completeness, accuracy, and time-saving use. At your Jobber soon!

"The Recording and Reproduction of Sound." A complete authoritative treatment of the entire subject of Sound, written by Oliver Read, editor of *Radio News*. Watch for it!

**HOWARD W. SAMS & CO., INC.**  
INDIANAPOLIS 7, INDIANA



# ONE OF THESE 5 WILL BEST FILL YOUR V.O.M. REQUIREMENTS

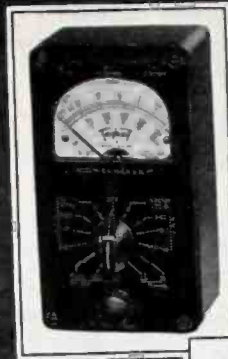

MODEL NO.  
630

MODEL NO.  
666-HH

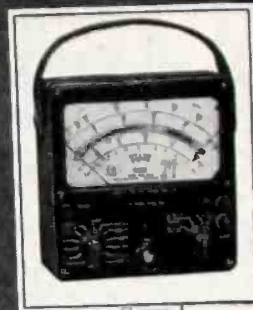

MODEL NO.  
625-NA

MODEL NO.  
2451

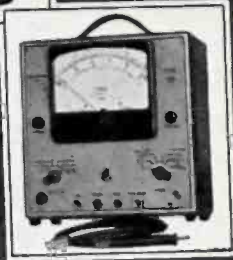

MODEL NO.  
2405-A



**MODEL 630.** Outstanding Features: (1) The new Triplett Molded Selector Switch with contacts fully enclosed . . . (2) Has Unit Construction with Resistor Shunts, Rectifier Batteries in molded base . . . (3) Provides direct connections without cabling . . . no chance for shorts . . . (4) Big easily read 5 1/2" Red • Dot Lifetime Guaranteed Meter.

#### TECH DATA

D.C. VOLTS: 0-3-12-60-300-1200-6000, at 20,000 Ohms/Volt  
 A.C. VOLTS: 0-3-12-60-300-1200-6000, at 5,000 Ohms/Volt  
 D.C. MICROAMPERES: 0-60, at 250 Millivolts  
 D.C. MILLIAMPERES: 0-1.2-12-120, at 250 Millivolts  
 D.C. AMPERES: 0-12, at 250 Millivolts  
 OHMS: 0-1000-10,000; 4.4 Ohms at center scale on 1000 scale; 44 Ohms center scale on 10,000 range.  
 MEGOHMS: 0-1-100 (4400-440,000 at center scale).  
 DECIBELS: -30 to -4, -16, -30, -44, -56, -70.  
 OUTPUT: Condenser in series with A.C. Volt ranges.

**MODEL 630.** . . . U.S.A. Dealer net price . . . \$37.50  
 Leather Carrying Case, \$5.75. . . Adapter Probe for TV and High Voltage Extra.

**MODEL 666-HH.** This is a pocket-size tester that is a marvel of compactness, and provides a complete miniature laboratory for D.C. and A.C. voltages, Direct Current and Resistance analyses. Equally at home in the laboratory, on the work bench or in the field . . . its versatility has labeled it the tester with a thousand uses . . . housed in molded case . . .

#### TECH DATA

D.C. VOLTS: 0-10-50-250-1000-5000, at 1,000 Ohms/Volt  
 A.C. VOLTS: 0-10-50-250-1000-5000, at 1,000 Ohms/Volt  
 D.C. MILLIAMPERES: 0-10-100-500, at 250 Millivolts  
 OHMS: 0-2,000-400,000, (12-2400 at center scale)

**MODEL 666-HH.** . . . U.S.A. Dealer Net Price . . . \$22.00  
 Leather Carrying Case, \$4.75.

**MODEL 625-NA.** This is the widest range laboratory-type instrument with long 5.6" mirrored scale to reduce parallax. Special film resistors provide greater stability on all ranges. Completely insulated molded case. Built by Triplett over a long period of time, it has thoroughly proved itself in laboratories all over the world.

#### TECH DATA

SIX D.C. VOLTS: 0-1.25-5-25-125-500-2500, at 20,000 Ohms/Volt  
 SIX D.C. VOLTS: 0-2.5-10-50-250-1000-5000, at 10,000 Ohms/Volt  
 SIX A.C. VOLTS: 0-2.5-10-50-250-1000-5000, at 10,000 Ohms/Volt  
 D.C. MICROAMPERES: 0-50, at 250 Millivolts  
 D.C. MILLIAMPERES: 0-1-10-100-1000, at 250 Millivolts  
 D.C. AMPERES: 0-10, at 250 Millivolts

OHMS: 0-2000-200,000, (12-1200 at center scale)  
 MEGOHMS: 0-40, (240,000 at center scale)  
 SIX DECIBELS RANGES: -30 +3.0, +15, +29, +43, +55, +69.  
 (Reference level "O" DB at 1.73 V. on 500-Ohm line.)  
 Six Output on A.C. Volts ranges.

**MODEL 625-NA.** . . . U.S.A. Dealer Net Price . . . \$45.00  
 Carrying Case, \$5.50. Accessories available on special order for extending ranges.

**MODEL 2405-A.** This instrument combines ultra sensitivity with a large 5 3/4" scale meter and is housed in a rugged metal case. . . It is furnished with hinged cover so that it can be used for service bench work or for portable field service. Gives A.C. Amperes readings to 10 Amps.

#### TECH DATA

D.C. VOLTS: 0-10-50-250-500-1000, at 20,000 Ohms/Volt  
 D.C. AMPERES: 0-10, at 250 Millivolts  
 D.C. MILLIAMPERES: 0-1-10-50-250, at 250 Millivolts  
 D.C. MICROAMPERES: 0-50, at 250 Millivolts  
 A.C. VOLTS: 0-10-50-250-500-1000 at 1000 Ohms/Volt  
 A.C. AMPERES: 0-0.5-1.5-10, at 1 Volt-Ampere  
 OHM-MEGOHMS: 0-4000-40,000 ohms—0-4-40 megohms (self-contained batteries)  
 OUTPUT: Condenser in series with A.C. Volt ranges  
 DECIBELS: -10 to +15, +29, +43, +49, +55. (Reference level "O" DB at 1.73 V. on 500-ohm line.)  
 CONDENSER TEST: Capacity check of paper condensers is possible by following data in instruction book.

**MODEL 2405-A.** . . . U.S.A. Dealer Net Price . . . \$59.75

**MODEL 2451.** Electronic Volt-Ohm-Mil-Ammeter . . . is easy to use in complicated testing . . . A must in F.M. and TV work in any sensitive circuit where low current drain is a factor . . .

#### TECH DATA

D.C.-A.C.-A.F. VOLTS: 0-2.5-10-50-250-500-1000  
 R.F. VOLTS: 0-2.5-10-50  
 D.C. MILLIAMPERES: 0-2.5-10-50-250-500-1000  
 OHMS: 0-1K-10K-100K  
 MEGOHMS: 0-1-10-100  
 INPUT IMPEDANCE: 11 Megohms on D.C. Volts.  
 4.8 Megohms on A.C.-R.F. Volts

**MODEL 2451.** . . . U.S.A. Dealer Net Price . . . \$76.50  
 External high-voltage probe available on special order. See the Triplett V.O.M. line at your local Radio Parts Distributor or write

**TRIPLETT ELECTRICAL INSTRUMENT COMPANY • BLUFFTON, OHIO, U.S.A.**

In Canada: Triplett Instruments of Canada, Georgetown, Ontario

*Precision first... to Last*





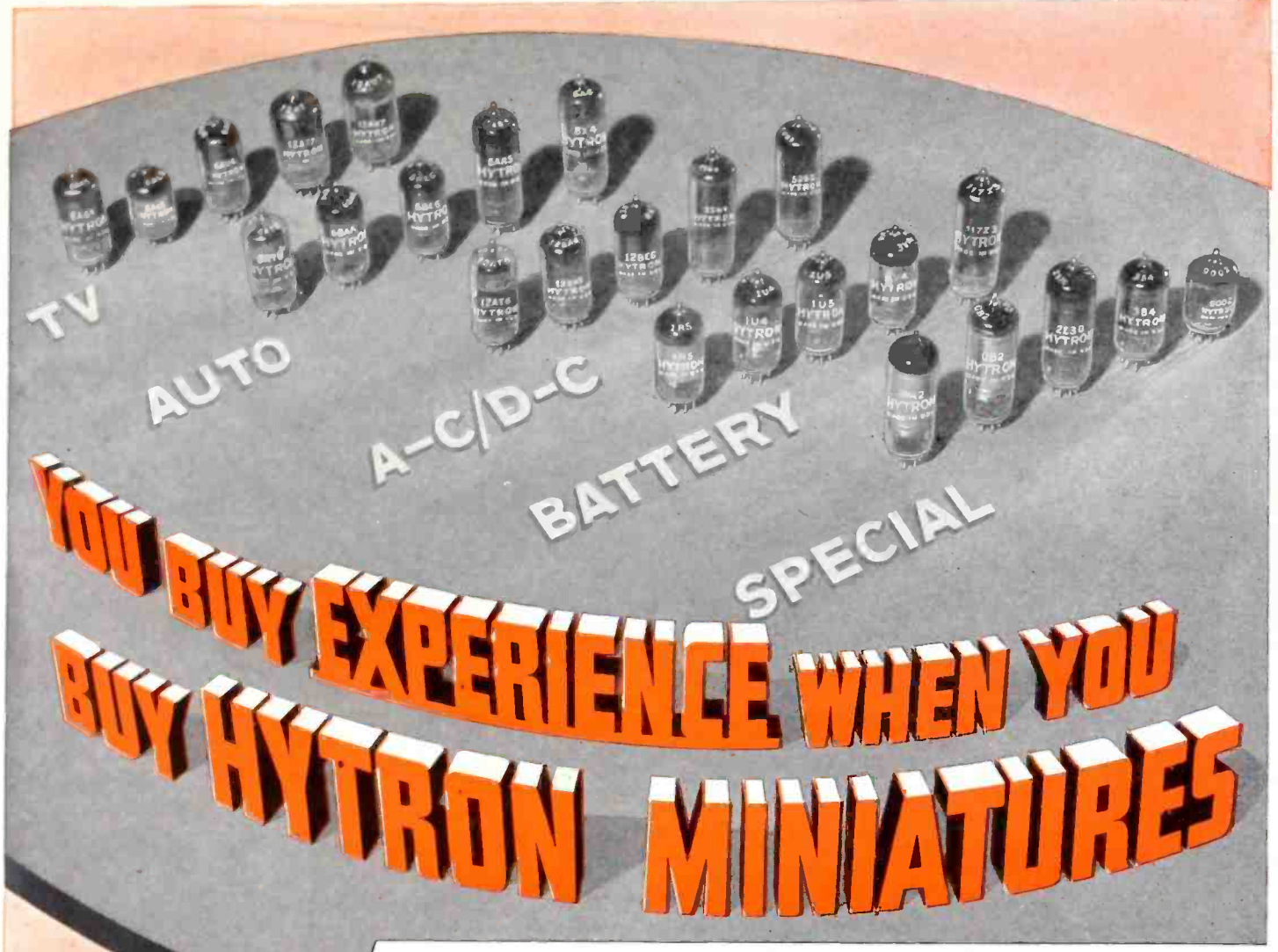

TV

AUTO

A-C/D-C

BATTERY

SPECIAL

**YOU BUY EXPERIENCE WHEN YOU BUY HYTRON MINIATURES**

AS YOU CAN READILY IMAGINE, these little fellows are tough to make—and make right—because they are so darned tiny. A heck of a lot of *experience* is a must.

Hytron has it. First to telescope standard glass tubes to Bantam GT size. First to originate the subminiature. First to make even subminiatures tinier. First to build the smallest subminiature used in the wartime proximity fuse.

With this background in making 'em *small*, Hytron manufactured millions of wartime miniatures like the 6AK5, 9001, 9002. Quite naturally, it began to originate miniatures too. Some of the more famous: 6AR5, OB2, 2E30. Hytron also originated the first and only Reference Guide (now in its third edition) for *all* miniatures, regardless of make. Yes, when you buy Hytron miniatures, you buy the most valuable advantage any manufacturer can offer you. *Experience*.

SPECIALISTS IN RADIO RECEIVING TUBES SINCE 1921

**HYTRON**  
RADIO AND ELECTRONICS CORP.

MAIN OFFICE: SALEM, MASSACHUSETTS





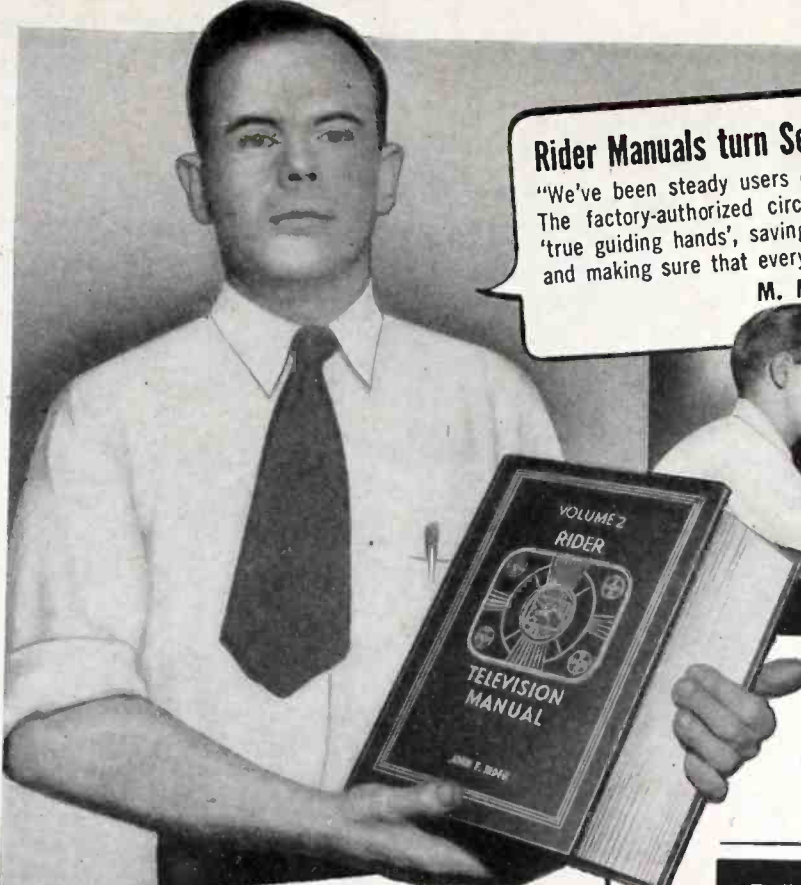

**Rider Manuals turn Servicing Problems into Servicing Profits**  
 "We've been steady users of Rider Manuals ever since we got the first one. The factory-authorized circuits and data on radio servicing have acted as 'true guiding hands', saving us time, enabling us to get at problems quickly, and making sure that every job we handle 'stays sold'."  
**M. M. HENLEY, Service Mgr., May Electric Appliance, 61 Fox Street, Aurora, Illinois**

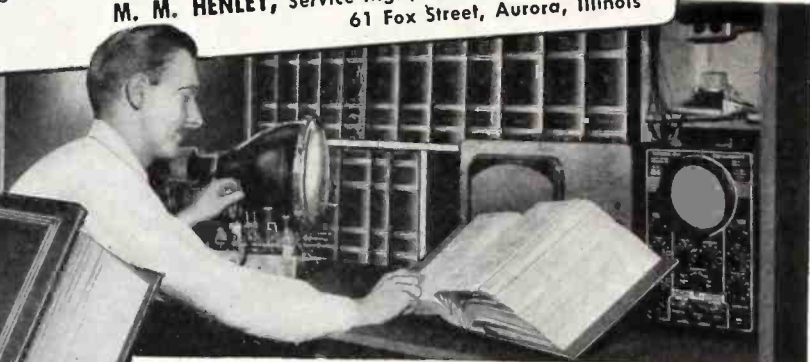

**20 YEARS OF LEADERSHIP IN  
 FACTORY-AUTHORIZED SERVICING INFORMATION**  
**Authentic, Official, Reliable!**

**RIDER RADIO MANUALS**  
**RIDER TV MANUALS**  
**RIDER PUBLIC ADDRESS MANUALS**

**Available Now! VOLUME XVIII**



2036 pages PLUS "How It Works" Book and Cumulative Index of VOLUMES XVI, XVII, XVIII. Covers products of 110 manufacturers up to January, 1949... AM-FM Auto Receivers and Record Changers. Complete . . . \$1980

**Available Now! VOLUME 2  
 Rider Television Manual**

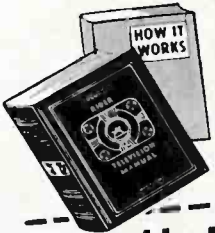

Equivalent of 2300 pages PLUS Cumulative Index Covering TV Volumes 1 and 2. Official, Authentic Service Data on Complete Receivers, Kits and Boosters from the Service Departments of 67 Manufacturers. Complete . . . \$18.00

**Available Now!  
 RIDER PA MANUAL**

The first industry-wide public address equipment manual, covering amplifier production of 147 manufacturers from 1938 to 1948. 2024 pages PLUS "How It Works" Book. Complete . . . \$1800

**Coming Soon! VOLUME XIX  
 RIDER MANUAL**

With the issuance of Volume XIX, we will have released to the radio servicing industry the world over approximately 31,000 pages of factory-authorized information. More than 100 manufacturers; more than 2100 pages. Available at your jobber late in May. **WATCH FOR IT!**

**Your Jobber Carries RIDER MANUALS  
 a Full Line of**

The world's greatest compilation of radio servicing information — direct from the manufacturers themselves. RIDER MANUALS are a "must" for Servicemen, Schools, Colleges, Public Libraries, Design and Development Laboratories!

**IMPORTANT NOTE!**

Are you receiving your copy of "Successful Servicing"? It's Rider's own publication of interest to every Serviceman. Send your name and address, and we'll put you on our list, FREE of charge.

**RIDER MANUALS**

Television Manual, Volume II	\$18.00 (plus "How It Works" and Index)
Television Manual, Volume I	18.00 (plus "How It Works" and Index)
Volume XVIII	19.80
Volume XVII	16.50
Volume XVI	8.40
Volume XV	19.80
Volume XIV to VII (each volume)	16.50
Volume VI	12.50
Abridged Manuals I to V (one volume)	19.80
Record Changers and Recorders	9.00
Master Index, Covering Manuals, Vols. I to XV	1.50

**RIDER MANUALS mean SUCCESSFUL SERVICING**

**JOHN F. RIDER, PUBLISHER, Inc.,**  
 480 Canal Street, New York 13, N. Y.  
 Export Agent: Rocke International Corp., 13 E. 40th St., N.Y.C. Cables, ARLAB.

NOTE: The Mallory Radio Service Encyclopedia, 6th edition, makes reference to only one source of radio receiver schematics — Rider Manuals.  
 ANOTHER NOTE: The C-D Capacitor Manual for Radio Servicing, 1948 edition No. 4, makes reference to only one source of receiver schematics—Rider Manuals.



Beanstalk? . . . No! But like the proverbial Beanstalk  
**RADIART SIMPLI-FLEX ANTENNA** *Sales*  
**HAVE** *Shot Up* **OVERNIGHT**

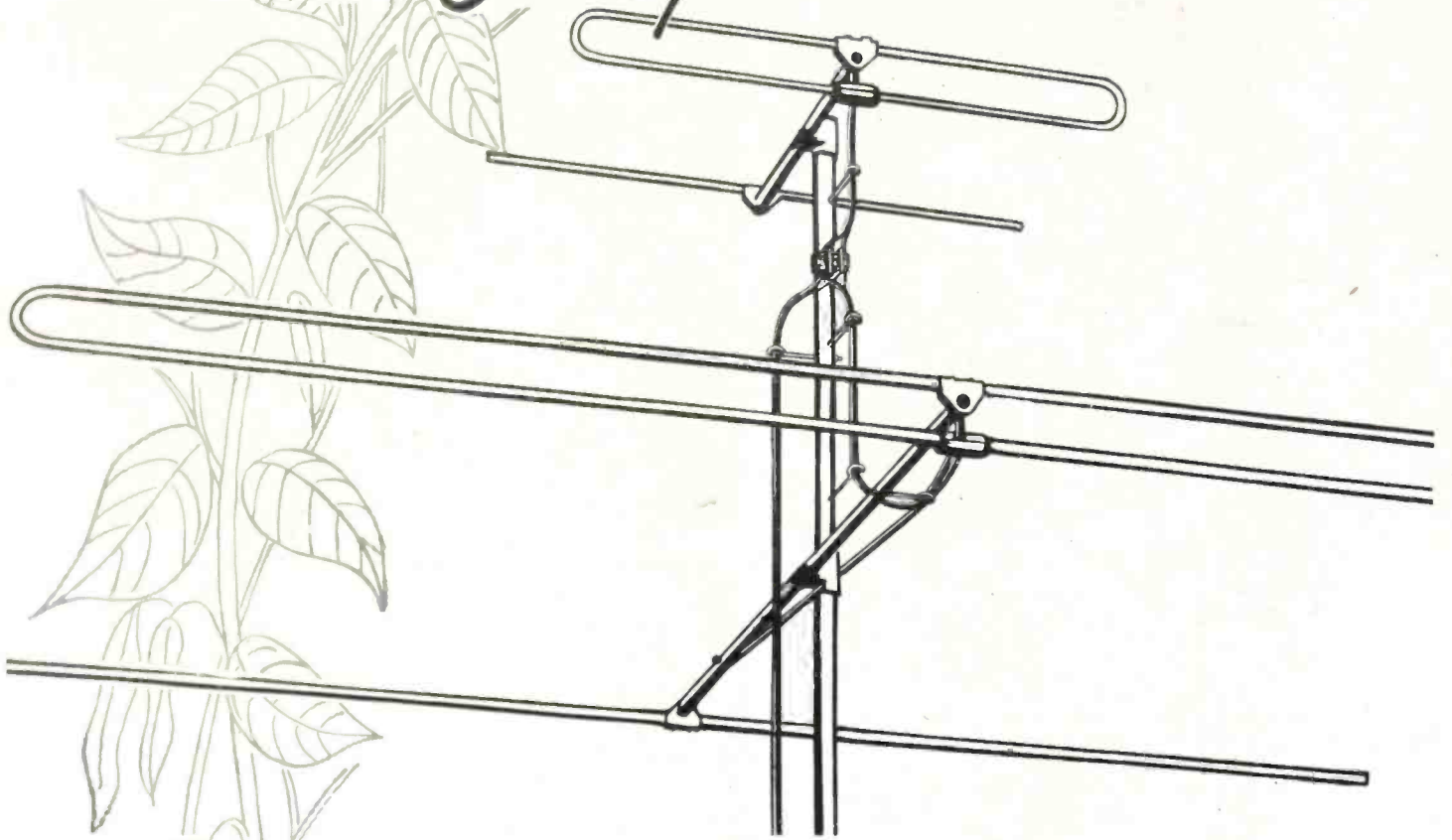

Wondering what all the excitement is all about? What is it that has shot up so quickly in demand? It's the RADIART line of SIMPLI-FLEX antennas! Practically overnight . . . *like the proverbial beanstalk . . . these antennas have grown and sky-rocketed in popularity and taken the country by storm!*

AND . . . the answer is simple enough . . . **ELECTRICALLY** . . . they out-perform all others—**MECHANICALLY** . . . they are easier to install, and more sturdy when installed!



IT'S RIGHT . . . WHEN IT'S RADIART

**THE RADIART CORPORATION**  
CLEVELAND 2, OHIO

Manufacturers of the Famous Red Seal Vibrators

Here's what  
radio men  
say about

# SYLVANIA'S DEALER CAMPAIGNS



TRY OUR RADIO SHOOTERS DEPENDABLE

**Mike's**  
RADIO AND TELEVISION SERVICE  
EXPERT SERVICE ON ALL MAKES

10308 WEST PICO  
LOS ANGELES, CAL.

PHONE: ARDMO

November 1, 1948

Advertising Department  
Sylvania Electric Products Inc.  
Emporium, Pa.

Gentlemen:

I would like this opportunity to tell you how much the Sylvania co-ordinated advertising campaign has helped my business.

Although I have used direct mail postal cards in the past for soliciting new business, the tie-in with national advertising offered in the Sylvania campaign was responsible for an extraordinary return. The response I have had from your campaign has been truly amazing.

As an example, I mailed 1000 postal cards in May at a cost to me of \$10.00. To date this investment has brought a return of \$352.19. During June, July and August I mailed another 1000 cards each month at a total cost of \$30.00. To date the return from this investment has amounted to \$760.46.

You will note that for a total investment of \$40.00 I have, to date, enjoyed an increase in business amounting to \$1,112.65 -- all from new customers. I can safely say that there is still more business to come from these cards in future months.

I mailed another 1000 cards to my prospect list of 12,964 names during October and November. I also expect to mail another 1000 cards during December.

Speaking for myself, I would certainly like to see this campaign become a regular 'shot in the arm' at least twice a year. It will do much to help business in the spring and early fall when business is usually slow.

Many thanks and best wishes.

Very truly yours  
MIKE'S RADIO SERVICE

By *Michael Waxman*  
Michael Waxman



BRING IN YOUR RADIO TUBES - WE TEST THEM FREE - DEALERS FOR Sylvania SEE TESTED TUBES

SCURLOCK'S RADIO SHOP  
ELECTRICAL APPLIANCES -- HARDWARE  
EVERYTHING PERTAINING TO RADIO  
SUMITON, ALABAMA

September 18, 1948

Advertising Department  
Sylvania Electric Products Inc.  
Emporium, Pa.

Gentlemen:

In 1937 when we started our radio repair business, we used personal postal cards to get our name before our prospective customers. For a beginner, this kind of advertising seemed a little more than we could pay, although it did wonders for our business.

We are happy that the service industry has a great company behind us with national advertising and personal postal cards. During your first co-ordinated advertising campaign we bought 1200 cards and mailed them to our customers according to Sylvania's specifications. The results were so effective that we are going to use the campaign again. We want to see if the campaign is really responsible for the extra business we are enjoying.

The "funny cards", as our customers call them, are even responsible for payment of some of our past due accounts. Our radio sales are up. We are making allowance for old radios which our customers get out for us to repair after receiving our atomic reminder card.

We want to personally thank Sylvania for taking an interest in us and giving us this low cost, yet effective, advertising.

VERY KINDLY YOURS  
*J. B. Scurlock*  
J. B. SCURLOCK

Like these service dealers you  
can increase your business

Sylvania's May, June, July and August campaigns are ready for you. Here's what you receive:

- 4 Postal Card Mailings—one for each month.
- 4 Window Displays—one for each month.
- 4 Window Streamers—one for each month.
- 8 Newspaper Ad Mats—two for each month.
- Radio Spot Announcements—several for each month.

Send for full details now! Remember, you pay only the postage on the government postal cards you mail. Sylvania supplies everything else free!

# SYLVANIA ELECTRIC

RADIO TUBES; CATHODE RAY TUBES; ELECTRONIC DEVICES; FLUORESCENT LAMPS, FIXTURES, WIRING DEVICES; PHOTOLAMPS; LIGHT BULBS

Sylvania Electric Products Inc.  
Advertising Department, R-1904  
Emporium, Pa.

Gentlemen: Send full information on your May, June, July and August Service Dealer Campaign

Name \_\_\_\_\_  
Company \_\_\_\_\_  
Address \_\_\_\_\_  
City \_\_\_\_\_ Zone \_\_\_\_\_  
State \_\_\_\_\_



RADIO · TELEVISION · ELECTRONIC  
**SERVICE**

### The Harrisburg Preventive Maintenance Campaign

PREVENTIVE MAINTENANCE, which has been praised on these pages on many occasions for the unusual business opportunities it affords to every Service Man and the unique public relations job it can do for the entire servicing industry, proved its worthiness during a recent test program in Harrisburg, Pennsylvania, under the sponsorship of the Mid-State Radio Servicemen's Association.

Selected as a trial point by the Federation of Radio Servicemen's Associations of Pennsylvania, to evaluate the possibilities of preventive maintenance programs, the Harrisburg guinea pig study disclosed that Service Men can step up their income substantially through this new approach. The records showed that the boys were able to increase their income from 25% to 30%.

Supported by direct mail, newspaper advertising and a spot broadcast announcement campaign, during a one-month period, the entire city became preventive maintenance conscious and responded enthusiastically. It was a common sight to see one or two receivers, a large percentage of which had been discarded because of a lack of parts, the war, or lack of confidence in Service Men, being brought in for repair. During calls to the home, many Service Men were asked to check up and repair as many as two or three receivers. The direct mail material, supplied by three national component manufacturers, included 10,000 blotters, 50,000 single sheet bulletins, 10,000 double postcards and thousands of imprinted window streamers, dummy tube cartons and giant size tube cartons.

Distributors and dealers also cooperated with a series of advertisements in the local papers carrying such messages as: "For radio preventive maintenance month—Don't neglect small symptoms in your radio, serious trouble can develop. A timely call to an expert technician will save you money in the long run. . . . Wise folks don't wait until they are flat on their backs before they see a doctor. Show the same wisdom with your radio—call your radio maintenance man. . . . If your radio needs service, call your radio maintenance man today. . . . If

you need service, contact your technician now."

MRSMA also participated in the advertising campaign with weekly listings of the members and copy stating: "For radio preventive maintenance see one of the following members of the Mid-State Radio Servicemen's Association." Among the members who participated in this campaign were: Beachley Radio, Fred W. Brown, T. L. Clarkson, Colonial Park Radio, Joe Cooper, George's Radio, George E. Hardy, Wayne E. Hite, Jay's Electronics, Jungman Electronics, Kline's Radio, Louer's Radio, William R. McCurdy, Megomell's, Schmidt's Electrical, L. B. Smith, Paul W. Smith and S. and W. Radio.

The effective nine-point MRSMA code of ethics, which also appeared in paid advertising served to stimulate interest in the campaign, the code revealing that MRSMA will: "Do the best possible work for every consumer; be honest and straightforward; use wherever practicable, original factory replacement parts; use only standard parts equal or superior in quality to the parts replaced; exercise special care in handling a customer's property; charge a fair and just price; guarantee parts and work for ninety days; refrain from unfair and unethical practices, misleading or untruthful advertising, unreasonable promises or statements, unjust or unfair criticisms of other Service Men or any conduct that might lead to lack of confidence in the MRSMA or any of its members; and furnish a standardized bill with each service job."

Regularly scheduled broadcasts over five stations also aided in bringing the preventive maintenance message to everyone in Harrisburg. One station, WHP, aired spots on Monday, Tuesday, Friday and Saturday and Sunday, with three announcements on Saturday and two on Sunday.

In an analysis of the results of the campaign, it was found that 65% of the receivers repaired were of prewar construction and 30% postwar. And in a review of the additional purchases made, it was found that 10% to 15% of the members purchased 35% more tubes, 15% more capacitors and 12% more controls; 20% to 30% of the

members bought 25% more tubes, 10% more capacitors and controls. From 40% to 60% of the members bought at least 20% more tubes and 10% more capacitors, with 5% of the purchases going for controls.

Not only did the campaign serve to bring an immediate increase in business, but pave the way for more contacts and a continued rise in income.

To MRSMA and FRSAP, we, and we are sure everyone, extend a rousing round of applause for their meritorious service, which reemphasized the virtues of preventive maintenance and the benefits which it offers to the consumer, Service Man, manufacturer, distributor, dealer, and the broadcasters, too, who were rewarded with not only an increased audience, but listeners who could now enjoy better listening, thanks to preventive maintenance.

### TV Servicing

THE INDEPENDENT SERVICE MAN is becoming a key factor in television servicing, according to a survey recently completed.

The study showed that there are about 1,500 service organizations now actively engaged in the installation and servicing of TV receivers and the possibilities are that these organizations will multiply more rapidly as the merits of decentralized and personalized service become more widely recognized.

Experts declared that there'll be a substantial growth of the smaller TV service groups to serve the many who appear to favor local service.

Clinics devoted to specialized TV training are increasing rapidly, too, the census indicated, with both basic and advanced courses being featured and sponsored by distributors and manufacturers. This move has proved its worth by not only providing a basic education, but serving as a refresher and in addition keeping the Service Man informed on the latest in developments and production changes.

It has been suggested that the idea of clinics be adopted on a national scale, with roving instructors serving as technical data liaisons between factory and the Service Man. A wise suggestion which should aid in the flow of information and accelerate both installation and service.—L. W.

# Aligning the TV Receiver

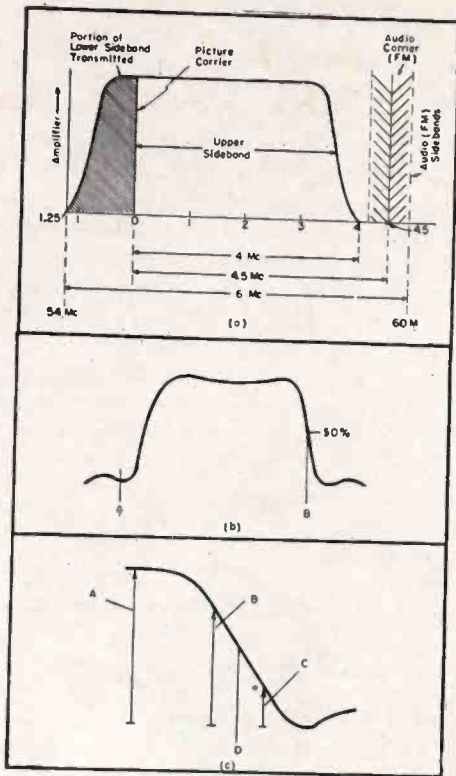
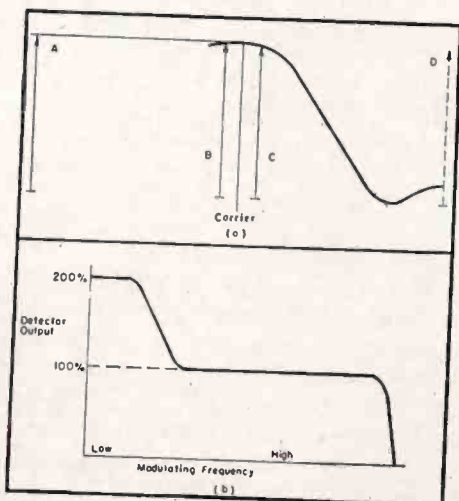

Fig. 1. Typical patterns which a properly aligned TV receiver exhibits. In (a) is the pattern of rf channel distribution. In (b) we have the video if amplifier passband; at A is the sound carrier and at B the video carrier. In (c) is an expanded view of the right-hand side of the plot shown in (b). In this plot at A is the typical high modulating frequency of the upper sideband (100%). At B we see the low modulating frequency at 75% of the upper sideband and in c is the same modulating frequency but for the lower sideband (25%).

Fig. 2. The effect of tuning the receiver's local oscillator so that the video carrier falls high on the if passband. In (a) we see the video carrier at the top of the passband; the upper sideband (hf) appears at A, upper sideband (lf) appears at B and the lower sidebands for lf and hf appear at C and D, respectively. Normal operation (dashed lines) and conditions of (a) shown in solid line are indicated in (b).



It is sometimes noted that, particularly in areas of low signal input, best picture and sound pickup do not occur simultaneously in TV reception. Upon the basis of this, it is usually contended that the receiver alignment is improper.

Actually the normal, properly-aligned television receiver exhibits such behavior for several reasons, as we can see from Fig. 1. In (a) of this illustration are represented the channel distribution of any television channel, showing that for low modulating frequency, there are two sidebands (upper and lower), while for high modulating frequencies there is but one, the higher (the lower one is cut off or attenuated at the transmitter). Now in (b) we have a typical video passband in the if amplifier with the video carrier at the 50% amplitude point, while the sound carrier is trapped out by sound traps. And in (c) we see that when the modulating frequency is low, the two sidebands contribute relative amplitude to total 100% detector output voltage. Also, the high-frequency sideband contributes 100%, and accordingly the detector output versus modulating frequency is a constant.

The effect of tuning the receiver's local oscillator so that the video carrier falls high on the if passband is illustrated in Fig. 2 (a). We note here that the lower modulating frequency signals appear in the detector output in increased magnitude, relative to those higher in frequency. Now, we see why such tuning produces an apparently better picture. Since the lower modulating frequencies were produced by the larger picture elements of the scene being telecast (and therefore reproduces the larger picture elements on the screen), these will appear in the picture to be accentuated or of greater brightness and contrast. Thus the picture appears to have more contrast and be brighter. That it is not actually a better picture is indicated by the fact that distortion is introduced; the larger picture elements have excessive contrast in comparison to the smaller elements.

In Fig. 3, we see that two conditions subscribe to the aforementioned effects: (1) The highest-frequency sidebands are outside the video if passband, and thus the fine image detail (resolution) has deteriorated (the pic-

ture has become brighter with large elements more evident but fine detail is lacking); (2) the sound carrier is no longer at the normal sound intermediate frequency, but it has moved outside the passband of the sound if passband and is no longer heard in the speaker.

## A Solution to the Problem

Normally, an attempt to increase the signal input is made by an adjustment to the antenna, or through the use of a more elaborate antenna array. A booster amplifier may help. However, if other measures fail, re-alignment can solve the problem and provide the best picture and sound simultaneously.

Analyzing (b) in Fig. 3, it appears that we could simply move the sound if amplifier and discriminator passband to the left, to meet the new sound intermediate frequency. Then, it would be necessary to also move the video if amplifier sound traps and (if they are used) adjacent channel traps. This may be done, but it is best not to tamper with the sound if and trap frequencies, and instead adjust the video if passband so that the carrier rides high, intentionally introducing distortion so that the picture appears to be brighter.

This adjustment is usually a simple one, often requiring the movement of not all of the slug or trimmer controls. Trap adjustments can be left untouched unless coupling between transformer and trap windings is so great that adjustment to the former seriously upsets the latter.

## Stagger-Tuned IF Adjustments

Fig. 4 illustrates the necessary adjustments required in the stagger-tuned if amplifier. Two curves, those at 21.8 and 22.3 mc, are moved to a higher frequency for the curve of (b) in this figure. By making this adjustment we not only increase the contrast in the larger picture elements, with a resultant loss of fine detail, but narrow the passband, resulting in reduced noise which produces grain or snow in the image. Also, the gain of the overall amplifier has been increased, possibly to twice its prior gain. It is possible, in fact, that the amplifier may oscillate under greatly increased gain



# for Fringe Area Reception

**Novel and Effective Aligning Techniques, Involving Adjustment of Video IF Passband, Provides An Apparently Brighter Picture and Simultaneous Improvement in Sound. Minimum of Bias also Recommended During Alignment. Method Also Provides for Adjustment of Sound IF Slugs Until Frequency Becomes Narrower.**

and that gain must be reduced somewhat.

### Setting the Bias

Most manufacturers state that in alignment there should be a certain fixed bias at the *if* amplifier grids. A typical value is -3 volts. This is because the tuning varies with change in bias.\* The effect of bias change in a typical amplifier is illustrated in Fig. 5. In fringe area reception, the bias is normally applied in low magnitude while receiving the picture; as much amplifier gain as possible is demanded. Therefore, it is well to align the receiver in such cases, with a minimum of bias so that alignment will be under typical operating conditions. Of course, such low-bias alignment may result in regeneration and possibly oscillation when the test equipment is connected in the circuit. Bonding between chassis of test equipment and receiver must be excellent, preferably

Fig. 3. Effect of tuning for the best picture. At (a) the normal tuning curve is shown and in (b) we have a plot of the video carrier up on the passband.

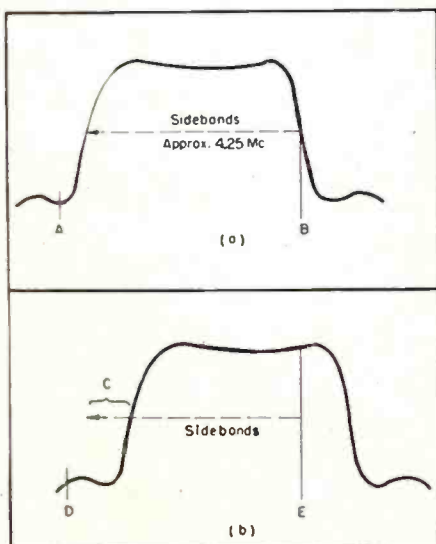

by **J. F. BIGELOW**

Director of Service Training  
The Magnavox Company

using a metal-topped workbench or a sheet of galvanized iron atop a wooden bench.

### Adjustments to the Sound Circuits

The sound *if* amplifier is characterized, usually, by a rather broad passband, somewhat double-peaked. This is to accommodate the frequency excursions of the frequency-modulated signal. If so, and if it be necessary to increase sound-signal sensitivity, this may be done by moving the slugs until the frequency response curve is sharper and narrower. This, of course, leads to sharper (more critical) tuning and possibly to some distortion. If, however, there must be a choice between intelligible sound and that which is unsatisfactory due to weak signal, the former is doubtless preferred. This increase is profitable up to the point, and slightly beyond, limiter saturation, when the background noise (AM) essentially disappears. The center of the curve should be at the manufacturer's stated sound intermediate frequency unless the sound *if* was changed according to the choice mentioned in connection with Fig. 3(b); leaving

\*Input capacity of a tube is  
 $C_i = C_{gk} + C_{g\text{supp}} + C_{gsc} + C_{gp}(1 + G)$   
where:  $g$  = control grid,  $k$  = cathode,  $\text{supp}$  = suppressor grid,  $\text{sc}$  = screen grid,  $p$  = plate and  $G$  = the gain of the amplifier. As gain varies with bias, input (tuning) capacity changes.

Fig. 4. Here we have an illustration of the necessary adjustments required in stagger tuned *if* amplifiers. At (a) is the original adjustment for a typical stagger tuned *if* system and in (b) we see how curves 1 and 2 have been modified for fringe-area reception.

the video *if* passband unchanged, and moving the sound circuits to accommodate a new sound *if*. In this case, the new sound *if* will be exactly 4.5 mc lower than the video carrier when that carrier is positioned at the top of the video *if* passband.

### The RF Amplifier

It may or may not be possible to realize any additional gain from the *rf* amplifier. In most receivers the passband over the entire channel range (2-13) varies between the double, overcoupled curve (a) of Fig. 6 to the single-peaked curve (b). If channels 13 and 6 are adjusted only, the rest of the channels then falling into line, it is probable that narrowing one channel will result in excessively narrow passband in one or more of the others. Should, however, the channels be tuned independently of the others, then a

(Continued on page 28)

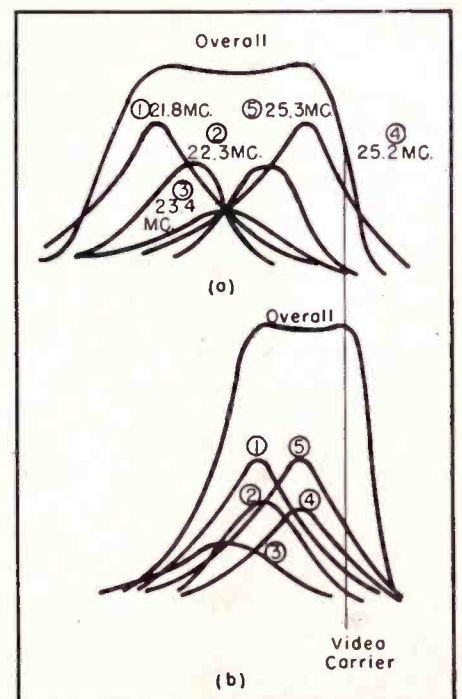

# 20-Tube 12 $\frac{1}{2}$ " TV Model

[See Front Cover]

by **WALTER H. BUCHSBAUM**

Chief Engineer

Vision Research Labs., Inc.

DIAGRAMED on the front cover, this month's the *rf* tuner of a 20-tube table model television receiver (Vision model 20-20) featuring a 12 $\frac{1}{2}$ " picture tube, type 12 TP4, with a beam-bender and magnetic deflection and focusing.

## The RF Tuner

Using a 300-ohm balanced input and a 6AU6 as an *rf* amplifier the *rf* circuit employs a double peaked *rf* response which is obtained through capacitive coupling on the high and additional inductive coupling for the low channels. The plate tuned circuit of the 6AU6 is coupled to the grid tuned circuit by a .82-mmfd capacitor. When the switch is in position for any of the low channels additional coupling is provided by the link which consists simply of a single turn of wire between the two coils. All high channels are aligned by adjusting a single series coil, while the low channels have to be aligned individually, starting with channel 6, and then going down in frequency. A 6J6 oscillator uses the now conventional push-pull circuit, and a separate inductance is switched into the circuit for each channel except that the channel 2 coil is in parallel with all others.

## IF Amplifier

Three stages and four stagger-tuned coils are used in the *if*. Alternating, the *if* coils are peaked to 34.45 and 37 mc respectively. This brings the sound *if* carrier to 32.8 mc, where it is trapped out by a series trap consisting of two capacitors ( $C_{33}$  and  $C_{30}$ ) and a slug tuned inductance in the grid circuit of the last *if* stage. The video *if* carrier must be about half way down at 37.3 mc, an arrangement which results in a strong enough beat between the picture and sound *if* carriers to produce the required 4.5 mc second sound *if*.

## Video Detector and Amplifier

The detector in this model is a crystal diode 1N34. Two stages of video

amplification are used, with a frequency-compensating network. This network is designed to give a peak at the higher video frequencies so as to compensate for any slight misalignment of the *rf* or *if* section, and still afford good resolution. The use of a 12AU7 in this circuit is somewhat novel, but since the tube capacities of this particular triode are rather small the usual objections against a triode; i.e., loading at the higher video frequencies do not hold. Grid leak *dc* restoration is used and a direct connection brings the picture signal to the picture-tube grid.

## Sound System

The 4.5-mc sound *if* is taken off the plate of the last video amplifier through a sharply tuned circuit in the grid of the 6AU6 sound *if* amplifier. A conventional ratio-detector circuit then removes the amplitude modulation and the *if* component. To align this ratio detector a 4.5-mc signal is fed in at the grid of the second video amplifier and the *vtrm* is first connected between ground and pin 2 of the 6AL5. The bottom slug is then adjusted for maximum *vtrm* reading, which should be about 2 to 4 volts negative. Then the *vtrm* is connected between ground and the junction of  $R_{10}$  and  $C_{22}$  and the top slug is tuned for zero at 4.5 mc.

A conventional audio amplifier using a 6AT6 as driver and a 6K6 as output tube feeds a 4 x 6 oval speaker.

## Sweep System

A single 6SN7 duo triode serves as vertical oscillator, discharge and output amplifier in a really condensed version of the usual two-tube circuit. The vertical hold control is part of a dual front panel adjustment, the vertical size and linearity controls both being mounted on the rear of the unit. When adjusting the height of the pic-

ture it is necessary to also adjust the vertical linearity.

A novel horizontal sweep and synchronizing system uses only one 6SN7 and 6BG6 output amplifier and yet permits a very effective *afc* for the horizontal sawtooth generator. A portion of the sweep output signal is fed back through  $R_{104}$  and  $C_{84}$  to the grid of the first half of the 6SN7 and the plate of the second half. When this feedback signal is out of phase with the incoming synchronizing pulses an error voltage is developed which corrects the oscillator frequency to conform with the incoming pulses. The blocking oscillator type sawtooth generating circuit uses a slug tuned transformer, which can be adjusted for the approximate horizontal sweep frequency. Another coarse adjustment is a trimmer,  $C_{60B}$ , while  $C_{60A}$  controls the sensitivity of the whole *afc* system. The horizontal drive control ( $C_{60C}$ ) is part of the triple trimmer assembly which is accessible at the rear of the chassis. To vary the horizontal sweep width without affecting the frequency a slug tuned width control coil is located inside the high voltage cover, but is adjustable with an alignment tool pushed through the proper slot.

## Contrast and AGC Network

One-half of a 6AL5 duo diode is used to rectify part of the video *if* signal for the *agc* voltage. This negative voltage is then applied through an isolating network to the *rf* amplifier and the first two *if* stages. The contrast control varies the voltage on the cathode of the *agc* diode and thereby determines the *agc* bias voltage. This arrangement permits very smooth and continuous contrast adjustment and also prevents overloading the receiver with strong signals. When the *agc* seems unable to overcome a very strong station, then the use of a 3 to 10-db attenuating network in the antenna lead-in is recommended. The contrast control may appear to overcome overloading, but spurious beats and generally unsatisfactory pictures

(Continued on page 29)



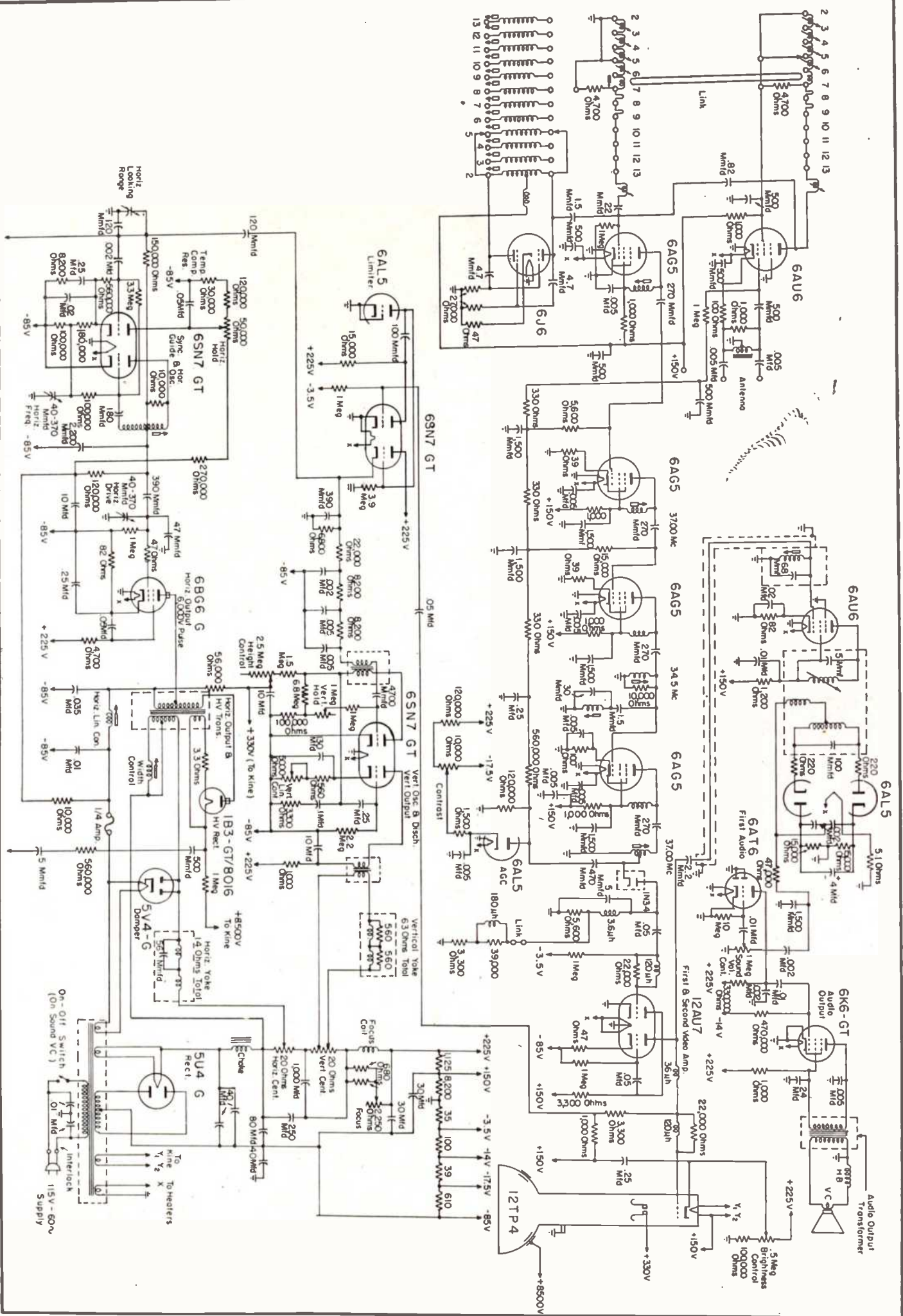

Circuit of the Vision Research model 20-20, shown in part, on the front cover.

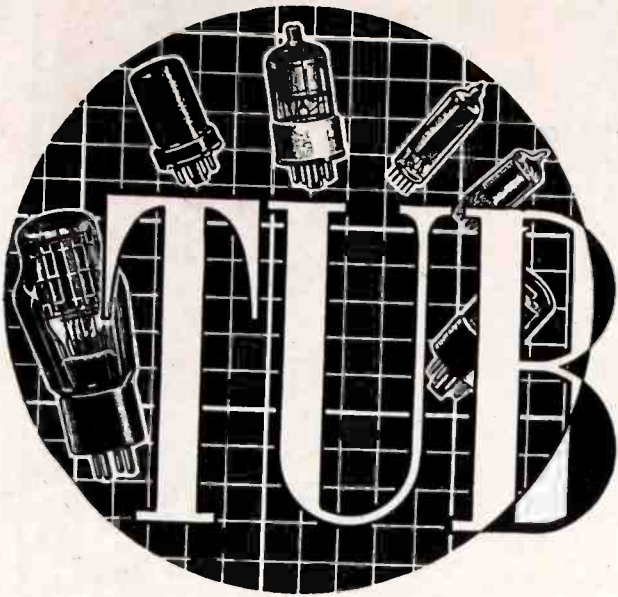

# TUBE

## News

---

### How Ballast Tubes Work . . . Circuits In Which They Operate Most Efficiently

---

A BALLAST TUBE, which is essentially a constant-current device, is a resistor whose resistance, at a certain critical temperature, varies with temperature so rapidly that, as the voltage across the tube varies, the current remains practically constant. The operation is the same on either alternating or direct current.

Most ballast tubes now manufactured have been designed for a specific application and, as a result have non-uniform ratings. Because of the wide range of voltage and current ratings possible, it has been practically impossible to produce a standard line. Ballast tubes may, however, be used in parallel or with shunting resistors across the load to increase or decrease the current rating, or with series resistors to increase the voltage rating.

#### **Ratings and Data**

In rating a ballast tube, the voltage range over which the current is nearly constant is supplied together with a maximum and minimum current. The upper limit of the voltage range is to be considered the maximum voltage at which the tube may be operated. Over the voltage range the current may vary two per cent above or below its average value. Therefore, considering change of current with life and any other factors which may

by **L. E. STEWART**

enter, the variation of current in a circuit using ballast tubes may be as much as five per cent above or below the average.

#### **Operation**

As the voltage across the filament in a ballast rises from zero, the resistance of the tube increases slowly in the same manner as most metals. As the lower end of the operating range is reached, the resistance of the filament increases quite rapidly with temperature, so that further increase in voltage causes practically no further increase in current. As the upper end of the operating range is reached, the resistance again becomes nearly constant. A still further increase in voltage causes an almost proportional increase in current.

This operation of the tube can be noted by observing the filament. As the voltage across the tube is increased from zero and approaches the lower end of the operating range, a small section in the middle of the filament will become red hot. As the voltage is increased further, the length of this red-hot section increases until the entire filament is visibly hot.

This represents the end of the operating range and any increase in voltage will overheat and damage the tube. Operating the tube above the upper limit of voltage will result in excessive expansion and contraction of the filament as the voltage varies; this will cause the wire to stretch out the coils of the filament or to knot, which will increase the current and speed up the destructive process already started, resulting, shortly, in a filament burn-out.

#### **Tube-Life Control**

If a steady voltage of a value in the middle of the operating range is applied to the tube continuously, its life will be tens of thousands of hours. Opening and closing the circuit with the resulting lengthening and shortening of the filament greatly reduces the life of the tube. If full voltage is applied to the tube, the circuit may be opened and closed only a few hundred times before the current is outside the limits or the filament is burned out. Thus the life of the tube will be determined entirely by its duty cycle.

#### **Tube Curves**

Because of the large thermal inertia of the tube, the temperature does



not reach its final value immediately when the circuit is closed or when the voltage changes. Since the cold resistance of the filament is quite low when the circuit is first closed, the initial current may be several times the final value.

After a few seconds, however, the current will have fallen to within 25 per cent of the final value, and from 15 seconds to several minutes, depending upon the size of the tube, will be required for the current to reach a steady state.

Three curves in Fig. 1 are presented to show the variation to be expected between tubes of a given rating. By choosing the proper coordinates, these curves are approximate for any ballast tube. Individual tubes may maintain the current to less than the range shown, but in any particular application variations up to plus or minus five per cent of the average may be expected.

### Application Circuits

The commonest use of the ballast tube is in series with the load.

When voltage is applied, the current which flows is determined by the intersection of the load and the tube characteristics. As the supply voltage varies the current remains practically constant. The load voltage remains practically constant because the tube voltage varies by an amount proportional to the supply-voltage variation. The tube used should have a voltage range equal to the variation in supply voltage.

### Inductive/Resistive Loads

A ballast tube may be used with inductive loads as well as with pure-resistance loads.

If it is necessary to use a tube whose current rating is too high or too low, either the load or the tube, as the case may be, may be bridged with a resistor to carry the excess or additional current.

The ballast tube also may be used to maintain constant current in a circuit requiring variation of the load.

Since the voltage across the ballast tube will vary with both the line voltage and load resistance (the potentiometer being considered part of the load) a greater voltage range will be required, and the ballast tube will use a greater percentage of power.

The minimum voltage across the ballast tube will occur with minimum supply voltage and with the load adjusted to the minimum point on a potentiometer in the control system. The

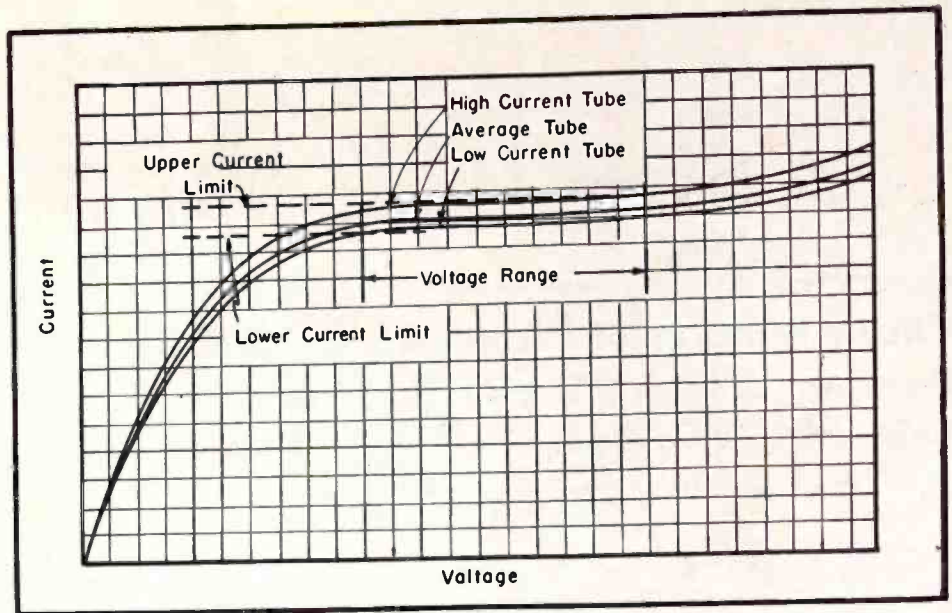

Fig. 1. Typical ballast-tube characteristics.

maximum voltage across the ballast tube will occur with the maximum supply voltage and with the load adjusted to the maximum point on the potentiometer. Since this circuit draws a constant current from the line, varying the potentiometer will not cause a variation in supply voltage to other apparatus on the line.

### Parallel Setups

Ballast tubes may be used in parallel provided their voltage ranges are equal or nearly so. If their voltage ranges are unequal, good ballasting will occur only over that part of the voltage range which is included by both tubes. The current for any voltage will be the sum of the currents in both tubes at that voltage.

### Series Arrangements

Ballast tubes cannot be used in series unless their current-voltage characteristics are identical. This will be noted by referring to Fig. 1. If two tubes, one having the maximum current and one the minimum for a particular rating, are used in series, the current will be the same in both tubes at all times. At the value at which the higher-current tube starts to ballast, the lower-current tube is operating above its ballasting range and hence is over-loaded. Thus, the safe operating range of the combination is only that of the lower current tube.

[Data courtesy General Electric electronics department.]

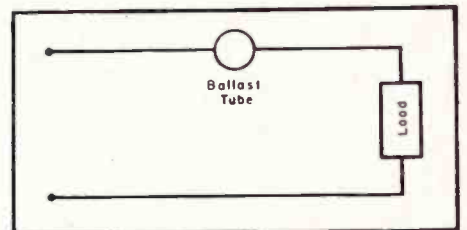

Fig. 2. Connection of ballast tube in ac or dc circuits.

Fig. 3. How to connect a ballast tube in a circuit using a transformer.

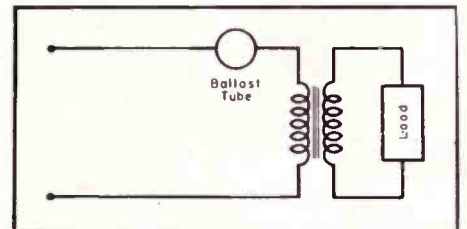

Fig. 4. A ballast tube in a circuit using too large a current.

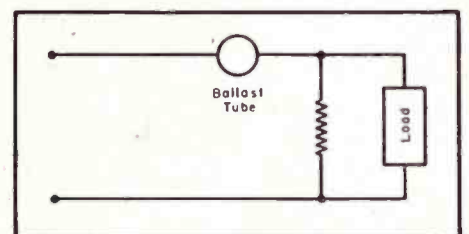
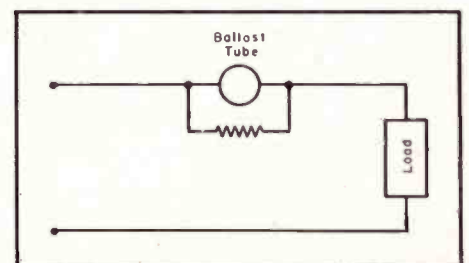

Fig. 5. Circuit with a ballast where the current is too small; this type of circuit is not recommended.



# SER-CUITS

## Circuit Features of Westinghouse H196 TV Model . . . Additional Analysis Data on Zenith Circular Screen TV Receivers . . . Circuit Highlights of Supreme TV 'Scope.

COMPACTNESS, fewer front-panel controls and circuit simplification are receiving detailed consideration in current TV receiver designs. An interesting example of this trend is the Westinghouse 28-tube model (H-196) diagramed in Fig. 1.

The *rf* unit in this model is constructed as a separate sub-assembly unit and consists of an *rf* amplifier, converter, and a high-frequency oscillator; *if* carrier is 26.1 mc and sound *if* carrier is 21.6 mc.

In the antenna circuit  $R_{50}$  and  $R_{60}$  (100,000-ohm units) provide a leakage path to ground for static or other electrical charges which may accumulate on the antenna and transmission line. A center-tapped, iron-core coil is used to provide a balanced input to the 6BH6 *rf* amplifier.  $L_{17}$  and  $L_{70}$ , small inductances connected in series across  $L_{10}$  on channels 7 to 13 inclusive, serve to increase the sensitivity of the *rf* amplifier on the high-frequency channels. These inductances are removed from the circuit on channels 2 to 6. The *rf* signal is fed from the antenna terminals to  $L_{30}$  by means of a pair of 220-mmfd coupling capacitors,  $C_{57}$  and  $C_{58}$ . A 750-ohm resistor ( $R_{135}$ ), in parallel with  $L_{30}$ , tends to provide a constant impedance (300 ohms) to the input of the *rf* amplifier. A 100-ohm cathode-bias resistor ( $R_{130}$ ) for the 6BH6, and 680-mmfd capacitor,  $C_{119}$ , are used to bypass the *rf* currents around  $R_{130}$ . Another 680-mmfd unit ( $C_{119}$ ) acts as an isolating capacitor to couple the *rf* signal to the 6BH6 control grid and to prevent loss of *agc* voltage.

The signal from the 6BH6 amplifier plate is coupled to a plate-load inductance by means of a 50-mmfd capacitor,  $C_{120}$ . Coupling between the plate-load inductance and the converter grid inductance is effected by means of a .68-mmfd capacitor ( $C_{130}$ ).

Further coupling is provided on the low-frequency channels by means of

1.5 and .47-mmfd capacitors ( $C_{124}$  and  $C_{125}$ ). The plate inductance ( $L_{38}$  to  $L_{40}$ ) and the converter grid inductance ( $L_{61}$  to  $L_{63}$ ) are similar and each consists of twelve small coils wired in series. As the channel selector switch is rotated toward the higher frequency channels, the inductance is progressively short-circuited, leaving only sufficient inductance to resonate the circuits at the frequency of the desired channel. The 6BH6 plate inductance and the 6AG5 converter grid inductance are separated electrically by means of a metal shield plate. A 4700-ohm resistor ( $R_{143}$ ) is used to increase the band-pass on the low-frequency channels.

The 6AG5 converter utilizes grid rectification of the oscillator injection voltage, fed through a 1-mmfd capacitor ( $C_{105}$ ) and the contact potential as operating bias. This bias voltage is developed across a 1-megohm resistor ( $R_{140}$ ).

The high-frequency oscillator utilizes a modified Colpitts circuit incorporating a 6C4 miniature triode tube. Unlike the *rf* circuit series inductances, separate oscillator coils are used for each channel. The proper oscillator coil is selected automatically when the channel selector switch is rotated. A 680-mmfd capacitor ( $C_{121}$ ) is used for *dc* blocking. A pair of 3-mmfd capacitors ( $C_{123}$  and  $C_{133}$ ) form the oscillator tank capacitance.  $L_{35}$ ,  $L_{70}$ , and two capacitors  $C_{123}$  (680 mmfd) and  $C_{33}$  (.005 mfd) are filament isolation chokes and *rf* bypass capacitors. These components prevent interaction and interstage oscillation in the *rf* circuits.  $R_{114}$  (1,000 ohms) and  $C_{113}$  (10 mfd) form a filter network to prevent hum modulation of the 6C4 oscillator, and  $C_{50}$  (680 mmfd) forms a low-impedance path for the *rf* currents to ground.

### The Input IF Amplifier

The 21.6 mc sound *if* and 26.1 mc picture *if* carriers which appear in the

plate circuit of the 6AG5 converter develop their respective voltage drops across  $L_{11}$  which is resonated at 22.3 mc. The signal voltages are then coupled to the control grid of the 6BH6 input *if* amplifier through a 270-mmfd capacitor,  $C_{43}$ . Inductively coupled to  $L_{11}$  is the adjacent channel sound trap  $L_{12}$ . The purpose of  $L_{12}$  is to remove the sound component from the next lower TV channel than the one on which the receiver is operating. This trap must be accurately tuned 6 mc higher than the accompanying sound channel or to 27.6 mc. Both  $L_{11}$  and  $L_{12}$  are slug-tuned coils,  $L_{12}$  being shunted by a small fixed capacitor ( $C_7$ ) and an 8,200-ohm resistor ( $R_{76}$ ). The purpose of this 8,200-ohm unit is to reduce the  $Q$  of  $L_{12}$ .  $L_7$  and  $C_{17}$  (.005 mfd) are the filament isolation choke and bypass capacitor.

$L_{13}$  is resonated at 25.9 mc. and functions as the plate load impedance for the 6BH6 input *if* amplifier. A 2,200-ohm resistor ( $R_{61}$ ) is connected in series with  $L_{13}$  and  $B+$  return. Across this resistor is developed the 21.6 mc sound *if* carrier voltage which is fed from the junction of  $L_{13}$  and  $R_{61}$  to a capacitance voltage divider network across the first sound *if* input inductance,  $L_1$ .

### Sound IF Amplifier

The sound section consists of a 6BJ6 first sound *if*, 6BH6 second sound *if*, 6T8 ratio detector and first *af* amplifier, and a 6AQ5 audio output.

The sound carrier is fed to the circuit across a 470-mmfd capacitor ( $C_{30}$ ) to avoid lowering the  $Q$  of the resonant circuit ( $L_1$ ,  $C_1$ , and  $C_{30}$ ). To prevent changes in the 6BJ6 input capacitance on strong signals, the cathode bias resistor (100 ohms)  $R_{105}$  is not bypassed.

From the plate of the 6BJ6 first sound *if* amplifier, the 21.6 mc signal

(Continued on page 18)



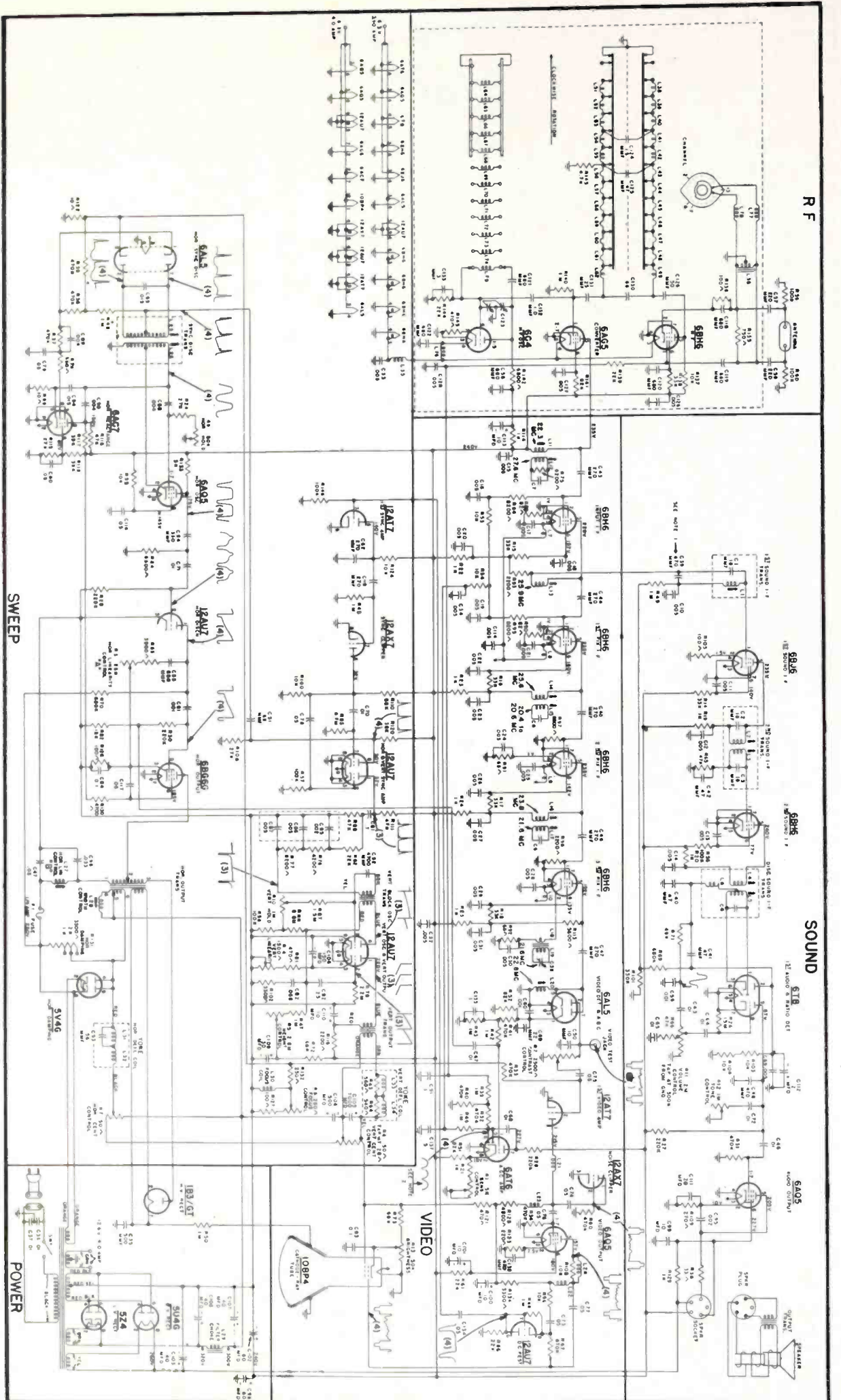

R F

SOUND

VIDEO

SWEEP

POWER

Fig. 1. Circuit of the Westinghouse H196 TV receiver.

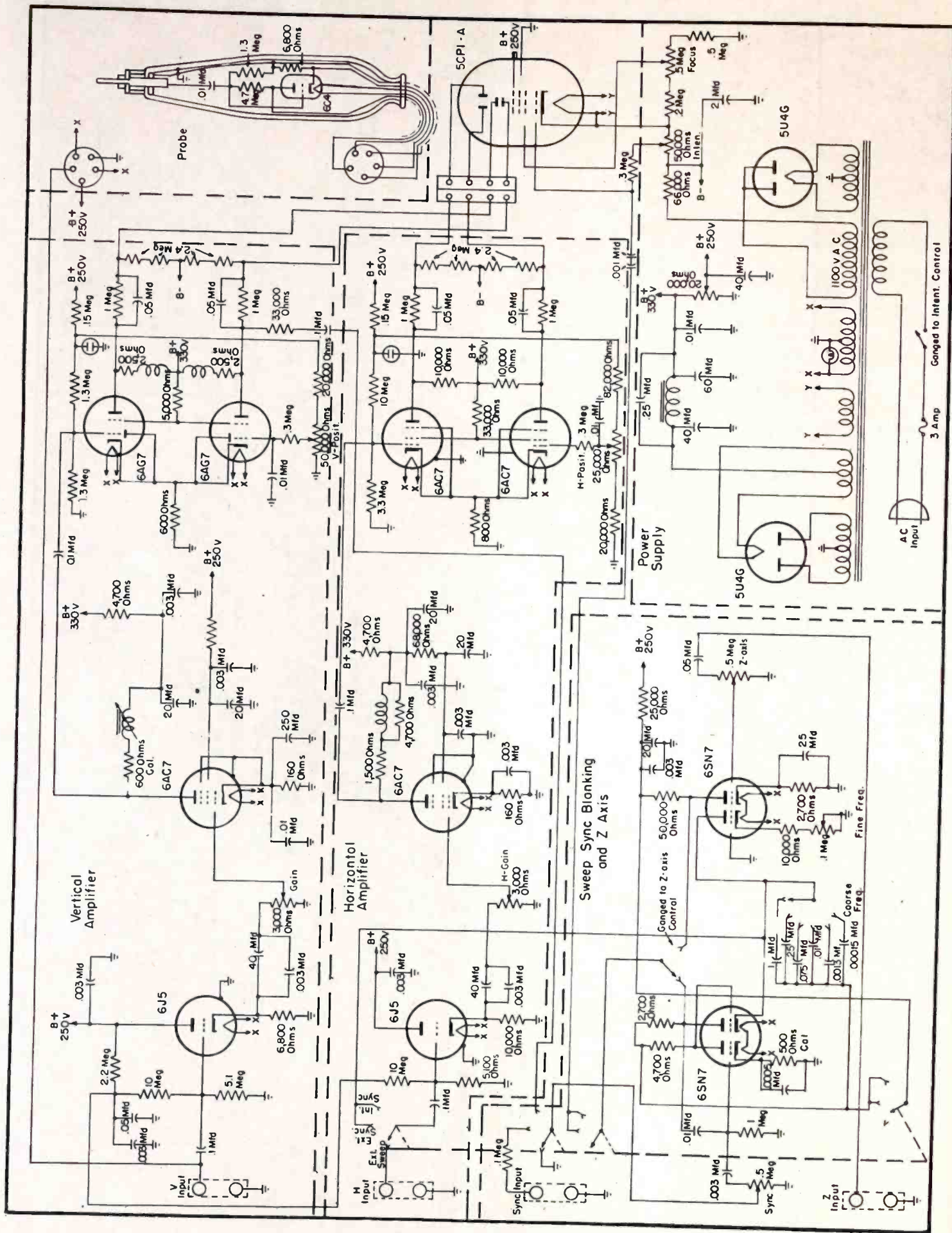

Fig. 2. Circuit of the Supreme 660 TV scope. (See page 37 for circuit analysis.)

is fed to the primary  $L_2$  of the second sound if transformer. Connected across

$L_2$  is an 18-mmfd fixed capacitor,  $C_2$ .  $L_2$  is resonated to 21.6 mc by adjust-

ment of an iron slug. The cold end of  
(Continued on page 30)



PERFORMANCE-ENGINEERED AT ELECTRONICS PARK



# SMALL-SIZE SPEAKERS

**That Talk in Terms of  
GREATER SERVICE SATISFACTION  
To 65% of Your Trade!  
Because they deliver more—**

**POWER  
SENSITIVITY  
FIDELITY**

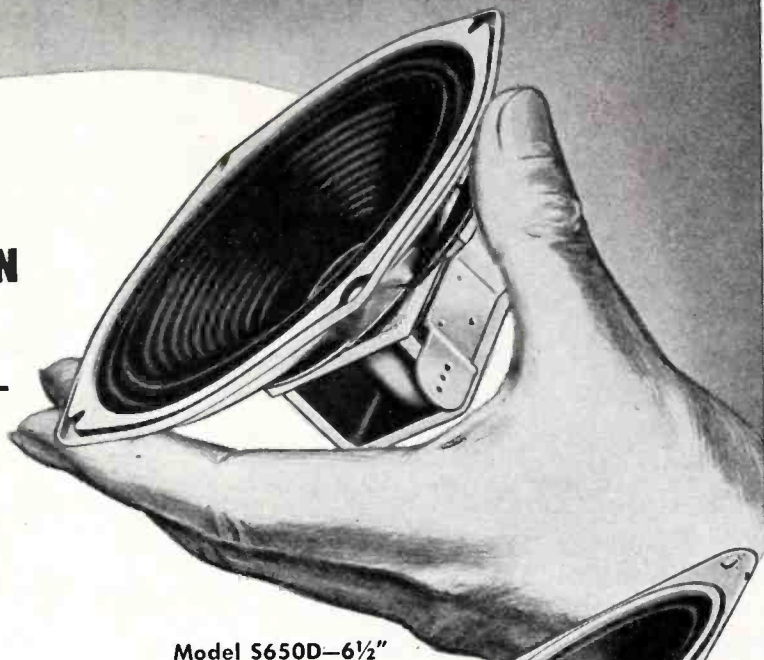

Model S650D-6 1/2"

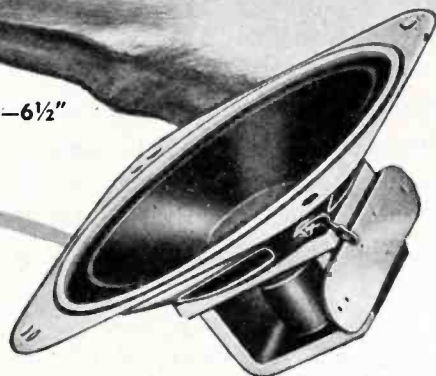

Model S525D-5 1/4"

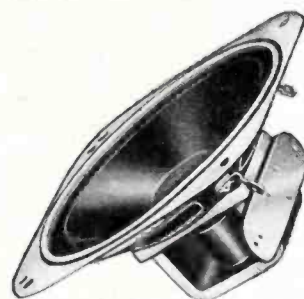

Model S400D-4"

A RECENT SURVEY shows that 65% of all speaker service requirements are on sets using 4 to 6 inch speakers! Remember—even the smallest General Electric speaker is rated at 4 watts... General Electric speakers, with sturdy all-weld construction, give you higher sensitivity because each G-E Alnico 5 magnet is fixed so firmly in the yoke that hundreds of pounds of pressure cannot budge it!

It costs no more to give your customers the finest! The G-E Speaker family is headed by the famous 1201—grand-daddy of 'em all. Build your reputation on the General Electric Value Line! Send for FREE BULLETIN on G-E speakers:

General Electric Company,  
Electronics Park,  
Syracuse, New York.

**Yes—Even the Smallest G-E Speaker  
Uses the Aluminum Foil Base Voice Coil**  
—not subject to warping resulting from high humidity. Provides much higher wattage handling capacity.

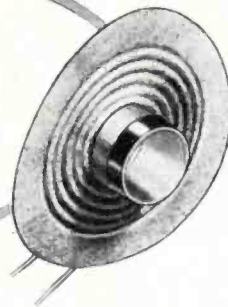

*You can put your confidence in—*

**GENERAL**



**ELECTRIC**



OVER 100 PAGES OF PROFUSELY  
DIAGRAMMED, PRACTICAL,  
UP-TO-THE-MINUTE  
INFORMATION COVERING—

NOW AVAILABLE  
THE FIRST PRACTICAL BOOK

ON THE INSTALLING OF TV and FM RECEIVER ANTENNAS

# TV...FM ANTENNA INSTALLATION

by IRA KAMEN

Manager, Television Antenna Dept.  
Commercial Radio Sound Corp.

and LEWIS WINNER

Editor, SERVICE and  
COMMUNICATIONS

## Antenna Tools

(Basic Tools Required . . . Application of the Correct Tools for Specific Types of Installations, Involving Flat-top Roofs, Slate Roofs, Tile Roofs, Chimneys, Etc.)

## The TV Antenna Installation Problem

(Fundamentals of All TV Installations . . . Judging Specific Application Features of the Various Types of Antennas Which Can Be Used for TV Work . . . Solving Reflection Problems . . . Improving Signal-to-Noise Ratio.)

## Solving the Problems of 12-Channel Reception

(Factors With Which Service Men Must Be Familiar to Accurately Install Antennas For Full-Band Coverage . . . Typical Problems Analyzed.)

## High Frequency TV Antenna Installations

(Antennas and Installation Procedures Which Afford Best Results. Solving Major Installation Problems Involving Tuned Indoor and Outdoor Antennas. Application of Stub Filters.)

(Indexed for Quick Reference)

## TV Interference

(Analysis of Nine Sources of Interference and Solutions Which Have Proved Effective.)

## Fringe Reception

(Selecting and Installing Antennas for Maximum Reception in Areas Over 45 Miles From Stations . . . Tower Installations . . . Estimating Tower Costs.)

## TV Master Antenna Systems

(Typical Multiple Dwelling Antenna Systems for Simultaneous Operation of Many Receivers From a Single Antenna Array and Amplifier Setup.)

## FM Antennas

(Analysis of Practical FM Antennas . . . Selecting Proper Antenna for Rural and Urban Jobs.)

## The Business of TV Antenna Installations

(How to Conduct Successfully TV Installation and Service Work Today . . . Proper Use of Correct Types of Installation and Servicing Agreements and Warranties.)

## TV Antenna Tricks of the Trade

(Antenna Installation Devices Which Will Improve Picture Fidelity.)

BRYAN DAVIS PUBLISHING CO., INC., Book Dept.  
52 Vanderbilt Avenue, New York 17, N. Y.

Send me a copy of TV . . . FM Antenna Installation, post-paid, for which I am enclosing \$2.00.

(Please Print)

NAME .....

ADDRESS .....

CITY AND STATE .....

AT YOUR JOBBER  
OR ORDER DIRECT

←  
Price \$2 Post Paid



# ASSOCIATIONS



## KTA

MEMBERS of the Kalamazoo Technicians Association observed their 14th anniversary with a dinner meeting recently.

Highlight of the meeting was the election of Clifford Bennett to the presidency of the organization. Bennett had served as acting president of the group during the last half of the past year in the absence of the president, Fran Lee Putnam.

Other officers named include Seth E. Lover, vice president; Wayne Moorlag, secretary; Leonard Dillon, treasurer; and William West, public relations officer.

In a discussion period following the dinner the association considered plans for membership drives the coming year and approved the extension of assistance to Service Men in area cities interested in forming similar associations.

The KTA was organized in 1935 under the leadership of its first president, Reginald Taylor. The organization weathered the effects of World War II, which saw many of its members called into service and now lists a large majority of Service Men in the city on its membership roll.

The Kalamazoo unit has already aided similar groups in Battle Creek and South Haven to organize and hopes to see this three-city combination expand to a state-wide association.

KTA qualifications are rigid enough to allow only experienced Service Men into the group. Each member must have had at least two years of full-time service work or five years of part-time experience. Each must abide by the KTA constitution, code of ethics and by-laws.

The policy of the KTA includes a written guarantee which provides that the KTA will see that any job undertaken by one of its members will be completed as far as the limitations of the set permit. If the member does unsatisfactory work, the KTA will step in to finish the job at no extra cost.

The association now owns two TV receivers, a sweep generator, and other equipment for use in their studies. At

present the members are also engaged in building a special TV test 'scope.

## ERSA

THE ERIE RADIO SERVICE ASSOCIATION was recently organized by a group of radio and television Service Men of Erie, Pa., and a four-point program was set up, covering: (1) Protection for customers against fraudulent and incompetent service, with equitable charges; (2) a pledge from all members to practice fair and honest business methods; (3) adoption of minimum price schedules; and (4) establishment of a training program to acquaint all members with existing service problems so they will be better able to serve the public.

The new association has begun an institutional newspaper ad campaign to acquaint residents of Erie with the group and urging them to "insist upon the Service Man with ERSA credentials, for honest, competent and reasonable service."

## ART, B.C.

TELEVISION has become a featured topic at meetings of the Associated Radio Technicians in Vancouver, British Columbia.

E. Mullins, serving as TV instructor for the association, has covered basic subjects and general receiving information. Incidentally, Mullins reported that he has been able to pick up KRSC in Seattle with some regularity.

## ARSD

FROM THE ASSOCIATED RADIO-SERVICE DEALERS, Columbus, Ohio, has come news on their recent election. Ray Horney is now president; George Dykes, vice president; Olin Payne, secretary; Gordon Barber, treasurer. Six were elected to the board of directors: Dana Young, Charles Hildreth, William Whitting, Dave Sears, John Graham and J. Brown of Appliance Distributing Co., representing associated jobbers. The ARSD weekly programs over WVKO have been very successful and will continue to be presented on Saturdays at 1:15 P. M.

## MSRSMA

RECENT MEETINGS of the Mid-State Radio Servicemen's Association of Harrisburg, Penn., have been extremely interesting with special talks by TV and sound authorities.

At one meeting Leedom, of Sprague, analyzed television components, explaining the specific characteristics which parts and accessories must meet in television receivers.

In another session, Norman C. Pickering covered phono pickups and their application to audio amplifiers.

## RTG

A SERIES of four three-hour television servicing lecture and laboratory peri-

(Continued on page 38)

At a recent meeting of the Mid-State Radio Servicemen's Association of Penna. at Harrisburg during which Norman C. Pickering delivered a talk on phono pickups and their application to audio amplifiers. Left to right: Wilfred Graham, of Morris F. Taylor Company, who sponsored the meeting; Norman C. Pickering; MSRSMA prexy T. L. Clarkson; J. Sweeney, MSRSMA vice president and Paul W. Smith, MSRSMA secretary.





Have ALL THE FUN  
SAVE 2/3 THE COST

Build  
YOUR OWN

# TEST EQUIPMENT

## 1 Heathkit VACUUM TUBE VOLTMETER KIT

Everything you want in a VTVM. Shatterproof solid plastic meter face, automatic meter protection in burn-out proof circuit, push pull electronic voltmeter circuit assuring maximum stability. Linear DC and AC scales. AC and DC full scale ranges of 3V-10V-30V-100V-300V-1000V. A total of 24 ranges. Isolated DC test prod for signal tracing and measurements of voltage while instrument is in operation. An ohmmeter section accurately measuring resistance of 1/10 ohm to one billion ohms with internal battery. Extremely high input resistance 11 megohms on all ranges DC and 6.5 megohms on AC. All these features and many more are the reasons hundreds of radio and television schools are using Heathkit VTVM's and recommending them to all students. Like all Heathkits, the VTVM kit is complete, 110V. 60 cycle power transformer, 200 microamp meter, tubes, grey crackle cabinet, panel, test leads, 1% ceramic precision divider resistors and all other parts. Complete instruction manual. Better start your laboratory now.

Shipping weight 8 lbs..... \$24.50

## 2 Heathkit SINE AND SQUARE WAVE AUDIO GENERATOR KIT

The ideal instrument for checking audio amplifiers, television response, distortion, etc. Supplies excellent sine wave 20 cycles to 20,000 cycles and in addition supplies square wave over same range. Extremely low distortion, less than 1%, large calibrated dial, beautiful 2 color panel, 1% precision calibrating resistors, 110V. 60 cycle power transformer, 5 tubes, detailed blueprints and instructions. R.C. type circuit with excellent stability.

Shipping weight 15 lbs..... \$34.50

## 3 Heathkit CONDENSER CHECKER KIT

Checks all types of condensers, paper mica—electrolytic—ceramic over a range of .00001 MFD. to 1000 MFD. All on readable scales that are read direct from the panel. NO CHARTS OR MULTIPLIERS NECESSARY. A condenser checker anyone can read without a college education. A leakage test and polarizing voltage of 20 to 500 volts provided. Measures power factor of electrolytics between 0% and 50%. 110V. 60 cycle transformer operated complete with rectifier and magic eye tubes, cabinet, calibrated panel, test leads and all other parts. Clear detailed instructions for assembly and use. Why guess at the quality and capacity of a condenser when you can know for less than a twenty dollar bill.

Shipping weight 7 lbs..... \$19.50

## 4 Heathkit SIGNAL TRACER KIT

Reduces service time and greatly increases profits of any service shop. Uses crystal diode to follow signal from antenna to speaker. Locates faults immediately. Internal amplifier available for speaker testing and internal speaker available for amplifier testing. Connection for VTVM on panel allows visual tracing and gain measurements. Also tests phonograph pickups, microphones, PA systems, etc. Frequency range to 200 Mc. Complete ready to assemble. 110V. 60 cycle transformer operated. Supplied with 3 tubes, diode probe, 2 color panel, all other parts. Easy to assemble, detailed blueprints and instructions. Small portable 9" x 6" x 4 3/4".

Shipping Wt. 10 lbs..... \$19.50

## 5 The NEW 1949 HEATHKIT 5-INCH OSCILLOSCOPE KIT

New improved model of the famous Heathkit Oscilloscope. Building an oscilloscope is the finest training for television and newer servicing technique and you save two-thirds the cost. All the features and quality of instruments selling for \$100.00 or more. Supplied complete with cabinet, two color panel, 5BP1 tube, 2 5Y3 tubes, 2 6SJ7 tubes and 884 generator tube. Power transformer supplies 1000 volt negative and 350 volt positive. Sweep generator 15 cycles to 30 M. cycles. Has vertical and horizontal amplifiers. Oil filled filter condensers for long life. Complete blueprints and instructions included. Shipping weight 25 pounds.

Express only..... \$39.50

## 6 Heathkit FM AND TELEVISION SWEEP GENERATOR KIT

A necessity for television and FM. This Heathkit completely covers the entire FM and TV bands 2 megacycles to 230 megacycles. The unit is 110V. 60 cycle transformer operated. Uses two 6J6 tubes, two 6C4 tubes and a 6X5 rectifier. An electronic sweep circuit is incorporated allowing a range of 0 to 10 MC. A sawtooth horizontal sweeping voltage and phase control are provided for the oscilloscope.

The coils are ready assembled and precision adjusted to exact frequency. As in all Heathkits, the best of parts are supplied, Mallory filter condenser, zero coef. ceramic condensers, all punched and formed parts, grey crackle cabinet, 5 tubes, test leads, etc. Better get it built now and be ready for the FM and TV business. Shipping Wt. 6 lbs...

\$24.50

## 7 Heathkit SIGNAL GENERATOR KIT

Every shop needs a good signal generator. The Heathkit fulfills every servicing need, fundamentals from 150 Kc. to 30 megacycles with strong harmonics over 100 megacycles covering the new television and FM bands. 110V. 60 cycle transformer operated power supply.

400 cycle audio available for 30% modulation or audio testing. Uses 6SN7 as RF oscillator and audio amplifier. Complete kit has every part necessary and detailed blueprints and instructions enable the builder to assemble it in a few hours. Large easy to read calibration. Convenient size 9" x 6" x 4 3/4". Ship. Wt. 7 lbs.....

\$19.50

ORDER DIRECT FROM THIS AD.

WE WILL SHIP C.O.D.  
Add Postage for Weight Shown

# HEATH COMPANY

BENTON HARBOR 11,  
MICHIGAN



# ELECTRONIC BARGAINS for EXPERIMENTERS and HOBBYISTS

ORDER NOW . . . ALL QUANTITIES LIMITED



**PE101C BC645 POWER SUPPLY**  
NO. 273. Complete power supply for BC 645. Operates from 12 or 24 Volts. Supplies both AC and DC required. Shipping Wgt. 13 lbs. Each **\$3.95**

**DM 35 12 VOLT DYNAMOTOR**  
NO. 274. New input 12 Volt at 18.7 Amperes. Supplies 675V at 275 MA or 1/2 above voltage from 6 volts. Excellent for auto use. Shipping Wgt. 11 lbs. Each **\$7.50**

## HOME WORKSHOP GRINDER KIT

NO. 230. Easily assembled 110V AC or DC ball bearing fully enclosed motor from Army surplus dynamotor. Purchaser to make simple changes and shaft extensions, detailed instructions and all parts supplied. Motor approximately 5,000 R.P.M. Ideal for tool-post grinder, flexible shaft tool, model drill press, saw. Shipping Weight 6 lbs. **\$3.95**

## COLLINS AUTOTUNE CONTROL HEAD

NO. 278. Brand new controls used on the ART/13, 100 Watt, Transmitter. Types 7, 8, 10, and 11 available. Get a spare while available as new cost is over \$22.00 each. Shipping Wgt. 3 lbs. Price any type (mention when ordering). Each **\$4.50**

**300 MA SELENIUM RECTIFIERS**  
NO. 209. Rated 300 MA at 36 Volts, complete with mounting brackets. Shipping Wgt. 1 lb. **3 FOR \$1.00**

## 1N90 FEED THROUGH INSULATOR

NO. 276. Heavy duty feed through, 2" diameter 4" long, complete with brass hardware and gasket. Shipping Wgt. 2 lbs. **2 FOR \$1.00**

## 1N86 STRAIN INSULATOR

NO. 277. Husky army type 1 1/4" diameter, 5 1/4" long. Brown porcelain. Shipping Wgt. 4 lbs. **4 FOR \$1.00**

## G. E. BC 306 ANTENNA TUNING UNIT

NO. 231. Matches any aerial to 150 Watt transmitter, used on BC 375. Brand new. Add postage for 20 lbs. **\$2.95**

## G. E. 1,000 VOLT 350 MA DYNAMOTOR

NO. 213. An ideal dynamotor for mobile operation in taxicabs, police cars, sound systems and amateur stations. Supplies above voltage from 12 Volts or 500V. at 350 MA from 6 Volts. Complete with starting relay, and fuses. New. Our Dynamotor A. Shipping Weight 72 lbs. **\$5.95**

## POWER TRANSFORMER Specials



NO. 226. Primary 117V. 60 cycle. Secondaries supply 746 V.C.T at 220 MA, 6.3V. at 4.5 A., and 5V. at 4A. Will handle 13 tube radio receivers. Supply is limited, order early. Shipping Weight 11 lbs. each. **\$3.95 . . . 3 for \$9.95**

## T32 TABLE MICROPHONE

NO. 210. One of the Army's best. Built by Kellogg, ideal for factory call system, public address, amateur use. Brand new in original cartons. Add postage for 5 lbs. **\$2.95**

## MINIATURE ELECTRIC MOTOR

NO. 211. Tiny Delco motor only 1" x 1 1/4" x 2" 10,000 RPM. Operates from 6 to 24 V. Excellent for models. Add postage for 1 lb. **\$2.95**

## OUTPUT TRANSFORMER

NO. 227. Push pull 6V6's to 6 - 8 ohm voice coil excellent characteristics. **3 for \$1.95**

## RCA SATURABLE REACTOR TRANSFORMER

NO. 246. New RCA No. CKV30531 AC current 750 MA DC current 2 Amperes. Rated 1.75 henries. Shipping wgt. 4 lbs. Each **\$1.00**

## 12.6V POWER TRANSFORMER

NO. 247. New cased 110 V 60 cy. Power Transformer. Supplies 440V CT. at 60 MA, 6.3V at 2A. and 12.6V at 1 Amp. Excellent for military sets. Shipping Wgt. 6 lbs. Each. **\$1.95**

## RCA INPUT TRANSFORMER

NO. 248. Heavy duty RCA No CKV-30529. Input has primaries 600 to 200 and 25 ohms secondary 250,000 ohms C.T. Shipping Wgt. 2 lbs. Each **\$1.00**

## FEDERAL POWER TRANSFORMER

NO. 252. New cased 110V 60 cy. Power Transformer. Supplies 480V CT at 50 MA and 6.3 V at 2.1 Amps. A beautiful transformer. Shipping Wgt. 4 lbs. Each **\$1.50**

## MILITARY POWER TRANSFORMERS

NO. 229. Convert your military receivers without rewiring the filament. "A" type supplies 500 VCT at 50 MA, 5V. at 2A. and 24V. at 1/2 A. "B" type supplies 500 VCT at 50 MA, 5V. at 2A. and 12V. at 1 Amp. State whether A or B type desired. **\$2.95** Shipping Weight 4 lbs.

## WALKIE TALKIE TRANSFORMER

NO. 744. Carbon microphone input transformer and output to headphone transformer, all in one case, excellent for building your own. Shipping Wt. 1 lb. **4 for \$1.00**

## LOW PASS FILTER UNIT

NO. 637. 3000 cycle cutoff consists of 3 inductances and 4 capacitors in network, 500 ohms in and out. Excellent for clipping all frequencies above 3000 cycles. Drawn steel case, shipping Wt. 5 lbs. **\$2.50**

## FM PUSH BUTTON TUNER

NO. 224. Brand new ten push button tuning assembly from Army FM receiver. Contains 4 gang 100 MMF silver plated tuning condenser. Add postage for 10 lbs. **\$2.50 EACH**

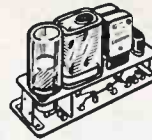

**BC 746 TUNING UNIT**  
NO. 257. Plug in transmitter tuning unit from army Walkie Talkie. Contains antenna and tank coils, tuning condenser, transmitting and receiving crystals. Ideal transmitter foundation. Shipping Wgt. 1 lb. Each **\$1.00** (Same as above except transmitter crystal in 80 meter amateur band \$2.50 each)

## T30 THROAT MICROPHONE

NO. 258. Makes excellent contact microphone for musical instrument or vibration pick-up. Shipping Wgt. 1 lb. **\$1.00 each** Extension cord with switch for above **\$.50 each**

## BC731 CONTROL BOX

with Weston Model 476 AC Voltmeter  
NO. 208. Excellent buy in motor control box. Size 8"x10"x5 1/2". Contains Weston 0-150V. AC 3 1/2" voltmeter, motor starting switch, 28 fuses all 30 Amp 110V. and 8 fuse holders. Fuses and holders alone worth the price. Shipping Weight 18 lbs. **\$7.95**

## METER SPECIAL

NO. 237. Brand new DeJur Model 312 0-800 M.A. D.C. Square 3" 0-10 M.A. basic meter with built in shunt. Probably the best buy ever offered in a surplus meter. Shipping Weight 1 lb. **\$2.95**

## HEARING AID HEADPHONES

NO. 216. The Army's best - eliminate flat ears and outside noise. Complete with transformer for conversion from low to high impedance. With cord and plug complete. Add postage for 1 lb. **\$1.00**

## BC 451 CONTROL BOX

NO. 236. Control box for 274N transmitters. Contains proper cv-voice switch, 4 channel switch, power switch, mike jack and telegraph key. Add postage for 2 lbs. **\$1.95**

## 100 MA FILTER CHOKE

NO. 641. Heavy 1.5 henry choke in drawn steel case, 50 ohm resistance, conservatively rated at 100 MA. Shipping Wt. 1 lb. **50c**

## FILAMENT TRANSFORMER

NO. 922. 220V. 60 cy. primary supplies 12.6V. at 3.5 Amps, 15.6V at 1 Amp. Supplies 6.3 at 3.5 Amps and 7.8V. at 1. Amp from 110V. Shipping Wt. 8 lbs. **\$1.50**

## PANEL METER

Burlington 0-300 VAC Meter  
NO. 290. Model 32XA 3 1/2" round AC Voltmeter 0-300 VAC full scale. Scale also calibrated 0-600V. Bakelite case. A beautiful meter in original carton. Shipping Wt. **\$3.95**

## DRIVER TRANSFORMER

NO. 651. Couples 3000 ohm plate to push pull parallel grids hermetically sealed. Ship. Wt. 1 lb. **\$1.00**

## OUTPUT and MODULATION TRANSFORMER

NO. 745. Companion transformer to above driver. A push pull output, 3000 ohms to 3.2 ohm voice coil, or to 1250 ohms at 80 MA. A high quality cased unit. Shipping Wt. 2 pounds. **\$1.00**

HOW TO ORDER . . . GIVE PART NUMBER AND DESCRIPTION . . . ADD POSTAGE FOR WEIGHT SHOWN. NO ORDERS UNDER \$2.00 . . . WE WILL SHIP C.O.D.



**The HEATH COMPANY**

. . . BENTON HARBOR 11, MICHIGAN



# Servicing Helps

## TV Antenna Installation Hints... Capacitor Checker Design and Application.

### TV Antenna Installation Hints\*

IN MANY geographical locations the quality of TV reception is directly related to the effectiveness of the antenna and lead-in line used in the installation. In some cases a high-gain antenna with a preamp are required to deliver a usable signal to the receiver while in other cases a piece of wire hanging out the window will give adequate response. Experience and a knowledge of the conditions prevailing in the area are generally necessary to determine the degree of antenna sensitivity demanded in that area.

Frequently the elimination of *ghosts* or other undesired signals is more important than actual antenna gain. Here backside sensitivity should be minimized by the use of a reflector. If the reflected as well as the direct signal is being received from the forward

Fig. 2. High and low-band field pattern of an antenna which combines the effects of a folded dipole and reflector cut for the low band.

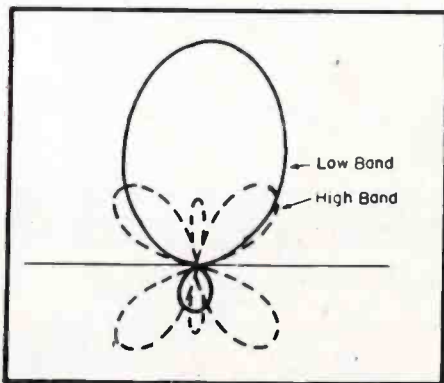

### by P. M. RANDOLPH

direction, the antenna must be turned so that both signals are being received on one side of the lobe. It is important to select that side of the lobe which favors the direct signal. This can be done by turning to both sides of the broadside position and noting which gives the greatest ghost reduction relative to the direct signal. The ghost signal can usually be reduced to a satisfactory level without bringing *snow* into the picture. It is sometimes necessary to tolerate a small amount of ghost in order to keep the direct signal

\*From data prepared by E. O. Vandevan, G. E. television component application engineer.

Fig. 1. Field pattern of folded dipoles in the high and low bands.

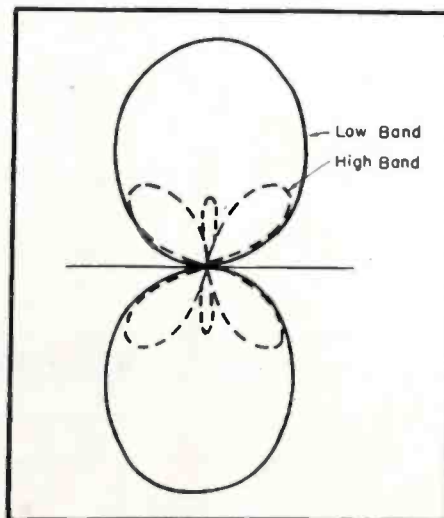

at a sufficiently high level. The best compromise should be found and the antenna installed in this position.

An effort should always be made to optimize the direct signal and not a reflection. The picture from the direct signal is always farthest to the left. If there appears to be a ghost to the left of the optimized signal it means that the antenna is oriented to favor a reflection. Occasionally, when the direct signal is being obstructed, it will be necessary to adjust for a reflection. The quality of such a signal will change from time to time depending on the condition of the reflecting surface.

In some installations it is impossible to improve the direct signal to reflected signal ratio. This is true when both signals are arriving at a very narrow angle with respect to each other. Television antennas have rather

Fig. 3. Total field pattern which results when the higher and lower-band elements of either the Fig. 2 and 3 antennas are connected in parallel with a folded dipole and reflector high-band adapter. At A and B, antennas #1 and #2 are used.

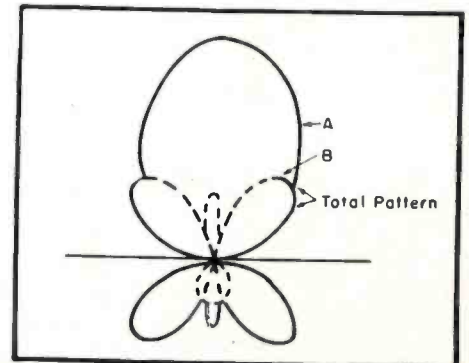



broad lobes and are not sufficiently selective to discriminate against undesired signals when the angular displacement with respect to the desired signal is relatively small.

The field pattern of a folded dipole<sup>3</sup> intended for primary area service in both the high and low bands appears in Fig 1. It will be noted that in the low band the lobes are perpendicular to the dipole. In the high band, however, the pattern takes a cloverleaf configuration. This fact is very significant; it means that high band and low band signals are picked up best when about 45° from each other. This condition will rarely exist and a compromise must be effected. The cloverleaf pattern in the high band means somewhat less gain in each lobe.

Since it has no reflector the antenna is equally sensitive in both broadside directions. It would therefore be used in areas where ghost signals and noises are not present. However the antenna will give very satisfactory low-band reception and good high-band reception when adjusted properly in a great many installations in primary service areas.

In Fig. 2 appears the high-band and low-band field patterns of an antenna<sup>3</sup> which combines the effects of a folded dipole and reflector cut for the low band. The reflector has the function of reducing the backside sensitivity of the antenna in the low band and increasing the gain in the forward direction. Here it will be noted there is an extremely small back lobe present in the low band. In the high band the antenna exhibits the typical cloverleaf characteristic. Again high band stations and low band stations are received best from different directions. The antenna must be oriented to give the best compromise for all stations.

These two antennas have average sensitivity in the high band. Two problems, however, are frequently present regarding high-band reception: (1)

additional gain is often required, and (2) optimized orientation for high band stations differs from that for stations in the low band. High band adaptors<sup>3</sup> have been designed to aid in solving this problem. Consisting of a folded dipole and reflector out for the center of the high television band it is usually mounted directly below either at the folded dipole or folded dipole and reflector. The high band and low band elements are connected in parallel giving a total field pattern essentially the sum of the individual patterns; Fig. 3. The high band lobe may be pointed in any direction by turning the adaptor on the mast. Thus high band and low band stations are optimized independently. Such an arrangement is highly advantageous especially where the signal level is low.

Occasionally it is desirable to run separate leadin lines from the high-band and low-band elements to an antenna switch at the receiver. This is the case when high band stations and low band stations are best received at different locations. Also in areas where the high-band ghost problem is particularly acute separate leadins are sometimes advantageous. This is true because the low band antenna has high band lobes in directions other than that of the high band antenna. The best solution to a particular problem may only be determined by trial and error.

In fringe and sub-fringe locations use of a high gain antenna is dictated. Such an antenna<sup>4</sup> consisting of two folded dipoles with reflectors stacked one above the other, has an input impedance of 600 ohms and connected by a 600-ohm transmission line. The input impedance at the center of this line is then 300 ohms which correctly matches a 300 ohm leadin line. This antenna gives approximately twice the gain of a single folded dipole and reflector and therefore will often bring an unusable signal up to a satisfactory level. The pattern of this antenna is shown in Fig. 4. It will be noted that the major lobe is broadside to the antenna in the direction of the folded dipole.

Fig. 4. Pattern of two folded dipoles with reflectors in a stacked arrangement.

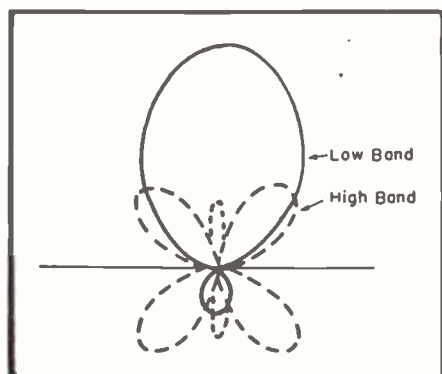

#### Capacitor Checker\*\*

The leakage factor of paper and mica capacitors often determines the application possibilities of the component in the receiver or instrument.

In some receivers, for instance, it is necessary that the capacitors used in

<sup>3</sup>G. E. UKA-005. <sup>4</sup>G. E. UKR-005.

<sup>3</sup>UKT-002. <sup>4</sup>G. E. UKR-007.

\*\*From notes prepared by K. N. Gray, Akron, Ohio.

coupling, tone and timer circuits have a leakage of 35 megohms or higher. Capacitors falling below that value are often used for cathode, relay contact and bypass purposes.

To check these leakage conditions, a multi-meter with a top range of 50 megohms is often used but this has been found a rather complex approach slowing up checking.

In a study of methods which could be used to simplify and accelerate the process, a rather novel circuit was evolved (Fig. 5), which was found to provide protection to the meter against shorted capacitors and with a 200-ma meter indicated a leakage above .75 megohm.

Rectified *dc* is filtered by two 8-mfd, 450-volt capacitors in series to withstand the high voltage. A 1-megohm bleeder aids in speeding up the check.

Any meter with not more than a 1-ma movement may be used with this circuit. This meter will give a leakage indication up to 25 megohms, while the 200-ma meter will indicate 100 megohms if necessary.

Resistors *A* and *B* are the essential factors of the unit. Various values for different meters may be found through several circuit alterations. With the meter and power supply connected, the resistor or resistors can be inserted in the *A* and *B* positions until as nearly as possible mid-scale reading is obtained on the meter. For example, with a 1-ma meter the total resistance of *A* and *B* together will be close to 2-3 megohms, depending upon the *dc* voltage available. In one case two 5-megohm resistors, as shown, provided exactly midscale reading. It will be noted that at the junction of *A* and *B* a lead goes through *PB*<sup>1</sup> to one of the test prods. The other test prod goes to negative of the power supply. Should a shorted capacitor appear across the test prods the meter will read full scale when *PB*<sup>1</sup> is depressed,

(Continued on page 39)

Fig. 5. Circuit of capacitor checker. *T* in this circuit is a midget replacement transformer used in standard receivers. The rectifier voltage should be one which will accommodate the rectifier used. For best results the entire high voltage secondary should be used to provide an output of 600 volts.

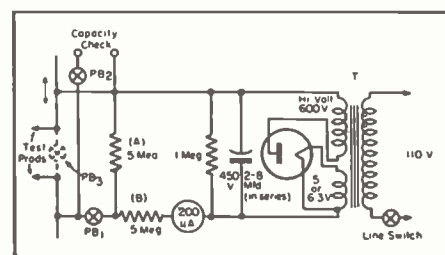

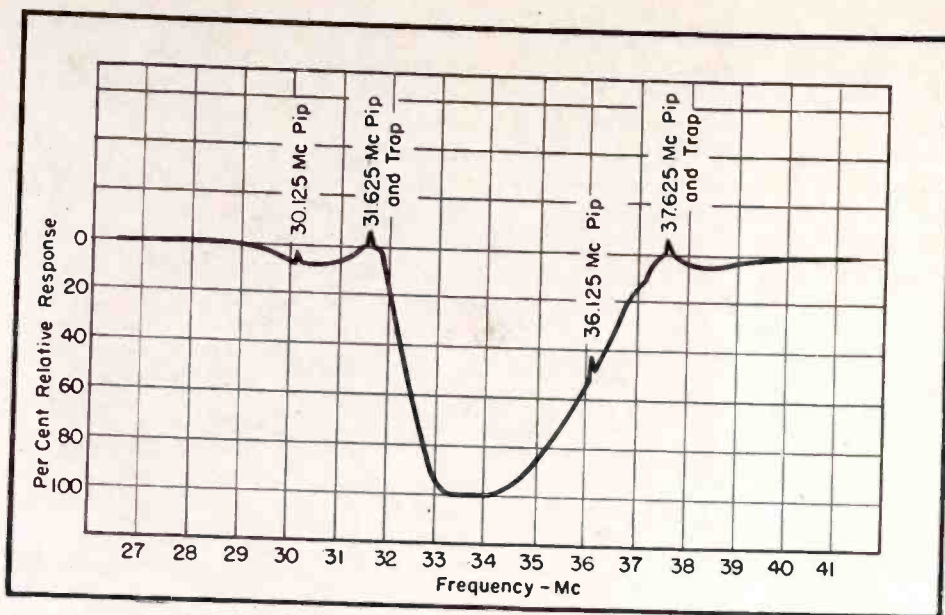

Fig. 1. Video *if* response curve, with the marker pips superimposed.

# TV Receiver Visual Alignment Techniques

**Concluding Installment on Alignment of Bendix 235 TV Chassis, Covering Alignment of 4.5-Mc Video Trap and RF Circuits.**

IN DISCUSSING how the discriminator zero reference level is secured during the alignment of the Bendix 235 TV receiver last month, it was pointed out the *vtrm* is connected between terminal *B* and ground. Then the output of the coaxial cable connected between the mixer tube shield and ground is shorted and the meter reading noted, this reading indicating the discriminator zero reference level.

This was cited as step 15. In step 16 (the numerical identity was inadvertently omitted last month) the short is removed from the coaxial cable and the 31.625-mc signal from the *if* marker generator allowed to come through, with the sweeping oscillator still turned off. Then the tuning slug of  $L_{17}$  (within  $T_1$ ) is adjusted to zero reference level after finding the sharp cross-over point of the discriminator, the *vtrm* is disconnected.

Now in step 17, the sweeping oscillator is turned on again and the *dipping* adjustment of  $L_{26}$  described in step 12, repeated. This is necessary because there is some interaction between the adjustments of  $L_{27}$  and  $L_{26}$ .

(18) To continue, we then examine the shape of the video *if* re-

by **LESTER L. LIBBY**

Chief Engineer

Omega Laboratories and Kay Electric Co.

sponse curve to see how it compares with the standard curve given in Fig. 1. Using the 36.125-mc (picture *if* carrier) marker pip as a reference, make such minor readjustments in the tuning slugs of  $L_{20}$ ,  $L_{20}$  and  $L_{14}$  as are necessary to *touch-up* the curve shape and to insure that the picture *if* carrier will fall at about the 50% to 60% point on the selectivity curve. At the same time, use a 32.4-mc birdie from the variable *if* marker generator as reference for the 50% to 60% point on the other side of the selectivity curve.

- (19) Connect the 'scope cable between terminal *B* and chassis ground and, with the sweep width of the sweeping oscillator adjusted for a frequency excursion of about 2 mc centered on about 31.6 mc, examine the re-

sultant discriminator curve for linearity of center portion, frequency separation of peaks and symmetry of peak amplitudes. The center portion should be reasonably linear for at least  $\pm 30$  kc, from 31.625 mc, and the peaks should each be at least 150 kc from the center frequency (400 kc peak-to-peak is the normal value). Care should be taken to keep the sweeping oscillator and *if* marker signals at a level low enough to prevent overload in the sound *if* amplifier circuits, otherwise a distorted discriminator curve shape may result.

## Alignment of 4.5-mc Video Trap

The 4.5-mc video trap  $L_{52}$ - $C_{148}$ , in series with the video lead to the cathode of the 10BP4 picture tube, may be aligned to reject the 4.5-mc intercarrier beat by the following procedure:

- (1) Replace the 10BP4 picture tube in the receiver.
  - (2) Switch the 29-39 mc marker
- (Continued on page 44)



# TV Receiver Production Changes

## Addition of Bias to Converter Grid

BIAS HAS been added to the converter grid in the 810, 811 and 814 G. E. TV models, to improve reception in areas of strong signal strength, especially on the *hf* stations. This addition was found necessary since the peaks of the signal, which are the vertical pulses, were causing the grid to draw grid current which, in turn, frequency-modulated the oscillator voltage at the vertical pulse rate (60 cps). This appeared in the audio as a buzzing sound.

In these TV models, the bias was added to the converter grid (pin 7) via two 1-megohm resistors and a 5,000-mmfd capacitor, as shown in Fig. 1. A terminal board has to be placed on the underside of the main chassis near the *rf* unit, to accommodate the extra parts and mounted so that short leads can be used.  $R_4$  must be removed from ground (under the oscillator trimmer  $C_{10}$ ) and connected to the junction of the new resistors on the new terminal board. Then the new capacitor is connected from junction of the new resistors to the ground point on the *rf* chassis under the oscillator trimmer.

The 5,000-mmfd capacitor should be dressed as far away as possible from the oscillator trimmer.

## Removing Raster Wiggle (G. E. 814)

To remove a slight wiggle at the left-hand end of the first few lines at the top of the raster, a 330-ohm resistor ( $R_{118}$ ) was added in parallel with  $C_{10}$ . This resistor was added in late production 814's.

## by DONALD PHILLIPS

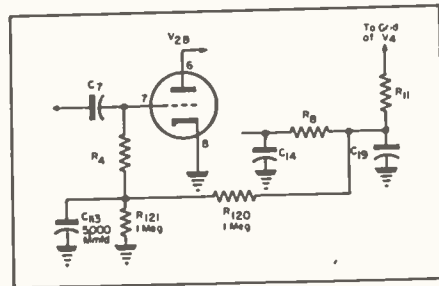
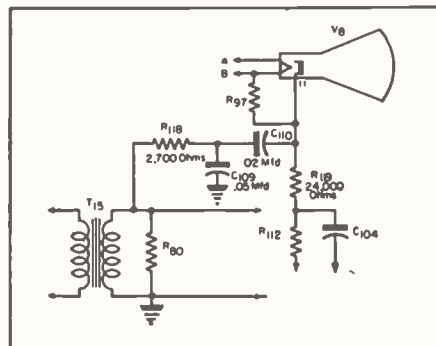

Fig. 1. Circuit changes made in the G. E. 810, 811 and 814 TV receivers to accommodate a bias on the converter grid.

## Removal of Vertical Retrace Lines (G. E. 810, 811, 814)

The circuit shown in Fig. 2 has been added in late production to remove the vertical retrace lines which appear when the contrast control is used at a

Fig. 2. Additions made on the G. E. 810, 811 and 814 to provide removal of vertical retrace lines which appear when the contrast is at a low setting or the brightness control is at a high setting.



low setting or the brightness control is used at a high setting. New parts required are a .05-mfd 600-v capacitor, .02-mfd 600-capacitor, and 2,700-ohm and 24,000-ohm  $\frac{1}{2}$ -w resistors.

## Transmission Line Wave Traps

Occasionally the use of a quarter-wave stub of transmission line is recommended for trapping out unwanted signals or partially attenuating powerful interfering nearby TV stations. This is satisfactory as far as the reduction or elimination of the undesired signal is concerned, but it will also cause a change in the *rf* response curve of the head-end unit on channels close to the tuned frequency of the stub. This may result in a serious impairment of the picture detail due to smearing.

It has been found that it is much more desirable to insert a small capacitor in series with each line of the stub at the point where the stub fastens to the head-end terminals. These capacitors should be of 5-mmfd value for stubs in the *lf* TV spectrum and the FM band, and 2 mmfd for stubs in the *hf* channels. This change provides a series-parallel tuned trap which is much sharper in response and will not affect the response curve of the head-end unit unless the stub is tuned directly in the channel.

The capacitors in the tuning stubs result in a longer piece of line being used for a particular frequency. The best method of determining the proper length of line is to clip off small por-

(Continued on page 39)

**Production Changes in G. E. 810, 811 and 814 Which Remove Buzzing Sounds in Audio, and Wiggle and Vertical Retrace Lines. Changes Required Where Stubs Are Used. Modifications in G. E. 811, 814, 820, 830 and 835 to Curb Audio IF Regeneration.**

# for TV Transformers insist on CHICAGO exact replacements!



## Available NOW—To Fit Today's Leading Television Circuits

You'll save time, save trouble, and save money in Television servicing by using components that *exactly* fit the circuits and the chassis. For TV transformers, insist on the CHICAGO line—made by the foremost suppliers of original equipment transformers to the Television industry. The four units described below are representative of the complete CHICAGO TV Transformer line—offering exact replacement equipment to fit today's leading Television receivers.

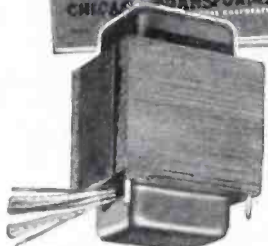

TP-365

**TV Power Transformer No. TP-365.** Designed to supply 405 volts d-c with two 5U4G's to an 80 mfd condenser input. Copper shorting band around core reduces external magnetic field; cuts image distortion to a minimum.  
Pri.: 115 v., 60 cycles  
H.V. Sec.: 362-0-362 v., a-c, .295 amps d-c  
Fil. No. 1: 12.6 v., 5 amps, C-T  
Fil. No. 2: 5 v., 2 amps  
Fil. No. 3: 5 v., 6 amps  
Exact equivalent to R. C. A. Type No. 201T6. List Price, \$26.00

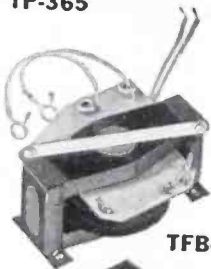

TFB-1

**Horizontal Scanning Output Transformer No. TFB-1.** Couples horizontal output circuits to horizontal deflection yoke. Provides high pulse voltage which, when rectified, supplies anode of picture tube. Also has rectifier filament winding.  
Exact equivalent to R. C. A. Type No. 211T1. List Price, \$11.25



TSO-1

**Vertical Scanning Output Transformer No. TSO-1.** Couples vertical output tubes to picture tube deflection yoke.  
Pri. Impedance: 19,000 ohms at 30 v., 60 cycles, 13 ma d-c  
Ratio, Primary to Secondary: 10 to 1  
Exact equivalent to R. C. A. Type No. 204T2. List Price, \$5.90



TBO-1

**Vertical Blocking Oscillator Transformer No. TBO-1.** 60-cycle unit for creating the vertical sweep "saw-tooth" voltages required in conventional circuits.  
Pri. Inductance: 1.15 hy  $\pm$  20% at 3 v., 1000 cycles  
Pri. Leakage Inductance: 8 mh  $\pm$  25%, -15%  
Ratio, Primary to Secondary: 1 to 4.2  
Exact equivalent to R. C. A. Type No. 208T2. List Price, \$3.10

See your Jobber for CHICAGO TV Transformers. GET CHICAGO'S COMPLETE TV TRANSFORMER CATALOG. Ask your jobber for it, or write us direct.



## CHICAGO TRANSFORMER

DIVISION OF ESSEX WIRE CORPORATION

3501 ADDISON STREET • CHICAGO 18, ILLINOIS

## TV Alignment

(Continued from page 11)

wide passband such as that of Fig. 6(a) may possibly be peaked to be narrower.

Whether this affords additional gain or not may only be determined by inspection of the curve; if the video and sound carriers fall far down on the sides of the curve, then the peaking operation may actually lead to lesser gain at the carrier frequencies. It is only when the amplitude of the curve at the carrier frequencies is raised, that the benefit of the operation prevails.

Under no circumstances, however, should the two carriers fall below about the 80% maximum amplitude point. No set rule may be stated; it is a matter of inspection of the curves and sharpening them to increase gain at the carrier frequencies if possible. There is a very wide differential between characteristics of the many rf units in use, and between the passband of the several channels in any given rf unit.

One might wonder why such adjustments, to accommodate fringe area reception, are not made during the production of the receivers. The proce-

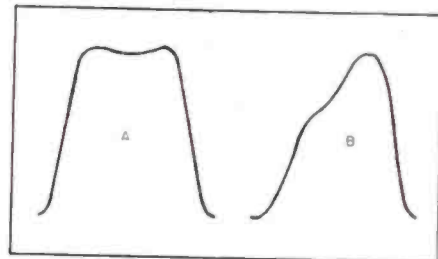
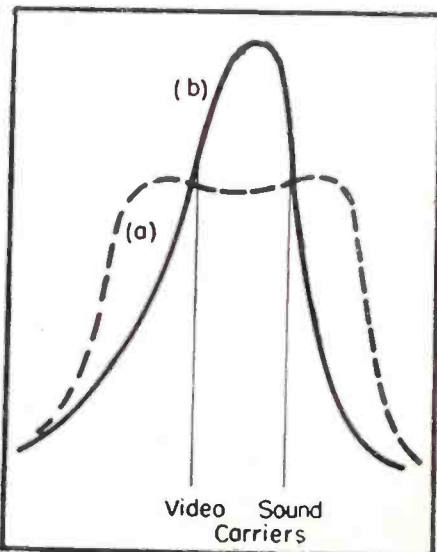

Fig. 5. The effect of video grid bias change is indicated here. The curve in A illustrates alignment with the normal -3 volts bias and the curve in B illustrates the change in shape and frequency with a low bias when receiving a weak signal.

Fig. 6. Two of the many possible differences in the rf passband. At (a) we have a coupled curve and at (b) a single peaked curve.





ture is not followed because in the main the receiver must be a compromise.

#### Fringe-Area Alignment Restrictions

If the receivers were aligned for fringe area work, as a general practice, they would not perform in any location according to the high-fidelity limits for which they were designed. It will be recalled that the highest-frequency sidebands are lost and picture detail therefore suffers. Mass production of receivers so adjusted would inevitably lead to some cases of inferior operation in areas of normal signal strength.

If the adjustments are made in isolated fringe-area cases as necessary, then the results will be very satisfactory.

Fig. 7. Curves illustrating adjustments which can be made to provide increased sound sensitivity. The dashed lines indicate the normal response and the solid lines the peaked results.

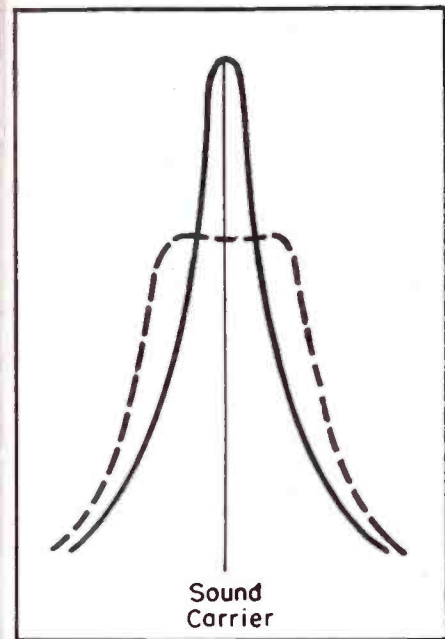

## 12½ TV Model

(Continued from page 13)

may result, without an attenuating network.

The ion trap or beam bender is of the permanent magnet type.

The B+ power supply transformer center tap is not connected to ground in this unit. A system of bleeders is used to supply 225 and 150 volts positive and four different negative voltages.

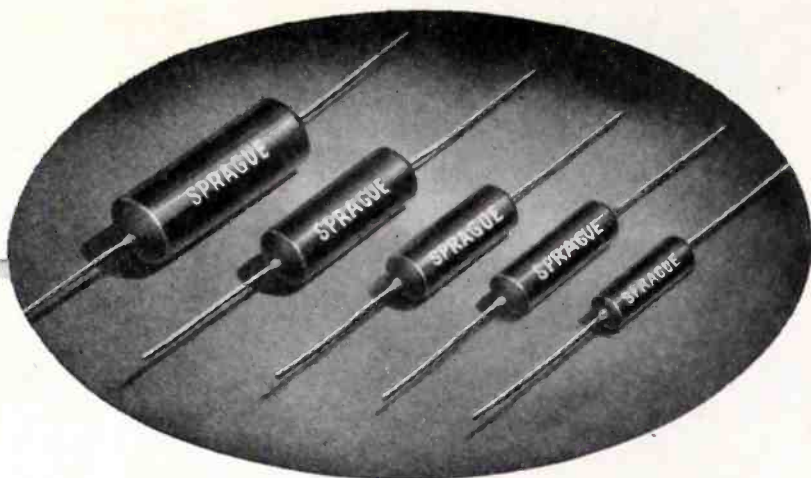

## THE LOW-DOWN ON Phenolic Molded Tubulars TYPES **TM** AND **MB**

(600 volts)

(1600 volts)

Sprague's introduction of the first practical phenolic-molded tubular capacitors was probably the most revolutionary capacitor development in radio servicing history. It is to clarify any misunderstandings which may exist regarding this remarkable advancement and explain things fully that the following information is given.

#### DO THEY COST MORE?

Not as far as you are concerned. Sprague TM and MB Molded Tubulars cost considerably more to manufacture, yet you buy them at the same prices as ordinary wax cardboard tubulars. TM's and MB's are truly premium capacitors at no premium price.

#### ARE THEY REALLY BETTER?

Most emphatically yes. Sprague Molded Tubulars represent just about as much improvement over conventional wax cardboard types as the new Ford does over the old Model A. They're tested at 95% relative humidity for 250 hours. They operate at temperatures from -40°F. to +185°F. without batting an eye. They're life-tested at 1½ times rated voltage for 250 hours. Their high-temperature thermo-setting phenolic jackets mean that they'll not only outperform conventional wax capacitors under severe conditions of heat, moisture, vibration and rough handling but last much longer and give better performance on ordinary jobs.

#### WHERE SHOULD I USE THEM?

Use them on any by-pass application where you want capacitors that won't cause trouble later. They're taps for auto and aircraft radio, television and other difficult jobs. And, because they cost you nothing extra, Sprague Molded Tubulars make ideal replacements for any service work where you want to do a really first-class job.

#### DOES EVERYBODY MAKE THEM?

Not by a jugful! However, because of the remarkable success of Sprague TM's and MB's there will soon be plenty of imitations. This means you'll be wise to ask for them by name and be sure of getting the original practical molded tubulars—thoroughly tested and proved through years of service.

#### WHO SELLS THEM?

Sprague Molded Tubulars are featured by leading distributors throughout the country. If you don't know the name of the one nearest you, write or wire and we'll advise you promptly.

#### WHERE CAN I GET COMPLETE INFORMATION?

Bulletin giving complete catalog information on Sprague TM and MB Molded Tubulars can be obtained from your Sprague jobber—or we'll mail one on request.

**SPRAGUE PRODUCTS COMPANY, North Adams, Mass.**

Jobbing distributing organization for the products of the Sprague Electric Company

CAPACITORS **SPRAGUE** \*KOOLOHM  
RESISTORS

\*T.M. Reg. U.S. Pat. Off.



## Checks all TELEVISION and Radio types SIMPSON 555 Tube Tester

- Basic RMA recommended circuit. Tests any tube regardless of base connections or internal connections of elements.
- Simpson designed 3-position lever operated toggle switches with molded rotor carrying silver plated contacts, self-cleaning through wiping action.
- Sockets for all receiving tubes on the market.
- Provision for future tube developments.
- No adapters or special sockets required.
- Properly fused, provides for line adjustment from 100 to 130 volts; smooth vernier control.
- Beautiful modern panel of shining silver and black anodized enduring aluminum.
- Large illuminated meter for easy readings.
- Unique jewel-like molded lucite housing encloses Neon bulb indicating shorts and inter-element leakages.
- Line adjustment control below dial opening. Easy to operate.
- Case of sturdy plywood with heavy fabricoid covering, slip hinges.
- Simpson patented "No-Backlash" Roll Chart.

SIZE: 16 $\frac{3}{4}$ " Wide x 12 $\frac{1}{2}$ " High x 6" Deep  
Dealer's Net Price, with Operator's Manual . . . . \$79.50

**Simpson**  
INSTRUMENTS THAT STAY ACCURATE

5200-18 W. Kinzie Street, Chicago 44, Illinois  
In Canada: Bach-Simpson Ltd., London, Ontario

See the 555 at your parts jobber or write for descriptive literature.



## Ser-Cuits

(Continued from page 18)

$L_2$  is bypassed to ground by a .005-mfd capacitor, ( $C_{12}$ ).

The second sound *if* amplifier is a 6BH6. This tube utilizes a 47,000-ohm resistor ( $R_{\omega}$ ) and a 47-mmfd capacitor ( $C_{\omega}$ ), connected in parallel in its control grid return. With this arrangement, the circuit acts as a limiter on strong signals and prevents overload of the ratio detector.

### Video IF Amplifier and Detector

The video *if* amplifier (not including the input *if* amplifier) consists of three type 6BH6 miniatures. The video detector utilizes a 6AL5 dual-diode rectifier, one section of which functions as *agc* rectifier.

In the plate circuit of the 6BH6 input *if* amplifier is  $L_{13}$ , a resonant coupling impedance, tuned to 25.9 mc. An 8,200-ohm unit ( $R_{\omega}$ ) serves as the 6BH6, first pix *if* amplifier, grid resistor, and broadens the response of  $L_{13}$  so that correct bandwidth is obtained. To prevent changes in the 6BH6 input capacitance at high signal levels the 82-ohm cathode bias resistor ( $R_{\omega}$ ) is not bypassed.  $L_{14}$  is a resonant coupling impedance, tuned to 25.6 mc, while  $L_{15}$  is a resonant rise trap. This trap resonated at 20.4 mc serves to eliminate a spurious response that appears around this frequency.

$L_{16}$  is a resonant coupling impedance tuned to 23.8 mc, while  $L_{17}$  is the accompanying sound trap. This trap is tuned to 21.6 mc and its purpose is to absorb the 21.6 mc accompanying sound carrier and prevent sound interference in the picture.

$L_{18}$  consists of a single turn of wire, closely coupled to the accompanying sound trap ( $L_{19}$ ), and connected in series with the cathode of the 6BH6 third video *if* amplifier.

The video detector utilizes one section of a 6AL5 dual-diode rectifier. The video *if* carrier envelope, containing the sync and blanking pulses and the picture information, is applied between the cathode of the 6AL5 and ground. When the polarity of the carrier is such that the detector cathode is negative with respect to ground, the diode will conduct and current will flow through a 2,500 ohm contrast control,  $R_c$ . The diode does not conduct when the polarity of the carrier is such that the diode cathode is positive with respect to ground and therefore no current will flow through the contrast control. The voltage drop across this control will be negative with respect to ground.

The second portion of the 6AL5 is used as an *agc* rectifier. In this circuit



the video *if* carrier envelope is applied to the *agc* diode plate, and *agc* cathode is returned to ground through a resistor network consisting of 82,000 and 470,000 ohms and 1 megohm ( $R_{22}$ ,  $R_{41}$  and  $R_{43}$ ). When the polarity of the video *if* carrier is such that the *agc* diode plate is positive with respect to ground, it will conduct and current will flow through the resistor network. The *agc* voltage output is taken from the voltage drop across the 1-megohm resistor,  $R_{43}$ . A .1-mfd capacitor ( $C_{135}$ ) across  $R_{43}$  and  $R_{41}$  forms an RC filter to further eliminate the *if* carrier and video component. The final rectified and filtered output from the *agc* rectifier is applied through a 1-meg unit ( $R_{42}$ ) to the control grid of the 6AT6 *agc* amplifier.

The *agc* circuit is unique inasmuch as a portion of the horizontal sawtooth sweep voltage from the horizontal sweep circuit is amplified, rectified, and then applied as *dc* to the 6BH6 *rf* amplifier and the input and first video *if* amplifiers as control grid bias. The amplification of the sweep voltage by the 6AT6 is controlled by the amplitude of the positive *dc* voltage supplied by the *agc* rectifier portion of the 6AL5.

[To Be Continued]

#### Zenith Circular Screen Receiver

In our analysis of the *agc* circuit used in the Zenith circular screen TV model, last month, we stated that the circuit consists of a cathode follower (one-half of a 12AT7), and a cathode-coupled grounded grid amplifier (one-half of a 6SL7GT), which obtains its plate voltage (15.75 kc sine wave) from the horizontal oscillator. The sync pulses which are applied to the grid of the 12AT7 are negative with respect to its cathode. As the sync pulse amplitude increases, with an increase in signal input, the grid is driven more negative resulting in less plate current flow and consequently less voltage drop across a cathode resistor. Since the bias of the 6SL7GT is developed across this resistor, the reduction of the voltage drop causes this tube to conduct more current which in turn leads to the development of additional negative feedback voltage for application to the *rf* and *if* grids. Now the application of the 15.75 kc sine wave voltage allows the tube to conduct during the positive half cycles. This is an *open gate* condition and exists at any time that the combined sine wave and sync pulse amplitude makes the plate of the 6SL7GT positive with respect to its cathode. During this conduction period (open

(Continued on page 32)

# Diamonds cost less . . .

**P**ICK-UP cartridges equipped with diamond styli may cost more than sapphire or metal stylus cartridges, initially, but the useful life of a diamond stylus cartridge is so much greater than the difference in cost that, from the viewpoint of length of service, listening pleasure and record life, diamond styli cartridges are cheapest by any comparison.

For those who want and demand the highest quality record reproduction and who don't want their records chewed up by being played with worn styli, the values of a Pickering Diamond Cartridge will prove most significant.

Pickering Diamond Cartridges are unique—their supremacy is unchallenged. They meet the exacting requirements of the most critical listener who wants to hear the realism and brilliance originally recorded and which makes record playing such a pleasure. The design and manufacture of Pickering Diamond Cartridges include all known factors which minimize record wear and eliminate unpleasant, annoying sounds while recreating the quality, brilliance and realism of the original recording.



The diamonds used for the stylus of Pickering cartridges are whole diamonds and not splints. They are more resistant to damage than any other stylus gem material (sapphire, ruby or diamond splints). They are well cut, gem-polished to high accuracy and precisely mounted to ride smoothly in the groove walls, reproducing all the fine modulations which can be pressed into modern recordings.

Pickering Diamond Cartridges are good for thousands of playings . . . compared with hundreds for sapphire and less for metal styli. An authority writing on wear resistance of stylus materials, states— ". . . the ratio of wear resistance between diamonds and sapphires is 90 to 1 in favor of diamonds."

Pickering Diamond Pick-up Cartridges are true gems for record playing . . . and cost less.

**Model D-120** for transcriptions  
lacquer discs

**Model R-150** for phonograph records

**Model D-140** for microgroove records

Order your Pickering Pick-up Cartridges  
from your favorite jobber.

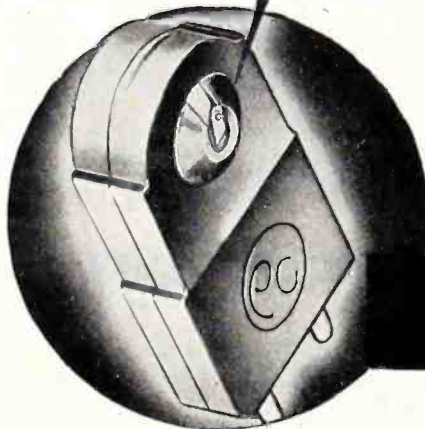

# PICKERING

& COMPANY, INCORPORATED  
OCEANSIDE, NEW YORK

(Continued from page 31)

**BRACH**

# TV ANTENNAS

build your  
**PROFITS**  
these **3** ways

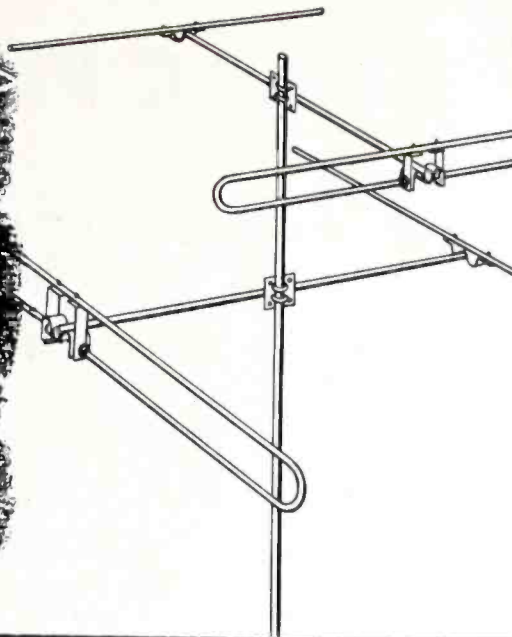

**1. SAVE INSTALLATION TIME.** Actually save enough for additional installations each week. Simplicity of Brach Antenna design, together with maximum pre-assembly at the factory, take whole hours of "time-on-the-roof" off your installation costs. And, for easier, quicker, on-the-job handling, Brach TV Antenna Kits are individually packaged, complete with all necessary hardware. Brach Universal Base Mount is a real time saver.

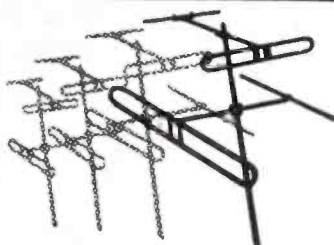

**2. ELIMINATE EXPENSIVE CALL-BACKS.** Brach quality engineering and bulldog ruggedness combine to help make your initial installation completely satisfactory. Developed by a name as old as radio itself, Brach TV Antennas are products of the manufacturer's own laboratory. From the rugged structural steel base mount to the tip of the sturdy mast, they're designed to stand up and shrug off the worst the weather has to offer—and deliver superior reception—longer. Factory pre-tuned and matched for 300-ohm transmission line, all Brach Antennas feature large-diameter aluminum elements for better signal pick-up.

**3. MAKE PURCHASERS YOUR BEST SALES-MEN.** The future success of your television line depends upon the success of your past installations. There's a Brach TV Antenna to meet every television problem better. Each Brach array you install puts you further ahead of your competition performance-wise.

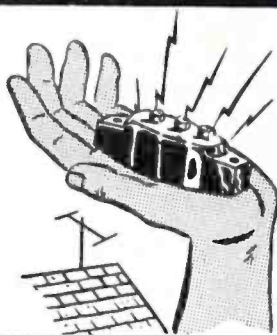
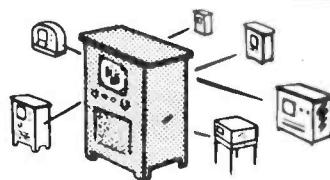

### A NECESSARY EXTRA BRACH LIGHTNING & STATIC ARRESTER #4004

Helps keep the buck and jump out of the image when due to static discharge. Protects certain delicate receiver parts. Complete with all necessary hardware, the Brach Rare Gas Arrester is easily attached to any downlead. Constructed of porcelain and non-corrosive metal parts. Tested and listed by Underwriters' Laboratories.

SEND FOR BRACH CATALOG NO. S-1304

**BRACH**

# L. S. BRACH MFG. CORP.

200 CENTRAL AVENUE, NEWARK, N. J.

WORLD'S OLDEST AND LARGEST MANUFACTURERS OF RADIO ANTENNAS AND ACCESSORIES

gate period) *agc* voltage is developed across a .01-mfd capacitor. The brief period of time that the gate is open is slightly longer than the 5 micro-seconds duration of the horizontal pulse. However, during the comparatively long interval of time between pulses, the gate is closed and noise pulses can have no effect on the *agc*.

The primary advantage of the gated *agc* system is its relative immunity to noise. Another advantage is the fact that short time constants are used which enable the *agc* to follow much faster changes in amplitude such as those developed by airplane reflections.

### The Vertical Sweep

The purpose of the vertical sweep is to gradually move the electron beam from the top to the bottom of the picture tube as it is swept from left to right by the horizontal sweep. It requires approximately 15,500 micro-seconds for the beam to move from the top of the picture tube to the bottom and approximately 1,166 micro-seconds to again return to the top for the next field. This period of time is the retrace and is blanked out. The frequency of the vertical sweep is 60 cycles. Because the 15.75-kc horizontal triggering must never stop, even during the vertical retrace, the vertical pulses are serrated so that they continue triggering the horizontal oscillator. Since the horizontal sweep continues, the beam does not go directly from the bottom of the picture tube to the top during the retrace. It is zig-zagged back to the top by action of the horizontal sweep. The retrace can be observed by reducing the contrast and advancing the brilliance control. Six equalizing pulses precede and follow the serrated vertical pulse to stabilize the circuits before and after the vertical sync pulse.

Both the horizontal and vertical pulses enter an integrating and filter network which consists of three 8,200-ohm resistors, and three .0047-mfd capacitors. Because of the long time constant in the integrating circuit, the short duration horizontal sync and vertical equalizing pulses have very little effect on developing a charge across the integrating capacitors. The slight charge that does develop leaks off during the interval of time between pulses and for all practical purposes, has no effect. The serrated vertical pulse, on the other hand, has a time duration of approximately 190 micro-seconds and very little time interval between pulses. Each pulse charges the integrating capacitor to a higher



potential until the voltage becomes high enough, and properly shaped, to trigger the blocking oscillator. A blocking oscillator (one-half of 6SN7GT) is designed so that its natural frequency corresponds to the approximate vertical frequency of 60 cycles. Its frequency of oscillation is determined by the  $rc$  time constant of a .01-mfd capacitor and the resistance in the grid circuit which consists of a *vertical hold control* and a 1-megohm resistor. The vertical hold control is adjusted to fire the blocking oscillator earlier than at its natural frequency, the time being determined by the vertical sync pulses from the transmitter. The circuits must be arranged so that the oscillator is triggered solely by the vertical synchronizing pulses and not from any other source such as noise, etc. When the positive sync pulse from the integrating and filter circuits appears at the grid of the blocking oscillator, the tube conducts heavily and its plate voltage is induced into the grid by transformer action through  $T_7$ . This makes the grid more positive and causes grid current flow which develops a bias voltage across the grid resistor, charging the .01-mfd capacitor to the value of the bias voltage. When the bias voltage becomes sufficiently high, plate current cut-off occurs. The charge on the .01 capacitor gradually diminishes, but because of the  $rc$  time constant the tube remains cut-off until the next positive pulse starts conduction and the next cycle.

A vertical saw-tooth voltage is developed across a .047-mfd vertical charge discharge capacitor. When plate current cut-off occurs, there is no appreciable voltage drop across the plate load resistor, which consists of the *vertical size control* and 470,000-ohm series resistor. Because there is no voltage drop the capacitor charges to nearly full plate potential in approximately 15,500 microseconds. This is the sweep portion of the saw-tooth voltage. When the vertical sync pulse causes the blocking oscillator to conduct again, the capacitor discharges through the internal resistance of one-half of the 6SN7GT. This is the retrace and occurs in approximately 1,166 microseconds. An 8,200-ohm resistor, in series with the charge discharge capacitor, shapes the voltage so that it will have a combination of saw-tooth and pulse which is necessary to produce a saw-tooth current through the deflection coils. A 6V6GT vertical amplifier develops the relatively high current for deflecting the beam.

A 5,000-ohm vertical linearity control shifts the operating point of the

(Continued on page 34)

# LP FLASH!

## Alliance Announces . . .

## TWO New Record Players!

Why Worry About Which Speed?

End your L-P Problems with  
these two Alliance FIRSTS!

### NEW—

Dual-Speed 33 1/3 and 45 r.p.m. Record Player (Model J.P.D.) combines both new slower speeds in one single player unit, complete with motor and turntable. Ideal as a single player, it can also be adapted to record changers!

### NEW—

Single-play 45 r.p.m. record player (Model J.P.-45), expressly for the new 45 r.p.m. records . . . a complete motor and turntable assembly.

Starting on March 1st, Alliance announced mass production on both new models! Like all other Alliance Phonomotors, they are built and engineered for long life and trouble-free operation.

*Service Repair Shops, Retail Service Dealers and Retailers* can order the new Alliance L-P players from their regular jobber. Both players come individually boxed—will make ideal units for conversion work and for resale to customers.

Meet the rapidly growing demand caused by the popular trend to the new record speeds by ordering Alliance players from your jobber—NOW!

## alliance motors

ALLIANCE MANUFACTURING COMPANY • ALLIANCE, OHIO  
Export Department; 401 Broadway, New York, N. Y., U. S. A.

Quality  
Engineered

# TRANSVISION

Precision  
Manufactured

## TELEVISION INSTRUMENTS

### EQUIPMENT AND COMPONENTS

For Better TV Performance and Lower Installation Costs

#### Eliminate the Variables in Television Installation with the Transvision FIELD STRENGTH METER

Improves Installations!! Saves 1/2 the Work!!

Has numerous features and advantages, including—(1) Measures actual picture signal strength . . . (2) Permits actual picture signal measurements without the use of a complete television set . . .



- (3) Antenna orientation can be done exactly . . .
- (4) Measures losses or gain of various antenna and lead-in combinations . . .
- (5) Useful for checking receiver re-radiation (local oscillator) . . .
- (6) 12 CHANNEL SELECTOR . . .
- (7) Amplitudes of interfering signals can be checked . . .
- (8) Weighs only 5 lbs. . .
- (9) Individually calibrated . . .
- (10) Housed in attractive metal carrying case . . .
- (11) Initial cost of this unit is covered after only 3 or 4 installations . . .
- (12) Operates on 110V, 60 Cycles, AC.

Model FSM-1, complete with tubes Net \$99.50

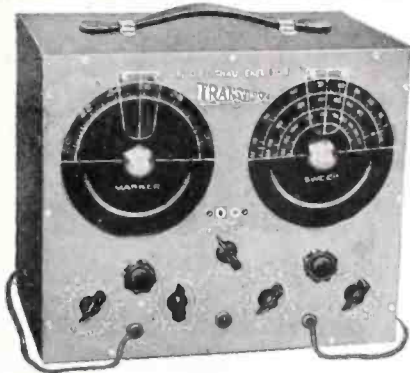

#### TRANSVISION TELEVISION and FM SWEEP SIGNAL GENERATOR

Complete frequency coverage from 0-227 MC with no band switching. . . Sweep width from 0-12 MC completely variable. . . Accurately calibrated built-in marker generator.

Model SG . . . . . Net \$99.50

#### TRANSVISION ALL-CHANNEL TELEVISION BOOSTER CONTINUOUS TUNING



Model B-1 . . . . . List \$32.50

#### TRANSVISION IS NOW EXCLUSIVE DISTRIBUTOR OF DU MONT TV/FM INPUTUNER

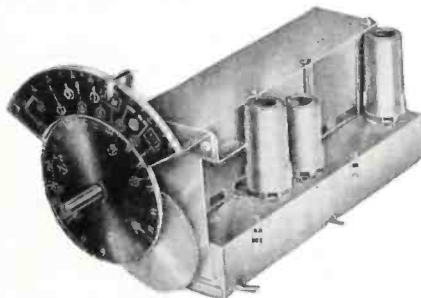

Model IT-1, with tubes . . . . . List \$59.95

All Transvision Prices are fair traded; subject to change without notice. Prices 5% higher west of the Mississippi

TRANSVISION, INC., Dept. S, NEW ROCHELLE, N. Y.

Please ship the following Transvision Products THROUGH YOUR NEAREST LOCAL OUTLET:—

S-4

I am enclosing 10% DEPOSIT in the amount of \$ . . . . ., balance C.O.D.  
( ) I want to get into the Television Business. Send me details of your Dealer Plan.

Name . . . . . City and Zone

(please print)

Address . . . . . State

(Continued from page 33)

tube so that the sweep is amplified along that portion of the plate current curve which results in a linear output.

Because the impedance of the vertical deflection coils is high at the 15.75-kc horizontal frequency, two 560-ohm damping resistors are shunted with the windings to prevent interaction between the two sweep voltages.

#### The Horizontal Sweep

The purpose of the combined horizontal sweep circuits is to develop a saw-tooth current through the horizontal deflection coils which produces a magnetic field that moves the electron beam horizontally across the picture tube. The horizontal synchronizing pulses from the transmitter must solely control the sweep. Noise pulses must be discriminated against so they are unable to produce triggering, and cause erratic operation and instability. The saw-tooth voltage originates in the plate circuit of a 6SN7GT horizontal discharge tube. The horizontal discharge tube could be triggered by noise as well as sync pulses. This very undesirable factor is overcome by designing the sweep so that the frequency and not the amplitude of the transmitted sync pulses control it. The frequency control circuit consists of a 6K6GT 15.75-kc horizontal oscillator, a 6AL5 phase detector and a 6AC7 reactance tube. The reactance tube, which is in parallel with the 15.75-kc horizontal oscillator resonant circuit, acts as a shunt reactance and affects the frequency of oscillation. The amount of shunt reactance depends on the mutual conductance of the tube, which in turn is dependent on the grid voltage. A change of .5 volt on the oscillator grid produces a corresponding frequency change of approximately 100 cycles. Normally the reactance tube is biased at -2.4 volts. It will be noted that this bias is in series with the *dc* output from the phase detector, and that the phase detector output voltage affects the reactance tube grid voltage.

The sync pulses from the sync separator are applied through a 75-mmfd capacitor to the center tap of the phase detector winding. Although the amplitude of each individual sine wave and sync pulse remains the same, the combined pulse and sine wave amplitude changes with difference in phase. At resonance, the horizontal oscillator is properly phased with the sync pulses. Each diode conducts equally and the *dc* voltages across the two load resistors are the same but opposite in polarity. The resultant voltage across the full load (cathode to cathode) is



zero. Since the output is zero, no change in grid voltage occurs and results in no oscillator frequency change. Under *high frequency* condition, the horizontal oscillator frequency is above that of the incoming sync pulses and the plate of the upper diode has a higher combined sine wave sync pulse amplitude than the lower diode. This results in more current flow in the upper diode circuit and a resultant positive difference voltage across the phase detector load. The positive voltage adds to the  $-2.4$ -v fixed bias and makes the grid more negative causing the shunt reactance to increase by the amount necessary to lower the frequency of the horizontal oscillator. Under a *low frequency* condition, the lower diode conducts more current and the difference voltage is negative. This voltage subtracts from the  $-2.4$  bias and makes the grid of the reactance tube less negative. A reduction in the shunt reactance occurs causing an increase in the frequency to correspond with the incoming sync pulses.

The *horizontal hold control*, which is connected from the grid of the horizontal oscillator to chassis, has a slight effect on the natural frequency of the oscillator. It is used to adjust the oscillator frequency to approximately that of the sync pulses after which the phase detector and the reactance tube assume control.

The output from the plate of the horizontal oscillator is a flat topped wave which is differentiated for triggering the discharge tube. A sawtooth voltage is developed by charging and discharging a 600-mmfd capacitor. The capacitor charges when the grid of the 6SN7GT becomes highly negative, due to the charge accumulated by a .01-mfd grid capacitor, and cuts off plate current flow. Since the tube does not draw plate current when cut off, there is no appreciable voltage drop across a 680,000-ohm plate load resistor and the capacitor charges to approximately full plate potential. It is the linear charge of this capacitor that produces the trace portion of the sawtooth voltage. When the positive half of the pulse appears at the grid, the horizontal discharge tube conducts heavily and the 600-mmfd capacitor discharges through it. The charge of the capacitor is the trace, and the discharge is the retrace.

#### The Damping Tube

The linear rise of current through the horizontal deflection coils moves the electron beam from the left to the right side of the picture tube in approximately 53 microseconds. The

(Continued on page 36)

# LOSE NO

# TIME

1

MAKE THE SALE!

2

MAKE THE INSTALLATION!

3

MAKE THE PROFIT!



With only 3 basic

models in the HANDY

TORQUE-DRIVE SALES and SERVICE

KIT, you can immediately replace any one of over

150 standard type pickup cartridges in common use. There's no

special trip to make to your supplier for a cartridge . . . there's no lost time,

no lost sale! You make a quick profit . . . you make your customer happy . . .

and you actually give him a superior cartridge! Ask your E-V Distributor or

send for Bulletins 141-142. (New Model L14 Microgroove Crystal Cartridge also available)

E-V Pat. Pend. Licensed under Brush Patents

**ELECTRO-VOICE, INC.**  
BUCHANAN, MICHIGAN

Export: 13 E. 40th St.,  
New York 16, U.S.A.  
Cables: Arlab

IT PAYS TO REPLACE WITH

# Electro-Voice



# Announcing A NEW LINE

Speakers illustrated are the PM5A and the PM57E permanent magnet speakers.

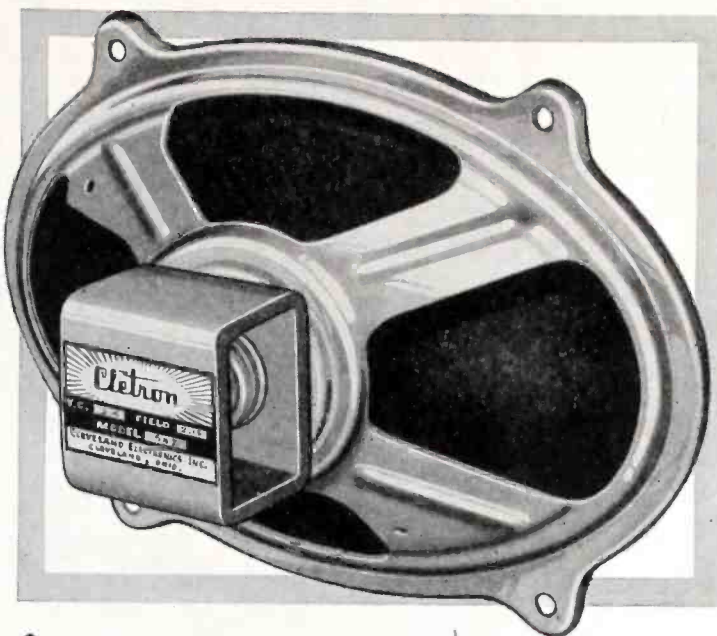

## Now AVAILABLE TO JOBBERS

A NEW NAME in radio replacement speakers . . . . CLETRON . . . . and a new source of Electro Dynamic and Permanent Magnet speakers in all types and sizes. Cletron Speakers feature Aluminum Voice Coils, rugged design, careful engineering and beautiful baked-enamel finish. Now available for immediate delivery. Write for details and prices. Cleveland Electronics, Inc., 6611 Euclid Avenue, Cleveland, Ohio.



### RADIO LOUDSPEAKERS

6611 EUCLID AVENUE  
CLEVELAND, OHIO  
MORHAN EXPORTING CORP.  
458 BROADWAY, N. Y., N. Y.

### Ser-Cuits

(Continued from page 35)

current must then return to its starting value in approximately 7 microseconds to produce the retrace. This sudden collapse of current through an inductance, produces an oscillatory condition which would destroy the linearity of the sweep and must be removed by a 5V4 damping tube. When the plate of the damping tube becomes more positive than the cathode, conduction occurs which heavily loads the circuit and prevents the undesirable oscillation. As a result of the conduction, a *dc* potential of approximately 80 volts is

developed and stored in a .25-mfd capacitor. This voltage is added to the plate voltage of the 6BG6 horizontal amplifier and raises its potential from 400 to 480 volts for greater output and better performance.

#### The Beam Bender

The electron gun of a picture tube emits both electrons and ions. The ions are much heavier than the electrons and if allowed to bombard the picture tube fluorescent screen, damage in the form of a burn could occur.

Picture tubes, such as the 10FP4 and 12KP4 which are used in some of these models, are constructed with

a metal backing directly behind the fluorescent screen. The high velocity electrons penetrate the backing and strike the fluorescent screen. Low velocity ions cannot penetrate the backing and do not reach the fluorescent screen where damage could occur.

Picture tubes, such as the 10BP4 and 12LP4 which are employed in other models of this series do not have a metal backing behind the fluorescent screen and if the ions were allowed to bombard the screen, a brown burn spot would result. To prevent this condition, the electron gun of these tubes is slightly bent so that the ion and electron stream is directed at the neck rather than at the screen of the tube. A beam bender, which is a permanent magnet fitted around the neck of the tube, bends the electrons back into their proper axis so that they strike the screen. The heavier ions are not affected by the magnetic field and do not reach the screen.

The beam bender has an identifying arrow stamped on it. When it is installed, the arrow must point towards the face of the picture tube. To make the adjustment, the beam bender should be moved and rotated along the neck of the tube until the brightest picture appears. It may be necessary to readjust the focus and intensity controls during the adjustment.

#### The Focus Coil

The *dc* flow through the focus coil develops a magnetic field which is parallel to the electron beam in the picture tube. As long as the parallel condition exists, the magnetic field remains uncut by the electrons and has little effect. If the electrons diverge from the parallel path, the magnetic field is cut and counters to force them back into their proper axis. An improperly adjusted focus coil causes the electron beam to hit the neck rather than the face of the picture tube, causing the corners of the raster to be shadowed.

#### Vertical Centering Control

A 20-ohm vertical centering control changes the polarity and magnitude of *dc* flow through the vertical deflection coils. Current flow develops a magnetic field which shifts the raster in a vertical plane. Since the centering control is in series with the 400-volt supply, current flow through the various circuits in the receiver produces the necessary voltage drop across it. Because the centering voltage is obtained from the center tap and arm of the control, voltage to the de-



flection coils can be positive, negative or zero, depending on the position of the arm.

**The Horizontal Centering Control**

A 100-ohm horizontal centering control regulates the polarity and magnitude of the *dc* flow through the horizontal deflection coils. The current flow develops a magnetic field which shifts the electron beam for proper horizontal centering of the picture. Two voltages which are in opposition, produce the current flow. Voltage 1 is developed by the damper tube and voltage 2 results from the drop across the centering control. Since the voltages are in opposition, current flow can be reversed by adjusting the centering control so that the difference voltage is either negative or positive.

**The Width Control**

A horizontal output voltage appears between terminals 1 and 3 on the output transformer  $T_{11}$ . A portion of the secondary winding is shunted by a variable inductance,  $L_w$ , which is the width control. Varying the position of the slug changes the shunt inductance and results in changing the magnitude of sweep voltage across the horizontal deflection coils. As the shunt inductance increases, the output voltage increases and the pattern widens horizontally. When the slug is removed from the coil, the shunt inductance is at minimum and the voltage and pattern width is minimum.

**Supreme 660 TV 'Scope**

In Fig. 2 appears the circuit of an unusually interesting TV test instrument, the Supreme 660 TV 'scope, which has wideband amplifiers in both the vertical and horizontal sections and a wide-range sweep oscillator (7 cps to 150 kc in seven steps).

In the vertical amplifier are a 6J5 cathode follower, 6AC7 voltage amplifier, and two 6AG7 power amplifiers. There are three tubes in the horizontal amplifier, a 6J5 cathode follower and two 6AC7 power stages. The sweep generator uses a 6SN7 and one-half of a 6SN7 as a sweep control tube, while the other half of this tube is used as a Z-axis amplifier. A 6C4 is employed in the probe, which can be used to trace the signal from the output of the *rf* stage through the converter stage, the *if* and to the plate of the power-output tube.

**THE TURNER MODEL 22**



**PREFERRED FOR PERFORMANCE**

**Time-tested general-purpose crystal or dynamic microphone**

The most popular general purpose microphone on the market. The Turner Model 22 has an exceptionally smooth response that appeals to discriminating users yet the price is moderately low. A great favorite with amateurs and widely used in paging and call systems, recording, and general sound work indoors or out. Fully shielded to prevent r-f pickup. Distinctive modern styling and rich satin chrome finish. Equipped with full ninety-degree tilting head and quick-change removable cable set.

**MODEL 22X CRYSTAL**

high quality humidity protected crystal in mechanical shock proof mounting. Response: 50-9000 c. p. s. Level: 52 db below 1 volt/dyne/sq. cm. List . . . . . \$20.00

**MODEL 22D DYNAMIC**

featuring high quality Alnico magnets in well balanced acoustic circuit. Response: 50-9000 c. p. s. Level: 54 db below 1 volt/dyne/sq. cm. at high impedance.

200, 500 ohms, or high impedance . . . . . \$25.50  
50 ohms. List . . . . . 23.50

**ASK YOUR DEALER**

**TURN TO TURNER FOR SOUND PERFORMANCE**

**THE TURNER COMPANY**

930 17th STREET N. E. • CEDAR RAPIDS, IOWA

**MICROPHONES BY TURNER**



Licensed under U. S. patents of the American Telephone and Telegraph Company and Western Electric Company, Incorporated. Crystals licensed under patents of the Brush Development Company.

# AMPHENOL TV ANTENNA

TEN YEARS AGO

From the Association News page of SERVICE, April and May, 1939

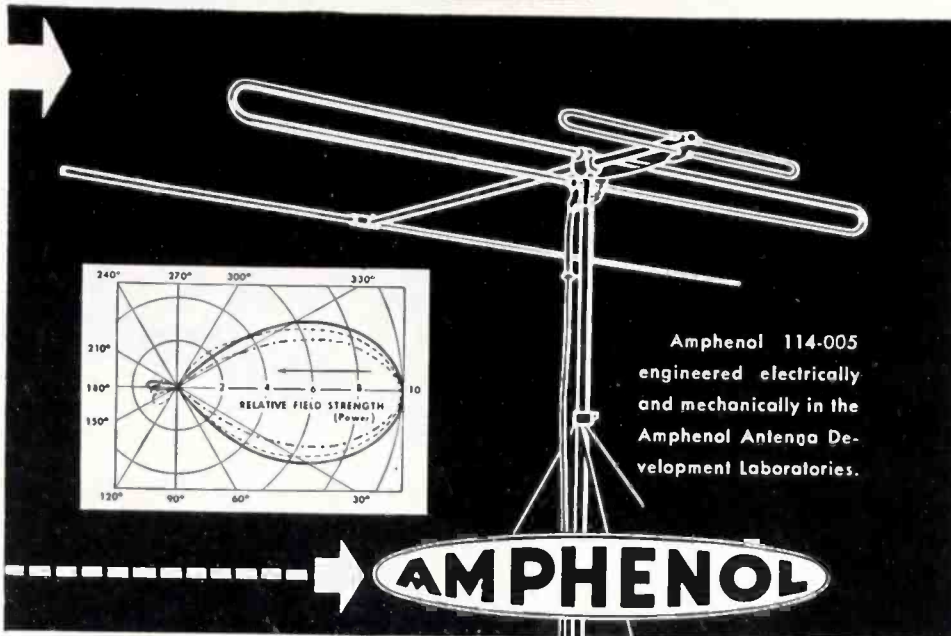

## ADDED GAIN MEANS BRILLIANT RECEPTION ON ALL BANDS

Streamlined and scientifically engineered for best reception and optimum gain, the Amphenol 114-005 Television Antenna incorporates two broadbanded folded dipoles and a low band reflector, with a common transmission line. Top performance is provided over all channels in both the high and low bands.

The radiation patterns as diagrammed are substantially unidirectional and maintain high front-to-back and front-to-side ratios over both bands.

The 114-005 is ideal for use with rotators.

## MORE SIGNAL STRENGTH BRIGHTER PICTURES

Standard Amphenol TV Antenna in stacked array (Model 114-301 or 114-302) provides additional high-gain for fringe areas. Each bay of the antenna may also be individually oriented in areas requiring reception from different directions.



## AMERICAN PHENOLIC CORPORATION

1830 SO. 54th AVE. • CHICAGO 50, ILLINOIS

## Association News

(Continued from page 21)

ods have been scheduled by the educational department of the Radio Technicians Guild of Rochester. A fee of \$2.50 a lesson is being charged. However, those who participated in the last television class will be admitted at no charge, provided dues have been paid. Classes are being limited to fifty persons.

The RTG report also discloses that the Council of the City of Rochester

has amended the municipal code relating to roof structures so that it now covers, in particular, antennas.

According to the code . . . "Antenna structures for television reception, not exceeding 16' in height, may be erected and maintained without a building permit, upon a roof of a building, providing such antenna structure is set back from any side of such building, which side is within 16' of any lot line of the lot on which the building is located.

. . . All antennas and masts shall be of substantial incombustible material and construction and shall be supported in

RESULTS of the annual election to the board of directors of the RSA were announced. Elected to serve until June 1, 1942, were George D. Wooley, Rock Island, Ill., sectional division 5; Fred Olson, Green Bay, Wis., sectional division 7; and Joseph A. Cole, Detroit, Mich., of sectional division 9, who was reelected. Elected to serve until June 1, 1941, were Frank L. Clark, Nashville, Tenn., sectional division 11; Winston B. Jones, Washington, D. C., sectional division 15; Carl A. Rauber, Somerville, N. J. (re-elected) sectional division 15; George F. Duvall, Brooklyn, N. Y. (re-elected), sectional division 15; and Norman W. Smith, Jamestown, N. Y., sectional division 19. Elected to serve until June 1, 1940, were Carl Williams, Phillipsburg, N. J., sectional division 14, and Ingvar Paulsen, Roxbury, Mass., sectional division 20. . . . Membership in the Chicago Chapter increased substantially, thanks to the special RSA TV service courses offered at the meetings. At one of the sessions, Charles Hirsch, chief engineer of Majestic, spoke on *Automatic Volume Expansion*, and supplemented his talk with demonstrations. At another meeting, members of the executive committee led a round-table discussion dealing with such topics as *What was the toughest service problem?* . . . The Radio Technicians Guild of Rochester set their plans for a one-day educational meeting on Sunday, May 28, at the Powers Hotel. . . . Chapters in Pekin, Ill., and Scranton, Pa., became affiliated with the RSA, bringing the total of active RSA Chapters to fifty-seven. . . . Second prize, a Rider IX manual, went to the Washington, D. C., Chapter for outstanding growth shown during the membership contest. . . . The greatest number of new members during the contest was obtained by the New York Metropolitan Chapter.

a rigid manner and shall be grounded in an approved manner. The antenna structure may be designed with a special heavy base of dimensions to make the mast self-supporting. All antenna structures 10' or over in height, with the exception of the self-supporting type, must be securely guyed."



## Servicing Helps

(Continued from page 25)

thus causing no damage to the meter movement.

To calibrate the meter a number of 5 or 10-megohm resistors are connected in series across the test prods.  $PB^1$  is depressed and the upswing noted or marked for say, values of 25-35-50 megohms, etc., depending upon the meter used. It is also possible to arrange pin jacks to enable the use of the meter in a standard multimeter tester, thus saving the cost of an extra meter.

If a capacitor is placed across the test prods and  $PB^1$  is depressed and held there until the capacitor is charged, the meter points will then return towards midscale. If no leakage is present the meter pointer will return to its original or mid-scale position. Leakage will be indicated by the meter pointer stopping at the 25-megohm mark on the meter scale. For example, a paper or mica capacitor of good quality will usually check above 50 megohms or higher.

$PB^2$  and the pin jacks marked capacity check are used to connect to an external capacity meter to check capacity tolerances. Releasing  $PB^2$  and depressing  $PB^1$  will provide a reading on the capacity meter.  $PB^3$  is used if desired to discharge the capacitors after all tests are made.  $PB^2$  and  $PB^3$  are, of course, only optional.

To provide rapid connection with the capacitor leads, a set of prods were made up using four old Schick razor blades set up in a V shape with the sharp edges facing each other and soldered to light metal right-angle pieces. One of the prods was made stationary, the other slotted to adjust to the various size capacitors.

## TV Changes

(Continued from page 27)

tions until maximum attenuation is obtained.

### Eliminating AF IF Regeneration

In the G. E. models 810, 814, 820, 830 and 835, audio regeneration may appear as a click in the speaker as the tuning control is tuned through the station. This can be eliminated by the use of a ceramic 5,000-mmfd capacitor across the audio *if* B lead. This capacitor is connected between the B and ground terminals at the terminal board located between the limiter tube socket and the discriminator transformer, T<sub>10</sub>.

# The little lamp that became the strong, silent type

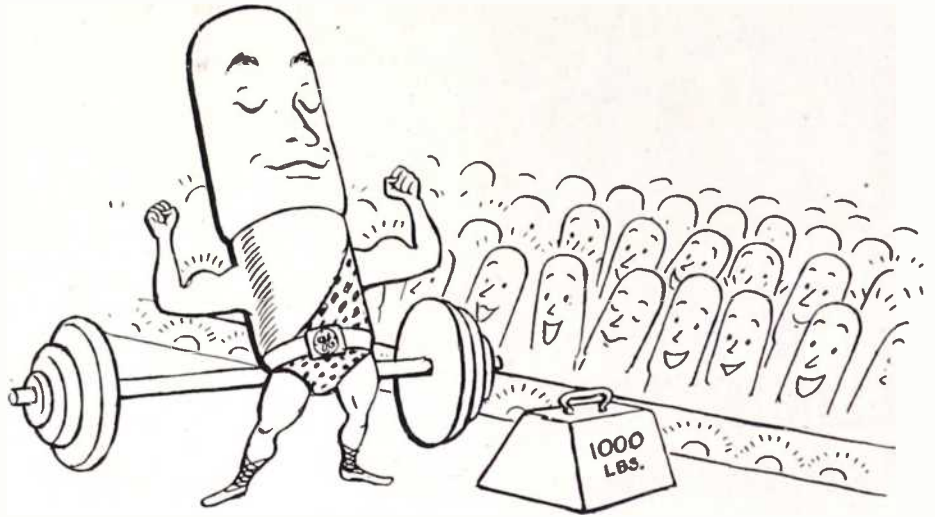

**L**IGHTING radio dials is no job for a "weaking" lamp. Testing many old style lamps, General Electric engineers found that certain frequencies caused severe vibration that often tore the filament apart. Poor contact between the filament legs and lead-in wires also resulted in tiny arcs or changes in resistance that caused radio interference.

That's why G-E dial lamps have been made "the strong, silent type." Improved design minimizes vibration, provides positive connection between the filament and lead-in wires.

For information on prices and types of G-E miniature lamps, call your nearby G-E Lamp office. Or write to General Electric Co., Division 166-S 4-49, Nela Park, Cleveland 12, Ohio.

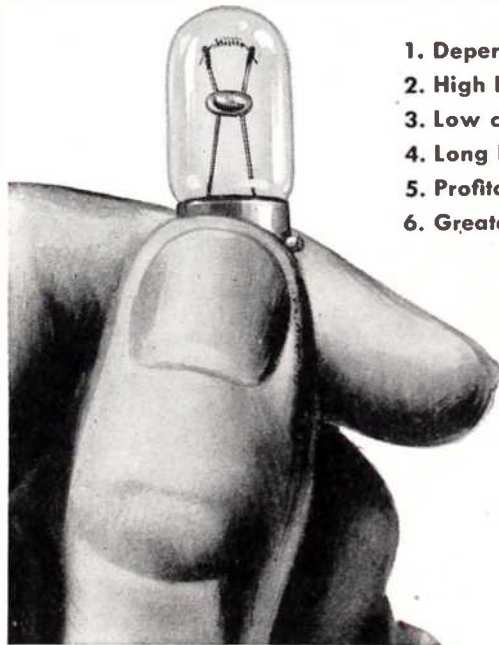

1. Dependable, trouble-free performance.
2. High level of maintained light output.
3. Low current consumption.
4. Long life.
5. Profitable to handle.
6. Greater dealer acceptance.

 Radio  
Dial Lights

**G-E LAMPS**  
**GENERAL  ELECTRIC**

FOR  
**DEMONSTRATING**  
 & **TESTING AUTO RADIOS**  
 from AC LINES



**ATR**

Visit ATR Booth 82  
 Chicago Radio  
 Parts Show

**"A" BATTERY  
 ELIMINATORS**



**for DEMONSTRATING AND  
 TESTING AUTO RADIOS**

New Models . . . Designed for testing  
 D. C. Electrical Apparatus on Regular  
 A. C. Lines. Equipped with Full-Wave  
 Dry Disc Type Rectifier, Assuring Noise-  
 less, Interference-Free Operation and  
 Extreme Long Life and Reliability.



**AUTO RADIO VIBRATORS**

A Complete Line of Vibrators . . .  
 Designed for Use in Standard Vibrator-Oper-  
 ated Auto Radio Receivers. Built with Pre-  
 cision Construction, featuring Ceramic Stack  
 Spacers for Longer Lasting Life.

NEW MODELS ✓ NEW DESIGNS  
 NEW LITERATURE ✓

ATR "A" Battery Eliminator, DC-AC Inverters,  
 Auto Radio Vibrators

See your jobber or write factory

**AMERICAN TELEVISION & RADIO Co.**  
 Quality Products Since 1931  
 SAINT PAUL 1, MINNESOTA-U. S. A.

**New TV Parts . . . Accessories**

**WARD INDOOR TV ANTENNA**

An indoor TV antenna, the TVI-43, has been announced by the Ward Products Corp., a Division of the Gabriel Co., 1523 E. 45th St., Cleveland 3, Ohio. Has chrome-plated brass telescopic dipoles. Will extend to 7' 9".

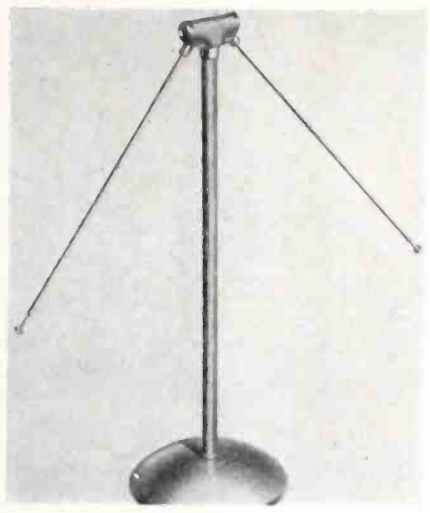

\* \* \*

**JFD TV ANTENNAS**

A series of TV antennas, the *D-Xer* line, has been developed by JFD Manufacturing Co., Inc., 6101 16th Ave., Brooklyn 4, New York.

One model, No. TA160, is a broadband conical antenna which has a 15° broadside tuning angle. Supplied with a *Wrap-Around* crossarm clamp employing an angular compression U-bolt.

A *Double D-Xer* stacked all-band conical television array, type TA 161, is also available.

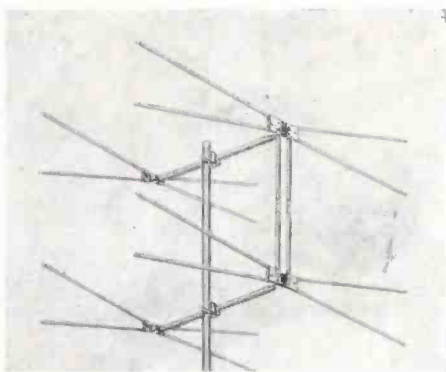

\* \* \*

**SYLVANIA TV REPLACEMENT TUBES**

A line of receiving tubes for TV receiver replacement service has been announced by the Sylvania Electric Products, Inc.

The line includes miniature, *GT*, and *Lock-In* styles, including: 1B3GT, 6AG5, 6AL5, 6BG6G, 6J6, 6K6GT, 7B4, 7B5, 7C5, 7F7, 7H7, 7N7 and 7Z4.

Tubes are identified by an orange branding, *Sylvania Television Tube* and orange and green cartons.

**PHILMORE CUSTOM-BUILT TV RECEIVERS**

TV receivers using 30-tube chassis, similar to the RCA 630TS and 830TS models, in completely wired form, are now available from the Philmore Manufacturing Co., Inc., 113 University Place, N. Y. 3, N. Y.

Receivers can be adapted for use with 10", 12" or 16" picture tubes.

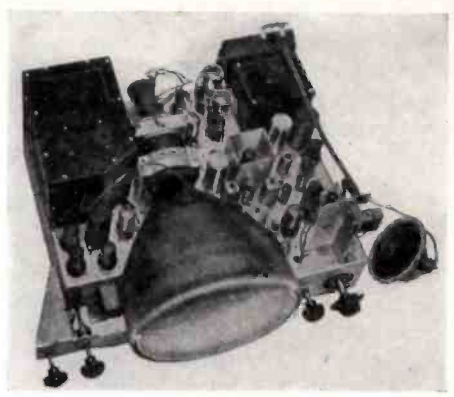

\* \* \*

**CHANNEL MASTER TV ANTENNA**

A TV antenna featuring two stacked dipoles on the low band and a stacked *vee* antenna on the high band, where the gain is said to be between 6 and 8 db has been announced by the Channel Master Co., 15 Chapel Street, Ellenville, N. Y. Antenna is said to be bidirectional.

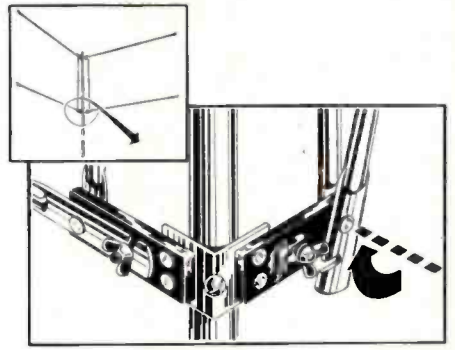

\* \* \*

**THALL TV LENS STAND**

A chrome-plated table stand for TV magnifying lenses has been announced by the Thall Plastics Engineering Co., 155 Chambers Street, New York City 7, N. Y.

Stand has a *tilt lock* arrangement, which in addition to the usual up-and-down adjustment, permits tilting in the vertical plane.





# American Beauty

## ELECTRIC SOLDERING IRONS

are sturdily built for the hard usage of industrial service. Have plug type tips and are constructed on the unit system with each vital part, such as heating element, easily removable and replaceable. In 5 sizes, from 50 watts to 550 watts.

## TEMPERATURE REGULATING STAND

This is a thermostatically controlled device for the regulation of the temperature of an electric soldering iron. When placed on and connected to this stand, iron may be maintained at working temperature or through adjustment on bottom of stand at low or warm temperatures.

## TRANSVISION TV ANTENNAS

A flip-up type TV antenna has been announced by Transvision, Inc., New Rochelle, N. Y.

Mast (7') of the antenna designed of non-conducting material which is said to prevent possible grounding and reduction of signal strength.

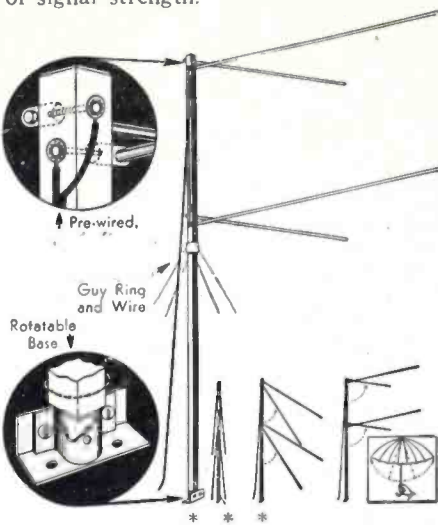

## WHEELER SOUND-POWERED PHONES

A two-way high impedance sound-powered communications system is now in production by The Wheeler Insulated Wire Company, Inc., 150 E. Aurora St., Waterbury 91, Conn.

The cord set of each unit is equipped with two rubber-insulated test clips. Handset caps and handle are molded of high impact black phenolic.



## PHILSON INDOOR TV ANTENNA

A TV-FM indoor antenna, the *Porta Vid*, has been announced by the Philson Manufacturing Co., 56 Chambers St., New York.

Dipoles are chrome plated. Supplied with 10-foot lead-in wire.

## G-C TELEVISION ANTENNA BRACKETS

Aluminum universal TV mounting brackets have been announced by General Cement.

One type, No. 8000, is a hinged mast bracket that can be used at any angle. Antenna can be assembled in downward position and then swung up. Another No. 8001 chimney mount, has brackets which can be spread to any width desired.

Holes are provided for universal mounting. Both types will hold masts up to 1 3/8" diameter.

# RCA

## TELEVISION COMPONENTS

**FIRST** in engineering  
**FIRST** in quality

Type 208T2 Vertical-Blocking Oscillator Transformer



Type 211T1 Horizontal-Deflection-Output and HV Transformer



Type 204T2 Vertical-Deflection-Output Transformer

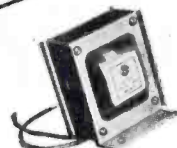

● *Better* because they're RCA-engineered . . . *widely accepted* because they're backed by the leader in television . . . RCA standard television components mean greater sales and service volume for you throughout the year.

RCA television components are the quality standards of the field for all TV replacement requirements.

Always keep in touch  
with your RCA Distributor

TURN TO NEXT PAGE

**RCA** ELECTRONIC COMPONENTS  
RADIO CORPORATION of AMERICA  
HARRISON, N. J.

For descriptive literature write

**AMERICAN ELECTRICAL  
HEATER COMPANY**  
DETROIT 2, MICH., U. S. A.



# ...Help end spark plug INTERFERENCE



Spark Plugs are miniature broadcasting stations, send signals that interfere with radio reception, distort television. The New Auto-Lite "Resistor" Spark Plug reduces this interference.\*



## Recommend NEW AUTO-LITE Resistor SPARK PLUG

### Here's How It Works to End Interference

The "Resistor" acts to dampen the spark plug radio signal to an acceptable level\* while still delivering the full high voltage discharge required to ignite the fuel.

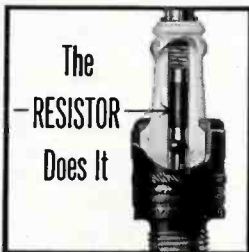

Auto-Lite Ignition Engineers, working with leading automotive manufacturers, have developed the new Auto-Lite "Resistor" Spark Plug with this built-in resistor that reduces spark plug interference.\* Remember, the "Resistor" also helps deliver smoother idling, improved economy, longer electrode life. Dealers are being supplied as rapidly as possible. Write for Booklet M-1186 for full information.

THE ELECTRIC AUTO-LITE COMPANY  
Toronto, Ontario Toledo 1, Ohio

\*Under 35mv/m from 540 k.c. to 150 m.c. at 50 ft.

Tune in "Suspense," Thursdays, 9:00 P. M., E. T., CBS

## New Parts, Accessories

### RCA MINIATURE LAMPS

A line of miniature lamps has been announced by the RCA Tube Department. The line includes sixteen different types for radio panel and miscellaneous replacement use, and eight types for flashlight replacement purposes.

### ARTISAN TOOL TRUCK BODY

An all-steel service truck body, model 60KD, for carrying tools and materials to and from the job has been announced by Artisan Products, Inc., 3540 West 140th St., Cleveland 11, Ohio. Model is for mounting on any late model 1/2 ton commercial chassis less the standard rear fenders. Service body is designed for shipping partially knocked-down to customer for final assembly and mounting on the chassis at destination.

Bulletin E describing body available upon request.



### TRIPLETT BATTERY TESTER

A pocket-size battery tester, model 698, which is said to provide tests, under actual load, of all dry batteries (1.5 to 90 volts), has been announced by The Triplett Electrical Instrument Co., Bluffton, Ohio. The condition of the battery is shown on a Low-?-Good three-color scale. Actual voltage readings may be made on the calibrated scales.

Size: 3 1/8" x 5 7/8" x 2 1/8". Weights: 1 1/4 pounds.



### THORDARSON REPLACEMENT TRANSFORMERS

A line of power and output replacement transformers (line 24) has been developed by the Thordarson Electric Manufacturing Division, Maguire Industries, Inc., 500 West Huron Street, Chicago.

Specific duty transformers available in four models; 2,000 to 25,000 primary impedance with 5 watts output.

Two models, universal output replacements, also available with four or eight watts output; primary impedance 4,000 to 14,000 and secondary impedance .1 to 29 ohms. Also announced is a universal line to voice-coil transformer with 70 v output taps, providing 10 watts with secondary taps from 1/4 to 10 watts.

## telrex INC. CONICAL ANTENNAS America's Outstanding Television Beam

- ★ The ONE antenna for ALL channels (no high frequency head needed)
  - ★ Maximum efficiency on ALL channels
  - ★ 4 to 1 front to back ratio on all frequencies
- TELREX Conical Antennas provide the highest possible gain to the receiver—since the full strength of the signal (as received at the antenna) is carried to the set with negligible loss—and with a definite reduction in the strength of ghosts or reflections.

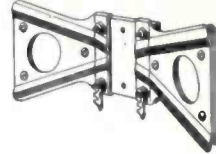

TELREX Conical Antennas are built better. Note this center clamp which provides such a strong grip over better than 3" of each rod surface. It is both a mechanical support and electrical contact second to none.

And is only one of the features which result in improved and steadier pictures—from a better antenna—a TELREX.

AVAILABLE IN A VARIETY OF MODELS TO MEET ANY NEED

At your distributor or write

**TELREX, INC.**  
ASBURY PARK 5, NEW JERSEY

## SURPLUS HIGH SPEED DRILLS MICROMETERS



Chrome plated, precision engineered and carefully tooling to give long life. All new.

- 0-1" capacity . . . each \$2.25
- 1-2" capacity . . . each 3.50
- 2-3" capacity . . . each 5.50
- 3-4" capacity . . . each 6.50



All New Drills! Orig. value \$15. 30 assorted sizes and lengths \$3.50

SEND FOR FREE DESCRIPTIVE CATALOG

Send check, money order or cash. 25% deposit required on C.O.D. orders. All prices F.O.B. Culver City, Calif.

**AIRBORNE SALES CO., INC.** DEPT. 5V  
CULVER CITY, CALIF.

### FM PERFECTUNER

A 5-tube FM tuner has been announced by the Perfect Products Co., 82-27 217th St., Queens Village, N. Y.

Housed in a walnut or mahogany cabinet. Has a temperature compensated oscillator. Incorporates a built-in antenna. Size: 8 3/4" wide x 6 3/4" high x 5 3/4" deep.

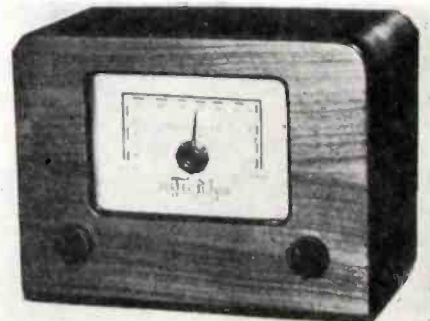



# SERVICEMEN

## Espey Radio Chassis

are

### Easy to Sell— Easy to Install—

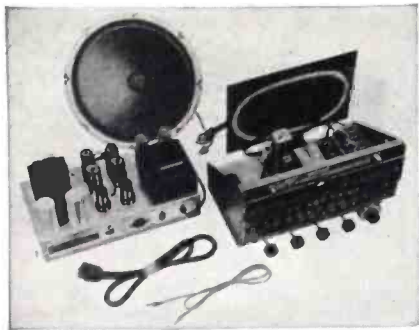

#514 AMPLIFIER #513 TUNER

**This New Deluxe Custom Built AM/FM Quality Chassis gives you increased Sales in the profitable Chassis Replacement market.**

Here is exquisite high fidelity in chassis form that will grace the finest cabinet.

The 513 De Luxe Tuner is easy to install in any console cabinet, old or new, and embodies the latest engineering refinements for lasting high quality at a price that defies competition.

The Espey 513 Tuner employs 10 tubes plus tuning indicator in a super heterodyne circuit and features a drift compensated circuit for high frequency stability, tuned RF on AM and FM plus phono input provision, and separate AM and FM antennas.

**Model 514 De Luxe Power Supply-Audio Amplifier** is designed specifically to work in conjunction with Model 513 Tuner, and is also used wherever a high quality audio amplifier is required.

With an output of 25 watts, Model 514 features a parallel push-pull output circuit, self-balance phase inverter system, extended range high fidelity response, and inverse feedback circuit.

**Write Dept. D2 for your free catalog.**

Makers of fine radios since 1928.

**ESPEY** TEL. BUTTERFIELD 8-2300  
**MANUFACTURING COMPANY, INC.**  
 528 EAST 72nd STREET, NEW YORK 21, N. Y.

## FOR T-V SERVICING

Investigate the Mega-line of instruments:

MEGA-SWEEP

MEGA-PIPPER

MEGA-MARKER

MEGA-MARKER SR.

Request Catalog

**Kay Electric Company**

19 Maple Ave., Pine Brook, N. J.

## GENERAL INDUSTRIES THREE-SPEED PHONO MOTOR

A three-speed motor, for 78 rpm,  $33\frac{1}{3}$  rpm and 45 rpm records, has been announced by the General Industries Company, Elyria, Ohio.

Three speeds are secured by positioning various spindles in contact with the idler wheel. The 78 rpm speed is secured in the conventional manner, with the rotor shaft directly contacting the idler wheel. For the slower speeds, secondary spindles are moved into contact with the idler wheel which automatically disengages the rotor shaft's contact. The secondary spindles are driven from the rotor shaft by specially compounded oil-resistant neoprene belts.

Speed shifting is accomplished by movement of a detented shift lever. Proper positioning of driving spindles for any one of the three speeds is assured by the positive detenting of the shifter assembly.

The entire mechanism is powered with a dynamically balanced two-pole shaded-pole motor.

Manual motor assemblies using  $6\frac{1}{2}$ ", 8" and 9" turntables are also available in which the three-speed principle is incorporated.

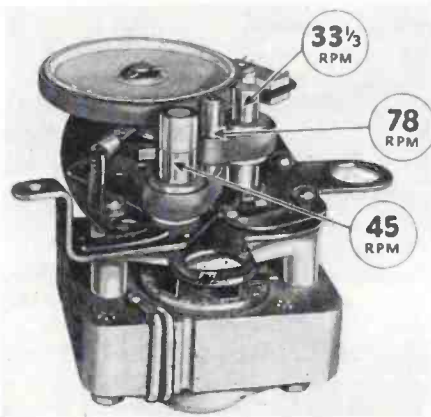

33 $\frac{1}{3}$  RPM

78 RPM

45 RPM

\* \* \*

## ASTATIC DOUBLE NEEDLE CARTRIDGE

A double-needle, turnover type pickup cartridge, the LQD, has been developed by The Astatic Corporation, Conneaut, Ohio.

Uses two separate, independent needles, one with one-mil tip radius to play the new long-playing records, and the other needle with three-mil tip radius for standard recordings.

Cartridge has a stamped aluminum housing. Frequency response is said to be 50 to 7,000 cps. Output voltages are 1.2 at 1,000 cycles with 78 rpm Audio-Tone test record; 0.75 with  $33\frac{1}{3}$  rpm Columbia 281 test record, and 0.5 with  $33\frac{1}{3}$  rpm Columbia 103 test record. Recommended needle pressures are 15 grams for 78 rpm and six to eight grams for  $33\frac{1}{3}$  rpm.

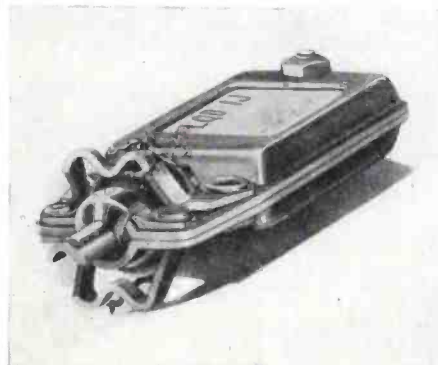

# RCA

## TELEVISION COMPONENTS

### A complete line for replacement purposes

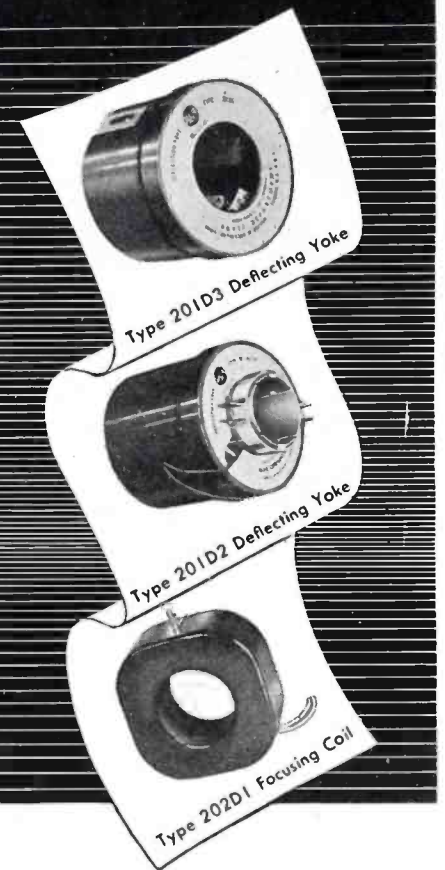

Type 201D3 Deflecting Yoke

Type 201D2 Deflecting Yoke

Type 202D1 Focusing Coil

● RCA has *all* the major components required for television receiver repair or construction. Designed at "Television Headquarters," RCA vertical and horizontal output transformers, yokes, focusing coils, etc., are the originals around which modern television receivers are designed. And you can get them all from *one* dependable source of supply . . . your local RCA Distributor.

Always keep in touch with your RCA Distributor

TURN TO NEXT PAGE

**RCA** ELECTRONIC COMPONENTS  
**RADIO CORPORATION of AMERICA**  
 HARRISON, N. J.



(Continued from page 26)

generator to its 4.5-mc crystal oscillator position, and feed the signal from its coaxial cable to the control grid (pin 4) of the 6AC7 video amplifier tube  $V_{13}$ , using a .1-mfd blocking capacitor to keep the *dc* on this grid from being grounded. Connection to the tube grid may be made by moving the tube, carefully looping one end of the blocking capacitor's pigtail around the prong of the tube, and replacing the tube in the socket, using a piece of spaghetti to prevent grounding this pigtail lead.

- (3) Using maximum output from the 4.5-mc crystal marker there will appear on the picture tube raster several faint horizontal bands of closely spaced wavy vertical lines, similar in some respects to diathermy interference. The tuning slug of trap coil  $L_{22}$  is adjusted to the point where these lines are either minimized or completely nulled out. The contrast control of the receiver should be at minimum and the brightness control near maximum for this operation.

### RF Alignment Procedure

To align the *rf* mixer and oscillator circuits of this receiver, the test equipment is set up in the same arrangement as was described in the previous installments, in connection with the preliminary overall alignment check. It will be recalled that this involves the use of the sweeping oscillator and the twelve channel crystal-controlled *rf* sound carrier marker generator, connected in tandem and fed through a coaxial-to-balanced resistive matching pad to the antenna input terminals of the receiver. Also, the alignment 'scope is connected to the receiver's *video test* terminal *G* as was previously described. The following procedure is then followed:

- (1) Disable the receiver *agc* circuit by placing a jumper from the *agc* amplifier grid (pin 4 of  $V_{13}B$ ) to the junction of  $R_{281}$  (contrast control) and  $R_{122}$ .
- (2) Set the contrast control to produce -4 volts of *rf* bias as measured with a *vtvm* from terminal *S* to chassis.
- (3) Push channel 2 button and then

# CHECK!

- ★ Smaller — only 15/16" dia.
- ★ With or without switch.
- ★ Features Clarostat stabilized element.
- ★ Tapers. Also with one tap.
- ★ Knurled aluminum shaft, standard.

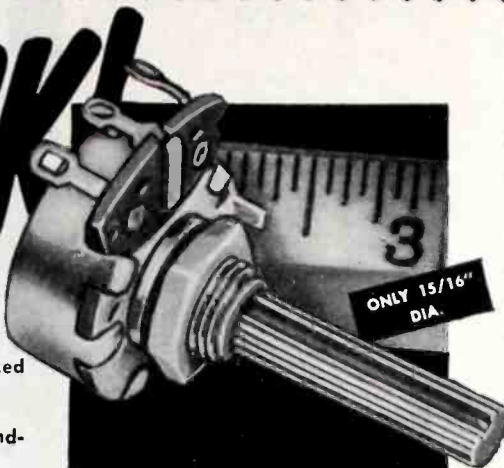

## THE MINIATURE CONTROL THAT "STAYS PUT!"

★ Just the thing for extra-tight spats. Quite a lot smaller than usual carbon controls yet does a full-sized job. And typically Clarostat construction: No-wiggle, no-wobble aluminum

shaft; easy-to-solder tinned terminal lugs; velvety-smooth rotation; longest-wearing element; special alloy contact arm; high immunity to humidity; and QUIET! This Clarostat 15/16" control is a honey!

Ask our jobber for  
15/16" Clarostat controls.  
Try them! Latest catalog on request.

CLAROSTAT



Controls and Resistors



CLAROSTAT MFG. CO., INC. • DOVER, NEW HAMPSHIRE • In Canada: CANADIAN MARCONI CO., LTD  
Montreal, P. Q. and branches



Ask for  
Model 533P

THE HICKOK ELECTRICAL INSTRUMENT CO.  
10521 Dupont Avenue • Cleveland 8, Ohio

## Dynamic Mutual Conductance TUBE TESTER

# HICKOK

Tests all the latest tubes, including television, with the famous HICKOK Dynamic Mutual Conductance circuits. Tests tube-life, an exclusive HICKOK feature. Scale readings are directly in Micromhos—a test originated and developed by HICKOK and used by most expert AM, FM and Television servicemen as the highest standard of accuracy.

For Originality

LOOK TO

# XCELITE

### 6 Quick-Change Screwdrivers in 1 Kit!

Kit includes XceLite "Combination-Detachable" Handle with these attachable double-end blades:

1. No. 1 Phillips and 3/16" Regular
2. No. 2 Phillips and 1/4" Regular
3. No. 3 Phillips and 5/16" Regular

The handiest kit you ever saw! ASK YOUR DEALER!

PARK METALWARE CO., Inc.

Dept. V, Orchard Park, New York

\*XCELITE REAMERS—ANOTHER XCELITE "FIRST". ALL fit the above handle.

PREFERRED BY EXPERTS



Quality Tools



trip button. Set the fine tuning capacitor at its half-way position.

- (4) Temporarily substitute the 29-39 mc *if* marker generator for the twelve channel *rf* sound carrier generator, and switch the marker oscillator to the 4.5-mc crystal position. There will appear on the displayed response curve a series of marker birdie harmonics every 4.5 mc up to well above the 15th harmonic. Identify the twelfth harmonic (54 mc) by means of the sweeping oscillator wavemeter and then adjust the receiver local oscillator trimmer capacitor,  $C_{25}$  (accessible by removing the chassis front cover plate located just below the face of the picture tube), until the 54-mc marker birdie disappears into the sound trap point on the displayed response curve. The sound trap point is on the high frequency side of the response curve when the overall *rf-if* characteristic is being displayed, as is the case for this setup.
- (5) Replace the twelve-channel crystal-controlled *rf* sound carrier generator, removing the 29-39 mc *if* marker generator from the setup.
- (6) Push channel 5 button on the receiver, retune the sweeping oscillator for a center frequency of approximately 79 mc (with a 15-mc sweep width) and switch the marker generator to channel 5.
- (7) Remove the channel 5 push button from the receiver and adjust the set-screw behind this button until the 81.75-mc crystal marker birdie disappears into the sound trap point of the displayed response curve.
- (8) Adjust *rf* and mixer trimmers  $C_6$  and  $C_{12}$  for maximum amplitude of the displayed response curve. (These trimmers are behind the same access plate as the oscillator trimmer discussed in step 4). At the same time that the response curve is maximized by adjustment of these trimmers it should also have *zero tilt* from its standard value. As the trimmers are adjusted to one side or the other the response curve will be seen to tilt slightly to the left or the right as well as becoming smaller in amplitude.
- (9) The remaining low channel buttons may now each be pushed

in any sequence, the marker oscillator and sweeping oscillator being set to the corresponding channel, and the push-button set-screws adjusted for the point where the marker birdie disappears into the sound trap point of the displayed response curve. This completes the *rf* alignment of the low channels.

For the *rf* alignment of the high channels, a similar procedure is employed:

- (1) Push channel 7 button and then trip button. Tune up sweeping oscillator to a center frequency of about 170 mc to obtain the response curve display on the 'scope.
- (2) Temporarily using the 29-39 mc *if* marker generator and obtain a 174-mc marker signal by using the fifth harmonic of this oscillator when it is set to 34.8 mc. Adjust the high-band oscillator trimmer  $C_{25}$  for the point where the marker birdie disappears into the sound trap point of the displayed response curve.
- (3) Reconnect the twelve-channel marker oscillator, set up channel 8 on the receiver, marker and sweeping oscillator, and adjust the push-button set-screw for absorption of the marker birdie into the sound trap point.
- (4) Adjust *rf* and mixer trimmers,  $C_6$  and  $C_{12}$ , for maximum amplitude and zero tilt of the displayed response curve.
- (5) The remaining high-channel buttons may now be pushed in any sequence and their set-screws adjusted as was done for the low channel buttons described in *rf* alignment step 9. This completes the *rf* alignment of the high channels, and the receiver is now ready for operation.

#### ALTEC MINIATURE MICROPHONE

A miniature microphone,  $\frac{1}{2}$ " in diameter and weighing less than  $\frac{1}{4}$  ounce, mounted on a tapering shaft shaped like a conductor's baton, and adaptable to all types of stand mountings or overhead suspensions, has been announced by Altec Lansing Corp., 161 Sixth Ave., N. Y. 13, N. Y.

Microphone is designed on the basis of electrostatic rather than magnetic principles. Moving element is a small diaphragm actually no larger than the human eardrum.

It is completely non-directional and can be mounted on a breastplate weighing a few ounces, as well as a lapel clip.

# RCA

## TELEVISION COMPONENTS

### The standards for TV set construction

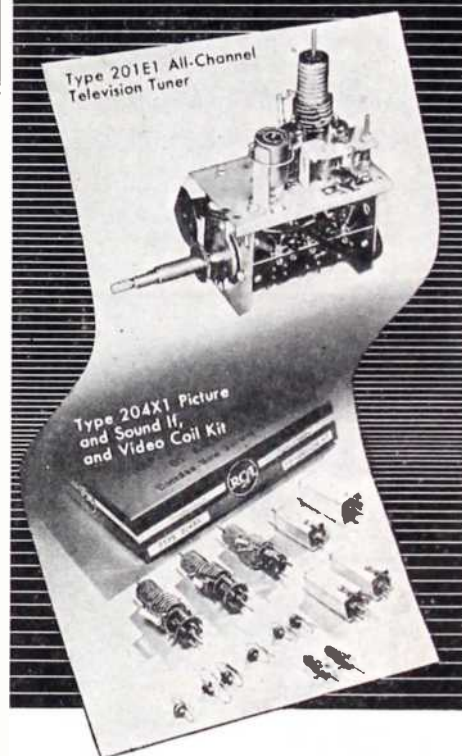

● You don't have to shop around for television parts. RCA has a complete line of genuine components and units for replacement needs . . . or shop construction of a top-quality television receiver.

The parts and units you need are all described in a new bulletin now available from your local RCA Distributor. Or write RCA, Commercial Engineering, Section 56CV, Harrison, New Jersey.

Always keep in touch with your RCA Distributor



ELECTRONIC COMPONENTS  
RADIO CORPORATION of AMERICA  
HARRISON, N. J.

*Best By Comparison!*

**THE MEISSNER 8C FM RECEPTOR**

**New Ceramic Components Assure Even Finer Performance**



This outstanding receptor now offers even finer performance, truer tone, more stability—the result of new design changes and the exclusive use, wherever possible, of ceramic components.

Designed for simple connection to present AM radio receivers, the 8C instantly converts them to standard AM or thrilling, static-free, high fidelity FM reception.

It is also excellent for use with Phono Amplifiers, or with Public Address Systems.

*Compare These Features:*

- **AUDIO FIDELITY:** Flat within plus or minus 2 db. from 50 to 15,000 CPS.
- **SENSITIVITY:** 40 microvolts.
- **AUDIO OUTPUT:** 3 volts R. M. S. at minimum usable signal input, 30% modulation. For greater signal inputs, output voltages as high as 15 volts R. M. S. obtained without distortion.
- **AMPLIFIER REQUIREMENTS:** Any high quality audio power amplifier may be used which has high impedance input and which will produce full output with 10 volts R.M.S. audio input.

**See and hear the new 8C Receptor at your Meissner Jobber.**

**MEISSNER** MEISSNER MANUFACTURING DIVISION  
Maguire Industries, Inc., Mt. Carmel, Illinois

*Be Sure...*  
Rely on these  
**ERIE RESISTOR**  
components



Be sure, too, that you visit ERIE RESISTOR at the Radio Parts Show, Chicago, May 16-20, Booth 142

*Electronics Division*  
**ERIE RESISTOR CORP., ERIE, PA.**  
LONDON, ENGLAND      TORONTO, CANADA.

*Another PHOENIX*  
*Speed Mount*  
**WALL BRACKET**  
Type PAB-8

Designed for fast, easy installation, the PAB-8 is made of rust-proof steel—allows 2 3/4" clearance from wall. Inexpensive — durable — ideal for most obstruction-free installations. Packed 12 to carton.

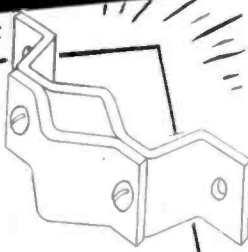

**LIST PRICE .....\$1.50 pair**

**PHOENIX ELECTRONICS, INC.**  
Lawrence, Mass.  
AT LEADING JOBBERS  
Write for folder M of complete line of television accessories.



**PHOTOFACT TV COURSE IN BOOK FORM**

The *Photofact* TV course, originally published serially in regular issues of *Photofact* folders, is now available in book form from Howard W. Sams & Co., Inc., 955 North Rural Street, Indianapolis, Ind.

Based on a series of sixteen theory and service orientation lectures originated by A. C. W. Saunders, the book incorporates an exposition of practical television receiver circuit principles, together with a coverage of television circuitry.

Illustrated with basic circuit diagrams, graphic functional charts and views of television parts, components and sub-assemblies.

Course was prepared under the personal direction of B. V. K. French, with the assistance of W. W. Hensler, W. D. Renner and J. R. Ronk of the Howard W. Sams engineering staff.

\* \* \*

**C-D FILTER DISPLAY**

A counter and window display unit with a reference guide for twelve assorted C-D *Quietone* filters is now available from Cornell-Dubilier Electric Corp., South Plainfield, N. J.

Filters in kit were selected as the most effective type for any application; two each of IF-4, IF-5, IF-6, IF-20, IF-24, and IF-54.

\* \* \*

**PHOENIX FOLDER**

A 6-page folder describing chimney mounts, wall mounts, vent-pipe mounts, wall brackets, universal antenna mounts, standoff insulators, mast and guy-wire clamps, and guy wire kits, has been prepared by Phoenix Electronics, Inc., Lawrence, Mass.

\* \* \*

**HICKOK CATALOG**

A 4-page folder describing and illustrating a line of dynamic mutual conductance tube testers, in counter, portable and display models, has been released by The Hickok Electrical Instrument Co., 10521 Dupont Ave., Cleveland 8, Ohio.

\* \* \*

**LEON ADELMAN NOW RMS SALES REP.**

Leon Adelman, 25 Chittenden Avenue, New York City, has been appointed sales rep for Radio Merchandise Sales, Inc., 550 Westchester Avenue, New York 55. Norman R. MacInnis, 53 Youle Street, Melrose, Mass., has also been appointed an RMS sales rep.

\* \* \*

**PICKERING BULLETINS**

Two 4-page bulletins describing cartridges and pickups have been prepared by Pickering and Co., Inc., Oceanside, N. Y.

One bulletin, No. PC48, covers crystal cartridges with sapphire and diamond styli for standard and microgroove recordings and an equalizer booster.

The second bulletin, No. PP48, contains data on magnetic type reproducers.



# favorite choice

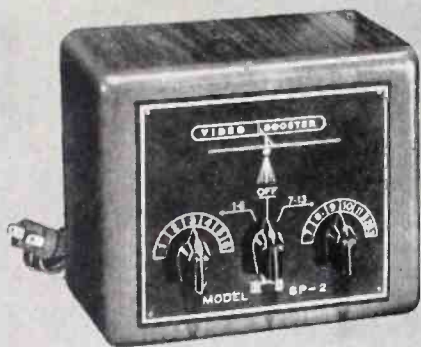

**RMS SP-2**

**video  
antenna  
booster**

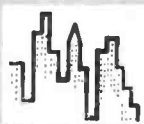

This is the **BOOSTER** that has become an accepted part of every **DEALER** and **SERVICE MAN'S** stock and kit. Tests have proved it the outstanding **BOOSTER** in the business



See the **RMS BOOSTER** at the **Parts Show, Stevens Hotel, Chicago, Booth 31.**

Send for "Data Sheet No. 215-B."



**RADIO MERCHANDISE SALES, INC.**  
550 Westchester Avenue, New York 55

## G.E.-KEN-RAD INTRODUCE SERVICE GARMENT PLAN

A new plan for supplying service garments to G. E. and Ken-Rad tube dealers has been announced by John T. Thompson, replacement tube sales manager.

In addition to the all-essential shop-coat, counter coats, shirt and trouser, and battle jacket and trouser combinations were made available, under an arrangement which provides for weekly delivery of freshly laundered garments through local linen supply services all over the country. Costs will be only a service charge which it is said is approximately equivalent to the normal laundering charge.

\* \* \*

## CHERTOK JOINS SPRAGUE ELECTRIC

Sidney L. Chertok has become a member of the application engineering staff of Sprague Electric Co., North Adams, Mass., and will also serve as sales promotion manager of the Sprague Products Co.

Chertok was formerly sales promotion manager of Solar Manufacturing Corp., North Bergen, N. J., and its distributing subsidiary, Solar Capacitor Sales Corp.



\* \* \*

## RMS TV ACCESSORY CATALOG

A 24-page catalog describing boosters, enlarger lens, masks, filters, masts and mounts, mast joining clamps, strapping, insulator screw-eyes, rubber standoffs and guy-wire rings, plus a variety of straight dipole, folded dipole and universal dipole antennas, has been published by Radio Merchandise Sales, Inc., 550 Westchester Ave., New York 55, N. Y.

\* \* \*

## CLAROSTAT RESISTOR AND CONTROL CATALOG

A catalog, No. 49, covering resistors, controls and resistance devices, has been published by Clarostat Mfg. Co., Inc., Dover, N. H. Listings in catalog concentrate on universal numbers wherever feasible.

\* \* \*

## RIDER PA SYSTEM BOOK

A 208-page book, *Installation and Servicing of Low Power P-A Systems*, has been published by John F. Rider Publisher, Inc., 480 Canal St., New York 13, N. Y.

Covered are fundamentals of sound, microphones and phono pick-ups, impedance matching, amplifier specifications, loudspeakers, installation and servicing. Sells for \$1.89.

\* \* \*

## ILLINOIS CONDENSER CATALOG

A catalog with detailed information on an expanded line of capacitors developed to serve the entire electronic field, from radio to television, has been published by The Illinois Condenser Co., 1616 North Throop St., Chicago 22, Ill.

# it's new!

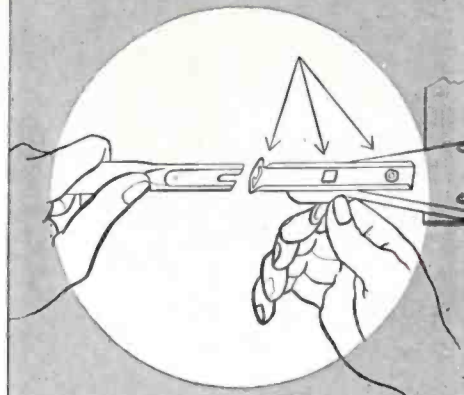

The **RMS** TV

**ANTENNA LINE** with the  
**New, Exclusive feature**

# SPEE-D-LOK\*

**assembly**

Dealers and service men across the country recognize these facts about the **RMS Antenna Line**:

1. **GREATER EFFICIENCY—BETTER RESULTS**
2. **SPEEDIER INSTALLATION IN MATTER OF SECONDS**
3. **MODERATELY PRICED**



See the **RMS Antenna Line** at the **Parts Show, Stevens Hotel, Chicago, Booth 31.**

Send for the **NEW Spring 1949 Catalog # 215.**



**RADIO MERCHANDISE SALES, INC.**  
550 Westchester Avenue, New York 55



# NATIONAL TELEVISION BOOSTER



5 to 6 times the gain

OF ANY OF FIVE COMPETITIVE MODELS

... in our own exacting performance tests. Brings in clear, strong pictures in fringe areas and with indoor antennas. Greatly reduces noise. A real working RF stage, using separate tubes for high and low bands. Receiver power cord plugs into booster and booster plugs into AC outlet. Single switch on booster turns on both. Fine tuning control assures best possible definition. Balanced input coils. Electrostatic shielding. **\$39.95**

(suggested retail price)

CAN BE SWITCHED IN OR OUT!

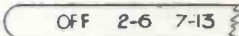

When control is in OFF position, the booster is out of the circuit. Turn the switch to high or low band and—presto—the picture comes into clear, sharp focus right before your eyes!

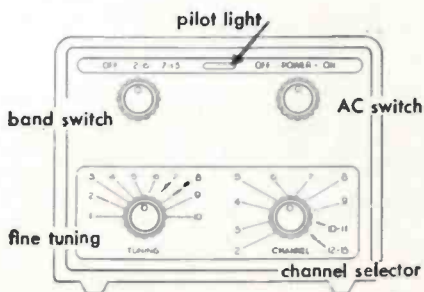

## JOTS AND FLASHES

TV SHOULD ACCOUNT for business activity totaling over a billion dollars in 1949, predicted John K. West, vice president in charge of RCA Victor public relations, during a recent meeting of the American Management Association in New York City. Mr. West pointed out that 14% of the families in the New York area already have TV in their homes and said that by next year over 21% would have television. Philadelphia is expected to have TV in nearly 20% of its homes by 1950, Washington in nearly 19%, Los Angeles in 15½% and Baltimore in 18%, according to West. . . . The vhf-uhf debate has become of great concern to the RMA, and resulted in the study of a public relations program which will provide an objective, orderly and constructive presentation of the situation. . . . A report from the RMA also indicates that the Town Meetings of Radio Technicians will be continued under their sponsorship. . . . Senator Homer E. Capehart, founder of the Capehart Automatic Phonograph Corp. and now a member of the Senate Interstate and Foreign Commerce Committee, concerned with radio legislation, will speak on May 19 at the membership luncheon of the RMA during the RMA Silver Anniversary Convention at the Stevens Hotel in Chicago. . . . John F. Rider Publisher, Inc., began its twentieth year in the field of servicing data publishing a 2,036-page Volume XVIII of the *Rider Manual*. . . . W. L. Rothenberger is now assistant general sales manager of the RCA tube department, and H. F. Bersche has become manager of the renewal sales section. . . . The Walter L. Schott Company, 9306 Santa Monica Blvd., Beverly Hills, Calif., have prepared new hardware packaging containers, the 99 Line, which contains 150 individually packaged radio hardware items in plastic containers. . . . Marvin H. Kirkeby, 437 Oliver Avenue South, Minneapolis 5, Minn., has become a rep for the Radiart Corp., and will represent them in the states of Minn., Iowa, N. Dakota, S. Dakota, Nebr., and Wisc. . . . Veribest Television Production, Inc., are now located at 233 Spring Street, New York City. Frank Trinkoff is president; Henry Lieberman, vice president in charge of sales, and Joseph Cretella, production engineer. . . . A sixteen-page sound equipment catalog has been released by the Terminal Radio Corporation, 85 Cortland Street, New York 7, N. Y. Described in the catalog are three-speed record changers, wide range tuners, magnetic and crystal pickups, etc. . . . A television test equipment center has been announced by Sun Radio and Electronics Co., Inc., 122-124 Duane Street, New York 7, N. Y. . . . The January, February and March issues of the *Aerovox Research Worker* were released recently. These technical bulletins describe video if amplifier design, the transistor and a TV booster amplifier, respectively. . . . Electrovox Co., Inc., have moved their plant and general offices to 60 Franklin St., East Orange, N. J. . . . Two catalogs, covering dynamotors and converters, have been released by the Carter Motor Co., 2644 N. Maplewood Ave., Chicago, Ill. One catalog (24 pages; No. 649) contains data on dynamotors and the other (16 pages; No. 349) offers information on converters.

## ADVERTISERS IN THIS ISSUE

SERVICE INDEX—APRIL, 1949

AIRBORNE SALES CO. Agency: W. C. Jeffries Co.	42
ALLIANCE MFG. CO. Agency: Foster & Davies, Inc.	31
AMERICAN ELECTRICAL HEATER CO. Agency: Dudgeon, Taylor & Bruske, Inc.	41
AMERICAN PHENOLIC CORP. Agency: Burton Browne, Advertising	38
AMERICAN TELEVISION & RADIO CO. Agency: Firestone-Goodman Adv. Agency	40
L. S. BRACH MFG. CORP. Agency: A. W. Lewin Co.	32
CHICAGO TRANSFORMER DIV. ESSEX WIRE CORP. Agency: George Brodsky, Advertising	28
CLAROSTAT MFG. CO., INC. Agency: Austin C. Lescarboua & Staff	44
CLEVELAND ELECTRONICS, INC. Agency: Bonalib Adv. Agency	36
CORNELL-DUBILIER ELECTRIC CORP. Agency: Belsa Advertising, Inc.	Inside Front Cover
ELECTRIC AUTO-LITE CO. Agency: Ruthrauff & Ryan, Inc.	42
ELECTRO-VOICE, INC. Agency: Henry H. Teplitz, Advertising	35
ERIE RESISTOR CORP. Agency: W. S. Hill Co.	46
ESPEY MFG. CO., INC. Agency: Regent Adv. Agency	43
GENERAL ELECTRIC CO. Agency: Maxon, Inc.	19
GENERAL ELECTRIC LAMP DEPT. Agency: Batten, Barton, Durstine & Osborn, Inc.	39
THE HEATH CO. Agency: G. Dean Arend, Advertising	22, 23
THE HICKOK ELECTRICAL INSTRUMENT CO. Agency: White Adv. Co.	44
HYTRON RADIO & ELECTRONICS CORP. Agency: Henry A. Loudon Advertising, Inc.	5
KAY ELECTRIC CO. Agency: George G. Felt	43
KEN-RAD DIV. GENERAL ELECTRIC CO. Agency: Maxon, Inc.	1
P. R. MALLORY & CO., INC. Agency: The Altkin Kynett Co.	Inside Back Cover
MEISSNER MFG. DIV. MAGUIRE INDUSTRIES Agency: Rudolph Bartz, Advertising	46
NATIONAL CO. Agency: John C. Dowd, Inc.	48
PARK METALWARE CO., INC. Agency: Melvin F. Hall Agency	44
PHOENIX ELECTRONICS, INC. Agency: Milton Richards	46
PICKERING CO. Agency: Sam J. Galley, Inc.	31
THE RADIART CORP. Agency: Stern and Warren	7
RADIO CORPORATION OF AMERICA Agency: J. Walter Thompson Co.	41, 43, 45, Back Cover
RADIO MERCHANDISE SALES, INC.	47
JOHN F. RIDER PUBLISHER, INC. Agency: Shappe-Wilkes Inc.	6
HOWARD W. SAMS & CO., INC. Agency: George Brodsky, Advertising	3
SIMPSON ELECTRIC CO. Agency: Burton Browne, Advertising	30
SPRAGUE PRODUCTS CO. Agency: The Harry P. Bridge Co.	29
SYLVANIA ELECTRIC PRODUCTS, INC. Agency: Newell-Emmett Co.	8
TELREX, INC. Agency: Shappe-Wilkes Inc.	42
TRANVISION, INC. Agency: H. J. Gold Co.	34
TRIPLETT ELECTRICAL INSTRUMENT CO. Agency: Western Adv. Agency, Inc.	4
THE TURNER CO. Agency: W. D. Lyon Co.	37



Long Life on Tough Jobs is  
 One Reason Why  
**MALLORY**  
**VIBRATORS**  
 are So Popular

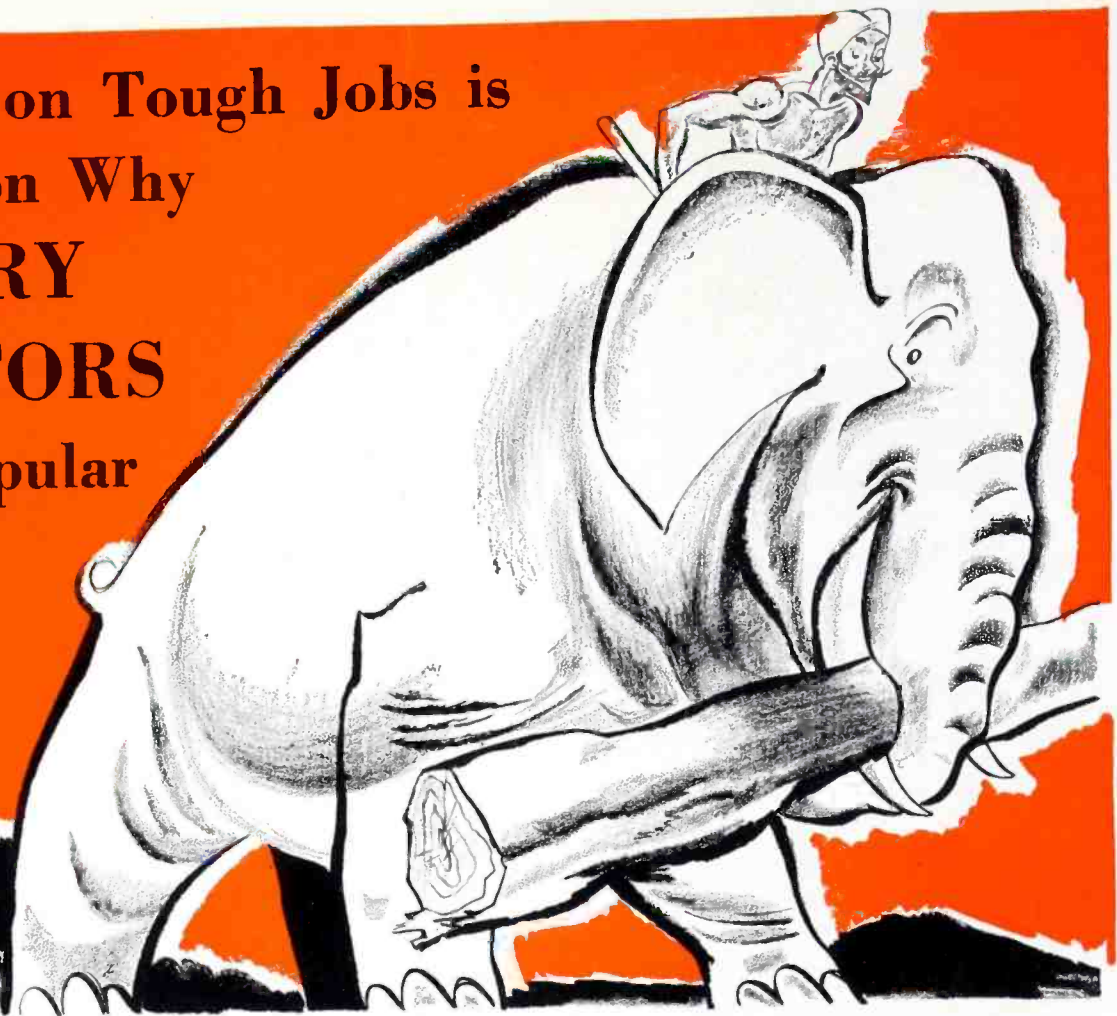

Long life in a vibrator results from a combination of good design and careful production.

The design of Mallory Vibrators is a product of an unusual combination of engineering talent

and resources in electronics, electrochemistry and metallurgy.

For example, the contacts in Mallory Vibrators are Mallory-specified and Mallory-made. And a patented Mallory design insures a perfectly balanced mechanism.

Convincing proof that Mallory maintains careful production is the fact that more Mallory Vibrators are in use as original equipment than all other makes combined.

You get not only *long life*, but *dependable starting*, and *high output efficiency* from Mallory Vibrators. No wonder they are so popular with radio service men everywhere—Mallory Vibrators are best for replacements. See your Mallory Distributor.

**Mallory "2448" Vibrator Deal**

This deal gives you a handsome storage and display cabinet for your stock of vibrators, together with a selection of vibrators and buffer capacitors that will answer 75% of your requirements.



You pay only the service man's net price of \$24.48 for the six vibrators and twelve buffer capacitors. There is no charge for the attractive, convenient cabinet. Your Mallory distributor has them in stock for immediate delivery.

MORE MALLORY VIBRATORS ARE USED IN ORIGINAL EQUIPMENT THAN ALL OTHER MAKES COMBINED

**P. R. MALLORY & CO. Inc.**  
**MALLORY**

CAPACITORS . . . CONTROLS . . . VIBRATORS . . .  
 SWITCHES . . . RESISTORS . . . RECTIFIERS . . .  
 VIBRAPACK\* POWER SUPPLIES . . . FILTERS

\*Reg. U. S. Pat. Off.

**APPROVED PRECISION PRODUCTS**

**P. R. MALLORY & CO., Inc., INDIANAPOLIS 6, INDIANA**



# First-line quality... the mark of every Cunningham tube for 33 years

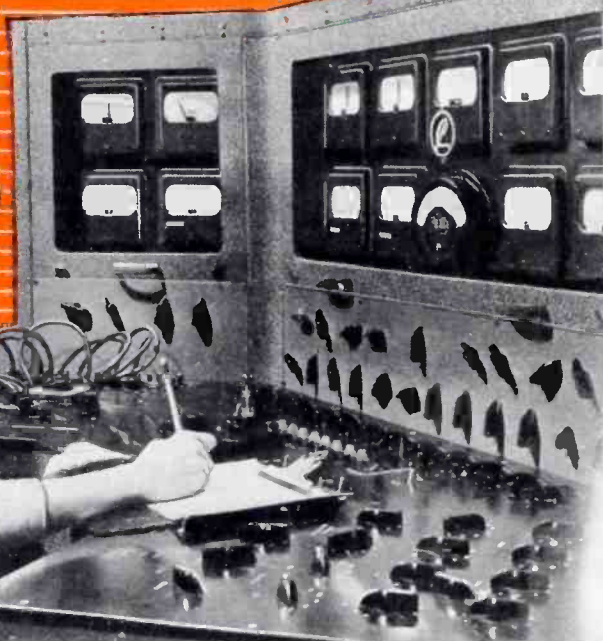

*CUNNINGHAM TUBES are tested regularly for electrode currents, cathode emission, gas, mutual conductance, power output, ac amplification, diode operation, amplification factor, and plate resistance as well as other characteristics.*

CUNNINGHAM TUBES have been famous for their consistently high quality, long life and top performance for over 33 years.

These high standards have been achieved through a system of quality control that provides a constant and precise check on factory production. By this means it is possible to correct any departure from control specifications as rapidly as it appears. That is why *less than one percent* of the Cunningham tubes sold are returned because of defects.

The first-line quality of Cunningham tubes is your guarantee of customer satisfaction. That's why they're selected by experienced servicemen as the No. 1 renewal tube.

**RCA LABORATORIES  
PRINCETON, N. J.**

Behind every Cunningham tube is the engineering leadership of the Radio Corporation of America.

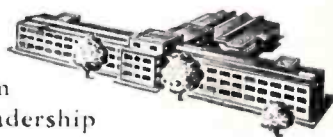

**SEE YOUR CUNNINGHAM DISTRIBUTOR TODAY**

**A QUALITY PRODUCT OF THE  
RADIO CORPORATION OF AMERICA**