

SERVICE

A MONTHLY DIGEST OF RADIO AND ALLIED MAINTENANCE

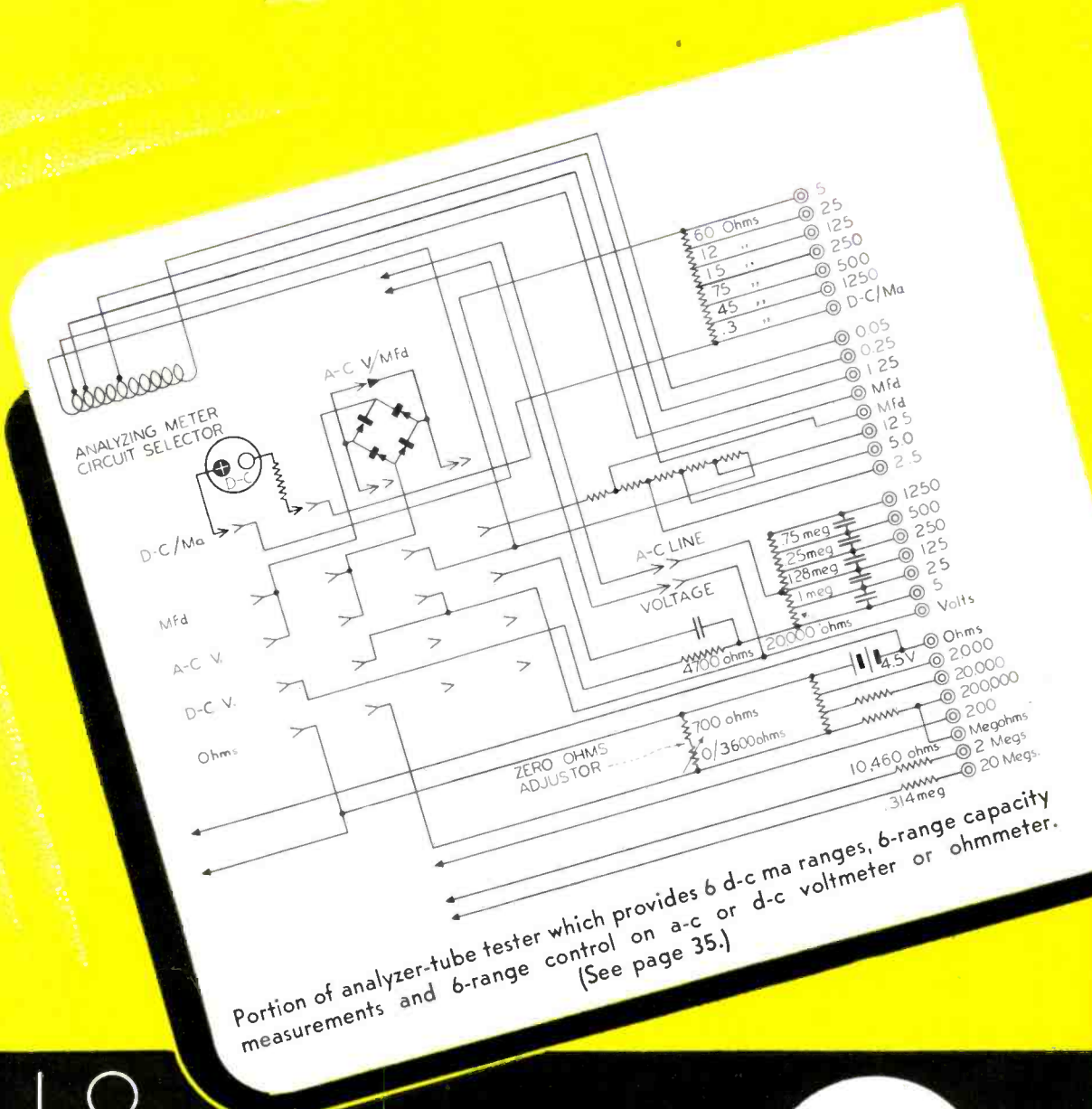

Portion of analyzer-tube tester which provides 6 d-c ma ranges, 6-range capacity measurements and 6-range control on a-c or d-c voltmeter or ohmmeter. (See page 35.)

★ RADIO
 ★ TELEVISION
 ★ ELECTRONICS

April
 1944

"Bring me the order book, Miss Jones!"



"It's going to be a pleasure to make out this order. Although we are not getting all the tubes we'd like, Hytron surely is doing its utmost to help us by its allocations. We certainly can use these tubes."

Hytron is happy to be able to do at least something toward supplying your demands for civilian receiving tubes. WPB rulings guide our actions entirely; we must ration carefully the few tubes available.

Please bear in mind, too, that Hytron is still helping to fight this war. The WPB has our full cooperation in its conscientious effort to do everything possible to fill the insatiable demand for tubes—both on the home front and on the fighting front. Naturally, the boys in the Services come first.

HYTRON HYLIGHTS

The WPB has ruled that, insofar as possible, MR receiving tubes available for civilian use shall be allocated to established distributors on a pro rata basis of their 1941 purchases. Unfortunately, this means that Hytron cannot accept orders from new distributors. In addition, we ask our authorized distributors to refrain from sending in their orders until they have been informed by the factory or by their Hytron representative, that tubes have been allocated to them.



OLDEST EXCLUSIVE MANUFACTURER OF RADIO RECEIVING TUBES

HYTRON
CORPORATION ELECTRONIC AND RADIO TUBES
SALEM AND NEWBURYPORT, MASS.



BUY ANOTHER WAR BOND

THESE GHIRARDI BOOKS GIVE YOU THE ANSWERS

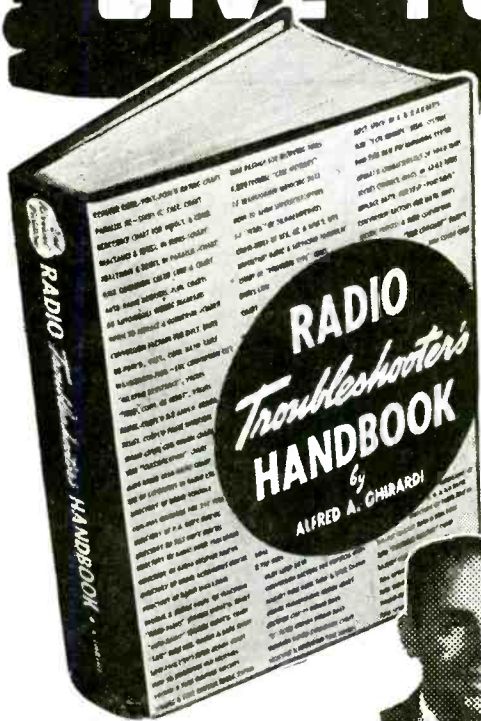

A. A. Ghirardi—the man who has personally answered over 50,000 inquiries on radio construction and servicing!



Speed Up! Do More Work in Less Time! Make More Money!

Regardless of what Radio set you are called upon to repair, this 3rd (Wartime) Edition of Ghirardi's famous **RADIO TROUBLESHOOTER'S HANDBOOK** is guaranteed to save you time! From beginning to end, it's designed to help you repair more radios **BETTER AND TWICE AS FAST**. Hundreds of servicemen write that it has paid for itself on the first job or two.

THE HELP YOU NEED!

Never before has such a wide variety of useful servicing information been compiled so helpfully. In addition to over 400 pages of Trouble Case Histories (common trouble symptoms, their causes, and remedies) for 4,820 specific receiver and record changer models, there are literally scores of time-saving graphs, and tables, which give instant answers to your daily problems.

A. A. Ghirardi is not a theorist. He is a practical radio man who spends more time in leading service shops and with manufacturers than he does in his own office. He knows exactly the help servicemen need—and this new, fully revised edition of his **RADIO TROUBLESHOOTER'S MANUAL** brings you full benefit of his years of rich experience.

GEARED TO WARTIME NEEDS

Included are I-F alignment peaks for over 20,000 superhets; dozens of pages on interchangeable tube types and modernizing old receivers; the most complete tube chart ever compiled; plug-in and ballast resistor replacement charts; a tabulation of I-F transformer troubles—condenser, resistor, coil, and transformer charts and formulae—and hundreds of pages more designed to give you just the help you need—**WHEN YOU NEED IT MOST!**

Sold for only \$5 complete (\$5.50 foreign) on an absolute 5-Day Money-Back Guarantee. Can you afford to be without it these busy days?

SAVE TROUBLESHOOTING TIME

Cut down your troubleshooting time with the greatest compilation of "Case Histories" ever published! This big new wartime edition of A. A. Ghirardi's Radio Troubleshooter's Handbook contains 4,800 trouble symptoms and remedies for over 4,800 receiver and record changer models—all carefully indexed for instant reference. A servicing information gold mine that has taken years to compile! Used daily by thousands of shops throughout the world!

SAVE REPAIR TIME

When a Radio comes in for repairs, first turn to your Handbook instead of to your tester. You'll be amazed what a whale of a lot of time you'll save. For remember: Ghirardi's **TROUBLESHOOTER'S HANDBOOK** isn't a "study" book. It's a reference book that you turn to when you want the answer to a specific repair question or to learn about some specific set.

MAKE MORE MONEY

Why bother figuring out things that have already been figured out for you and recorded in easily-found, quickly-understood style in this big new 710-page manual-size book? Smart servicemen everywhere say Ghirardi's **TROUBLESHOOTER'S HANDBOOK** is helping them turn out from 50% to 100% more work with less labor and that means 50% to 100% more money for the same amount of effort!



Only \$5 complete (\$5.50 foreign)—or

See Special Money-Saving Combination Offer Above Coupon

THIS IS THE BOOK THAT WILL TEACH YOU RADIO SERVICE WORK Right!

Ghirardi's famous 1300-page **MODERN RADIO SERVICING** is a hard-hitting, intensely practical course in modern service work... the only single, inexpensive book that gives a thorough explanation of the workings of all Test Instruments; Receiver Troubleshooting Procedure; Circuit Analysis; Testing and Repair of Component Parts; Installation; Adjustment; Maintenance; etc. 706 illustrations, 720 self-testing review questions, 766 different topics.

SPECIAL MONEY-SAVING COMBINATION OFFER

Make your servicing library complete—keep it up-to-the-minute and profit accordingly. Get both Ghirardi's **RADIO TROUBLESHOOTER'S HANDBOOK** and **MODERN RADIO SERVICING**—a big \$10 value for only \$9.50 (\$10.50 foreign). Over 2,000 pages chock-full of the finest, most practical help money can buy!

RADIO & TECHNICAL DIVISION OF
Murray Hill Books, Inc.
Dept. S44, 232 Madison Ave., New York 16, N. Y.

Enclosed find \$5 (\$5.50 foreign) for Ghirardi's new 3rd Edition **RADIO TROUBLESHOOTER'S MANUAL**, postpaid; or send C.O.D. (in U. S. A. only) for this amount plus postage. I may return the book at the end of 5 days and receive my money back.

Check here if you wish to take advantage of **MONEY-SAVING COMBINATION OFFER** (see above).

\$9.50 enclosed (\$10.50 foreign) or send both big books C.O.D. (in U. S. A. only).

Name

Address

City & Dist. No. State

5-DAY MONEY-BACK GUARANTEE

MAIL THIS NOW!

EDITORIAL

STRIKING predictions on the size of the f-m and television postwar market have been made during the past few weeks. According to Zenith's chief engineer, J. E. Brown, there will be 20,000,000 f-m receivers and 2,000 transmitters within five years after the war. He pointed out that at least 28,000,000 homes can be served conveniently and economically by f-m broadcasting.

In a television prediction, J. D. McLean of General Electric stated that eighteen months after construction of equipment begins, we will have forty active television stations covering a service area of thirty million. And within five years after this period, there will be one-hundred active stations covering a service area of sixty-seven million people.

Allen B. DuMont, in a recent talk, appropriately titled *TNT or Television Now and Tomorrow*, said that television will set new standards in marketing, fully in keeping with the coming age of super-marketing.

There appears to be quite a field in the making for the Service Man!

FROM New Zealand Service Man, E. B. Menzies, has come a choice bit on the future of the service industry. He says, "This war has brought and will bring many changes in the service industry. And one prediction for the future can now be made with certainty. Those who do not or did not believe in training, and who firmly believed in the infallibility of just a screw driver and a voltmeter, are due to be sadly disillusioned in the future. For the Service Man will have to have a fuller understanding of all principles, a basic knowledge of mathematics, and complete familiarity with both the equipment being tested and the testing equipment being used. The postwar Service Man should be able to check receivers and components as thoroughly and as accurately as a careful manufacturer."

SERVICE

A Monthly Digest of Radio
and Allied Maintenance

Reg. U.S. Patent Office

Vol. 13. No. 4

April, 1944

ALFRED A. GHIRARDI

Advisory Editor

LEWIS WINNER

Consulting Editor

F. WALEN

Managing Editor

	Page
Antenna Coupling and Switching Methods (Part III). By M. E. Heller	14
Distribution Lines of the Sound System By Sidney Harman	10
Electronic Voltage and Speed Regulators (Part III). By S. J. Murcek	22
Ser-Cuits By Henry Howard	28
Servicing Helps	20
The Winners in the Service Contest	9
Cover	
Analyzer-Tube Tester (Supreme 385)	35
Circuits	
Admiral A-7	16
Emerson DD268, 270, 272, 276	14
G. E. J-709	16
G. E. H-87	18
G. E. J-64	19
Philco 41-220, 225	18
RCA 18T	19
Sentinel 236	19
Sentinel 216J	28
Supreme 385 (cover)	35
Truetone D1176	14
Zenith 6S596, 597	16
Zenith 6D512	18
Index to Advertisers	36
Manufacturers	
News	32
New Products	34
Jots and Flashes	36

Copyright, 1944, Bryan Davis Publishing Co., Inc.

Published monthly by Bryan Davis Publishing Co., Inc.

19 East 47th Street, New York, 17, N. Y. Telephone PLaza 3-0483

Bryan S. Davis, Pres.
F. Walen, Secretary

Paul S. Weil, General Manager
A. Goebel, Circulation Manager

James C. Munn, 10515 Wilbur Avenue, Cleveland 6, Ohio
Pacific Coast Representative: Brand & Brand, 816 W. Fifth St., Los Angeles 13, Calif.



Entered as second-class matter June 14, 1932, at the Post Office at New York, N. Y., under the Act of March 3, 1879. Subscription price: \$2.00 per year in the United States of America and Canada; 25 cents per copy. \$3.00 per year in foreign countries; 35 cents per copy.



on the threshold of a new Era!

THIS is an "Electronics" war! Radio and electronics are writing a most vital chapter in the history of modern warfare. Many of the new developments in electronic tubes are military secrets, but in the postwar period the whole world will benefit by the tremendous strides in the engineering achievements and manufacturing methods born of military needs.

Yes, the foundation is being laid *today* for the glorious peacetime era of electronic achievement that will begin on that *tomorrow* when victory is assured. Then, as now, Raytheon will supply electronic tubes with the "Plus-Extra" performance qualities that have built the Raytheon reputation over the years.

When the Peace is won, Raytheon, due to its unique wartime experience, will be better qualified than ever before to supply manufacturers of postwar radios and of industrial electronic equipment with electronic tubes for the most exacting applications.

Raytheon Production Corporation

Newton, Massachusetts • Los Angeles • New York • Chicago • Atlanta



All Four Raytheon Divisions Have Been Awarded Army-Navy "E" Plus Stars

RAYTHEON

High Fidelity
RADIO & ELECTRONIC TUBES



DEVOTED TO RESEARCH AND THE MANUFACTURE OF TUBES FOR THE NEW ERA OF ELECTRONICS

SPRAGUE TRADING POST



A FREE Buy-Exchange-Sell Service for Radio Men

IMPORTANT NOTICE!

We discourage offers to buy or sell anything beyond the O.P.A. ceiling prices, and will not knowingly accept such ads for the Sprague Trading Post.

TUBES FOR SALE OR TRADE—Approx. 900 in all of the following types: 1LA4; 1LB4; 1LH4; 1LD5; 1D8; 1Q5; 1A5; 1A6; 1B5; 1C5; 1D7; 1G4; 1G5; 1E5; 1F7; 1H6; 1S5; 2A4; 2A6; 2B7; 3A8; 3C7; 6E7; 6A3; 6A4; 6A5; 6B8; 6C5; 6C8; 6J5; 6L5; 6L6; 6N6; 6N7; 6P5; 6V7; 6Z7; 6AB5; 6AE6; 6AF5; 6AP6; 6AD6; 7A4; 7A5; 7B5; 7B8; 7B4; 7E6; 7F7; 7H7; 7L7; 7V7; 7S7; 7G7; 7XL; 7XD; 8XFM; 8XB; 485; 182; 41; 59; 84; 6Z4; 89; 99. Vogue Radio, 2725 Boston Blvd., Detroit 6, Mich.

WANTED—Good test and lab. eqpt. for cash. Describe fully. All letters answered. A.A. Radio Service, 1455 Glenam Pl., Denver 2, Colo.

USED TUBES FOR SALE—Large number, all types, set-tested. Also five 954 acorn tubes. Domestic Appliance Service, Bridgehampton, N. Y.

32V. EQUIPMENT WANTED—Cash for radios, irons, cleaners, fans, motors & 32V light plants, new or used. Or will trade completely modernized AC-49 Hickok tube tester. Norwest Radio Laboratories, Shelby, Mont.

FOR SALE—Aerovox L-C checker, model 95. Like new. M. E. Armstrong, Austin, Minn.

WANTED FOR CASH—Sky-traveler S-29 in any condition, also capacitor analyzer or bridge, motor turntable unit, 5-band coil assembly. Lt. Hsieh James, Hq. Sq., Scott Field, Ill.

WANTED—Good V-O-M for cash. Norman Berg, Box 183, Hillsboro, Kans.

NEW TUBES FOR SALE—Guaranteed, in original cartons. About 50 6-v. receiving tubes, both metal and glass, also 25 other types. Write for list. R. L. Lindell, 1761 Fontainebleau Crescent, Norfolk 5, Va.

FOR SALE—Late issue, 56 National Radio Institute instruction and reference texts. \$10 f. o. b. J. H. Wickman, Jonesville, Mich.

FOR SALE—Triplet 1210A tube tester in good condition. O. T. Bolick, 227 Rebance St., Charlotte 2, N. C.

WANTED for Air Station Base: Gen. Industries home recording unit, recording output meter, good dynamic mike, hi-fi speaker, or what have you? Sgt. T. M. Yule, H.Y.D. M.O.T.G. 81 Marines, Edenton, N. C.

FOR SALE OR TRADE—S-29 Halli-crafter in good cond., \$50, or will trade for Triumph oscillograph, wobulator, or RCP 414P and 803, Hickok 510X or what have you? Cash difference. R. E. Tutt, Loyalton, Calif.

FOR SALE—Rimeo Dynalyzer (dynamic set analyzer) like new. C. Kettler, 1408 Virginia St., Sioux City, Iowa.

WANTED—Short wave receiver for soldiers' day room. Lt. Leo Melster, Office of Chief of Ordnance, Washington, D. C.

WILL TRADE—Latest Dumont 164E oscillograph in perfect cond. for RCA Chanalyst equally good. Russo Bros., 509—76th St., Brooklyn 9, N. Y.

WANTED—7" foundation meter in good condition. Richesin Radio Lab., 1611—4th St., San Rafael, Calif.

WANTED—Carron or Supreme 571 sig. generator, also late tube tester, Hickok 510X preferred, R. T. Warner, 433 Birch St., Boulder City, Nev.

RADIO STORE WANTED—In good location, New York or 100 miles from it. Give full details. George Radio 101 Elwood Ave. Mt. Vernon, N. Y.

FOR SALE—Late model Fada port. radio; Deico table radio; 5-tube kit with tubes; and 175" 7x22 phosphor bronze aerial wire. Albert Cummings, 51 Hancock Street, Auburndale, Mass.

FOR SALE—Signal tracer, \$20; Battery eliminator for portables, \$20; also many types of tubes, new and used. Weir Cove Radio, 508 Garden Way, Weir Cove, W. Va.

WILL TRADE new Superior 1240 tube checker, 70 tubes, many new filters, cabinets, and cash. Want Reflex camera, must do 4.5 or better. H. Samkofsky, 527 Bedford Ave., Brooklyn, N. Y.

WANTED—E-200 Precision signal generator. W. W. Story, 812 N. Harvard, Tulsa, Okla.

WANTED—All-wave sig. generator, tube checker, oscillograph, analyzer, and other test eqpt. Hyman Weiss, 32 Home Ave., Albany, N. Y.

WANTED—Tube tester and sig. generator. Clarence Lynch, 245 Worcester St., Southbridge, Mass.

WILL TRADE job printing for radio test equipment. Roy B. Wanders, 3228 N. Osanum Ave., Chicago 34, Ill.

WANTED—good multimeter; sig. generator (10 meg.) battery or electric; tube tester not more than 3 yrs. old with instructions. James Simmons, 1739 Elmwood Ave., Norfolk, Va.

WANTED—New or used Isolantite socket for 955 tube (acorn). Need three. (Cpl. J. J. Horvath, 35532979, Btry. C., ECP, Fort Bliss, Texas.

WANTED—One 50L6 or 50L6/GT for soldier's radio. Tech. Sgt. E. Keene, Anti-Tank Co., 405 Infantry, A.P.O. 102, Camp Swift, Texas.

WANTED—Good record player attachment for table radio or phono motor and pickup and arm for making one. Lt. H. McLean, C.A.A.F., Childress, Texas.

WANTED—Sig. generator and test eqpt., any make or model. Describe. Quick Service Radio & Elec. Co., 5119 Florida Ave., Tampa, Fla.

FOR SALE—New R.C.P. sig. generator #703 in original factory carton, \$30. S/Sgt. G. B. Wiggins, 7 Valley Pl. So., New Haven 15, Conn.

FOR SALE—Clough-Brenzle tube tester. #125A, A-1 condition, with inst. & tube charts, \$30. Herbert H. Ledbetter, Elizabethtown, Ill.

WANTED FOR CASH—Good 2nd hand tube tester, late model. Describe. Also want 50L6, 35Z5, 35L6, 12SA7 tubes. Price's Radio Service, 47 Lincoln Ave., Trenton 9, N. J.

WANTED—1-6C5G; 1-6N7G; 1-80; and 2-2A3 tubes. Phillip Landis, P. O. Box 1296, Jacksonville 1, Fla.

WANTED FOR CASH—Late model tube checker and a sig. generator. Fred A. Kethel, P. O. Box 205, Rosiclare, Ill.

WANTED—Late model receiver, must have good B.F.O. tube & operate on 110v. a-c or d-c. Also want port. radio. T/4 Chas. O. Rice, H.Q. Btry. 921 F.A., A.P.O. 96, Camp White, Ore.

WANTED—Superior 1280 set tester and 1230 sig. generator; Triplet push button vibrator tester 1671; Readrite "Ranger" tube tester 432-A; R.C.P. 308P port. tube tester; 16mm. sound projector; also radio sets of all kinds, tubes, parts. Kenneth C. Burpee, Goldentone Radio Sales & Ser., Rt. #1, Dowling, Mich.

WANTED—Supreme 561 oscillator, 562 adolyzer, V-O-M, and cond. tester or other eqpt. to start small shop. C. E. Harmon, 3rd St., Chester, W. Va.

WANTED—All-wave sig. generator & multimeter. E. L. Smart, P. O. Box 292, Liberty, Texas.

RADIO PARTS WANTED—New or used, also tubes. Cash waiting. Frank Henderson, Marine Radio Service Station, 201 Monroe St., Mobile, Ala.

WANTED—Good used oscilloscope with or without wobulator. Cpl. E. T. Greene, Box 193, Bainbridge, Ga.

FOR SALE—Howard com. receiver #400, A-1 condition; also comb. all-wave, battery-operated oscillator & V-O-M in port. case, like new. C. E. Ecklen, 217 N. Washburn, Minneapolis 5, Minn.

TUBES FOR SALE—Have several hundred 50L6; 35Z5; 35L6; etc. Send old tubes to turn in & we will give 10% off. F. S. M. Bailey, 12th & Market, Brownsville, Texas.

WANTED—50L6GT tube & a 50,000 ohm wire wound potentiometer, preferably new. Eugene T. Menkoff, 201 S. 36th W Pl., Tulsa 6, Okla.

WANTED—Test eqpt. urgently needed for new shop; V-O-M, late tube checker, analyzer, signal generator, diagrams, etc. Also parts. B. V. Hurley, Box 272, Soquel, Calif.



HOW TO SUBSTITUTE CAPACITORS Accurately

Besides listing the "Victory type" Sprague Atom Electrolytics and TC Tubulars for wartime service use, this folder contains helpful information on making these 18 Capacitor types do the work of the 473 capacitors normally included in our catalog. Send a post card today for your copy.

WANTED—Pair of earphones, at least 2,000 ohm. David Wood, RFD #2, Bethel, Conn.

FOR SALE—5" Dumont #148 oscilloscope. Needs 3 sweep condensers that can easily be replaced. Otherwise perfect. George Miller, 520 W. 124th St., New York 27, N. Y.

WANTED—Used television receiver, can be home-made job, but must be in A-1 condition. Cash or will swap Weston 771 tube tester with ohmmeter and DC wobbulator all in one unit. Also have Readrite 712 tester, 3-meter with plug-in socket cable. Also have 16mm. films and silver screen. Henry Bollmann, Springfield & Plainfield Aves., Berkeley Heights, N. J.

FOR SALE—Hickok R.F.O.-5 3" scope, practically new, \$170 f.o.b.; Garrard-R.C. 11 automatic changer \$75; AC-DC new Webster 3-post changer R.M.E. 69 with D.B. 20 & speaker mounted on relay rack, \$225 f.o.b. Sterling Electronic Labs., 521 W. 131st St., New York, N. Y.

YOUR OWN AD RUN FREE!

This is Sprague's special wartime advertising service to help radio men get needed parts and equipment, or dispose of radio materials they do not need. Send your ad today. Write **PLAINLY**—hold it to 40 words or less. Due to the large number received, ads may be delayed a month or two, but will be published as rapidly as possible. We'll do everything we can to help you—and the fact that thousands of pieces of Radio-Electronic equipment are in operation today as a result of sales or "swaps" made through The Trading Post offer convincing proof of the far-reaching effectiveness of this service. Remember that "Equipment for Sale" ads bring best results.

Different Trading Post ads appear monthly in Radio Retailing-Today, Radio Service-Dealer, Service, Radio News, and Radio Craft. Sprague reserves the right to reject ads which do not fit in with the spirit of this service.

When buying Capacitors—please ask for Sprague's by name. We'll appreciate it!
HARRY KALKER, Sales Manager

Dept. S-44, SPRAGUE PRODUCTS CO., North Adams, Mass.

SPRAGUE CONDENSERS KOOLOHM RESISTORS

Obviously, Sprague cannot assume any responsibility, or guarantee goods, services, etc., which might be exchanged through the above advertisements

A Third **CITATION** FOR THE INSTRUMENT LEADER



... FOR MERITORIOUS WAR PRODUCTION

This third citation for meritorious war production . . . climaxing a long record of war service . . . is a source of justifiable pride to the men and women of WESTON.

The record began back in the earliest days of our defense period, when a large segment of WESTON'S capacity was assigned to the production of instruments vital to military needs. Thus, when we finally were forced into this world struggle, WESTON was ready for *full-scale war production*.

This new star which adorns our "E" pennant marks the *third* time WESTON has been *first* in this highly specialized field to receive each successive war citation. Weston Electrical Instrument Corporation, Newark 5, New Jersey.

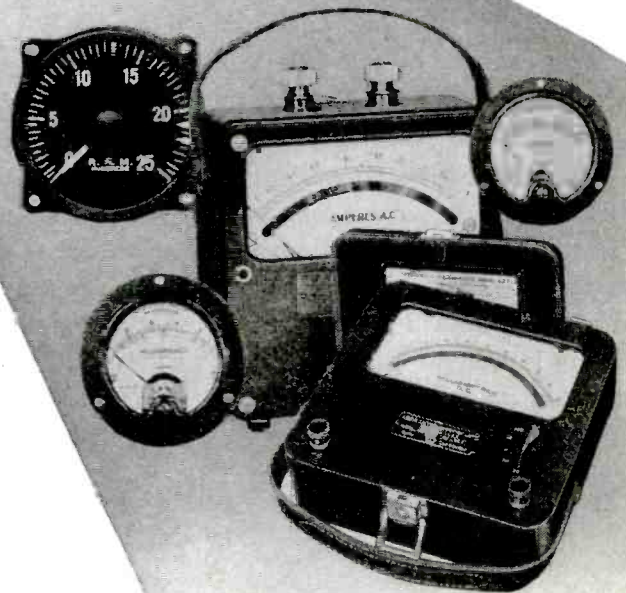

Laboratory Standards . . . Precision DC and AC Portables . . . Instrument Transformers . . . Sensitive Relays . . . DC, AC, and Thermo Switchboard and Panel Instruments.

WESTON

Specialized Test Equipment . . . Light Measurement and Control Devices . . . Exposure Meters . . . Aircraft Instruments . . . Electric Tachometers . . . Dial Thermometers.

FOR OVER 55 YEARS LEADERS IN ELECTRICAL MEASURING INSTRUMENTS

Are you properly emphasizing the **SAVINGS FEATURE**

OF YOUR PLANT'S PAYROLL SAVINGS PLAN?



WITH the war swinging into its tensest phase, now's the time to emphasize over and over again the *savings* feature of your Payroll Savings Plan. To press home to all your people the need of building up their savings—the need of building up their savings not only in wartime but also in the years directly after the war. To point out that a bond cashed before its full maturity is a bond killed before it has given its fullest service to its

owner—or to his country!

Buying War Bonds, holding War Bonds, and keeping wartime savings mounting—all are absolutely vital. But no one of these is enough by itself. The *savings habit* must be carried over into the years of reconstruction which will follow the war. For if, at war's end, we have 'flash-in-the-pan' spending, *everybody loses*. The spender loses, you lose, and the country loses! While a working public, convinced of

the value of continued, planned saving, is the soundest possible foundation for private enterprise of every sort.

We call these bonds War Bonds—and with their aid we will win this war at the earliest possible moment! But they're Peace Bonds, too—and, rightly used, they will win for their holders, *and for all of us*, a happy and prosperous place in the years of peace to come. WAR BONDS to Have and to Hold.

The Treasury Department acknowledges with appreciation the publication of this message by

SERVICE

★ **Let's All Back**
★ **the Attack...**
★ **with War Bonds!**

This is an official U. S. Treasury advertisement—prepared under auspices of Treasury Department and War Advertising Council



DYNAMIC DEMONSTRATOR



THE
RADIO CIRCUIT
DIAGRAM
THAT ACTUALLY
OPERATES

BUY MORE WAR BONDS

UNIVERSALLY accepted for practical laboratory and vocational instruction in radio.

Consists of the working parts of a six-tube radio receiver, mounted in proper functional position on a large schematic diagram suitable for use in visual instruction. Jacks are provided for interruption and test of the various circuits. When used with modern radio test instruments, facilitates both qualitative and quantitative analysis of radio circuit conditions — an ideal setup for rapid radio instruction. RCA Dynamic Demonstrators, like the one shown above, are in very extensive use today in practical laboratory and vocational radio training schools. For audio demon-

strations — for service adjustments — for signal tracing technique — for all manner of measuring, checking, testing, analyzing. (NOTE: Currently, deliveries can be made from stock; subject to prior sale, on a priority of A-1-a or higher.) Please address inquiries to Test and Measuring Equipment Section, RADIO CORPORATION OF AMERICA, Camden, New Jersey.

RCA Test and Measuring Equipment
RADIO CORPORATION OF AMERICA

ENVY OF AN INDUSTRY...

MEISSNER'S FAMED "PRECISION-EL"



Men of Long Experience: You don't have to be much of a judge of character to know that here's a man who knows his job from A to Z, takes pride in his work. He's typical of the "precision-el" who turn out Meissner's famous line of "Precision-Built" electronics products.



The Meissner "Know How" has long been envied by many in all phases of the electronics industry. There are said to be more electronics technicians per thousand population in Mt. Carmel than in any other American city.



Mighty Unit of America's Might: As far as the camera's eye can reach, it seems, are row upon row of skilled workers engaged in producing vital electronics material for Uncle Sam. This is one unit of the main Meissner plant at Mt. Carmel, Illinois.



Four of a Kind: From miles around Mt. Carmel, entire families have turned to electronics for a place in Meissner's great postwar plans. This family group of four employes, combining many years of varied experience, is about to report at one of the big gates.



ULTRA COMPACT!

Right — it's Meissner's "mighty midget" — a Cartwheel I. F. Transformer only $1\frac{1}{8}$ " by $1\frac{1}{32}$ " by $1\frac{1}{4}$ " high! The perfect replacement unit for the many sets using odd shapes and locations for their I. F. transformers. Excellent, too, for countless AC-DC or Midget type receivers. It's complete with dual trimmers, with one-piece molded plastic trimmer base. Unshielded. For 456-kc only. Our supplies, of course, are limited.



MEISSNER

MANUFACTURING COMPANY • MT. CARMEL, ILL.

ADVANCED ELECTRONIC RESEARCH AND MANUFACTURE

THE WINNERS IN THE SERVICE CONTEST

TO a Chicagoan, Ray Pentecost, of Metropolitan Radio Service, 4314 Elston Avenue, Chicago 41, has been awarded the \$100 War Bond first prize in the SERVICE contest. Mr. Pentecost, who is a veteran of World War I and has been in the servicing business since 1920, provided several unique wartime repair notes in his winning entry. He covered reconditioning of variable condensers, i-f and antenna coil substitutions, power transformer maintenance, noise cures in speakers, and tube substitutions.

In his discussion of condenser repairs, Mr. Pentecost pointed out how he reconditioned warped, die cast type 4-gang condensers, and repaired bearings and stripped screws. Pie-wound i-f and antenna coil primary repairs through the use of an ohmmeter, and soldering or welding via receiver plate power, were also described.

Second Prize Winner

THE \$50 War Bond second prize was awarded to Nat Bader, 709 Brighton Beach Avenue, Brooklyn, New York. Mr. Bader, who at the present time is engaged in war work, disclosed replacement and substitution methods in his winning entry. These substitution ideas concerned filter chokes, resistor line cords, and power transformers.

Third Prize Winner

PAUL GRANUCCI, 174 North Whittelsey Avenue, Wallingford, Connecticut, was awarded third prize, a \$25 War Bond.

Mr. Granucci is a Yale University graduate. He holds amateur license W1FRK and also a commercial first class telephone license. He analyzed power transformer and tube substitu-



First prize winner, Ray Pentecost, of Metropolitan Radio Service, 4314 Elston Avenue, Chicago 41, Illinois. Mr. Pentecost is a World War I veteran, and has been a Service Man for the past twenty years.

tion problems in his entry. Mr. Granucci is a former civilian member of the U. S. Signal Corps.

Fourth Prize Winner

FOURTH prize, also a \$25 War Bond, was awarded to Chester W. Sharp who runs a radio shop on West Main Street, Pryor, Oklahoma. Mr. Sharp has been in the radio servicing field since 1928.

In his winning entry he discussed

In the May issue will appear the first prize entry of Ray Pentecost. In subsequent issues, the entries of other prize winners will also be presented.

intermediate frequency and volume control substitutions and repair.

Fifth Prize Winner

A veteran Canadian Service Man, E. M. Dewar, 1515 St. Antoine Street, St. Hyacinthe, Quebec, was awarded the fifth prize, a \$25 War Bond.

A complete analysis of an r-f 8-tube receiver conversion was presented by Mr. Dewar as his entry. Featured in this analysis were tube substitutions, i-f stage conversions, speaker and dial replacements.

War Stamp Winners

FIVE \$10 War Stamp awards were also made. Winners were David V. Chambers, 5856 Market Street, Philadelphia; Paul Sarnoluk, 117-21 147 Street, South Ozone Park, New York; C. L. Fairchild, 620 Wright Avenue, Elgin, Illinois; Fred Guska, 1220 Buhres Avenue, Cleveland, Ohio; and John A. Smith, 535 Liberty Street, Belleville, Michigan.

David Chambers covered repairs of filter condensers, filter chokes and bleeder resistors in his SERVICE entry.

Repair of volume controls and speakers on the old type Stromberg-Carlsons was discussed in the entry of Paul Sarnoluk.

The use of substitute tubes in the old type Colonial receivers, as well as in the popular variety of five-tube a-c/d-c receivers, was the subject of C. L. Fairchild's entry.

Fred Guska's entry covered the repair of a 35Z5 when the filament is burned out. He also showed how to eliminate hum in a 25L6 output.

The use of a p-m speaker in place of a defective dynamic speaker was described by John A. Smith in his contest entry.

DISTRIBUTION

SOUND

by **SIDNEY HARMAN**

David Bogen Co., Inc.

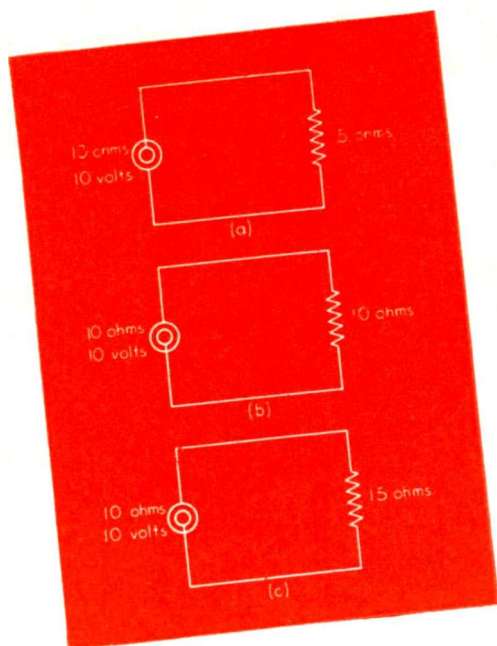

Fig. 1
Three conditions of load:
(a) below exact match,
(b) exact match, (c)
above exact match.

WE have previously analyzed the various aspects and problems of determining the sound system equipment. Certainly, it is necessary that a competent selection and location of speakers be achieved and that the correct amplifying equipment, microphone, tuner and record player be selected. However well these problems may be solved, the end result will be unsatisfactory if the various components of the system are not put together properly.

Matching Speaker Lines

Examination of any amplifier manufactured by a reputable company will disclose that the secondary of the output transformer (or transformers) is multi-tapped. These taps may be at 4, 8, 15, 250 and 500 ohms, and in the case of an amplifier, providing two separate power output stages, a 1000-ohm tap may be made available. This will permit paralleling of the two 1000-ohm secondaries to provide full output from the separate power sections on a 500-ohm line.

What actually is a 500-ohm line, or an 8-ohm or a 15-ohm line? Very simply it is a distribution line which requires a load of either 500 ohms, 8 ohms or 15 ohms to effect the most efficient transfer of power. Thus if an amplifier is to be employed with a single permanent magnet speaker of 8-ohms impedance, best matching will result from connecting the speaker to the 8-ohm tap of the output transformer.

To see this condition most clearly,

let us consider Fig. 1. Assume that the a-c generator provides a source of 10 volts and that it has an internal impedance of 10 ohms. Consider three possible conditions of load: (a) less than exact match, 5 ohms; (b) exact match, 10 ohms; and (c) more than exact match, 15 ohms.

Voltage Across Load

Under each of the three conditions, the following equations show the voltage across the load.

$$E = \frac{5}{15} \times 10 = 3 \frac{1}{3} \text{ volts} \quad (a)$$

$$E = \frac{10}{20} \times 10 = 5 \text{ volts} \quad (b)$$

$$E = \frac{15}{25} \times 10 = 6 \text{ volts} \quad (c)$$

The greater the load, of course, the greater the voltage across it. We are not interested in voltage, however, but in power, the formula for which is

$$P = \frac{E^2}{R}$$

Power Developed in Load

Let us determine the power developed in the load under each of the three conditions above.

$$P = \frac{(3 \frac{1}{3})^2}{5} = 2.2 \text{ watts} \quad (a)$$

$$P = \frac{(5)^2}{10} = 2.5 \text{ watts} \quad (b)$$

$$P = \frac{(6)^2}{15} = 2.4 \text{ watts} \quad (c)$$

It is evident from the above that a perfect match provides maximum transfer of power.

It will be remembered that earlier in the article, reference was made to the practice of using output transformers with multi-tapped secondaries. It should first be remembered that when a load in the form of a speaker is connected to the secondary of the output transformer, a condition similar to that represented in Fig. 2 exists. Reference to a tube manual will show the value of load required for optimum operating condition of the output tube.

The Output Transformer

In order to provide the required load, the output transformer is used. It is so designed that when its secondary is properly loaded, the reflected impedance on the primary will be the value required to match the output tube.

The reflected load is obtained from the formula

$$Z_{RL} = N^2 Z_{SL}, \text{ where}$$

Z_{RL} is the reflected load, N^2 is the square of the turns ratio of the transformer, and Z_{SL} is the secondary load. Thus, the reflected impedance on the primary of the output transformer (the impedance which loads the output tube for power transfer), is a function of the product of the square of the turns ratio between the primary and secondary windings of the transformer and the load on the secondary.

Selecting Output Transformer

A good practical method for selecting the output transformer, is to make certain that the inductive reactance ($X_L = 2\pi f l$) of the primary, when the

LINES OF THE SYSTEM

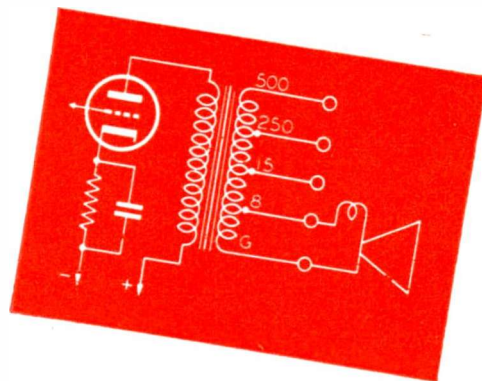

Fig. 2. Typical single-tube output circuit, showing multi-tapped secondary transformer, with 8-ohm winding loaded with permanent magnet speaker.

secondary winding is unloaded, is at least five times the reflected load, at the lowest frequency to be amplified. If X_L of the primary is lower than 5 times the value of the reflected load (Z_{RL}), a loss of low frequency response will result. It should not be construed from the above that this is a completely accurate or invariable rule. For one thing it is offered only as a practical guide and for another, it is conceivable that under certain conditions it would be desirable for the inductive reactance to be lower in value than five times the reflected impedance. Consider the case discussed in the previous article of this series (SERVICE, March 1944). It was shown that the elimination of all frequencies below 400 cycles reduces articulation by less than 5%, and that 50% of the power output of an amplifying system is required to reproduce the band of frequencies under 400 cycles. Therefore, limiting the amplified band to those frequencies over 400 cycles would permit the use of smaller powered amplifiers to do bigger sound jobs. This, then, is one of a number of situations in which it might be desirable to have a lower X_L than that determined by the method outlined above.

It should be pointed out that transformer losses also affect the accuracy of the formula, $Z_{RL} = N^2 Z_{SL}$. If the resistance of the secondary winding is relatively high with respect to the secondary load, the value of Z_{RL} will be higher than calculated. Transformer magnetic core losses cause the value of Z_{RL} to be less than the calculated value.

Line Losses

In most installations, the speakers are located at a considerable distance

from the amplifier, and as a result rather long speaker lines must be run. When lines longer than 50 feet are run, the consideration of line losses usually becomes a most important one.

For example let us consider an amplifier providing an output of 20 watts, and driving four loudspeakers, each with a voice coil impedance of 8 ohms, and all connected in parallel to the four-ohm secondary tap of the output transformer, as shown in Fig. 3.

It will be seen that the speaker loop has been shown as two resistors in series with the paralleled speaker voice coils in Fig. 3b. These represent the d-c resistance of the line. Let us assume that the total value of this resistance is 2 ohms. The total load on the secondary of the output transformer is 4 ohms, and this loads the secondary perfectly. The amount of power dissipated in the line, however, is equal to that dissipated in the speakers and there converted to sound energy. This is obviously inefficient.

18 Wire Resistance

The familiar 18 wire has a resistance of 6.38 ohms per thousand feet. Fifty feet of two-conductor 18 wire, therefore, represents a total resistance of .638 ohm, and if the total length of speaker cable in the system shown in Fig. 3 were fifty feet, the system as shown would be a satisfactorily efficient one. It would actually be preferable under this condition to connect the speakers to the two-ohm tap, for a better match would then be achieved.

Long Speaker Lines

When long speaker lines are used, it

becomes necessary to use speaker line-matching transformers. These transformers serve two purposes: (1) to raise the impedance presented by the loudspeakers, so that the resistance of the line is small by comparison; and (2) to furnish different amounts of power to the different speakers in terms of the requirements indicated by the survey. (SERVICE, March 1944).

Ten-Speaker Arrangement

We shall use an example to demonstrate these points. Let us assume a system requiring 100 watts of power to be distributed among ten speakers in the following manner: 2 speakers require 20 watts each; 4 speakers require 10 watts each; and 4 speakers require 5 watts each.

Let us assume that the total run of cable is 2,000 feet. (This example is shown in Fig. 4.)

We shall examine the problem in terms of using a single 100-watt amplifier. Actually, it would be good practice to use an amplifier or combination of amplifiers which would make at least 120 watts available.

The total line resistance, if 18 wire is used, is roughly 25 ohms. If we use a 500-ohm line, and select the speaker matching transformers carefully, a most efficient system will result, for the resistance of 25 ohms is negligible compared to 500. It may seem that the

Fig. 3. Speaker line, run at 4 ohms, and matching four 8-ohm speakers to the output of a twenty-watt amplifier.

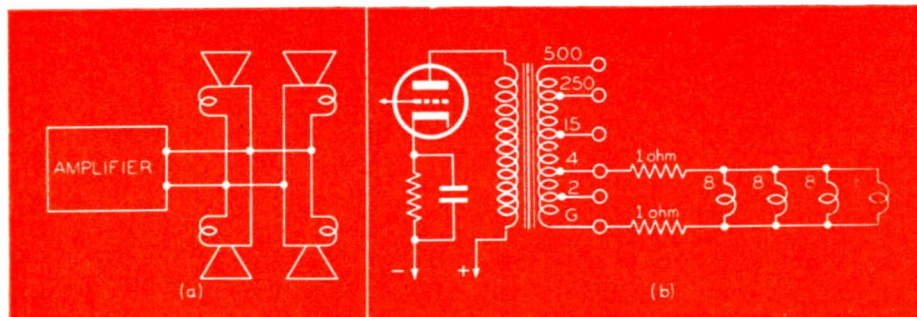

higher the impedance of the line the more efficient the system, but there are a number of conditions which limit the value of the line to be used. In actual practice, lines of 100 to 500 ohms are usually employed.

Disadvantages of High Impedance Lines

Should a distribution line higher than 500 or 600 ohms be used, the voltages in the line would be higher, increasing the possibility of leakage and insulation breakdown. It is quite evident that a leakage of 8,000 ohms between the two wires of the speaker lines is unimportant when the impedance of that line is 500 ohms, but that it would become a serious consideration if the impedance of the line were 4,000 ohms.

If too high a line impedance is used, a loss of high frequency response will also result, due to the capacity of the line. A total distributed capacity of .015 mfd may very well exist between the two conductors of the speaker lines. At 6,000 cycles this represents a capacitive reactance of approximately 2,300

$$\text{ohms } (X_c = \frac{1,000,000}{2\pi fc}), \text{ and provides}$$

an easy path relative to the 4,000-ohm impedance of the line.

Selection of Matching Transformers

We shall, then, use a 500-ohm line, paralleling all speakers to insure the continued operation of all other speakers in the system, should one speaker voice coil open.

Most transformer and amplifier manufacturers make available tapped matching transformers with the primary values clearly marked for given values of secondary load. These transformers are also available with varying power handling capacities. One can obtain matching transformers, designed to handle 5, 10, 15 or 20

watts, with primary taps ranging from 500 to 14,000 ohms when the secondary is loaded with 8 ohms.

In order to determine the value of primary impedance required to transfer the required power from the line to the speakers as outlined above, the following simple formula may be used

$$Z_L \left(\frac{P}{p} \right) = Z_{RL}$$

where Z_L = the impedance of the line
 P = power output of the amplifier
 p = power required in the given speaker
 Z_{RL} = required value of primary impedance of line matching transformer

In our problem, this equation becomes

(A) For the speaker requiring 20 watts

$$500 \left(\frac{100}{20} \right) = 2,500 \text{ ohms}$$

(B) For the speaker requiring 10 watts

$$500 \left(\frac{100}{10} \right) = 5,000 \text{ ohms}$$

(C) For the speaker requiring 5 watts

$$500 \left(\frac{100}{5} \right) = 10,000 \text{ ohms}$$

All speakers are in parallel, and it can be determined that the effective value of all speakers in parallel is 500 ohms, a perfect match for the 500-ohm line.

Interpolating Impedances

It may sometime prove necessary to obtain primary impedances of the line matching transformers which cannot be obtained in standard transformers. In many cases it will be found possible

to obtain the required value or one sufficiently approximate to it to prove acceptable.

A standard line matching transformer may have a primary winding tapped at 500; 1,000; 1,500, and 2,000 ohms. The impedance between any two taps can be determined from

$$Z_p = (Z_B - Z_C)^2$$

where Z_p is the reflected impedance on that portion of the primary transformer between any two of the taps.

Thus, the reflected impedance between the 2,000 and 1,000 ohms is 172 ohms.

The Baffle

[A discussion of baffles, omitted from the March issue because of lack of space, is presented herewith.]

Cone type speakers require baffles in order to provide a bass response. Since low frequencies tend to diffuse, they radiate from the front of the cone to the rear and there, due to phase relationships, are cancelled out. A baffle is used to extend the effective path of sound from the front to the rear of the cone, thereby reducing cancellation. In some systems where fidelity is a requisite, a good bass response will be demanded, and sometimes it is desirable to limit the frequency response of the amplifier for reasons of economy or efficiency. Once the lowest frequency to be amplified and distributed has been established, the following simple formula can be used to determine the baffle size:

(1) baffle length in feet = $\frac{1}{2}$ wavelength of lowest frequency to be amplified and distributed.

As an example, let us use the case outlined previously, where it was decided to limit the low frequency response to a cutoff at 400 cycles. In the first article of this series, the formula for wavelength was established as

$$(2) \text{ wavelength in feet} = \frac{\text{Velocity}}{\text{Frequency}}$$

At 0° C, the formula becomes $W = \frac{1100}{400} = 2.75 \text{ feet}$

The baffle length, in accordance with equation 1, would, therefore, be 1,375' or 16 1/2". This is the length from the front of the cone to the rear, and if the sound man wishes to construct a simple baffle which will adequately serve the purpose, a piece of plywood 16" square with the speaker mounted in the center, will do splendidly.

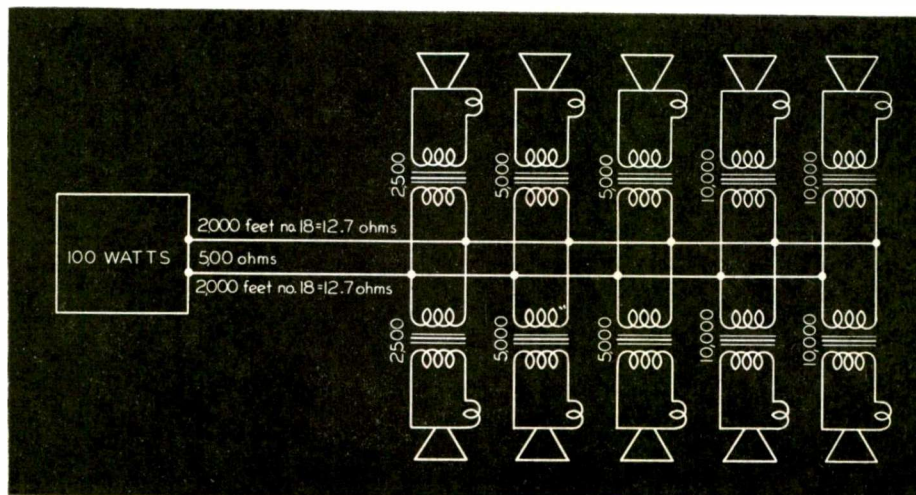
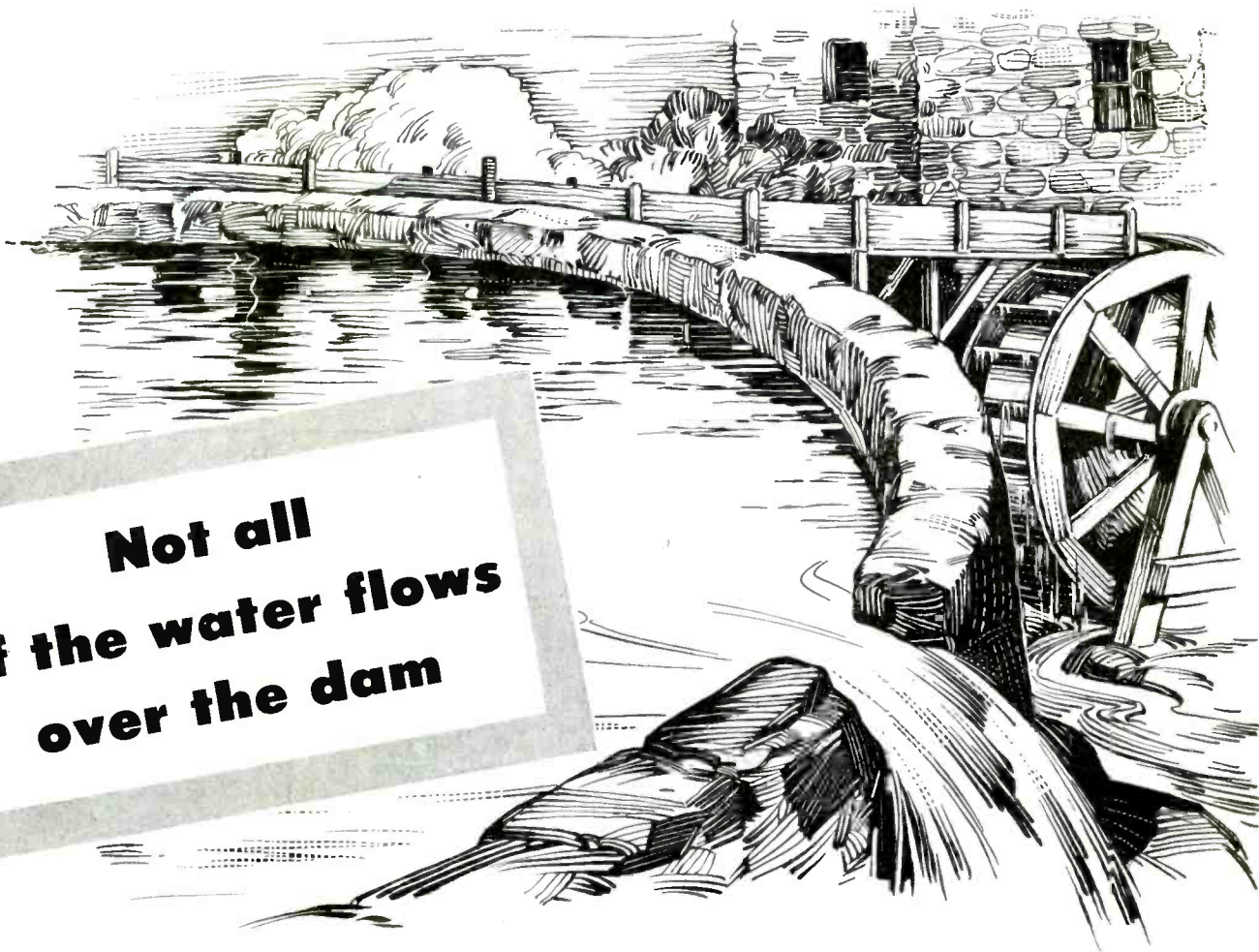

Fig. 4. System of 10 speakers, receiving different amounts of power over a 500-ohm line, 2,000 feet long.



**Not all
of the water flows
over the dam**

BEFORE it becomes just "water over the dam", every working hour, every problem solved, contributes in some measure to the reservoir of practical knowledge we call experience.

There is a wealth of such experience behind Simpson instruments and testing equipment. Into their making has gone all the knowledge acquired during the more than 30 years which Ray Simpson has devoted to the design and manufacture of electrical instruments—all the experience and know-how of a group of men who have long been associated with him.

The important thing today, of course, is that this enables Simpson to build instruments of proven accuracy and stamina, at a rapid rate. Each one has a full bridge type movement with soft iron pole pieces. For the first time this admittedly finer design has been made a matter of mass production—with all the resulting economies and speed.

When it comes time to apply the many things learned under the impetus of war, remember that true progress has its roots in the past. For the utmost in lasting accuracy, and value, look to Simpson.

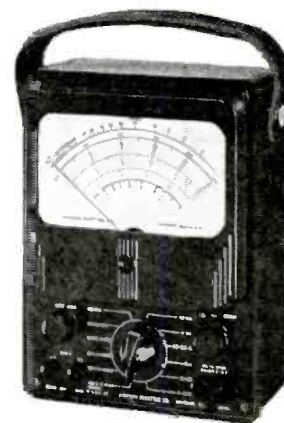

SIMPSON ELECTRIC COMPANY
5200-5218 W. Kinzie St., Chicago 44, Illinois

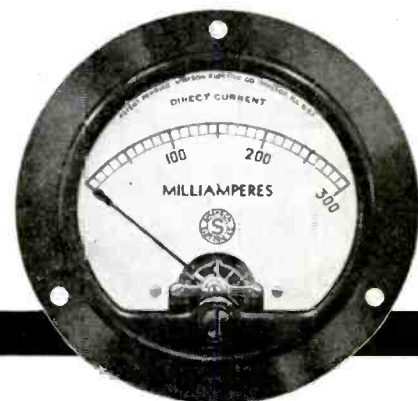

Simpson

INSTRUMENTS THAT STAY ACCURATE

Buy War Bonds and Stamps for Victory

ANTENNA COUPLING AND SWITCHING METHODS

by M. E. HELLER

PART TWO

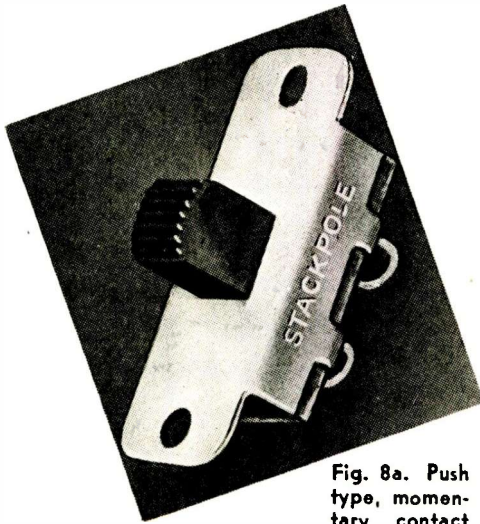

Fig. 8a. Push type, momentary contact slide switch. (Courtesy Stackpole)

LET us consider some loop receivers where plenty of circuit tricks are introduced to provide antenna coupling. Not all use switching methods. We have some 2-band sets where no switching is required, as, for instance, the Truetone model D1176 shown in Fig. 10. This set contains both a loop and foil antenna, the latter serving principally for s-w. Both the s-w primary and the loop primary are low impedance. Thus the

signal voltage is pretty well divided, and not much s-w voltage is lost in the loop primary. The secondary switch is a simple spdt in the converter grid.

A similar 2-band coupling circuit is shown in Fig. 11. The loop primary consists of a single turn around the outside of the loop. Capacity coupling is minimized by connecting the input grid to the inside turn and grounding the outside turn of the loop. Thus, the inside hot turns are somewhat shielded by the low potential outer turns. The loop primary is, of course, of very low impedance so there is little loss of s-w signals.

An alternative method of solving the 2-band coupling problem appears in Zenith models 6S596-6S597, Fig. 12. When an external antenna is not used, a short cabinet antenna supplies the pickup for s-w signals. A short-

ing bar is placed across the high impedance loop primary, as well as a

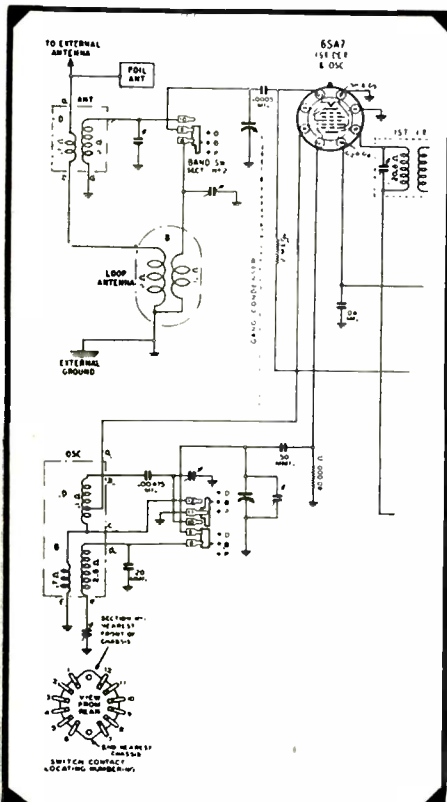
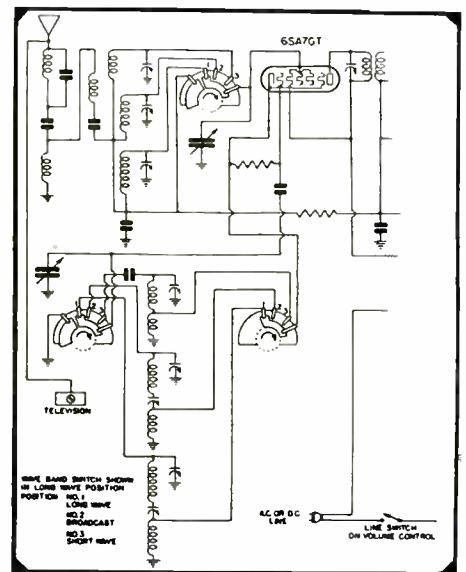

Figs. 9 (upper right) and 10 (lower left). In Fig. 9 appears a portion of the Emerson DD-268, 270, 272, and 276 covering l-w, b-c, and s-w bands with inductive coupling, and with an i-f of 455 kc. A series type of trap is tuned to this frequency and the primary coil is isolated by two .02-mfd series condensers. No antenna switching is performed, but the unused secondaries are shorted. In Fig. 10 appears the input circuit of Truetone D1176. Here a foil antenna is used for s-w. Since the s-w primary and the loop primary are of low impedance, the signal voltage is pretty well divided and there is very little loss in the loop primary.

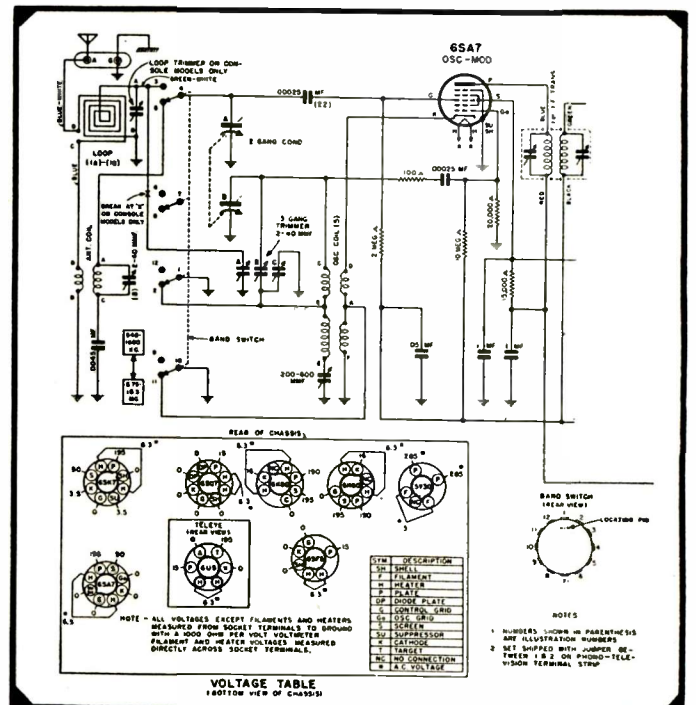
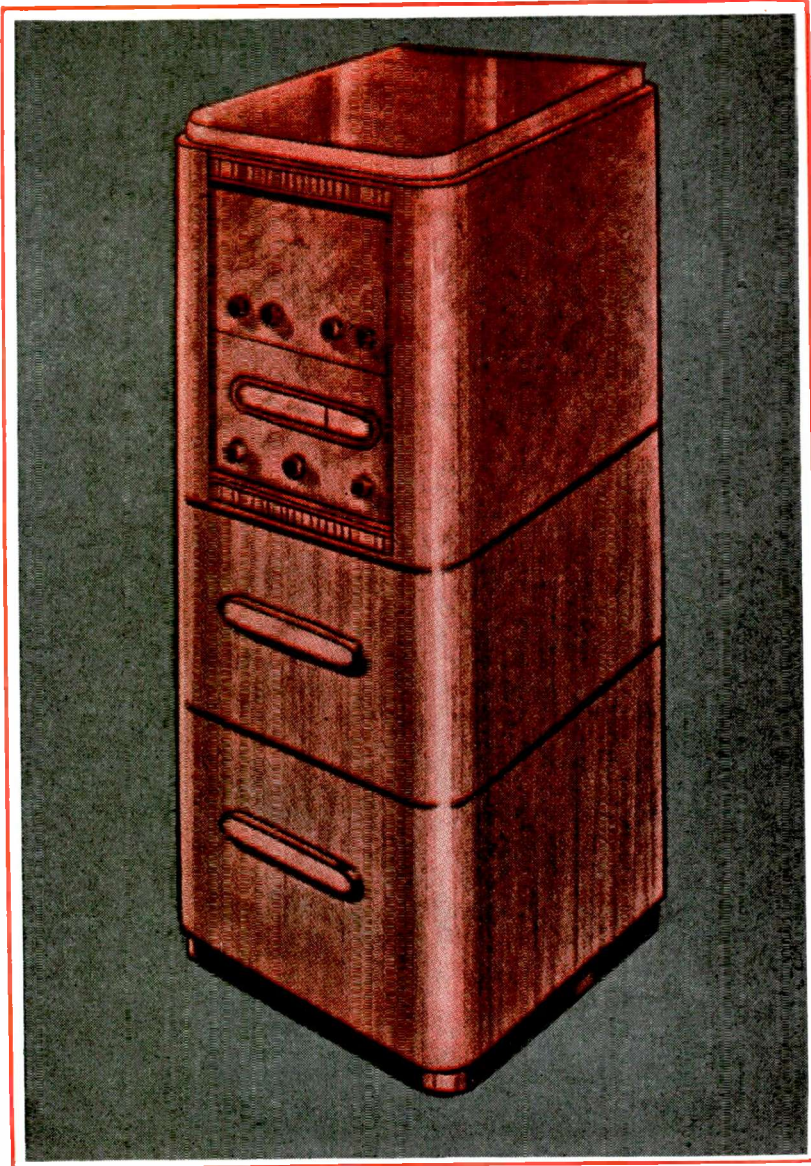

Fig. 11. Sentinel seven-tube 2-band receiver with a loop primary consisting of a single turn wound around the outside of the loop.



The Voice of Good Management

New rulings make sound equipment available *now* to many industrial plants. Good judgment dictates to good management the use of new, compact Meck Industrial Sound Equipment. It gives management a friendly voice to the ear of every co-worker. The Meck clear-hearing voice channel cuts through factory noises pleasantly and positively. Sound in industry saves time through personnel paging, stimulates workers through music. Build morale, reduce absenteeism and labor turnover with Meck Industrial Sound.

NEW YORK: 500 Fifth Avenue
Chickering 4-3545

CHICAGO: 540 N Michigan Ave.
Delaware 1561



MECK INDUSTRIAL SOUND

JOHN MECK INDUSTRIES • PLYMOUTH, INDIANA, U.S.A.



BRACH Radio Antennas

... in war Today ... as in peace Tomorrow
DEPENDABLE PERFORMANCE - - Always

BRACH Antennas and other radio and electrical products are rendering a distinguished service on fighting fronts everywhere. But when the war is over, they'll be back where they belong ... in your store, making sales.

L. S. BRACH MFG. CORP.

World's Oldest and Largest Manufacturers of Radio Antennas and Accessories
 55-65 DICKERSON STREET • NEWARK N. J.

ANTENNA COUPLING

(Continued from page 14)

50-mmfd condenser. When greater signal levels are desired, the shorting bar is removed and an external antenna connected to the A post. The bypass condenser has little effect on b-c signals being transferred to the loop, but it readily bypasses s-w signals to the s-w transformer, preventing r-f choking action of the loop primary. The loop is electrostatically shielded and operates with a loading coil on the grid side. Fig. 13 shows a similar arrangement with a high

impedance loop primary but, instead of using a cabinet antenna for s-w re-

Fig. 12. Input circuit of Zenith 6S596-6S597 with a shorting bar placed across the high impedance loop primary, as well as a 50-mmfd condenser. To increase signal strength the shorting bar is removed and an external antenna is connected to the A post.

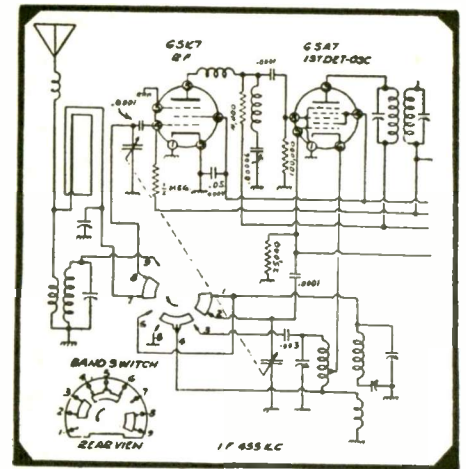
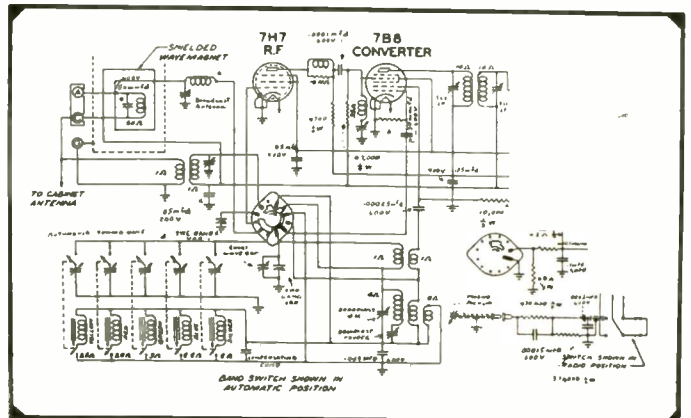

Fig. 14. Antenna-loop input circuit of Admiral A-7 receiver. The antenna is connected at the junction of the loop and an s-w transformer.

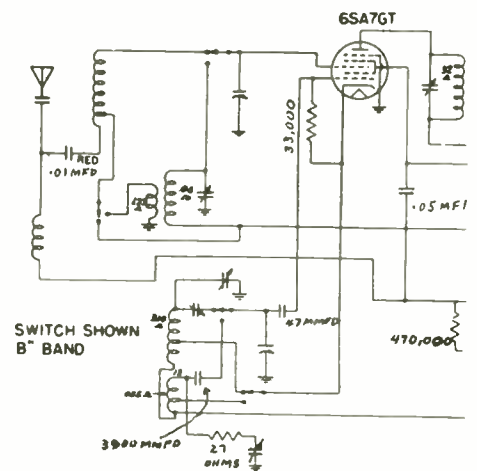
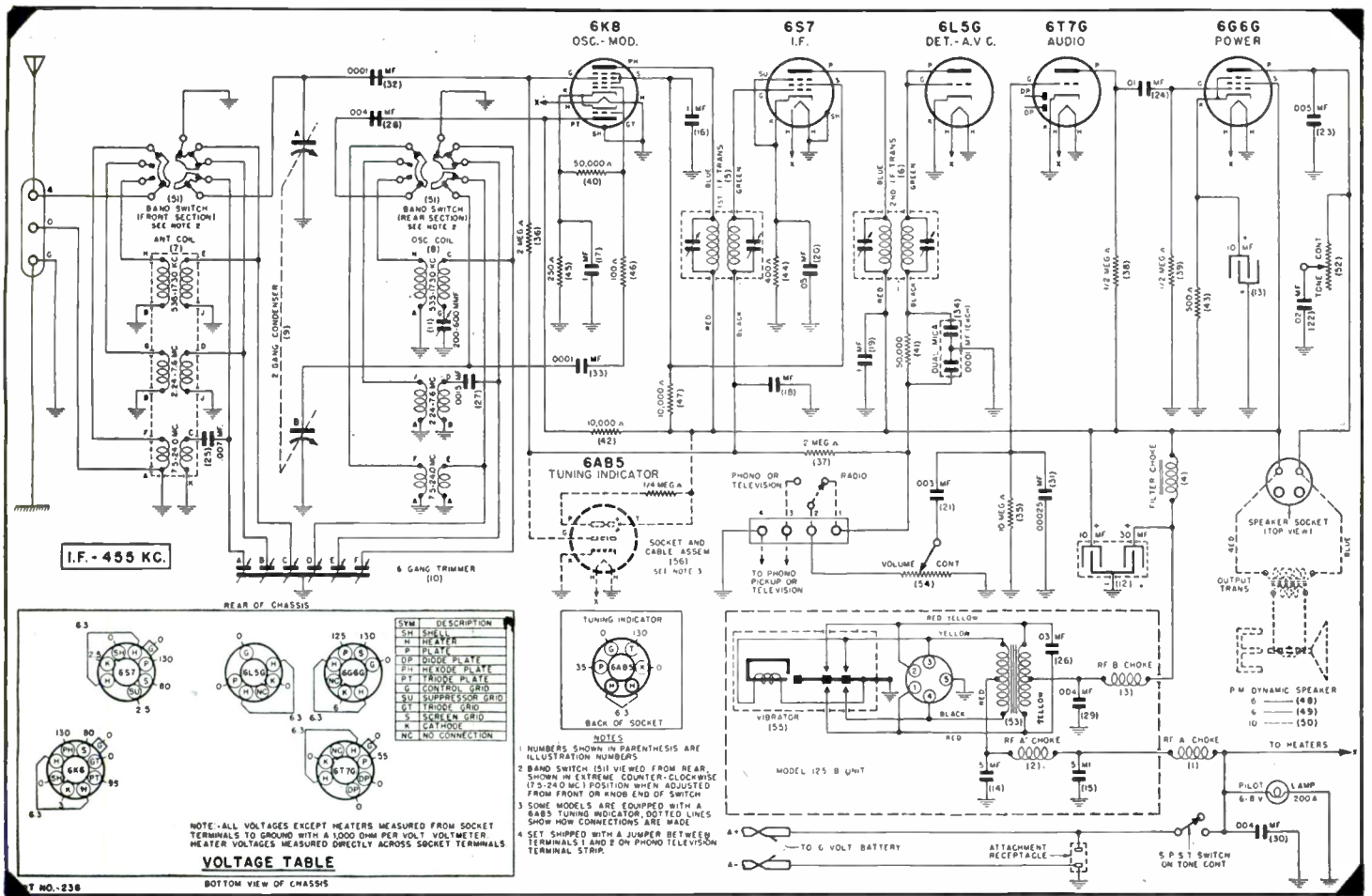

Fig. 15. Autotransformer coupling used in the General Electric J-709 receiver. Note the .01-mfd. series condenser, r-f choke to ground, and a second .01-mfd condenser in the antenna circuit.

ception, a pickup from a third wire in the line cord is used. A 50-mmfd series condenser is also employed. This loop is not shielded nor is it loaded with a series coil

Still another method of obtaining 2-band antenna coupling in a loop re-
 (Continued on page 18)



parallel with the loop to cover the s-w band, and a small loop is used for the second s-w band. A 4-position antenna switch inserts a 1000-ohm resistor in series with the main loop primary for push-button or manual b-c tuning, connects the primary directly on the first s-w band and connects the antenna directly to the small loop for the second s-w band. Another receiver which uses a large loop for A and B bands and a separate small loop for the C s-w band is the RCA Victor 18T, Fig. 19. A short-

ing link is used for loop operation. No antenna resistors or condensers are used.

Figs. 18 (below) and 19 (right). In Fig. 18, three-band G.E. J-64 with two separate loop antennae. Large loop serves for b-c and first s-w band. Fig. 19, RCA 18T, which also uses a large and small loop method of tuning.

Fig. 20. Battery type Sentinel 236 receiver with band-switch covering 535-1730 kc, 2.24-7.6 mc, and 7.5-24 mc bands.

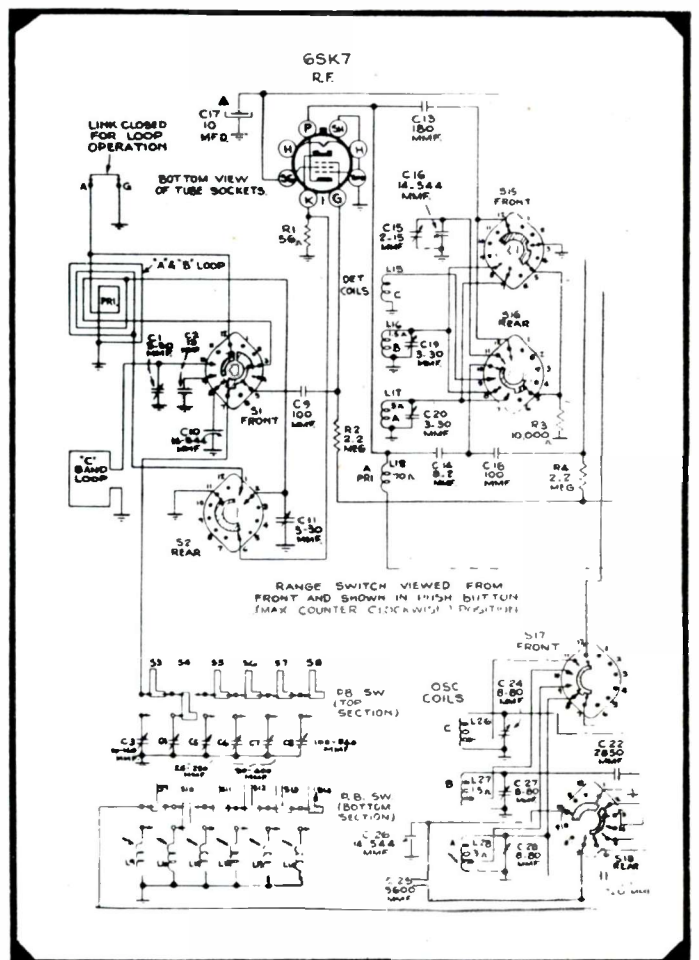
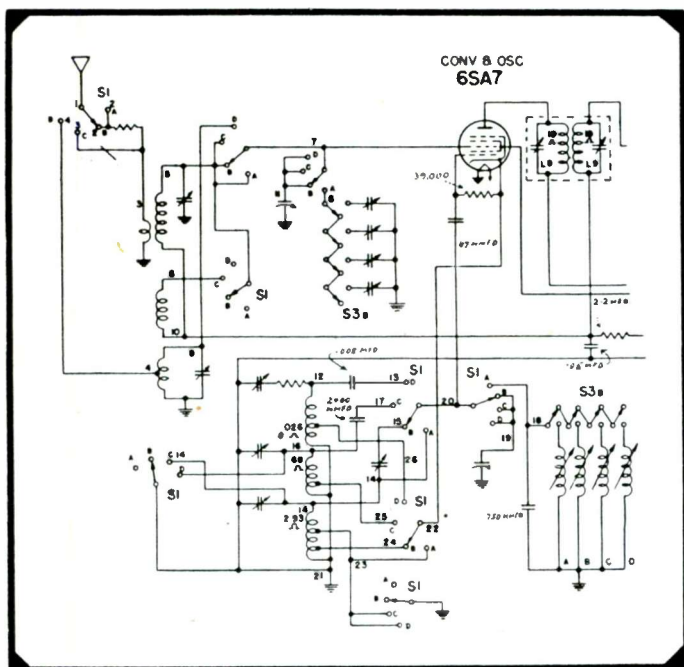

KEN-RAD

ELECTRON TUBES

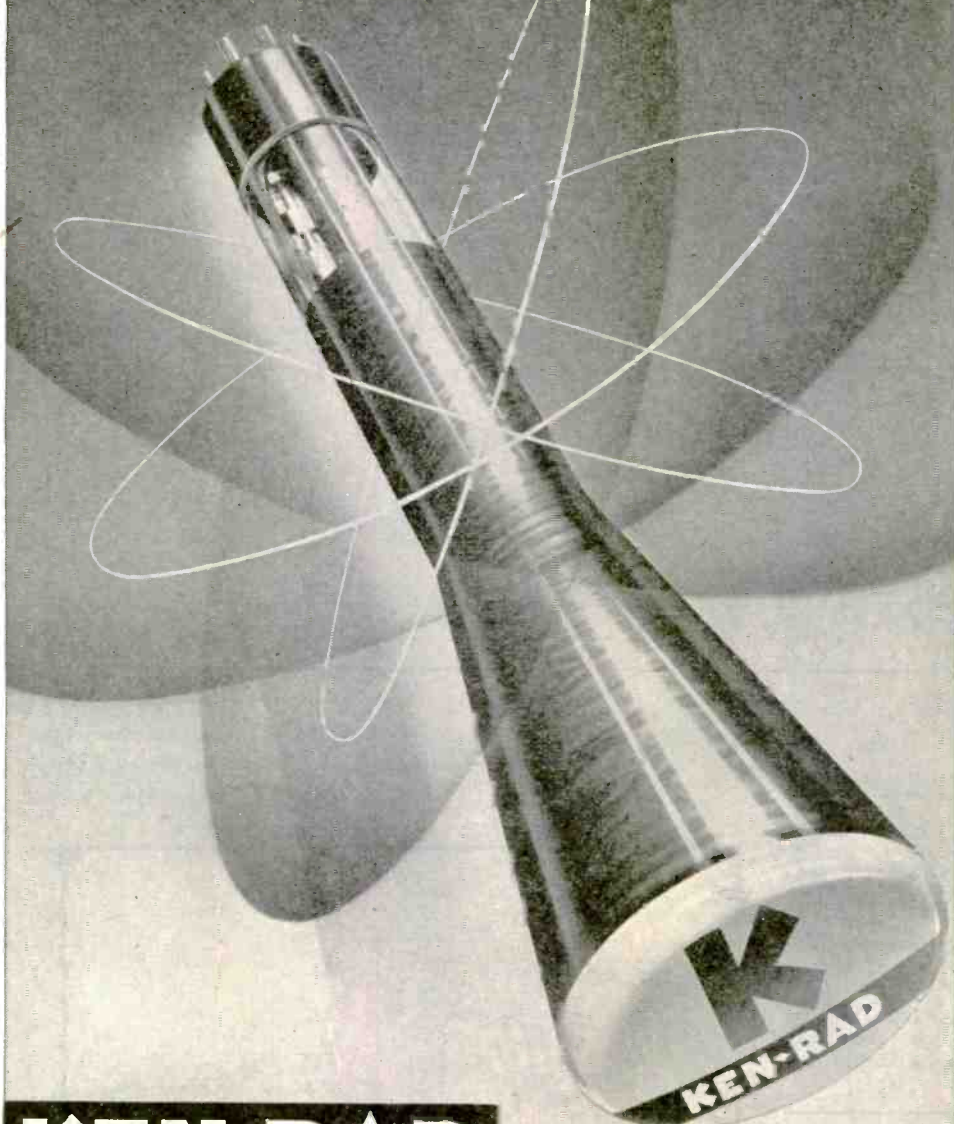

KEN-RAD

EXECUTIVE OFFICES
OWENSBORO, KENTUCKY
EXPORTS 15 MOORE STREET NEW YORK

TRANSMITTING
TUBES

RECEIVING
TUBES

CATHODE RAY
TUBES

INCANDESCENT
LAMPS

SPECIAL
PURPOSE TUBES

FLUORESCENT
LAMPS

SERVICING HELPS

ELIMINATING VOLUME CONTROL SQUEAKS

When the volume control on the radio begins to squeak, a few drops of carbon tetrachloride dropped in between the leaves will generally cure the noise in a jiffy. After dropping the carbon tetrachloride in between the leaves, the control should be given a few twists to distribute the solvent. Generally the noises are caused by some oil that has

become slightly hard. The carbon tetrachloride dissolves whatever grease may have hardened between the leaves.

Stephen Porter Lathrop.

ZENITH 5G501M 3-WAY PORTABLE

B voltage drops: In this model, which is frequently operated on batteries, the *B* voltage may drop too low for receiver operation. Assuming the batteries to be okeh, the 11726 rectifier

should be checked. If this is normal, check the first filter for open or loss of capacity. If rectifier is defective, check the other condensers for shorts, before inserting a new 11726.

Clifford R. Stout.

AIRLINE 62-196

Wartime replacement for hard-to-get special dual volume control used on some of these models: Front section is a conventional 1-megohm audio taper control, which can be replaced. The rear section, however, is a rheostat, used to vary cathode bias, with a 150 ohm limiting resistor in the circuit. Simply eliminate rheostat and ground limiting resistor.

Clifford R. Stout.

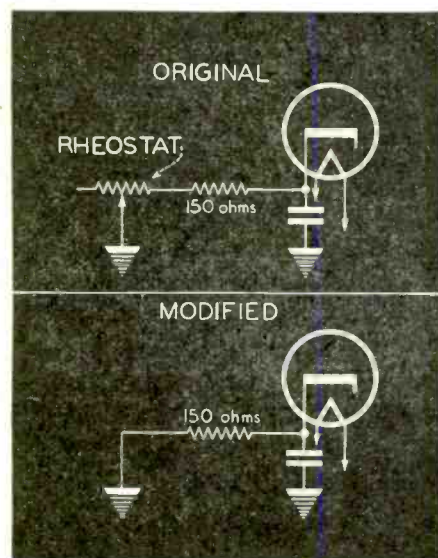

SILVERTONE 7083 3-WAY 1942 PORTABLE

High pitched whistle which sounds like an audio oscillation: Originates in the 1H5 amplifier-detector avc tube and is due to a slight microphonic condition often present in these tubes. Change tubes. Or for a permanent cure, place an .0005-mfd 600 v condenser from 1H5 plate to ground. This latter method caused a slight high frequency cut-off, but is considered by many customers to be an improvement.

Clifford R. Stout.

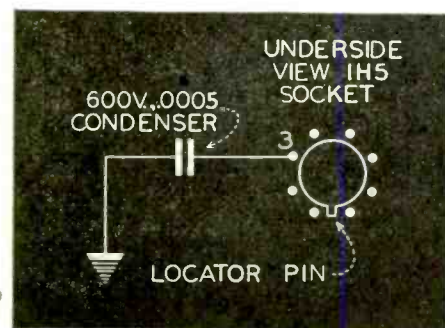

Famous Signatures

Michelangelo Rembrandt

Morganstouff

Whistler

Leonardo da Vinci

Rubens

Vincent Van Gogh

A. VANDYCK

Raphael

P. Cezanne

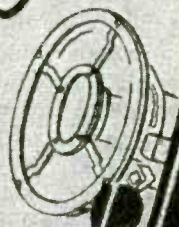

Jensen

Manufacturers and Designers of Fine Acoustic Equipment

ELECTRONIC VOLTAGE AND SPEED REGULATORS

PART THREE

by S. J. MURCEK

THE operation of the a-c voltage regulation system in Fig. 5 is very similar to that of the d-c system in Fig. 1. In Fig. 5, decrease of the power loading on the output terminals 8, 9, and 10 of the alternator 2, results in an increase in the a-c voltages across these terminals. As a result, the voltage across the terminals of the voltage indicator tube 37 increases, increasing its filament temperature, and, in turn, its plate current.

The rise in the indicator tube plate current results in an increase in the voltage across resistor 36, which swings the control grid of the pentode 30 positive, with respect to its cathode. Since the pentode plate current increases, this is also true of the voltage across the plate resistor 29, swinging the plate of the pentode more negative with respect to its screen grid. Here, the rectifier thyratrons energizing the alternator field winding 7 conduct later in each positive

a-c half-cycle, the cathodes of these tubes being common with the screen grid of the pentode and the control grids effectively with the pentode plate. It is self-evident that the a-c output voltages decrease because of the decrease in the field excitation current.

An increase in the alternator loading results in a decrease in the alternator output voltages. This, quite evidently, brings about the reverse of the reactions occurring with alternator voltage increases.

Control of the regulation voltage level is accomplished through variation of the pilot voltage across the

pilot tube 34. The pilot voltage is subdivided into several separate components by the voltage divider system consisting of the resistors 42 and 43, and resistance of the potentiometer 35. The minimum a-c voltage to which the system output may be reduced occurs when the sliding contact of the potentiometer 35 is at its positive terminal. With such an adjustment, the grid of pentode 30 begins to swing positive, and to reduce the system output voltage, when the voltage across resistor 36 is greater than that across resistor 42. With the potentiometer slider arm at its negative terminal, however, the voltage across resistor 36 must equal the voltage across resistances 42 and 35, which is considerably greater than in the former instance. Variation of the potentiometer slider arm position varies the system output voltage.

Electronic speed regulators bear a close resemblance to electronic voltage regulators. Since the speed of the electric motor shaft rotation is dependent on the electrical power considerations under which it operates, electronic regulation may be thus applied to equipment speed control.

The d-c motor is effectively a d-c generator. When operated as a generator, the voltage output of the device is directly dependent on the armature speed and the field structure magnetization. If the field magnetization is made constant, the armature voltage varies only with its shaft speed, and may be said to be directly proportional to the shaft speed. In a given motor, designed for operation from a 125-volt d-c source with a running speed of 2,500 rpm, reduction of the input voltage to 75 volts gives a shaft speed, therefore, of

$$\frac{75}{125} \times 2,500 \text{ or } 1,500 \text{ rpm}$$

It is quite evident that the voltage across the motor armature is a direct
(Continued on page 24)

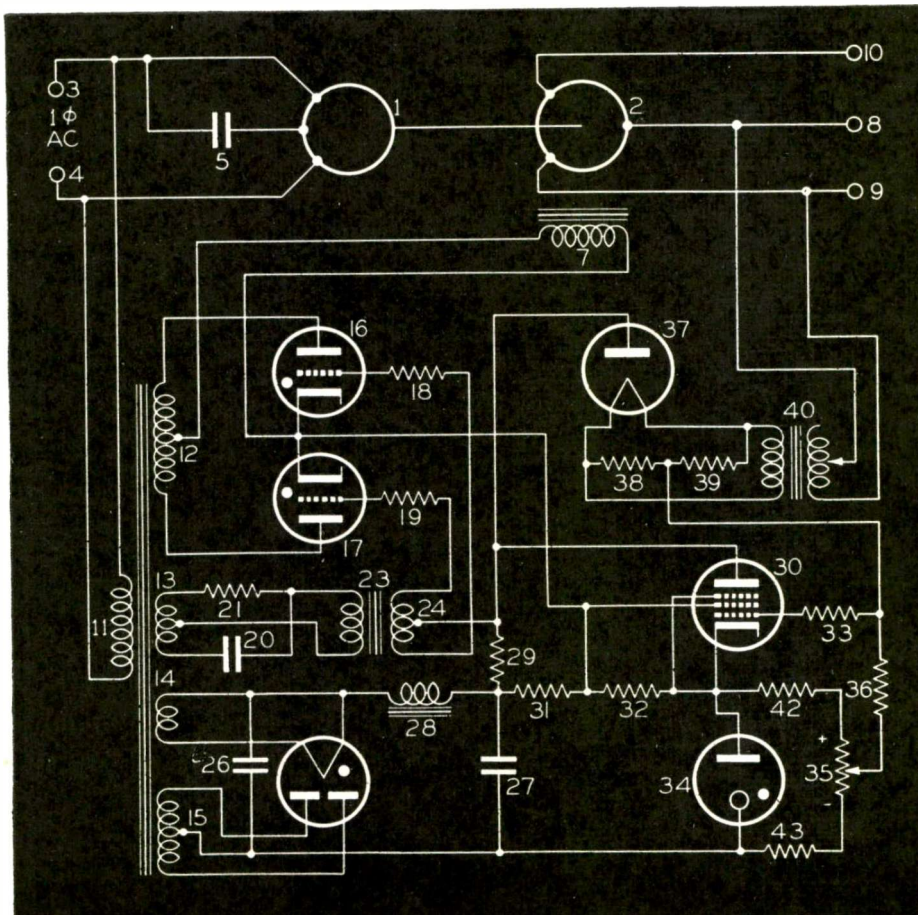

Fig. 5. A conventional a-c electronic voltage regulation system. A single-phase capacitor-operated motor drives a d-c exciting field winding. This is very similar to the d-c type of regulation system.

NEW RCA TUBE GUIDE HELPS YOU SERVICE RADIOS FASTER

16-page Directory lists
304 RCA Receiving Tubes
with over 2000 suggested
substitutions

HOT off the press! The most complete Tube Substitution List ever issued by any tube manufacturer! Another great scoop for RCA Service Men and Dealers! Another timely RCA contribution — to help you use available tubes in place of hard-to-get types when you service civilian radio receivers.

With radio Service Men and Dealers, time means money. By showing you how to service radio sets in less time, RCA's new TUBE SUBSTITUTION DIRECTORY puts real, extra dollars in your pocket today!

Here's what's in your Directory:

A listing, in numerical-alphabetical order, of all 304 RCA Receiving Tube types — and in most cases one or more substitution types which can be used as replacements. Notations (with clear, detailed explanations) of the space limitations and the wiring, filament- or heater-circuit, and socket

changes involved in making the substitutions. Sample calculations of series and shunt resistors in heater strings. Suggested substitutions are cross-indexed and keyed to cathode voltages and functional groupings tabulated in the "Classified Chart of Receiving Tubes" which is also included.

Don't fail to get this valuable new RCA Directory at once. Ask your RCA Distributor for a copy today, or fill out coupon below and mail it, with your name and address and 10¢ to cover costs, to RCA, Commercial Engineering Section, 598 South 5th St., Harrison, N. J.

Where else but to RCA can you look for practical, dollars-in-the-pocket support like this?

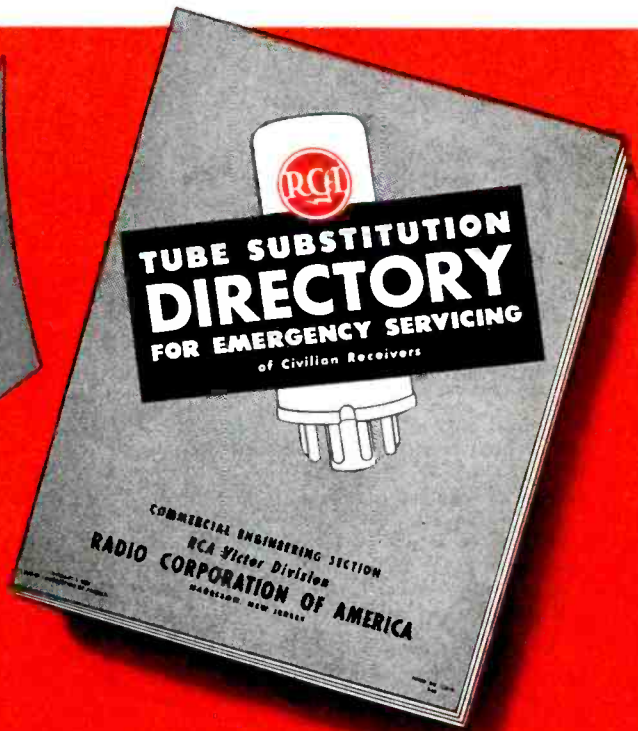

BUY MORE
WAR BONDS

RADIO CORPORATION OF AMERICA

RCA, Commercial Engineering Section,
598 South 5th St., Harrison, N. J.

Enclosed is 10¢ for TUBE SUBSTITUTION DIRECTORY FOR
EMERGENCY SERVICING OF CIVILIAN RADIO RECEIVERS.
Please mail my copy at once to:

Name.....

Address.....

"THE HELP SITUATION" by Lariat

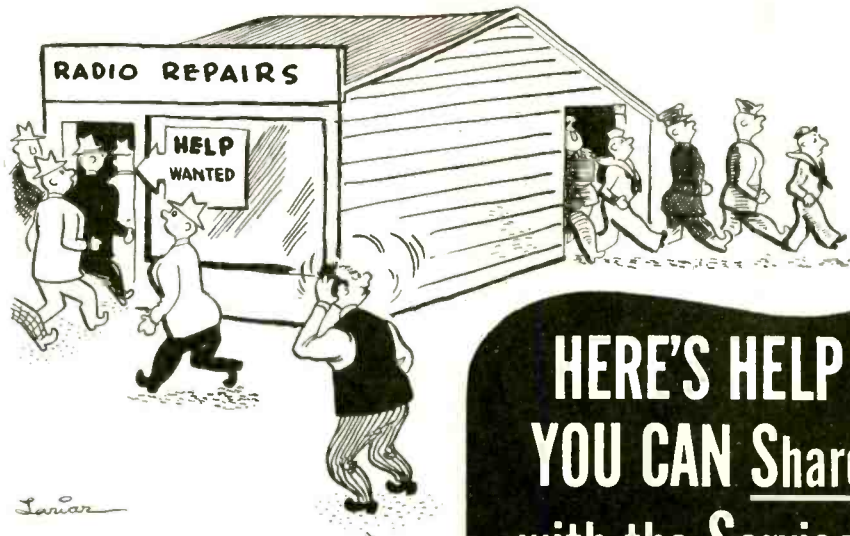

The members of the radio servicing industry can well be proud of the valuable contribution they have made in preparing technicians for specialized work in the armed forces—even if it hasn't been easy to see your help "come in one door and go out the other."

However, there is one important group of workers that you can share with the services—Rider Books. Used in every branch of our armed force, for the training of radio personnel, these books are also making it possible for civilian servicemen to meet their obligation to "keep 'em playing"—even under today's difficult conditions.

Rider Manuals make it easy to trace the circuit in a faulty receiver. Other data in the thirteen volumes simplify your servicing work. Be sure you have a complete set on each of your benches.

Also check the other Rider Books in the list at the right. They're chock full of proven principles that will further speed your work and enable you to make the most of your opportunities to serve your customers and your country.

HERE'S HELP YOU CAN Share with the Services

RIDER MANUALS (13 VOLUMES)

Volumes XIII to VII.....\$11.00 each volume
 Volumes VI to III..... 8.25 each volume
 Abridged Manuals I to V [1 volume]....\$12.50
 Automatic Record Changers and Recorders 6.00

OTHER RIDER BOOKS YOU NEED

The Cathode Ray Tube at Work
 Accepted authority on subject.....\$3.00
 Frequency Modulation
 Gives principles of FM radio..... 1.50
 Servicing by Signal Tracing
 Basic Method of radio servicing..... 3.00
 The Meter at Work
 An elementary text on meters..... 1.50
 The Oscillator at Work
 How to use, test and repair..... 2.00
 Vacuum Tube Voltmeters
 Both theory and practice..... 2.00
 Automatic Frequency Control Systems
 —also automatic tuning systems..... 1.25
 A-C Calculation Charts
 Two to five times as fast as slide rule..... 7.50
 Hour-A-Day-with-Rider Series—
 On "Alternating Currents in Radio Receivers"—
 On "Resonance & Alignment"—
 On "Automatic Volume Control"—
 On "D-C Voltage Distribution".....90c each

JOHN F. RIDER PUBLISHER, INC.

404 Fourth Avenue, New York 16, N. Y.
 Export Division: Rocke-International Electric Corp.
 13 E. 40th Street, New York City Cable: ARLAB

RIDER MANUALS

GIVE YOU THE HELP YOU NEED!



ELECTRONIC VOLTAGE AND SPEED REGULATORS

(Continued from page 22)

indication of its shaft speed. This fact provides a means whereby electronic voltage regulation may be readily applied in the control of motor speeds.

A fundamental electronic motor speed regulation system is given in

Fig. 7. This system is essentially a voltage regulated control system, in that the motor shaft speed varies directly in accordance with the system regulation voltage.

Power for operation of this motor and its associated speed regulation

system is taken from an a-c supply source, being applied to the primary winding of the power transformer 1, at terminals 2 and 3. A portion of this power is rectified by means of the vapor rectifier tube 14, being subsequently filtered by capacitors 11 and 13, and inductor 12. The resulting d-c voltage is regulated by means of the gaseous voltage regulator tube 16, then applied to the field winding 17 and the speed control potentiometer 18 resistance element. Here, it should be observed that the field magnetization and the voltage across the resistance element of the speed control potentiometer are constant.

In series with the slider arm of the speed control potentiometer is the 90° a-c grid voltage component lag network, so characteristic of thyatron grid circuits. This network consists of the transformer winding 4 on the power transformer core, the resistor 9 and the capacitor 10. It provides the a-c grid voltage lagging component necessary for phase-shift control of the thyatron 20.

Initially, the motor armature is started by closure of switch 22. Since the armature shaft speed, at this time, as well as the voltage across the armature, is zero, the grid of thyatron 20 is positive with respect to the cathode over the entire positive a-c half-cycle, by the voltage existing between the slider arm and the negative terminal of the speed control potentiometer. Thyatron 20 must, therefore, conduct, and the motor shaft begins to rotate. As the shaft speed increases, the armature voltage also increases, the latter approaching the voltage existing between the potentiometer slider arm and the negative terminal of the d-c power supply. Since the negative brush of the motor armature is common with the negative d-c lead, the voltage between the grid and cathode of the thyatron decreases.

Eventually, the voltage across the motor armature approaches the voltage which exists between the negative terminal and the slider arm of speed control potentiometer 18. Here, the negative half-waves of the a-c thyatron grid voltage component cause the thyatron to conduct later in each positive a-c half cycle, until the armature voltage tends to decrease, preventing further rise in the motor shaft speed. This is the equilibrium speed condition.

Increase in the loading of the motor shaft increases the armature current, the increased system voltage drop causing a resultant decrease in the armature voltage, and therefore the motor shaft speed. Consequently,

(Continued on page 26)

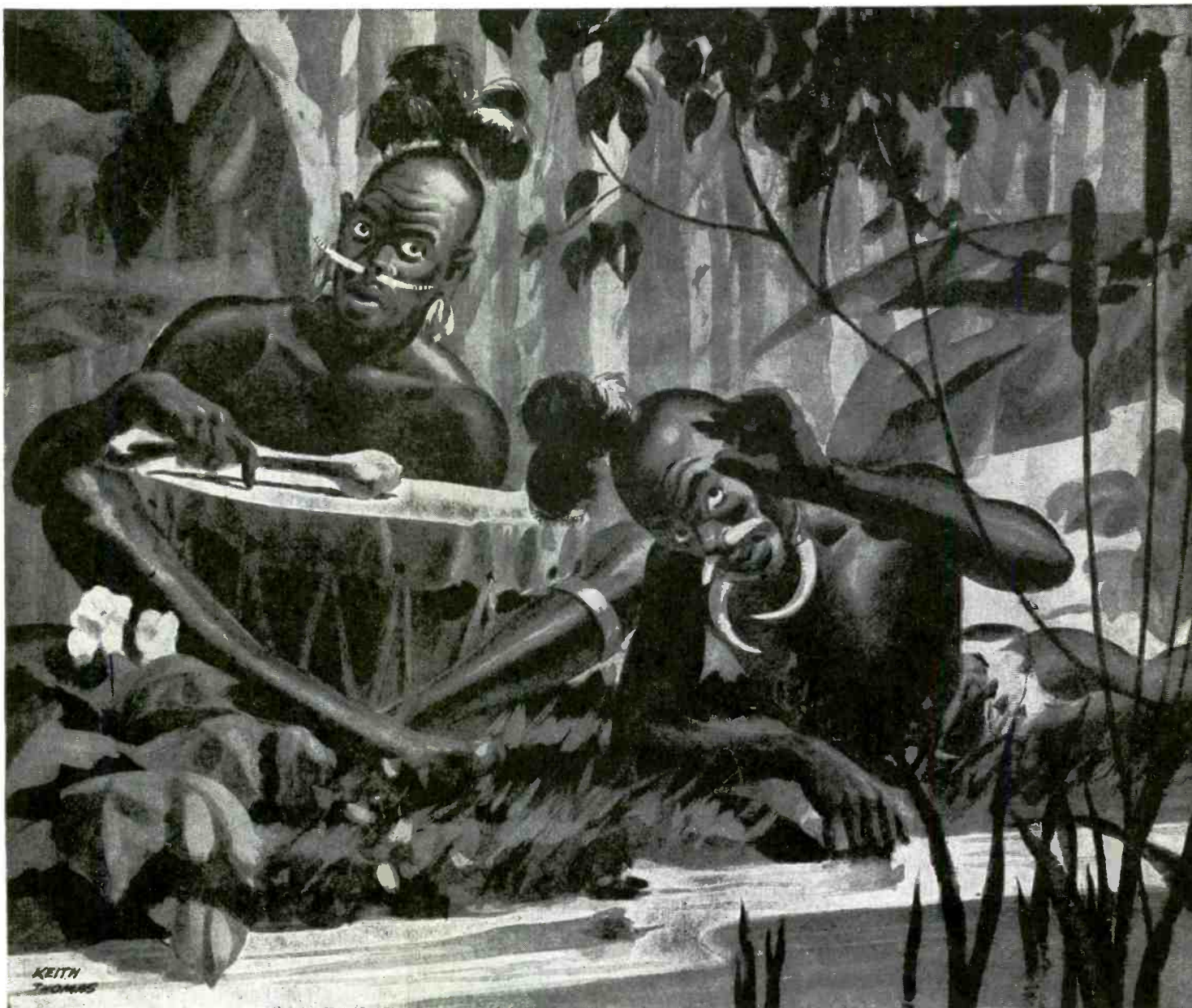

History of Communications Number Three of a Series

PRIMITIVE COMMUNICATIONS

An early communications instrument was the Tom-Tom—to prove its efficiency, it is still used by the natives of Africa. Tom-Tom signals are “Beat out” along jungle lined rivers, but even then distance is a handicap, and “repeater” stations are many.

Like all means of communications, other than voice communication, translation of coded signals must take place in which additional skill is required, and another chance of error is presented. As in the case of the Tom-Tom beater: knowledge of the Tom-Tom code was restricted to a special family within the tribe, and was handed down from generation to generation.

Today, Universal Microphones in the hands of the fighting men of the Allied Armed Forces are performing a simple but vital need in electronic voice communications where their quality and efficiency are bringing us one step closer to victory.

< Model T-30-S, illustrated at left, is but one of several military type microphones now available to priority users through local radio jobbers.

UNIVERSAL MICROPHONE CO., LTD

INGLEWOOD, CALIFORNIA

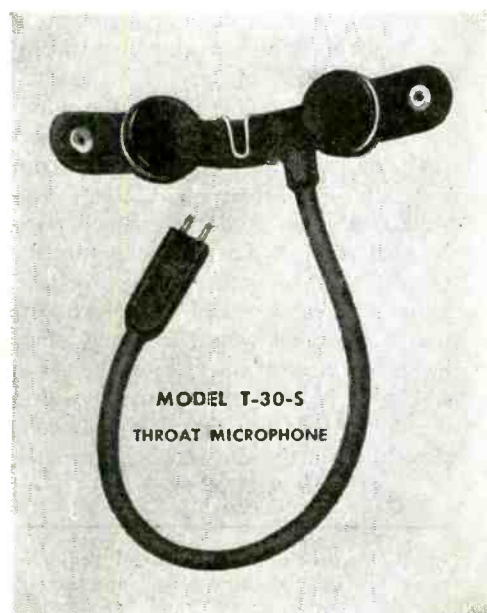

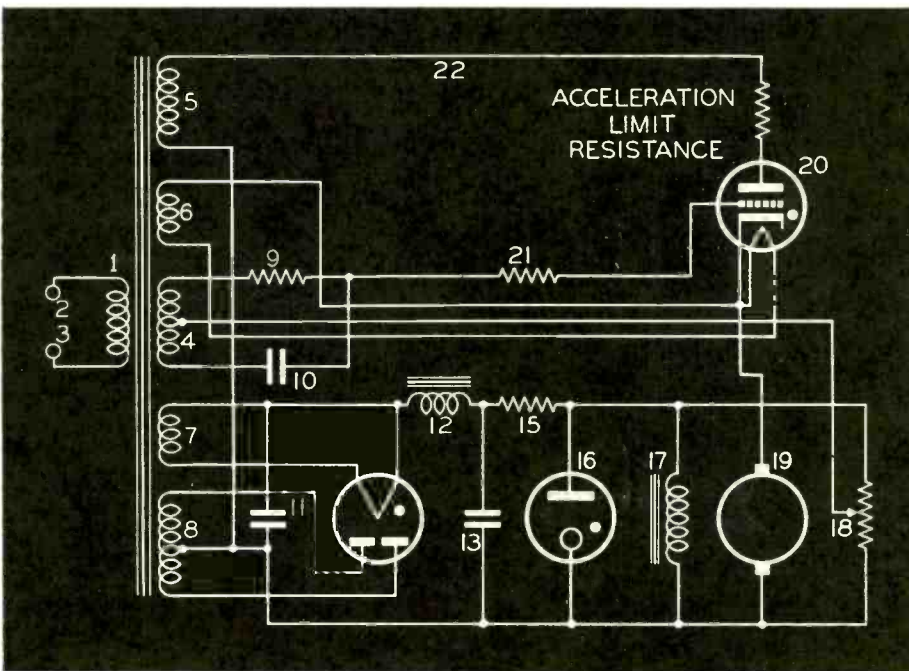

Fig. 7. A fundamental electronic motor-speed regulation system circuit. This is essentially a voltage regulated control system, since the motor shaft speed varies directly in accordance with the system regulation voltage.

the control grid of the thyatron 20 is slightly more positive with respect to the cathode, enabling the tube to conduct earlier in each positive half-cycle. In this manner, the armature voltage is returned to the equilibrium condition, restoring the motor shaft speed to the original value. Conversely, a decrease in the loading of the motor shaft decreases the armature current, and the system voltage drop disappears as a direct result. At this time, due to the increased voltage across the motor armature, the

armature speed tends to increase. However, also as a result of the increased voltage across the armature, the cathode of the thyatron is more positive with respect to the arm of the potentiometer 18. Hence, the tube conducts later in each positive half-cycle, decreasing the effective voltage across the motor armature, thus maintaining its speed constant.

The circuit of Fig. 7 may be modified in various ways, through the introduction of suitable electronic control voltages operating directly on the

thyatron grid circuit. These additional voltages may provide acceleration current surges, or may operate to limit the maximum armature current conducted through the motor armature. This circuit is common in most industrial motor control applications.

A precision motor speed regulator, shown in Fig. 8, utilizes the voltage developed across the commutator of a small tachometer generator as the means for controlling and regulating the motor speed. In this circuit, the tachometer generator 2 is provided with a permanent magnetic field structure, 5. Therefore, the voltage across the generator brushes varies only with the shaft speed. Usually, the tachometer is directly connected, sometimes belt driven, to the shaft of the controlled motor 1. The controlled motor, in the instance of Fig. 8, is a d-c motor which receives its armature power from a separate source, through the terminals 3 and 4. The electronic regulator operates on the field winding 6 of this motor.

In general, the circuit of Fig. 8 operates in much the same manner as the voltage regulator circuit of Fig. 1. In Fig. 8, if the motor shaft speed rises, the voltage across the armature of the tachometer generator also increases. Thus, the control grid of pentode 34 is driven positive with respect to its cathode, which, due to the increased plate current, causes the anode of the tube to assume a negative polarity with respect to its screen grid. Since the plate is common to the control grids of the two thyatron rectifiers in series with the a-c phase-shift voltage from the winding 12 and the phase shifting network, and the tube cathodes are connected to the screen grid, the thyatrons must conduct later in each positive half-cycle. Later conduction by these tubes decreases the voltage across the motor field 6. Normally, the motor speed would increase, since the field is weakened. However, the field winding 6 operates in opposition to another field winding which is connected across the d-c supply terminals,

(Continued on page 30)

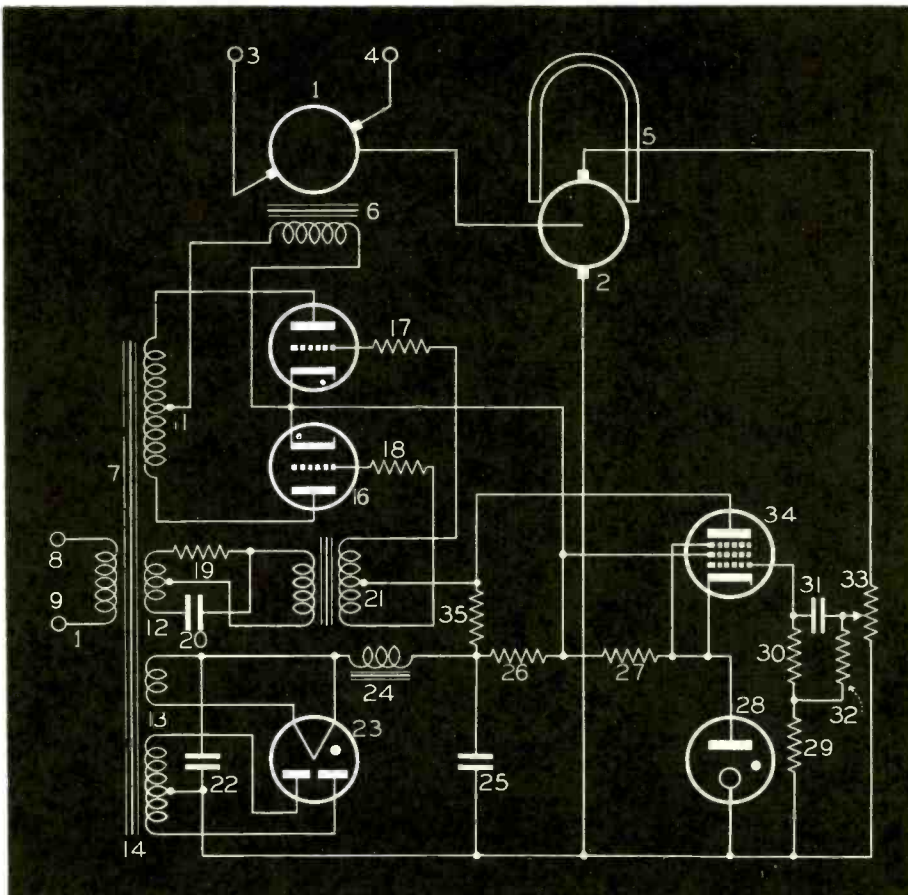

Fig. 8. A precision motor-speed regulator system utilizing the voltage developed across the commutator of a small tachometer generator as the means for controlling and regulating motor speed.

Can YOU use this



VARIABLE INDUCTOR

Culminating a number of years of research, the UTC Variable inductor is an ideal tunable device for peaked amplifiers, filters, etc. This sealed unit measures 1 1/4" x 1 7/16" x 1 7/16". Available in inductance value from 10 Mhy. to 10 Hys.

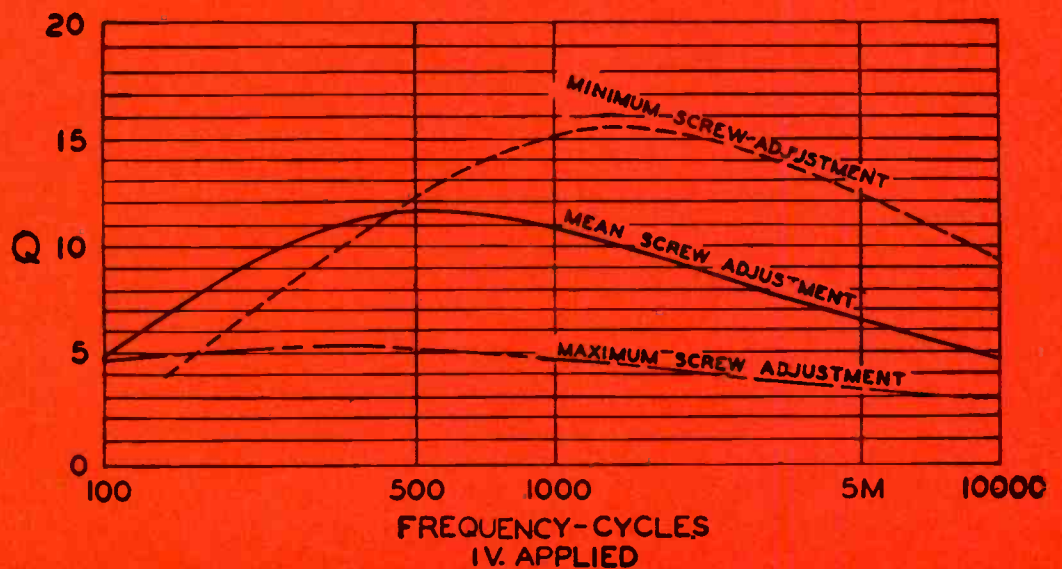
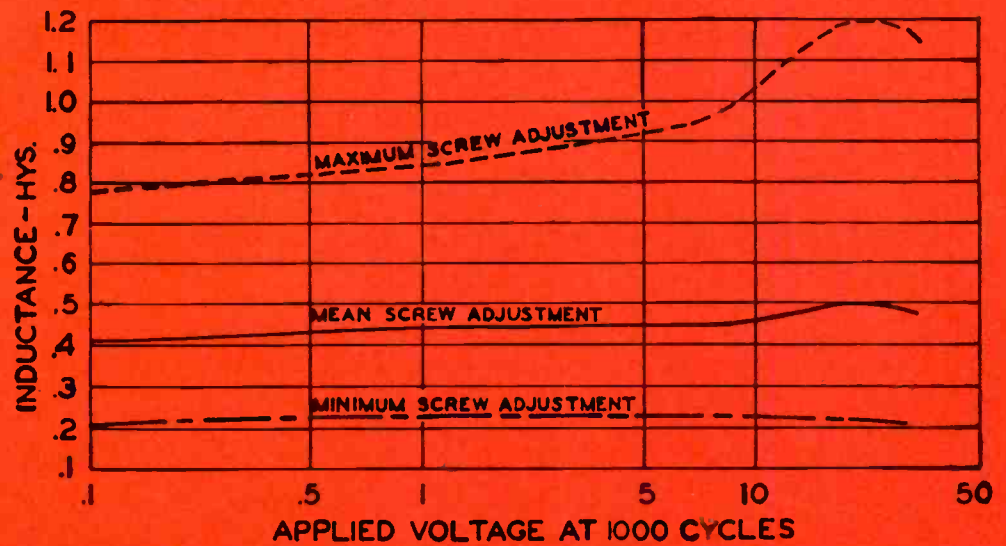

United Transformer Co.

150 VARICK STREET

NEW YORK 13, N. Y.

EXPORT DIVISION: 13 EAST 40th STREET, NEW YORK 16, N. Y., CABLES: "ARLAB"

OPPORTUNITIES WITH SPRAGUE

Wanted for production and product development:
JUNIOR ENGINEERS FOR QUALITY CONTROL

For this work, we need four or five practical men who are qualified, not only to check up on capacitor and resistor production, but who can also pick up a soldering iron or other tool on occasion and show how things should be done. Technically-informed men with better-than-average radio service or similar practical experience should find this a worthwhile opportunity.

RESISTOR ENGINEER

The man to fill this position will need a good, practical working knowledge of resistance problems and a particular leaning toward the broad electrical field rather than radio alone. The work is interesting and has to deal with further development and expansion of the most unusual and most rapidly-growing resistor line.

WRITE AT ONCE if you feel that you can qualify for either of these positions. To the right men, Sprague offers interesting work, good living conditions and salaries in keeping with experience, plus worthwhile future opportunities made possible by planned post war developments of far-reaching importance.

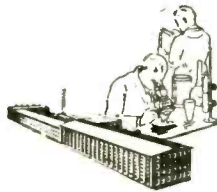

Dept. S. Personnel Section

SPRAGUE SPECIALTIES CO.
NORTH ADAMS, MASS.

Applicants will, of course, be engaged only in strict compliance with regulations of the War Manpower Commission.

SER-CUITS

by **HENRY HOWARD**

A **RECORDER** combination, Sentinel model 216J, is shown in Fig. 1. The antenna circuit has many features. Note that the diagram shows the bandswitch in short-wave position. The antenna coil is arranged for a doublet. A loop is used on b-c with the antenna being coupled capacitively across a .007-mfd condenser on the ground side. A hot-cathode oscillator circuit is used on both bands, the short-wave coil remaining in the cathode circuit when switched to b-c. The b-c padder is in the high side towards the grid.

Separate diodes are used with delayed avc. A tone control using a 5-megohm variable is connected in the volume control circuit. The arrangement is most unusual for the 5-megohm variable as well as the volume control is tapped. The tap is grounded. When the arm is at the left, the bass compensation system is inoperative, accentuating the highs; with the arm at the tap, there is, of course, no effect.

Fig. 1. Sentinel 216 J.

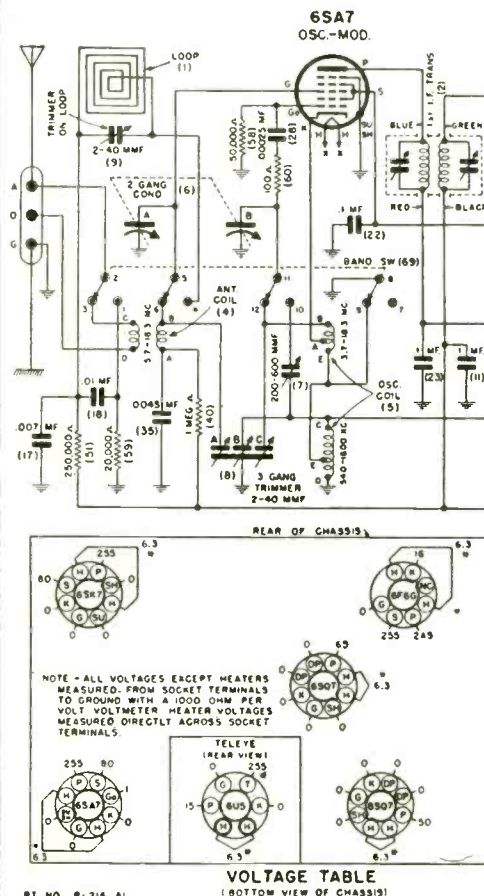

4 STANDARD TYPES
of Amperite Regulators replace over 400 types of AC-DC Ballast Tubes now in use. Amperites are real REGULATORS... have patented Automatic Starting Resistor which prevents initial surge and saves pilot lights... Ask Your Jobber.

AMPERITE

THE *Simplest* WAY TO REPLACE **BALLASTS**

WRITE FOR REPLACEMENT CHART
AMPERITE CO. 561 BROADWAY, NEW YORK, N. Y.

VICTORY CONDENSERS

Here it is!... the Government approved Victory Condenser that we are producing for immediate delivery on L265 ratings or better. Write for complete list of Victory items and prices.

For VICTORY Buy United States War Bonds and Stamps

POLYMET CONDENSER CO.

699 E. 135th ST., NEW YORK 54, N. Y.

Brush Crystal

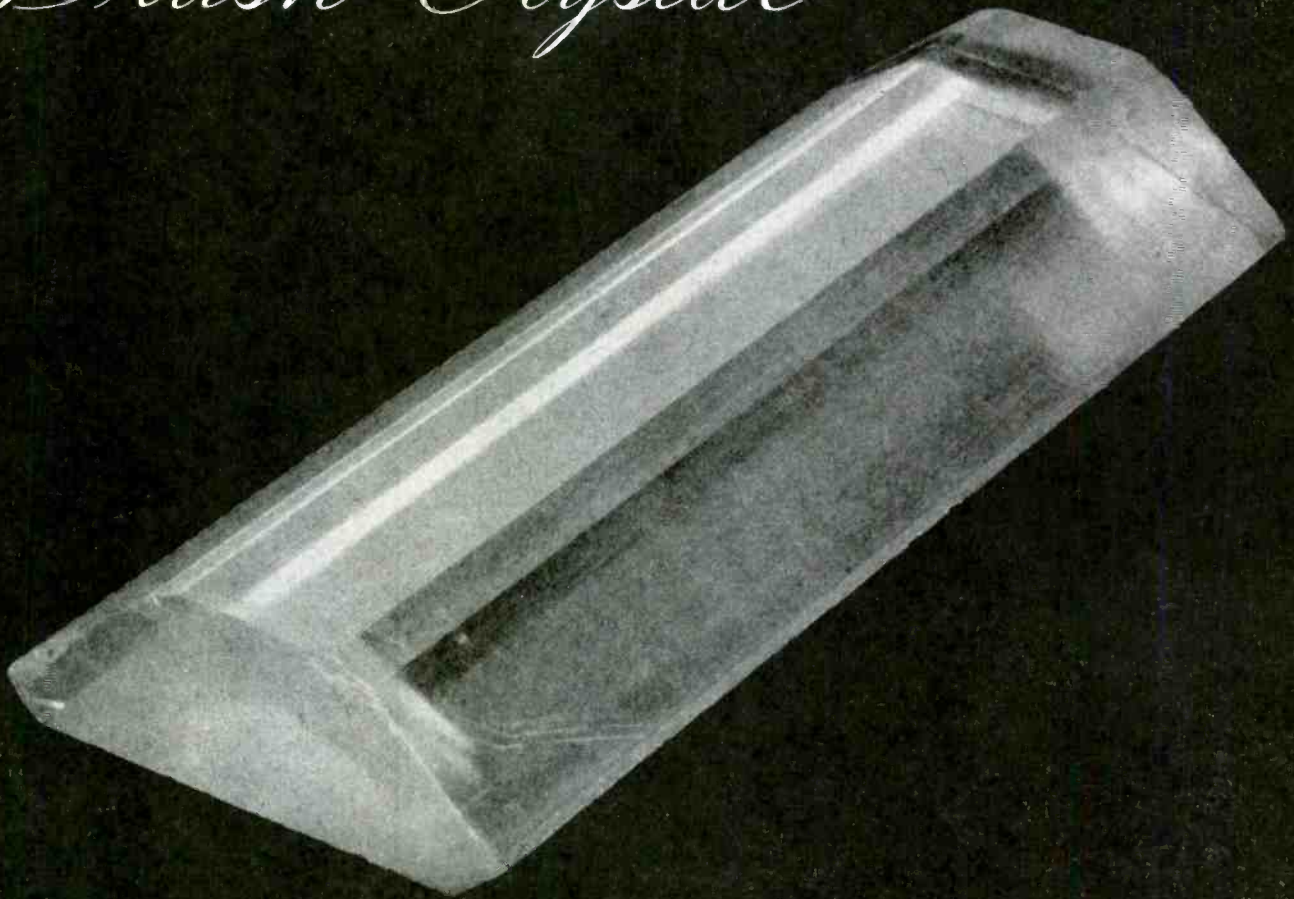

Piezo-electric products—born of Brush Crystal—are working for Victory. Soon we hope, these products and others to come will be building greater progress for you in the postwar world.

Yours for Postwar

THE BRUSH DEVELOPMENT CO.

3315 PERKINS AVENUE

CLEVELAND, OHIO

DUMONT

OIL-FILLED Ceramic SEALED CAPACITORS

*For
Dependable
Service
work*

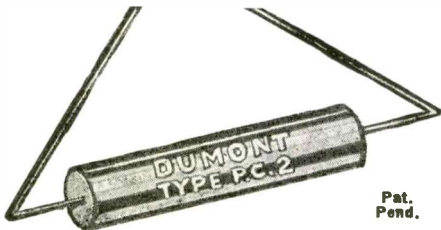

Pat.
Pend.

For long life in repairs for those expensive high-class service jobs on amplifiers, public address, police and school systems and all good electronics equipment.

All capacitors from .0001 to .25 from 600 volts to 2000 volts.

It is
your duty
to buy
war bonds

Literature and prices
on request

**DUMONT
ELECTRIC CO.**
MFR'S OF
CAPACITORS FOR EVERY REQUIREMENT
34 HUBERT STREET
NEW YORK, N. Y.

ELECTRONIC CONTROL REGULATORS

(Continued from page 26)

(not shown in Fig. 8). Thus, the field strength of the motor field structure is increased, decreasing the speed of the motor.

With a decrease in the speed of the motor shaft, obviously the inverse of these reactions will occur, the strength of field ϕ increasing. Thus a portion of the magnetization provided by the constant field winding is cancelled. In this manner, the speed of the motor shaft is increased.

The speed of the motor is regulated at such a level that the voltage across resistor 29 just equals that existing across the glow regulator tube 28. So that this condition will exist, the voltage across resistors 29 and 32 must be such that the requisite voltage magnitude appears across resistor 29. This is equally true of the potentiometer 33, which controls the speed of the motor shaft through manipulation of the voltage level at which the system stabilizes.

A sudden increase in the speed of the motor shaft, in Fig. 8, causes the capacitor 31 to charge, in series with the resistors 30 and 29. Thus, the thyatron rectifiers are momentarily cut-off by the increased voltage drop occurring across the plate load resistor 35. The loss of the excitation current by field winding ϕ permits the full strength of the constant exciting field to be applied to reduce the speed of the motor shaft. Such action by the circuit is required, for the inductance of the auxiliary field winding ϕ is sufficient to delay the application of corrective current variation rapidly. Therefore, a momentary decrease of the current to this field winding to zero, is sufficient to cause a small change in the field magnetization.

On a sudden decrease of the motor

shaft speed, the inverse of these reactions takes place. The control grids of the thyatron rectifiers are driven to the maximum positive d-c voltage. Here, the tubes conduct *fully forward*, conducting the entire positive half-cycle through the winding ϕ of the motor field structure. This, in turn, effects a small, but rapid change in the level of field magnetization so that the motor speed is increased.

In each of the instances mentioned in the preceding two paragraphs, the effects of the charge current of capacitor 31 are momentary, since the current must eventually decline to

DON'T WAIT!

Complete all jobs' immediately, —for those hard-to-get tube types, and increase your weekly profits, with handy tube guide books that feature:

- ★ over 225 substitutions and change-overs
- ★ 8 substitutes for 12SA7
- ★ 6 substitutes for 50L6GT
- ★ 4 substitutes for 1A7GT
- ★ complete adaptor construction data
- ★ universal rectifier socket and adaptor

contained in the

"Radio Tube Substitution & Change-Over Manual"

Price: \$1 per copy

and the new

"Radio Tube Substitution Supplement"

Price: 50 cents per copy

For the set of two booklets, or the manual or supplement only;

See your radio parts jobber, or write to:

OELRICH PUBLICATIONS

1627 So. Keeler Ave.
Chicago 23, Ill.

STANCOR

Transformers

THE STANDBY OF SERVICEMEN

Call your nearest Stancor Jobber—or write us for his address

STANDARD TRANSFORMER CORPORATION

1500 NORTH HALSTED STREET • CHICAGO



zero, as the capacitor voltage rises to that existing across resistor 33. The circuits associated with capacitor 31 are known as an *instantaneous response* system.

Maintenance and repair of electronic voltage and speed regulators is carried out in much the same manner as that of audio frequency or public address systems. All the experience and testing equipment, used in audio maintenance and repair are just as useful in serving electronic equipment of this nature.

Direct Coupled Similarities

In carrying out a diagnosis of defective operation by such a system, only one salient characteristic of such systems must be borne in mind by every Service Man: except for the customary dynamic control portions of such circuits, the regulating circuits are always of the directly-coupled type, somewhat reminiscent of the old *Loftin-White* system. Otherwise, circuit functions will respond to instrumentation in much the same manner as conventional audio circuits.

Low Audio Frequency Tests

The dynamic portions of electronic regulation systems are tested with, in most instances, low audio frequencies. This is especially true of the inverse feedback circuits associated with the circuit of Fig. 1. Instantaneous response systems should be checked at high frequency, near 5,000 cps, as well as at low frequency. In each system, the purpose of the test is intended to establish the a-c continuity of each such system thus tested.

In reviewing some of the highlights of electronic voltage regulation we find that the electronic voltage regulator consists of a thyatron rectifier which supplies the d-c power to a generator or alternator field winding, a control preamplifier and a voltage analyzing system. The major difference between the a-c and d-c generator voltage regulators lies only in the voltage analyzing circuit arrangement.

In the d-c generator voltage regulator system shown in Fig. 1, Part I of this series, we noted that a d-c generator was driven by a three-phase a-c power motor with the d-c power output of the system appearing between the d-c terminals.

Installations which are complicated and difficult to diagnose should be referred to the service engineering department of the factory which manufactured the regulator. In such instances, it is well for the Service Man to function as a consulting technician. This procedure places the latter in a position to receive the necessary diagrams and information required to effect a correct installation or repair.

THE STANDARD OF QUALITY FOR A THIRD OF A CENTURY



The Ultimate and Exclusive

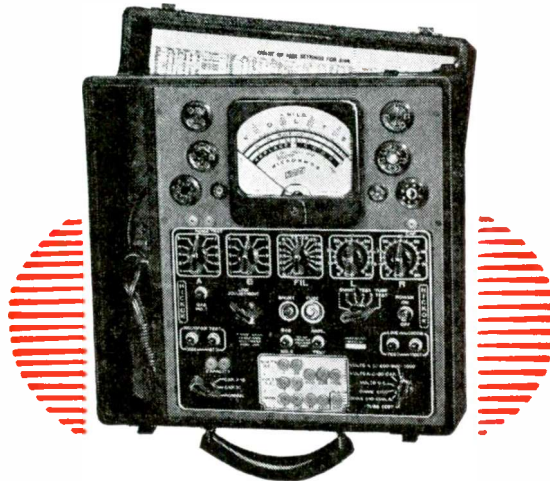

DYNAMIC MUTUAL CONDUCTANCE

Tube Testers

M E A S U R I N G I N M I C R O M H O S

● **HICKOK Tube Testers constitute the ultimate and exclusive in commercial testers. They do more than merely determine the presence or absence of cathode emission. They measure the tube output in MICROMHOS and still secure 100% modulation. Model shown also measures Volts, Ohms, Milliamperes, Capacity, Inductance, Leakage, and Decibels with accuracy. Other models in portable, counter and display types. Get your name and address on file now for new catalog ready soon.**

**THE HICKOK ELECTRICAL INSTRUMENT CO.
10521 Dupont Avenue, Cleveland 8, Ohio**

Pays its own way...

Improves your Radio Service

Fourth Revised Edition
**WARTIME
 RADIO SERVICE**

**TUBE SUBSTITUTIONS
 REPAIRING BURNED OUT TUBES
 CHANGING FARM RADIOS FOR
 ELECTRIC OPERATION**

**BEST METHODS FOR MAKING ADAPTORS
 \$3.00 Postpaid**

The only book of its kind—first job pays for it. You can't afford to figure it out yourself. If you have one of the old books send only \$1.00 and the publishers imprint on the lower half of the front cover. This latest edition contains 32 pages, including over 300 additional substitutions and other important information. All compiled from practical experience. IR5 always works satisfactorily to replace IA7—no squeals—late substitutions for many tubes you have in stock or can obtain. Service men all over the country are finding this book an invaluable aid. Buy yours today from your distributor or order direct from

CITY RADIO COMPANY
 The RADIO CITY of Phoenix, Arizona
 504-506 E. Washington St.

Canadian orders to
Sparling Sales Ltd., Winnipeg
Hygrade Radio Ltd., Vancouver

**RADIO
 AND
 ELECTRONIC
 DEVICES**

**15 YEARS
 OF
 SERVICE**



BURSTEIN-APPLEBEE CO.
 1012-1014 McGee St. Kansas City, Missouri

**WHEN YOU CHANGE
 YOUR ADDRESS**

Be sure to notify the Subscription Department of SERVICE at 19 E. Forty-seventh St., New York 17, N. Y., giving the old as well as the new address, and do this at least four weeks in advance. The Post Office Department does not forward magazines unless you pay additional postage, and we cannot duplicate copies mailed to the old address. We ask your cooperation.

NEWS OF THE REPRESENTATIVES

The annual convention of the Representatives of Radio Parts Manufacturers will be held June 6 and 7 at the Hotel Stevens, Chicago, according to David Sonkin, national secretary. The board of governors will meet on June 6, and the delegates on June 7.

The Chicagoland chapter has designated the following delegates to the convention: Royal A. Stemm, Harry Halinton, and Walter Bauman. The New England chapter will be represented by Raymond Perron and Harrison Reynolds.

Two chapters elected new members recently. Alfred Crossley of 549 West Randolph Street, Chicago, has been added to the Chicagoland chapter roster. The Missouri Valley chapter has accepted Jules Bencke, 578 Arcade Building, St. Louis, as a member; and L. D. Marsh, 110 Battery Street, Seattle, Washington, as a member-at-large.

* * *

LIP MIKE DEMONSTRATED ON RADIO PROGRAM

The lip mike, developed by the Electro-Voice Manufacturing Company of South Bend, Indiana, in collaboration with the Fort Monmouth Signal Corps unit, was given a public demonstration over CBS recently in a two-point hook-up on the Vox-Pop program. Parks Johnson interviewed workers of the ELCO submarine plant at Groton, Connecticut, who were equipped with the small microphone, while Warren Hull and workers of ELCO's PT Boat plant at Bayonne, New Jersey,



also wearing the lip mike, completed the two-point broadcast.

* * *

**ELECTRIC INSTRUMENT DATA SHEETS
 ISSUED BY G-E**

The first series of a new kind of parts publication, covering 2½" d-c and r-f ammeters and voltmeters of the internal-pivot design for radio and aircraft, has been published by G.E. This series includes nine loose-leaf pages.

An interesting feature of these pages is that they illustrate the parts exploded in their proper relation to each other in an assembled instrument, making it possible to identify the parts easily and giving a clear picture of the construction of an instrument.

* * *

**FABEL ELECTED VICE PRESIDENT OF
 CARDWELL**

Joseph K. Fabel, former assistant district manager of the New York section of the Army-Navy Electronics Production Agency, has been elected vice president in charge of sales of the Allen D. Cardwell Manufacturing Corporation, Brooklyn, New York.

* * *

RCA TUBE SUBSTITUTION DIRECTORY

A 16-page *Tube Substitution Directory* has just been published by Radio Corpora-

tion of America, 596 South Fifth Street, Harrison, New Jersey. The directory, which covers more than two-thousand substitutions, includes a listing of 304 RCA receiving tube types with substitution types which may serve as replacements, a classified chart of receiving tubes, and sample calculations of series and shunt resistors in heater strings. The directory costs ten cents, and may be had from RCA distributors or the Harrison office.

* * *

KIEVIT PROMOTED BY SYLVANIA

Ben Kievit, supervisor of customer services of Sylvania Electric Products, Inc., Emporium, Pennsylvania, is now field engineer in the equipment sales department for the New York and New England area. He will be located at the N. Y. City office, 500 Fifth Avenue.

Mr. Kievit has been with Sylvania since 1930, when he joined the company as a research physicist. He is a senior member of the Institute of Radio Engineers, and a member of the Electronics Committee of that group. He has served as technical editor of the *Sylvania Engineering News Letter* and the *Technical Manual*.

* * *

**ELLMORE NOW UTAH ENGINEERING
 SALES VICE-PRESIDENT**

W. A. Ellmore has been named vice president in charge of the sales and engineering departments of Utah Radio Products, Chicago.

Other appointments announced include the promotion of Chester L. Walker, formerly chief engineer, to sales manager in charge of Utah's manufacturing and

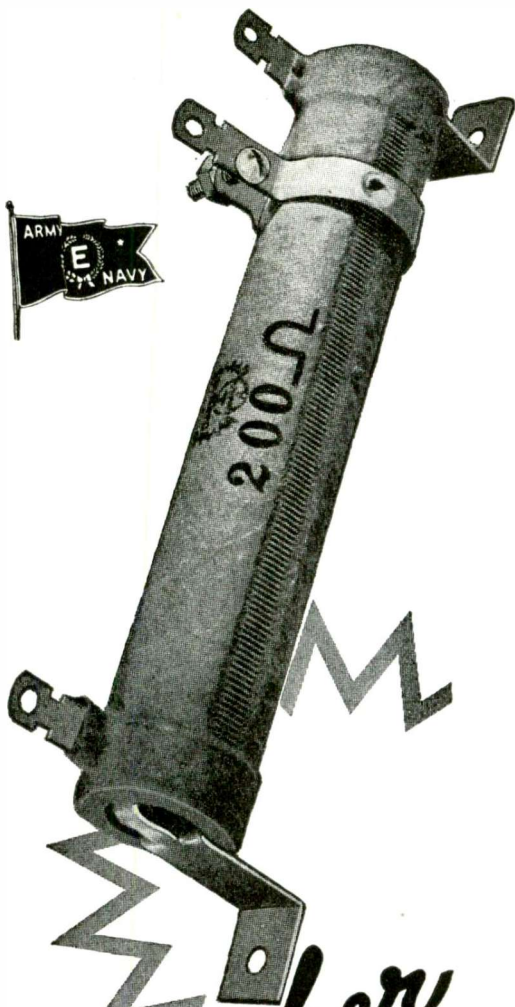

Tougher POWER RESISTORS

★ Clarostat Greenohms — those green-colored inorganic-cement-coated power resistors — are found today in most radio, electronic and electrical assemblies that must stand the gaff. They are the *tougher* power resistors. They can take it — and then some.

Available in wattage ratings up to 200. Widest choice of resistance values. Fixed, adjustable, tapped. Also a choice of mountings and terminals.

★ Ask Our Jobber . . .

Ask him about Clarostat Greenohms and other Clarostat products for your wartime servicing.



CLAROSTAT MFG. CO., Inc. · 285-7 N. 6th St., Brooklyn, N. Y.

equipment division. Marion S. Danisch has succeeded Mr. Walker as chief engineer; and Gordon S. Carbonneau, formerly production engineer, has been appointed engineer in charge of the quality control division.

* * *

RCP TEST INSTRUMENTS CATALOG

Catalog No. 128 has been released recently by Radio City Products Inc., 127 West 26 Street, New York 1, New York. The catalog describes and illustrates standard commercial testing instruments, including multimeters, insulation testers, limit bridges for precision resistance testing, vacuum tube testers, electronic voltmeters, combination tube, battery and set testers with plug-in analyzer units, volt-ohm milliammeters, signal generators, and push button analyzers.

* * *

NEW OFFICES FOR ELECTRICAL APPARATUS COMPANY

The Electrical Apparatus Company has moved its offices from 1018 Commonwealth Avenue to 1200 Soldiers Field Road, Boston, Massachusetts.

* * *

LEON GOLDER LEAVES ROLA CO.

After a period of service dating from the establishment of the company, Leon Golder has resigned as secretary and sales manager of The Rola Company Inc., Cleveland, Ohio.

* * *

IRC APPOINTS HARDWICK

International Resistance Company, Philadelphia, has appointed A. H. Hardwick to the company's executive sales staff. Mr. Hardwick was formerly president of Hardwick, Hindle Inc., Newark, New Jersey. He will make his headquarters in New York City at 165 Broadway.



* * *

NEW COLOR TELEVISION TECHNIQUE

The Scophony Corporation of America, 527 Fifth Avenue, New York, has announced the development of a new carbon technique for theatre television by the National Carbon Company. This improvement is said to increase the carbon crater intensity of brilliance by seven times the normal standards of color television.

* * *

HAZELTINE AND RCA LICENSES TO MECK INDUSTRIES

Hazeltine and RCA licenses to manufacture radio receivers after the war have been issued to the John Meck Industries, Plymouth, Indiana.

* * *

SYLVANIA OPENS WEST COAST HEADQUARTERS

A west coast headquarters office at 111 Sutter Street, San Francisco, has been opened by Sylvania Electric Products Inc. B. K. Wickstrum, Pacific Coast sales manager for Sylvania's lighting products, is in charge of this office.

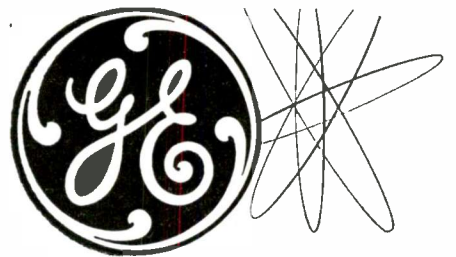

. . . PORTABLE TUBE CHECKER

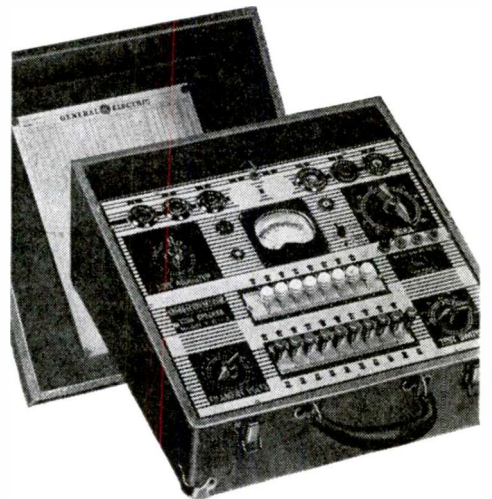

This portable G-E Tube Checker contains sockets for all American tube types . . . provides practically a complete service shop of tube analyzing equipment. Equipped with the ingenious PMT Circuit Switch, this instrument is just one in the new General Electric line of SERVICE TESTING EQUIPMENT.

Among the other sturdy G-E units available for testing electronic circuits and component parts are: G-E uni-meters, audio oscillators, oscilloscopes, condenser resistance bridges, signal generators and other utility test instruments. For complete details about these accurate instruments, please fill out the coupon below. . . .



**ELECTRONICS DEPARTMENT
GENERAL ELECTRIC CO.
Schenectady, N. Y.**

Please send, without obligation to me, the General Electric Testing Instrument Catalog, S-4 (loose-leaf), for my information and files.

Name _____

Company _____

Address _____

GENERAL ELECTRIC

Electronic Measuring Instruments

SERVICE, APRIL, 1944 • 33

NEW LETTER CONTEST for SERVICEMEN!

**ELEVEN 1st PRIZE WINNERS IN 5 MONTHS
IN CONTEST NO. 1!**

Yes sir, guys, the hundreds of letters received were so swell that *double* first prize winners had to be awarded each of the first four months and there were *triple* first prize winners the fifth and last month...

SO — HERE WE GO AGAIN!

Get in on this NEW letter contest—write and tell us your *first hand* experiences with *all* types of Radio Communications equipment built by Hallicrafters including the famous SCR-299!

RULES FOR THE CONTEST

Hallicrafters will give \$100.00 for the best letter received during each of the five months of April, May, June, July and August. (Deadline: Your letter must be received by midnight, the last day of each month.)

For every serious letter received Hallicrafters will send \$1.00 so even if you do not win a big prize your time will not be in vain.

Your letter will become the property of Hallicrafters and they will have the right to reproduce it in a Hallicrafters advertisement. Write as many letters as you wish. V-mail letters will do.

Military regulations prohibit the publication of winners' names and photos at present... monthly winners will be notified immediately upon judging.



BUY A
WAR BOND TODAY

hallicrafters RADIO

THE HALLICRAFTERS CO., MANUFACTURERS OF RADIO AND ELECTRONIC EQUIPMENT, CHICAGO, 16, U. S. A.

NEW PRODUCTS

SUPERHET DEMONSTRATOR

A 5-tube instruction type superhet, assembled on a 30" x 36" imprinted panel and mounted in a reinforced hardwood frame 3" deep is now being made by the Lafayette Radio Corporation, 901 West Jackson Boulevard, Chicago 7. It may be set up on a table or blackboard or placed on a wall for vertical observation.

Wired for 110-volt a-c/d-c operation. Demonstrator boards come with drilled panel in kit form or completely assembled and wired.

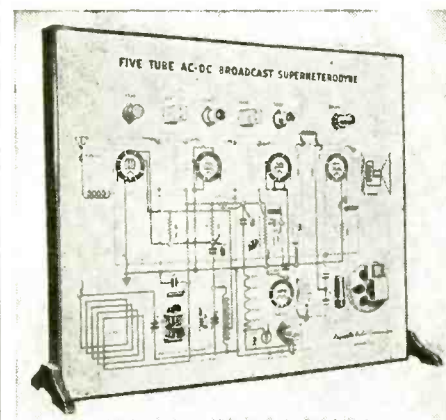

* * *

CENTRALAB SILVER MICAS

Capacity ranges of from 6 to 2000 mmfd measured at 1 megacycle are now available in silver mica capacitors being made by Centralab.

Types 830, 833, and A831 have ranges of from 6 to 650 mmfd. Terminal types available include light right angle, heavy right angle, long tongue, U-shaped and post terminals.

Type A831 is of *feed-thru* construction available with one or two terminals riveted to the center capacitor plate. Also available with center terminal rivet drilled .030" maximum for the purpose of threading a wire lead through the hole.

Type 832 is similar to type 830 but with a deeper cup to accommodate more mica film. It is available with or without threaded stud. Capacities from 650 to 2000 mmfd can be manufactured. Available with light right angle, heavy right angle, long tongue and U-shaped terminals.

Type 833 provides a capacity ground to the chassis with *lead-thru*.

Power factor of all types is said to be .08% for resonant circuit application, .12% for bypass or blocking use. Leakage resistance is said to be 10,000 meg-ohms.



why Radiart Vibrators EXCEL

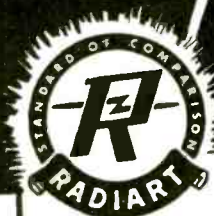

3. ADVANCED PRODUCTION METHODS

Radiart Engineers have developed improved production methods for RADIART VIBRATORS and VIPOWERS that assure consistent high quality.

Constant inspection controls over materials, parts and sub-assemblies guarantee perfect operation from each finished product.

Such perfection is doubly necessary now for much of our present production is for our Armed Services.

RADIART VIBRATORS and VIPOWERS justify these rigid production standards by their exceptional performances under severest battle conditions.

Radiart Corporation

3571 W. 62nd. St.

CLEVELAND 2, OHIO



You're really due a pat on the back. The war effort has made the tools of your profession mighty scarce, but the case is rare that you've failed to keep your customer's radio in operation.

Sure, you've scratched your head over a job that required a substitution. The proper type tube was no longer available. The socket had to be changed, pin connections re-wired. Boy, what fun! But the darn thing worked . . . and did it tickle the set owner! Another receiver snatched from the graveyard.

Thousands of thousands of similar problems are solved daily by you and your brother servicemen. And your sixth sense . . . your test equipment . . . is helping you do the job. We at Supreme are proud that with many servicemen this sixth sense is Supreme Test Equipment.

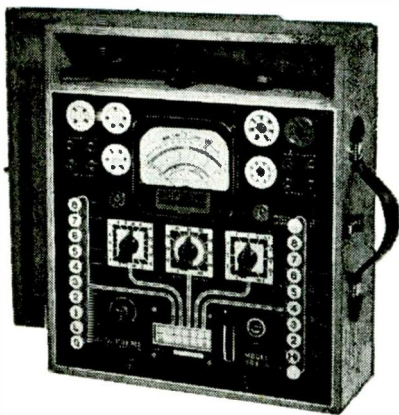

Model 504-A
Tube and Set Tester

Today SUPREME is engaged 100% in war production. When conditions permit, Supreme again will be engaged 100% in producing test equipment that will make YOUR work as a serviceman simpler, surer, faster, more profitable.

SUPREME

SUPREME INSTRUMENTS CORP.
Greenwood, Miss., U. S. A.

ANALYZER-TUBE TESTER

[See Front Cover]

THIS analyzer and tube tester, Supreme 385, tests tubes for emission and provides 6-range voltage and current measurements, a-c/d-c for voltage and d-c for current. The instrument also provides for 5-range resistance measurements, 6-range capacity measurements, leakage measurements of paper and electrolytic condensers, tests for gassy tubes and output measurements.

On the cover appears a portion of the analyzer which serves as a d-c milliammeter, capacity meter and a-c or d-c voltmeter and ohmmeter. The one mil d-c meter has a 300-ohm resistor in series as a protection against overloading.

D-C Milliampere Ranges

For the six d-c milliampere ranges the meter is connected across the entire shunt potentiometer. On the highest range, 1250 ma, the shunt value across the binding posts is .3 ohm, the series resistance value being 75 ohms.

For capacity measurements the meter is connected to a full-wave rectifier which is switched across a second potentiometer. For a-c voltages the rectifier is connected in series with a condenser for the five-volt range and to a tapped multiplier for the other ranges up to 1,250 volts. Provision is made for reading the line voltage and for adjusting the primary tap on the power transformer by simply pushing a button which places the meter on the 125-volt scale. For d-c voltages a 4,700-ohm resistor is connected to the meter and the same multiplier is used.

The ohmmeter uses a 4.5-volt battery for 200, 2,000 and 20,000-ohm ranges, and a separate high voltage rectifier supply for the .2, 2 and 20-megohm ranges.

Capacity Measurements

In making capacity measurements, a separate high voltage winding on the power transformer is used to provide the potential and the meter-rectifier combination is used as a milliammeter. The highest a-c voltage is, of course, used on the lowest capacity range, or .001 to .05-mfd. When low voltages are used it is permissible to test the high capacity ranges of electrolytic condensers on a-c. The low capacity ranges must not be used for electrolytics, in the event insufficient reading is obtained on the high ranges, because of the excessive voltage.



● Eight selected capacitance values make up the Aerovox Victory Line of paper tubulars. Used individually or in combination, these values take care of upwards of 90% of usual paper capacitor replacements.

Otherwise, these paper tubulars are just the tried and proven Aerovox Type '84. Non-inductive paper sections. Extra-wax-sealed cartridges. Colorful label jacket. Bare pigtail leads that won't work loose. Note the listings:

AEROVOX VICTORY PAPER TUBULARS

D.C.W.V.	Capacitance
600.....	.001 mfd.
600.....	.002 mfd.
600.....	.005 mfd.
600.....	.01 mfd.
600.....	.02 mfd.
600.....	.05 mfd.
600.....	.1 mfd.
600.....	.25 mfd.

● See Our Jobber . . .



AEROVOX CORP., NEW BEDFORD, MASS., U. S. A.

In Canada: AEROVOX CANADA LTD., HAMILTON, ONT.

Export: 13 E. 40 ST., NEW YORK 16, N. Y. Cable: 'ARLAB'

TUBE PULLING
MADE EASY

SYLVANIA SERVICEMAN SERVICE

by
FRANK FAX



THIS gadget makes it easy to pull radio tubes of the "Lock-in" type. And only 25 cents buys it.

Here's how it works:

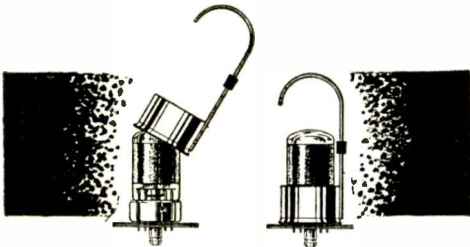

Slip the rubber bushing, packed with the Puller, over the handle to $\frac{1}{2}$ -inch from the collar. Then insert the Puller over the "Lock-in" tube. Push it down so that the collar grips the tube base shell firmly.

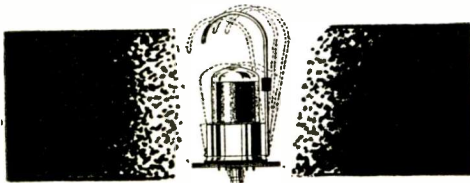

Push handle sideways, or rotate, until a *snap* indicates unlocking of the "Lock-in" pin. Do not lift up on the Puller until the tube is unlocked. After the unlocking, the tube can be lifted without any trouble.



To release tube from Puller, hold the curved handle with one hand, push down firmly on top of the tube with thumb of other hand, holding open end of the Puller toward the palm so that the released tube does not fly out.

If your jobber does not have this item in stock, write to FRANK FAX, SYLVANIA, EMPORIUM, PA.

SYLVANIA
ELECTRIC PRODUCTS INC.
RADIO DIVISION • EMPORIUM, PA.

JOTS & FLASHES

GOOD to see Lieutenant Henry Johnson (j. g.), USN, former Sylvania ad man, on furlough after long and eventful action in the Pacific. . . . Ralph P. Glover opens consulting engineering office at 1024 Superior St., Oak Park, Ill. . . . A. H. Hardwick managing new New York offices of International Resistance Co. and the Connector Corp. at 165 Broadway. . . . "Mike" F. Mayger, Chicago ad agent specializing in radio, becomes father of baby girl . . . congratulations, Mike. . . . W. A. Ellmore, v-p in charge of engineering at Utah Radio Products, assumes additional duties of sales manager . . . thanks to all you servicers for your entries in the SERVICE contest . . . winners are announced in this issue . . . sorry to report death of Joseph E. Galvin, Motorola Radio official who had been in charge of production and employee relationships . . . new tube plant acquired by Ken-Rad in Rockport, Ind. Army-Navy "E" award to Wilcox-Gay Corp. of Charlotte, Mich. . . . Stromberg-Carlson Co. awarded second white star for its "E" pennant . . . George T. Bryant named hearing-aid sales manager by Graybar Electric with headquarters at 420 Lexington Ave., N. Y. . . . radio tubes are NOT subject to the new 20% Federal Excise Tax . . . Sylvania to enlarge their radio tube factory at Brookville, Pa. . . . Oden F. Jester, ex v-p in charge of sales for Utah, has been appointed a v-p of Meissner Mfg. Co., Mt. Carmel, Ill. . . . Meissner also announces opening of new sales offices in Palmolive Bldg., Chicago . . . here's hoping that conditions will soon permit an easing of current paper restrictions . . . we're anxious to add more pages to SERVICE . . . can't do much about it now under present drastic regulations . . . 5th War Bond Drive gets under way in June . . . be prepared to do your share and more . . . April Fool number of *The Solar System*, full of comedy and cartoons . . . a swell employee morale stimulant . . . if you're not receiving *The Acrovox Research Worker* better request that your name be added to the mailing list . . . it's chock full of good technical data for you . . . RCA-Victor of Canada names Frank R. Deakins as president . . . Frank D. Thompson, known by many radio men through his past association with radio and electrical publications, now Pvt. F. D. Thompson, Signal Corps, USA, Co. B 37, Camp Crowder, Mo. . . . J. H. "Robby" Robinson, director of distributor sales for National Union, recently completed business trip through South and Midwest.

ADVERTISERS IN THIS ISSUE*

SERVICE INDEX—APRIL, 1944

AEROVOX CORPORATION	35
Agency—AUSTIN C. LESCARBOURA & STAFF	
AMPERITE CO.	28
Agency—H. J. GOLD CO.	
L. S. BRACH MFG. CORP.	16
Agency—UNITED ADV. AGENCY	
BRUSH DEVELOPMENT CO.	29
Agency—GREGORY ADVERTISING, INC.	
BURSTEIN-APPLEBEE CO.	32
Agency—FRANK E. WHALEN ADV. CO.	
CITY RADIO CO.	32
CLAROSTAT MFG. CO., INC.	33
Agency—AUSTIN C. LESCARBOURA & STAFF	
DUMONT ELECTRIC CO.	30
Agency—A. ROTHSCHILD	
GENERAL ELECTRIC	33
Agency—N. W. AYER & SON, INC.	
HALLICRAFTERS CO.	34
Agency—BURTON BROWNE, ADVERTISING	
HICKOK ELECTRICAL INSTRUM. CO.	31
Agency—WHITE ADV. AGENCY	
HYTRON CORP.	Inside Front Cover
Agency—HENRY A. LOUDON—ADVERTISING	
JENSEN RADIO MFG. CO.	21
Agency—BURTON BROWNE, ADVERTISING	
KEN-RAD TUBE & LAMP CORP.	20
Agency—ALLEN, HEATON & McDONALD, INC.	
MECK INDUSTRIES	15
Agency—WESTERN ADV. AGENCY, INC.	
MEISSNER MFG. CO.	8
Agency—GARDNER ADV. CO.	
NATIONAL UNION RADIO CORP.	Back Cover
OELRICH PUBLICATIONS	30
Agency—SANDER RODKIN	
POLYMET CONDENSER CO.	28
Agency—STERNFIELD-GODLEY, INC.	
RADIART CORP.	34
Agency—KENNETH H. KOLPIEN	
RADIO CORPORATION OF AMERICA	7, 23
Agency—KENYON & ECKHARDT, INC.	
RADIO & TECHNICAL DIV. MURRAY HILL BOOKS, INC.	1
Agency—THE HARRY P. BRIDGE CO.	
RAYTHEON PRODUCTION CORP.	3
Agency—BURTON BROWNE, ADVERTISING	
JOHN F. RIDER PUBLISHER INC.	24
Agency—LANSFORD F. KING	
SIMPSON ELECTRIC CO.	13
Agency—KREICKER & MELOAN, INC.	
SOLAR CAPACITOR SALES CORP.	Inside Back Cover
Agency—O. S. TYSON & CO., INC.	
SPRAGUE PRODUCTS CO.	4
Agency—THE HARRY P. BRIDGE CO.	
SPRAGUE SPECIALTIES CO.	28
Agency—THE HARRY P. BRIDGE CO.	
STANDARD TRANSFORMER CORP.	30
Agency—BURNET-KUHN ADV. CO.	
SUPREME INSTRUMENTS CO.	35
Agency—O'CALLAGHAN ADV. AGENCY, INC.	
SYLVANIA ELECTRIC PRODUCTS INC.	36
Agency—ARTIUR KUDNER, INC.	
TRIPLETT ELECTRICAL INSTRUM. CO.	17
Agency—WESTERN ADV. AGENCY, INC.	
U. S. TREASURY DEPARTMENT	6
UNITED TRANSFORMER CO.	27
Agency—SHAPPE-WILKES INC.	
UNIVERSAL MICROPHONE CO., LTD.	25
Agency—RALPH L. POWER AGENCY	
WESTON ELECTRICAL INSTRUM. CO.	5
Agency—G. M. BASFORD CO.	

*Due to paper restrictions several advertising pages had to be omitted from this issue.

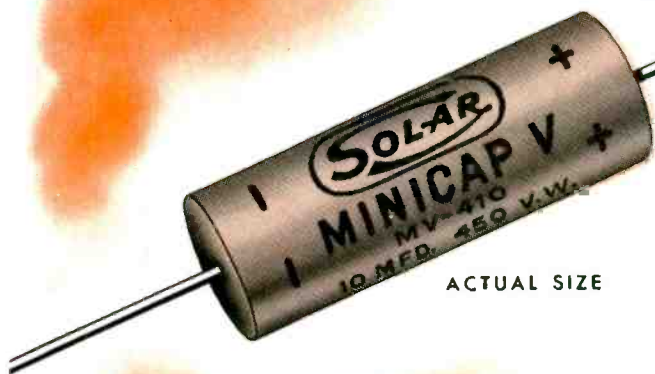

Meet the **NEW**
 "MIDGET
MINICAP"

TINY ELECTROLYTICS BY Solar

**10
 CAPACITY AND
 VOLTAGE
 RATINGS**

These replacement Capacitors are dry electrolytics of *very small diameters*. They fit!

They are built to American War Standards. Their dependability is guaranteed by Solar's "Quality Above All". And they make for peace ... your peace of mind!



25 VOLTS WORKING

25 Mfd.

PART NO. MV-2525 List Price \$.60
 Diameter 9/16" Length 2 1/4"

100 Mfd.

PART NO. MV-25100 List Price \$.85
 Diameter 3/4" Length 2 1/4"



50 VOLTS WORKING

10 Mfd.

PART NO. MV-5010 List Price \$.55
 Diameter 9/16" Length 2 1/4"



150 VOLTS WORKING

20 Mfd.

PART NO. MV-220 List Price \$.75
 Diameter 11/16" Length 2 1/4"



20 + 20 Mfd. Negative Common

PART NO. MV-2020 List Price \$1.30
 Diameter 13/16" Length 2 1/4"



50 Mfd.

PART NO. MV-250 List Price \$1.10
 Diameter 15/16" Length 2 1/4"



250 VOLTS WORKING

20 Mfd.

PART NO. MV-2520 List Price \$1.00
 Diameter 13/16" Length 2 1/4"



450 VOLTS WORKING

10 Mfd.

PART NO. MV-410 List Price \$.85
 Diameter 13/16" Length 2 1/4"

10 - 10 Mfd. Negative Common

PART NO. MV-41010 List Price \$1.40
 Diameter 1" Length 2 3/4"



40 Mfd.

PART NO. MV-440 List Price \$1.75
 Diameter 1-5/16" Length 3 1/4"



NOTE: Government regulations prohibit the former practice of supplying metal mounting straps with these capacitors. However, the small size and light weight of Minicap "Vees" make them truly "self-mounting."



CAPACITORS

SOLAR CAPACITOR SALES Corp., 285 MADISON AVE., NEW YORK 17, N. Y.

SOLE NATIONAL DISTRIBUTORS OF SOLAR CAPACITORS TO THE JOBBING TRADE

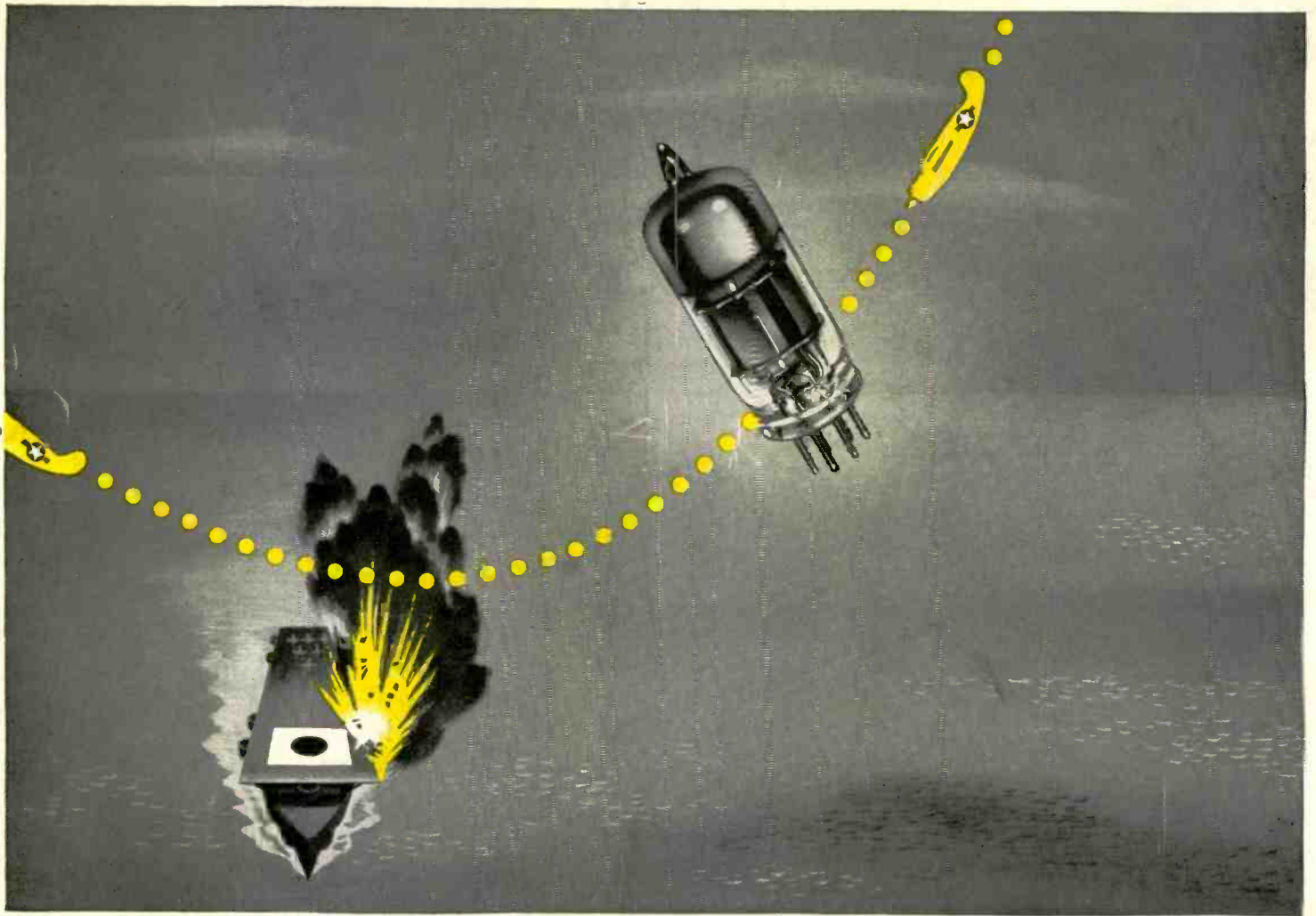

They know their **G's**

 What is this menace to flying men and their equipment which our scientists call "G's"? And why are N. U. engineers who design tubes for airborne radio and electronic devices taking so much pains these days, to *know* their "G's"?

In a mild form, most of us have felt "G's" at work on a roller-coaster, when we take the turns and hit the dips. However, in high speed flight, with its shifting, twisting, turning, about-face maneuvers—"G's" *really* shake your insides. Think of a dive bomber pilot as he pulls out of a high vertical power dive. That's when

"G's" can become dangerously high. And when there are *too many* "G's"—look out!

Research into the effects of "G's" on the delicate, indeed flimsy filaments and other parts of tubes, has enabled N. U. engineers to provide our armed forces with tubes individually tested to withstand many more "G's" than a pilot or a plane ever has survived. For such battle-tested N. U. Tubes there will be many post-war uses, with profit opportunities for service engineers. *Count on National Union.*

NATIONAL UNION RADIO CORPORATION, NEWARK, N. J.
Factories: Newark and Maplewood, N. J., Lansdale and Robeson, Pa.



NATIONAL UNION

RADIO AND ELECTRONIC TUBES

Transmitting, Cathode Ray, Receiving, Special Purpose Tubes • Condensers • Volume Controls • Photo Electric Cells • Panel Lamps • Flashlight Bulbs