

# SERVICE

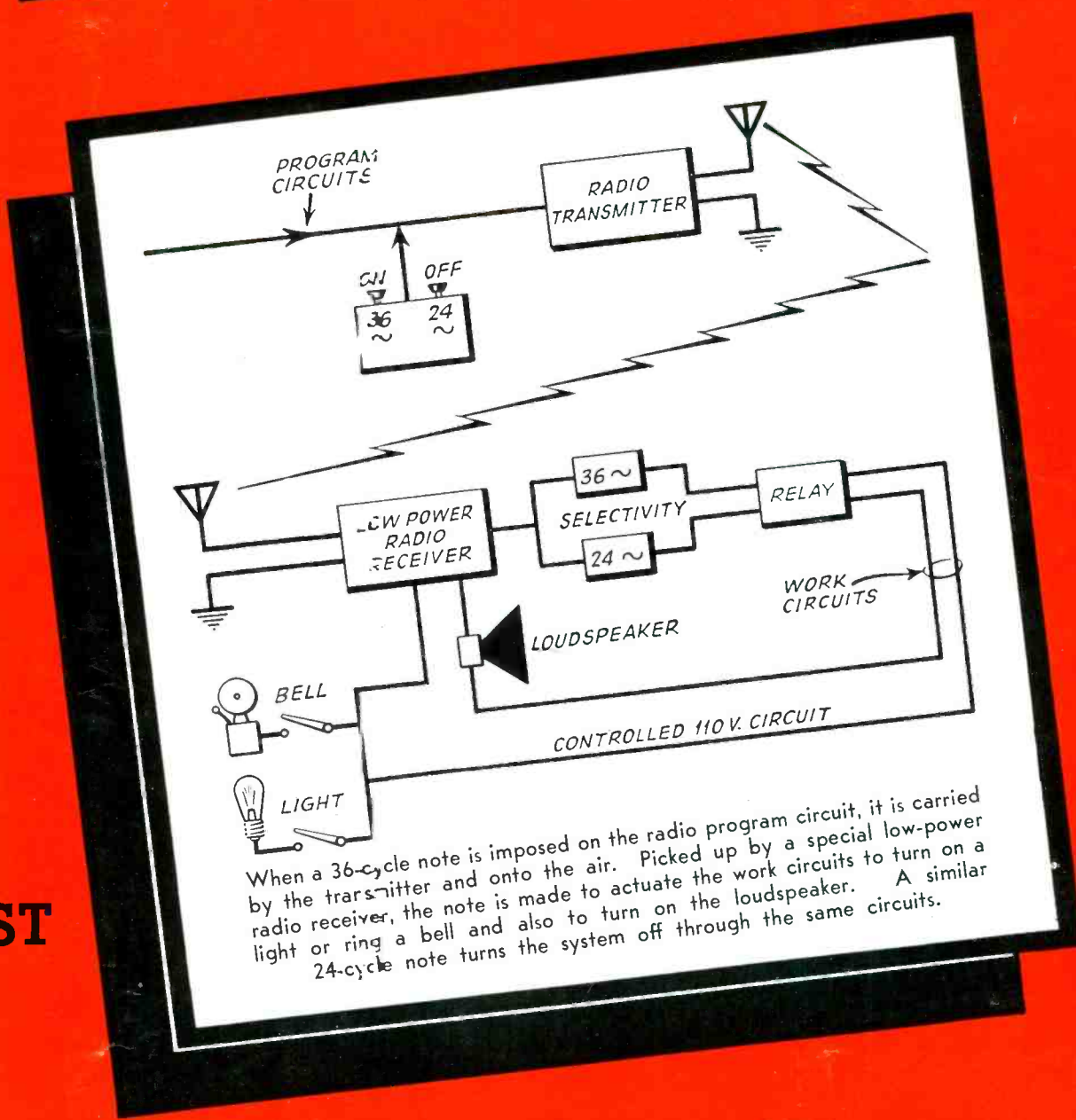

AUGUST  
1941

# Just Out! **MYE**

## THE NEW 4<sup>TH</sup> EDITION

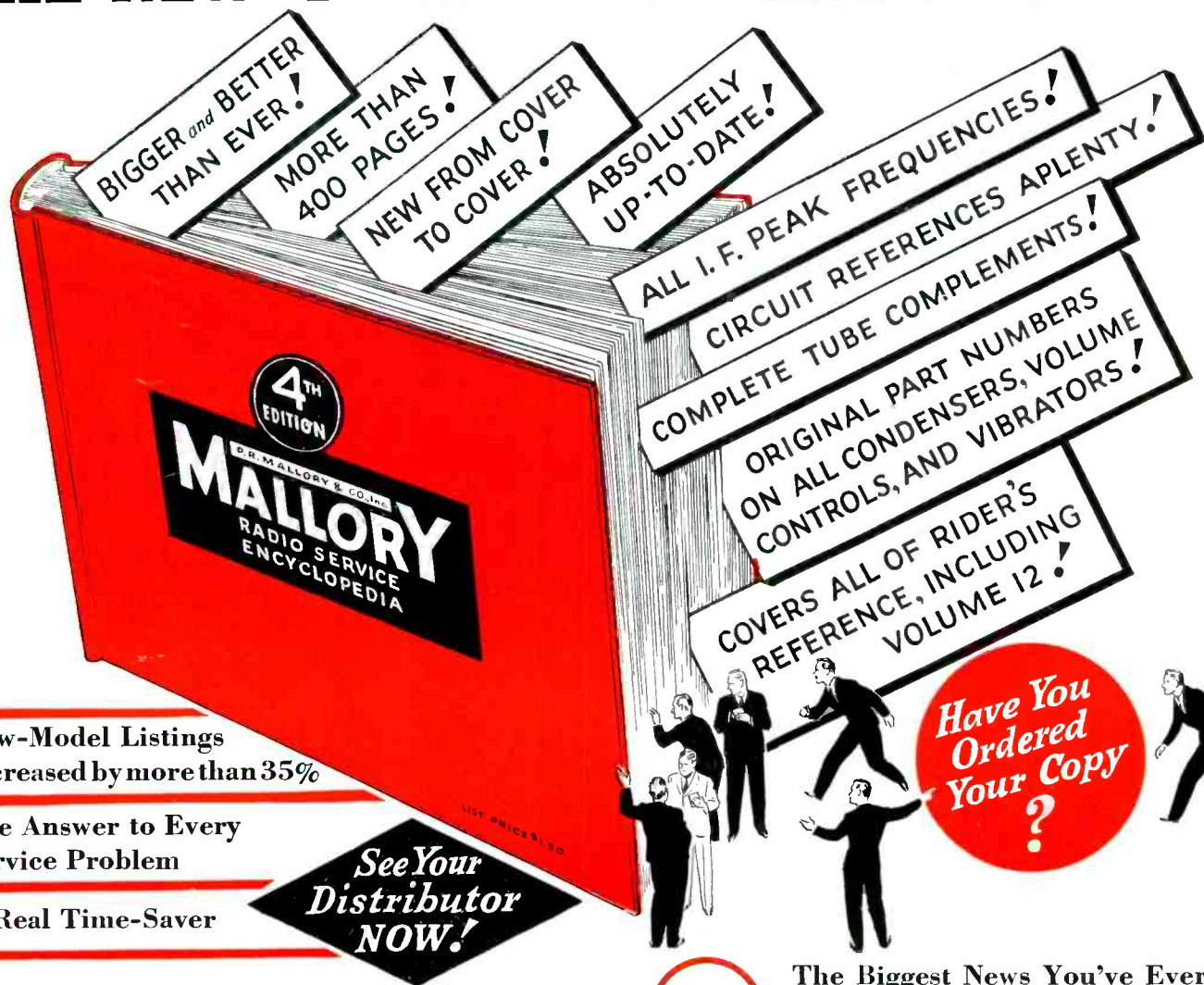

New-Model Listings  
Increased by more than 35%

The Answer to Every  
Service Problem

A Real Time-Saver

See Your  
Distributor  
NOW!

Order your copy of this new, 4th edition MYE *today!* The supply is limited. And once the present printing is exhausted, *there won't be any more!*

So don't delay. Get your Mallory distributor on the phone—NOW—Order your copy today.

*Save your old Aluminum parts. It is patriotic to give them to National Defense.*



### The Biggest News You've Ever Had On Volume Controls!

New mechanical and electrical precision. Rugged! Easily installed. An A-C switch that snaps on and stays on. Quiet operation. Start using them *today!*



### This Is Mallory's Year On Replacement Condensers!

More have gone into service in 1941 than in any other year! Use Mallory Replacement Condensers for fast, efficient work and your customers' satisfaction!

P. R. MALLORY & CO., Inc., INDIANAPOLIS, INDIANA

More  
than ever  
—INSIST ON

P. R. MALLORY & CO. Inc.  
**MALLORY**  
APPROVED  
PRECISION PRODUCTS

VIBRATORS • VIBRAPACKS • CONDENSERS •  
VOLUME CONTROLS • ROTARY SWITCHES •  
SINGLE AND MULTIPLE PUSH BUTTON SWITCHES  
• RESISTORS • RADIO HARDWARE

# Busy days are here...

## FOR SERVICEMEN

**Keep them profitable  
with dependable  
test equipment!**



**NOW AVAILABLE  
FOR FM AND TELEVISION**

### WESTON

Model 787

**UHF Oscillator**



Fundamental frequency coverage from 22 to 150 megacycles. No harmonics . . . no band switching. Used with portable antenna or standard output leads. Reads 40 kc per division at 40 mc. Self contained battery operation; compact and extremely portable.

Today, as never before, the American public *wants radio* and can afford to pay for radio. Proof is that the demand for new sets has virtually doubled. But with long deliveries prevalent in so many fields, more old sets probably will be retubed and repaired than ever before. » » » A period like this is *made to order* for the servicemen with WESTON Test Equipment. For WESTONS help produce greater profit on every job. Measurements are simpler, surer . . . trouble can be spotted quicker . . . when these basic, direct-reading instruments are used.

But the *big profit* from WESTONS is shortly to come; for FM and television are rapidly getting into stride. *These same WESTON Test Instruments fully meet the new servicing problems involved. No new and expensive equipment will be needed for the job.* Thus it *pays . . . and continues to pay . . .* to use dependable WESTONS for all servicing needs. Weston Electrical Instrument Corporation, 604 Frelinghuysen Avenue, Newark, N. J.

# WESTON

## Test Instruments



A Monthly Digest of Radio and Allied Maintenance  
Reg. U. S. Patent Office

**A** MONTHLY newsstand magazine with widespread distribution has made the claim that 64% of the radio Service Men are prone to gypbery. The magazine has taken this stand on the basis of what we feel was a very limited and unscientific survey. It is our opinion that the statements published as a result of this survey are inaccurate and misleading.

The indictment has been made, however, and you, as a radio Service Man, should take every possible step to counteract its effects. Flood your neighborhood with advertising material stressing the length of time you have been in business rendering reliable and efficient service. Do this now, while the article is still fresh in the minds of the public. Let them know that you guarantee all your work but don't promise anything that you won't be able to produce.

To a large extent, the public itself is responsible for such borderline tactics as might exist in the radio service field. Because of general unwillingness on the part of the public to pay for time spent in making a diagnosis of radio receiver trouble, some few Service Men attempt to recoup for this lost time by charging excessively for replacement parts or in rare cases by charging for parts not even used. There is no ethical justification for such practices. Time charges should appear on each invoice as such. If such time is legitimately spent, it will need no other justification.



**O**N AUGUST 8, the Defense Communications Board outlined nation-wide plans to use standard broadcast stations for air raid warnings and other messages, communique and announcements in the event of military emergency. The plans were made known by James Lawrence Fly, Chairman of the DCB and the FCC.

Present plans, under consideration by the DCB and the Office of Civilian Defense, are concerned with ways of linking broadcast stations to local defense centers for immediate receipt of local and regional messages. Also, a nation-wide supernetwork is said to be available for messages of national importance.

	Page
Alert Receiver (RCA) .....	20
Capacity and Inductance Measurement. By J. E. Willson .....	12
Communications Receiver (RME99) .....	16
Directory of Radio Schools .....	30
National Defense and Radio. By Lewis Winner .....	18
Pilot Lights Will Get You. By Walter R. Jones and Frank D. Langstroth .....	7
Reactance Charts .....	13
Remote Level Controls for Sound Systems. By Robert G. Herzog .....	10
Sound Ideas. By Jay Allen .....	14
Speakers. By Henry Howard .....	5
<b>Associations</b> .....	21
<b>Book Review</b> .....	29
<b>Case Histories</b> .....	22, 26, 31
<b>Circuits</b>	
Bias from Speaker Field Circuits .....	5
Bogen P-A Remote Level Control .....	11
Capacity and Inductance Measuring Circuits .....	12
Clarion (TCA) P-A Remote Level Control .....	11
Pilot Light Circuits .....	8, 9
RCA Alert Receiver .....	Front Cover
RCA P-A Remote Level Control .....	10
RME99 Communications Receiver .....	16
Series Filament Circuits .....	7, 8, 9
Speaker Field Connections .....	5
<b>Cover Diagram</b>	
Alert Receiver (RCA) .....	20
<b>Index to Advertisers</b> .....	36
<b>Manufacturers</b>	
Catalogs, Etc. .....	23
Displays .....	33
Expansion .....	28
New Products .....	33, 35
Personnel .....	28
Sound News .....	23
<b>Short Items</b>	
CBS Television Pattern .....	25
Ignition Noise .....	15
Modernize Your Shop .....	34
RCA Automatic Record Player .....	27
Radio Locator .....	25
Special Service. By Martin Francis .....	29
<b>Sound</b>	
Remote Level Controls for Sound Systems. By Robert G. Herzog .....	10
Sound Ideas. By Jay Allen .....	14
Sound News .....	23
Speakers. By Henry Howard .....	5

Copyright, 1941, Bryan Davis Publishing Co., Inc.

BRYAN S. DAVIS  
*President*  
PAUL S. WEIL  
*General Manager*  
JAS. A. WALKER  
*Secretary*  
Chicago Office:  
608 S. Dearborn Street  
C. O. Stimpson, Mgr.  
Telephone: Wabash 1903

Published Monthly by the  
**Bryan Davis  
Publishing Co.**  
Inc.  
19 East 47th Street  
New York City  
Telephone: PLaza 3-0483



F. WALLEN  
*Advertising Manager*  
A. GOEBEL  
*Circulation Manager*  
Wellington, New Zealand  
Tearo Book Depot  
Melbourne, Australia:  
McGill's Agency

Entered as second-class matter June 14, 1932, at the Post Office at New York, N. Y., under the Act of March 3, 1879. Subscription price: \$2.00 per year in the United States of America and Canada; 25 cents per copy. \$3.00 per year in foreign countries; 35 cents per copy.

# Now You can Hear them ALL at their BEST!

...with a New Jensen Coaxial Speaker

- ↑ "FM," Television Sound
- ↑ Transcriptions, Quality "AM"
- ↑ "AM" Radio
- ↑ Phonc Records, "SW" Broadcast

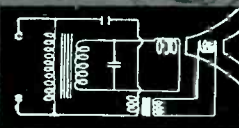
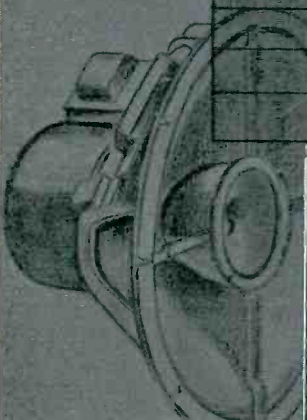

Separate coaxially-mounted speakers for low and high frequencies, with integral two-channel net work. (Range control not shown. Some models have simplified bridging net work.)

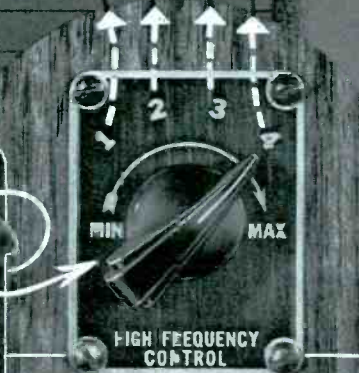

Jensen High Frequency Control gives you the kind of reproduction you want when you want it... all the way from two-way system high fidelity, to conventional single speaker performance. Now you can adjust or best results on every program, every record, every type of service.

### Jensen Bass Reflex

Acoustically-corrected Bass Reflex Cabinet gives smoothly extended low register. Better than in "infinite" baffles... efficiently uses back radiation too.



*A New Series of Fine Reproducers*

**Designed to Meet Your Needs Now...and for Years to Come!**

- ★ Two Speakers, Coaxially mounted.
- ★ Built-in Frequency-Dividing Network.
- ★ Jensen High Frequency Range Control for all-purpose flexibility.
- ★ Jensen "Bass Reflex" enclosure for full low register.
- ★ Elegant fully styled walnut cabinets.

Never in the history of sound reproduction have you been able to buy so much performance...such complete versatility...at so low a cost! For now Jensen brings you the ultimate in general purpose reproducers, with top performance so fine, so nearly ideal acoustically that obsolescence is eliminated for years to come...you can instantly adjust response for most pleasing results with every type of input in use today. Ideal for professional and home use for FM-AM reception and monitoring, transcriptions, commercial phonograph records... for practically every moderate-level high-quality application. Write now for Data Sheet 120 for technical descriptions and prices.

Four complete reproducer types with 7" to 15" speakers, priced at \$75.25 to \$118.75 list in striped walnut cabinets. Utility cabinet models down to \$64.25 list. Coaxial speakers only as low as \$29.50 list.

# Jensen

6601 SOUTH LARAMIE AVENUE CHICAGO, ILLINOIS  
CABLE ADDRESS: JERAD, CHICAGO

# THE NEW IRC VOLUME CONTROL MANUAL IS HERE!

(3rd Edition)



## 35% MORE LISTINGS—MORE ACCURATE—EASIER TO USE

- ★ The finest, most complete manual of its kind ever published. Unexcelled in its helpfulness to every serviceman who makes control replacements.
- ★ Lists correct controls for over one-third more radio receiver models than ever before.
- ★ Every replacement recommendation checked and double-checked against manufacturers' drawings, revised specifications or latest engineering data, etc.
- ★ Gives everything you need to know about a control *at a glance*—from manufacturers' original part number to Rider's Manual reference, price, switch data, etc.
- ★ Trade and brand names listed *alphabetically* so that you can find them quickly.
- ★ Auto radios listed the logical, easy-to-find way—by make of car.
- ★ New, large 8½" x 11" size with 136 pages and many new features including a handy information section, charts and formulas and complete IRC Control and Resistor catalogs.
- ★ The latest, most up-to-the-minute Manual of its kind on the market—now available through IRC Volume Control Jobbers.

**Don't Miss It . . . Get Your Copy Today!**

## STANDARDIZE ON TYPE D CONTROLS ... IT PAYS!

Except for the necessary "specials", etc., this new IRC Manual is based entirely on the use of Type D Controls with Tap-in Shafts—IRC's famous small-size "Universal" Controls that have been breaking one sales record after another for more than two years. They are fully dependable—easier to install—more efficient. Tap-in Shafts frequently avoid the use of more costly "specials"—and a small, inexpensive control stock equips you for the big majority of all jobs. "Streamline" your work by using Type D's.

18 Controls, 6 Switches, 5 Special Extra Shafts—to handle 60% to 75% of your control needs—all included in the attractive IRC Metal Cabinet for only \$14.97 net, \$24.95 list.

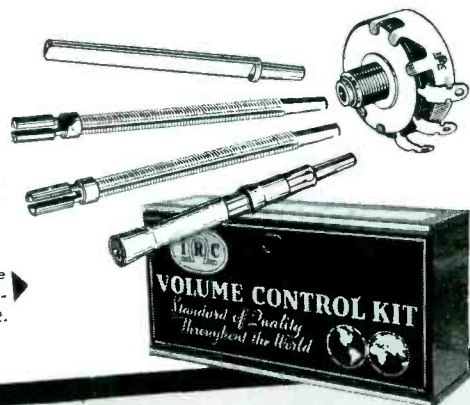

## INTERNATIONAL RESISTANCE CO.

401 N. Broad Street • Philadelphia, Pa.

S P E A K E R S

By HENRY HOWARD

IN THE fascinating old days of radio (then known as wireless) loudspeakers were non-existent. Wireless communication was mostly in code and headphones were always better for code reception as they helped the operator concentrate. In the early days of broadcasting, radio was still a hobby rather than the necessity it has now become, but everybody was anxious to listen in at the same time and there seldom were enough pairs of phones to go around. Thus, speakers were born.

Early Types

The first speakers were simply headphones with a megaphone attached. The efficiency of a horn was recognized very early in the game. Baldwin brought out an armature actuated mica diaphragm type of phone which was generally considered tops at the time. The standard magnetic types with metal diaphragm were not very different from our present magnetic phones. Very little audio power was available at this time, but phone units often took a severe beating nevertheless. We thought the quality of these units was quite good, all things considered, even though there was a complete absence of bass.

Magnetic Cones

When the magnetic type cone speakers came along with substantial bass, many listeners had to cultivate a taste for them. Western Electric brought out a 12-inch cone which was considered by many as the standard speaker. Later, a better 18-inch cone took the honors. A large number of home-made speakers were used about this time, principally the airplane cloth type which used a standard driving unit with a long driving pin. The cloth was decorated or painted with a favorite subject and was then doped to shrink it and make a tight cone. The magnetic

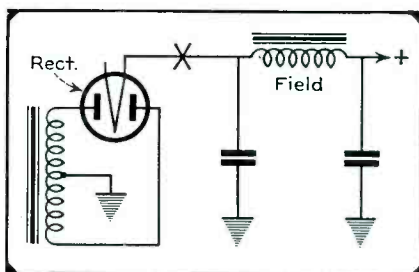

Fig. 1. The speaker field coil is used as a filter choke in this circuit, with large electrolytic capacitors to attenuate the hum.

speakers gave but little output before distortion set in, according to our present standards, because at high amplitudes the force-displacement characteristic became non-linear.

Moving Coil Types

Moving-coil speakers, known as dynamics, were introduced by Magnavox in the early days. This speaker used a 6-volt battery for field excitation and had a large horn. The voice coil electro-dynamics that we know now were not forthcoming until much later. They began with fields designed for 6-volt battery operation or they had their own rectifier type supply—some with a separate '80 rectifier tube, others with a Rectox dry disc rectifier fed from a step-down transformer. RCA brought out a speaker with a 110-volt copper

Fig. 2. A tapped field has been used as a voltage divider and bleeder in some circuits. D-c with less ripple voltage is required for this application.

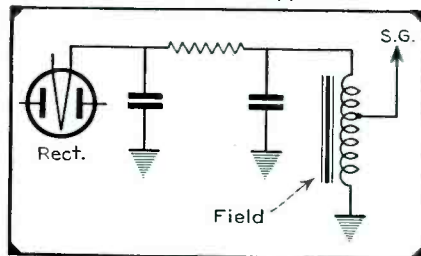

oxide bridge circuit rectifier, which eliminated the need for a transformer.

Low Pitch Speakers

Around 1928 and '29 there was a bass craze. Low-pitch speakers were demanded by the public. Some manufacturers had to recall all their sets from jobbers and stores and install shunt condensers from grid to ground in the a-f stages to give a false bass effect. The public was kidding itself—but it liked it. To the jazz crazy, cutting the highs accentuated the rhythm, but to the musical it was only an obnoxious boom-boom in which all bass notes sounded alike. The resonant point of these speakers was placed so as to aggravate this condition.

Two Other Types

Two types of speakers distinctly different from the dynamics appeared about 1929 and early in 1934. The first was an electro-static speaker or capacity type brought out by Peerless and called the "Kylectron." This was a very high impedance device which used a 199 tube as a rectifier for the d-c bias. The performance was very satisfactory, but they didn't stand up. Redesigning with modern materials would probably make a satisfactory job. The second type of speaker was the crystal speaker which was especially good on the high frequencies. For some unknown reason—possibly price considerations—this type never made much headway. The way radio is being deprived of many essential materials today by the more important defense activities, it may be a good idea to take stock of these forgotten types with a view toward reclaiming them and thus aiding the defense program.

Permanent Magnet Dynamics

When battery portables came along,

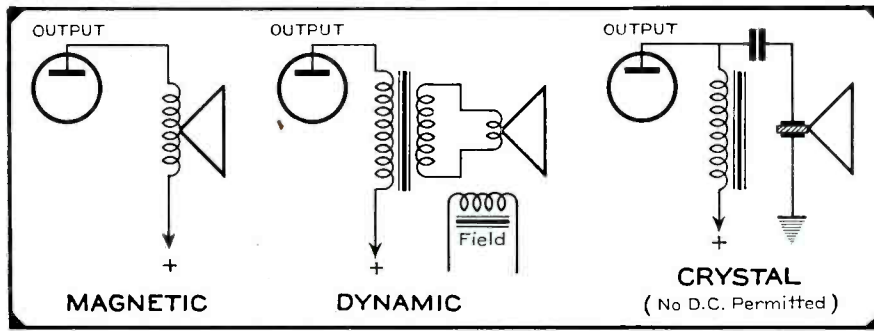

permanent magnet dynamics, called p-ms, became popular to get the most from these low-powered sets. New magnetic materials of the aluminum-nickel-cobalt family gave considerable impetus to this development, permitting high flux densities to be obtained with small, light-weight magnets. Many manufacturers also used p-ms in their standard a-c sets to get sufficient flux density in the speaker field. Now, however, because all these metals are needed for our defense effort, manufacturers have agreed to use p-ms (with a maximum magnet weight of three ounces) for battery receivers only. This is, of course, with the view to stretch radio's allotment of the precious metals as far as possible.

#### Present Speakers

Practically all speakers in new sets, except portables, will be of the electro-dynamic type. Surprising as it might seem, the conversion efficiency or electrical input to acoustical radiation is generally less than 5% for these speakers. This is due to the poor coupling between the air and the cone. The air is too "thin," offering too little resistance to the cone vibrations. In professional high-power installations of audio systems horns are always used. There's a good reason for this—the conversion efficiency can be increased to 50% with a properly designed horn. Efficiencies of 25% are common. The reason for the high efficiency lies in the ability of the horn to act as a sound transformer or acoustic transducer, securing a better impedance match.

#### Baffles

An adequate baffle is imperative for low-frequency output, the smallest dimension being equal to, or greater than ½ wave length of the lowest frequency to be properly reproduced. The baffle should have an irregular outline so as not to exhibit sharp cut-off characteristics. Without an adequate baffle, sound pressure at low frequencies is prevented from being built up because of the short path from front to rear of the speaker. Theoretically, at 100 cycles the shortest dimension should be about 5½ feet,

With the possibilities of an extreme shortage of magnetic materials, crystal speakers may be used to replace the more familiar magnetic and dynamic types.

which is figured from the formula:

$$\text{wave length} = \frac{\text{velocity}}{\text{frequency}}$$

where the velocity of sound is about 1100 feet per second.

Because of these cumbersome dimensions, baffles are not suited to home use and many devices have been invented to replace them. All designs are based on the theorem that radiation from the rear of the speaker must not be allowed to cancel the direct radiation from the front. One class of device aims to completely dissipate the rear radiation making any cancellation impossible. There can be no openings in the speaker cabinet, so the sound must be absorbed by directing it along paths lined with special sound absorbing material. Another class of device aims to make the bass notes travel such a critical path that they are radiated in phase

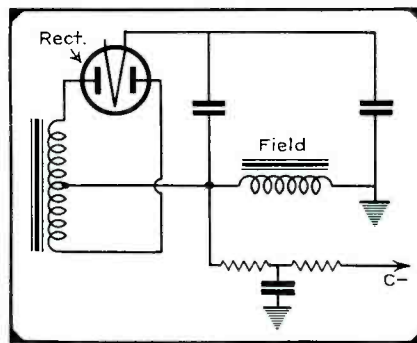
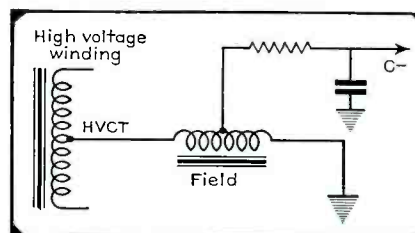

Fig. 3(a). (Above) The bias for the output stage has often been obtained from a resistance divider across the field coil which was connected in the negative leg of the power supply. Fig. 3(b) (below) shows the same application with a tapped speaker field.



with the direct front sound waves and are thus put to good use instead of being wasted as in the first case. The dimensions are critical in these designs and a great deal of research work has gone into them to get the present high-quality reproduction. The high frequencies must be completely absorbed because only a very limited spectrum can be properly phased. Cancellation would begin to take place if the range were extended. Stromberg Carlson's labyrinth is a notable development in this field.

#### Field Supply

The problem of d-c field supply for dynamic speakers has always been interesting. Separate external supplies have been mentioned. Most present sets supply the field from the main rectifier in one of the following ways: as a filter choke; as a screen supply drop resistor and bleeder; in the negative high-voltage lead as a choke and C-bias drop resistor or in shunt with the rectifier output.

Fig. 1 shows the field as a choke with large electrolytic condensers to attenuate the hum. The larger the first condenser, the less the speaker hum, but the rectifier has to handle larger capacity currents which may wreck it. Where excessive speaker hum is encountered due to insufficient field filtering, inserting a low value resistor at X and increasing the first condenser should give substantial improvement. The resistor will protect the rectifier. Values from fifty to many hundred ohms are being used.

Fig. 2 shows a tapped field acting as bleeder and voltage divider for the screen grids. Smoother d-c is required in this application. Fig. 3(a) shows the bias application for triodes which require considerable voltage, and Fig. 3(b) shows the tapped field necessary for pentode application. The same total voltage must appear across the whole coil in order to obtain sufficient magnetizing power, but the pentodes require only a small bias voltage. For UL approval, field coils, as well as transformer coils, must be wrapped with asbestos so as to eliminate fire hazard.

#### Hum

To reduce hum in speakers due to field supply ripple, hum-bucking coils or shading rings are often used, especially in cheap sets where more filtering cannot be used. Hum voltage in the bucking coil is used to cancel that in the field coil. By carefully adjusting the number of turns in the bucking coil, the fundamental frequency can be completely cancelled out, but, because of wave form

(Continued on page 32)



# PILOT LIGHTS WILL GET YOU

BY WALTER R. JONES

DIRECTOR OF COMMERCIAL ENGINEERING  
HYGRADE-SYLVANIA CORP.

and

FRANK D. LANGSTROTH

COMMERCIAL ENGINEER  
HYGRADE-SYLVANIA CORP.

**I**T'S ONLY an open filament! All you need is a new tube!" How many times have you said that to a customer? Perhaps a great many, for it is true that a large number of service calls are occasioned by tubes with open filaments.

It was easy for you to slip in a new tube and let it go at that. However, when you heard the tone of your customer's voice a short time later informing you that the very same thing had happened all over again, were you embarrassed? We suppose that depended on how much you charged her!

Had you realized that in the majority of cases open filaments do not "just happen," but are "caused" you wouldn't have been satisfied with merely replacing a tube, but you would have found the cause and cured it. Certainly you value your reputation as a Service Man and the good will of your customers enough for that.

It is therefore the purpose of this article to present a few of the filament problems encountered, with the hope of making them recognizable, and to suggest simple cures which will enable you to have a better understanding of what has appeared to be complications in the past.

Modern radio tubes are indeed very rugged when one considers the exacting requirements under which they must function in their various applications. However, there are a few problems which must be given careful consideration if long life and best results are to be assured.

One of these problems is the importance of operating and maintaining the filament voltage within the published ratings of the tubes!

This problem sounds very simple—so simple in fact that we ignore it. We take it for granted that if a series of 1.4 volt tube filaments total six volts and we place six volts across it everything is perfect; or if a 150 ma series adds up to the line voltage, why not put it directly across the line? Well, why not? We will take this problem first.

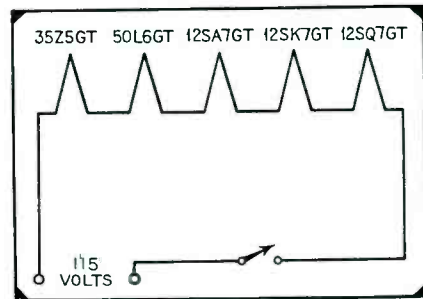
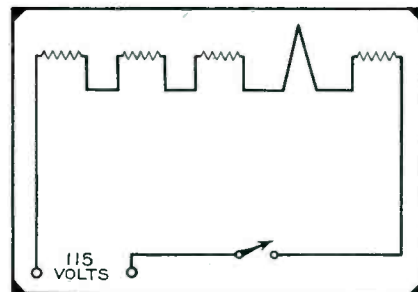

Fig. 1. The total filament voltage of these tubes, connected in series, is more than the line voltage.

We will say that one of your customers has an a-c, d-c receiver in which she continues to find open filament tubes—sometimes it is the 12SQ7GT, sometimes it is the 12SK7GT. She is vexed over the whole situation. You have tested the voltage across the various filaments and they are within the recommended limits. The total rated filament voltage in series adds to 121 volts and your line voltage is only 115 volts. Everything looks good to you. Why in "Sam Hill" do they "pop" out? Well, suppose we start taking measurements on this set again and place a volt-meter across the filament of one of the 12-volt tubes and turn the set on—Wow! For a few seconds the filament voltage goes up to 26 volts and then gradually drops down to 12 volts. It is this initial surge voltage that causes the filaments to open! Why do we have this condition?

The filament circuit of a typical a-c,

Fig. 2. Four of the five filaments act as a ballast for the fifth.



d-c receiver is shown in Fig. 1. There are five tubes having their filaments in series so that the total filament voltage will equal the line voltage across which the series string is connected.

If we visualize each filament as being a resistor, we can better understand the functions of this circuit. In other words, the filaments of the first, second, third, and fourth tubes act as a resistor to cut the voltage down to its proper value for the fifth tube, while the first, second, third and fifth filament is the dropping resistor for the fourth tube, and so on. We always have four filaments acting as the ballast resistor for the fifth as shown in Fig. 2.

According to Ohm's law, everything should work fine with this circuit; it would if it were not for one condition. The resistance of the filaments which we are using as dropping resistors is variable—it varies with temperature.

When the filaments are first turned on the resistance is low because the tubes are cold. As they become hot, the resistance increases to a steady value.

Even so, this would not be quite so bad if all the filaments reached their steady value at the same time. However, we have tubes of various voltages in the series string and the higher voltage filaments have a greater mass to heat, thus causing them to have a slower heating time than the low voltage filaments.

The result is that we do not have sufficient ballast for the low-voltage tubes which have already reached their operating temperature. This causes a higher voltage to appear across their filaments until the resistance of the other filaments have reached their steady value. The heating time of these latter filaments is further reduced because the high resistance of the low-voltage filaments reduces the voltage applied to them.

It can be seen, therefore, that something is necessary to keep the line voltage reduced until the tubes are warmed up. This can easily be done by inserting a small resistor in series with the

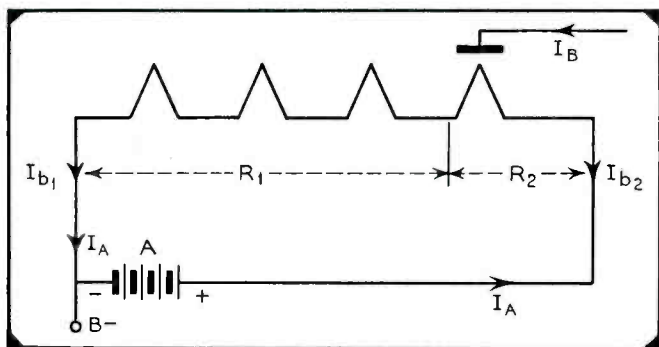

Fig. 3. In sets designed for battery and line operation it is usually necessary to operate the tube filaments in series for both line and battery operation. The total B current consumed by these tubes must return to B— and only way this can be accomplished is for the current to pass through filament string.

line voltage and the filament string.

This protective resistor tends to function automatically. As the resistance of the series filament string is very low, when the receiver is first turned on, there will be a high-current drain through the resistor. This will cause a large voltage drop, thereby reducing the voltage applied across all the filaments. When the tubes are hot the resistance of the filaments increases, reducing the current through the resistor and allowing more voltage for the series filaments.

The application of this protective resistor will naturally drop the filament voltage a few volts, but this should in no way affect the functioning of the receiver, as the loss of voltage will be distributed among all the five filaments.

#### 1.4 Volt Filaments

The increasing popularity of the battery-operated receiver has no doubt caused you numerous headaches. We often find open filament tubes and continue to wonder why, especially when some of these tubes have been replaced two or three times.

In sets designed for both battery and a-c, d-c operation, it is usually necessary that the filaments of the tubes be operated in series during operation from the power line. Series operation is also frequently employed for battery operation to simplify switching. There appears to be nothing wrong with this type of circuit. We see no reason why we cannot series operate tube filaments providing, of course, their currents are all the same. Here again, however, there exists a condition which was not always taken into consideration in early re-

ceiver designs of this kind. The fact that the tubes have plate and screen voltages applied to them was often ignored. The total B current consumed by the tubes must return to B—, and the only way that this can take place is for the current to pass through the filament string, thus adding additional current. At times this is sufficient to overload the tube filaments.

In series connected filaments, therefore, the difference between the filament current at each end of the string must be the total B current. Most of this is contributed by the power output tube which is placed at the positive end of the string so that its bias may be obtained by returning the grid to the negative end.

The way the B current divides between the A+ and A— circuits depends upon the resistance of these circuits. For the circuit in Fig. 3, this division of the B current can be expressed as:

$$\text{Percent } I_b \text{ in A+ circuit} = I_b \left( \frac{R_1}{R_1 + R_2} \right)$$

$$\text{Percent } I_b \text{ in A— circuit} = I_b \left( \frac{R_2}{R_1 + R_2} \right)$$

It is apparent that in a-c operation where A+ is connected through a large dropping resistor, practically all of the current flows out of the negative end of the filament string. During a-c opera-

Fig. 4. (Below) Where filament type tubes are used in series, it is desirable to shunt the B current of the power tube around the other filament circuits, especially if this current is large.

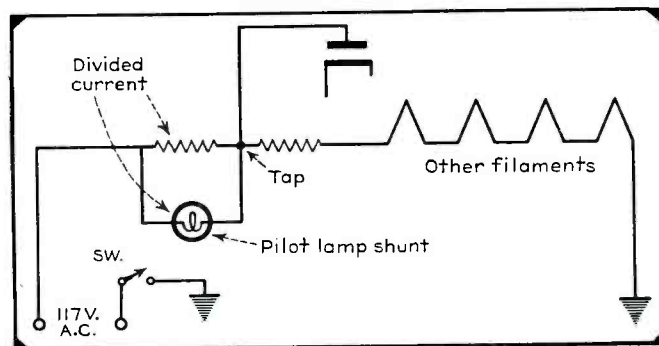
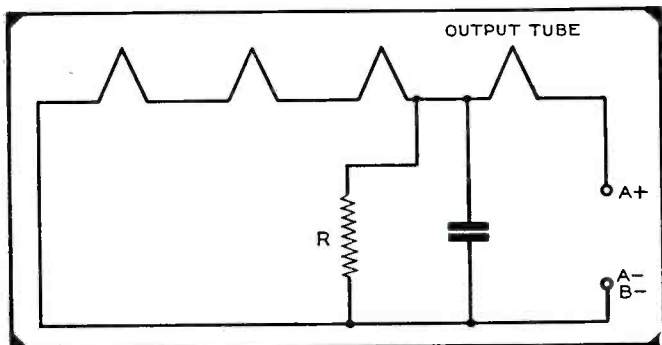

Fig. 5. (Above) In 35Z5 and 45Z5 rectifier tubes the heater has a tap brought out for a pilot lamp at a point 7.5 volts from one end of the heater when only heater current flows.

tion, therefore, it is desirable to shunt the B current of the power tube around the other tube filaments, especially if a tube of high B drain is used. This may be done by a suitable resistor R as shown in Fig. 4. This shunting resistor will equalize the current in the tube filaments for both line and battery operation.

To provide complete protection, the last A filter condenser should be placed directly across the shunting resistor. Thus the resistor also serves as a bleeder upon the last filter condenser in the A filter circuit and prevents this condenser from being subjected to excessive voltage when a tube is removed from the set while operating on a-c. If the condenser is not damaged, the charge accumulated is sometimes sufficient to burn out several tubes when the filament circuit is again established upon the insertion of a tube. Although this connection allows some a-c ripple to flow through the output tube filament, the amplification is not high enough to render it objectionable.

The filter condenser serves two purposes when used in this position, one as the A filter and the other to prevent modulation currents of the output tube from passing through the filament string into the r-f tubes. This condenser must be of high capacity, from 100 to 200 mfd, in order to effectively by-pass the audio component of the total plate, screen and filament current of the output tube.

In receiver designs where the output tube is of the double filament type, extreme care should be taken to see that each 1.4 volt section carries an equal share of the total cathode current. Generally the negative section receives the greatest amount. This will necessitate the use of a resistor of approximately 250 ohms in parallel with the negative section or a suitable resistor may be used between the filament center tap

and —A to secure equalization.

In order to provide more power output when a-c operated, a separate output tube is sometimes used whose cathode current is returned through the remaining 1.4-volt tubes and thus provides their filament current. Some of

these sets subject the 1.4-volt tubes to a severe surge of filament current if the set is switched suddenly from a-c to battery operation. This results from the fact that the cathode of the a-c power output tube remains hot long enough to provide additional current from the B battery to flow through the 1.4-volt fila-

Fig. 6. (Below) With a missing or burned out pilot lamp the tapped section of the rectifier must complete the circuit for both the plate and filament currents of the tube.

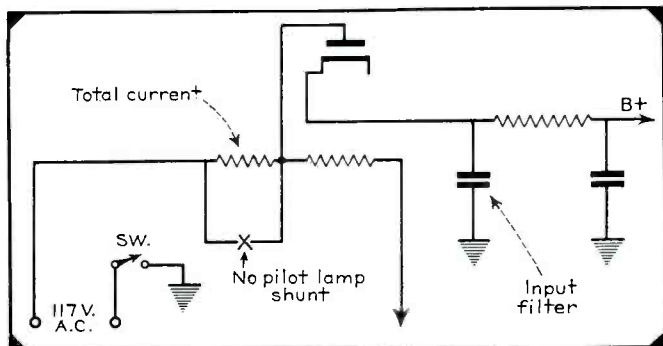

ments which are now being supplied from the A battery.

Although the 1.4-volt tubes will operate over a wide range of filament voltages, care should be exercised to see that the filament circuits are equalized in order to prevent excessive surges.

#### 35Z5 Filaments

Another filament failure often encountered is that of the rectifier tube, particularly the close-spaced types. Perhaps the 35Z5GT and 45Z5GT are the greatest offenders of them all because here we have two filaments to contend with—the rectifier filament and the pilot lamp filament section.

Fig. 5 shows the circuit employed in using 35Z5's and 45Z5's in typical receivers. The 35Z5 and 45Z5 are similar to other half-wave, close-spaced, rectifier tubes with the exception that the heater has a tap brought out for a pilot lamp at a point which is 7.5 volts from one end of the heater when rated heater voltage is applied and only heater current flows. Therefore, a pilot lamp can be placed across this tapped section which eliminates the necessity of a ballast resistor as is required to secure the pilot lamp voltage when using other type rectifiers.

However, in order to increase the brilliancy of the pilot lamp it is current design practice to connect the rectifier plate also to the heater tap so that the total plate current of the receiver will pass through the pilot lamp. This is why panel lamps flicker on strong signals—because the plate current varies with the signal strength and naturally the amount of plate current passing through the pilot lamp will also vary.

You have often noticed that the pilot lamp in these receivers light up like a lighthouse when the set is first turned on. This is due to the fact that when the tube filaments are cold, as they

would be when first turned on, the current drawn by the series string is very high (the resistance of the filaments is low). When the filaments become hot their resistance increases and the current is reduced. Since the pilot lamp is shunted across a section of the filament there is a large voltage drop across the pilot lamp, caused by the high current of the cold tubes. It is this high voltage drop that can damage the pilot lamp and cause it to open. As soon as the tubes are warm this voltage decreases and the pilot lamp hardly lights until plate current starts to flow, then the light comes up to normal brilliancy.

Now look at Fig. 6 and see what would happen if that damaged pilot lamp was not replaced. Remember that the pilot lamp acts as a shunt across a section of the rectifier filament and keep in mind that the total plate current of the receiver also passes through this shunted section. With a missing or burned-out pilot lamp the tapped section of the rectifier filament must complete the circuit for the plate current. It must then carry both the rectifier and filament currents.

The filament is designed to carry 150 ma, but the plate current is now added (normally around 50 ma) and we have a total of 200 ma passing through the tapped section. This subjects the tube to a considerable power overload which will shorten its life. In other words, there is approximately 10 volts across a section that is designed to have only 7.5 volts.

Should the receiver be turned off and on without allowing the tubes to cool, another problem presents itself which generally causes the filament of the tapped section to burn out. This problem is called "On and Off Cycling," and depends a great deal upon the capacity of the input filter condenser.

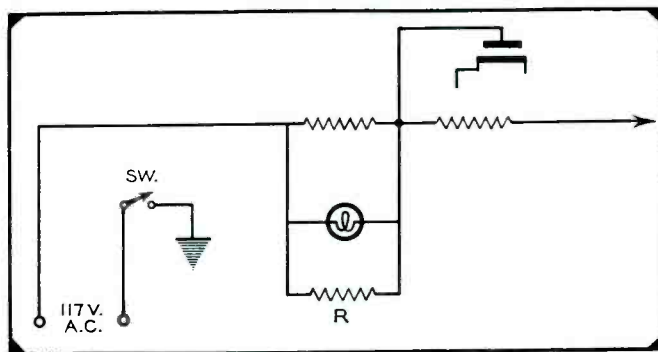

Fig. 7. (Above) A 300-ohm resistor connected across the pilot lamp circuit is all that is needed to correct the difficulty and prevent the lamp from burning out too quickly.

"On and Off Cycling" can be illustrated by the following example: Mrs. Smith had not replaced the pilot lamp in her receiver and one evening she thought she heard the telephone ringing, so she turned off her radio for an instant to make sure. The telephone was quiet so she turned on the set again—the set failed to work.

The set didn't work because when Mrs. Smith switched off the current the cathodes of the tubes were hot and had consumed all the voltage that was stored in the filter condensers. Then the next instant the current was turned on again and the rectifier cathode, still hot, allowed current to flow to charge the filter condensers again. The current consumed in charging the input filter condenser is very high and the larger the capacity the higher it is. This current is plate current and must pass through the tapped section of the rectifier filament, thereby adding to the filament current and causing it to be high enough to burn out the filament. It often happens that this same charging current is high enough to exceed the peak plate current limit of the rectifier, thereby causing the cathode tab to melt. The melted cathode in turn may short to the filament or plate causing a-c voltage to be applied across the filter condenser which will certainly cause it to break down. To help prevent this difficulty, look at Fig. 7. All that is needed is the resistor R shunted across the pilot lamp. This resistor not only prevents the high voltage surge from damaging the pilot lamp when the receiver is first turned on, but will protect the tapped section should the lamp be removed. Furthermore, it will help protect the tube from the high charging current drawn by the input filter condenser.

The value of resistor R is 300 ohms when a No. 40 or No. 47 pilot lamp is used. Should the receiver have no pilot lamps, then a resistor of 80 ohms may be shunted across the tapped section.

If you carry a supply of good phonograph needles with you on each service call you may be able to get some of your phono-equipment owning customers to buy their supply from you regularly.

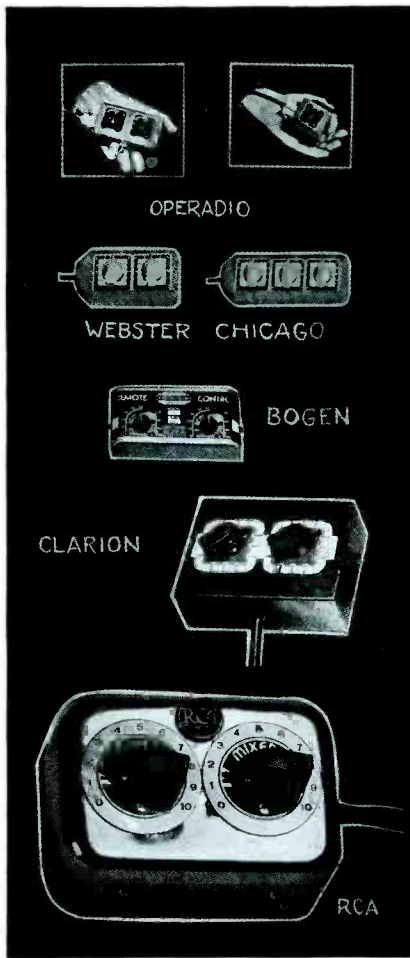

# Remote LEVEL CONTROLS For Sound Amplifiers

By Robert G. Herzog

EDITOR

Fig. 1. Remote level controls, such as those shown at the left, are inexpensive, easily connected and universally applicable to any sound problem. Once connected they will enable you to eliminate guesswork by adjusting the volume level from the audience itself. They are foolproof in operation and generally permit control both at the amplifier proper or at the control unit. They are not connected in the signal circuits of the amplifier and there is no limit as to the length of cable which may be used to connect them.

operated volume level controls. With one of these remote devices connected to the amplifier, an operator can be located at an appropriate spot in the audience and can hear the sound as they hear it. Eliminating guesswork, he can, with an ear toward perfection, adjust the volume as often as may be necessary.

### Installation

Typical control units of this type are shown in Fig. 1. They are, for the most part, comparatively small and can fit in the palm of the hand. As many channels as desired can be controlled at the remote point with a separate control for each channel. A pair of wires is required for one channel and only one extra wire for each additional channel. No special type of cable is required. Since the controls are not connected in the signal circuits and are adequately by-passed, they may be located anywhere within hearing distance of the amplifier without introduction of hum or noise and without affecting the quality of the reproduction.

The installation may be permanent, that is the wires from the control to the amplifier may be run in rigid conduit

**W**E CAN probably say, and almost without contradiction, that the average sound system is operated with the volume level controls turned up too high. The general practice followed is to turn the control up until the loudspeakers start to howl and then to back the control off a notch or two to quiet them down. The operator probably feels that this adjustment will carry over any combination of audience and noise and hence will require the least attention. Throughout all this he seems especially desirous that the loudspeakers be heard.

sound coming from the loudspeakers should never be louder, anywhere in the audience, than it is at the actual source.

### The Remedy

It is peculiar that these requirements are not met in practice, especially when we consider that sound engineers have made available a simple, inexpensive, easily connected and universally applicable remedy in the form of remotely

### Reinforcement Not Amplification

As a matter of fact, however, the installation would sound considerably more natural if the sound does not appear to be coming from the loudspeakers at all. It may seem strange, but the actual function of the average amplifying system is to reinforce rather than amplify the sound. Except in systems used to cover large outdoor events, tremendous volume is not only undesirable but will make the sound lose much of its natural lifelike qualities. To be thoroughly effective, the amplifier need only give the sound that little added boost which it might require to carry over the noise level that normally exists wherever people gather to listen. The

Fig. 2. RCA's remote control unit is connected in the cathode circuit of a double-grid tube and varies the bias applied to one of the grids.

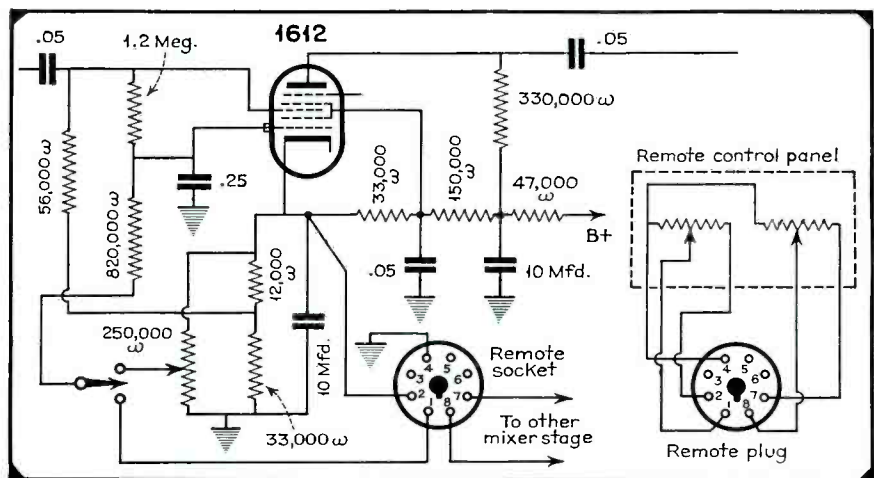

or bx, along or through walls, etc., or a flexible cable may be employed in a temporary or semi-permanent arrangement. No shielding is required but if it is used the grounded return may be connected to the shielding and the connecting cable can then have one wire less.

With the device connected to the amplifying system practically foolproof control of volume can be obtained. It is usually possible to increase or decrease the volume, noiselessly, either at the remote unit or at the amplifier controls. Amplifiers equipped for remote control connection can be operated with or without the control unit attached.

### RCA Circuits

Fig. 2 shows the circuit used in the RCA MI4726 and MI4733 amplifiers. In these chassis the amplifier control as well as the remote control are located in the cathode circuits. A switch is employed to shift from one to the other. Should requirements make it necessary to adjust the volume at the amplifier

a 820,000-ohm load resistance to the arm of volume control. The signal is by-passed at this grid. The two grids are connected together by means of a 1.2 meg resistance.

Because of the relatively small value of the load resistor in the sharp cut-off grid circuit (56,000-ohms as compared

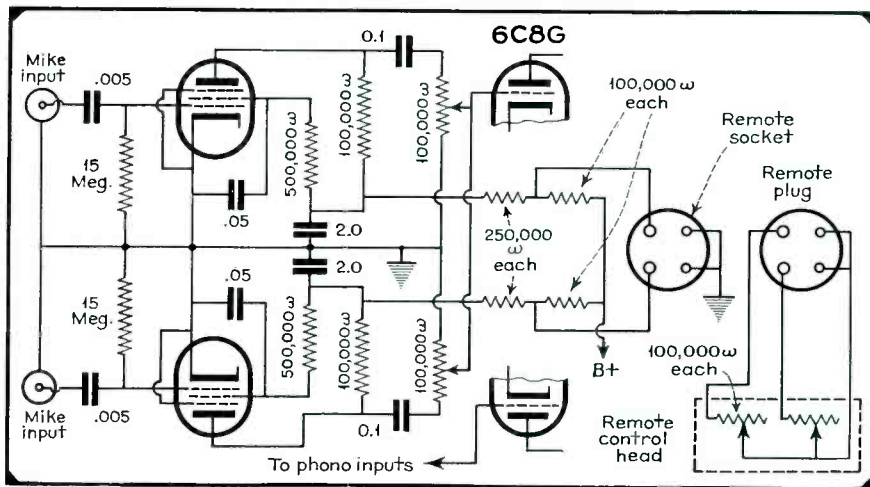

Fig. 3. The remote control unit for the Clarion amplifiers is connected in the plate and screen return and adjusts the voltage supplied to these circuits.

proper while the remote unit is connected and in operation this is accomplished through the use of a "Master Volume Control".

A special type of tube, the RCA 1612, which has two control grids much the same as the more familiar Type 6L7, is employed in the input mixer circuit. In addition to the normal 1,200-ohm bias resistor a 33,000 loading resistance is connected in the cathode circuit. The 250,000-ohm local or remote level control is connected across both of these resistors. (See Fig. 2.) The sharp cut-off grid of the 1612 is returned through a 56,000-ohm resistor to the junction between the two cathode resistors as is shown in the diagram. The remote cut-off grid is returned through

with 1,200,000 plus 820,000), this grid remains more or less at its normal bias regardless of the position of the volume control.

As the position of the arm on the volume control is changed, however, the bias on the remote cut-off grid is altered and consequently the amplification of the tube is likewise altered.

Since the signal impressed on this stage is always very small the amplification may be shifted over a very wide range, in this manner, before any ill effects will be noted.

### Clarion Circuits

The Transformer Corporation of America employ a somewhat different system to accomplish the same result in their Clarion amplifiers. In some of their latest models a 12SJ7 input tube is used, connected in a normal manner. Bias for the tube is obtained by means

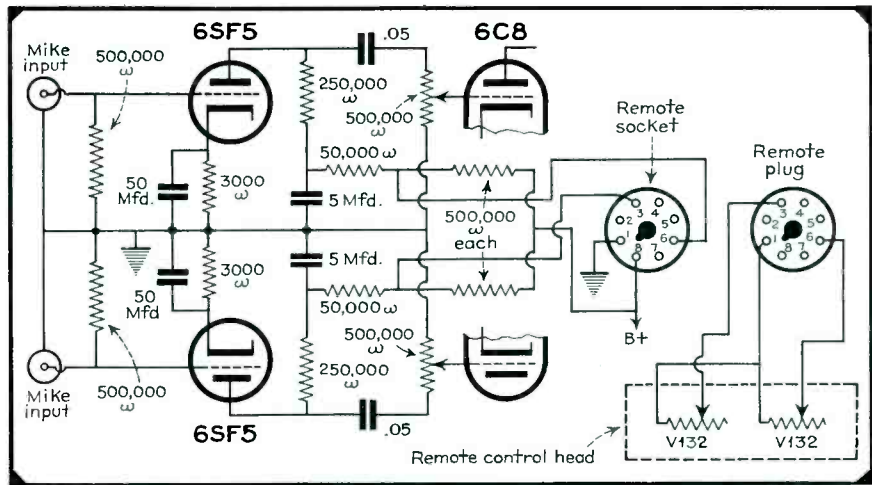

Fig. 4. Bogen's control varies the plate voltage applied to the 6SF5 input triode and thus varies the gain of the stage.

of the contact potential drop across the 15 meg grid-load resistor. (See Fig. 3.) Volume is controlled at the amplifier proper by means of a typical control in the signal-grid circuit of one of the triode sections of a 6C8G tube used in the second stage.

The plate and screen returns of the 12SJ7 input tube are connected together and through a suitable isolation network to a tap on the voltage divider of the B supply. The 100,000-ohm remote volume control connects from the screen and plate return to ground. Varying the control will change the voltage supplied to the plate and screen and, consequently, will vary the amplification of the tube.

Since the signal applied to this stage is always small, as in the previous case, the volume may be adjusted over a sufficiently wide range without any ill effects.

### Bogen Circuits

The Bogen Models E14 and E20 amplifiers utilize a system which operates on the same principles as that of the Clarion amplifiers discussed above. In the Bogen amplifiers 6SF5 high- $\mu$  triodes are employed in the input stages. (See Fig. 4.) These are connected in the normal manner with bias obtained from a self-biasing resistor in the cathode circuits.

At the amplifier proper volume is controlled by means of a 500,000-ohm potentiometer in the signal grid circuit of the second stage (one triode section of a 6C8G tube). The remote control unit is connected from the plate return, (with suitable isolation) of the 6SF5 tube to ground. As this latter control is varied the plate voltage supplied to the input tube is also varied. This in turn alters the amplification of the tube. Here again the signal is small and no ill effects result.

# CAPACITY & INDUCTANCE MEASUREMENT

By J. E. WILLSON

P. R. MALLORY & CO., INC.

*The supposedly complicated problem of accurately measuring inductance and capacitance at radio frequencies is simplified by the author in this article. The calibrated condenser which he suggests can usually be loaned or rented from a college laboratory and used to compare with your own. In the absence of such a unit, one can be made, with a fair degree of accuracy by means of a known value of inductance and the same system described herewith. A chart can be plotted showing capacity value for various degrees of rotation for any good condenser which you may have in your shop. These values can be determined for every broadcast frequency within the range of the condenser and the known inductance. For general service work the values so obtained will be sufficiently accurate.*

MEASUREMENTS of inductance and capacitance can be made at radio frequencies by using only a standard radio receiver having automatic volume control and an accurately calibrated variable condenser. Any commercial radio station may be used as the signal generator. The principal advantages of this are that the frequency will be known very accurately, usually within a few cycles, and that the frequency will not vary due to a load being placed on the generator.

A superheterodyne receiver having automatic volume control may be used as an aperiodic detector when making the measurements. From the theory of automatic volume control it is known

that the plate current will be maximum.

In a parallel tuned circuit containing inductance and variable capacity the impedance at resonance will be maximum. Therefore, at resonance only a very small part of the signal of the resonant frequency will pass through the circuit. If a parallel tuned circuit is placed in series with the antenna of a receiver and made to resonate at the frequency to which the receiver is tuned, there will be a minimum input signal to the receiver at that frequency. At any point other than resonance of the tuned circuit there is a much greater received signal. As the circuit is tuned through resonance, an indicating milliammeter placed in the plate circuit of any tube

any frequency if one has a suitable calibrated condenser which will resonate the tuned circuit at the frequency of the incoming signal. The only requirements of the standard condenser are that its calibration must be accurate and that it must be the correct value to cause resonance in the tuned circuit at the frequency of the generator. If the broadcast band alone is used, inductances of 20 mh and above yield better results when a standard variable condenser of 1000 mmfd or larger is used.

The circuit connections are made as shown in Figs. 1 and 2. The parallel tuned circuit is inserted in the antenna lead of the receiver, an external ground

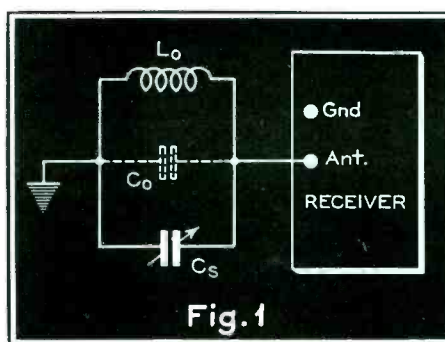

Fig. 1. The standard condenser, in parallel with the unknown inductance, is connected in series with the antenna input to any radio receiver equipped with a.v.c.

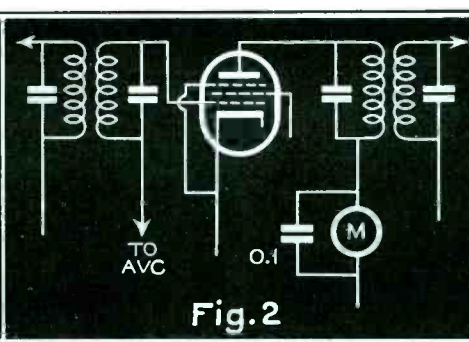

Fig. 2. A milliammeter connected in plate circuit of a.v.c controlled tube indicates maximum when trap circuit resonates with frequency of station to which receiver is tuned.

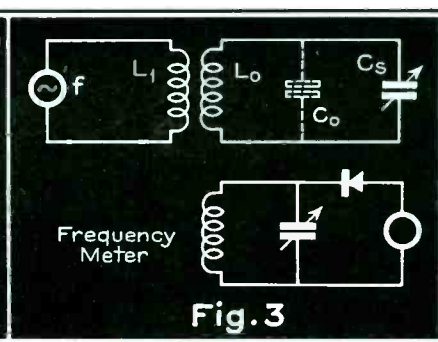

Fig. 3. Measurements made on standard equipment are much more complicated, but are not necessarily more accurate than those obtained by the method outlined in the accompanying article.

that the smaller the incoming signal the greater the plate current of the controlled tubes will be due to the change in grid bias caused by the a-v-c action. Therefore, with a minimum input sig-

controlled by the a-v-c circuit will indicate maximum current at the resonant point of the tuned circuit.

If a multiband receiver is used, measurements can be made at nearly

being used as an aerial. By using the ground as an antenna the rotor of a standard condenser could be grounded, thus preserving the original calibration.

The equations used for calculating

## REACTANCE CHARTS

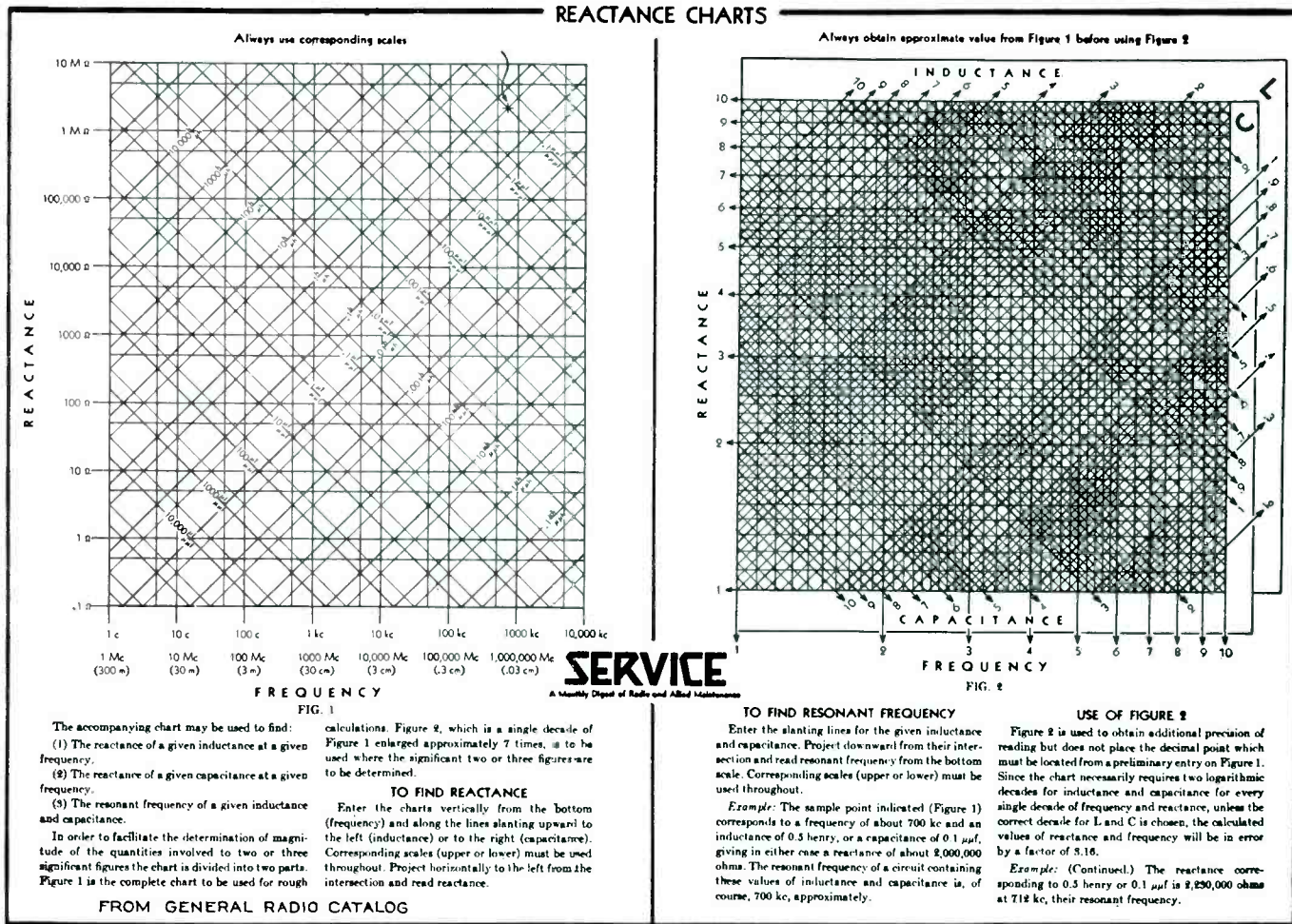

the distributed capacity and pure inductance of a coil will contain two of frequency and two values for the settings of the standard condenser. It was found desirable to make measurements at two slightly separated frequencies and combine the results into one equation. This gave much better accuracy than measurements made at a single frequency.

The procedure used in making the measurements is as follows: The receiver is tuned to some commercial transmitting station and the standard condenser is varied until there is a maximum current indicated on the milliammeter. The frequency of measurement and the setting of the variable condenser should be noted. This same procedure is followed at another frequency close to the first. The values of frequency and capacity obtained are then substituted in the equations, which when solved will show the values of inductance and capacity.

In Fig. 3 it must be assumed that there is a mutual coupling between the inductances  $I_1$  and  $I_2$ , yet that the close proximity of the two coils does not change their absolute values of inductance. This can be assumed because the method outlined above utilizes a radia-

The reactance charts can be used to obtain corresponding values of capacity and inductance for any resonant frequency. In applying formulae or the charts, make sure that you use the proper units. Formulae call for farads and cycles per second. Charts are in kc, mc and give values in mmfd.

tion rather than an induction field of the generator.

The equation for determining the inductance from the known quantities is:

$$L = \frac{1}{4\pi^2 f^2 C}$$

where

L is the desired inductance

$\pi$  equals 3.14

f is the frequency of the station used in cycles per second.

C is the value of the capacity (in farads) which tuned the inductance to resonance.

If a known value of inductance is used to determine an unknown value of capacity the same equation can be transposed to read:

$$C = \frac{1}{4\pi^2 f^2 L}$$

with the symbols having the same meanings.

The values can be read directly from the charts in Fig. 4, in accordance to the directions indicated.

This method of measurement, even though it requires very simple equipment, will yield accurate results. Results may be attained to an accuracy as good as the standard condenser.

### TRANSMITTING TUBE GUIDE

RCA's engineering and amateur guidebook on transmitting tubes contains comprehensive data on 69 air-cooled transmitting tubes, including the new important types 815, 816, 8000, 8001, 8005 and the midjet tubes 9001, 9002, and 9003. Complete data supplemented by carefully proven circuits show how RCA transmitting tubes may be used to the best advantage. The book contains 150 circuits and illustrations and is twice the size of last year's edition.

The outstanding feature of the new guide is found in the transmitter designs which are shown in great detail. They were designed, constructed and tested specifically for inclusion in the book.

Among the transmitters is included complete constructional information on a plate-modulated RCA-815 transmitter operating from 2½ to 20 meters, a high-power single-control 813 transmitter, an 809 economy transmitter and others.

All of the equipment described represents a wide range of application and meets modern demands for ready transmitter simplicity coupled with efficiency, economy and flexibility. Price is 25 cents a copy. Copies may be obtained from RCA Commercial Engineering Section, Harrison, N. J.

# SOUND NEWS



Fig. 2. The main purpose of the amplifying system installed in the Civic Center Building in St. Charles, Illinois, is to supply power for sounding the Westminster Chimes each quarter hour. Provision has also been made for other possible uses, however.

By JAY ALLEN

WITH the approach of Fall, fairs of all kinds are being planned throughout the country. It goes without saying that a good sound system is as essential to a fair as is the live stock and prize farm products. To be sure, many fairs can do with quite a number of sound systems.

Each year the Northwest looks forward to the Western Washington Fair at Puyallup, Washington. It's one of those hang up affairs to which everybody and his uncle comes in their Sunday finery. Fig. 1 shows the Puyallup Stadium and grandstands with a live stock pen visible in the center. This picture was taken during last year's fair. A high-power sound system played an important part last year announcing the various races, contests, competitions and displays. It was also used to play marches whenever the stands were being filled or emptied and to play entertaining reproductions during lull periods. At times the announcer gave a rolling commentary of the Fair, discussing who was present and whom to expect.

The sound installation at the Fair employed eight Atlas Sound Type RA72 six-foot trumpets, equipped with Type PM25 permanent-magnet dynamic units, mounted in the middle of the stadium on towers. These are circled in the photograph (Fig. 1) and can be seen to the right rear of the live-stock pen. About five or six Atlas Sound cone projectors were also used along the top of the grandstand to assure complete coverage. Four of these can be seen circled in the photograph (Fig. 1) along the top edge of the grandstand.

Three seventy-five watt amplifiers were used to power the trumpets and speakers. All the units were connected in parallel. A single record player supplied the marches and recordings, but

it required four microphones to cover the wide variety of events which took place at the Fair. These were suitably mixed and supplied to all the amplifiers and speakers in the installation.

## Civic Center Sound

Community centers throughout the country are live prospects for elaborate sound installations. An excellent example of this is shown in the installation recently made in the Civic Center Building (see Fig. 2), in St. Charles, Illinois. The primary function of this

sound equipment installation is to provide the power for sounding the Westminster Chimes each quarter hour. The entire equipment is installed in two specially constructed rooms, one of which is completely sound proofed. The chimes and the microphone for picking them up are installed in the sound-proofed room. (See Fig. 3.) The Operadio Du Kane 200-watt amplifier, consisting of three rack and panel assemblies measuring approximately 5 ft by 6 ft by 18 inches and weighing approximately 2,000 lbs, is installed in the

Fig. 4. The 200-watt, 3-rack amplifying system is installed in a specially constructed room.

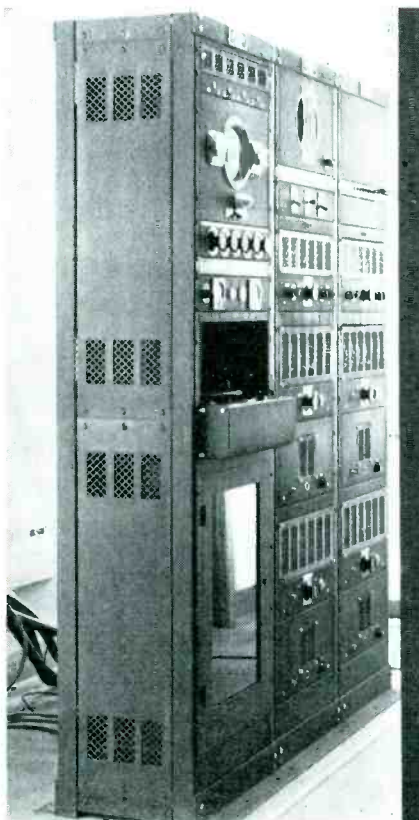
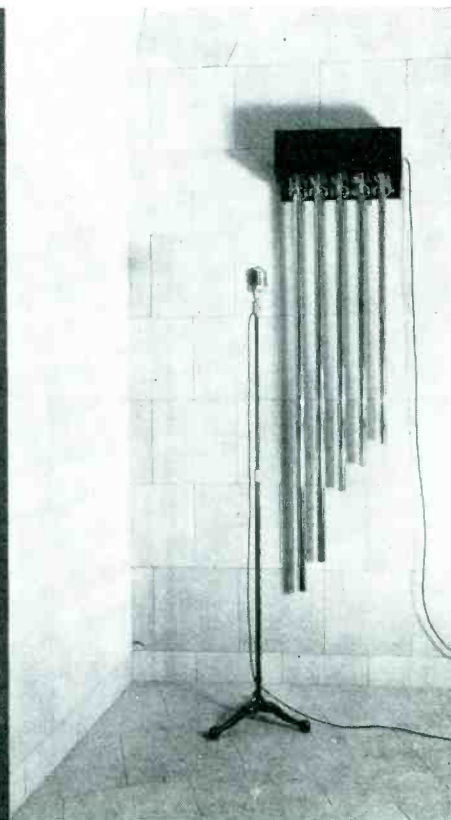

Fig. 3. The room in which the chimes and its associated microphone are located is sound-proofed to prevent echo.





second room. (See Fig. 4.) Twelve Operadio 820T weatherproof horn loud-speaker assemblies are mounted in four groups of three each in the top of the tower behind the four marble grills (those not used for clock faces).

The amplifying equipment is synchronized with the master clock so that the amplifiers are turned on two minutes before each striking time. At each quarter hour, an automatic chiming mechanism is set in motion which determines the number and proper sequence of the notes to be struck. At two minutes after the chimes are sounded, the amplifiers are automatically turned off and remain off until two minutes before the next quarter hour. This is repeated for any predetermined number of hours during the day and night.

The amplifying of the chimes is, however, only one of the possible func-



Photo courtesy Lord & Taylor

Fig. 5. Sound accompaniment to an action window display should always prove profitable. The picture shown is one of a New York City department store Christmas window.

tions of the equipment. In addition, any radio program may be picked up and amplified. The automatic phonograph record changer incorporated in the rack and panel amplifier can provide an uninterrupted program of phonograph recordings. Microphone outlets, installed in various locations within and without the building, make it possible to pick up various programs originating in and around the Civic Center Building. Four Shure Brothers Model 555 broadcast cardioid microphones are used for this purpose. A separate remote line running to the Hotel Baker, makes it possible to amplify the organ in the Hotel as well as any other program originating there.

The Operadio Manufacturing Company who designed the equipment, sought to supply complete flexibility so that every type of program which might be of interest to the city, could be provided.



Fig. 1. The Western Washington Fair, at Puyallup, Washington, is a very popular affair in which a series of amplifying systems play an important part. They are as essential a part of the proceedings as the live stock and prize farm products.

### Window Display Sound

One of the most profitable types of sound installation is that made in connection with an action window display. Department Stores are particularly anxious for new ideas along these lines and are usually willing to pay a sizable bonus for each idea.

An outstanding example of a highly effective action display was that employed by Lord & Taylor, a department store located in New York City, in their last year's Christmas window. A group of bells in the window (see Fig. 5), with chimes records reproduced through a Bogen Model DX30 sound system and trumpet speakers above the sidewalk, so aptly interpreted the spirit of Christmas cheer that even the buses, passing along fifth Avenue, slowed down to afford passengers a moments enjoyment.

An action display used to call attention to the "sleep shop" operated by another well known New York City department store, is another example where sound plays an important part.

The window was made up to parody the popular moving picture production "That Uncertain Feeling" which featured Melvyn Douglas and Merle Oberon. Displayed throughout the window were various gadgets that could be used to dispell "That Uncertain Feeling" and help produce sleep. As the center of attraction a pair of twin beds were made up with a cardboard cutout of Miss Oberon in one bed and a cut-out of Mr. Douglas in the second. Mr. Douglas was sleeping and snoring vociferously, with the benefit of full sound effects, while poor Miss Oberon sat on the edge of her bed and held her ears.

The sound effects were reproduced in the front of the store window, for the benefit of the passers-by, by means of a phonograph record, an automatic record

player and a low-power sound system. Hardly a person went past that window without stopping, whenever the record was grinding out its snores.

### IGNITION NOISE

**I**F EXCESSIVE motor noise is encountered in the cars listed below, the procedures given, in addition to the regular steps taken for suppression of motor noise, may prove helpful.

#### Pontiac—1940

These cars have an under seat heater hose which must be shielded to reduce radiated interference. This heater hose must be wrapped with braided shielding starting at the motor block, continuing through the motor compartment and for about one foot under the car body. Ground this shielding at both ends.

#### Ford

In some models the battery wire to the heater and the low-tension wire to the distributor are run through the same conduit that carries the spark-plug wires. Remove the heater and low-tension distributor wires from this conduit and run them over separately to the heater and distributor, adequately spaced from the conduit which carries the spark-plug wires.

#### Studebaker—1941

Ground the radiator core and place the heater hose as close as possible to the car frame. An excellently illustrated article containing complete information on this subject will be found in the November, 1940, issue of SERVICE. SERVICE DEPT., WELLS-GARDNER & CO.

# COMMUNICATIONS RECEIVER

(RME 99)

THE RME 99 is a twelve-tube receiver, having three stages of i-f and one stage of r-f, designed primarily for communication work. By incorporating a new type of crystal filter it was possible to design the i-f channel of this receiver to have a fairly wide acceptance band without the crystal in the circuit. With the crystal in on the first position the selectivity is comparable to other communication receivers. When the crystal switch is turned to the sharper positions the full advantage of the crystal may be



The Radio Manufacturing Engineers Model RME99 communications receiver.

realized for noiseless code reception.

## Features

The RME99 incorporates a noise limiter circuit which is fully automatic but also is adjustable for different modulation percentages. This silencer is effective on staccato interference such as automotive ignition noise, etc.

A beat oscillator is provided for the reception of continuous-wave signals. The beat frequency is adjustable from the front panel. Loktal type tubes are

(Continued on page 26)

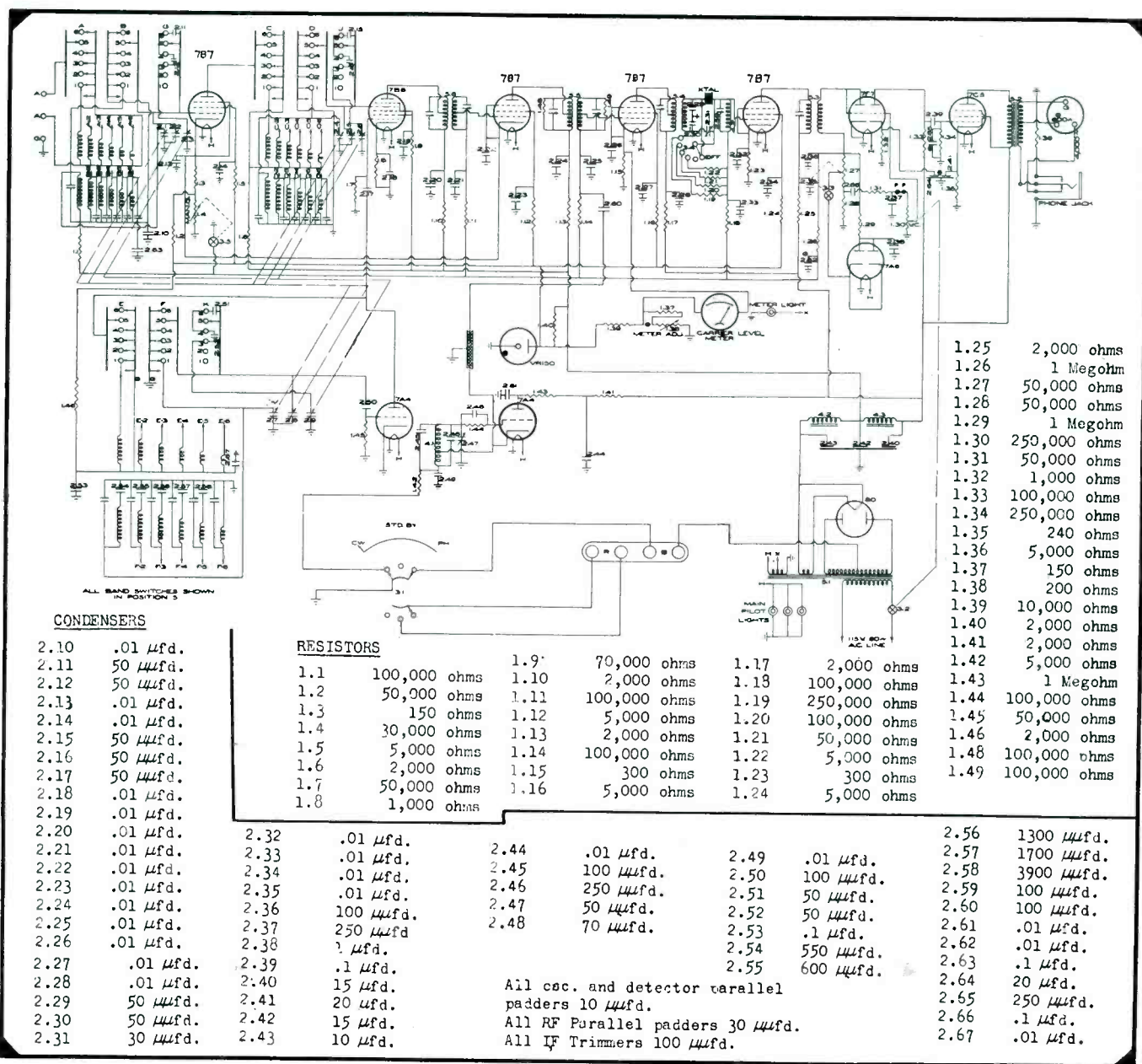

# WHERE YOU FIND NATIONAL UNION

# YOU FIND *Better* RADIO SERVICE



Used N. U. equipment plan when I first started in business 9 years ago and if it hadn't been for N. U. I would never have gotten the equipment up to date.



Bay Shore Radio & Appliance Bay Shore, N. Y.  
(William Exeter, Jr., Prop.)

The Success of Better Equipped Radio Shops speaks for itself. Here is a profitable radio service business built up in the shadow of one of the nation's most competitive markets, Metropolitan New York.

**NATIONAL UNION** invites all radio service dealers to enjoy the benefits of the **N. U. SHOP EQUIPMENT PLAN**. The latest in tube testers and test equipment are available to you, immediate delivery. More than 50,000 completed deals prove the success of this plan. Investigate Now.

## ADDITIONAL PRODUCTS . . .

PANEL LAMPS  
EXCITER LAMPS  
PHOTO ELECTRIC CELLS  
DRY BATTERIES

CATHODE RAY TUBES  
SOUND EQUIPMENT  
SOUND ACCESSORIES  
FLASH LIGHT BULBS

**Ask Your N. U. Distributor or Write**

# NATIONAL UNION RADIO Corp.

57 STATE STREET  
NEWARK, N. J.



### Radio Tubes

. . . More Radio Service Dealers use National Union than any other make . . . there must be a good reason why.



### Condensers

Complete line . . . Same Super Quality as found in N. U. Tubes. Just try them.



### Sound Extra Tubes

. . . a line of heavy duty radio tubes for sound work . . . an exclusive N. U. development.



### Batteries

. . . The only line of Dry Batteries sold exclusively to the radio Trade . . . You can make more money.

# NATIONAL DEFENSE AND RADIO

By LEWIS WINNER

MARKET RESEARCH ENGINEER

**P**RACTICALLY all of the major receiver problems prompted by national defense have been solved with commendable effectiveness in the Fall receivers. However, a shortage of even the substituted-substitutes may produce some new problems in the production of receivers next Spring and again alter the format of design. These hardships may be halted by the increased production of substitute materials. Then again, increased production may be difficult to achieve promptly, in view of the huge waves of purchasing that must take place in so complex a market. Whatever the conditions may be, however, production will proceed in some form or other. Parts and receivers will be produced in curtailed form, but not too curtailed to deny public and Service Man their requirements.

Although such metals as aluminum, nickel and zinc find themselves heading the "must" list on defense requirements, sufficient allotments will be made to help along with receiver and parts production. However, it will be the new material standards that have been adopted, such as steel, iron, plywood, lead, plastics,\* paper, etc., that will constitute the essentials on which future production will be planned. Perhaps even these materials may not find themselves in exactly the same physical and electrical state, as at present, but it will be these, nevertheless, that will form the bases of substitute development.

This state of metals can be best appreciated from the ratio of recent estimates of civilian needs to available supplies. For instance, it has been found that the ratio of aluminum needs to supplies is 15 to 1. This wide ratio indicates, of course, that there is the serious shortage, of which we well know. However, with steel, the ratio is only 10 to 9. This close ratio shows the tendency to a less severe shortage. Other interesting estimated ratios are: copper, 5 to 2; nickel, 2 to 1; zinc, 3 to 2; rubber, 10 to 7; mica, 3 to 1; tin, 3 to 2; mercury, 3 to 2; tungsten, 2 to 1; plastics, 2 to 1; alloy steels, 2 to 1; manganese, 3 to 2; lead, 1 to 1 minus. These ratios are,

\*"Plastics in Radio and National Defense," Lewis Winner, p. 16, Aug., 1941, *Communications*.

of course, after defense requirements have been deducted.

Now, it is true that the above materials are on the priorities listing, but, as we can see, it does not mean in many instances that a definite shortage exists or impends. The issuance of that listing is a precautionary measure which makes it possible for the Army and Navy to assign preference rating certificates which will assure prompt delivery for military purposes. In a number of lines, the Army purchases are well ahead of schedule. Should deliveries be slow or an emergency situation arise, it would be possible for the defense officials to demand and get prompt delivery. And speaking of preference ratings, the Service Man is in a position to secure a more constant flow of parts than even the manufacturer. This is due to the advanced preference rating (B2) that was originally

assigned to orders for the manufacture of parts for the repair or replacement of existing apparatus, equipment and devices. These must continue to operate in order to preserve essential production and services. The receiver manufacturer, thus far, has had to be contented with the feeble B7 rating. To adjust this rating, however, special rulings have been put into effect. Thus some materials, such as aluminum, have already been allowed to feed on to the production line of manufactured receivers, in limited quantities, of course.

The Service Man, thus, is in an excellent position to maintain consistent service facilities, essential to civilian as well as defense needs.

In the listing of essentials that are and will be used in production, mention is made of plastics.\* The exact type of plastics that will eventually be accepted as the standard will be predicated on many factors. For instance, formaldehyde, used in alliance with urea and phenol compounds to produce two of the very popular and efficient types of plastics, is now on the shortage list. This is so because formaldehyde is derived from methanol, which is made

(Continued on page 24)

The appearance of receivers next Spring will not differ much from the portable above, but its attractive fabric case may be supplanted by pressed paper board with a lithographed covering that has been lacquered. The receiver may be a bit larger and heavier, too, for it may have to have storage cells, instead of zinc dry cells.

Photo courtesy Westinghouse



FOR BETTER  
DELIVERIES

•  
ANOTHER



PLANT

Added facilities in another UTC plant now bring the size of UTC to thirty times that in 1933. This new plant assures a continuance of UTC's fine delivery record.

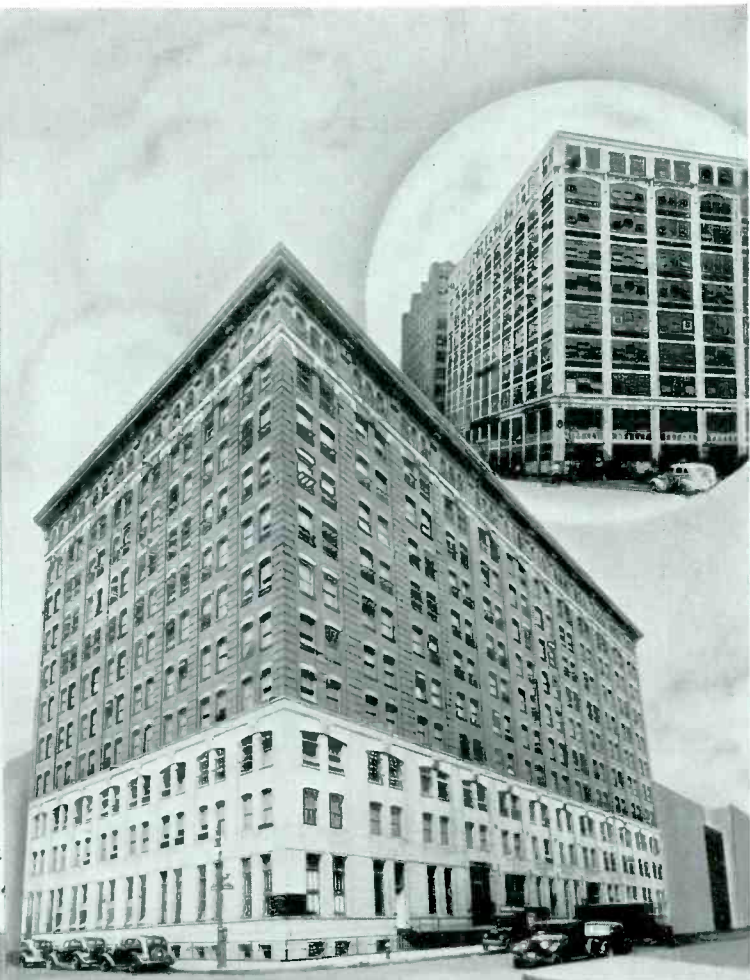

For Better Products ... Continuous Research

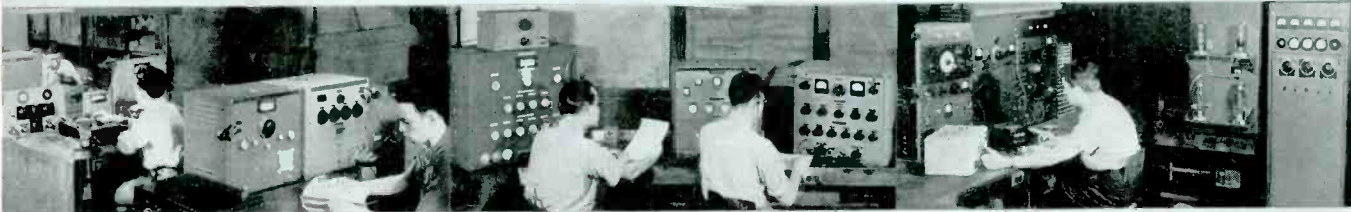

As an organization founded on research and design ingenuity, the UTC research laboratories are unusually fine. A continuous research and development program is maintained to improve the quality and dependability of UTC products. In addition, customers' problems and their solutions are handled by a competent staff of application engineers.

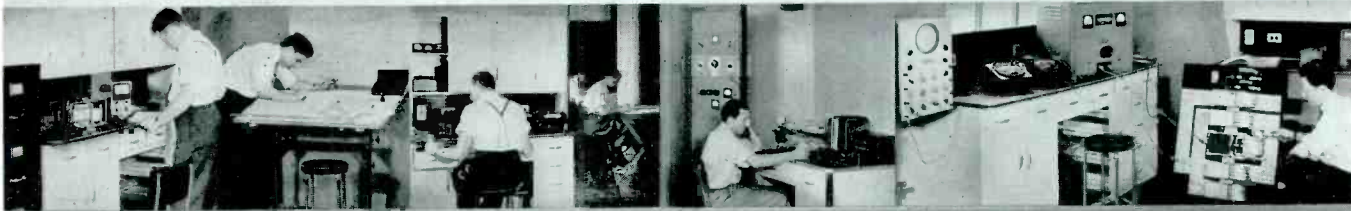

**UNITED TRANSFORMER CORP.**

150 VARICK STREET ★ NEW YORK, N. Y.

EXPORT DIVISION: 100 VARICK STREET NEW YORK, N. Y. CABLES: "ARLAB"



David Sarnoff, President of the Radio Corporation of America, and New York City's Mayor F. H. LaGuardia watch the operation of the Alert Receiver at LaGuardia Airport, New York, during a recent test.



The Alert Receiver was developed by Arthur F. Van Dyck, Harmon B. Deal and Stuart W. Seeley, engineers of the RCA License Laboratories, who are shown watching the operation of the transmitter during the test.

# A L E R T R E C E I V E R

*See Front Cover*

WITH New York's Mayor LaGuardia and RCA's David Sarnoff participating, the Radio Corporation of America recently demonstrated a new RCA Alert Receiver<sup>1</sup> that turns on automatically when it receives a special inaudible signal from a broadcasting station, rings a bell to summon listeners and then shuts itself off when an all-clear signal is flashed. The Alert receiver is a simple instrument, about the size of a portable radio set. Engineers believe the day will come when radio sets throughout the country will be provided with this attachment to summon listeners when an important message is about to be broadcast. Present receivers are not designed to hear the special signal and it will in no way interfere with programs on the air over the same station at the same time.

Since existing license arrangements with RCA cover the Alert receiver, widespread application of the instrument is possible in the interest of civilian defense. To assist manufacturers, RCA is making complete specifications available to their licensees and to broadcasting stations.

The Alert Receiver was developed by Arthur F. Van Dyck, Stuart W. Seeley and Harmon B. Deal, engineers of RCA Laboratories. They describe it as a small, three-tube set requiring negligible power for operation and, there-

<sup>1</sup>The possibility of a receiver of this type was discussed in an article "Looking Ahead," by Arthur Van Dyck, in the April 1939 issue of SERVICE, 159-162, 188-189.

fore, it can be connected twenty-four hours a day over a long period of time at low cost. It can be fixed-tuned to any one broadcasting station. It is then receptive to the inaudible signal from that transmitter. The RCA Alert has a loudspeaker of its own, which normally is silent until the special impulse is received. When the signal arrives (see front cover), it energizes an electric relay which clicks the loudspeaker into the circuit to reproduce the program from the broadcasting station. Simultaneously, the bell rings. If the Alert signal is flashed in the night, the bell, acting as an alarm clock, will awaken the listener. If desired, the bell may be located at a remote point so that the listener, although in another part of the house, will not miss the call. Several bells could be used toward the same end.

Engineers consider that production can be accomplished at a cost about equivalent to that of the average low-priced table model radio set. Furthermore, the Alert receiver can be designed to operate on alternating or direct current, or batteries. Therefore, it may be portable and independent of power line failure, which, of course, would be an important factor in time of emergency.

The apparatus at the transmitting station consists of a vacuum tube oscillator which generates the two subaudible frequencies—one to turn on the Alert receiver, while the other will turn it off. These frequencies may be 24 and

30 cycles a second, as employed in the demonstration. The signal generating unit is connected to the broadcast transmitter like a microphone. In fact, the control room operator plugs the oscillator device and electric button into the microphone circuit. When the button is pressed it releases the "On" subaudible signal, which turns on all receivers equipped to be actuated by it.

Application of the Alert to Civilian Defense communication obviously is valuable, since it provides a local, regional or nation-wide instantaneous radio call system without expensive new equipment. The engineers stress the fact that its use is automatically as flexible as the highly developed transcontinental broadcast network systems, which permit the hook-up of two stations or hundreds by means of intricate switching arrangements already in service. Moreover, the Alert does not require even one additional frequency allocation for its full use. The instrument is so designed that it can be installed at a broadcasting station without disturbing a single wire used for normal broadcasting service. Numerous possibilities are foreseen for these Alert receivers in peace time as well as emergency.

Outlining the utility of the new device, it is pointed out that there has been set up by the Federal Government a Civilian Defense organization with Mayor LaGuardia as executive head.

*(Continued on page 31)*

# ASSOCIATIONS

## RADIO TECHNICIANS GUILD

### Boston, Mass., RTG

June, the thirtieth, will probably be a memorable date for our departing president, Emil J. Maginot, for it was that day that the Radio Technicians Guild of Boston held its testimonial dinner in his honor at the Hotel Manger, Boston. Many of his associates and friends were there to wish him Godspeed in his new venture as Technical Sales Engineer of the National Union Radio Corp. of Newark, N. J. Mrs. Maginot was given a beautiful bouquet of flowers in appreciation for doing without her illustrious husband on Guild meeting nights. We learned later that the gift was doubly appropriate



Emil J. Maginot, formerly president of Boston's Radio Technicians Guild, has been appointed Sales Engineer for National Union Radio Corp.

because it also happened to be her birthday. Joe De Mambro of De Mambro Radio of Boston was there with his Mrs. to do Mr. Maginot honor, even though the day happened to be his wedding anniversary also. The climax of the evening came after many expressions of good wishes from representatives of the Lawrence, Marlboro and Boston chapters as well as many friends, when Mr. Saunders, our beloved papa of the R. T. G., made the presentation of his (Mr. Maginot's) gavel and block, which had been his symbol of authority for the past two years, fashioned together to form the base plate for a fountain-pen and holder. The block also had a bronze plaque on it upon which these words were engraved: "Life Member Radio Technicians Guild, Boston Chapter—Emil J. Maginot, 1941."

Elwyn N. Glynn, Press Secretary.

### Lawrence, Mass., RTG

More than 150 members, and their families and friends were in attendance June 29 at the Fourth Annual Outing of the Lawrence Chapter, RTG, held at Angle Pond Sandown, N. H. Large delegations were also present from other New England chapters, and an interesting program was conducted during the day. Competitive swimming contests were held and other games enjoyed. John Sestini, president; Howard C. Parker, committee chairman, and Robert C. Bingham, James A. Mulligan, Ronald Bernard, Herbert Stadler, Abraham Hyder, Almeric Dussault, and Herbert Grosser were in charge of affairs.

James A. Mulligan, Secretary.

### New Bedford, RTG

The June meeting of the Whaling City Chapter, New Bedford, Mass., was an informal affair held at the home of J. A. Sumner. The meeting featured a general discussion of frequency modulation. Mr. Brooks, of the Yankee Network, who was in New Bedford making a survey of

fm conditions, was among the guests. He gave us considerable information concerning high frequency antenna design.

Jas. L. Shepley, Secretary

## RSA

### Allentown, Pa.

At the July meeting the September parts and equipment show was discussed. The article in *Reader's Digest* was reported and communication with a member of their staff established. A Radio Quiz of fifty questions, in which all present participated, found Rees as the winner with Buss runner up.

The Third Annual Clambake will be held on August 18 at Feilbach's Grove, Bethlehem, from 6:00 to ??? (or until Carl can't stand up, and if you know Carl that's a long time!)

Ray E. P. Abbott, Secretary.

### Boston, Mass.

Although we have been "enjoying" very hot weather here, Boston RSA is carrying its usual schedule and finds that members turn out rather well. The present schedule provides a series of lectures on radio fundamentals, with practical applications of the material to radio servicing. Speakers are selected from the membership, which promotes a very friendly atmosphere.

Raymond C. Wyman, Chairman.

### Chicago, Ill.

Since the beginning of 1941, our executive board has devoted most of its time and efforts to finding ways and means of building up attendance at chapter meetings. In order to stimulate interest we arranged meetings at various radio manufacturers. The results: new members, better meeting attendance and the name RSA further enhanced to the manufacturers.

For the summer months, we planned a series of "Jobber House Parties" so our members may get better acquainted with their parts distributors. The first one was held July 9 at the Radolek Co. Mr. Braun of Radolek told us about the parts situation under the present priority ratings.

The social highlight of July was our annual picnic on Sunday, July 13. Almost two hundred attended and all had a swell time.

Hellmuth Junkel, Publicity.

### Danville, Ill.

July 9 brought the annual election of officers to Danville Chapter. The new officers are: president, F. S. "Mike" Mosier; vice president, Ben Williamson; secretary, Evard Welch; treasurer, Earl Drollinger; membership, Harry Longer; examiner, G. R. "Doc" McKinney; advertising, Lyl Cummings; program, Owen McArdle; and editor the *Serviceman's Dirt*, Cal Stapp. The retiring officers entertained at an after dark picnic on July 23. The affair took place at Doc McKinney's "Ranch," and everything went fine until it started raining. It really opened up and let us have it. Some of the fellows sought shelter under the beer truck and the rest drove to the RSA Hall to wind up the evening. The few that stayed under the beer truck really got soaked after the rain was all over!

The Sea Scout school conducted by Danville RSA has been dismissed for a summer vacation.

From the "Serviceman's Dirt."

### Detroit, Mich.

Business conditions have become so good for Service Men in this area that we cannot find enough men to turn out the work received. We are considering writing our Congressmen to pass a bill for more than twenty-four hours a day, because with the oil shortage we may not be able to get enough midnight oil.

A swell turnout was given to a recent meeting with Sylvania speakers. Another very good meeting on Motorola was highly appreciated by the boys who work on radios in the iron holes.

Art Cole took the fatal step July 5 and just returned to the test prods after a two-week honeymoon. Congratulations Art and the Missus.

### La Porte, Indiana

All RSA extends a welcome to the newest chapter, the LaPorte Radio Servicemen's Association, LaPorte, Ind.

Ray B. Mould, 319 E. Maple St., LaPorte, is president of the chapter, and Stanley A. Kubit, 119 Laurel St., LaPorte, is secretary-treasurer. Eleven members form the nucleus; an excellent job, considering the size of the city of La Porte.

### New York

Speaking at the July 14 meeting of the Metropolitan New York Chapter of RSA, at the Hotel Capital, Clifford E. Denton, chairman of the Radio Educational Commission of the Advisory Board on Vocational Education, stressed the need for training of Service Men in preparation for an emergency. "There is a grave shortage of trained men and this shortage may become acute in the near future," he said.

Max Spitalny, Editor.

### Pittsburgh, Pa.

Ken Vaughan of Johnstown, the newly elected National President of RSA, visited our meeting of July 10 and told of the Chicago Board meeting and a few of the RSA plans for the future.

R. G. Devaney read a communication from Major Armstrong in regard to FM receivers. Pittsburgh RSA and W47P are planning to conduct an educational campaign in cooperation with WWSW in which FM will be explained to the public and they will be urged to buy FM from stores that are equipped to properly install and service them.

Our Annual Picnic and Field Day was held at Idlewild Park at Ligonier on July 27. A very large turnout enjoyed the games and sports program, with fine prizes donated by the jobbers. Corn on the cob, coffee, and ice cream were served. It was one of the biggest affairs.

Richard G. Devaney, Publicity.

### Tri-County, Pa.

At the regular meeting of our chapter held in Johnstown, Pa., July 22, new officers were installed. These are: Robert Pickerell, president; Sam Miros, vice president; Christ Ashcraft, treasurer; and Blair Ressler, secretary. Directors are James Gerber, John Krissinger, Steve Varmeecky, and Stephen Nagy.

It was also decided that we would collect aluminum and save old radio tubes as our part in the National Defense Program.

Blair Ressler, Secretary.

## SALES MANAGERS CLUB

The Sales Managers Club, Western Group, has appointed a Priorities Committee to make an effort on behalf of the manufacturers of radio parts to secure a better rating for (a) the parts industry in general, (b) parts to be used to maintain existing receivers, and (c) parts which find their way, either directly or indirectly, into Defense Supplies. Eventually it will be necessary for everyone in the industry to keep accurate records relating to the sale of their merchandise.

In order to facilitate its work the Sales Managers Club urges all purchasers of radio parts and accessories to adopt the following procedure:

(1) Find out from your customer what use will be made of the merchandise;

(2) If it is sold to a government agency or is destined to find its way into Defense Supplies then get the contract number or a preference rating, or if there is no number or rating, then get the customer's affidavit that the merchandise is being used for Defense Supplies;

(3) When you place an order with a manufacturer for component parts to replace merchandise sold "off your shelves" or being used by you in the completion of a defense contract, be sure to attach to the order the contract number, the preference rating or the customer's affidavit.

This may enable parts manufacturers to keep you stocked with new merchandise. This practice should permit manufacturers to get larger quantities of scarce materials to fabricate parts which will replace those you are selling and will sell.

## OTHER GROUPS

### Long Beach, Cal.

We have had several important instructive lectures recently. Irwin Steimberger of RCA gave us complete information on record changers and how to repair them. Charles Hansen of the Jensen Speaker Co. covered speakers and speaker equipment very thoroughly. Paul O'Connor of the Miller Coil Co. gave us direct information on the manner in which they are going to construct coils in accordance with the new priorities control of metals for defense uses. Mr. Miller is permitting us to visit the plant and see the coils being manufactured.

Mr. Kenna of the Hadley Bookkeeping Co., spoke at the last meeting giving viewpoints and suggestions on accurate and inexpensive methods of keeping books, both with sales tax and Federal tax breakdowns.

Since the club has incurred more expenditures than its income, we held an auction of parts and accessories, for which we had very little use, at the last meeting. Proceeds were turned over to the treasurer to pay accrued debts.

Incorporating the RTA under the State Laws of California as a non-profit association became final early in July. Provision was also made that other groups may subchapter under the RTA of Long Beach.

The association's officers are to be retained for the remainder of the year. They are: Harry E. Ward, Jr., president; Walt Rundquist, vice president and treasurer; and Bob Hayden, secretary.

Harry E. Ward, Jr., President.

### Oakland, Cal.

Three feature pictures were shown at the meeting of the Radio Service Association of California, Inc., held at 1512 Franklin St., Oakland, Aug. 11. Two were supplied by Frank Clark; one on gas refrigeration and the other on salesmanship. The third picture was a color film taken by Bill Thomas.

A preview on the technical features of 1942 receiver models occupied the rest of the evening. Free refreshment tickets were distributed to all members attending for use at the picnic to be held Aug. 24 at Russellman Park.

## PRMSA

For the past six or seven weeks we have been announcing the names of two or three members of the Philadelphia Radio Service Men's Association, who live outside of Philadelphia, at the end of our program "Peaceful Valley." This program is broadcast every Saturday night at 8:15 P.M. over radio station WFIL, Philadelphia, on 5600 kc.

Have you heard your name yet? Tell your friends to listen in.

#### CLINTON 247

*Inoperative:* Absence of plate voltage on the 6A7 mixer disclosed an open primary in the first i-f transformer. Replacement was necessary. *Willard Moody.*

#### CLINTON 610SP

*No sensitivity, distortion:* A high-resistance open in the plate and screen resistors to the 6C6 second detector can cause these defects. A 6C6 instead of the 6D6 mixer often proves helpful in increasing the sensitivity. *Willard Moody.*

#### CHRYSLER-PHILCO C1808

*Replacing push-button switch and coil assembly:* When replacing the push-button switch and coil assembly in the early Model C1808 Chrysler-Philco auto radio with a new switch assembly, the leads are connected somewhat differently. The new connections are as follows:

- 1) Connect the brown and white lead through a 20-mmfid condenser to the chassis subbase.
- 2) Connect the red and white lead between the condenser 2 and resistor 3.
- 3) Connect the white lead to the white lead coming out of the oscillator coil of the inductive tuning unit.
- 4) Connect the short green and white lead to the control grid of the type 7A7 r-f tube.
- 5) Connect the long green and white lead at the back of the switch to the end terminal on the panel which has the green and white oscillator tracking coil lead.
- 6) The brown lead should be connected to the ground terminal on the subbase.
- 7) The blue and white lead is not used.

*Replacing inductive tuning:* Early production inductive tuning units had six leads. However, the replacement new unit will have four leads. The connections are as follows:

- 1) Connect the white lead to the white lead on the push-button switch.
- 2) Connect the green and white lead to the lug on the terminal panel on the switch, which already has a green and white wire.
- 3) Connect the orange and white lead to the lug on the terminal panel on the switch, which already has an orange and white wire.
- 4) Connect the red and white lead to the ungrounded side of the wave-trap padder or mica condenser on the terminal panel.
- 5) Connect the red lead to the cathode of the type 7A7 r-f tube.

#### FADA 131

*Distortion when antenna lead is connected to the set:* This was traced to an open condenser in the avc-grid return circuit of the 6A7 mixer tube. *Willard Moody.*

#### DE WALD 44

*Noise; cuts off suddenly:* Look for a short where the line cord enters the chassis. Use a rubber grommet. *Willard Moody.*

#### EMERSON CX2°2

*Removing chassis:* This is a compact phono-combination portable. After working on several of these models I devised a method of removing the chassis without taking the speaker or the phono mechanism out of the cabinet, thus saving much time and

labor which results in a quicker estimate:

- 1) Remove batteries from cabinet
- 2) Unsolder brown lead from loop which is mounted on the right side of cabinet (looking from back).
- 3) Remove all tubes from chassis.
- 4) Move chassis toward speaker which is fastened to the rear right side of cabinet.
- 5) Tilt chassis, with dial toward bottom of cabinet and set will fit out easily giving you ample room to work on bottom of chassis.

*William C. Santora.*

#### EMERSON BA199

*Mushy reception:* Check 25L6G output tube. *Willard Moody.*

## Case

## Histories . . .

#### GENERAL ELECTRIC GD62

*Push-button tuning inoperative:* This can be caused by snapped leads at the switch contacts or by defective switches. Occasionally it is caused by a stripped screw in the trimmer. *Willard Moody.*

#### PHILCO FT9 AUTO RADIO

*Inoperative:* Replaced shorted mica condenser mounted on the r-f choke coming from the rectifier. *Willard Moody.*

#### RCA 96T

*Push-button tuning mechanically obstructed:* In order to make these buttons operate satisfactorily it was necessary to ream the holes in the cabinet through which the button rods travelled. *Willard Moody.*

#### RCA 98X

*Tone control inoperative:* A small spot of solder found between this control and the tandem volume-tone control may cause this trouble. If the spot of solder is removed, the tone control graduates the tone from brilliant to mellow, the volume control, however, may not reduce the volume level on strong stations. In such cases connect a small condenser in series with the antenna post. *Willard Moody.*

#### RCA 98YG

*Noisy operation:* This can be caused by loose self-tapping screws on the metal bracket that holds the 6U5 tuning indicator tube to the chassis. The noise is occasioned because the bracket makes intermittent contact with the chassis. Similar trouble may be evident in cases where the nuts on the band switch or volume control are loose. *Willard Moody.*

#### RCA HF6

*Push-button tuning inoperative:* A defective contact in the fidelity control switch opened the motor circuit. *Willard Moody.*

#### WELLS GARDNER 6A43-1 O4WG-614, 619, 621, 621NI

*Production changes, etc.:* In the schematic

diagram, Manuals 302 and 306, the connection from No. 2 terminal of band switch section No. 1 should be shown connected to the ungrounded or inner terminal of the phono socket. On later models, two resistors were added to the phono circuit. One, a 1.5-megohm resistor, was connected in series with No. 2 terminal on the band switch (section No. 1) and the ungrounded terminal of the phono socket. The other resistor, 0.5 megohm, was connected between the ungrounded terminal of the phono socket and ground. The speaker field resistance, which was omitted from the schematic diagram should be 1,480 ohms. *Wells-Gardner & Co.*

#### WELLS GARDNER 6C17, 6C18

*Production changes:* To secure improved performance, the following changes are made in issue B chassis: The oscillator grid resistor is increased from 20,000 ohms to 40,000 ohms. The r-f plate resistor is decreased from 20,000 ohms to 15,000 ohms. The r-f screen is disconnected from the modulator screen and connected to the r-f plate. In the Series 6C18 only, the modulator screen resistor is increased from 10,000 ohms to 12,000 ohms. To permit easier installation, the issue B chassis use a socket and plug arrangement for the speaker connection. Issue A chassis used pin tips and clips to connect cable to the speaker. *Wells-Gardner & Co.*

#### WELLS GARDNER 9A46

*Production changes:* Issue C chassis have a first i-f coil with optional i-f expansion. In the sharp position, tuning is sharp and the high-frequency range is normal. In the broad position the tuning is broadened and the high-frequency range is extended, permitting high-fidelity reception. The selectivity control switch is located on the top of the chassis base at the rear right corner (from back). The high end of the tone control is connected to the ungrounded end of bass-boosting condenser C39 in the tone compensating circuit. By making this connection, the bass boost is controlled by the tone control. As the tone control knob approaches the treble position, condenser C39 is short circuited, resulting in no bass boost at this position.

On the issue D chassis, the selectivity control switch is operated by the tone control knob. On the previous C issue this control was located on the back panel of the chassis base and was a sliding type switch. Also, on the D issue chassis the phono-radio switch, which was previously operated by the tone control knob, is now a separate control connected to the chassis by a shielded cable. On the back of the chassis base is a 6-prong socket to which the cable is connected. Phonograph combination models are factory equipped with the cable and switch. Table and console models not factory equipped with a record player, have a plug inserted in the phono-switch socket. If it is desired to connect a record player to the radio, this plug should be removed and the plug on the phono cable and switch assembly inserted in its place. The cable and switch assembly can be purchased separately. The phono pickup should be connected to the small pickup socket on the chassis base. *Wells-Gardner & Co.*

#### WESTINGHOUSE 366

*Distortion:* Check the speaker voice coil form for circular symmetry. Any elliptical tendency should be corrected or a new cone installed. *Willard Moody.*



# Sound News . . .

*Additional information and prices of the equipment described below may be obtained, without obligation, from the respective manufacturers.*

## PHONO AMPLIFIER

Webster-Rauland's new phono amplifier features automatic volume expander up to

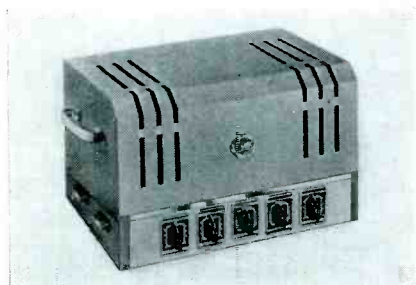

10 db; dual fader-phono unit (permitting mixing and fading of two phonos); two separate tone controls, each increases or decreases treble and bass, respectively and master volume control with ac switch.

## RECORDING DISCS

Allied Radio Corp., 833 West Jackson Blvd., have added a non-inflammable, Underwriters' Laboratories approved, double faced, 6½-in. paper-base recording disc to their line. The discs are packaged in strong manila envelopes in gray and maroon.

## OUTDOOR AMPLIFIER

John Meck Industries, 1313 West Randolph St., Chicago, announce their Model B70C 70-watt stadium amplifier for use in installations requiring high power. The amplifier features four independently con-



trolled microphone input channels; one phono input; two separate power transformers, with individual rectifiers and multiple output impedances. Monitor speaker and control is optional.

## REUSING ALUMINUM DISCS

In connection with reusing aluminum recording discs, Presto Recording Corp., 242 West 55th St., New York City, point out that an announcement issued recently by the Office of Civilian Defense states specifically that only aluminum "no longer of use to the consumer" should be asked for in the aluminum collection campaign.

Broadcast stations and studios have a definite and legitimate use for their used aluminum recording blanks; they provide an important part of the station's programs.

Aluminum base discs are still the most practical for mailing over long distances.

Instead of attempting to obtain more new aluminum under the terms of their priority rating, Presto is recoating discs in some cases 20 or 30 times thus making more efficient use of the supply of aluminum now owned by the recording industry. In so doing, they actually release more aluminum to the defense industries than would be made available if the used discs were turned in as scrap.

## MOBILE PICKUP

The Astatic Model AB8M mobile pickup, designed especially for use on mobile equipment, is said to be mechanically counterbalanced so as to track on recordings even in a vertical position without jumping the groove. The hinged head may be tilted



upward for changing of needles. Astatic Corp., Youngstown, Ohio.

## CRYSTAL PICKUP CARTRIDGES

Shure W40A and W42AN, high-voltage low-pressure crystal pickup cartridges make available 1.4 volts output at 1,000 cps (Audiotone record) with 1-ounce needle pressure; over twice the output voltage of any other lightweight pickup cartridge,



it is said. The cartridge is designed for permanent point needles. Shure Brothers, 225 W. Huron St., Chicago, U.S.A.

## CALL SYSTEM AMPLIFIER

A 10-watt amplifier, for use in call systems, small restaurants, and other places where low power is needed, has been announced by John Meck Industries, 1313 W. Randolph St., Chicago. This unit offers microphone and phonograph input channels, each with separate volume control. Dual action tone control affords adjustment for various applications. Four and eight-ohm outputs provided for use with single or

dual speaker systems, or the unit may be arranged for use with many speakers.

## P-A SYSTEMS

Erwood Sound Equipment Co., 228 W. Erie St., Chicago, have announced a series of 30-watt portable and fixed public-address systems. The amplifiers have provision for using four microphones and a new method of tone equalization which is said to give increased tone range control. Microphones are of the uni-directional type. Speakers are of the permanent-magnet type



and are available in either portable cases, or in permanent type walnut baffles.

## BULL SPEAKER

The new Bull type of radial 360° loud-speaker, Model 2RYR, is announced by University Laboratories, 195 Chrystie St., New York City. It is of the long exponential reflex driver unit design. A special multiple acoustic throat is used to adapt the high-power driver units to the reflex radial horn. These driver units are housed in a mushroom shaped, weather-proof cover. Power handling capacity is 50 watts.

## AMPLIFIER

In the accompanying illustration is shown the 48-watt amplifier of the Bell Sound Systems, Inc., 1185 Essex Ave., Columbus, Ohio. The unit incorporates inverse feed back and has individually controlled electronic base and treble boost and



three microphone channels and a phono channel with separate volume controls.

## Catalogs, etc. . . .

• • • • "Forming Aluminum" is the title of a booklet issued by the Aluminum Company of America, Pittsburgh, Pa. This 56-page booklet gives detailed information on available alloys, blanking and piercing, drawn shapes, spun shapes, shape forming, embossing, coining and stamping.

• • • • A 12-page catalog (No. R42) on antennae, antennae masts and accessories is available from Premax Products, Division Chisholm-Ryder Co., Niagara Falls, N. Y.

# Radio's MASTER ENCYCLOPEDIA

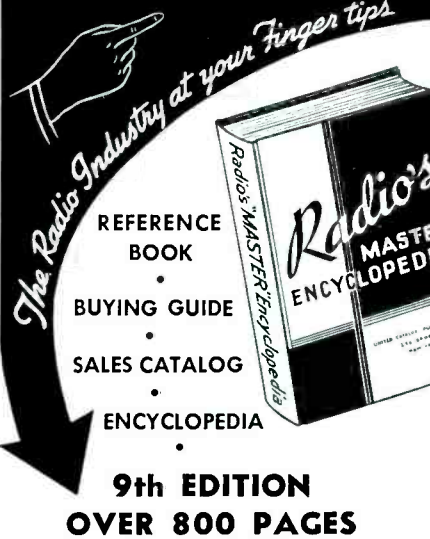

## THE ONLY OFFICIAL RADIO PARTS AND EQUIPMENT MANUAL

It took six years and thousands of dollars to develop this "MASTER CATALOG" of the radio industry to its present size—yet it costs you only \$2.50.

Compiled in co-operation with and approved by the Radio Manufacturers Group as the industry's official source book.

### GIVES THIS IMPORTANT DATA

Contained within the hard covers of this 800 page MASTER BOOK are the listings of the products of 90% of all Radio Parts and Equipment Manufacturers in the industry. In it you will find many thousands of items, such as electronic devices, transmitting and receiving sets, tubes, antennas, transformers, condensers, replacement parts, meters, laboratory test equipment, relays, plugs, coils, wire, and numerous other radio components. Thousands of clear illustrations with descriptions and specifications. —Yes, this is your "MUST HAVE BOOK".

### •• WHO USES IT? ••

As the official source book of the radio industry it is constantly used by many American and Foreign governmental agencies, also industrial organizations, engineers, purchasing agents, laboratories, radio amateurs and service men, radio distributors, broadcast stations, schools, colleges, libraries, and by many others interested in Radio and allied fields.

### SAVES TIME—SAVES MONEY

WHERE, WHAT AND HOW MUCH: Such information is instantly at your fingertips. This valuable RADIO MASTER eliminates the maintenance of bulky files. It is completely indexed for speedy reference.

If you buy, sell or specify you will find the RADIO MASTER an indispensable and handy book to have around at all times.

### MONEY BACK GUARANTEE!

Order your copy today—look it over. You will find it to be an excellent investment; if not, return it to us in five days for full refund.

The price is only \$2.50 shipped anywhere in U.S.A. — \$3.00 elsewhere. We prepay transportation charges if remittance accompanies order.

**UNITED CATALOG PUBLISHERS, Inc.**  
106A Lafayette St. New York, N. Y.

## NATIONAL DEFENSE & RADIO

(Continued from page 18)

with equipment that can be quickly converted towards the production of ammonia. And ammonia is that important element that is used in manufacturing many types of gunpowder. Cellulose nitrate plastics are also in the problem class, since cotton linters and nitric acid, required to produce this plastic, is also essential in explosives. The acrylic plastics, also popular in production work, derive their essentials from methanol, and so, too, are on the "out" list now. However, every attempt is being made to relieve these conditions, with the building of extra reducing equipment. Thus, it is hoped that soon these popular plastics will be available for radio use. Of course, it must be remembered, too, that plastics do not have the wide spread application that we all possibly had hoped for. Two unfortunate circumstances have temporarily halted rapid plastic progress. These are, shortage of molds and skilled help. While every effort is being made to speed schooling and mold production, such "speed" must be held down, because of the extremely critical requirements essential to this type of work. In addition, aside from cabinets, various forms of insulating materials, tubes for electrolytic condensers, decorative pieces and wire coverings, plastics at the present moment, do not appear to be able to take any complete hold as a suitable substitute for metal parts. With the development of the material, probably, as a base for metallic flashings, spraying and painting, plastics may be inducted as an aid to metal.

Among those plastics using ingredients that are plentiful now, and suitable for standard applications is the soybean plastic. This material consists of a cellulose fibre of 70% of the total and a 30% soybean resin binder. In the cellulose portion of this plastic will be found 50% southern slash pine, 30% straw, 10% hemp and 10% ramie. The ramie plant is of Egyptian origin, growing, however, quite extensively in America now. In place of soybeans, wheat and corn may be used, and thus we again see what tremendous resources are at our command, affording consistent production, regardless of the difficulties. According to tests made at the Ford automobile plant, where soybean plastics are used most extensively, sheets of soybean plastic will absorb a blow ten times as great as steel without denting.

Paper has become another important contributor to our vast substitute campaign. There are some difficulties at present in securing adequate production

of all the forms of paper required, but authoritative sources indicate that this is due to the sudden flurry of buying, that is now beginning to subside. Accordingly, sufficient paper will be available. The receivers now in production already boast of many parts using paper in one form or another. The electrolytic and fixed capacitors, always large users of paper, have become wholesale users now. The only metal in them is the aluminum or lead foil. Their outer wrappings are now almost exclusively paper or board, heavily dipped in wax. Shields are also being made with a paper or board base, flashed or painted with metallic scrap.

Dial faces will use paper exclusively, hereafter, treated with a form of lacquer. Pressings of board to afford a substantial base and structural quality, equivalent to metal or plastics, will be pressed into service, if necessary.

Wire insulation, a shortage of which was indicated in prior articles in this publication, has become more acute with the freezing of silk stocks. However, steps have already been taken to overcome this difficulty by using plastic coatings. The freezing order now, of course, makes it imperative that many types of plastic coverings be adopted, to accommodate the variety of circuit and component requirements. While on the subject of wire, we come across the topic of copper, which, of course, is quite an essential factor in any receiver. While copper is on the priorities listing, sufficient supplies are being made available to the industry to fill the comparatively small needs. The conductivity of copper is so high that few metals, of similar cost, are available that might be pressed into service in the event of greater shortage. However, in an emergency, available alloys will have to be used and any deficiencies accounted for in the improved design of the part or the complete equipment. This critical possibility is most remote, at the present time.

With the shortage of some materials comes the thankful thought that standardization will become a most important factor in production, particularly next Spring. Every component and accessory will be affected. It will be essential to produce receivers whose components will be similar in many characteristics, not only to speed production, but also to eliminate waste. Odd sizes and styles of equipment will disappear from the scene, to be supplanted by fewer models that will serve the same purpose.

*Save your aluminum scrap for national defense. Every little bit helps. See your local Boy Scout or American Legion Commander.*

## THE RADIO LOCATOR

ONE of the first great advances in radio to come out of the present war is the new Radiolocator which Britain has developed for the detection of enemy aircraft. This secret weapon has proved very successful in protecting the British civilian population from night bombers. Ground stations equipped with this device can detect enemy aircraft far enough away to enable the night fighter planes of the RAF to intercept them. They have been installed on night fighter planes themselves enabling pilots to shoot down night raiders on the blackest nights. So successful is this new invention that it has long been a mass production product in England and the country is completely covered with a network of stations. To help man these new weapons Britain is organizing the Civilian Technical Corps in the United States and is enlisting American radio men.

Much interest has been shown by radio men in this country concerning the device which differs radically from all types of locators used previously. Naturally, the British Government is not releasing any details of this highly secret apparatus at present. In general, however, it would appear that a highly directive ultra-short wave beam is transmitted from the locator. This beam might be directed by a parabolic reflector and aimed in any desired direction. Upon striking an enemy aircraft the beam is reflected to a receiving station. Here a receiver with a directive antenna would receive the reflected signal and indicate the direction of the plane.

Radiolocators can have many peacetime applications because the reflecting surface does not have to be another airplane, but can be any solid body. Thus, it will indicate the presence of mountains or tall buildings in the path of an airplane. The distance above the surface of the ground can also be determined, and not merely the distance above sea level as is the case with most of the altimeters previously used. They can also be used by ships to prevent collisions in fog and to end the menace of icebergs. Other uses will undoubtedly be found when the full details of this invention are known.

### The CTC

Many radio men are interested in joining the Civilian Technical Corps, but hesitate to volunteer for service in England. These men should look at the future and realize that the use of Radiolocators will just be entering on a period of great expansion when the war is over. As this secret weapon of war is harnessed to its many peacetime applications there will be an enormous demand for men trained in the installation, operation, and repair of these devices. At the present time Great Britain is the only place in the world where such training can be obtained. The technician who joins the Civilian Technical Corps will receive an intensive training in the use and maintenance of this marvelous apparatus. Although he will be given training in its operation so that he may determine when it is functioning properly, he will not usually be called upon to operate this equipment, but rather to work in co-operation with female operators who are specially trained in the operation of these machines but who do not have the technical ability necessary to maintain and repair them.

Application for membership in the CTC



**"Servicing by Signal Substitution" with the combination of Precision Series 920 and Series E-200 will solve your problems with amazing speed and simplicity.**

## ELECTRONOMETER Series 920 E-200 SIGNAL GENERATOR

**Dynamic Mutual Conductance Type  
Tube, Battery and Set Tester**

An indispensable, single compact instrument for both field and service laboratory ★ 33 AC-DC set testing functions to 3000 Volts, 10 Megohms and 12 Amperes ★ Provides the individual functions of tube tester, battery tester and multi-range meter ★ Permits simplified, rapid check of tubes, voltage, current, resistance, etc., in troublesome stages, quickly localized through "Servicing by Signal Substitution."

**Series 920P, illustrated above...\$59.95**

**Featuring a Simplified Method  
of Dynamic Receiver Analysis  
"Servicing by Signal Substitution"**

Not only an efficient laboratory Signal Generator, but ALSO specifically designed for complete, systematic dynamic signal analysis of every receiver stage from loud speaker to antenna post, regardless of age, make, type. "Servicing by Signal Substitution" provides a new high in simple, rapid localization and determination of receiver troubles with a minimum and economical selection of Basic test equipment.

**Series E-200, illustrated above...\$39.95**

Now in its THIRD printing, and FREE to all purchasers of Series E-200, an illustrated text book describing this amazingly simplified speed approach to receiver adjustment problems, "Servicing by Signal Substitution." Also available at your local distributor or direct from factory at only 35¢.

See the more than 40 Precision 1942 models at your local distributor.

**PRECISION TEST EQUIPMENT**  
*Standard of Accuracy* **SEE THEM AT YOUR JOBBER**

**PRECISION APPARATUS COMPANY • 647 KENT AVENUE • BROOKLYN, N. Y.**  
**Export Division: 458 Broadway, New York City, U.S.A. Cable Address: Morhanex**

should be addressed to the Civilian Technical Corps, care British Consulate General, 25 Broadway, New York City.

### CBS TELEVISION PATTERN

The black-and-white television test pattern of the Columbia Broadcasting System is transmitted an extra hour daily from 3:30 to 4:30 P. M. to facilitate testing of the change-overs required by existing television receivers to pick up Channel No. 2 on which WCBW, the CBS television station, is operating. The test pattern continues to be transmitted each afternoon from 2 to 2:30 and each evening from 7:30 to 8. Program transmissions continue under authorization of the Federal Communications Commission, which has granted WCBW a 30-day extension of the

original 30-day program test period.

Dr. Peter C. Goldmark, Columbia's chief television engineer, suggests:

"At the time change-overs are made, it is advisable for set-owners to have the position of their television antennas checked. Some antenna positions will have to be altered if there is to be satisfactory reception of the signals of all television broadcasters."

CBS plans to continue daily experimental color transmissions from 4:45 to 5:45 P. M.

**Auto radio and sound—Two phases of this business that should be especially profitable during the coming months. Are you getting your share?**

SERVICE, AUGUST, 1941 • 25

# WORLD'S GREATEST all around ELECTRIC TOOL

**DRILLS — GRINDS — SANDS  
SAWS — POLISHES  
SHARPENS — CARVES**



The new WHIZ ELECTRIC TOOL is the handiest power tool ever made. A rugged tool for power and precision work. Drills through  $\frac{1}{4}$  inch iron plate in 42 seconds or engraves intricate designs. Handles any material: Metals—Woods—Alloys—Plastic—Glass—Steel—etc. Saves time. Eliminates labor. Plug into any socket AC or DC, 110 volts. Chuck  $\frac{1}{4}$  inch capacity. Ball bearing thrust. Powerful, triple-gear motor. STANDARD MODEL, with Normal Speed (uses 200 different accessories, instantly interchangeable). **Price only \$7.95.**

*The only DRILL-TOOL with a full year's guarantee.*

**FREE** Accessory outfit (Value \$2) includes set of drills, mounted  $\frac{1}{2}$  inch grinder, sanding discs, cutting wheels, mounted brush, polishing wheel, carving burr, etc. FREE with each tool ordered NOW. We pay postage.

**10 Day Trial—Money Back Guarantee**

**PARAMOUNT PRODUCTS CO.**

DEPT. 8 SER

545 FIFTH AVENUE

NEW YORK, N. Y.



## A real Choice...

• Don't handicap your servicing by a limited choice of condenser types! The Aerovox line offers the greatest range of types. That makes it easier to pick out just the right condenser for any job you may have.

In electrolytics, for example. Aerovox offers you anything and everything from inexpensive midget-can types in single and dual sections, to tubular and cardboard-case types, and again to small and large metal-can types. Also wet electrolytics.

### Ask Our Jobber...

He'll gladly show you this adequate choice of condensers, and take care of your needs. Ask for latest catalog—or write us direct.



## COMMUNICATIONS RECEIVER

*(Continued from page 16)*

used in the RME99, with the advantages of their single ended construction and internal shielding.

A new feature of the RME99 is the large calibrated band-spread dial. This dial is accurately calibrated for amateur 80-, 40-, 20- and 10-meter bands. In addition, there is one arbitrary 0-180° scale which may be used for the amateur 160-meter band or for the various high-frequency broadcast bands.

Another feature provided in the RME99 is the voltage regulator tube. This tube maintains a constant voltage on critical circuits in the receiver regardless of line voltage fluctuation.

A number of other facilities are provided in this all-purpose receiver such as relay and break-in circuits.

### Antenna

The performance of any receiver is in a great measure determined by the antenna to which it is connected. It is therefore necessary to give the same intelligent consideration to the construction and installation of a receiving antenna as it is in the case of a transmitting antenna.

The input impedance across the doub-

let antenna circuit is designed to match a twisted pair feed line or a Marconi antenna. The impedance of the input circuit connected across the terminals should be more than 100 ohms. It will be found that high-impedance circuits will operate satisfactorily, but low-impedance circuits such as a concentric line will cause difficulty. Zeppelin feeders may be used if condensers are inserted in series to raise the impedance.

### Output

Two output impedances are available. One 4,000 ohm, for use with ordinary output transformers and the other 600 ohms, for use in feeding low-impedance lines.

Between the speaker socket and the antenna terminal strip there is a four-terminal strip (one pair of terminals marked "R" and one pair of terminals marked "B"). These are for communication purposes, only. When the receiver is shipped from the factory the pair marked "B" are jumpered out so that the receiver will operate without any other connection to the terminals. The jumper, of course, should be left on unless it is desired to use the break-in connection.

### Tuning Control

The main tuning control and scale is used for most of the tuning except when using the band-spread scale. The tuning knob is connected to the tuning condenser by a planetary drive and a set of preloaded gears. The scale is accurately calibrated in megacycles on all six bands and is divided into convenient divisions between the cardinal points for accurate reading.

The band selector switch (B) is used to select the range through which it is desired to tune. The total range of the receiver (550 to 33,000 kc. or 0.55 to 33 mc) is divided into six ranges, as follows: 0.550 to 1.6; 1.6 to 2.95; 2.95 to 5.45; 5.45 to 9.8; 9.8 to 18.5; 18.5 to 33.0 megacycles.

### WELL GARDNER 5B12-1

*Production changes:* On this issue radio, the loop antenna covers the entire cabinet back. The line cord which was formerly wound around a reel on the back, now is placed in the battery compartment.

In order to provide space for the line cord, the cabinet was enlarged and the batteries rearranged. To insure proper fitting of the batteries in the cabinet a block is provided on the bottom of the cabinet and a shaped cardboard filler is furnished.

To eliminate slippage of the drive cord, the strength was increased from 18 lb to 30 lb, test.

*J. K. Rose, Service Manager  
WELLS GARDNER & Co.*

**A good, well equipped service bench is vital to successful servicing. Read SERVICE each month for the latest developments.**

## RCA AUTOMATIC RECORD PLAYER

THE "Magic Brain" with the tandem tone arm, a new type of automatic record changer which plays both sides of phonograph records without removing them from the turntable or turning them over, is being introduced in the 1942 RCA Victrola phonograph radios. The instrument provides two hours of uninterrupted music at the touch of a button.

To operate a Magic Brain record player it is only necessary to stack the



This is the RCA Victrola's new automatic record changer which plays both sides of phonograph records without turning them over. It is known as the "Magic Brain" and provides two hours of uninterrupted music when the starting button is touched, as the hand is shown doing here. The Magic Brain is a combination of several developments, including the Tandem Tone Arm (shown in the foreground), the Magic Tone Cell (the pickup cartridge), the Flexible Tone Bridge and the Jewel-Lite Scanner (replacing the needle). It is only necessary to stack the records on the automatic mechanism and press the starting button. The Tandem Tone Arm, which is actually two arms and two pickups, swings over automatically and plays the top side of the bottom record of the stack (there is no record on the turntable in this photo in order to show the mechanism more clearly) which has been dropped to the small turntable. After reaching the end of the record, the Tandem Tone Arm swings clear of the record while the direction of the turntable's revolution is reversed. Then it rises far enough to make contact with the bottom side of the record. When the under side has been played, the Tandem Tone Arm swings away so that the record may be deposited into a felt-lined compartment (through the opening shown to the left), after which another record from the bottom of the stack drops into place. The cycle is repeated until all the records have been played. The Magic Brain then automatically shuts off. Records in any sequence—manual, automatic mechanism, or drop mechanism—may be played. The large lever above the hand in the picture adjusts the mechanism for playing either one or both sides of the records.

records on the automatic mechanism and press the starting button. The tandem tone arm, which is actually two arms and two pickups (one for playing the top side of a record and the other for reproducing the lower side)

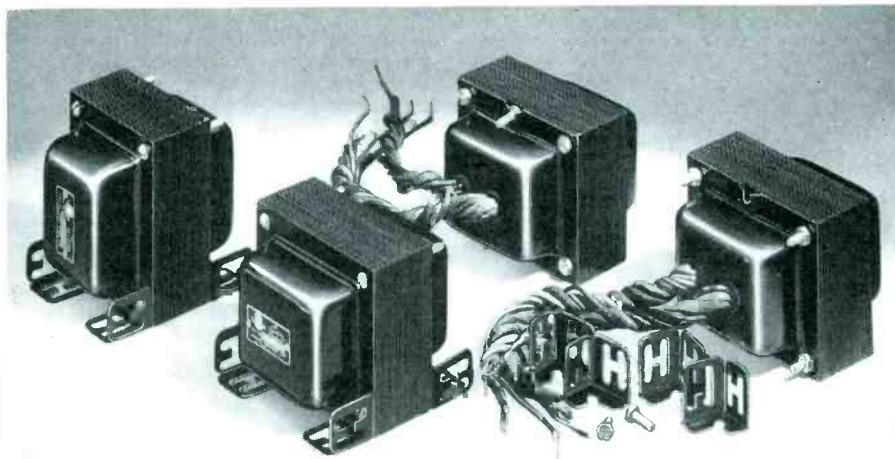

### EXCLUSIVE FEATURES!

- ★ More universal THAN ANY OTHER transformer.
- ★ Choice of FIVE mounting positions.
- ★ Smaller laminations with higher stack on many units to permit MORE half-shell applications.
- ★ Fits more than 80% of all power transformer replacements.
- ★ All units electro-statically shielded.
- ★ Heavy eight-inch flexible leads.
- ★ Four neat black enameled universal brackets and 2 bolts supplied with each unit.



### FREE!

This 56-page combination catalog and service guide. Chock full of valuable information. Get your copy today!

## EASY INSTALLATION WITH STANCOR UNIVERSAL POWER TRANSFORMERS

STANCOR universal power transformers are the most popular ever introduced to the industry. They cover the widest range in electrical and physical requirements in a minimum number of units. They provide the choice of five mounting positions, all desirable voltage combinations and many special windings not incorporated in any other group of transformers. Leading jobbers in all principal trading areas carry a complete line of Stancor transformers.

### TROPIC IMPREGNATED!!

ALL Stancor replacement transformers are tropic impregnated and at NO EXTRA COST!



shaped somewhat like a tuning fork, swings over and plays the top side of the lowest record of the stack which has been dropped to the turntable. After reaching the end of the record, the tone arm swings clear of the record while the direction of the turntable's revolution is reversed. Then it rises far enough for the lower arm to make contact with the bottom side of the record.

When the under side has been played, the tandem tone arm swings away, and the record is deposited into a felt-lined compartment, and another record from the bottom of the stack drops into place. The cycle is repeated until all the records have been played. The Magic

Brain then automatically shuts off the mechanism.

The Magic tone cell, an important part of each tone arm, is made up of the flexible tone bridge and the "Jewel-Lite" scanner. The former is a fine wire filament designed to eliminate objectionable needle chatter at the source. The scanner is a carefully ground sapphire point which replaces the usual needle. The balanced Magic tone cell exerts a minimum of pressure on the record which, combined with perfect tracking, assure indefinite life for the sapphire point and the records and avoids chatter, it is said.

## Personnel . . .

• • • • The Daven Co., Newark, N. J., announce the appointment of Norman B. Neely Enterprises, Hollywood, Cal., as West Coast Representatives.

• • • • Walter A. Knoop has joined Allen B. Du Mont Laboratories, Inc., Passaic, N. J., manufacturers of cathode-ray tubes, oscillographs, television equipment and allied products, as sales engineer. He is assisting Len Cramer who heads the instrument and television transmitter sales.

• • • • Joseph M. Muniz, general sales manager of Howard Radio Co., Chicago, announces the appointment of Raymond Jaffe as advertising manager.

• • • • G. V. Rockey, vice president of Meissner Manufacturing Co., Mt. Carmel, Ill., announces the installation of Ben Miller as sales manager of the Meissner Jobbing Division.

• • • • National Union Radio Corp., Newark, N. J., announce the appointment of William J. Brennan as sales engineer. Mr. Brennan recently was engaged in post-graduate work in Communication engineering at the Cruft Laboratory at Harvard.

• • • • Milton Reiner, president of Radio City Products Corp., New York City, announces the appointment of L. M. Bornstein, 5418 Paseo, Kansas City, Mo., to represent R.C.P. for the territory including Missouri, Kansas, Iowa and Nebraska.

• • • • Radio Wire Television, Inc. (Lafayette Radio), New York City, announces the appointment of Guy Maken as purchasing agent. Mr. Maken has served for some time as assistant purchasing agent and now steps into the post vacated by Ben Miller, who has resigned to join Meissner Mfg. Co.

• • • • Appointment of H. Geo. Shefler, 2360 E. Moreland, Phoenix, Ariz., is being announced by The Turner Co., Cedar Rapids, Iowa. Mr. Shefler will be sales representative for Turner microphones, microphone equipment and the Turner push-pull vibrator, in Arizona, New Mexico, and El Paso, Texas.

• • • • "Win" Hartford, formerly sales manager for Thordarson Electric Manufacturing Co., has been appointed sales manager for Webster-Chicago, Chicago, Ill.

## Expansion . . .

• • • • The Blair-Steinberg Sales Co., manufacturers' representatives for the Cornell-Dubilier Electric Corp., David Bogen Co., Inc., University Laboratories, Jackson Electrical Instrument Co., Vaco Products Co., and Atlas Resistor Co., announce the removal of their offices to 395 Broadway, New York City, where they will maintain Eastern Seaboard stock facilities for the benefit of their distributors.

• • • • To keep pace with growing

demands of national defense and also the many new applications for its high-frequency iron cores and custom-built ceramics in industry, Henry L. Crowley & Co., West Orange, N. J., has added a wing to its plant.

• • • • In order to keep pace with the increasing demand for Hallicrafters communications equipment by both distributors and National Defense, W. J. Halligan, president of The Hallicrafters Co., announces the opening of plant No. 2. The new plant will be used for fabricating steel chassis. This is the second expansion this year, and the third since 1940 for the Hallicrafters Co.

• • • • Howard Radio Co., Chicago, announce the opening of their new cabinet plant which will be under the supervision of Charles B. Shapiro, executive vice-president.

• • • • The Ohmite Manufacturing Co., manufacturers of rheostats, resistors, tap switches, and chokes, has recently completed an addition to their factory on W. Flournoy St., Chicago. The enlarged plant doubles the production space and greatly expands the company's facilities to take care of the increased requirements for Ohmite Products in Industry and National Defense.

• • • • Sun Radio Co., 212 Fulton St., New York City, announce the expansion of their public address department with the leasing of the entire second floor at 210 Fulton St., adjacent to their building.

• • • • Webster-Rauland, manufacturers of sound equipment, will move during the first week of September, to their new one-story plant at 4245 Knox Ave., Chicago.



### 30-WATT PORTABLE AND FIXED—THE RIGHT SYSTEM FOR AUDITORIUMS — THEATRES

needing as many as four inputs with proper mixing

- Product of long experience and laboratory facilities.
- For crowds up to 5,000 persons.
- Flexibility to meet varying conditions.
- Conservatively rated; distortion less than 5%.
- Inputs — 4 microphone or 3 mike and phono.
- Complete record playing attachment.
- Smart two-tone finish; chrome panel.
- Controls to match auditorium acoustics.
- Gain — 132 DB on microphone; 75 on phono input.
- Uses eleven tubes.
- Portable and fixed system available separately.
- Greatest dollar value — satisfaction assured.

SEND FOR ERWOOD'S NEW CATALOG — System 8 to 75 Watts; also Mobile, Country Club and School Systems.  
Licensed by agreement with Electrical Research Products, Inc. under Patents owned or controlled by Western Electric Co. & American Telephone & Telegraph Co.

**ERWOOD**  
SOUND EQUIPMENT CO. 222 W. ERIE ST., CHICAGO, ILL.

# ALWAYS IN LINE



**DEPENDABLE**  
**KEN-RAD** Radio Tubes

## SAVE \$1.00!!!

- The Group Subscription Plan for *Service* enables a group of service men, dealers or jobbers to subscribe at one-half the usual yearly rate.
- The regular individual rate is \$2.00 a year. In groups of 4 or more, the subscription rate is \$1.00 a year. (In foreign countries, \$2.00.)
- Each subscriber should print his name and address clearly and state his occupation—whether a dealer, jobber, independent service man, service organization, etc.

**Remember this Group Plan when Your Subscription Expires**

# SPECIAL SERVICE

# BOOK REVIEW

By **MARTIN FRANCIS**

**T**O SUPPLEMENT his regular tube testing instruments, R. L. Andrews, owner of the City Radio Service Company, 303 East Missouri Street, El Paso, Texas, has constructed a service board which has helped him a great deal in his every-day work. This board, through the use of a low price ammeter, is able to test the filament circuit of the tube very accurately. It is connected in series with the filament and shows up slight differences in the particular tube which might prevent it from giving satisfactory service, especially in series operated circuits. A white light on top of the service board flashes in connection with the test.

As another feature of this original board Andrews has hooked up a set so that tube oscillation and performance can be checked under actual set operating conditions. Whenever possible, Andrews has the customer present when such tests are made. These customers are impressed by what is being done,

and often recommended the shop to their friends.

"This board has served me well to supplement the other commercial test equipment I have," stated Andrews,

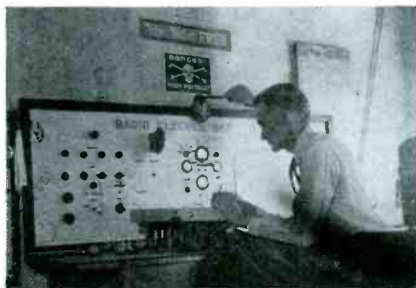

R. L. Andrews, City Radio Service Company, 303 East Missouri Street, El Paso, Texas, believes in rendering that little extra service that convinces his customers of his reliability, and has them recommending him to their friends.

"and has helped me solve many knotty problems at very low cost.

*IRC VOLUME CONTROL REPLACEMENT MANUAL, 3rd Edition, prepared by the International Resistance Co., 401 North Broad St., Philadelphia, Pa., 136 pages, 8½ by 11 in., paper covers, price, 10c.*

The third edition of the IRC Volume Control Replacement Manual has been enlarged in contents and size and includes considerable additional information over the previous editions. All the information needed to select the proper volume control for replacement from the manufacturers' original part numbers to Rider's Manual reference, price of the IRC replacement, resistance value, switch data, etc., is given for each of the many thousand receiver listings. All trade and brand names are listed alphabetically for easy reference. Auto radio sets are listed by make of automobile rather than under the name of the actual manufacturer of the receiver, thus avoiding some confusion. Chassis and model numbers of receivers are conveniently cross-indexed.

In addition to much helpful information on the installation, use and construction of controls, the Manual includes complete control and resistor catalogs as well as a handy reference section with charts and formulae.

The Manual is a necessary addition to every Service Man's library.

## ALL THE IMPORTANT SETS FROM 1930 TO 1935 in One Mammoth Rider Manual



OUT AUGUST 20TH  
2000 Pages — Only **\$12.50**

Here is aid for those servicemen who would like to have a complete set of Rider Manuals, but who cannot afford the early volumes. Although the Abridged Volume I to V does not contain all the

information in the original individual volumes I to V, it does cover the most widely distributed sets manufactured between 1930 and 1935. 2000 pages! — Only \$12.50!

Individual Volumes I to VI—covering sets issued between 1920 and 1936 —\$7.50 each.

Volumes VII to XII—covering sets issued between 1936 and 1941—\$10.00 each.

### Attention Servicemen!

Here is a plain statement of fact. Rider Manuals will prove of greater value to you in the future than ever before. If you are going to buy any Rider Manuals—*Buy Them Now.*

For ten years we have kept the price of Rider Manuals stable, but the materials which go into their make-up are more difficult and more expensive to get.

We have absorbed every price increase for the past five years. As much as we do not wish to raise prices, such increases are imminent.

Again we repeat—if you are going to buy—

**Buy Now!**

**JOHN F. RIDER Publisher, Inc., 404 Fourth Ave., New York City**

Export Division: **Rocke — International Elec. Corp., 100 Varick St., N.Y.C. • Cable: ARLAB**

*Built for*  
**PUNISHMENT**

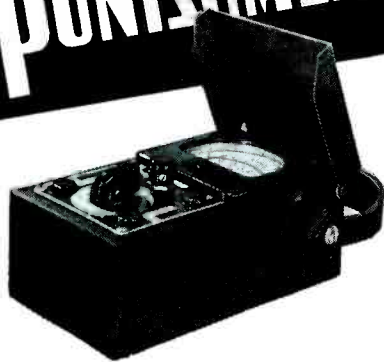

Popular Supreme Model 542 and Model 543 in a Blitzkrieg dress—used by the army—and telephone companies—where hard knocks are the rule rather than the exception. *Built for Punishment.* Heavy steel cover protects meter—snaps into place. Full protection without the inconvenience of the old style lid. Large, sturdy leather handle, but still small enough to slip in your pocket. Size 3½" x 6¼" x 2¾". Wt. 2 lbs. 2 oz. See your jobber or Write Dept. S-7 for information.

● **Notice—Model 542-543 Supreme Owners.** You can secure this new type case for your present instrument at the small cost of \$2.25.

**SUPREME**

GREENWOOD, MISSISSIPPI, U. S. A.

**WHEN YOU CHANGE YOUR ADDRESS**

Be sure to notify the Subscription Department of SERVICE at 19 E. Forty-seventh St., New York City, giving the old as well as the new address, and do this at least four weeks in advance. The Post Office Department does not forward magazines unless you pay additional postage, and we cannot duplicate copies mailed to the old address. We ask your cooperation.

**Directory of RADIO SCHOOLS**

*The National Defense effort calls for thousands of specially trained men for advanced jobs in radio engineering and communications! A vast new science of electronics is rapidly becoming part of our every day lives! The Service Man is best suited to take on remunerative jobs in these fields if he can meet the requirements. A brief course may be all that you need. Write for catalogs today!*

**American Radio Institute**

1123 Broadway  
New York City  
Correspondence courses.

**American Schools**

Drexel Avenue at 58 Street  
Chicago  
Correspondence courses.  
Both secondary and college levels.

**American School of Aircraft Institute**

3903 San Francisco Road  
Glendale, Cal.  
(See advertisement page 31)

**American Television Laboratories**

433 East Erie Street  
Chicago, Ill.

**Capitol Radio Engineering Institute**

3224 Sixteenth Street, N. W.  
Washington, D. C.  
Correspondence and Resident.  
Both secondary and college levels.

**Commercial Radio Institute**

38 West Biddle Street  
Baltimore, Md.  
Resident courses.

**Dodge's Telegraph & Radio Institute**

Valpariso, Ind.  
Resident courses.  
College level.

**International Correspondence Schools**

Scranton, Pa.  
Correspondence courses.

**Massachusetts Radio & Telegraph School**

18 Boylston Street  
Boston, Mass.  
Resident courses.

**Midland Radio & Television Schools, Inc.**

Power & Light Building  
Kansas City, Mo.  
Resident and combination courses.

**National Radio Institute**

Sixteenth & U Streets, N. W.  
Washington, D. C.  
Correspondence courses.

**National Schools**

4000 S. Figueroa Street  
Los Angeles, Cal.  
Combination resident and correspondence.

**New York Technical Institute**

108 Fifth Avenue  
New York City  
Resident courses.

**Nilson Radio School**

51 East 42 Street  
New York City  
Correspondence courses.

**Pacific Radio School**

735 Larkin Street  
San Francisco, Cal.  
Resident courses.

**Port Arthur College**

Port Arthur, Texas  
Resident courses.  
College level.



**Old Man Centralab** reminds you to always "specify Centralab" when ordering parts.



**FIXED RESISTORS**



**CERAMIC CAPACITORS**



**VOLUME CONTROLS**



**WAVE CHANGE SWITCHES**



**TOGGLE SWITCHES**

**Centralab**

DIVISION OF GLOBE UNION INC.  
MILWAUKEE, WIS.

**RCA Institutes**

75 Varick Street  
New York City  
1154 Merchandise Mart  
Chicago, Ill.  
Resident courses.  
Secondary and college levels.

**Radio Television Institute, Inc.**

480 Lexington Avenue  
New York City  
Resident courses.  
Secondary and college levels.

**Radio Training Association of America**

1559 Devon Avenue  
Chicago, Ill.  
Correspondence courses.

**Smith Practical Radio Institute**

1311 Terminal Tower  
Cleveland, Ohio  
Correspondence courses.

**Sprayberry Academy of Radio**

2548 University Place, N. W.  
Washington, D. C.  
Correspondence courses.

**Universal Television System, Inc.**

Candler Building  
Kansas City, Mo.  
Correspondence courses.

**YMCA Schools**

5 West 63 Street  
New York City  
1115 Bedford Avenue  
Brooklyn, N. Y.  
Resident courses.

*A good, well equipped service bench is vital to successful servicing. Read SERVICE each month for the latest developments.*



# STOP Feedback

with the New

## TURNER CARDIOID

Compare Its  
Performance With  
Mikes Costing  
**TWICE as MUCH!**



Here's the mike that's licked Feedback! The scientific answer to the sound man's problems! When the going is tough, and acoustic conditions practically impossible... a Turner Cardioid will do the job! 2-element generator gives true cardioid characteristics; offers the best features of both the velocity and the dynamic. Extra sensitive to sounds originating in front of the mike, while completely dead in the rear. And Just LOOK at the low prices!

- 101A Standard, all impedances, List...\$55
- 101B De Luxe, with 3-way switch, List...\$65
- 101C Broadcast, range extended to 10,000 cycles, List...\$70

Write for Free New Mike Catalog

### THE TURNER CO.

906 17th St. NE., Cedar Rapids, Iowa

## AVIATION NEEDS



### Radio and Instrument Men

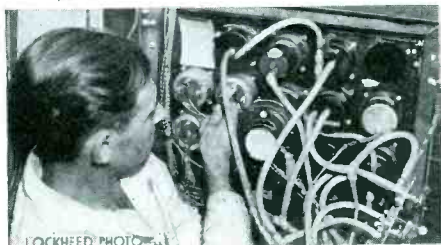

● Your previous experience, plus special aircraft training, leads to interesting good-pay jobs in radio, electrical, and instrument testing and installation work in aircraft manufacturing... and in instrument maintenance. This training prepares you for a lifetime career in aircraft manufacturing, with airlines, or in Civil Service at Army and Navy aircraft maintenance depots. All these divisions of booming aviation industry calling for many more trained men that we can supply. This oldest and largest school of its kind will send you complete information on its fine training for a MORE profitable lifetime career... and on your big IMMEDIATE opportunities. Send coupon NOW.

## AMERICAN SCHOOL of Aircraft Instruments

3903 San Fernando Road, Dept. R-8  
Glendale (Los Angeles County), Calif.  
Please send details on opportunities in Aviation for radio service men.  
Name ..... Age.....  
Address .....  
City ..... State.....

## ALERT RECEIVER

(Continued from page 20)

Local organizations will exist in every strategically important city of the country. In New York City there will be nearly 200,000 air-raid, fire wardens and others trained for Civilian defense. They will be directed by hundreds of zone and district chiefs. The problem is to reach them all simultaneously and instantaneously. This, of course, would require considerable time by telephone, telegraph or by radio broadcasting since, up to now, there has been no way of suddenly calling all to listen. The Alert receiver could solve that problem.

Similarly, in television, the Alert can be made to notify set owners of an unscheduled event. Also, vast public service can be performed by the Alert receiver in time of earthquakes, fires, floods and storms. In the police field, wide application of the Alert radio idea is envisaged. In war-time, the Alert might be built, according to the engineers, to sound a series of one-ring to signify the approach of enemy bombers, while a series of two rings would give the signal to evacuate schools. Three rings might be the warning for all in a certain area to seek air raid shelters. It is even possible for the Alert signal to be keyed as three dots and a dash, forming the Morse code letter "V" for Victory.

*Standard, nationally known parts and accessories are guaranteed for quality and performance. It pays to use them—and only them—in your work.*

### STEWART WARNER 02-4C1, 02-5T1, 02-428-, 12-4D1, 205CA, 205CK

*Repairing on-off indicator:* Each of the above models utilizes an on-off indicator located in the dial face. The on-off indicator is operated mechanically by an arm attached to the volume control shaft. Since this arrangement is of necessity a friction drive, you may encounter isolated cases where a small burr or rough surface will make the volume control knob exceedingly hard to turn. This action is noted particularly when an attempt is made to turn the set off.

The remedy for the above condition is to first examine the arm and slider (arm attached to volume control shaft and slider located under dial scale) to determine if these parts are smooth and free of burrs. Any burrs or roughness can be corrected by filing. Then place a small amount of grease or vaseline on the portions of both parts which make a sliding contact. This lubricant will make the parts operate much easier.

*Stewart-Warner Corp.  
Service Department*

**Advertisers in SERVICE are world renowned for the quality of their products. Insure your work by buying from them.**

# FREE



## SUPPLEMENT TO SYLVANIA'S TECHNICAL MANUAL

**T**HIS supplement lists all the types of tubes announced since the Fifth Edition, Second Printing of the Sylvania Technical Manual was released.

Base views and operating characteristics are either given... or referred to equivalents. This saves time and space. Cross references used are clear and easy to follow.

The supplement is so made that you can glue it inside the Sylvania Technical Manual you now have. If your Manual is old or worn... write for another. The supplement is already glued in the new Manuals.

The cost for a complete Manual is but 35c. The supplement is sent to you free. Just fill out and mail coupon below.

SYLVANIA RADIO TUBE DIVISION

## HYGRADE SYLVANIA CORPORATION

EMPORIUM, PA.

Please send me.....copies of the Sylvania Technical Manual Supplement.

Enclosed is 35c for Technical Manual.

Name .....

Address .....



**FREE!**  
... your copy  
of the most  
complete and  
authoritative  
Vibrator Guide  
A FREE VIBRATOR  
if you find a mistake

**RADIART  
VIBRATORS**  
are **EXACT  
Duplicate**  
not only in can size  
and prong arrange-  
ment, but in load limit  
and in frequency, which  
are designed to work  
with the other compo-  
nents of the circuit.

**THE RADIART CORP., Cleveland, Ohio**

# NEXT MONTH!

## *Annual Radio Serviceman's Equipment Directory*

To Be Published as a Section of

# SERVICE

Member of A.B.C.

For the first time—a practical and comprehensive "Buyers Guide", prepared specifically for the better service and sound man. Its ready reference value will assure a full year's life.

### **MANUFACTURERS!**

Be certain to promptly return the blue questionnaire recently sent to you—filling in complete data on your products for the service and sound field to insure correct directory listings. Additional forms available, if you need them.

Advertising forms close September 10th.

Make your space reservation promptly for the spot you want.

## **SPEAKERS**

(Continued from page 6)

distortion, some harmonics always remain.

### Speaker Design

There is a great deal of art in cone designs. The material, the shaping, the type of spider, the suspension around the edge, the type and weight of the voice coil—are a few of the playthings of the speaker designer. A free cone has the greatest bass response. Soft, pliable leather around the edge takes away very little from this perfect condition. Aluminum wire on voice coils reduces the mass and increases the high response. Spiders, originally made of aluminum, are made of bakelite, fish paper, corrugated celluloid or acetate. The cone itself is, in some cases, used as the spider. Corrugated spiders are most common and also serve as dust covers.

### Future Speakers

We do not pose as soothsayers, but the defense program is going to cause some radical changes in speaker design very soon. With materials hard to get and prices rising, more money will be spent for speakers. It will be feasible to allow closer tolerances with better all-around workmanship and inspection. Fields will be smaller and use less copper. Tighter cones with less air gap will increase the sensitivity or efficiency. There is a trend toward low-frequency cones in combination with regeneration for good bass response in small sets. New magnetics with free cones with high flux density and close gaps have more bass than was ever heard from this type speaker. Elliptical speakers, of foreign origin, are gaining in popularity. A 5 by 7 inch speaker is better than a 6-inch diameter common type and, besides, is excellent support for the slide type dials.

Two-inch pocket set p-ms are being improved for the new crop of novelty ultra-midgets. We wouldn't be at all surprised to see some crystal, or even capacity speakers coming back pretty soon. Keep in mind that anything can happen now!

### **RCA U40, U42, U46, etc.**

*Gear noise in automatic record changer:* A small amount of heavy fibrous gear grease (such as Texaco Crater Compound No. 2) applied to the spindle pinion and main gear teeth, will satisfactorily reduce mechanical gear noise produced at this point. Care should be exercised to avoid getting this grease near or into the spindle bearing. It is best to apply grease while gear is in motion.

# Displays . . .

Additional information on the products described below may be obtained, without obligation, directly from the respective manufacturers.

• • • • A wall rack for service shops has been announced by the Walter L. Schott Co., 5264 W. Pico Blvd., Los Angeles, Cal., makers of Walsco products. It holds an assortment of Walsco Unibelts (new adjust-



able dial belts), a spool with several kinds of dial cords and cables, and a bottle each of Walsco radio cement, cement solvent, contact cleaning fluid and dial oil.

## GIFT PACKAGE

To be announced in time for Christmas selling, this gift package illustrated contains a stream-styled modern flashlight in maroon and chromium with matching



pocket penlight, packed in tweed gift box. Gift package is wrapped with a "holiday spirit" cellophane band. Included with each deal is a full-color Kodachrome counter card. Burgess Battery Co., Freeport, Ill.

## FILAMENT TRANSFORMER

Thordarson Electric Mfg. Co., 500 W. Huron St., Chicago, announce their No. 19 series filament transformer recommend-



ed for use with the new RCA 816 rectifier tube. The No. 19 is an open frame type with a 115-volt, 50-60-cycle primary. Its secondary rating is 2½ volts at 5 amps. ct. The test voltage is 7,500 volts, rms.

# QUALITY PAYS—OR WHY MR. VAN DROOL DROPPED HIS SPOON IN THE SOUP

It happened during the dinner hour at the Van Drool mansion.

Rich Mr. Van Drool was sipping soup in perfect rhythm to the music of his super de luxe radio console. Suddenly came a noise like a firecracker as a midget condenser—which serviceman Wilbert Fixit had installed just the day before—exploded. Mr. Van Drool jumped, dropped his spoon and swore. What made him so mad, he said afterwards, was not that he dropped his spoon in the soup, but that he burned his fingers getting it out.

That experience taught Serviceman Fixit a lesson. No more midget dry electrolytics for him. He'd use big, full-sized replacements and play safe. One day, however, his jobber gave Wilbert a sample Sprague Atom and some literature about it.

"Guaranteed not to explode!" snorted Wilbert as he read the literature. "Phoo!"

But Wilbert was a methodical man. He put the Atom under test. No matter what he did, it wouldn't explode. Although the condenser was only rated at 450 Volts, he had to smack it with over 750 volts before it even broke down. Then Wilbert brought a dozen more Sprague Atoms and found they tested equally good.

While he was testing them, Mr. Van Drool's chauffeur dragged one of the upstairs radios into the shop.

"The boss wants this fixed in an hour," he explained. "And no foolin' He says

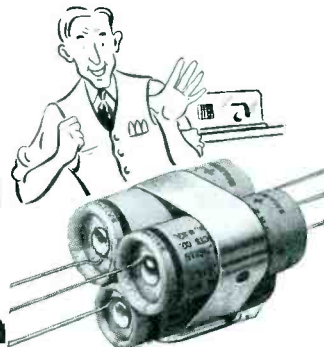

it's your last chance to please him."

"Lordy," groaned Wilbert, after examining the set. "A three-section condenser gone bad. It'll take me a week to get one from the factory."

Then he thought of his Sprague Atoms and the ST mounting strap the jobber had supplied with them. He could take two 8 mfd. 350 V. Atoms and a 25 mfd. 25 V.

Atom, strap 'em together—and the job would be done. It was the only thing Wilbert could do, so Wilbert did it.

To his surprise the three Atoms when strapped together were actually smaller than the original three-section condenser. Also, his total net cost on the Atoms was only 96c, whereas a duplicate unit would have cost \$1.20.

What's more, the Atoms stayed put.

Mr. Van Drool was more than pleased—and that meant Wilbert was pleased, too. Today he uses Atoms for practically all of his replacements, big or little.

"I save 'steen ways by using Atoms," is the way he puts it. "I save money, I save shoe leather, I save time, I save my good disposition—and I save customers. Best of all, Mr. Van Drool will never drop his spoon in the soup again."

Drooly yours,

**SPRAGUE PRODUCTS CO.**  
NORTH ADAMS, MASS.

## COMMUNICATIONS RECEIVER

The Echophone Commercial Model EC2 is a low-priced communications type receiver which operates from either a-c or d-c lines and utilizes eight tubes to cover the continuous range from 0.55 to 30.0 megacycles. The receiver is housed in a gray oven-baked crinkle cabinet of metal and the chassis is suspended therein on live rubber for required electrical isolation when



operating from d-c lines. A 5-inch p-m speaker is mounted inside the cabinet top. Echophone Radio Co., 201 East 26th St., Chicago.

## SIX RADIOLA MODELS

A new series of 1942 Radiolas consisting of four a-c, d-c table models, a phonograph-radio Electrola and a battery-powered farm radio, has been announced by John C. Marden, Radiola sales manager of the RCA Manufacturing Co., Inc., Camden, N. J.

"These new instruments are in addition to a number of Radiola models recently announced to RCA Tube and Equipment Distributors," Mr. Marden said.

**A "LAB" to fit your pocket**

**Readrite RANGER**

**MODEL 739**

**\$10.89**

Dealer Net Price

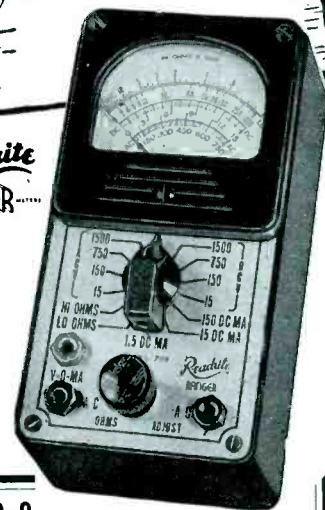

**A. C. D. C. VOLT-OHM-MILLIAMMETER**

Pocket Volt-Ohm-Milliammeter with Selector Switch. Molded Case. Precision 3-Inch Meter with 2 Genuine Sapphire Jewel Bearings. AC and DC Volts 0-15-150-750-1500; DC MA, 0-1-15-150; High and Low Ohm Scales. Dealer Net Price, including all accessories, \$10.89 MODEL 739 . . . DC Pocket Volt-Ohm Milliammeter. Dealer Net Price . . . \$8.25

WRITE FOR CATALOG  
Section 817 College Drive

**READRITE METER WORKS, Bluffton, Ohio**

SERVICE, AUGUST, 1941 • 33

# YOU SAVE \$1.00

## by using the Group Subscription Plan

OUR GROUP SUBSCRIPTION PLAN enables you and three or more of your co-workers to subscribe to SERVICE at one-half the regular yearly rate. In other words it will cost you and your friends only \$1.00 each for twelve issues of SERVICE. The G-S-Plan low rate only applies when 4 or more subscriptions are ordered at one time. (Foreign \$2.00.)

*Speak to three or more of your friends . . . let them sign up with you and then you can remit for the whole group. (Renewals or extended subscriptions are acceptable as part of a group.)*

### TEAR OUT AND MAIL

SERVICE—19 E. 47th St., N. Y. C.

Please enter annual subscriptions (12 issues) for each of the undersigned for which payment is enclosed at the rate of \$1.00 each; foreign \$2.00. (This rate applies only on 4 or more subscriptions when occupations are given.)

Name .....  
Address .....  
City-State .....  
Occupation .....  
Employed by .....  
State whether Employer is a Service Organization, Dealer, Jobber  
or Manufacturer .....

Name .....  
Address .....  
City-State .....  
Occupation .....  
Employed by .....  
State whether Employer is a Service Organization, Dealer, Jobber  
or Manufacturer .....

Name .....  
Address .....  
City-State .....  
Occupation .....  
Employed by .....  
State whether Employer is a Service Organization, Dealer, Jobber  
or Manufacturer .....

Name .....  
Address .....  
City-State .....  
Occupation .....  
Employed by .....  
State whether Employer is a Service Organization, Dealer, Jobber  
or Manufacturer .....

## MODERNIZE YOUR SHOP

FROM a survey of some 31 shops, SERVICE has discovered that net profits increased an average of 15% as a result of modernization. Sales costs decreased approximately 10%. We sum up our findings on the advantages of service equipment modernization as follows:

1)—Gives customers more confidence in your ability to do the work efficiently.



The two photographs presented herewith show the Radio & Sound Service Company, 2253 East Eleventh Street, Tulsa, Oklahoma, before and after modernization. E. B. Roberts, owner and manager, built the new bench himself with little expense. He has been at the above address for three years and has been servicing sets for twelve. His business has doubled since he modernized his shop.

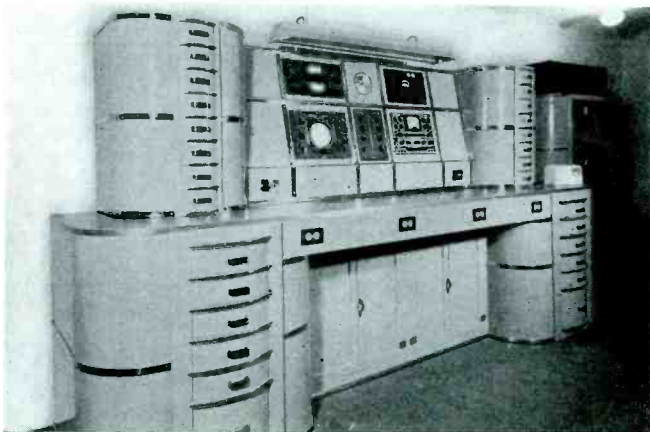

2)—Speeds up service, cuts costs and creates better customer satisfaction.

3)—Builds more profitable service sales because there is less tendency to cut prices.

4)—Reduces your idle time. Increases ratio of productive labor.

5)—Provides immediate and accurate estimates in shop or field.

6)—Minimizes material spoilage.

7)—With increasing circuit complexities, the need for modern, flexible test equipment is paramount. Modernization enables you to do more and better work in less time, hence means more profit for you.

8)—Especially where a flat price is given to the customer, it cuts down time spent on job, hence increases profits.

Finally, this survey discloses that whether you make \$1,000 yearly or \$20,000 yearly, the adequacy of your equipment has a definite relationship to net profits. Profits rise when you modernize.

## Parts, etc. . .

Additional information and prices of the equipment described below may be obtained, without obligation, from the respective manufacturers.

### SPECIAL CAPACITOR

Cornell-Dubilier Electric Corp., South Plainfield, N. J., have announced their Type KGT6250-1 high-voltage, high-capacity capacitor designed for flashing electronically operated ultra-speed flash lamps for photographic purposes. The new unit provides 25 mfd at 2,000-volt rating.

### R-F PLATE CHOKE

A 2½-meter r-f plate choke, Type Z-O, has been added to the ohmite series of r-f plate chokes. It is single layer wound on a low power-factor steatite tube. The winding is covered with a moisture re-

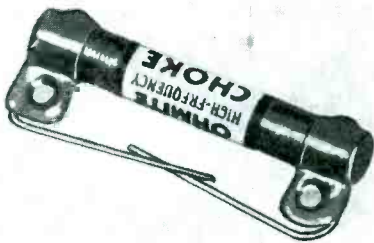

sisting insulation material to protect the wire. The new choke measures 1¾ by ¼-inch in diameter. Mounting is by means of wire leads. Other sizes available are for the 5, 10, 20, 40, 80, and 160 meter bands. Ohmite Mfg. Co., 4835 Flournoy St., Chicago.

### E-Z MOUNT CAPACITOR

Cornell-Dubilier Electric Corp., South Plainfield, N. J., have introduced their Type EZ dry electrolytics with a universal mounting arrangement said to provide for simplicity in mounting. The units are

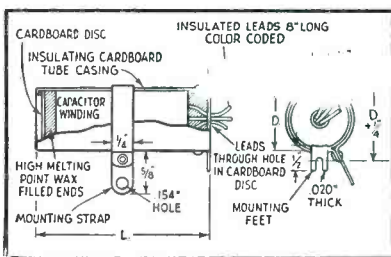

equipped with a conventional mounting strap around their center together with a pair of slotted feet at one end. They are available in single, dual, triple and quadruple section units in a variety of capacity and voltage ratings.

### ELECTRIC ETCHER

A small, inexpensive etcher for permanently marking small tools and parts is announced by the Ideal Commutator Dresser Co., 4025 Park Ave., Sycamore, Ill. As its name "Thin Line" implies, this etcher writes with a fine line, burning the mark, identification number or name right into the metal, so it cannot become blurred

# The FINEST MICROPHONES

for P. A. and RECORDING!



**AMPERITE VELOCITY MICROPHONE WITH PATENTED ACOUSTIC COMPENSATOR**



**New P. G. DYNAMIC WITH NEW SUPER OR ELIPSOID PICK UP PATTERN!**



**AMPERITE KONTAK MIKES IDEAL FOR AMPLIFYING STRINGED INSTRUMENTS USED WITH ANY AMPLIFIER AND WITH RADIO SETS.**



ASK YOUR JOBBER . . . WRITE FOR FOLDER

# AMPERITE

561 BROADWAY NEW YORK



or worn off with ordinary usage. All parts are fully enclosed and out of the way when



not in use. Etching heat 125 watts. Weight 3¼ lbs. Size only 4¼" x 4¼" x 7".

### KNOB PULLER

The General Cement Mfg. Co., Rockford, Ill., have introduced their G-C knob puller, designed to slip behind the knob and help

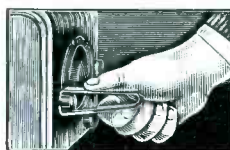

in removal. It is said to save time, prevent breakage of the knob and marring of the cabinet.



**CINAUDAGRAPH SPEAKERS**

**TOLERANCE**

*Takes on a New Meaning . . .*

Until the present hectic days came into being we used the word tolerance only as it applied to precision measurements. Today . . . we speak of customer tolerance . . . as we watch our frantic efforts to keep abreast of the ever-increasing demand for a product that justly deserves the recommendation . . . "IN ALL THE WORLD . . . NO FINER SPEAKER."

Anticipate your needs . . . see your Jobber at once . . . be tolerant of his efforts to give you the fastest possible service in these trying times.

**CINAUDAGRAPH SPEAKERS, INC.**

921 W. Van Buren St.  
Chicago, Ill.

# BUT WHAT OF Tomorrow?

"All-out" production to meet today's pyramiding orders does not mean that Triplett has lost sight of the broader requirements of tomorrow. Instead, research and engineering programs actually have been "stepped-up" to assure constant improvements in products and processes; in addition to needed developments in new fields.

Today's demands are important, but the needs of tomorrow cannot be slighted—and are anticipated in never flagging engineering and research developments. You have assurance that in the months and years to come, new Triplett products will serve in expanded fields, where they will merit values and savings for every dollar spent in their purchase.

**THE TRIPLETT ELECTRICAL INSTRUMENT CO.**  
Bluffton, Ohio



## FOR WIRED MUSIC OPERATORS



Breastplate "Dispatcher" type. Leaves hands free. Handsome dialectic black finish. Adj. neck-band. Choice of single or double headset, high or low impedance. Available total of 12 dif. types and imp. Most attractive, lightweight, rugged, practical chest mike yet devised for operators of wired music units. At your dealer or jobber.

## FOR BETTER MUSIC RECORDING

"A recorder is no better than its microphone." Outstanding velocity microphone for orch. stage and drama pickup, vocal and inst. use. Small, compact. All highs and lows in true relation. Tilts, does not hide face. Fine, highly pol. chrome. 25 ft. cable. Four impedances. Wt. 16 oz. At your dealer or jobber.



**UNIVERSAL MICROPHONE CO., Ltd.**  
Inglewood, Calif., U. S. A.

## Index to Advertisers

A	
Aerovox Corp. ....	26
American School of Aircraft Instruments	31
Amperite Co. ....	35
C	
Centralab .....	30
Cinaudagraph Speakers, Inc. ....	35
E	
Erwood Sound Equipment Co. ....	28
H	
Hygrade Sylvania Corp. ....	31
I	
International Resistance Co. ....	4
J	
Jackson Fluorescent Supplies. ....	36
Jensen Radio Mfg. Co. ....	3
K	
Ken-Rad Tube & Lamp Corp. ....	28
M	
Mallory & Co., P. R. ....	Inside Front Cover
N	
National Union Radio Corp. ....	17
P	
Paramount Products Co. ....	26
Precision Apparatus Co. ....	25
R	
RCA Mfg. Co., Inc. ....	Back Cover
Radiart Corp., The. ....	32
Radio Amateur Call Book, Inc. ....	36
Readrite Meter Works. ....	33
Rider Publisher, Inc., John P. ....	29
S	
Solar Mfg. Corp. ....	Inside Back Cover
Sprague Products Co. ....	33
Standard Transformer Corp. ....	27
Supreme Instruments Corp. ....	30
T	
Triplett Elec. Inst. Co., The. ....	36
Turner Co., The. ....	31
U	
United Catalog Publishers, Inc. ....	24
United Transformer Corp. ....	19
Universal Microphone Co., Ltd. ....	36
W	
Weston Electrical Instrument Corp. ....	1
Y	
Yaxley Mfg. Division. ....	Inside Front Cover

# SAVE 60% WITH FLUORESCENT LIGHTING



## Choice of Complete Fixtures or Ready-to-Assemble Kits

The fluorescent lighting industry offers you the greatest business opportunity in years. Everybody recognizes the greater economy, increased lighting efficiency, the cool daylight quality of this epochal improvement in electric lighting. Now—through the new Jackson Kit Service—you can easily assemble, install and fluorescent lighting for farms and stores.

## Send for Wholesale Catalog

### Direct from Factory Prices

Here is the most complete fluorescent line in the country in your choice of complete assemblies or ready-to-assemble kits—all at lowest wholesale, direct-from-factory—with profit margins up to 60%. The Jackson Line includes every type of fluorescent light, with all necessary fixtures, accessories, lamps and supplies—with full directions and diagrams for assembly and installation. Send for this complete FREE Catalog today—and full details of our special Dealer Plan.

**JACKSON FLUORESCENT SUPPLIES**  
Dept. 7, 205 W. Wacker Drive, Chicago, Illinois



## SERVICEMEN

who are

## RADIO AMATEURS

buy a fresh copy today of the

## RADIO AMATEUR CALL BOOK

The CALLBOOK is the only publication that lists all licensed radio amateurs in the United States and foreign countries.

Complete . . . Accurate . . . Up-to-Date

Issued Quarterly

MARCH . . . JUNE . . . SEPTEMBER  
and DECEMBER

Annual subscription \$4.00  
Single copies \$1.25

Buy your copy now from your radio jobber or direct from:

**Radio Amateur Call Book, Inc.**  
608 S. Dearborn St., Chicago, Ill., U. S. A.

QUALITY  
Above All

SOLAR

# MAKE *Every* LINK A *Strong* ONE

There's an age-old axiom that "a chain is only as strong as its weakest link". Weak, inferior parts endanger reputations. Avoid them. Make every "condenser link" strong and trouble-free. Standardize on SOLAR Capacitors... they strengthen both circuits and reputations.

**SOLAR Mfg. Corp.**  
Bayonne, N. J.

QUALITY  
Above All

SOLAR

Send for our new  
Catalog No. 11  
and other literature

# THE *Signal's* THE THING!

## ... Radio Testing Should be Done on the Basic Signal and Not Depend Upon the Interpretation of Secondary Effects

Proper signal reproduction is the basic function of radio and communication equipment.

When this fails, there can be no more direct method of locating the cause than by checking the progress of the signal through the instrument—and that is exactly what RCA Signal Tracing Instruments are designed to do.

Instead of depending upon the interpretation of secondary effects, RCA Instruments go right to the source of the trouble. By picking up the signal where it is present in any circuit they quickly indicate the exact point in the circuit sequence where the signal ceases, weakens or becomes distorted. Once this point has been found, the trouble can quickly be isolated by using one of the RCA Electronic Measuring Instruments. These instruments make it possible to measure voltages with-

out loading the circuit sufficiently to appreciably disturb its normal functioning. Here again, the basic conditions of signal operation are maintained.

RCA Signal Generators are designed to give signals at r-f, i-f or audio frequencies. Sufficient controls and adjustments are available so that a signal can be reproduced which will approximate closely the normal signal encountered in the particular circuit being tested.

Thus, Signal Tracing is the keynote behind all RCA Test Equipment. Because RCA has recognized the basic servicing idea that "The Signal's the Thing," instruments like the RCA-Rider Chanalyst, VoltOhmyst, Signalyst and various others have set new high standards in radio and communication servicing.



## Test Equipment

MODERN DEVICES for MODERN METHODS

RCA MANUFACTURING CO., Inc., Camden, N. J. • A Service of the Radio Corporation of America

In Canada: RCA Victor Company, Limited, Montreal

