

# SERVICE

A MONTHLY DICEST OF

# RADIO

AND ALLIED MAINTENANCE

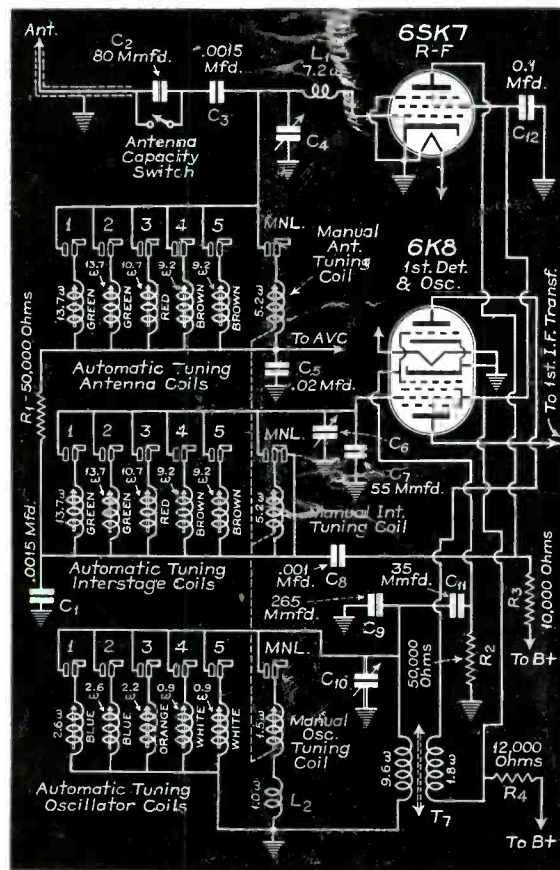

PER COPY  
25 CENTS

PERMEABILITY TUNING  
(See page 120)

MARCH  
1939

# Best! by Test-



After assembly, every Mallory Vibrator mechanism is carefully checked to see that all mechanical adjustments are perfect.



After assembly, every Mallory Vibrator is tested for electrical characteristics . . . output, balance, wave form, starting voltage and steady operation on this meter-board and cathode ray oscilloscope.

## P. R. MALLORY & CO. Inc. Replacement Vibrators



Every Mallory Vibrator is tested for noise in a sound-proof room under actual set operating conditions.



Life test. A percentage of every production run on every type of Mallory Vibrator is tested under actual set operating conditions for 1000 hours.

*Insist on Mallory —  
Buy the best —  
They cost no more!*

Mallory Vibrators have won overwhelming preference as original equipment in the majority of auto radio receivers by "Show Down" tests. Tests and long life records have settled the question of "what vibrator to use" indisputably in their favor. Manufacturers find them better. That's why it is no wonder that Mallory Replacement Vibrators lead the field.



Only the Second Edition Mallory-Yaxley Radio Encyclopedia gives you *all* data on every Vibrator application. It covers every servicing problem — you cannot afford to be without it. Ask your distributor.

Use  
P. R. MALLORY & CO. Inc.  
**MALLORY**  
REPLACEMENT  
CONDENSERS . . . VIBRATORS

P. R. MALLORY & CO., Inc.  
INDIANAPOLIS, INDIANA  
Cable Address — PELMALLO

Use  
**YAXLEY**  
REPLACEMENT  
VOLUME CONTROLS

Edited by

ROBERT G. HERZOG

# SERVICE

A Monthly Digest of Radio and Allied Maintenance

Reg. U. S. Patent Office

March, 1939

Vol. 8, No. 3

MEMBER  
Audit Bureau of  
Circulations

Published Monthly  
by the

**Bryan Davis  
Publishing Co.**  
Inc.

19 East 47 Street  
New York City

Telephone PLaza 3-0483

BRYAN S. DAVIS  
President

JAS. A. WALKER  
Secretary

SANFORD R. COWAN  
Manager

PAUL S. WEIL  
Advertising Manager

A. GOEBEL  
Circulation Manager

Chicago Office:  
608 S. Dearborn Street  
C. O. Stimpson, Mgr.  
Telephone Wabash 1903

Wellington, New Zealand:  
Tearo Book Depot

Melbourne, Australia:  
McGill's Agency

Entered as second-class  
matter June 14, 1932, at  
the Post Office at New  
York, N. Y., under the  
Act of March 3, 1879.  
Subscription price: \$2.00  
per year in the United  
States of America and  
Canada; 25 cents per  
copy. \$3.00 per year in  
foreign countries; 35  
cents per copy.

## Contents

### FEATURES

Amplifier Analysis <i>By Glenn H. Browning and Francis J. Gaffney</i> .....	110
Crosley 118 Reado Printer.....	118
DeWald 411 Wireless Phonoscope <i>By Mark Glaser</i> .....	132
Etched Foil Electrolytics <i>By Stanley H. Walters</i> .....	103
Facsimile <i>By Fred C. Ehlert</i> .....	116
Inductive Tuning <i>By O. J. Morelock</i> .....	108
Microphone Characteristics <i>By R. Lorenzen</i> .....	123
Microphone Ratings <i>By John H. Potts</i> .....	123
New Tubes.....	133, 137
Permeability Tuning (Cadillac C8).....	120

<b>Advertisers Index</b> .....	150
<b>Antenna</b> .....	100
<b>Associations</b> .....	142
<b>Circuits</b>	
Condenser Test Bridge.....	106
DeWald 411 Wireless Phonoscope.....	132
Permeability Tuning (Cadillac C8) Front Cover	
Precision 870 Volt-Ohmmeter.....	138
Sentinel-Erla 119B.....	114
Stewart-Warner 91-64 to 98-64 (Chas. 910-64).....	115
Vocagraph 30PX Amplifier.....	140
<b>Auto-Radio</b>	
Permeability Tuning (Cadillac C8).....	120
Philco 921, 922 Case History <i>By Eugene Triman</i> .....	114
<b>Book Review</b> .....	137
<b>Cover Diagram</b>	
Permeability Tuning (Cadillac C8).....	120
<b>Facsimile</b>	
Crosley 118 Reado Printer.....	118
Facsimile <i>By Fred C. Ehlert</i> .....	116
Facsimile in Education.....	131
<b>General Data</b>	
Crosley 118 Reado Printer.....	118

Etched Foil Electrolytics <i>By Stanley H. Walters</i> .....	103
Facsimile <i>By Fred C. Ehlert</i> .....	116
Inductive Tuning <i>By O. J. Morelock</i> .....	108
New Tubes.....	133, 137
Sentinel-Erla 119B.....	114
Stewart-Warner 91-64 to 98-64 (Chas. 910-64).....	115
<b>Highlights</b> .....	148
<b>Manufacturers</b> .....	146
<b>Sound Notes</b>	
Amplifier Analysis <i>By Glenn H. Browning and Francis J. Gaffney</i> .....	110
DeWald 411 Wireless Phonoscope <i>By Mark Glaser</i> .....	132
Particles Around Voice Coil.....	114
Microphone Characteristics <i>By R. Lorenzen</i> .....	123
Microphone Ratings <i>By John H. Potts</i> .....	123
Vocagraph 30PX Amplifier.....	140
<b>Television</b>	
Inductive Tuning <i>By O. J. Morelock</i> .....	108
<b>Test Equipment</b>	
Precision 870 Volt-Ohmmeter.....	138

Copyright 1939 Bryan Davis Publishing Co., Inc.



# Antenna

## RMA-NAB JOINT CAMPAIGN

**S**UB-COMMITTEES of the Radio Manufacturers Association and the National Association of Broadcasters met recently to formulate plans for an extensive, all radio, joint campaign to promote the industry in the eyes of the public.

Four fundamentals were regarded as basic to the campaign which will enlist the cooperation of broadcasters, networks, manufacturers, distributors and Service Men: "(1) to increase the amount of listening; (2) to improve the quality of home reception; (3) to sell the excellence, variety and extent of American radio program service; (4) to sell the American system of broadcasting and the contributions made thereto . . ."

Underlying the sub-committee's first planning session was the thought that a broader public appreciation of the variety and character of program service now being broadcast by radio stations ultimately created a demand for more and better radio sets. A foundation of mutual beneficial interest is thus established.

An additional consideration, however, is the fact that a program of joint activity which would unite all elements within radio would operate in more rapid advancement and best interests of the industry.

While details of the plan are now being prepared, the committee members agreed that it would be administered through the public relations department of the National Association of Broadcasters for the time being.

For the purpose of organizing every community behind the campaign, broadcasters will invite distributors, retailers and Service Men in their areas to a meeting which will be held either in the station studios or at some other agreeable location. The local broadcaster will serve as chairman of this meeting and will present the entire project. The campaign will be ready for announcement very shortly.

As a forerunner, the National Association of Broadcasters has released two booklets. One is called, "The ABC of Radio," and is an excellent treatise on what radio is and how it works, written in terms that the average layman can easily understand. The other "How to Use Radio in the Classroom," treats the many advantageous uses for radio in the schoolroom.

We are pleased to see this noble effort and, it is needless to say, urge our readers to cooperate to the fullest extent. Everyone concerned will undoubtedly reap ample reward.

## TUBES

**I**T IS, indeed, a poor salesman who listens to a customer tell him that the tubes in her receiver are sev-

eral years old and then does nothing about it.

For your own protection against comeback, make it a point to sell replacement of all tubes used for more than 1,500 hours, regardless of their condition. Stress breakdown possibility. Mention necessity of recalling you in case of the failure of even a single tube, plus the added expense, plus the inconvenience of doing without reception during the breakdown period, etc., etc.

Your customers have long been educated to the point where they realize that tubes can be bad even if they still light. Many of them even realize that the set can still play, but with decreased efficiency, with one or two weak tubes. It might be advantageous to point out that the efficiency of a tube decreases very slowly at first and then drops suddenly toward the end of its useful life.

## WE PRESENT

**O**N PAGES 123, 124, 125 and 126 of this issue, we present a series of charts giving the characteristics and ratings of practically all the popular microphones. We hope that this information should prove helpful when the job of selecting the proper microphone for the particular purpose presents itself.

From the charts it is evident that microphone ratings, and especially outputs, have not been standardized. However, if the conditions upon which a microphone's output is based, are known this output can be converted to any reference level. Mr. Potts (on page 123 of this issue) attempts to show how this can be done. We suggest that you read his article carefully and work out the problem he gives. Try several others and keep at it till you are sure you know how it is done.

**F**RED C. EHLERT gives the second article in his series on servicing facsimile receivers on pages 116 and 118. In this series we expect to cover all commercially available facsimile receivers, each in an individual article.

**G**ANG condensers have been the accepted method of tuning receivers for so long a period that few of us think of any other possible methods. On page 108, O. J. Morelock shows a practical tuning inductance especially advantageous on the ultra-high-frequency bands.

On the front cover a device for gang tuning of a receiver in the broadcast band by means of movable iron cores is shown. The device is described on page 120. Both of these methods are used in equipment now on the market.

Announcing...

# a new **Jensen** AUDITORIUM SPEAKER . . . .



## 18 INCH PERMANENT MAGNET

Efficiency and Power Handling Capacity fully equal to the well known 18-inch Jensen Field Coil Speaker.

*A distinguished new Member of  
JENSEN'S  
Auditorium Family*

### FOUR TYPES DIFFERING ONLY IN RESPONSE CHARACTERISTICS . . . .

- Type PMJ-18— For voice and music reproduction.
- Type PVJ-18— Where reproduction of voice is the principal requirement.

- Type PHJ-18— High Fidelity for improved quality where input is free from high frequency distortion.
- Type PLJ-18— For reproduction of low frequency in combination systems.

For Theatres, Public Address, Phonographs or any application where high speaker efficiency, superlative quality and exceptional power handling capacity are requisites, these new 18-inch Auditorium Speakers are unrivaled. And, of course no field coil power is required.

Jensen quality is not confined to products such as these new 18-inch speakers. The most complete line of speakers known are trademarked **Jensen** and every one from the small 5-inch size up are built to meet the high standard of Jensen quality. There is no price premium for quality of this kind; why not insist on it—always.

*Literature, Prices and Technical Data on Request*

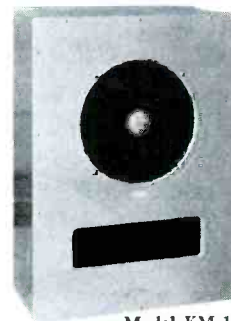

Model KM-18

### PERI-DYNAMIC REPRODUCERS

with **BASS REFLEX**  
ARE NOW AVAILABLE WITH  
18-inch Permanent Magnet Speakers

Jensen Peri-dynamic Reproducers with Bass Reflex are offered with 8, 10, 12, 15 and 18-inch speakers and some with dual speakers. No baffle required. Enclosures are shipped in knock-down kit form for convenience and low cost. Write for Peri-dynamic Catalog.

**JENSEN RADIO MANUFACTURING COMPANY**  
6601 SOUTH LARAMIE AVENUE CHICAGO, ILLINOIS

*"The Name Insures the Quality"*

# NEW

BOOK BY  
**RIDER**  
COMPLETELY  
EXPLAINS

**"SERVICING  
by SIGNAL  
TRACING"**



## A BASIC SYSTEM OF SERVICING For All Communication Systems

A complete explanation of the system of servicing which many authorities believe will revolutionize present methods of locating defects in communication systems of all frequencies — transmitting or receiving. This system is fundamental, because it operates on the common denominator of all sets regardless of circuit—The SIGNAL!

Because of this fact the book is also a veritable text book on radio receiver operation for it discusses the functions of the various parts of all receivers—the paths of signal currents—the development of control voltages, etc. The book covers all modern receivers including television and facsimile.

**RIDER BOOKS**  
*Banish  
Bewilderment!*

Successful servicemen in all parts of the world banish the bewildering complexity of modern service problems—get a sure grasp of underlying theory—by using the up-to-date Rider Books listed below. Theory and practice are combined on every page to make them doubly valuable in the crucible of daily service work.

300 pages, bound in hard covers, out in April . . . . . **\$2.00**

*Coming* A series of books by Rider on timely subjects such as Television-Radio Facsimile and Servicing. These will be released during the coming months.

## Free TO OWNERS OF ALL NINE RIDER MANUALS

RIDER 100% Group Certificate Material consists of (1) A Certificate for framing; (2) A 3-color Poster for your counter; (3) A Pocket Certificate showing sets covered by your Rider Manuals.

That you may let customers know you know—that you may merchandise your Rider Manuals—we will send FREE to every owner of all

nine Rider Manuals the material listed above. This 100% Group Certificate will prove to your customers that you have the circuit information necessary for servicing any American made radio receiver. Just send us the nine (9) title pages from your nine Rider Manuals and we will send you Rider 100% Group material.

### AUTOMATIC FREQUENCY CONTROL SYSTEMS

With Automatic Frequency Control Circuits in most new higher-priced models, knowledge of "AFC" means money in your pocket! Learn the practical facts, from these easy-to-understand explanations. Get your copy today. Cash in on profitable "AFC" work. Hard covers. 144 pp. . . . . **\$1.00.**

### THE CATHODE-RAY TUBE

Written especially so you can understand the subject. With introduction of new, cheaper Cathode-Ray Tubes, this book is even more indispensable for its complete practical information on Oscillographs, etc. 336 pp. 450 illustrations. . . . . **\$2.50**

### SERVICING SUPERHETERODYNES

Changes, changes, changes! That has been the history of the superheterodyne circuit. Make repairs quickly by analyzing the different parts of the circuit quickly. Rider shows you how in this revised edition which has 288 profusely illustrated pages. . . . . **\$1.00**

### "AN HOUR A DAY WITH RIDER" BOOKS —60¢ each

ON AUTOMATIC VOLUME CONTROL will speed up your AVC work. 96 pp. 65 illus. ON RESONANCE & ALIGNMENT. You need this! 96 pp. 48 illus. ON D-C VOLTAGE DISTRIBUTION IN RADIO RECEIVERS. How d-c voltages are led to tube elements, etc. 96 pp. 69 illus. ON ALTERNATING CURRENTS IN RADIO RECEIVERS—with drawings and diagrams.

DID YOU SAY 9?

**YOU NEED ALL 9 Rider MANUALS**

YES, I SAID 9!

NOW 11,270 PAGES OF AUTHORIZED SERVICING DATA IN NINE VOLUMES OF RIDER MANUALS

ORDER YOURS TODAY

**JOHN F. RIDER, Publisher, 404 FOURTH AVE., NEW YORK CITY**

# SERVICE

A Monthly Digest of Radio and Allied Maintenance

FOR MARCH, 1939

## ETCHED FOIL ELECTROLYTICS

By STANLEY H. WALTERS\*

Oil, mica or air dielectric condensers consist fundamentally of two metallic plates separated by a dielectric of oil, mica or air as the case may be. The electrolytic type embraces the same essential components but their form is considerably different. Only one of the conducting plates is metal, the other is an electrolyte which may take one of three forms. It may be a true liquid similar in appearance to water, it may be a viscous liquid of the consistency of glycerine, or it may be a nearly dry paste. Whatever its form, its function is the same in all cases. It is one conducting plate of the condenser.

Between the metallic plate and the electrolytic plate, is the dielectric. This consists of a very thin film which is formed directly on the metallic plate by making the latter the anode in a so-called forming solution.

An electrolytic condenser consists then of three essential components. A metallic plate, the dielectric film (formed on the metallic plate) and the electrolyte adjacent to the film. In addition to these parts, there are two others which are necessary for practical reasons. In order to make an electrical connection to the external circuit wires must be connected to the two plates. In the case of the metallic one the wire may be joined directly by a rivet or other suitable means. To make a connection to the electrolyte another metal strip of foil is included in the condenser winding. A wire can then be riveted to this metal for connection to the external circuit. To hold the electrolyte in place and to mechanically separate the two metals some sort of absorbent material such as paper or gauze is included. The electrolyte is forced into the separator after the condenser is wound. At the present time, this process of impregnation is accomplished by centrifugal force.

Directly after impregnation, the units are subjected to a d-c voltage slightly in excess of their rated working voltage to

MORE technical refinements have been made in the last year or two in the manufacture of electrolytic condensers than in their entire previous history. In addition there are increasing numbers of applications for these condensers, particularly those employing etched foil. It is the purpose of this article to acquaint the users of electrolytic condensers with some of these developments, with the general processing, construction and performance characteristics of the etched foil type of unit.

rebuild slight imperfections in the dielectric film which may have been caused by winding and impregnation operations. The unit is then sealed into its final container, which may be a metal can or cardboard box or tube.

The capacity of any type of condenser with a given type of dielectric material is directly proportional to the surface area of the plates and inversely proportional to the distance between them. The distance between plates is the thickness of the dielectric. Applied specifically to an electrolytic condenser, this means that if the surface area of the metallic plate is doubled, the capacity (in mfd) will be doubled. Also if the thickness of the thin dielectric film is halved, the capacity will also be doubled. The thickness of the film in the case of an electrolytic condenser varies directly (for all practical purposes) with the voltage applied during the forming process. For a required formation voltage the film thickness is fixed. The only remaining method of controlling the capacity of the condenser is to vary

Fig. 1. The wide acceptance of the small etched foil tubular condenser has necessitated the addition of a device for allowing excessive gas pressure to escape.

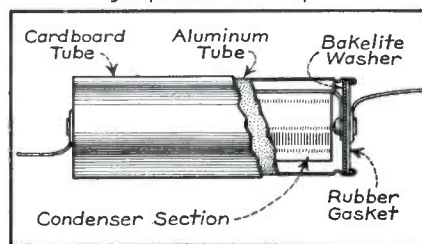

the area of the metal plate.

If three square inches of aluminum foil are immersed in a suitable electrolyte and 200 volt d-c applied until the current is at a very low value, it will be found when the foil is made into a condenser the resultant capacity measures approximately 1 mfd. The design constant for this particular voltage is then 3 sq. in per mfd, if we assume that the surface of this foil is smooth.

If a similar foil of the same area is processed in such a manner that its surface is roughened or etched, and the foil is formed in the same manner as before, it will be found that the condenser when assembled may now measure from 6 to 10 mfd. By this etching process, the physical size of the condenser has not been materially increased. Also the material comprising the condenser has not been increased, but the capacity has been increased from 6 to 10 times. The reason for this increase is that the surface area of the foil has been increased by this amount, by allowing the etching solution to eat minute holes or valleys into the originally flat surface. During the formation process, the film followed the contours of the roughened surface and in turn the electrolyte followed the contours of the film. Conversely, the decrease in physical size for a given capacity and voltage rating is possible with etched foil over plain.

The method of etching varies among the different manufacturers. A common chemical method employs hydrochloric acid. This chemical has a very great corrosive action on aluminum. The metal is eaten away at different rates over minute parts of the surface. By a careful control of concentration, temperature and time of immersion, the depth and pattern of the dissolved regions are controlled. This control governs the magnitude of area increase.

Another method which has proven highly successful is the electro-chemical etching process. In this type, the dissolving agent is the chlorine ion, derived from a chlorate salt. The energy

\*Physicist, Cornell-Dubilier Electric Corp.

is supplied by an electric current. A steady dissolution of the aluminum as aluminum chloride and its subsequent precipitation as hydrated aluminum oxide takes place. Practically none of the chlorine ions are lost and the solution remains of uniform concentration once equilibrium is reached. Surface increase is uniform and is controlled by the current supply.

A continuous machine is used with this method as well as with most of the others. The foil unwinds from a large spool, is drawn through the etching and washing solutions and is then rewound on to a spool at the exit end.

#### FORMATION PROCESS

The characteristics of the final condenser depend to a great extent on the effectiveness of the formation process. The machine used is very similar to that used in the etching. It varies in the nature of the solution which fills its tanks. The foil is drawn at constant speed through the forming solution in the tanks and is rewound at the exit end. The foil passes over contact rollers (which are connected to the positive side of a d-c generator) before entering the formation tanks. Within the solution and adjacent to the foil are metal plates which are connected to the negative side of the same generator. Current from the generator, passing from the foil, through the solution to the metal cathodes, forms the dielectric film on the aluminum foil. As the foil enters the tank initially the current density is high because the foil has no dielectric film. As it progresses through the tank, the film is gradually built up and the current density decreases to a low value, until at the exit end the film possesses the necessary dielectric quali-

ties for the finished condenser.

The voltage to which it is desired to form the foil is adjusted by suitable generator controls. With each voltage desired there is an economically optimum speed of foil travel. For this reason, the machines are generally provided with a variable speed control.

An initial rush of current, as the raw foil enters the formation solution, would result in an inferior film. The effect would cause high power factor for the resultant condenser. It is important, therefore, to control the current density at the entrance end of the tank. To accomplish this the resistance of the solution may be raised by suitable control of the concentration of the component chemicals, or the design of the tank and metal cathodes may be such that there is a long path of the solution between foil and cathodes. These methods have the effect of putting a high current limiting resistance in the path of the current at the entrance end of the tank.

With etched foil, the importance of this current control was first realized. When the plain foil or un-etched type of anode was used, the foil formed rather quickly at the entrance position and the current was almost immediately controlled by the dielectric film itself. With etched foil each square inch represents perhaps 10 sq. in which must be formed. This concentration of surface causes a high current density at the entrance point, which results in high temperatures. The net result is a dielectric film of inferior characteristics.

The electrolyte used in forming is generally a water solution of boric acid and either sodium or ammonium borate. The voltage of formation is from

15 to 100 volts higher than the rated working voltage of the final condenser. A condenser rated at 450 volts, for example, would have the film formed to approximately 550 volts.

#### CHARACTERISTICS

The common type of electrolytic condenser as used in radio sets is essentially a d-c condenser. It operates satisfactorily only when the anode foil, on which is formed the dielectric film, is positive with respect to the electrolyte. When this d-c voltage is reversed, it will be found that the condenser will no longer exhibit the blocking or dielectric properties but will pass considerable current. This high direct current will heat the unit and dry out its electrolyte, rendering it inoperative. There is more d-c leakage associated with an electrolytic condenser than with the other types. The dielectric film is not a perfect insulator. Furthermore, this leakage current may change with time, when the condenser is idle as in the time intervening between manufacture and use. An important feature of these condensers is their so-called recovery characteristics. This term has to do with the manner in which the leakage falls off to a minimum when voltage is applied after long periods of idleness. No electrolytic has the characteristic of maintaining the insulating nature of the film perfectly. A good condenser, on the application of rated d-c voltage, will almost immediately form a film equivalent to its original one and the leakage will drop to a safe, low value. If the current does not drop immediately the excessive current will cause the temperature of the condenser to rise. An increase in temperature causes an increase in d-c leakage which in turn causes a further increase in temperature. Thus a cycle sets in which rather quickly causes the electrolyte to be expelled, ruining the condenser. It is therefore highly important to control the manufacture such that the original leakage current is very low and that it will quickly return to a low value after long periods of idle shelf life. The condition is brought about by controlling first the initial formation of the dielectric film. The best possible type of formation is first applied by careful control of the speed of the formation machine and the concentration and purity of the forming solutions.

The type of electrolyte is also important. The electrolyte functions in a dual role. It is one of the conducting plates of the condenser, and it also is a film maintaining agent. The electrolyte must in itself be capable of forming and maintaining the dielectric film. The forming process and the structure of the final electrolyte have been the sub-

Discharge of an electrolytic through its inherent resistance cannot be too accurately predetermined because the resistance is variable and depends upon the instantaneous voltage. The values shown in the graph are approximate, since individual condensers will vary.

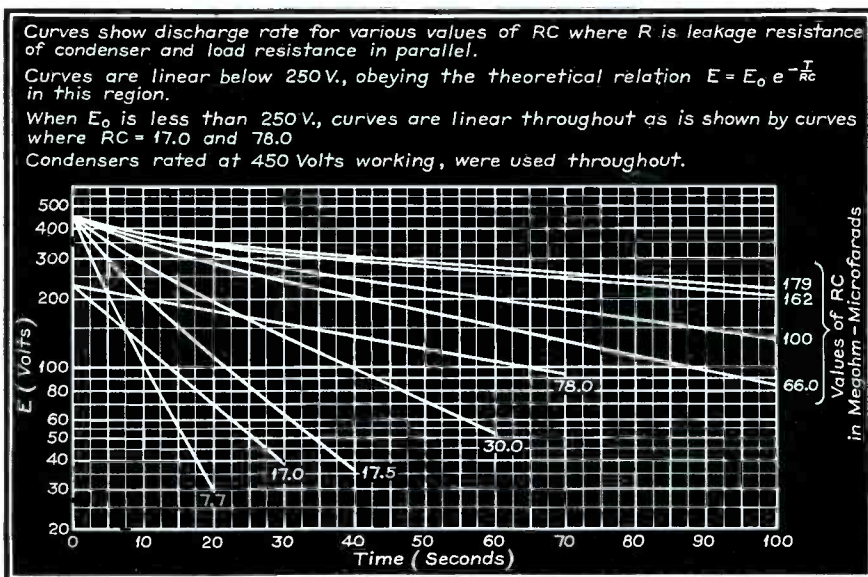



ject of intense research in the last year or more.

The discussion of idling characteristics is particularly important in connection with etched foil condensers of the small tubular type. The final temperature rise of a condenser above ambient varies with the physical size of the unit with constant power input. The relatively large plain foil electrolytic condenser would have less temperature rise than would the extremely small etched foil unit of the same capacity and voltage rating. For this reason the etched foil unit must have even better recovery characteristics than the plain foil or it would fail where the larger unit would not.

The decrease in bulk and surface area of the etched foil condenser over the plain, makes it impossible for the former to radiate heat as effectively as the latter for the same power input. To counteract this defect, the power which the etched foil unit is called upon to radiate has been reduced; first by reducing the d-c leakage, by virtue of a better film and second by a reduction in the power factor.

#### POWER FACTOR

Electrolytic condensers, in radio sets, are generally subject to a combination of d-c and a-c voltage. The a-c is superimposed on the d-c and is a small fraction of the latter in value. The alternating current delivers power to the circuit only when there is some resistance or its equivalent present. Applied to an electrolytic condenser, if the power which the unit consumes as heat by the application of a known a-c voltage and resultant current could be measured, the following relation would hold.

$$\text{power factor} = \frac{\text{watts}}{\text{volts} \times \text{amps}}$$

In a-c circuits the product of the voltage and current must be multiplied by some factor to arrive at the true power absorbed by the circuit. This factor is termed the power factor and ranges in value from 0 to 1.00 (or 0% and 100%), depending upon the constants of the circuit. The actual power developed within an electrolytic condenser is always less than the product of the alternating voltage and current. The power is absorbed by the condenser in the form of heat and must be radiated into the surrounding air if the temperature of the unit is to remain low. The total power liberated may be divided into two parts. Some is liberated within the dielectric film. The remainder is liberated within the electrolyte, since the latter offers resistance to the flow of the alternating current. Power may always be set equal to the product of the square of the current and the resist-

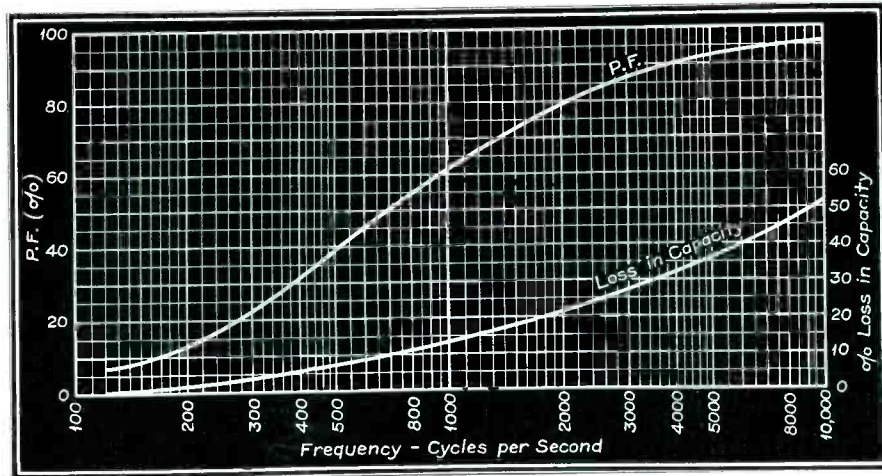

Fig. 3. The product of  $f$  and  $R$  increases with the frequency and hence the power factor also increases. Variations shown are for a high voltage unit.

ance in an a-c circuit.

If  $W$  is the total power (in watts) liberated within the condenser,  $I$  is the measured alternating current,  $R$ , expressed in ohms, becomes what is known as the equivalent series resistance of the condenser. Part of this  $R$  is associated with the power lost in the resistance of the electrolyte and the remainder with that lost in the dielectric film. If a theoretically perfect condenser (one having no power losses) were connected in series with the resistance  $R$  and the capacity made equal to the capacity of the electrolytic, then the resultant unit would be equivalent to the electrolytic condenser. It would have equal capacity and power factor, the only electrical criteria for a condenser.

The bridge circuit shown in Fig. 5 is commonly used in measuring the capacity and power factor of an electrolytic condenser.

When the bridge is balanced, the indicated value of the various standard condenser gives the capacity of the electrolytic directly and the value of the variable resistance gives directly the equivalent series resistance. Sometimes, a d-c polarizing voltage is placed across the electrolytic during test. This is for the purpose of measuring the leakage current at rated voltage simultaneously with the above.

It is desirable to express the power factor of the condenser in terms of the quantities which are measured on the bridge, rather than in terms of wattage at a given alternating voltage and current. The original expression for power factor can be readily changed to show this relationship so that

$$\text{power factor} = 2\pi fCR$$

This is then the expression for the power factor in terms of the capacity ( $C$ ), the equivalent series resistance ( $R$ ), and the frequency ( $f$ ).

The equivalent series resistance was neglected in computing the impedance.

This introduces errors in the derived formula when the power factor is high. It is sufficiently accurate for factors as high as 40%. Units higher than this are not commonly encountered.

For a given capacity condenser operating at some fixed d-c voltage and superimposed a-c voltage, the alternating current is fixed. The rate at which the condenser must dissipate power varies directly with the power factor. In the majority of cases this is not too important since the amount of power is very small and an increase in operating temperature of negligible amount only, is caused by an increase in power factor of from 8% to 20%. It may assume greater importance, however, in the case of a small etched foil unit as the entrance condenser of a standard pi-filter, where the a-c component may be high. Here, depending on the value of the a-c, a low power factor can mean the difference between satisfactory operation and overheating. Electrolytic condensers with ratings from 150 to 450 volts a-c are now made with power factors of from 6% to 9%. This applies to the etched foil, dry type with measurements made at 120 cycles.

#### BREAKDOWN VOLTAGE

Electrolytic condensers of the dry type have a characteristic breakdown or maximum surge voltage rating. Higher instantaneous d-c voltages than this may cause the condenser to become permanently short-circuited. This voltage is determined largely by the characteristics of the electrolyte. With any given electrolyte there is some voltage which when impressed across the film causes minute sparks to be emitted at the surface of the electrolyte adjacent to the film. This voltage may be termed the sparking or scintillation voltage of the electrolyte in question. When this sparking occurs within the condenser it acts as a miniature explosion which disrupts the separator material and causes the cathode connector foil to

come in physical contact with the anode foil on which the film is formed. A subsequent spark at this point will then destroy the film at the point of contact and cause a permanent short circuit.

The sparking voltage of an electrolyte varies directly with its resistivity. The electrolyte resistance varies directly with this resistivity. The power factor of a condenser is controlled in part by the resistance of the electrolyte. If an electrolyte of high resistance is used in making the condenser, the breakdown voltage will be higher, but the power factor will also be higher.

In practice, a suitably high breakdown voltage is chosen and the power factor reduced by optimum foil processing. The breakdown voltage is never sacrificed to provide extremely low power factors.

#### POWER FACTOR AND VOLTAGE RATING

A plain foil electrolytic with a d-c voltage rating of 150 requires 3 sq. in. of anode surface per mfd. A similar unit with a rating of 300 volts requires approximately 6 sq. in. of foil per mfd. Thus if two units were made of identical capacity with ratings of 150 and 300 volts respectively, the latter would have twice the surface area. Likewise it would have twice the amount of electrolyte. This additional electrolyte would be situated in the condenser so that it adds an identical resistance in parallel to the first. The part of the equivalent series resistance which is due to the electrolyte resistance would be one half the value in the case of the 300 volt condenser. Therefore, it follows that the power factor for the higher voltage is lower than for the lower voltage when both are impregnated in the same electrolyte.

In practice, the resistivity of the electrolyte is adjusted to the particular voltage rating of the condenser. By this means, the power factor is about the same for all ratings up to 500 volts.

In the multiple type, where anode foils of different voltage ratings are incorporated into a single winding, the entire unit must necessarily have the same electrolyte, since the electrolyte is added to the entire section after it is wound. For example it is quite common to employ a triple capacity condenser, incorporating two high voltage capacities for the filter circuit and one low voltage capacity for a cathode by-pass. The low voltage section must have a higher power factor than the other sections, since a high resistance electrolyte must be used. If the resistance of the electrolyte were adjusted for the low voltage unit, the breakdown voltage of the other sections would be too low. Thus the type of electrolyte to be used in this design is governed by the voltage rating of the highest voltage section.

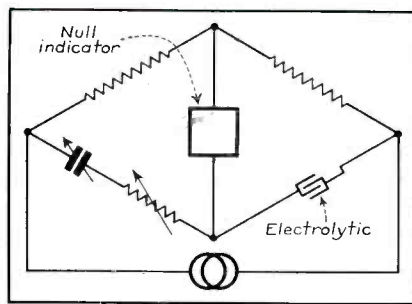

Fig. 5. The capacity and power factor of an electrolytic is generally measured on a bridge type of circuit.

Electrically, a better unit could be made by employing a separate winding with separate, low resistance electrolyte, for the low voltage section and then assembling it finally with the others. This design, however, is more costly. The former design can be made quite satisfactory by employing sufficiently high capacity to make the impedance low in the low voltage unit in spite of its higher power factor.

#### TEMPERATURE

A temperature limit must be set for the satisfactory operation of the electrolytic condenser. The limit must be set for two reasons. First the danger of a destructive cycle setting in whereby the high temperature causes an increase in d-c leakage, which further raises the temperature resulting in an eventual failure of the unit. Secondly, an increased temperature causes the electrolyte, which is a partial liquid, to dry out. This results in the electrolyte becoming of higher resistance with consequent increase in power factor of the unit. Also the electrolyte will dry out to such an extent that portions of the film surface will lose contact with the electrolyte effectively decreasing the surface area of the condenser, resulting in loss of capacity.

The increase in power factor and loss in capacity may be minimized by sealing the unit in a metal box or can. The metal can is preferable for high ambient temperature operation as well as for guarding against the entrance of moisture from the surrounding air, as this would lower the breakdown voltage of the electrolyte. The metal can type of

construction is much better suited for operation in the tropics than the more common cardboard box construction due to the perfect hermetic seal possible with the former.

The recommended safe temperature limit for dry electrolytic condensers is 50° C. although units can be made to successfully stand 70° and 80° C. For long life at these higher temperatures, the working voltage should be 50 volts less than rated.

#### VENTS

The wide acceptance within the past year of the small etched foil tubular condenser (see Fig. 1) has necessitated the addition of a device for allowing excessive gas pressures to escape. These small units will explode if for any reason they become sufficiently overheated to vaporize the electrolyte content unless a vent is provided.

The commonest cause of failure of this nature is in a-c, d-c radios, used on a-c where a short circuit in the rectifier tube places alternating current directly from the line across the first section of the filter condenser. This condenser is designed and rated for d-c only and will immediately overheat under this condition.

A similar situation will occur if the condenser is connected with reversed polarity, or if the applied voltage is in excess of the condenser rating. A failure is rare when the condenser is used in the proper manner.

Several methods of providing a safety vent to guard against explosions if a situation as outlined above occurs, are being used. One method is to provide a small hole, generally in the end of the unit, which is filled with wax. If overheating occurs, the wax will melt and allow the gas to escape. A similar type has the hole in the metal case and is covered with a strip of adhesive tape. This is generally under the cardboard sleeve which covers the metal case and is not visible.

If pressure is built up inside the unit, the tape is pushed away from the hole allowing the gas to escape. Another method is provided by piercing the rub-

(Continued on page 128)

Fig. 4. Operation at higher a-fs is generally confined to electrolytics employed for cathode by-pass. The impedance is made low by employing higher capacities. The curves are for a low voltage unit.

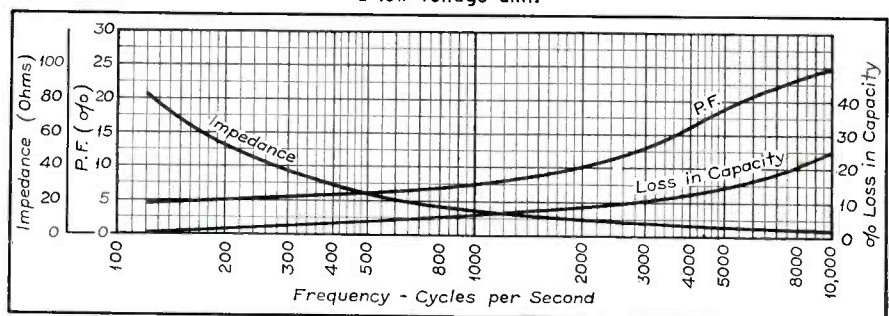

**BLOCKADE THE WEST ROAD!  
TWO MEN AND A WOMAN!  
BE CAREFUL! THEY'RE KILLERS!**

**WITH THE AID OF  
RAYTHEON TUBES**

## **Illinois Police Radio Blockade Cuts Crime Careers Short!**

The "radio blockades" of the Illinois State Police and police of many other states have become famous throughout the country. In Cook County, Illinois, the blockade begins in the well-equipped police station WQPC pictured below. Once the alarm is sounded, every road is blockaded immediately—cutting off all escape channels for fugitives.

Fighting crime is no game for "panty-waists." Police must be tough and efficient. Squad cars must be swift and sturdy. And radio tubes must be dependable—and ready for emergency flashes.

That's why RAYTHEONS are used by so many State Police organizations. Why RAYTHEONS are used, too, in millions of homes, in leading auto set radios, by leading Commercial Airlines, the U. S. Forestry Service, Coast Guard, Weather Bureau, etc.

Anywhere sturdiness and long life under adverse conditions are required—you will find RAYTHEONS. Yet they cost no more than the second-best tube.

RAYTHEON is your guarantee of the best turnover of any tube investment!



# **RAYTHEON**

NEWTON, MASS. • NEW YORK • CHICAGO • SAN FRANCISCO • ATLANTA

**"WORLD'S LARGEST EXCLUSIVE RADIO TUBE MANUFACTURERS"**

MARCH, 1939 •

SAY YOU SAW IT IN SERVICE

107

# INDUCTIVE TUNING

By O. J. MORELOCK\*

THE method of tuning radio-frequency circuits by variations in inductance is far from new. In fact, the earliest tuning device for commercial receivers was an adjustable inductance consisting of a cylindrical coil and a contactor sliding along the coil parallel to its axis. The contactor jumped from one turn to another and picked up the required inductance for the tuned circuit. Progressively, the so-called variocoupler was an elaboration of the earlier arrangement and included a tapped secondary winding along with the mutual coupling between the two coils. The variometer then appeared and following this came the double roller type of tuner involving a bare wire wound from an insulated roller onto a bare metallic roller for varying the inductance of the insulated coil.

Since then the variable condenser has taken the primary position in the field of tuned circuits. Although years of skillful development of the variable condenser as a tuned circuit component have brought many improvements in this device, there is still room for considerable improvement and economy in meeting stricter requirements for resonant circuits, especially in the high-frequency field. A new basic method of inductive tuning was described last year in the *I.R.E. Proceedings* for March, 1938, under the heading "A New System of Inductive Tuning". Since that time considerable development work has been undertaken<sup>1</sup> in adapting this principle to actual production devices, especially in the high-frequency tuning bands.

There are two basic advantages of the

inductive tuning system over the condenser tuning system:

- (1) Much broader frequency coverage is possible with the inductive tuning system. Frequency ratios of 7 or 8-to-1 can be obtained as against ratios of 3 or 3½-to-1 for condenser tuning systems. This has been verified in actual production devices.
- (2) Increased amplification and higher resonant-circuit voltages are available with the inductive system.

If a simple resonant circuit for coupling to the input of a vacuum tube is observed, theoretically the voltage across such a circuit would be equal to the induced voltage across the coil itself, or  $E$  in Fig. 1. This however, will be the case only if the circuit components are lumped in each section of the parallel circuit, i. e.,  $L$  and  $C$  are pure in-

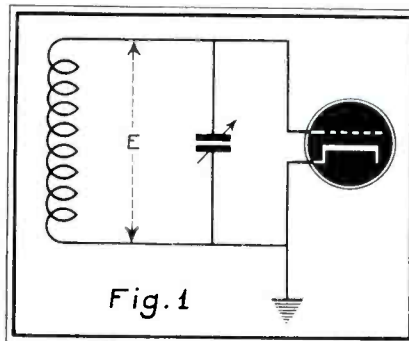

Fig. 1

Theoretically the voltage across a tuned circuit is equal to the induced voltage across the coil itself.

ductors and capacitors respectively. In high-frequency work, it is well known that there is very appreciable inductance

<sup>1</sup>This work has been undertaken by the Weston Electrical Instrument Corp. under its license.

\*Radio Engineer, Weston Electrical Instrument Corp.

The improved performance, with the end inductance will be noted by comparing curves 1 and 2.

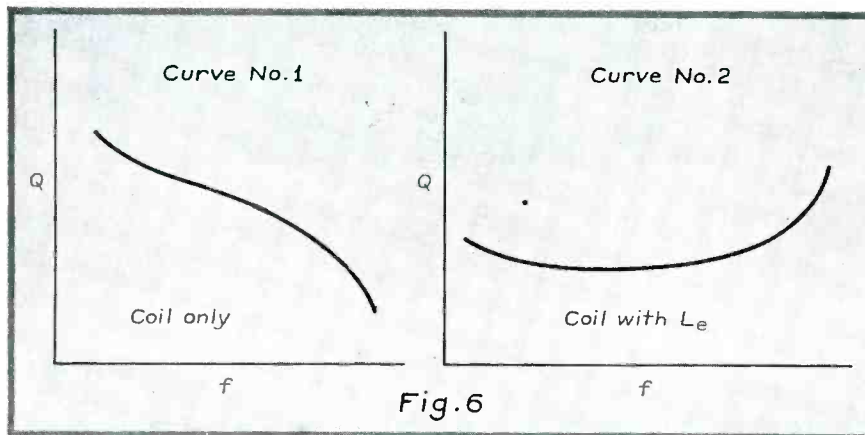

Fig. 6

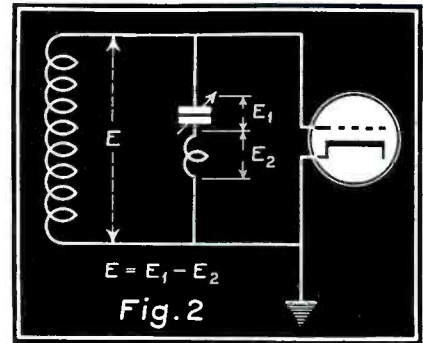

Fig. 2

The actual voltage available at the input of the vacuum tube will be reduced considerably by the inductive drop across the variable condenser and leads.

in a variable condenser and its connecting leads. The actual voltage  $E$  available at the input of the vacuum tube will, therefore, be reduced considerably by  $E_2$ , the inductive drop across the variable condenser and leads, as shown in Fig. 2. If, on the other hand, a variable-inductance device is used to resonate with a small highly stable fixed condenser designed for minimum inductance, considerably higher voltages would be available in a tuned circuit of this type. At the high-frequency end of the tuning range, the ratio of desired to undesired reactance is considerably increased. The input voltage to the vacuum tube would be available across the points shown in Fig. 3 wherein the inductance of the capacitive leg of the parallel circuit would be kept at an absolute minimum. An inductance-tuning device involving principles wherein high-gain circuits of this type are entirely practical at relatively high frequencies, is described in the following paragraphs.

## MECHANICAL DESIGN

The continuously variable inductance (CVI) system makes use of a rigid coil which rotates on its own axis driven by a direct or geared shaft. A contactor is constrained to slide directly along the length of the coil wire whenever the coil is rotated. This contactor is mounted in a small carriage which is allowed to slide along the axis of the coil and is moved in this direction by a small insulated pulley, grooved to follow the convolutions of the wire. When the coil is rotated for tuning, the carriage and likewise the contactor, is moved in a direction parallel to the coil axis, depending upon the direction of rotation. A rod, likewise parallel to the coil axis acts as the guide for the motion of the

carriage. The carriage assembly itself is compressed between the guide rod and the coil form, maintaining a light pressure between the contactor and the wire on the coil.

The contactor itself takes the form of a small bifurcated phosphor bronze spring having two parallel nibs which ride on the outside diameter of the coil conductor. The contactor spring itself is not called upon to perform any mechanical function other than that of supplying the continuous contact at all times. The bifurcated contact spring greatly improves the contact reliability of this device and hence enables reduction in required pressure due to the double contacting arrangement. Any minute obstruction on the outside surface of the wire under conditions of single contact, might cause a break in the direct continuity but with the double contact arrangement such irregularities have little or no effect.

Grid and ground contacts are picked up at the opposite ends of the coil. The contactor itself operates at ground potential and determines by its position, the grounded or low-potential end of the tuned circuit. The unused portion of the coil is grounded at all times and the upper limit of tuning range is determined by the natural period of the unused portion of the coil when the contactor approaches the grid end. Voltage is picked up at the high potential or grid end of the inductor through a contactor mounted on a small insulating strip suitably spaced from the grounded end plate. This connects to an "end" or minimum inductance which, in turn, is connected into the resonant circuit in the regular manner. This end inductance takes the form of a coil of heavy wire having a diameter of approximately  $\frac{1}{2}$ " and from 1 to 7 turns depending upon the tuning range required. This coil is adjustable and is somewhat analogous to the trimming

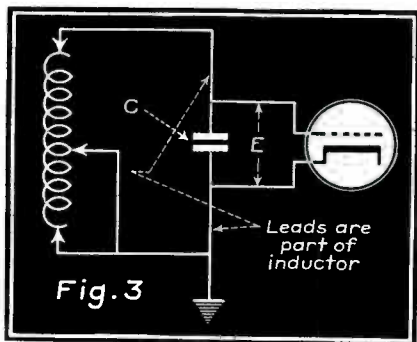

The inductance of the capacitive leg of the parallel circuit is kept at an absolute minimum.

condenser used for the minimum capacity adjustment on a variable condenser. The end inductance is adjusted correctly for the high-frequency track-

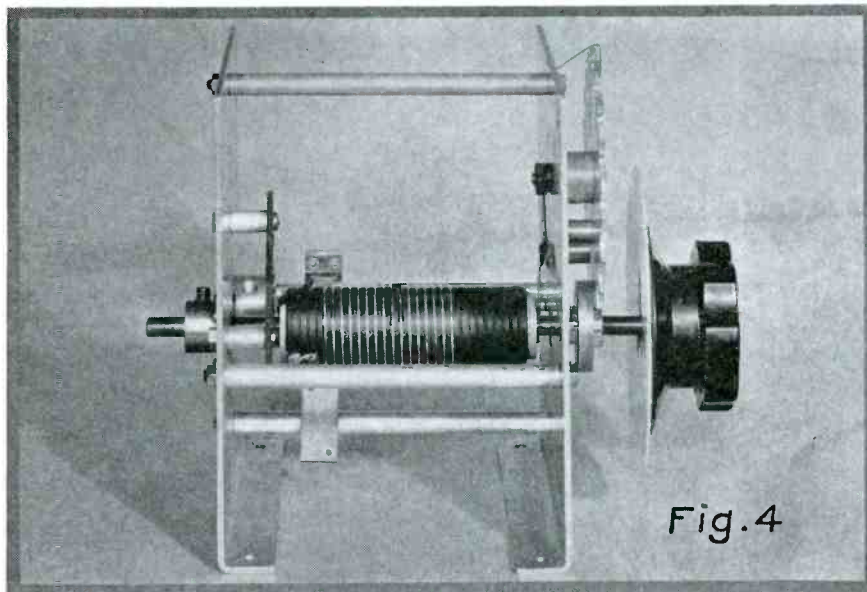

A continuously variable inductance system makes use of a rigid coil which rotates on its own axis. A contactor is constrained to slide directly along the length of the coil whenever the coil is rotated.

ing and determines the high-frequency limit of the coil resonated with a fixed condenser.

The coil rotates on a copper shaft which connects to the coil end ring and

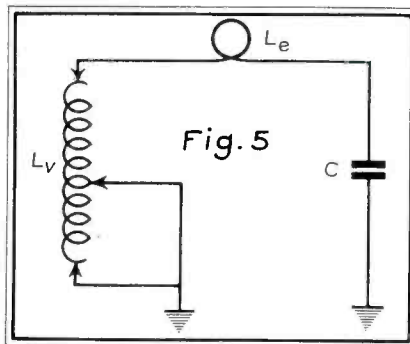

The end inductance connects directly in series with the fixed tuning capacitor.

to the ground contactor, and is maintained at ground potential. This shaft rotates in suitable insulated bearings so as to maintain a low noise level for high-frequency operation in receivers.

In multiple-section units, the shaft is cut to length depending upon the number of units required and each inductance section mounts between end plates directly on the shaft. With a single knob, a direct-drive mechanism is thus obtained with a multiplicity of full revolutions, depending upon the required coverage of the tuning unit. The units are adaptable to several types of dial mechanisms with a spiral dial calibration and with this arrangement a calibrated dial with markings extending over 5 or 6 feet of spiral length, may be used with the continuously variable inductance units. A stop mechanism mounted either on the back or front end plate is designed to allow free movement of the coils through a predeter-

mined number of revolutions and in turn, this mechanism stops the coil rotation near the end of the winding. A novel stop mechanism and turn counter has been developed in conjunction with this device and this as well as other application problems, will be discussed in a second article to appear in future.

#### ELECTRICAL CHARACTERISTICS

A typical circuit representing a variable-inductance fixed-capacitance arrangement is shown in Fig. 5. In this case the end or fixed inductance is represented by  $L_e$  in the figure and connects directly in series with the fixed tuning capacitor. A sliding contactor is represented by the arrow and this in turn, maintains ground potential at the point indicated on the coil periphery. The use of the end inductance provides superior performance to an equivalent mechanically stopped off variable inductor. With the end inductance an increase in  $Q$  of the circuit is available with increase in frequency. Without this end inductance, the curve of  $Q$  versus frequency drops off at the high-frequency end. The improved performance with the end inductance will be noted by comparing curves 1 and 2 in Fig. 6.

The maximum frequency limit for any inductively-tuned circuit is determined by the natural period of the unused part of the variable coil. Absorption will take place if the circuit is tuned past this natural frequency, this being due to the mutual coupling between the used and unused parts of the variable coil; the natural frequency, of course, decreasing as the contactor approaches the high-frequency end of the tuning range. It is therefore considered essential to ground the unused end of the coil as this in turn, raises quite con-

(Continued on page 130)

# AMPLIFIER ANALYSIS

By GLENN H. BROWNING and FRANCIS J. GAFFNEY\*

CONSIDER the case in which it is desired to use 2 speakers whose voice-coil impedances are known and to each of which it is desired to deliver a certain fraction of the total power when these speakers are connected by means of a 3-winding transformer to the output tube of an amplifying system. The circuit diagram for such a case is shown in Fig. 1. We have already seen<sup>1</sup> that in an iron-cored transformer the voltages appearing across any two windings are proportional to the number of turns in the windings. Thus, in

$$\frac{E_1}{E_2} = \frac{N_1}{N_2} \quad \dots \dots \dots (1)$$

and that

$$\frac{E_1}{E_3} = \frac{N_1}{N_3} \quad \dots \dots \dots (2)$$

Where  $E_1$ ,  $E_2$  and  $E_3$  are the a-c voltages across the primary, across  $R_2$  and across  $R_3$  respectively and  $N_1$ ,  $N_2$  and  $N_3$  are the number of turns on the primary, on winding 2 and on winding 3 respectively.

From the law of conservation of energy we have also seen<sup>1</sup> that the total a-c power consumed in the secondary windings must equal the a-c power fed to the primary of the transformer, or

$$W_1 = W_2 + W_3 \quad \dots \dots \dots (3)$$

If  $R_1$  is the total resistance reflected into the primary by the 2 voice coils connected across the secondary windings, the total power in watts developed in the primary winding is

$$W_1 = \frac{(E_1)^2}{R_1} \quad \dots \dots \dots (4)$$

(Reflected resistance is that a-c resistance which would be measured between the terminals a and b with the speaker voice coils connected to the secondaries as shown in Fig. 1.)<sup>1</sup>

Similarly, the power in watts developed in the speaker coil  $R_2$  is given by

$$W_2 = \frac{(E_2)^2}{R_2} \quad \dots \dots \dots (5)$$

and in

$$W_3 = \frac{(E_3)^2}{R_3} \quad \dots \dots \dots (6)$$

\*Browning Labs., Inc.  
<sup>1</sup>"Amplifier Analysis," by Glenn H. Browning and Francis J. Gaffney, SERVICE, December 1938, p. 5.

IN A PREVIOUS article<sup>1</sup>, the writers have in some detail described the practical theory of power amplifier tubes and their use in conjunction with speaker loads through impedance matching output transformers. It remains in this article to treat the principles in matching, by means of a multiple winding transformer, several speakers or other loads to a power tube or tubes.

The treatment in these articles, though it involves only algebra and a few fundamentals, is necessarily somewhat involved. However, it is hoped that many of you will be able to use this series as a reference to enable you to more understandingly attack problems which will sooner or later be presented to you in the course of your routine work.

You will undoubtedly be called upon at some time or other to install several speakers operated from the same amplifier. In such an event the problem of choosing the correct output transformer will present itself. To do an efficient job you should be able to answer the following questions:

Given the voice-coil impedances of a number of speakers and the load impedance required for a given amplifier output system, can you determine the turns ratios required for the output transformer?

Having at hand several output transformers, can you measure the characteristics so as to be able to choose the one which will best match a given system to a number of speakers to obtain maximum undistorted output? Can you determine the effect on quality of reproduction if the impedance match so obtained is not perfect?

Can you measure the power delivered to each of the speakers with a definite signal fed into the input of the amplifier, as well as the total power fed to the output transformer?

If we substitute these values of power in equation (3) and divide both sides by  $E_1$ , we have,

$$\frac{1}{R_1} = \frac{(E_2)^2}{(E_1)^2} \times \frac{1}{R_2} + \frac{(E_3)^2}{(E_1)^2} \times \frac{1}{R_3} \quad \dots (7)$$

Using turns ratios in place of voltage ratios, we obtain,

$$\frac{1}{R_1} = \left(\frac{N_2}{N_1}\right)^2 \times \frac{1}{R_2} + \left(\frac{N_3}{N_1}\right)^2 \times \frac{1}{R_3} \quad \dots \dots \dots (8)$$

In considering reflected resistances<sup>1</sup> we have seen that the resistance reflected into the primary by  $R_2$  of Fig. 1 would be obtained from,

$$R_2' = \left(\frac{N_1}{N_2}\right)^2 R_2$$

where  $R_2'$  is the resistance reflected by  $R_2$ . Similarly, if we let  $R_3'$  be the impedance reflected by speaker  $R_3$ , we obtain

$$R_3' = \left(\frac{N_1}{N_3}\right)^2 R_3$$

Thus, we see that the first member of the right side of equation (8) is the reciprocal of the resistance reflected by

$R_2$  or is equal to  $\frac{1}{R_2'}$ . Similarly, the

second member is equal to  $\frac{1}{R_3'}$ . Re-

writing equation (8) using this notation, we obtain

$$\frac{1}{R_1} = \frac{1}{R_2'} + \frac{1}{R_3'}$$

Solving this equation for  $R_1$ , we have

$$R_1 = \frac{R_2' R_3'}{R_2' + R_3'} \quad \dots \dots \dots (9)$$

This is the law for the equivalent of 2 resistances connected in parallel. Thus the total resistance as it appears looking into the primary winding of a multiple winding transformer is obtained by finding the equivalent resistance of the several reflected resistances due to loads across the secondary windings.

If, in equations (1) and (2), we substitute the values of  $E_2$ ,  $E_3$  and  $E_3$  as obtained from equations (4), (5), and (6), respectively, we obtain

$$\frac{N_2}{N_1} = \frac{E_2}{E_1} = \sqrt{\frac{W_2 R_2}{W_1 R_1}} \quad \dots \dots \dots (10)$$

and

$$\frac{N_3}{N_1} = \frac{E_3}{E_1} = \sqrt{\frac{W_3 R_3}{W_1 R_1}} \quad \dots \dots \dots (11)$$

From these equations, we may obtain the turns ratios required when the resistances of the voice coils, the amount of power which it is desired to develop in them, and the total resistance which

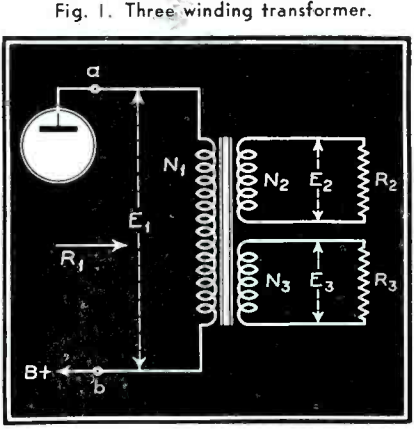
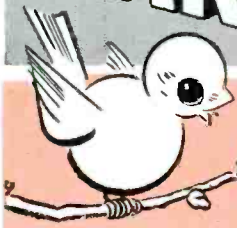

Fig. 1. Three winding transformer.

# MAKE MORE MONEY *This Spring!*



## DISPLAY...

# Cunningham Radio Tubes

The striking Cunningham Radio Tube display illustrated is the Spring Tonic your radio tube business needs now. Use it to start a big push on Cunningham Radio Tubes that will mean real profits for you. This display is only part of the fine 1939 Cunningham Window Display Service which consists of:

1. Four separate 8-color window displays, each made up of a number of individual pieces—any or all of which may be used effectively by itself as a display for different parts of your store.

2. Two attractive window streamers will be furnished with each of the four window displays.

3. A quantity of World Series score sheets.

4. A supply of complete 1939 collegiate football schedules.

This sales-getting material will help you make more money—not only this Spring—but all year long. Ask your Cunningham Distributor how you can obtain this service.

Over 90 million Cunningham Radio Tubes have been sold for replacement service work.



# Cunningham Radio Tubes

Standard Since 1915  
A PRODUCT OF THE RCA MANUFACTURING COMPANY, INC.

the transformer primary must present to the tube or tubes of the output system are known.

#### MAXIMUM EFFICIENCY

If a transformer with given turns ratios is available and it is desired to use this transformer in conjunction with 2 or more speakers, how can we determine the resistance which the transformer primaries will present to the tube or tubes of the amplifying system so that we may know whether or not the amplifier is working at its maximum efficiency, that is, delivering maximum undistorted output. The value of this total reflected resistance can be obtained from equation (8) by substituting

the values of  $\frac{N_2}{N_1}$ ,  $\frac{N_3}{N_1}$ ,  $R_2$ , and  $R_3$ , and

solving for the reflected resistance  $R_1$ . This, then, is the a-c resistance which is actually presented to the final tube or tubes in the amplifier.

Suppose, for example, it is desired to operate 2 speakers from a pair of 6L6 power tubes connected in push-pull, Class A and from which we wish to obtain 10 watts. One speaker has a voice-coil with an a-c resistance of 10 ohms, and since it is designed for the bass and middle frequencies, we desire to feed 9/10 of the power, or 9 watts, to this speaker. The other speaker is a tweeter and has an a-c resistance of 2000 ohms. To this speaker, we desire to deliver only 1/10 of the total power. Since most of the sound energy is required in the frequencies below a thousand cycles 1 watt will suffice. It is desired to choose an output transformer with a primary and 2 secondary windings which will have the correct turns ratios to operate these speakers under the required conditions.

From a tube manual, we find that the plate-to-plate resistance for maximum undistorted power output of two 6L6s is 5000 ohms. With this load resistance and full grid excitation, these tubes would deliver 14.8 watts with self-

Fig. 2. If an impedance of 10 ohms is placed across winding A, the impedance looking into the transformer primary is 10,000 ohms.

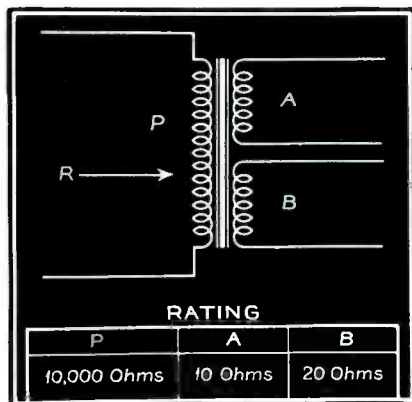

bias. In our installation the total power output will be kept to 10 watts by decreasing the amplifier gain to slightly below full excitation. In any event, a plate-to-plate resistance of 5,000 ohms will provide the best operating conditions, giving minimum distortion. Using Fig. 1, let  $R_2$  represent the 10-ohm speaker and  $R_3$  represent the 1000-ohm speaker. Substituting in equation (10), we obtain

$$\frac{N_2}{N_1} = \sqrt{\frac{W_2 R_2}{W_1 R_1}} = \sqrt{\frac{9 \times 10}{10 \times 5000}} = 0.0424$$

Thus,  $N_2 = 0.0424 N_1$ .

Similarly,

$$\frac{N_3}{N_1} = \sqrt{\frac{W_3 R_3}{W_1 R_1}} = \sqrt{\frac{1 \times 1000}{10 \times 5000}} = 0.1414$$

so that  $N_3 = 0.1414 N_1$ .

The primary may have any number of turns, the higher the better, as long as the transformer iron does not reach saturation during the a-c swing. The total number of turns used on the primary of a transformer is limited by this factor and also by the excessive increase in distributed capacitance when more than a certain number of turns is employed. The latter causes the transformer to become self-resonating in the a-f band after which point higher frequencies will be sharply attenuated.

#### POWER OUTPUT

The measurement of power in the circuits being considered can most readily be accomplished by measuring the a-c voltages with a high resistance a-c voltmeter (1000-ohms-per-volt or better). In order to determine the values which these voltages should have, we solve equations (4), (5), and (6) for  $E_1$ ,  $E_2$ , and  $E_3$ , respectively, obtaining

$$E_1 = \sqrt{W_1 R_1} = \sqrt{10 \times 5000} = 224 \text{ volts}$$

$$E_2 = \sqrt{W_2 R_2} = \sqrt{9 \times 10} = 9.50 \text{ volts}$$

$$E_3 = \sqrt{W_3 R_3} = \sqrt{1 \times 1000} = 31.6 \text{ volts}$$

The amplifier gain is then adjusted until the a-c voltage,  $E_1$ , as measured from plate to plate of the output tubes, is 224 volts. The voltages across the 2 voice coils should then be 9.50 and 31.6 volts, respectively, if the system is operating correctly. It will be remembered, however, that in all of this discussion it has been assumed that the entire impedance of the speaker voice coils was in the form of a resistance. This is not strictly the case. The values of  $E_2$  and  $E_3$  may depart somewhat from the calculated values as obtained above. If the values obtained are within 10% of those calculated, it may be assumed that the system is operating correctly.

#### TURNS RATIO

It is desired to operate two speakers from a pair of push-pull 6L6s in a Class A audio system. You have avail-

able, let us say, a 3-winding transformer, the primary of which is center-tapped, but you have long since mislaid the turn ratio information (or the impedance matching values as they are usually given by manufacturers) of the transformer. The turns ratio of the windings can most easily be obtained by impressing a small a-c voltage on the secondary windings and measuring the a-c voltage developed across the primary. The turns ratios are then directly proportional to the ratios of the voltage obtained. A high resistance voltmeter should, of course, be employed.

Having the turns ratio  $\frac{N_2}{N_1}$  and  $\frac{N_3}{N_1}$  and

knowing the a-c resistance of the voice coils  $R_2$  and  $R_3$ , will the transformer be suitable for matching the speakers to the amplifier output system? Let us assume some figures such as might occur in practical instances. Suppose that the turns ratios are measured, as described above, and found to be

$$\frac{N_2}{N_1} = 0.05$$

$$\frac{N_3}{N_1} = 0.30$$

The 2 speaker voice coils are measured and their a-c resistances found to be

$$R_2 = 20 \text{ ohms}$$

$$R_3 = 2000 \text{ ohms}$$

We may find the total resistance which this combination will reflect through the transformer to appear across the plates of the output tubes by applying equation (8), and substituting the values given above. In making this substitution, it is logical to use the 10-ohm speaker across winding 2 and the 2000-ohm speaker across winding 3 since, if these positions were reversed, almost no power would be delivered to  $R_3$ . Substituting the values in their proper form in equation (8), we obtain

$$\frac{1}{R_1} = (0.30)^2 \times \frac{1}{2000} + (0.05)^2 \times \frac{1}{20} = 0.000170$$

$$R_1 = \frac{1}{0.000170} = 5880 \text{ ohms}$$

The proper plate-to-plate resistance for Class A operation of two 6L6s in push-pull is 5000 ohms. The resistance which we have obtained is consequently too high. Let us, however, calculate the amounts of power which would be delivered to each speaker under these conditions. Dividing equation (4) by equation (5), we obtain

$$\frac{W_1}{W_2} = \frac{(E_1)^2}{(E_2)^2} \times \frac{R_2}{R_1} = \left( \frac{N_1}{N_2} \right)^2 \times \frac{R_2}{R_1}$$

• SERVICE FOR



Thus

$$W_2 = \left( \frac{N_2}{N_1} \right)^2 \times \frac{R_1}{R_2} W_1$$

Now

$$\left( \frac{N_2}{N_1} \right)^2 \times \frac{1}{R_2} = \frac{1}{R_2'}$$

which is the reciprocal of the resistance reflected into the primary by the speaker  $R_2$ . Thus

$$W_2 = W_1 \times \frac{R_1}{R_2'} \quad \dots \dots \dots (12)$$

From the values obtained above,

$$R_2' = \frac{1}{(0.05)^2 \times \frac{1}{20}} = 8000 \text{ ohms}$$

so that

$$W_2 = \frac{5880}{8000} W_1 = 0.737 W_1$$

The power delivered to the tweeter ( $R_3$ ) is similarly given by

$$W_3 = W_1 \times \frac{R_1}{R_3'}$$

From the values above

$$R_3' = \frac{1}{(0.30)^2 \times \frac{1}{2000}} = 22,500$$

So that

$$W_3 = \frac{5880}{22,500} = 0.263 W_1$$

The greater part of the power is developed in the dynamic speaker for the lower frequencies which is as it should be. However, the output tubes are operating into a resistance which is too high and this, in pentode output systems, causes considerable increase in third harmonic distortion. Suppose, then, that we consider doctoring the tweeter to make its resistance lower so that the total reflected resistance will be decreased. To do this, suppose we place a resistance of 3,000 ohms in parallel with the voice coil of this speaker. The total resistance of the voice coil is now given by

$$R_2 = \frac{(2000)(3000)}{2000 + 3000} = 1200 \text{ ohms}$$

Thus

$$\frac{1}{R_2'} = (0.30)^2 \times \frac{1}{1200} \times 0.000075$$

Adding this to the previously obtained

value for  $\frac{1}{R_3'}$ , we obtain

$$\frac{1}{R_1} = \frac{1}{R_2'} + \frac{1}{R_3'} = 0.000075 +$$

$$0.000125 = 0.00020$$

So that the total reflected resistance  $R_1 = 5000$  ohms which, as we have seen,

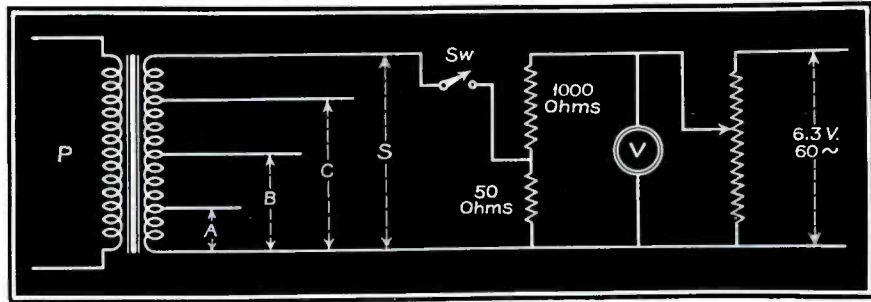

Fig. 3. The turns ratio can be most conveniently measured at 60-cycles by impressing about 0.5 volt across the total secondary and measuring the induced primary voltage with a high resistance voltmeter.

is the correct value to match the output tubes.

The total power delivered to  $R_2$  and the 3000-ohm resistance in parallel with it is given as before by

$$W_2 = W_1 \times \frac{R_1}{R_2'}$$

and since

$$R_2' = \frac{1}{0.000075} = 13,300 \text{ ohms}$$

$$W_2 = W_1 \times \frac{5000}{13,300} = 0.376 W_1$$

But  $R_2$  now consists of the speaker having 2000-ohms resistance in parallel with a resistance of 3000 ohms which contributes, of course, nothing to the audio power. If two resistances are placed across the same a-c voltage, the power delivered to each is inversely proportional to the resistance, so that in the above case 3/5 of the power  $W_2$  will be delivered to the speaker and 2/5 of  $W_2$  will be consumed in the parallel resistance. Let  $W_2'$  be the audio power actually produced in the speaker. Then,

$$W_2' = \frac{3}{5} (0.376 W_1) = 0.150 W_1$$

The power now delivered to the other speaker is obtained by

$$W_3 = W_1 \times \frac{5000}{8000} = 0.626 W_1$$

so that the total audio power is  $0.776 W_1$ , or 77.6% of the power delivered to the output transformer, leaving 22.4% of the total delivered power dissipated in the parallel resistance across  $R_2$ . If the maximum total power to be developed by the system is 10 watts, the power dissipated in the resistance will be  $W_r = W_1 \times 0.224 = 10 \times 0.224 = 2.24$  watts, and the resistance must be capable of safely dissipating this power. Since the total power output obtainable with a value of 5880 ohms reflected resistance is about 8% lower than that obtainable with the correct matching resistance of 5000 ohms, we have lost power by making this adjustment, but the output now delivered to the speakers is considerably freer from third harmonic distortion than it would have been had we allowed the system to operate undoctored. Also

a slightly better ratio of the power delivered to the woofer to that delivered to the tweeter is obtained.

#### RATING TRANSFORMERS

The rating shown in Fig. 2 means that if an impedance of 10 ohms is placed across terminals of winding A, the impedance looking into the transformer primary is 10,000 ohms. Thus,

turns ratio of  $\frac{N_A}{N_p}$  is

$$\frac{N_A}{N_p} = \sqrt{\frac{10}{10,000}} =$$

$$\sqrt{\frac{1}{1,000}} = \frac{1}{31.6}$$

Similarly,

$$\frac{N_B}{N_A} = \sqrt{\frac{20}{10,000}} =$$

$$\sqrt{\frac{1}{500}} = \frac{1}{22.3}$$

Now if the rated loads (i.e. 10 ohms and 20 ohms, respectively) are connected *simultaneously* to the two secondary windings, will the resistance  $R$  looking into the primary still be 10,000 ohms? Referring to equation (12), we see that such is not the case. The true value of the reflected resistance must be obtained by placing both reflected resistances in parallel. Since each load alone reflects 10,000 ohms into the primary, the total reflected resistance is one-half this value or 5000 ohms. Suppose now that both of these windings were connected in series aiding. The aiding connection can be determined by impressing an a-c voltage on the primary and noting the series connection of secondaries which give the greatest voltage. The turns ratio of the total series connected secondary to the primary is then given by

$$\frac{N_s}{N_p} = \frac{N_A + N_B}{N_p} \quad \dots \dots \dots (13)$$

The right side of equation (13) is equal

$$\text{to } \frac{N_A}{N_p} + \frac{N_B}{N_p} \text{ or to the sum of the 2}$$

turns ratios of the individual sec-  
(Continued on page 134)

# General Data

## SENTINEL-ERLA 119B ALIGNMENT OPERATIONS

Connect Generator to	Dummy Antenna	Generator Frequency	Dial Setting	Peak Trimmer
6D8G Grid	0.02 mfd	455 kc	540 kc	1, 2, 3, 4
Antenna	250 mmfd	1730 kc	1730 kc	8B
Antenna	250 mmfd	1400 kc	1400 kc <sup>1</sup>	8A

<sup>1</sup>Tune receiver to signal.

## SENTINEL-ERLA 119B

**T**HIS model is a 4-tube battery-operated superheterodyne designed for operation from a 6-volt d-c source.

A synchronous vibrator is used to convert the 6-volt supply to the higher voltage required in the plate and screen circuits. A 1,000-ohm resistor is used, in lieu of a choke, together with a 20-mfd and a 12-mfd electrolytic condenser to filter the ripple from the rectified voltage.

### SPECIFICATIONS

Tuning: Manual.

Range: 540 to 1730 kc.

Power Supply: 6-volt d-c.

Speaker: 4837, 5-in p-m: 10073, 8-in p-m.

Pilot Light: No. 40.

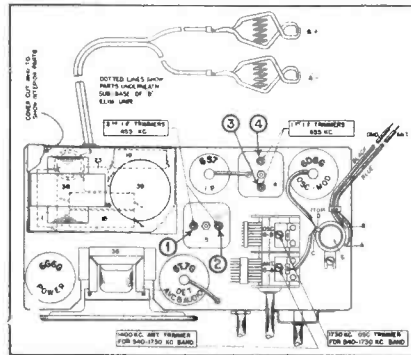

A 1000-ohm resistor together with a 20-mfd and a 12-mfd electrolytic filters the entire plate supply for the Sentinel-Erla Model 119B. Four tubes are used to provide a power output of approximately 0.6 watts.

## PARTICLES AROUND VOICE COIL

**W**HERE there are particles in the air gap, it is frequently possible to blow them out by means of compressed air. In using compressed air, care must be taken that the blast of air does not injure the cone. In other cases, small particles which are in the inner air gap can be removed with a thin speaker shim. A small, clean paint brush will often help.

*J. N. Gotten.*

## PHILCO 921, 922

**Dead short:** Some of these models develop a short circuit that persists when the vibrator is removed. Before starting to remove all A circuit wires to trace the trouble, remove the can which shields the power transformer. Inspect the inside of the can for a heat mark. Intermittent shorts have been found in these cans caused by unguarded connections which move with strains on, or vibrations of the case and chassis of the set.

Do not invite future trouble by neglecting to insert a fiber-paper sheet where shorts may occur.

*Eugene Triman*

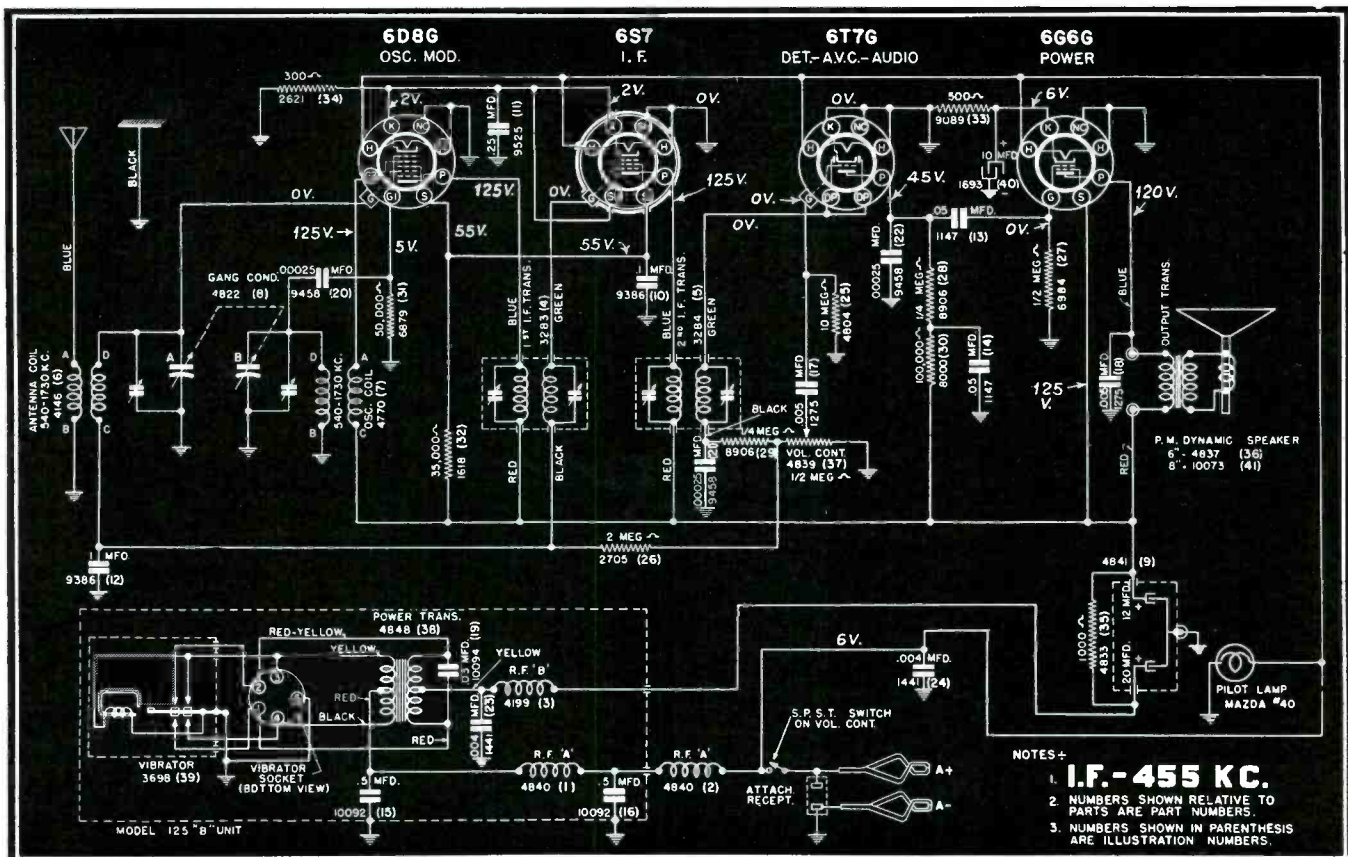

# CIRCUIT DIAGRAM AND ALIGNMENT OPERATIONS STEWART-WARNER 91-64, 98-64 (CHASSIS 910-64)

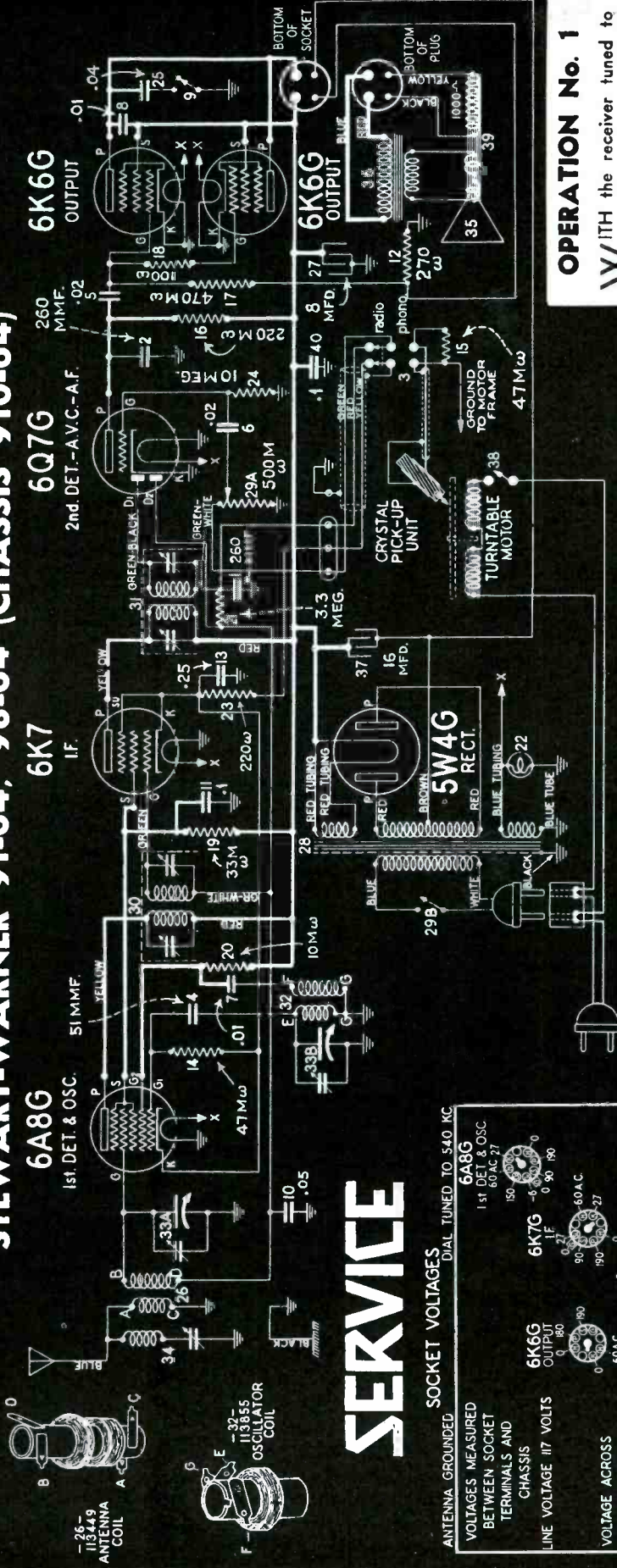

## SERVICE



**SPECIFICATIONS**  
Tuning: Manual and Automatic.  
Range: 540 to 1720 kc.  
I-F: 465 kc.  
Power Supply: 117v, 60c.  
Speaker: Electrodynamic; Field: 1000 ohms.  
Phonograph: A-C Operated.  
Pickup: High-Impedance Crystal.

**OPERATION No. 3**  
SHIFT the generator frequency to 1500 kc and feed this signal to the receiver antenna lead through a 200-mmfd condenser. Adjust trimmers 6 and 7 for maximum output. Repeat the entire alignment for greater accuracy.

**OPERATION No. 1**  
WITH the receiver tuned to a quiet spot near 600 kc, feed a 465-kc signal to the grid of the first-deflector-mixer tube through a 0.1-mfd condenser. Adjust i-f trimmers 1, 2, 3, and 4 for maximum output. Repeat the adjustment.

**OPERATION No. 2**  
WITH the signal generator still tuned to 465 kc, connect its output to the receiver antenna lead through a 200-mfd condenser. Adjust wave-trap trimmer 5 for MINIMUM output. It may be necessary to increase the signal generator output to obtain an optimum setting.

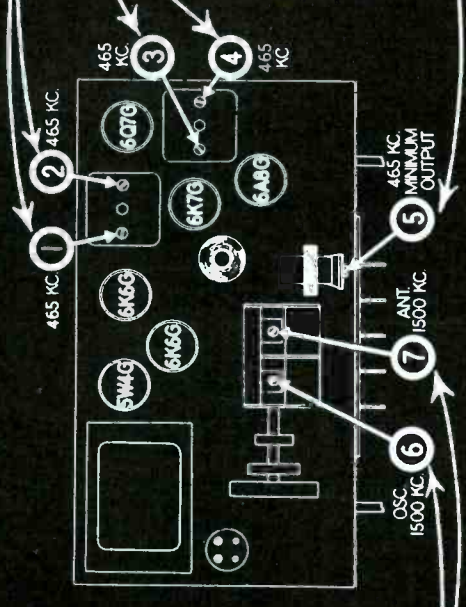

# FACSIMILE

By FRED C. EHLERT\*

**I**N ANY system of facsimile transmission the original printed matter must be analyzed in elementary dots or lines. That is, the picture is traced across point to point in consecutive horizontal lines, and the density value of each point is sent over the transmitting medium. At the receiving end, these dots must be recorded in their proper place and be of the same density as the original.

The Finch System makes use of this general method and the elementary dot is 0.01 in in diameter. Each traced line is about four inches long so there are about 400 dots to the line. The period of the sweep across each line is one-half second, so the rate of change is in the order of 800 dots per second. Accordingly, for each second of time a line 0.01 in in thickness is drawn, and the scanned copy as well as the recording paper is advanced 0.01 in. In order that each dot will appear in its proper place, the mechanism must be synchronized at the start of each line.

## TRANSMITTER

The scanning device incorporated in the transmitter consists of an 1800 rpm synchronous motor which drives (by means of a 30 to 1 worm reduction gear) a shaft carrying three cams. These cams in turn take care of all the necessary mechanical motion. The first cam operates a spring switch, which at the start of each stroke, closes the circuit to the line, and also shunts a condenser across the grid circuit of an oscillator and thus changes the frequency of the oscillator from a normal value of 2000 cycles per second to 500 cycles per second. As the tracing arm starts the stroke the 2000-cycle note is restored for the duration of the stroke. This same switch opens the line circuit during the return of the tracing arm.

\*Finch Telecommunications Labs., Inc.

When the Crosley 494 (a conventional) record player is used with special records it will demonstrate the facsimile recorder for your customers.



"Out of the air on to white paper . . . news flashes . . . sport reports . . . pictures . . . when they happen." Thirteen stations are already equipped to transmit pictures under the Finch system and are sending programs.

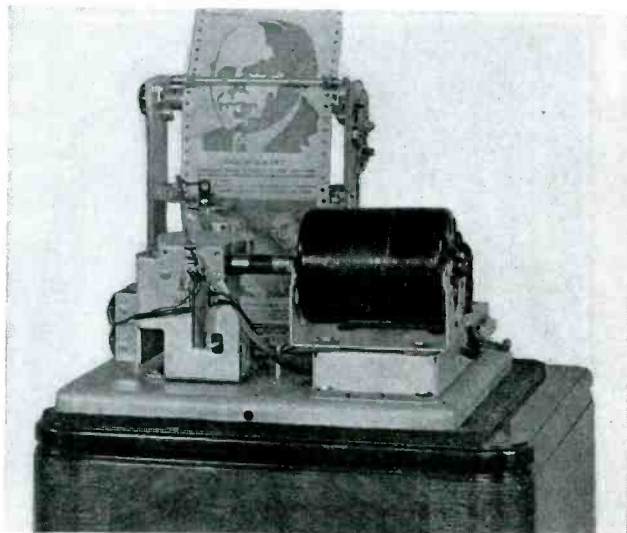

The second cam drives the tracing arm. This arm is 5½-in long and moves across the paper in an arc of this radius. A curved piece of spring metal holds the paper in position. On the arm is a lamp housing and lens system from which a beam of light is focused on the paper in a spot 0.01 in in diameter. Also carried on the arm is a photo electric cell into which the light from the paper is reflected. Then as the arm travels across the paper, the reflected light varies in accordance with the density of the printed matter, and this in turn



Transmission of pictures on the normal broadcasting band, 530 to 1570 kc, is now limited to hours between 12 p. m. and 6 a. m. Crosley electric time switch can turn on the recording equipment for the prescribed period.

varies the output of the photo cell. The output of the photo cell is used to change the amplitude of the signal from the oscillator mentioned above. The circuit is so arranged that, when the print is black, the amplitude is the greatest and any degree of grey causes a corresponding change of signal.

The oscillator employs a push-pull circuit and uses an audio transformer in the tuned circuit. Normally, the output frequency is 2000-cycles per second, but can be changed to 500-cycles per second by means of a condenser across half of the grid circuit. In operation, the 500 cycles is used only for a very short time at the start of each stroke for the purpose of synchronizing the scanning sweep to the recording sweep.

The 2000 cycles is used in the scanning of the material and its amplitude is controlled by the photo cell. The output of the oscillator is fed through an amplifier and out on to the line feeding the broadcast transmitter.

The third cam operates a ratchet mechanism which in turn advances the paper 0.01 in for each sweep of the arm. The advance is made on the return stroke of the arm when no signal is on the line.

One complete cycle of operation can be described as follows: as the arm starts the sweep stroke the 500-cycle note is on the line for about ten cycles, then the 2000-cycle note is on the line for the printing stroke, and the amplitude of this note varies with the density of the printing. On the completion of the printing stroke the line circuit is opened and the back stroke is started. When the stylus is approximately half way back, the advance mechanism moves the paper up and this vertical motion of the paper is completed by the end of the back stroke. At the completion of the back stroke the spring switch again closes the circuit to the line and the operation is ready to be repeated. The signal is then sent either by wire or radio facility to the receiver and recorder.

## RECORDER

The action of the recorder is very similar to the transmitter. It also consists of a synchronous motor drive, worm gear arrangement, and the same type of shaft and cam mechanism. The transmitted signal is received and amplified to the proper level. The signal is rectified by means of a full wave rectifier and the rectified current is connected to one contact of a cam operated spring switch. A filter that by-passes 2000 cycles is shunted across the secondary of the transformer that feeds the rectifier and is also connected to the spring switch. When the friction drive is locked, no 2000-cycle current is rec-

# The Biggest *News* in VIBRATORS



FROM coast to coast the best Parts Jobbers now have complete stocks of Meissner Vibrators—the finest that money can buy.

No expense has been spared to make the Meissner name mean "tops" on vibrators just as it always has on coils.

The Meissner line is complete, a model for every replacement—all extensively field tested.

Each Meissner Vibrator is manufactured, tested and aged on the shelf at the factory. Then it is tested again to be sure the metallurgical changes have not impaired its efficiency or uniformity. We believe this expensive safeguard is not done by any other vibrator manufacturer. It is your GUARANTEE of top quality. And, of course, Meissner Vibrators cost no more than less reliable ones.

Mail the coupon today or ask your Parts Jobber for your FREE copy of the Vibrator Replacement Guide. With its aid you can tell in a minute exactly which vibrator to use in what set for top efficiency.



# Meissner

MT. CARMEL, ILLINOIS

COMPLETE RECEIVER KITS • I. F. TRANSFORMERS  
SERVICE PARTS • DIALS • SWITCHES • TUNING UNITS

MEISSNER MFG. CO.

Mt. Carmel, Illinois, Dept. S-3

**FREE** copy of the Vibrator Replacement Guide is to be mailed to the address given below.

Name .....

Address .....

City..... State.....

"A FAMOUS NAME FOR TWO DECADES"

tified and no d-c reaches the switch until the 500-cycle note is received. When the 500-cycle note is received and rectified, d-c reaches the switch and from this point is connected to a magnetic release which starts the cam shaft in motion. The start of this motion opens the magnetic release circuit, removes the by-pass from the 2000-cycle circuit and connects the recording pen in the circuit. The 2000-cycle signal is then rectified and connected to the recording pen, the pen sweeps across the paper and, as it does so, the intensity of the voltage on the pen is varying in accordance with the amplitude of the 2000-cycle note, with this amplitude dependent on the density of the printed matter of the original. At the end of the stroke, the signal is cut off at the transmitter and the printing stops. On the return stroke the paper is advanced in the same manner as in the transmitter. About half way back the spring switch cam moves the switch to place the magnetic release in the circuit, close the by-pass circuit and removes the pen from the circuit. At the close of the stroke the friction drive is again held until the synchronizing pulse is received, and then the action is repeated. If the recorder is running in synchronism with the transmitter, the synchronizing pulse will come at the exact time that the friction drive is released and the machine will be essentially free running. If the recorder leads the transmitter the recorder will be synchronized at the beginning of each stroke. If the recorder lags behind the transmitter, the recorder will fall out of synchronism entirely.

#### PRINTING

The action of the actual printing is

A roll of coated paper feeds through the recorder a line at a time. A stylus moves back and forth across the paper emitting small electrical impulses synchronized with each dot as scanned and transmitted by the broadcasting station. Each dot penetrates the white coating on the paper.

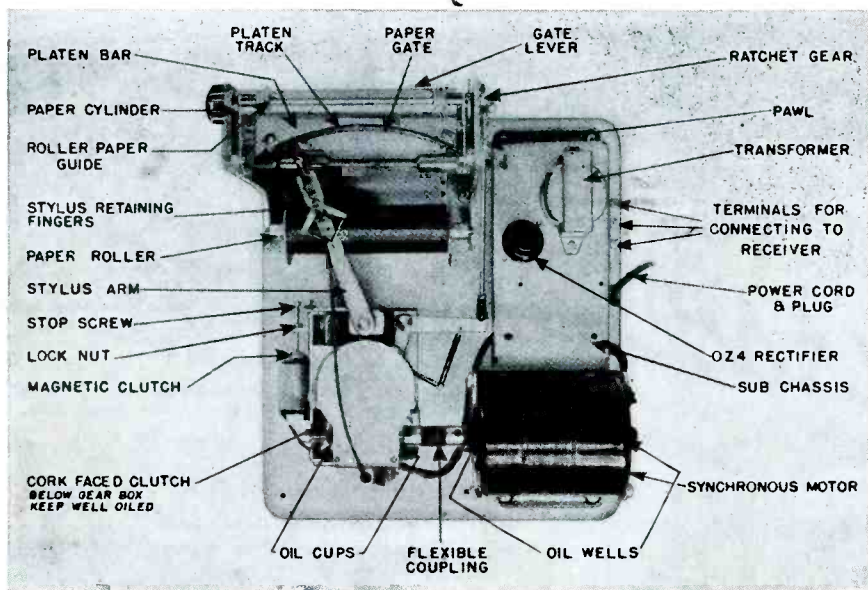

electro-chemical; when the rectified voltage is supplied to the pen, it comes in contact with a coated carbon impregnated paper, the current through the paper is a function of the applied voltage and the consequent removal of the surface coating is also a function of the applied voltage. The voltage is of course dependent on the amplitude of the 2000-cycle signal which is in turn dependent on the density of the printed matter.

#### CROSLY 118 READO PRINTER

THE Crosley Model 118 Reado printer is a home facsimile recorder designed to operate on a 60-cycle, 115-volt power line. It requires a radio receiver to supply the necessary audio signal for the printer. A time clock and special antenna are also available. Instruction for setting-up the printer are given herewith.

#### INSERTING PAPER

(A) The roll of paper should be placed on the roller so that if you were to pull on the end the paper would unroll toward you.

(B) Insert paper between the lower roller and the base.

(C) Lift stylus cleaning brush to a vertical position.

(D) Push lever, on back of platen bar to the left. (Platen is the center bar that supports paper for stylus.) This springs the paper gate open. Pull paper up between the gate and platen.

(E) Lift bar with the roller paper guides.

(F) Place paper over paper cylinder and through the opening in the back of the cabinet. Be sure that the paper fits over pins in cylinder.

(G) Release catch holding lever on platen bar, then push roller guides down on the paper.

(H) Replace cleaning brush so that the bristles just bear lightly on the paper, with the bristles toward the stylus.

#### STYLUS

For protection during shipment the stylus or pen is at right angles to the stylus arm.

Carefully spread metal fingers or prongs and turn the stylus assembly so that the point is toward the paper (be sure not to bend point) then release fingers. The metal fingers or prongs should hold the stylus assembly in line with the stylus arm.

Turn the motor by hand. To do this turn the rubber coupling away from you clockwise direction until stylus comes to rest at the left hand side of the paper.

While turning the motor by hand depress the magnetic clutch. The stylus will then move across the paper. Check the stylus pressure against paper by listening for a slight rub as stylus crosses paper. The correct pressure is indicated by a slight rub but not sufficient to leave a mark on the paper.

#### RATCHET AND PAWL

By turning the motor over by hand the operation of the ratchet and pawl (that

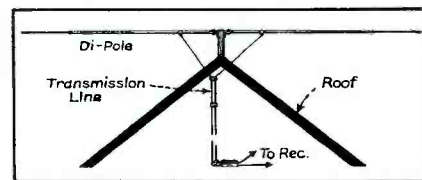

For minimum noise on the ultra-high-frequency band, on which daytime facsimile broadcasts are transmitted, Crosley suggests a special dipole.

moves the paper cylinder) can be checked.

While turning motor by hand and depressing the magnetic clutch as before; turn motor until the stylus arm is at the right hand side of the paper. While the arm is traveling back to the left side of the paper, the ratchet moves up one tooth and is locked by the pawl. This movement of one tooth acts through the gear train and turns the paper cylinder, so that the paper moves up 0.01 in.

If everything checks normal up to this point, plug the power cord into a convenient receptacle (110-volts, 60-cycles). With motor running, listen carefully for any excessive mechanical vibrations. If present they may be minimized by adjusting the four bolts that mount the motor bracket and the four bolts that mount the sub-chassis to the base.

#### CONNECTING TO RECEIVER

For the proper operation of the printer the receiver must have at least 5-watts distortionless power output, avc and a suitable arrangement for switching from recorder to radio and vice versa.<sup>1</sup>

#### TUNING-IN

The importance of accurate tuning to the facsimile signal cannot be overemphasized.

#### MAINTENANCE

*Care of the stylus:* The stylus may tend to bind in the bakelite block after considerable service due to small particles of carbon collecting on shaft. If this occurs, loosen collar and remove shaft and clean.

*Care of the platen plate:* The platen track is a strip of spring steel that is in back of paper gate and the platen bar. Due to the method of printing this track collects deposits of carbon after quite a few hours of service and will cause the stylus to stick or the printing density to vary in shade for one sweep. To clean, carefully turn stylus assembly at right angles to the stylus arm. This is done so as to pre-

<sup>1</sup>See "Finch RB Facsimile Recorder," SERVICE, Feb. 1939, p. 74.

(Continued on page 131)

# CAN YOU TEST THE TUBES

they'll announce

## NEXT MONTH?



NEW SUPREME MODEL 504

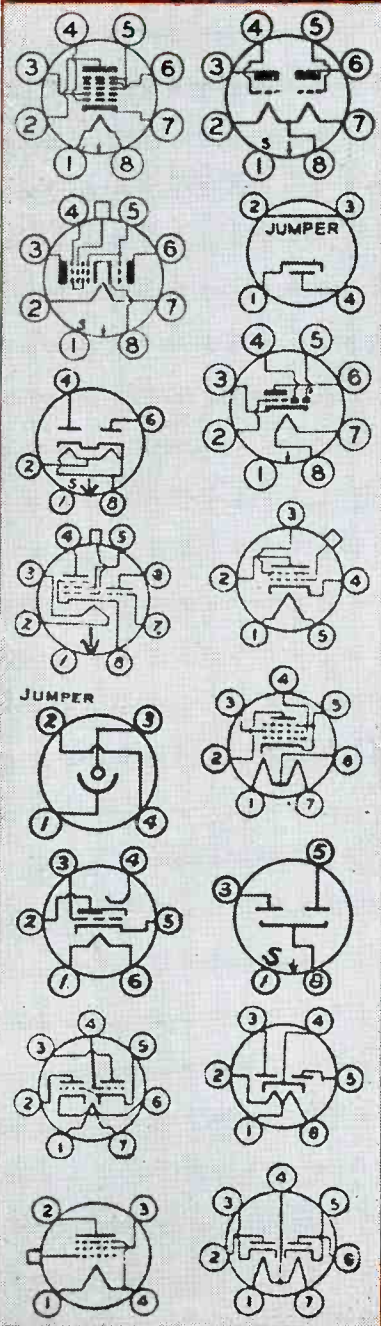

New filament arrangements just announced and to be announced are obsoleting thousands of tube testers. The demand for a better tube, one which would perform at higher frequencies, necessitated a mechanical change in tube design which resulted in the single-ended tube. This same mechanical change, primarily developed for television, has been incorporated in radio receiving tubes because of its many advantages. In changing the ordinary tube to a single-ended tube, filament termination can not be held constant; the grid gets the most consideration and the filaments have to look out for themselves.

At left are shown a few tube bases with different filament terminations. There are at present fifteen filament arrangements (1 & 4, 1 & 5, 1 & 6, 1 & 7, 1 & 8, 2 & 3, 2 & 7, 2 & 8, 7 & 8, 2 & 7 with filament center tapped at 8; 2 & 6 with filament center tapped at 1; 1 & 7 with filament center tapped at 6; 1 & 7 with filament center tapped at 4; and 2 tube base types without filaments). More new filament arrangements will soon be announced.

Remember, there are 143 different filament terminations possible without considering center-tapped type filaments. Center tapped filament combination possibilities raise this figure to several hundred.

Most tube testers in use today are already obsolete—the oft-bragged about spare socket is of little or no help, and the constant purchase of adapters will soon equal the original cost of the tester. So the average serviceman must buy a new tube tester—but which one? For TODAY'S tubes there are any number of new model tube testers to select from, but how about TOMORROW'S tubes—those which will be announced next month or next year?

### ONLY SUPREME HAS THE PATENTED "DOUBLE FLOATING" FILAMENT RETURN SELECTOR PUSH BUTTON SYSTEM!

No matter how filament terminations roam—no matter if they are center tapped or not—the SUPREME MODEL 504 "TOMORROW'S" TUBE AND SET TESTER will check them. With SUPREME'S unique and exclusive "Double Floating" Filament Return Circuit, you just press a button and the tube's filament is automatically connected across the filament potential supply, regardless of the tube's base terminations.

By terminating one side of the tester's filament supply in a rotary switch and the other side along a row of sturdy push-buttons, you can set-up any type of filament termination conditions possible. Center-tapped filaments present no problem—just set the rotary switch to the center tap and the push buttons to the corresponding filament ends. This places the two filament halves in parallel and provision is made to apply the correct filament potential across them. GET TOMORROW'S TUBE TESTER for TOMORROW'S TUBES!

### FULL COMPLEMENT OF USABLE RANGES

- 7 DC Voltage ranges—0.1 to 2500 volts—0/5/25/100/250/500/1000/2500.
- 5 AC Voltage ranges—0.1 volt to 1000 volts—0/5/10/50/250/1000.
- 7 Direct Current ranges—10 microamperes to 10 amperes—0/500 Microamperes/2.5/10/50/250 milliamperes/1/10 amps.
- 5 Output ranges—0.1 volts to 1000 volts—0/5/10/50/250/1000.
- 5 Ohmmeter & Megohmmeter ranges—0.1 ohm to 20 megohms—3.5 ohm center scale—0/200/2M/20M/2 meg/20 meg.

ALL electrostatic capacitors checked—for leakage up to 20 megohms on meter.  
 ALL electrolytic capacitors checked—for leakage on English Reading meter scale. Includes all capacitors and working voltages such as high voltage filters and low voltage by-pass types. All tests made at correct working voltages.

All ranges except DC 2500 volt and 10 amperes operate from but one set of pin jacks. New "Permi-grad" temperature compensated AC rectifier circuit. NO SAFETY SWITCH REQUIRED! Copper-oxide rectifier guaranteed the same as every other part. All multimeter ranges calibrated to within 2% on DC and 3% on AC. All current ranges use wire wound resistors. Individual, specially selected aged ceramic resistors used in balance of ranges. Uses 500 microampere meter built to U. S. Navy standards.

A complete portable laboratory with set tester ranges costing only 51c per range additional over comparative tube tester models.

Let us send you complete information on the Model 504. Then compare the 504 with (1) a \$40.00 tube tester (2) a \$35.00 set tester (3) a \$20.00 condenser analyzer. You get all of this, and more, in one compact unit. You'll say, too.—Model 504 is the buy.

See this remarkable value in tube and set testing equipment at your jobbers TODAY or write for full literature on this and many other completely new 1939 models of SUPREME test equipment!

CASH PRICE \$55.50. Installment terms, \$5.09 cash and 11 monthly payments of \$5.09.

**NOTICE:** Even if you wrote us last week, you still don't have the new illustrated literature, just off the press, covering the 504 and SUPREME'S complete 1939 line. Write for it TODAY!

# SUPREME

SUPREME INSTRUMENTS CORP.  
 GREENWOOD, MISSISSIPPI, U. S. A.

EXPORT DEPT., Associated Exporters Co., 135 W. 45th Street, New York  
 Cable Address: LOPREH, N. Y.

### MAIL COUPON TODAY!

SUPREME INSTRUMENTS CORP., Dept. S 4,  
 Greenwood, Miss.  
 Please RUSH me your newest information on SUPREME  
 504 and many other completely new SUPREME 1939 Models.  
 Name: \_\_\_\_\_  
 Address: \_\_\_\_\_  
 City: \_\_\_\_\_ State: \_\_\_\_\_

# Auto-Radio

## PERMEABILITY TUNING

(See Front Cover)

THE Cadillac 1939 Model C8 is an 8-tube auto radio featuring permeability tuning instead of the conventional gang condenser.

### ADDITIONAL FEATURES

Permeability tuning; a noise-limiting circuit in the audio system controlled by signal voltage developed by the second

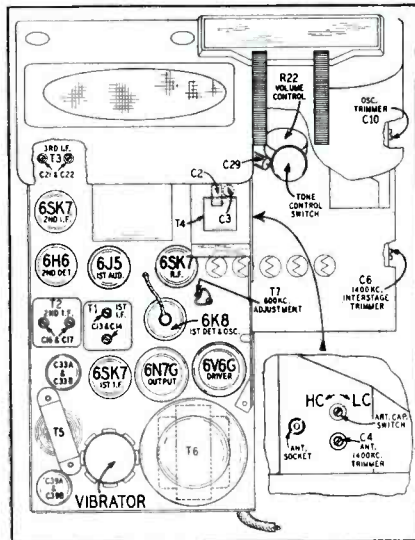

Cadillac C8, 8-tube auto-radio receiver features permeability tuning instead of the conventional gang condenser.

detector and the avc network, providing effective noise-limiting action without affecting sensitivity; two stages of intermediate frequency, increasing avc action; a three-circuit automatic tuner, providing the same sensitivity on both manual and automatic tuning sections; an off-switch incorporated in the push-button operating mechanism to provide practically complete automatic operation, making it necessary to push only one button to select a station, tune and turn on the radio.

### MANUAL TUNING

When the manual tuning button is depressed, the manual antenna tuning coil is connected to the grid of the 6SK7 r-f amplifier tube through a series motor-noise filter. The plate of the r-f tube is fed through a resistor and is capacity coupled to the detector grid of the 6K8 tube through the manual intermediate tuning coil. This grid is also controlled by the avc system through the manual intermediate tuning coil. The manual oscillator tuning coil is capacity coupled to the oscillator grid of the 6K8 tube in parallel with the fixed oscillator coil T7 which also functions as the low-frequency adjustment.

## CADILLAC C8 ALIGNMENT OPERATIONS

Connect Generator to	Dummy Antenna	Generator Frequency	Dial Setting	Peak Trimmer
Prong 4, 6SK7 second i-f.....	0.1 mfd	456 kc	1550 kc	C21, C22
Prong 4, 6SK7 first i-f.....	0.1 mfd	456 kc	1550 kc	C16, C17
Grid cap 6K8 first det.....	0.1 mfd	456 kc	1550 kc	C13, C14
Grid cap 6K8 first det.....	0.1 mfd	1550 kc	1550 kc	C10
Antenna.....	35 mmfd	1400 kc	1400 kc <sup>3</sup>	C6, C4
Antenna.....	35 mmfd	600 kc	600 kc	T7 <sup>4</sup>
Antenna.....	35 mmfd	1400 kc	1400 kc <sup>3</sup>	C10 <sup>4</sup>

<sup>1</sup>Insert antenna cable at chassis and short circuit open end of cable to cable shield for all i-f and oscillator adjustments.

<sup>2</sup>Remove antenna cable short circuit and insert 35 mmfd condenser between open end of antenna and signal generator.

<sup>3</sup>Tune to signal.

<sup>4</sup>Rock dial.

All the automatic tuning coils are open circuited when the manual tuning button is depressed.

Manual tuning is accomplished by varying the inductance of the manual tuning coils by changing the permeability of the magnetic circuit. This is accomplished by moving an iron core of special design in and out of the coil by rotating the manual station selector drum.

The extreme position of the iron cores within the coils has been precision adjusted at the factory and should not be disturbed.

### AUTOMATIC TUNING

Automatic tuning is accomplished by the use of a three-circuit push-button permeability tuner.

The tuning of the r-f, interstage and oscillator circuits, is accomplished by varying the inductance of the coils, by changing the permeability of the intermediate circuit and by moving the iron core in and out of the coil. The iron cores within the coils are rigidly secured to a brass rod. This brass rod moves in and out of the coils as the adjustment screw is turned, changing the inductance of the coils, giving the same result as the variable tuning condenser across the coil.

Alignment between the oscillator, antenna and interstage automatic tuning coils is obtained by changing the antenna (center) and interstage (rear) coil positions while the iron cores are held stationary on the shaft. To describe the connections for automatic tuning, let us assume that button No. 1 is depressed. (See front cover.) The automatic tuning antenna coil, No. 1, is connected to the grid of the r-f tube. The plate of the r-f tube is fed through a resistance and is capacity coupled to the automatic tuning interstage coil No. 2, which is connected to the control grid of the 6K8 tube. The manual in-

terstage tuning coil is short-circuited. The automatic tuning oscillator coil, No. 1, is capacity coupled to the oscillator grid of the 6K8 tube.

### CIRCUIT

Two stages of i-f amplification are employed, using 6SK7 tubes. The primary and secondaries of each of the i-f transformers are tuned by small trimmer condensers. Directly below the secondary of the second i-f is a third winding which couples the control grid circuit of the second i-f tube to the second i-f transformer.

The signal voltage across the secondary of the second i-f transformer is

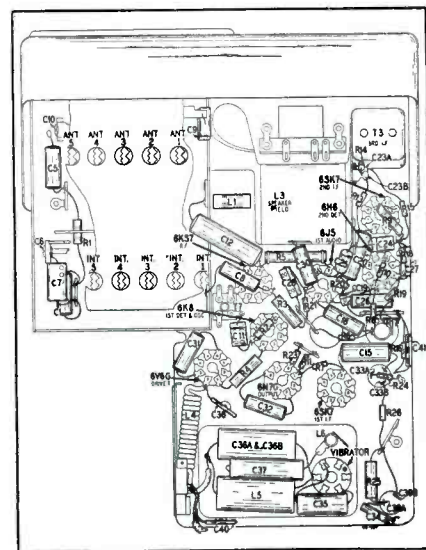

An off-on switch is incorporated in the push-button mechanism. This makes it necessary to push only one button to select a station, tune and turn on the receiver.

used to drive the plate of the avc section of the 6H6 tube. Avc voltage is applied to the control grid circuits of the r-f first detector and first and second i-f tubes. The rectified output of the second detector section of the 6H6



tube is applied to the control grid of the 6J5 tube.

At no signal, the 6J5 tube is biased to cut off by virtue of the current flowing through a resistor network (R16 and 17). This gives a constant potential across R17, which keeps the tube biased to cut off when no signal is being received. When a station is being received, a positive voltage is applied to the control grid by both sections of the 6H6 tube through resistor networks (R13, 14 and 15, and R18, 19 and 20), causing a very rapid reduction in bias so that the noise gate or noise limiter does not affect the sensitivity of the receiver.

The 6J5 is resistance coupled to the 6V6G driver tube. The 6V6G is transformer coupled to the 6N7G output tube. This tube is a class B power amplifier and combines two triodes in one envelope. A 6-in. electro-dynamic reproducer is employed.

Degeneration, or negative feed-back, is used in the audio amplifier. The voltage developed across the separate small secondary of the output transformer is fed back into the cathode circuit of the driver tube. The voltage fed back is of the proper phase to reduce the amplitude of certain frequencies. This results in a reduction in distortion.

A synchronous type vibrator is used in the power unit. This vibrator interrupts the current through the primary of the power transformer and also rectifies the current in the secondary circuit.

#### ALIGNMENT PROCEDURE

The chassis must be removed from the case, but the front cover must remain on the chassis with all screws in place. The volume control must be at maximum for all adjustments. The normal-quiet control must be in the normal position for all adjustments. The antenna capacity switch (see Fig. 2) screw should be in the maximum clockwise position for the low capacity (vacuum type) antenna. The total capacity of the low capacity antenna and the shielded lead is 59 mmfd. Connect chassis to ground post of signal generator with a short heavy lead.

#### ANTENNA TRIMMER

After the radio is installed and the car antenna is connected, it is necessary to readjust the antenna 1400 kc trimmer.

There are two small holes in the chassis case near the antenna connection through which the antenna capacity and antenna trimmer adjustments are to be made. (See Fig. 2.) With the Cadillac vacuum antenna, the screw marked "capacity" should be set to the extreme clockwise position. With the Cadillac under car or running board antenna, the

(Continued on page 130)

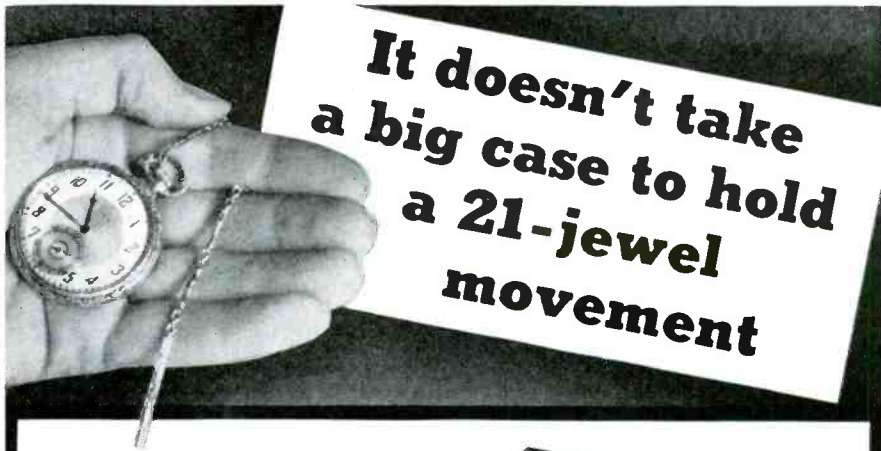

**J**UST as the small case often holds the finest watch or the finest camera, the Simpson Testing Instruments illustrated here are one more example of "good things coming in small packages." They are the final answer to every need for compact but versatile testers—built for life-time service—moderately priced.

Like the larger Simpson Testers, these smaller instruments reflect the beauty of design, the unerring accuracy, and the downright dollar value that could only have been built into them by Ray Simpson and a group of associates who have made a life study of instrument building.

There is a Simpson Instrument covering every conceivable requirement—each built to that high standard which can only be described as Simpson. Ask for complete descriptions. See them at your jobber's.

**SIMPSON ELECTRIC CO.**  
5214 Kinzie St., Chicago, Ill.

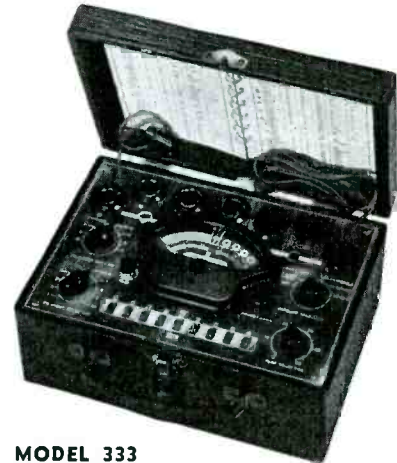

#### MODEL 333 TUBE TESTER

The "most" tube tester ever offered at the price. Tests all tubes including new Loctal and other late types. Has double-filament switching. Only 7½ x 10 x 5". Your price... **\$26.50**



**MODEL 215**—The first small instrument with big 4½ inch meter. Five A.C. and D.C. voltage ranges—five decibel ranges—0 - 10 - 100 - 500 milliamps; 0-250 microamps; 0-4000 - 400,000 ohms; 0-4 megohms. Your price... **\$25.75**

**MODEL 230**—Smallest A.C. - D.C. instrument on the market, yet has ranges of 0-10 - 250 - 1000 A.C. volts; 0 - 10 - 50 - 250 - 1000 D.C. volts; 0-10 - 50 - 250 D.C. milliamps; 0-1000 - 100,000 ohms. Your price... **\$14.25**



#### MODEL 240 "HAMMETER"

A remarkable value in a pocket size (5¼ x 2⅞ x 1¾") 3,000 volt, self-contained tester. Four A.C. and five D.C. voltage ranges at 1,000 ohms per volt; 0-15 - 150 - 750 milliamps; 0-3000 - 300,000 ohms. Your price... **\$14.75**



**MODEL 205**—Pocket size, but highest quality. Highest resistance ranges ever made in instrument of this size, 0-2000 - 200,000 ohms - 2 megohms. Volts, 0 - 10 - 50 - 250 - 1,000 D.C. only; milliamps, 0-10 - 500. Your price... **\$13.25**

See them  
at your  
jobber

**SIMPSON**  
INSTRUMENTS THAT STAY ACCURATE



--- with an  
**Augmented (bigger)**  
**Company of**

# Centralab

## LOW CAPACITY LEVER ACTION SWITCHES

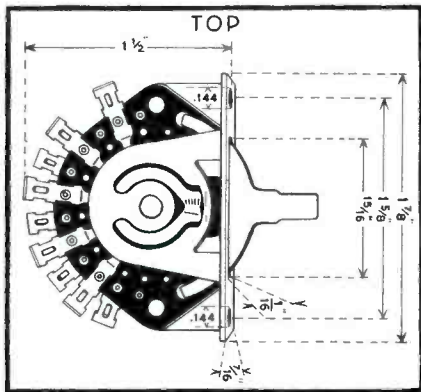

Contact clips of spring brass heavily plated (silver) treated for easy soldering. Switching combinations available use up to 12 clips per section.



It's been a "sell out" from the very start . . . the audience composed of set manufacturers, P.A. folks, broadcasting engineers, test instrument makers and industrial technicians have been giving this swell chorus their hearty approval.

Now . . . augmented combinations cover every probable requirement you may have. The program (libretto) now lists the complete line-up. Just write and ask for special Bulletin No. 680 for full details, or see your jobber.

**CENTRALAB: DIVISION OF GLOBE UNION, INC.** - - - -

**MILWAUKEE, WIS.**

# MICROPHONE RATINGS

By JOHN H. POTTS

**I**F YOU talk into a microphone, a minute voltage results across its terminals, which must be amplified to actuate a speaker. If the voltage is known, under specified conditions, it is possible to determine not only the amplifier gain required to produce a given electrical power output, but also the equivalent sound level which actuates the microphone. In order to do this, it is necessary to correlate microphone ratings with both amplifier and acoustical level ratings, all of which are expressed in different terms. It is the purpose of this article to show just how this may be done.

## MICROPHONE RATINGS

Microphones are rated on the basis of their electrical output for a given sound input. When you talk into the microphone in an average conversational tone at a distance of approximately 10 in., a sound pressure of one bar (or one dyne per sq. cm.) is exerted upon the microphone. This standard level of sound pressure causes the microphone to produce a small voltage of an amount depending upon its sensitivity. This sensitivity rating is expressed in db below a reference level of one volt per bar.

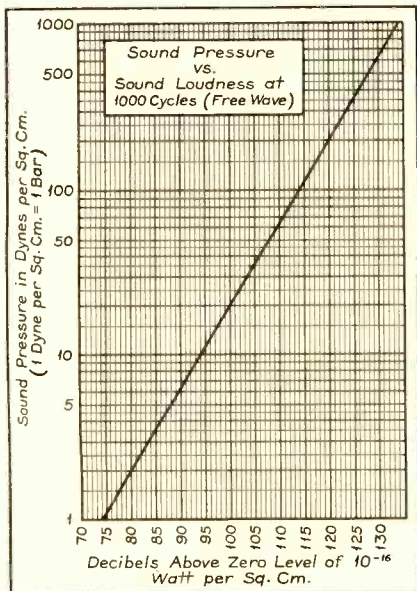

Fig. 2. A sound pressure of 1 bar (1000-cycles) is equivalent to 74 db above  $10^{-16}$  watts per sq. cm.

This rating is therefore a voltage ratio as follows:

$$\text{Microphone sensitivity in db} = 20 \log E_o/1 \text{ (per bar)}$$

in which  $E_o$  is the output voltage and 1 is the reference level of one volt. If the

output voltage for a sound pressure of one bar is  $10^{-3}$  volt (1 millivolt), the microphone rating is -60 db. Both sound pressure and voltage output are expressed in rms values. Most microphones are rated from about -60 db to -100 db corresponding to voltage outputs of  $10^{-3}$  and  $10^{-5}$  respectively. These are generally open-circuit output volt-

## MICROPHONE CHARACTERISTICS

**T**HE charts shown on the following pages are the result of an attempt to present the specifications and characteristics of all commercially available microphones. They are compiled by R. Lorenzen from data supplied by the various manufacturers.

Information on the subject of microphone characteristics is scarce, largely because such characteristics are exceptionally difficult to determine and any discussion is extremely involved and rather uninteresting.

We can only say that the reliability of the manufacturer as well as your own past experience should have more weight than the figures presented.

The output ratings given by the manufacturers are based upon several reference levels. To be able to convert from one to the other the exact conditions of test should be known. There is, however, only 4 or 5 db difference between the ratings based upon the 0.006-watt level and those based upon the 1-volt-per-bar level. Those with the latter reference level usually look worse, that is the rating will be a larger negative number for the same output.

ages, whether or not the microphone is designed to work into a low-impedance line. A microphone with a built-in transformer designed to work into a 250-ohm line, for example, will give only half this rated output when the line is terminated with a 25-ohm load, corresponding to that of a suitable matching transformer. This reduces the level by 6 db.

Some microphones are rated on a basis of a sound pressure of 10 bars. To convert such a rating to a one-volt-per-bar rating, simply add -20 db to the latter. Thus a microphone which delivers 1-millivolt output for a sound pressure of 10 bars will produce 0.1 millivolt at a 1-bar level and its rating at the lower level would be -80 db instead of -60 db. The 10-bar level cor-

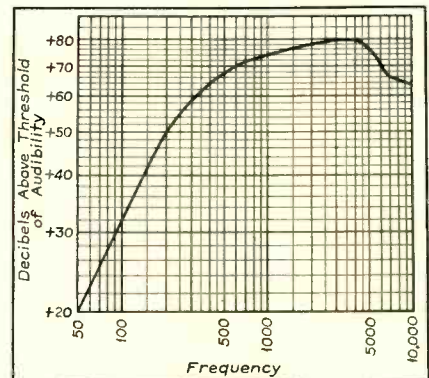

Fig. 1. One bar tones of different frequencies have different loudness levels.

responds to about four times the sound pressure produced by the average speaker before an average audience.

## AMPLIFIER GAIN

In order to find the amplifier gain required to produce a given electrical power output, it is usually necessary to convert the microphone voltage output to a power output level, since all amplifiers are rated by the ratio output power delivered to the speaker to the input power required to produce this output. The input power is that which is dissipated in the input resistance of the amplifier. When this resistance is low, and matches that of the microphone, no difficulty arises. But when the microphone works directly into a high resistance, representing the grid load of the input tube misleading results occur. For example, a microphone of a high-impedance type, designed to work into a 2000-ohm line, would deliver substantially the same voltage to an amplifier with an input resistance of 1-meg as it would to 10-meg. There would, however, be a 10-db variation in *input power* while the *output power* of the amplifier would remain constant. Often, too, the impedance of the cable connecting the microphone to the amplifier will be lower than that of the input resistance of the amplifier.

For practical purposes, it is customary to assume that the input resistance of the amplifier is from 80,000 to 150,000-ohms for the purpose of calculating gain. The actual figure used is, or should be, given by the amplifier manufacturer. Even this artifice causes misleading results when there is a wide discrepancy between the microphone in-

(Continued on page 135)

CRYSTAL MICROPHONES (Continued)														
MANUFACTURER	MODEL	PRICE \$	IMPEDANCE (Ohms)	OUTPUT FOR REF. LEVELS SEE FOOTNOTES	FREQUENCY RANGE (Cycles)	db VARIATION OVER FREQUENCY RANGE	DIRECTIVITY	CABLE SUPPLIED (Feet)	FINISH	ACCESSORIES INCLUDED	SPECIAL FEATURES	COMMENTS		
* SHURE BROTHERS	700D	25.00	NOTE 1 5 MEG.	NOTE 3 -52	30- 10,000	±5	NOTE 6 SEMI	NOTE 7 25	SATIN CHROME	-	TILTING HEAD	-		
	701D	"	5 MEG.	-52	"	±5	SEMI	" 25	"	-	SKYSCRAPER GRILL-TYPE CASE	-		
	702D	"	"	-52	"	±5	SEMI OR NON-DIR.	" 25	"	-	SPHERICAL CASE	-		
	705D	"	"	-52	"	±5	SEMI	" 25	"	-	TILTING HEAD	-		
	706S	27.50	GREATER THAN 500,000	-50	SPEC. RISING CHARACTERISTIC	•	"	" 7	"	DESK MOUNT	"	COMMUNICATIONS TYPE		
	720B	45.00	5 MEG.	-74 -63 -78 ‡	NOTE 3 30-10,000 5 30-10,000 10-10,000	±5 ±7	NON UNI BI	" 25	"	-	UNI-DIR. BI-DIR. OR NON-DIR. RESPONSE SELECTED BY SWITCH IN MIC.	-		
	730A	29.50	"	-62 ‡	30- 10,000	±	UNI	" 25	"	-	TILTING HEAD	-		
	750A	25.00	"	-50	"	±7½	-	7	SATIN CHROME IRIDESCENT GREY	-	HAND MIC.	-		
	760A	30.00	"	-40	SPECIAL HIGH INTELLIGIBILITY VOICE RESPONSE	•	-	7	"	-	HAND MIC. SPECIAL DISCRIMINATION AGAINST BACKGROUND NOISE	-		
	70H	22.00	"	-44	30- 10,000	±7½	SEMI	NOTE 7 7	SATIN CHROME	-	-	HEAVY DUTY MODEL		
70SW	25.00	GREATER THAN 500,000	-44	SPEC. RISING CHARACTERISTIC	•	"	" 7	"	DESK MOUNT	-	COMMUNICATIONS TYPE			
76B	25.00	"	-50	SPECIAL CHARACTERISTIC	•	"	25	IRIDESCENT GREY	-	WEIGHT ONLY (½ OZ. CLIP LABEL TYPE)	SPECIAL CHARACTERISTIC TO COMPENSATE FOR ANGULAR PICKUP			
SUNDT ENGINEERING COMPANY	211	30.00	5 MEG.	NOTE 3 -48	•	±5	30°	25	BLACK	-	MIC. HANGS AROUND NECK, LEAVING SPEAKERS HANDS FREE WHILE TALKING	-		
THE TURNER COMPANY	77	27.50	1 MEG. APPX	NOTE 3 -54	40- 8000	±4 APPX	SEMI OR NON-DIR.	25	BRONZE	-	-	-		
	55-C	15.95	"	-56	50- 7000	"	SEMI	15	PLATED	-	-	-		
	55	14.95	"	-56	"	"	"	8	BLACK & ALUMINUM	-	-	-		
	30-30	22.50	"	-54	40- 8000	"	"	25	BLACK & CHROME	-	-	-		
	78	30.00	"	-70	20- 2000	"	"	8	CHROME	-	HEART BEAT PICKUP	-		
	83-B	25.00	"	-60	60- 8000	"	"	25	BLACK	-	LAPEL MIKE	-		
	30-36	27.50	"	-52	150- 8000	"	"	8	CHROME & BLACK	SPEC. SW.	-	-		
	30-B4	24.00	"	-52	160- 8000	"	"	25	"	-	-	-		
	VT-73	18.00	"	-50	150- 8000	"	SEMI OR NON-DIR.	6	"	-	-	-		
	30-36	26.50	"	-52	"	"	SEMI	8-25	"	-	HAND MIKE	-		
	30-BT	24.00	"	-52	100- 8000	"	"	8-25	"	-	-	-		
	30-BTS	25.00	"	-52	10- 8000	"	SEMI OR NON-DIR.	8-25	"	-	-	-		
	T-9	19.50	"	-56	50- 7500	"	SEMI	8	"	-	-	-		
	24	22.50	"	-52	"	"	"	8	CHROME	-	-	-		
	DB-50	22.50	"	-50	"	"	"	8	BROWN & CHROME	-	-	-		
2-X	50.00	"	-65	20- 10,000	"	NON	25	CHROME	-	LABORATORY MIC.	-			
38	22.50	"	-56	40- 7500	"	"	25	"	-	-	-			
UNIVERSAL MICROPHONE COMPANY LTD	202	18.50	5 MEG.	NOTE 2 -70	50- 5000	±3 APPX	UNI	10	POLISHED CHROME	-	HAND MIKE	-		
	203	22.50	"	-60	"	"	"	10	"	-	"	-		
	15MM-X	24.50	"	-64	"	±2 APPX	SEMI OR NON-DIR.	25	"	DUVELO CLOTH HOOD	-	-		
* NOTE 1: IMPEDANCE IS VALUE OF TERMINAL RESISTANCE TO BE USED FOR SPECIFIC FREQ. RESPONSE. LOWER TERMINAL RESISTANCE CAN BE USED WITH SOME LOSS OF LOW FREQ. RESPONSE. NOTE 2: 0.006 WATTS. NOTE 3: 1 VOLT PER BAR. NOTE 4: 0.01 WATT ON 500Ω LINE. NOTE 5: LOW FREQ. RESPONSE DEPENDS ON DISTANCE BETWEEN SOURCE AND MICROPHONE. NOTE 6: DIRECTIVITY CONSIDERED IN BOTH HORIZ. AND VERTICAL PLANES. NOTE 7: BUILT-IN CABLE CONNECTOR WITH PLUG ATTACHED. ‡ OUTPUT AT END OF 25 FT. CABLE. • NO INFORMATION SUPPLIED.														
CARBON MICROPHONES														
MANUFACTURER	MODEL	PRICE \$	IMPEDANCE (Ohms)	OUTPUT FOR REF. LEVELS SEE FOOTNOTES	FREQUENCY RANGE (Cycles)	db VARIATION OVER FREQUENCY RANGE	No. OF BUTTONS	BUTTON VOLTAGE	BUTTON CURRENT (Ma)	DIRECTIVITY	CABLE SUPPLIED (Feet)	FINISH	SPECIAL FEATURES	COMMENTS
ELECTRO-VOICE MFG. CO., INC.	50	5.00	200	NOTE 4 -40	45- 6000	•	DOUBLE	•	•	SEMI	0	GUNMETAL	-	-
	75	7.50	"	-40	40- 7000	•	"	•	•	"	6	"	-	-
	100	10.00	"	-40	"	•	"	•	•	"	6	GUNMETAL & CHROME	-	-
	202	12.00	"	-40	40- 5000	•	SINGLE	•	•	UNI	6	BLACK	-	-
SHURE BROTHERS	3B	5.50	200	NOTE 3 -42	30- 5000	±10	DOUBLE	-	4-7	SEMI	0	SATIN CHROME	SPRING MOUNT	-
	5B	10.00	"	-42	30- 7000	"	"	-	"	"	0	"	"	-
	10B	10.00	"	-42	30- 5000	"	"	-	"	"	6	"	CONVERTIBLE HAND MIKE	-
	15A	15.00	"	-42	"	"	•	-	"	-	7	SATIN CHROME IRIDESCENT GREY	HAND MIKE	FITS IN PALM OF HAND
	16A	20.00	"	-30	•	•	•	-	"	-	7	"	SPECIAL DISCRIMINATION AGAINST BACKGROUND NOISE	"
STROMBERG-CARLSON TELEPHONE MFG. CO.	6		100	NOTE 2 -20	•	•	SINGLE	1.5	15	•	•	-	HAND MIKE	-
	D-2948		"	-20	•	•	"	1.5	15	•	•	-	DESK MIKE	-
UNIVERSAL MICROPHONE COMPANY, LTD	W	3.00	200	NOTE 2 -38	200- 2000	±5 APPX	SINGLE	3	•	SEMI	0	BLACK BAKELITE	-	-
	A	15.00	"	-45	100- 3500	±3	"	3	•	"	0	POLISHED CHROME	SPRING MOUNTING	-
	XX	10.00	400	-50	100- 4000	"	DOUBLE	3	•	"	0	"	"	-
	XI	7.50	200	-50	"	"	SINGLE	3	•	"	0	"	"	-
	BB	25.00	400	-50	50- 5000	"	DOUBLE	3	•	"	0	"	"	-
	200	10.00	200	-40	150- 3000	"	SINGLE	3	•	UNI	6	"	HAND MIKE	-
	201	15.00	400	-55	100- 4000	"	DOUBLE	3	•	"	6	"	"	-
	AR-IM	35.00	200	•	200- 3000	"	SINGLE	•	•	"	4	BLACK	"	-
	AR-IS	35.00	"	•	200- 3000	"	"	•	•	"	4	"	"	-
HW	5.00	"	•	200- 2000	"	"	•	•	"	6	BRONZE	"	-	
NOTE 2: 0.006 WATTS. NOTE 3: 1 VOLT PER BAR. NOTE 4: 0.01 WATT ON 500Ω LINE. • NO INFORMATION SUPPLIED.														

# NOW

## .. ULTRA HIGH FREQUENCY SIGNALS WHERE YOU WANT THEM



### 24 hours a day!

### WITH THE NEW WESTON Television ULTRA HIGH FREQUENCY OSCILLATOR

- Frequency—continuous range 22 to 150 megacycles—no band switching.
- All frequencies fundamental.
- High order of stability and resetability over entire range.
- Equipped for television modulation.
- Employs continuously variable inductive tuning.\*
- Battery operated (self contained).
- Equipped with 400 cycle modulator.
- Used with portable antenna (included) or with standard output leads.
- Jack provided for external power to increase radiation.
- Over 5700 degrees of continuous dial rotation.
- Meter equipped for six control measurements.
- Small size, light weight, extreme portability.

\* Patents Pending



Essential for all branches of television, for police radio, aircraft, maintenance trucks, etc.

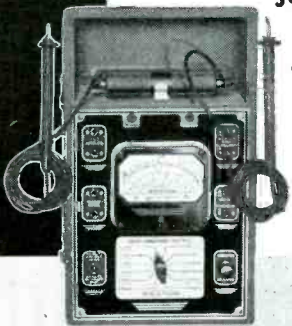

Model 772  
5000 VOLT

#### TELEVISION AND RADIO ANALYZER

Sensitivity 20,000 ohms-per-volt.  
 Input impedance 100 megohms on top range.  
 Specially designed low-leakage jacks.  
 Breakdown voltage in accordance with AIEE safety standards... 11,000 volts.  
 Current readings down to 1/2 microampere.

NOTE—present owners of 20,000 ohms-per-volt analyzers can bring them up-to-date with the compact WESTON 5,000 volt Televerter... an inexpensive multiplying unit which fits the carrying case.

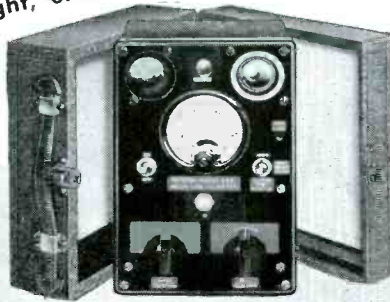

Model 669

**VACUUM TUBE VOLTMETER**—measures gain in video and sound amplifying channels—peak voltages in thyatron (saw-tooth) generators in oscillator circuits—grid potentials on cathode ray tubes—as well as other essential measurements in all sound receivers.

SEND COUPON FOR COMPLETE INFORMATION

Weston Electrical Instrument Corporation  
 604 Frelinghuysen Ave., Newark, N. J.  
 Send bulletin describing the Model 787 Ultra High Frequency Oscillator and other WESTON Instruments.

Name \_\_\_\_\_  
 Address \_\_\_\_\_  
 City \_\_\_\_\_ State \_\_\_\_\_

# MILLION VOLT RESISTORS...

Maybe you don't need million volt resistors . . . yet it is worth knowing that the same famous IRC Metallized resistance principle, best known in the little 1/2-, 1- and 2-watt Insulated Resistors for radio use, has now made possible outstanding advances in both high voltage and ultra high frequency resistors for advanced scientific research purposes.

10,000 ohms at 1/2 watt—100,000 volts at 150 watts—1,000 megohms at 150 volts . . . regardless of the need, the IRC Metallized element can supply them all, dependably and economically.

"Metallized" Resistors are made under IRC patents in eight countries. The Metallized type of element is the most adaptable yet produced. No other resistance material holds such an outstanding record of past success. None holds such broad possibilities for future development. Whatever your need—insist on the best!

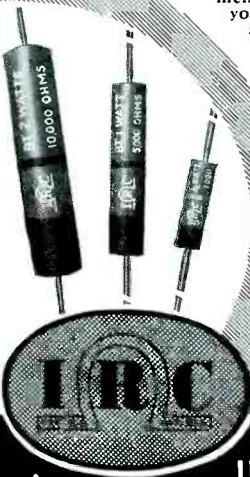

*"They Stay Put"*

**INSULATED**  
*Metallized*  
**RESISTORS**

TYPE BY  
**INTERNATIONAL RESISTANCE CO**  
401 N. Broad St., Phila., Pa.

## ELECTROLYTICS

(Continued from page 106)

ber washer which seals the ends of the unit, with a very small needle. When pressure is exerted the rubber stretches outward, opening the hole.

### A-C LIMITATIONS

Although the dry electrolytic condenser is normally a d-c device, the nature of its applications are such that some amount of alternating current must flow through it. The alternating voltage is always superimposed on a much greater value of d-c voltage in the common functions in sets or d-c voltage supplies. This means that the anode is always at a positive potential with respect to the cathode lead, but that this potential may vary slightly about a mean. The variation in potential causes current to flow through the condenser. The amount of this alternating voltage or ripple voltage is not detected by the ordinary voltmeter and may give rise to unsuspected voltage peaks which will be dangerously close to the breakdown voltage of the unit. The voltage may be measured either by a cathode ray oscilloscope or by a peak-reading voltmeter. Lacking these instruments it may be computed by inserting an a-c milliammeter in series with the condenser. The voltage is then 1.4 times the product of the current (in amperes) and the impedance of the condenser. The impedance is obtained with sufficient accuracy by the following formula.

$$Z = \frac{10^9}{2\pi f C}$$

The alternating current causes a decrease in capacity over periods of time if allowance is not made for it. The cause of this loss of capacity is because the direction of the alternating current on each half cycle is such that a film may be formed on the cathode connector plate. The alternate half cycles do not tend to remove it. The effect of the film is to place another condenser in series with the original one with the inevitable decrease in resultant capacity of the combination.

The decrease in capacity of the entire condenser is obviously dependent on the value of the capacity due to the film on the cathode connector. If this capacity is very large, the decrease is small and conversely. The cathode formation is fortunately equivalent to a very low voltage formation; the film is extremely thin. This results in very high capacity per unit area. For the higher voltage condensers the effect is so slight as to be negligible. For example, an 8-mfd, 450-volt condenser, the capacity added by the cathode formation may be several hundred mfd and the decrease in

# COILS



- Ideal for replacement use.
- Complete line.
- I. F. Transformers.
- Antenna, R. F., and Oscillator coils.
- Iron Core or Air Core Types.
- Mica trimmed and permeability tuned types.
- Litz wire wound.
- Fully guaranteed.

• Consolidated coils are made uniform by rigid manufacturing control plus prealigning and checking on special testing equipment. Each coil treated carefully with special compound to exclude moisture and assure permanency of original adjustment.

See Them at Your Parts Dealer's Today!

**CONSOLIDATED**  
WIRE AND ASSOCIATED  
**CORPORATIONS**

518 S. PEORIA ST. CHICAGO, ILL.

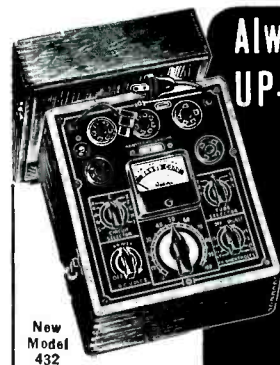

Always Kept  
UP-TO-DATE

*Readrite*  
RANGER

only  
**\$21.60\***

\* Complete in Quartered-Oak Case

**CHECKS ALL TYPES RADIO RECEIVING TUBES**

**Model 431 . . . . . \$15.90**

Checks all receiving tubes. (No ballast or gaseous rectifier test.) Tester uses dependable Readrite meter. Quartered-Oak case same as for Model 432.

- Tests New 1.5, 35 and 50-volt Series, Loctal Base Types, OZ4 and Other Gaseous Rectifiers.
- Separate Plate Tests on Diodes and Rectifiers.
- Neon Short and Leakage Tests.
- Ballast Tube Continuity Test.
- Uses Attractive Triplett Direct Reading Instrument, 3" Size. (GOOD-BAD) Scale.
- Line Voltage Adjustment.
- New Improved Low Loss Switch.

Write for Catalog.

READRITE METER WORKS  
Section 317, College Drive  
Bluffton, Ohio

Please send me complete information on new Model 432.

Name .....

Address .....

City..... State.....

overall capacity is unimportant. For low voltage condensers the effect cannot be neglected. An 8-mfd, 10-volt condenser would show considerable drop, for in this case the capacity added in series by the cathode formation could very easily be of the order of 8 mfd also. The resultant capacity would then be about 4 mfd or a drop in capacity of 50%.

With plain foil condensers the effect is not too noticeable even for the low voltage units. With the demand for very small condensers using etched foil, it became highly important, since this resulted in a decrease in size of anode by the amount of the increased surface due to etching. Plain foil cathode connectors cannot be used for the low voltage etched foil units for these reasons. To eliminate the difficulty, one of three remedies is possible. The cathode may be of etched foil, so that when its film is formed it will be of sufficiently high capacity to cause no appreciable drop in the net capacity of the condenser, the cathode may be initially formed to a low voltage so that no additional formation is possible by the range of currents encountered, or an excess capacity may be allowed in the design such that when capacity drops, it will still be within the desired range.

This problem of cathode formation then serves as a further limit on the value of alternating current which may be allowed to flow through an etched foil unit.

A table of maximum permissible currents which apply to the small metal clad condensers is given in Fig. 2. These values take into consideration the peak voltage limitations, cathode formation and also heat radiating ability.

#### A-F CHARACTERISTICS

Electrolytic condensers differ considerably from oil or paper condensers with respect to their a-f characteristics. In the latter types the power factor is fairly constant over wide ranges whereas, in the former it increases very rapidly with frequency. In oil condensers the greatest portion of the equivalent series

Fig. 2. Although the electrolytic is essentially a d-c device the nature of its applications are such that some a-c must flow through it. A table of the maximum permissible a-c for small etched foil units is given below.

D.C. Working Voltage	Capacity Ratings - Mfds.							
	4	8	12	16	20	30	40	
150	65	110	140	150	185	190	200	
200	65	110	130	150	160	170	200	
250	65	100	120	140	150	160	175	
300	70	100	120	130	140	150	160	
350	70	100	120	130	130	140	150	
400	70	100	110	120	130	140	140	
450	70	100	110	110	120	130	140	

# Sure you can own a RIDER CHANALYST!

**NATIONAL UNION WILL GIVE YOU ONE  
IF YOU BUY 80 N. U. TUBES AND/OR  
ELECTRO CONDENSERS PER MONTH**

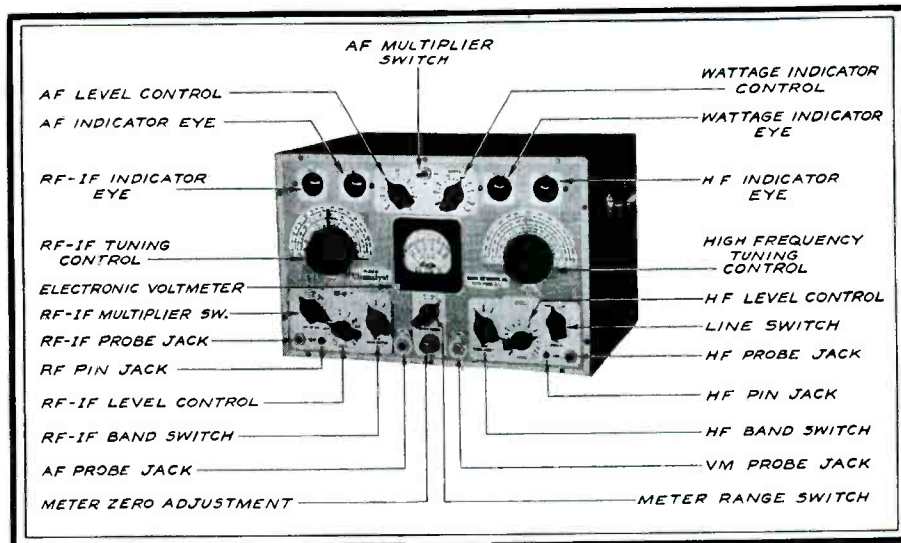

## ASK YOUR NATIONAL UNION JOBBER HOW TO GET A CHANALYST FREE

The CHANALYST is a great piece of modern high efficiency test equipment . . . an invaluable asset to your service business. It is guaranteed by John F. Rider and approved by National Union Engineers. Now YOU can own one.

*Come on!*

**BUILD CUSTOMER CONFIDENCE  
WITH NATIONAL UNION  
TUBES and CONDENSERS!**

NATIONAL UNION RADIO CORP. 8-339  
Newark, New Jersey

Who is nearest Nat. Union Jobber?

Name.....  
Street.....  
City..... State.....

resistance is made up of the losses in the dielectric and but very little is contributed by the resistance of wires and connecting mediums. The losses in the dielectric vary considerably with frequency but the product of R and f are approximately constant, and it follows that the power factor ( $2\pi fRC$ ) is also constant.

In electrolytic condensers part of the equivalent series resistance is made up of the electrolyte. The electrolyte resistance doesn't change its value to any great extent over wide ranges of frequency. The result is that the product of f and R is not a constant but increases with frequency, and so the

power factor also increases. Fig. 3 shows these variations for a high voltage unit, and Fig. 4 for a low voltage. It will be noted that the effective capacity drops in value appreciably with increasing frequency.

In the receiver operation at the higher audio frequencies is generally confined to the electrolytics employed as cathode by-pass condensers. Since the high frequency current is relatively low, the problem of excessive heating does not often occur and so the power factor is relatively unimportant. The impedance is made low by using higher capacities. From 10 to 50 mfd are commonly used. (See Fig. 4.)

# Better RESISTORS

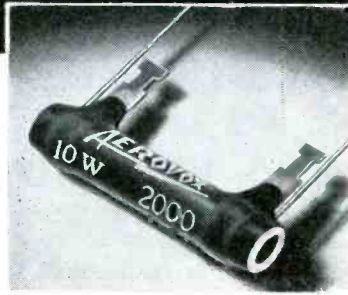

• Fit companions for AEROVOX condensers, these AEROVOX resistors are the product of constant refinement over a decade and a half. You'll be surprised how good wire-wound or carbon resistors can really be. Just try them!

## PYROHM, JR.

- A lot of power resistor in a mighty small size. Due to better grade materials. Quality resistance wire. Crack-proof refractory tubing. Coated with powdered glass enamel fired at red heat. Vitreous enamel tightly fused to wire, terminal connections, tubing. 10- and 20-watt. Popular resistance values.

## SLIDEOHM

- Same specifications as above but with adjustable slide band contact. Any resistance value and tap within unit's range. Additional contact bands at slight added cost. 25, 50, 75, 100 and 200 watt ratings. Popular values.

## CARBON

- Insulated molded carbon resistors in 1/2 and 1 watt ratings. Lacquer coated carbon resistors in 1/4, 1/2 and 1 watt ratings. All popular resistance values. They stand up best!

## Ask Your Jobber . . .

- Along with those AEROVOX condensers, get AEROVOX resistors and place your jobs on the soundest basis. Get your copy of our latest catalog—from local jobber or from us direct.

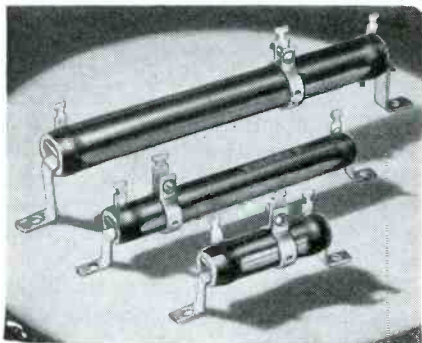

**AEROVOX**  
CORPORATION  
NEW BEDFORD, MASS.  
IN CANADA: AEROVOX CANADA, Limited Hamilton, Ont.

## PERMEABILITY TUNING

(Continued from page 121)

screw marked "capacity" should be set to the extreme counter clockwise or high capacity position.

To adjust trimmer, tune in a weak signal at approximately 1400 kc with the volume control about three-fourths on, turn the adjusting screw (marked trim) in or out until maximum output is obtained. On vacuum antenna this adjustment should be made with antenna fully extended.

### SPECIFICATIONS

Chassis No. 1433970.  
Tuning: Manual and automatic.  
Range: 530 to 1560 kc.  
Sensitivity: Manual and automatic, 1 microvolt at 0.5 watt output.  
Selectivity: 35 kc at 1000 times the signal.  
I-F peak: 456 kc.

Antenna capacity screw settings:

Low capacity: 59 mmfd, in tight (clockwise), total of antenna and shielded cable.

High capacity: 193 mmfd, out (counter clockwise), total of undercar antenna and shielded lead.

Trimmer range: + or - 15 mmfd.

Power supply: 6.3 v. d-c.

Power consumption: 8 amp at 6.3 v.

Speaker: 6-in, electro dynamic.

Tube complement:

R-F amplifier: 6SK7.

First detector-oscillator: 6K8.

I-F amplifier: 6SK7 (2).

Second detector-avc: 6H6.

First audio-noise limiter: 6J5.

Driver: 6V6G.

Power amplifier: 6N7G.

Vibrator: Synchronous.

## INDUCTIVE TUNING

(Continued from page 109)

siderably the natural frequency of the unused portion. This is automatically taken care of by the ground contactor at the low-potential end of the coil.

There are two factors that account for the increased frequency coverage of the inductive tuner over that of the variable condenser

(1) The LC product of the inductively-tuned circuit may be reduced to a much smaller magnitude than in the case of the variable-condenser circuit where the LC product minimum is limited by the minimum capacity of the variable condenser plus the capacity of the external circuit. This is especially true in high-frequency circuits where the minimum capacity of the variable condenser and leads is a large percentage of the total.

(2) By increasing the number of turns in the variable-inductance coil, the low-frequency end of the tuned circuit may be extended so long as the natural frequency of the unused part of the coil is above the operating range. Actual pro-

**ASTATIC**  
MODEL T-3

**THE MIKE THEY LIKE**

Entertaining artists and speakers alike marvel at the performance and flexibility of Astatic Model T-3 Crystal Microphone. Self-locking, tilting head adjustable to directional or non-directional position. All chrome finish.

Complete with interchangeable socket connector and 25-foot cable. \$25.00.

See your Astatic Jobber or write for literature.

**ASTATIC MICROPHONE LABORATORY, Inc.**  
YOUNGSTOWN, OHIO  
Licensed Under Brush Development Co. Patents  
Astatic Patents Pending

**Servicemen—  
MORE THAN  
1,000,000  
AUTO RADIO  
AERIALS  
MUST BE  
REPLACED**

**WE HAVE CREATED  
the RADIART  
Performance  
PROVER**

**to make it EASY for  
wide-awake service-  
men to get this profit-  
able EXTRA BUSINESS**

ASK YOUR JOBBER, or WRITE FOR BULLETIN NO. 342  
**THE RADIART CORPORATION**  
SHAW AVENUE • CLEVELAND, OHIO



**A NEW ELECTRONIC  
D-C  
VOLTMETER-  
OHMMETER  
WITH EXTREMELY  
Wide Ranges**



PRICE  
\$57.50

Unlike anything heretofore available to the servicing industry, it fills a long-existing gap.

**THE VOLTMETER**

Measures from 0.05 to 5000 volts.  
Input resistance constant at 16 megohms on all ranges.  
"Contact potential" error eliminated.  
No readjustment of zero when changing ranges.  
Measures d-c operating and control voltages under dynamic conditions with f-i and a-i present—input capacitance 1 mmf.  
Checks oscillator operation up to and including ultra-high frequencies.  
Will indicate plus or minus voltages without switching leads.

**THE OHMMETER**

Measures from 0.1 ohm to 1 billion ohms.  
Low voltage across resistance being checked—from 0.030 volt across 0.1 ohm to a maximum of 3 volts across 1000 megohms.  
Convenience of operation—one scale—one zero adjustment—does not require readjustment when range is changed.  
7 overlapping ranges for maximum accuracy and ease of reading.  
Stable zero.  
Finest parts—high safety factors—protected against humidity.

**SEND FOR  
COMPLETE  
SPECIFICATIONS  
AND  
LITERATURE**

**The RIDER  
VoltOhmyst  
SERVICE INSTRUMENTS, INC.**  
404 Fourth Avenue, New York City  
Foreign Division—147 W. 45th Street, N. Y.,  
Cables—"Servicin"

duction devices have been manufactured with tuning ratios of 7 or 8-to-1 in the u-h-f bands. The continuously variable inductance unit shown in Fig. 4 actually consists of a coil and fixed capacitor covering a frequency spread from 22.5 to 150 megacycles in a single range with no band switching. This involves 16 complete dial rotations in a continuous band. There are already 2 or 3 applications of this system in actual equipments, which will appear shortly on the market.

**CROSLY 118**

(Continued from page 118)

vent possible damage to the stylus point when removing paper gate. Then push lever back on platen bar and carefully remove platen gate. With a very fine sand paper using a wiping motion from one side to the other, polish the platen track. Replace paper gate. Replace stylus to printing position.

**Motor:** The motor should be oiled (each bearing) about once in every three-hundred hours of service with a high grade of light lubricating oil.

**Clutch:** It is essential that the clutch plate be thoroughly lubricated at all times, check at least once a week.

**HELPFUL HINTS**

**Variations in density or blackness of printing:** Receiver may not have the avc circuit capable of keeping the output constant over wide variations of incoming signal strength. Receiver may not have sufficient output. Stylus may be stuck in bakelite bracket. Stylus may be worn. Platen track may have small deposits of carbon on it.

**Wobbly printing:** Receiver not tuned properly (printer not synchronized with transmitter). Bent or loose stylus point.

**Not printing:** Power off. Loose or open connection between receiver and printer. Stylus stuck.

**Stylus arm keeps moving:** The stylus arm should come to rest at the left hand side of the paper when the volume or level control setting is reduced appreciably. If it keeps moving back and forth, the end of the magnetic clutch arm that engages the dog on the clutch plate may be slightly worn. If this is the case it may be compensated for by a slight adjustment of the magnetic clutch stop screw (see illustration). Loosen the stop screw lock nut, then turn screw to the left (counter-clockwise) about a quarter turn or just enough to cause the magnetic clutch arm to engage dog on clutch plate.

**FACSIMILE IN EDUCATION**

ONE OF the most unique demonstrations in the history of education was conducted by Cleveland school authorities as they flashed lesson instructions, assignments, bulletins, maps and drawings into four city schools in a series of experimental radio facsimile transmissions.

Utilizing the Board of Education's ultra-high frequency station WBOE, the city's school authorities demonstrated the educational possibilities of a simplified radio facsimile system, developed in the RCA Victor laboratories, to the educators who attended the convention of the American Association of School Administrators.

H. M. Buckley, assistant superintendent of Cleveland schools, supervised the demonstrations. Technical arrangements were in charge of Dr. William B. Levenson, director of station WBOE, assisted by John D. Woodward, chief engineer.

**ANNOUNCING  
The  
RIDER CHANALYST  
with  
RACK AND PANEL  
ASSEMBLY**



**Brings All the Leads Out in  
Front—Adding Still Further  
to Time Saved by Chanalyst.**

**SERVICEMEN  
Continue to Praise**

"I find the Chanalyst indispensable. Every time I use it, it seems to become more valuable."—A. Coppotelli, A. C. Radio Service, Chicago Heights.  
"Your Chanalyst advertisements express my sentiments exactly. I find the instrument indispensable in my work, and use it constantly."—I. Rosenberg, Custom Radio & Elec. Lab., New York City.  
"Wouldn't be without the Chanalyst—INDISPENSABLE!"—Carr & Pheil, Chambersburg, Pa.  
"A terrific weapon against those 'hard to isolate' troubles."—Bruce N. Carpenter, New Castle, Del.  
"Going through a set with the Chanalyst is almost instantaneous. With . . . (another instrument I have) I took all day and was angry before I was through."—Lester J. Berry, Newark, Ohio.  
"I am very pleased with my Chanalyst. It has helped me find the trouble in several tough jobs already and I am learning new uses for it every day."—Carl J. Anderson, Marietta, Ohio.

The rack and panel is sold separately at \$15.  
The price of the Chanalyst complete with rack and panel is \$122.50 (without, \$107.50)

**SEND 25¢  
FOR 80 PAGE  
BOOK ON  
OPERATION—  
PERFORMANCE  
OF CHANALYST**

**The RIDER  
Chanalyst  
SERVICE INSTRUMENTS, INC.**  
404 Fourth Avenue, New York City  
Foreign Division—147 W. 45th Street, N. Y.,  
Cables—"Servicin"

# the TOPS in TUBE TESTER VALUE



## PRECISION Dynamic Electrometer SERIES 900

Tests all tubes including the new LOKTAL and SINGLE ENDED types. A MODERN "push-button" operated dynamic mutual conductance tube tester . . . Combined with a 25 multi-range A.C. and D.C. volt-ohm-decibel-milliammeter . . . plus a ten ampere range for complete point to point set analysis . . . includes ballast test facilities . . . A complete laboratory in compact form. Size only 12x12x6.

Net Price..... \$49.95



## ELECTRONOMETER SERIES 510

An efficient modern tube analyzer capable of testing all types including the new LOKTAL and SINGLE ENDED tubes . . . incorporates ballast test facilities. Usual PRECISION Standard of Accuracy and ability to accommodate FUTURE tube releases. Portable hardwood case. Size 12x12x6.

Net Price..... \$29.95

All "PRECISION" testers include telephone cabling, wire wound shunts and matched metallized multipliers of 1% accuracy. INDIVIDUALLY calibrated and checked against laboratory standards to maintain CLOSE ACCURACY. See these tube analyzers and the complete line of Precision multi-testers and signal generator at your favorite distributor. Catalog describing 12 models available upon request.

**PRECISION APPARATUS CO.**  
821 EAST NEW YORK AVENUE  
BROOKLYN, NEW YORK

Export Div.: 458 BROADWAY, N. Y., U. S. A.  
Cables: Morhanex

## DEWALD 411 WIRELESS PHONOSCOPE

THE DeWald Model 411 is a 2-tube wireless record player that permits the owner to play recordings through a remote radio receiver or directly through an a-f amplifier and a small speaker incorporated in the playback unit. The device employs two new multipurpose 0.3 amp tubes, the 12B8GT r-f pentode-triode and the 32L7GT beam power amplifier-rectifier.

The high-mu triode section of the 12B8GT amplifier tube serves as an audio amplifier in both modes of operation. With the switch in the r-f playback position, the a-f amplifier is necessary to provide a high percentage of modulation. In wireless playbacks where the pickup operates directly into the r-f oscillator the percentage of modulation is often too low. This makes



By operating a switch the DeWald Model 411 phonoscope can be used either as a wireless record player to reproduce recordings through a remote receiver or as a complete unit with its own amplifier and speaker.

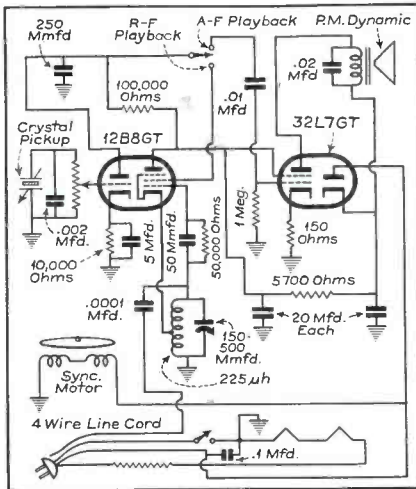

it necessary for the listener to turn the receiver gain up higher in order to obtain normal room volume even though a strong carrier is being received from the oscillator. Excessive carrier hum results.

In addition, low percentage modulation requires more radiation to produce a satisfactory signal at the receiver. Also, the interference range of the transmitter varies inversely as the depth of modulation. Too high a modulation level, however, would cause frequency modulation and consequent distortion. To prevent this a modulation level control is incorporated as an element of the pickup tone corrector.

With the switch in the audio playback position, a complete record player and amplifier is available with no additional equipment required. This feature is obtained at only a slight additional cost over an ordinary wireless record player, since the power supply, heater resistor and cabinet

# Confidence

WORKS IN A CIRCLE WHEN YOU standardize on C-D

For confidence in the products you use—standardize on quality products. You'll find it pays all around. Pays in fewer repeat calls, pays in customer goodwill, pays in future business. That's why so many servicemen today are standardizing on Cornell-Dubilier capacitors. They're quality-built throughout. And when you have confidence in the products you use, your customers are bound to have confidence in you. Resolve now to Standardize on C-Ds—for better business all around! For details on the complete C-D line of capacitors and Quietone Radio Interference filters, send for Catalog No. 161.



Mica -- Dykanol -- Paper -- Wet & Dry Electrolytic Capacitors

**CORNELL-DUBILIER ELECTRIC CORPORATION**  
1026 Hamilton Blvd., So. Plainfield, N. J.  
Cable Address: "CORDU"

# Now... Get REAL RESULTS with New 1939 BRACH Antennas

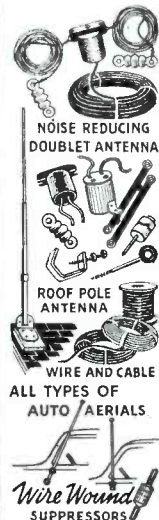

Scientifically Designed to Insure—

- ✓ BETTER RECEPTION
- ✓ EASY INSTALLATION
- ✓ PERMANENCE
- ✓ SATISFIED CUSTOMERS
- ✓ GOOD PROFITS
- ✓ MORE SALES

The BRACH line is a complete line and every item is priced right. Large stocks on hand at all times insure prompt deliveries. Send for new catalog today!

World's Largest Makers of Antenna Systems  
**L. S. BRACH Mfg. Corp.**  
55-67 Dickerson Street

Newark, N. J. Established 1906

are required even if this feature were omitted. A power output of 1.4 watts is available to the permanent magnet dynamic speaker.

Two controls are used, one for level with the on-off switch incorporated and the a-f, r-f switch. The carrier frequency is adjustable over a small range around 550 kc. The paddler is accessible through a hole in the top of the panel.

A 4-wire line cord is used, 3 wires for the power and filament resistor and the fourth is the antenna. This arrangement with the antenna coupled to the hot end of the oscillator tank through a 0.0001 mfd condenser, allows satisfactory reception as a wireless unit up to about 40 feet. A 0.1 mfd by-pass condenser across the line keeps the r-f energy from the lighting circuit.

The phonograph motor is a self-starting, constant speed induction motor. A crystal pickup is employed with a tone correcting load circuit. The resistor is the volume control in the a-f position and the modulation level control in the r-f position. The high-mu triode feeds the beam-power tube in the a-f position or the screen grid of the pentode oscillator section in the r-f position. The plate of the power tube is returned to the input of the filter while the screen is connected to the second filter section to reduce hum. In the a-f position, the oscillator is cut off by opening the screen grid lead.

Mark Glaser

### NEW TUBES 12B8GT

The 12B8GT is a high-mu triode-r-f pentode in one envelope.

#### Tentative Ratings

Heater voltage.....12.6 v  
Heater current.....0.3 amp  
Base.....Octal  
Bulb.....T9

#### Characteristics Triode Section

Plate voltage.....100 v  
Grid bias.....-1 v  
Plate current.....0.6 ma  
Transconductance.....1500 mumhos  
Plate resistance.....73,000 ohms  
Amplification factor.....110

#### Pentode Section

Plate voltage.....100 v  
Screen voltage.....100 v  
Signal grid bias.....-3 v  
Plate current.....8.0 ma  
Screen current.....2.0 ma  
Transconductance.....2100 mumhos  
Plate resistance.....0.17 meg  
Grid bias for  $G_m = 10$ .....-35 v

Two dual purpose tubes are used in the DeWald phonoscope. Their characteristics are given below.

Illustration courtesy Arcturus Tube Co.



**Basing**  
Pin 1 P. cathode & suppressor Pin 5 T. plate  
Pin 2 Heater Pin 6 T. cathode  
Pin 3 P. plate Pin 7 Heater  
Pin 4 P. screen Pin 8 T. grid  
Top cap P. Grid

### 32L7GT

The 32L7GT is a combination beam power output tube and a half-wave rectifier in one envelope.

#### Tentative Ratings

Heater voltage.....32 v  
Heater current.....0.3 amp  
Base.....Octal  
Bulb.....T9

#### Characteristics

##### Beam-Power Amplifier

Plate voltage.....110 v  
Screen voltage.....110 v  
Grid bias.....-7.5 v

Plate current.....32 ma  
Screen current.....3.0 ma  
Transconductance.....6,000 mumhos  
Plate resistance.....15,000 ohms  
Load resistance.....3,000 ohms  
Power output.....1.4 watts  
Second harmonic.....3%  
Third harmonic.....7%  
Cathode resistor.....140 ohms

#### Rectifier

A-C voltage (rms).....125 v max.  
Peak current......425 ma  
D-C load......65 ma max.  
Tube drop at 130 ma.....18 v

#### Basing

Pin 1 Rect. cathode Pin 5 Amp. grid  
Pin 2 Heater Pin 6 Rect. plate  
Pin 3 Amp. plate Pin 7 Heater  
Pin 4 Amp. screen Pin 8 Amp. cathode

(Continued on page 137)

# COST-SAVER ✓ TIME-SAVER ✓ PROFIT-MAKER ✓

## The New UTAH Service-Pak

More profitable servicing is made possible by the new Utah Service-Pak. Every active service man needs one—should have one. And it's priced so low you can't afford to be without it.

The Utah Service-Pak includes a stock of essentials and accommodations for additional parts which are basic necessities for normal radio servicing. The attractive kit, 17" x 39" x 10", is actually a complete, convenient, easy-to-keep-up miniature stock room. It provides important economies—it saves time and space—it reduces costs—it safeguards parts—it permits a perpetual inventory to be kept easily.

Make the savings provided by the new Utah Service-Pak and add them to your profits. Phone or write your jobber today—ask him to show it to you. If your jobber can't supply you, write us for complete information.

Sold only through recognized jobbers.

UTAH RADIO PRODUCTS CO., Chicago, Ill.  
Cable Address—UTARADIO-CHICAGO

DEALERS NET PRICE \$29.95  
Including Cabinet



### THE NEW UTAH SERVICE-PAK

contains the following high-grade UTAH products: 35 Assorted 10-Watt Vitreous Resistors, 6 Assorted 25-Watt Adjustable Vitreous Resistors, 16 Assorted Volume Controls, 6 Volume Control Switches, 3 Assorted Chokes, 5 Assorted Audio Transformers, 3 Assorted Universal Output Transformers, 4 Assorted Power Transformers, 1 5" Electro-dynamic Speaker. And it will accommodate UTAH vibrators, condensers, etc., to complete the normal service stock.

ASK YOUR JOBBER IF HE CAN'T SUPPLY YOU—WRITE US

**YOU SAVE**

**33%**



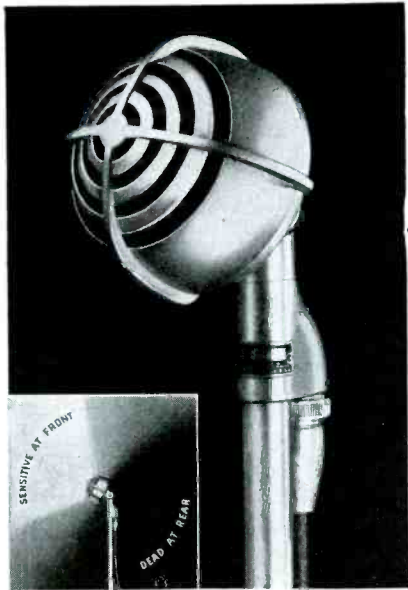

## 9 Out of 10 P.A. SYSTEMS Need this Shure UNIPLEX

**Because** . . . the UNIPLEX gives high quality response from 30 to 10,000 cycles at the front—yet is dead at the rear! Stops unwanted sounds—eliminates feedback, audience and background noise in theatres, night clubs, auditoriums, schools, churches, and similarly difficult acoustic locations. And with it all, the UNIPLEX is the lowest cost true uni-directional microphone available today! ★Finished in rich Satin Chrome. Complete with built-in Cable Connector and 25 ft. of special noise-free Super-Shielded cable. Model 730A "UNIPLEX" Crystal Microphone. List price **\$32.50**

Ask Your Jobber or write for Catalog 150S.

"SOUND SYSTEMS SOUND BETTER  
WITH SHURE MICROPHONES"

Shure Patents Pending. Licensed under patents  
of the Brush Development Company.



### WHEN YOU CHANGE YOUR ADDRESS

Be sure to notify the Subscription Department of SERVICE at 19 E. Forty-seventh St., New York City, giving the old as well as the new address, and do this at least four weeks in advance. The Post Office Department does not forward magazines unless you pay additional postage, and we cannot duplicate copies mailed to the old address. We ask your cooperation.

## AMPLIFIER ANALYSIS

(Continued from page 113)

ondaries. These have already been determined to be 0.0316 and 0.0448 respectively in the case considered. Their sum then is 0.0764 and

$$\frac{N_p}{N_s} = 0.0764$$

If it is desired to maintain a primary input resistance of 10,000 ohms, the resistance necessary across this total series connected secondary is given by

$$R_s = \left( \frac{N_s}{N_p} \right)^2 R_p = (0.0764)^2 \times 10,000 = 58.3 \text{ ohms}$$

If the two secondaries are connected in series so that the voltages induced in them oppose each other, the effective number of turns will be  $N_s - N_A$  and the turns ratio will be  $\frac{N_s}{N_p} = \frac{N_B}{N_p}$  —

$$\frac{N_A}{N_p} = 0.0448 - 0.0316 = 0.0132$$

Then the resistance which must be placed across the secondary to reflect 10,000 ohms into the primary is

$$R_A = \left( \frac{N_A}{N_p} \right)^2 R_p = (0.0132)^2 \times 10,000 = 1.74 \text{ ohms}$$

Thus, the transformer illustrated may be used to match a tube having a required load resistance of 10,000 ohms to one or more voice coils connected so as to have a total impedance of approximately 60, 20, 10, or 1.7 ohms. With a transformer having three separate secondary windings, each of a different number of turns, 9 combinations are available which give 9 different primary-secondary turns ratios. This allows the transformer to match the tube to any one of 9 different loads.

### TAPPED TRANSFORMERS

Many transformers are constructed with a single secondary tapped at several points rather than with a number of separate secondary windings. The practical problem of determining the turns ratios of such a transformer often presents itself when the manufacturer's specifications are not readily available. Consider the transformer shown in Fig. 3. The primary-total secondary turns ratio of an output transformer is of the order of 100 to 1. The turns ratio can most conveniently be measured at 60 cycles by impressing about 0.5 volts across the total secondary and measuring the induced primary voltage on a 0-50 or 0-150 high resistance a-c voltmeter. Since fractions of a volt are not readily measured on the voltmeters usually available in the service shop an arrangement such as that shown may be employed. The resistances of the voltage dividing system may be mea-

BUICK  
'39

# Sell CROWE CONTROLS for Increased Profits

CHEVROLET '39

EASIER servicing—better satisfaction—with Crowe Interchangeable Custom-Built Controls and Panel Kits—a steadily growing line—more complete than ever! They're different! They exactly match official styling!

Thousands of auto radios in use with Crowe Controls need only new Crowe Kits to fit 1939 cars. Others need Controls and Kits for new cars. A highly profitable, growing market. Cash-in on it!

Ask for Bulletin 230

**CROWE NAME PLATE & MFG. CO.**  
1775 GRACE ST. CHICAGO, ILL.

- FADA •
- SPARTON • HORN • DELCO • KARADIO •
- PHILCO • EMERSON • FIRESTONE •
- TRAVLER • STEWART • WARNER •
- PACKARD • BELL • TIFFANY • TONE •
- ADMIRAL • MISSION • BELL • TROY •

- ARVIN •

sured on an ohmmeter with sufficient accuracy, and the voltage across the secondary calculated from the total impressed voltage and the resistances in the voltage dividing system. The required voltage is most conveniently obtained from a filament transformer. The voltmeter used in the primary circuit should have a sensitivity of at least 1000-ohms-per-volt so that the resistance as it appears to the secondary will be large in comparison with the portion of the voltage dividing system across which the secondary is placed. The primary-total secondary turns ratio is, of course, the ratio of the primary and secondary voltages. The turns ratio of each of the secondary sections to the primary may be measured in similar fashion, although some difficulty may be experienced with low impedance taps due to the small voltage which must be placed across them to limit the voltage appearing across the primary to a reasonable value. The number of primary secondary ratio combinations obtainable with a multi-tapped secondary is large. For a secondary having one tap, 3 combinations are possible. With two taps, 6 combinations are available, while with 3 taps it is possible to get 10 different primary-secondary turns ratios.

## MICROPHONE RATINGS

(See page 123)

ternal resistance and the figure used for computing amplifier gain.

To avoid these complications, the amplifier gain ratings should be expressed in terms of its voltage sensitivity, i.e., the voltage input required to produce a given power output. This can be done in the following manner. Taking the usual expression for amplifier gain in db:

$$= 10 \log \frac{\text{output power}}{\text{input power}} = 10 \log \frac{(\text{output voltage})^2 / \text{output load}}{(\text{input voltage})^2 / \text{input load}}$$

$$= 20 \log \frac{\text{output voltage}}{\text{input voltage}} \text{ plus } 10 \log \frac{\text{input load}}{\text{output load}}$$

From this it is seen that the voltage gain in db

$$= 20 \log \frac{\text{output voltage}}{\text{input voltage}} = \text{rated power gain in db} - 10 \log \frac{\text{input load}}{\text{Output load}}$$

For an amplifier to give its rated output it is necessary that its voltage gain in db be equal to the microphone output voltage rating in db across the amplifier input load. When this load is very high in comparison to the internal resistance of the microphone, the open-circuit voltage delivered by the microphone, expressed in db, gives the required information.

In a typical amplifier, for example, the manufacturers rating is 120 db with an input resistance of 100,000 ohms. The output power is developed across a 10-ohm load. Its voltage in db becomes:

$$120 - 10 \log 100,000/10 = 120 - 40 = 80 \text{ db}$$

A voltage input of —80 db (reference level 1 volt) will thus cause the amplifier to deliver its rated output. Since microphones are rated on this basis, this formula and method is most convenient. A further advantage is its independence of the reference level used in amplifier ratings.

When the input and output resistances of the amplifier are the same, the voltage gain and the power gain, in db, are the same. When the input resistance of the amplifier equals the internal resistance of the microphone, only half the microphone output voltage appears across the input of the amplifier. In such cases, the amplifier gain should be 6 db greater.

### LOUDNESS

An amplifier and microphone may be combined to indicate sound pressure levels as picked up by the microphone when the rating of each is accurately known. Often it is desired to know the loudness of the sound in so far as it affects the human ear. Loudness is a psychological effect which varies with frequency and is expressed in db above

**HICKOK**

The Standard Unit of Measurement of Mutual Conductance is the Micromho

# New DYNAMIC MUTUAL CONDUCTANCE TUBE TESTER with readings in MICROMHOS!

MODEL 51-X

**TESTS—** Loktal Tubes  
Ballast Tubes  
Pilot Lamps  
New 50-volt Tubes  
All old type Tubes

**MEASURES—** MICROMHOS—A.C. & D.C. VOLTS—OHMS—MILLIAMPERES—CAPACITY—INDUCTANCE—OUTPUT and DECIBELS.

### SPECIAL FEATURES—

\*A patented *uniform* single scale is used for indicating both A.C. & D.C. voltages.

\*Reliable Electronic (No copper oxide) Rectifiers are used for A.C. Volts. No burnt out rectifiers. No trouble.

\*A simple and positive noise test is provided for demonstrating noisy tubes.

A rapid and accurate instrument for one call portable service. Engraved metal panel, 14" x 13 3/4" x 6".  
Micromhos Readings—0-3000, 0-6000, 0-15000. Also indicates "Good," "Replace," "Doubtful."

Manufactured under Patent No. 1,999,858.

Remember, it is not Dynamic Mutual Conductance unless it reads in Micromhos.

Mail the Coupon for Complete New Folder.

**THE HICKOK ELECTRICAL INSTRUMENT CO.**  
10478 DUPONT AVENUE CLEVELAND, OHIO

THE HICKOK ELECTRICAL INSTRUMENT CO., Cleveland, Ohio

Gentlemen: Please send me your new Bulletin on Model 51-X Dynamic Mutual Conductance Radio Tester.

I am also interested in

- Oscillograph  
 Signal Generator  
 Volt-Ohm-Milliammeter  
 Zero Current Voltmeter

Name .....  
Address .....  
City ..... State .....

a reference level of  $10^{-16}$  watts per sq. cm.

Since microphones are rated on a sound pressure basis representing average conversational speech while sound loudness is based on a reference level corresponding to the least audible intensity of a given frequency, to correlate the two we must express the microphone sound pressure level of one bar in terms of the acoustical reference level of  $10^{-16}$  watts per sq. cm. By reference to the chart (Fig. 1) it is seen that a sound pressure of 1 bar corresponds to plus 74 db in terms of the relative loudness of a 1000-cycle note in free air above the threshold of audibility,  $10^{-16}$

watts per sq. cm. If the microphone rating is —60 db at a reference level of 1 volt/bar its output for one bar sound pressure is  $10^{-3}$  volt (1 millivolt). In terms of the acoustical level of  $10^{-16}$  watts, its output is  $10^{-3}$  volt for a 1000-cycle free wave 74 db above the threshold of audibility. Assuming that the microphone calibration curve is flat, the microphone output would be the same for a 50-cycle tone only 20 db above the threshold of audibility because the sensitivity of the ear is far less at very low frequencies. Fig. 1 shows the relative loudness of tones of different frequencies at a sound pressure of one bar.

# 8624

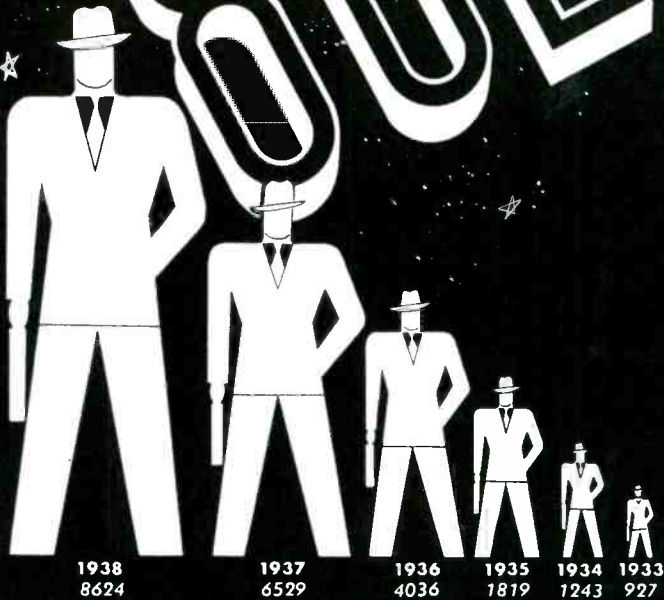

Yes...eight thousand six hundred and twenty-four attended the National Radio Parts Trade Show in Chicago last June—the biggest get-together the Radio Parts Industry has ever held! Look at the record—see how the National Radio Parts Trade Show has grown in interest and attendance with each successive year! Every branch of the Industry has been represented. Manufacturers, Jobbers, Manufacturers' Agents, Engineers, Factory Men, Sound Specialists, Servicemen and Amateurs—from all over the world—meet in this one and only big annual event for the Radio Parts Industry.

## IT PAYS TO ATTEND THE TRADE SHOW

Whatever you do, don't miss the next National Radio Parts Trade Show at the Stevens Hotel in Chicago, June 14, 15, 16, 17. Over 100 Manufacturers have already taken exhibit space. That's setting a new record—and means the biggest show ever! Make plans now to attend.

1939 JUNE 1939			
WED	THU	FRI	SAT
14	15	16	17
<p>OPEN these two days to Jobbers, Manufacturers, Manufacturers' Agents, and Manufacturers' Engineers only.</p>		<p>OPEN on these two days to Servicemen, Amateurs, Retailers, Students and others.</p>	

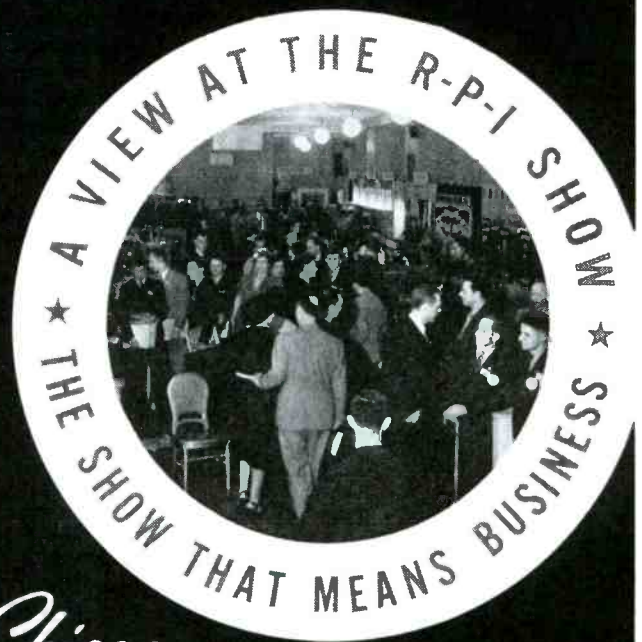

*Stevens Hotel—Chicago*



## National Radio Parts Trade Show

Sponsored by Radio Manufacturers Association and Sales Managers Club  
 ★Executive Office—53 West Jackson Boulevard, Chicago, Illinois

## Book Review

**HOW TO USE THE CATHODE RAY TUBE**, by J. H. Reyner, published by Furzehill Laboratories, Boreham Wood, Herts, England, 1938, 40 pages, paper covers, price 1/—.

This excellent book, although small in size, covers in a clear and concise manner the principle applications of the cathode ray oscillograph with which the Service Man is concerned.

Starting with a brief description of the fundamental theory underlying the cathode ray tube, this manual continues with a description of the various controls to be found on any oscillograph.

An interpretation of the patterns obtained on the fluorescent screen is given, whereby the Service Man is able to locate distortion and hum in audio frequency amplifiers and to determine whether tubes are being operated at their proper voltages. The alignment of superheterodyne receivers is capably described.

This book is highly recommended to all Service Men. R. L.

### NEW TUBES

(Continued from page 133)

#### 35Z5GT, 45Z5GT

These tubes have the same characteristics except for the overall filament voltage.

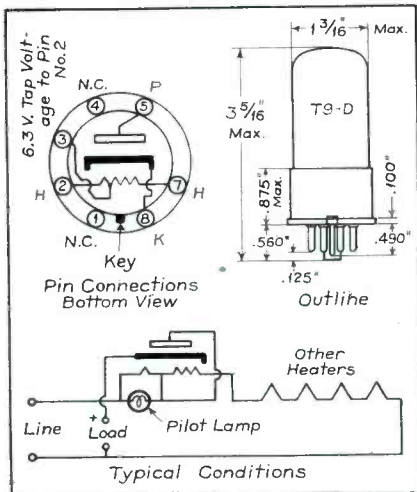

New series of tubes have pilot lamp tap on heater.

They are cathode type half-wave rectifiers designed for service in a-c, d-c receivers. They feature a 0.15 amp heater with a tap brought out from the heater so that with proper external connections a single 0.15 amp pilot lamp can be lighted to normal brilliancy. It is recommended that the plate current of the rectifier be passed through the pilot lamp and 6.3-v section of the heater.

Tentative Ratings	
Heater voltage (35Z5GT)	35.0 v
Heater voltage (45Z5GT)	45.0 v
Heater current	0.15 amp.
Base	Octal
Bulb	T9

Characteristics	
Plate voltage (rms)	125 v max.
Load current	100 ma max.
Voltage drop at 200 ma	16 v

*Data courtesy Hytron Corp.*

MARCH, 1939 •

## For Speedier, Safer Testing—The NEW RCP ANALYST



RCP announces a new, revolutionary achievement in push-button operation. The only completely safe push-button test instrument on the market. Now, push-buttons are safer than rotary selector switches. You can push two or more buttons without causing "shorts" or other circuit complications. Only the Analyst affords this "extra" safety.

Some of the exclusive Analyst features are: Unnecessary to keep buttons depressed manually—individual locking device eliminates necessity for "release" button. Connections to tester do not have to be changed for different measurements. Both current and voltage

measurements in same circuit can be made at one time. Meter polarity reversed by changing polarity of circuit buttons. First plug in analyzer unit available with six sockets, including local built into panel. Send for catalog TODAY. Read about the many other Analyst features.

At \$14.95 no shop can afford to be without the Model 504C, with 3" case. Model 504, less case, is only... **\$13.75**

### HAVE YOU SEEN THE MODEL 411 Supertester?

It truly is the greatest instrument value ever developed for the money. Some of the features of the Model 411 are:

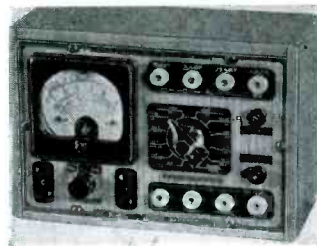

5 stage AC-DC voltage range to 5,000 volts. 3 stage AC-DC current range to 25 amps. 3" meter with 200 microamps or 5,000 ohms per volt. 3 stage ohmmeter range to 4 megohms. DC ma. 0/10/100. Center of scale, on low ohmmeter range only 5 ohms with each of first ten division measuring 0.1 ohm. Model 411 complete, your cost **\$16.25** only. Model 411B—Same as 411 but with socket and direct reading ballast tube tester **\$17.95**

### TUBE CHECKER ACCURACY MEANS CUSTOMER CONFIDENCE!

Only "Dynoptimum" checking gives complete RMA specification tube testing at low cost! This combination portable and counter model (No. 307P), only **\$18.95** Model 307, complete at low price of only **\$16.95**



**ALL RCP TUBE TESTERS COMPLETELY EQUIPPED FOR TESTING LOCAL TUBES.**

For real Instrument values have your jobber demonstrate RCP units. Complete information on request.

# RADIO CITY Products Co.

88 PARK PLACE NEW YORK CITY

## SAVE \$1.00 !!!

- The Group Subscription Plan for *Service* enables a group of service men, dealers or jobbers to subscribe at one-half the usual yearly rate.
- The regular individual rate is \$2.00 a year. In groups of 4 or more, the subscription rate is \$1.00 a year. (In foreign countries, \$2.00.)
- Each subscriber should print his name and address clearly and state his occupation—whether a dealer, jobber, independent service man, service organization, etc.

**Remember this Group Plan when Your Subscription Expires**

SAY YOU SAW IT IN SERVICE

137

# Radio's MASTER ENCYCLOPEDIA

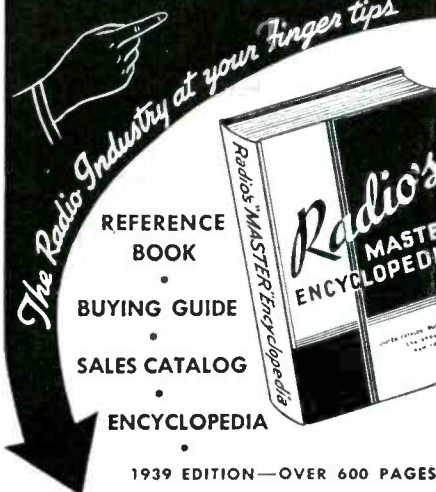

## THE ONLY OFFICIAL EQUIPMENT MANUAL of the Radio Industry!

Compiled in cooperation with and approved by Radio Manufacturers, this authentic source book of over 600 pages is crammed full of vital, essential information that is indispensable to everyone identified with Radio and allied lines.

### GIVES THIS IMPORTANT DATA

The New 1939 Edition of Radio's Master Encyclopedia is the most comprehensive ever issued. No other book like it. Important data that you need in your business—conveniently cross-indexed for split-second reference. Thousands of illustrations, specifications and prices on every conceivable type of Equipment, Accessories, Parts; ranging from Tubes to Transmitters, and including the latest in television tubes and parts. Contains Directory of over 1000 Manufacturers, where located and what they make—gives index of trade names.

### •• WHO USES IT? ••

Universally used and accepted by the Radio Industry, Schools, Colleges and Governmental Agencies. The Service Man and Dealer will find the encyclopedia a valuable aid in soliciting business whether it be a quotation on a replacement part or a complete amplifying system. Only List Prices are shown, so that the book can be readily opened before the prospective customer.

### SAVES TIME—SAVES MONEY

Radio's Master Encyclopedia is truly a complete Radio and Equipment Manual all bound under one cover taking the place of files and files of miscellaneous catalogs and information. WHERE—WHAT—HOW MUCH, instantly at your fingertips! Thousands in everyday practical use proving invaluable and unsurpassed as a REFERENCE BOOK, SALES CATALOG or BUYING GUIDE.

### MONEY BACK GUARANTEE!

Radio's Master Encyclopedia, now in its third year, has served the industry well. That's why, with complete confidence we are ready to send it to you on an absolute "Money Back in 5 Days" Guarantee. If you are not 100% satisfied. To save the cost of transportation, send your remittance with order,—\$2.50 in U.S.A., \$3.00 Elsewhere. Or if you prefer, we will ship C.O.D., plus postage charges—in either case, our "Money Back in 5 Days" is your assurance of complete satisfaction.

**UNITED CATALOG PUBLISHERS INC.**  
7 WARREN STREET, NEW YORK, N. Y.

# Test Equipment

## PRECISION 870 VOLT-OHMMETER

THE Precision Series 870 push-button tester is designed so that all ranges (except 3000-volt) are available from a pair of polarized tip jacks. Switching is accomplished by means of 4 circuit-selector buttons and 5 range-selector buttons. Only one additional control is required, a zero adjustment, for use with the ohmmeter scales.

The decibel scales provided on the instrument are direct reading on a 500-ohm line and the instrument must be used with a suitable blocking condenser to prevent d-c from reaching the meter.

### SPECIFICATIONS

Finish: Wood case, metal panel.  
Controls: Push-button; 4 circuit-selector buttons and 5 range-selector buttons.

#### Ranges:

D-C volts: 0 to 6, 30, 300, 600, 1200 and 3000.

A-C volts: 0 to 12, 60, 600, 1200 and 3000.

D-C milliamperes: 0 to 1.2, 12, 120, 600 and 1200.

Ohms: 0 to 5000, 500,000 and 5 meg.

Db: 5 ranges from -10 to +64 db.

#### Sensitivity:

D-C voltage measurements: 1000-ohms-per-volt.

A-C voltage measurements: 500-ohms-per-volt.

#### Accuracy:

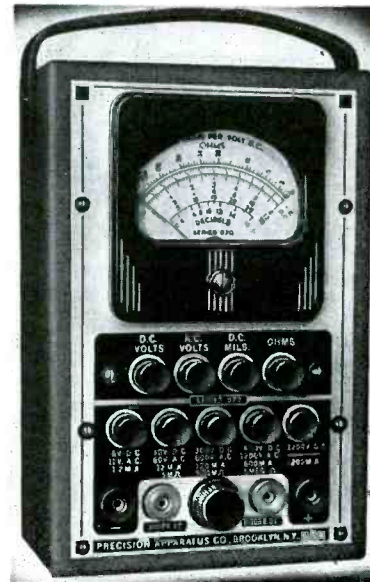

The Precision Model 870 tester is only 4 1/4 by 7 in.

D-C ranges: 2% of full scale.  
A-C ranges: 5% of full scale.  
Battery requirements: 3-volt (inside case, supplied with instrument). 27 volt for 5 meg range. (External.)

Resistors and connections are provided so that an external battery (27 v) can be used to extend the range of the ohmmeter to 5 meg.

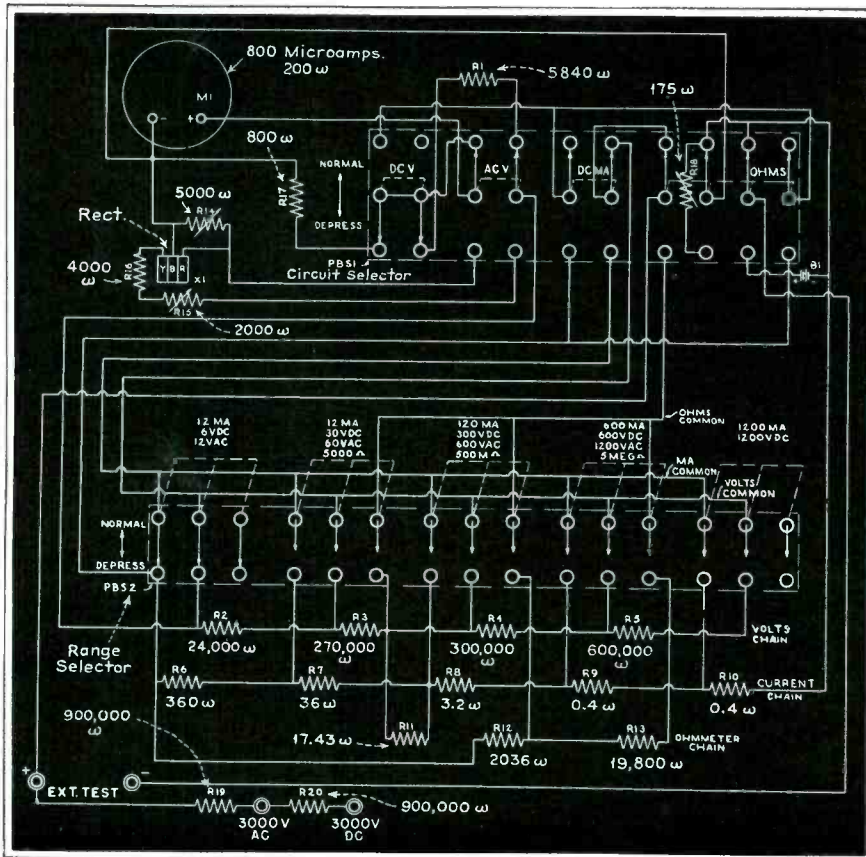



Save  
\$1.00  
on your  
1 year  
Subscription  
to  
**SERVICE**  
by  
using the  
**GROUP SUBSCRIPTION PLAN**

Every progressive service man should have his own subscription to **SERVICE**. He must know more than just the fundamentals of radio circuits. He must know the Theory of Electricity . . . Acoustics . . . Salesmanship . . . Parts Merchandising! These and many other subjects of primary importance are found in every issue of **SERVICE**.

Tear Out — Mail Today

**SERVICE**

19 E. 47th St., New York, N. Y.  
Enter annual subscriptions for the undersigned. Payment enclosed at \$1.00 each. (Foreign subscriptions are \$2.00.)

Name .....  
Address .....  
City-State .....  
Occupation .....  
Employed by .....

Name .....  
Address .....  
City-State .....  
Occupation .....  
Employed by .....

Name .....  
Address .....  
City-State .....  
Occupation .....  
Employed by .....

Name .....  
Address .....  
City-State .....  
Occupation .....  
Employed by .....

To help every service man, dealer and jobber obtain his individual yearly subscription to **SERVICE** for \$1.00 (or 1/2 the regular rate of \$2.00) the Group Subscription Plan was formed. When four or more men sign up at the same time, the subscription rate is only \$1.00 per year each. (\$2.00 per year for foreign subscriptions.)

Use the convenient form at the left. Your co-workers and service men friends will sign up with you at the half-price rate if you tell them about the "G.S.P." Sign up your group today.

**SERVICE**  
19 E. 47th St.  
New York, N. Y.

**NEW 3 IN 1  
SERVICEMEN'S  
HELP!**

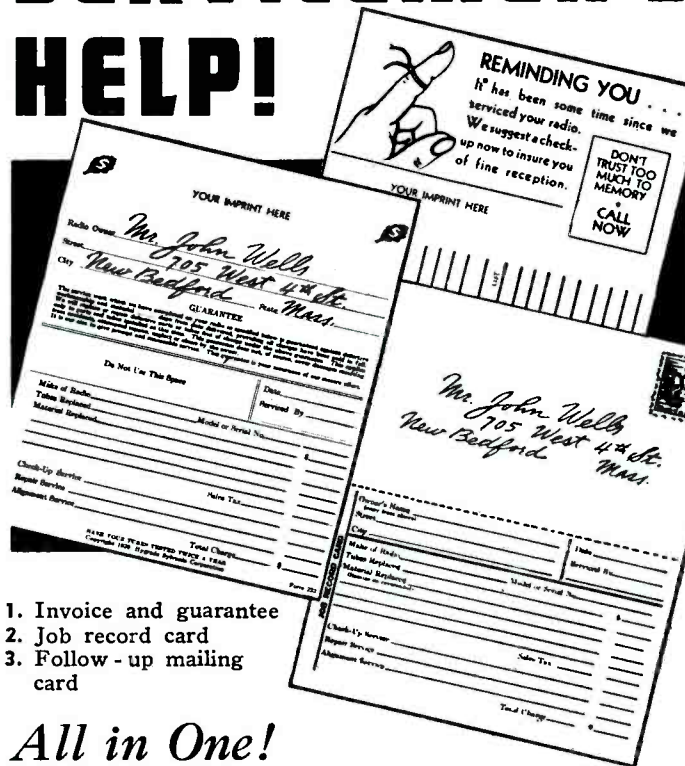

1. Invoice and guarantee
2. Job record card
3. Follow - up mailing card

*All in One!*

IT'S SIMPLE — efficient — easy-to-use! This newest Sylvania "first" fills a long-felt need in the radio servicing business.

Just write out the invoice (on which is also printed your guarantee of satisfaction)—give it to your customer—and "presto", a carbon sheet has neatly filled out both the cardboard job record for your file and the follow-up mailing piece to be sent your customer later on. No repeat writing, no extra effort.

This Sylvania service form, with your imprint, is available in pads of 25 sets each. Send today for free sample or use the convenient order form below—or see your Sylvania jobber.

**SYLVANIA**

SET-TESTED RADIO TUBES

Also Makers of Hygrade Lamp Bulbs.

HYGRADE SYLVANIA CORP., Emporium, Pa. S-39  
Please send me 100 sets—\$1.50; 250 sets—\$2.50; 500 sets—\$4.00. (Check one). I enclose \$..... in payment.  
Imprint (Please print) .....  
Name .....  
Address .....  
City ..... State .....

**PRICE IS IMPORTANT, yes—but so is QUALITY!**

**You get both in CINAUDAGRAPH  
PERMANENT MAGNET AND ELECTRO-DYNAMIC SPEAKERS**

Continuous research and product development has enabled Cinaudagraph engineers to manufacture a better speaker. The wide acceptance accorded Cinaudagraph products by manufacturers of radio receivers and public address equipment has made possible the production of permanent magnet and electro-dynamics at prices within the reach of all. No longer is it necessary to sacrifice quality for price! Cinaudagraph offers a complete line of speakers from 5 to 27" for every "replacement" and "sound" application at competitive prices.

Increase your profit and repeat business by building customer confidence. Cinaudagraph Speakers can show you how.

Complete description of the Cinaudagraph speaker installation at the New York World's Fair on request. Catalog on entire line also available.

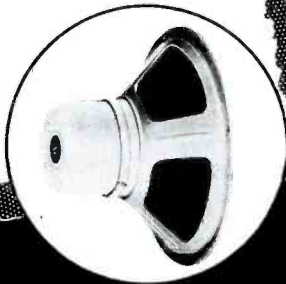

**CINAUDAGRAPH CORPORATION**  
STAMFORD, CONNECTICUT

**VOCAGRAPH 30PX**

THE Vocagraph Model 30PX is a 30-watt, 8-tube portable amplifier system in a 3 piece case. It is provided with 2 microphone input positions, a phono pickup position and a dual electronic tone control. When the control is adjusted for flat amplification the bass response may be increased 9 db above normal and the treble 11 db. By adjustment in the opposite direc-

tion the bass response may be cut 5 db below normal at 50 cycles, and the treble 20 db below at 10,000 cycles.

**SPECIFICATIONS**

Finish: Blue & maroon metalescent crystalline with chromium trim.  
Controls: 2 input gain controls, bass & treble controls, switch & pilot light.  
Microphone input gain: 130 db (approx.).  
Minimum input for normal output 0.0015 v. (approx.).

Microphone input impedance: 3 meg.  
Phono input gain: 80 db (approx.).  
Phono Input impedance: 0.5 meg.  
Power supply: 110 to 120 v, 60 cycles.  
Power consumption: 120 watts (approx.).  
Power output: 30 watts.  
Output level: 37 db (above 0.006 mw).  
Distortion: 7% (approx.).  
Hum: -52 db (below max. output).  
Frequency characteristic: 40 to 10,000 + or - 1 db (approx.), with bass and treble controls set for flat amplification.  
Total possible compensation: (Measured at 40 and 10,000 cycles, respectively). Bass: 14 db; Treble: 31 db.

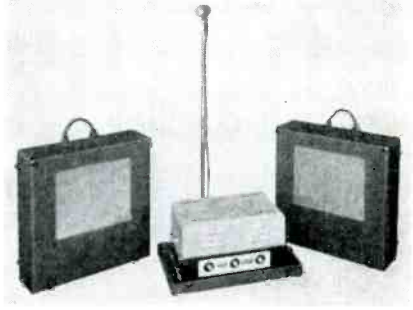

The Vocagraph 30PX is a fully portable, 8-tube, 30-watt system provided with Col-graph electronic tone control.

Output impedances: 2, 4, 8, 166, 250 and 500 ohms.

Speakers: 12-in pm.

Voice coil: 6 to 8 ohms at 1000 cycles.

Tubes:

Preamplifier: 6F5 (2).

Mixer: 6F8.

Electronic tone control: 6C8G.

Driver: 6N7.

Output: 6L6G (2).

**CORRECTION**

In spite of the vigil eye of the editorial staff an error crept into the February 1939 issue. In the article Wireless Phonographs, by Ray D. Reitenmeyer, page 69, the caption under Fig. 1, should read *Wilcox-Gray* instead of *Wilcox-Gray*. To our knowledge there is no manufacturer of record players by the latter name.

Inputs are provided, on the Vocagraph 30PX amplifier, for two microphones and a phono pickup.

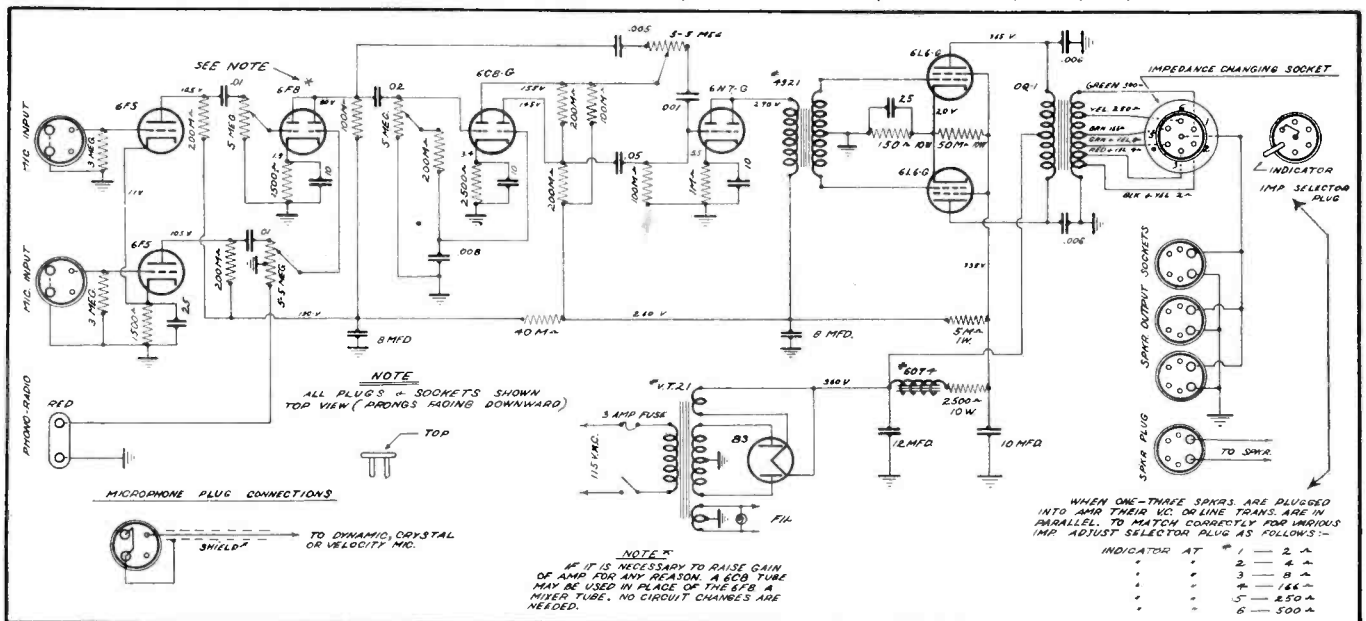

# Business Opportunities

THE MAN we're looking for need not invest his capital—but he must have a representative radio service business, equipped to meet his competition in technical knowledge and set-up.

He must be a good enough merchandiser to turn over his tube stock at least every three or four months. Such a man will have proper facilities for using the attractive, sales-producing displays we will provide.

He will appreciate the necessity for maintaining established prices—and can be depended on to make monthly reports of CONSIGNED

stock with remittance for tubes already sold. Last but not least, he will have a location free from interference with our already established agents.

UP also newly ACAd-  
d. large, nosphere,  
adway)—  
s; \$5 up.  
rge. light;  
set home.  
le; 2-room  
my 2-9093.  
light outside  
ess man pre-  
family; mod-  
ademy 2-1688.  
)-Large front  
ished; running  
high-class build-  
WEST.  
LES, DOUBLES.  
TO \$9 WEEK.  
facing Cathedral,  
est traveling facili-  
telephones, baths.  
ew studios, singles,  
ing service; \$4-\$9.  
A RESIDENCE CLUB  
dented studios (single-  
tendly refined environ-  
Exceptional  
ping, Homelike, Service;  
ork Studios, \$5-\$10.  
levator, switchboard; spe-  
s.  
T (5C)—Morningside Resi-  
dished 1920; delightful  
"Smart Studios"  
in Columbia section  
furnishings, service;  
\$8.50.  
ARLIGH"  
OS, 18

IF YOU are this man, you qualify under the Tung-Sol Consignment Plan. This means an adequate supply of world-famous Tung-Sol Tubes without investment. Write for details.

TUNG-SOL LAMP WORKS INC.  
Dept. D Radio Tube Division



SALES OFFICES: Atlanta · Chicago · Dallas · Denver · Detroit · Kansas City · Los Angeles · New York  
General Offices: Newark, New Jersey

# IT'S READY! Complete Transformer Replacement Data FOR

## RIDER'S VOLUME IX

As usual Thordarson is first and original in compiling this complete and reliable data on replacement transformers for the receivers listed in Rider's Volume IX. The correct choke, audio and output as well as power transformers are indicated for all types of receivers listed by Rider—whether AC, AC-DC or battery models.

ASK YOUR  
DISTRIBUTOR  
FOR  
No. 243-D



Free supplement to No. 243 and 243-S for Rider's Volumes I to VIII inclusive. Thordarson Replacement Transformer Encyclopedias now cover receivers listed in all of Rider's Manuals—approximately 8,000 radios—ranging from the earliest models of about 1925 up to present day 1938-1939 sets. Ask your distributor for your FREE copy or fill in the coupon below and send it to the factory today!

Gentlemen:  
Please send me, without charge, the items checked.  
 1939 Supplement to Thordarson Replacement Transformer Encyclopedia, No. 243-D.  
 Complete Transformer Catalog, No. 400-CX.  
Name \_\_\_\_\_  
Address \_\_\_\_\_  
City \_\_\_\_\_ State \_\_\_\_\_

**THORDARSON ELECTRIC MFG. CO.**  
500 W. HURON ST., CHICAGO, ILL.  
*Demand "Power by Thordarson"*

# Associations

## RADIO SERVICEMEN OF AMERICA

**NINETEEN** chapters won Rider's Volume IX service manuals in the 1939 Renewal Dues Contest, which closed Jan. 31. Fifteen of these scored 100% renewals, while the other four were very close. District 10 led with five 100% chapters. District 2 was second with three 100% chapters.

### Allentown

"Present and Future Possibilities of the Serviceman" was the subject of a talk by Sam Harper of the Clough-Brengle Company at our meeting of Jan. 30. This was our First Annual Banquet and Test Equipment Show. Five of the local jobbers displayed their test equipment. Ed. Pond was Toastmaster.

At a previous meeting in January, officers for 1939 were elected: president, Kenneth Keck; vice-president, Thomas Glose; secretary, H. H. Fillman; and treasurer, J. A. Muthard. Walter Rees was elected to the board of directors.

*H. H. Fillman, secretary*

### Binghamton

A few of our officers enjoyed a brief visit with a lad by the name of Joe Marty, Jr., Sunday, Feb. 12. We were extremely sorry that Joe could not visit us on a meeting night and meet the entire membership.

At our last meeting in Jan., Harry Spencer, one of our new members, gave a talk on the construction and use of a vacuum tube output meter. He stressed its ability to work with a very low signal input.

At our Feb. 7 meeting, Eddie Donnelly presented a device which gives an audible indication of a cutoff in an intermittent receiver. The device may be connected to r-f, i-f, or audio circuits. Eddie had a radio set? (a-c, d-c) to demonstrate the working model. We tried to fool the thing, but no go. (A similar device was described in *Service*, Nov. 1938, p. 38. **EDITOR.**)

Our vice-president, Leon Van Buskirk, is sojourning with the rest of the rich folks in sunny Florida.

*Earl L. Pittsley, reporter*

### Boston

On Feb. 6, Boston Chapter was addressed by R. Perron, of the Clough-Brengle Co., who spoke on "Dynamic Testing of Radio Sets." Refreshments were served.

We had a very fine meeting at our new headquarters at the Hotel Manger on Feb. 20. One of our members, Raymond Wyman, gave a splendid talk on tubes, using a display numbering hundreds of tubes, from the earliest diodes to the latest multipurpose tubes. It was the first of a series. A different member will speak each meeting on a branch of radio service technique.

A bunch of us are planning to attend the New Hampshire Chapter's Banquet on March 7.

*Ingvor Paulsen, secretary*

### Bridgeport

Jan. 23: P. Stern gave a talk on "cut-throat" prices and a possible cure for same. A committee to investigate practices was appointed: J. Durante, P. Stern, and B. Stern. B. Stern spoke on his views on service charges. (Get in touch with us. **EDITOR.**)

Feb. 6: Arthur Hatton, engineer, Electrical Apparatus Co., Boston, spoke on "Ceramic Capacitors." Refreshments were served.

Feb. 20: A communication from the executive secretary of RSA presenting our charter was read, and the charter accepted. The secretary volunteered to have it suitably framed. A membership talk by our president culminated in the signing of five applications, with more to follow at our next meeting. J. Gompertz gave a very interesting talk on a new type of television antenna to be used at the World's Fair. He also told of new test equipment needed to service television sets.

*A. H. Stendahl, secretary*

### Chicago

On Feb. 8, we had George Devine of G. E. fill out the evening richly with a discussion of the Armstrong system of frequency modulated transmission, and its theory of interference elimination. It's all very involved, and, it seems that only by analogy and vectorial explanation could one expect to get a clear conception of the whole idea. In this the lecturer succeeded beautifully. Another feature was his thorough discussion of the Faraday shielded loop antenna and its application in present day receivers. Besides distributing G. E. booklets with authoritative informa-

tion on television, and the surprise of door prizes, he also found time to give us the details about the new "Pee Wee" line, including the "arty" (whack, whack) procedure of their speaker cone alignment. Three prizes were drawn by Harold Johnson, L. J. Covell, and E. E. Bazzle.

Feb. 22: At this well attended meeting, chief engineer D. von Jenef, of Million Radio and Television Lab., introduced the Signalizer as the latest addition to the line of channel testing equipment.

*Al Kilian, publicity*

### Cleveland

We celebrated the new year by combining our Annual Dinner with election of officers for '39, on Jan. 18, with some ninety participating. Dinner, refreshments, and good clean fun was provided for all, and everyone had a swell time. We decided to hold an election at an open meeting, and it worked out all ok. Members were given ballots, the nominees were introduced just after dinner, and, after the election, the elected men were called on for a speech. This gave our visitors an idea of what an RSA election is.

The new officers are: Chairman, Alex Plakadis; vice-chairman, Ed George; secretary, Thomas Holmes; and treasurer, Nate Dishler. All are top notchers.

*L. Vaugunten, reporter*

### Danville

On Jan. 27 L. S. Hicks of Thordarson addressed us on "Transformers in Service." He brought forth some very interesting information on transformers and their application in relation to our work.

We discussed plans for a banquet to be held some time in the future. We plan to make this a big event in our history.

After the usual business meeting of Feb. 10, Owen McArdle took charge of the instruction end of the program to present "Inverse Feedback." He certainly covered his topic completely, and much was gained by all those present.

*Cal Stapp, secretary*

### Decatur

Last meeting was devoted entirely to criticisms and personal suggestions as to exactly what each member expected and hoped to receive from RSA. Everyone was urged to freely unload whatever might be on his chest. In the end, it was pretty clearly understood that just a few members could not accomplish much without the wholehearted cooperation and the regular attendance of every member.

Gene Payton took the fatal leap last week. Everybody wishes Gene and the new bride the best of everything.

Lester Dunscomb is the proud papa of a new Miss Dunscomb.

*Dewey L. Otta, reporter*

### Duluth

The ground-hog might have seen his shadow and crawled back into his hole, but the Duluth chapter is on the go. Our Feb. meetings have started off with a bang. The first brought a good attendance of members and a number of jobber visitors, who attended to join in a friendly discussion of trade practices.

The Service Men pleaded their case of lost retail trade, which meant their bread and butter. The jobbers contended the tube business was coming back to the Service Men (see *SERVICE*, Feb. 1939, p. 56.—**Ed.**) and that leaks in parts business were very meager.

Our Feb. 20 meeting was addressed by Rudolph Luukinen, who spoke on the subject of "Microphones." The different types, their limitations, advantages, and disadvantages were explained. Charley Snyder also conducted an informal discussion of the Iconoscope television tube.

Don Roach—addition to family, a boy, was born with a pair of cutters in his hand. Playthings: "Scope, etc. First words: "I can buy 'em wholesale!"

*E. N. Holmlund, secretary*

### Flint

Jan. 27: Elected officers for 1939: Chairman, Harold Wilke; vice-chairman, Arlie McGee; secretary, William F. Lutes; treasurer, James Pugh. Executive board: Wilke, Pugh, McGee, Long, Lutes and Jensen.

Feb. 7: Adopted a price schedule of suggested minimum service charges. Our executive board contacted the Telephone Directory Advertising Co. regarding a half-page free service call ad.

We got action at once, resulting in the cancelling of this objectionable ad, and the promise that no more would be accepted.

Feb. 8: Full turnout to hear Leland Hicks, of Thordarson. This was good practical stuff that we use every day. Mr. Hicks is an RSA member himself, and gave us some fine plugs in his talk. Seven new members were signed up. Service Men from Lapeer and Bay City, who were present, are planning to start an RSA chapter. Beer and sandwiches were served, thanks to Radio Tube Merchandise Co.

*William F. Lutes, secretary*

### Fremont

Frank Barnhart spoke on "A Vibrator Tester" at a recent meeting. We agree that it is a fine tester and well worth the effort of construction. Sidney Olson, of Olson Brothers, spoke on "What a Service Man Should Earn."

*Don Daymon, secretary*

### Green Bay

A program was arranged for our meeting of Feb. 7. Otto Schroeder gave us a taste of the sailing and fishing advantages of Green Bay, by technicolor movies. He also showed a reel of fighting snowdrifts in our locality.

A round table discussion was led by Adolph Nejedlo on identifying ballast tubes and their function in the present day radios. Ad advertising committee headed by Joe Holzem, our chapter president, is in the middle of a cooperative advertising campaign to use the local press and broadcasting station to put the RSA over to the people in this territory. Samples of the Finch facsimile transmission from WLW were passed out and created very favorable comment.

*Adolph E. Nejedlo, publicity*

### Holyoke

A skit entitled, "The Work of a Cheap Service Man," showing the things a Service Man should not do on a service call, introduced a talk by Bert Taylor, Service Man-Salesman for T. F. Cushing, Springfield, Mass., presented Jan. 24.

*William Foley, secretary*

### Houston

Communications were read at our meeting of Feb. 8 and quite a discussion was carried on regarding cooperation by the manufacturers and the district representatives toward the goal of supplying the membership with more actual data on service, including data on parts used in servicing. It was decided that data on parts and accessories was as important as circuit diagrams. (*SERVICE* is featuring a series on vital receiver parts and accessories currently.—**EDITOR.**)

*T. F. Stephenson, secretary*

### Interstate

On Feb. 4 we held our meeting at Liberty Hall, Rock Island, Ill. It was a strictly business meeting, at which we laid plans for future activities.

George Wooley, our ex-President, has just invested in some new Supreme test equipment including a 'scope. Nice going, George.

*Clarence L. Swanson, secretary*

### Jamestown

On Feb. 7 the Jamestown chapter held their annual mid-winter banquet and installation of officers. This was one of the largest affairs that the local organization ever held; visitors were present from Erie, Buffalo, Dunkirk, Westfield and other nearby towns. Fred Beaumont of Jamestown and Buffalo presided as toastmaster and installed the new officers: president, Richard Bonsteel; vice-president, Larry Lodestro; secretary, Lawrence S. Babcock; treasurer, C. Leonard Johnson. Our officers responded with a brief talk.

The principal speaker of the evening was John H. Potts of Service Instruments, Inc. Mr. Potts gave a very interesting talk and demonstration of the Chanalyst.

*Lawrence S. Babcock, secretary*

### Johnstown

Joseph Marty, Jr., executive secretary of RSA, presented an educational talk at our meeting of Feb. 5 at the Tavern. Mr. Marty discussed the history, organization and plans of the RSA.

Members of the chapter tendered a dinner in Marty's honor Saturday night in the Dairy Dell. Those in charge of the affair were Ralph Galasso, D. L. Kaufman, Kenneth Vaughan, George W. Martin, J. T. Noll, Joseph E. Gerber and R. J. Emmerling.

*Jim Emmerling*

(Continued on page 144)

# FOR 1939—It's ATR Vibrators!

FULLY GUARANTEED FOR ONE YEAR

A Complete Line of Replacement Vibrators for Auto and Farm Radios Featuring:



- Large Oversized  $\frac{3}{8}$ " Diameter Tungsten Contacts having Full Wiping Action—for greater reliability and Longer Life.
- Perforated Reed of Highest Quality Swedish Spring Steel—for uniform flexibility and prevention of reed breakage.
- Highly Efficient Magnetic Circuit with Formed Base—for greater accuracy and more uniform operation on both high and low voltages.
- Mica and Metal Stack Spacers with Two-Bolt Stack Construction—for adjustment permanency under any operation condition.
- Extra Flexible Leads with Tinned Clamp Supports—for good low resistance connections and freedom from lead breakage.
- Highest Precision Construction and Workmanship—Practically all parts used are held to within a tolerance of 0.0005 of an inch.

New descriptive catalog No. 139 now ready, covering New Products, Models, Prices—everything operated and in Vibrator-Rectifier Power supplies. Write today for your free copy.

## FREE

To win new customers and friends, ATR will give absolutely Free one No. 1240 Vibrator (Competitive 4-prong non-synchronous type listing at \$1.75) to every dealer or serviceman purchasing any 6 Vibrators shown on the ATR Vibrator Guide. Merely send to the factory six "order reminders" taken from ATR Vibrator cartons (there is one on each) with your jobber's name written or stamped on and date of purchase. For each group of six ATR Vibrator "order reminders," one No. 1240 ATR Vibrator will be given free, postpaid. All purchases must be 1939. This offer good until May 1, 1939. Act Now! Remember—insist on ATR Vibrators; there are none better!!

ATR Vibrators are VALUE PLUS—and Prices, 25% Lower!!

Write for your FREE Copy of the ATR Vibrator Guide and Equivalent Chart. Your ATR Vibrator Distributor will be Happy to Serve You.

## AMERICAN TELEVISION & RADIO CO.

World's Largest Manufacturer of the Most Complete Line of Vibrators, Vibrator-Operated and Rectifier Power Supplies. ST. PAUL, MINNESOTA, U.S.A. Cable Address: "Likex" New York

## CHECK THE NEW LOCTAL TUBES WITH CERTAINTY!



### For Emission Type Checkers

Loctal top-octal base.  
No. 988L1S ..... List \$1.25  
No. 9-LO Unwired Parts... .40



### For Mutual Conductance Type Checkers

986L1S	985L1	Tests in	Socket	List
Adapter				
*986L1S	1231,7A7	6C6	\$1.25	
*985L1	7Y4	84	1.00	
*986L3	35A5	43	1.00	
*986L3	7A6	6H6	1.00	
*987L1SA	7A8	6A7	1.25	
*986L2S	7C6	75	1.25	
*986L4	35Z3	25Z5	1.00	



### For 7 Prong Latch Type Analyzer Plug and Panel Socket

No. 978LSA ..... List \$1.25  
No. 988L2 ..... List 1.00



### For Toggle-Lock Analyzer Plug and Panel Socket

No. 988TLNL ..... List \$1.00  
No. 988L2 ..... List 1.00

Special adapters or special circuits available promptly. Write us for further information.

ALDEN PRODUCTS CO., Dept. SA, Brockton, Mass.



Naald Adapters are the ones you can safely buy—worked out in collaboration with instrument and tube manufacturers, they insure perfect operation over long life period.

Loctal tubes with their small pins and peculiarities in the base shape, require a molding designed to get the longest possible contact. Alden has provided for this maximum contact in designing adapters for these tubes.

The increased number of insertions placed on these loctal adapters and sockets demand that the contacts be able to withstand this severe wear with perfect operation over a long life period. Naald patented Parallel Precision contacts—silver-plated—the same type of contact that withstood life tests of perfect contact after more than 1,750,000 repeated insertions, give you assurance of dependable operation.

Insist on Naald sockets in any new equipment which you purchase—use no other than Naald to bring your present equipment up to the minute.

It is an item you buy but once—get the best—correctly wired—correctly thought out—with contacts which have proven themselves superior in long life service.

# VOCAGRAPH

deluxe sound equipment  
--- is easier to sell

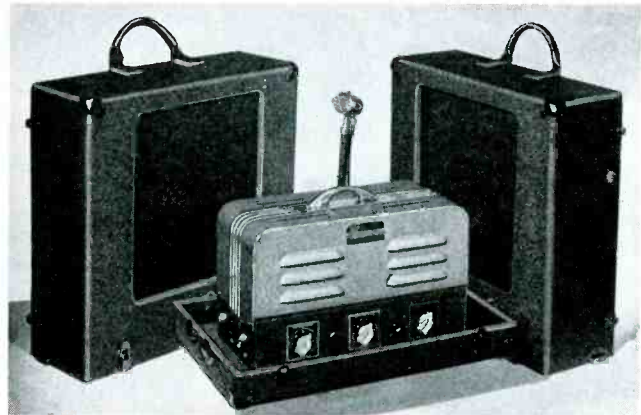

## Priced Lower Than Ever!

Choose sound equipment that best suits your customer's needs—that is easiest to sell.

Complete system with dynamic microphone, stand, carrying case, etc. .... list \$75.00

Only VOCAGRAPH offers world known performance at prices 20% to 50% lower than former standards. This means easier selling and bigger profits.

20-WATT—Dual microphone input, high gain amplifier. .... list \$47.50

Look over these pace-setting models—and write for the new VOCAGRAPH catalog.

Two speaker system with carrying case, dynamic microphone, stand, etc. .... list \$118.00

5-WATT—Complete portable with crystal microphone, p.m. dynamic speaker, table stand, carrying case. .... list \$50.00

The complete VOCAGRAPH line also includes 30-watt, 40-watt, and 100-watt amplifiers that offer more for your money. Write for your copy of the new spring catalog that completely describes all models.

12-WATT—Push-pull beam power amplifier, high gain, tone control, etc. .... list \$32.50

## Three New Mobile 6-110 Volt Amplifiers



38-WATT—A new mobile amplifier with power to fill stadiums and cover large meetings. Built in 6 and 110 volt power supplies. Lid protects pick-up and turntable. .... list \$160.00

28-WATT—A new high power 6-110 volt amplifier at an astonishing price. Power, dependability, and portability. COMPARE what VOCAGRAPH offers. .... list \$90.00

15-WATT—An exclusive development in the 6-110 volt field. Power to spare for countless applications. .... list \$55.00

Write for complete specifications of all above models.

Buy a demonstrator on TIME PAYMENTS



## VOCAGRAPH SOUND SYSTEMS

Division of Electronic Design Corporation  
162-B N. May Street, Chicago, Ill.

Send us full details on how we can buy a new 1939 VOCAGRAPH demonstrator (any model) for a small down payment and convenient monthly payments. Also send copy of the new spring catalog.

Name .....  
Address .....  
City ..... State .....

MAIL  
AT  
ONCE

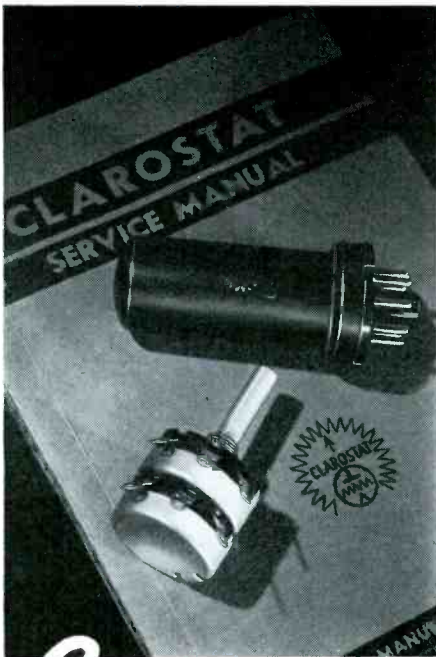

## Essentials to Profitable SERVICING

- ★ The RIGHT data, the RIGHT replacement, the RIGHT performance — that's what you need for PROFITS. And that's precisely what CLAROSTAT provides in its controls, resistors and Service Manual:

### CONTROLS

- ★ The CLAROSTAT Midget (Series M) Composition-Element Control, designed from scratch, was introduced almost two years ago. Since then it has gained a host of friends. Remarkably quiet. Highest immunity to humidity and climatic conditions. Mighty accurate—and stays that way for years of use. Choice of tapers. Handy Ad-A-Switch feature. You really don't know how good a modern control can be until you've tried a CLAROSTAT Midget.

### RESISTORS

- ★ CLAROSTAT pioneered Plug-In Resistors for AC-DC sets. Now offers largest line of exact-duplicate units. Also universal types for minimized stocks. Handy Tester indicates condition of any unit. CLAROSTAT also offers voltage-dropping power cords, flexible resistors, power resistors and other essential types.

### PRACTICAL DATA

- ★ Handy listings of all standard sets in CLAROSTAT Service Manual. Indicates at a glance the correct control and plug-in resistor replacements. New edition now coming off the press. Get your copy from local CLAROSTAT jobber — or write us direct.

See us at Booths 620-622—Hertz Ave. Radio Parts Manufacturers' National Trade Show—June 14, 15, 16 and 17.

## CLAROSTAT



MANUFACTURING CO.  
Incorporated  
285 North Sixth St.  
Brooklyn, N. Y.

## ASSOCIATIONS

(Continued from page 142)

### Lansing

Leland S. Hicks, of Thordarson, gave us an illustrated talk on "Transformer Applications for Radio Service Men" at our meeting of Feb. 7.  
*L. W. Aubil, secretary*

### Long Island

On Feb. 16, National Union presented a speaker who discussed the construction and applications of etched foil condensers.  
We are trying a new trick which seems to help attendance.  
*Arthur Cyr, secretary*

### Nashville

R. Thomas discussed the progress of a bill now pending in the Tennessee Legislature for the licensing of Service Men.

Earle F. Parker was appointed to the duties of secretary, subject to approval of the special standing committee.

We sure did have some fast and furious bidding on the Rider's Manual we are to receive as a prize in the renewal dues contest. Earle Parker was the highest bidder. The proceeds of the sale will go to our local treasury.

Fellows, if you need a cigarette holder, just get in touch with L. B. Cozart. He uses one which he made by drilling the "stem" and "bowl" of a combination fiber aligning tool. A true service man's gadget!

*Earle F. Parker, secretary*

### Newark

Carl Rauber, director of our district, gave a very interesting talk, and led a discussion of television at our meeting of Feb. 14. Mr. Gnadinger donated mimeographed copies of a treatise on "Vacuum Tube Voltmeters." Each member received one. Thanks a lot, "Knaddy."  
*Albert Fasanella, secretary*

### New Hampshire

A special meeting was held Jan. 11 in order to hear a very interesting lecture on volume controls and vibrators by Mr. Arvin of the Mallory Co. It was followed two days later by another special meeting, at which John H. Potts, of Service Instruments, Inc., gave a lecture on the Rider Chanalyst.

Plans for our annual banquet to be held at Yankee Flyer Cottage, Nashua, N. Y., on March 7, were discussed at our meeting of Jan. 24. A membership drive was also undertaken.  
*Ray Rogers, secretary*

### New York

Some 300 men attended our meeting of Feb. 13 and got a clearer understanding of the use of condensers. The speakers were William M. Bailey, who spoke on paper and Dykanol capacitors; Stanley Walters, who covered wet and dry electrolytics and their applications and characteristics, and Frank Taylor, who showed pictures of the Cornell-Dubilier plant in operation. All of the speakers were from the Cornell-Dubilier organization.  
*Selig Rosengarten, secretary*

### Oklahoma City

The Oklahoma City chapter, at its first meeting of 1939, Jan. 3, voted to reduce the local dues to \$1.00 annually, and put on a membership drive. It was also voted to reduce the number of business and technical meetings from weekly to 2 each month. One social meeting each month will be arranged by the program committee.  
*L. G. Dearing, secretary*

### Peoria

A strictly business meeting, at which we discussed plans for a new membership drive, was held Feb. 14.  
*George Hartley, secretary*

### Pittsburgh

"Idle Time—What It Costs," was the subject of a talk by Bert A. Bregenzar at our meeting in the Hotel Henry on Feb. 14. A general discussion of receiver case histories followed the regular meeting.  
*William Irlam, secretary*

### Pontiac

We had a fine meeting Feb. 9. Leland S. Hicks, of Thordarson, gave a talk and blackboard discussion on transformers. Our attendance was fine, despite an ice storm that stopped traffic for a time.

Joe Cole, director of the district, spoke on "Bookkeeping Methods and Records," Feb. 20. He showed expense, time and profit charts and ledger pages.  
*S. W. Christie, secretary*

## Electro-Voice DYNAMIC AND VELOCITY MICROPHONES

A distinguished Dynamic line, designed - for - function and built to the highest standards of engineering and appearance. Four brilliant new models (including a hand type) for every sound pick-up application, priced from \$22.50 to \$30.00, list.



The "V" Series Velocity Microphones, long America's favorite are now still further improved. New style and engineering features, new construction and improved durability make the "V" Series the leader in value. Three models priced from \$25.00 to \$50.00, list.

Write for catalogue No. 32, just released.

**ELECTRO-VOICE MFG. CO., Inc.**

1237 South Bend Avenue,  
South Bend, Indiana

Export Office: 100 Varick St., New York, N. Y.

### Quincy

On Jan. 30 Quincy chapter elected the following officers for 1939: President, Dwight Peters; vice-president, H. A. Wenzel; secretary, Gale Venghaus; treasurer, Elmer Hagenbauer.

The article on chassis code marking in the Jan. Serviceman came in for a lot of attention, as did some of the other things mentioned in Chapter Chatter.

*H. A. Wenzel, vice-president*

### Springfield

Minimum prices and local interference elimination were discussed at our meeting of Feb. 15.

Gene Parish was appointed chairman of the Public Relations Committee.  
*Ray Westerfield, secretary*

### Stuebenville

President Harris gave a talk on the noise situation in town at our meeting of Feb. 7, stating that we as an organization should work together to reveal and eliminate the source of the interference. Plans were made for two parties to trace it down with directional receivers.

At our meeting of Feb. 21 we discussed the subject of how to compete or eliminate the merchants and chain stores that are offering a well known make of tube to the public at discounts of 40%.  
*Leonard Roberts, Jr., secretary*

### St. Joseph

Election of officers for 1939 was held at our meeting of Feb. 6. Cleo Blodgett, president; Oliver Parsons, vice-president; Russell Goerke, treasurer; and Jack Abercrombie, secretary. Jack Abercrombie gave the talk on "The Decibel System."  
*Jack Abercrombie, secretary*

### St. Paul

After the business meeting of Feb. 2, a disassembled Philco condenser was shown to the group, and a discussion followed. Some very good motion pictures taken by Henry Gerner were shown to us by Paul Biehler. We had some sandwiches and coffee and Henry and Paul wanted some film on the bunch.

Charles W. Fox spoke on "Resistance and Current Distribution" at our Feb. 16 meeting. After the business we had coffee and sinkers and a good gabfest.

It is strongly rumored that Arndt Jensen is going to take that fatal step soon.  
*Noel J. Granger, secretary*

**NEW!  
UNIVERSAL  
COWL  
AUTO ANTENNAS**

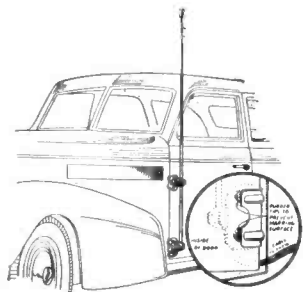

**NO DRILLING . . . NO  
MARRING OF CAR!**

Antennas are made of ALL BRASS STAINLESS STEEL, and guaranteed rustproof for the life of the car. Last word in value . . . good looks . . . and easy installation. No drilling. And there are 8 more powerful reasons why you should demand ICA Universal Bracket Cowl Antennas. WRITE FOR 8-PAGE ILLUSTRATED FOLDER now while you think of it.



**INSULINE CORP.  
OF AMERICA**  
25 PARK PLACE  
NEW YORK, N. Y.

**GET ALLIED'S SPRING CATALOG**

JUST OUT!



**SAVE**  
on everything in  
**RADIO**

**SOUND!**



**SETS!**



**PARTS**



**TESTERS**

**FREE  
CATALOG**

Now, see the remarkable values in ALLIED's new Spring Catalog. Every service need at lowest prices! Over 14,000 parts, test equipment, newest PA systems, 8 to 65 watts; recording equipment, discs, and accessories; Amateur Gear, kits, books, tools, etc.; and 62 new Knight Radios, 4 to 16 tubes, with ideal price-leaders as low as \$6.95! Page after page of record-breaking values. Send coupon for new Spring Catalog today.

**ALLIED  
ALWAYS HAS IT!**

Faster service, good merchandise, and lowest prices have made ALLIED service headquarters for thousands of service men. Next time, try ALLIED, and profit!

ALLIED Radio Corp.  
Dept. 19-C-9  
833 W. Jackson Blvd.  
Chicago, Ill.

Send me your new Spring Catalog.

Name .....

Address .....

City..... State.....

**OTHER GROUPS**

**Associated Radio Servicemen**

The Radio Servicemen of Fresno, Calif., and vicinity have formed their first radio service association. Eventually it may include members within a 100-mile range.

The two preliminary meetings in Dec. and one on Jan. 12, '39 were to start the ball rolling. Committees have been hard at work getting in new members and attending to by-laws and various other details.

On Jan. 12 the subject of radio interference was highlighted in detail by Richard Lake of San Joaquin Light & Power Co.

The election of officers on Jan. 26, '39, were as follows: President, Jack Schiefer; vice-president and program chairman, Andy Brown; secretary-treasurer, Geo. Artman; sergeant-at-arms, Ben Heitkotter; publicity, Earle Bancroft.

The amount of dues decided upon was \$3.00 per year. Our main meetings will be once a month with a possible extra meeting for special events.

It may be necessary to furnish Sergeant-at-Arms Ben Heitkotter with a baseball bat in order for him to subdue Horton when he swings that chair again. The pre-meeting stories ought to prove interesting as time goes on. Someone ought to be able to outdo Horton on the ones he was telling. There was a mention of some kind of bust later on. I wonder if that guy ate too much? Well, maybe it's one of the special events we spoke about.

Earle J. Bancroft, publicity

**California**

Several months ago, after the last Chevrolet pictures, the company decided to discontinue their showings. However, in response to an avalanche of letters protesting, including one from this association, they reconsidered with the result that we had the finest group yet presented at the Feb. 20 meeting.

Al Grabau gave a technical presentation of "Tube Styles of '39," starring Lotta Loktal. (Service also presented this little skit Feb. 1939, p. 62.—Editor.) Last and not least, "Helpless Hints for Hapless Sets," by ye scribe.

Last meeting we enjoyed a talk by Dr. Reukema whose description of the universe involved such vast distances as to preclude any possibility of Herr Hitler demanding "Anschluss" with the Rig Dipper.

Wm. Appleton

**Hudson County**

The Hudson County Radio Servicemen's Association, composed of all the qualified Service Men available, are meeting twice monthly at 22 Liberty Ave., Jersey City, N. J. Present indications are that this group will become one of the largest independent groups in the country.

The energetic officers and members are planning to educate radio owners to the advisability of employing only qualified Service Men. The State Fair Trade Acts of New Jersey and New York have given them the weapon to fight the price cutters. The part time mechanic will find it impossible to bring his tough repair jobs to his full time competitor, as the established Service Men are no longer doing work at discounts to the part timers. Other ideas are being tested, and as soon as they are proved satisfactory, they will be released to radio associations in other communities.

Edward A. Turnier, publicity

**Philadelphia**

G. E. DeNiko, advertising manager of the National Union Radio Corp., addressed 200 servicemen at the Architects' Building, Philadelphia, Tuesday night, Feb. 21 on advertising methods for Service Men. The talk was jointly sponsored by the Radio Electric Service Co., Inc., and the Philadelphia Radio Servicemen's Association.

**The Representatives**

Charles Farrell of "Parts" started the New York members of The Representatives off with a pep-talk on the value of education of the jobbers' salesmen by the factory sales representative. At the conclusion of his talk, Mr. Farrell held an open forum during which all present discussed the various problems of the factory sales agent.

This regular meeting of The Representatives was held on Jan. 10 at the Fifth Avenue Tavern. The members discussed plans for their annual shindig and decided to hold it earlier in the year; time and place, etc., to be announced later. The Social Committee are busy trying to find out just what kind of a good time the boys would enjoy.

Jack Simperkoff has been up at the new Aero-vox plant to see that production keeps rolling for his many jobber friends.

Ed Kolman returned full of enthusiasm and new ideas from Chicago, where he attended the Automotive Service Industries Show at the Navy Pier, and also the annual sales meeting of the Kester Solder Company.

C. B. Cooper, publicity

**NEW  
Flexibility IN  
VIBRATOR TESTING**



**VIBRATOR TESTER  
push button type**

**Model 1671..\$41.67 Dealer Net**

- Tests All Standard 6-Volt Vibrators.
- Easy to Operate. . . . Roll Chart Shows Correct Button Settings.
- Uses Approved 5000 Ohms Load.
- Tester Fused Against Shorted Vibrators.
- Flexible Push-Button Switching Permits Placing Proper Voltages on Each Reed, Guarding Against Possibility of Obsolescence.

Triplet Model 1671 will take the guess out of vibrator testing . . . help you locate trouble quicker . . . sell more vibrators.

This new tester has been developed with the cooperation of leading vibrator engineers, and uses the standardized 5000 ohms-8 mid. load. It will test all standard makes of six-volt vibrators as used in automotive and home battery receivers. The model 327-A indicating instrument has three scales: 0-10 volts to show input voltage to vibrator for start or running tests. . . . A two-zone, two-color merit scale used in conjunction with the load rheostat shows vibrator condition as GOOD or BAD. . . . A 0-100 scale permits inter-comparison of vibrator outputs under standardized input conditions. A roll chart incorporated immediately below the push-buttons reduces test settings to utmost simplicity. Tester has tip jack facilities for oscilloscope connections. Like provisions have been made for connecting external buffer condensers if desired.

Model 1671 in Standard Triplet DeLuxe Metal Case, 14 1/2 x 7 1/2 x 4 1/2 in. Black Suede Finish . . . Silver and Black Etched Panel. . . Dealer Net . . . \$41.67

Model 1671 in Standard Triplet DeLuxe Leatherette Case With Removable Cover and Compartment for Accessories. . . Dealer Net . . . 45.67

Also Available . . . Model 1670 with selector switch controls. In DeLuxe Metal Case. Dealer Net . . . 24.00



SEE YOUR JOBBER OR WRITE FOR CATALOG

THE TRIPLET ELECTRICAL INSTRUMENT CO.  
173 Harmon Ave., Bluffton, Ohio

Please send me more information on  
 Model 1671  Model 1670

Name .....

Address .....

City..... State.....

# Manufacturers

## VERTROD ANTENNA

The Vertrod antenna has been designed for mounting on windows, gabled roofs, chimneys, parapet walls, etc.

Additional information can be obtained from the manufacturers, *Alesi & Fener*, 132 Nassau St., New York City.—SERVICE.

## MORLEN AMPLIFIER

Morlen Electric Co., Inc., have announced a new line of portable amplifiers. The 20-watt model, shown in the accompanying illustration, 131 db gain, 20-watts output, and push-pull output. The total harmonic distortion at full output, is only 2 per cent, it is said. Multistage inverse feedback is employed.

Additional information may be obtained



from *Morlen Electric Co., Inc.*, 60 W. 15th St., New York City. SERVICE.

## HICKOK SUBSTITUTE SPEAKER

Hickok announce a combination substitute speaker and vibrator tester. A meter is used in conjunction with the substitute speaker to indicate watts output. The speaker is of the pm type with a universal output transformer. Substitute fields are



available from 300 to 10,000 ohms.

For additional information write the *Hickok Electrical Instrument Co.*, Cleveland, Ohio. SERVICE.

## VOLTOHMYST

The latest product of the Successful Servicing Laboratories of John F. Rider is a combination electronic voltmeter and ohmmeter. Resistances from 0.1 ohm to 1,000 meg and d-c voltages from 0.05 to 5,000 volts can be measured. The input resistance of the voltmeter is 16 meg for all of the nine ranges. Ohmmeter zero adjustment does not require resetting when scales are changed.

Additional information may be obtained

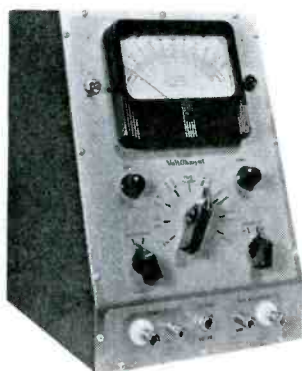

from *Service Instruments, Inc.*, 404 Fourth Ave., New York City.—SERVICE.

## CLAROSTAT POWER RESISTORS

Ferrule clip terminal type resistors are now available in the Clarostat wire-wound inorganic cement-coated power resistors line recently introduced by *Clarostat Mfg. Co., Inc.*, 285 N. 6 St., Brooklyn, N. Y.—SERVICE.

## OHMITE SOLDERING CONTROL

The Ohmite rheostat control has been designed to control the heat of soldering irons, solder pots, etc., in shops where operators must leave their irons idle while pre-

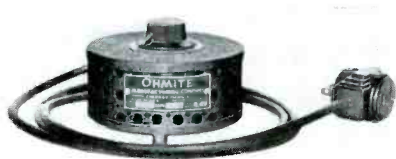

paring their work. It is available in 6 ratings from 50 to 500 watts.

Additional information may be obtained from *Ohmite Mfg. Co.*, 4835 Flournoy St., Chicago. SERVICE.

## N. U. STUBBY 5-IN. TUBE

A stubby 5-in cathode-ray television tube has been announced by National Union. The latest videtron measures 13-in long, 3½-in less than earlier units with



the same size screen.

Additional information can be obtained from *National Union Radio Corp.*, Newark, N. J.—SERVICE.

## CONSOLIDATED CONTROLS

Consolidated Wire have added a line of volume and tone controls in resistances from 5,000 ohms to 1 meg, with various combinations of switches and taps to cover replacement requirements for a great number of receivers.

Additional information may be obtained from *Consolidated Wire & Associated Corps.*, 518 S. Peoria St., Chicago.—SERVICE.

## REK-O-KUT RECORDER

Rek-O-Kut Corp. announce a recording mechanism for attachment to a suitable

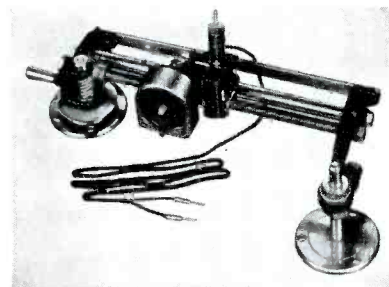

turntable. The assembly consists of a spindle and worm gear, feed screw and cutting head. The cutter operates with as little as 2-watts of audio power, it is said.

Write to the *Rek-O-Kut Corp.*, 254 Canal St., New York City, for additional information. SERVICE.

## BOGAN AMPLIFIER

The latest Bogan Amplifier, Model DX-



18, features electronic tone corrector, which is said to make allowances for varying room acoustics. Two low-gain and two high-gain input channels are provided.

Additional information can be obtained from *David Bogen Co., Inc.*, 663 Broadway, New York City.—SERVICE.

## DANIEL RECORDERS

Daniel Electrical Laboratories announce a portable and a console type instantaneous recorder.

In the console type a radio tuner is a built-in feature. Both machines are equipped with sound level indicators and are designed for cutting aluminum, acetate or processed blanks.

For additional information write to *Daniel Electrical Laboratories*, 87 Walker Street, New York City. SERVICE.

(Continued on page 148)



# THE NEW MILLION TEST SENSATION SIGNALYZER— FOR MODERN, ACCURATE CHANNEL TESTING

Sensational in Performance and Versatility

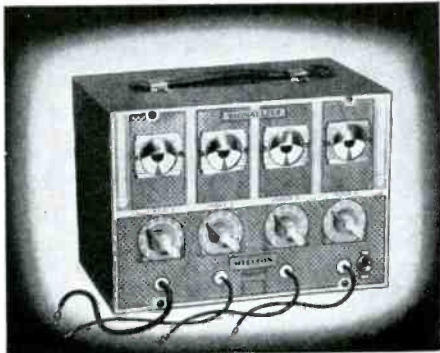

**HOW IT WORKS** →

← **NOTE COMPACTNESS**  
For **EASY-QUICK OPERATION**

**DEALERS**  
**NET COST** **\$24.95**  
**ONLY** →

**FOR ALL TESTS—WITHOUT AFFECTING CIRCUIT UNDER TEST**

• The Million signalyzer is new, four electronic "eye" signal analyzers in one unit for trouble shooting in modern receivers. Each "eye" has an amplifier stage preceding it to provide high sensitivity. Full closing of the "eye" occurs with a signal input of only .1 volt. One tenth of this or .01 volt is easily detected. This sensitivity provides visual evidence of the signal from the service oscillator through the entire receiver at every step from the antenna to the loud speaker. With your present oscillator and the signalyzer you can thoroughly check any receiver. Connecting the probes from the instrument to the RF, IF, AF and power circuits of the receiver under test; you are able to visually observe the presence of signal. Each probe has an insulated alligator clip.

**ORDER FROM YOUR JOBBER — LITERATURE ON REQUEST**

**NOTE**

All current model Million tube testers test both Loctal and S series tubes without adapters. All older models can be modernized—write for prices.

**MILLION RADIO and TELEVISION LABS**

671 NO. UNION ST.

CHICAGO, ILLINOIS

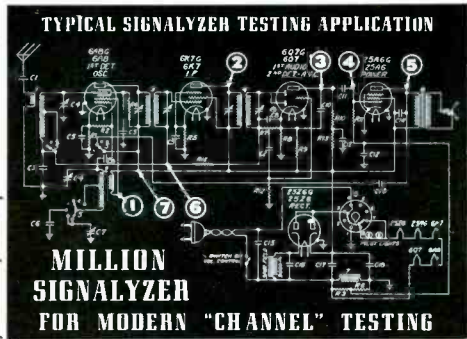

1. Local oscillator plate—check for output over entire tuning range.
2. Plate of intermediate frequency amplifier—check for IF signal and resonance.
3. Plate of second detector—check for audio output.
4. Grid of output tube—check for audio signal.
5. Plate of output tube—check for audio signal.
6. AVC voltage—check for variation with tuning.
7. B+ check for DC voltage from power supply.

*New Profits Assured for You!*  
*Announcing Two New*  
**TURNER Microphones**

**Dynamic 88 -- Crystal 66**

You get trouble-free sales—prompt turnover and wide margin with these handsome super-performance new Turner models. Weighted frequency response—inertia mounted cartridges—narrow beam pickup on all frequencies—wind and blast proofing—are exclusive Turner features. Designed to sell on sight, built to stay sold.

Open up rich new sales fields, and be free of "returned goods" headache. Write for free literature and details of liberal discounts on Models 88 and 86. Act today!



**The TURNER Co.** **\$25.00** LIST  
CEDAR RAPIDS, IOWA

**MODEL 88**  
Professional style. Level, —59DB, 60-8000 cycles! All impedances. 25 ft. cable. Order now.

**A GOOD NAME GOES A LONG WAY**



Ken-Rad makes a complete line of quality radio receiving tubes, backed by a continuous record of over 40 years in the manufacture of electric lamps.

**KEN-RAD TUBE & LAMP CORPORATION**  
Owensboro, Kentucky

**KEN-RAD**  
DEPENDABLE RADIO TUBES

*Way Up North—Way Down South*



**IT'S OHMITE**

In the bitter cold of the Arctic and Antarctic—or in the humid, sweltering heat of the tropics—Ohmite Resistance Units deliver unfailing, trouble-free service day-in and day-out. That's why they are so widely used by Servicemen, as well as Engineers and Manufacturers, in every climate in every part of the world. Ask your Jobber for Ohmite Brown Devils, Dividohms, Chokes, Cordohms Rheostats, etc.

wire-wound replacement resistors. Extra-sturdy all-porcelain construction with the permanent protection of Ohmite Vitreous Enamel just as in the big Ohmite industrial units. Resistances from 1 to 100,000 ohms.

**Send Coupon Today for FREE CATALOG 17**

**OHMITE MANUFACTURING CO.**  
4879 Flournoy Street, Chicago

Please send me free Catalog 17.

Name .....

Address .....

City .....

Occupation .....

*Be Right with* **OHMITE**  
RHEOSTATS • RESISTORS • TAP SWITCHES

# Highlights

## OXFORD-TARTAK DISPLAY

Oxford-Tartak have released a six-color display to their dealers and jobbers. The display, featuring Oxford speakers, has catalogs placed right in the display proper. Further information may be obtained directly from Oxford-Tartak Radio Corp., 915 W. Van Buren st., Chicago.

## RADIANT AERIAL DATA

Radiart Corp., Cleveland, Ohio, have issued an illustrative and descriptive bulletin covering their line of auto-radio aeri-als. Copies may be obtained directly from Radiart.

## PHILCO CORRESPONDENCE COURSE

Through a cooperative arrangement between the Philco Radio & Television Corp., and the Utilities Engineering Institute, 404 No. Wells St., Chicago, a specialized home training program in domestic refrigeration and air conditioning is available to members of the Philco RMS at a special rate.

Additional information can be obtained from Radio Manufacturer Service, c/o Philco Radio & Television Corp., Tioga and C Sts., Philadelphia, Pa.

## WEBSTER ELECTRIC BULLETINS

Webster Electric Co., Racine, Wis., have issued a series of bulletins illustrating and describing their line of crystal pickups. Copies may be obtained directly from Webster.

## THORDARSON CATALOG

The spring-summer edition, No. 400CX, of the Thordarson transformer catalog is now available from Thordarson Electric Mfg. Co., 500 W. Huron St., Chicago.

## ATR CATALOG

Catalog 139 of the American Television & Radio Co., covers their complete line of vibrator operated and rectifier power supplies, Shaverpacks, inverters, polarity changers, A battery eliminators, battery chargers, A-B power units and vibrators.

Copies may be obtained from American Television & Radio Co., 300 E. 4 St., St. Paul, Minn.

## AEROVOX N. Y. OFFICE

To insure close association with the trade in New York the Aerovox Corp., now of New Bedford, Mass., announce the opening of a New York sales office at 347 Fifth Ave.

## RADIO CITY LITERATURE

Descriptive and illustrative literature on the Radio City Model 504 push-button analyst is available directly from the manufacturer, Radio City Products Corp., 88 Park Pl., New York City.

## TELEVISION COURSE

The Radio Electronic Television Schools, 4709 Woodward Ave., Detroit, Mich., have announced a new training plan for Service Men in television, electronics and radio. Heretofore the school has offered both home-study and residential training courses. The new plan contemplates an interchangeable arrangement for all students whereby a home-study student may transfer to the residential school, or vice versa, at any time during the training program.

## RCA CHARACTERISTIC CHART

RCA have issued their Receiving Tube Characteristic Chart 1275B. This booklet gives characteristics data on 191 RCA tubes including glass, glass-octal, GT, and metal types in numerical-alphabetical sequence. Socket connections with RMA designations are shown at the end of the booklet.

Copies may be obtained from Commercial Engineering Section, RCA Mfg. Co., Inc., Harrison, N. J.

## C-D DEALER HELPS

Cornell-Dubilier Electric Corp., S. Plainfield, N. J., are supplying their jobbers and dealers with flasher displays for window and counter use. These displays are in 8 colors on heavy cardboard. They show graphically a difference in reception when C-D Quietone filters are used.

## DX COIL CATALOG

The DX Radio Products Co., 1571 Milwaukee Ave., Chicago, have issued a catalog illustrating and describing their complete line of replacement coils, chokes and trimmer condensers.

Copies may be obtained directly from the DX Co.

## DACO BULLETIN

The Dayton Acme Co., 1100 Sycamore St., Cincinnati, Ohio, have issued an illustrative bulletin describing Daco test equipment for the Service Man.

Copies may be obtained directly from Dayton Acme Co.

## STEWART CATALOG

F. W. Stewart Mfg. Corp., 340 W. Huron St., Chicago, have issued a full color catalog illustrating and describing their replacement controls for auto-radio receivers. Panels are shown for practically all cars from 1934 to 1939 inclusive.

Copies of this catalog may be obtained from F. W. Stewart.

## IRC REPLACEMENT GUIDE

Fully revised and based on a complete IRC line, including the new midgets and the low range wire-wound units, edition No. 2 of the IRC replacement guide is now available. Copies may be obtained from International Resistance Co., 401 N. Broad St., Philadelphia, Pa.

## TRADE SHOW

The regular annual membership meeting of Radio Parts Manufacturers National Trade Show will be held at 12:00 noon, Friday, June 16, at the Stevens Hotel, Chicago. The meeting will adjourn in time for the opening hour of the show.

Wednesday and Thursday, June 14 and 15, are jobber days at the Trade Show. Friday and Saturday, June 16 and 17, will be given over to the general trade with the Service Men carrying on their principal activities on Friday, and the amateurs on Saturday.

This is the first time that specific days have been set aside for various sections of the parts industry. The advantages are obvious. Jobbers will have an opportunity to discuss problems with their manufacturers, and then on the general trade days, the Service Men and amateurs will find the booths manned by technicians who are

familiar with the problems of the technical groups.

A schedule of the Show Hours at the 1939 National Radio Parts Trade Show follows:

Wednesday and Thursday, June 14 and 15, 10:00 a.m. to 6:00 p.m.

Friday, June 16, 2:00 p.m. to 11:00 p.m.

Saturday, June 17, 2:00 p.m. to 10:00 p.m.

Closing the Trade Show at 6:00 p.m. on jobber days will give the manufacturers and their jobbers time to attend the RMA banquet on Wednesday evening; and to participate in various festivities and business conferences.

More than a hundred manufacturers had contracted for over 130 booths in the Trade Show by the first of March. The number of exhibitors, as well as the amount of space contracted for, is running ahead of last year's record by nearly a month.

The joint meeting of the Sales Managers Club, Eastern and Western divisions, will be held at 10:30 a.m., Friday, June 16, at the Stevens Hotel, in Chicago.

The biggest Service Man convention ever staged is being planned for June 16th and 17th, when RSA members will meet in their Second Annual Convention.

A program of extra interest and value is being planned, with a television demonstration and technical lecture probably the high spot. The Parts Show has set aside Friday and Saturday as our days, when technical attendants will be in the booths to answer our questions and show their wares.

Arrangements are being made for reduced fares on railroads and bus lines from chapter cities.

## MANUFACTURERS

(Continued from page 146)

### SPRAGUE KITS

Kits containing 6 or 12 Atom condensers have been introduced by Sprague for the replacement market.

Atom electrolytics are self supporting and can be mounted by means of their connecting wires similar to tubular condensers.

For additional information write Sprague Products Co., North Adams, Mass.—SERVICE.

### ASTATIC MIKE LITE

Astatic Microphone Labs., Inc., have introduced a microphone with adjustable spotlights to throw a halo upon the speaker. The lights are provided with rose tinted frosted lenses, are adjustable and spot the

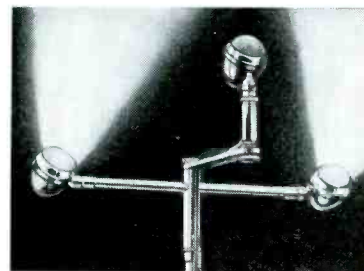

speaker from both sides.

Additional information may be obtained from Astatic Microphone Laboratory, Inc., Youngstown, Ohio. SERVICE.

# A pair of Aces!



**BRUSH** HL MIKES  
HM MIKES



• Here's a mike to remember on your next low gain amplifier problem—Brush Model HL. This diaphragm crystal type mike will please hams and professionals alike with its high level performance and good response from 100 to 5,000 c.p.s. plus or minus 5 db. Plenty of eye-appeal in its satin chrome finish, and flexible *Vari-Swiv* mounting.

You can specify this mike with confidence and be sure of a good profit for you.

• You can make your next low impedance job a better job with Brush HM Mike. It's a diaphragm crystal type, built into a handsome bullet shaped case containing the mike and a high grade transformer with taps for 50, 200, and 500 ohm lines. Gives low impedance operation, and high level (minus 46 db.). Comes complete with *Vari-Swiv* mounting. A dependable mike that will insure customer satisfaction.

**THE BRUSH DEVELOPMENT CO.**  
3318 PERKINS AVE. CLEVELAND, OHIO



MISS JONES

is married now . . .

She'll tell her husband how good your service has always been and he too will have you do their radio repairs. That's the way business grows. Use dependable Ward Leonard Replacements. They stand up, thus help make satisfied customers. Send for Price List 507.

WARD LEONARD ELECTRIC CO.  
36 SOUTH STREET, MOUNT VERNON, N. Y.

Please send me Price List 507.

Name .....

Firm .....

Address .....

City ..... State .....

# OF THE SERVICEMAN, BY THE SERVICEMAN, FOR THE SERVICEMAN!

## MAIL THIS COUPON!

RADIO SERVICEMEN OF AMERICA, INC.  
304 S. Dearborn Street, Chicago, Ill.  
Gentlemen:

I hereby make application for membership in the  
Radio Servicemen of America.

Name .....

Address .....

City ..... State .....

I am enclosing \$4.00 for Dues and Initiation. (Does not include  
Local Chapter Dues where Local Chapters are organized.)

Yes . . . the RSA is yours, Mr. Serviceman! It's run by and for its members—uncontrolled by any outside interests. You elect your representatives (all responsible officers are bonded)—and they work for you!

Here is what RSA gives you: ★ Advanced Circuit Notes for Members each month. ★ Technical Help on Service Problems. ★ Access to its National Speakers Bureau. ★ Advanced Service Courses to Members at slight cost. ★ A Monthly RSA Publication. ★ Annual Convention. ★ And many other benefits now being planned.

Make progress this year by using your time to the best advantage. Send the Coupon *Today*—and be "in" with your fellow servicemen!

National Yearly Dues . . . . . \$3.00

Initiation Fees . . . . . \$1.00

*Let's Grow Together in 1939!*

**RADIO SERVICEMEN OF AMERICA, INC.**

Joe Marty, Jr., Executive Secretary ★ 304 S. Dearborn Street, Chicago



# Now! BALLAST REPLACEMENT

made  
**AMAZINGLY  
SIMPLE**

- Servicemen, with only 4 standard types of Amperite AC-DC Regulators you can replace 90% (over 100 types) of AC-DC Ballast Tubes now in use! Consult your jobber.
- Amperite Regulators are equipped with a patented Automatic Starting Resistor to prevent untimely burnouts and save pilot lights.
- New Low Price on Amperite AC-DC Regulators: \$1.00 LIST  
Amperite Replacements for 2V Battery Set ballasts \$1.25 list

**AMPERITE  
Company**  
561 BROADWAY  
NEW YORK



WRITE  
FOR  
CHART  
A R

**AMPERITE**  
AUTOMATIC REGULATORS

## DON'T LET TELEVISION CATCH YOU NAPPING!



**Train For Your  
Share of Profits  
Now!**

Are you awake to the great money-making possibilities that stretch out before you in Television and Facsimile work? Here are two phases of Radio that will literally recruit an army of Servicemen in a new multi-million-dollar industry. Will you be prepared to get on this enormous payroll? Competition demands that you know your "stuff". As in all phases of Radio Service and Installation work, you must have a better-than-average technical knowledge to do more jobs quicker and with greater efficiency . . . with greater profits.

That's why SPRAYBERRY ADVANCED "MASTER SERVICE TRAINING" was developed. Includes over 50 new lessons, clear and simply written, on almost every essential Radio repair subject, including latest TELEVISION and FACSIMILE instruction. It's a compact, "all-meats" type of Training in Set Testing, Repairing, Parts Testing, Trouble Shooting, etc.

### Do Better Jobs . . . Quicker

It shows you the easiest ways of doing the hardest jobs. Shows you time-saving short-cuts besides training you in actual business-getting methods. Many Servicemen have easily paid for this practical Course out of increased earnings. Sold on terms as low as \$3.00 down—\$3.00 per month with iron-clad MONEY-BACK Agreement.

Don't fall into the rut of being satisfied with your present earnings. Self-improvement is the surest way to greater usefulness and bigger pay. Let me send you complete information at once. For your own sake, don't put it off.

### RUSH Coupon for FREE Facts

SPRAYBERRY ACADEMY OF RADIO  
1500-C University Place, N. W.  
Washington, D. C.

Please send, without obligation, complete details of your MASTER SERVICE COURSE.

Name .....

Address .....

City ..... State .....

(Paste on penny postcard or mail in envelope)

## Advertising Index

A	
Aerovox Corp. ....	130
Alden Mfg. Co. ....	143
Allied Radio Corp. ....	145
American Television & Radio Co. ....	143
Amperite Co. ....	150
Astatic Microphone Lab., Inc. ....	130
B	
Brach Mfg. Co., L. S. ....	132
Brush Development Co., The. ....	149
C	
Centralab ....	122
Cinaudagraph Corp. ....	140
Clarostat Mfg. Co., Inc. ....	140
Consolidated Wire & Associated Corps. ....	128
Cornell-Dubilier Electric Corp. ....	132
Crowe Name Plate & Mfg. Co. ....	134
E	
Electro-Voice Mfg. Co. ....	144
H	
Hickok Electrical Instrument Corp, The	135
Hygrade Sylvania Corp. ....	139
I	
Insuline Corp. of America. ....	145
International Resistance Co. ....	128
J	
Jensen Radio Mfg. Co. ....	101
K	
Ken-Rad Tube & Lamp Corp. ....	147
M	
Mallory & Co., Inc., P. R. ....	Second Cover
Meissner Mfg. Co. ....	117
Million Radio & Television Labs. ....	147
N	
National Radio Parts Trade Show. ....	136
National Union Radio Corp. ....	129
O	
Ohmite Mfg. Co. ....	147
P	
Precision Apparatus Corp. ....	132
R	
Radiart Corp., The. ....	130
Radio City Products Co. ....	137
Radio Servicemen of America, Inc. ....	149
RCA Mfg. Co., Inc. ....	111, Fourth Cover
Raytheon Production Corp. ....	107
Readrite Meter Works. ....	128
Rider, John E., Publisher. ....	102
S	
Service Instruments, Inc. ....	131
Shure Brothers ....	134
Simpson Electric Co. ....	121
Solar Mfg. Corp. ....	Third Cover
Sprayberry Academy of Radio. ....	150
Standard Transformer Corp. ....	139
Supreme Instruments Corp. ....	119
T	
Thordarson Elec. Mfg. Co. ....	141
Triplett Elec. Inst. Co., The. ....	145
Tung-Sol Lamp Works, Inc. ....	141
Turner Co., The. ....	147
U	
United Catalog Publishers, Inc. ....	138
Utah Radio Products Co. ....	133
V	
Vocagraph Sound Systems. ....	143
W	
Ward Leonard Electric Co. ....	149
Ward Products Corp. ....	150
Weston Electrical Instrument Corp. ....	127
Y	
Yaxley Mfg. Division. ....	Second Cover

## Now... 5 VITAL FEATURES COMBINED IN AMPERITE VELOCITY WITH ACOUSTIC COMPENSATOR



UNI-DIRECTIONAL PICK-UP FIELD COMPENSATOR UP



PICK-UP FIELD COMPENSATOR DOWN

- it's a VELOCITY
- it's a DYNAMIC
- UNI-DIRECTIONAL
- NON-DIRECTIONAL
- HIGH OR LOW PITCH

By moving up the Acoustic Compensator, you change the Amperite Velocity Microphone to dynamic operation — without peaks. At the same time you reduce the back pickup, making the microphone practically UNI-DIRECTIONAL.

With the Acoustic Compensator down, the microphone is BI-DIRECTIONAL . . . 120 degrees front and back without frequency discrimination. Rotating the microphone until it parallels the ceiling makes

the microphone NON-DIRECTIONAL. **THE ACOUSTIC COMPENSATOR** is a regular feature of these models: RBHk (hi-imp); RBMk (200 ohms) LIST \$42.00. RSHk (hi-imp); RBSk (200 ohms) LIST \$32.00

Write for Complete Illustrated Bulletins and Valuable Sales Helps.

**AMPERITE Co.** 561 BROADWAY, N. Y.  
Cable Address: Alkem, New York  
**AMPERITE Velocity MICROPHONES**

# WARD AERIALS ARE EASY TO SELL - EASY TO INSTALL - FREE!

Write for new catalog of Ward's complete line of low-priced manufacturers - approved aerials for car and home - also get on mailing list for free magazine packed with selling and service tips.

**WARD PRODUCTS CORP.**

WARD BLDG. CLEVELAND, O.

Probably the most popular  
testing equipment  
ever introduced



## CAPACITOR ANALYZER



Capacity, power factor, leakage, resistance — directly on the panel, quick as a wink! Small wonder that service men everywhere have voted YEA for this precision instrument with the MAGIC TUBE! Indispensable!

*Prompt delivery from your jobber  
Catalogue upon request*

**SOLAR MFG. CORP., 599-601 BROADWAY, NEW YORK**

# Making Their Bow! 2 NEW RCA AUTO ANTENNAS THAT WILL BRING YOU PROFITABLE SALES

## A Cowl-mounting Antenna that's NOISE-PROOF!

The noise-proof feature of this fine antenna is one you've been seeking for a long time! Noise pick-up is eliminated by shields over mounting bolts. This beautiful, highly efficient antenna is easily installed permanently to the side of the cowl. It enhances the beauty of any car... is guaranteed rust-proof. High gloss chrome finish with chromium trim on ceramic insulators. Weighs only 17 oz. Comes to you individually packed. Its price includes 36" shielded low capacity cable with bayonet fitting. Antenna extends from 28 1/4" to 66 1/4" in length.



LIST PRICE  
**\$3.35**  
STOCK NO.  
9855

**RCA COWL ANTENNA**  
2 INSULATOR... 3-SECTION TYPE

## A Rodtenna Offering TILT-MOUNTING

This fine new antenna may be mounted at an angle, thus greatly adding to the beauty of modern streamlined cars. Is easily installed, requires but a few minutes for the complete job. Mounts simply on door hinge pin. No drilling, soldering or cementing required. This highly efficient antenna is beautifully finished in high gloss chrome and is guaranteed rust-proof. Weighs only 16 oz. Comes to you individually packed. Price includes 36" shielded low capacity cable with bayonet fitting. Antenna extends from 30 1/2" to 69".

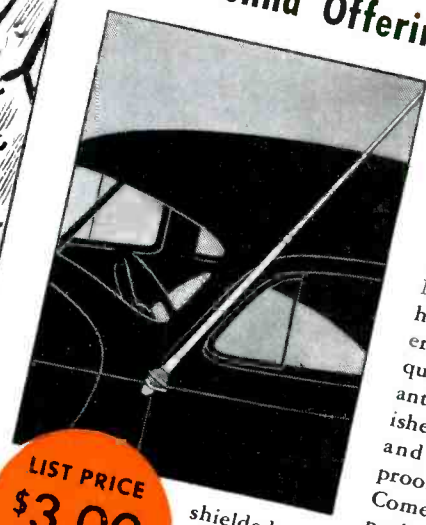

LIST PRICE  
**\$3.00**  
STOCK NO.  
9856

**HIGHLY EFFICIENT...**  
3-SECTION TYPE

## Another Hit—from Coast to Coast

# RCA MAGIC WAVE ANTENNA SYSTEM

Operates from 1 to 16 Radios

Here's an RCA Antenna that has everyone excited! Home and apartment house owners cheer it because it not only operates as many as 16 radios—but because it provides a brand of performance that's head and shoulders above the average. Its low price, too, is a great attraction. Service men like it because it steps up performance, is easy to install and has many outstanding features! Look them over—they speak for themselves.

### Look at these Magic Wave Antenna Features

1. Noise reduction on all wave bands from 530 to 23,000 kcs
2. Easily installed with antenna lengths from 20 to 120 feet
3. Adaptable to existing installations—no doublets or critical antenna transmission lengths
4. Operates up to 16 outlets simultaneously when used with RCA distribution and coupling transformers
5. Adaptable to many different types of installation—vertical, horizontal, apartment house, or home. Transmission line can be installed under ground



NEW LOW PRICE  
**\$5.95**  
LIST STOCK NO.  
9812

### A typical Special Installation made possible by the Magic Wave Antenna

By using five distribution transformers and 16 receiver coupling transformers you can make a complete noise reducing installation for operation of up to 16 outlets. Diagram at right shows how only one distribution transformer is necessary for each four outlets. No serious loss in signal or efficiency is present at any outlet. No interaction between receivers. Dis-

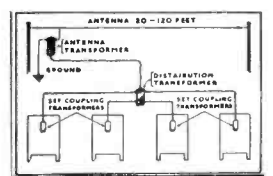

tribution transformer Stock No. 9814 costs \$3.00; additional set coupling transformers, Stock No. 9813, costs \$2.50.

RCA presents the "Magic Key" every Sunday, 2 to 3 P.M., E.S.T., on the NBC Blue Network.

Over 325 million RCA radio tubes have been purchased by radio users... in tubes, as in parts and test equipment, it pays to go RCA All the Way.



# Parts FOR PROFIT

RCA Manufacturing Co., Inc., Camden, N. J. • A Service of the Radio Corporation of America