

SERVICE

A MONTHLY DIGEST OF RADIO AND ALLIED MAINTENANCE

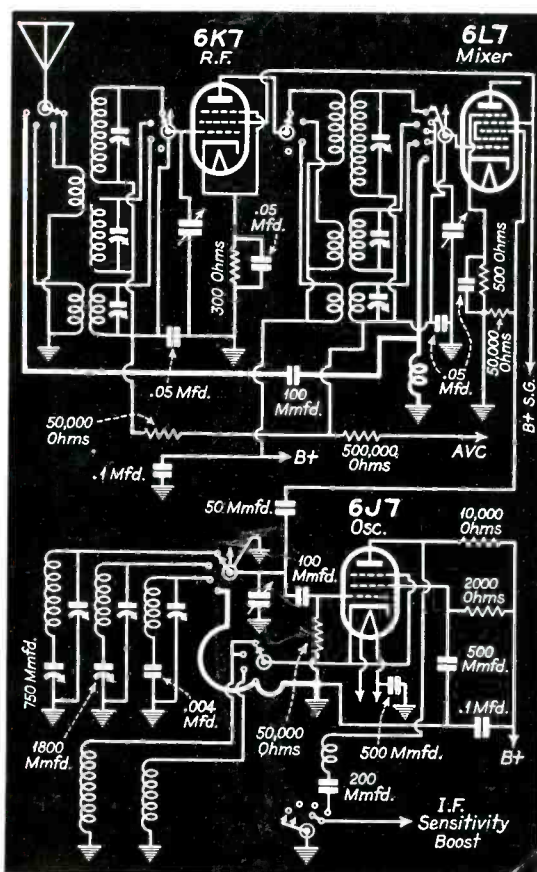

PER COPY
25 CENTS

All-Wave R-F System
(See Page 302)

JULY
1936

Build your business with

MALLORY

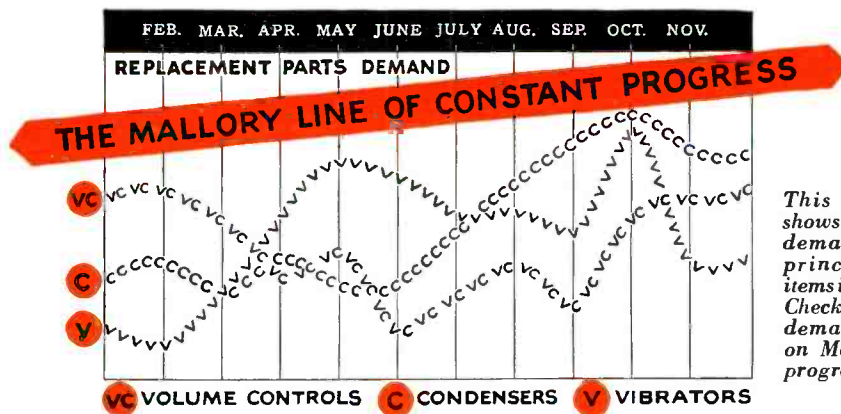

This composite graph shows the trend of service demand for the three principal replacement items in daily service work. Check your needs with the demand — and depend on Mallory for constant progress.

Study seasonal rise and fall in demand with your principal service items and peaks and valleys of service activity will iron out to a line of steady progress.

Especially — when you depend upon the Mallory Yaxley Replacement Line — Mallory Condensers, Mallory Vibrators and Yaxley Volume Controls. The Mallory Yaxley line is designed for the service man's requirements; — to enable him to give quality service, with a minimum of cash investment, yet with constant progress in building a profitable service business.

Consider the Mallory Yaxley line

Sixty-nine Mallory Replacement Condensers now fulfill *all* service needs — meeting requirements that would heretofore have necessitated literally thousands of condensers.

★ ★

A mere handful of Mallory Replacement Vibrators render universal service to over 3,000,000 auto-

Line up with Mallory — and establish for yourself — a line of constant progress.

mobile radio sets. Two out of three of *all* automobile radio vibrators now in use are Mallory made.

★ ★

In developing constant improvements in Yaxley Replacement Volume Controls, Yaxley engineering has brought about undreamed of precision in universal application to meet all service needs for over 4000 different radio receiver models.



MALLORY

P. R. MALLORY & CO., Inc.
INDIANAPOLIS INDIANA
Cable Address—Pelmallo

YAXLEY

RESEARCH KEEPS GENERAL ELECTRIC YEARS AHEAD



Focused Tone

It is G.E.'s new radio circuit that **AUTOMATICALLY** and **VISIBLY** shifts itself into hair-line tuning—perfect tone.

It is the new G-E Colorama Dial that changes from red to green to tell you that your program is perfectly tuned.

It is the Personalized Radio with the custom-tailored dial—your own local station letters flash on when you tune in.

It is Silent Tuning—you can switch from one program to another without a single squeal, squawk, or screech.

It is the combination of all the new and revolutionary G-E Radio inventions and developments — G-E Metal Tubes; G-E Sentry Box; G-E Stabilized Dynamic Speaker; G-E Sliding-rule Tuning Scale; G-E "V-doublet" All-wave Antenna—which give you the finest, truest tone of any radio ever built—that's Focused Tone! Only the new G-E gives it to you — **AUTOMATICALLY!** — **VISIBLY!** — **INSTANTLY!** — every time you tune in.

GENERAL  **ELECTRIC**

Focused Tone Radio

APPLIANCE AND MERCHANDISE DEPT., GENERAL ELECTRIC COMPANY, BRIDGEPORT, CONN.

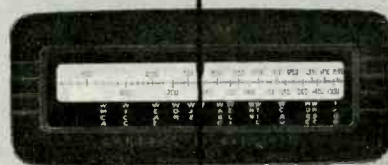

**RADIO'S
NEWEST
MARVEL**

**REVOLUTIONIZES
TUNING**

**AUTOMATICALLY
ASSURES
PERFECT
TONE**



SERVICE

A Monthly Digest of Radio and Allied Maintenance
 Reg. U. S. Patent Office. Member, Audit Bureau of Circulations

EDITOR

Robert G. Herzog

JULY, 1936

VOL. 5, NO. 7

EDITORIAL CONTENTS

FEATURES		Calibrated R-F Attenuators <i>By W. W. Waltz</i>	301
All Wave R-F System.....	302	Philco 680.....	305
A Universal Test Instrument <i>By Carl J. Penther</i>	303	Putting the Oscilloscope to Work.....	299
Beam Power Amplifier <i>By I. A. Mitchell</i>	312	Technical Features of 1937 Crosley Radios..	308
Calibrated R-F Attenuators <i>By W. W. Waltz</i>	301	Zenith Chassis 1203.....	307
Putting the Oscilloscope to Work.....	299	HIGHLIGHTS	330
ANTENNA	296	MANUFACTURERS	328
ASSOCIATION NEWS	326	ON THE JOB	
AUTO RADIO		Added Speaker <i>By George J. Damm</i>	322
Arvin 33.....	311	Binder for SERVICE <i>By Arthur Terry</i>	322
Initial Failure Note.....	311	Multiple Meter Scale <i>By Harvey H. Schock</i>	322
CIRCUITS		Series Shunt <i>By D. L. Van Leuven</i>	322
Added Speaker.....	322	Shorted Turn Tester.....	322
All-Wave R-F System.....	Front Cover	PUBLIC ADDRESS	
Arvin 33.....	311	Beam Power P-A Amplifier <i>By I. A. Mitchell</i>	312
A Universal Test Instrument.....	304	RECEIVER CASE HISTORIES	324
Beam Power P-A Amplifier.....	312	TEST EQUIPMENT	
Calibrating Amplifier Gain.....	300	A Universal Test Instrument <i>By Carl J. Penther</i>	303
Calibrating the Oscilloscope.....	299	Calibrated R-F Attenuators <i>By W. W. Waltz</i>	301
Checking Damping.....	300	Clough-Bregle OM-A Inductor Sweep....	320
Checking Hum.....	300	Hickok OS 10 Oscillator <i>By Walter A. Weiss</i>	318
Clough-Bregle Inductor Sweep.....	320	Multiple Meter Scale <i>By Harvey H. Schock</i>	322
Hickok OS 10 Oscillator.....	318	Putting the Oscilloscope to Work.....	299
Inductance Attenuator.....	301	Series Shunt <i>By D. L. Van Leuven</i>	322
Philco 680.....	306	Shorted Turn Tester.....	322
Relaxation Oscillator.....	316	Solar Capacitator Analyzer CB <i>By William M. Robinson</i>	316
Resistance Attenuator.....	301	Triplett 1231 Signal Generator <i>By F. E. Wenger</i>	314
Series Shunt.....	322		
Shorted Turn Tester.....	322		
Solar Capacitator Analyzer.....	316		
Triplett 1231 Signal Generator.....	314		
Wein Bridge.....	316		
Zenith 1203.....	307		
GENERAL DATA			
All-Wave R-F System.....	302		

BRYAN S. DAVIS
President

JAS. A. WALKER
Secretary

Chicago Office—608 S. Dearborn St.—C. O. Stimpson, Mgr.
 Telephone: Wabash 1903
 Wellington, New Zealand—Tearo Book Depot.

Published Monthly by the

Bryan Davis Publishing Co., Inc.
 19 East 47th Street
 New York City

Telephone: Plaza 3-0483

SANFORD R. COWAN
Advertising Manager
 PAUL S. WEIL
*Eastern Advertising
 Manager*
 A. B. CARLSEN
Circulation Manager

Cleveland Office—10515 Wilbur Ave.—J. C. Munn, Mgr.
 Telephone: Republic 0905-J

Melbourne, Australia—McGill's Agency.



Entered as second-class matter June 14, 1932, at the Post Office at New York, N. Y., under the Act of March 3, 1879. Subscription price \$2.00 per year in the United States of America and Canada; 25 cents per copy. \$3.00 per year in foreign countries; 35 cents per copy.

NEW

"PRECISION" ELECTRONOMETER SERIES 600

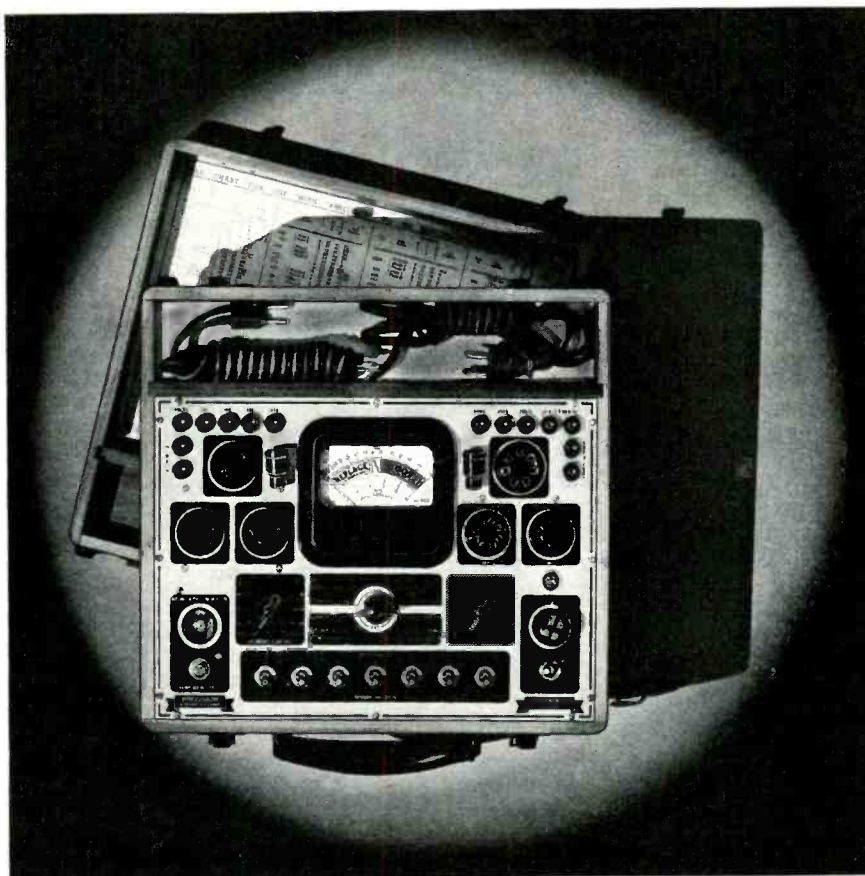

TUBE ANALYZER and VOLT OHM MILLIAMMETER

An ideal tube and set testing combination of compact size equally suitable for the shop or in the field. Eliminates the inconvenience of carrying several testers. Housed in an attractive natural finish hardwood case. Size 12 $\frac{3}{4}$ x11 $\frac{1}{2}$ x6 inches. Approximate carrying weight only 11 pounds.

The 600 "Precision" ELECTRONOMETER incorporates the most advanced circuit features for tube analyzing in combination with adequate voltage, resistance and current measurements for set analyzing. Also provides for checking leakage in paper condensers and, through the use of MA posts, qualitative analyses of electrolytic condensers can be obtained.

ALSO MANUFACTURED IN LABORATORY AND PANEL TYPES

FOR DETAILS AND PRICES . . . MAIL THIS COUPON

PRECISION

Apparatus Corporation

821 EAST NEW YORK AVENUE
BROOKLYN, NEW YORK

PRECISION APPARATUS CORPORATION
821 East New York Avenue
Brooklyn, New York

Gentlemen: Please send me full information on the NEW ELECTRONOMETER, Series 600; also include the name and address of my local distributor where I may see it in operation.

NAME

ADDRESS

CITY STATE

THE ANTENNA . . .

TEST EQUIPMENT

IT IS GENERALLY CONCEDED that the Service Man is no more efficient than the test equipment he uses. With the increasing complexity of radio receivers and their many "automatic" features trouble shooting and repairs can no longer be accomplished by guesswork. Tube testers, set analyzers, signal generators, capacity analyzers, and even cathode-ray oscilloscopes are becoming everyday essentials in the Service Man's work shop.

It is to the Service Man's special advantage that he familiarize himself with the internal construction of his equipment so that he can realize its flexibility and use each instrument to the greatest extent. It is his duty to himself and to his clients that he learn every service short cut and apply them in his daily work.

Good equipment will not help the Service Man if it remains idle on his bench. He should construct suitable switching arrangements, as well as numerous jigs and fixtures, to enable him to reconnect his various instruments easily to obtain greater flexibility.

In previous issues of SERVICE the publicity value of test equipment was stressed. Service equipment should be neatly interconnected and surgically immaculate. It should be made to play an important part in dramatizing the value and dignity of the job for the benefit of the client. When soliciting business, folders playing up the completeness of test equipment with photos where possible are suggested. This not only impresses the prospective client but also gives the Service Man an edge over his competitors who might not possess the equipment. When making an investment in new equipment it is to the Service Man's advantage to consider not only the quality and utility of the equipment but also to make certain that he can take advantage of its display value. In so doing he is taking proper steps to insure a reasonable return on his investment.

. . .

ACCURACY

THE ACCURACY OF A TEST instrument depends upon that of its various components and upon the accuracy of its original calibration. In manufacturing test equipment the instrument maker has at his command numerous accurate standards for comparison as well as intricate bridges, meter standards, etc., for the accurate calibration and measurement of the individual components and also of the finished instruments. It is the instrument makers job to set the tolerances in the industry. His precision equipment must not only be within the limits of accuracy he advertises, but it must be able to maintain that accuracy through much abuse over long periods and under adverse conditions.

The individual Service Man without these facilities, attempting to duplicate a particular device can at best

construct only a crude imitation of the manufacturer's product. This does not apply, as a rule, to test equipment accessories. The accuracy and calibration required in these gadgets can usually be obtained through the use of the equipment that the Service Man has available on his service bench.

. . .

TIME ELEMENT

BEFORE THE ADVENT OF high fidelity, avc. afc, and the many other "automatic" features, test equipment was used largely to simplify and speed up the processes of trouble shooting. Tubes could be tested in an operating receiver; voltages could be located with a screw-driver; condensers could be checked by the snap obtained on shorting them; resistance and continuity could be determined by means of a small battery and a sensitive bulb.

The picture is changed somewhat by the modern receiver. The many intricate types of tubes cannot be tested in any one receiver—a tube tester is absolutely essential. The voltages used in automatic control circuits cannot be tested with a screw-driver. Electrolytic condensers cannot be tested by the snap they make. All-wave receivers require the use of signal generators and sensitive output meters for alignment. Intricate circuits require closer tolerance in resistances; these must be checked with more accurate ohmmeters. High-fidelity receivers require the use of the cathode-ray oscilloscope to accomplish broad-band alignment.

The Service Man, to keep up with his clients' repair problems, *must* have complete equipment and must know how to use it, not only to save himself time, but to be able to accomplish his daily repairs. He may be able to string along for a few more months, but as more and more of the new receivers are sold he will find himself gradually losing customers.

. . .

CATHODE-RAY OSCILLOSCOPES

THE ARTICLE ON THE CATHODE-RAY oscilloscope featured in this issue is the first of a series to be continued in future issues of SERVICE. These articles are written with the hope that they will enable the Service Man to become completely familiar with the many applications of the cathode-ray oscilloscope. In each article one or more of these applications will be completely described with adequate illustrations and definite instructions.

Announcing...

Tru-Fidelity

**BY
THORDARSON**



FEATURES

- ▶ Wide Range Frequency Response—
High permeability core—Special coil construction
for low distributed capacity and leakage reactance.
- ▶ Maximum shielding from external fields through case
design. (Additional shielding cases unnecessary.)
Electrostatic shielding between primary and secondary
coils.
- ▶ Capacitively and Inductively balanced for use on
equalized transmission lines. Effect of stray fields
neutralized.
- ▶ Line coupling transformers reflect proper impedance
on ALL taps, reducing line reflection.
- ▶ Ingenious mounting permits above panel—sub-panel
or combination wiring—single hole mounting bushing
permits rotation without disturbing connecting leads.

**MOST SENSATIONAL
AUDIO DEVELOPMENT
SINCE the DYNAMIC SPEAKER**

**STUPENDOUS! HISTORY MAKING!
TRU-FIDELITY by THORDARSON.**
For the first time, full range—clear—yes
PERFECT audio reproduction is available.
Others have tried, THORDARSON
has succeeded and brings you laboratory
perfection in commercial production with
TRU-FIDELITY.

Ask your jobber for catalog No. 500 for complete
listing and data of models, or write factory.



THORDARSON ELECTRIC MFG. CO.

500 West Huron St., Chicago, Ill., U. S. A.



Why Be Puzzled

about the proper

ANTENNA-CATHODE

Volume Control Replacement?

Electrad Offers 3 Specially Designed Controls for use in Antenna-Cathode Circuits—Complete Table in New Guide Simplifies Selection.

Correct taper is the important thing in an Antenna-Cathode volume control. When the taper is not exactly right, the control either gets noisy and burns out quickly—or the control of volume may be “jerky.”

To provide for all receiver requirements, Electrad has designed three standard controls for use in this circuit—No. 240, No. 201 and the heavy-current-carrying No. 875. Selection of the proper control is guided by a complete table of which the following is an excerpt:

Tube	No. of Tubes	Control	Taper	Bias Resistor
27	1	201	C	3500
	2	240	C	1500
	3	875	H	1250

By consulting the complete table it is immediately evident that if three R.F. tubes have their cathodes tied together, and then to one end of the volume control, thru the proper bias resistor, the No. 875 control must be used. Column 4 shows fixed resistance value needed to give proper minimum bias to the tubes in question.

Servicemen who have used these new Electrad controls report complete satisfaction and a tremendous simplification of the job of selecting the right control for this frequently troublesome replacement.

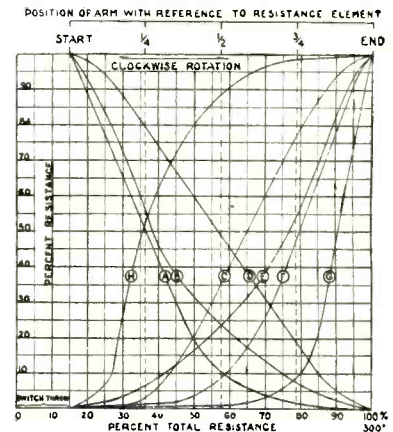

Above chart shows standard control tapers. Curves H and C are recommended for Antenna-Cathode circuits.

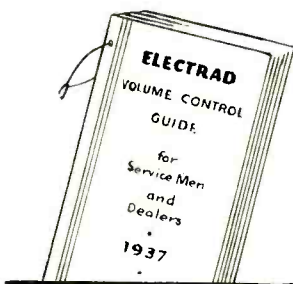

Complete Antenna-Cathode Replacement Tables and More than 100 Pages of Other Valuable Data in the New Electrad Guide.

Send 2 complete Electrad Volume Control cartons at once for your copy of this invaluable manual. Larger, more complete, more helpful than any previous editions. All servicemen on the Guide list also receive the new Electrad Contact FREE. Supply is limited. Act now! Write Dept. S7.

ELECTRAD, INC.
175 VARICK STREET, NEW YORK

SERVICE

A Monthly Digest of Radio and Allied Maintenance

FOR JULY, 1936

PUTTING THE OSCILLOSCOPE TO WORK

IN discussing the cathode-ray oscilloscope with representative Service Men it would seem that the entire subject is treated with a great deal of awe. Service Men hope to own their own instrument but feel that it is too complicated for them to use in their daily service jobs. The simplicity and flexibility of the oscilloscope are points that cannot be stressed too much. The cathode-ray oscilloscope can be used to special advantage (with very little additional equipment) in practically every service test encountered in every day radio repairs.

OVER 200 PAGES OF APPLICATIONS

In his book "The Cathode Ray Tube at Work," John F. Rider devotes an entire chapter of over 100 pages to the numerous applications in which the oscilloscope can be used to exceptional advantage. Five additional chapters, each to a separate application, totaling another 100 pages, are devoted to those tests which can be accomplished only through the use of the cathode-ray oscilloscope and its accompanying equipment.

National Union, R.C.A., Clough-Brengle, Supreme—in fact every manufacturer of cathode-ray equipment—publish quantities of material on the many applications of the oscilloscope and distribute this material rather freely.

In this article some of the various uses of the oscilloscope will merely be summarized. A similar summary may be found in a pamphlet which the National Union Radio Corp. distributes with their Type 3-5 oscillograph. John F. Rider in his book "The Cathode Ray Oscillograph at Work," describes each use more or less completely as applied to most of the present day commercial oscilloscopes. In future articles of this series these uses will be amplified with the view toward enabling the Service Man to locate receiver troubles by the use of the oscilloscope and its accompanying equipment alone.

VOLTAGE AND CURRENT MEASUREMENTS

For this type of application the oscilloscope is essentially a universal high-resistance voltmeter. Since the trace on the screen is produced by an inertialess beam of electrons the unit will respond to direct current or alternating current of any frequency up to 100 mc. Switching must be planned so that the signal can be fed directly to the deflection plates only (instead of through a coupling condenser and shunt resistance). This allows d-c voltages to be measured and increases the input impedance to approximately 5 megohms.

In this case only one pair of plates is used and the deflection of the spot indicates the magnitude of the voltage applied. It must be remembered in a-c measurements that the oscilloscope measures peak voltages and the length of the (a-c) line on the screen will represent twice the peak value of the voltage applied.

A method of calibration is shown in Fig. 1. After calibrating the particular instrument in this manner the calibration will be accurate to 100 mc. The amplifiers may be similarly calibrated and the instrument can then be used for the measurement of minute high-frequency voltages.

When current measurements are made with the oscilloscope it is used as a millivoltmeter with an external shunt. A resistance is placed in series with the circuit under test and the oscilloscope is used to measure the voltage drop across this resistance. The

current may then be computed. In the case of a-c currents it is advisable to use a small value of resistance and use the amplifiers to obtain a suitable deflection on the screen.

VACUUM-TUBE CHARACTERISTIC

Dynamic curves of vacuum tubes may be taken with the oscilloscope with the tubes operating normally in the actual circuit in which they are to be used. In this way tubes may be checked for performance and compared for quality under actual individual operating conditions instead of under some set of rated condition which may not be similar to those encountered in use.

A small a-c signal is applied to the grid of the tube under test. This same signal is applied as a sweep voltage to the horizontal plates of the oscilloscope. The vertical plates are connected through the amplifier to the load impedance in the plate circuit of the tube under test. The resulting trace obtained will be the grid voltage-plate current curve of the tube under actual operating conditions.

Performance curves for detector circuits may be obtained by following the same general procedure.

FREQUENCY MEASUREMENT AND COMPARISON

If two voltages of different frequency are applied—one to the vertical plates and one to the horizontal plates—Lissajou figures are obtained. If one frequency is known the other may be determined from the pattern obtained. The frequency ratio is equal to the number of peaks on one side of the wave divided by one plus the number of horizontal lines of intersection.

FREQUENCY RESPONSE CURVES

Since the oscilloscope is independent of frequency a more accurate frequency response curve can be obtained than with most types of measuring instruments. The output of a variable frequency audio oscillator is applied to the

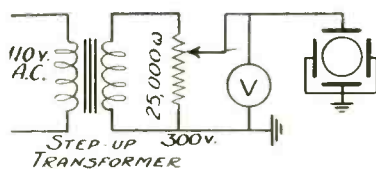

Fig. 1. Calibrating the oscilloscope.

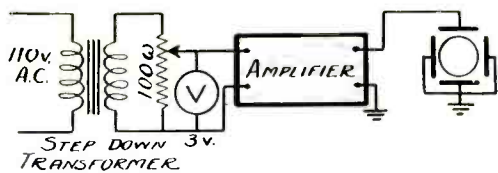

Fig. 2. Calibrating amplifier gain.

input of the stage to be checked; the output of the stage is connected to the vertical plates of the oscilloscope (either direct or through the amplifier). The audio oscillator is varied through the desired range and voltage measurements of the output taken for a suitable number of points. These may be plotted as a response curve. The oscillator should be checked for uniformity of output voltage before the measurements are made.

In this way an amplifier may be checked stage by stage or as a complete unit and the gain and frequency response of each component part determined under actual operating conditions.

Frequency response of audio equipment and radio receivers may be checked with the additional use of the sweep circuit. This latter method has the advantage that at the same time the frequency response is being taken the operator has a continuous check of distortion and overload. For each frequency setting the sweep circuit should be adjusted to that frequency or a sub-multiple of it. It is also possible to check the overall audio fidelity of a receiver by applying a modulated oscillator to the receiver input and connecting the vertical plates across the voice coil of the speaker. The audio modulating voltage is then varied and the overall response at each frequency determined.

ANALYSIS OF AUDIO EQUIPMENT

The general procedure in analysis work of this type consists of supplying a voltage of known wave form to the equipment under test and then comparing this wave form with that obtained from various points throughout the equipment. Any deviation of the wave shape of the output wave from the input wave indicates some form of distortion or overload. For comparison purposes it is advisable to adjust the gain of the oscilloscope amplifier so that the traces obtained are always of the same amplitude.

The specific procedure to be followed is to connect the audio oscillator to the vertical plates of the oscilloscope, adjust the sweep frequency equal to or a sub-multiple of the oscillator frequency and obtain a tracing of the input wave.

The oscillator is then connected to the input of the apparatus to be tested and the vertical plates of the oscilloscope connected to the output or any inter-

mediate point and the wave shapes compared. In this way overall performance as well as the performance of each stage may be checked.

As the voltage input to the apparatus is increased the change in the distortion and the point of overload may be determined. Overload is usually indicated by a flattening of the top of the wave.

HUM MEASUREMENTS

The frequency and magnitude of hum at any point in a receiver or amplifier may be determined by applying the rectified voltage to the vertical plates of the oscilloscope. The sweep should be adjusted and locked to an external 60-cycle synchronizing pulse. A 60-cycle hum will produce one wave on the screen and a 120-cycle hum two waves.

Thus the hum at various points in the

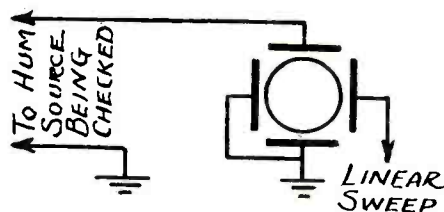

Fig. 3. Measuring hum.

filter network may be checked as well as the hum at any desired point in the receiver or amplifier. The oscilloscope is also very useful in tracing hum pick-up in transformers and wiring.

NOISE MEASUREMENTS

To measure the noise on a power line the line is connected to the vertical plates and the frequency of the sweep adjusted to the frequency of the line. Any noise in the power supply will then show up as jagged variations in the wave trace. Since most lines have one side grounded it is desirable to use a condenser in series with the ground post of the oscilloscope.

To locate noise in a receiver the output is applied to the vertical plates and the sweep adjusted to any frequency from 40 to 100 cycles. Any noise in the receiver will be indicated by jagged

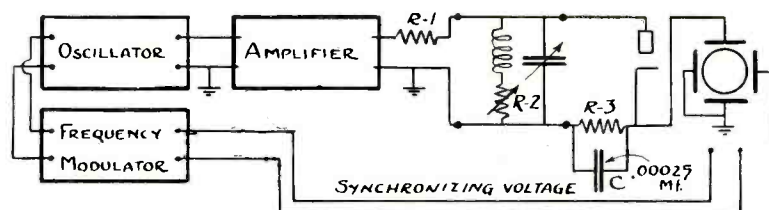

Fig. 4. Checking damping in a tuned circuit.

peaks on the horizontal trace produced by the sweep. If noise is present the output may be taken off at any point until the noisy component is isolated.

FEEDBACK AND REGENERATION

The oscilloscope may be very conveniently used to detect the presence of undesired oscillation and regeneration. If the leads from the vertical plates are placed across the various points in the circuit, with no signal applied, only the straight horizontal trace produced by the sweeps should appear on the screen. The presence of stray oscillation is indicated by a block pattern or by any widening of the sweep trace. Regeneration, short of actual oscillation, may be checked by observing the output wave shape of the receiver when a modulated signal is fed into it. Regeneration usually causes serious distortion of the wave shape.

DETECTOR AND OSCILLATOR PERFORMANCE

A complete analysis of the performance of the detector stage may be made including translation gain, linearity, distortion, voltage output, frequency response and dynamic curves.

Oscillators may be checked for voltage output, frequency range, uniformity of output, ability to oscillate at the high frequencies, etc.

VISUAL ALIGNMENT

One of the most valuable applications of the cathode-ray oscilloscope is its use for obtaining visual resonance curves of all types of tuned circuits. An r-f oscillator is provided with a small motor driven vernier variable condenser connected in parallel with its main tuning capacity. This vernier serves to vary the frequency of the oscillator a few kc either side of the frequency to which the main circuit is tuned. This motor driven condenser is called a frequency modulator.

This varying r-f frequency is applied to the stages to be tuned and the output of these stages is applied to the vertical plates of the oscilloscope. At the same time the linear sweep circuit of the oscilloscope is adjusted to twice the frequency at which the motor rotates and this sweeping frequency is applied to the horizontal plates in the usual manner. Hence as the frequency modulator

(Continued on page 304)

CALIBRATED R-F ATTENUATORS

By W. W. WALTZ*

MANY Service Men have hesitated to tackle the problem of constructing calibrated attenuators for radio frequencies because of a prevailing belief that there is something mysterious about such units. Furthermore, there has been a dearth of published material on the subject. What has appeared has all too often been in a form not easily reducible to a practical device. The two attenuators to be described have been used by many laboratories and have been eminently satisfactory, especially so to the degree of accuracy which most Service Men can expect to attain without the ultra-precise equipment of the big laboratories.

Of the two attenuators, the choice is largely a matter of cost, although the greater cost of the resistance attenuator will be off-set for some by its greater ease of adjustment. In so far as accuracy is concerned, that is so dependent upon the skill and patience of the individual that we hesitate to make a prediction. Presumably, the precision with which the sections of the resistance at-

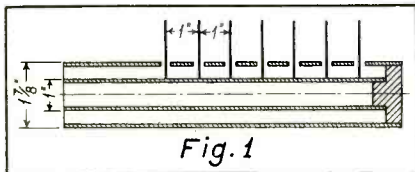

tenuator can be adjusted is somewhat better than that with which the inductance attenuator can be constructed, but for the man who does not own or have access to a bridge, the inductance attenuator seems to be the best if not the only answer.

THE INDUCTANCE ATTENUATOR

Fig. 1 shows, in cross-section, the details of the inductance attenuator. The device consists essentially of two tubes—of brass or hard-drawn copper—arranged co-axially and fastened together at one end by means of a metal plug. The smaller—inner—of the tubes is drilled and tapped at equally spaced points along its length. The larger tube is drilled to allow clearance for connecting wires which pass through it to screw into the tapped holes in the smaller tube.

The model of this attenuator which the author has used and calibrated employs a brass tube having an *inside* diameter of $1\frac{7}{8}$ " for the outer electrode;

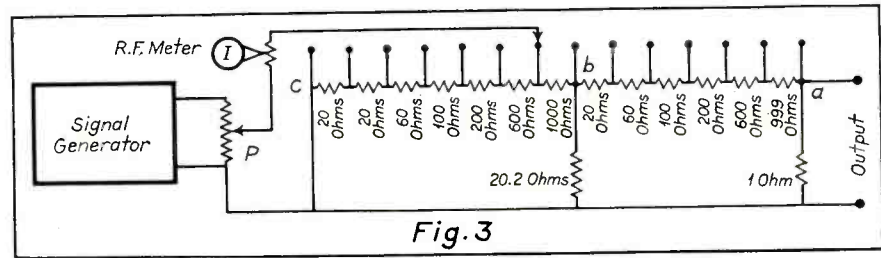

the inner conductor is a brass tube of 1" *outside* diameter; both tubes have walls $1/16$ " thick. The tubes are brazed on to a brass plug of the shape shown in the shaded portion of the drawing (Fig. 1). For reasons of convenience the holes in the tubes were spaced 1" apart. Closer spacing may be desirable so that the voltage can be adjusted in finer steps. The holes drilled in the inner tube were made with a No. 49 drill and tapped for a 2-56 thread. The wires were short pieces of 12-gauge, hard-drawn copper; these were threaded with a 2-56 die, and screwed into the holes in the inner tube after the tubes were assembled. The holes in the outer tube were drilled with a No. 19 drill. Of course, the holes in the two tubes must be in proper alignment; the wires should not touch the outer tube. Care should be taken during the brazing operation to maintain this alignment.

Fig. 2 shows the attenuator connected between a signal generator and a receiver. The meter used with the attenuator was of the thermo-couple type, but any meter of the required sensitivity, which is accurate at radio frequencies, may be used.

The attenuator depends on the voltage drop along the length of the tubes; i.e., the drop due to the inductive reactance—it is consequently proportional to the frequency. A chart giving the calibration for the attenuator described above is shown in Fig. 6. Equations are

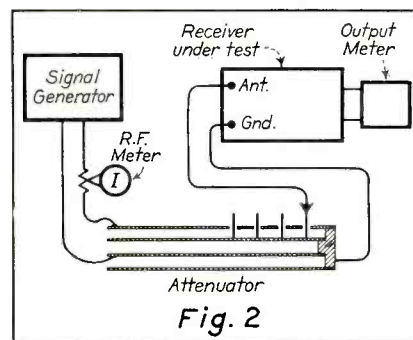

available for any diameter tubing, and similar charts may be prepared to suit the individual problem.

THE RESISTANCE ATTENUATOR

The resistance attenuator, the circuit for which is shown in Fig. 3, will no doubt appeal most to the man who has access to a bridge. The various resistance elements can be measured with direct current and, if proper care is taken with their construction, the cali-

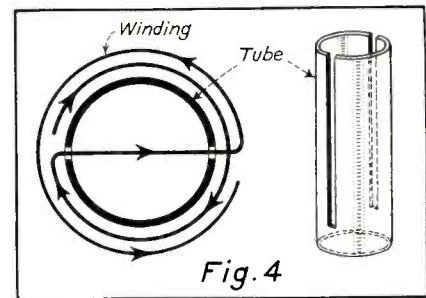

bration should hold at 2.5-3.0 megacycles.

This type of attenuator was described by A. G. Jensen, of the Bell Telephone Laboratories, Inc., in a paper which appeared in *The Physical Review* for July 1925. The principles outlined in Jensen's paper have been accepted as standard practice in the design of radio-frequency attenuators.

The resistance network of the attenuator must be constructed in the form of a toroid; this insures that the start *a* and the finish *c* of the coils will be close together and opposite the point *b*. The original model described by Jensen was wound on a hard-rubber toroid, the so-called *reverse loop* winding being employed. This resulted in a unit practically free of reactance.

The attenuator which this writer has used has a toroidal arrangement of resistance coils, each coil being wound reversed-loop. This type of winding, shown in Fig. 4, is not a difficult problem, although care must be exercised with the fine wire used.

As can be seen from the drawing, the

*Editor, RADIO ENGINEERING

resistance coils were wound upon small diameter, thin-wall bakelite tubes. These tubes were slit along one diameter for about three-fourths of the length. The wire, which was No. 38 manganin, was wound on, to the amount necessary to give the required resistance, as indicated by the arrow-heads in Fig. 4. Calibration, after a suitable "aging" to permit the resistance to become definitely established, was by a d-c bridge. The connections between the coils and to the switch points of a 14-point tap switch were made with No. 12 bus wire. The 20.2-ohm bridging resistance and the 1-ohm terminating resistance were not included in the toroidal arrangement, but were connected as closely as possible to the appropriate parts of the network. The bridging and terminating resistances were made of bi-filar loops of double-silk-enamel manganin; for the sake of stiffness and permanence they were cemented to small, thin strips of bakelite after being adjusted to the proper value on the bridge.

As mentioned, the reactive component of the impedance of these coils is quite low; this means that the coils are practically "pure" resistance. Measurements taken some time ago indicated that at 500 kc the reactive drop across the largest coil was something less than 5 percent of the d-c resistance of the coil.

Referring again to Fig. 3, the meter is a thermo-milliammeter, although, as mentioned in connection with the discussion of the inductance attenuator, any meter of suitable range and which will accurately measure radio frequencies will serve.

In operation, the current to the attenuator is adjusted to some convenient value by means of the potentiometer P. With one milliamperes entering the network—as read by the meter—the voltage across the 1-ohm terminating resistance will have values from 0.1 microvolt to 1 millivolt, depending upon the setting of the tap switch. By increasing the value of the current entering the net-

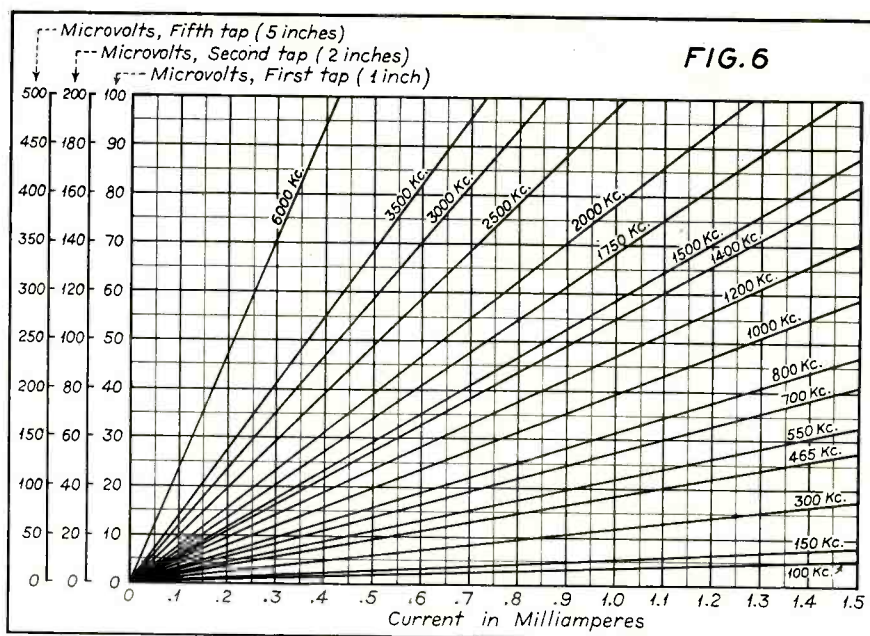
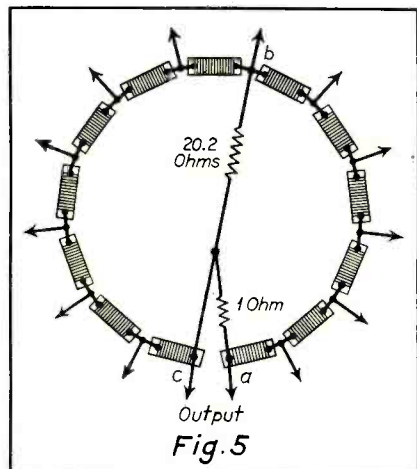

Fig. 6. Inductance attenuator calibration.

work, the range may be extended—*however, bear in mind that the current carrying capacity of the resistance wire must not be exceeded!*—and if the r-f meter is sufficiently sensitive, the current may be reduced with a consequent

reduction of the range of the attenuator. The ratios provided by the attenuator for various positions of the tap switch, reading to the left from *a*, are: 1.0; 0.5; 0.2; 0.1; 0.05; 0.02; 0.01; 0.005; 0.002; 0.001; 0.0005; 0.0002 and 0.0001.

ALL-WAVE R-F SYSTEMS

(See Front Cover)

ALL-WAVE reception is more than just an added feature in the 1937 receivers. Using the r-f and oscillator circuits shown on the front cover one manufacturer covers the entire spectrum from 540 kc to 65 mc. Separate coils are used for each band; these coils together with their parallel trimmers are carefully shielded from one another. While the particular circuit shown is not used by the other set manufacturers it is typical of the effort exerted, in their 1937 receivers, to assure complete all-wave reception.

THE OSCILLATOR CIRCUIT

The oscillator circuit is unconventional in that the tickler coils are in the cathode circuit of the oscillator tube. This is done to obtain sufficient band coverage with the additional capacity of the 6L7 tube injector grid across the tuned circuits and also to accommodate the receiver to the operation up to 65 mc. One tickler serves for both the broadcast and police-amateur bands and the second tickler serves the short-wave band; it is switched in and out by means

of the range switch. The parallel trimmers used to track the oscillator stage with the r-f and detector stages are of the air-dielectric type to assure minimum loss at the high frequencies.

The tuned circuit for the ultra-short-wave band consists of three pieces of heavy bus wire (shown by the heavy lines on the cover diagram). The cathode taps into this circuit and causes oscillation at the high-frequency end of the band. In addition, on this band, a small coil which is inductively coupled to the bus-wire coil is switched into the plate circuit and causes the tube to oscillate at the low-frequency end of the band. No tracking is required on this band since tuning is accomplished in the oscillator stage alone. During the operation of this band the antenna stage is switched out of the circuit and grounded, and the first detector stage remains untuned.

On the other bands the plate of the oscillator tube is bypassed to ground through the padding condensers of the oscillator tuned circuits, assisting the oscillator at the low-frequency end of each band.

A UNIVERSAL TEST INSTRUMENT

By CARL J. PENTHER

INNUMERABLE analyzers have been described in the popular technical magazines since the Service Man first found that he needed something more elaborate than a three-range voltmeter and screwdriver, and each had some features which were new and unusual. The analyzer described in this article has many features which are not to be found in any commercial equipment now on the market.

METER RANGES

Ranges of 5, 10, 100, 250, 500, 1,000 and 2,000 at 1-mil sensitivity are available for both a-c and d-c readings; 1, 2, 5, 50, 100, 200 and 400 volt ranges are available in addition at a sensitivity of 200 microamperes (5,000-ohms-per-volt) for d-c only. Six ohmmeter ranges, all served by a built-in power supply, allow ranges of (nominal) 1,000, 10,000, 100,000, 1 meg, 10 meg, and 50 meg; the minimum scale marking is $\frac{1}{2}$ ohm and the maximum is 150 meg.

The current ranges are: 1, 5, 10, 100, 250, 500 and 1,000 ma in d-c, and 1, 100, 250, 500 and 1,000 ma, and 2.5, 5.0, 10.0 and 25.0 amp in a-c. The a-c ranges are brought out to separate jacks which have been reamed to fit a tapered plug so that the heavier current ranges have ample contact surface without going to large binding posts. A 100-ma iron vane meter is used in conjunction with a current transformer to obtain the a-c ranges.

Three capacity ranges with a maximum current of 1 ma in the test circuit (shorted condensers merely give a zero reading on the meter) provide readings on either electrolytic or paper condensers, from 0.0005 to 6 mfd.

The 1-ma a-c meter is used as a db meter with a range of -12 to $+50$, as measured on a 500-ohm line with corresponding ranges for lines of other impedances.

THE CIRCUIT

All zero adjustments are made with the one control, a primary rheostat which is mounted in such a way that when the knob is pressed down the test leads are shorted so that when making zero adjustments the zero adjust knob is pressed down and turned until the meter reads zero.

In keeping with complete flexibility, each circuit from the analyzer plug is brought through closed circuit jacks to the sockets so that it is possible to measure current in any tube element and voltage or resistance between any two elements. A ground lead is also brought to the panel so that a complete point-to-point analysis of a receiver can be made.

The ohmmeter circuit is arranged so that the output of the rectifier and filter is placed across a 10,000-ohm voltage divider, tapped at 1, 10, 100 and 1,000 ohms, giving voltages of 0.03, 0.30, 3.0, 30.0 and 300.0 volts. These voltages,

with the proper series resistor, bring the meter to full scale or zero reading. This method allows a reading of as low as $\frac{1}{2}$ ohm with only 1 ma flowing in the circuit.

The capacity meter, with the same voltage divider, uses voltages of 1.5, 15.0 and 150.0 volts. This arrangement also allows only 1 ma to flow in the circuit even when a shorted condenser is placed across the test circuit. The low voltage used for the high-capacity range enables electrolytic condensers to be tested without a polarizing voltage.

The d-c milliammeter makes use of the series type of shunt which enables the ranges to be changed under load without damage to the meter.

Special a-c scales for the 5 and 10 volt ranges, allow the same multipliers to be used for both d-c and a-c meters.

Multiplier tolerances are better than 1 percent, and are wire-wound. The voltage divider is wound and tapped with a tolerance approximating 2 percent, necessitating only slight adjustments of the zero control for the various ranges.

The picture of the rear of the panel shows every part rigidly mounted in place, and while no space is wasted, there is ample space for ventilation around those components that warm up during operation. The various resistors and the power supply are mounted on a metal subpanel fastened to the front panel with two brackets. It will be

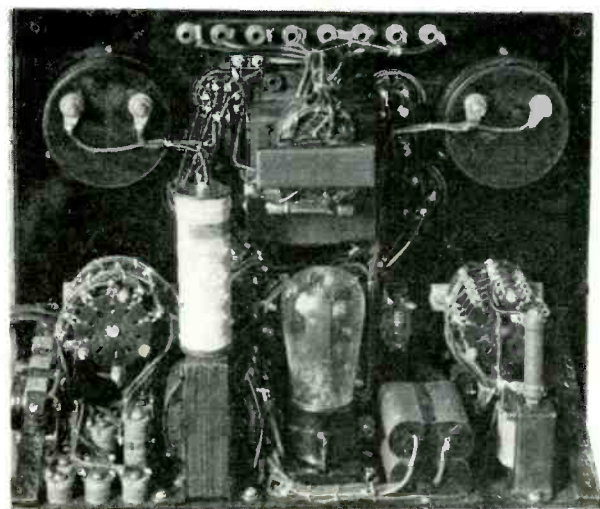
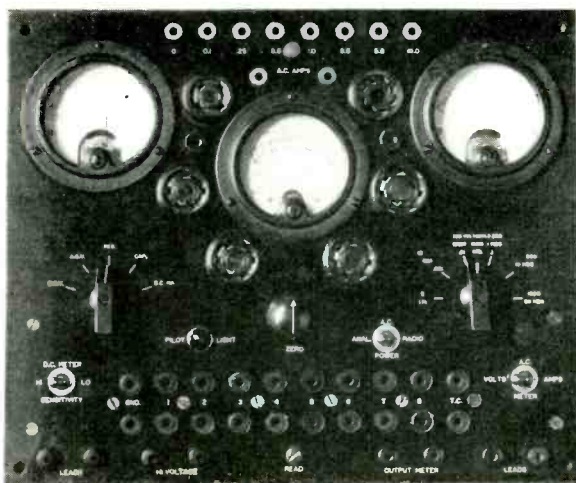

Fig. 1. Front and rear views of the instrument.

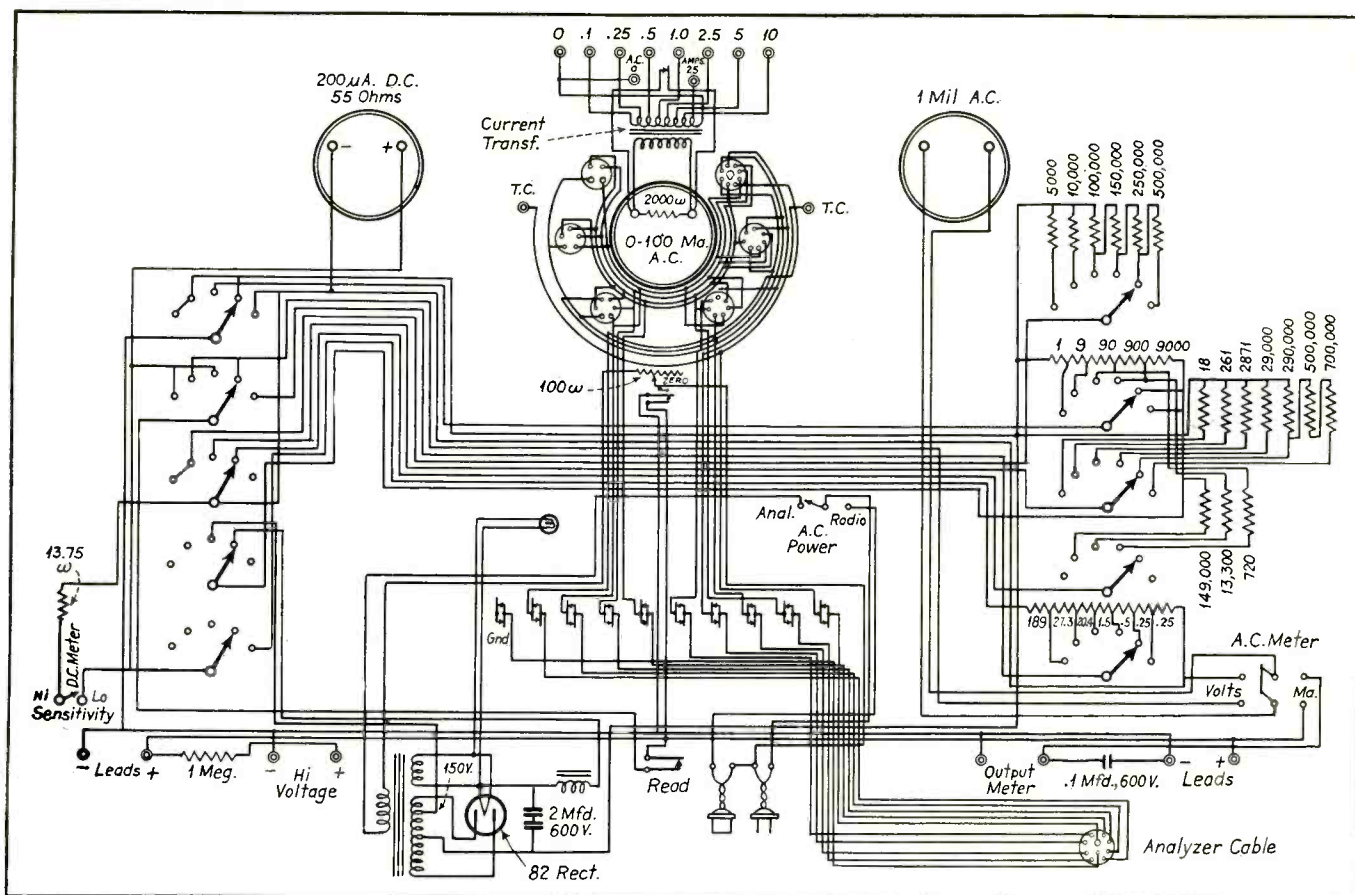

Fig. 2. Circuit diagram of the analyzer.

noted that a minimum of mounting screws project through the front panel. This helps greatly to give the instrument a professional appearance. All wiring is tightly laced into cables which also gives the instrument a professional appearance and assures trouble-free performance.

USING THE INSTRUMENT

The scale on the ohmmeter is direct reading for the third, or 100M-ohm point on the range switch. It is divided by 100 on the first or 1M-ohm point, and by 10 on the second or 10M-ohm point. It is multiplied by 10 on the fourth or 1-meg point, by 100 on the fifth or 10-meg point, and by 500 on the last or 50-meg point.

The first capacity range, the 0.001-mfd point, divides the scale by 100 while the second or 0.01-mfd point divides the scale by 10. The instrument is direct reading on the 0.1-mfd point on the switch.

For safest operation, the "read" button should be left in the open position until it is desired to take a reading, and returned to this position while switching. It is also standard practice to start with the range switch on the highest range unless the approximate value of

voltage or current in the circuit is known.

Another necessary innovation is the cord outlet into which the receiver under test is plugged to receive its power supply. The power in this outlet is controlled by the power switch on the analyzer which powers the analyzer in one position and the receiver in the other. This serves to protect the analyzer, as well as being a handy control on the receiver, by making it necessary to turn off the receiver before the ohmmeter or capacity meter can be used to measure components in the receiver.

The 50-meg range of the ohmmeter with its maximum reading of 150 meg is an excellent check on the leakage of paper condensers, giving a true indication of leakage regardless of the capacity of the condenser. The 10-meg range is used for checking the leakage of high-voltage electrolytic condensers while the 1-meg range with its 30 volts is used for electrolytics of lower voltage. *Note: When using the ohmmeter, the polarity of the leads is reversed—the black lead is positive.* A tenth of a mil leakage per 2-mfd section is average condenser leakage, with this test, after the plates are thoroughly formed. Just leaving the condenser connected in this test for a period of time will serve to

form the plates. Care must be taken to see that any condenser is discharged before applying it to the capacity meter.

PUTTING THE CATHODE-RAY OSCILLOSCOPE TO WORK

(Continued from page 300)

varies the frequency of the oscillator, the linear sweep moves the spot horizontally across the screen. The voltage output of the tuned stages which is applied to the vertical plates, will be indicated by the movement of the spot in the vertical direction at any frequency over the range covered. Thus the horizontal movement of the spot is proportional to the frequency variation and the vertical movement of the spot is proportional to the voltage output of the tuned stages under test. The result is that an actual curve is traced on the screen of voltage output versus frequency.

As the Service Man becomes more and more familiar with his oscilloscope he will be able to make it accomplish exceptional feats in his daily service work.

Bibliography

The Cathode-Ray Tube at Work by John F. Rider.
The National Union Type 3-5 Cathode-Ray Instruction Book.

General Data . . .

Philco 680

The Philco Model 680 is a 15-tube superheterodyne, using glass tubes throughout. Several recent circuit innovations are featured in the 680, such as double avc, shadow meter control, automatic bass compensation, and bass amplification.

Four bands cover practically the complete range of frequencies between 150 and 22,000 kc. The 6A3 output triodes provide a peak power output of over 20

watts. The total (a-c) power consumption is 142 watts.

ALIGNMENT PROCEDURE

Before attempting to adjust the i-f stages turn the condenser gang so that the rotor plates are fully meshed with the stator plates. The glowing arrow should then be between the two vertical lines at the extreme left of the low-frequency calibrations. The bass control should be turned off (to left). The fidelity control in the selective position (left). Adjust the hum control (back of chassis) for minimum hum. Turn the volume control to maximum (right).

Turn on the signal generator and tune to 460 kc. Turn condenser 133 (shadow meter compensator, Fig. 2) approximately four turns to the left.

I-F ALIGNMENT

Attach the signal generator to the grid of the second i-f tube and the ground lead to the ground post on the chassis. Adjust condensers 136, 128 and 131 (Fig. 2) for maximum output, keeping the signal just readable by means of the attenuator on the signal generator. Readjust 133 for minimum output.

Move the signal generator lead to the grid of the first i-f tube and adjust condensers 96 and 94 for maximum output.

Move the signal generator lead to the grid of the first detector tube and adjust condensers 89 and 87 for maximum output.

Turn down the volume control on the

receiver and advance the signal generator attenuator until the shadow meter width decreases approximately 50 percent. Adjust condenser 133 for minimum shadow width.

Couple the signal generator lead to the aerial post on the receiver with a 125-mmfd condenser in series. Turn the volume control back to maximum. Adjust the wave-trap condenser, 1, for minimum output, increasing the attenuator to obtain a better reading.

Reconnect the generator lead to the grid of the first detector. If the fidelity-selectivity control is turned to the extreme right, it will be found upon varying the frequency of the signal generator that two definite peaks will appear in the output meter reading—one at 452 kc and the other at 468 kc. The amplitude of these peaks should be equal; that is, the same output meter reading should be obtained for both. Any variations in these two meter readings can be corrected by a slight readjustment of the shadow meter i-f primary trimmer 131. If the peak at 452 is higher than the peak at 468 kc, the trimmer will have to be turned out. If the re-

verse is true, the capacity of the trimmer must be increased (turned in). In any case the readings must be made equal by dividing the difference through readjustment.

R-F ALIGNMENT

Short Wave

Turn the fidelity control back to the extreme left and the waveband switch to the extreme right (band 1). Connect the signal generator antenna lead to the aerial post on set through a 2-meg resistor. Tune the set and signal generator to 18 mc. Turn the signal generator attenuator to maximum and adjust the volume control of set for ¼ scale reading on the output meter. Adjust condenser 56 for maximum output meter reading. Turn the dial of the set to approximately 17.1 mc and check the image frequency.

Turn the dial of the set back to 18 mc and connect a variable condenser (approximately 250 mmfd) across the oscillator section of the gang (second from front of chassis). Turn the variable shunt condenser in until the 18 mc signal gives a reading on the output meter. Adjust condensers 9 and 38 for maximum output meter reading.

Removing the shunt condenser, turn the dial of the set and signal generator to 8 mc and adjust condenser 42 for maximum output meter reading. Readjust condenser 56 with set and signal generator tuned to 18 mc.

Police

Turn the waveband switch to position 2 and tune the set and signal generator to 6 mc. Adjust condensers 8, 37 and 55 for maximum output.

Turn the dial of the set and signal generator to 2.4 mc and adjust condenser 44 for maximum output. Turn both set and generator back to 6 mc and readjust condenser 55.

Standard

Turn waveband switch to position 3. Tune set and generator to 1500 kc and adjust condensers 7, 26, 36 and 54 for maximum output.

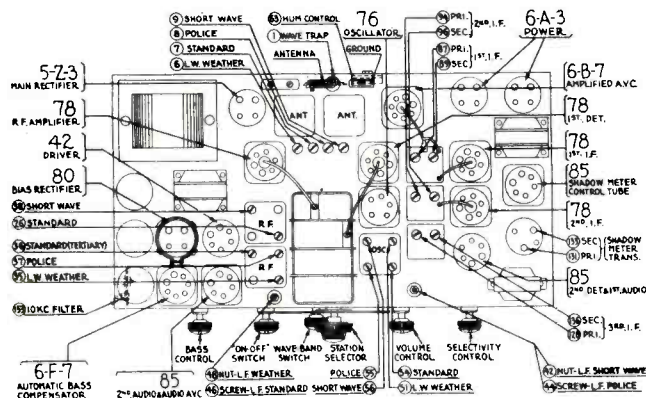
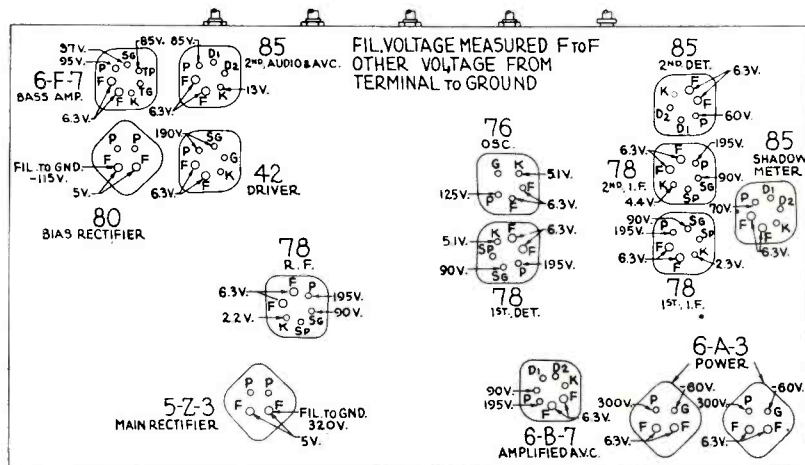

Fig. 2. Philco 680 chassis view showing tube and trimmer locations.



○ RED
○ BLACK
○ GROUND
○ ANTENNA

ALL SWITCH-SECTIONS SHOWN IN POSITION NO.-1

NUMBERS INDICATE RELATIVE POSITIONS OF SWITCH-SECTIONS FROM FRONT OF CHASSIS

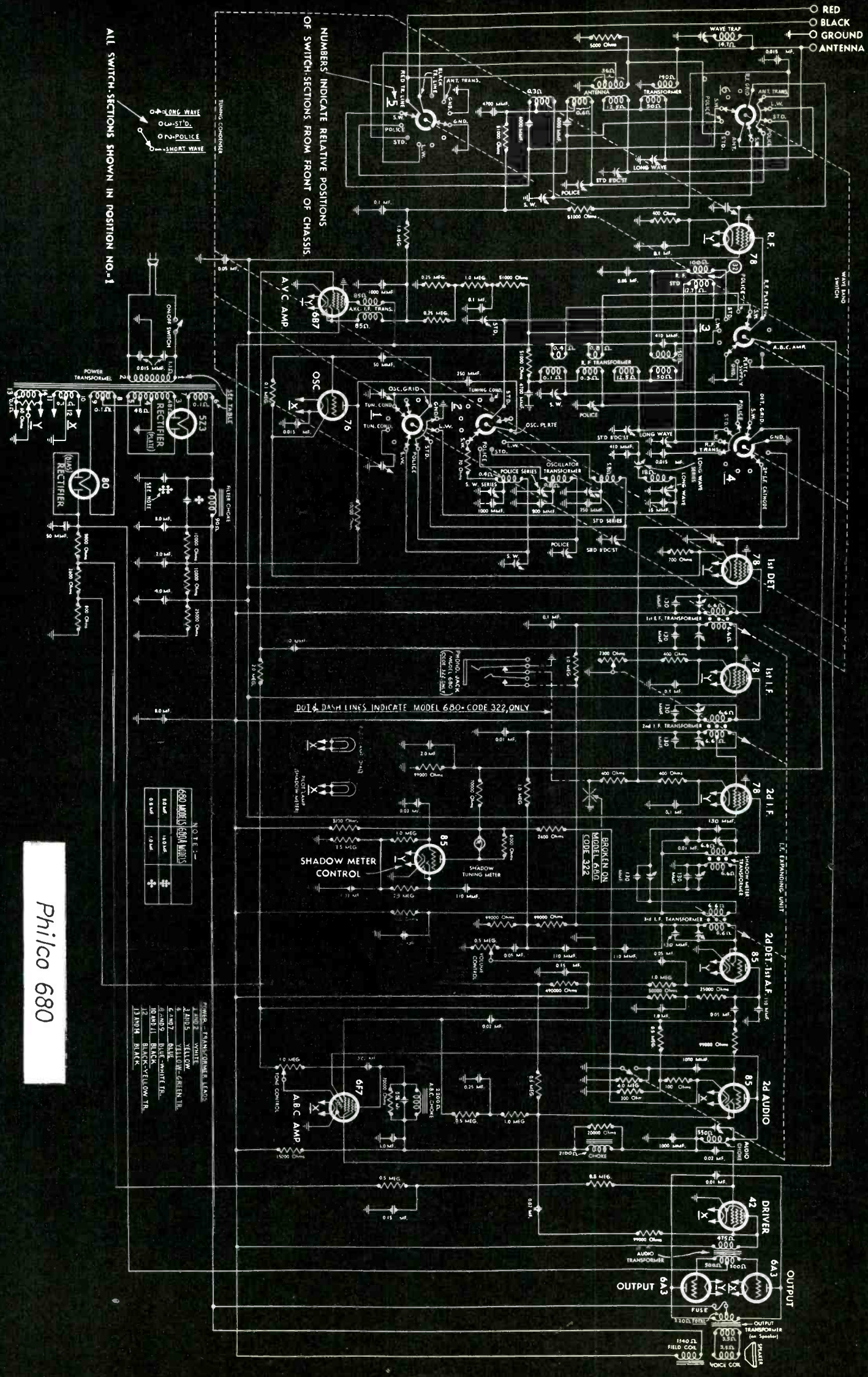

Philco 680

680 MODEL		680A	
680A	680B	680C	680D
680E	680F	680G	680H

PHILCO TRANSFORMER LEADS

1 AND 2	YELLOW
3 AND 4	YELLOW-GREEN
5 AND 6	BLUE
7 AND 8	BLUE-WHITE
9 AND 10	BLACK
11 AND 12	BLACK-YELLOW
13 AND 14	BLACK

GENERAL DATA—continued

Turn the dial of the set and signal generator to 580 kc, and remove the two-meg resistor from the antenna lead. Turn the volume control to maximum and adjust the signal generator attenuator for approximately 1/4-scale output meter reading. Adjust condenser 46 for maximum output meter reading.

Weather

Turn the waveband switch to position 4. Tune set and signal generator to 340 kc. Adjust condensers 6, 35 and 51 for maximum output.

Turn set and generator to 175 kc and adjust condenser 48 for maximum output. Readjust condenser 51 to 340 kc.

Turn the waveband switch back to position 3 and tune the set and signal generator to 580 kc. Adjust condenser 46 for maximum. Tune the set and generator to 1500 kc and adjust condenser 54 for maximum. Turn down the volume control and turn up the attenuator on the signal generator. Adjust condenser 36 for maximum output.

10-kc filter.

The 10-kc filter in the audio circuit

will rarely require readjustment. As the proper adjustment of this padder (153 on diagram) requires an accurately calibrated audio oscillator, it should be reset only in the event that it has been tampered with or in cases where it has become necessary to replace one of the elements of the filter.

VOLTAGE READINGS

An under chassis view is given in Fig. 3 showing the locations of the tubes, the tube prongs, and the various voltages encountered throughout the chassis. These voltages were measured with a 1,000-ohm-per-volt voltmeter with the volume control on full, and the antenna and ground shorted together. Actual readings may vary 15 percent from those given.

Zenith Chassis 1203

The Zenith Chassis 1203 is a 12-tube, 4-band superheterodyne using metal or metal glass tubes throughout. The chassis is used in both the model

12-U-158 and the model 12-U-159 console receivers. A complete circuit diagram is given in Fig. 1, with the tubes used, their functions and the voltages encountered throughout the receiver lettered on the diagram. These voltages were measured with a 1000-ohm-per-volt voltmeter from the points indicated to the chassis. The antenna was shorted to the ground and the volume control was on maximum during the measurements. The line voltage was 112 volts. The total power consumption of the 1203 is 120 watts; the power output 17 watts.

I-F ALIGNMENT

Connect the output leads of the signal generator to the control grid of the first detector and receiver ground. Also connect an output meter across the speaker transformer leads.

Set the signal generator at 456 kc and carefully adjust the four i-f trimmers to the point giving the highest reading on the output meter. The i-f transformers

(Continued on page 320)

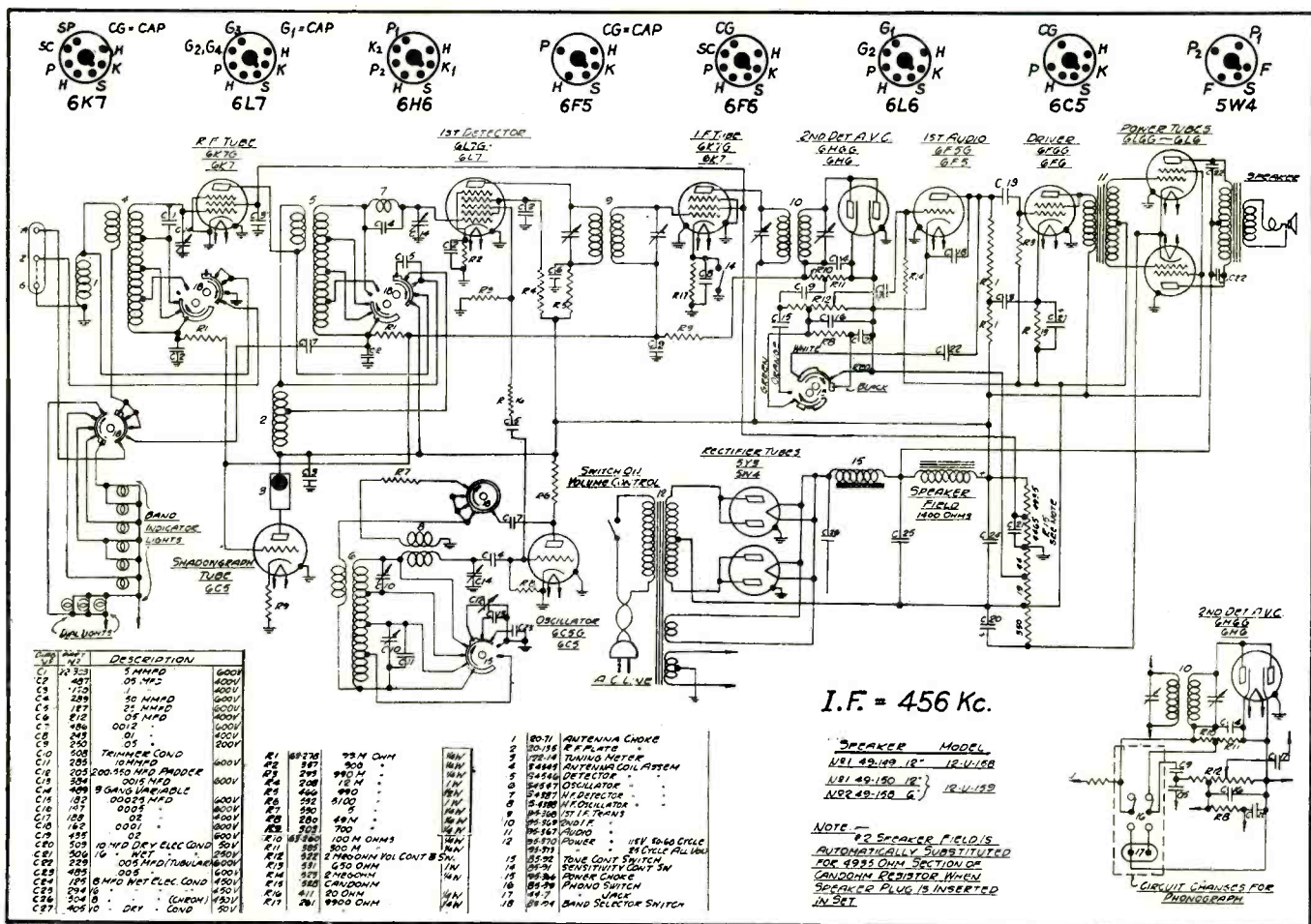

Fig. 1. Zenith 1203 circuit diagram.



For Radio Vibrators MALLORY Is the Accepted Standard

Mallory progressiveness in vibrator design and manufacture has developed new standards of vibrator performance. That's why Mallory-made vibrators are standard equipment on America's most popular automobile radio receivers—and in 6 volt and 32 volt household sets.

What's more, Mallory ingenuity has created new standards of vibrator practice for service men everywhere.

Mallory Replacement Vibrators made universal service an actuality. More than 3,000,000 automobile radios can now be serviced with a handful of Mallory Replacement Vibrators. They save time, inventory—stock investment. They are dependable in service—and easy to install.

For prompt, efficient, profitable servicing, use Mallory Replacement Vibrators. It *pays*—and you have the word of thousands of service men for that!

BUILD YOUR
BUSINESS WITH
MALLORY

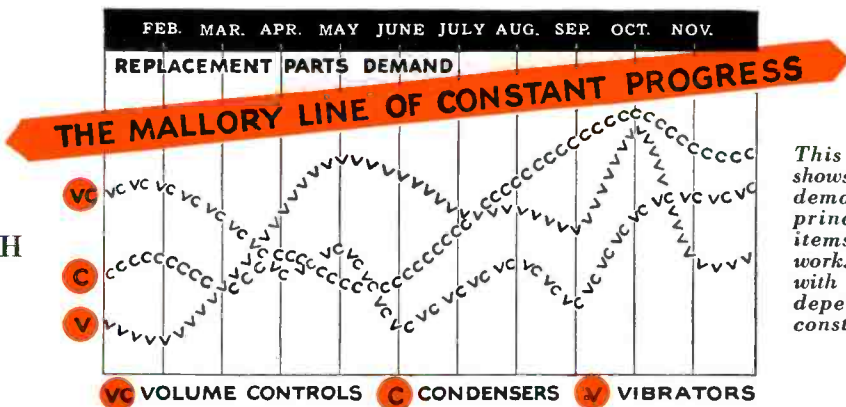

This composite graph shows the trend of service demand for the three principal replacement items in daily service work. Check your needs with the demand—and depend on Mallory for constant progress.



P. R. MALLORY & CO., Inc.
INDIANAPOLIS INDIANA
Cable Address—Pelmallia





The BRIDGE ANALYZER -- A precision laboratory instrument -- built ruggedly for field work -- at the right price!

*For You
Mr. Serviceman*

CONDENSER BRIDGE ANALYZER

A combination of condenser-resistor bridge and condenser analyzer. The serviceman who is a sound technician cannot afford to be without this instrument. Capacity range, 10mmf to 100mf! Measures resistances from 1 to 1,000,000 ohms. For checking service standards and field work. Visual null indicator in bridge circuit. Neon lamp for routine condenser checking. Built in power supply. Instant detection of shorts, intermittants and open condensers. MEASURES POWER FACTOR -- showing up condensers that though below par check okay on ordinary tests! Checks ALL TYPES OF CONDENSERS -- electrolytics, paper, etc. A precision instrument, yet rugged and portable in handsome hand rubbed walnut carrying case -- complete with 01A, 6E5 indicator and one neon tube. LIST PRICE \$48.00

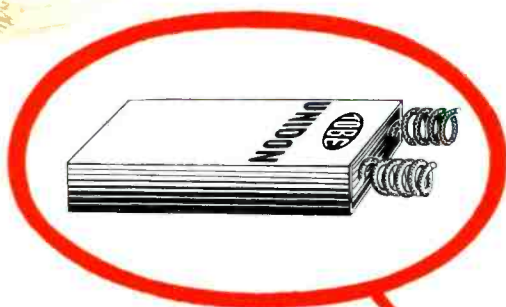

UNIDONS

The UNIDON-- unit capacitor -- is a compact dry electrolytic made with the TOBE mechanically etched process. They may be used individually, or as replacement units in the TOBE FLEXIDON multi-unit condenser. Non corrosive design prevents electrolytic action between foils and leads. Peak voltage, 500.

Type	Mfd.	Size
U514	4	3 1-4 x 1 5-16 x 5-8
U518	8	3 1-4 x 1 5-16 x 7-8

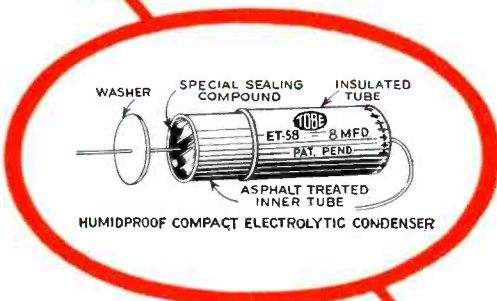

TOBE list prices are the lowest in the field! Subject to the usual discount.

TUBULAR COMPACTS

Triple "HUMIDPROOF" seal. Designed especially for humid climates, they are best for all around use. Big condensers in capacity, but so small, due to TOBE mechanical etched electrolytic construction, that the 16mf size will mount almost anywhere on the chassis. Fitting in the tightest spaces, the serviceman need only stock the larger capacity sizes for a complete replacement kit! Peak voltage, 525.

Type	Mfd.	Size
ET54	4	2 1-8 x 15-16
ET58	8	2 1-8 x 1

*Write for
Catalog*

TOBE

TOBE DEUTSCHMANN CORP.
CANTON - MASS.

Auto-Radio . . .

R-F ALIGNMENT

Move the antenna lead of the generator to the antenna terminal of the transmission line coupler. Set the signal generator to 1560 kc. Tune the receiver to 1560 kc (on the dial).

Adjust the oscillator shunt trimmer (No. 4, Fig. 2) for maximum output.

Set the signal generator to 1400 kc. Tune the dial of the receiver till the output meter indicates that the signal is being received at maximum. Adjust the r-f and antenna stage trimmers (No. 5 and 6, Fig. 2) for maximum output, keeping the signal just audible by means of the signal generator attenuator. Do not readjust the oscillator trimmer at this point. Readjust trimmers 5 and 6 to assure correct alignment. Check reception at 1000 kc and 600 kc.

Arvin 33

The Arvin 33 is a 6-tube superheterodyne, using metal tubes. The frequency range is from 535 to 1600 kc. The peak audio power is 3.5 watts. The complete circuit diagram is given in Fig. 1, with the tubes used and the voltages encountered at the various socket prongs lettered on the diagram. These voltages were measured with a 1,000-ohm-per-volt voltmeter with the volume control on full and the antenna shorted to the chassis. The oscillator grid voltage (2.5 v) was measured with a vacuum-tube voltmeter with the set in operation on 1500 kc from the signal generator.

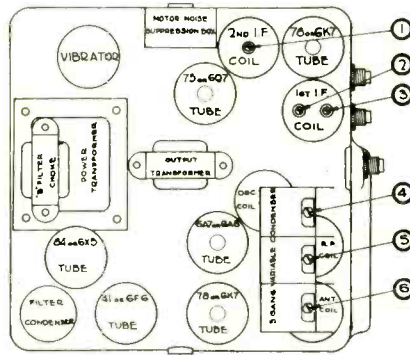

Fig. 2. Arvin 33 trimmer locations.

I-F ALIGNMENT

Connect the antenna lead of the signal generator to the grid of the 6A8 tube. Connect the ground lead of the generator to the chassis ground. Tune the test oscillator to 170 kc. Adjust its output so that a slight indication is shown on the output meter.

Adjust the i-f trimmers 1, 2, 3 in that order, for maximum output. (See Fig. 2.)

Repeat these adjustments to assure correct alignment.

ALIGNMENT PROCEDURE

The Arvin car radios must be balanced in conjunction with the Arvin type T transmission line coupler.

The output meter should be connected across the voice coil or across the primary of the speaker transformer. Set the volume control at maximum. Turn on both receiver and signal generator.

Initial Failure

Place a d-c ammeter in the hot leg of the battery feed. If the meter kicks off scale the trouble is in a filter condenser or the vibrator is stuck. If the drain is less than 15 amperes the trouble is in some other part. To isolate the trouble an old B eliminator may be used. The high voltage lead from the rectifier is disconnected from the choke and the B supply connected in its place. If the set plays the trouble is in the pack; if not, it is in the set.

RCA Service Tip File

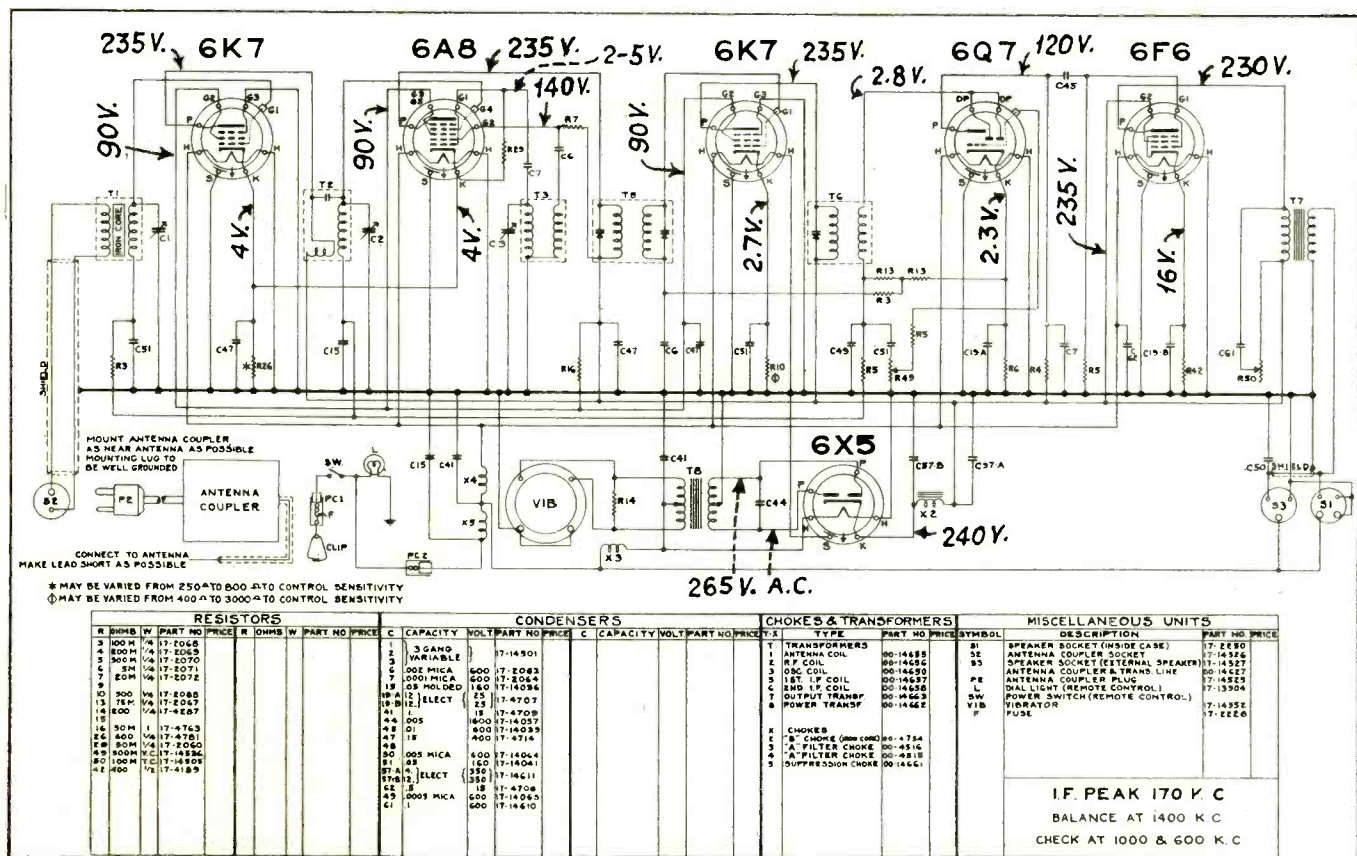

Fig. 1. Circuit diagram Arvin 33.

SERVICEMEN CASH IN

with the new Technical Manual



• Servicemen all over the country are cashing in on the New Sylvania Technical Manual! Here's the book that has the answers to those knotty problems that stump you. Read just a few of the features of this new book!

1. A 50% increase in contents.
2. 141 tube types listed with important circuit application information given on each type.
3. Characteristics on all types are the latest, including all the standard types of metal tubes.
4. A section on circuits has been increased to include 13 typical radio receiver and amplifier circuits which show proper use of the most popular types of tubes now being employed.
5. Curve data on ballast tubes for battery sets.
6. The convenient pocket size has been retained in spite of the large increase in contents.

Clip this coupon right now! Let Sylvania show you the way to increased profits!

Hygrade Sylvania Corporation makers of Sylvania Radio Tubes and Hygrade Lamps. Factories at Emporium, Pa., Salem, Mass., and St. Mary's, Pa.

SYLVANIA

The Set-Tested Radio Tube

HYGRADE SYLVANIA CORPORATION S-76
Emporium, Pa.

Please send the new Sylvania Technical Manual. I enclose 15c in stamps.

NAME

ADDRESS

CITY STATE

2 P. A. SYSTEMS For The COST of 1

Universal 6 V (D.C.) or 110 V (A.C.) (Patent Pending)



Permanent Magnet Speakers reduce storage battery drain by 3 amperes.

- 20 Watts Output
- Amplifier and Turntable built in one unit
- Two 12" Permanent Magnet Speakers
- Hand Type Dual Diaphragm Crystal Microphone

- Strict Dealer Policy
- Fully Licensed
- Time Payment Plan



System MP-420

The economical system for the radio service dealer. This system can be used on either 6 V D.C. or 110 V A.C. by plugging-in the right power pack. Thus you have two complete systems. It can be used for any kind of rental and has many distinct applications for sales where this type is most ideal.

The plug-in type power pack is an exclusive WEBSTER-CHICAGO development (Patent Pending). The use of the phonograph turntable and pickup as an integral part of the system reduces size and cost. Excellent frequency response and low hum level.

System MP-420 is complete and has all the latest refinements. Hand-type crystal microphone, two 12" Permanent Magnet Speakers with dustproof voice coil construction. Mixes microphone and phonograph. Tone control also incorporated. Phonograph unit has high fidelity pickup and Universal electric turntable motor.

All equipment including tubes furnished with the system.

See your nearest WEBSTER-CHICAGO jobber. This system and other models on display. Unexcelled quality, thoroughly competitive prices, full dealer protection and outstanding advertising and merchandising plans make WEBSTER-CHICAGO the most profitable line for the dealer to handle and build up for the future.

WEBSTER-CHICAGO manufactures a complete line of synchronized public address systems, sound equipment amplifiers and accessories of all kinds.

WRITE FOR CATALOG

THE WEBSTER COMPANY, Section JL-5, 3825 W. Lake St., Chicago, Ill.

Without obligation please send me

..... More information on Model MP-420. New 1936 Catalogue.

Name

Address

City State

TEST EQUIPMENT...

The test oscillator is one of the most important pieces of service equipment on the repair bench. In reality it is a miniature broadcasting station completely under the control of the Service Man. It can be used for neutralizing and aligning receivers; determining gain in any part or all of the receiver; checking conditions of tubes; testing individual component parts; checking avc circuits, checking selectivity, etc.

DESIRABLE FEATURES

The practical oscillator should incorporate the following features:

1. It must cover a band of frequencies from 100 kc to 18 mc or higher.
2. It must be frequency stabilized. That is, changes in temperature, voltage, etc, must not cause frequency drift.
3. The attenuation should be such that the amount of power taken off will not affect stability.
4. The attenuation must also be of such flexibility to supply sufficient signal strength to the weakest radio, or the radio that is badly out of line. It must also supply a signal of low enough intensity so the avc will not function on the modern powerful set.
5. It must be extremely accurate as to dial setting, especially on the intermediate frequencies, where its tolerances are more or less critical.
6. The modulation should be around 40 percent as this will give extreme sharpness without overloading the radio.

7. The oscillator must be shielded to prevent strays.

Other features such as ease of control, portability, etc., are also desirable.

GENERAL ALIGNMENT PROCEDURE

The general procedure in aligning a radio set of the superheterodyne type varies with the individual set manufacturer. However, generally speaking, the i-f transformers are first adjusted to the desired frequency. This may be anywhere between 100 and 512 kc, depending upon the make of set. The oscillator padding and tracking condensers are then adjusted so that the oscillator section of the tuning condenser will track over the entire dial.

After these two adjustments are made they should be repeated to secure maximum transfer of energy between all stages and the antenna stage. The tuned radio stage should then be aligned for maximum resonance.

The service bench should be equipped with a sensitive output meter which when connected properly to the radio set will measure the gain or loss as the trimming condensers are adjusted.

Again the oscillator trimmer is generally adjusted at around 1400 kc and the oscillator padder at around 600 kc. On short wavelengths, that is, below the broadcast band, the dial is generally set at four-fifths of the highest frequency range for that particular band which is being aligned.

DESIGN OF OSCILLATOR
The Triplet 1231 battery-operated signal generator is designed as follows: The r-f oscillator itself consists of the well-known feedback tickler type oscillator which has proven its reliability over a number of years. Six

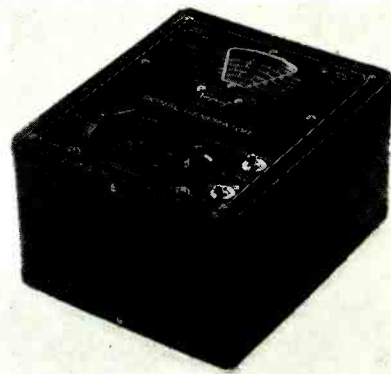

Triplet 1231

separately shielded and individually calibrated coils are used. The range change switch is mounted directly over the coil terminals and is shielded from the coils themselves. This permits short wiring, making for less change in the oscillator circuit due to placement of wires and hygroscopic conditions. The switch is the positive contact type.

The signal pickup (which is not inductive) is close to the range change switch attenuator shield. This again permits short wires. The wire used in wiring the Triplet 1231 is a special non-hygroscopic wire preventing frequency drift. A separately shielded attenuator is arranged to provide attenuation without frequency drift.

A 0.00053-mfd variable condenser is controlled by a dial drive which in turn gives a vernier ratio of approximately 50 to 1 for 340°. The dial is direct reading. This gives a 12" scale length on the i-f scale and allows accurate settings of frequencies.

OSCILLATOR IS STABILIZED

The oscillator is stabilized against frequency and amplitude drift by the proper selection of LC ratio, resistors and condensers. The oscillator is modulated by a 400 cycle note generated by a Hartley audio oscillator circuit.

The modulation can be removed by means of a modulation switch.

Both oscillator tubes are type 30, and the required batteries are three 1½-volt dry cells for filament power and 67.5-volt ribbon batteries for B power.

Bridge type construction is used throughout and the entire assembly is rigidly mounted on the T type sub-panel, totally shielded by the metal unit case.

F. E. Wenger

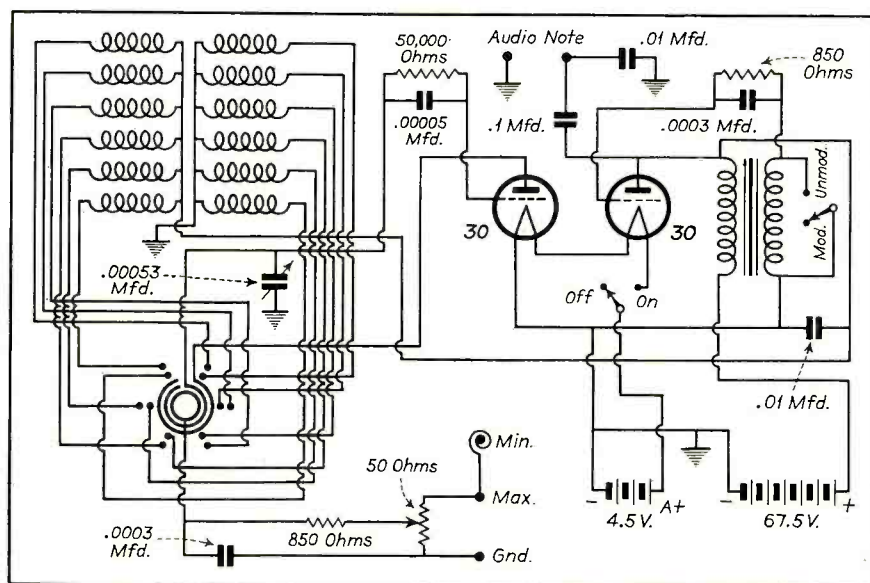

Fig. 1. Circuit diagram Triplet 1231.

LOOK TO for **REAL ADVANCEMENTS** IN AUDIO TRANSFORMERS!

Those who have followed the advancement of audio transformer design in the past few years realize that the pioneering work in this field has been done under the UTC insignia. The reputation of leadership which UTC has attained is not accidental but the result of years of design experience gained by exacting research and laboratory development.

Announcements of so called radically NEW transformer designs have appeared frequently, but analysis of these claims readily shows that they are only copies or imitations of UTC design features. UTC takes great pride in the fact that most of the modern developments in high quality audio transformer design have been perfected by its engineering staff.

SOME OF THESE DEVELOPMENTS WHICH HAVE BEEN IN USE **FOR OVER 2 YEARS** AT UTC ARE:

- HIGH PERMEABILITY CAST SHIELD . . . maximum shielding from inductive pickup.
- TRUE HUM BALANCING COIL STRUCTURE . . . maximum neutralization of stray fields.
- BALANCED VARIABLE IMPEDANCE LINE . . . permits highest fidelity on every tap of a universal unit . . . no line reflections or transverse coupling.
- REVERSIBLE MOUNTING . . . permits above chassis or subchassis wiring.
- FULL ELECTROSTATIC SHIELDING BETWEEN WINDINGS . . . brought out to separate terminal.
- MULTIPLE COIL, SEMI-TOROIDAL COIL STRUCTURE . . . minimum distributed capacity and leakage reactance.
- PRECISION WINDING . . . accuracy of windings .1%, perfect balance of inductance and capacity; exact impedance reflection.
- HIPERM-ALLOY . . . a STABLE high permeability nickel-iron core material.
- HIGH FIDELITY . . . UTC Linear Standard transformers are the **ONLY** audio units with a **GUARANTEED** uniform response, from 30 to 20,000 cycles.



Imitation is the Sincerest Form of Flattery

UNITED TRANSFORMER CORP.

72 SPRING STREET

NEW YORK, N. Y.

EXPORT DIVISION: 100 VARICK STREET NEW YORK, N. Y. CABLES: "ARLAB"

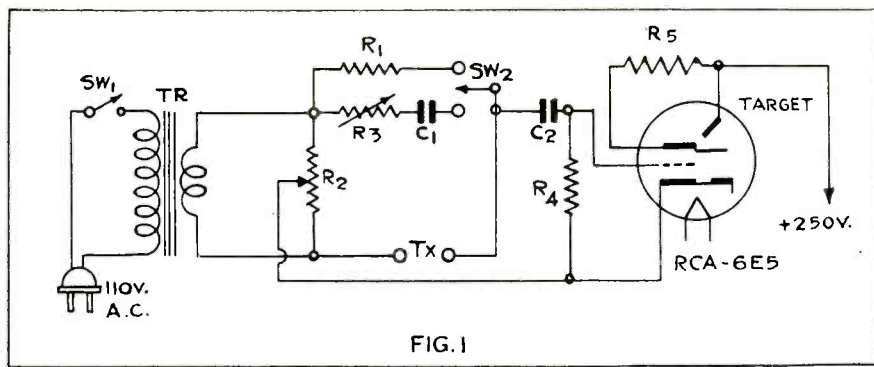

Solar Capacitator Analyzer CB

Formerly condenser defects could be generally classified as open or shorted, but now a number of terms hitherto unimportant to the Service Man have been added to this classification, such as high power factor, low capacity, high leakage, intermittent operation, high impedance, floating capacity, microphonics, noisy radio-frequency coupling, etc.

Due to gradual deterioration, condensers have a detrimental effect on reception long before they become permanently defective. The problem of determining the quality or operation efficiency of a condenser requires a complete measurement of its capacity, leakage resistance and power factor.

THE CIRCUIT

The Wein bridge circuit shown in Fig. 1 consists of a potentiometer R_2 , capacity and resistance standards C_1 and R_1 , and test terminals T_x . The signal voltage to the bridge is provided by a step-down transformer TR which can be connected to any a-c power line which has a frequency rating from 25 to 60 cycles.

When a resistor or a condenser is connected at T_x , and SW_2 is switched to a corresponding standard, R_2 is adjusted until the output voltage of the bridge and the resultant grid bias of the 6E5 is reduced to zero volts. This is the balance condition of the bridge and the 6E5 will indicate a shadow angle of 90° .

For capacity tests of electrolytic condensers, it is frequently necessary to adjust rheostat R_3 to correct for the phase difference in the bridge arms usually introduced by inherently high power factor of this type of condenser.

A circuit for testing the leakage of electrolytic condensers and the insulation resistance of solid dielectric condensers is shown in Fig. 2. A $\frac{1}{4}$ -watt neon glow lamp N is used as a leakage

current indicator for testing electrolytic condensers when SW_3 is in position A and the rated d-c working voltage is impressed across terminals T_x . When

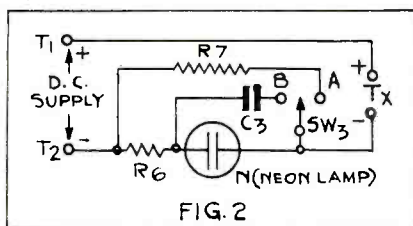

SW_3 is in position B, this circuit functions as a relaxation oscillator and can be used for testing the insulation resistance of paper and mica condensers.

SCALE READINGS

The model CB contains a Wein bridge and a neon-glow tube insulation

tester. More than 45 inches of calibrated markings on 5 color-coded scales are provided for capacity measurements from 0.00001 mfd to 70.0 mfd and for resistance measurements from 50 ohms to 2 megohms.

The power factor of all types of electrolytic condensers can be read directly from a scale which is calibrated from 0 to 50 percent power factor. In this way the relative filtering efficiency of condensers can be determined.

The leakage test part of the device consists of a built-in d-c power supply connected to the neon circuit shown in Fig. 2. A switch is provided with voltage settings suitable for testing all types of electrolytic and paper condensers which may be encountered in the field.

A reliable and practical test to determine the quality of a paper condenser is a measurement of its insulation resistance. Although the resistance values may be higher than 100 megohms this test can be made by the use of the neon relaxation oscillator provided in this instrument.

APPLICATIONS

Mica condensers usually become defective because of the failure of the mechanical assembly. High-resistance contacts may develop at the lead connections and the losses along the surfaces of the mica, due to the passage of moisture through minute defects in the pro-

Fig. 3. Circuit diagram Solar C B Capacitator Analyzer.

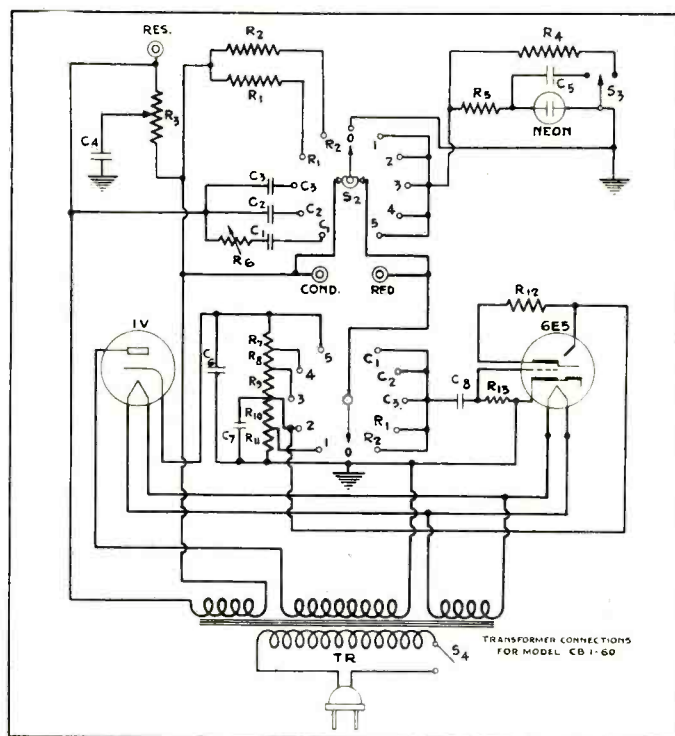

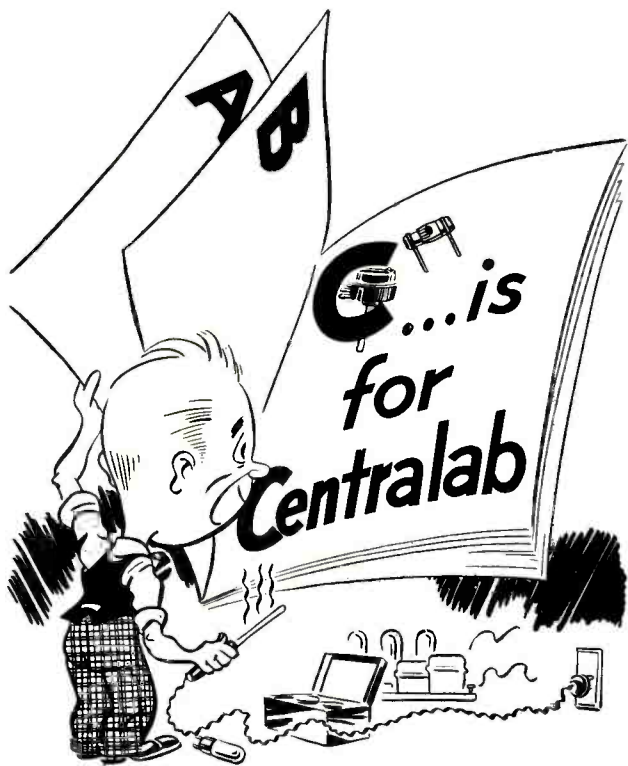

Big boy—you've learned your service lesson well when you've memorized this page. For it leads on to page "P" for PROFITS and page "S" for Success. Be wise—stick to CENTRALAB for ALL replacement work.

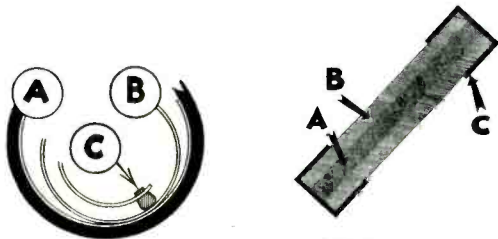

Every Radio Service Man should be a member of the Institute of Radio Service Men

Centralab

MILWAUKEE, WIS.

British Centralab, Ltd.
Canterbury Rd., Kilburn, London, N. W. 6, England

Centralab
68-70 Rue Amelot, Paris, France

**VOLUME CONTROLS
FIXED RESISTORS**

WARD AUTOMOBILE ANTENNAS

"An Auto Radio Is Only as Good as Its Aerial"
The WARD PRODUCTS Corp.
manufactures the
WORLD'S FINEST AUTO AERIALS

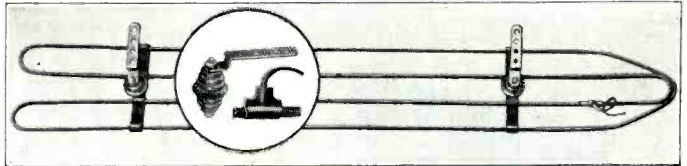

"Rubber Seald"
Model 4RC—Streamline List Price \$2.95

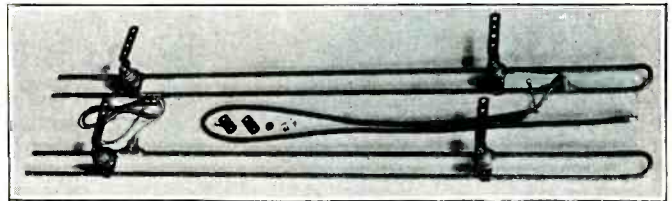

"Rubber Seald"
Model HPR—Long-Range Twins List Price \$4.00

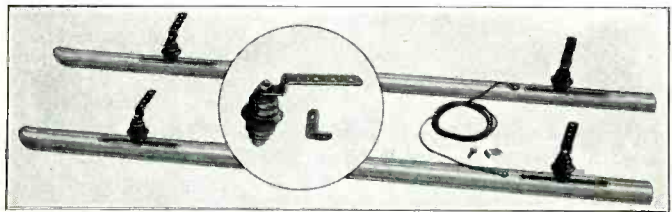

Featuring the MAGIC-SKI Bracket
Model 2SK1—Duo Magic-Ski List Price \$3.50
Model 1SKI—Mono Magic-Ski List Price \$2.00



The Best Antenna Buy on the Market
Model 2MW—Dual Marvelwave List Price \$2.75
Model 1MW—Single Marvelwave List Price \$1.50



Model 1M—Magic-Super Aerial
Over 68,000 already in use. Now improved in performance and construction.
List Price \$3.50

ORDER TODAY FROM YOUR JOBBER!
Mail Coupon for More Information—and for free copy—
"AERIAL NEWS"

To **WARD**
PRODUCTS CORP.
2129 Superior Ave.
Cleveland, Ohio

Please send more information about WARD Aerials—and free copy "AERIAL NEWS."

Name

Address

TEST EQUIPMENT—continued

tective casing are the fundamental reasons for mica condensers becoming inoperative.

It is impossible to test mica condensers properly without suitable measuring equipment because of the low ranges of capacity and the high insulation resistance of these units. The accuracy generally required for such



Solar Model CB.

measurements can be obtained by the use of a Wien bridge and a neon glow tube relaxation oscillator.

The capacitor analyzer meets the requirements of radio Service Men for an instrument which will detect leaky, shorted, low-capacity, high-capacity and high-power factor condensers of both

the usual and intermittent types.

In addition to the measurements previously described, this type of instrument may be used for many other applications. Some of these applications are: calibration of variable condensers, rheostats, potentiometers, etc.; measurement of insulation between coil windings in transformers, wires in cables, terminal strips, etc.; measuring continuity and ohmage; measurement of capacity of shielded wires, between cabled wires, or strays in component parts, etc.

William M. Robinson

Hickok OS 10 Oscillator

The Hickok OS 10 oscillator includes a complete built-in power supply consisting of a transformer, rectifier and filter. It may be operated from any 110/120-volt a-c line, 40 to 65 cycles with slight change on other voltages and frequencies. A complete circuit diagram is given in Fig. 1.

THE CIRCUIT

The variable r-f circuit utilizes the type 41 pentode as an electron-coupled r-f oscillator. The frequency range is continuously variable from 85 kc to 25 mc in six ranges. Each range is marked on the main tuning dial and extends over 7 in of scale length. The electron coupled circuit is used for its stability and freedom from frequency variation

with line voltage. A type 6C6 is used as a negative-resistance oscillator at 400 cycles or at a fixed frequency of 150 kc. When used as the 400-cycle oscillator its output may be used to modulate the r-f carrier approximately 50 percent. When used as a 15-kc r-f oscillator it can beat against the main oscillator to produce a variable frequency audio note from zero to approximately 11,000 cycles.

The negative-resistance oscillator has the inherent advantage of extreme freedom from harmonics and consequently develops a pure sine wave which is essential for oscillograph operation. A type 6D6 tube is used as a demodulator-

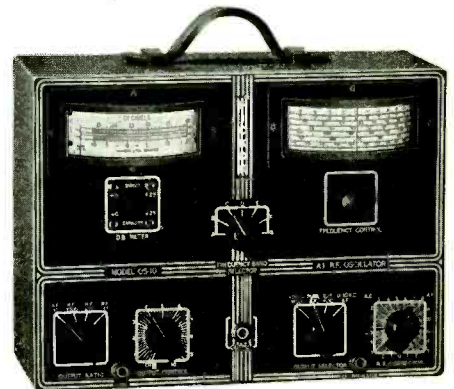

Hickok OS 10.

mixer for mixing the outputs of the two oscillator sections and providing a decoupling amplifier to isolate the input from the output circuit. It also acts as an amplifier, and amplifies the radio and audio frequency to the high level of 3 volts output which is essential for modern visual alignment. The type 1V tube is a half-wave cathode type rectifier and is used to rectify the alternating current supplied by the secondary of the power transformer.

The r-f coils are mounted integral with the switch so that the proper coil is selected and all the other coils are grounded when not in use. The coil and switch assembly is housed in a metal shield.

A meter calibrated directly in decibels is part of the OS 10. When connected across a 400-ohm line it has an accuracy of 1 percent. Two ranges are included, the first from -10 to +15 db and the second from +15 to +40 db. Provisions are also made for a capacity connection to the output meter so that the output may be taken directly from the plate of a tube.

OUTPUT SELECTOR AND CONTROL

A control enables the Service Man to select any desired output. When this

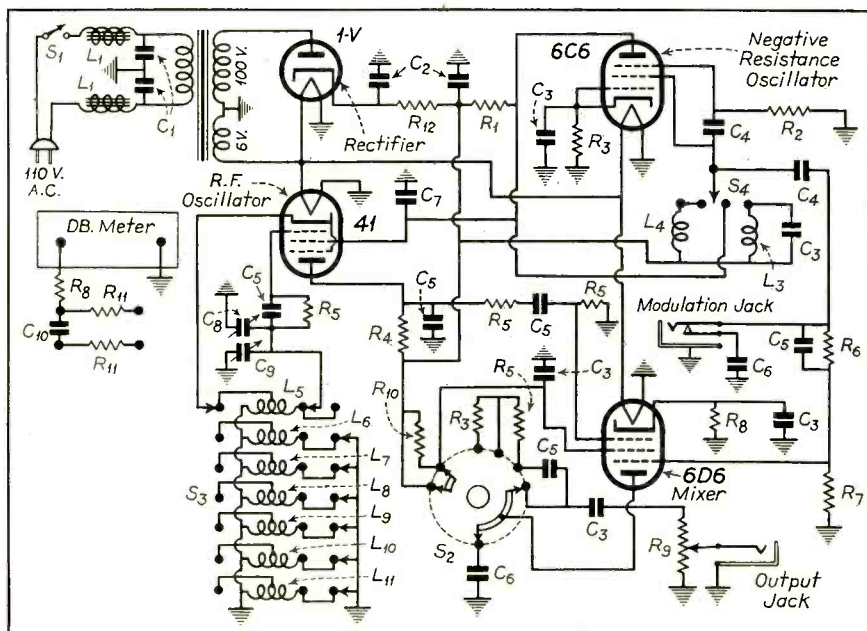
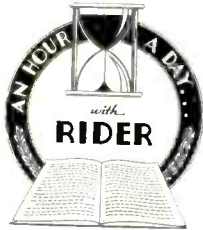

Fig. 1. Hickok OS 10 oscillator circuit.

Every Angle of the Servicing Industry is considered in Rider Publications



SERVICING RE-
CEIVERS BY
MEANS OF RE-
SISTANCE MEAS-
UREMENT

Diagnosing troubles in a receiver quickly is the secret of successful servicing and one way is to know the part that resistance plays in the functioning of any set. Could you take the schematic of any receiver and check all the circuits with an ohmmeter? Rider tells you how to do all this and more in the 203 pages of this well illustrated book. Price, \$1.00.

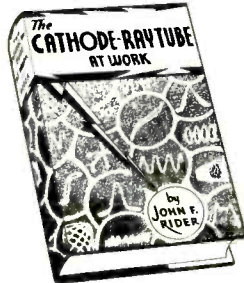

The Cathode-Ray Tube at Work

The progressive serviceman will prepare himself for the new era in the servicing of receivers, P. A. Systems, transmitters, etc., by means of the cathode-ray oscillograph. The theory of the cathode-ray tube and its accompanying circuits are fully considered in the first half of this 338 page book and the second half is devoted to practical applications of commercial oscillographs to servicing and adjustment problems. Price \$2.50.

AND THE SIX RIDER MANUALS need no introduction to servicemen, for they are recognized in all countries as the world's finest. . . . There are 6651 models covered in the 6560 pages of the six Manuals and they have proved to be the soundest investment ever made by thousands of servicemen. . . . The price? \$7.50 per volume, except Vol. II and that's a dollar less.



ASK YOUR JOBBER

An Hour A Day With Rider

Are you keeping pace with the developments made in modern receivers? Are you prepared to service the 1936-37 sets? Get ready now to use modern methods in servicing the modern receivers by spending

An Hour A Day With Rider On Resonance and Alignment
D-C Voltage Distribution in Radio Receivers
Automatic Volume Control
Alternating Currents in Radio Receivers
Pocket Size—Hard Covers—Illustrated
60c each book

Servicing Super-heterodynes

In order to service superhets with profitable speed, you must be able to analyze the different parts of the circuit quickly and accurately and this is what Rider tells you how to do in this 288 page book. Not only is the theory clearly explained, but actual servicing details are most complete. Price. \$1.00.



CDV 180 16 CHICAGO ILL 910 AM 20
WATCH FOR NEW UTAH DEVELOPMENTS
TO BE ANNOUNCED SOON STOP
IMPORTANT TO EVERY JOBBER AND
SERVICEMAN
UTAH RADIO PRODUCTS CO.

VIBRATORS For Every Purpose • SPEAKERS • Magnetic • Dynamic • Permanent Magnet Dynamic • Orthovox • Auto-Radio Speakers • VOLUME CONTROLS • TONE CONTROLS • RESISTORS • Variable, Fixed, Carbon, Wirewound, Vitreous Enamel, Center Tap • JACKS • Short Spring, Long Spring • JACK SWITCHES • Short Spring, Long Spring • PUSH BUTTON SWITCHES • PLUGS • TRANSFORMERS • Power • Filament • Audio • Input • Output • Impedance Matching • Amateur Transmitting • CHOKES • Power, Audio, Filter, Swinging, Amateur •



REPLACEMENT PARTS

UTAH RADIO PRODUCTS CO.
ORLEANS STREET CHICAGO

MAIL THIS COUPON

UTAH RADIO PRODUCTS CO., Orleans Street, Chicago

RUSH full information on UTAH Products which I have checked below.

Vibrators, Speakers, Volume Controls, Tone Controls, Resistors, Jacks, Jack Switches, Push Button Switches, Plugs, Transformers, Chokes.

NAME

ADDRESS

TEST EQUIPMENT—continued

control is turned to the 400-cycle position the r-f carrier is modulated with the 400-cycle note for use in receiver alignment, etc. When this switch is turned to the r-f position the modulation is disconnected and pure r-f is available at the output. In the external modulation position the r-f may be frequency modulated by proper connection with an electronic frequency modulator or from an external audio source. In the 0-10,000-cycle position the control in the lower right corner of the panel can be used to obtain a variable audio-frequency note between the limits indicated. The output of the oscillator for these ranges is constant within about $\frac{1}{4}$ db over the entire range.

The output of the r-f and a-f circuits is controlled by a step attenuator labeled "Output Control" on the instrument panel.

R-F CORRECTOR

An r-f corrector is provided on the front panel and is labeled plus or minus 0 to 5. With this corrector set at the zero position the accuracy of calibration of the main tuning dial is approximately $\frac{1}{2}$ of 1 percent. However, calibration data can be supplied giving a plus or minus setting for most frequencies used, bringing the accuracy to better than 0.2 of 1 percent. The r-f corrector may also be used for varying the frequency established on the main tuning dial about 5 kc for testing response above or below the frequency.

The upper half of this corrector has the calibration for the variable audio-frequency oscillator and can be read to an accuracy of approximately 2 percent.

Walter A. Weiss

Clough-Bregle OM-A Inductor Sweep

The Clough-Bregle OM-A frequency modulated r-f signal generator has an output signal which swings rapidly back and forth over a 20-kc band with constant modulation.

This arrangement is made possible by rotating an eccentric copper disc in the field portion of the inductance. In each complete rotation the disc swings into inductive relationship to the coil, decreasing its inductance, then out of the inductive plane, allowing the coil to assume its natural inductance. Hence the "wobble" is determined by the speed of the synchronous driving motor, operating at what is practically zero load.

The entire inductor sweep assembly with the exception of the motor is enclosed in a cast aluminum sealed housing to eliminate all effects of temperature, atmosphere, and other factors that

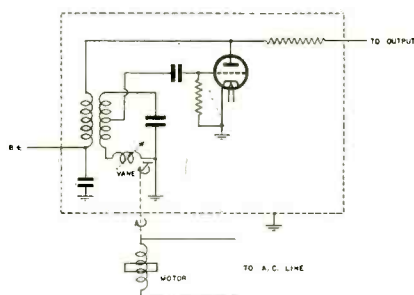

Clough-Bregle sweep circuit.

cause oscillator drift. Metal tubes are used throughout.

This instrument may be used with any standard oscillograph for visual

alignment of radio receivers. Flat-top i-f stages may be aligned accurately using the OM-A Inductor Sweep in conjunction with a suitable output meter in the event that an oscillograph is not available. By means of a fixed sweep principle a uniform wobble is secured at all test frequencies.

The OM-A makes a suitable sweep circuit for oscillographic analysis of incoming audio-frequency waveforms for more complete portrayal of the ability of a radio receiver.

To meet the alignment specifications of all set manufacturers, provision for both single and double trace alignment is made.

GENERAL DATA—continued

are of a very high gain, selective type, and these adjustments should be repeated several times in order to secure maximum accuracy. All adjustments should be made using as weak an output from the signal generator as possible in order to prevent the AVC action from affecting the output readings.

R-F ALIGNMENT

Change the signal generator leads to the antenna and ground terminals of the receiver.

Set signal generator at 1400 kc. Switch receiver to band A and adjust broadcast oscillator trimmer A (located on front of chassis) for correct dial reading. Also adjust the r-f and detector trimmers on gang condenser for greatest output.

Set signal generator at 600 kc and rock pointer past 600 kc on dial scale, meanwhile adjusting the broadcast pad-

der until combination is reached which gives the greatest output reading.

Readjust broadcast trimmers at 1400 kc.

Set signal generator at 5.5 mc. Switch receiver to band B, and adjust trimmer B (located on front of chassis) while rocking pointer past 5.5 on dial scale for combination giving the highest output reading.

Set signal generator at 18 mc. Switch receiver to band D and adjust the short-wave trimmer D (located on front of chassis) while rocking the pointer past 18 mc on dial scale to combination giving the highest output reading.

There are no adjustments on the (C) ultra-short-wave band. *Caution!* The length and position of the leads on both coil trimmers and band switch greatly affect the tuning on the short wave bands. These leads should not be altered in any way.

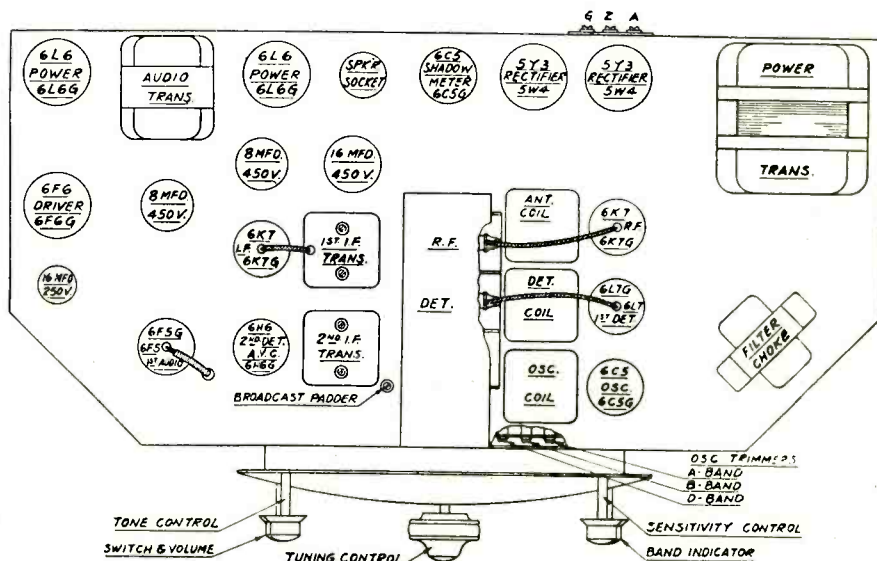

Fig. 2. Zenith 1203 chassis view showing tube and trimmer locations.

INSIST ON
Radiart
VIBRATORS

FROM CANADA TO MEXICO
IN FARM AND AUTO RADIO
IT'S RADIART THAT MAKES 'EM GO

KATALIE CATALANELLAS
W5CXQ

SHULER SUPPLY CO.
1700 TO 1720 POYDRAS STREET
NEW ORLEANS, LA.
July 9th, 1936.

The Radiart Company
Shaw Ave. at 133rd St.
Cleveland, Ohio.

Attention Mr. L. E. Wildberg:

Gentlemen: You will probably be interested in knowing that Radiart vibrators have met with unusual success in the New Orleans territory. We are very glad that we changed over to Radiart from the other line of vibrators we had been selling.

One thing in your favor is that Radiart units are exact duplicates of many original factory vibrators, while other competitors simply make replacement units which in most cases won't fit the sets they are designed for. Complaints of noisy operations have been eliminated since we are handling Radiart.

With kindest regards and trusting that that we shall have the pleasure of seeing you again real soon, we remain,
Yours very truly,
SHULER SUPPLY CO. EAST
A. J. Ballam

HJB:DD

THE SOUTH'S LARGEST RADIO REPLACEMENT PARTS HOUSE

WRITE OR WIRE

THE RADIART CORPORATION
Shaw Ave. at East 133rd St. Cleveland, Ohio

HICKOK

OSCILLOGRAPH

RFO-1

with ELECTRONIC FREQUENCY MODULATOR

The composite masterpiece. Only your own oscillator and the RFO-1 oscillograph are necessary for modern visual alignment and Radio Frequency testing.

- NOTE THESE FEATURES:**
- Utmost economy in initial cost.
 - Simplified control grouping. Segregation of controls into individual panels simplifies operation.
 - Single or double trace alignment.
 - All controls, including the beam, centering on the main panel.
 - Calibrated screen supplied with each Oscillograph.
 - High sensitivity horizontal and vertical amplifier. 0.2 volts per inch.
 - Wide range sweep circuit Oscillator, 15 to 25,000 cycles per second.

THE INSTRUMENT EVERY SERVICEMAN NEEDS

Other HICKOK
Radio Frequency Testing Equipment

- OS-10 OSCILLATOR**
Designed to the exacting standards of modern visual and precision alignment. Only popular priced meter equipped unit available.
- OA-3 FREQUENCY MODULATOR**
Connected directly to the OS-10 Oscillator, it converts that unit to a frequency modulated oscillator with variable width sweep from 5 to 30 K.C. Not necessary with HICKOK Oscillograph.
- OA-2 (OSCILLATOR) AUDIO MICROMETER**
Two ranges—0-900 cycles and 0-17,000 cycles. Can be connected direct to any model OS-10 Oscillator to spread the audio range for precision A.F. alignment and testing.

Write for information and prices on all of these Hickok Instruments.

THE HICKOK ELECTRICAL INSTRUMENT CO.
10514 Dupont Ave., Cleveland, Ohio

SEPTEMBER 18, 19, 20

1936 NEW YORK RADIO TRADE SHOW

THE
ENTIRE
RADIO INDUSTRY
IS
INVITED

THOUSANDS OF PROGRESSIVE MEMBERS OF THE RADIO INDUSTRY ATTEND THIS ANNUAL GATHERING TO KEEP ABREAST OF THE TIMES.

THIS SHOW WILL PRESENT THINGS OF VITAL IMPORTANCE FOR:

RADIO SERVICE MEN
RADIO DEALERS
RADIO DISTRIBUTORS
MANUFACTURERS REPRESENTATIVES
RADIO MANUFACTURERS
RADIO ENGINEERS

ON THE JOB . . .

Series Shunt

A series shunt differing somewhat from the one in May SERVICE is shown in the accompanying illustration. In this type the shunt is connected across

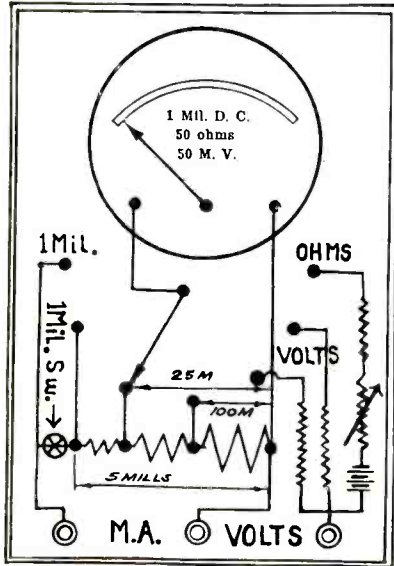

the load and the meter is switched to the various ranges on the shunt.

D. L. Van Leuwen.

Added Speaker

If you want to add another speaker upstairs or at any other place near the antenna lead-in you can do so without running extra wires. Connect one side of a magnetic speaker to the lead-in

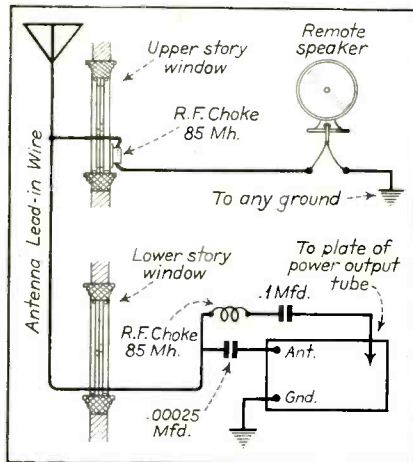

through a r-i choke (about 85 mh) and the other to a radiator or similar ground. At the antenna post of the receiver a series condenser (about

0.00025 mfd) must be used. From the antenna side of this condenser connect another r-f choke and an 0.1-mfd condenser to the plate of the output tube of the receiver. This method will not be applicable to those sets from which a high pitched whistle results.

George J. Damm

Binder for SERVICE

The individual issues of SERVICE can be conveniently bound into one volume in the manner indicated in the accompanying illustration. The first two numbers of the volume are strapped together with a one-inch strip of gummed paper of suitable length. The third number is then strapped to the second with a similar piece of gummed paper pasted just below the first. The fourth is strapped to the third, and so forth, until the entire volume is completed.

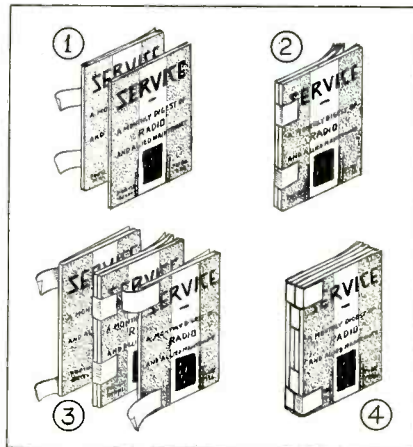

A large strip of binding tape can then be pasted over the many straps and the name SERVICE lettered up and down with the year and volume number.

Arthur Terry.

Multiple Meter Scale

In test equipment using a single meter to cover a multitude of ranges the device illustrated will prove advantageous in interpolating the actual reading from that shown on the meter.

The exact scale indicated on the meter is reproduced in one quadrant of the white sheet as shown. In the remaining three quadrants the actual ranges covered by the instrument are etched. This sheet is then pasted on a board using a good grade of rubber cement. A bushing from an old inductance switch or rheostat is mounted on a properly drilled and countersunk hole

in the center of the board.

A transparent circular disc with etched quadrant divisions and a knob

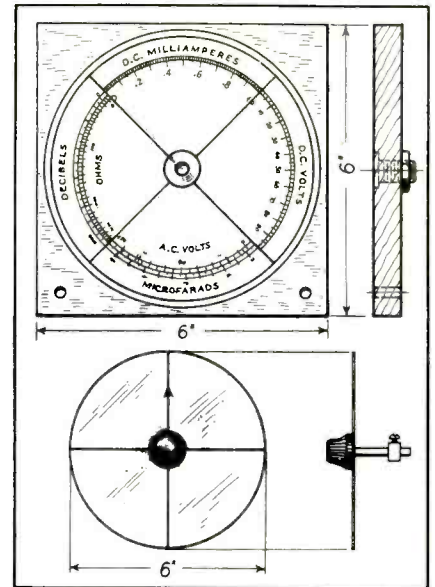

and shaft to fit the bushing on the board is used to transfer readings from one scale to another.

Harvey H. Schock

Shorted Turn Tester

A handy tester for shorted turns in coils and chokes is shown in the accompanying illustration. The sensitivity of the instrument depends largely on the a-c meter used. Any a-c voltmeter or ammeter will serve if a suitable shunt is used. For example, if a Weston 476, 5-volt, a-c meter is used a shunt of approximately 1 ohm would be necessary. Comparison is made of the reading ob-

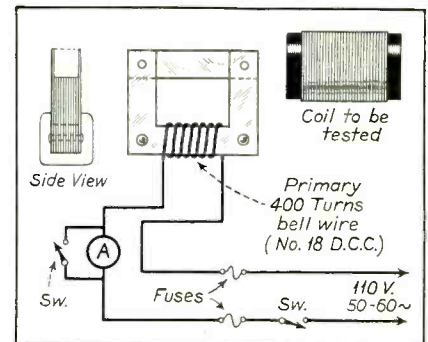

tained with the laminations alone with that obtained when the coil to be tested is placed over the laminations. In cases where a doubt exists, an external shorted loop may be slipped over the coil and the change in the reading noted.

WRIGHT-DECOSTER New 12-inch Speaker



**Model
990**

Cone diameter
12 inches

Overall depth
7 inches

- Features:
- Universal Field Coil
 - Universal Transformer
 - Para-Curve Diaphragm
 - Appearance
 - Improves Any Radio

The Universal field coil furnishes all standard resistances and is a brand new feature.

List Price \$9.90

There's a big market waiting for this item.

Write for complete catalog and name of nearest distributor. Wright-DeCoster distributors are always anxious to cooperate.

WRIGHT-DECOSTER, Inc. 2253 University Ave.,
St. Paul, Minnesota

Export Dept.: M. Simons & Son Co., New York

Cable Address: "Simonrice"

Canadian Office: Wright-DeCoster, Inc., Guelph, Ontario

KAY Quadruples Production in New Larger Quarters!

KAY products—sold in every corner of the earth—have helped thousands of distributors and servicemen to increase auto-radio profits.

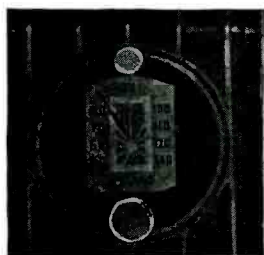

Illustrated
FORD 1935-1936
LINCOLN-ZEPHYR 1936

NOW—we are ready to show you how to increase yours.

KAY control heads fit every auto radio . . . truly universal custom instrument panel units.

22 KAY universal escutcheons match the interiors of all 1935 and 1936 cars.

KAY Universal Control permits new car purchasers to easily re-install auto-sets, bought previously, in the instrument panel without the necessity of cutting, drilling or otherwise marring appearance of dash.

Dealers-Servicemen: Write for new catalog and displays.
Distributors: 100% sales cooperation in your territory.
Representatives: Some good territory still open, write us.

KAY auto-radio remote control heads are protected by Patent No. 2,042,061. Infringers will be prosecuted.

KAY PRODUCTS OF AMERICA, Inc.
3901 Queens Boulevard Long Island City, N. Y.

FREE

POPULAR P. A. SYSTEM thru NATIONAL UNION

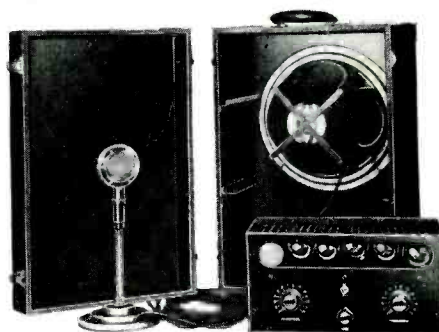

THE LARGEST PER CENT OF INCREASE THIS YEAR IN THE RADIO BUSINESS IS BEING DONE IN SOUND EQUIPMENT



Webster-Chicago Model PA-417A

A complete portable sound system having a dual diaphragm crystal microphone, a 4-stage amplifier using 6 tubes (furnished), a dual input mixing system, and one D. C. dynamic speaker; all contained in carrying case.

National Union believes this field should gravitate to the radio service dealer. Now is the time to get started. National Union makes it easy for you to go into this business by furnishing equipment on National Union deals, requiring minimum outlay of cash. Further, National Union will help you learn the business; how to sell, how to rent, how to expand, how to explore the possibilities, just the same way that they did in helping service dealers build up service work. Don't delay—Get into sound now!

Other National Union Offers

In SOUND EQUIPMENT items available include 17-watt portable system, 10-watt portable system, 6-watt portable system, phonograph pickup and turntable, etc. In SERVICE EQUIPMENT items available include tube testers, analyzers, oscilloscopes, signal generators, modulators, meters, etc. In SHOP EQUIPMENT items available include stock cabinets, coats, display signs, etc. All items available free on attractive National Union deals.

The National Union Way

Through National Union's help, radio service dealers everywhere have been able to set up better equipped shops to do better work; also to obtain merchandise helps that produce more customers. National Union has constantly put the latest advances in scientific equipment as well as modern selling aids within reach of the service dealer. The National Union deal calls for a dealer deposit which is rebated when the specified number of tubes have been purchased. Over 50,000 completed deals. Every service dealer should investigate.

THE ROAD TO BETTER BUSINESS

1. Full guarantee on highest quality radio tubes.

2. Cut price business not solicited.

3. Price Protection.

4. N. U. jobber stocks are complete. No hunting for odd types.

5. Timely business building aids.

**ACT NOW!
SEND COUPON!**
Let National Union Help You!

National Union Radio Tubes Are Handled and Recommended By More Service Dealers Than Any Other Make. See Your National Union Jobber. Write for Complete Information.

NATIONAL UNION RADIO CORPORATION
570 Lexington Ave., New York City

S-737

.....Free offer for Webster-Chicago Model PA-417A.

.....Free offer for.....

Dealer's Name

Address

City..... State.....

RECEIVER CASE HISTORIES

Motorola Golden Voice

Intermittent operation: Should you encounter a Golden Voice set that cuts out intermittently, or at times fails to come up to full power output, it will be found due to low battery voltage delivered to the radio. Check all connections between the car battery and the radio set to avoid undue voltage drop in the car wiring, as the OZ-4 rectifier tube will fail to start and fail to operate on a battery voltage of less than 5½ volts.

The OZ-4 tube requires 15 milliamperes or more of drain to produce ionization and proper rectification in this tube, and on battery voltages of less than 5½ volts the plate current drain of the receiver is insufficient to provide the 15 milliamperes starting current. Should the car wiring and the condition of the car battery indicate that at times the voltage may fall below 5½ volts, replace the OZ-4 rectifier tube with a 6X5 metal filament type rectifier.

With the exception of a few Golden Voice sets the filament contacts of the rectifier socket have been wired at the factory and the 6X5 rectifier may be plugged into the socket in place of the OZ-4. This will completely eliminate the difficulty due to low battery voltage.

On those Golden Voice sets not having the filament contacts of the rectifier socket wired, this wiring can be inserted by inverting the chassis and removing the cover from the hash compartment and connecting the filament contacts of the rectifier socket, as shown in the accompanying sketch. One contact to ground as indicated by the heavy arrow at the bottom of the socket and the other contact to the 0.5-mfd condenser as in-

dicated by heavy arrow at the top of the sketch. When replacing cover be sure that all screws are tight.

Galvin Mfg. Corp.

Philco 80

No control of volume: The receiver still gives room volume even with the control at minimum. Reception, however, is sharp. Replace r-f by-pass (C 35 on the circuit diagram); value 0.05-mfd.

Al. Beers

Radiola 66

Improving tone and volume control operation: This model uses a power detector in which the bias voltage becomes less as the volume control is turned on and as a result on strong stations there is distortion and a cutting off effect when the volume control is advanced. To remedy remove one wire running from cathode of second detector to cathode of oscillator, and insert a 30,000-ohm resistor from second detector cathode to ground. This gives a fixed bias voltage on the detector resulting in improved tone and volume control operation, and with only slight sacrifice of sensitivity on weaker stations.

Paul D. Shields

Silver Marshall C

Hum: Plate voltages low, tone thin and volume not up to normal, whistles while tuning from station to station. Replace the first filter condenser section C-21 with one of 4- or 8-mfd instead of 2-mfd as in the original. For intermittent reception, replace C-16, a 0.08-mfd coupling condenser, using a 0.1-mfd section.

Also replace R5, and R3, 25,000 and 10,000 ohms, respectively.

E. M. Prentke

Sparton 45

Service note: Always replace the 1250-ohm bias resistor for the 45 tubes, using a 10-watt wire-wound unit. The original candohm unit often shorts to the chassis. The 10,000-ohm carbon resistor connected from the chassis to one side of the volume control should also be replaced preferably with a wire-wound unit.

W. Manola

Sparton 600, 610, 620, 737

Weak reception: Also broad tuning on the lower frequencies in this model is often caused by a leaky by-pass condenser in the cathode circuit of the first 484. If its terminal resistance is less than 10 megohms replace; value 0.2-mfd.

Al. Beers

Steinite 70, 80, 95

Service note: Always replace the five wire speaker cable. The original cable has a rubber insulation that easily rots and causes short circuits. When repairing these models replace the r-f plate and screen supply by-pass condensers; value 0.5-mfd.

E. M. Prentke

Stromberg Carlson 29

Hum: Audio hum can be reduced by shielding the a-f grid lead running across the bottom of the chassis to the volume control.

Allan Epstein

Triplet 1200 Tester

Zero setting: It is often difficult to adjust the zero setting on the 1500-ohm and the 1.5-megohm ranges of the ohmmeter. This was found to be caused by poor contacts on the multipoint switch which reduced the effect of the meter shunts (connected to the circuit by this switch). Cleaning the contacts and springing the arms should remedy the difficulty.

I. Dlugatch

Triplet 1230 Oscillator

No filament voltage: The flashlight batteries used to light the filaments in this instrument are connected together by a brass contact. Improving this contact should eliminate the trouble.

I. Dlugatch

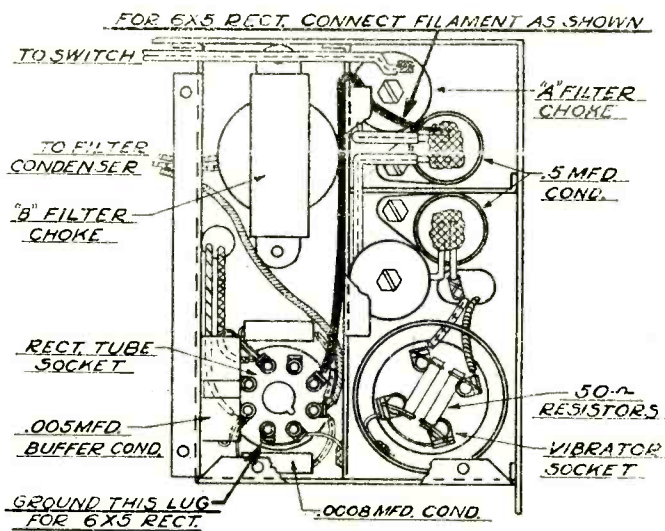

Motorola Golden Voice circuit change for 6X5.

"NEVER A PEEP FROM WIREWATT!"

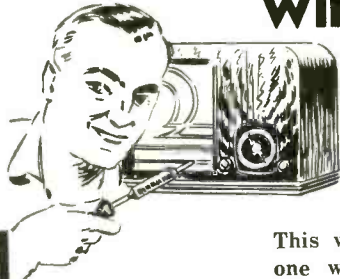

says
Bill Fixit

This wire-wound resistor rated at one watt is absolutely noiseless! And resistance values do not vary with voltage and temperature changes. WIREWATT makes many repair jobs better than new. Being the same size as composition units, WIREWATTS are usable in nearly all radio circuits. They are wound over a porcelain core, and covered with special insulating material. Resistance wire is mechanically locked and then brazed to terminal lugs. The 1½ inch tinned lead wires guarantee easy installation. WIREWATTS are made in values from 100 through 25,000 ohms. Ask your jobber or write for Catalog 14.

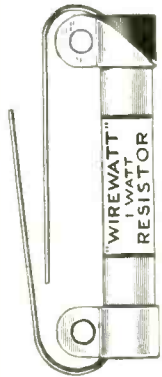

OHMITE MANUFACTURING CO.

4827 Flournoy St., Chicago, Ill.
Manufacturers of Resistors and Rheostats of All Types

FOR GREATER PROFITS.....

ATR AUTO RADIO

"A" BATTERY ELIMINATOR
Specially designed for demonstrating and testing auto radio sets on regular A.C. Lines 105-125 volts, 50-60 cycles.



Dealers' Price, \$12.95 Net

EQUIPPED WITH:
On-Off Switch . . . Pilot Light Indicator . . . 10 ampere fuse . . . Rubber Mounting Feet . . . 6 foot All-Rubber Cord Set.
Cabinet is of heavy gauge metal having attractive black wrinkled finish.
Size: 7½" x 7½" x 5".
Shipping weight: 20 pounds.
(Packed one to carton.)

All Prices Slightly Higher West of the Rockies and in Canada
SOLD BY LEADING JOBBERS EVERYWHERE
Write or Wire for Additional Information

ATR DC-AC INVERTERS

Produces A.C. CURRENT ANYWHERE—In cars . . . On Farms . . . In D.C. Districts.

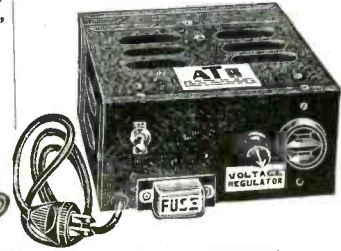

List Price, \$18.50*

* Without radio filter. \$22.50 with built in filter. (Standard Discounts Apply.)

Proven—Dependable—Guaranteed Outstanding Features:
● Interference Free All Wave Radio Operation.
● New Improved Long Life ATR Vibrators.
● Four Point Voltage Regulators. Available in 16 different types for operation on D.C. Input Voltages ranging from 6 to 220 volts and having A.C. output voltages of both 110 and 220 volts.

IMPORTANT! Write for descriptive literature on ATR BATTERY CHARGERS
Designed for pepping up storage batteries right in the car.

AMERICAN TELEVISION & RADIO CO.

St. Paul, Minnesota, U. S. A. Cable Address: "LIKEX" New York

Get a Political Job It's Easy Money

STENTORIAN SOUND AMPLIFIER NUCLEUS

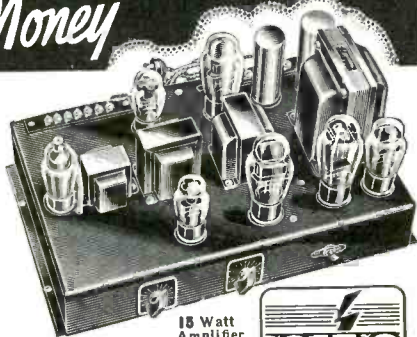

15 Watt Amplifier Nucleus
High Gain for Crystal or Velocity or Carbon Microphones



The hottest political campaign in years is directly ahead! Political organizations of all parties will need public address systems with a "Stentorian" tone. Dealers and Sound engineers can make good quick profit in selling or renting sound amplifiers built the "Stentorian" way. G.T.C. Nuclei furnished for stationary and mobile outfits. Easy to understand directions for wiring supplied with each Nucleus. Power supply units are the HEART—the very nucleus of Sound Amplifiers. Each "Stentorian" NUCLEUS includes matched power transformer, chokes, audios, outputs with neat black wrinkle finished chassis, lettered terminal strips, marked tube sockets. "Stentorian" Sound Amplifiers provide wide tone range and good clear sound coverage for convention halls, auditoriums, stadiums, refectories, athletic fields, ballrooms, night clubs, taverns, lodge halls, banquet programs, political rallies, office and factory call systems, truck or auto advertising for concession barkers, race track announcements, depot train call systems, and the like.

The "Stentorian" way is the most economical way for Quality Sound Amplifiers.

GENERAL TRANSFORMER CORPORATION
(Manufacturer of Replacement Units)
502 S. Throop Street
Chicago, Ill.

Free for the Asking!

Interesting Illustrated bulletin on "STENTORIAN" Sound Amplifier Nuclei and name of distributor nearest you.

"MICROPHONE HEADQUARTERS"
Presents
The NEW SHURE

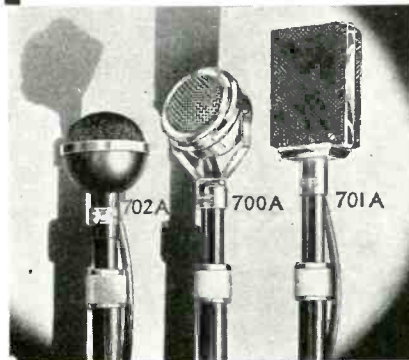

Crystal Microphones
with these
8 EXCLUSIVE FEATURES

- Ultra "Wide-Range" Reproduction from 40 to 10,000 cycles with a uniformity of response closely approaching the most rigid True High-Fidelity tolerances.
- New Shure "Cruciform" Crystal Mounting makes possible highest output level ever attained in a diaphragm-type crystal microphone of comparable frequency response.
- Dual-Drive High-Capacity Grafoil Bimorph Crystal.
- New single high-efficiency Curvilinear Diaphragm.
- Internal Screen-Protected Cartridge Unit—no exposed diaphragm when case is opened.
- Complete Barometric Compensation.
- Crystal "Moisture-Sealed" by new special process.
- Semi-Nondirectional and Semi-Directional models with new Spherical, Swivel and "Grille-Type" case designs.

Only Shure "ULTRA" Crystal Microphones can give you these new "highs" in performance, dependability and utility at such low cost! Three models Spherical, Swivel, and "Grille-Type" . . . List price, each, only **\$25.**

Write for data today!

(Models 701A and 702A available now. Model 700A available August 15.)

Licensed under patents of the Brush Development Company. Shure patents pending.

SHURE MICROPHONES
SHURE BROTHERS • MICROPHONE HEADQUARTERS
215 WEST HURON STREET • CHICAGO, U. S. A.

ASSOCIATION NEWS . . .

INSTITUTE OF RADIO SERVICE MEN REPORTS

The IRSM Qualification Project

The National Radio Service Qualification Project announces that arrangements have been made to hold the first examination under the auspices of the National Board of Radio Service Standards at the Hotel Sherman in Chicago, Monday, August 24. Arrangements are also being made to hold a series of examinations during the three days of the Fourth Annual New York Convention of the Institute of Radio Service Men at the Hotel Pennsylvania in New York City.

Examinations in other cities will be arranged just as rapidly as the program can be organized, and chapters of the institute have offered their hearty cooperation in the making of the necessary arrangements.

Plans are being made to forward application forms directly from the offices of the National Radio Service Qualification Project.

The offices of the National Radio Service Qualification Project are located at 500 N. Dearborn Street, Chicago. Service Men who wish to obtain information may address their inquiries to the Managing Director of the Qualification Project.

The long-awaited "Questions and Answers Handbook," compiled by the Institute and which is to be loaned for use in making preparations for the examinations under the Qualification Project, has been printed.

New York IRSM Convention

Preparation for the Fourth Annual New York Convention and the 1936 New York Radio Trade Show cause rumblings of considerable activity in the office of the Institute these days.

Having originally set the dates late in October, the IRSM now advises that arrangements have been made to hold the event Sept. 18 to 20, at the Hotel Pennsylvania. An announcement to the trade brought the reservations for space scurrying and on the first of the month, the Institute reports that more than fifty percent of the space available had been absorbed.

The dates for the 1936 New York Convention and Show were advanced in order to get in ahead of the busiest days for the Service Men, and to give the exhibitors an opportunity to participate in the show in advance of the time when their representatives should be spending their full time in the territory.

Then, too, setting the time for the meeting in September will afford those who desire to do so to visit the National Electrical and Radio Exposition being held under the auspices of the Electrical Association of New York at the Grand Central Palace. The Show at the Palace, while primarily a public show, perhaps, will contain features that are of interest and value to the radio trade as well. Unfortunately, however, the Electrical Association's Show will close at 11:00 o'clock on Saturday night, which means that those who attend the IRSM Convention and Show on Sunday only will not have the privilege of seeing both affairs during their stay. Time did not permit making

arrangements for the two shows to close simultaneously, and it is believed that in another year the two associations can collaborate in the matter by arranging dates further in advance.

There is a rumor afloat that the officials of the IRSM have been approached by RMA with reference to joint sponsorship of radio trade shows. No decision has been made on the question, and whatever is done will not affect the arrangements for the current year.

Ken Hathaway, Executive-Secretary.

New York Chapter

A regular meeting of the New York Chapter of the IRSM was held at the Hotel Pennsylvania, June 29. Mr. Chas. Seidman opened the meeting with the usual service forum. Mr. Robert G. Herzog, editor of *SERVICE*, as guest speaker of the evening held an interesting and instructive discussion on "Circuit Constants." After a full 2-hour period, Mr. Herzog was permitted to stop only on promise that he would continue the discussion at some future meeting.

A business meeting followed directly after the discussion.

Joseph Flaum, Secretary.

Akron Chapter

The Akron Chapter of the IRSM is under full swing and membership is increasing rapidly with each meeting. Mr. E. Nerhood, chairman, urges all Service Men in and around Akron to communicate with him at 1193 Berwin St., Akron, Ohio, with the prospect of joining the chapter.

Meetings are held regularly the first Tuesday and the third Thursday of each month.

Cleveland Chapter

As part of our educational program the June 17 meeting was turned over to Mr. Ed Price, of Strong Carlisle and Hammond Co. Service Men as a rule have no use for sales managers but they sat and listened to Ed, liked it and asked for more. He has a knack of talking in our own language.

Al Theriault, our chairman is up to his neck in plans for the boat trip up the lake to be held August 23. The outing will include fish, beer, and SOHARSM. Nuff sed! All Service Men and their wives are invited.

The Cleveland IRSM Radio Trade Show will be held October 25 and 26 at the Hotel Cleveland.

L. Vangunten, Secretary

ART OF BRITISH COLUMBIA

The RCA Victor Co. presented a special entertainment at the meeting held May 26 at D.V.A. Hall. The program was both interesting and instructive.

The Association's headquarters are now located at 918 Rogers Building, Vancouver,

B. C., Canada. All communications should be addressed to this new location.

MARYLAND RADIO SERVICE ASSOCIATION

At an open meeting held June 26, at the New Howard Hotel, Howard and Baltimore Streets, Baltimore, Md., Mr. E. N. Deacon, General Sales Manager of R. C. A. Radiotron Division, delivered an illustrated lecture on the topic "Helping the Service Man Make More Money." Mr. R. G. Herzog, Editor of *SERVICE*, also attended the meeting and was introduced to the members. An old-timers get-together was announced to take place on July 24.

Another service meeting of the Maryland Radio Service Association is to take place on August 28, at the New Howard Hotel, and is to be sponsored by the General Electric Co. Door prizes are promised and refreshments will be served.

Wm. A. Thompson, Secretary

R.T.G. OF NEW ENGLAND

Every member of the Radio Technician Guild will henceforth be rated as an apprentice, until he has passed an examination for his journeyman's license, and will remain a journeyman until he has passed examination for his master's license.

These licenses will be granted by the Guild, signed by an examining officer, and countersigned by three notaries.

Rhode Island Chapter

An interesting lecture was held at the Swedish Hall on Chestnut St., Providence, May 21, sponsored by the Radio Technicians' Guild of R. I. The Radiart Corp. of Cleveland, Ohio, and the local distributor, W. H. Edwards & Co., of Providence, R. I. The Radiart Corp. was represented by Mr. Shapiro, who ably discussed with the body the subject at hand.

Mr. Edwards used an amplifier system which worked very well; he also had an oscillograph to demonstrate the action taking place in the various circuits.

PRISMA NEWS

Start right now to root out those corners and brush the dust off the assorted gadgets which have been cluttering up your shop. In August we're going to spring another auction-rummage sale of odds and ends and tubes and meters.

J. T. Gallagher in Prisma News

WASHINGTON RADIO SERVICE SOCIETY

The Third Annual Convention of the Washington Radio Service Society will be held August 14th and 15th at the Olympic Hotel, Seattle, Wash. This year it is expected to be twice as large as the previous years due to the fact that we have more exhibitors and a more interesting program to attract the delegates from the different parts of our territory.

We are also making arrangements to have at this convention a large number of broadcast engineers, U. S. Army and Navy engineers, sound engineers and the student body of the University of Washington. From the reaction we have already had there is no doubt that this year's convention will supersede any turnout that the Pacific Northwest has ever experienced heretofore.

C. E. Graves, Secretary

• SERVICE FOR

Beat the Heat!



with **CORNELL DUBILIER**
Electrolytics

DON'T let excessive humidities and temperatures worry you!

Cornell-Dubilier Electrolytic capacitors, triply sealed, are scientifically designed to withstand the most abnormal summer conditions.

Retain your customer's confidence by insisting on C-D electrolytics. Available in a complete capacity range from 25 to 500 volts D.C., at all C-D authorized distributors.

THE MOST COMPLETE CONDENSER LINE IN THE WORLD. WET & DRY ELECTROLYTIC - MICA - PAPER - DYKANOL.

CORNELL-DUBILIER
CORPORATION

4375 BRONX BOULEVARD
NEW YORK



A New Combination Vacuum-tube Voltmeter and Peak Voltmeter



Model 88
Net \$42.50

High sensitivity affords full scale deflection of large fan-type meter with 1.2 volt input. Metal type 6F5 voltmeter tube is on a 30" extension cord to eliminate lead losses. As vacuum-tube voltmeter, input is direct to tube grid with no shunt resistor. As peak voltmeter, reads 0-10 and 0-100 volts. Achieves new low in wave form and frequency errors. Voltage readings accurate to 30 mc. Entirely self contained in a single unit for direct operation from 110 v, 60 cycle a.c.

Write for descriptive bulletin

The CLOUGH-BRENGLE CO.

2817 West 19th Street
JULY, 1936 •

Chicago, U. S. A.

SAY YOU SAW IT IN SERVICE



Here is what users of **OPERADIO** **UNIT-MATCHED** **EQUIPMENT** say:

"The use of OPERADIO P. A. Equipment has enabled us to increase the attendance of our airport as high as 400%."—Large Chicago Airport.

"It looks like we'll have to doff the old bonnet to OPERADIO with reference to your Model 62 Portable Auto Amplifier. It certainly is a honey."—Illinois Radio Shop.

"It will be pleasing to you to know of the hundreds of complimentary remarks made to members of the committees on the excellent loud speaking equipment furnished by your company for our picnic."—Dallas, Texas, Commercial Association.

"We find that the message we want to deliver to the public is done more directly over the OPERADIO Public Address System than through any other medium and is therefore more effective."—Chain Store Ladies' Apparel Shop, San Francisco.

"Your OPERADIO Sound Equipment has been in use in our 11th Street Store for a period of six months. To date we are completely satisfied with this System and would say that were we in a position to do so, we would also install same in our 27th Street Store."—Milwaukee Drug Shop.

"We furnished your new

Model 18A Junior Portable OPERADIO Public Address Unit to Rear Admiral Richard E. Byrd for his lecture in the local theatre where he talked to about 1700 people. He made the statement that yours was the finest system that he had ever used in connection with the many lectures he has given."—Indiana Radio Sales & Service.

"We received a real pleasant surprise in the performance of the OPERADIO Sound System purchased from you, and it is our belief that other shows will adapt its usage rapidly."—Nationally known circus.

"Facsimile copies of letters from which the above statements were taken will be supplied on request.

Address Dept. S for Catalog 10.

Ask About Our Convenient Time Payment Plan



OPERADIO
MANUFACTURING COMPANY
Unit-Matched P. A. Equipment at its Finest
ST. CHARLES, ILLINOIS

ONE WAY TO TELL IS BY **WEIGHT**

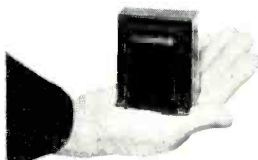

**MORE EXPENSIVE
TO MANUFACTURE**

but

LESS FAILURES

and

**NO INCREASE IN
PRICE**

TRY HALLDORSON VACUUM-SEALED TRANSFORMERS

The correct design with full measure of wire of proper size and length is necessary to protect a transformer from overheating and premature breakdown. Halldorson VACUUM-SEALED transformers definitely give better operating satisfaction. That is why they are selected by so many of the "aces" in the Radio Service Business.

Try one of these transformers—give it "the works" and you too will join that select class of radio servicemen who are getting the maximum in transformer operation at **No Increase in Cost**

CAN YOU ANSWER
Will a high ratio audio transformer give greater volume than one of a comparatively low ratio?



SEE
HALLDORSON
HOUSE ORGAN
JUNE-JULY
ISSUE

SEE YOUR JOBBER—WRITE

The
Halldorson Company
4500 Ravenswood Ave.
Chicago, Ill.

Please send me FREE
 New Catalog #6.
 Halldorson June-July House Organ.

Name

Address

City..... State.....

THE MANUFACTURERS . . .

ELECTRO ACOUSTIC PHONETTE

The Electro Acoustic Products Co., subsidiary of The Magnovox Co., Fort Wayne, Indiana, has announced a radio attachment for reproducing musical recordings in combination with a radio. It is known as the Phonette.

SHURE CRYSTAL MICROPHONES

Three new crystal microphones with response curves closely approaching true high-fidelity performance have been announced by Shure Brothers, 215 W. Huron

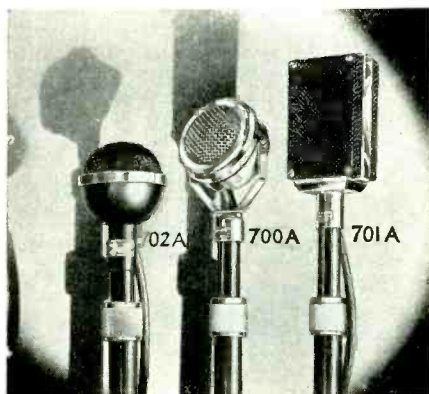

St., Chicago. All three models are licensed under patents of the Brush Development Co.

FOX TONE-BELL REPRODUCER

Capable of reproducing a wide range of frequencies and designed to augment and strengthen sound with complete distribution, the Fox low-level tone-bell reproducer is a new item of production at the Fox Sound Equipment Corp., Toledo, Ohio.

TUBE EXTRACTER

The American Radio Hardware Co., 476 Broadway, New York City, manufacture the metal tube extractor shown in the illustration. The jaws of the extractor are so

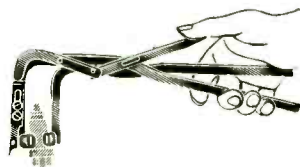

designed that any type of metal tube may be gripped tightly without damage.

Additional information may be obtained from the manufacturer.

RADIO-BAK

Radio-Bak Mfg. Co., Vail's Gate, N. Y., announces a back to keep dust out of radios and prevent reverberation of sound between the baffle-board and the wall in back of the radio. One Radio-Bak fits various sizes of radios neatly, consisting of loosely woven, shirred cloth and elastic.

Additional information may be obtained from the manufacturer.

WRIGHT-DECOSTER UNIVERSAL SPEAKER

Wright-DeCoster, Inc., 2253 University Ave., St. Paul, Minn., announce a universal speaker. The speaker is 12 inches in diameter and has a universal output transformer to match any type output tube. The field has 7 taps so that it may be used by the Service Man as a substitute speaker for bench repairs. A para-curve diaphragm is employed enabling true high-fidelity reproduction during repairs of high-fidelity receivers and amplifiers.

Additional information may be had from the manufacturer.

KEN-RAD 6B8 AND 6B8G

The Ken-Rad Corporation, Owensboro, Ky., has announced the 6B8, an all-metal tube, and the 6B8G, similar in characteristics but a glass tube equipped with the octal base. Generally speaking these tubes are for the same service as the familiar glass type 6B7.

Characteristics, etc., may be obtained from the manufacturer.

DISTRIBUTION PANEL

The latest product of the Radio Engineering and Mfg. Co., Jersey City, N. J., is a sound distribution panel, useful in centralized sound systems, in hotels, amusement parks, auditoriums, etc., where several branch circuits are loaded on the output of the main power amplifiers, and a certain audio level must be maintained in each circuit.

ALADDIN I-F

A three-circuit, continuous, flat-top band-expansion i-f transformer is the latest development of Aladdin Radio Industries,

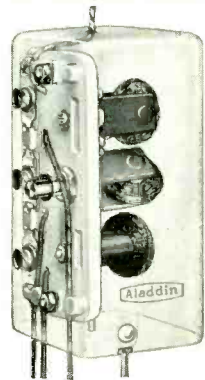

Inc., 466 W. Superior St., Chicago, Ill. This coupling device, known as the type D-101, makes it possible to obtain selective band expansion.

JEFFERSON AMPLIFIER KIT

An amplifier circuit employing 6B5 tubes in push pull has been released by Jefferson Electric Co., Bellwood, Ill., and is described in bulletin PA-11. This circuit features a double channel input with gains of 138 or 98 db. Jefferson components consist of the power transformer, two chokes, input and output audio transformers, the chassis base and the fuse and fuse block. A template furnished with each chassis base simplifies assembly.

FREED PORTABLE RADIO

The Freed-Eiseman Radio Co., New York City, present the model F.E.58, an a-c, d-c receiver in a compact traveling case. The chassis is a five-tube super-heterodyne and covers the band from 540 to 1750 kc.

BURTON-ROGERS SERVICE ESTIMATOR

The Burton-Rogers Co., are marketing a complete tube analyzer together with a 3-range high-resistance voltmeter, a 2-



range milliammeter and a 3-range ohmmeter. The entire unit is contained in an oak case with a removable lid 12" by 12" by 5" overall.

Additional information can be obtained from the Burton-Rogers Co., 755 Boylston St., Boston, Mass.

IRC WIRE SOUND RESISTORS

An economical, completely insulated wire-wound 1/2- and 1-watt resistor, similar in size and appearance to the IRC insulated metallized units, has been announced by the International Resistance Co., of Philadelphia.

ICA SECTIONAL RACK

ICA presents a useful item to the Service Man in their sectional standard con-



struction rack. In this rack, any number of standard panels of any desired standard size may be accommodated simply by mounting together the requisite sections, which are available in as many sizes as there are standard panel widths.

Additional information can be obtained from the Insuline Corp., 25 Park Place, New York City.

(Continued on page 330)

The WINNING HAND

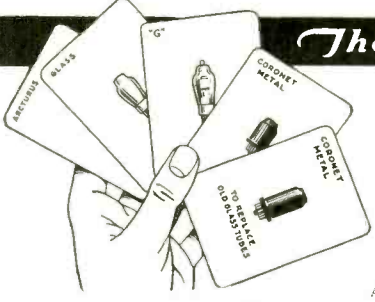

ARCTURUS offers the dealer ALL 4 TYPES of TUBES his customers want—GLASS, "G," METAL and the NEW CORONET METAL TUBE for modernizing old glass-tube sets!

For full details of the 4-WAY Arcturus line and the new Coronet Metal Tubes write:

ARCTURUS RADIO TUBE CO.
NEWARK, N. J.

ARCTURUS
CORONET METAL "G" AND GLASS RADIO TUBES



Curtis Electrolytic CONDENSERS

Any style, size or shape.



Patent No. 1950352

CURTIS CONDENSER CORPORATION
3088 WEST 106TH ST. CLEVELAND, OHIO

GET ON THE LIST FOR THESE BIG FREE CATALOGS



• The four mastheads, illustrated show the four big catalogs sent to every Burstein-Applebee customer this year. Each catalog is brim full of latest information and lowest wholesale prices on Radio, Electrical and Refrigeration Equipment. Write today—get your name on the list to receive every Burstein-Applebee catalog issued.

BURSTEIN-APPLEBEE CO.
1012-14 McGee Street Kansas City, Missouri

Cardohms ARMORED WIREWOUND RESISTORS



MUTER

OVER TWELVE MILLION IN USE
WRITE TODAY FOR COMPLETE CATALOG

THE MUTER COMPANY
1235 SO. MICHIGAN AVENUE, CHICAGO

TRIPLET

MAKE YOUR INVESTMENT TODAY

PAY BIGGER DIVIDENDS TOMORROW



Model 1200 Volt-Ohm-Milliammeter Dealer Price \$21.67

Model 1206 Master Unit Test Set Dealer Price \$84.33

Buy one unit today. Own a complete Master tomorrow

Obsolescence is the bugaboo of radio. It is particularly the bugaboo of the radio serviceman when it comes to investing in test equipment.

Of course there are going to be changes in radio, of course this industry is going forward. But test equipment can be designed whereby possible loss from obsolescence is minimized. For instance, it is hard to conceive of a radio change that would obsolete the Triplet Volt-Ohm-Milliammeter, as this measures the electrical standards of the volt, the ohm and the ampere.

Consider also, the Triplet Master Unit Test Set is built up of four distinct units, the Volt-Ohm-Milliammeter, the Tube Tester, the Signal Generator and the Free Point Tester. Every individual unit. But if a revolutionary change should come along, all units would certainly not be obsoleted. Compare this then, with other equipment from the standpoint of obsolescence and you will realize why your investment today in Triplet will pay bigger dividends tomorrow.

The Triplet Electrical Instrument Co. 177 Harmon Drive Bluffton, Ohio

Without obligation please send me More information on Triplet Master Unit Test Set.

Name
Address
City State

See Your Jobber.
Write for Catalogue.

Your Guide To NEW SOUND DOLLARS FREE!



Never before was there such an interest in sound systems as there is now. Political campaigns are largely responsible as bands and spell-binders carry their own systems with them. Plenty of money has been made in sound in the past year; there's twice as much to be made during the next six months alone! Get on the SOUND wagon—it's going places. Learn all about the different apparatus available, what it will do. Send the coupon NOW for free catalog, including prices.

RCA For SOUND SYSTEMS

RCA MANUFACTURING CO., Inc., Camden, N. J.
Commercial Sound Section 5
Please send me your free Commercial Sound Catalog 210

Name.....
Street.....
City..... State.....

HIGHLIGHTS . . .

KAY PRODUCTS MOVES

Kay Products, manufacturers of universal control heads for all makes of auto radios, have moved to larger quarters at 39-01 Queens Blvd., Long Island City, N. Y. The new quarters not only more than quadruple manufacturing facilities but brings Kay in closer proximity to its parent company, the Etched Products Corp. The personnel has also been increased.

Irving Karlin, general manager of Kay, has revealed that their attorneys have served notice on a competitive manufacturer claiming infringement upon Kay universal auto-radio remote control heads. Similar notice has been served upon auto-radio makers using the competitive product which is alleged to infringe patent No. 2,042,061.

SVEA-ONICS

The Swedish Iron & Steel Corp., 17 Battery Pl., New York City, in a bulletin (No. 24) recently published under the title "Gas in Metal," explains the presence of gas in metal and the how and why of its removal.

Copies of this bulletin may be obtained upon request.

NATIONAL UNION PROMOTES P-A

National Union has made arrangements with Webster, Chicago, manufacturers of sound equipment, so that high efficiency sound systems are to be supplied to service experts free with the purchase of National Union radio tubes.

Additional information on these p-a deals may be obtained from National Union Radio Corp., 570 Lexington Ave., New York City.

RELAYED FREQUENCY PICKUP

In response to many requests from SERVICE readers we are pleased to announce that the "Relayed-Frequency" Pickup illustrated and described by Mirko Paneyko in the June issue is the result of scientific research and development by Maximilian Weil of the Audak Co., 500 Fifth Ave., New York. This new Microdyne Pickup is now manufactured and marketed by Audak.

SYLVANIA SOUTHERN SCHEDULES

After a very busy spring, W. R. Jones and G. C. Connor, Sylvania tube service engineers, are finishing the season with a series of service school engagements in the South.

BUD CATALOG

Bud Radio, Inc., Cleveland, Ohio, have published the third edition of their parts catalog. Bud Radio manufactures a complete line of r-f chokes, variable condensers, coil forms, chassis, and other small parts for the experimenter and Service Man.

Copies of the catalog may be had upon request.

WEBSTER CHICAGO CATALOG

The Webster-Chicago Co., 3825 W. Lake St., Chicago, publish a 12-page illustrated catalog describing their line of public-address amplifiers, microphones, pickups, etc.

Copies of this catalog may be had upon request.

AN HOUR A DAY

John F. Rider, 1440 Broadway, New York City, has just published the second book in his "An Hour a Day with Rider" series. The 96-page book titled "D-C Voltage Distribution in Radio Receivers," covers a general review of simple electric theories as well as a complete discussion of series and parallel circuits and their application in actual receiver circuits.

TRANSFORMER CORP. REORGANIZES

Transformer Corp. of America, recently reorganized, has opened a plant at 69 Wooster St., New York City, for the manufacture of radio and p-a equipment under the Clarion trademark.

Mr. H. L. Shortt has been elected president and general manager of the corporation and Mr. F. H. Skrotzki, treasurer and sales manager.

STROMBERG-CARLSON PARTS DISTRIBUTOR

Sanford Samuel Corp., 136 Liberty St., New York City, have been appointed New York distributors for Stromberg-Carlson replacement parts and receiver accessories. A complete catalog of these items is in the process of preparation.

UTAH APPOINTMENT

Mr. Robert M. Karet has been given the post of director of sales of the jobber division of Utah Radio Products Co., radio parts manufacturers.

Mr. Karet, formerly associated with Radiart Corp., Metro Mfg. Co. and The R. B. Rose Co., has been active in the development of the radio industry and is known by jobbers and dealers.

WEBSTER LICENSED

The Webster Electric Co., Racine, Wis., announces that it now offers to the trade a full line of sound systems licensed under patents owned or controlled by Western Electric Co., Inc., and the American Telephone and Telegraph Co.

ARCTURUS ANNOUNCEMENTS

The Arcturus Tube Co., Newark, N. J., simultaneously announces new prices on its Coronet and G lines with the following additions: The 1F4, battery-operated output pentode; the 5W4-G and the 5W4-Coronet, full-wave vacuum rectifiers; the 6L6-G and the 6L6-Coronet, beam-power amplifiers; 6N6-G double-triode power amplifier, and the 6R7-G double-diode triode.

Characteristics of these types as well as the new list prices may be obtained from the manufacturer.

MANUFACTURERS—continued

STEWART WARNER AUTO ANTENNA

Stewart Warner Corp., manufactures a rubber insulated twin antenna for installation under the running boards of modern turret topped cars. A special set of brackets insures easy mounting without drilling the running board.

INTRA-DEPARTMENT COMMUNICATING SYSTEM

Cost to business, of communicating or conversing between different departments, took a drop with the announcement of a low-priced intra-department communicating system by Bell Sound Systems, Inc., 61-63 East Goodale Street, Columbus, Ohio. This equipment, under the trade name of Bellphone, offers to even the smallest establishments the advantages of equipment that has previously been considered a luxury

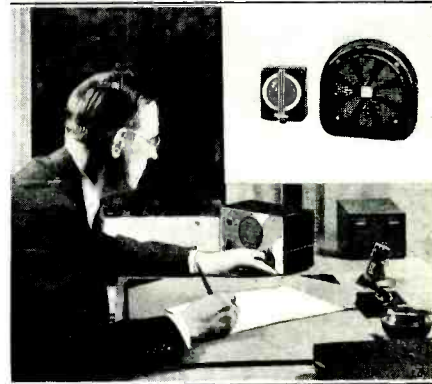

suited only for larger firms. Using an amplifier, microphone and loudspeaker, it permits the transmission of voice from one department to another, with a box, approximately the size of the smallest midget radio, placed on the desk or counter. A volume control and two different types of loudspeakers permit the voice to be of any degree of loudness for the communication with a party stationed either at one point or various places in a department. In stock rooms or kitchens, more than one loudspeaker can be used. Even though a person may be standing 25 or more feet from the receiver, his reply, in a normal voice, will be picked up and transmitted.

By a combination of two or more of these small, compact units, very simply wired, a wide variation of systems can be accomplished. One station can talk to anyone of a number of stations by means of a selector key. Also, with a multiple hookup, there can be a number of simultaneous conversations.

OPERADIO JR. SPEAKERS

The Operadio Junior Series is available in 5, 6, 8, 10 and 12-inch sizes. All mounting holes are interchangeable with any standard speaker. All are available with universal matching transformers and in standard field coil ratings, and they come packed in most attractive cartons. Catalog 10-D gives information covering these chassis. Write Operadio Manufacturing Co., St. Charles, Ill.

POWER CHARGER

Briggs & Stratton Corp., Milwaukee, Wis., manufacturers of 4-cycle gasoline motors, has announced a 6-volt, 200-watt power-charger to charge 6-volt batteries for radio and lights and to supply gasoline motor power for running small equipment.

Additional information may be had from the manufacturer.

• SERVICE FOR

Electronic Mixers for Crystal Microphones,
Phono Units or other high impedance input.

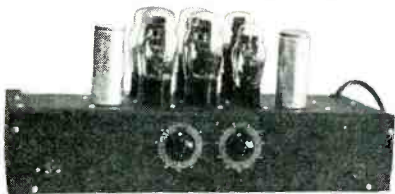

Two-position Mixer. Also supplied
for 3 or 4 positions.

Each position consists of a 2-stage
push-pull amplifier
with a balanced 2-
unit volume control
between stages.

Write for
Bulletin 14

SOUND SYSTEMS, INC.

6545 CARNEGIE AVENUE CLEVELAND, OHIO



Ken-Rad Radio Tubes

Ken-Rad Radio Tubes are
made to give clear, depend-
able reception. They satisfy
customers and build good will
for dealers. Write for full
information.

Genuine Glass or All-
Metal Radio Tubes

THE KEN-RAD CORPORATION, Inc., Owensboro, Ky.
Division of The Ken-Rad Tube and Lamp Corporation
Also Mfrs. of Ken-Rad Incandescent Electric Lamp:

TRIMM GROUP HEARING AIDS

ARE THE

FINAL CHOICE OF CHURCHES

- Superior Quality
- Excellent Performance
- Dependable Service
- Reasonable First Cost
- Low Maintenance Cost

SERVICEMEN

This is your
field

Go after those
extra profits.

TRIMM RADIO MFG. CO. Dept. S-7
1770 W. Berneau Ave., Chicago, Ill.

ELECTRO-VOICE



For high-fidelity P.A. work, the ELECTRO-
VOICE V.2 meets every requirement. Its wide,
flat response gives a naturalness of reproduction,
rarely found in other types. Feed-back is greatly
reduced and hum pick-up eliminated through
ingenious design. Incorporates many other de-
sirable features such as the locking cradle, inter-
nal shock-proof assembly and 20' well shielded
cable. Performance, appearance, simplicity of
operation and value merge in the ELECTRO-
VOICE Model V.2. Try one on your next in-
stallation. List price: \$35.00.

See your distributor or write for literature.

ELECTRO-VOICE MFG. CO., INC.
332 E. Colfax Ave., South Bend, Ind.
Export Office: 15 Laight St., New York, N. Y.

GET ON THE P. A. BAND WAGON
TO MORE BUSINESS AND
GREATER PROFITS WITH THE
CINAUDAGRAPH

Magic Magnet Speaker

CINAUDAGRAPH CORPORATION

Speaker Division — Dept. A.
STAMFORD, CONNECTICUT, U. S. A.

RACON 6 FOOT UNBREAKABLE TRUMPETS



"The World's Finest"

Demountable into three sections. Made of RACON
Acoustic Storm Proof material, reinforced through-
out, and guaranteed unbreakable. The ultimate in
trumpet design, highly efficient and able to stand
the roughest treatment.

Send for RACON catalog S-7 describing the com-
plete line of RACON Horns, Electro-dynamic
Units, and Acoustical Sound Projectors.

RACON ELECTRIC COMPANY, INC.
52 EAST 19TH STREET NEW YORK CITY

RADIO AMATEUR CALL BOOK



is the only publication listing all radio
amateurs throughout the entire world.

It also includes a complete list of
High Frequency Commercial Stations,
International Abbreviations and "Q"
Signals, High Frequency Press and
Weather Schedules, "Q", "R" and "T"
Signals, U.S. Radio Inspection Dis-
tricts, International Prefixes.

Every radio amateur should have a
copy of this valuable book. Always
up-to-date, published quarterly, single
copies \$1.25, annual subscription \$4.

RADIO AMATEUR CALL BOOK, Inc.
612 So. Dearborn Street Chicago, Illinois

New

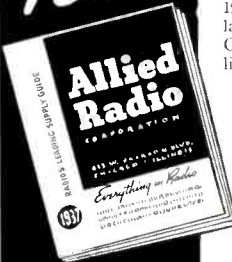

1937 ALLIED RADIO CATALOG

SERVICEMEN! — Here it is! — The new
1937 ALLIED Radio Catalog — Radio's
latest, largest, and most complete Supply
Guide. 152 pages packed with 10,000 dupli-
cate and replacement parts; dozens of
new test instruments, analyzers, tube
checkers, oscillographs, meters, etc.;
new Public Address equipment; page
after page of All-Wave, Dual-Wave,
and Short Wave sets; Build-your-own
kits; books; tools—Everything in Radio
at lowest prices. Every Serviceman
needs this great book. Write today
for your FREE copy! Dept. 19-G.

Free

ALLIED RADIO
833 W. JACKSON BLVD. CHICAGO



TRIAD



THE QUALITY NAME IN RADIO TUBES

TRIAD MANUFACTURING CO., Inc.

PAWTUCKET, RHODE ISLAND



This CONTROL does the trick!

Because it's precisely matched with original volume control equipment. Just look up set model in CLAROSTAT Guide. That tells you the replacement control to use. Your jobber supplies that unit. Result: You save time, trouble, kicks.

FREE MANUAL: If you haven't a CLAROSTAT Guide at hand, write for same today. Simply ask for Guide No. 3.

CLAROSTAT
MANUFACTURING CO., Inc.
285-7 N. SIXTH ST. :: BROOKLYN, N. Y.

YOU'LL FIND
EXTREME
SENSITIVITY
in the FOX
ELECTRO
DYNAMIC
UNIT

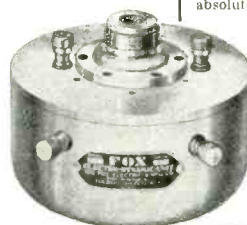

Assures complete elimination of distortion under pressure of range and volume, unbalanced tone, background noises and overheating under forcing.

Ideal for public address and theatre systems where tone shades, whispers, and light musical effects are as important as heavy orchestral and organ volume. Its sensitivity is possible because of the exceptional lightness of the diaphragm and voice coil, its structural design and its high magnetic efficiency.

The diaphragm is fully protected by a substantial die casting which shields it perfectly without obstructing it or reducing its effectiveness. Parts are absolutely interchangeable, and tolerances of .001 are maintained.

The Fox unit is the only one in which the voice coil can be replaced without factory service. (Fox voice coils are guaranteed for one year.)

The Fox unit has a power handling capacity of 25 watts. The impedance of the voice coil is 16 ohms. Exciting energy of the field coil must be 8-8 volts at 1 1/2 amperes, which can be secured from either an ordinary six-volt storage battery or an especially designed Fox dry rectifier.

FOX SOUND EQUIPMENT CORP.
3120 Monroe St. Toledo, Ohio

**YOUR
JOBBER
SELLS**

AMPERITE VELOCITY MICROPHONES

*Watch for
Sensational
Announcement!*

INDEX TO ADVERTISERS

A	G	Racon Elec. Co..... 331
Aerovox Corp..... 333	General Electric Co..... 293	Radiart Corp., The..... 321
Allied Radio Corp..... 331	General Transformer Corp..... 325	Radolek Co..... 333
American Television & Radio Co..... 325	H	Rider, John F..... 319
Amperite Corp..... 332	Halldorson Co., The..... 327	S
Arcturus Radio Tube Co..... 329	Hickok Elec. Inst. Co..... 321	Shure Brothers..... 325
B	Hygrade Sylvania Corp..... 313	Solar Mfg. Corp..... Third Cover
Bell Sound Systems, Inc..... 333	K	Sound Systems, Inc..... 331
Brush Development Co., The... 334	Kay Products of America, Inc. 323	Superior Instruments Co..... 334
Burstein-Applebee Co..... 329	Ken-Rad Corp., The..... 331	T
C	M	Technical Appliance Corp..... 333
Centralab..... 317	Mallory & Co., Inc., P. R. Second Cover-309	Thordarson Elec. Mfg. Co..... 297
Cinaudagraph Corp..... 331	Meissner Mfg. Co..... 333	Tobe Deutschmann Corp..... 310
Clarostat Mfg. Co., Inc..... 332	Muter Co., The..... 329	Triad Mfg. Co., Inc..... 332
Clough-Brengle Co., The..... 327	N	Trimm Radio Mfg. Co..... 331
Cornell-Dubilier Corp..... 327	National Union Radio Corp... 323	Triplett Elec. Inst. Co..... 329
Cornish Wire Co..... 334	O	U
Curtis Condenser Corp..... 329	Ohmite Mfg. Co..... 325	United Transformer Corp..... 315
E	Operadio Mfg. Co..... 327	Utah Radio Products Co..... 319
Electrad, Inc..... 298	Oxford-Tartak Radio Corp..... 333	W
Electro-Voice Mfg. Co., Inc... 331	P	Ward Products Corp..... 317
The..... 331	Precision Apparatus Corp..... 295	Webster Co., The..... 313
F	R	Wholesale Radio Service Co... 334
Fox Sound Equip. Corp..... 332	RCA Mfg. Co., Inc. Fourth Cover-329	Wright-DeCoster, Inc..... 323
	Y	Yaxley..... Second Cover-309

Meissner



MAJESTIC COILS
EXACT REPLACEMENT

All specifications from original manufacturers blue-prints. Transformers pre-tuned at factory. Practically no adjusting. Guaranteed electrically and mechanically perfect.

SOLD BY ALL LEADING JOBBERS

MEISSNER MFG. CO.
Mt. Carmel - Illinois



Build Your Own
CONDENSER BANKS

Here are quality condensers, uncased, in handy form for repairs and new construction. Non-inductively wound sections of pure linen paper. Thoroughly impregnated with high melting point compound for protection against heat. Wrapped in black varnish paper. Pigtail leads. • Ask your jobber about them. Or write us direct.

In short, medium and long units.

200, 400, 600 and 1000 v. ratings.

All popular capacities—1 to 4 mfd.



CORPORATION

80 Washington St.

Brooklyn, N. Y.

Can You Use Extra \$\$\$?

That's easy. You can sell almost every set owner a TACO Antenna System. Installed in a jiffy. Sure-fire results. Ideal reception in broadcast, amateur and short-wave bands. Self-selecting. Minimum background noise. Priced for every class of trade. You clear extra dollars on every deal. Like finding money!

WRITE for data on latest kits—No. 500 (for price) and No. 200 (for superior results). Ask the jobber to show you these kits. Better still, try them out.

TECHNICAL APPLIANCE CORP.
Pioneers in Noiseless Antenna Systems
17 EAST 16th STREET :: NEW YORK CITY



Just Change the Field!

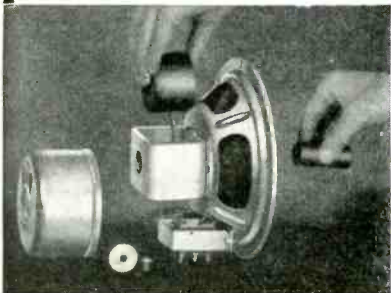

Practical! Efficient!
SPEAKERS
by **OXFORD**

You can see at once how easy to service... how flexible and economical to use... these new "Changeable Field" Dynamic Replacement Speakers really are! Ideal for amateurs, too! See—Hear—these and other OXFORD quality Reproducers at your Jobber—or write for Bulletin 361A—Now!

EXPORT DIVISION:
15 Laight St.
New York, N.Y.
Cable: "ARLAB"

OXFORD-TARTAN
RADIO CORPORATION
915 W. VAN BUREN ST. • CHICAGO, U. S. A.



POLITICAL MEETINGS

Need 'em bad!



A BIG YEAR FOR A CLEANUP WITH BELL P. A. EQUIPMENT

Model P. A. 3C—A practical size. Good capacity with remarkable fidelity. 15 watt output. Two input channels with separate volume controls. Tone control, selector switches and A.C. on-off switch. Crystal "Mike" and 10" speakers.

Bell also has Mobile Units. Permanent Sound System—and the new, popular Belfone Intra-Department Communicating System. A full profit-making line.

Mr. Jobber, we have an interesting story for you, too.

Looking for some extra profit? Bell P. A. Equipment is the answer. Efficient—Portable—Economical... just what every political meeting needs to get their campaign speeches to the audience clearly. Sell 'em or rent 'em. There's a size Bell for every condition. Radio men that are going after this business are "cleaning up." Start doing the same.

Write TODAY for full details.

BELL Sound Systems, Inc.
61-62 East Goodale St.
Columbus, Ohio



Your Guide to Profits!

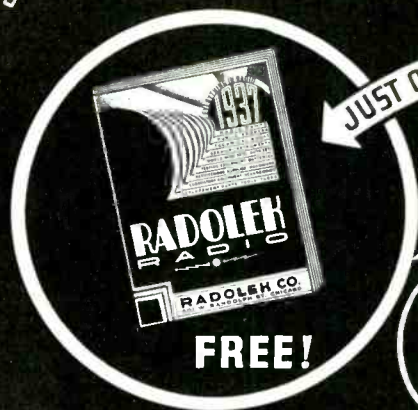

JUST OFF THE PRESS

FREE!

EVERYTHING IN Radio

Rely On Radolek For Radiol!

New Radolek Radio Profit Guide

Completely revised—right up to the minute—everything in radio—at the right price. Radolek makes money for you. Over 10,000 Repair Parts—a complete selection of Receivers, Amplifiers, Tubes, Tools, Books, Instruments—always in stock—ready for speedy shipment to you. You need this big Radio Parts Catalog. It's free! Send for it.

Radolek endeavors to restrict distribution of The Profit Guide to those actively and commercially engaged in the Radio Business. Enclose Business Card or Letterhead.

Send this Coupon

RADOLEK

610 W. RANDOLPH ST., CHICAGO
Send the Radolek Profit Guide Free.

Name.....
Address.....
Serviceman? Dealer? Experimenter?

BRUSH *General Purpose* MICROPHONE

The Brush G2S2P sound cell microphone—an all around general purpose microphone for program—remote pickup and announcing work. Widely used in high grade public address installations. A typical sound cell microphone built to Brush's traditionally high mechanical and electrical standards. Non-directional. No diaphragms. No distortion from close speaking. Trouble-free operation. No button current or input transformer to cause hum.

Beautifully finished in dull chromium. Output level minus 70 D.B. Size 3 inches by 1 1/4 x 1 1/8 inches. Furnished complete, at no extra cost, with a Brush S-1 socket that facilitates easy installation. Full details will be found in Data Sheet No. 4 Free. Send for one.



BRUSH *Headphones*

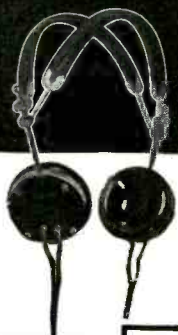

Meet every headphone requirement. Response 60 to 10,000 cycles. No magnets to cause diaphragm chatter. Specially designed cases minimize breakage. Light in weight. Only 6 oz., complete with headband and cords. A quality product at a low price. Details, Data Sheet No. 10. Copies on request. Send for one.

The **BRUSH** DEVELOPMENT COMPANY
 PIEZO ELECTRIC CLEVELAND, O.
 1882 E. 40th St.
 MICROPHONES • MIKE STANDS • TWEETERS • HEAD PHONES • LOUD SPEAKERS

Presenting A SIGNAL GENERATOR that "Does Everything" \$12.40

Released by Superior Instruments Co. for limited time only.



Model T-37 All-Wave Signal Generator, wired, in shielded cabinet with carrying handle and calibrated, tested: complete with 3 tubes, instructions, (shipping weight 7 lbs.)..... \$12.40

SUPERIOR INSTRUMENTS CO.
 139 Cedar St., New York City
 Gentlemen: Enclosed you will find:

\$12.40. Please send me your Model T-37 Signal Generator complete.

..... Deposit for one of your Model T-37 Signal Generators complete. Please ship balance C.O.D.

Name

Address

City..... State.....

- 110 Volts A.C. or D.C. 100 kc.—20 megacycles all on fundamentals.
- Dial is direct reading in frequencies.
- R.F. output may be taken from a high impedance or a low impedance post, in with attenuation present for either.
- Separate audio output at 2 amplitude levels, so that tone may be used for checking public address systems, audio amplifiers in receivers, and speech amplifiers in transmitters.
- Two extra posts on front panel enable leakage tests. Condensers may be checked for leakage, so may tubes, and other normally high resistance currents, otherwise difficult to test.



"NOISE-MASTER"

Makes every receiving set a BETTER set

Electrically AUTOMATIC in operation

LIST PRICE \$6.75

Also available with special transformers for European broadcast bands . . . list \$7.00

Eliminates static on both broadcast and shortwave bands.



QUIET is what the set-owner craves, and here's the way to give 'em what they want. This A.A.K. licensed product, designed and engineered with typical CORWICO thoroughness, needs no manual operation after a qualified service-man has adjusted it. It eliminates noise and improves reception EVERYWHERE. Use it on your next installation!

Write for descriptive literature on this and other CORWICO units.

Cornish Wire Co., Inc.
 30 Church Street New York City

POLITICS PAYS PA PROFITS



Sound trucks . . . portable P.A. systems . . . permanent P.A. installations . . . are all in greater demand this year because it is a presidential campaign year.

Political organizations of all parties are going to rent, or purchase outright, various types of public address equipment. We are exclusive world-wide distributors for Lafayette who have prepared a special LIST PRICE catalog to help YOU sell P.A. equipment. Most important of all Lafayette engineers have spent months in the development of new, finer P.A. equipment. Send for your FREE copy of Lafayette's complete P.A. list price catalog No. 64-G5. Get on the political band wagon with Lafayette for profits in P.A.!

WHOLESALE RADIO SERVICE CO.
 NEW YORK, N.Y.
 100 SIXTH AVE.
 CHICAGO, ILL. 901 W. JACKSON BLVD.
 ATLANTA, GA. 430 W. PEACHTREE ST. N.W.
 BRONX, N.Y. 542 E. FORDHAM RD.
 NEWARK, N.J. 219 CENTRAL AVE.

New

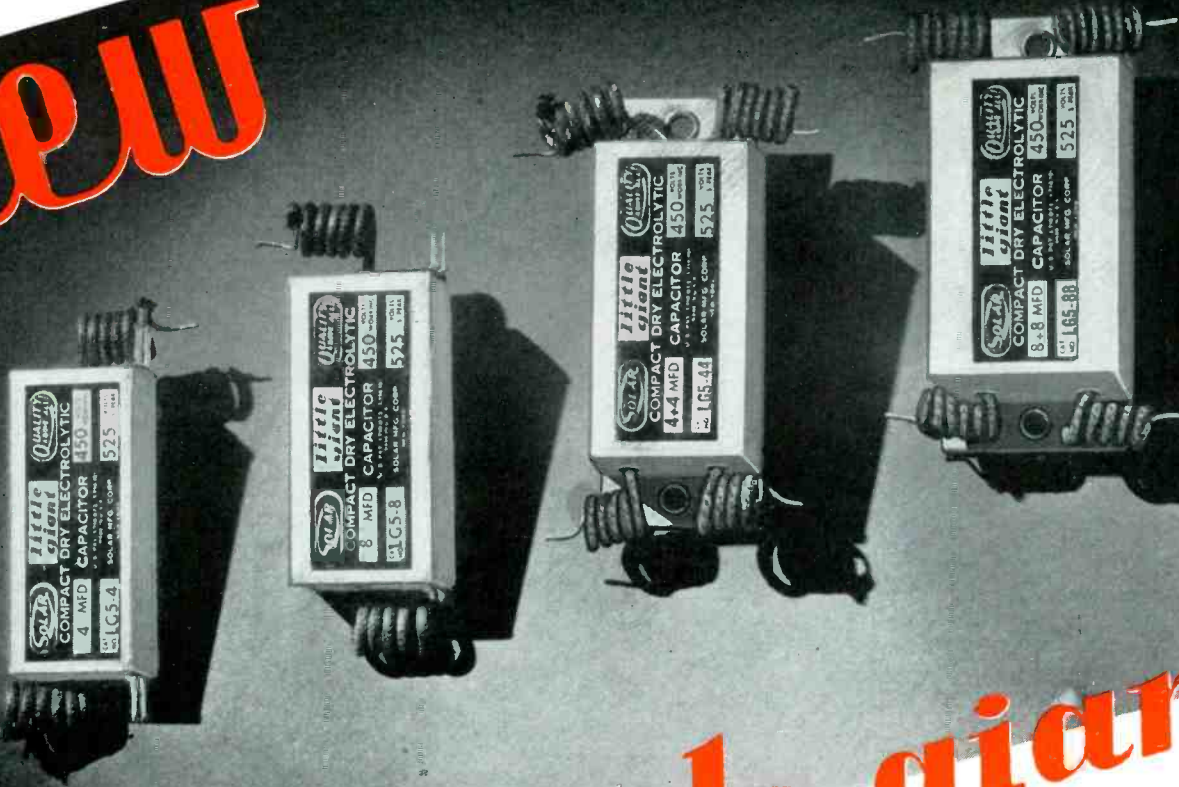

“little giants”



with “FLEX-MOUNT”

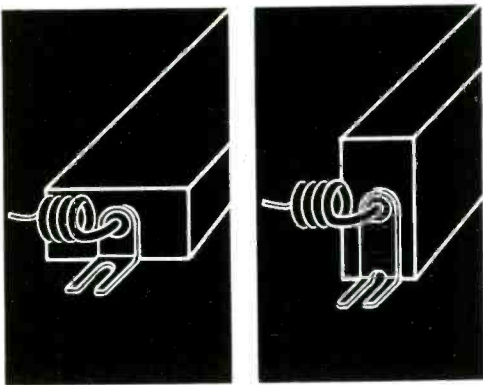

“FLEX-MOUNT” reverses!
Choose your position—
flat or on edge.

NEW NOVEL PRACTICAL

SOLAR “little giant” dry electrolytics- the original and most dependable tiny condensers- are now available with “FLEX-MOUNT” MOVABLE UNIVERSAL TABS combining reliable operation with ease of mounting, either flat or on edge. Ask your jobber for “FLEX-MOUNT” “little giants”-made only by SOLAR.

SOLAR MANUFACTURING CORPORATION

599-601 BROADWAY, NEW YORK, N. Y., U. S. A.

MANUFACTURING AFFILIATES IN LONDON, PARIS, BERLIN, MILAN

NOW! *Easy Payments* ON MODERN RCA TEST EQUIPMENT



RCA BEAT FREQUENCY OSCILLATOR uses four new acorn-type tubes, generates 30 to 15,000 cycles per second. For testing speakers, measuring fidelity and audio frequencies, etc. **\$64.50** complete with tubes and power supply.

TERMS: \$10 down—\$5.24 per month—12 months to pay.

RCA CATHODE RAY OSCILLOGRAPH simplifies most complicated service problems. Visually aligns tuned circuits, measures hum, checks modulation, etc. Entirely self-contained, complete with tubes **\$84.50**

TERMS: \$10 down—\$6.92 per month—12 months to pay.

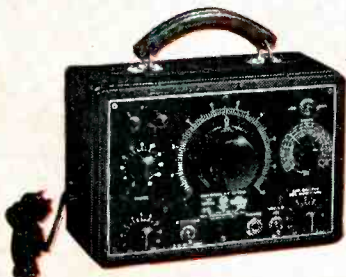

RCA UNIVERSAL AC BRIDGE measures Inductance, 100 microhenries to 10 henries; Capacity, 10 micro-microfarads to 10 microfarads; Resistance, 1 ohm to 1 megohm. Essential in every shop. Price **\$49.65** complete with all tubes and standards, f.o.b. Camden.

TERMS: \$10 down—\$5.71 per month—8 months to pay.

NOTE:

RCA's Easy Payment Plan also applies to a combination purchase of two or more RCA Test Instruments.

RCA Test Instruments not listed here include: RCA Piezo-Electric Calibrator, RCA Regulated Power Unit, RCA Vibration Pickup, RCA Test Oscillator and RCA Frequency Modulator.

Here's an announcement of the greatest importance to you, for it's the first time RCA's complete line of famous Test Instruments has ever been offered on the popular **EASY PURCHASE PLAN!**

Probably millions of people have bought radios on credit, and now credit is being extended to you who service the nation's sets. This makes it exceptionally easy to get the famous RCA Cathode Ray Oscillograph and other equipment needed for servicing modern receivers.

HERE'S THE PLAN—Go to your nearest RCA Parts Distributor at once. Select whatever RCA Test Equipment you need, and put it to work in your shop **IMMEDIATELY**. No strings attached. Make only a small down-payment. You have as much as 12 months to pay the remainder. Instruments pay for themselves while you're using them, and earn you many times their cost—by increasing the quality of your service work, speeding up operations and bringing many new customers to your shop.

Don't overlook the new easy purchase plan, which makes it easier than ever before for you to own these valuable RCA Test Instruments. Go to your RCA Parts Distributor immediately for further details.



Test Equipment

RCA Manufacturing Co., Inc., Camden, N. J., a Service of Radio Corporation of America