

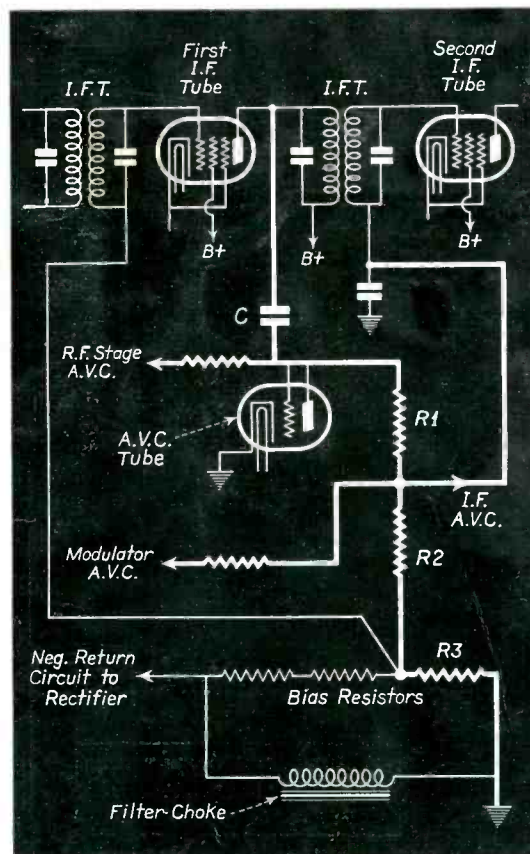

SERVICE

A MONTHLY DIGEST OF
RADIO
AND ALLIED MAINTENANCE



Retroactive AVC Circuit

(See Page 111)

PER COPY
25 CENTS

MARCH
1935

| 1935 | | MARCH | | | 1935 | |
|-----------------|-----------------------|-------------------|----------------------|-----|------|-----|
| SUN | MON | TUE | WED | THU | FRI | SAT |
| New Moon 4th | First Quarter 11th | Full Moon 20th | Last Quarter 27th | | 1 | 2 |
| 3 | 4 | 5 | 6 | 7 | 8 | 9 |
| 10 | 11 | 12 | 13 | 14 | 15 | 16 |
| 17 | 18 | 19 | 20 | 21 | 22 | 23 |
| 24 31 | 25 | 26 | 27 | 28 | 29 | 30 |

READY

the new **STANCOR** catalog

| | |
|--|--|
|  | <p>exact-duplicate replacement power and audio transformers chokes filters</p> |
| <p>universal replace- ment power trans- formers, audios, half-shell power transformers</p> |  |

... a loose leaf form of catalog this time, fit to go right into your ring binder . . . 24 pages, 8½" x 11" page size, with listings, specifications and supplemental information most clearly, cleanly and easily found.

This is without doubt the most comprehensive catalog of Replacement Transformers ever put into the hands of the service man for his convenience in selecting the exact type of unit best fitted to accomplish his job.

This includes the EXACT-DUPLICATE Replacement Power and Audio Transformers, Chokes and Filters . . . Universal Power Replacement Transformers both semi and fully shielded . . . Power Transformers half-shielded and a complete line of general purpose audios, chokes and filters . . . all made with the identifying trade mark of STANCOR, packaged in the distinctive STANCOR boxes and each accompanied by a planographed wiring diagram and standard color code. Distributed by authorized STANCOR distributors all over the United States, Canada and our Island possessions.

If you are not on the list of a distributor, write direct to this office for your copy of the new book.

a complete replacement transformer service

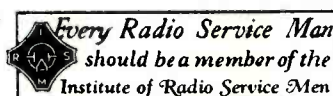

STANDARD TRANSFORMER CORP. . . . 866 Blackhawk St., Chicago, Ill.

NEW! and 20 TIMES more SENSITIVE



DEALERS REPORT TUBE SALES
UP 50% SINCE INSTALLING
THIS SUPER-SENSITIVE
**DAYRAD "TRI-TEST"
TUBE CHECKER!**

MICRO-LEAK TEST

Detects Leakage Up to 2 Megohms! Reveals Slightest Tube Faults Simply!

The ONLY Tube Checker with ALL THESE FEATURES

Big difference registered between
"Good" and "Bad" Tubes.

2,000,000 ohm leakage indicated by
new "Micro-Leak" Test.

Noisy tubes shown instantly.

Square 4-inch DAYRAD switch board
meter, English Reading Dial. Original
DAYRAD design.

Simplified Test Procedure—two easy
steps.

TESTS ALL TUBES.

Positive wide range line control, 100-130
volts.

400 Volt D.C. Meter Range—Handy for
service estimates.

40,000 ohm calibrated ohmeter range.
Checks resistors — dial lights — ballast
tubes—condensers.

DAYRAD LEADS AGAIN with a Tube Checker that tells
you more about tube-condition than any testing machine ever
made. It tells the TRUE story and it tells the WHOLE story
—so sensitive that it discovers those tiny troublesome tube
noises that ordinarily escape detection in testers, but raise
havoc with the best of radios.

In brief, the advanced design of this checker greatly multi-
plies the effectiveness of your tests for leakages, noise and
shorts—and it is an established fact that
*this represents two-thirds of all tube
faults.* Go after this lion's share
of tube replacement business
with this new DAYRAD.

WHY PAY MORE
FOR LESS?
Price to dealer,
only

\$31.75

in walnut carrying
case as illustrated

MAIL COUPON FOR CATALOG

Our new catalog of RADIO SER-
VICE INSTRUMENTS is just off the
press. It gives complete details
about the DAYRAD TRI-TEST TUBE
CHECKER and all other precision
instruments manufactured by DAY-
RAD.

THE RADIO
PRODUCTS CO.
Dept. B.
Dayton, Ohio

Please send at once, and without obligation
your new CATALOG of DAYRAD RADIO
SERVICE INSTRUMENTS, including full
information on the new DAYRAD TRI-
TEST CHECKER, Series 20.

Name

Street

City

State

THE RADIO PRODUCTS COMPANY

125 SUNRISE PLACE

DAYTON, OHIO, U. S. A.

SEE OUR DISPLAY AT CHICAGO CONVENTION
MARCH 22-24th—HOTEL SHERMAN—BOOTH 45

MARCH, 1935 •

SAY YOU SAW IT IN SERVICE

101

SERVICE

A Monthly Digest of Radio and Allied Maintenance

Vol. 4, No. 3
MARCH, 1935

EDITOR
M. L. Muhleman

ASSOCIATE EDITOR
Ray D. Rettenmeyer

EDITORIAL CONTENTS

FEATURES

- Retroactive AVC Circuit 111
Service Applications of the RCA Cathode-Ray
Oscillograph 109
The Service Man and Group Hearing Aids
By Paul A. Bottorff 126
Wave Propagation and Receiving Antennas,
Part I
By William F. Osler 112

ANTENNA

- The All-Wave Customer 104

ASSOCIATION NEWS

- 134

AUTO RADIO

- Philco Model 11 124

CIRCUITS

- Grunow 11-A Chassis 119
Hard-of-Hearing Installation Circuit 128
Philco Model 11 124
RCA Type TMV-122-B Cathode-Ray Oscil-
lograph 110
RCA Victor 220-Volt AC-DC Set 122
Retroactive AVC Circuit Front Cover
Stewart-Warner R-126 Chassis 116

GENERAL DATA

- Addition of Condenser in Sparton Model 36.. 128
Grunow 11-A Chassis 118
International Kadette 132
Kolster Model 6K 132
National Union Type 6E6 114
Philco General Change 111
Philco Models 201 and 509 120
Philco Model 29 118
Philco Model 32 111

- Philco Model 34 120
Philco Model 38 (Code 123) 128
Philco 54-C Howl 132
Possible Cause for Hum in Sparton Model 333 122
Possible Cause of Oscillation in Sparton
Models 65 and 66 128
Possible Howls in Sparton Models with Aero-
plane Dials 114
RCA Victor 220-Volt AC-DC Set 122
Repairing Colonial Wave Switches 118
Retroactive AVC Circuit 111
Silvertone 550, Sentinel 550 132
Stewart-Warner R-126 Chassis 115
Vibration in Sparton Models 67, 68, 691 128

HIGHLIGHTS

MANUFACTURERS

ON THE JOB

- Filing Technical Data
By E. M. Prentke 132
International Kadette
By U. V. Blake 132
Kolster Model 6K
By E. M. Prentke 132
Philco 54-C Howl
By R. E. Walters 132
Removing Wire Kinks
By Frank Bentley 132
Silvertone 550, Sentinel 550
By E. M. Prentke 132

PUBLIC ADDRESS

- The Service Man and Group Hearing Aids
By Paul A. Bottorff 126

SERVICE-MAN'S NOTEBOOK

- Vacuum Tubes and Their Applications,
Part III 130

BRYAN S. DAVIS
President

JAS. A. WALKER
Secretary

New York Telephone: Plaza 3-0483

Chicago Office—608 S. Dearborn St.—C. O. Stimpson, Mgr.
Telephone: Wabash 1903
Cleveland Office—10515 Wilbur Ave.—J. C. Munn, Mgr.
Telephone: Garfield 0905.J

Published Monthly by the

Bryan Davis Publishing Co., Inc.
19 East 47th Street
New York City

SANFORD R. COWAN
Advertising Manager

A. B. CARLSEN
Circulation Manager

St. Louis Office—505 Star Bldg.—F. J. Wright, Mgr.
Wellington, New Zealand—Tearo Book Depot.
Melbourne, Australia—McGill's Agency.

Los Angeles Office—2743 San Marino St.—J. E. Nielsen, Mgr.
Telephone: Drexel 0718

Entered as second-class matter June 14, 1932, at the Post Office at New York, N. Y., under
the Act of March 3, 1879. Subscription price \$2.00 per year in the United States of America;
25 cents per copy. \$3.00 per year in Canada and foreign countries; 35 cents per copy.



EVERY FORM OF SALES PROMOTION to sell your service and tubes

Business comes to the dealer or serviceman who goes after it. The wide-awake radio dealer gains a big edge on competition through the constant use of the potent, sales-building Arcturus dealer helps. Arcturus sales promotion material is designed to build up your whole business generally and to establish your store as the radio service center of your community.

Just ask your Distributor to show you his elaborate portfolio of Arcturus dealer helps. You've never seen such a long list of sales and service helps... equipment deals, direct-mail campaign, displays, novelties, stationery, etc. Now you have an outstanding quality tube backed up by these outstanding helps.

Send the coupon today... we'll have our Distributor show you these aids to extra sales and extra profits.

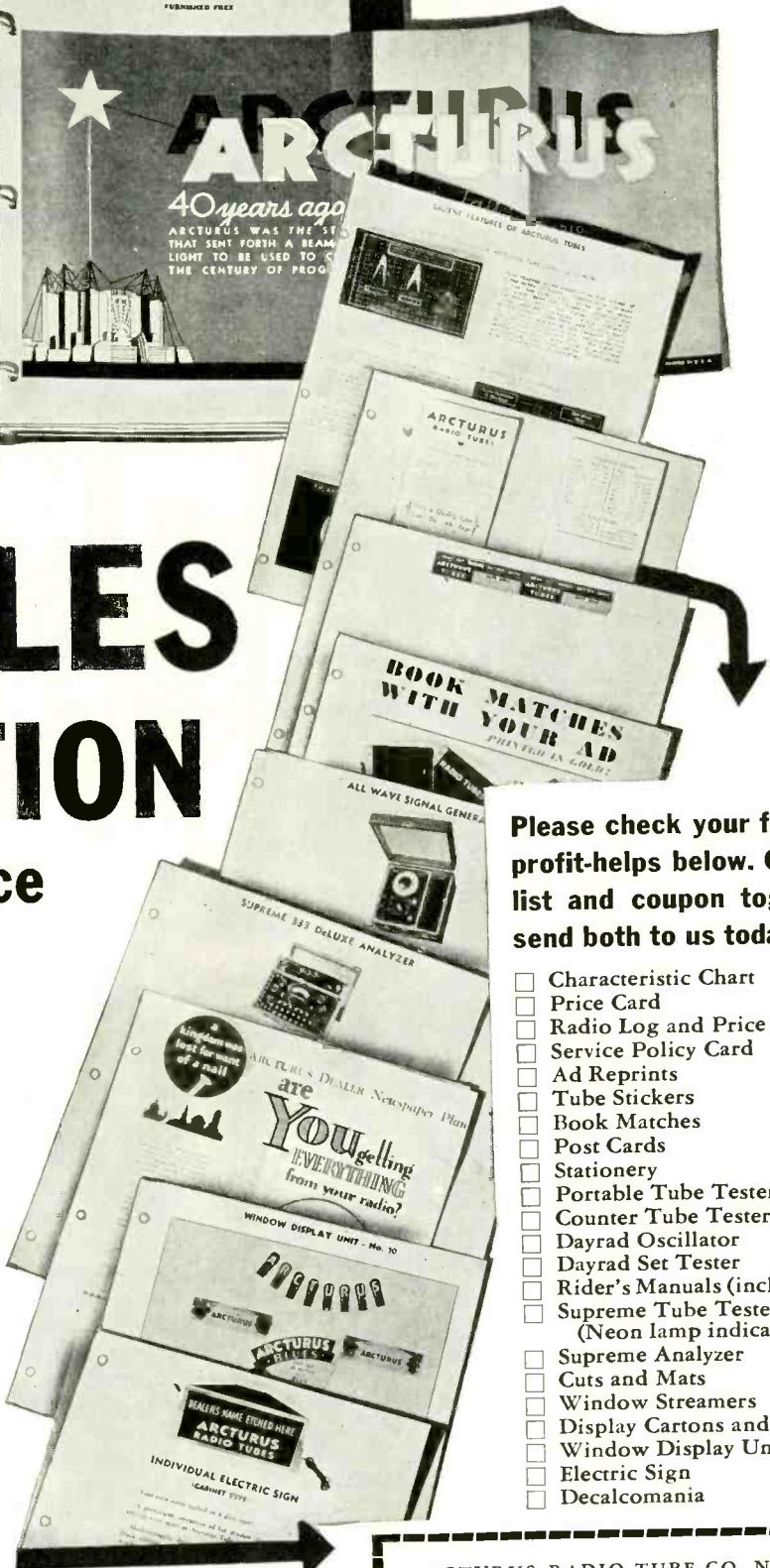

Please check your favorite profit-helps below. Cut out list and coupon together, send both to us today:

- Characteristic Chart
- Price Card
- Radio Log and Price List
- Service Policy Card
- Ad Reprints
- Tube Stickers
- Book Matches
- Post Cards
- Stationery
- Portable Tube Tester
- Counter Tube Tester
- Dayrad Oscillator
- Dayrad Set Tester
- Rider's Manuals (incl. Vol. 5)
- Supreme Tube Tester (Neon lamp indicator)
- Supreme Analyzer
- Cuts and Mats
- Window Streamers
- Display Cartons and Tubes
- Window Display Units
- Electric Sign
- Decalcomania

SEND COUPON & LIST TODAY

ARCTURUS RADIO TUBES

Pioneer of 6 out of the 7 Fundamental Developments in a. c. tubes.

MARCH, 1935 •

SAY YOU SAW IT IN SERVICE

ARCTURUS RADIO TUBE CO., Newark, N. J.
I want to look over your big portfolio of dealers' sales and service helps.

Name

Street

City, State

Jobber's Name S

Jobber's Address, City

THE ANTENNA . . .

The All-Wave Customer

MANY Service Men and radio manufacturers report that a large number of the purchasers of all-wave receivers are not obtaining the reception results they should. This is not due to receiver faults, but rather to poor installations and a lack of knowledge as to all-wave receiver operation.

We have been impressed by the detailed literature on all-wave reception supplied by many manufacturers with their receivers. It hardly seems possible that a purchaser could go wrong after having absorbed the information on installation, tuning, listening times, etc., contained in these little booklets, but the fact remains that they do.

Possibly this is because the information really is too technical—more often than not, engineers over-estimate the average man's understanding of technical matters—or it may be that some people simply will not read instructions or, having done so, fail to carry them out.

Good reception is the concern of the entire radio industry; it is the concern of the broadcaster, the radio manufacturer, the radio engineer, the radio retailer and the radio Service Man. For this reason, we all prefer to do what we can to improve reception conditions, educate the radio public and keep all equipment in good repair. In so far as the repair of equipment is concerned, only the Service Man can see to it that home receivers are adequately maintained.

In a sense, the radio Service Man is the radio industry's "public information bureau." It is he who recommends, it is he who advises and it is he who answers silly question number 1001. It is a part of the servicing business and has its compensations.

So, why shouldn't the Service Man "jump into the breach" so to speak, and straighten out the customer on all-wave reception? And why shouldn't he make money out of it, either through a direct fee for consultation, as an indirect means of obtaining special installation jobs, or as a means of advertising his business?

We firmly believe that there are many people who would be glad to pay in one way or another for information or servicing that would lead to better all-wave reception. We further believe that the enterprising Service Man can boost his profits by making a play for this type of business. It is certainly worth a trial.

There is one situation in all-wave reception that is apt to prove damaging to radio business in general—and that is the noise situation. People simply cannot understand—without proper explanation of the subject—why it is that a receiver which operates practically free from noise in the broadcast band, becomes an instrument of sound and fury when switched to the short-wave bands. Some people believe this to be an actual receiver fault, while others take the noise for granted and presume short-wave reception to be impractical.

This is a point the Service Man can clear up. He can explain to the all-wave customer that the electrical impulses created by vacuum cleaners, washing machines, dial telephones, etc., are short-wave impulses and not broadcast wavelength impulses, and for this reason are heard only when the receiver is switched to a short-wave

band. He can also explain that in most cases the signals from distant short-wave broadcast stations, police transmitters, etc., are weak in comparison to the signals of the average broadcast station tuned in and that for this reason the receiver is automatically operated at high sensitivity when receiving short-wave transmissions.

These explanations can well lead up to the statement that there are special aerial systems for all-wave receivers wherein the signal-collecting wire is placed out of reach of interfering impulses from electrical devices and the actual signal from this wire led to the receiver through a transmission line shielded from such noise. Once having appreciated the value of such an aerial system, the customer will more than likely have one installed.

Each time you install a noise-reducing aerial system, you are benefiting not only yourself, but also the radio manufacturer, the broadcaster and the customer.

Another matter which remains to be cleared up is tuning. People are so used to rapid and none too precise tuning in the broadcast band that they go about short-wave tuning in the same manner. Here again, the average person cannot understand the situation. Why, he wishes to know, should short-wave tuning be any more difficult than broadcast tuning? Not being able to answer the question to his own satisfaction, he totally ignores the situation and tunes the old way. The result is that he completely misses about 50 percent of the transmissions in the short-wave bands.

The Service Man can materially assist the industry by teaching people how to tune their all-wave receivers. The next time you make an all-wave receiver installation, spend an extra 15 minutes in demonstrating to your customer how simple a matter it is to pass right by a short-wave station unless one tunes slowly across the band. Also demonstrate the point that, due to signal fading, a station imperceptible at one moment may be received with good volume the next moment and that this condition may be explained by the fact that foreign broadcasters go through long silent periods during which intervals the station carrier cannot readily be heard.

It is also a good idea to demonstrate to the customer the value of the tone control in short-wave reception. Explain to him that noise, as well as the most common types of station interference, are of high audio-frequency and may therefore be reduced by turning the tone-control knob further to the right.

Then there is the matter of listening time. The owner of an all-wave receiver lacking station schedules, or data on wavelengths used, is apt to listen in the wrong bands at the wrong time. So, when you install or service an all-wave receiver, why not leave with the customer a short, typewritten list indicating that the 13-, 16- and 19-meter wavelengths are essentially daylight bands, the 25- and 31-meter wavelengths twilight bands and the 31-, and 49-meter wavelengths evening bands. You can explain that there are exceptions to the rule but that the list should be used as a general guidance in tuning.

Don't think for a moment that the extra time you devote to the customer is wasted. He will appreciate it and remember you the next time his set goes blooey.

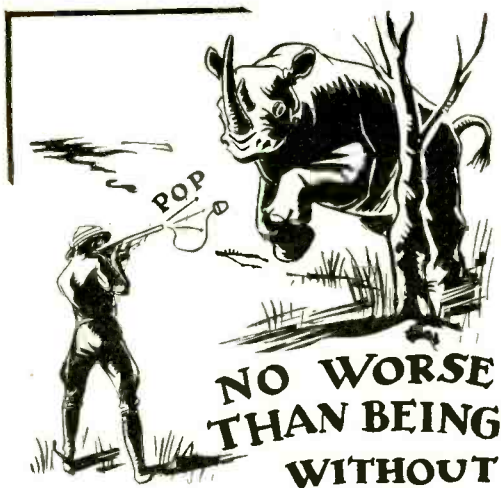

RIDER's MANUALS

Doing servicing jobs without RIDER's Manuals is like shooting a rhino with a popgun. Modern conditions require real equipment that will enable you to service any one of the hosts of different receivers which may come into your shop. Only RIDER's gives you RIDER coverage. No similar manuals contain as many manufacturers, as many receiver models, as many chassis views, I-F peaks, voltage data, etc. RIDER's Manuals help you do a better job . . . faster, and more profitably. You can use them year after year . . . they are as vital as your testing equipment.

SERVICING SUPERHETERODYNES

\$1.00 288 pages of accurate analysis, a boon to the service-man with superhet problems. This valuable little treatise has been called the "bible" in its field.

SERVICING RECEIVERS BY MEANS OF RESISTANCE MEASUREMENT

\$1.00 203 pages, telling you how to use the ohm-meter in diagnosing trouble . . . a scientific aid to greater profits, enabling you to cut corners to the solution of many a bothersome problem.

SPECIALIZED AUTO RADIO MANUAL

\$3.50 350 pages, including an installation section that covers comprehensively practically all of the best-known sets. Enables you to specialize in auto radio servicing.

RADIO SERVICE QUESTIONS AND ANSWERS

\$1.00 168 pages of pure factual experience, boiled down to indispensable reference-data for the serviceman on his daily rounds.

COMBINATION

Contains Volumes I, II and III, with Carrying Handles, \$25.00

2870 pages with cumulative index. Steel-backed stiff cover binder with patented Herculox mechanism. Also available without carrying handles for \$21.50.

Pertinent, detailed service information, in the most practical and valuable Manuals ever presented to the Radio Servicing fraternity. RIDER's Manuals truly have EVERYTHING!

| | | |
|------------------|------------------|--------|
| Volume I . . . | 1000 pages . . . | \$7.50 |
| Volume II . . . | 800 pages . . . | 6.50 |
| Volume III . . . | 1070 pages . . . | 7.50 |
| Volume IV . . . | 1060 pages . . . | 7.50 |
| Volume V . . . | 1200 pages . . . | 7.50 |

The CATHODE-RAY TUBE AT WORK

by JOHN F. RIDER

\$2.50

POSTPAID

320 pages
6x9 inches

Publication in
APRIL

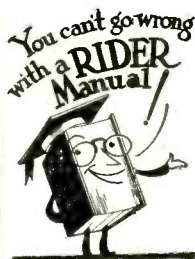

FREE "Successful Servicing," our 8-page monthly house organ, with valuable data pertaining to RIDER's Service Manuals, should be reaching you regularly. Be sure you are on our list, if you are interested in successful radio servicing.

JOHN F. RIDER, Publisher
1440 Broadway, N. Y. City

PROFITABLE SERVICING DEMANDS
 AN *Accurate* ALL-WAVE OSCILLATOR

Here it is

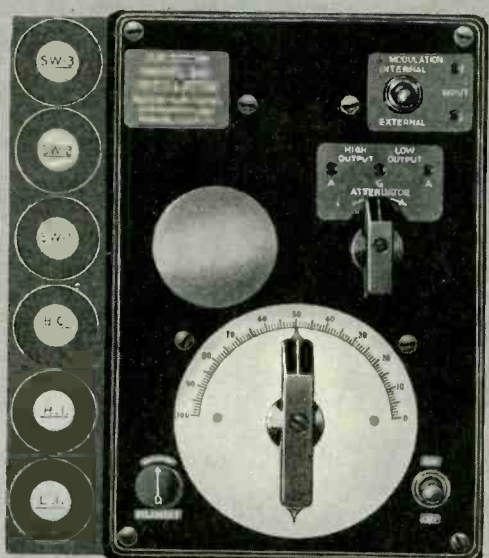

ALL WAVE!
Complete Receiver
Frequency Coverage

STRAY FIELD!
Below 1/2 Microvolt
at all Frequencies

Triple Shielded
Attenuator

High Impedance
Input for External
Modulation

Individually
Designed Coils
for Each Band

BASIC!
Frequency Band
Depends Only on
Plug-In Coil

OUTPUT!
1 to 100,000
Microvolts

Independent
Modulation Circuit
Constant Percentage

Constant Impedance
200 Ohm Output
Circuit!

Here's the complete solution to your oscillator problem! Weston supplies it in the new Model 692 . . . an oscillator designed to do a precision aligning job on radio receivers.

A few of the outstanding features of this all-wave precision oscillator are shown above. Study them carefully . . . and make your own compar-

isons. Then, send for the descriptive bulletin which contains all the facts on Model 692 . . . the oscillator you have been waiting for . . . one that will enable you to give complete customer satisfaction on every aligning job. Be sure to mail the coupon today . . . Weston Electrical Instrument Corp., 604 Frelinghuysen Avenue, Newark, N. J.

WESTON
Radio Instruments



Weston Electrical Instrument Corporation, 604 Frelinghuysen Avenue, Newark, New Jersey.

Send for Bulletin on Model 692 All-Wave Oscillator.

Name _____

Address _____

City _____

State _____

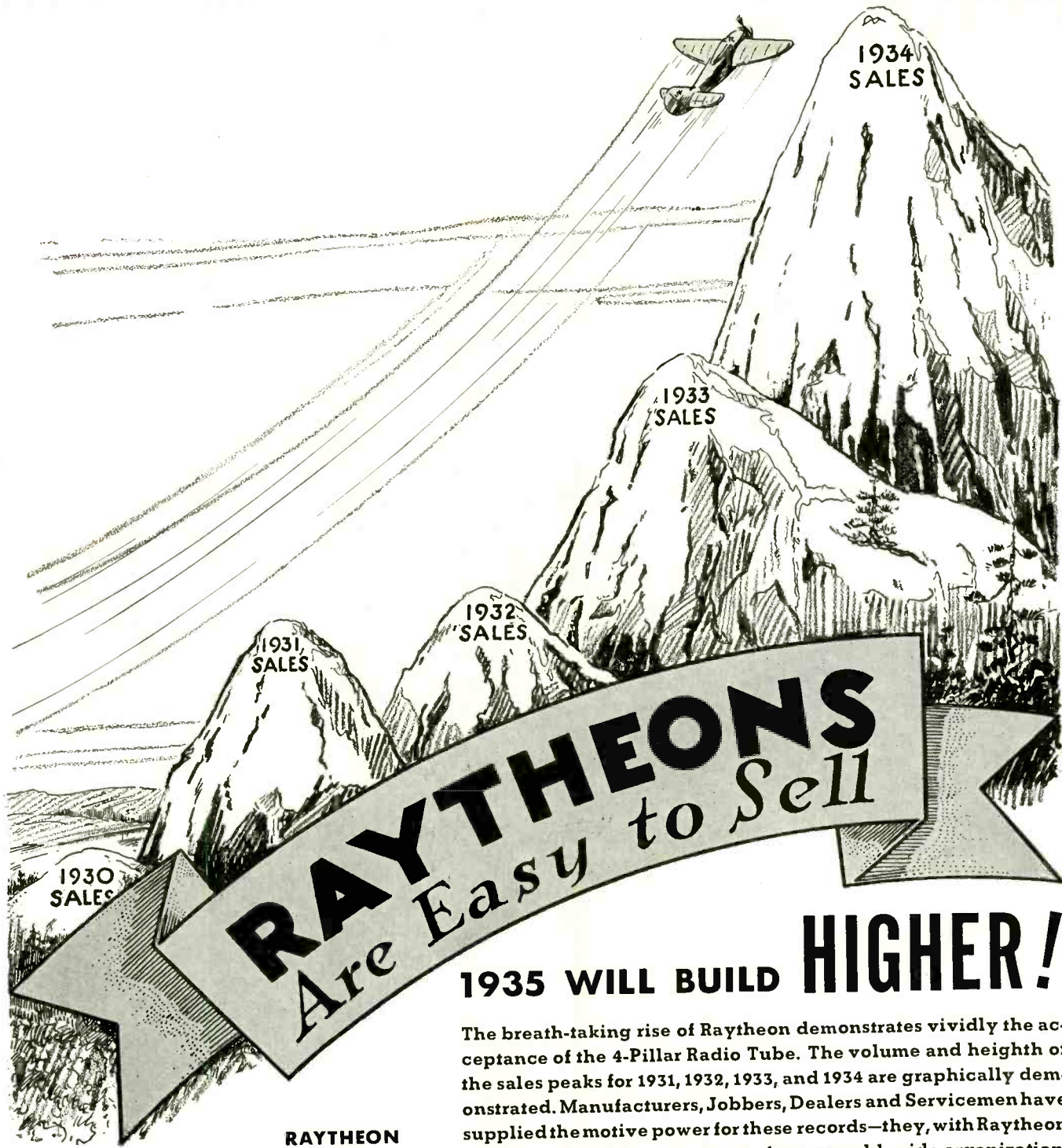

RAYTHEONS

Are Easy to Sell

1935 WILL BUILD HIGHER!

The breath-taking rise of Raytheon demonstrates vividly the acceptance of the 4-Pillar Radio Tube. The volume and height of the sales peaks for 1931, 1932, 1933, and 1934 are graphically demonstrated. Manufacturers, Jobbers, Dealers and Servicemen have supplied the motive power for these records—they, with Raytheon quality and public acceptance, form a world-wide organization.

RAYTHEON PRODUCTION CORPORATION

30 E. 42nd Street
New York

55 Chapel Street
Newton, Mass.

445 Lake Shore Drive
Chicago

555 Howard Street
San Francisco

Ask for...New merchandise and service bulletin...New display material

RAYTHEON CONTRIBUTES...

Unexcelled quality and the Only 4-Pillar Radio Tube • Intelligently conceived and comprehensive advertising, promotion and display material • Universal public acceptance • Profit possibilities that are never questioned by jobber, dealers and servicemen.

RAYTHEON

TRADE-MARK

4-PILLAR RADIO TUBES

RAYTHEON PRODUCTION CORP.,
Dept. F-3, 30 E. 42nd St., New York, N. Y.

Please send

- New Merchandise and Service Bulletin
 New Display Material

Name _____

Address _____

Dealer: (yes) (no) _____

Service Man: (yes) (no) _____

it's Complete!
it's Authoritative!

it's Invaluable!

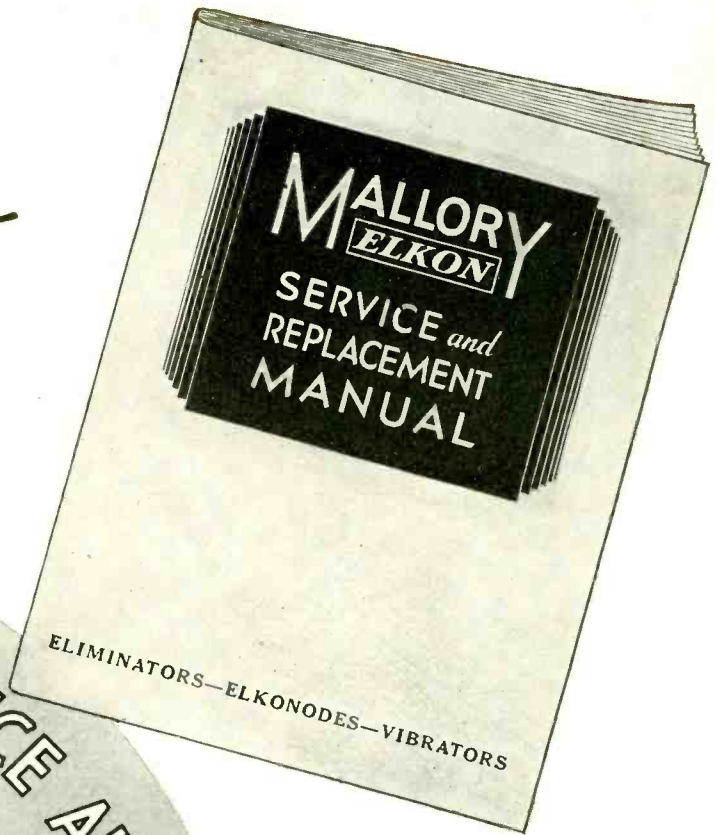

WHEN YOU SERVICE AUTOMOBILE
RADIO SETS..... Save Time
and Money with this Book

IT'S FREE!

Mallory put information in this manual that will put *money* in the pockets of any man who wants to meet the ever-increasing requirements of the automobile radio industry with greater ease and greater profit! Mallory created a sensation in the vibrator field when it created the famous Mallory Elkonode. Mallory scored again with this remarkable manual which marks a great advance over all former publications. Surely you've heard about it. Certainly you'll want to profit by it—and sending for your copy today is a real move in the direction of *making 1935 a more prosperous year.*

Think of it—28 big pages of information that will make every working day of 1935 a more profitable day! Get it—read it—use it! Mail the coupon now and get *your* copy of this money-making manual *absolutely free.*

**JUST
MAIL THE
COUPON**



P. R. MALLORY & CO., Incorporated
INDIANAPOLIS, INDIANA
Cable Address—Pelmallo

P. R. MALLORY & CO., Incorporated
Indianapolis, Indiana
Gentlemen:

As a legitimate authorized service man, I am interested in securing a copy of your Mallory Service and Replacement Manual which I understand is free. Please send this to me quickly without charge.

Name _____
Address _____ (City) _____ (State) _____
My Jobber is _____

SERVICE

A Monthly Digest of Radio and Allied Maintenance

FOR MARCH, 1935

SERVICE APPLICATIONS OF THE RCA CATHODE-RAY OSCILLOGRAPH

MUCH has been written of the principles upon which the cathode-ray oscillograph works. However, very little has appeared on the actual details necessary for successfully applying these principles to service work. Most Service Men realize that this instrument should be of extreme usefulness to them. Very few know just the exact needs that he may or may not have for it.

As with any other electrical test equipment, it is impossible to mention all of the possible applications, any more than it would be possible to list all the things that a voltmeter will do. However, to suggest the variety of possible applications, it might be said in simple language that the Cathode-Ray Oscillograph is a peak voltmeter that also records time and does not have an appreciable amount of inertia. Analyzing this statement, we find that:

The cathode-ray oscillograph can be used as a very high-resistance voltmeter for all kinds of alternating current-voltages.

Because it records time, the intensity of any alternating-current phenomena may be spread on the screen so that time can be easily seen.

Because it does not have any inertia, the indication may be repeated a sufficient number of times per second to draw a pattern on the screen.

The Service Man will probably find the greatest immediate application for the cathode-ray oscillograph in:

- (1) *Checking intermittent conditions of reception.*
- (2) *Checking overload and distortion.*
- (3) *Visually aligning r-f and i-f stages in conjunction with certain auxiliary equipment.*
- (4) *Demonstration of overall operating performance.*

In many of the applications, an r-f test oscillator such as the RCA TMV-97-B is necessary.

CHECKING INTERMITTENT OPERATION

In checking intermittent conditions in a receiver, the easiest method is to tune in a modulated radio-frequency signal in

the usual manner and then examine its performance throughout each stage of the receiver. A convenient method of making such connections is to connect the vertical plates of the cathode-ray oscillograph between plate and ground of each successive stage. The horizontal saw-tooth oscillator of the cathode-ray oscillograph must be set at a value that interlocks with the modulating voltage in the case of the radio-frequency signals and at the same, or a lower value than the audio frequency in the case of audio signals.

Let us suppose that a receiver under test operated for a few minutes and then went off. Turning the set on or off would restore operation temporarily, but it invariably went off after a few moment's time. To examine the signal at the r-f stage, the procedure is as follows:

- (1) *Place the receiver in operation and connect the output of the test oscillator to the input of the receiver.*
- (2) *Impress a modulated r-f signal on the input at a frequency which is known to give intermittent operation.*
- (3) *Connect the vertical plates of the cathode-ray oscillograph from the plate of the r-f tube to ground through the vertical amplifier.*
- (4) *Set the saw-tooth oscillator.*

The r-f signal wave-form would then appear upon the screen of the oscillograph. If, after operating for a while, the signal did not disappear or change, then we would know definitely that the trouble is not in the r-f stage. It might be pointed out here that there is no other means of checking an r-f signal at this stage with the usual Service Men's equipment.

Continue this same method at each stage and we will arrive at a stage either in the r-f or audio system where the signal will go in and out intermit-

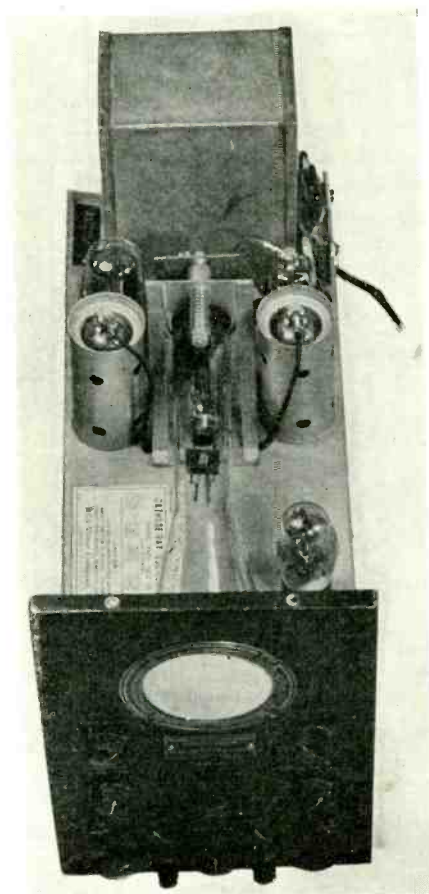

Interior view of the RCA Cathode-Ray Oscillograph, showing the amplifier tubes at the rear, the cathode-ray tube, and the saw-tooth oscillator tube near the front of the panel.

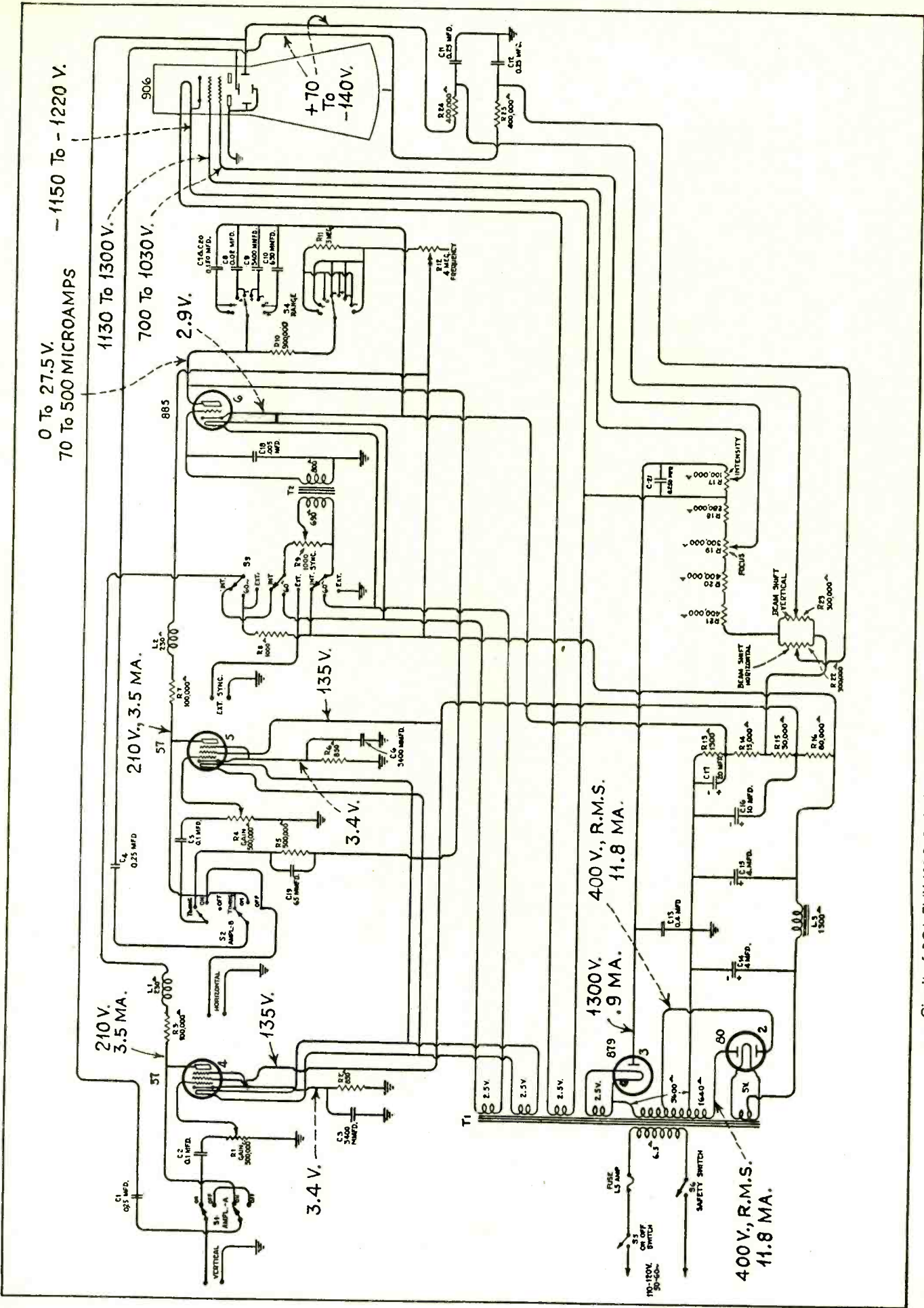

Circuit of RCA TMV-122-B Cathode-Ray Oscillograph. Condenser C-21 is not included in all instruments.

tently, similarly to the original condition of the set.

After locating the particular stage, it is but a simple matter to find the exact cause of the difficulty and make the necessary repairs.

CHECKING OVERLOAD AND DISTORTION

Often the Service Man is confronted with the problem of distorted reproduction. This may be due to a number of causes, any of which may be difficult to find. The cathode-ray oscillograph provides a simple and exact method for checking such distortion. In connection with this application a modulated r-f oscillator, such as the RCA TMV-97-B is again required.

Connect the input of the receiver to the output of the test oscillator and tune in a signal at any frequency which is known to give distortion. The oscillograph should then be placed in operation and the output of any particular stage in the audio system connected to the vertical deflecting plate and a horizontal sweep frequency used that will show several cycles of modulation. By successively connecting the vertical plates to the output of the detector, to the audio stage and to the output stage, one can easily find not only the stage in which the distortion occurs, but if it occurs only at high volume the stage which overloads first. For example, if the wave-shape is entirely symmetrical at one stage and distortion occurs in a later stage, then we know that the stage which shows distortion is the offender. After locating the exact stage at which such distortion occurs, it is usually a simple matter to locate the actual part causing the difficulty.

In conjunction with this application, it might be pointed out to experimenters and others building amplifiers, etc., that this is especially useful because an engineered amplifier will result. By this is meant that the full output of any stage may be utilized before adding another stage and the point at which distortion occurs can be definitely determined.

R-F AND I-F ALIGNMENT

To visually align the r-f or i-f stages of a receiver with the cathode-ray oscillograph, it is necessary that a test oscillator, such as the TMV-97-B (modified) and a frequency modulator, such as the TMV-128-A be used. The principle upon which such alignment is based is as follows:

The radio-frequency or intermediate-frequency signal is fed through the stages to be aligned and varied at an audio rate by means of the frequency modulator. (The frequency modulator consists of a rotating condenser of small capacity, and an ac impulse generator.) Simultaneously with such frequency

variation it is necessary that an ac voltage be generated to properly synchronize the horizontal deflection in the oscillograph with this r-f frequency variation. Under such conditions the overall curve of the tuned circuit between the point at which the oscillograph is connected, and the point which the variation and r-f frequency is applied, will be shown on the oscillograph screen. The effects of any trimmer adjustments on the overall curve is immediately shown and the alignment may be quickly and simply made. This is especially important in receivers of later years which may have flat top i-f's and in which the width of an i-f channel to pass a given frequency band controls the amount of high-frequency response delivered to the loudspeaker.

DEMONSTRATION OF OVERALL OPERATING PERFORMANCE

There are several methods for demonstrating the overall performance and the fidelity of the receiver by means of the cathode-ray oscillograph. Perhaps

one of the simplest methods is to take the output of the power stage that is being fed to the voice coil of the loudspeaker and connect it to the vertical plates of the oscillograph with an arbitrary value of sweep frequency (within the audio range of the receiver). From this, it will be seen that receivers having a limited output will give a limited voltage change for variations in intensity, still receivers with high output will give a greater change in intensity which will be at once noticeable on the screen of the cathode-ray oscillograph. Other demonstrations can be made to show the modulating envelope of any broadcast station as well as the various volume levels at which distortion occurs, such as previously described.

Association with cathode-ray equipment quickly discloses many ways of doing it for practically any problem encountered in the radio field. The foregoing which gives a few of the important points, will serve as a guide for other applications.

RETROACTIVE AVC CIRCUIT

(See Front Cover)

The 1935 Crosley Model 1014 "Centurion" has something new in the way of automatic volume control which is worth looking into. The arrangement has a number of advantages not to be found in other avc systems.

Referring to the diagram on the front cover, it will be seen that the avc tube is fed from the plate circuit of the *first* i-f tube, through the .00025-mfd condenser, C. The avc voltage developed across resistors R-1 and R-2 is not only fed back to the r-f and modulator tube, but is also fed *forward* in a retroactive manner to the grid of the *second* i-f tube. This means that the automatic volume control voltage developed that is fed to this latter tube is not dependent upon the signal impressed on that tube, but on what signal was developed *prior* to that tube.

The system has two advantages. First, it is valuable with very strong signal input where most automatic volume control systems are apt to distort. Since the avc tube is fed from a point below maximum gain, but still exerts bias control on both i-f stages, overloading is obviated. Second, the avc tube is operated from a point of reduced selectivity (the first i-f stage) with the result that when the receiver is detuned (tuned between stations) the noise background serves to reduce the gain and thereby provide a partial avc action without requiring a separate tube for this purpose. In other words, since the noise level is greater at the point of reduced selectivity, it actuates the avc

tube which in turn reduces the gain of the receiver.

By virtue of the bias voltage developed across resistor R-3, only a comparatively high noise level can actuate the avc tube, with the result that the sensitivity of the receiver to weak signals is not impaired. It is obvious, then, that in operating the receiver, noise can be heard between stations, but its volume is never objectionable.

Philco General Change

Models 18-60-66-89-118-144-200-201

In order to make the use of European (78-E) tubes possible in the above models interchangeably with standard 78 tubes, the wiring to the type 78 tubes has been changed as follows: Suppressor grid connected direct to ground instead of to cathode. Cathode circuit remains unchanged otherwise.

Philco Model 32

Starting with Run No. 5, Model 32 will use a type 77 detector-oscillator tube instead of a type 36. This change gives more stable performance of the oscillator.

This change involves using a six-hole tube socket instead of the original five-hole socket used for type 36. It also requires making the following substitutions:

Part (16), No. 6208 resistor (15,000 ohms) is replaced by 33-1114 (8000 ohms).

Part (15), No. 5863 condenser (700 mmfd) is replaced by 7007 (1400 mmfd).

WAVE PROPAGATION AND RECEIVING ANTENNAS

By WILLIAM F. OSLER*

PART I

SCIENCE tells us that waves are made up of two kinds of fields: The magnetic field and the electrostatic field. The former is typified by the magnetic field that exists about the ends of a horseshoe magnet, or in the core and the air gap of an electrical relay, or, more commonly, in the core of the power transformer of the conventional radio set. We say the magnetic field is made up of lines of magnetic flux or, more simply, magnetic lines, in order that we may have some unit in which to express the effectiveness of different fields in inducing voltages by their growth or motion. It is precisely this type of field which, moving through space, constitutes, in part at least, the radio wave which carries our signals for us.

In addition, there is the second type of field, commonly termed the electrostatic, or more briefly, the electrical field. It is in the generation of this type of field within the paper condenser, which has been charged to a high voltage, that the energy has been stored.

Both of these fields exist in the traveling wave, the moving magnetic field generating voltages by its motion as part of the wave, and this voltage gives rise to the electric field as the voltage charges the space in which the wave travels. The charging process, like the charging of any condenser, is, of course, accompanied by a charging current which, in turn, creates further magnetic fields, etc., etc., and thus the wave progresses through space, or radiates.

CHARACTER OF WAVE

Since the motion of the wave is merely the result of the repeated interchange of the energy of the wave from magnetic form to electric form and the reverse, the real energy in either of these two fields is the same, and the effect of the radio can be quite as well understood by considering either one of the two fields.

For many reasons, it has become common practice to consider only the electrostatic field of the wave, and so it will be considered here. There is, however, left the need for a more detailed picture of the electric field of the wave than is suggested by its mere name.

Such a picture can, happily, be given if it is borne in mind that the electric field as it moves along through space in the form of a radio wave is in its essentials a disembodied, immaterial,

but still effective voltage. It is as if the wave consisted of an unimaginably large number of small batteries draped over the surface of a moving sheet, arranged regularly in horizontal and vertical lines, all batteries being connected in series in one of these two directions

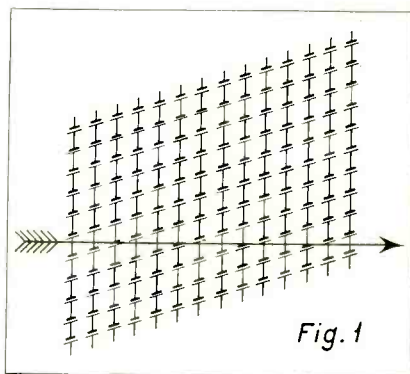

Representation of a collection of voltages in an advancing radio wave.

but completely dissociated from one another in the other.

I have attempted to show in Fig. 1 such a collection of voltages as they would appear in the front of a radio wave if we could observe it by flying along with the wave at the almost 200,000 miles per second at which it travels. In this case, the signal wave is assumed to originate in a vertical antenna not too remote and is further assumed to have travelled along the ground to the point of observation.

This conception of the wave agrees extremely closely with all of our experience with radio waves and forms the simplest basis upon which we can base our speculations and calculations. In fact, it is now common practice to express the effectiveness of radio waves in terms of the voltage along these imaginary lines of series voltages or, more specifically, to express the intensity of the traveling wave in terms of the volts per foot, yard or meter, along its face.

But for simplicity of presentation, it is suitable to represent the wave merely as lines of voltage, as shown in Fig. 2, in which the elementary batteries have been replaced with straight lines indicating the lines along which the voltages are in series, that is, along which they add up.

WAVE IN MOTION

It is to be remembered, however, that if we, as observers, were able to watch the passing radio wave we would see not this single sheet of voltages, but a continuous stream of them, one follow-

ing closely on the heels of the other and being greater or less in the total voltage in any given height than its predecessor depending upon their relative positions in the wave. There would, of course, be a sheet of maximum field of voltage followed by sheets of decreasing voltage field until a sheet quite free of voltage would be observed, after which the following sheets would have a successively increasing voltage, but in reverse polarity or direction, the maximum in this reverse direction being the same as that observed in the first group, after which would follow sheets of decreasing voltage, decreasing of course to zero and thus introducing the next group with a second reversal of the polarity of the direction of the voltage. All of these series of voltage sheets differing from one another in voltage so as to provide a sinusoidal distribution, the fields of maximum voltage being distant from one another by one-half a wavelength.

Such a picture of the radio wave provides all we need to know about it to allow us to choose the proper type of receiving antenna for any desired kind of radio reception.

WAVE INTENSITY

In practice we find tremendous differences in the intensity of various radio waves, as between those originating with a local, powerful radio station and those originating with a remote and relatively weak station. More specifically, we rarely find any wave to provide useful signals having less than a few millionths of a volt per meter, while it is equally rare that we are ever faced with the problem of providing satisfactory operation of a radio receiver in regions so close to powerful radio transmitters as to have available more than a volt or two per meter. But the Service Engineer is constantly being required to install, and make satisfactorily operative, conventional radio re-

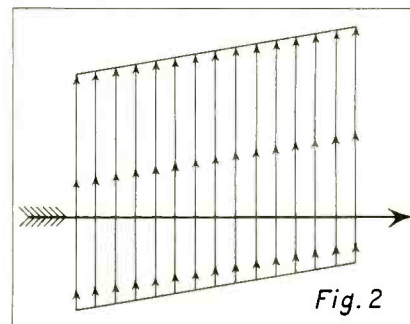

The voltage lines of an advancing radio wave.

*Vice-President, Cornish Wire Co.

ceivers under the greatly differentiated and widely varying conditions indicated by this tremendous range of signal or field intensity.

From this picture of the field constituting the radio wave, certain conclusions as to the height, arrangement and position of the receiving antenna are immediately evident.

VOLTAGE PICKUP

Note in Fig. 3 the effect of the position of the antenna with respect to the wave on the amount of the voltage intercepted by the antenna. Each of the three antennas there shown is 20 feet—6 meters—long, and is standing in a wave the field intensity of which is 10 millivolts per meter of height. It will be seen that in antenna *a*, all the elementary voltages constituting any one line of the electric field will act directly on the wire of the antenna, and will add directly to one another to give a total induced voltage of 6×10 , or 60 millivolts. Not so in antenna *b*, however, for in this case the antenna is tilted over so that its remote end is only half as far above ground as antenna *a*, that is, 10 feet—3 meters—and while each electric line of the wave will induce in it a voltage directly additive to that induced by its neighbor, its position is such that each of these elementary voltages, as well as the sum of all of these induced voltages, will be only half of that induced in antenna *a*, namely, 30 millivolts.

More interesting than this is the effect of the wave on antenna *c*, which is parallel to the ground and thus intercepts voltage from many of the parallel lines constituting the wave front. All of these small voltages will be applied across and not along the antenna wire, so that only a completely negligible voltage will finally be intercepted by the antenna, and it will give little signal to any equipment attached to its terminals.

It follows, then, that for the interception of the maximum signal, the antenna wire should be quite parallel to the field constituting the wave, and of greatest possible length. But that leaves the grave question of determining, in any practical installation, the direction of the field of the wave.

PREFERABLE ANTENNA

A series of observations made on local broadcasting stations, especially where any extremely large and high-conducting structure, such as steel-frame buildings, metal towers, and the like are lacking, almost invariably show that the field of the wave is in a plane perpendicular to the earth, and with the voltage lines vertical. Thus, for local broadcast reception, a vertical antenna wire should—and almost invariably is found to be—the best.

The addition of a horizontal section, thus making an inverted "L" type of

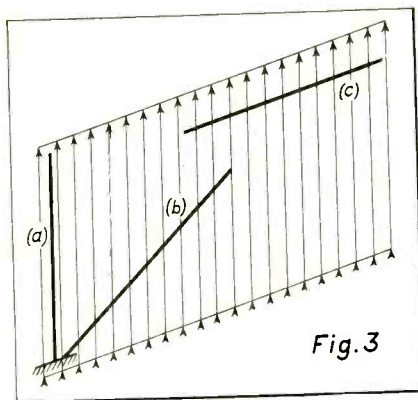

Three types of antenna in the field of an advancing radio wave.

antenna, is not to be criticized for the addition of the possibly costly "flat top" constituted by the horizontal wire, since, while this portion of the antenna usually contributes little in the way of signal pickup, it does contribute certain other characteristics to the antenna itself, which assist in tuning it and generally improving its operation. But it is to be remembered that it is the vertical portion that is largely responsible for its intercepting of the signal, and that while the commonly given instructions to provide an antenna of a certain length of wire for a particular receiver may be required by the limiting-tuning arrangements provided by the receiver, its signal-intercepting properties are determined completely by the length of the antenna wire that is located in the vertical portion.

REMOTE SIGNAL PICKUP

This does not, however, apply in the reception of signals originating in a remote broadcasting station. In this case, the Service Engineer knows that a horizontal wire not only gives satisfactory signals, but is often found to be more generally effective than the purely vertical antenna.

The explanation for this fact is revealed by a simple investigation, as suggested above, of the direction of the field constituting the wave. Such a series of observations may be made by employing a rotatable antenna, and will almost invariably show the interesting fact that either there is no position of the antenna which gives a very markedly greater signal than any other position or, if there is any preferred position for the antenna, it will be found to be a horizontal one.

The explanation of this superficially confusing condition is not hard to find if one gives consideration to the mode of transmission over long distances. It will be remembered that at almost any of the frequencies employed for broadcasting, the intensity of the wave transmitted along the ground decreases rapidly, and that at relatively short dis-

tances from the broadcasting station it becomes uselessly low. That portion of the transmission from the broadcasting station which is sent up to the heavens and there meets the reflecting layers of the ionosphere and is thence reflected back to earth far removed from the transmitter, is much diffused in its reflections, as in the case of any irregular reflection. If it will be remembered how the headlights of a motor car, which normally send out twin beams in advance of the car, lose all semblance of definition when the lighted car is driven through fog and, in fact, are so irregularly reflected as to be directed back into the eyes of the driver, it will be more easily understood how irregular is likely to be the reflection from the deep and electrically heterogeneous ionosphere through which the signals from remote broadcasting stations travel. And it will be further understood why, at the remote receiving point, none of the nicely marked field direction of the locally transmitted wave is likely to be evident; or if any direction of the field is found predominant, why it is most unlikely that that direction will agree with that of the originally transmitted wave.

Thus, for the reception of a remote transmitter, none of the simple rules indicated in the earlier part of this discussion are likely to be of significance, leaving little to guide the Service Engineer in his choice of position and location of the antenna.

NOISE INTERFERENCE

There are, however, other considerations that are important in the devising and providing of the remote-reception-type of antenna, notably the matter of locally generated noise and the need for its rejection by the antenna.

There is much evidence to indicate that the locally generated noises are of troublesome intensity only relatively close to their sources, which are normally near the ground-level. This is probably largely true as a result of the fact that they are in great measure not strictly radiated energy, but rather constituted of transfer of electrical energy by direct induction, which becomes greatly attenuated at relatively short distances from the source unless carried along associated conductors to the vicinity of the radio equipment. Thus by the elevation of the antenna well above nearby conductors and metallic structures, as well as its incidental removal from noise sources commonly at the ground-level, much of the troublesome noise pickup is avoided and a signal relatively free from noise is intercepted by the receiver.

It is obvious, however, that the mere elevation of the antenna well above the ground-level is by no means a universal panacea for radio noise, since there is

invariably the possibility that the structure that is used for the support of the antenna may, itself, house a noise-source and provide even more convenient coupling between the noise-source and the antenna when the antenna is supported thereby.

It is essential, therefore, that the antenna location be not only well removed from the noise-sources at the ground-level, but from such sources at elevated positions as may be troublesome.

The common location of elevator-motor-and-control equipment at roof levels is an especially prolific source of trouble, and must be avoided in the determination of a suitable antenna location. Similarly, the location of power transformers at pole tops in suburban electrical-distribution systems is to be given consideration in the location of the antenna.

None of these noise-sources carry with them a wide area of disturbance, however, and the troublesome effect can almost always be avoided without great elevation of the antenna above them by the careful choice of antenna location as horizontally remote as possible from them.

NOISE REDUCTION

There is, then, left the problem of the means to be supplied for conducting the signal from the elevated antenna to the radio set at a lower level, usually near the ground-level, without the interception of the electric noises at the ground-level, and without loss of the signal in the process of transmission.

The subject of the loss of signal to be encountered in such a transmitting system, and the methods for their minimization is too broad for inclusion in this brief article and will, in fact, be the subject of a later discussion, but it is pertinent to point out, in connection with the explanation given above with reference to the importance of antenna position, how a simple two-wire line serves for such transmission without the interception of radio noises.

In Fig. 3 is shown our now well-understood radio-wave field, which in this case will be assumed to represent the undesired noise. Suppose that passing through it is a simple pair of conductors. The conductors are so disposed with respect to the field as would, if they were to be used as an antenna, give maximum noise interception. In such a case the signal voltages induced in each of the two conductors are in exactly the same direction, and of precisely equal magnitude, and in this fact lies the clue to the elimination of their influence.

TRANSMISSION LINE

To connect this line to the antenna post of the radio receiver is to provide no protection against radio noise that

would not be provided by a conventional antenna since, when so connected, it constitutes just such an antenna. If, however, the line is terminated not in the receiver directly, but in a simple coil or transformer in which the two portions are precisely alike—the mid-point being grounded and the outer terminals being connected to the radio set—the noise currents which are flowing in both sides of the line in the same direction, flow directly to ground and completely nullify one another in their influence on the radio receiver and thus provide the noise-suppressing means so much desired.

In addition, of course, there are electrical disturbances other than those represented by the electric field here discussed, which must be avoided in the installation of any receiving antenna. These, of course, are those which affect the antenna system by the magnetic field which they provide.

To guard against them, nothing more than the nicely-balanced termination referred to above is required, and that additional requirement is met by the "transposition" of the line—that transposition may be secured by any means by which alternate small sections of the line interchange their lateral positions with respect to one another economically.

Simple blocks of dielectric material serve to bring about that transposition where the conductors constituting the line must be kept well separated from one another; but where proper coupling and terminating devices as will later be discussed are used, the inherent transpositions of the conventional "twisted pair" are sufficient to give the desired effect.

National Union Type 6E6

The 6E6 is a heater-cathode type of tube combining two low- μ output triodes in one bulb. It is intended for use in the output stage of automobile radio receivers or ac-operated receivers. The triode units have separate external terminals for all electrodes except the cathodes and heaters, thus permitting the triode units to be operated either in parallel, or push-pull.

6E6 CHARACTERISTICS

| | |
|---------------------------|------------------------------------|
| Heater Voltage (ac or dc) | 6.3 Volts |
| Heater Current | 0.6 Ampere |
| Bulb | ST-14 |
| Base | Medium 7-pin |
| Maximum Overall Height | 4-11/16" |
| Maximum Diameter | 1-13/16" |
| TYPICAL OPERATION: | |
| Plate Voltage | 180 250 Max. Volts |
| Grid Voltage | -20 -27.5 Volts |
| Plate Current | 11.5 18 ma per Plate |
| Mutual Conductance | 1400 1700 Micromhos per Triode |
| Amplification Factor | 6.0 6.0 |
| Plate Resistance | 4300 3500 Ohms per Plate |
| Load Resistance | 15000 14000 Ohms Plate to Plate |
| Undistorted Power Output | 0.75 1.6 Watts per Pair of Triodes |

The 6E6, although primarily designed for push-pull service, may be used in single tube service without the second harmonic distortion exceeding five percent. In the case of parallel operation of the triode, the proper load resistance is one-fourth of the plate-to-plate value given under "Characteristics."

BIASING

It is preferable that grid voltage be obtained from a self-biasing resistor in

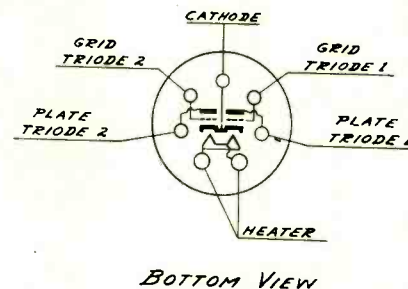

Bottom view of 6E6 tube base, showing element connections.

the cathode circuit. For 250-volt operation, this resistor should be 770 ohms, while for 180-volt operation, it should be 870 ohms. For parallel tube operation, the resistor should either be heavily by-passed, or a suitable filter network be installed to prevent excessive degeneration at the lower frequencies. Transformer or impedance coupling to the grid circuit is recommended, where a grid resistor is used with any type of input coupling, the resistance should not exceed one-half megohm per grid where self-bias is used. With fixed bias, the resistance should not exceed 100,000 ohms.

The base pins of the 6E6 fit the medium seven contact socket (0.855 inch pin-circle diameter) which may be installed to operate the tube in any position.

Possible Howls in Sparton Models With Aeroplane Dials

The new Sparton Models employing aeroplane type dials may howl or otherwise show microphonic trouble if the dial assembly is allowed to touch the cabinet.

These Models are designed to permit a clearance between the dial and the cabinet. However, rough handling or careless assembly of the chassis and cabinet in your shop may result in the dial touching the cabinet. Speaker vibrations are then transferred to the chassis and microphonic action may then occur.

It may be advisable to put a coat of clear lacquer on the wires which pass through the oscillator coil. The lacquer prevents vibration of the wires which can also cause microphonic action.

General Data . . .

Stewart-Warner R-126 Chassis

The Stewart-Warner R-126 Chassis is used in receiver Models 1261 to 1269. Chassis R-126-P and R-126-X are arranged for use with a phonograph pickup, and have universal power-transformer connections permitting the use of either chassis on lines from 100 to 260 volts, 25 to 133 cycles. The phonograph connections are shown in Fig. 1.

The readers of SERVICE have expressed their approval of and desire for lengthy descriptions of circuit functions, alignment data, etc. We are pleased to meet this request and take particular pleasure in providing the data on the alignment of all-wave receivers to follow, so ably prepared by J. N. Golton, Manager of the Stewart-Warner Radio Service Department. All of the data deals specifically with the R-126 Chassis, but many of the pointers given are equally as applicable to the alignment and adjustment of other all-wave receivers.

CIRCUIT DESCRIPTION

The complete circuit of the Stewart-Warner Model R-126 Chassis, together with parts values, voltages, tube locations, etc., is shown in Fig. 2. It is an all-wave superheterodyne, covering a frequency range from 530 kc to 23 mc in four tuning ranges, which can be selected by means of the range switch. This range switch is used to connect proper coils into the antenna and oscillator circuits, different coils being used for each range. Trimmer condensers are provided on each coil so that each circuit may be properly adjusted to give maximum efficiency on every frequency range. The spacing between the two coils wound on each form is sufficient to prevent coupling. To further guard against dead spots due to the absorption effects of the unused coils, the range switch is provided with contact arms which short circuit all coils of the ranges lower in frequency than the one in use.

Special, electrically symmetrical, antenna coils are employed so that efficient, relatively noise-free short-wave reception can be secured with a doublet-type of antenna without the use of additional coupling devices. These coils are also designed so that a standard antenna having a single-wire lead-in can be used where the noise level is low on the short-wave ranges.

A tuned pre-selector circuit is used only on the broadcast range to improve

selectivity. After passing through this circuit, the signal is fed into the 6C6 first detector where it beats with the output of the type 76 oscillator tube to produce a 456-kc intermediate-frequency signal. This particular frequency is chosen as the best value for an all-wave receiver, since it reduces image interference on the short-wave ranges.

The 456-kc signal is amplified by the two-stage, high-gain, i-f amplifier using two 6D6 tubes. The amplified signal is then rectified by the type 75 diode, producing a modulated dc voltage drop across the 500,000-ohm volume control. Any selected part of this voltage is impressed on the triode section of the 75 tube.

The triode section of the 75 operates as an a-f amplifier, which is resistance coupled to the type 42 pentode power tube.

The avc voltage is secured by smoothing out the modulated dc voltage drop across the volume control and applying it to the control grid of the first i-f tube. To improve the avc action, part of the voltage is also applied to the control grid of the first detector tube.

CALIBRATION AND ALIGNMENT

Experience has definitely shown that a selective radio chassis such as the R-126 cannot be properly aligned by ear or "on the air." A high-grade modulated service oscillator and output meter are absolutely essential.

The oscillator should be capable of generating the frequencies of 456 kc, 600 kc, 1400 kc, and a short-wave range extending to 4000 kc or more. This oscillator must provide a wide range of signal output—very weak for proper alignment of the various bands so that the avc circuit will not be actuated, and very strong for use when the receiver is badly out of adjustment or for short-

wave alignment where harmonics may be used.

PRECAUTIONS

When using your oscillator do not rely on calibration curves for frequency determination, but check the frequencies by comparison with broadcast station signals.

At all times during calibration and alignment use the lowest output meter scale which will provide a steady reading and adjust the oscillator output so that the output meter reads near the center of the scale.

For making trimmer adjustments use a bakelite aligning tool which has only a small metal screwdriver tip.

Very important: In aligning all but the i-f stages it is absolutely necessary to have a 400- to 500-ohm carbon resistor in series with the antenna lead to the oscillator. Do not omit this resistor or the alignment will be incorrect.

PRELIMINARY STEPS

To align the R-126 Chassis proceed as follows:

Remove the chassis from the cabinet. Connect the output meter across the primary of the output transformer on the dynamic speaker. (Center and blue wires on terminal strip.) Turn the volume control to maximum volume position.

TRIMMER LOCATIONS

Practically all the adjustments can be made from the top of the chassis. In the illustration of Fig. 3, the points marked (1) and (2) are the trimmers for the first i-f transformer. (3) and (4) are the trimmers for the second i-f transformer, while (5) and (6) are the trimmers for the third i-f transformer. The other trimmers indicated are the adjusters on the first detector and oscillator coils and are as follows:

530 to 1540 kc Broadcast Range (No. 1)

- (7) Oscillator calibration trimmer.
- (8) Detector shunt trimmer.
- (9) Pre-selector shunt trimmer.
- (10) Oscillator padding trimmer.

1500 to 4600 kc Short-Wave Range (No. 2)

- (11) Oscillator calibration trimmer.
- (12) Detector shunt trimmer.
- (13) Oscillator padding trimmer.

Fig. 1. Radio-Phonograph connections for the Stewart-Warner R-126-P and R-126-X chassis.

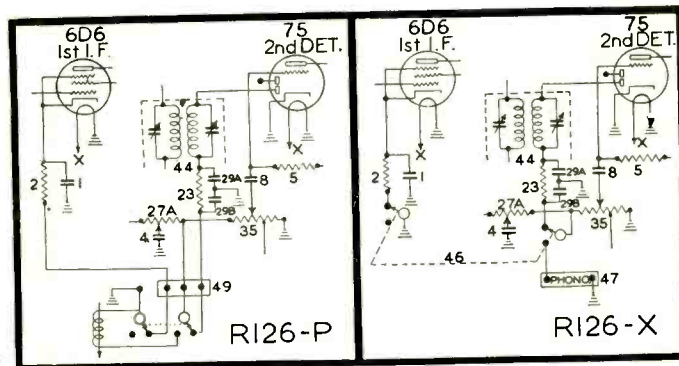

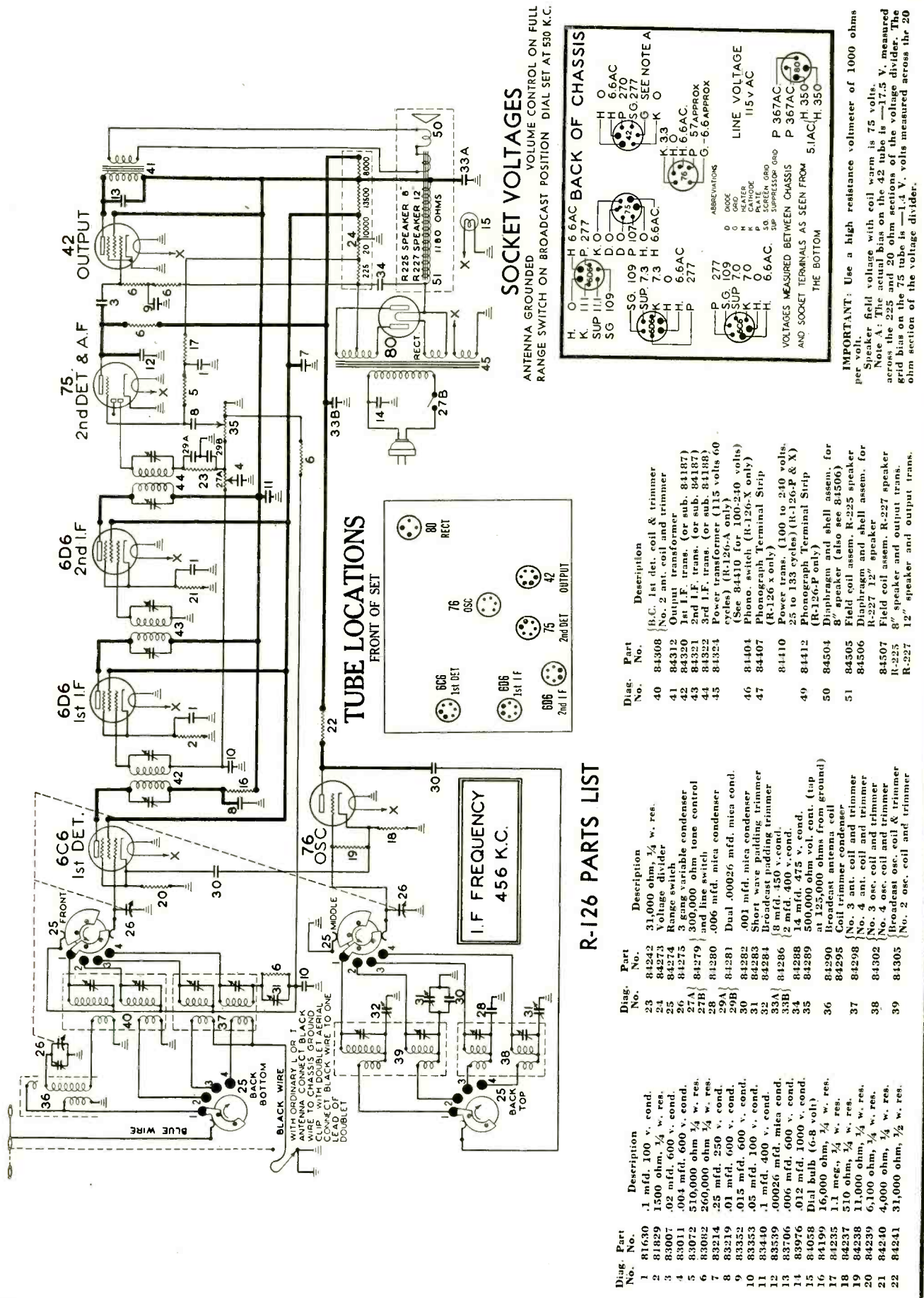

Fig. 2. Complete schematic diagram of the Stewart-Warner R-126 chassis, together with parts values, tube locations and socket voltages.

GENERAL DATA—continued

4.3 to 12.6 mc Short-Wave Range (No. 3)

- (14) Oscillator calibration trimmer.
- (15) Detector shunt trimmer.

11.0 to 23.0 mc Short-Wave Range (No. 4)

- (16) Oscillator calibration trimmer.
- (17) Detector shunt trimmer.
- (18) Oscillator padding trimmer.
- (19) Detector padding trimmer.

PROCEDURE

The following procedure on the proper adjustment of the various trimmers is divided into two classifications, *calibration* and *alignment*. *Calibration* consists of the adjustment of trimmers so that the signals can be received at the proper dial settings. Calibration on the R-126 is made at the high-frequency end of the dial. In addition, there is also a calibration adjustment at the low-frequency end of the range No. 4. *Alignment* consists of adjustment of trimmers such that the antenna and oscillator circuits are tuned to give maximum sensitivity. Alignment thus does not concern the dial setting so that it is often only necessary to check calibration. However, if a re-calibration is made it is always necessary to go over the alignment. The calibration and alignment of each range is independent of all others so that one range may be re-calibrated or re-aligned without necessitating going over the trimmer adjustments on any of the other ranges.

I-F ALIGNMENT

1. Set the test oscillator to *exactly* 456 kc. Then connect the output leads of the oscillator to the 6C6 control grid and ground. Follow this by setting the range switch (lower center knob) to the broadcast position (dial pointer on black dial scale). Make certain that no station is tuned in.

Then carefully adjust the i-f transformer trimmers Nos. 1, 2, 3, 4, 5, and 6 for maximum output meter deflection. Repeat the six trimmer adjustments since the adjustment of each trimmer has some effect on the others.

RANGE No. 1 (BROADCAST) CALIBRATION

2. Check the position of the dial on the condenser shaft by turning the rotor plates of the gang condenser to full mesh. The dial should then read 530 kc. (The last division at low-frequency end of the broadcast range.)

3. Leave the range switch in the broadcast position.

4. Use a broadcast station signal between 1300 and 1420 kc to calibrate the receiver dial on the broadcast range. If no such station can be heard, you can use a 1400-kc signal from your

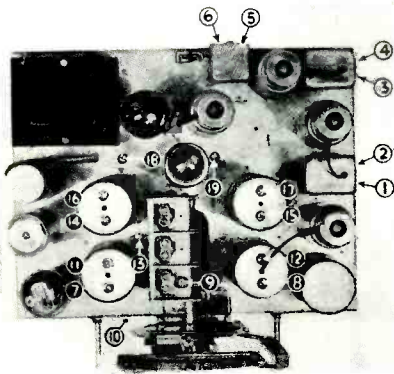

Fig. 3. View of the R-126 chassis, showing location of trimmers and padders.

oscillator provided its calibration is accurately known. Proceed as follows:

(a) Set the receiver dial pointer to the exact frequency setting of the signal (either a station or the oscillator).

(b) Carefully adjust trimmer No. 7 (Range No. 1 broadcast oscillator calibration trimmer) until the signal may be tuned in with maximum volume at its correct frequency setting.

RANGE No. 1 (BROADCAST) ALIGNMENT

5. Connect a 400- or 500-ohm, 1-watt carbon resistor in series with the test oscillator output and the receiver antenna lead. This resistor must remain connected for all broadcast and short-wave adjustments in order to secure proper alignment of the antenna stage. Ground the receiver chassis and connect the oscillator ground lead to the chassis.

6. (a) Set the test oscillator to approximately 1400 kc and carefully tune the receiver to the signal.

(b) Adjust trimmers No. 8 and No. 9 (Range No. 1 broadcast detector shunt trimmer and Range No. 1 broadcast pre-selector shunt trimmer, respectively) for maximum output meter reading.

(c) Retune the receiver and check the adjustments of trimmers No. 8 and No. 9. Do not touch trimmer No. 7 since this will change the calibration.

7. (a) Set the test oscillator to approximately 600 kc and tune the receiver to the signal.

(b) Adjust trimmer No. 10 (Range No. 1 broadcast oscillator padding trimmer) to get maximum output meter deflection.

(c) Retune the receiver dial to a peak and readjust the trimmer.

(d) Continue this procedure of adjusting the trimmer and retuning the set until the output meter reading cannot be increased. *This procedure must be followed or the receiver will not be properly aligned.*

8. Repeat 6 a, 6 b, and 6 c.

RANGE No. 2 CALIBRATION

9. Turn receiver range switch to the range No. 2 position (Dial pointer on red dial scale).

10. (a) Adjust the oscillator to *exactly* 4000 kc.

(b) Set the receiver dial pointer to exactly 4000 kc, on the red dial scale and adjust trimmer No. 11 (Range No. 2 oscillator calibration trimmer) until the signal comes in with maximum volume. If there are two peaks, the proper one is that with the trimmer screw farthest out.

(c) To be sure you have not adjusted trimmer No. 11 to the image frequency, check this point by tuning the receiver dial to the image frequency, approximately 3100 kc and see if the image signal can be heard. (*The image frequency is signal frequency minus twice the i-f frequency or in this case $4000 - 912 = 3088$ kc or approximately 3100 kc.*) If no signal can be heard at about 3100-kc dial setting even with greatly increased test oscillator output, trimmer No. 11 is evidently improperly adjusted and so must be reset to a new peak with the screw farther out. After re-adjusting trimmer No. 11 again check to see that the image comes in at 3100-kc dial setting.

RANGE No. 2 ALIGNMENT

11. (a) Tune the set very carefully to the oscillator signal at 4000 kc for maximum output meter reading.

(b) Adjust trimmer No. 12 (range No. 2 detector shunt trimmer) to a peak.

(c) Check the adjustment of trimmer No. 12 by tuning the receiver to the image at about 3100 kc and noting if the image signal is much weaker than the 4000-kc signal. If the signal at 3100-kc dial setting is equal to or stronger than the 4000-kc signal, trimmer No. 12 is not set to the proper peak and must be reset until a recheck shows that the signal at 4000-kc dial setting is much stronger than at the 3100-kc image dial setting.

12. (a) Set the test oscillator to approximately 1750 kc and tune the receiver to the signal.

(b) Adjust trimmer No. 13 (range No. 2 oscillator padding trimmer) to get maximum output meter deflection.

(c) Retune the receiver dial to a peak and readjust the trimmer.

(d) Continue this procedure of adjusting the trimmer and retuning the dial until the output meter reading cannot be further increased.

(Continued on page 120)

Grunow 11-A Chassis

Here is a neat job if ever there was one. All the dope is provided in the diagram on the opposite page.

This is an 11-tube, all-wave job, covering the continuous frequency range from 540 to 21,500 kc, thus taking in all the worthwhile short-wave bands. Tuning in these bands is made easier through the use of a beat oscillator, which will be covered later.

OSCILLATOR-MIXER SYSTEM

A 6D6 tube is used in the r-f stage. This is coupled to a 6A7 which is used as the mixer only—a fine arrangement. The mixer is coupled to the oscillator through the suppressor grid, which makes it a sort of electron coupling. The important point is that the suppressor forms a high-impedance circuit with the result that no appreciable load is placed on the oscillator tube. With small load, the oscillator tube is less apt to drift in frequency—a very important consideration at high frequencies.

DELAYED AVC

The 6A7 mixer feeds a 262-kc signal to an i-f stage using a 6D6 tube. The i-f stage is in turn coupled to a type 85 tube, one diode of which is used for rectification and the other diode for supplying delayed avc voltage. This latter diode—number 3 in the diagram—is coupled to the plate circuit of the i-f tube through a small fixed capacity, and provides avc bias for the r-f and the mixer tube. The avc action is delayed by virtue of the bias on number 3 diode. This bias is developed across the 2000-ohm resistor in the cathode circuit of the 85 tube. It will be noted that this bias is not impressed on diode number 4—the rectifier diode—since the return circuit of this diode connects directly to the cathode.

CLASS A PRIME AUDIO

The triode section of the 85 tube functions as an a-f amplifier, and feeds a pair of 76 tubes connected in parallel. These tubes act as a driver stage for the 45 tubes in Class A Prime push-pull.

The 76 drivers receive their bias from the 164-ohm section of the voltage-divider extension. The 45 tubes receive their bias through the voltage drop in the speaker field.

The rectifier tube is a 5Z3, the output of which is well filtered through the choke action of the speaker field, the tuned filter choke, and the four 8-mfd electrolytic condensers.

The broadcast section of the receiver consists of the following four tuned circuits: r-f input, bi-selector, mixer input

and oscillator. These circuits are tuned with a 4-gang variable condenser.

The short-wave section of the receiver consists of three tuned circuits, the bi-selector being cut out to prevent losses when the receiver is working at the higher frequencies.

BEAT OSCILLATOR

A separate 76 tube is used as the beat oscillator or Signal Beacon, plate voltage being applied by closing the switch on the tone control.

When this tube is brought into operation it acts as a local oscillator and beats against the incoming signal. The presence of a station's signal is indicated by a high-pitched whistle, which becomes lower in pitch as resonance is approached. The Signal Beacon note becomes very low and finally reaches zero; at this point the oscillator is in zero beat with the signal, which indicates exact resonance.

The Signal Beacon may also be used for the reception of cw signals.

CONTINUITY AND VOLTAGE

Continuity and voltage readings should be taken from the underside of the chassis. The values given on the schematic diagram are average. The socket layouts given show each socket from the under side.

Repairing Colonial Wave Switches

There are three types of waveband switches used in the current line of Colonial receivers. One of them is the multi-section ganged type used in the all-wave receivers. The other two are of the single-section type shown in Fig. 1 and Fig. 2. Although these two are similar to each other, they can easily be told apart by the shape of their lugs.

MULTIPLE-SECTION GANGED SWITCHES

This type of switch can be repaired by turning it to such position that the double contact fingers are disengaged. Then squeeze these fingers together with a pair of long nosed pliers. *Caution:* Certain of the fingers have no disengaged position. Do not attempt to squeeze such fingers.

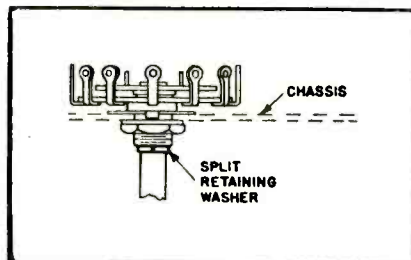

Fig. 1. Details of Colonial all-wave switch.

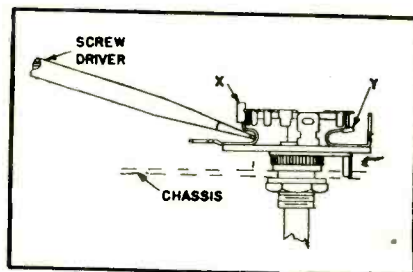

Fig. 2. Showing how to increase switch-contact tension.

SINGLE-SECTION SWITCH, TYPE "A"

Faulty operation of this type of switch (See Fig. 1), may be due either to a thin film of rosin on the contact surfaces or to insufficient contact tension. To remove rosin, brush liberal amounts of alcohol onto the switch contacts and, at the same time, work the switch back and forth. *Caution:* Do not allow the alcohol to get onto any cabinet surfaces. If this does not remedy the trouble, increase the tension of the contact springs as follows:

Remove the split washer that holds the switch together. This washer is in the groove in the shaft just forward of the threaded bushing. See Fig. 1. The rotating part of the switch then can be removed. Bend the contact springs slightly and re-assemble the switch.

SINGLE-SECTION SWITCH, TYPE "B"

The same procedure should be used for cleaning this switch of rosin as was used for the Type "A" switch. If difficulty still is experienced, the tension of the contact fingers should be increased as follows:

Loosen the mounting nut of the switch to permit the switch to be turned so that all of the contacts are accessible. Notice that there are two types of contacts on this switch. These are indicated "X" and "Y" in Fig. 2. The tension of the "Y" type of contact can easily be increased by turning the switch to the position where the "Y" contact is disengaged and then bending the contact up slightly. The tension of the "X" contacts can be increased by tapping lightly on a screwdriver placed as indicated in Fig. 2. It may be necessary to bend the connection lugs down out of the way to make room for the screwdriver.

Philco Model 29

Starting with Run No. 15, cathode resistor (8) was changed from Part No. 7217 (200 ohms) to Part No. 33-3010 (300 ohms). This improves stability.

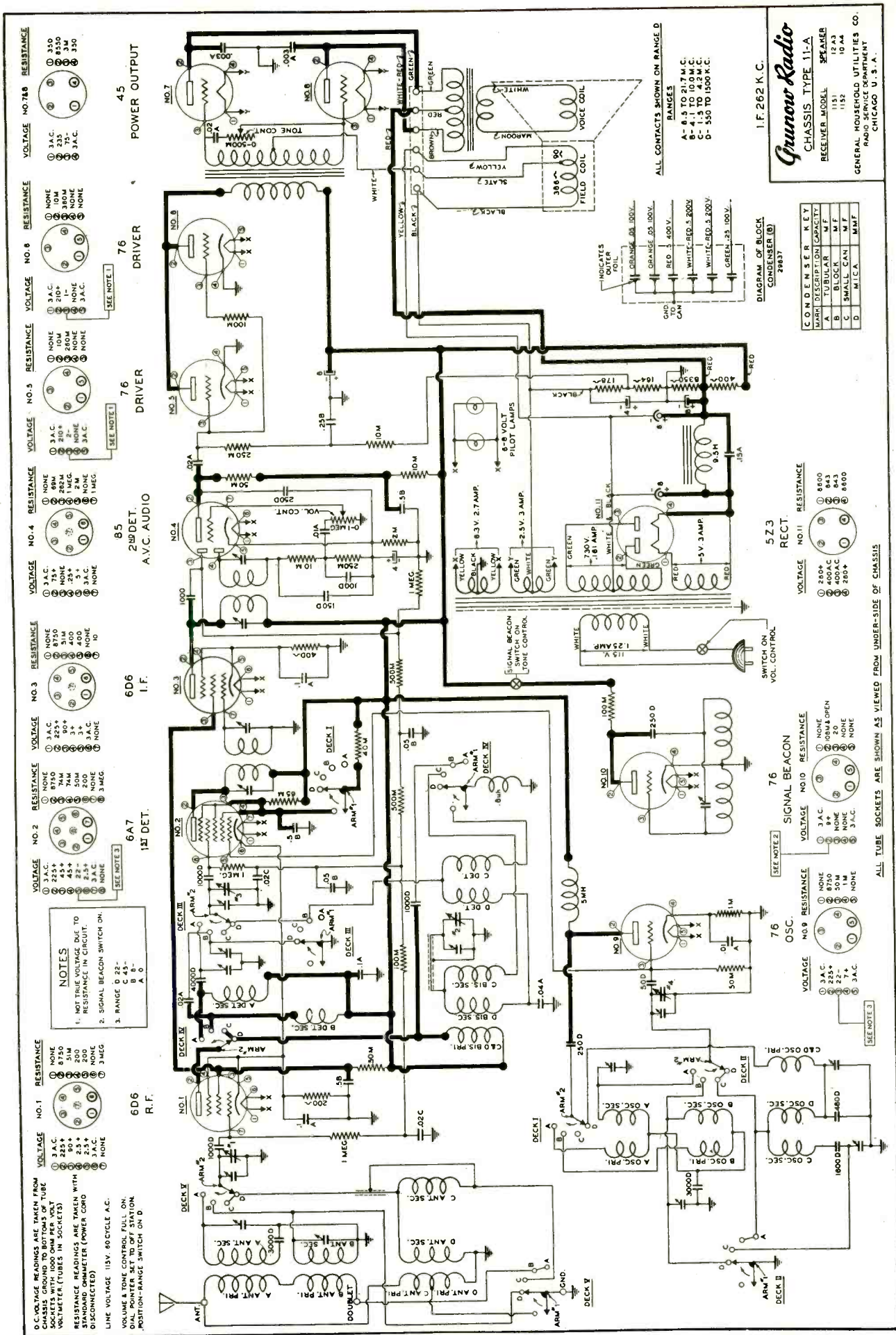

Complete schematic diagram of the Grunow 11-A chassis, together with parts values, voltages, point-to-point resistance values and socket connections. High-voltage leads are shown in heavy lines. The 1-f used in this chassis is 262 kc. Note that there is a Signal Beacon tube.

GENERAL DATA—continued

(Continued from page 117)

RANGE No. 3 CALIBRATION

13. Turn the receiver range switch to the range No. 3 position (dial pointer on green dial scale).

14. (a) Adjust the test oscillator to *exactly* 12,000 kc. If you cannot obtain this frequency on your oscillator, you may use the second harmonic of 6000 kc, the third harmonic of 4000 kc or the fourth harmonic of 3000 kc, all of which will give a 12,000-kc signal.

(b) Set the receiver dial pointer at *exactly* 12.0 mc on the green dial scale and adjust trimmer No. 14 (range No. 3 oscillator calibration trimmer) until the signal is tuned in with maximum volume. Usually there will be two peaks. The proper one is that with the trimmer screw farthest out.

(c) To be sure you have not adjusted trimmer No. 14 to the image frequency, check this point by tuning the receiver dial to the image frequency, approximately 11.1 mc, and see if the image signal can be heard. If no signal can be heard at 11.1-mc dial setting even with greatly increased test oscillator output, trimmer No. 14 is evidently improperly adjusted to the image frequency and so must be reset to the proper peak with the screw farther out. After re-adjusting trimmer No. 14, again check to see that the image comes in at 11.1-mc dial setting.

RANGE No. 3 ALIGNMENT

15. (a) Tune the set very carefully to the oscillator signal at 12.0 mc for maximum output meter reading.

(b) Adjust trimmer No. 15 (range No. 3 detector shunt trimmer) to a peak. After this is done try to increase the output meter by detuning trimmer No. 15 slightly and retuning the receiver dial. Continue detuning trimmer No. 15 and retuning the set until maximum output meter deflection is secured.

(c) Check the adjustment of trimmer No. 15 by tuning the receiver to the image at 11.1 mc and noting if the image signal is much weaker than the 12.0-mc signal. If the signal at 11.1-mc dial setting is equal to or stronger than the 12.0-mc signal, trimmer No. 15 is not set to the proper peak and must be reset as in 15 (b), until a recheck shows that the 12.0-mc dial setting is much stronger than at the 11.1-mc image dial setting.

RANGE No. 4 CALIBRATION

16. Turn the receiver range switch to the No. 4 position (dial pointer on purple dial scale).

17. Leave the test oscillator set to *exactly* 12,000 kc.

(a) Set the receiver dial pointer to

exactly 12.0 mc on the purple dial scale.

(b) Adjust trimmer No. 18 (range No. 4 oscillator padding trimmer) until the signal gives maximum output meter reading.

(c) To be sure that you have not adjusted trimmer No. 18 on the image frequency, tune in the image signal at approximately 11.1 mc on the receiving dial. If no signal can be heard at 11.1 mc even with greatly increased test oscillator output, but can be heard at 12.9-mc dial setting, trimmer No. 18 is evidently adjusted to the image frequency and so must be reset to the proper peak with the trimmer screw farther out. After re-adjusting trimmer No. 18, again check to see that the image comes in at 11.1-mc dial setting and not at the 12.9-mc dial setting.

18. (a) Set the test oscillator to *exactly* 20,000 kc. If your oscillator cannot reach this frequency, use the second harmonic of 10,000 kc, the third harmonic of 6666 kc, the fourth harmonic of 5000 kc, or the fifth harmonic of 4000 kc, all of which will give a 20,000-kc signal.

(b) Set the receiver dial pointer to *exactly* 20.0 mc on the purple dial scale.

(c) Adjust trimmer No. 16 (range No. 4 oscillator calibration trimmer) until the signal is tuned in with maximum volume. In adjusting the trimmer, there usually will be two peaks. The proper one is that with the trimmer screw farthest out.

(d) To be sure you have not adjusted trimmer No. 16 to the image frequency, check this point by tuning the receiver dial to the image frequency, approximately 19.1 mc and see if the image signal can be heard. If no signal can be heard at 19.1-mc dial setting even with greatly increased test oscillator output, but can be heard at 20.9-mc dial setting, trimmer No. 16 is evidently improperly adjusted to the image frequency and so must be reset to the proper peak with the screw farther out. After re-adjusting trimmer No. 16 again check to see that the image comes in at 19.1-mc dial setting and not at 20.9-mc dial setting.

RANGE No. 4 ALIGNMENT

19. (a) Tune the set very carefully to the oscillator frequency, 20.0 mc, for maximum output meter reading.

(b) Adjust trimmer No. 17 (range No. 4 detector shunt trimmer) to a peak. After this is done try to increase the output meter reading by detuning trimmer No. 17 slightly and retuning the receiver dial. Continue detuning trimmer No. 17 and retuning the set un-

til maximum output meter deflection is secured.

(c) Check the adjustment of trimmer No. 17 by tuning the receiver to 19.1 mc and noting if the image signal is much weaker than the 20.0-mc signal. If the signal at 19.1-mc dial setting is equal to or stronger than the 20.0-mc signal, trimmer No. 17 is not set to the proper peak and must be reset as in 19 (b) until a recheck shows that the signal at the 20.0-mc dial setting is much stronger than that at the 19.1-mc image dial setting.

20. (a) Set the test oscillator to about 12,000 kc or use the second harmonic of 6000 kc, the third harmonic of 4000 kc, or the fourth harmonic of 3000 kc, all of which give a 12,000-kc signal.

(b) Tune the set very carefully to the oscillator signal at 12.0 mc to get maximum output meter reading.

(c) Adjust trimmer No. 19 (range No. 4 detector padding trimmer) to get maximum output meter deflection.

(d) Retune the receiver dial to a peak and readjust the trimmer.

(e) Continue this procedure of adjusting the trimmer and retuning the receiver until the output meter reading cannot be increased.

(f) Check the adjustment of padding trimmer No. 19 by tuning the receiver dial to the image signal at 11.1 mc and noting if the image signal is much weaker than the 12-mc signal. In case the signal at the 11.1-mc dial setting is equal to or stronger than the signal at 12.0-mc, padding trimmer No. 19 must be re-adjusted to a different peak as in 20 (c), 20 (d) and 20 (e), so that the 11.1-mc dial setting signal is much weaker than the 12.0-mc dial setting signal.

NOTE: To prevent the trimmers from being jarred out of adjustment, use Duco Household Cement or some similar product to fasten the trimmer screws in position after completing the alignment. Be careful that you do not apply too much cement because it must not be allowed to run between the trimmer plates.

Philco Model 34

Starting with Run No. 4, an r-f choke, Part No. 32-1514 is added, connected in the 135-volt B battery lead, between the points where (37) and (45) join it. This prevents oscillation in the i-f.

Philco Models 201 & 509

Correct i-f of these sets is 260 kc, not 460 kc.

"You bet I got my
10c WORTH"

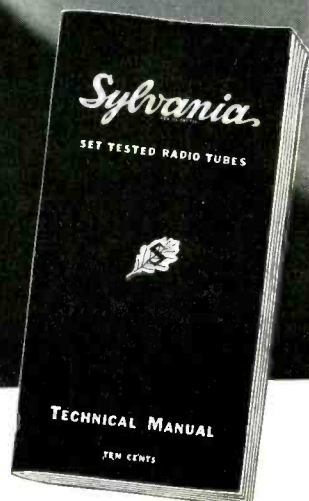
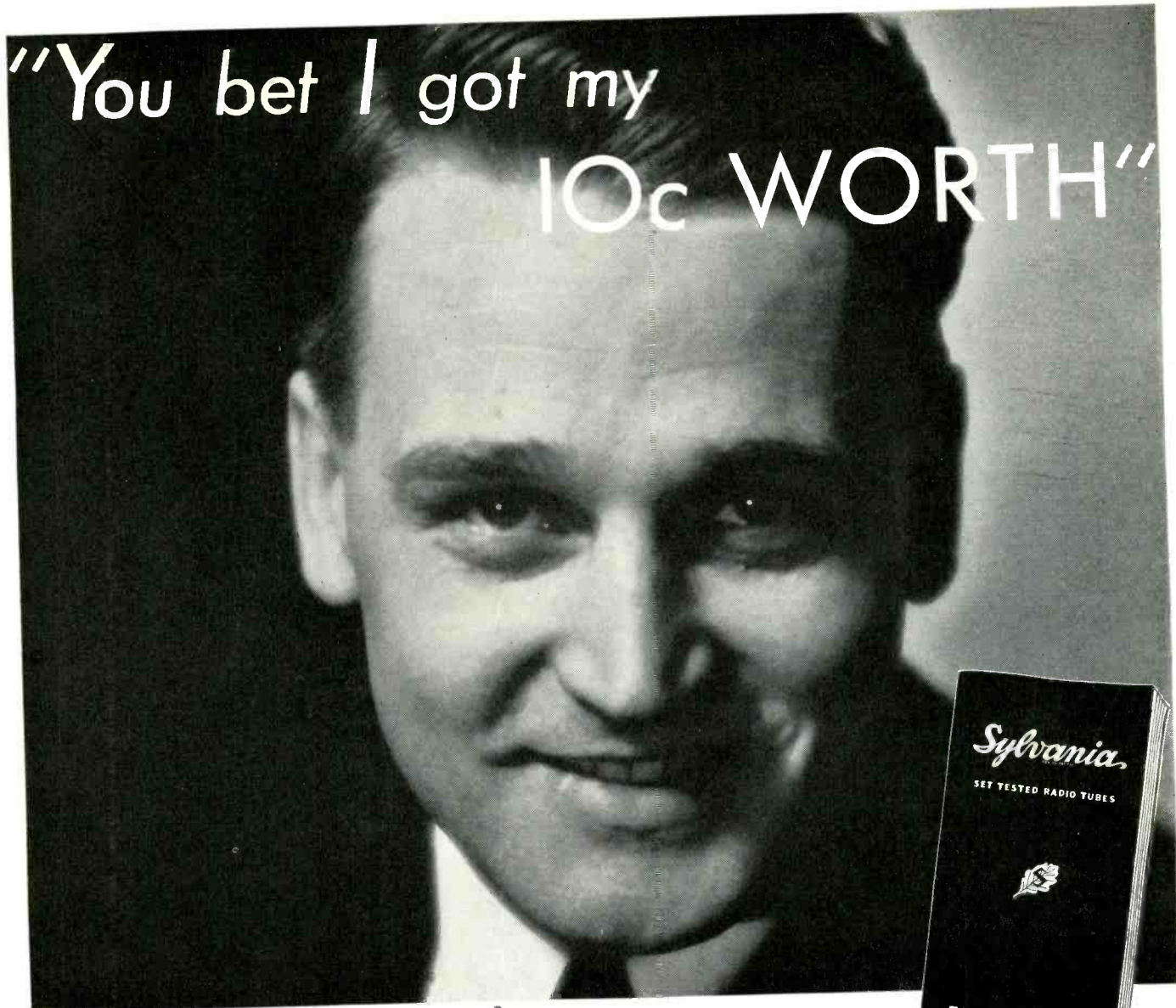

... thousands of service men have sent for this valuable book ... GET YOUR COPY FOR 10c

● "Yes, sir, this book has been worth money to me. It just cost me a dime, but that was sure 10c. well spent! I never saw a book crammed with so much useful information for radio men."

Yes, and 34,000 other service men feel the same way. We wish you could read some of the letters we've received. Men in California, Texas, New York write in and tell us that this handy service manual has actually put money in their pockets.

It's got the latest data on all tubes, including types 15, 18, 255, 25YS, 2Z2, 46B1 and 182B. 104 pages filled with information that takes the guess work out of tube application!

Don't wait! Send for this pocket manual today. It will help you recognize tube and set troubles and, *most important*, show you how to solve these problems. It's yours for 10c. in stamps!

Sylvania
REGISTERED U.S. PAT. OFF.
THE SET-TESTED RADIO TUBE

Makers of
Sylvania Tubes
Hygrade Lamps
Electronic Products



Factories
St. Mary's, Pa.
Emporium, Pa.
Salem, Mass.

10c. — Technical Manual — 10c.

HYGRADE SYLVANIA CORPORATION (C21)
Emporium, Pa.

Please send me the new Sylvania Technical Manual. I enclose 10c. in stamps.

Name

Address

City State

GENERAL DATA—continued

RCA Victor 220-Volt AC-DC Set

This is a 5-tube superheterodyne designed for operation from a 200 to 230-volt line, direct current, or 50-60 cycle alternating current. When operated from a dc line, the power consumption is 85 watts, and when operated from a 60-cycle ac line, the power consumption is 105 watts.

The receiver has a frequency range of 540 to 1500 kc. The undistorted power output is 1.5 watts.

THE CIRCUIT

The complete schematic diagram is shown in Fig. 1. There is an r-f stage using a type 78 variable-mu pentode which is transformer-coupled to a type 6A7 tube. This tube functions both as mixer and oscillator. The 175-kc output of the mixer is fed through a single i-f transformer to the type 77 second detector tube. The output of this biased detector is resistance coupled to a type 43 power pentode. The pentode feeds the amplified signal to a dynamic speaker.

The power supply system consists of a type 12Z3 half-wave rectifier; the field of the dynamic speaker which functions as the filter choke; an 8-mfd filter condenser, and a voltage divider consisting of resistors R-10 and R-11. The potentiometer R-12, in series with the voltage divider and the return circuit, functions as the volume control by varying the bias on the r-f and mixer tubes.

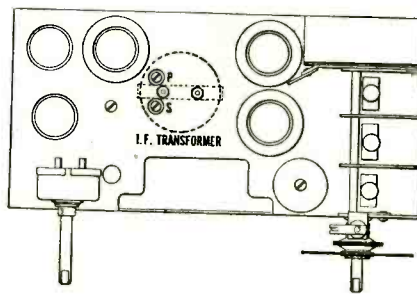

Fig. 2. Chassis layout, showing location of trimmers.

Bias for the second detector tube is provided by the voltage drop in the 20,000-ohm cathode resistor R-3. The 500-ohm cathode resistor R-8 provides bias for the type 43 pentode power tube.

VOLTAGE READINGS

The voltages given in the diagram of Fig. 1 were measured at 220 volts ac, 60 cycles, with volume control in maximum position. Voltages with 220 volts dc supply will be approximately 10 percent less than the values given.

LINE-UP ADJUSTMENTS

The line-up condenser adjustments for the i-f stage and for the r-f circuits should be made in the following manner:

(1) Use a modulated oscillator giving a signal at 175 kc and 1400 kc. An output meter and non-metallic screwdriver are also necessary. Fig. 2 shows the location of the i-f condensers.

(2) The i-f line-up condensers should be adjusted first. This is done by placing the oscillator in operation at 175 kc, coupling its output between the control grid of the mixer and ground, connecting the output meter across the cone coil of the speaker and adjusting the two i-f line-up condensers until maximum output is obtained.

(3) After the i-f circuits are aligned, the r-f and oscillator circuits are adjusted at 1400 kc. Prior to making the adjustment, however, the dial should be checked. This is done by making sure the dial indicator reads 530 (indicator in center position) when the tuning condenser rotor plates are fully meshed with the stator plates. The adjustments are then made in a manner similar to that of the i-f except that the oscillator is set at 1400 kc, its output is connected from antenna to ground of the receiver, and the dial is set at 140. The adjustment is made with the trimming condensers located on top of the gang condenser and each trimmer is adjusted for maximum output.

Possible Cause for Hum in Sparton Model 333

A possible cause for a hum in the Model 333 Auto-Radio Receiver may be a "floating" ground at the eyelet of the type 42 output tube.

One side of the heater circuit is grounded at this point and if the eyelet (Continued on page 128)

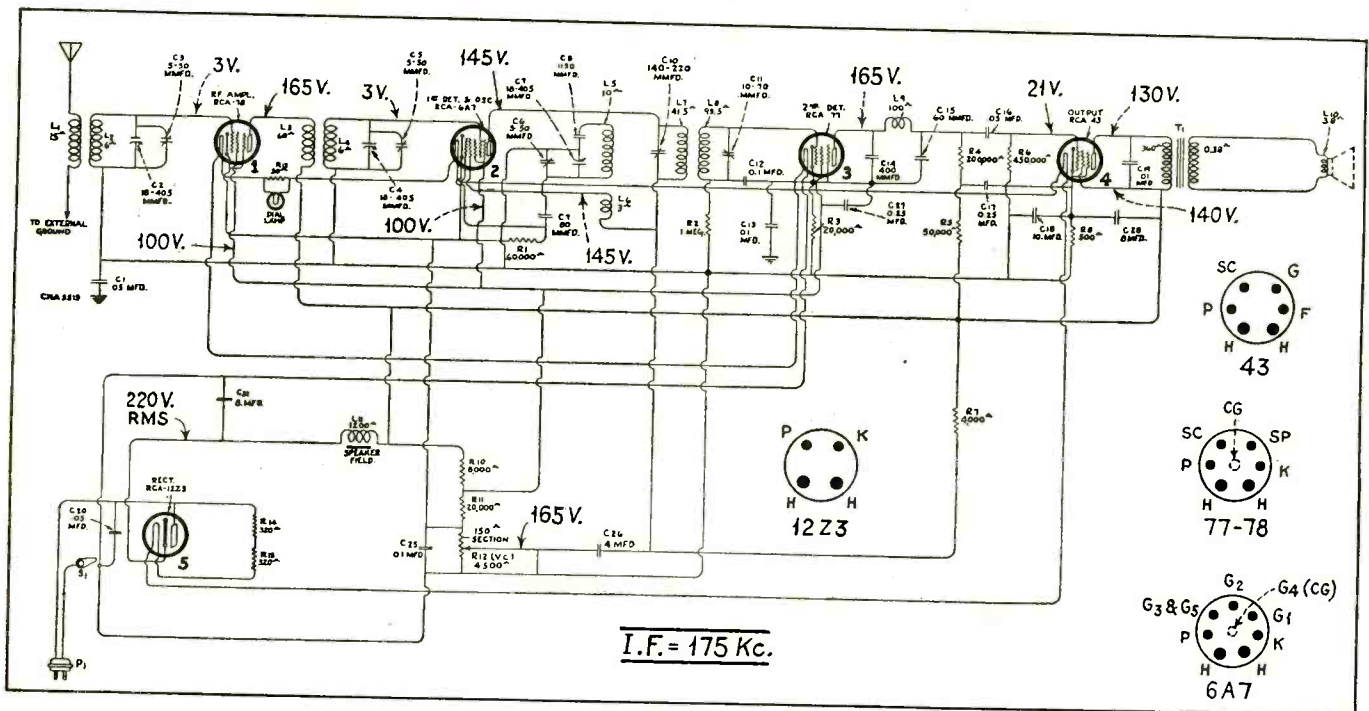

Fig. 1. Schematic diagram of the RCA Victor 220-Volt AC-DC Set.

REPLACEMENT PARTS • HEADQUARTERS •

QUALITY — SERVICE — PRICE! These are the 3 factors upon which your business has been built. Each is important . . . but together they make or break your business. In the same way our business has been built upon the same foundation. We know from an intimate knowledge of your business that we must render you Fast Service, sell you Quality Merchandise and give you Lowest Wholesale Prices. For that reason we carry the world's largest stock of radio parts to insure service. We carry more nationally known lines than any other company and maintain our Bureau of Standards to guarantee highest quality merchandise. We have established as our policy: "We will not be undersold" . . . and we back it up by giving you **LOWEST WHOLESALE PRICES** to protect your profits. For that reason we have become the largest organization of its kind in the world . . . catering to the requirements of thousands of servicemen from Maine to California. For the sake of your business, buy from Radio Headquarters

**AT LOWEST
WHOLESALE PRICES**

A FEW TYPICAL BARGAINS FROM RADIO HEADQUARTERS

Lafayette Universal Bridge

Measures resistances .01 ohm to 1 megohm; capacities from 100 mfd. to .0001 mfd. with overall accuracy within 5%. Size: 9 1/2" x 4 1/2". Scales etched on front panel in white. No. SXP 15969. Your cost **\$11.95**



Tubular Condenser Kit

Contains 25 tubular condensers; all standard size; no "fluke" capacities or voltages. Range from 200-600 v. D.C.; working voltage from .005-1 mfd. SXP 3258 **89c**



P.P. Input Transformer

Exceptionally fine frequency characteristics. Ratio 3:1. Can be used to service 75% of receivers on the market today. Size: 3 1/4" x 2 1/4". Strap mounting type. SXC 1843 **45c**

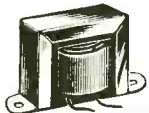

SANGAMO Audio Transformers

Strap mounting Units. Size: 2 1/4" x 2 3/4" x 1 3/4". TYPE AX—Straight audio, overall ratio 3:1. Flat response from 30-6000 cycles. SXZ 365 **49c**
TYPE HX171—P.P. output to match a pair of 71-A's, 45's, or 50's to a 5-15 ohm voice coil of a dynamic speaker. For mounting directly on speaker or chassis. SXA 374 **59c**
TYPE F—Plate impedance. Used in plate circuit detector tube to prevent feed back; also for impedance coupled amplification. Tap for auto-transformer coupling. SXA 366 **29c**



10 HENRY CHOKE. Resistance 200 ohms, 50 M.A. maximum D.C. SXC 1601 **25c**



Test Lead Bargain

37" test leads equipped with phone tips at one end and 3" insulated prods at other end. Sharp pointed prod ends. Flexible wire. A real bargain **18c** price. SXM 12989

RCA Touchup Kit

Contains all necessary equipment for repairing scratched, dented furniture. Packed in leatherette case; 1 can Refco oil for cleaning; 1 can Volvoline for rubbing; sandpaper, assorted stick shellac, Aniline stain powers, brush spatula rubbing block, etc. SXP 15238 **\$2.90**



30 Henry—50 Ma. Filter Choke

Open frame type. Inductance 30 henries. Current carrying capacity 50 milliamperes. D.C. Resistance 450 ohms. 6" leads. Size: 2 1/2" x 1 3/4" x 2 3/4". SXA 246 **29c**



*Calling All
SERVICEMEN*

JUST OUT RCA CATHODE RAY OSCILLOGRAPH

Wholesale's Radio Service Company is always first with every latest development in radio. Leading manufacturers come to us for they know that we can quickly carry the story of each new device to you as soon as it appears.

The new R.C.A. Cathode Ray Oscillograph is a typical example of our ability to bring you each development as soon as it appears.

The R.C.A. Cathode Ray Oscillograph, making use of the type 906 Cathode Ray tube, is designed to permit the Service Engineer to analyze receivers, amplifiers, etc. more thoroughly. It is indispensable for

- ★ measuring frequency and magnitude of hum;
- ★ checking percentage of modulation;
- ★ examining wave forms;
- ★ aligning the multitude of circuits used in the newer type receiver.

This oscillograph incorporates many new features, is housed in a metal cabinet with black crackle finish and handle for easy portability. Operates on 110 v. AC.

SXN13943—R.C.A. Cathode Ray Oscillograph type TMV—122 B. Complete with all tubes and 906 Cathode Ray Tube—

\$84.50

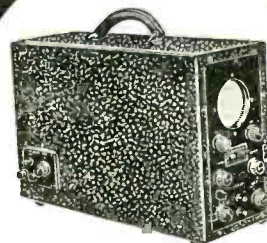

Dry Electrolytics

Can negative. 500 v. Peak. 450 v. working voltage. A high grade, first quality unit. 5" x 1 1/4" diam. **49c**



6 Tube Chassis—Cadmium plated. Open sides. Has 18 cutouts and holes. Sizes: 10 1/2" x 7 1/4" x 2". SXM 12869 **34c**

Dual 8 Mfd. 450 Volt Cans—A Special offer of 8-8 mfd., 450 v. condensers. Peak 500v. In waxed cardboard container. 3 3/4" x 1 1/4" x 1-15/16". SXC 1022 **39c**

WHOLESALE RADIO SERVICE CO.

NEW YORK, N.Y. - 100 Sixth Avenue

ATLANTA, GA. 430 W. Peachtree St.

NEWARK, N.J. 219 Central Ave.

WHOLESALE RADIO SERVICE CO.,
Inc.

100 Sixth Avenue, Dept. S-35
New York, N. Y.

Send me the order described in attached letter.

Name

Address

City..... State.....
Please mention No. when ordering.

Auto-Radio . . .

Philco Model 11

The Philco Model 11 Transitone uses a 44 in the r-f stage which is inductively and capacitively coupled to a 77 functioning as mixer and oscillator. The 260-kc signal from the mixer is amplified in an i-f stage using a 39-44 tube and is then fed to the paralleled diodes of a 75 tube. The diode provides both rectification and avc. The control bias is impressed on the r-f and i-f tubes. The triode section of the 75 tube is used as an a-f amplifier, and its resistance coupled to a 42 power pentode.

The receiver employs a dynamic speaker, the field for which is fed directly from the car storage battery. The high-voltage supply system uses a vibrator-transformer in conjunction with an 84 full-wave rectifier. The high voltage is taken from the cathode of this tube and filtered by the choke (58) and the electrolytic condensers (57).

Noise and mush interference is eliminated by the use of r-f chokes in the "A" and "B" circuits. These chokes are numbered (46), (48) and (59) in the diagram.

ADJUSTMENTS

The circuit diagram of the receiver is shown in Fig. 1 and the chassis layout in Fig. 2.

When making padding adjustments, remove the speaker lid from the receiver

and then remove the grid cap terminal from the 77 tube.

Set up the signal generator and adjust it to exactly 260 kc. Connect the generator lead to the grid cap of the 77 tube and then connect up the output meter.

The receiver volume control must be turned on to approximately full volume and the attenuator in the signal gener-

wrench for the maximum reading on the output meter.

Then adjust the screw (22) for maximum reading on the meter. This adjustment is critical. Note the maximum reading obtainable and then turn the screw in again and readjust, just bringing the adjustment up to the maximum reading. Do not pass it and then back off.

Repeat the above procedure with the condensers (12) and (16).

After padding the first i-f stage, remove the generator lead from the 77 tube and reconnect the grid lead to the 77 tube. Set the signal generator to 1500 kc and then connect the generator lead to the antenna lead.

There are four holes in line, one in each of the sections of the tuning condenser housing (see Fig 2). Place a nail of the size that fits snugly through the holes and then turn the condenser plates out of mesh until they strike against the nail.

With the tuning condenser in this position adjust the high-frequency padder (14) until the maximum reading is obtained in the output meter. This is the true setting for 1500 kc (150 on the dial scale).

Next turn the condenser plates in mesh to 140 on the scale, 1400 kc, and set the signal generator for 1400 kc. The r-f padder (9) and the antenna padder (3) are next adjusted for the maximum reading on the output meter.

Re-check the adjustments and then remove all test leads. If this procedure has been carefully followed and an accurately calibrated signal generator used, the receiver is adjusted properly.

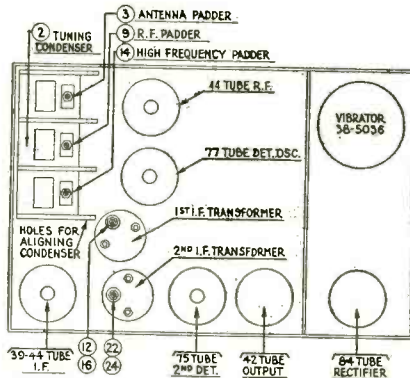

Fig. 2. Philco Model 11 chassis layout.

ator set for a half-scale reading of the output meter.

The padders (22) and (24) are adjusted first. Turn the adjusting screw (22) all the way in. A metal screwdriver can be used for this. Then, with the signal generator attenuator set so there is approximately half-scale reading, adjust the nut (24) with a fibre

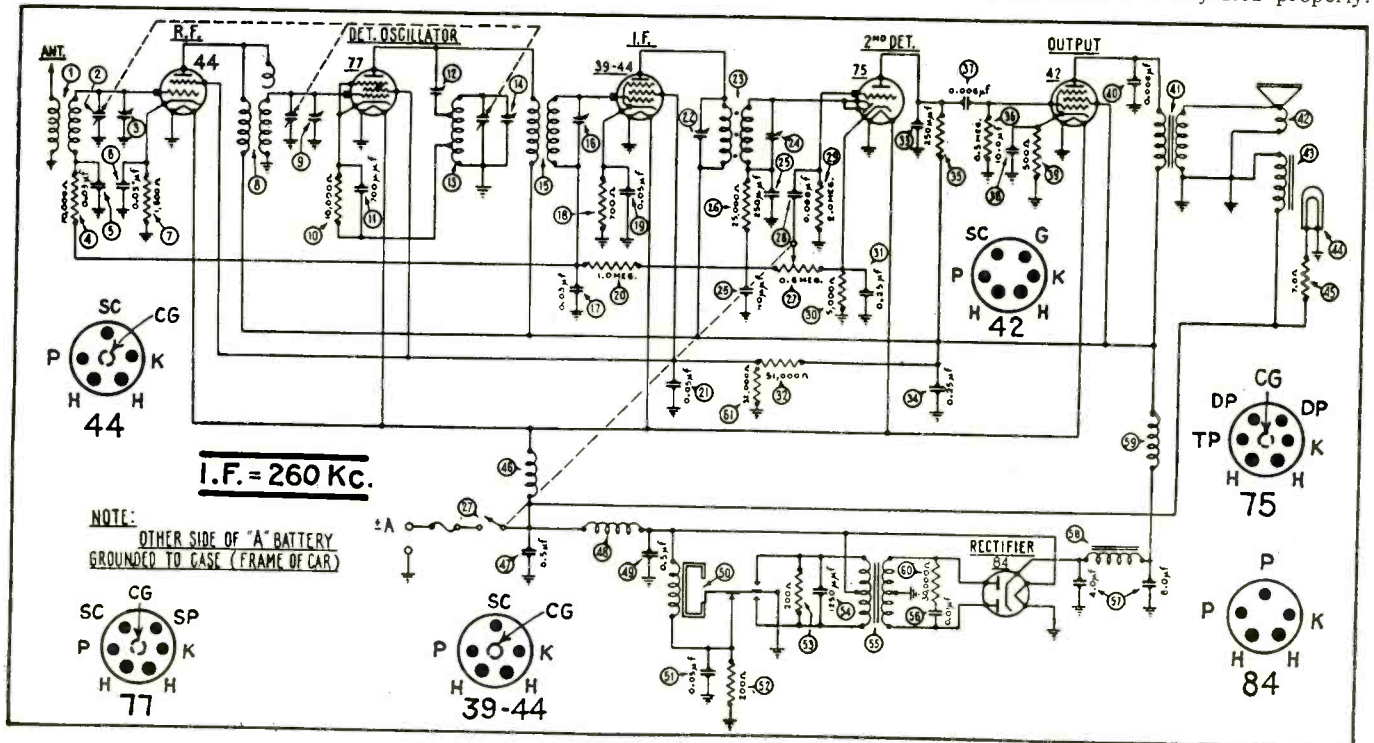

Fig. 1. Circuit of Philco Model 11 auto radio.

HONEST VALUE IN CONDENSERS

Sets serviced with Cornell-Dubilier electrolytic condensers stay serviced...

... because

1. Performance is the standard of honest values in Cornell Dubilier condensers.
2. Twenty-five years of pioneering —of development—of experience is in every C-D condenser.
3. The C-D label is your iron clad guarantee for all around satisfaction.

Now — Cornell-Dubilier is ready to prove that their latest laboratory development on electrolytic condensers—the "Hi-formation" process of manufacturing, makes them the finest in the world.

★ ★ ★ ★ ★ ★ ★



The Type EB single section, Hi-formation dry electrolytic with wire leads.

A quality condenser that is yours at no extra cost.

★ ★ ★ ★ ★

Write for your copy of the new No. 128 catalog—just off the press.

LOOK FOR THE C-D LABEL

CORNELL-DUBILIER
CORPORATION
4375 BRONX BOULEVARD
NEW YORK

OPERADIO

Equipment Adds PLUS VALUE to the Meaning of the Word "SERVICE"

Operadio engineering safeguards the reputation of those who service, sell or use Sound Amplifying Equipment. We present here a few leaders in the Operadio line of Unit-Matched* Equipment.



MODEL 478 ALL-PURPOSE AMPLIFIER

Capacity, 12 watts, Class A output. Adequate for average P. A. job. If extra power is needed our Model 483 Booster may be added at slight additional cost, providing a powerful unit of 36-watt capacity. This BUILD-UP feature is exclusive with Operadio. It's a money-maker and a money-saver.

MODEL 60 PORTABLE P. A. SYSTEM



A compact unit, comprising a powerful Class A Amplifier for maximum undistorted output; heavy duty 10" electro-dynamic speaker; two-button hand-type microphone; specially designed mixing control box and all accessories. All contained in attractive leatherette case.

MOBILE TYPE AMPLIFIER

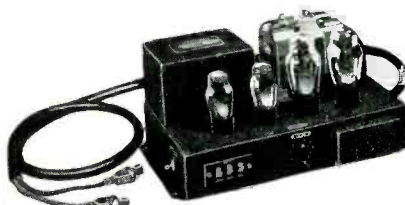

A 6-volt Class A unit, ideal for mobile use in advertising, ballyhoo, electioneering, etc.

Powered with 6-volt storage battery. Output, 18 watts undistorted amplification.

* A complete system composed of parts designed especially to work together, one with the other. Another exclusive Operadio feature.

Get a copy of the Operadio Portfolio for Service Men. It's Free.

OPERADIO MANUFACTURING CO.
ST. CHARLES, ILLINOIS

Something NEW!

LOOK IN AT BOTH NO. 50 DURING THE TRADE SHOW. A number of outstanding new Operadio developments will be exhibited and explained in detail. If unable to attend the show, write us for details of WHAT'S NEW!

Public Address . . .

THE SERVICE MAN and GROUP HEARING AIDS

By PAUL A. BOTTORFF*

THE Service Man has an opportunity of acquiring an additional volume of business by installing group hearing aids for the hard-of-hearing. Throughout the country people have become conscious that certain of their neighbors were unable to attend the theatre, church, lodge, and so on, simply because no satisfactory method of conveying sound to them was at hand. But, with this awakening has come an ever-increasing number of installations designed to aid those who live in silence.

The equipment used consists essentially of a microphone, or in special cases in theatres, a transformer across the main sound line; an amplifier of high quality, wiring, outlet boxes and earphones—all equipment with which the Service Man is acquainted.

INSTALLATION DATA

The microphone used is generally of the two-button carbon type, although of course any type may be used. It should be located as near the amplifier as is possible in order that the numerous difficulties with long amplifier leads may be prevented. In churches the microphone is frequently located in some out-of-the-way location permitting freedom of the entire platform if needed; in fact, when a lecture is to be picked up it is frequently desirable to locate the microphone some distance from the speaker in order that he may move about without causing a great

variation of loudness in the group hearing aid as would be the case if the microphone were very close to the speaker.

If a microphone is used in a theatre, which is frequently the case in small communities, it should be located in such a manner that it will pick up both programs from the stage and from the loudspeaker. In very small theatres where there is very little or no use of a stage and in large theatres in which special microphones are used to pick up programs from the stage to be re-broadcast through the regular amplifier system, frequently a bridging transformer across some part of the sound line is used. This feeds an auxiliary amplifier which raises the sound to the desired level.

It should be noted that in small theatres it is sometimes possible to use the main sound amplifier if a tapped transformer is used.

THE AMPLIFIER

The amplifier should be built by a reputable manufacturer to insure the quality of its performance. In particular the amplifier should have a high-quality output and should be humless. Being free from ac hum is especially important because it is very noticeable when earphones are used.

LOCATION OF OUTLETS

Upon the selection of the location of the outlets depends to a large extent



Fig. 1. Showing manner of mounting outlet box on theatre seat.

the success of an installation. To consider an example, the author would like to mention the case of a theatre which had made provision for the hard-of-hearing several years ago. The seats reserved for this purpose were in the last row of the balcony. Although a well-known theatre, few of the hard-of-hearing would make use of the facilities. When it was realized that the hard-of-hearing would not be segregated the outlets were scattered in groups, several here, several there, and immediately the number of hard-of-hearing patrons increased many times. From a study of a number of installations, and interviews with many having impaired hearing, the author concluded that the group hearing aid installations in which the outlets were all in one group are not nearly as successful as those in which the outlets are scattered.

CHURCH INSTALLATIONS

For a church installation each regular hard-of-hearing member should be permitted to choose the pew desired and with the extra guest outlets in good locations in full view of the speaker. In the case of a theatre installation outlets should be located in groups of two on the seat frames (see Fig. 1) between the first and second seats, and the second and third seats, thus permitting considerable flexibility in seating, since two hard-of-hearing people may then be seated in any of the first three seats. Several or all of these groups of outlets may then be along one aisle, preferably in the rear half of the church. Outlet boxes should contain in addition to the phone jack, a potentiometer volume control to permit the correct volume to be readily attained. It should be noted that the degree of hearing loss varies considerably for different individuals.

The outlet boxes are obtainable in several different types of finishes in



Fig. 2. Showing a typical outlet box, with jack and volume control, and two types of light-weight phones. A bone-conduction unit is shown at the extreme left.



NIKLSHIELD Power Amplifier Kits will insure a profitable P.A. Rental Season

There are many new circuits to choose from within a very broad price range. Compare

NIKLSHIELD "NK-1" KIT

Double push pull power amplifier (56's into 45's) having a peak power output of 14 watts. Normal output 10 watts. Gain 45 db. List price of complete kit with chassis \$27.00.

YOUR NET PRICE
\$16.20

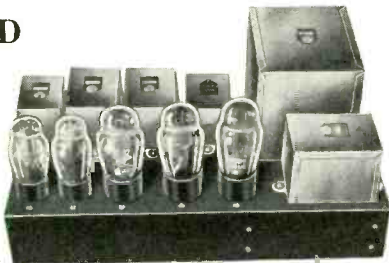

Overall dimensions, 14 x 7 1/2 x 2 1/2

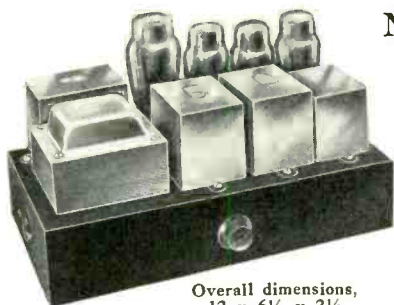

Overall dimensions, 12 x 6 1/2 x 2 1/2

NIKLSHIELD "NK-2" KIT

This three stage 6A6 power amplifier has sufficient gain for use with the newer types of crystal microphones. Gain 108 db. 10 watts output. List price of complete transformer kit with chassis \$19.50.

YOUR NET PRICE
\$11.70

NIKLSHIELD "NK-3" KIT

Three stage 46 class B power amplifier (57-46-46's) Output stage may be connected to voice coils or RF stage. Gain 84 db. 30 watts output. List price of complete transformer kit with chassis \$26.00.

YOUR NET PRICE
\$15.60

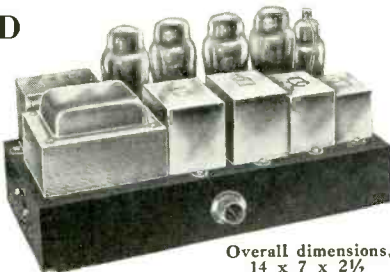

Overall dimensions, 14 x 7 x 2 1/2



Overall dimensions, 16 1/2 x 8 1/2 x 2 1/2

NIKLSHIELD "NK-4" KIT

Three stage push pull parallel fixed bias 2A3 or 45 A prime NIKLSHIELD power amplifier having a normal output of 30 watts (57-56's-445's). Gain 85 db. List price of complete transformer kit with chassis \$33.50.

YOUR NET PRICE
\$20.10

FOR MORE COMPLETE DESCRIPTION WRITE FOR BULLETIN NST

Send for your free Copy Today

UNITED TRANSFORMER CORP.
264 CANAL STREET NEW YORK, N. Y.

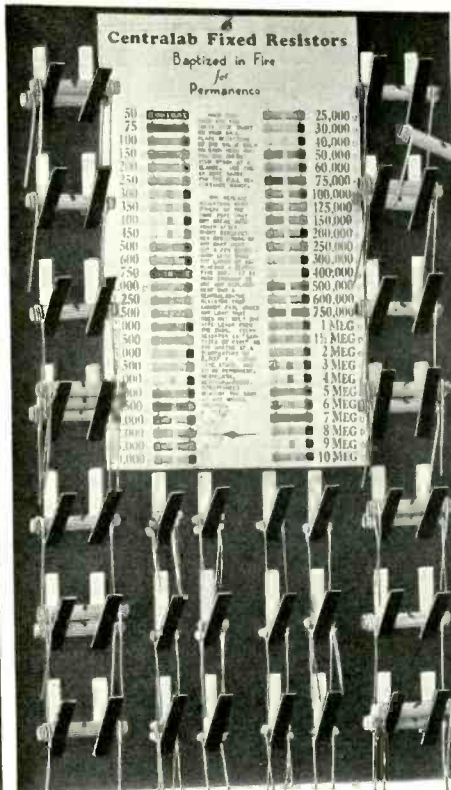

Free!

Centralab HANDY FIXED RESISTOR RACK

Say goodbye to lost resistors . . . throw away the cans and bottles that formerly held 'em. Hang this CENTRALAB RACK on your wall and know at a glance just where they are . . . and what resistance values you have on hand. It is yours absolutely FREE with a

SPECIAL DEAL

consisting of 20 1 1/2 watt 316 type and 20 1/2 watt 310 type CENTRALAB RESISTORS.

The RACK is of heavy sheet metal and will give years of service. The R.M.A. Color Chart is in full colors.

Write for descriptive information today.

CENTRALAB

Division of Globe Union Mfg. Co.

CENTRALAB

900 E. Keefe Ave., Milwaukee, Wis.

Please send me information about your special deal which includes a FREE HANDY FIXED RESISTOR RACK.

Name
Address
City State
My Jobber Is Service



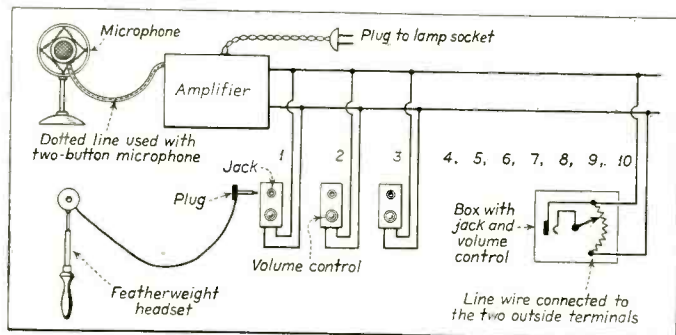

Fig. 3. Circuit of a typical hard-of-hearing installation. Any type of good microphone and amplifier may be used with a system of this sort.

order that they may harmonize with existing furnishings. Generally a white or ivory finish is used in theatres due to their greater visibility in the semi-darkness.

EARPHONE DESIGN

The design of earphones has within the last several years advanced so rapidly that it is no longer desirable to use the old, heavy type of phone; in fact the newer light-weight, flat types are superior in performance, comfort and ruggedness to anything previously available. The phones used should be the product of a manufacturer having a reputation for producing quality and fully guaranteed merchandise, as the entire installation is judged by the quality and performance of the phones. (See Fig. 2.) The essential requirements of earphones is that they be light in weight, comfortable to wear, of rugged construction and especially capable of handling large volumes of sound without appreciable distortion, and their impedance should be such as to match the rest of the equipment.

The lorgnette-type phone, which consists of a single receiver attached to a handle is almost always used in churches, while for the longer, more sustained program of the theatres the single phone with a very light-weight headband is preferred.

SELLING THE JOB

The largest problem of the Service Man is not in installing the equipment, but is in selling the installation to the potential customer. A great deal of this sales resistance is now broken down and the theatres are willing to add this equipment as well as the churches.

To sell the churches it may be possible to learn of one individual who may be hard-of-hearing or who may have a friend with a hearing impairment who will be willing to pay the entire cost of the installation. To this person the Service Man should present the benefit to be derived and the happiness given to the ones thus handicapped.

Another plan is to find someone willing to make the installation as a memorial to honor a father or mother; and still another plan is for the hard-of-hearing people using the service to pay for the equipment personally.

Theatre installations are not put in for philanthropic purposes, but essentially to increase the box-office receipts. Therefore it is absolutely necessary to show that a group-hearing aid will be a paying project. The author is acquainted with a number of installations which have paid for themselves in a relatively short time. One example is that of a theatre seating about twelve hundred located in a suburban town, has an installation of 10 phones and has an average weekly attendance of hard-of-hearing patrons of one hundred and fifty.

GENERAL DATA

(Continued from page 122)

becomes loosened, a poor ground results, causing an intermittent or "fading" hum of the same pitch as the vibrator.

This may be corrected by soldering two additional ground connections of the same type and in the same circuit, one at the type 6F7 socket and one at the type 78 socket. A grounding wire should also be run from the ground circuit heater terminal of the type 75 socket over to the resistor mounting plate which should be grounded.

Mr. Charles Wengert, of the Bushwick-McPhilben Corporation, New York City, who struck upon the cure, states that the above remedy has been successful in all cases.

Vibration in Sparton Models 67, 68, 691

Some Model 67 chassis have a small piece of rubber in the middle of the rear edge of the chassis base plate to prevent vibration against the chassis frame.

If vibration is found in any of these sets, it may be corrected by removing this rubber and placing small strips of

one-inch masking tape along the edges of the base plate, thus preventing the base plate from vibrating against the chassis frame. One end of the tape should be stuck to the top side of the plate, and the other end folded around to stick to the bottom.

This same remedy may be used on any other models causing the same trouble.

Note: Masking tape may be obtained from local hardware and paint dealers.

Addition of Condenser in Sparton Model 36

To protect the life of the vibrator in the Sparton Model 36 Auto-Radio, add a .01-mfd, 1600-volt condenser (Part A-5237) across the secondary winding of the power transformer (Part A-10376) in the Eliminator Unit.

Install this condenser in every Model 36 Auto-Radio set that you may service, adding the cost of the condenser and the installation to the customer's service charge.

Possible Cause of Oscillation in Sparton Models 65 and 66

In case the metal braid shielding on the control-grid lead to either of the type 78 tubes, in the Sparton Models 65 and 66, becomes pushed down on the leads, these receivers may oscillate or otherwise operate improperly.

This shielding may be pushed down accidentally when removing or installing the tube packing, or changing tubes.

Therefore, always pull these shields up to their full length in case of oscillation in the Models 65 and 66.

NOTE

Before attempting to operate a Model 65 or 66, the front chassis screw must be loosened so that the chassis rides freely on the front rubber cushion. If this is not done, the dial pointer may not turn when you turn the knob.

Philco Model 38 (Code 123)

Effective with Run No. 9 a change in the volume control and its circuit has been made in this Model. The Part No. of the new control is 33-5094. The value is the same (20,000 ohms). However, the lead from antenna series condenser (40) is connected to the arm of the control instead of the upper end (in diagram). The upper end is left open.

At the same time a bypass condenser Part No. 6287K (.15 mfd bakelite block) has been added, from the lower end of the volume control to ground.

These changes give quieter operation of the receiver.

"NOISE-MASTER"*

ANTENNA

insures perfect reception



Cat. No. 14, List Price \$6.75

Recommended in locations where there are sufficient "man-made" noises to interfere with radio reception over both the short-wave and broadcast bands. The last word in antenna design, licensed under the Amy, Aceves & King patents Nos. 1,920,162, 1,938,092 and 1,965,539. A highly engineered product which makes one aerial act electrically as two perfect antennas, by automatically selecting the varying frequencies of short-wave and broadcast signals. Two or more sets (preferably not more than four) can be operated at the same time, on the same antenna, by using an additional lower transformer unit on each additional set.

"Explorer"
Cat. No. 11
\$3.70

"Conqueror"
Cat. No. 12
\$3.40

*Combining CORWICO manufacturing skill and the engineering talent of Amy, Aceves & King.

For every set . . . EVERYWHERE . . . this masterly antenna is the Service Man's ideal! Brings in foreign stations stronger—filters out the annoying "man-made" static, heightens the enjoyment of both broadcast and short-wave reception. Service organizations can increase their profits and good will in 1935 by concentrating on this *de luxe* CORWICO unit.



AN IDEAL STORE DEMONSTRATION KIT

—USE THIS COUPON—

CORNISH WIRE CO. Please place us on your mailing list for
30 Church St., N. Y. City information of interest to Service Men.

Name

Address

City..... State.....

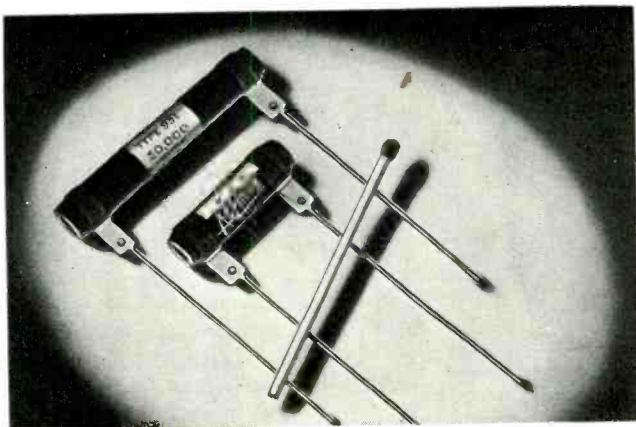

SMALLER yet BETTER!

5, 10, 15, 20 watt ratings. All resistance values.

Quality wire. Refractory tube. Wire ends brazed to lugs. Pigtails soldered to terminal bands.

Vitreous-enamel coating. Permanent seal against moisture and damage.

GENUINE wire-wound vitreous-enamel 10-watt and 5-watt Pyrohm Jr. Resistors . . . smaller than a match! Aerovox engineered . . . for tight places . . . without sacrificing performance or life. Just the thing for those jobs that must stay put. Here's wire-wound security for only a few pennies more.

Send for DATA: New 1935 condenser and resistor catalog on request. Sample copy of monthly Research Worker, too. And remember, Aerovox list prices are usually lower. Aerovox quality is unchallenged. Check these points with your local jobber.



SERVICE DEALERS *learn*
to sell **RADIO SERVICE!**
More Business! Better Business!



FIND OUT NOW WHAT THIS EMBLEM AND NATIONAL UNION CAN MEAN TO YOU

National Union Radio Corp. of N. Y., 400 Madison Avenue, N. Y. C.
Send me the book—"MERCHANDISING RADIO SERVICE" 8335

Name

Street.....City.....State.....

Vacuum Tubes and Their Applications

THREE-ELEMENT TUBE

Fig. 6 indicates diagrammatically a three-element vacuum tube having a grid inserted in the space between the cathode and plate. Normally the grid

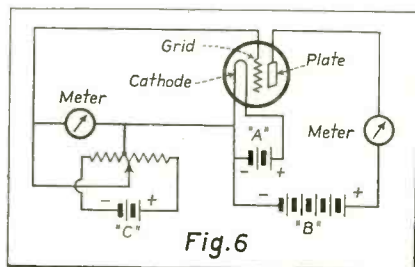

Fig. 6
Vacuum-tube circuit for illustrating effect of grid on electron flow.

will consist of a series of parallel wires with spaces varying from $\frac{1}{4}$ " to about one-hundredth of an inch between them. The plate, of course, normally consists of a solid sheet of metal. Therefore, the electrons boiled off of the cathode by the application of heat will be attracted to the plate in the usual manner, but on their way will be forced to pass through the windows between the grid wires. If the potential of the grid is made positive with respect to the cathode it will, of course, oppose the field set up by the space charge and will tend to accelerate the electron flow. In other words, a positive grid will speed up the electrons from the cathode and increase the number of electrons collected by the plate. Since, by the time they are attracted to the grid, the attraction from the plate will become very strong and most of them will flow through the windows of the grid. However, some of the electrons will alight upon the grid wires setting up a current which will flow in the grid circuit of the tube. Likewise, if a negative potential is placed

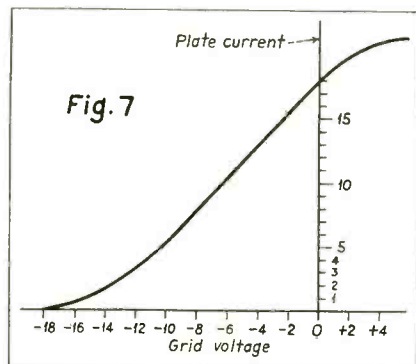

Fig. 7
Typical plate current-grid voltage characteristic of three-element tube.

The third of a series of thumb-nail sketches on the characteristics and functions of vacuum tubes and how they are applied to modern radio-receiver circuits. . . . THE EDITOR

upon the grid it will reduce the plate current. The plate current-grid voltage characteristic of a typical three-element tube is shown in Fig. 7.

TRIODE AS AMPLIFIER

Now if the potential of the grid with respect to the cathode is varied, a corresponding variation will appear in the plate current of the tube. Consequently, if a generator of voltage, such as a microphone, is connected to the grid circuit of the tube, as shown in Fig. 8-A, an amplified variation of the micro-

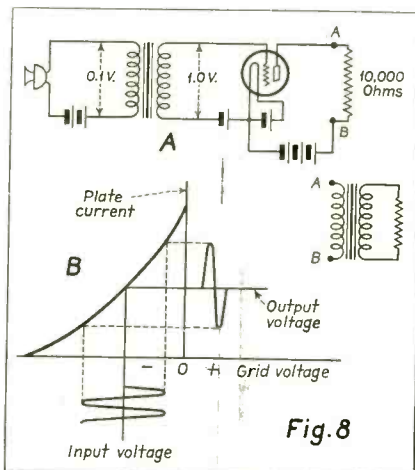

Fig. 8
A shows mike connected to grid circuit of tube. This is an amplifier arrangement. Resultant input and output voltages shown at B.

phone voltage will appear in the plate circuit of the vacuum tube. This will, of course, be due to the fact that the normal plate current of the tube will be increased and decreased in magnitude by the fluctuating potential applied to the grid from the microphone. The arrangement of Fig. 8-A is called an amplifier. It will be noticed that the grid is biased about half way between zero grid bias and the grid bias corresponding to zero plate current (Fig. 8-B).

TRIODE AS DETECTOR

Now suppose it is desired to use the triode as a detector or rectifier. In this case the grid is biased as shown

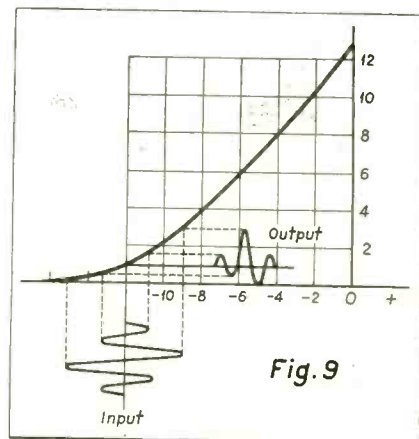

Fig. 9
Resulting input and output voltages when grid is biased to large negative value.

in Fig. 9, so that the normal plate current of the tube is very low. As a result, only positive fluctuations of the grid will cause large variations in plate current. This is shown in Fig. 9.

TRIODE AS OSCILLATOR

Let us suppose that the three-element tube is connected to a three-winding transformer as shown in Fig. 10, and biased as shown in the characteristic of Fig. 8-B; that is, to act as an amplifier. Now, any variation in microphone current such as might be caused by speaking into the microphone, will be transformed into a voltage applied to the grid of the vacuum-tube amplifier. This voltage will then be amplified and will in turn be transferred, by means of the transformer, back into the grid circuit of the vacuum tube. Since this second voltage applied to the grid will be larger than the initial voltage and since this second voltage will again be amplified by the vacuum tube and flow around that circuit as before, it is evident that the pulse of voltage will continue to be conducted around the circuit as long as the tube functions normally.

(To be continued)

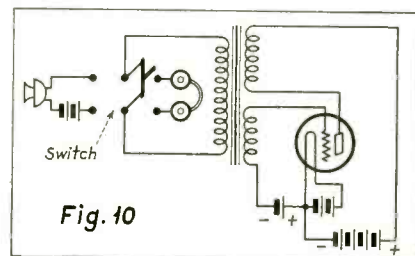
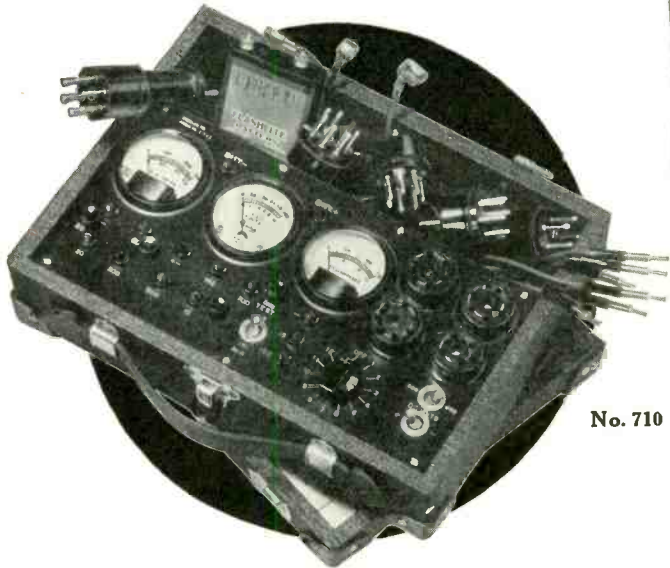

Fig. 10
Circuit used for illustrating triode used as an oscillator.

Here is the
SIMPLEST SET TESTER
 Yet Devised



No. 710

MORE and more, professional service men are turning to the Readrite No. 710 Tester, because it incorporates many advanced features and enables them to quickly and accurately test all types of radios, both new and old. It easily handles the most advanced circuits and newest tubes. This very practical 3-meter set tester is equipped with a selector switch which makes it easy to check all tube circuits by plugging directly into the receiving set sockets.

The selector switch connects all D.C. circuits to the D.C. Voltmeter. Jacks are used to make connections for individual ranges of the different meters. Simultaneous readings of plate voltage, plate current, and heater voltage, can be made. A 4½ Volt battery is furnished for continuity and resistance testing. This unit is furnished with complete instructions and charts for both capacity and resistance tests. The D.C. voltmeter reads 0-20-60-300-600 volts—A.C. voltmeter 0-10-140-700 and the D.C. milliammeter 0-15-150.

AT YOUR JOBBER

No. 710—Dealer's net price \$16.50
 No. 712—Same as No. 710, but equipped with a Triplett D.C. Volt-Ohmmeter, 0-15-60-300-600 volts with 1000 ohms resistance per volt, and 300,000 ohms direct reading scale when used with 4½ volt battery. Dealer's net price 22.20

READRITE METER WORKS

152 COLLEGE AVENUE

BLUFFTON, OHIO

MAIL COUPON FOR CATALOG!

READRITE METER WORKS

152 College Ave., Bluffton, Ohio

Send me a catalog on Readrite Instruments.

Name

Street

City..... State.....

announcing the
KENYON
"SILVER GROUP"



A COMPLETE NEW
 LINE OF AUDIO
 AND POWER
 TRANSFORMERS &
 FILTER REACTORS

This low priced, high performance transformer and reactor group is specially designed for public address amplifier, radio receiver, and radio service applications. Despite its popular price, it conforms to the same high standards of quality and dependability "Kenyon" has pioneered and maintained.

The Silver Group is not "just another transformer line." Kenyon scores again with the presentation of this group of units manufactured for a market which defines an economical transformer as a low-priced unit designed electrically and mechanically to precise application with no unnecessary frills. The Silver Group embodies many distinct advantages heretofore found only in the most expensive units.

1. HOUSING

The Silver Group Transformers and reactors are built into attractive silver cases which act as complete electrostatic and electro-magnetic shields.

2. IMPREGNATION

The Silver Group units are poured with a humidity-proof compound and subjected to a double vacuum impregnation treatment. This important factor assures long life and dependable operation because climatic and atmospheric conditions cannot affect them.

3. MOUNTINGS

The Silver Group can be mounted with a minimum of effort by simply drilling two holes. No lugs can short to chassis assembly. Two more holes permit bringing the lead terminals through the chassis.

4. ADAPTABILITY

All audio transformers were designed for maximum electrical versatility. For example, a single transformer can be used to work from either a 50, 200 or 500 ohm line to a 50, 200 or 500 ohm load.

KENYON

TRANSFORMER CO., INC.

840 Barry Street

New York City

KENYON TRANSFORMER CO., INC.,
 840 Barry St., New York City.

Gentlemen: Please send the Kenyon Silver Group Service Data, which gives complete specifications for all these new units, and which shows numerous amplifier combinations.

Name

Address

My Dealer is.....

ON THE JOB . . .

Kolster Model 6K

Kolster 6K with volume control in series with 26 tube filaments: To replace with efficient control use a dual 10,000-ohm antenna and 25,000-ohm C bias control; remove the old one and short the wiring that went to it. Connect the antenna binding post through a shielded wire to the left terminal; ground the right terminal, and connect the variometer to the center terminal. Then for the bias control (rear element), disconnect the black wire that went to the center tap of the hum control and connect it to the left terminal of the bias control. Connect the center tap of the hum control to the other terminal of the bias control. This can be used on the Zenith sets using filament rheostats, and other makes.

E. M. Prentke.

Filing Technical Data

We receive about a half dozen technical publications each month, as well as about a dozen manufacturers' bulletins, in which there are countless suggestions that may be priceless to us in the future, providing that they are filed in a way that they may be found quickly when needed.

Here is a way we have found to be both efficient and easy: A card file is used for storing three by five inch library cards, and alphabetical indexes are made with the following main headings: "General Index of Receivers, Circuits and Notes"; "General Technical File," and "Public Address," as well as one headed, "Improving Old Sets."

A sample of the card we use is shown herewith, and each month the articles appearing in the various magazines are copied on the cards, showing the make

of set, model number, and description of the article, as well as the name, month, and page of the issue.

In filing articles in manufacturers' leaflets that are not saved, the articles desired are cut out, pasted on cards, and filed under appropriate headings.

In a few years' time this system provides one with a source of information not to be excelled.

Other headings suggested are: "Causes of Hum"; "Causes of Oscillation"; "Intermittent Reception Notes," and so on, to suit the taste of the individual.

E. M. Prentke.

International Kadette

The most common cause for complaint in the International Kadette is the No. 1 or 1-v rectifier tube. These tubes must be replaced often. A new 1-v will nearly always revive a dead receiver of this type. The speaker in this set also is bad about getting out of adjustment. The adjusting screw may be reached with a screwdriver through a hole in the front of the cabinet just to the right of the center.

U. V. Blake.

Removing Wire Kinks

The sharp kinks and bends in small insulated wire are not easy things to remove without damaging the insulation, particularly light silk or cotton-covered bell or magnet wire.

An excellent and very simple home-made device easily put up for this purpose is shown herewith. Saw through one side of a small and inexpensive cord pulley, making the cut wide enough for the largest wire to be handled.

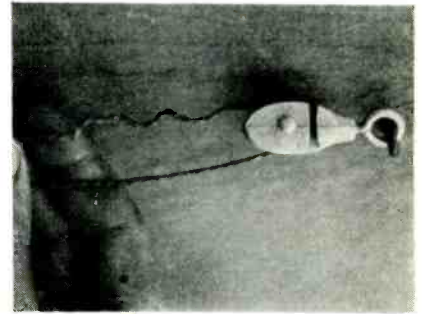

Simply grip the wire with the fingers and draw it back and forth over the small roller. The solid end of the casting below and the rivet neatly molds the roller against the strain of the wire. The wire riding in the bottom of the pulley groove is straightened quickly and easily with absolutely no damage to its insulation no matter how light the covering may be.

The wire needs only to be drawn around the bottom of the wheel groove once or twice and the kinks are taken out nicely.

Frank Bentley.

Silvertone 550, Sentinel 550

Silvertone 550 and Sentinel 550: All socket voltages test o. k., but no signal comes through. If oscillator lead is touched to first detector grid nothing can be heard. However, if lead is put on grid of i-f tube or second detector, the oscillator signal comes through all right. The trouble seems to be in the oscillator circuit, but is really not there.

By installing a new 8-mfd filter condenser from the set side of the filter choke to the common negative return, the set is found to be normal again. The same difficulty applies to many midget superheterodynes.

E. M. Prentke.

Philco 54-C Howl

On the popular Philco Model 54-C receiver an audio howl occurs intermittently on quite a few sets which come into our shop. This howl usually increases as the volume control is increased and generally starts when the edge of the carrier is struck while tuning in a station. The howl was found to be caused by the plate lead from the 43 output tube running across in close proximity to the two diode grids of the 75 second detector. Lengthening and rerouting the plate lead to remove it from the 75 tube will remedy the trouble.

R. E. Walters.

| Model | Make | Mag. | Yr. | Mo. | Pg. |
|-------|--------------------------|---------|-----|------|-----|
| 711 | XYZ Circuit and Notes | Service | '34 | Feb. | 27 |

DO YOU KNOW?

- What equipment is the most desirable and effective for mobile use?
- What type of amplifier has the proper quality for orchestra use?
- How to place the speakers in the average type of school auditorium installation?
- What wattage and what type of sound equipment is required for full coverage of a stadium seating 15,000 people?
- The most suitable pre-amplifiers for use with the new crystal microphones?
- How to plan a centralized control Sound Rack and Panel for multiple speaker installation?
- What type of equipment will give splendid service for theatre use at an amazingly low price?

WEBSTER-CHICAGO Has an Answer for EVERY SOUND NEED..

NO matter what type of sound problem you are confronted with—no matter how complicated or simple the specifications may be—WEBSTER-Chicago can serve you better. We invite you to write to us, to submit your Public Address requirements for the careful personal consideration of our Engineers. We are in a position to recommend complete Sound Systems made up of precisely matched components to cover all types of installation demands. We also place at your disposal the most complete line of individual amplifier units for mobile, portable and permanent application, microphones of advanced design, pre-amplifiers, mixers, baffle speakers, horns, etc. It will pay you to write for the valuable WEBSTER bulletins which will help you sell Sound at bigger profits. Write us about your Public Address needs for complete valuable answers and for the name of your nearest WEBSTER dealer.

WEBSTER AMPLIFIERS TYPES A-30 and B-50

New Webster units built completely into well-ventilated steel cabinets as illustrated. The A-30 is a Class "A" 30 watt amplifier suitable for high fidelity indoor installations. It uses 2-57, 2-56, 4-2A3, 1-83 and 1-80 tubes. The type B-50 is a 50-watt Class "B" amplifier for powerful high volume level operation out-of-doors, in skating rinks, armories, etc. It employs 2-57, 6-59 and 1-83 tubes. Both amplifiers have microphone and phonograph input, with individual controls permitting any degree of "mix." (For further details mail the coupon below.)



Meet Us at the I-R-S-M Show

We cordially invite you to visit our display at the I-R-S-M Convention and Show in Chicago on March 22, 23, and 24. Our Engineers will be on hand to describe and explain the advanced new types of WEBSTER Sound Equipment which will be featured at the Show. Here's a splendid opportunity to discuss your Sound problems and needs with us personally. We look forward with genuine pleasure toward meeting you at the I-R-S-M Show.

WRITE NOW. WEBSTER CO. CHICAGO

The current months offer rich opportunities for Profit in Sound. Outdoor events are in full swing everywhere. Wherever people gather in crowds—at county fairs, at political rallies, at athletic meets—you will find a demand for Sound. And more than ever before, every Church, every School, every theatre and store is a prospect. Don't pass up these opportunities. Let WEBSTER work with you—and help you to better Profits.

THE WEBSTER COMPANY,
3827 W. Lake St., Chicago, Ill.

Send me a complete description of the Webster A-30 and B-50 Amplifiers illustrated above. I am also interested in Sound Equipment as discussed in the letter enclosed.

Name

Address

"SURGPROOF" and "OPENPROOF" TOBE TUBULAR CONDENSERS

Lowest prices consistent with our High Standard of Quality and true ratings

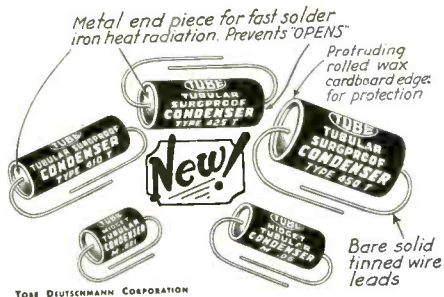

All TOBE products are stocked by the following jobbers in the states listed below:

- (See past issues for other states)
- WASHINGTON**
- Harper-Meggee, Inc., Republican and Terry Ave.....Seattle
 - Seattle Radio Supply, Inc., 2319 2nd Ave.....Seattle
 - Wedel Co., Inc., 520 Second Ave.....Seattle
 - Spokane Radio Co., 611 First Ave.....Spokane
 - Homer King, Inc., 748 St. Helens Ave.....Tacoma
- OREGON**
- Stubbs Electric Co., 33 N. W. Park Ave.....Portland
 - Wedel Co., Inc., 1207 S. W. Washington St.....Portland
- IDAHO**
- Radio Supply Co., 1017 Main Street.....Boise
- BRITISH COLUMBIA**
- Vancouver Radio Engineers, 1009 Robson St.....Vancouver
- TOBE DEUTSCHMANN CORPORATION**
CANTON, MASSACHUSETTS

FOR THOSE EXACTING SHORT WAVE NEEDS

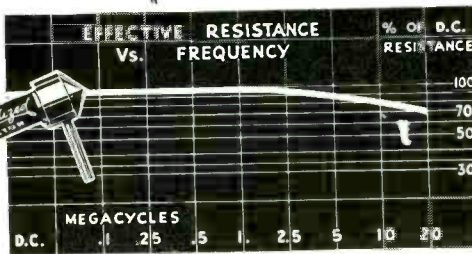
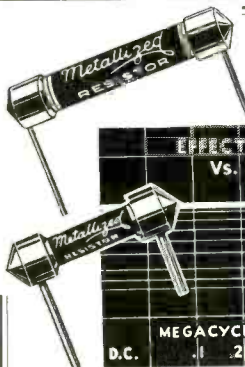

They're NON-INDUCTIVE!

This chart based on an exacting and impartial test by an outside testing laboratory tells its own story of IRC Metallized Resistor performance on high frequencies—only a change of 30% in resistance value on 20 megacycles!

Compare this with 100% and 200% D.C. value changes of ordinary resistors under similar conditions and you will quickly see why IRC Metallized (Filament type) Resistors are unexcelled for the exacting requirements of Short Wave oscillator circuits, AVC filter circuits or as grid leaks across r.f. tubes in addition to all ordinary radio requirements.

You can't go wrong if you standardize on IRC's for every service replacement or amateur need.

WRITE FOR CATALOG

INTERNATIONAL RESISTANCE CO.

2100 Arch St., Philadelphia, Pa.
(In Canada, 187 Duchess St., Toronto, Ont.)



ASSOCIATION NEWS . . .

INSTITUTE OF RADIO SERVICE MEN REPORTS

I. R. S. M. THIRD ANNUAL CONVENTION

The Executive Office of the Institute of Radio Service Men is busily engaged in the final preparations for the Third Annual Chicago Convention and Trade Show that is to be held at the Hotel Sherman, March 22, 23 and 24.

That the I.R.S.M. Conventions have come to be recognized as a potential necessity, filling a vacancy that has existed since radio servicing became a profession and a business, is exemplified by the fact that every one of the available booths was taken a month before the date set for the opening of the Show. The management of the Convention has tried to find a way to expand upon the exhibit space in order to accommodate other applicants who were not prompt enough in sending in their applications.

EXTENSIVE PROGRAM

An extensive program is being arranged. The Exhibition is scheduled to open officially at 2:00 p. m. on the afternoon of March 22nd, but the Convention will not begin until eight o'clock in the evening, when a representative of the Association of Commerce will deliver an address of welcome, which will be followed by a technical lecture that will be of value to Service Men, engineers and amateurs.

SPECIAL MEETINGS

On Saturday morning two very important meetings have been arranged, the first that of the Parts Division of the Radio Wholesalers Association, the second the Service Section of the Radio Manufacturers Association. The distributors' meeting will be conducted by W. C. Braun, Chairman of the Parts Division. The Service Section meeting will be conducted either by E. M. Hartley, Chairman of the Section, or by Jerry Golten, Chairman of the Western Division of the Section.

The Saturday afternoon session is laid out as an informal demonstration period at which time the instrument manufacturers will be arranged around the lecture hall for the purpose of demonstrating their new apparatus, following a general lecture on the subject by L. O. Gorder.

TALK ON TUBES

On Saturday night, the principal speaker will be Walter Jones, of Hygrade Sylvania Corporation, on a subject having to do with the application of vacuum tubes in circuits. Tentative arrangements have been made for Mr. B. G. Erskine, President of Sylvania, to give a short talk, but in the event that he is unable to be present he will be represented by Mr. C. G. Pyle.

Antenna systems will constitute the subject matter for the discussion on Sunday afternoon, and auto radio will occupy the last session of the Convention on Sunday night.

Reports have been received from all parts of the midwest that Service Men, distributors, manufacturers, publishers and others are planning to attend this Convention. Those who were present last year remember

the delegation from Indianapolis and again this year they have requested reservations for a busload and instead of spending one day, they are staying through two of the three days.

From up through Madison, Milwaukee, Sheboygan and other points in Wisconsin, as well as St. Paul and Minneapolis comes the word to reserve a place for them. Down in Louisville, too, they are laying their plans to attend, and in Cleveland, and out through Missouri, Iowa and Omaha.

Altogether, the Third Annual Convention gives promise of being the largest meeting of its kind ever held anywhere, and those who attend will go back to their homes fired with enthusiasm that will give them an incentive to go out and do things that they never thought of doing before.

THE EXHIBITORS

In the Exhibition Hall, too, will be the array of booths in which the products of the leading manufacturers will be on display. Following is a list of the Exhibitors:

AEROVOX CORP.
ALLIED RADIO CORP.
AMERICAN PHENOLIC CORP.
"BOB" ANDERSON.
ARCTURUS RADIO TUBE CO.
W. W. BOYD & CO.
BRYAN DAVIS PUBLISHING CO.
P. J. BURRILL.
CARRON MANUFACTURING CO.
CENTRAL RADIO LABS.
CLOUGH BRENLE CO.
CONTINENTAL CARBON, INC.
L. G. CUSHING.
S. DARMSTADER.
TOBE DEUTSCHMANN CORP.
ELECTRAD, INC.
ELLINGER SALES CO.
FAIRBANKS-MORSE HOME APPLIANCES, INC.
FARKAS & GAINES.
GENERAL TRANSFORMER CORP.
GALVIN MFG. CORP.
THE HICKOK ELECTRICAL INSTRUMENT CO.
D. S. HILL.
T. B. HUNTER.
HYGRADE SYLVANIA CORP.
INSTRUMENT SALES CORP.
INTERNATIONAL RESISTANCE CO.
JEFFERSON ELECTRIC CO.
THE KEN-RAD CORP.
LUKKO SALES CO.
ARTHUR H. LYNCH, INC.
P. R. MALLORY & CO., INC.
MID WEST RADIO MART.
NATIONAL UNION RADIO CORP.
NEWARK ELECTRIC CO.
OHMITE MANUFACTURING CO.
OPERADIO MANUFACTURING CO.
RADIO AMATEUR CALL BOOK.
THE RADIO PRODUCTS CO.
RADIO RETAILING.
RADIO WEEKLY.
THE RADOLEK CO.
RAYTHEON PRODUCTION CORP.
RCA MANUFACTURING CO.
RCA RADIOTRON DIVISION.
READRITE METER WORKS.
LEO REILLY.

JOHN F. RIDER, PUBLISHER.
RYAN, GERALD.
SEARS, ROEBUCK & CO.
SERVICE.
F. L. SPRAYBERRY.
STANDARD TRANSFORMER CORP.
C. O. STIMPSON.
SUPREME INSTRUMENTS CORP.
TECHNICAL APPLIANCE CORP.
THORDARSON ELEC. MFG. CO.
TRIPLET ELECTRICAL INSTRUMENT CO.
TUNG-SOL RADIO TUBES, INC.
TURNER MICROPHONE CO.
UNITED AMERICAN BOSCH CORP.
EARL WEBBER CO.
THE WEBSTER CO.
WESTON ELECTRICAL INSTRUMENT CO.
YAXLEY MANUFACTURING CO.

NORTHWEST SERVICEMEN'S CONVENTION IN MAY

The Northwest Radio Servicemen's Association is sponsoring a Service Men's convention in Minneapolis the 5th, 6th and 7th of May, at the West Hotel. This convention is for Service Men of Minnesota, North and South Dakota, Iowa and the northwestern part of Wisconsin.

The convention committee is making plans for an interesting program and a number of very prominent speakers. This committee will welcome any suggestions and co-operation from associations throughout the Northwest. Jobbers and factories interested in displays are asked to communicate with Mr. R. A. Prehm, Chairman of the Convention Committee, 1406 Fourth Avenue, South.

On Sunday, May 5th, the program will start at 1:30 p. m., immediately after the conclusion of the Mid-American ARRL Amateur Convention, which is being held in the same place the preceding two days. A number of Service Men who are also interested in amateur activities will already be in the city and a large number of other Service Men are expected.

The discount card plan now being started for the Twin Cities will be considered for the entire Northwest.

On Monday evening there will be a banquet followed by an important national speaker and then a stag. Tuesday afternoon prizes will be drawn, followed by adjournment at 3 p. m.

GEORGE HANSON, Chairman.

BOSTON SECTION OF I. R. S. M.

The Boston Section of the I. R. S. M. held a meeting at the Hotel Statler on Nov. 16, 1934. Over 275 members and guests were present. Vice-Chairman Ingvar Paulsen presided.

Mr. Aiken, Engineer, of the RCA Victor Co. was the main speaker. The recent development of the Terra Wave Police transmitters and receivers was discussed; the advantages of this type of transmitter over the "conventional" police transmitter were brought out. The actual operation of this Terra Wave transmitter was witnessed by those present.

Improved methods of phonograph recording and reproduction were demonstrated and also application of phonograph attachments for existing radio receivers was discussed.



Send for . . .
**SERVICE
 ENGINEERING
 BULLETIN 102
 FREE!**

It tells you how to:

- Modernize a 1 M.A. Meter
- Make a Decade "R" Box
- Measure Voltage Characteristic and
- Determine the Proper Size

**CONTINENTAL CARBON
 Resistors for every job!**

**CONTINENTAL CARBON
 Manufactures all sizes of Neutral-Po-
 larity Paper Dielectric Condensers for
 Replacement Service.**

Write Now! Latest Bulletins! Free!



13912 Lorain Avenue, Cleveland, Ohio



Type B Mounting

**Successful
 Servicing**

depends upon the care in which you handle each job. Your work must be intelligent and thorough. Every detail must be attended to. Every joint a perfect joint.

But if the joints you make must be perfect, even more important are the invisible connections in the transformers you use. Halldorson **FULL REGULATION** Transformers are famous for their reliability. Every joint is scientifically made, carefully inspected, rigidly checked, and subjected to a severe break-down test. Your servicing will be successful if you use Halldorson **FULL REGULATION** Transformers.

Halldorson Transformers with **FULL REGULATION** insure correct voltage even on overload, which means better tone quality and better volume.

THE HALLDORSON COMPANY
 4500 Ravenswood Avenue, Chicago

Write for new replacement bulletin listing complete line, including new universal outputs for A.C. and D.C. midgets—Free!

Halldorson
Replacement **Transformers**

This **TRIPOLET**
Universal Tester Is A
COMPLETE SERVICING OUTFIT

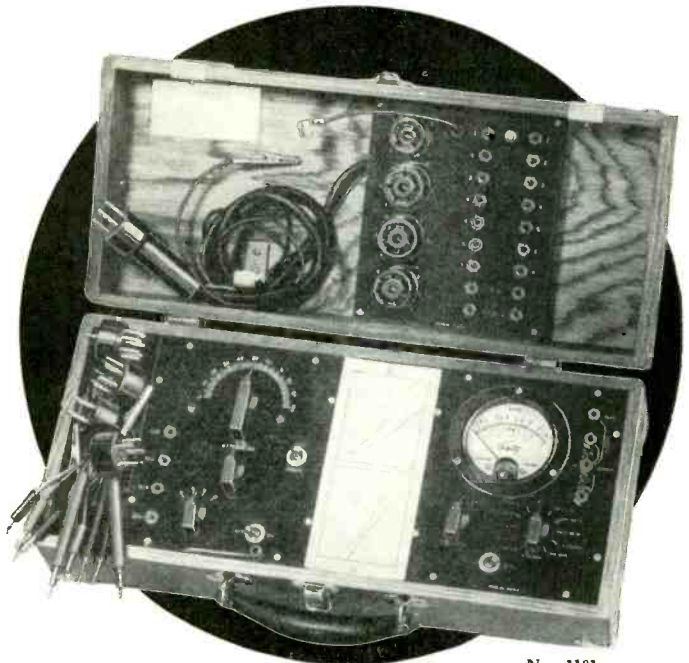

No. 1181

EVERY needed test that a service man has to make can be handled by this compact Test Set. Consists of three essential units:

Volt - Ohm - Milliammeter with precision universal meter, reading both A.C. and D.C. volts at 1000 Ohms per volt, up to 750 volts; Milliampers up to 150, both A.C. and D.C., and resistances up to 3 megohms. Complete with batteries.

Free-Point unit is fastened in the tester cover. When used in conjunction with the Volt-Ohm-Milliammeter, all voltage-current-resistance tests can be made direct from the radio set sockets. All-Wave Signal Generator covers frequency ranges from 110 to 18,000 Kc. Frequency stabilized. Attenuation perfected for all sets. Hand calibrated charts. Tube furnished. This improved unit is an outstanding part of the 1181.

The handsome quartered oak case in which it comes will appeal to every professional service man.

No. 1181 . . . Dealer's Net Price . . . \$38.00

Your Jobber Can Supply You

THE TRIPLET ELECTRICAL INSTRUMENT CO.

137 Main St.

Bluffton, O.

Mail today for details!

THE TRIPLET ELECTRICAL INSTRUMENT CO.
 137 Main St., Bluffton, O.

Gentlemen: Send me catalog on Triplet Universal Test Set, and complete line of radio servicing instruments.

Name

Street Address

City..... State.....

HIGHLIGHTS...

IMPORTANCE OF ELECTRONIC DEVICES IN SERVICING

The use of the cathode-ray tube or oscillograph in servicing promises to increase within the next few years to a point where it will be the most important and most widely used method of testing radios, according to F. L. Sprayberry of Washington, D. C., whose "Practical Mechanics of Radio Service" is well known to Service Men.

"Up to now," states Mr. Sprayberry, "it has not been possible to determine the individual characteristics of a tuned r-f or i-f stage. All that could be done was to connect your output meter to one or more stages and adjust the trimmers for maximum scale deflection.

"This did not tell you if one stage was over-coupled, had 'double humps' or was oscillating. For instance, most Service Men have aligned many receivers to what they thought was perfect adjustment, yet when tuning to actual broadcast channels, they found distortion, oscillation, etc. Then they had to back off on the trimmers to get practical, stable adjustment. Even then they could not be sure of correct adjustment. All this was due to lack of a precise instrument which would indicate beyond a doubt the exact conditions in any tuned circuit.

"The cathode-ray tube now comes to your rescue, and for the first time you can duplicate the adjustments that the factory and laboratories are able to apply to a receiver. With the aid of an Oscillograph you can actually see the pattern of the curve of a tuned stage.

"The above is just one single application of the Oscillograph—it has hundreds of other uses in every radio repair shop in this country and many more will be developed in short order as the use of the instrument progresses."

Citing the rapidly growing importance of electronic devices, Mr. Sprayberry points out the need for complete and careful study on the part of Service Men in order that they may be qualified to apply these instruments intelligently. Thus, included among other improvements designed to keep it fully abreast of rapidly changing service trends, three comprehensive lessons on the Oscillograph have just been added to "Sprayberry's Practical Mechanics of Radio Service." While valuable to beginners as well, the Sprayberry Course has been specifically designed for those already in the service business who recognize the necessity for constant advanced study as a means of insuring their business future.

CONSOLIDATED SUPPLEMENT

In keeping with its policy, the Consolidated Wire Corporations of Chicago, Illinois, has just issued a new supplement in which is featured a variety of all-wave antennas. These are constructed along the doublet, Hertz half-wave, and Marconi quarter-wave systems and are designed for operation with all of the popular receivers.

In addition are featured a number of late developments in the antenna accessories field. A copy of this supplement can be had from the Consolidated Wire & Associated Corporations, Peoria and Harrison Streets, Chicago, Illinois.

NEW CORNELL-DUBILIER CATALOGS

Three new 1935 catalogs are announced by the Cornell-Dubilier Corporation, condenser manufacturers, of 4377 Bronx Boulevard, Bronx, N. Y.

Catalog No. 128 (16 pages) is for use by radio parts distributors, dealers, Service Men and amateurs. It lists a wide variety of mica, paper and electrolytic condensers in many capacities, voltage ratings and sizes for general radio applications. Supplementing this, is Catalog No. 129, which contains a comprehensive listing of standard types of replacement condensers of both paper dielectric and electrolytic construction.

For manufacturers and engineers, a special industrial catalog bearing the number 127 has been compiled. This contains much useful information on the use of condensers in power-factor correction, motor starting, high-voltage circuits, etc.

Copies of these catalogs are available free of cost to users of condensers. Requests should be mailed directly to the main office of the Cornell-Dubilier Corporation at the above address.

RCA VICTOR SERVICE MEETINGS ON AUTO RADIOS

Following closely a successful series of Service Men's meetings on antenna systems, a new series will be devoted to an analysis and study of the newest RCA Victor auto-radio receivers. Another interesting feature of the programs will be a description and display of a new automobile antenna system which RCA Victor engineers have designed to meet the problems of providing noise-free reception in the new, steel turret-type automobiles. The new RCA Victor auto-radio receivers which will shortly be announced to the trade will be demonstrated to the radio technicians and their circuits analyzed with the aid of the RCA Cathode-Ray Oscillograph.

RADOLEK P-A BOOKLET

The Radolek Company, 601 West Randolph Street, Chicago, offer free to radio Service Men and public-address engineers a 24-page booklet describing the latest 36-watt, 10-tube Radolek amplifier and giving an interesting three pages to "Where and How to Make Money With a Radolek Dual Crystal P-A Amplifier." This section was written for the Radolek Company by one of their most successful customers, it is said. Two pages, also, are devoted to the prevention of feedback. List prices on amplifiers and associate equipment are quoted, thus permitting the use of this book as a sales manual.

RAYTHEON BULLETIN

The Raytheon Production Corporation, 30 East 42 Street, New York City, have available a bulletin describing various items designed for the Service Man. This bulletin describes such items as a suede bag, repair kit, pocket edition trouble-shooter, tube stickers, window and counter displays, and the like. These items are available at a minimum price when accompanied by a specified order for Raytheon 4-Pillar Tubes.

RADIO-INTERFERENCE STICKERS

The Tobe Deutschmann Corporation of Canton, Mass., are now distributing throughout the country radio-interference stickers. These stickers inform the reader that the war on interference is their war. This sticker is said to have been first introduced by Tobe Deutschmann in 1928, a time when few gave much consideration to the thought of radio noises.

TRANSFORMER COMPONENTS

The United Transformer Corporation, 264-266 Canal Street, New York City, New York, have available a catalog on Transformer Components. This 24-page catalog contains a great amount of technical data, circuit diagrams and the like. Also included is a very useful chart for determining values of L, C and R at different frequencies.

FLECHTHEIM TENTH ANNIVERSARY

A. M. Flechtheim Company, Inc., of 136 Liberty Street, New York City, is celebrating its ninth successful year of activity in the radio industry, having started in 1925. Leading distributors and retailers throughout the United States handle Flechtheim condensers and resistors.

An interesting new booklet illustrating and describing the entire Flechtheim line will be mailed upon request.

TUBE BASE CONNECTION FINDER

The National Union Radio Tube Base Connection Finder dial designed and perfected by Mr. W. M. Perkins of the National Union Laboratory went into a third edition this week, brought up to the minute with the showing of connections for eighty-five different tube bases.

The device is a series of three cardboard circles and quickly gives readings through holes punched in the two outer pieces. It is compact and can be slipped into the coat pocket or carried in the tool kit with ease.

NEW SPOKANE RADIO CATALOG

The Spokane Radio Company, Inc., 611 First Avenue, Spokane, Washington, have available their 1935 Wholesale Catalog covering Radio Parts, Accessories and Sound Equipment. That the catalog is quite complete is evidenced by the fact that this catalog contains some 228 pages.

The Spokane Radio Co. are basically a supplier of radio and sound equipment of all kinds (with the exception of broadcast receivers).

HATRY AND YOUNG OPEN NEW BRANCH

Hatry and Young, 203 Ann St., Hartford, Connecticut, wholesale radio distributors, announce the opening of a new branch at 86 Meadow St., New Haven, Conn. The Hartford store is well known throughout Connecticut to Service Men, dealers and amateurs; and has enjoyed a consistent and steady growth of business even during the depression years.

Service Men and dealers throughout Connecticut are contacted weekly by the Hatry and Young "Radio Wagon".

• SERVICE FOR

GREETINGS

to Members of

I. R. S. M.

Chicago Convention

May you live long and prosper and always use—

Curtis
Electrolytic
CONDENSERS



Patent No. 1950352

CURTIS CONDENSER CORPORATION

3088 WEST 106TH ST. CLEVELAND, OHIO



Model 390 VC

GONE are Cone Replacements!

A WRIGHT-DECOSTER chassis can now be purchased for practically the same price as it costs to install a cone. The patented solid center spider removes the "grief" by keeping dust, grit and filings out of the air gap. Dollars ahead in sales, more profit and a thoroughly satisfied customer result from the installation of a WRIGHT-DECOSTER chassis. There is one to fit every radio.

Model 390 VC—5-inch Chassis—\$3.90

The better automobile sets have separate speakers because they can be placed in exactly the right position to give the best results and may be equipped with a cord for operation outside the car. Any good radio can be greatly enhanced by the installation of a separate speaker.

Model 780 VS—\$7.80

Write for complete catalog, dealer's discount and name of nearest distributor. You will find the Wright-DeCoster distributor anxious to cooperate in every way possible.

Wright-DeCoster
Incorporated

2253 University Ave.
ST. PAUL, MINN.

Export Dept.: M. Simons & Son Co.
25 Warren St., New York

Cable Address:
SIMONTRICE, New York



Model 780 VS

**AUTO-RADIO
POWER SUPPLY
SERVICE
MANUAL**

ORIGINAL
PIONEER GEN-E-MOTOR CORP.
140 W. Superior St., Chicago, U.S.A.

Free AUTO-RADIO POWER SUPPLY SERVICE MANUAL

How to service an Auto-Radio so that you can GUARANTEE the job and make money on it! The thing that gives you the most trouble—power supply—is *thoroughly* covered in this manual. It is invaluable. Get your FREE copy before the supply is exhausted and before the summer season starts!

TEAR OUT THIS AD, pin it to your letter-head (or write your name and address in the margin) and mail it together with 12c in stamps to cover costs of postage, addressing, mailing, etc.

ORIGINAL
PIONEER GEN-E-MOTOR CORP.

458D W. SUPERIOR ST., CHICAGO, U. S. A.

See our announcement to the Auto-Radio owner in the March 23, SATURDAY EVENING POST

THEN THEY CAME! TO SPRAYBERRY!



"I AM A GRADUATE of three other home study schools—yet can truthfully say it was worth while in every sense to have taken your course."—HORACE W. HART, Yonkers, N. Y.



"I WANT TO SAY that the Sprayberry Course is the finest I have ever seen. It contains more information than many other courses combined."—A. WALMSLEY, Vancouver, B. C.



"I HAVE TAKEN several radio courses, but none which have compared with yours. Sprayberry's is the best I have ever seen."—LOYD HENDERSON, Grinnell, Iowa.

SPRAYBERRY'S PRACTICAL MECHANICS OF RADIO SERVICE

NEWS FLASH!

Our three new complete lessons on the use of the Cathode Ray Tube or Oscilloscope may prove to be worth more to you than the surprisingly low price asked for the entire course!

F. L. SPRAYBERRY
2548 University Place, N.W.
Washington, D. C.

Sure—send me the dope—free! Also tell how I can get the NEW SERIES of Sprayberry Data Sheets at no extra cost.

Name

Address

S-3/35

THE MANUFACTURERS . . .

DAYRAD TEST EQUIPMENT

The Radio Products Company, Dayton, Ohio, now have available their new line of Dayrad Radio Service Instruments. This new line includes meters, condenser testers, tube testers, conductance testers, signal generators, output indicators, set testers, milliamperes volt-ohmmeters, and the like.

The "Tri-Test" Portable Checker Series 20 has been designed to test all present tubes with ample provision for future types. This instrument has a 400-volt dc meter range and a 40,000-ohm calibrated ohm-meter range. This unit will check resistors, dial lights, ballast tubes and condensers. A similar unit is available for counter uses and is known as the Series 22.

The Series 60 Output Indicator has been designed around a sensitive, differential type neon glow lamp. High- and low-impedance outputs may be measured through the use of an impedance-matching transformer built into the circuit.

The Series 26 Grid Shift Mutual Conductance Tube Tester is a store or service laboratory instrument designed to test all present tubes with provision for future types. Tubes may be tested in normal circuit. Line-voltage control operates over range from 105 to 135 volts. Series 24 is the similar portable unit.

Series 28 Signal Type Dynamic Mutual Conductance Checker tests tubes as they operate in the set. This unit applies dc plate, screen and bias voltage; applies ac grid signal to control grid; and measures output on Bridge Type Meter connected to Universal Shunt System. Operation is from 110-volt, 60-cycle ac.

The Series 56 "Mult-O-Meter" is a milliamperes volt-ohmmeter covering volts and mils dc and volts ac in the following ranges 0—5, 0—25, 0—125, 0—500, and 0—1250. The following ohm ranges are also available: 0—3000, 0—30,000, 0—300,000 and 0—3,000,000.

Another test instrument is the Series 14 Tube Tester which operates on 105 to 125 volts, 60-cycle ac, and which uses a basic circuit that gives complete test on all types of tubes. A similar unit adapted for 25-cycle operation is available.

Of particular interest, however, is the Series 36 All-Wave Signal Generator which is shown in one of the accompanying illustrations. This unit has a range from 60 to 60,000 kc (or 5000 to 5 meters).



Dayrad All-Wave Signal Generator.

The ranges are: 50—180, 165—550, 500—1600, 1500—4750, 4500—17,500, 16,500—62,000 kc. The dial is of the airplane type and is direct reading, no charts being required; and a neon tube output indicator is built in. This signal generator has available a 400-cycle audio for external use. Operation is from 110-volt, 60-cycle ac, a Faraday shield being used to isolate the ac line. A three-section attenuator controls both high and low outputs. The Series 38 is also a signal generator, but is battery operated. This latter unit covers the frequency range from 100 to 20,000 kc.

The unit shown in the other illustration is the Series 54 Radio Set Tester. This instrument has the following scales for volts (ac and dc) and mils dc: 0—5, 0—25, 0—125, 0—500, and 0—1250. Ohms are measured in three scales, namely, 0—30,000, 0—300,000 and 0—3,000,000. The meter is arranged to be connected in any of the milliamperes, dc volt, ac volt, ohms, output volts condenser leakage or tube circuits through a special circuit selector switch. It is not necessary to use plugs and leads. Condensers are tested on their rated voltages through the use of a self-contained power pack furnishing dc potentials up to 500 volts. The leakage value is indicated directly on the meter scale. Uses



Dayrad Series 54 Radio Set Tester.

type 80 tube for leakage and three megohm resistance scales. A 4½-volt C battery is used on all other ohm scales. The Dayrad "circuit selector" analysis method is used to read voltage, current, and circuit constants through the plug and cable set connection.

Four-inch, square-type, switch-board meters are used with all of the different instruments mentioned here with the exception of the Series 14 Tube Tester. These meters, designed by Dayrad, have a 3¼-inch scale length. The movement is a high torque d'Arsonval type with light moving coil, reinforced bridge, and jewel bearings. Standard, 0—1 milliamperes, 1000 ohms per volt.

A catalog covering all of this equipment is available from the Radio Products Company. Write for Bulletin 50.

"TESRAK"

A rack for holding radio chassis and the like, so that they may be held and rotated



in any position while servicing, is now being manufactured.

It is said, that the set may be running while the necessary tests are being made, and that the set may be revolved without jar to tubes, intermittent by-pass or coupling condensers.

The Tesrak, manufactured by the Test Rack Company, 314 Talbot Ave., Akron, Ohio, enables the operator to work with both hands while the set is held firm and also allows the set to be observed from top and bottom without disturbing.

LYNCH DRI-LECTRIC CONDENSERS

The Lynch Manufacturing Company, Inc., 405 Lexington Ave., New York, N. Y., are presenting to the trade their new Dri-Lectric Condensers. These units have been designed to give longer life and better service, it is stated.

After several years of research the Lynch Manufacturing Co. are said to have developed an electrolyte which is a single chemical and not a mixture, there being no tendency (as a result) during manufacture or life for the parts to separate and no tendency for a change in the characteristics. This gives a uniform product and maintains a higher degree of efficiency during both shelf-life and active service. Other features claimed for these condensers are: Electrolyte has characteristic of being non-soluble towards the oxide coating, permits higher overload voltages, peak voltage increases with shelf-life, and low-leakage current.

These condensers may be obtained for operating voltages of 25 to 500 volts, the capacity ratings being from 2 to 500 mfd.

WELLING GENERAL MANAGER POLYMET

The Polymet Manufacturing Corporation, 829-839 East 134 Street, New York City, N. Y., recently announced several changes in their executive personnel. Leonard C. Welling, well-known pioneer in the field of radio, is now acting as the General Manager of Polymet; while Mr. James H. Herrick and Mr. E. B. Tyler have assumed their duties as President, and Vice-President and Sales Manager, respectively.

It has also been announced that several new condensers have been added to the Polymet line.

• SERVICE FOR

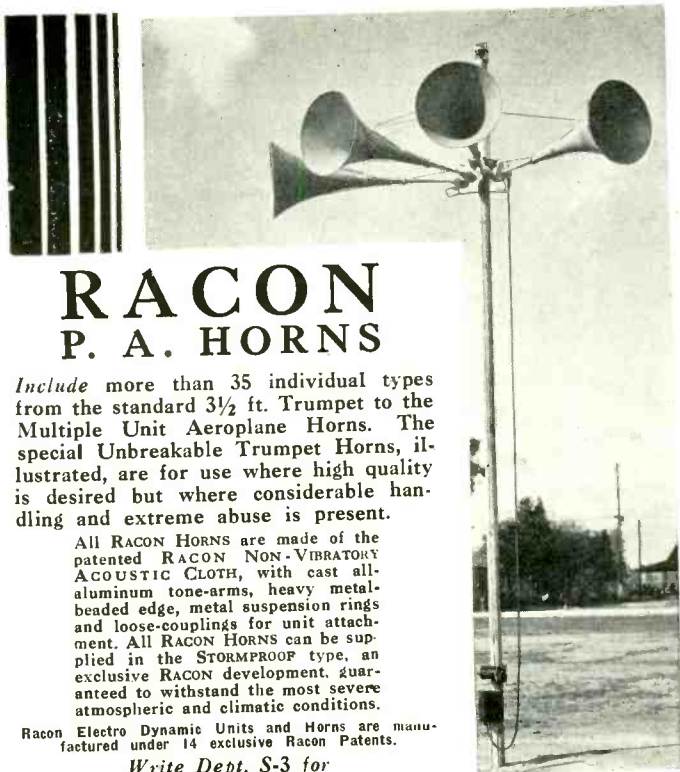

RACON P. A. HORNS

Include more than 35 individual types from the standard 3½ ft. Trumpet to the Multiple Unit Aeroplane Horns. The special Unbreakable Trumpet Horns, illustrated, are for use where high quality is desired but where considerable handling and extreme abuse is present.

All RACON HORNS are made of the patented RACON NON-VIBRATORY ACOUSTIC CLOTH, with cast all-aluminum tone-arms, heavy metal-beaded edge, metal suspension rings and loose-couplings for unit attachment. All RACON HORNS can be supplied in the STORMPROOF type, an exclusive RACON development, guaranteed to withstand the most severe atmospheric and climatic conditions.

Racon Electro Dynamic Units and Horns are manufactured under 14 exclusive Racon Patents.

Write Dept. S-3 for Complete Details

RACON ELECTRIC CO. INC.

52 East 19th St., New York, N. Y.

London, Eng.

Toronto, Can.



"E. H. Rietzke
SPEAKING!"



Mr. E. H. Rietzke, President of CREI and originator of the first thorough course in Practical Radio Engineering.

Are You ASKED ... or TOLD How To Service a Job?

TECHNICAL TRAINING is the difference between the "boss" and the service man. One ASKS how a job should be done . . . the other TELLS how! Of the thousands of Service Men in Radio, there are not many who take the time to train themselves for better jobs and a brighter future. Being BETTER than your requirements is a big step toward a BETTER JOB!

CREI Home-Study or Residence Instruction
Is Not Over the Heads or Budget
of Any Service Man

C.R.E.I. has hundreds of Service Men now studying the home-study courses . . . some have actually given up their jobs to come to Washington for Residence School training . . . that's real AMBITION! Write us today for full details of our various courses and how easily you can pay for them.

FREE! New 44-Page Catalog, which includes an answer for all of your questions; and pictures of our equipment, laboratories, etc.



Capitol Radio Engineering Institute

Dept. S-3

14th & Park Rd., N.W., WASHINGTON, D.C.

Oxford Dynatest... Speaker

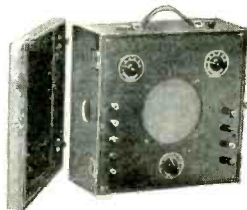

- For All Radio Sets!
- Locates Trouble!
- Simplifies Testing!
- Saves Your Time!
- Easy to Use!
- In Portable Case!
- Handles 5 to 10 Watts!
- List Only \$22.50!

A UNIVERSAL TEST SPEAKER for SERVICEMEN

Tapped Field Coil matches any speaker field supplied from the rectifier section of a radio set! Special Coupling Transformer with six taps matches any voice coil circuit to the Dynatest Speaker. Universal Coupling Transformer matches any single or push-pull tubes to the Dynatest Speaker Circuit.

Rotary switches and combination plug binding posts make connections easy. SEE THIS NEW DYNATEST SPEAKER AT THE I.R.S.M. BOOTH 32-33.

Ask Your Jobber To Show You This Speaker. . . . Write for Free DYNATEST SERVICE INSTRUCTIONS

OXFORD RADIO CORP.
350 W. Huron St. Chicago, Ill.

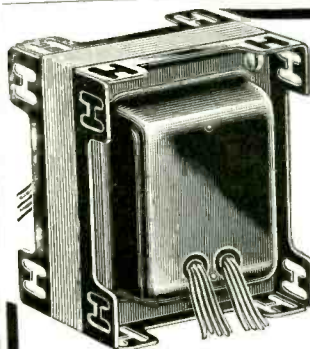

"Multi-Tap"
(Trademark)
**POWER
TRANSFORMERS**

STOCK OF ONLY FIVE (5)

Power Transformers provide immediate renewal of original performance in case of trouble in the transformer—the heart of the radio—in

any of more than 95% of all receivers, whether "orphanned" or current models.

PATENT CLAIMS ALLOWED!

. . . that protect distributors and their service engineer customers in the full profit to which they are entitled—placing the radio servicing profession on a staple basis.

CIRCUIT COMBINATIONS DEMONSTRATED
at I.R.S.M. 3rd Annual Convention and Trade Show
March 22-23-24, 1935—Hotel Sherman, Chicago—Booth 21
U—R—INVITED

Free for the Asking!

"Multi-Tap" Guide, listing 2114 Models of radios which you can immediately service with one of only five (5) "Multi-Tap" Power Transformers.

GENERAL TRANSFORMER CORP.
502 SO. THROOP STREET, CHICAGO, ILLINOIS

MAIL THIS NOW

GENERAL TRANSFORMER CORP.
502 South Throop Street, Chicago, Ill.

Send me without charge my copy of the "Multi-Tap" Guide, and name of nearest distributor.

Name
Address
City State

BRUSH-SUPPRESSOR FOR FORD V-8

A recent automotive-radio development now being manufactured by The Ohio Carbon Company, 12508 Berea Road, Lakewood, Ohio, is a carbon brush containing high-resistance material and designed for use on radio-equipped Ford V-8 cars. As all radio men know, it is customary when installing radio sets in cars to introduce resistance between the distributor and the coil. This was not previously possible in the case of the Ford V-8 car because of the combined distributor-coil unit. The new brush, however, fulfills the same function. In developing this brush the manufacturers state that its long-wearing and other qualities have been in no way sacrificed.

HIGH-FIDELITY AMPLIFIER

Radolek announces two new p-a amplifiers which are said to combine the features that usually require three or four separate pieces of equipment, in one chassis. The unit is shown in the accompanying illustration.

Its features follow: Combines two pre-amplifiers with a voltage-gain amplifier and an 18- or 36-watt power amplifier, using 7 or 10 tubes; handles one or two crystal microphones without circuit changes

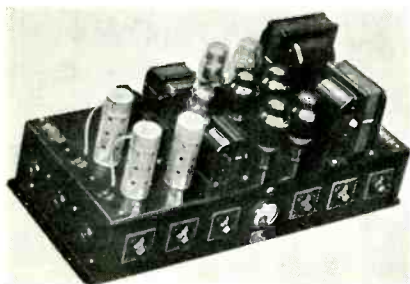

or one or two ribbon or dynamic microphones with grid-input transformers separate; provides input circuit for any other electro-acoustical source to be coupled to second stage of one pre-amplifier in place of a microphone, (40 db less than maximum gain); any two input sources may be mixed or faded in any proportion and individual tone control is provided for each circuit; employs a master, overall, tone control; and also a master volume control.

Special 2" ac meter indicates volume level of entire output. Both plug-in and terminal connections for microphones and one to three speakers are provided, speaker field supply being of the 400-volt, 40-watt type. This unit delivers 36 watts with less than 5 percent distortion and can be pushed up 4 watts further.

Less than 1/10-watt hum voltage is said to be present in output at full volume and proportionally less at lower volume levels. Audio range is from 40 to 12,000 cycles, with all tone controls open. Conventional Edison base, 3 amp fuse. It has been designed for 115-volt, 60-cycle ac.

RCA PHONOGRAPH OSCILLATOR

The RK-24 Phonograph Oscillator is a small broadcast-band oscillator unit designed for use with the RCA Victor Record Player (Model R-93). It may be attached to radio sets of all kinds and types. In addition to its primary use with the



R-93, it may also be used for attaching any type of magnetic pickup to any type of receiver with but slight modifications.

The primary purpose of this Phonograph Oscillator, shown in the accompanying illustration, is to insure proper phonograph reproduction within the limits of the receiver, avoiding the necessity of any circuit changes.

Of particular interest is its ability, through the use of the 6A7 or the 2A7 tubes, to be used with receivers having either 2.5-volt or 6.3-volt heater-type tubes.

The RK-24 is actually a miniature transmitting station, modulated with the output of the phonograph pickup. As the frequency range of the pickup is usually equal to or better than the transmission range of the ordinary broadcasting station and there is no intervening factor such as fading and distortion due to transmission, the phonograph quality is said, in practically all cases, to be that obtained with the very best possible local broadcasting stations to which the receiver may be tuned.

NEW REPLACEMENT SPEAKERS

Sonochorde Sales Company, 200 Boston Avenue, Medford, Mass., offers a new line of electro-dynamic replacement speakers in four sizes:—5", 6", 8", and 11". Two types of automobile speakers are also available.

Through a wide variety of field and transformer values, seven hundred and forty-one different combinations can be supplied.

Diaphragms are of high-quality acoustic material and the 5-ohm voice coil is supported by the Sonochorde "wave-form" spider. Normal power, 4 to 12 watts; with re-inforced voice coil, 4 to 20 watts.

A unique assembly method enables any speaker to be completely taken apart, cleaned and reassembled in a few moments without the usual difficulty in securing proper pole clearance, it is stated.

Tests run on these speakers are also said to show a highly efficient response.

NEW BELL PA SYSTEM

The New Model P-A, 3C, shown, is a complete 15-watt public-address system, and is self-contained in two sturdy portable carrying cases.

The amplifier uses a four-stage resist-



ance- and impedance-coupled, Class AB, circuit, utilizing the following tubes: 2-53's; 1-56; 2-2A3's; 1-5Z3. All filter components are incorporated in the chassis. The following output impedances are available: 500, 250, 166, 125, 100 and 83 ohms. These impedances permit the use of from 1 to 6 500-ohm lines or speakers in parallel. The frequency response is within plus or minus 2 db from 30 to over 10,000 cycles.

A feature of this amplifier is the fact that two entirely independent high-impedance input channels are provided permitting the mixing of two crystal microphones, one microphone and phono pickup or two phone pickups. The following controls are provided, two volume controls, tone control, two selector switches and power switch.

Two heavy duty 12-inch dynamic speakers, crystal microphone and all necessary cables are furnished. The entire system being housed in two carrying cases. The approximate weight is 80 lbs.

VOLTAGE-REGULATING TRANSFORMER

In localities with great fluctuation of line voltage—much higher or much lower than normal—as is frequent on lighting plants in rapidly growing cities or sub-



urban sections, the highest performance of electric appliances can be maintained more easily, and the life of appliances greatly increased by keeping the voltage supply nearest normal rating.

The Voltage-Regulating Transformer herewith illustrated, manufactured by the General Transformer Corporation, Chicago, has a positive, manually-controlled adjustment. A snap selector switch at the front is easily turned to primary tap to deliver proper voltage to the appliance. A sensitive voltmeter, mounted on the transformer case—dial up (convenient for reading), plainly indicates when the unit delivers rated voltage.

The unit is housed in an attractive wrinkle finish black steel case. Size, 4 3/4" x 7" x 6 3/4" high. It is provided with four non-scratching (soft) rubber supports.

These Voltage-Regulating units are regularly supplied in three models . . . one for normally 110-volt 50-60 cycle which transforms 70-80-90-100-110-120 or 130 volts to 110 volts at 160 watts.

One for normally 220-volt 50-60 cycle which transforms 100-115-130-145-160-175 or 190 volts to 110 volts at 160 watts.

One for normally 220-volt 50-60 cycle which transforms 140-160-180-200-220-240 or 260 volts to 110 volts at 160 watts.

Other voltages or higher capacities are furnished according to specifications.

BIRNBACH Kinkless TEST LEADS

A TIME and trouble-saving boon for busy service men—TEST LEAD WIRE THAT WON'T KINK OR BREAK DOWN under hard usage and repeated bendings.

Leads, including high-grade red and black fibre prods, with needle-point or solderless pin tips and connecting lugs (as illustrated), 50c complete. Same with alligator clips or solderless pin tips on connecting ends, 75c complete.

Also KINKLESS TEST LEAD WIRE for replacement—25 ft. 75c; 100 ft. \$2.15; 500 ft. \$10.50.

Write Dept. S-3 for Complete Catalog of Service Equipment

BIRNBACH RADIO CO., Inc.
145 HUDSON STREET NEW YORK CITY



50c
and
75c
Complete
•
Overall
Length
50 inches

A FEW GOOD TERRITORIES STILL OPEN REPRESENT US — THERE IS GOOD MONEY IN IT!

FREE EDGE
CONE AND VOICE
COIL ASSEMBLIES



MAKERS OF

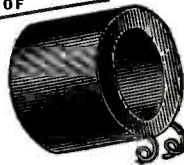

BAKELITE BOBBINS
FIELD COILS FOR
ALL DYNAMIC SPEAKERS

We also Manufacture Various Types of Magnetic Speakers
We can Supply and Remedy Your Speaker Needs
SPEAKER MANUFACTURERS SINCE 1921
LEOTONE RADIO CO. 63 Day Street, New York City

SPEAKER REPAIR KITS

DEALERS AND
SERVICEMEN

Here is your opportunity to secure a Kit or a complete assortment of Kits suitable to your particular needs. Our own experience in this field has enabled us to design Kits which will simplify your speaker repair work and increase customer satisfaction.

You can't afford to be without it.

MULTIPLEX RADIO SERVICE, INC.
88—4th AVENUE BROOKLYN, N. Y.

Send
for this
FREE
Attractive
Folder



RADIO SERVICING

Residence course, 6 months, modern methods, new courses, special work on service equipment and super-heterodyne servicing; instruction on public address systems, photo cell and cathode ray tubes included. Other courses obtainable: Radio Engineering — 9 months; Marine Radio—6 months; Morse telegraphy—6 months; Combination Engineering and service courses —12 months. School established 1874. All expenses low. Catalog free.

DODGE'S INSTITUTE, Thirteenth Street, Valparaiso, Ind.

SOUND RESEARCH LABORATORIES Theatre Equipment Says:

SALT LAKE CITY, UTAH

We are very happy to advise you that we are MORE THAN PLEASED with the results of your velocity microphone from a standpoint of natural quality of reproduction, dependability, and excellent frequency response.

We are convinced your microphone is equally as good as the (competitor's name) velocity mike selling at about twice as much money.

SOUND RESEARCH LABS, Inc.
(Signed) P. S. Guss.

HIGH FIDELITY

The BRUNO Models "L" and "M" Velocity Microphones employ a proven principle which overcome to a great extent the defects inherent to the carbon and other pressure type microphones. They are highly directional and this extremely desirable feature attenuates extraneous noises and reverberated sounds; in a Public Address installation, "feedback" is reduced to a minimum and the system may be operated at a higher acoustic gain.



Model "M"
List Price
\$40.00

CONSTRUCTION

The microphone can withstand severe abuse; is not affected by temperature and humidity changes; is absolutely quiet in operation and, since it is a low impedance device, maybe placed at any distance from the pre-amplifier. Cobalt steel magnets are used to produce a strong and lasting magnetic field.



Model "L"
List Price
\$25.00

"Bruno"

LABORATORIES

20-22 West 22nd Street, New York City

Time is money, Mr. Service Man!
Don't waste it on inferior aerial
installations. Use only

LYNCH

HI-GAIN

TRADE MARK REGISTERED

ANTENNA } .. { SHORT-WAVE
SYSTEMS } .. { ALL-WAVE
AUTO RADIO

No mechanical difficulties—each part plainly marked—quickly installed, they do what they are made to do every time.

PATENTED and GUARANTEED
For Your Protection • To outperform any other aerial

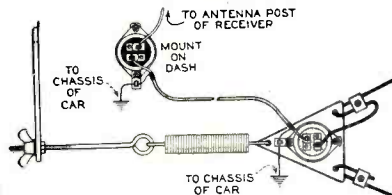

A new series of auto-radio antenna systems now ready. Priced from \$3.50 to \$8.00 list. Diagram of coupler kit A-3 shown here. Send coupon for complete data on all Lynch aerials.

ARTHUR H. LYNCH, Inc., 227 Fulton St., New York, N.Y.
Your aerial installation data will be appreciated by

Name

Street City and State

MANUFACTURERS—continued

NEW CONDENSER ANALYZER

The Federal Engineering Co., 286 Mercer Street, New York City, have just brought out a condenser analyzer, shown, which tests dry, paper, electrolytic con-



densers by applying dc voltage equal to working voltage of the condenser. Equipped with a tapped switch to select various standard working voltages. A second control knob provides a by-pass across the neon tube, affording definite good or bad reading. The by-pass is so regulated that normal leakage will not light bulbs but any leakage in excess of normal will cause neon tube to glow. Working voltages of unmarked condensers can be determined by manipulating all three controls.

Attractively housed in steel container, black baked enamel lacquer finish with sloping panel for easy reading.

Complete descriptive circular on this and other Federal products will be sent on request.

NEW EQUIPMENT

Wholesale Merchandisers, Inc., 626 Broadway, New York City, have announced that their new line of Amplifiers and Public-Address Systems is ready for distribution. It is said that the new equipment contains many new features not heretofore found in apparatus of a similar type. Complete literature on this new equipment is available on request.

NEW AC-DC AMPLIFIER

An interesting new amplifier has just been announced by the Morlen Electric Company of 100 Fifth Ave., New York City. This amplifier is a dual service-unit, it being possible to operate it from either a six-volt dc power source, such as an automobile storage battery, or from standard 110-volt, 60-cycle ac lines. The amplifier, shown in the accompanying illustration, is completely self-contained, there being no external power packs of any kind.

The tube lineup is a 6C6 feeding an 89 driver Class A connected, which feeds a pair of 6A6 tubes in a Class B output stage. The power output is 20 watts and the quality is said to be excellent for all

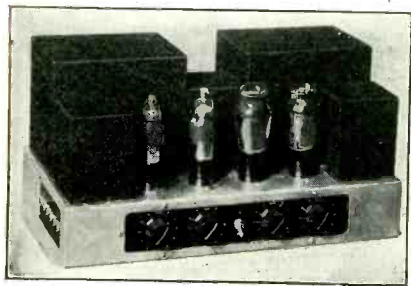

classes of p-a work even at the maximum power output.

This new amplifier is also available as a portable case unit, in addition to the standard Morlen chassis type. For all classes of truck and sound-car work and for traveling shows requiring both indoor and outdoor ballyhoo this new amplifier will render excellent service, it is stated.

A bulletin describing this unit is available.

ELECTRONOMETER MODEL 400

Designed to meet the latest requirements in radio tube testing, the Precision Apparatus Corporation, Brooklyn, New York, has developed the Electronometer Model 400, the advanced Tube Analyzer, shown in the accompanying illustration.

The Electronometer Model 400 is said to give a tube three rigid tests before it can pass as "Good."

Tubes that have a high resistance or leakage between elements will test good



when given the ordinary emission test . . . they will not, however, perform satisfactorily in the radio receiver. The Electronometer Model 400 will not pass these tubes when given the "Triple Test," it is stated.

The Model 400 is available in three different types: counter, portable and panel.

Literature fully describing this model may be obtained by writing the Precision Apparatus Corporation, 821 East New York Avenue, Brooklyn, N. Y.

UNIVERSAL MODEL 2000

The Universal Model 2000 speaker and cabinet is shown in the accompanying illustration. It is a product of Wright-DeCoster, Inc., St. Paul, Minnesota.

The Universal Model 2000 was made especially to meet the demand for a cabinet of proper style and proportions to house both speaker and chassis of the many interesting short-wave kits and circuits now being built by short-wave enthusiasts. The cabinet is of modern design and is finished in dark walnut, with face edges of base and top black walnut. The cabinet opening is cut to fit a 16-inch wide by 8-inch high panel. It is equipped with a standard Wright-DeCoster Model 530 speaker

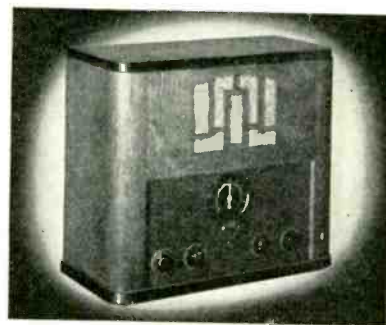

and with a Universal transformer to match all output tubes.

NEW CLASS B AMPLIFIER

A 26-watt Class B Amplifier, designed for mobile applications, that can be completely operated either from a 6-volt storage battery or from 110 volts ac or from both, has been introduced by the Coast to Coast Radio Corp., 555 6th Ave., N. Y. C. This unit offers the following features: A self-contained input mixer fader system which permits any two input signals to be super-imposed upon each other; self-contained current supply for double-button microphones; universal input-impedance terminals for 200-200 ohms (double-button microphone); 200 and 500 ohms for phono pickups and input lines as well as 5,000-150,000 ohms for high-impedance input devices; universal output impedances of 500, 200, 16, 8, 4, 3, 2, 1½, and 1 ohms; and low power consumption between 75 and 95 watts.

The 6-volt model utilizes four tubes in the following circuit arrangement: One 77 screen-grid high-gain input stage is impedance coupled into a 6A6 driver stage which is in turn push-pull transformer coupled into two 6A6 Class B power-output tubes. The universal operating model employs one 83 rectifier for 110-volt ac operation. The gain of the amplifier is 86 db at 1,000 cycles. Field current is supplied for one to four 110-volt dc, 2500-ohm dynamic speakers. Hum level is said to be negligible.

Convenient terminal strips are provided on the rear of the crystalline finished steel case. Ample ventilating louvres are provided for heat dissipation.

GILLETTE CONDENSER ANALYZER

The Gillette Condenser Analyzer, shown in the accompanying illustration, has been designed to test electrolytic, paper and mica condensers. This unit is manufactured by the Radio Devices Manufactur-



ing Company, 142 Washington Street, New York City.

This analyzer features: One-knob control, heavy steel container with black crystalline finish and brass panel.

MIKES—HORNS—UNITS—AMPLIFIERS



MILES—since 1923

the finest custom built public address equipment!

For 12 years MILES has been manufacturing P. A. equipment of the highest quality to individual specifications of users. Not cheap, inferior apparatus but comparable with the finest that money can buy. And, MILES prices are very low for top quality equipment. Let us quote on your needs—anything in public address work.

FREE interesting literature on amplifiers and 300 Miles Quality Products. . . . Write for it.

MILES REPRODUCER CO.
114 W. 14th STREET NEW YORK, N. Y.

Macy Directional Baffle

Ideal for all P. A. requirements, indoor and out, controlled sound distribution eliminates feed back difficulties, improves the fidelity and increases "speaker efficiency"; constructed of reinforced spun aluminum; free from all metallic resonance, 100% weatherproof; overall size, bell 17 in., length 20 in. Available for all speaker cone sizes up to 12 in. in diameter. Shipping weight 5 lbs. Model MB-10

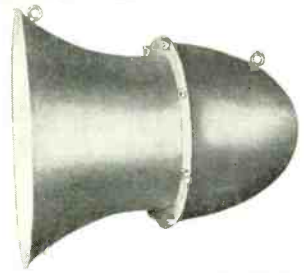

Net Price \$8.82

Macy Engineering Co., 1452 39th St., Brooklyn, N. Y.
Write for complete P. A. Catalogue—desirable territory available for representatives.

MAKE EXTRA MONEY

A rich new field is open to the Service Man in installing group hearing aids for the Hard of Hearing in theatres and churches. Daily, more theatres are putting in this equipment. YOU are the logical man to sell it to them and to install it.

Become an authority on group hearing installation. Write TODAY.

TRIMM

RADIO MFG. CO.
Dept. S-3
1528 Armitage Ave.
Chicago



NEW! Essential Tools in Color

Neutralizing tool and compensating screw drivers made of AMEROID in attractive colors—model shades. Won't chip or break in normal use. Easily identified in service kit.

FOUNTAIN PEN STYLE

Contains insulated screw driver; 1/4" and 5/16" insulated wrenches for compensating and balancing I-F Transformers, Variable and Equalizing Condensers, etc., clip for vest pocket carrying. List price 60c—any color



COMPENSATING SCREW DRIVER

Colors correspond with Neutralizing Tools: knurled end assures non-slip grip. List price 30c

SUPPLIED 12 OF EACH TOOL MOUNTED ON ATTRACTIVE DISPLAY CARD.

American Radio Hardware Co., Inc.
135 Grand St. New York, N. Y.

At your distributor—or direct—at 40% discount. Complete data on American radio parts on request.



THE EYES OF THE RADIO SERVICE INDUSTRY

WILL BE TURNED TO

CHICAGO

MARCH 22, 23, 24, 1935

WHEN THE
THIRD ANNUAL CONVENTION
AND

TRADE SHOW

OF THE

RADIO SERVICE INDUSTRY

WILL BE HELD AT THE HOTEL SHERMAN
The Institute of Radio Service Men, Inc. (a Professional Association)
AND

The Institute of Radio Service, Inc. (a Trade Association)

Invites You to Attend

ADMISSION FREE

MARCH, 1935 •

SAY YOU SAW IT IN SERVICE

143

SERVICE ENGINEERS:
Send for this **NEW**
100% RADIO CATALOG

Just out—the new 1935 Spring and Summer ALLIED Catalog. You need this Double-Value Profit Guide. It's packed with thousands of exact duplicate parts—all leading lines of test equipment, tools, etc. Offers many new money-making ideas. Send for this FREE valuable Catalog now. Consult it always before you buy it—will repay you in bigger profits!



ALLIED RADIO

ALLIED RADIO CORPORATION
833 W. Jackson Blvd., Chicago, Ill. Dept. N.
 Send me your FREE 1935 Spring & Summer Catalog.

Name

Address

FREE WRITE NOW!

ANNOUNCING: A new BELL P. A. system.

MODEL P. A. 3C
15 watts output.
2 channel input.
CRYSTAL MICROPHONE
(Two may be used.)
2 12" A.C. dynamic speakers.
Provision for 1 to 6 speakers.



Other models for portable or permanent installation.
Prices from \$59.50 up.

Some valuable territory still available. Write for details.

BELL SOUND SYSTEMS, INC.
264 N. FOURTH STREET COLUMBUS, OHIO

WHY YOU MAY RECOMMEND THIS RADIO TRAINING
A MESSAGE TO SERVICE EXECUTIVES

MANY times you are asked to recommend a radio training course . . . or you yourself would like to know of a school to which you might safely send the men under you.

May we, then, present a few facts about RCA INSTITUTES? . . . And may we send you a copy of our catalog in which both Resident

School and Home Study courses are described?

RCA INSTITUTES resident schools have extensive modern equipment for instruction and laboratory training.

Our Extension Courses for Home Study are intended for the beginner or for one in need of instruction in theory and elementary principles.

RCA INSTITUTES, Inc.

Dept. SV-35, 75 Varick St., New York—1154 Merchandise Mart, Chicago

SERVICE ENCYCLOPEDIA OF ACTUAL RADIO TROUBLES

Bertram M. Freed has compiled all his important service notes into a book consisting of 200 pages and 46 diagrams. It is closely packed with information covering the weak points in over 500 different model receivers with their symptoms and corrections.

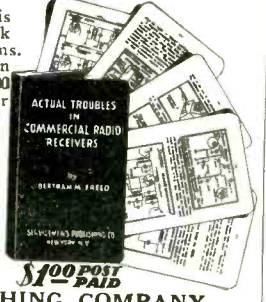

Price includes one FREE Supplement which contains over 200 additional Models, Diagrams, and Illustrations. **\$1**

If your regular Jobber or Mail Order House cannot supply you, write direct to—

SERVICEMEN'S PUBLISHING COMPANY
136 LIBERTY STREET NEW YORK CITY

Federal CONDENSER ANALYZER
For Every Service Man

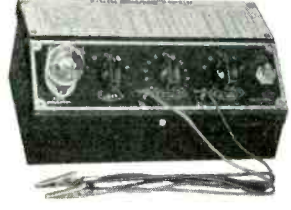

TESTS them quickly and efficiently by applying D.C. voltage equal to working voltage of condenser.

Easily determines voltages of unmarked condensers.

Instantaneous reading of good or bad units. Neon tube glows whenever condenser being tested has more than normal leakage.

Attractively housed in a steel container, shrivelled black baked enamel lacquer finish. Engraved sloping panel affords easy reading.

LIST PRICE \$20
40% off to SERVICE MEN
Ask your distributor or write direct
Write for catalog of Federal "Quality" Replacement Transformers, Tubulars, P.A. Equipment and other products.

FEDERAL ENGINEERING CO., INC.
286 MERCER STREET NEW YORK, N. Y.

NEW PHOSPHOR BRONZE DIAL CABLE
The Handiest Spool Made
Nothing Like on the Market

SAMPLE SPOOL 25 FT. 50c
Only One to a Dealer

ALL OTHER ORDERS THRU YOUR JOBBER
We Can Furnish Your Complete Requirements for Wire Goods and Antenna Equipment

ALL WAVE ANTENNA KITS. \$2.16
Send for Catalogue Sheet
Regular Aerial Kits, Complete . . . 49c

RIVARD MFG. CO.
1014 MADISON AVE. TOLEDO, OHIO

MAJESTIC REPLACEMENT COILS

Matches perfectly chassis and shielding designated. Mechanical and electrical properties and mounting arrangements are as required. Wound according to latest developments. Complete assemblies containing shield cans, trimmer condensers, resistors, by-pass condensers, and original Majestic coding of leads, as required. Approved by former Majestic engineers.

| Number | Code | Description | List Price |
|--------|------|---|------------|
| 9908 | MACE | 1st I. F. model 20 | \$2.50 |
| 9907 | MAKE | 2nd I. F. model 20 | 2.50 |
| 10148 | MALE | 1st I. F. model 460 | 1.50 |
| 10258 | MALL | 2nd I. F. model 460 | .80 |
| 4430 | MASK | Antenna models 15 and 15B | 1.00 |
| 4431 | MASH | R. F. models 15 and 15B | 1.00 |
| 4428 | MALT | Composite Osc. and I. F. models, 15, 15B and 150 | 2.75 |
| 4429 | MANE | 1st I. F. local-distance switch, models 55 and 15 | 1.70 |
| 8384 | MANY | 1st I. F. without local-distance switch, models 15, 15B and 150 | 1.60 |
| 8323 | MARS | 1st I. F. model 111 | 2.00 |
| 6984 | MART | 1st I. F. model 120B | 2.50 |

Send for latest coil kit bulletins.

USUAL JOBBER'S AND DEALER'S DISCOUNT
EDWIN I. GUTHMAN & CO., INC.
1321 So. Michigan Avenue, Chicago, Illinois



No. 4428

Ken-Rad Radio Tubes
DEPENDABLE LONG LIFE



Ken-Rad Radio Tubes are made to give clear, dependable reception. They satisfy customers and build good will for dealers. Write for full information.

THE KEN-RAD CORPORATION, Inc., Owensboro, Ky.
Division of The Ken-Rad Tube and Lamp Corporation
Also Mfrs. of Ken-Rad Incandescent Electric Lamps



RADIO ENGINEERING

Covering the design, production, engineering and test of Radio Receivers, Tubes, Parts, Amplifiers, Recording and Sound Projection Equipment. Published monthly.

Subscription, \$2.00 Yearly
(Foreign, \$3.00)



COMMUNICATION AND BROADCAST ENGINEERING

Covering Radio Communication, Broadcasting, Police, Marine and Aeronautical Radio, Telephony and Telegraphy, Facsimile and Television. Published monthly.

Subscription, \$3.00 Yearly
(Foreign \$4.00)

BRYAN DAVIS PUBLISHING CO., INC.
19 EAST 47th STREET, NEW YORK CITY

Don't Miss It



If you've changed your address since receiving our 1933 Catalog, or if you have not received a catalog from Radolek recently, send us your business card or letter-head immediately.

THE **RADOLEK** CO.
596 W. Randolph Street
CHICAGO

Supplemented for 1 year free.
STEP AHEAD

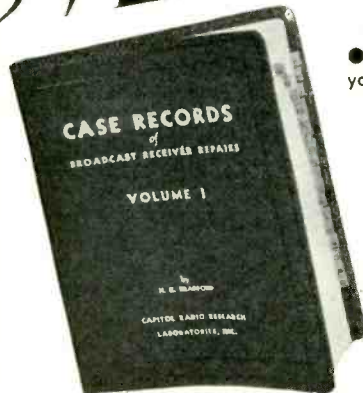

of the rank and file—with "CASE RECORDS" OF BROADCAST RECEIVER REPAIRS

● Add 10,000 hours to your service experience!

● ELIMINATE GUESS WORK IN YOUR SERVICING!

● DON'T PUZZLE YOUR PROFITS AWAY!

Your work has already been done and recorded for you in CASE RECORDS. This 9x12" flexible leatherette binder contains

1,500 alphabetically and numerically arranged CASE RECORDS of successfully completed

service jobs. Each Record tells—symptom—parts responsible—electrical values—location, and best replacement or repair. This Manual introduces the fastest technique known to the service profession. \$4.75 postpaid with supplements.

108 receiver makes listed. 3,000 models.

Capitol Radio Research Laboratories, Inc.
1503 TWENTY-FIRST STREET, N. W., WASHINGTON, D. C.

Originators of Case Record Servicing Technique

Please send me complete information on "CASE RECORDS OF BROADCAST RECEIVER REPAIRS." I understand that this does not obligate me in any way.

NAME

ADDRESS

INDEX TO ADVERTISERS

| | | | | | |
|---|-----|--|----------|--|-----|
| A | | I | | Radio Device Mfg. Co. | 147 |
| Aerovox Corp. | 129 | International Resistance Co... 133 | | Radio Products Co., The | 101 |
| Allied Radio Corp. | 144 | | J | Radolek Co., The | 146 |
| American Radio Hardware Co. 143 | | Jefferson Electric Co...Third Cover | | Raytheon Production Corp... 107 | |
| Arcturus Radio Tube Co..... 103 | | | K | Readrite Meter Works..... 131 | |
| B | | | | Rider, John F. | 105 |
| Bell Sound Systems | 144 | Ken-Rad Corp., The..... 144 | | Rivard Mfg. Co..... 144 | |
| Birnbach Radio Co., Inc..... 141 | | Kenyon Transformer Co., Inc. 131 | | S | |
| Bruno Labs. | 141 | | L | Servicemen's Publishing Co.. 144 | |
| Bud Radio, Inc. | 147 | Leotone Radio Co..... 141 | | Solar Mfg. Corp. | 147 |
| C | | Lynch, Inc., Arthur H. 141 | | Sonochorde Sales Co. | 147 |
| Capitol Radio Eng. Inst..... 139 | | | M | Sprayberry, F. L. | 137 |
| Capitol Radio Research Labs., Inc. 146 | | Macy Engineering Co..... 143 | | Standard Transformer Corp. 137 | |
| Centralabs | 127 | Mallory & Co., P. R. 108 | | Second Cover | |
| Continental Carbon, Inc. 135 | | Miles Reproducer Co..... 143 | | T | |
| Cornell-Dubilier Corp. 125 | | Multiplex Radio Service, Inc.. 141 | | Tobe Deutschmann Corp...133-148 | |
| Cornish Wire Co. | 129 | | N | Trimm Radio Mfg. Co..... 143 | |
| Curtis Condenser Corp..... 137 | | National Union Radio Corp. of N. Y. 129 | | Triplet Elec. Inst. Co., The... 135 | |
| D | | | O | Try-Mo Radio Co., Inc. 147 | |
| Dodge's Institute | 141 | Ohmite Mfg. Co. 148 | | U | |
| F | | Operadio Mfg. Co. 125 | | United Transformer Corp.... 127 | |
| Federal Engineering Corp.... 144 | | Oxford Radio Corp. 139 | | Upco Engineering Labs..... 148 | |
| Flechthelm & Co., Inc., A. M.. 147 | | | P | W | |
| G | | Pioneer Gen-E-Motor Corp... 137 | | Webster Co., The | 133 |
| General Transformer Corp... 139 | | | R | Weston Elec. Inst. Corp..... 106 | |
| Guthman & Co., Inc., E. I..... 144 | | RCA Institutes, Inc. 144 | | Wholesale Merchandisers, Inc. 147 | |
| H | | RCA Mfg. Co., Inc....Fourth Cover | | Wholesale Radio Service Co., Inc. 123 | |
| Haldorson Co., The..... 135 | | Racon Elec. Mfg. Co..... 139 | | Wright-DeCoster, Inc. 137 | |
| Hygrade Sylvania Corp. 121 | | Radiart Corp., The..... 148 | | | |
| | | Radio City Products Co..... 147 | | | |

FLECHTHEIM

SUPERIOR CONDENSERS

10 Years of Dependable Service to the Radio Trade—1925- 1935



Known the world over as the best.

Paper and electrolytic condensers (lincensed), paper tubulars, resistors, auto condensers and suppressors.

FREE: Catalog, data sheets and interesting new booklet just off the press. Write for it.

A. M. Flechtheim & Co., Inc.
136 Liberty St. New York City



R
C
P
•
R
C
P
•
R
C
P
•
R
C
P
•
R
C
P
•
R
C
P

New DEPENDABLE METERS

**Improved AC-DC
COPPER-OXIDE
RECTIFIER TYPE**



3 1/2" Bakelite Case with 500 microamp D'Arsonval Movement, accuracy 2%. Designed for Multirange use, A.C. and D.C. Voltage and current scales—0-250-750 and separate ohmmeter scale. 2000 ohms per volt sensitivity.

Includes full wave copper oxide rectifier with leads. A.C. Accuracy 5%. Licensed under most advanced circuit patents.

Meter complete with rectifier and test equipment diagrams\$7.25

Write Dept. S-3 for FREE Data Sheets

RADIO CITY PRODUCTS CO.
28-30 W. Broadway, New York City

3 1/2" Diameter

Knife Edge Pointer

Accuracy Guaranteed Within 2%

Special!

RADIO PARTS KIT

IN a recent clearance sale thousands of various radio parts remained. In order to clear our shelves immediately for additional lines, we made up a special assortment of parts and offered them for sale at from 2 to 3 times below their regular price if bought singly. As an added feature we tender the purchaser—absolutely free of additional charge—an all-metal, shelf-a-tray tool chest and a Radio Servicing Manual.

\$1.25

NOTE!
Write for full particulars about FREE MEMBERSHIP to the TRY-MO MONEY SAVING CLUB.

Send for Free 184-page Catalog of Radio Equipment at Bargain Prices!

TRY-MO RADIO CO. INC.
85 CORTLANDT ST. 179 GREENWICH ST. N.Y.C.

SOLAR

WET AND DRY ELECTROLYTIC PAPER AND MICA CONDENSERS

RECOGNIZED FOR SUPERIOR QUALITY IN ALL CLIMATES THE WORLD OVER

SOLD BY LEADING JOBBERS EVERYWHERE

SOLAR MFG. CORP.
599 BROADWAY NEW YORK

BEST BY TEST!

ASK FOR CATALOG OF EXTREMELY COMPACT TYPES HANDY FOR SERVICE

Gillette

CONDENSER ANALYZER ONE KNOB CONTROL

Accurately tests electrolytic, mica and paper condensers.

Dealer Price, \$12.50

Attractively housed in a durable steel container finished in black crystal. The panel is brass, nickleed, metal etched (not lithographed). Only the highest quality parts used in construction. Efficiently engineered.

Wholesalers—Some valuable territory still open. Write for our interesting proposition.

RADIO DEVICE MANUFACTURING CO.
142 WASHINGTON ST. NEW YORK, N. Y.

SONOCHORDE

Electro-Dynamic Reproducers

Now Available to

DEALERS AND SERVICEMEN

The kind of Speaker Service you have been waiting for—prompt service on four sizes: 5"-6"-8"-11", with 741 "specifications" from which to choose. Two sizes replacement Auto Speakers and speakers with re-inforced voice-coils for P.A. work. Sonochorde Speakers possess unusual tonal quality and frequency response.

New Low Prices!

Write for catalog and net-price sheets, TODAY!

Sonochorde Sales Company
200 Boston Ave. Medford, Mass.

RIGHT OFF THE PRESS

NEW 1935 CATALOG

Including the largest assortment of PUBLIC ADDRESS Equipment ever assembled in a catalog.

ALSO: Replacement Parts, Sets, Tubes and Accessories.

Be sure to write for your copy to-day. We sell to the trade only.

We Manufacture an Amplifier for Every Purpose.

Wholesale Merchandisers, Inc.
626 Broadway, Dept. E, New York City

BUD DeLuxe Test Leads

Universal, heavy duty de luxe leads with removable tips. The ideal test lead for point to point measurements from socket prongs, as removable socket prong tips are furnished in both sizes which will plug into tube socket. Continuity test tips are of the chuck type so either phono needles or long sewing needles can be used to pierce insulation or corrosion. Heavy duty handles are polished hard rolled fibre, and heavily insulated tinsel cords 60" long with extreme flexibility comprise these deluxe leads. Phone tip terminals. Worn cords are easily replaced without soldering. Furnished complete with two sets of removable tips.

No. 621Price \$1.25

Your favorite jobber carries a complete line of BUD parts. Write for new 1935 Catalog.

BUD RADIO INC. 1937 E. 55th ST. CLEVELAND, O.

Warning . . . Condenser Leakage!

Electrolytic condensers increase in leakage current due to radio set heat, or the application of working voltage higher than the rated condenser voltage. The electrolyte dries out, the capacity falls, hum level rises. Use the



TOBE

CONDENSER ANALYZER

to find these defective condensers instantly.

Only \$11.40 net to servicemen. Order one today from your jobber.

All TOBE products are stocked by the following jobbers in the states listed below:

(See past issues for other states)

IOWA

Easton & Arthurs, 102 Third Ave. Cedar Rapids
Terry-Durin Co., 409-7th St. Cedar Rapids
Willey's, 106 E. 2nd St. Davenport
Hieb Dist. Co., 905 Walnut St. Des Moines
Iowa Radio Corp., 1212 Grand Ave. Des Moines
Duke's Radio Service, 5th and Wesley. Sioux City
Warren Elec. Co., 647 Water St. Sioux City
Standard Battery & Elec. Co. Waterloo

MINNESOTA

Kelley-How-Thomson Co., 309 S. Fifth St. Duluth
Palmer's Trading Post, Route No. 1. Duluth
Southern Minnesota Supply, Cor. 2nd and Main Sts. Mankato
Jalisco Radio Service, 1215 Nicollet Ave. Minneapolis
Low Bonn Co., 2484 University Ave. St. Paul

NEBRASKA

H. C. Noll Co., 2226 Harney St. Omaha

TOBE DEUTSCHMANN CORPORATION
CANTON, MASSACHUSETTS

RIDE A WINNER IN THE RACE FOR BUSINESS!



Ohmite resistors are helping service men everywhere to do better work and to make more money. The addition of the ten watt and twenty watt BROWN DEVIL resistors enables you to choose either vitreous enameled or cement coated units at the same price. Use the coupon below for the new Ohmite Catalog No. 11 which describes and lists the complete line of replacement resistors.

OHMITE

MANUFACTURING COMPANY
627 N. Albany Ave., Chicago, Ill.

Please send my copy of the NEW Number 11 Catalog at once.

NAME
ADDRESS
CITY STATE

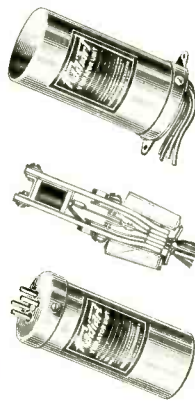

Radiart

Radiart originated the idea of an exact duplicate replacement vibrator for every make and model of automobile radio. There are now more than 300 jobbers through the country handling the Radiart line of replacement vibrators and more than 50,000 of these replacements have been sold. The universal satisfaction expressed by jobbers, dealers, and service men everywhere is a definite proof that you make no mistake when you use Radiart. Follow the judgment of the engineers who designed the sets you are servicing. Use Radiart and you will be sure of satisfied customers.

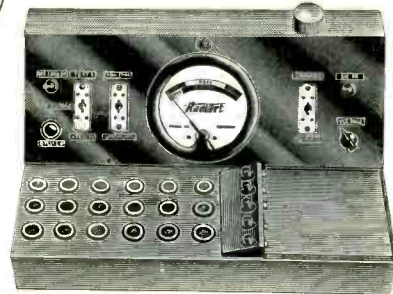

NOW

This new instrument will save its own cost in a very short time. It tests every known make and model of 6-volt auto radio vibrator, giving every essential test which experience has shown us is necessary to determine whether a vibrator is good or bad. An ingenious circuit and switching arrangement reduces each test to a definite "good" or "bad" on an English reading meter. Write for further details.

THE RADIART CORPORATION

East 133 at Shaw—CLEVELAND, OHIO

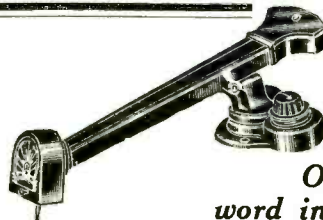

UPCO PRODUCTS

Offer the last word in Sound Equipment

Balanced Pick-Up Plays both the OLD (78 R.P.M.) records and the NEW (33 1/3 R.P.M.) records. We also manufacture a complete line of Upco Pick-Ups to meet manufacturers' special requirements. Special types for portable combinations as well as radio and phonograph console styles.

We build Special Recording Equipment for Aluminum or Celluloid Recording. We produce Recording Heads for both processes.

Write for Catalog and full details on the UPCO line of Acoustic Products

UPCO ENGINEERING LABORATORIES

254 Canal St. ANTON BORSUK, President New York

HOW DO YOU DO IT?

How do you solve the many servicing problems with which you have to contend . . . what special kinks have you worked out which help you in servicing receivers . . . have you developed shortcut schemes for testing, or built test devices that do the work better and faster?

No matter what the scheme or the device, there are many Service Men who would like to know the how's and why's—just as you would like to know about the schemes and devices employed by others.

All you have to do is give us the outstanding points, and a rough pencil sketch of the device if it happens to be such—and we will do the rest.

Write up those ideas now and send them in to the . . .

ON THE JOB DEPARTMENT

Each Jefferson Transformer comes in individual carton with complete instruction sheet prepared by Jefferson radio engineers.

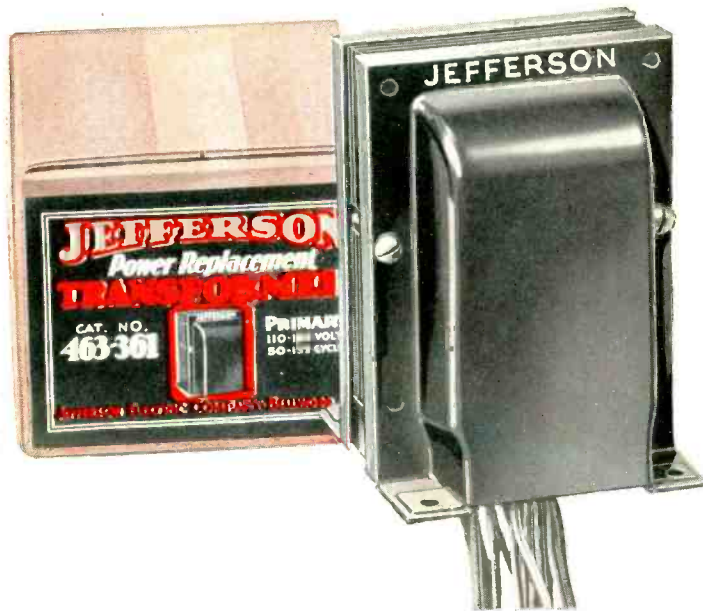

4 Shielded Power Transformers cover all replacement needs—from 4 to 5 tube midgets to the largest sets—including 6.3 volt tubes.

How to Get Profitable Prices for Repair Work

Radio service men often remark that customers are unwilling to pay a reasonable amount for a repair job. The experienced and well-informed radio men overcome this by pointing out the value of a quality job using quality replacement parts.

For example, when replacing transformers, it is easy to show how the tone quality and long life provided by Jefferson Transformers makes a set as good or better than when new.

Ever since radio set manufacturers started in business, Jefferson Transformers have been used by the leading mak-

ers, year after year. Jefferson Transformers are built to high standards—they have withstood the scientific tests of leading radio engineers and the everyday tests of millions of radio set owners.

There is no magic in transformers—efficient performance and long life must be designed and built into them. The Jefferson plant—engineering department—Jefferson facilities make possible the high consistent quality of Jefferson Transformers.

You give satisfaction and get profits by selling Jefferson Transformers.

JEFFERSON ELECTRIC COMPANY
Bellwood (Suburb of Chicago) Illinois
Canadian Factory: 535 College St., Toronto

JEFFERSON

Radio Transformers

Jefferson Radio Transformers

- Inputs
- Outputs
- Audio
- Power
- Microphone
- Filaments
- Wire Chokes
- Glass Fuses
- Fuse Clips
- Auto-Transformers

Get New Amplifier Diagrams—FREE

We have a set of Amplifier Diagrams, including a late mobile amplifier—that we will be glad to mail—free of charge. Clip and fill out the coupon now.

JEFFERSON ELECTRIC COMPANY,
Bellwood, Ill.
No. PA-7 Other amplifier circuits
Catalog information sheet No. 343R

Please send free Mobile Type Amplifier circuit

Name _____ Address _____
City _____ State _____

5 TIMES AS MANY SPECIFIED "RCA RADIO TUBES"

in American Magazine Survey



The American Magazine sent a questionnaire to 10,000 of its subscribers, located in all parts of the country. Among other things, the questionnaire asked: "If you were replacing the tubes in your radio set, what make would you buy?"

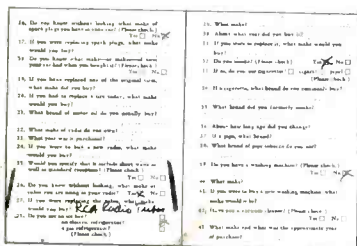

This is a sample of the American Magazine questionnaire which proved, as all such surveys prove, that RCA Tubes are the public's overwhelming choice.

The tabulated results showed: Over five times as many subscribers specified RCA Radio Tubes as against the next highest brand. RCA Radio Tubes received more than twice as many votes as all other brands combined!

The soundest of all selling rules is "Give the people

what they want". This rule is not always easy to follow, because often the public's wants are difficult to determine. But in the case of radio tubes, the choice . . . the overwhelming choice, as proven by every tube survey ever conducted . . . is clear. You can't go wrong when you give them RCA Radio Tubes.

This is how the public voted in the American Magazine survey:

| | | | |
|---------------------------|-------|------------------------|-------|
| RCA RADIO TUBES | 66.4% | Fourth brand | 2.0% |
| Second brand | 10.3% | Fifth brand | 1.3% |
| Third brand | 2.3% | All others | 17.7% |



RADIO TUBES

RCA Radiotron Division of the RCA Manufacturing Co., Inc., Camden, N. J.