

THE

RADIO

handbook



The foremost and
most authoritative
text and reference
work on

**Construction
Equipment
Operation
Theory**

of high-frequency
and ultra-high-
frequency radio

ANOTHER PUBLICATION
BY THE
EDITORS OF
RADIO

ONE DOLLAR FIFTY CENTS

Published in U. S. A.

Copyright 1934 by R. M. M. Co.

ANOTHER PUBLICATION
BY THE
EDITORS OF
RADIO



The "RADIO" Handbook

By the
TECHNICAL STAFF
of "RADIO"
The National Monthly Magazine
Established 1917

Publication Offices:
PACIFIC BUILDING
SAN FRANCISCO, CALIFORNIA, U. S. A.

First Printing, May, 1935

Copyright, 1935
All Rights Reserved

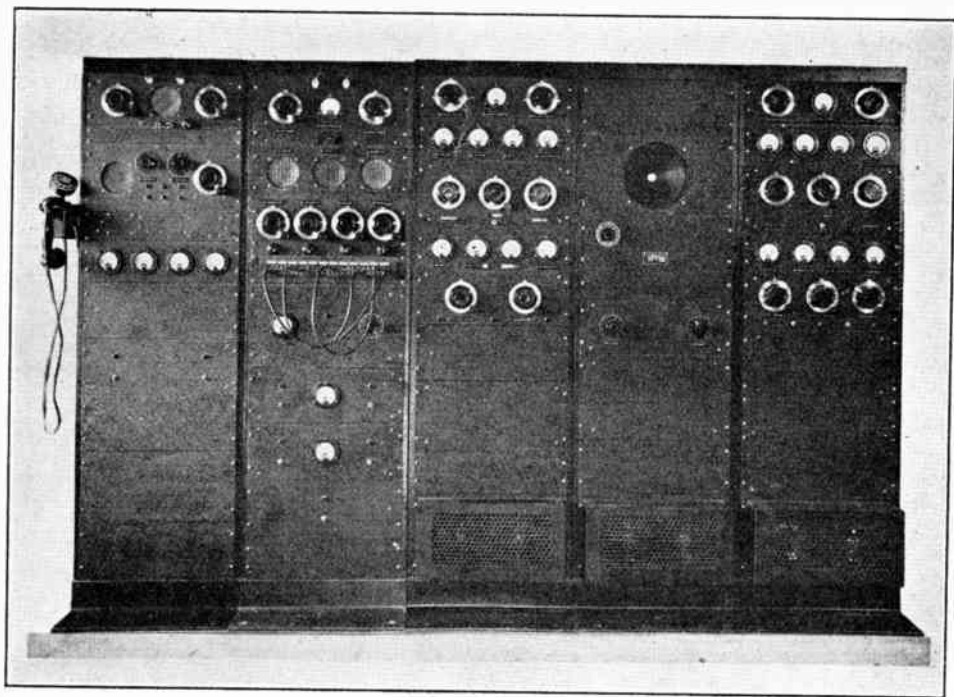

W6ITH—An outstanding example of ultra-modern amateur radio construction. All-band operation.

Why "The 'Radio' Handbook"

Many radio amateurs and experimenters find difficulty in keeping abreast of the rapid advance in the art of high-frequency radio communication. This difficulty arises not only from the multiplicity of new kinds of apparatus, but also from the discovery of new operating principles. There is consequently a widespread demand for comprehensive information on how to get the best results at the least cost. "THE 'RADIO' HANDBOOK" is published to meet this demand.

It is written in plain language so that even the novice can solve any problem that bothers him. The experienced technician, also, will find in its pages a wealth of facts not to be found elsewhere. Theoretical explanations are minimized to the barest necessities, and emphasis is placed on practical methods.

The text has been written and compiled by the editorial staff of "RADIO," the amateur and short-wave magazine. It represents the answers to questions which have been asked during the past two years. Every statement in the book has been tested by actual experience in the laboratory and on the air. The information is dependable and useful. Each chapter has been prepared by a specialist on that subject.

The introductory chapters on Receiver Design and Construction were written by Clayton F. Bane, whose simple and efficient receivers, including superheterodynes, are as easy to build as they are useful.

Those on Antennas and Ultra-High Frequency Communication are the work of Frank C. Jones, designer of the 5-meter equipment which aids the construction of the San Francisco Bay Bridge.

Those on Piezo-Electric Crystals represent the experience of W. W. Smith as a manufacturer of quartz crystals for amateur and commercial use.

That on Self-Excited Transmitters, necessary for completeness in treatment but to be discouraged for use, is by C. C. Anderson, the well-known DX operator.

J. N. A. (Jayenay) Hawkins, contributor of many useful ideas in the art of radiotelephony, wrote the chapter on this subject.

D. B. McGown, widely-experienced sound engineer, is the author of the section on transformers, chokes and filters.

Chas. Perrine, Jr., owner and operator of W6CUH, gave the published facts on transmitter efficiency.

The foregoing examples illustrate the authoritativeness of the information and the thoroughness of the treatment. Yet, in presenting this first edition, the publishers realize that some problems may have been overlooked and will welcome reader suggestions as to other questions to be answered in future editions. The purpose of the book is to help the amateur operator to solve all his radio problems.

Introduction to Amateur Radio

EVERY radio amateur must be duly licensed if he desires to operate an amateur transmitting station. His transmitting station must also be licensed. The licenses are issued by the Federal Communications Commission. The addresses of the various district offices are shown in the Appendix. No licenses are required if the amateur desires to operate only a receiving set. In order to secure a license the applicant must pass an examination in order to prove his technical knowledge of the theory and practice of amateur radio communication, as well as being able to copy the Continental Code at a speed of ten words per minute. Those who desire to learn the code without aid from others can do so by means of a code practice set. Several kinds of these practice sets can be built. The simplest is not always the best. Any amateur will be glad to help the beginner construct a code practice set. One of the prime requisites of a code practice set is the ability to produce a sharp, clear signal in the headphones. The audio tone of the practice set or oscillator should closely simulate the c.w. signal heard in a short-wave receiver. Such a practice set can be assembled in a few minutes by using parts available from any radio store. If difficulty is encountered in making the code practice oscillator work, any service man or amateur will be glad to help remedy the trouble.

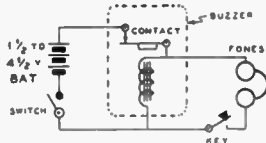

FIG. 1

Fig. 1 shows the simplest code practice oscillator. It consists of a high-frequency buzzer, one or two dry cells, a telegraph key and pair of headphones. The advantage of this oscillator is that the buzzer operates continuously in order to obtain a stable tone. The headphones and the telegraph key are in series and connected across the buzzer coil. The buzzer contacts should be adjusted for the least change in note when the key is pressed. Although the buzzer operates continuously, as long as current is supplied from the batteries, the tone is heard in the headphones only when the key is pressed.

Fig. 2 is a simple Hartley Oscillator using a cathode heater tube. The 2.5 volt or 6.3 volt tubes can be used with equal success. The type 76 tube is the 6.3 volt equivalent of the type 56 tube. Because the type 76 tube draws only 0.3 ampere filament current, it can be operated from common dry cells, three cells connected together in series. The trans-

former is a conventional audio transformer of any ratio and the primary and secondary of the transformer are connected in series, with a connection taken from the mid-point to the cathode of the tube. The telegraph key is in series with the headphones and

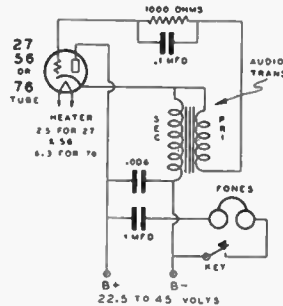

FIG. 2

negative "B". The pitch of the note can be varied to suit individual requirements by merely increasing or decreasing the "B" voltage. A pleasing note is secured when an ordinary 22½ volt B battery is used for plate current.

Fig. 3 is another version of the Hartley Oscillator and the circuit is similar to the practice set shown in Fig. 2. A center-tapped output transformer is used and the headphones are connected directly across the secondary of the transformer, with the telegraph

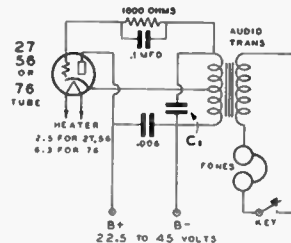
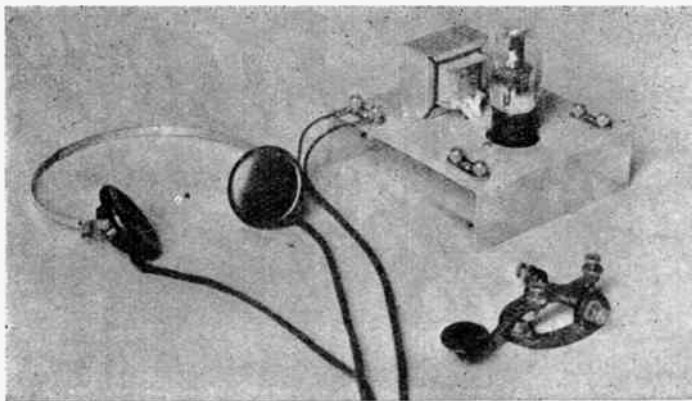

FIG. 3

key in series with one of the secondary leads. The transformer for the circuit in Fig. 3 can be any of the conventional types, known as "Push-Pull Input to Dynamic Speaker Voice Coil". The pitch of the note can be varied by changing the capacity of condenser C1, or by varying the amount of "B" voltage. Here again, 22½ volts will give a very pleasing note. If condenser C1 has a higher capacity than .005 mfd, the note will be of lower pitch.

How to Master the Code

There is nothing complicated about learning the code. Many young boys and girls have succeeded in attaining a code speed of



CODE PRACTICE OSCILLATOR

A code practice set requires an audio oscillator of some sort, a method of interrupting the oscillations, such as a telegraph key, and a means of making the audio oscillations audible, such as a pair of phones or a loudspeaker. See Fig. 3, page 4, for circuit diagram of this code practice set.

ten words per minute with but a few months' practice. The first thing to remember when learning the code is to distinguish dots from dashes. A dot is always a dot, no matter how fast or how slow it is sent. The same holds true for a dash. A dash should be three times as long as a dot. Too many beginners make the mistake of "holding the dots", i.e., they do not make dots at all, they make long and short dashes. Fix firmly in your mind the thought that a dot is merely one quick, sharp touch of the key, and never make a dot anything but a dot, no matter how slow you may wish to send. Do not make a dash longer than the time required to make three quick dots. No matter how slow you send, a dash should be made no longer than if it were part of a 40-word-per-minute transmission. The difference between slow and fast sending is in the time interval between letters which comprise words, not between the characters which make a letter. The spacing between letters and between words can be lengthened when slow speed sending is used. Read that over again; it is of vital importance. Make the spaces between letters and between words as long as you desire, so that you can send as slow as you want to send, but make all dots (or dashes) the exact same length, no matter whether you are attempting to send 5 or 50 words per minute. The secret of success of good operating is in the spacing between letters and between words, but there should be no spacing between the dots and dashes which make up an individual letter. Take the letter A for example; it consists of a dot and a dash. Do not consider it as the letter A, but firmly establish in your mind the fact that it is a dot and a dash. Pronounce it "did-daw", "did" for dot, "daw" for the dash. Thus the letter A is "did-daw", not dot-dash, as some pronounce it. Repeat it to yourself, over and again . . . "did-daw", "did-daw", "did-daw". But do not pause between the "did" and the "daw". The two should literally "roll into

each other", thus—"diddaw". One of the greatest mistakes made by many operators is the fact that a pause is permitted to come between the did and the daw. Now repeat it rapidly to yourself . . . "diddaw", "diddaw", "diddaw". That is the letter A, repeated three times. The letter B is a dash and three dots. Again, there must be no spacing between the dash and the three dots. B is "dawdiddiddid". If you make a space between the daw and the three dids, your character will be the letters T S, and not the letter B, which you desire to send.

Send slowly, cautiously, surely! Haste makes waste. You often hear of the operator "who falls all over himself". He becomes confused, sends faster than he can receive. Nothing is more painful to listen to than the fast, erratic operator who cannot read his own sending. How, then, does he expect others to copy his sending?

The well-known and widely-used SOUND system of learning the code is still the best method for any beginner to use. The operator does not think in terms of letters of the alphabet, he thinks in terms of SOUND. Each letter has a sound and a "swing" of its own. When you hear the SOUND of "diddaw" you know it is the letter A, but you think of it only in terms of "diddaw", not as an A.

With your code practice set connected, grasp the key gently with your thumb, fore-

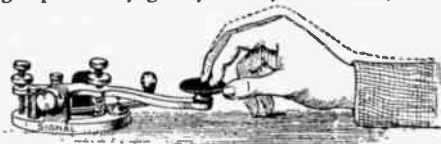

The Proper Grip

finger and index finger on the knob of the key. The illustration shows how to properly manipulate the key. Avoid cramping your hand when you send. Relax yourself. Forget entirely that your thumb and fingers are

on the key. You are interested in one thing . . . you want to make the telegraph signals, dits and daws. Send slowly, until you become more adept to the knack of sending. Do not open the key too wide, else your sending will be "choppy". On the other hand, if the key does not have sufficient play, your sending will sound "sloppy". Do not make the key too "stiff" by exerting too-great pressure on the spring. Ask a more-experienced operator to adjust the key for you, but first make sure that the person is a fairly-good operator himself.

Begin learning the code without assistance from others. First memorize a few letters of the alphabet, or start with the letter A, diddaw. After you have repeated it to yourself many times and after you have sent it over and again on the telegraph key, turn on your short-wave code receiving set and try to pick out as many diddaws as possible from a slow-sending station. Every time you distinguish a "diddaw", write down the letter A. After you have thoroughly acquainted yourself with the SOUND of "diddaw" and after you can distinguish it when you hear it on your receiving set, go to the next letter in the alphabet. After you have memorized a number of letters in the alphabet, make short words, such as "AND". Practice this word on your key, thus: diddaw space dawdid space dawdidid. Keep sending it over and over. If some one is asked to practice with you, let the other party do the sending. Tell him to send the characters of the letter A, then a space, making the space as long as you desire until you have recalled by SOUND the characters diddaw (letter A) and then write the letter A on your scratch pad.

Do not go to the next characters until you have first mastered the knack of reading the first characters which make up the first letter and have written the letter on the scratch pad.

Take simple words to start, such as the words "is", "his", "sis", "see", "she". All of these words are composed entirely of dots.

Then take words composed entirely of dashes, such as "to", "tom", "otto". Words composed entirely of either dots or dashes give the beginner an excellent opportunity to learn proper spacing between letters. As soon as you run the letters together, the sentence structure is ruined, and the receiving operator will not know what you are trying to say.

The next step is to make sentences consisting of words, some of which are all comprised of dots, others all dashes, such as: "She Sees Otto." The first two words are comprised solely of dots, the last word is made up entirely of dashes.

Then go further and make short sentences of words consisting of combinations of dots and dashes. It is easier to begin by learning

only a few of the code characters of the alphabet rather than to first memorize the entire code, from A to Z, and then learn how to make the characters on the telegraph key. You can first learn all of the characters which make up the letters E, I, S and H. E is "did", I is "diddid", S is "diddidid" and H is "diddididid". All of the "dids" must run

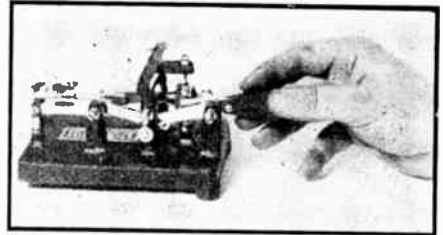

Correct "grip" and position of wrist for operating automatic key ("bug").

together, there must be no pause between the "dids", otherwise the letter H will be a combination of two letters, or a combination of the letters S and E. Make sure that you master the art of steady, accurate sending. Do not send "jerky". Make an H like this—did did did did, but run all four the dits together, thus: "diddididid". Keep sending it until you have learned how to do it properly. Send the four "dids", make a pause, send them over again, make another pause, etc., until you thoroughly remember the character by SOUND. Don't think of the four "dids" as an H, think of the combination as "diddididid", and soon you will automatically write the letter H on your scratch pad every time you distinguish it.

After you have memorized a number of the simpler combinations in the alphabet, practice the entire alphabet, going from A to Z. Pause between each letter, make the pause long enough so that you have distinguished what you have sent, then go to the next letter. Some good code practice can be secured by listening on the amateur bands when the "CQ" calls are sent. Amateurs who call "CQ DX" usually send quite slow. It is easy to copy these signals, and it is good practice, too, because the operator usually sends all groups of characters slowly when calling CQ DX.

On your way to work and at various times throughout the day, repeat the did daws to yourself as often as possible. Make up a short sentence, such as the word "AND", which is "diddaw dawdid dawdidid", or CQ, which is "dawdidawdid dawdidawdidaw". Do not think of the letters CQ, think in terms of SOUND . . . in dits and daws, and you will be amazed to learn how simple it is to gain speed in a relatively short period of time.

Fundamentals of Electricity

● A study of electrical or radio phenomena requires a knowledge of the electron conception of matter and energy. All matter is composed of positive and negative particles of electricity, the former called protons and the latter called electrons. The proton has approximately 1,800 times the mass of an electron. Thus it is seen that an electron is the smallest unit into which matter can be subdivided.

Electrons and protons cannot exist alone. The smallest particle of matter which can exist alone is the atom. It consists of a heavy nucleus of one or more protons surrounded by an equal number of electrons. The outermost electrons revolve in circular or elliptic paths around this inner nucleus. Every atom of matter has as many electrons as protons, and therefore the total number of positive and negative charges neutralize each other. As long as these charges are neutralized the atom is neutral, electrically. Under certain conditions it is possible to add to, or subtract from the number of electrons, which gives to the atom an electrical charge. If the number of electrons is increased the atom possesses a negative charge, while if there is a deficiency of electrons the atom possesses a positive charge.

All matter is made up of 92 different kinds of atoms, which differ only in the number of protons and the configuration of the equivalent number of electrons in, and surrounding the nucleus.

In all substances which are non-conductors of electricity, the electrons in the atoms are held permanently in place in fixed orbits about the nucleus, but in the atoms of all electrical conductors one or more of the electrons farthest out from the nucleus is attached rather loosely and may, by various means, be drawn away from the atom altogether. These are termed free electrons.

In all insulating substances the atomic structure is such that all the outlying electrons are tightly held in their orbit; thus they cannot be freed by external forces. This statement is relative, because given enough external force, even the atoms of the very best insulators can be made to give up an electron.

Electromotive Force

Electricity consists of a movement of electrons, from a point of excess to a point of electron deficiency; in other words, from a negative point to a positive point, in any closed circuit.

The looseness with which the outer electrons are held in any atom is related to the electrical conductivity of the substance composed of this particular atom. The more loosely the free electrons are attached to their

nuclei, the better the electrical conductivity. Thus the flow of current in a conductor consists of a stream of electrons moving along the conductor, from atom to atom, in a definite direction under the influence of an outside applied force or pressure. In electrical circuits this outside force consists of an equalizing tendency on the part of the electrons which, like water, seek their level. Thus there will be a flow of current in any conductor which possesses an excess of electrons at one point, and a deficiency of electrons at another point, until the number of electrons at all points along the conductor are equal. This equalizing force is called the electromotive force, abbreviated EMF, and is usually expressed in volts. Thus electromotive force, or voltage, as it is commonly called, is due to a non-uniform distribution of free electrons in a circuit. For example, if a battery is placed in a closed circuit a current of electricity will flow around the circuit. This is because the battery pulls electrons into one terminal, and pushes the electrons out of the other terminal. The terminal through which the battery is trying to push electrons is the negative terminal, and the terminal which has a deficiency, and thus attracts electrons from any conductor attached to it is the positive terminal. The words POSITIVE and NEGATIVE have no meaning, but were merely chosen to distinguish between the two types of electrical charges. These terms were chosen many years before the electron-movement theory was established, and for a long time it was assumed, for reasons of uniformity, that current flowed from a positive terminal to a negative terminal. It is now known that the electrons, which comprise the current, actually move in the opposite direction, or from negative to positive terminals.

Because electrons are particles of like charges, they violently repel each other, and thus the excess electrons at a negative point in any circuit push the other free electrons of the circuit ahead of them around to the positive terminal to neutralize the deficiency of electrons at that point. As the battery by its action continues to push electrons through itself from the positive to the negative terminal, there results a constant stream of electrons through the circuit, as long as it is closed. The actual migration, or progress of each individual electron through a conductor, ranges from 3 to 15 centimeters per second, although due to the push which each electron exerts on the electron immediately ahead of it, the effect is as if the flow approached the velocity of light, which is 186,300 miles per second.

Electric Potential

The electric potential between any two points defines the difference in pressure between those two points. If the points are joined by a conductor, the electrical potential corresponds to the electromotive force which draws current through the conductor. Thus electric potential is measured in volts, and determines the deficiency of electrons at the more positive of the two points.

The Electrical Circuit

The simplest electrical circuit consists of a source of electromotive force and a continuous path from the negative terminal to the positive terminal through a resistance. The source of electromotive force may be either unidirectional (DC), or alternating (AC). If the source is unidirectional, the positive and negative terminals remain the same, but if the source is alternating the polarity of the two terminals is periodically reversed. In an alternating current circuit the direction of electron movement reverses once each cycle. In the ordinary 60 cycle alternating current power line the polarity of the AC generator reverses 60 times per second. This corresponds to a FREQUENCY of 60 cycles per second. Alternating and Direct currents have quite different characteristics and thus the study of electricity is divided into two parts, Direct Current Circuits, and Alternating Current Circuits.

Electrical Resistance

When the free electrons in a conductor are given movement by some electromotive force, a current flows through the wire. The electrons in their movement continually collide with the atoms of the wire. These collisions slow the electrons down, which limits the amount of current which can flow through a given circuit when a given electromotive force is applied. This limiting of the current, due to collisions of the electrons with atoms, is termed the RESISTANCE of the conductor, which is expressed in OHMS. When an electromotive force of one volt impressed on a circuit will force a current of one ampere through the circuit, the circuit has a resistance of one ohm.

The collisions between the free electrons and the atoms move the atoms around slightly, which takes energy away from the electron stream. This energy heats the conductor and explains why resistors that carry current heat up.

Electric Current

Electric current describes the rate of flow of electricity through a circuit, and the unit of current flow is the AMPERE. Electric currents are measured either by their heating effect on a conductor (thermo-ammeters, etc.), or by their magnetic effects (moving coil and moving iron instruments).

Sources of Electricity

An electromotive force (and therefore a flow of current) can be produced either by chemical or mechanical means. All batteries produce electricity by converting energy from one form to another by means of a chemical reaction. All of the common types of electrical generators transform mechanical energy into electrical energy, either by magnetic or electrostatic action.

Series and Parallel Circuits

A simple circuit can contain any number of resistances.

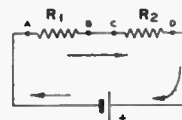

FIG. 1

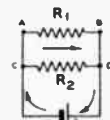

FIG. 2

Fig. 1 shows a circuit which has two resistances in series, while Fig. 2 shows a circuit with two resistances in parallel. The current in a parallel circuit will divide between the various resistance branches, and will not be equal in each branch unless the resistance of every branch is equal. In a series circuit, however, the current flow is equal at every point in the circuit.

Ohm's Law

The resistance of any conductor depends on the material of which it is made, its cross section, and its length. The relationship between the electromotive force (voltage), the flow of current (amperes), and the resistance impeding the flow of current (ohms), is expressed in Ohm's Law, which states: "For Any Circuit or Part of a Circuit the Current in Amperes is Equal to the Electromotive Force in Volts Divided by the Resistance in Ohms." This relationship is usually expressed by the following three formulas:

Where I is the current in amperes,
E is the electromotive force in volts,
R is the circuit resistance in ohms.

$$E=IR \quad I=\frac{E}{R} \quad R=\frac{E}{I}$$

Thus resistance equals voltage divided by current.

Current equals voltage divided by resistance.

Voltage equals current times resistance.

In many commonly used circuits it is found that there are resistances connected in series, in parallel or in series-parallel, as shown in Fig. 3. In order to calculate the total resistance of any network composed of two or more resistors connected in any of the above three ways, the formula shown in Fig. 3 is

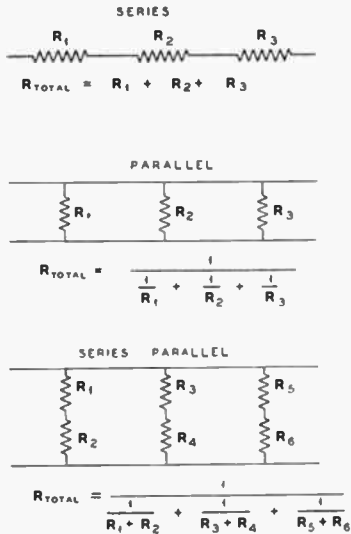

FIG. 3

used. It should be remembered that the total resistance of resistors connected in series is larger than that of the highest resistance in the circuit. Also, the total resistance of resistors connected in parallel is less than that of the lowest resistance in the circuit.

Electric Power and Heating Effects

The heat generated in a conductor by the flow of current varies directly with the resistance of the conductor and as the square

into heat in the resistor. Using the symbols described above, plus $W = \text{Watts of Power}$, it is found that the following relationships hold true:

$$W = EI \quad W = I^2R \quad W = \frac{E^2}{R}$$

Electrical power can do other forms of work besides generating heat, such as driving a motor, radiating waves from an antenna or driving a loud speaker. Electrical power takes many different forms and can be transformed from one form to another by means of a motor-generator, transformer or vacuum tube.

**Electrical Inertia
Electromagnetic Phenomena**

The flow of electric current through a conductor produces a magnetic field around that conductor. It is known that electrons, being particles of like charge, repulse each other. This repulsion is due to the electrostatic field of force which surrounds every electron. The electrostatic field of force surrounding an electron repels any other electron with a force inversely proportional to the square of the distance. Thus if the repulsion at any distance is a certain value, the repulsion at twice this distance is one-half squared, or $\frac{1}{4}$ as much. The electrostatic field around any electron which is at rest, or moving with a constant velocity, can be visualized by a group of concentric equipotential circles surrounding the electron. See Fig. 4.

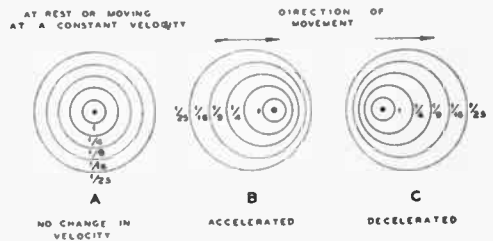

FIG. 4

R M A STANDARD RESISTOR COLOR CODE

A BODY COLOR-1st. figure of resistance value.
B COLORED END-2nd figure.
C CENTER DOT-number of ciphers following first two figures.

figure	color	figure	color
0	BLACK	5	GREEN
1	BROWN	6	BLUE
2	RED	7	VIOLET
3	ORANGE	8	GRAY
4	YELLOW	9	WHITE

When an electron moves, it must carry its field of force along with it. Due to the relatively enormous volume of the field of force, each electron has considerable inertia. Thus when a switch in a circuit is closed the current does not instantly jump to the final value determined by the voltage divided by the resistance.

This gradual build-up of current in any circuit depends on the characteristics of the circuit. It takes longer for the current to build up in a circuit where the wire is coiled up than it does in a circuit where the conductor is a long, straight wire. This is because the electrostatic fields surrounding

of the amperes of current flow. The unit of power is the Watt and equals the product of the voltage across a resistor, times the current through the resistor. This equals the amount of electrical power transformed

electrons in adjacent turns of the coil overlap. The energy stored at any point in space is proportional to the square of the electrostatic intensity (or force) at that point. Thus by coiling the wire the energy concentration stored in the space around the coil has been materially increased, due to the increased overlap in the fields of the electrons. If the electrostatic intensity at any point has been increased a hundred times over that of a point near a straight wire, the energy storage is 100 squared, or 10,000 times that of the energy stored in the space surrounding the long, straight wire. This stored energy comes from the source of power supplying the circuit, and any given current in a coil represents much more stored energy than the same current in a straight wire. Thus for a given impressed voltage it takes more time to start or stop the current flow in a coil than in a straight wire. Likewise, to start or stop the current flow in a coil in a given time requires the application of a larger voltage than would be necessary to start or stop the same current flow in a straight wire.

The inertia offered by a circuit to either an increase or a decrease in current is termed the Inductance of the circuit. This inertia can be visualized in the following manner: When an electron is accelerated, or speeded-up, its electrostatic field does not instantly respond to the motion of the electron because the electrostatic disturbances caused by the sudden acceleration of the electron travel outward from the electron with the speed of light.

Thus when the electron is being accelerated, different parts of the field are moving at different speeds, as shown in Fig. 4 (B), and the concentration of energy ahead of the electron is greater than the concentration behind it. As soon as the electron attains constant velocity its field again becomes symmetrically arranged. When the electron is decelerated the concentration of energy behind it becomes greater than that ahead of it, as shown in Fig. 4 (C). These non-uniform concentrations of energy tend to oppose any change in the velocity of the electron, and it should be evident that the overlapping of the electron fields which occurs in a coil increases the non-uniform energy concentration which accompanies any change in the velocity of an electron, thus increasing the opposition to change, or inertia of the electron. This inertia therefore exerts a force opposing any change in the current through an inductance, and this opposing force is called the Back Electromotive Force.

Induction and Induced Voltages

When an alternating current is passed through a coil of wire, energy is alternately stored in the field and returned to the wire. The greater the number of turns of wire on the coil, the greater is the magneto-motive

force. This force varies with the number of turns, the diameter of the coil and the current. MMF corresponds to magnetic pressure.

Magnetic Flux

Magnetic flux consists of the lines of magnetic force which surround any conductor. Magnetic flux might be termed magnetic current, just as magneto-motive force corresponds to magnetic voltage. The reluctance of a magnetic circuit could be described as the resistance of the magnetic path and the relationship between magnetic flux; magneto-motive force and reluctance is exactly similar to that between current, voltage and resistance, (Ohm's Law).

Magnetic flux depends on the material, cross-section and length of the magnetic circuit and varies directly as the current flowing in the circuit. Reluctance depends on the length, cross-section, permeability and air-gap, if any, in the magnetic circuit.

Permeability

Permeability describes the difference of the magnetic properties of any magnetic substance compared with the magnetic properties of air. Iron, for example, has a permeability of approximately 3100 times that of air, which means that a given amount of magnetizing effect produced in an iron core by a current flowing through a coil of wire will produce 3100 times the flux density that the same magnetizing effect would produce in air. The permeability of different iron alloys varies quite widely and permeabilities up to 10,000 can be obtained, if required. Permeability is similar to electric conductivity. However, there is one important difference—the permeability of iron is not independent of the magnetic current (flux) flowing through it, although electrical conductivity is usually independent of electric current in a wire. After a certain point is reached in the flux density of a magnetic conductor, an increase in the magnetizing field will not produce any material increase in the flux density. This point is known as the point of saturation. The inductance of a choke coil whose core becomes saturated declines to a very low value. This characteristic is extremely valuable in the swinging choke and in the saturable reactor used in some controlled carrier modulation systems.

The magnetizing effect of a coil is often described in ampere-turns. Two amperes of current flowing through one turn equals two ampere-turns, or one ampere of current flowing through two turns also equals two ampere-turns.

Mutual Inductance

When two parallel wires are placed in proximity to each other and a varying current flows through one of them, the non-

uniform energy concentrations around the accelerating and decelerating electrons in the conductor carrying the varying current cause an induced electromotive force to be applied to the free electrons in the neighboring conductor. This electromotive force (voltage) produced in the neighboring conductor is always in the same direction as the back-electromotive force set up in the conductor which is carrying the exciting current. This point helps to explain why the inductance of a circuit containing many turns of wire is greater than that of a circuit composed only of a straight wire. In a coil, each turn has a back-electromotive force induced by the changing current within itself. In addition, it has an induced electromotive force in the same direction, due to the changing current in the adjacent turns on each side of the portion of the coil under consideration. The self-inductance of a coil in henrys equals the induced voltage in volts across that coil when the current is varying at the rate of one ampere per second.

If a second coil is wound directly over the first coil, any change in current in the first coil will induce a voltage in the second coil, and the mutual inductance in henrys between the two coils equals the voltage induced in either coil when the current in the other is varying at the rate of one ampere per second. The unit of inductance is the henry.

Inductive Reactance

The principal property of an inductance is to resist any change in current through it, and therefore an inductance will impede the flow of alternating current through it. The higher the frequency of the alternating voltage impressed across the inductance coil, the lower will be the current through the coil. The current flowing through the inductance coil therefore is related to the inductance in henrys and the frequency in cycles per second.

Formula:

Where X_L is the inductive reactance in ohms,
 f is the frequency in cycles per second,
 L is the inductance in henries,

$$X_L = 2\pi fL$$

Thus if the inductance of a coil and the frequency of the impressed alternating voltage is known, the current in any AC circuit composed of an inductance can be determined by dividing the voltage by the inductive reactance.

Inductances can be connected in series or in parallel. The effect of connecting inductances in series or in parallel is quite similar to the effect of connecting resistors in series or in parallel. Inductances in series:

$$L_{\text{total}} = L_1 + L_2 + L_3, \text{ etc.}$$

Inductances in parallel:

$$\frac{1}{L_{\text{total}}} = \frac{1}{L_1} + \frac{1}{L_2} + \frac{1}{L_3} + \text{etc.}$$

Transformers

It was seen that a variation of a current flowing through a coil induces a voltage in any other coil with a common magnetic circuit. This explains the operation of the transformer, which is very widely used in radio circuits. The winding of the transformer which carries the exciting current is usually termed the primary winding, and the coupled winding in which it is desired to induce a voltage is termed the secondary winding. If the primary and secondary windings each have the same number of turns, closely coupled, and if neither of the windings is tuned by means of a capacity to resonance at the frequency of operation, the voltage across the secondary will be equal to the voltage across the primary. If the secondary has twice as many turns as the primary, the induced voltage in the secondary will be twice the exciting voltage across the primary. For any other turns ratio between the primary and secondary windings the ratio of the secondary voltage to the primary voltage will always be equal to the ratio between the number of secondary turns and the number of primary turns. These relationships hold as long as no current flows in the secondary winding, which is the case in all low-level audio circuits. When a load is connected across the secondary, as in a power transformer, or an audio output transformer, the DC resistance and the leakage reactance of the transformer windings modify the voltage relationship slightly.

$$\frac{Z_p}{Z_s} = \left(\frac{N_p}{N_s} \right)^2$$

Where Z_p = primary impedance,
 Z_s = secondary impedance,
 N_p = number of primary turns,
 N_s = number of secondary turns.

Condensers and Capacitive Reactance

A condenser stores electric energy. A condenser in its simplest form consists of two parallel and adjacent plates separated by an insulator, such as air for example. If the two plates are connected to a source of DC voltage, one plate will take on a positive charge and the other will take on a negative charge. As soon as the potential difference between the two plates becomes equal to the voltage of the DC source, the current in the circuit will cease. If the condenser is connected to a source of AC voltage, the current will surge back and forth every cycle, because first one plate takes on a positive charge, then the other. During that part of the cycle when one plate becomes negative, the excess of electrons driven on to this plate repels an equal number of electrons off the other plate. These electrons then travel back toward the positive terminal of the voltage

source. On the next half cycle this process is reversed. No electrons actually pass through the condenser from one plate to the other, but because the electrons arriving at one plate drive an equal number away from the other plate, the effect on the circuit is the same as if the electrons actually passed right through the condenser—except for the phase relation between the impressed voltage and the resulting current.

The quantity of electricity stored in the condenser is proportional to the voltage impressed across it; this relationship is called the capacity of the condenser. The unit of capacity is the farad. A condenser has a capacity of one farad if one volt impressed across it causes an energy storage of one coulomb of electricity. Most condensers used in radio work have a very small fraction of this capacity, and thus the usual unit of capacity is the micro-farad, which is one-millionth of a farad.

The capacity of a condenser depends on the area of the plates, their spacing, and the dielectric properties of the insulator which separates the plates. For mechanical reasons it is desirable to construct condensers with more than two plates. Thus most radio condensers consist of two paralleled sets of plates, each set connected together conductively. Different insulators have different dielectric properties. The dielectric properties of any material indicate its ability to store energy when subjected to an electrostatic field. The dielectric constant of any material describes its ability to store energy in terms of the energy storage of air.

One of the most common types of condensers used for radio work is the variable condenser, one whose capacity can be varied by the rotation of the shaft which supports the rotor plates.

Capacitive Reactance

Alternating current does not flow through a capacity without some impeding effect taking place, which is termed capacitive reactance. This is inversely proportional to the frequency and to the capacity of the condenser. Formula:

Where X_C is the capacitive reactance in ohms, f is the frequency in cycles per second, C is the capacity in microfarads.

$$X_C = \frac{1,000,000}{2\pi fC}$$

Thus if the capacity of a condenser and the frequency of the impressed alternating voltage is known, the current through any condenser can be determined by dividing the voltage by the capacitive reactance.

Condensers can be connected in series or in parallel, but the effect is just the opposite to that of connecting inductances or resistances in series or in parallel.

Condensers in series:

$$\frac{1}{C_{total}} = \frac{1}{C_1} + \frac{1}{C_2} + \frac{1}{C_3} + \text{etc.}$$

Impedance

When an inductance, a capacity and a resistance are connected in series, the combined effect is called the impedance of the circuit. The capacitive reactance and inductive reactance are of opposite sign, because the current through a condenser leads the impressed voltage by 90 electrical degrees, while the current through an inductance lags the voltage by 90 degrees. Thus the current is 180 degrees out of phase with that through the inductance. The reactance of the circuit becomes $X_L - X_C$. Since the current through an inductance or capacity lags or leads that through a resistance by 90 degrees, it is necessary to take the square-root of the sum of the squares to solve for the total impedance of the circuit to the flow of current.

$$Z = \sqrt{R^2 + (X_L - X_C)^2}$$

With any two quantities known, the third can be solved from the following formulas:

$$E = IZ \quad Z = \frac{E}{I} \quad I = \frac{E}{Z}$$

From the equation of the impedance of a series circuit it can be seen that the impedance is equal to the resistance when the inductive reactance is equal to the capacitive reactance. This is known as resonance.

Alternating Current Considerations

Alternating current produces a heating effect in a resistor in spite of varying and reversing its direction of flow. A generator produces alternating current which starts at zero, reaches a maximum, returns to zero, reverses direction and repeats the performance. This variation follows a mathematical law which can be called a sine wave. The actual heating effect of this alternating current depends on the effective value of each half sine wave. This is called the R.M.S. value and is equal to the peak value divided by 1.41, in case it is a pure sine wave. The RMS value of either voltage or current is the value read on most AC voltmeters or ammeters.

In considering alternating current the actual power is not the product of I^2Z , since the effect of either inductance or capacity is to make the current lag or lead that through the resistance of the circuit. The lag or lead is known as the phase angle and the power can be computed from the expression $P = E \times I \cos \phi$. The $\cos \phi$ represents the power factor and thus in the circuit containing resistance only, this becomes unity, or 100%. A perfect condenser having no resistance would have zero power factor, thus providing a method of comparing different condensers.

Fundamentals of Radio

In power, telephone and telegraph lines, electrical energy is carried from the sending point to the receiving point through individual and isolated conductors. All radio signals, however, utilize a common conducting medium, the ether. This mixing of thousands of radio signals in one conducting medium necessitates some method of selecting the desired signal and rejecting all others. This is accomplished by means of resonant circuits involving inductances and capacities in series or in parallel. Vacuum tubes are used to amplify the signals, while tuned circuits are used for selecting the desired signals.

Radiation

Radio waves are transmitted from an antenna through space in two general types of waves. One is called the ground wave, which follows along the surface of the ground, and for very short waves it is quite rapidly attenuated. The ground wave is useful in long wave radio communication and also for very short distance work on ultra-short wavelengths. The other form of wave is known as the sky wave, since it is reflected back to earth by ionized layers in the upper atmosphere known as the Kennelly-Heaviside Layers. The sky waves are propagated from the antenna at angles above the horizon.

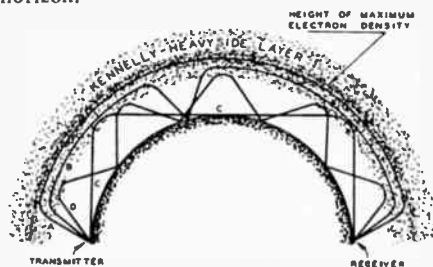

FIG. 5—Reflection of radio waves from the Heaviside Layer around the earth.

At very low angles of radiation the waves go out practically tangent to the earth's surface, penetrate into the ionized layers and are bent back to earth at a very distant point. Higher angles of radiation are bent back to earth at shorter distances until a certain high angle is reached for any particular frequency which will not be bent back to earth. This angle varies with the season of the year, frequency and time of day. At angles slightly less than this value at which the layer is penetrated, the radio wave can be carried around through one of the upper layers to extremely great distances before being bent back to earth. Very short waves are not bent back to earth, no matter what the angle of propagation, and thus these waves are only useful for short distances of

not much more than twice the range of a light beam. This makes these waves useful for local communication and they will probably be used extensively in television transmission.

The Kennelly-Heaviside Layer is a strata of ionized air molecule due to ultra-violet radiation from the sun. This layer (or layers) varies in distance above the earth from less than a hundred miles to several hundred miles elevation. The density is greatest in the layer closest to the earth, especially in the daytime and in summer. However, it is not constant, but varies from year to year and seems to depend upon sunspot activity.

Inductance Considerations

Inductances are used in radio, audio and power circuits. An inductance used for the latter purpose can be designed from a rather simple formula:

$$L = 1.257 N^2 P \times 10^{-9}$$

Where N equals the number of turns of wire; L equals the inductance in henrys, and P is the permeance of the complete magnetic circuit.

Most of the magnetic circuit is confined by means of a magnetic core, such as iron, to the close proximity of the coil itself. For radio frequencies some form of air core coil is generally used. Extremely finely divided iron is being used for low and medium frequency coils, such as those used in intermediate frequency transformers in receivers. Inductance of an air core solenoid can be calculated from the formula:

$$L_1 = N^2 dK$$

Where L_1 equals the inductance in microhenrys, N equals the number of turns, d equals the average diameter of the coil and K is a constant depending on the ratio of length to diameter of the coil.

This formula shows that inductance of radio frequency coils varies as the square of the number of turns and directly as the diameter of the coil.

An inductance has a certain amount of resistance due to the metallic conductor used in winding the coil. At radio frequencies this resistance is a great many times more than the resistance would be for direct current. At radio frequencies the current tends to concentrate at the surface of the conductor, which in effect gives an increase in the resistance. This crowding of the current density toward the surface of the conductors is known as the "skin effect".

The ratio between the inductive reactance of the coil and its effective resistance gives a measure of its efficiency and is known as the "Q" of the coil. "Q", therefore, is the factor of merit of a reactance element.

$$Q = \frac{2\pi fL}{R}$$

Capacity Considerations

The capacity of a condenser consisting of two parallel plates is given by the formula:

$$C = .08842 k \frac{A}{D}$$

Where C equals the capacity in micro-microfarads, A equals the area of active dielectric in square centimeters, D equals spacing or thickness of dielectric in centimeters and k equals the dielectric constant, which is 1 (one) for air. Increasing the number of plates in a condenser increases the area of the active dielectric and thus increases the capacity of the condenser.

The effective series or shunt resistance of a condenser is easily calculated if the power factor and frequency of operation is known.

$$\text{Series resistance} = \frac{\text{power factor}}{2\pi fC}$$

$$\text{Shunt resistance} = \frac{1}{2\pi fC \times \text{power factor}}$$

The losses in a tuned circuit are almost entirely due to the losses in the inductance, because condenser losses are extremely small up to about 100 megacycles.

Series Resonance

When an inductance, resistance and capacitance are connected in series, there will be a certain frequency at which the inductive reactance is equal and opposite in effect to the capacitive reactance. At this, the resonant frequency, the flow of current is only limited by the effective resistance of the circuit. At frequencies higher than resonance the capacitive reactance is less than the inductive reactance, with the result that the impedance is higher than that at resonance. The same holds true at lower frequencies, except that the larger reactive term is capacitive. The reactive voltage drop across either the coil or condenser is very high at resonance, because the current is only limited by the resistance of the circuit. This reactive voltage may be several hundred times the value of the impressed voltage, as given by the expression:

$$E_L = \frac{E \times 2\pi fL}{R} = \frac{E}{2\pi fCR} = E \times Q$$

For example, if the impressed voltage is 10 volts, and if the "Q" of the coil is 100, the reactive voltage across the condenser or the coil would be 1,000 volts. The sharpness of a resonance curve depends upon the "Q" of the coil. For example:

$\frac{1}{2Q}$ — difference of frequency from resonance will only give 70% of the resonant current.

$\frac{1}{Q}$ — difference of frequency from resonance will only give 45% of current at resonance.

Series resonance is often used in antennas, antenna feeders and occasionally in audio frequency or filter circuits.

Parallel Resonance

Parallel resonant circuits are used in both transmitters and receivers for purposes of selectivity or coupling between vacuum tubes. At frequencies below resonance the inductive branch draws high current, but the capacitive branch draws low current, resulting in a lagging current and thus inductive reactance. The opposite holds true for frequencies higher than resonance. At resonance the inductive reactance is equal to the capacitive reactance, and the parallel impedance is effectively a very high resistance. The parallel impedance at resonance is equal

$$\text{to: } \frac{(2\pi fL)^2}{R} = 2\pi fL Q$$

This shows that at resonance there is a resonant rise in impedance of "Q" times the reactance of either branch. This means, for example, that a tuned radio frequency amplifier would have more gain and also better selectivity with a high "Q" coil in the tuned coupling circuits. The plate impedance of an RF amplifier tube is usually much greater than 100,000 ohms and thus the interstage tuned circuits should have a very high resonant impedance in order to obtain a good impedance match and maximum voltage gain.

Where parallel resonant circuits are used across the grid or plate circuit of a transmitting power amplifier tube, the impedance of the tank is greatly reduced. This is caused by the fact that a fairly low shunt resistance is placed across the parallel tuned circuit. The effect of a shunt resistance is to increase the effective series resistance of the same circuit by an amount given in the following formula:

$$r = \frac{r_s}{r_s \times [2\pi fC]^2 + 1}$$

where r_s is equal to the shunt resistance.

For example, a shunt resistance of 2,000 ohms would increase the effective series resistance of a representative tank circuit from 5 ohms to 100 ohms at a frequency of 7 megacycles. Assuming the circuit had a "Q" of 100 without any shunt load, the "Q" would be reduced to 5, due to the loading of the tube. The parallel impedance (from the above formulas) would be about 2500 ohms under load conditions, and 50,000 ohms with no load. This example brings out the effect of a resistance shunted across a parallel tuned circuit.

The resonant frequency of a parallel tuned circuit is given by the expression:

$$f = \frac{1}{2\pi\sqrt{LC}}$$

for high "Q" circuits.

The resonant frequency is affected by the effective series resistance, and consequently the above expression is slightly in error for low "Q" circuits. The sharpness of resonance is similar to that of a series resonant circuit and the same "Q" formulas can be used for determining the currents at frequencies slightly off resonance.

In many applications of parallel tuned circuits it is desirable to obtain a step-down ratio of impedance. A typical example is in matching a 500 ohm single wire antenna feed line to the tuned output circuit of a transmitter, as shown in Fig. 6.

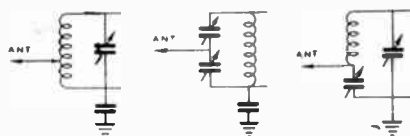

FIG. 6

In this case the load is only connected across part of the parallel tuned circuit impedance in order that optimum power transfer will be obtained.

Another case of parallel resonance occurs in radio frequency choke coils which are used to prevent radio frequency currents from flowing into undesired circuits. The self capacitance of the coil resonates it with its inductance to a frequency usually much lower than the operating frequency. The RF choke acts like a very small condenser of not more than two or three micro-microfarads which presents a high impedance to RF current at most frequencies used by amateurs. At frequencies below resonance the RF choke acts like an inductance having an apparent value equal to $\frac{L}{1 - m^2}$ where m is

the ratio of applied frequency to the natural resonant frequency of the coil, and L is the theoretical inductance. This apparent inductance can be very great near resonance.

Coupled Circuits

Single reactive circuits are not always suitable for use in radio transmitting and receiving circuits. It is usually desirable to use various forms of coupled circuits which can be resolved down into the four simple forms shown in Fig. 7. The presence of a secondary circuit changes the impedance of the primary circuit by an amount equal to the expression:

$$\frac{(2\pi fM)^2}{Z_2}$$

The equivalent primary impedance becomes $Z_1 + \frac{(2\pi fM)^2}{Z_2}$

Where Z_1 equals the series impedance of the primary alone, Z_2 equals the series impedance of the secondary alone, and M equals the mutual inductance of the coils L_1 and L_2 .

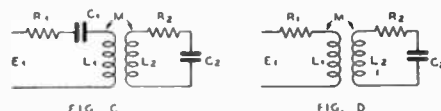
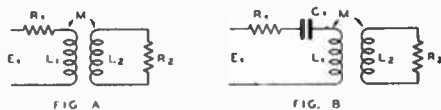

FIG. 7

The effect of the secondary circuit upon the primary circuit can be determined from the above expression in any of the four types shown. When Z_2 is low, such as at resonance, and M is not small, the effect on the primary is large. Nearly any transmitter or receiver circuit can be analyzed, roughly, by the above method.

Power transformers are a form of coupled circuits of the type shown in Fig. 7A, above. The difference between a power transformer and a similar RF coupled circuit is that the leakage reactance may only be about two per cent in the former case, and as high as 90 per cent in the latter case. The leakage reactance is much higher at radio frequencies because most high frequency coupled circuits are resonant and require very loose coupling with a very small value of M to attain the desired result. In many cases the coupling between two or more circuits is obtained by other methods using some form of inductive or capacitive reactance, or even resistance coupling.

Band-pass circuits are special forms of parallel resonant coupled circuits. The coupling is increased until the secondary causes an extreme broadening of the resonance curve or it may even form a double resonant peak in the primary circuit. True band-pass circuits are seldom used in short wave radio receivers or transmitters because selectivity and gain are more important to the amateur than a level frequency response over a range of frequencies.

Antennas

An antenna is a device for transforming high frequency electrical energy into radio waves when used for transmitting, and transforming radio waves into electrical energy when receiving. An antenna is similar to any tuned circuit, except that the capacity and inductance are distributed usually along the wire instead of being lumped, as in a tuned circuit. At resonance, the voltage and current distribution along a half wave antenna is sinusoidal in the form of a standing wave. A wavelength is twice the distance between adjacent minima or maxima of standing waves on the antenna. The resonant frequency of an antenna is given the expression:

$$f = \frac{300,000,000}{\lambda}$$

Where λ is the wavelength in meters,
 f is the frequency in cycles per second.

300,000,000 is the velocity of wave propagation, which is the same as the speed of light in meters per second.

The impedance along a half wave antenna varies from a minimum at the center to a maximum at the ends. The impedance at the ends can be several thousand ohms. The impedance at the center would be theoretically about 73 ohms if the antenna was infinitely high above the earth and not near any other objects. The actual center resistance varies as shown in Fig. 8 for various heights above ground.

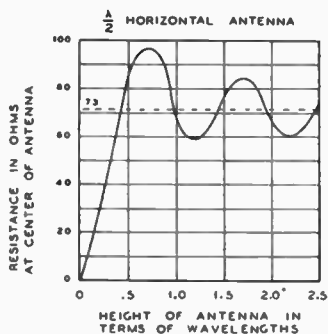
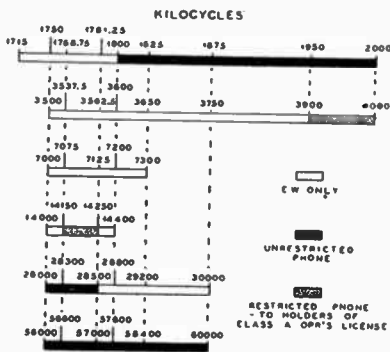

FIG. 8—Radiation resistance of half wave horizontal antenna for various heights above ground.

From this curve it can be seen that the radiation resistance varies with the antenna height above ground. Radiation resistance is a term which is useful in expressing the power radiated by an antenna. It is that resistance which would consume the same amount of power that is radiated from the

antenna. This resistance depends upon the antenna length and construction, and proximity of nearby objects. The theoretical radiation resistance of a grounded vertical quarter wave antenna is 36.2 ohms at the voltage node. In addition to radiated energy, power is also lost as a result of wire and ground resistance, corona and induced power losses in nearby objects. These losses can also be represented as a resistance in series with the antenna consuming an equivalent amount of power. For ultra-high frequency antennas the radiation efficiency can be higher than 90 per cent.

The directive effect of simple antennas is discussed in the antenna chapter. Occasionally, antenna arrays are used to obtain more directivity and stronger radiated signals. These antenna arrays usually consist of simple half wave antenna elements spaced and energized in such a manner as to obtain the desired characteristic. Antenna directivity results from phasing the radiation from adjacent antenna elements in such a manner as to neutralize the radiation in the undesired directions, and to reinforce the radiation in the desired directions. Directivity can be obtained in either the horizontal or vertical plane. Recent developments in directive antennas are along the lines of adjustable or rotatable axes of directivity.



The most commonly used amateur bands are shown in the Bliley chart above. The figures refer to frequency, in kilocycles. The band shown on top of the chart is the 160 meter band; next in order are the 80, 40, 20, 10 and 5 meter bands. The vertical dotted lines pass through integral multiples of the lower frequencies, showing which portions of each band permit doubling into the higher frequency bands. Amateurs are also permitted to operate anywhere above 100 megacycles (below 3 meters) although by general agreement they are grouping near 112 MC (2½ meters) and 224 MC (1¼ meters).

Vacuum Tubes

● The vacuum tube is the heart of practically all equipment used in the transmission and reception of radio messages. It acts as an AC generator of high frequencies. These frequencies which are then amplified and keyed, or modulated by other tubes, are then finally radiated into the ether. In finding their way through the ether, the radio waves are tremendously attenuated and sometimes must be amplified millions of times in other vacuum tubes located in the receiver, before the amplitude of the wave is sufficient to drive headphones or a loudspeaker. Other types of vacuum tubes serve special purposes, such as changing AC into DC (Rectification) or for controlling power circuits.

A radio tube consists of an evacuated glass or metal envelope which encloses a cathode and one or more additional electrodes. Connections are brought out to connectors from the cathode and from the other elements. The cathode supplies electrons, while the other electrodes control and collect electrons.

The radio tube is unique in its ability to exercise a practically instantaneous control over the flight of the millions of electrons supplied by the cathode. The energy required to give this control is much smaller than the amount of energy being controlled. From this feature comes the ability of a tube to amplify small electric currents. The term "amplify" is perhaps not strictly accurate, because nothing is actually added to the incoming energy. In fact, the energy that reaches the control grid of a vacuum tube is usually entirely dissipated at that point, and never reaches the output circuit.

What happens is that the energy applied to the grid controls the release of energy in the plate circuit. Under certain conditions, the energy released in the plate circuit can be an exactly similar equivalent of the grid energy, except for its amplitude or amount. Thus the energy supplied to a load circuit by the plate circuit of the vacuum tube is a close enough replica of the smaller controlling energy that it is considered to be an amplified version of the applied controlling energy. The best conception of vacuum tube operation is to consider the tube as a power convertor.

Because the control action of the vacuum tube is almost instantaneous in action, it can operate efficiently at frequencies much higher than possible with rotating machinery, such as alternators and motor generators.

Theory of Operation, Electrons, Emission and Conduction

The performance of thermionic vacuum tubes depends on the flow of electrons through a vacuum.

The electrons associated with each atom

of matter are in constant motion, and the rate of motion increases with temperature. When certain metallic conductors are heated, the motion of the electrons becomes so rapid that some of them break away from the surface of the material and are set free in space. In the absence of any external attraction, most of these freed electrons return to the conductor, because by leaving the conductor these free electrons left the conductor with an electron deficiency, or positive electrical charge. This positive charge attracts the negative electrons nearby. In addition, the negative charge exerted by the electrons already present in the "Space charge" exerts an inward repelling force on those leaving the conductor. This release of electrons by a heated body is called **electron emission**. The heated body that acts as the source of electrons in a vacuum tube is the cathode. A cathode may take the form of a directly heated filament wire, heated by the passage of electric current, or it may be an indirectly heated metallic sleeve, heated by an internal heater winding that is connected to a source of electric energy. In all modern vacuum tubes the surface of the cathode material is chemically treated to increase the emission of electrons when heated. The two principal types of surface treatment include **Thoriated Tungsten Filaments**, as used in medium and high power transmitting tubes, and **Oxide Coated Filaments**, or cathode sleeves, such as used in most receiving tubes. Pure Tungsten filaments are practically obsolete except for use in high power water-cooled transmitting tubes where it is impossible to maintain a high enough vacuum to permit the use of the superior Thoriated Tungsten type of filament.

Emission Current

When a heated cathode and a separate metallic plate are placed in an evacuated envelope, it is found that a few of the electrons thrown off by the cathode leave with sufficient velocity so that they reach the plate. If the plate is connected electrically to the cathode, these electrons will flow back to the cathode, due to the difference in electrical charges caused by the electron leaving the cathode and reaching the plate. This small current that flows is the **plate current**. If a battery, or other source of DC voltage is placed in the external circuit between the plate and the cathode, so that the battery voltage places a positive potential on the plate, the flow of current from the cathode to the plate is greatly increased. This is due to the high attraction offered by the positively charged plate for any negatively charged particles (electrons) nearby. If the

positive potential on the plate is increased, the flow of electrons between cathode and plate will also increase up to the point of saturation. Saturation current flows when all of the electrons leaving the cathode are attracted over to the plate, and no increase in plate voltage can increase the number, because the plate is already getting all of them. If the temperature of the cathode is raised, there will be an increase in the number of electrons thrown off the cathode, and thus the plate current will be raised. Operating a cathode at a temperature materially above rating will cause a shortening of the life of the cathode. Attention should be called to the fact that tubes with Thoriated Tungsten

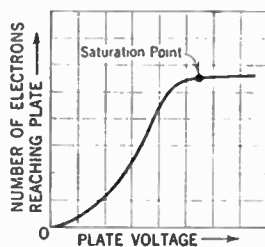

FIG. 9. Curve showing emission from a cathode.

filaments are rather sensitive to changes in filament temperature; thus a close control over the filament heating voltage should be provided. If there is any doubt about the filament voltage, it is better to operate the filament slightly higher than normal, rather than below normal, especially if the tube is operating with high plate current.

Diode Rectification

If a negative charge is applied to the plate, the electrons in the space charge are repelled back to the cathode and no current flows in the circuit between cathode and plate. Thus, in a vacuum tube, current can flow from cathode to plate . . . but not from plate to cathode. If an alternating voltage is applied to the plate, current will flow only when the plate is positive with respect to the cathode. This current will be pulsating, but unidirectional. If a suitable smoothing filter is placed in the circuit, the pulsations will be smoothed out, and the result will be a flow of direct current in the external circuit. This is the process known as rectification and it is widely used in radio circuits. All vacuum tubes used as amplifiers require the application of a rather high positive DC potential to the plate. This potential is usually obtained by stepping up, rectifying and then smoothing the alternating current supplied by the power mains. Other applications of the principle of rectification occur in radio receivers and transmitters. Detection, or demodulation of a high frequency wave, requires that the wave be rectified. The process of modulation necessari-

tates a form of rectification, or non-linear response.

Vacuum Tubes As Amplifiers

The addition of a mesh-like grid in the space between the cathode and the plate in a vacuum tube allows a wide control over the electron flow from cathode to plate to be exercised by the application of a relatively small control voltage to the grid. A three-element tube is termed a triode. When the grid is given a negative charge, with respect to the cathode, it repels inward the electrons around the cathode, which reduces the flow of plate current. If the voltage on the grid is made high enough, it totally stops the flow of plate current. The negative grid voltage at which the flow of plate current is stopped is called "cut-off bias", and depends on the grid-to-plate spacing, as well as the closeness of mesh of the grid structure. When the potential of the grid is made positive, with respect to the cathode, electrons are attracted outward and away from the space charge area surrounding the cathode, and most of them speed on through and past the grid and reach the plate with increased velocity. This increases the plate current.

FIG. 10. Showing how a rectifier changes AC into DC.

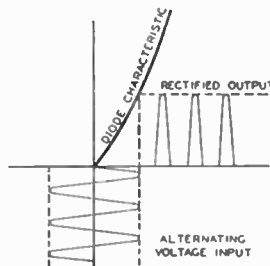

Some of the electrons are intercepted by the grid and flow back to the cathode through the external grid circuit, but this grid current is usually quite small in comparison to the plate current. The ideal grid structure would be one that would give high acceleration to the electron flow when positive, yet would not intercept any grid current. The interception of grid current requires that the source of the controlling voltage applied to the grid will supply enough power to swing the grid voltage to the required positive point, in spite of the resisting effect of the grid current.

A vacuum tube amplifies the voltage excursions of the grid by reason of the fact that the effected change in plate current causes a similar amplified voltage drop to take place across an impedance in series with the plate circuit.

Tetrodes and Pentodes

Tetrode indicates the presence of four elements, and Pentode indicates five elements.

A tetrode consists of a triode to which has been added a second grid between the control grid and the plate. This grid is usually maintained at a positive potential, with respect to the cathode. The purpose of this grid is twofold. First, it accelerates the electron flow from cathode to the plate, improving the ability of the tube to amplify voltage. Second, it provides a grounded

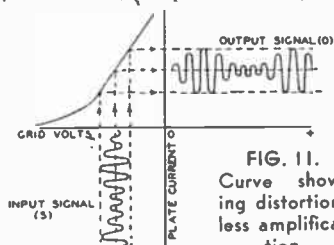

FIG. 11.
Curve showing distortionless amplification.

electrostatic screen between the plate and the control grid, so that energy will not be fed back to the control grid through the plate-to-grid capacitance of the tube. If the amplification through the tube is high enough, this feedback, or regeneration of energy, might set the tube into self oscillation, which would destroy its usefulness as an amplifier. This regeneration is put to work in certain detectors and in all oscillators, but its presence is undesirable in most amplifier applications. The tetrode has several disadvantages, the principal one being that the instantaneous AC plate voltage caused by the changing plate current cannot be allowed to swing to a value below the fixed positive potential on the outer, or screen grid. When the potential on the plate becomes less than the potential on the screen grid, the secondary electrons constantly being driven out of the plate by the impact of those arriving from the cathode fall into the more positive screen, instead of falling back into the plate, as they normally do. This increases the screen current and, under certain conditions, gives the tube negative plate resistance. This effect causes bad distortion in a voltage amplifier and limits the output of a power amplifier.

The pentode was developed to avoid this disadvantage of the tetrode. A third grid is added between the screen grid and the plate for the purpose of shielding the plate from the screen grid, so that the secondary electrons emitted from the plate will be forced to fall back into the plate and are prevented from going over to the screen. This outer grid in a pentode is called the suppressor grid because it suppresses the secondary electrons driven out of the plate.

Pentodes are highly useful for all class A voltage and power amplifications, although they are not as desirable as triodes in high efficiency power amplifiers (above 40% plate

efficiency). The main drawback to the use of tetrodes and pentodes in high efficiency power amplifiers is the fact that the presence of the additional grids raises the plate resistance somewhat more than the amplification factor. Thus the control-grid to plate Transconductance cannot be as high as in a similar triode. Transconductance is the best yardstick of ability to amplify power, particularly at the high plate efficiencies required by economy considerations in the construction of radio transmitters.

Gaseous Conduction

If a diode vacuum tube is evacuated and then filled with a gas, such as mercury vapor, its characteristics differ materially from the high-vacuum type of diode tube.

As the electrons, emitted by the heated cathode, move toward the plate at a constantly increasing velocity, during the half cycle during which the plate is positive with respect to the cathode, they collide with the atoms of gas or mercury vapor. If the moving electrons attain a velocity equivalent to falling through a potential difference of 10.4 volts (for mercury), they are able to knock electrons out of the atoms of mercury with which they collide. The atoms which have thus lost an electron are left with a positive charge and are called positive ions. These positive ions are repelled by the positive plate and attracted by the negative cathode. Thus the positive ions move inward toward the cathode. The positive field surrounding the ions tends to neutralize the negative space charge as long as saturation current is not drawn out of the cathode. This neutralization of the negative space charge around the cathode tremendously reduces the voltage drop across the tube, which reduces the heating of the diode plate as well as improving the voltage regulation of the circuit in which the tube is used. This greatly increases the efficiency of rectification because the voltage drop across any vacuum tube represents a waste of power.

If a grid is placed between the cathode and plate in a gaseous vacuum tube, the starting of the plate current flow can be controlled. A negative bias (or an absence of the required positive bias, in positive grid control tubes), prevents the flow of electrons from starting. However, once the flow of electrons has started and the gas has become ionized, the grid loses all control over the electron stream, and plate current will continue to flow until the positive potential is removed from the plate. The grid will regain control if the positive potential is removed from the plate, even if only momentarily. As the plate potential changes in polarity during each AC cycle when the tube is used as a rectifier, the grid can gain control of the flow after every positive half cycle when the plate goes negative. Grid

controlled rectifiers (trade names: Thyatron and Grid Glow tubes) are quite useful in variable output DC power supplies, because the grid allows a control over the output voltage by varying the point in each AC cycle that the tube starts to pass current. The later the starting point, the less the voltage output, due to the shortening of the plate current pulses. Grid controlled rectifiers are also used in keying a CW transmitter, and also in applying carrier control to the plate power supply of a modulated amplifier.

Grid controlled rectifiers, as well as all gaseous conduction tubes, are useful only at very low frequencies, 500 cycles and below. They are very unstable at higher frequencies due to the finite time required for the internal gas to de-ionize after each cycle of conduction.

Vacuum Tube Characteristics

The characteristics of a vacuum tube define the various electrical features which describe the ability of the tube to perform the various functions for which vacuum tubes are used. The characteristics of a tube are obtained by operating the tube under certain known electrode voltages, and then measuring the electrode currents. By plotting the change in any electrode current as any one of the electrode voltages is changed, a characteristic curve is obtained. The static characteristic curve is obtained with different DC potentials applied to the tube elements, while the dynamic characteristic curve is obtained by applying an AC voltage on the control grid under various conditions of DC potentials on the electrodes. The Dynamic Characteristic gives an indication of the performance of the tube under actual operating conditions.

From three sets of static curves it is possible to calculate in advance the actual performance of practically any type of vacuum tube amplifier or detector. Dr. Everitt and Dr. Terman have done a great deal of work in developing means by which the optimum operating conditions for the operation of class B and class C power amplifiers can be accurately determined in advance. This information, in the form of curves or tables, will probably be made available soon by the tube manufacturers, so that proper values of bias, plate voltage, grid current and plate current can be chosen in order to obtain optimum power output and plate efficiency from any power amplifier.

Dynamic Characteristics Amplification Factor

The amplification factor, or μ , is the ratio of the change in plate voltage to a change in control grid voltage in the opposite direction,

given the condition that the plate current stays constant. For example, if the plate voltage is changed 20 volts, and if it requires a change of 2 volts (opposite polarity) in the control grid voltage to hold the plate current constant, the amplification factor is 20 divided by 2, or 10.

The amplification factor alone does not indicate the ability of a tube to amplify! It does offer a hint as to the usefulness of the tube as a voltage amplifier, but without specifying plate resistance it is absolutely useless as an indication of power amplification. The bias required by any type of vacuum tube amplifier is closely related to the amplification factor of the tube used.

Plate Resistance

The plate resistance (R_p) of a vacuum tube defines the AC resistance of the plate to cathode circuit of a vacuum tube. It is the ratio of a small change in plate voltage to the resulting change in plate current. For example, if a change in plate voltage of 20 volts causes a change in plate current of 10 MA, the plate resistance equals 20 divided by .01 ampere (10 MA), or 2000 ohms. It is desirable to make the plate resistance of a tube as low as possible, especially in power amplifiers. This enables the load circuit coupled to the plate to make a more effective impedance match, and also allows the use of a lower plate voltage than would otherwise be possible.

Transconductance

The control grid-plate transconductance (S_m) (formerly called Mutual Conductance) combines in one term the μ and the plate resistance of a vacuum tube, and is the ratio of the first to the second. Transconductance is also the ratio of a small change in plate current to the small change in grid voltage causing the change, given the condition that all other voltages remain constant. For example, if a grid voltage change of 5 volts causes a plate current change of 10 MA, the transconductance is .01 divided by 5, or .002 mho. This is usually expressed as 2000 micromhos. The MHO is the unit of conductance, and was named by spelling OHM backward. This is logical, since conductance is the reciprocal of resistance.

A convenient means of determining transconductance without any calculations is to read the plate current change caused by a change of exactly one volt on the control grid. By multiplying the resulting plate current change in milliamperes by 1000, the transconductance is obtained directly in micromhos.

Vacuum Tube Amplification

A tube amplifies by reason of the fact that a small change in grid voltage produces a larger change in plate current than would be produced by the same change in plate voltage. See Fig. 11, page 19. This function can be used in a wide variety of ways, depending on the result desired. There are three principal types of tube amplifiers, and two secondary types. These types differ largely in choice of bias axis, angle of plate current flow and whether the average DC plate input is constant or variable.

Class A Amplifier

The class A amplifier is biased usually in the middle of the linear portion of the dynamic characteristic curve. Plate current flows for the whole AC cycle, or 360 degrees. The average plate input is constant and independent of signal amplitude.

This type of amplification is used in all RF, 1F and low-level audio amplifiers of receivers. It is characterized by low plate efficiency and power output, but almost infinite power gain, because the control grid never goes positive and thus requires no grid driving power.

Class B Amplifier

The class B amplifier is always biased to the point known as "Theoretical Cut-Off". The plate current is not zero at this point, but is quite low (no signal present on the grid). Theoretical cut-off bias equals the plate voltage divided by the μ_p or amplification factor. It can also be determined by extending the linear portion of the dynamic characteristic down to the zero plate current line and reading the negative bias intercepted at that point. In class B amplifiers the useful plate current flow should last for exactly 180 electrical degrees, or one-half a cycle.

The class B amplifier is used as an audio power amplifier where it is too expensive to provide the required audio power output from a class A amplifier. It is also used to give distortionless amplification of a radio-frequency wave that has been modulated in some preceding stage of the transmitter. Class B is characterized by maximum plate efficiencies of from 40% to over 70%, depending on application. This type of amplifier is a very good compromise between power gain and power output, when used as an amplifier of unmodulated radio-frequency power. When used as an audio amplifier, undistorted amplification requires the use of two tubes in push-pull. The plate input varies widely with the signal when used as an audio amplifier, but the input remains constant when amplifying a modulated radio-frequency wave.

Class C Amplifier

The class C amplifier is biased considerable beyond the cut-off point. Plate current flows for less than 180 degrees and the plate current pulses are usually quite peaked, which renders this type of amplifier unfit for distortionless amplification. Thus it is practically always used as a radio-frequency amplifier. When used with high bias, plate voltage and grid drive it is capable of very high plate efficiency and power output, although the power gain drops as the plate efficiency and power output go up. It is also used as a plate modulated RF power amplifier, in which case it must be biased to at least twice cut-off.

Class AB Amplifier

The class AB amplifier is biased somewhere between the class A and the class B point. Plate current flows for more than 180 degrees, but less than 360 degrees. The plate efficiency and power output are intermediate between class A and class B, and tubes with low plate resistance and low amplification factor are usually used in this type of service. This type of amplification is almost exclusively used for audio frequencies, and must be used as a push-pull amplifier to avoid distortion. The class AB amplifier was formerly called the class A Prime amplifier.

Class BC Amplifier

The class BC amplifier is biased somewhat beyond cut-off, and thus plate current flows for less than 180 degrees. The only applications of the class BC amplifier at the present time are the modulation gaining RF linear amplifier and the grid bias modulated RF amplifier. In both these amplifiers, fixed low resistance bias equal to Theoretical Cut-Off is supplemented by approximately an equal amount of cathode resistor bias. This arrangement permits the angle of plate current flow to be constant and independent of the audio modulation signal, even though the actual plate current flow is less than 180 degrees. The power output, plate efficiency and power gain are intermediate between class B and class C.

Detection

The process of detection, or demodulation, is used to separate the audio modulation from the radio frequency carrier wave that brings the signal from the transmitter to the receiver. Detection always involves rectification, or non-linear amplification of an AC wave. All other detectors provide exactly the same rectification but the triode, tetrode and pentode detectors also combine the function of amplification, which is advantageous in that more overall amplification can be obtained from fewer tubes. The plate detector (or bias

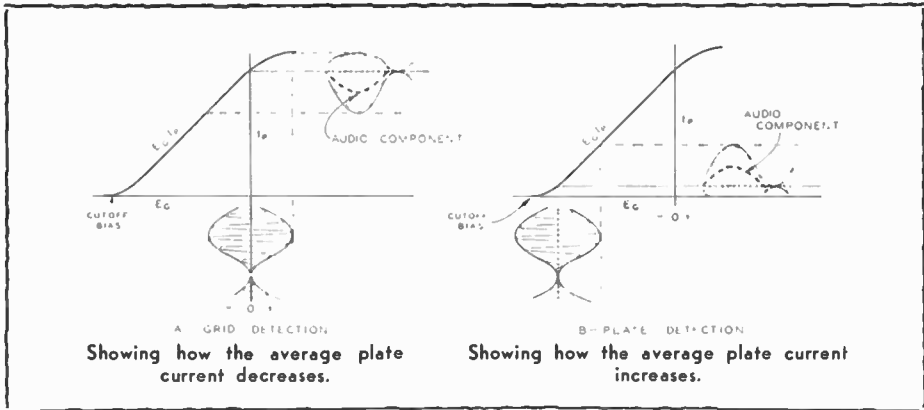

detector, sometimes improperly called power detector) amplifies the radio-frequency wave and then rectifies it and passes the audio signal component on to the succeeding audio amplifier. This detector works on the lower bend in the plate current characteristic as it is biased out close to the cut-off point. It might be called a class B amplifier. Plate detectors can be either of the weak signal, or power type. The plate current is quite low in the absence of a signal and the audio component is evidenced by an increase in average unmodulated plate current. The grid detector rectifies in the grid circuit and then amplifies the resulting audio signal. The only source of grid bias is the grid leak, so that the plate current is maximum when no signal is present. This detector works on the upper, or saturation bend, at higher plate voltage, and the demodulated signal appears as an audio frequency decrease in average plate current. However, at low plate voltage most of the rectification usually takes place as a result of the curvature in the grid current characteristic. As with plate detectors, grid detectors can be either of the weak signal or power type. By a proper choice of grid leak and plate voltage, distortion can be held to a small value. The grid detector takes some power from the preceding stage because it draws some grid current. The higher gain through the grid detector does not indicate that it is more sensitive. Detector sensitivity is a matter of rectification efficiency, not amplification alone.

The grid detector has an advantage when used as a regenerative detector because the grid-leak usually allows a somewhat smoother control of regeneration than is possible with any form of plate or bias detection.

Oscillation

The phenomena of sustained oscillation is obtained by coupling the output of a vacuum tube amplifier back into its input or grid

circuit so that the first impulse to reach the grid of the tube is successively amplified and then fed back to be again amplified until the amplitude of the impulse becomes as large as the tube can handle, at which time the amplitude of the impulse becomes constant and oscillation becomes continuous. The frequency of oscillation is usually determined by the resonant frequency of a tuned circuit located in either the grid circuit, plate circuit or common to both circuits. Most oscillators operate class C, draw grid current on part of each cycle and obtain their grid bias from the voltage drop caused by the flow of the grid current through a grid leak resistor.

The best way to classify regenerative vacuum tube oscillators is by the feedback coupling method. All such oscillators use either capacitive or inductive coupling from the plate circuit back into the grid circuit. Usually very low-frequency oscillators (below 100 KC) use some form of inductive coupling. Oscillators for use between 100 and 100,000 KC can use either capacitive or inductive feedback, while oscillators that use regenerative feedback above 100,000 KC usually require some form of capacitive feedback.

At frequencies above 100,000 KC (3 meters) the effectiveness of the regenerative oscillator drops off rapidly because the time of flight of the electrons between grid and plate becomes a large fraction of one cycle of oscillation. The losses in regenerative oscillators also become so large at these high frequencies that the plate circuit is incapable of supplying the grid losses, let alone supplying power for driving an amplifier or antenna.

Thus at frequencies above 100 MC (100,000 KC), the newer Electron Orbit oscillator is becoming more widely used. This type of oscillator can be of several forms, the more important being the Magnetron and the Barkhausen-Kurz oscillators.

Analyzing the Receiver

IN ORDER to attempt a complete analysis of a radio receiver, the parts that inductance, capacity and various associated elements play in a circuit must first be considered. For ease of explanation, it is advisable to begin with the more simple receivers. We will first consider simple detectors of the grid-leak and plate detection types. Each element in a typical receiver will be treated according to its importance in the circuit.

Electro-magnetic waves produced by a distant transmitting station cut across the receiving antenna in such a manner as to induce a voltage of a small magnitude in the receiving antenna. By means of either the lead-in or feeder, this minute voltage is applied across an inductance placed in series with the antenna lead. When this small voltage passes through the inductance it induces a current in it that is proportional to the reactance. This current, in turn, sets up an electro-magnetic field around the inductance, the strength of this field being dependent upon the amplitude of the current, the number of turns and the coil reactance at the frequency of the incoming wave.

Reactance is the property of a coil or condenser that offers opposition to the flow of alternating current. Impedance is the sum of the reactances, either inductive or capacitive, or both, and the resistance.

Assuming that the inductance in the antenna circuit is untuned, i.e., an inductance without any shunt capacity other than its own distributed capacity, we find that the induced voltage across the coil will be equal to the current times the reactance. This reactance is called the Inductive Reactance and is equal to two times π (3.1416), times frequency, times the inductance. What we are trying to obtain is the maximum voltage across the antenna coil so that we may have a stronger magnetic field to cut across the turns of the receiver grid coil. Anything that can be done to increase the magnitude of the voltage in this coil will result in a greater voltage being applied to the grid of the detector tube. This means greater amplification.

Returning to impedance and its relation to voltage, consider the effect of changing the untuned antenna coil into a tuned, parallel resonant circuit. This can be accomplished by the simple expedient of adding a capacity, capable of variation, across the inductance. As soon as this is done, the voltage is no longer equal to the inductive reactance times the current, but is now equal to the current times the ratio of the reactance and the resistance. The impedance of such a circuit drops off rather rapidly at either side of resonance; the voltage, and

consequently the signal, fall off proportionately.

The above, simplified, means that an antenna circuit that is tuned exactly to the signal frequency will give considerably greater gain than one that is untuned and that may consequently differ from the resonant frequency by considerable amounts.

The energy from the antenna can be applied either directly, or across the plates of a condenser connected to the grid side of the coil. This latter form of coupling is known as Electrostatic Coupling. From the previous analysis of electromagnetic coupling it will be apparent that this type of coupling has no voltage gain in itself, and is therefore inferior, though possibly more convenient than the former.

In any case, where the antenna circuit is coupled closely to the grid circuit, some electrostatic coupling is bound to exist, due to the capacity between the metals in both inductances. A combination of these two forms of coupling is undesirable in most cases, since electrostatic coupling permits steep wave-front voltages, such as static and noise, to have greater paralyzing effect on the grid. Pure inductive coupling is usually only possible if the separation between the two coils is made large, or through the use of an electrostatic shield (Faraday screen).

When a voltage is applied across the antenna coil an electromagnetic field is set up around this coil. It is a fundamental law of electricity that when a conductor cuts through a magnetic field, a voltage is set up in the conductor; the amplitude of this voltage depends upon the strength of the magnetic field at the point at which the conductor cuts it. It follows, therefore, that to induce a voltage in the grid coil of a detector circuit, it is merely necessary that this coil be placed in proper relation to the antenna coil; in other words, coupled to this coil. The amplitude of the induced voltage will depend upon the strength of the magnetic field set up, the proximity of the two "tanks" and the impedance of the grid "tank" to the particular frequency.

The impedance of the grid tank will follow the same rules as set forth for the antenna tank, since they are both parallel resonant circuits and are both maintained at resonance with the incoming frequency. At this point it is necessary to take into consideration another property of resonant circuits and that is what is familiarly known as the "Q". This "Q" may be defined as the inductive reactance divided by the resistance, and is further greatly influenced by the physical dimensions of the coil. The "Q" of a coil is a factor of merit; the higher the "Q" the better the coil. Authorities differ quite widely on the ideal shape for a coil, but it

is fairly safe to say that very long, narrow coils or short, squatty coils are to be avoided. A coil whose length is approximately equal to its diameter is generally considered best.

The diameter of the wire used to form the coil also has a definite influence on the "Q". Generally speaking, the wire size should be as large as is practicable to get into a given winding space. It should be remembered that nearly all the resistance in a parallel resonant circuit is contributed by the inductance; the average well designed condenser has negligible resistance. Nearly all of the resistance in the inductance is contributed by "skin effect." This skin effect increases almost directly with frequency and is introduced at high frequencies because the current does not distribute itself equally throughout the conductor but travels only on the outermost surface. As a helpful means of visualizing this phenomenon it is well to suggest a mechanical analogy. Try to imagine a force moving through a hollow tube with such velocity that matter ahead of it, instead of being pushed so as to evenly fill the opening of the tube, is pushed with such force that the force actually gets ahead of it and repels the matter to the walls of the tube. It is clear, then, that in order to provide ample surface for the current to pass along, it is necessary to use a much larger diameter conductor than would be the case if the current was equally distributed throughout the conductor.

Round conductors are always better than flat strips because, even if the flat strip has more surface area, the fact remains that the current does not distribute evenly over the entire surface but has a maximum density at the edges, with low density on the sides.

Distributed capacity, or that capacity existing between successive turns and also between these turns and the ends, is to be avoided in any receiver coil since this capacity has the effect of lowering the "Q". Space winding is one means of lessening this effect. Where the conductor is large in diameter, space winding is also of advantage in cutting down the skin effect due to the currents set up in adjacent turns. Dielectric loss due to poor material coil forms also has the effect of lowering the "Q".

In summarizing the ideal inductance it would be one having the following properties:

1. A shape such as to make the length approximate the diameter.
2. Entirely air supported. Since this condition is practically impossible for general use, a compromise must be adopted. It takes the form of a coil support of low-loss dielectric, such as Isolantite.
3. A wire size of ample proportions. This also must be a compromise, since with excessive diameters of wire, the skin effect and distributed capacity more than offset the gain

due to increased surface. For all practical receiving purposes the wire size should hardly exceed No. 16 gague.

4. A spaced type of winding. The spacing will be more or less dictated by the length-to-diameter rule. In general, the spacing should not exceed twice the diameter of the wire.

Considering the coil and condenser as a unit (a parallel resonant circuit) the following stipulations should prevail:

1. In order for the circuit "Q" to be as high as possible, the inductance-to-capacity-ratio should be very high, i.e., the circuit should have a preponderance of inductance to tune to a given frequency. Here, again practicability dictates the largest amount of inductance that can be used.

2. The tuning condenser should be of a good mechanical and electrical type and should preferably have a material such as Isolantite for the insulating portion. Some sort of pigtail or a good positive, wiping contact must be used to make contact to the rotor in order to reduce high resistance at this point.

The Vacuum Tube as a Detector

BEFORE TAKING the amplified voltage from the tank circuit and applying it to the grid of the detector, let us first consider some fundamental properties of vacuum tubes so that we may better understand the functions.

The question often arises as to why a detector must be used at all. Consider the nature of the incoming signal. This signal, we will assume, will take the form of a sine wave at, let us say, 3000 KC. or 3,000,000 cycles. A moment's thought will convince the most skeptical that even the finest of telephone receivers are incapable of responding to such frequencies due to the inherent inertia of the diaphragm.

In order to convert signals at radio frequencies into signals that may, through sound waves, impress themselves upon the ear, it becomes necessary to rectify the incoming signal. This rectification demands that the signal be passed through some form of device that will allow current to pass in one direction only. The ordinary rectifier used for receiver power supplies is such a rectifier, and the comparison is not so far fetched as it may seem, since the forerunner of all vacuum tubes, the Fleming Valve, was just such a device. This type of rectification is, of course, half-wave-rectification, since only one half of the cycle of the sine wave is passed and the resultant wave form is pulsating DC.

If the radio frequency wave is passed through such a device the output wave, being in one direction only, is capable of operating telephone receivers, or a loud speaker.

No longer does the wave contain both positive and negative half-cycles. Consequently the diaphragm of the receiver can register. The frequency of the rectified signal is still the same of the original signal and obviously the inertia of the diaphragm is such as to

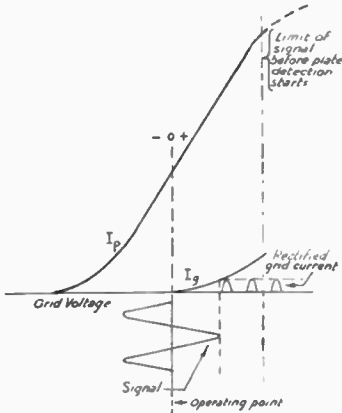
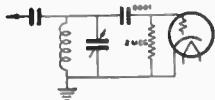

FIG. 1

make such fast movement impossible. We are speaking now of a pure, unmodulated sine wave signal. If the original signal carries modulation, either in the form of a single or complex frequencies, the story is quite differ-



Grid-Leak Type Detector.

ent. In this case, the incoming signal will be varying in amplitude in accordance with the modulation frequencies, originally impressed upon it and the output from the rectifier would also vary in the same relation. The result of

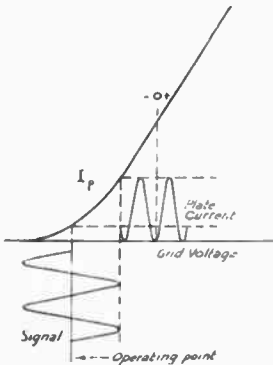

FIG. 2. Plate detector.

this is to allow the receivers to move in more or less direct accordance with the rectified output. In this manner, the original signal is changed from radio frequency to sound wave impulses which we are able to hear.

It should not be thought for a moment that the simple phenomenon that has just been described is the entire story of detection—quite the opposite, it is considerably more involved. With the above facts well in mind, the reader should be in a receptive mind for what is yet to come.

Rectification can be accomplished by applying a signal to a device in which the output current is not proportional to the input voltage. The vacuum tube is such a device, under proper operating conditions.

WHAT RECEIVER SHALL I BUILD?

● The first problem which confronts the builder of a receiver is to determine what type of receiver best suits his needs. There are practically as many types of receivers as there are kinds of amateurs. There is no such thing as the perfect receiver because conditions under which they are operated, and the personal choice of the operator vary under wide conditions. Any receiver represents a compromise of such factors as cost, size, accessibility, convenience, dependability, versatility, output desired and the purpose for which it is to be used.

The first step in determining the receiver best suited for your purpose is to decide whether a regenerative autodyne, or a superheterodyne is to be built. If the constructor has had no experience in building receivers, he is advised to first build the more simple autodyne type receiver, using from two to four tubes, instead of the more complicated multi-tube superheterodynes which may have from six to twelve tubes, or more.

The constructor who chooses the regenerative autodyne receiver will then weigh the compromises involved in this type of receiver. If he lives in a metropolitan area, where power lines, street cars, oil furnaces and other sources of man-made interference are prevalent, he must choose a particularly well shielded receiver. He may also resort to battery operation in order to minimize the noise pick-up from sources of interference which are carried into the receiver through the 110-volt power line. If, on the other hand, he lives in the country, remote from serious man-made noise, shielding is a matter of lesser importance and thus a somewhat simpler receiver will give entirely satisfactory results.

If his location is closely adjacent to powerful transmitters which might block the receiver or cause the detector to lock up, it

will be necessary to provide a tuned stage of radio-frequency amplification, or some other form of volume control, in order to obtain satisfactory selectivity. At the same time it may be necessary to choose a somewhat less sensitive detector circuit in order to make the detector less susceptible to overload.

One of the most important features is cost. Although every set builder will desire to use the most expensive coil forms, tuning condensers and vernier dials, it is essential to strive for a happy medium when choosing a receiver circuit which makes the best use of the parts available.

A receiver which is to operate on only one band is much easier to build than one which must operate satisfactorily in the entire range of from 160 meters to 10 meters. A band-spread condenser combination which gives good results when used on 20 meters will not be satisfactory when used to cover the 160-meter band. Thus if the constructor desires to operate on two such widely different frequencies, he must sacrifice a little convenience and efficiency on one or both of these bands.

After having built one or two autodyne receivers, the constructor may then desire to undertake something a little more complex, such as a superheterodyne receiver. Few superheterodynes are more sensitive than a good regenerative autodyne, although they are far more selective. In other words, they reject unwanted signals to a greater degree and they are less susceptible to overloads from powerful local stations.

In general, superheterodynes should be classified according to their use, because the ideal superheterodyne for CW reception differs in many respects from a superheterodyne which is to be used entirely for phone reception. Superheterodynes for both CW and phone reception must necessarily be a compromise between the two ideals.

In a superheterodyne purely for CW reception, the two most important points are (1) extreme selectivity; (2) freedom from noise. There has not yet been a superheterodyne built which is too selective for CW use or too free from noise. A superheterodyne for CW use also must have particular attention given to the high-frequency and beat-frequency oscillators, because the frequency drift in either oscillator, even if only a few cycles, can cause the received signal to entirely disappear. This point is less important in a receiver for phone use, because a phone signal is considerably broader than a CW signal, and oscillator drift is rarely troublesome.

Conventional automatic volume control systems have no place in a CW receiver because they are designed to operate from the variations in a continuous carrier and the variations in sensitivity caused by a CW

signal merely make the signal hard to read. Likewise, high fidelity has no place in a superheterodyne for CW use. In fact, many of the best CW superheterodynes utilize intentionally-poor audio fidelity by means of a peaked audio filter which passes the audio beat note being received, and suppresses all others.

A superheterodyne used only for phone reception should not have the extreme selectivity required for CW use because it must pass the modulation sidebands as well as the carrier coming from a distant transmitter. Thus the conventional type of series crystal filter is usually undesirable in a phone receiver because the extreme selectivity of the crystal filter seriously impairs the intelligibility of the received voice signal.

Automatic volume control belongs in a receiver for phone use, as does good fidelity in the audio channel. A receiver for phone use will usually have more audio amplification than a receiver for strict CW reception, in order to satisfactorily drive a loud speaker. This is because the majority of phone operators prefer loud speaker reception, while most of the CW men prefer the use of headphones. A receiver designed exclusively for phone use probably would not require a beat frequency oscillator, but in a CW receiver the beat-frequency oscillator is essential in order to produce an audible tone in the headphones.

The question of pre-selection arises in the design of both CW and phone superheterodynes. Pre-selection ahead of the first detector is used solely to minimize what is known as "image interference." An explanation of image interference requires a brief outline of how a superheterodyne operates. The important point to remember in connection with a superheterodyne is that instead of tuning the heart of the receiver to the incoming signal, it remains fixed on one frequency and the received signal is then changed in frequency to the frequency of the intermediate amplifier, which is the real heart of the superheterodyne. This portion of the superheterodyne provides 90 per cent of the selectivity and amplification achieved in the entire receiver. The undesired image response is a characteristic of the frequency changer in the front-end, which consists of the first detector and high-frequency oscillator. An incoming signal from the antenna is applied to the input of the first detector, or mixing tube. Another signal is applied to this detector or mixing tube; this second signal originates in the high-frequency oscillator. The presence of these two signals in the mixing tube causes the generation of sum and difference beat notes in the mixing tube plate circuit. For example: suppose the signal coming from the antenna is exactly 7,000 KC, and the signal coming from the local

high frequency oscillator is 7,460 KC. In the plate circuit of the mixing tube there will be, therefore, the sum and difference of these two frequencies, namely 14,460 KC and 460 KC. It is the 460 KC that is wanted, because this is the frequency to which the intermediate frequency amplifier is tuned, in this particular case. It will be seen that the difference frequency is the one usually chosen. The sum frequency (14,460 KC) would be bypassed to ground in the first intermediate amplifier transformer.

While the desired signal was 7,000 KC, and the local oscillator frequency was 7,460 KC, it is seen that if there is a signal of 7,920 KC present in the antenna and first detector circuits, this 7,920 KC frequency will also "heterodyne" or "beat" with the local oscillator frequency of 7,460 KC to produce a difference frequency of 460 KC. Because one 460 KC signal is just like any other 460 KC signal, the intermediate frequency amplifier has no way of rejecting the undesired beat produced by the 7,920 KC interfering signal. This 7,920 KC signal has been termed "the image," and the frequency of the image signal is almost always two times the intermediate amplifier frequency higher in frequency than the signal which the operator is attempting to receive. Therefore, the only way in which the undesired image response can be minimized is to provide enough tuned circuits, or selectivity, AHEAD of the first detector in order to select the desired signal and at the same time to reject the image.

Image interference is not always present. It only occurs when there happens to be a rather powerful transmitter in operation on a frequency twice the intermediate frequency away from the desired signal being received. Because the intermediate frequencies chosen for most amateur work are in the neighborhood of 450 KC, the image interference is largely from stations approximately 900 KC higher in frequency than the signal being received. This means that the image cannot be produced by other amateur stations, because none of the commonly-used amateur bands are 900 KC wide. Thus the interference generally originates from a commercial or government station and because these stations are rather widely spaced in frequency it will usually be found that there are less than about six bad image points in each amateur band. A selective pre-selector located between the antenna and the first detector will eliminate, or at least minimize this form of interference, but the cost of this preselection should be weighed against the fact that the necessity for this pre-selection may only occur at about six points in each amateur band.

It is suggested that the beginner avoid the difficulties inherent in constructing an effi-

cient pre-selector and thus choose a super without pre-selection. It is easy to add pre-selection to a superheterodyne after it is built and operating properly, if it is felt that a pre-selector is necessary.

The Choice of a Detector in a Regenerative Autodyne

The detector is the heart of a regenerative autodyne receiver. There is a wide variety of tubes available for use as detectors, each having certain advantages and disadvantages. The four most commonly used detector tubes are the 76 and 6C6, for operation from house lighting current, and the 30 or 32 types for battery-operated sets. The 76 is a triode, as is the 30, while the 6C6 and 32 are both of the screen-grid type. Screen-grid detectors are somewhat more sensitive than the triodes, although they are more susceptible to overload and also somewhat more difficult to get going. In place of the 6C6 or 32, it is often desirable to utilize a tube with a variable mu, such as the 6D6 or 34. The variable mu screen-grid tubes are slightly less susceptible to overload than the sharp cut-off detectors, such as the 6C6 and 32, and the variable mu tubes also afford a smoother control of regeneration. These advantages usually necessitate a sacrifice in sensitivity.

It should be remembered that the 24, 36 and 57 tubes are very similar to the 6C6. By the same token, the 39 and 58 are similar to the 6D6. Likewise, the 27, 37 and 56 will act exactly like the 76 in most circuits. In the battery-operated field there is less choice, although the 99, 201A and the 12A are quite similar in characteristics to the 30, and the type 22 can be used in a circuit designed for a 32.

Audio Coupling

The detector can be coupled to an audio amplifier stage in three different ways. (1) Resistance coupling; (2) Impedance or Choke coupling; (3) Transformer coupling.

Resistance coupling is the least desirable of the three methods, when working out of a regenerative autodyne detector, because the question of fidelity is relatively unimportant in a regenerative receiver, and fidelity is the principal advantage of a resistance-coupled amplifier. Resistance coupling can be used out of either triode or screen-grid detectors.

Impedance coupling (or choke coupling) is particularly recommended when working out of a screen-grid detector because it enables the full plate voltage to be applied to the detector and also has enough distributed capacity so that any radio-frequency present is easily by-passed to ground. The only disadvantage of impedance coupling is that it affords no voltage step-up, as does transformer coupling. An impedance to work

out of a triode detector should be approximately 50 henries at 15 to 20 milliamperes. An impedance designed to give best results out of a screen-grid or pentode detector should be rated at more than 250 henries at 5 milliamperes.

Transformer coupling is unsuited when using a screen-grid or pentode detector, although it is recommended when working out of a triode detector. A step-up ratio of approximately three-to-one gives the best all-around results.

Audio Tubes

The choice of the audio output tube is largely dictated by the amount of audio power required. If loudspeaker operation is desired, two stages of audio amplification will usually be required, with a triode, such as a 76, in the first stage, and a pentode, such as a 41, in the second stage.

If headphone reception is desired, the second stage will usually be eliminated, and the phones will be connected in the plate circuit of the first amplifier stage. For loudspeaker use, any of the following pentodes are recommended: 38, 41, 42, 47, 59, 89, 33 or 43. Any of the following triodes may be used, but will require somewhat more amplification: 12A, 71A, 45, 46, 2A3, 31, 120, etc.

For headphone reception any of the following tubes are entirely suitable for use as audio amplifiers: 99, 30, 201A, 112A, 27, 37, 56, 76 and either of the following pentodes when connected as triodes (screen and suppressor grids tied to plate): 57 and 6C6.

Plug-in Coils

Practically all regenerative receivers use plug-in coils. This is also true of some of the highest priced amateur and commercial superheterodynes. The advantages of plug-in coils are only obtained when low-loss materials and low-loss design are used. The very best low-loss coil form is "dry air," or self-supporting of the coil winding. Next best are the ceramic forms which use isolantite, mycalex, or their equivalents. Then follow the special mica compounds, such as the XP-53 and R39 compounds. Whereas celluloid is not as good a dielectric as the aforementioned materials, its advantage is the fact that an extremely thin form will serve to effectively support a coil winding, and because losses are a function of the volume of dielectric material in an electric field, the thin celluloid therefore makes possible the construction of an extremely low-loss coil form.

Wire for Coil Winding

Bare wire is better than insulated wire. It should be as large in diameter as possible, in order to reduce the radio-frequency resistance. The coil winding should be space-

wound, although grooved coil forms are generally undesirable because they increase the distributed capacity. The coils should be placed as far away from metallic shielding as possible. The socket material is as important as the material from which the coil form is made, because the socket is in the direct field of the coil. Thus a good grade of ceramic socket should be used. Leads to the tube socket and tuning condenser should be as short and direct as possible. Sharp bends should be avoided. All joints should be carefully soldered with rosin-core solder. A hot iron should be used for all soldering operations. The connecting wires should be made mechanically secure to the connecting points and all wiring should be well remote from metal shielding.

METHODS OF BAND-SPREADING

● Band-spreading is an electrical means of obtaining tremendous gear reduction on the tuning condenser dial of a receiver. High-frequency receivers must cover a very wide range of frequencies and therefore it is difficult to design a dial and drive mechanism which will cover the desired ranges, yet still provide sufficient "vernier" (geared-down) drive so that weak signals will not be passed over and missed without hearing them. In newer all-wave broadcast receivers this problem is solved by the use of a two-speed dial arrangement, the low reduction being provided for rough tuning and the high reduction for fine tuning. This is usually accomplished mechanically by means of planetary gears. The system is quite satisfactory, but rather difficult to manufacture by the average amateur or experimenter. Practically the same effect can be obtained by means of electrical band-spread. Almost all receiver circuits use a variation in the capacity of the tuned circuit for tuning purposes. In order to obtain a small variation in tuning it is essential that the capacity be increased or decreased by a very small amount. It is difficult to control a small increase or a small decrease in the capacity of a large tuning condenser, and thus most electrical band-spreading systems utilize two tuning condensers—one a large condenser to give the rough tuning, the other a very small condenser (two or three plates) which can be connected in a wide variety of ways to give fine tuning. The first system is shown in Fig. 1 (A). It is the most common system and consists of a small condenser C₂, connected directly in parallel with the large condenser C₁. In most high-frequency receivers the capacity of C₁ will be chosen so that the coil and condenser combination will cover a fre-

METHODS OF BAND SPREADING

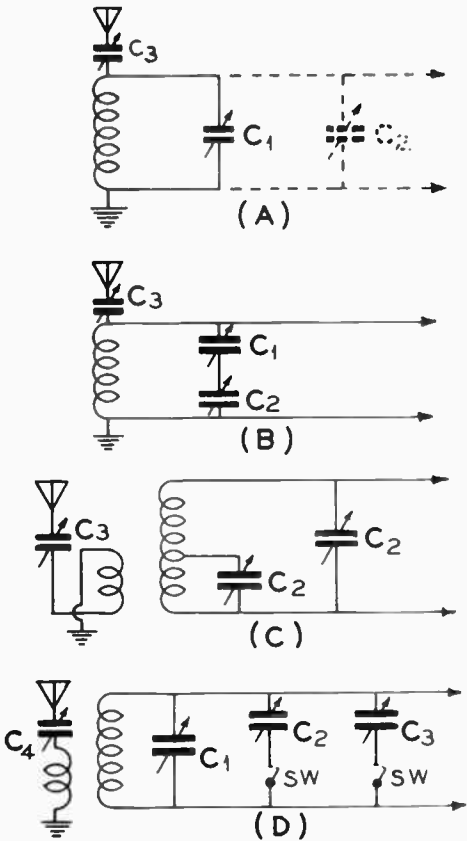

FIG. 1

quency range of between 2-and-3-to-one. The condenser C2 is much smaller than C1 and will often be chosen so as to cover a band of approximately 1000 KC.

Fig. 1 (B) shows a band-spreading condenser in series with the main tuning condenser. Because the capacity of two condensers in series is always smaller than the capacity of the smaller of the two condensers, it will be seen that both condensers in Fig. 1 (B) must be considerably larger in capacity than the corresponding condensers in Fig. 1 (A), in order to cover the same frequency ranges. Both of the systems shown in Fig. 1 (A) and Fig. 1 (B) have the disadvantage in that the degree of band-spread varies with the tuning of C1, and thus if a given coil covered both 40 and 20 meters, the system may provide too much band-spread for 40 meters and not enough band-spread for 20 meters. In Fig. 1 (C) a method is shown whereby the band-spread effect can be kept more or less constant over a wide range of frequencies by tap-

ping the band-spread condenser across part of a coil, instead of being tapped across the entire coil, as in Fig. 1 (A). The position of the tap varies with frequency. On the larger low-frequency coils, the tap will be placed near the top of the coil. On the smaller high-frequency coils, the tap will be placed proportionately farther down on the coil in order to maintain an approximately constant degree of band-spread. This system has the disadvantage in that some selectivity in the tuned circuit is lost. Fig. 1 (D) shows another means of equalizing the degree of band-spread over a wide range of frequencies. C1 is the conventional large tuning condenser of between 140 and 350 uufds. C2 and C3 are both band-spread condensers. C2 is a condenser of approximately 50 uufds, for band-spredding the 80 and 160-meter bands. Condenser C3 can be approximately 15 to 20 uufds and is used on the 40 and 20 meter bands. The proper condenser is chosen by means of the switches shown. This system has the disadvantage in that rather long leads are required, as well as a possibility of losses in the switch contact.

How To Calculate Filament Dropping Resistor Values

It is important that the filaments of all tubes, either in a transmitter or receiver, be operated at the rated filament voltage. If the voltage is too low or too high, tube life is materially reduced. When in doubt, it is advisable to operate the filament at a slightly higher than normal voltage, rather than at lower than normal voltage. The value of a

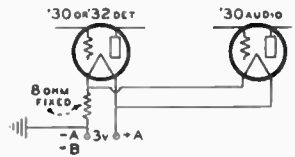

TWO TUBES IN PARALLEL
FIG. 1

filament resistor can be calculated by means of Ohm's Law, a very simple formula which indicates the relationship between voltage, current and resistance. There are three factors in the equation. If any two are known, the third can be determined. The three forms of this equation are:

$$E = IR \quad R = \frac{E}{I} \quad I = \frac{E}{R}$$

In these equations the symbol E stands for voltage (electromotive force), I stands for current (in amperes), and R stands for resistance (in ohms).

For example, assume that you are using two type 30 tubes with their filaments in parallel and a 3-volt battery is used as a source of

filament power. The 3 volts must be dropped through a series resistor so as to get two volts, which is the rated operating voltage for the type 30 series of tubes. In order to

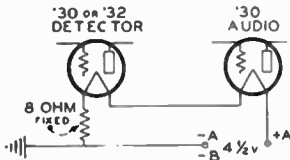

FIG. 2. Two 60 MA tubes in series.

calculate the value of the filament dropping resistance, the current drawn by the two tubes from the battery must be determined. The current in this case is 120 milliamperes,

or .12 amperes. From the equation $R = \frac{E}{I}$ the resistance is computed by dividing the desired

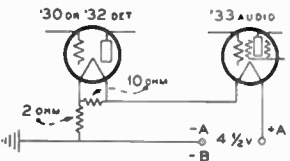

FIG. 3. Series connection for dissimilar filament currents.

voltage drop of one volt, (which is "1" in this case), by 12/100, which is the same as multiplying by 100/12. The equation then is

$$\frac{1}{1} \times \frac{100}{12}, \text{ which equals } 8.3 \text{ ohms. There-}$$

fore 8 ohms is the proper value of filament resistor to use, because fractional value resistors are not obtainable. (See Fig. 1).

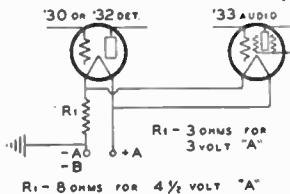

FIG. 4. Two dissimilar tubes in parallel.

Fig. 2 shows a circuit diagram of two volt 60 milliamperes filament tubes with the filaments connected in series. When connecting two tubes in series it becomes necessary to provide twice as much heating voltage as when only one tube is used; however, there is no increase in heating current. When the filaments of two type 30 tubes are connected in series, it is necessary to provide 4 volts at 60 milliamperes (.06 amperes). Either a 4½ volt "C" battery or three 1½ volt dry cells connected in series provide a convenient means for operating two tubes in series. The

dropping resistor should be 8 ohms, which is determined by dividing the voltage drop of ½ volt by the total filament current of .06 amperes. Care should be taken to see that tubes which draw different values of filament current should not be connected in series unless special precautions are taken, as shown in Fig. 3. A shunt resistor must be connected across the filament of the tube drawing the least current, so that the sum of the current through the resistor, plus the current through the filament which it shunts, is equal to the current drawn by the other tube.

Fig. 4 shows the proper values of the dropping resistor when the filaments of dissimilar tubes are connected in parallel across a 3 or 4½ volt supply. Resistors for filament dropping should preferably be of the variable type, such as a rheostat, and an accurate low-range DC voltmeter should be used to indicate the voltage across the tube socket terminals.

Coil Winding Data For Beginners' Receivers

● Coil winding tables vary with the size of the coil form used. The standard form is 1½ inches outside diameter. A table is given below for the number of turns required for the coil winding to cover the four popular amateur bands. If forms larger than 1½ inches in diameter are used, obviously fewer turns will be required. Conversely, a smaller form requires a greater number of turns for each coil. It is a simple matter to use the "cut and try" method when winding coils. However, the table shown gives the winding data for coils wound on standard forms and tuned with a 100 mmfd. midget variable condenser.

Wave-length	L1, Secondary Winding	L2, Tickler Winding
20 M	7 turns, No. 18 DCC, spaced two diameters.	4 turns, No. 22 DSC, close wound.
40 M	18 turns, No. 22 DSC wire, spaced one diameter.	Ditto.
80 M	36 turns, No. 22 DSC wire, close wound.	6 turns, No. 22 DSC, close wound.
160 M	72 turns, No. 32 DSC or SCC wire, close wound.	11 turns, No. 22 DSC or SCC, close wound.

Spacing between secondary and tickler coils to be ⅛-inch. The wire should be tightly wound on the coil forms. Insulating varnishes should be used sparingly, if at all. The most common form of coil "dope" is known as Collodion, made by diluting small pieces of celluloid in a vessel containing about an ounce of Acetone.

Tickler Winding

If the detector does not regenerate, reverse the tickler connections or add a turn or two of wire to the tickler coil, until smoothest regeneration is obtained.

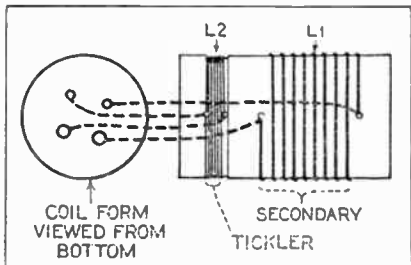

Reading from Right to Left, the coil connections are as follows: Antenna (and grid condenser), Ground, Plate, B Plus.

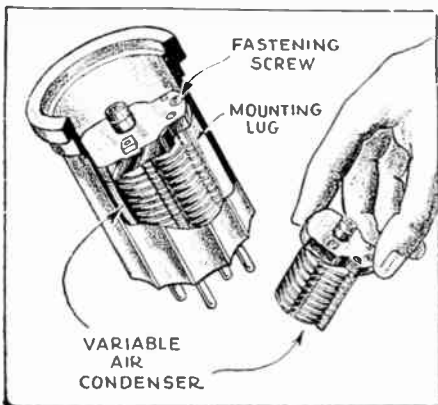

A convenient method for "padding" a tuning coil is to place a small variable condenser inside the coil form, as shown. This condenser is connected in shunt with the secondary winding. By adjusting the condenser to the desired value, only a band-spread condenser will be needed on the main receiver panel.

The Knight 2-Tube "DX-ER"

● This receiver does not in any sense represent a new development in the short-wave construction field. Instead, it is one in which the designer combined well-known and accepted principles to produce a set that is simple and inexpensive to build.

As will be seen from the schematic diagram the circuit is the old familiar "stand-by" single-circuit regenerative type, with tickler feed-back. The placement of the parts is extremely important for effective results. One of the line drawings illustrates the most practical layout for maximum efficiency. It is also important to use good quality parts. Shoddy equipment thrown together carelessly will not bring the desired results.

Parts List for Knight "2-Tube DX-ER"

- 1—7x9 Drilled Hard-Rubber Panel.
- 3—1 prong Sockets.
- 1—140 mmf. Midget Tuning Condenser.
- 1—20 ohm Rheostat.
- 1—50,000 ohm Regeneration Control.
- 1—1 to 5 ratio Shielded Audio Transformer.
- 1—Antenna Condenser, 80 mmf. max.
- 1—Knight RF Choke.
- 1—.0001 mf. Knight Mica Condenser.
- 1—.001 mf. Knight Mica Condenser.
- 1—3 megohm Resistor.
- 1—200,000 ohm Knight Carbon Resistor.
- 8—Clips.
- 1—Baseboard.
- 1—Vernier Dial.
- 2—Knobs.
- 1—Kit of Screws, Nuts, Hardware, Wire, etc.
- 1—4-prong plug-in Coil Kit (4 coils).
- 2—30 Tubes.
- 2—Dry Cells (1½ volts each).
- 2—15 volt "B" batteries.
- 1—Pair Headphones.

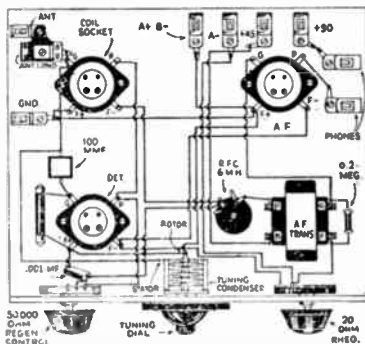

Layout of parts and circuit diagrams for the Knight 2-Tube "DX-ER"

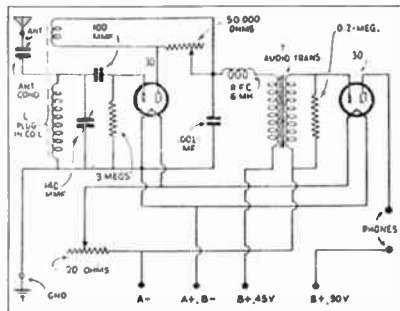

For economical operation, two type 30 low-drain two-volt tubes are used. The first serves as a regenerative detector; the second is used as an audio amplifier. The tuning range of the receiver is 15 to 200 meters, covered by a set of four improved plug-in

coils. Regular broadcast reception is optional, by adding a set of two plug-in coils to cover 200-500 meters.

Only two dry cells and two 45 volt "B" batteries are required for complete operation.

It should be kept in mind that phone signals are loudest just below the oscillation point and CW signals just above the oscillation point. When tuning the "DX-ER" the regeneration control should be set to the point where the detector just starts to oscillate. Then, the tuning dial should be carefully manipulated until a "whistle" is heard. Careful tuning at this point and further adjustment of the regeneration control will bring in the intelligible signal.

Regeneration in the "DX-ER" is controlled by a 50,000 ohm variable resistor connected across the tickler leads. The output of the detector is transformer-coupled to the audio tube by a shielded transformer having a ratio of 1 to 5. A load resistor of 200,000 ohms is connected across the secondary of the audio transformer to eliminate any possibility of "fringe howl."

The antenna is coupled to the tuning coil by a semi-variable "postage-stamp" condenser having a maximum capacity of 80 mmf.

Tuning is accomplished by a 140 mmf. midget variable condenser mounted on the front panel. A smooth vernier type dial is used to insure proper tuning.

The Beginner's "Gainer"

The model of the "Gainer" shown here is an adaptation of the original receiver developed by the technical staff of "RADIO" and described in the February, 1934, issue. The detector is one of the new 6D6 tubes and is equivalent to the 57 except that it is intended for operation from a 6-volt battery or transformer. The type 76 tube employed in the audio stage is the 6-volt equivalent of the 56. Either a storage battery or a

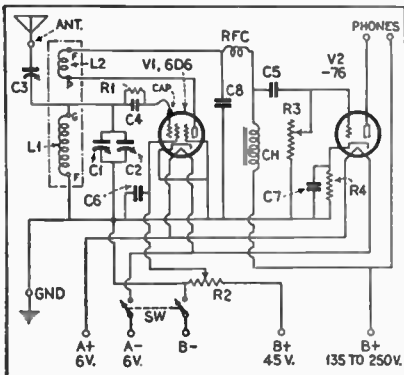

FIG. 1. Schematic Circuit of the Beginner's "Gainer" Receiver

List of Parts

- C1—Midget variable condenser, type MC-20S Hammarlund.
- C2—Midget variable condenser, type MC-140M, Hammarlund.
- C3—Equalizer condenser, type EC-35, Hammarlund.
- L1, L2—Four-prong plug-in coil set, type SWK-4, Hammarlund.
- RFC—RF choke, type CH-X.
- 1 Isolantite 4-prong socket, type 5-4 (for coil).
- C4—.00025 mfd.
- C5—.01 mfd.
- C6—.1 mfd.
- C7—.5 mfd., 200 volts.
- C8—.00015 mfd.
- CH—200 henry audio choke.
- R1—1 to 5 megohms.
- R2—Yaxley potentiometer, type V50MP, 50,000 ohms.
- R3—Yaxley potentiometer, type Y500MP, 500,000 ohms.
- R4—10,000 ohms, 2 watts.
- 1 5-prong tube socket.
- 1 6-prong tube socket.
- 1 vernier dial (large).
- 1 toggle switch, d.p.s.t.
- 1 aluminum panel, 12 inches by 7 inches (cut and drilled).
- 1 baseboard, 10½ inches long, 9½ inches deep.

6-volt AC filament supply may be used. For the plate supply either a B-eliminator or B batteries may be used. The voltage may be up to 200, although 135 volts will give good results.

Band-spread tuning is provided; the 140-mmfd. condenser, C2, serving as the coarse tuning or band-setting condenser, while the critical tuning is accomplished with the 20 mmfd. condenser, C1, which is controlled by the main tuning dial.

The circuit as shown in Figure 1 employs the conventional means for obtaining regeneration in the plate circuit, controlled by varying the screen-grid voltage of the 6D6 detector for which purpose the potentiometer R2 is employed.

The Improved "Gainer"

The illustration below shows the rear view of the improved "Gainer" receiver, the circuit diagram and the technical details for which are shown on the facing page.

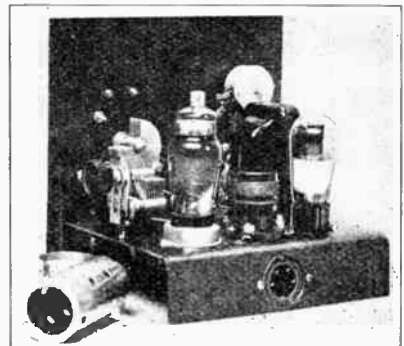

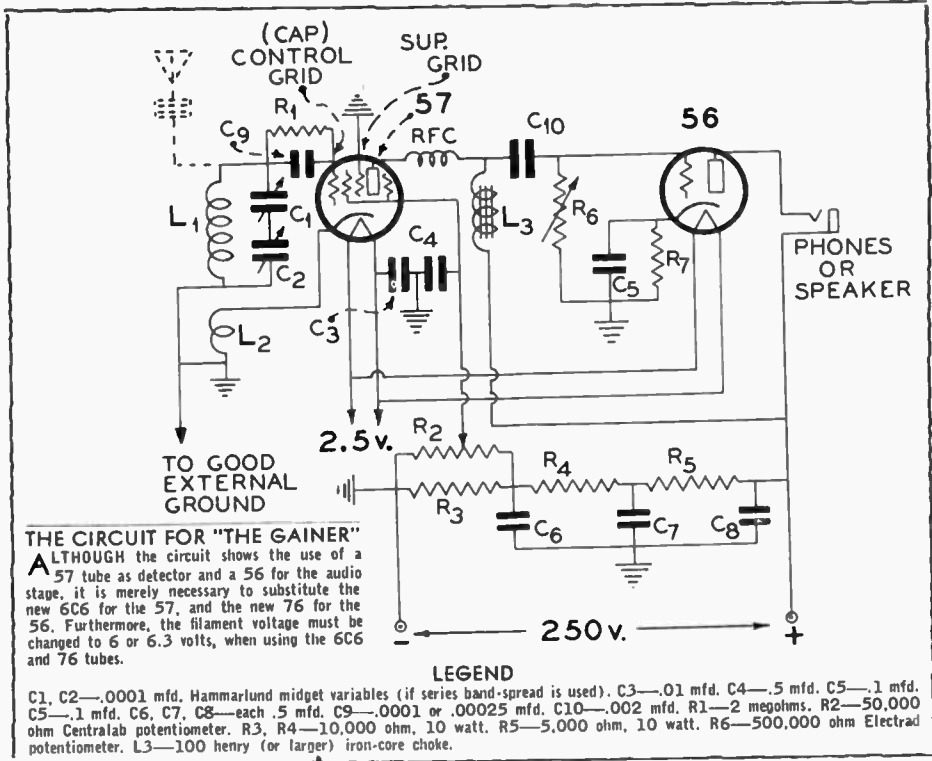

The AC Operated Gainer—An Ideal Amateur Receiver

Of the many two-tube receiver circuits developed for amateur reception, the improved "GAINER" circuit shown above is one of the very best. Although series band-spread tuning is shown, the constructor can use parallel band-spread tuning, if he so desires. In fact, the latter is a more simple method for the beginner to use. See Fig. 1 (A) on page 29. If parallel band-spread is used, the variable condenser C1 shown in the circuit above should have a capacity of 100 mmf. It is shunted across coil L1. The band-spread condenser C2 should be a 3 plate midget, 15-25 mmf., and it is shunted across C1, the "tank condenser." The improved "GAINER" should be mounted on a metal chassis, 9x7 inches, with a "U" bend 2 inches high. Under chassis space is utilized for mounting the resistors R3, R4, R5, R7, as well as condensers C3, C4, C5, C6, C7, C8. The regeneration control R2 is mounted on the front panel, as is the control for R6 (gain), and the band-spread tuning dial for condenser C2. The "tank" tuning condenser knob for C1 should also be on the front panel. The grid condenser C9 and the grid leak R1 should be "air-supported" above the chassis, close to the grid cap of the 57 detector tube. The lead from R2 to the screen grid of the 57, and the lead from R5 to the phone

jack should be run through shielded braid. Plug-in coils are used for this receiver. L1 is the secondary coil, L2 is the cathode (regeneration) coil. L1 and L2 are wound on ordinary 4-prong tube bases, or on standard plug-in coil forms, 1¼ or 1½ inches in diameter. The coils are wound as follows:
 L1—20 Meters 8 turns of No. 22 DCC.
 20 Meters 16 turns of No. 22 DCC.
 80 Meters 32 turns of No. 22 DCC.
 L2—(Wound on same form as L1, spaced about 1/8" from L1) 4 turns of No. 22 DCC. (L2 is the same for all coils.)

Front view of the "GAINER" showing the General Radio vernier tuning dial, regeneration control and volume control. A metal panel is used to mount the controls. An on-off toggle switch cuts off the B supply when the transmitter is in operation. Connecting leads to the power supply should be run thru shielded braid.

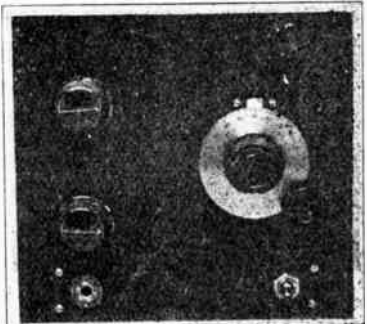

The Quartz-Crystal Filter

THE subject of quartz crystal filters is confusing to many users, due to a lack of understanding of the technical nature of the device.

The use of a quartz crystal as a resonator is not new. Dr. Robinson, a British Scientist, applied the idea of a practical quartz crystal as a resonator to a radio receiver. His receiver, however, was designed for broadcast use and was named the "Stenode". The Stenode receiver did not attain wide popularity because the selectivity was so great that most of the higher-frequency components of the modulated carrier were "lopped off".

A quartz crystal, cut on certain axes and ground with the faces parallel, has the property of oscillation, and the same plate has another unique property . . . that of a resonator.

In order to better illustrate the function of resonator, take the crystal from its place in the circuit and replace it with its electrical equivalent in inductance and capacity. A crystal of 451.5 KC has an equivalent inductance of 3.5 henries and a capacity of less than one-tenth micro-microfarad! The effective "Q" of such a circuit is well over 1000. Realizing that the "Q" of a circuit is the property which governs the shape of the resonance curve, it is found that such a circuit would have a very narrow shoulder, sharply-peaked resonance curve. It would be impossible to obtain such a resonance curve from any combination of inductance and capacity; the quartz crystal alone possesses these unique properties.

Again likening the quartz resonator to an equivalent circuit, the crystal has all of the properties of a series-resonant circuit. Series-resonant circuits offer a very low impedance to the resonant frequency (that frequency where the inductive reactance and the capacitive reactance are equal), while at the same time presenting very high impedance to all other frequencies. Impedance is that property of a circuit which offers opposition to the flow of an alternating current. More properly, the impedance of a circuit is the sum of the reactances and the resistance. Taking the first definition into consideration, it can be seen that a series-resonant circuit will pass the resonant frequency (in this case the signal to which the receiver is tuned), and reject other adjacent signals. The resonance curve does not have straight up and down sides; it has sloping sides. The slope of the sides, or the "steepness", is dependent, among other things, upon the "Q" of the circuit. With a circuit having a resonance curve with gradual sloping sides, an interfering signal removed ten KC from the desired signal may be only ten points down in strength from the desired signal at the output of the

receiver. In contrast, a circuit such as a quartz filter with extremely steep sides can cause the interfering signal to be down from the wanted signal ten thousand times. These figures are merely illustrative of the effect of the extreme discrimination or selectivity of such circuits as compared with the ordinary tuned-parallel-resonant circuits used in an IF amplifier.

Fig. 1 is the crystal filter used in the Hammarlund Comet-Pro receiver. It incorporates

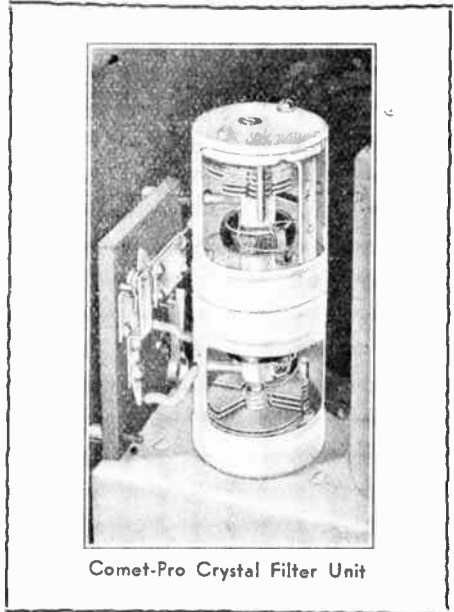

Comet-Pro Crystal Filter Unit

several good features and improvements. The mixer stage is fed through the primary of an ordinary IF transformer, but in lieu of the conventional tuned secondary loosely coupled to the primary a smaller, untuned winding closely coupled to the primary is used instead. The impedance of an ordinary tuned circuit can be estimated to be approximately 100,000 ohms. Maximum transfer of energy results when input and output impedances are equal. If an ordinary tuned secondary works into the crystal, the impedance of the crystal would approximate 100,000 ohms. Using Terman's "Radio Engineering" as a reference, it is found that a 451.5 KC crystal actually has a resistance of only 9,036 ohms.

Again from Terman, the formula for the resistance of an X-cut crystal is given with

fair approximation as follows: $R = 130,000 \frac{t}{lw}$,
 where R = resistance, t = thickness of the crystal, l = length of crystal and w = width

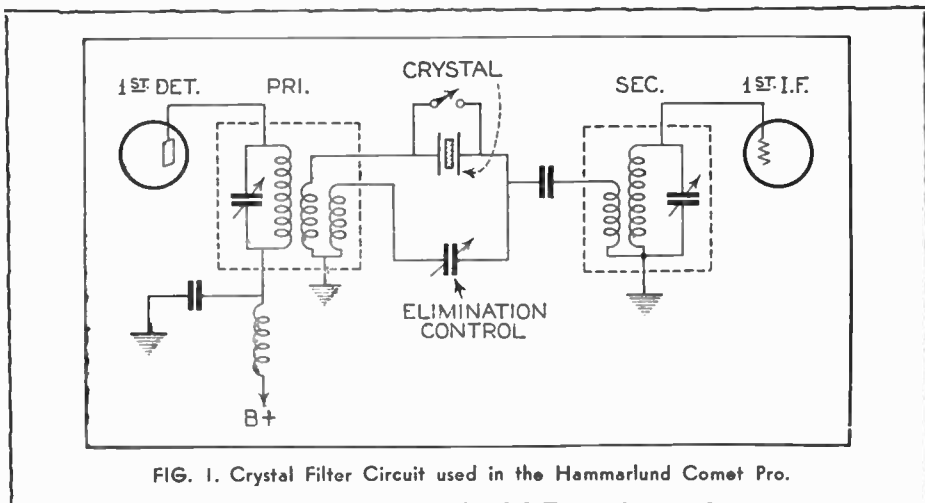

FIG. 1. Crystal Filter Circuit used in the Hammarlund Comet Pro.

of crystal. Thus it can be seen that the resistance of all crystals is not the same; it varies according to the physical dimensions of the crystal. All dimensions are in centimeters when the above formula is used.

In order to obtain the proper impedance match it is necessary to transform the 100,000 ohms impedance of the primary down to the 9,000 ohms of the crystal, an impedance step-down ratio of roughly 10 to 1. The turns-ratio would be the square root of 10, or 3.16 to 1. All this can be better illustrated by a typical example of a matching transformer to work into a crystal of 9,000 ohms from a primary of 100,000 ohms. Assume that an IF transformer of 451 KC. has a winding of 250 turns. Although this is an arbitrary value, it is fairly correct for most transformers. 250 divided by 3.16 equals 79.1 turns, which is the correct value for the low-impedance coil. This lower-impedance winding must be center-tapped. Thus it is necessary to use 79 turns on each side of center; both windings are wound in the same direction with the inside leads of one winding and the outside lead of the other tied together. These windings should be wound directly over the primary and should be wound with No. 32 DSC wire, although litz wire is preferable if it can be obtained. When the impedance is stepped-down to match the crystal, the voltage is accordingly stepped-down, so that on the output winding there will be 79 turns, wound in the same manner, which affords the necessary step-up voltage ratio.

The opposite half of the input winding is for the purpose of supplying a voltage equal and opposite, which is applied through the phasing condenser across the crystal. This condenser is used for neutralizing the capacity of the crystal holder, which is effectively

in parallel with the crystal. Parallel resonance has the opposite effect of the crystal resonance, i.e., it offers a high impedance to the resonant frequency and low impedance to all other frequencies, the effect somewhat cancellative on the incoming signal. By adjusting the phasing condenser an undesirable signal near the wanted signal can be attenuated to a considerable extent. The explanation is simple; the crystal works in the usual manner to pass the wanted signal, while at the same time its parallel rejectivity effect is shifted over to the unwanted signal. The coupling condenser from the junction of the crystal and the phasing condenser should be made adjustable with a maximum capacity of 50 mmf. Proper setting of this condenser can best be determined by experiment.

The selectivity of the type of filter described is so great that, when first used, one is apt to tune over some signals without hearing them. It may seem that the volume drops appreciably when the filter is switched in, because the background noise disappears entirely, but when the signals are tuned-in on the exact peak, they seemingly come right up out of nowhere.

A crystal filter should usually be followed with two stages of IF amplification and possibly an additional tuned circuit to give a proper degree of selectivity. Peculiarly enough, additional selectivity is a very necessary requirement, because practically all crystals have an additional peak on either side of resonance. These peaks are governed somewhat by the physical dimensions of the particular crystal in use, but in general all crystals have two peaks and some have even more. In order to minimize the effect of these spurious peaks, the selectivity of the tuned circuits following the filter must be adequate. In general, the more tuned cir-

cuits, the better, although each tuned circuit adds a small amount of loss.

It has been found that an air-gap holder is necessary for proper operation of a resonator because the removal of the top plate from actual contact with the crystal allows a greater freedom of vibration with attendant increases in efficiency. The gap is not critical, however, and can be about the thickness of a sheet of paper.

In lining-up the IF amplifier for use with a crystal filter, it is almost necessary to use the crystal itself as an oscillator. This is not difficult to do, although some resonators make poor oscillators. The crystal is hooked-up as a conventional crystal oscillator in a transmitter, with the exception that a small air gap is used and the usual grid leak and choke combination is eliminated entirely. Use a winding from an IF transformer for the plate inductance with the trimmer attached. For lining-up purposes, a type 30 tube can be used for the oscillator, with 2 volts AC on the filament. The AC is desirable to modulate the signal and to simplify the adjusting process. Plate voltage (180 volts) is secured from a tap on the voltage divider of the bias supply used for the transmitter. A 0-25MA meter in the plate circuit is a good indicator for oscillation. The plate current will dip as the trimmer condenser tunes the inductance to the resonant frequency of the crystal. A piece of insulated wire is brought near the inductance and the far end of the wire hooked over the grid input to the first IF. Tuning the IF to exact resonance with the crystal then becomes a simple matter.

Good shielding is important in the IF amplifier. All signals from the front end must pass through the crystal itself and they must not leak through to the grid of the first or second IF because of poor shielding. As a simple test, remove the crystal from the holder, re-assemble it and replace it in

the filter unit as if though the crystal were inside. Put the switch on "Crystal" position and adjust the phasing condenser until the signals disappear entirely, or nearly so; the more effective the shielding, the lower the signal strength will be. The phasing condenser is merely used to balance-out the signal voltage across the capacity created by the plates of the holder. Exact neutralization is practically impossible, so that in making this test the final results are merely comparative.

An I.F. Amplifier With New Features

● An exceptionally sensitive, selective and quiet foundation unit for a good superheterodyne is shown in the circuit diagram below. The two principal portions of a superheterodyne can be separated without encountering important losses. Practically every set builder has his own ideas as to what constitutes a good "front end" for a superheterodyne. A short-wave converter will function much better when used with this IF amplifier than when connected to a BCL set.

This unit is designed primarily for the CW operator. It is capable of remarkable signal-to-noise ratio when used with a quiet front end. The crystal filter employs the new circuit developed by Frank C. Jones. There is no loss in sensitivity when switching from the "off" to "series" position, because the impedances remain matched whether the crystal is "in" or "out." While claims of "matched impedance" are made for other circuits, this particular circuit is actually the only one which keeps the sensitivity high in the "series" position.

The IF stages appear normal, insofar as the circuit diagram is concerned, but the ordinary types of IF transformers must be changed

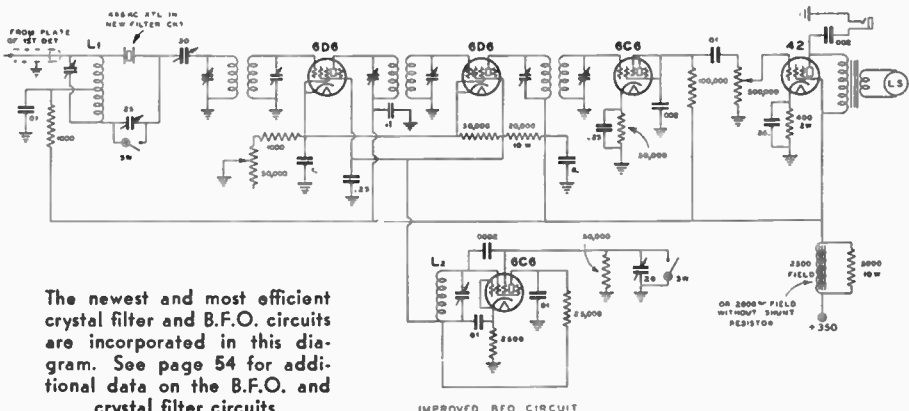

The newest and most efficient crystal filter and B.F.O. circuits are incorporated in this diagram. See page 54 for additional data on the B.F.O. and crystal filter circuits.

IMPROVED BFO CIRCUIT

if the best results are expected. Most IF transformers are designed with a certain amount of over-coupling in order to make them useful for phone signal reception. Because the IF amplifier here described is designed purely for CW use, it is desirable to reduce the coupling in order to increase the selectivity. The spacing between the coils in an IF transformer must be determined by experiment, because coil efficiency varies widely with various makes of IF transformers. With some transformers it has been found necessary to increase the spacing between coils as much as $\frac{1}{2}$ inch. Reducing the coupling by increasing the spacing usually increases the gain, and sometimes tends to make the amplifier unstable and break into oscillation. Thus it is essential that short and direct leads be used, together with good

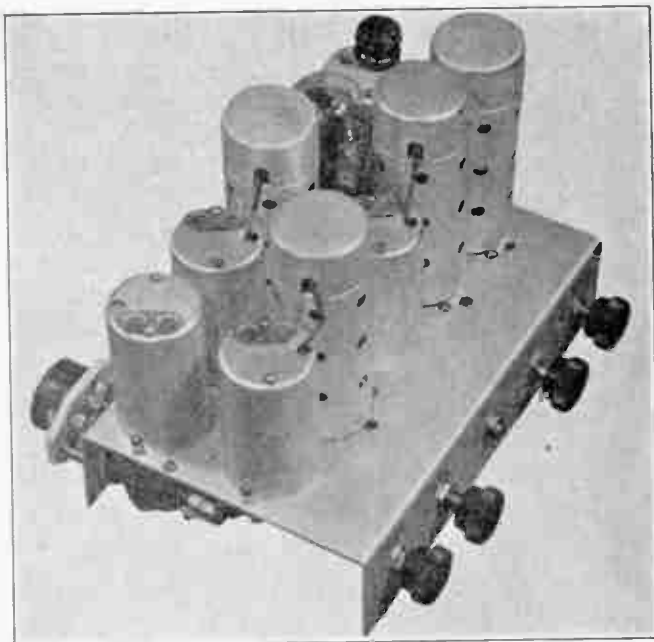

The complete IF Crystal Filter, BFO, Detector and Audio Unit, mounted on an aluminum chassis only $9\frac{1}{2}$ inches long, 6 inches wide, 2 inches deep. The Bliley 465 KC Crystal is plainly seen at the rear.

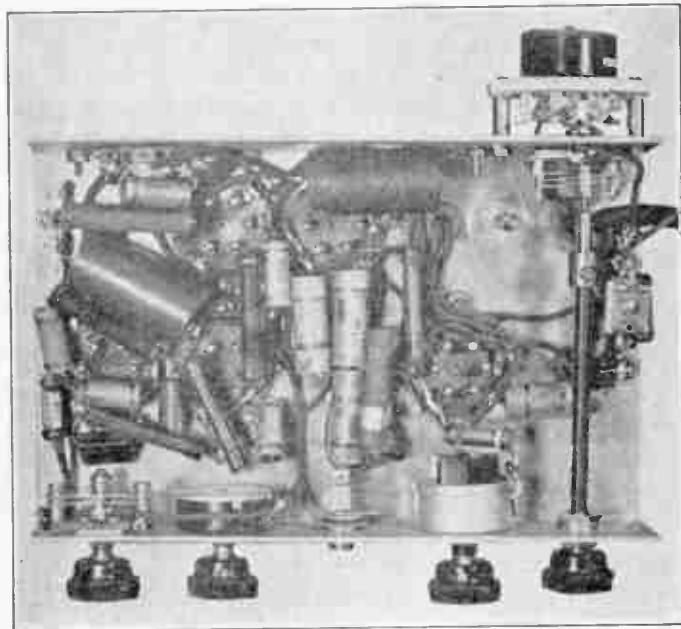

Under chassis view of the complete unit, showing placement of variable condensers, controls, resistors, etc. Ordinary wafer sockets are used throughout, except for the socket which holds the 465 KC Crystal.

shielding and isolation, if maximum gain is to be realized.

One stage of IF amplification will give more than enough gain for most purposes and the second stage is used mainly to increase the selectivity. Selectivity in the IF transformers is for the sole purpose of reducing the effect of undesired humps found in all quartz crystals. When it is possible to obtain a high "Q" resonator crystal without humps on each side of the main peak, it will be possible to materially simplify the IF amplifier.

The beat-frequency oscillator utilizes the new negative resistance pentode oscillator developed by RCA. Its principal advantage is its freedom from harmonics.

A Regenerative Pre-Selector With Variable Antenna Coupling

● Many superheterodyne receivers which have no radio frequency amplification ahead of the first detector have been built for or by amateurs. This usually results in a high ratio of noise to signal and has given the superheterodyne receivers a reputation of being excessively noisy.

Radio frequency amplification can be obtained either by the use of one or two RF stages or by means of regeneration in the first detector. The main purpose is to amplify the signal, as much as practically possible, before heterodyning it to the IF frequency in the plate circuit of the first detector. This invariably gives a better signal to noise ratio and the really weak signals are made readable through the receiver noise.

The pre-selector here described consists of a single stage of RF amplification to be used ahead of any short-wave superheterodyne receiver. By the use of variable antenna coupling and cathode regeneration, this single stage can be made equivalent to the usual two stage RF pre-selector. It not only increases the signal to noise ratio but also reduces image interference.

The variable antenna coupling is obtained by means of a sliding coil and it is not necessary to change this part of the coil circuit for the different amateur bands. An efficient plug-in coil is used as the tuned circuit inductance in order to obtain maximum efficiency and correct cathode tap for each band. Regeneration is controlled by means of a 50,000 ohm potentiometer which varies the screen voltage. The screen-grid series resistor of 5,000 ohms, shown in the circuit diagram, tends to prevent the regeneration control from introducing noise as the latter is varied. The plate voltage is fed through a small Hammarlund multi-section RF choke which is effective over all of the amateur bands.

The plate circuit is connected through a coupling condenser to the receiver so this can connect to the antenna post on the main receiver, or this lead can be twisted around the first detector grid lead a few times to obtain capacity coupling. In the latter case, the detector trimmer condenser should be re-set for best results.

The cathode circuit uses a 1,000 ohm resistor for self-bias. This is by-passed by means of an .01 mfd. condenser. Normally from 400 to 600 ohms is sufficient for cathode bias, but with variable screen voltage and regeneration, a value of 1,000 ohms seems to be desirable. This higher value also tends to prevent strong local signals from causing cross-talk interference in this stage. Many superhets suffer from cross-talk in either the first detector or RF stage. This cross-talk is especially bothersome in the broadcast range on some all-wave sets. This cross-

talk usually is in the form of numerous whistles on top of broadcast station channels where no heterodyne interference should be had. On short wave channels it takes the form of whistles, or mush, from local stations near the frequency to which the set is tuned.

The regeneration is affected slightly by the plate circuit load, so a little juggling of

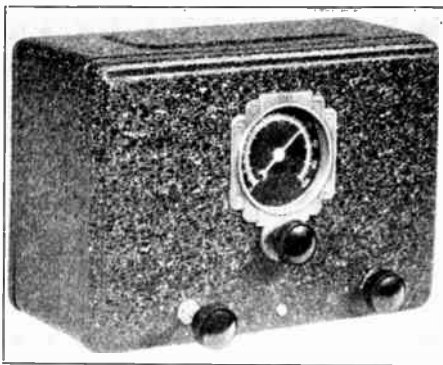

The Pre-Selector is mounted in a metal cabinet, with illuminated airplane dial.

the cathode tap and the coupling to the receiver may be necessary in some cases. The RF tube will slide into oscillation smoothly when the pre-selector is functioning properly. The point just below oscillation gives the greatest gain and selectivity.

The antenna coupler is made of two pieces of bakelite tubing, each $1\frac{1}{2}$ inches long. The larger one is $1\frac{1}{8}$ -in. outside diameter and the smaller one $\frac{7}{8}$ -in. diameter, so the latter with its winding of 8 turns will slide readily inside of the other tube. The larger tube has 20 turns of No. 28 DSC wire, close wound, and this should connect to a doublet antenna for maximum outside noise reduction. This link coupling system reduces antenna capacitive coupling to a very small value, and thus a balanced doublet antenna with transposed or twisted-pair lead-in will work extremely well. Reduction of capacitive coupling to the antenna, if the latter uses a two-wire feeder, means less pick-up from the down lead and consequently a great reduction in automobile ignition interference. The latter is usually had on 20 meters and occasionally even on 40 meters. The smaller antenna coil is fastened to a piece of $\frac{1}{4}$ -in. diameter round brass rod, $3\frac{3}{4}$ -in. long, by means of two 6/32 machine screws through the brass rod and bakelite tubing. This rod slides through an ordinary telephone jack of the short type and the plunger

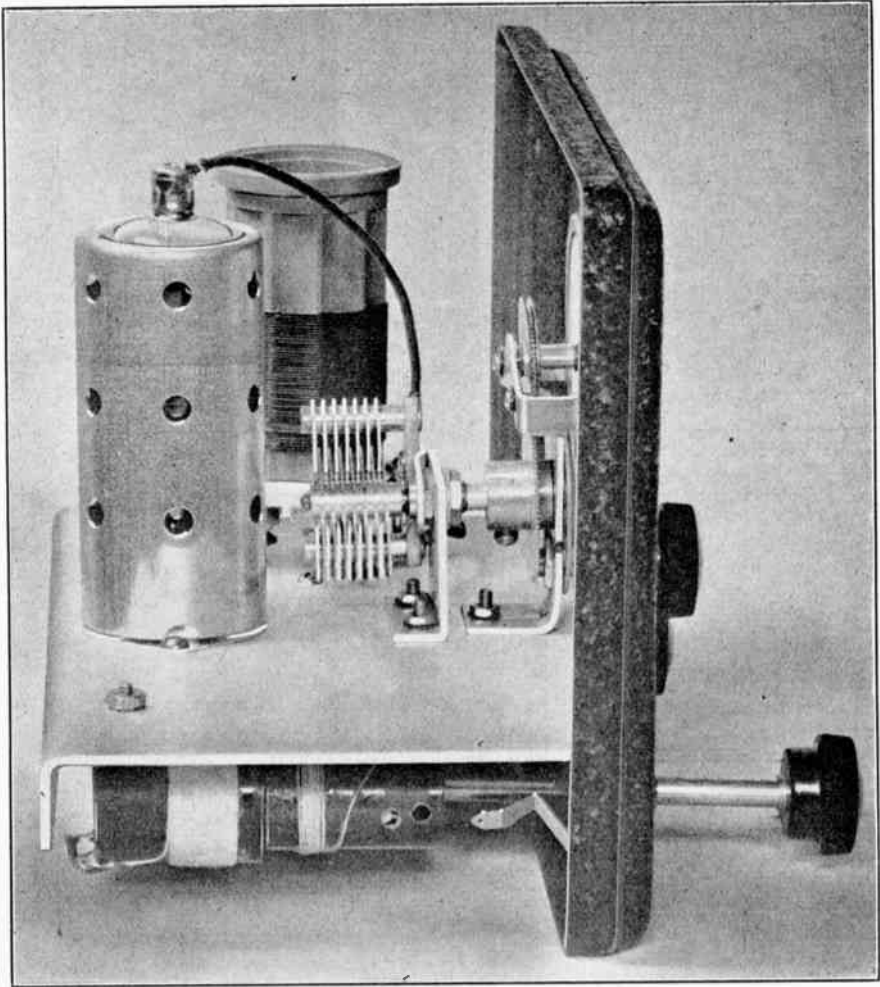

The Completed Pre-Selector, showing proper location for variable antenna coupler.

action of this coil is controlled by means of a knob on the front panel which pulls in and out. The jack acts as a bearing and the jack spring presses against the rod and holds it in place at whatever point is necessary. This is a very simple mechanical device which has proven very satisfactory for adjustment of antenna coupling.

The tuning condenser can be any of the midget types having good insulation and a maximum capacity of about 100 mmfd. A small aluminum bracket holds the condenser at the proper level for the airplane type dial used on this set. The parts are mounted on a piece of 12-gauge aluminum bent in the shape of an inverted U. The original piece should be $8\frac{1}{2}$ -in. long and 7-in. wide, $1\frac{1}{2}$ -in.

on the front edge and $\frac{3}{4}$ -in. on the rear edge are bent down, so the top of the chassis is $8\frac{1}{2}$ -in. by $4\frac{3}{4}$ -in. The antenna coupler mounts underneath on one side, and the regeneration control on the other; the entire unit mounts in a can which comes equipped with dial. The approximate dimensions of this can are $9\frac{1}{2}$ -in. long, 5-in. deep and 6-in. high. The front and back are removable so the coil can be changed by snapping off the rear cover or by means of an opening in the rear. The dial is fastened to the chassis by means of a right-angle bend in the dial mounting strap and fastening the latter down with a machine screw. The chassis is fastened to the front cover or panel.

It is desirable to twist the antenna leads

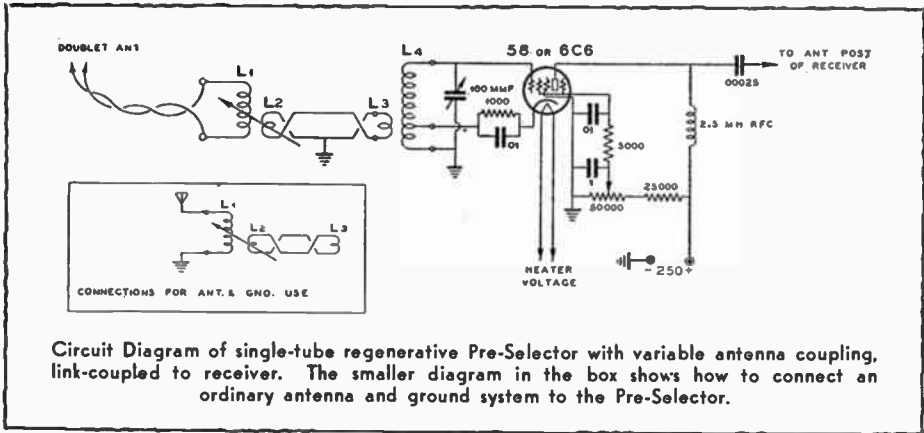

Circuit Diagram of single-tube regenerative Pre-Selector with variable antenna coupling, link-coupled to receiver. The smaller diagram in the box shows how to connect an ordinary antenna and ground system to the Pre-Selector.

together for the two leads into the pre-selector. The plate coupling lead should come out at the other side of the rear cover and be as short as possible in its connection to the radio receiver. Coupling between this plate lead and the antenna would cause undesirable effects. Power for the tube can usually be obtained from the receiver because it only needs heater current and a high voltage tap of from 180 to 250 volts. If a doublet antenna is not used, one of the antenna leads should be grounded. This antenna coupler is incorporated in the "222" Receiver described on pages 45, 46, 47 and 48.

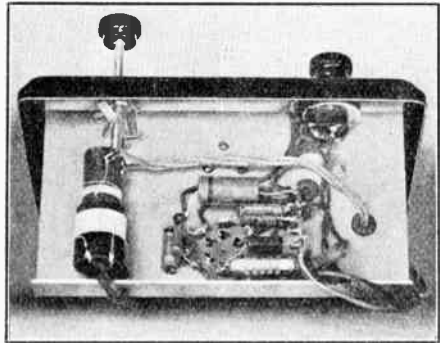

Under the chassis. All wiring is plainly visible. A twisted-pair of flexible leads is attached to the movable coupling coil, as shown. Below: Chassis layout.

Coil winding table for Pre-Selector.

- L1—Same for all bands. 20 turns, No. 28 DSC, close wound on 1 3/8-in. dia. tubing.
- L2—Same for all bands. 8 turns, No. 28 DSC, close wound on 3/8-in. dia. tubing. Coupling between L1 and L2 variable. L2 slides into, and out of L1.
- RF COIL FOR 160 METERS**
- L3—10 turns, No. 22 DSC, close wound on 1 3/8-in. dia. low-loss coil form.
- L4—60 turns, No. 22 DSC, close wound, and tapped 1 3/4 turns up from ground end. L4 is wound on same coil form as L3, and is spaced 3/8-in. from L3.
- RF COIL FOR 80 METERS**
- L3—7 turns, No. 22 DSC, close wound, on 1 3/8-in. dia. form.
- L4—35 turns, No. 22 DSC, close wound, and tapped 3/2 turn up from ground end. Spacing between L3 and L4 to be 3/8-in.

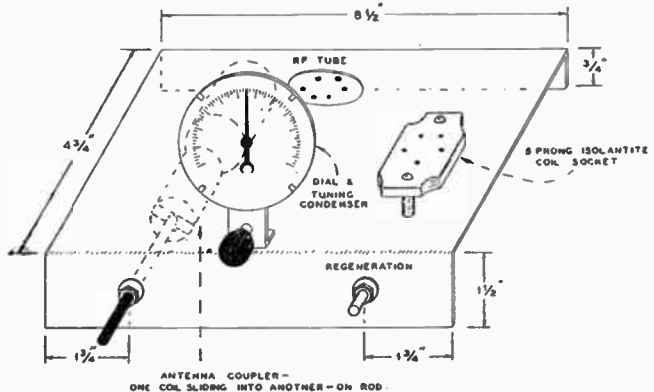

- RF COIL FOR 40 AND 20 METERS**
- L3—5 turns No. 22 DSC, close wound, on 1 3/8-in. dia. form.
- L4—12 turns, No. 18 DSC, space-wound over a winding space of 1 3/8-in., and tapped 3/4 turn from ground end.

NOTE—The ground end of the L4 is the bottom of the coil. The top end of L4 connects to the grid of the 5B or 6C6 tube in the Pre-Selector.

Noise-Free Two-Tube Autodyne

● The circuit of this receiver is conventional in every respect. It utilizes a 57 detector in the familiar electron-coupled circuit which has proven so simple to make oscillate, especially at the higher frequencies. The Hartley type of oscillator is used. Regeneration is controlled by varying the screen-grid voltage with a potentiometer, which gets its voltage from across the voltage divider incorporated in the set. There is a RF filter in the plate lead from the detector, as a precaution against RF in the audio impedance. The audio stage is a 56 type tube, used because of its high gain, although a 27 could be used. Everything is conventional and standard practice, except the filtering of the phone and power leads, and the link coupling to the antenna.

The panel is made of aluminum, 7½-in. deep. The aluminum sub-panel is made by bending over the front and back of another piece of aluminum, these sides being 2-in. deep. A bottom is closely fitted, and fastened by tapping holes in the ¼-in. dural corner posts. A top is also closely fitted and it merely rests on the corner posts. The photographs show this more clearly than words. The tuning condenser is mounted on an aluminum bracket which serves to rigidly support it and also to shield the audio impedance from the detector stage, found necessary to completely eliminate the last trace of fringe howl. The grid condenser and leak are mounted directly on the tuning condenser so that the lead to the grid of the detector tube will be short. That all of this care about short leads is not wasted effort is shown by the ease with which the set oscillates on 28 MC, and the fact that all coils required many more turns than is common practice. This high L-C ratio makes for sensitivity, as will be discussed later. The plate filter is mounted above the subpanel to keep leads short and RF from under the subpanel.

Under the subpanel the wiring and arrangement is completely conventional, with the possible exception of the RF filters and the use of so many by-pass condensers. Note, for example, that the screen grid of the detector tube is by-passed twice—once right at the socket by C6, and again by a .5 mfd condenser across the regeneration control. This latter condenser is used mainly to eliminate any noise that might be caused by a poor potentiometer. A simple filter consisting of two .00025 mfd. condensers and two RF chokes was used, and the condensers, with the phone jack, were included in their own special shield can, as can be seen. The other

shield can contains the power supply RF filter, which merely consists of a pi section filter of two .01 mfd. condensers and a RF choke. The two shield cans are easily made of pieces of aluminum bent to form three

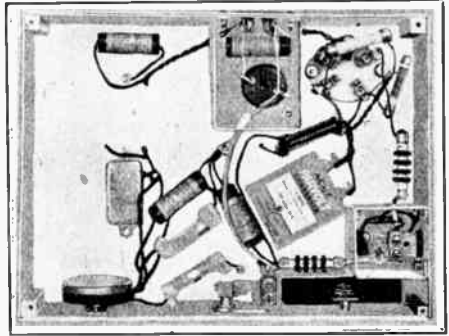

Under-chassis view. Note the separate small shielding boxes in which the noise-filter parts are housed. These boxes are made of aluminum and secured to the chassis with machine screws. The boxes must be covered with aluminum top pieces, or lids. The lids were removed for the purpose of photographing the parts inside the small shield boxes. In the shield box at the rear of the chassis the filament and plate power filter parts are located (three .01 condensers, one of them non-inductive, and an R.F. choke). The other shield box houses the headphone-circuit by-pass condensers. These condensers keep hum and house power-line noise out the receiver, which would otherwise be picked-up by the phone cord. Hand-capacity is also minimized; furthermore, monitoring the transmitter is made possible.

sides of the box, and another piece with the edges bent over so as to fit snugly over the can.

Proper band spreading is achieved by using the usual padding condenser across the tuning condenser. There is no condenser shown in the photographs or wiring diagram. Each coil contains its own padding condenser. A piece of No. 28 enameled wire is soldered to the ground side of the coil, right in the coil itself, and this is wrapped around the lead that goes up to the grid end of the coil. This permits accurate spotting of each coil right into the band, and the more turns, the more capacity and consequently the more bandspread. When the coil has once been adjusted, the extra wire is cut off, and the coil is adjusted once and for all. Right here let us make a plea for a little experimentation by set-builders. If your coil doesn't hit the band, even though you built the coil "just like the book," experiment a bit. By cutting and pruning you may end up with a coil twice as good as before.

Link coupling was incorporated in the receiver, the link running through flexible shielding to a copper box which contains the

two-turn coupling loop, wound on a tube base and almost smack up against the Faraday screen. A two-inch hole in the box is the only opening, and is covered by the screen (described later). Therefore, the only way any signal can get into the receiver is through the screen, and this has to be by magnetic coup-

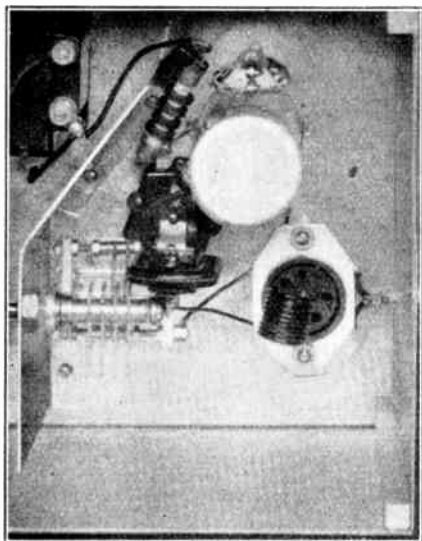

Close-up of the 10-Meter Coil.

ling, which is obtained from the tuned antenna circuit. The Faraday screen is made by winding a layer of paper over a scrap piece of aluminum, winding No. 22 enameled wire around this (spacing the turns with string). The ends are fastened, the string unwound, and the wire fastened to the paper by painting with collodion. After several coats have been applied and dried, one edge is cut and the paper and winding removed from the form, leaving two flat windings. One of these is trimmed up and the wire along one edge scraped and soldered to a common wire. Any method of construction is satisfactory, the result desired being an effective comb of wire, with the wires separated approximately their own diameter, fastened together at one end, and open at the other. The screen is mounted on the inside of the copper box, and the common wire soldered to the box. The antenna coil is mounted in a socket, to facilitate band-changing, and mounted on a board with the antenna tuning condenser. To loosen the coupling (a very convenient vol-

COIL DATA FOR L4

3.5 MC—46 turns No. 30 enameled, close wound, tapped $1\frac{1}{2}$ turns up.

7 MC—23 turns No. 18 enameled, spaced diameter of wire, tapped $\frac{7}{8}$ turns up.

14 MC—11 turns No. 18 enameled, spaced $1\frac{1}{2}$ diameters, tapped $\frac{3}{4}$ turns up.

(Above coils wound on $1\frac{1}{2}$ -inch five-prong coil forms).

28 MC—9 turns No. 14 enameled wound $\frac{3}{4}$ -in. diameter on air, tapped $1\frac{1}{8}$ turns up. Turns spaced about $\frac{1}{2}$ diameter.

Each link coupling loop consists of two turns interwound between the two bottom turns of each coil.

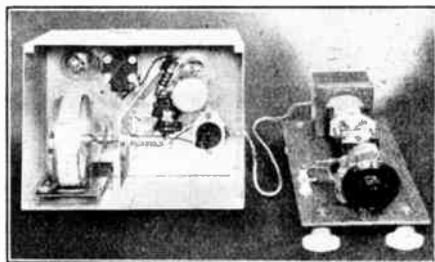

Looking into the receiver from the top. Not how the aluminum shield partition is bent. This shield minimizes interaction and fringe howl.

ume control, by the way) the board is moved away from the link housing. The system works well with any length wire as an antenna, functioning the same as an end-fed antenna. Doublets are still better, and have the advantage of no hand capacity.

The leads from the power supply are run through shielded cable and terminate in a four-prong plug which plugs into the wafer socket on the back of the set. Completely air-tight joints and complete filtering of the heater leads (they are only by-passed) would probably be the answer. The use of 6.3 volt tubes would enable the use of simple heater lead chokes which would only require No. 20 wire to carry the current. Obviously the 2.5 volt type tubes require too much current to make for compact chokes. This receiver handles on 28 MC like it handles on 7 MC, and the sensitivity certainly is not lacking. The sensitivity is no doubt due to the use of high L and low C, which gives maximum voltage on the grid, but does not make for extreme stability.

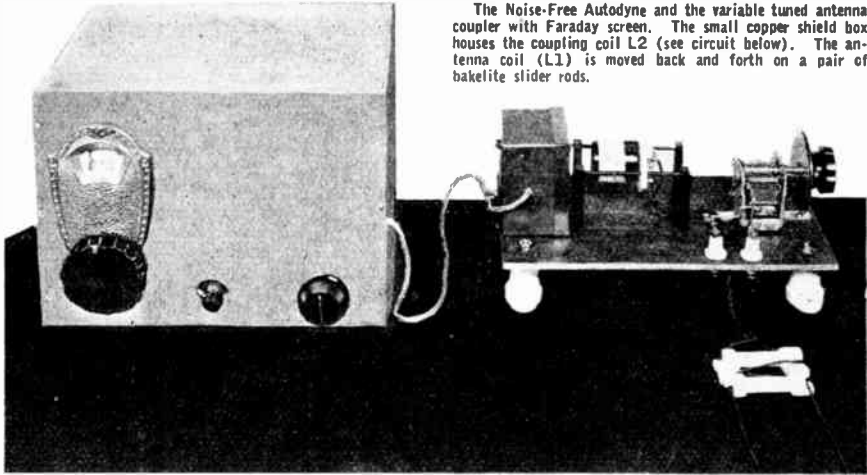

The Noise-Free Autodyne and the variable tuned antenna coupler with Faraday screen. The small copper shield box houses the coupling coil L2 (see circuit below). The antenna coil (L1) is moved back and forth on a pair of bakelite slider rods.

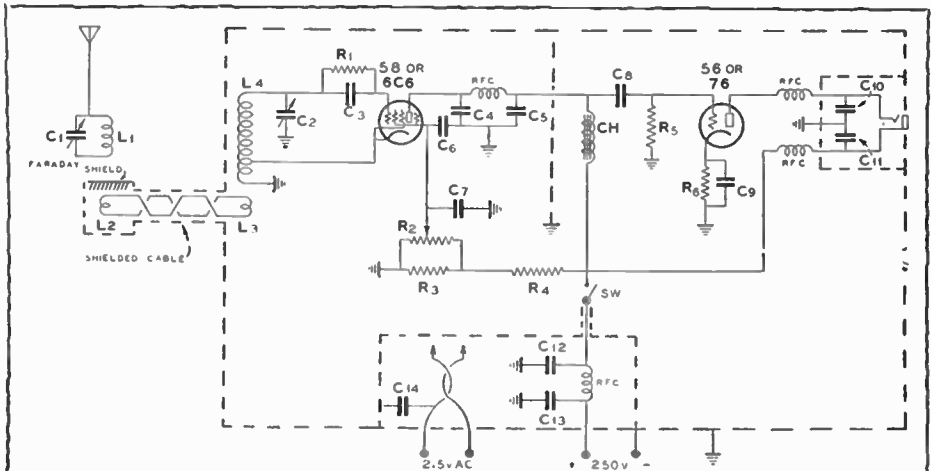

LEGEND FOR THE NOISE-FREE AUTODYNE

L1, L2, L3, L4—Described in Text. C1—100mmf, midget variable. C2—20mmf. National SEU-20. C3—100mmf. Sangamo, with grid clip. C4, C5, C10, C11—250 mmf. mica Aerovox postage stamp type. C6, C12, C13—.01mfd. mica condensers. C7— $\frac{1}{2}$ mfd. 400 volt non-inductive condenser. C8—.01 mica, Sangamo. C9—1 mfd. 200 volt paper condenser. C14—.01 mfd. non-inductive. R1—2 to 5 megohm gridleak (experiment for noiseless one). R2—50,000 ohm Centralab variable resistor. R3—4000 ohm 10 watt. R4—15,000 ohm 10 watt. R5— $\frac{1}{2}$ megohm 1 watt. R6—3000 ohm 1 watt. RFC—good short-wave choke (Hammarlund or National 100). CH—Old A.F. Transformer or high inductance choke.

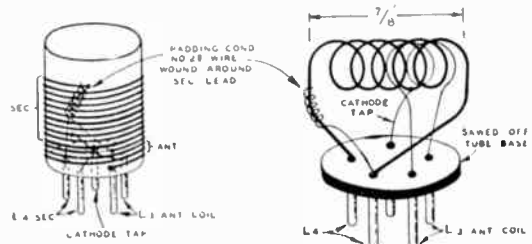
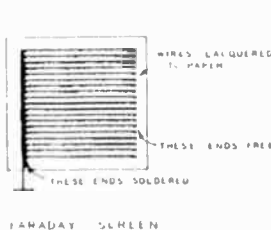

Showing how to make the Faraday screen, 3.5, 7 and 14 MC coil and (right) the special 28 MC coil.

An Unusually-Fine 3-Tube Tuned RF Regenerative Receiver

One of the most efficient circuits for a tuned radio frequency receiver is here shown. A receiver of this type is infinitely more desirable for amateur communication because the tuned R.F. stage rejects the unwanted interference from broadcast stations which operate in the low frequency bands. The resistors in the voltage divider portion of the circuit should be of the 10-watt size. The newer 6.3 volt tubes can be substituted for those shown in the diagram.

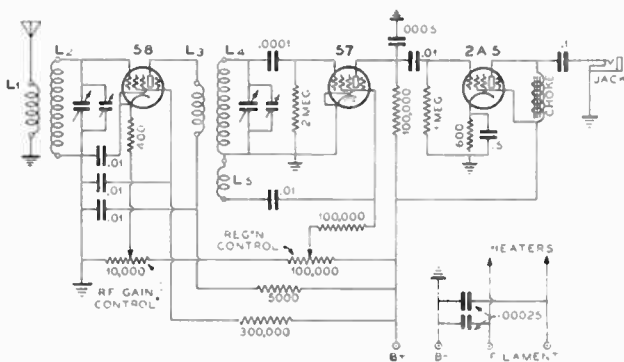

Circuit diagram for 3-tube receiver designed by E. M. Sargent.

COIL WINDING TABLE FOR 3-TUBE RF RECEIVER SHOWN IN ABOVE DIAGRAM

Note—These specifications are for coils on $1\frac{1}{2}$ " O.D. forms, shielded by a 3" dia. aluminum shield can

R.F. COILS 4-PRONG FORMS	Primary		Spacing between coils		Secondary	
15-32 METERS	2 $\frac{3}{4}$ turns, close wound, No. 32 DSC.		Spacing $\frac{1}{8}$ -inch between "A" and "C".		4 $\frac{1}{4}$ turns, No. 24 DSC, space wound, $\frac{1}{8}$ -inch between turns.	
26-53 METERS	4 $\frac{3}{4}$ turns, close wound, No. 32 DSC.		Spacing $\frac{1}{8}$ -inch between "A" and "C".		9 $\frac{1}{4}$ turns, No. 24 DSC, space wound, $\frac{1}{8}$ -inch between turns.	
49-106 METERS	7 $\frac{3}{4}$ turns, close wound, No. 32 DSC.		Spacing $\frac{1}{8}$ -inch between "A" and "C".		18 $\frac{1}{4}$ turns, close wound, No. 24 DSC.	
100-208 METERS	10 $\frac{3}{4}$ turns, close wound, No. 32 DSC.		Spacing $\frac{1}{8}$ -inch between "A" and "C".		41 $\frac{1}{4}$ turns, close wound, No. 28 DSC.	

DETECTOR COILS 5-PRONG FORMS	"A" (Primary)		"B" Spacing between A & C		"C" (Secondary)		"D" Spacing between C & E		"E" (Tickler)	
15-32 METERS	3 $\frac{3}{4}$ turns, close wound, No. 32 DSC.		$\frac{1}{8}$ -inch		4 $\frac{1}{4}$ turns, No. 24 DSC space wound, $\frac{1}{8}$ -in. spacing between turns.		Top 1 $\frac{2}{3}$ turns of "E" are interwound with bottom 2 turns of "C".		[See "D"] 1 $\frac{2}{3}$ turns, No. 32 DSC interwound with "C", and 2 turns wound separately. Total 3 $\frac{2}{3}$ turns on "E".	
26-53 METERS	5 $\frac{3}{4}$ turns, close wound, No. 32 DSC.		$\frac{1}{8}$ -inch		9 $\frac{1}{4}$ turns, No. 24 DSC space wound, $\frac{1}{8}$ -in. spacing between turns.		$\frac{1}{8}$ -inch		4 $\frac{2}{3}$ turns, close wound, No. 32 DSC.	
49-106 METERS	13 $\frac{3}{4}$ turns, close wound, No. 32 DSC.		$\frac{1}{8}$ -inch		18 $\frac{1}{4}$ turns, close wound, No. 24 DSC.		$\frac{1}{8}$ -inch		3 $\frac{2}{3}$ turns, close wound, No. 32 DSC.	
100-208 METERS	35 $\frac{3}{4}$ turns, close wound, No. 32 DSC.		$\frac{1}{8}$ -inch		41 $\frac{1}{4}$ turns, close wound, No. 28 DSC.		$\frac{1}{8}$ -inch		5 $\frac{2}{3}$ turns, close wound, No. 32 DSC.	

The "222" Amateur Superheterodyne Series

● This receiver was designed by Frank C. Jones for the amateur who likes to build his own sets and who is primarily interested in three band operation. The parts are available from most radio supply houses and the cost is not excessive. It is the next logical step from a TRF receiver and costs much less than an elaborate crystal filter superheterodyne. The set will cover the 20 and 40 meter amateur bands without coil changing, which is a convenience when one is interested in two bands, such as 20 and 40 meters. For 80 meter operation a separate set of coils is needed.

The receiver is very sensitive on 20 and 40 meters due to the special first detector circuit employed. Regeneration is used and a variable antenna coupling allows maximum effect from the regeneration. The antenna coupling is the same as that shown for the Pre-selector on page 38. Link coupling is used between the antenna coil and the first detector coil and one of these link coils slides back and forth for variable coupling. This also minimizes capacity coupling to the antenna without using a Faraday electrostatic screen, thus reducing man-made static. The same antenna and link coil assembly are used on all bands, thanks to the link coupling as applied to receivers.

Regeneration is obtained by means of a cathode tap on the detector coil because this gives a more uniform regeneration effect over the wide range of any one set of coils. The conversion gain of this detector is very high, due to regeneration, and to the method of oscillator coupling used. The suppressor grid connects directly to the plate of the electron-coupled oscillator. This practically eliminates oscillator radiation into the antenna because the screen grid is by-passed to ground and electrostatically shields the suppressor grid from the control grid circuit. The positive potential on the suppressor grid works fine in giving a very sensitive regenerative first detector.

The first and second oscillators are orthodox electron-coupled circuits with good frequency stability. The first oscillator is made to oscillate strongly for good conversion gain, while the second one oscillates weakly to minimize harmonics which would cause steady beat note whistles in certain spots in the short wave range. Adjustment of this oscillator strength and twisted wire coupling capacity to the second detector grid also allows maximum signal to BFO noise ratio. The use of a high plate and screen grid resistor limits the harmonic output and simplifies the shielding problem for the BFO. A strong oscillator for the BFO means that it should be double-shielded and usually results in high noise level in the audio output. This trouble has been eliminated in this receiver.

The IF amplifier uses only one stage because two stages complicate the set and provide more noise than signal, unless a crystal filter is to be used. With only one high gain IF stage operating at about 500 KC, no isolating condensers and resistors are needed in plate, screen-grid and cathode circuits. An IF and audio volume control are both provided because often low audio gain and high IF gain will pull a weak signal into readability through the noise level.

A stage of audio amplification is used to provide a method for audio and tone control and also more gain when necessary. The set is designed for headset operation but has actually enough volume to drive a magnetic speaker to good volume on signals that are well down into the noise level. The type 76 or 56 tubes make good power detectors and audio amplifiers. The audio amplifier uses the headset as a bias resistor for this tube, with the tone control across the phones. This connection allows the telephone jack to be grounded to the aluminum chassis or panel. The grid circuit audio signal is confined to the grid and cathode by means of a 0.1 megohm resistor and a 0.1 mfd by-pass from the audio transformer to cathode. This prevents any audio degeneration and loss of signal—so the output is the same as if a cathode resistor and large by-pass condenser were used and the headset placed in the usual plate circuit.

A separate power pack is used. B batteries and a 6-volt storage battery can be used, providing the on-off switch external to the set cuts both A and B leads in the off position. The IF amplifier uses a pair of the new Aladdin iron-core transformers which have a little better selectivity and gain than the ordinary air core type. They are tuned by means of trimmers, like any other IF transformer. If these transformers are not available the usual air core units can be used with entire satisfaction. In any of these IF units, the coupling has been adjusted at the factory for best broadcast reception gain and band width. This is generally too close for best short-wave practice where greatest selectivity and good gain are desirable. The two coils should be at least an inch apart and $1\frac{1}{4}$ inches works very well with most small air-core IF transformers. Some makes can be adjusted by warming the supporting tube with a soldering iron tip until the wax softens, then sliding the coils apart. The iron core transformers have a pair of coils mounted at right angles to each other on short molded straight cores. Coupling is adjusted by a screw adjustment on the lower coil which slowly moves it along its axis.

As previously stated, a single stage of IF will give ample gain if the front-end of a

super is functioning as it should. A stage of RF ahead of the first detector is sometimes desirable, but it does not compare with a super using a regenerative first detector unless regeneration is used in the RF stage. This adds complications and means another ganged circuit, which does not simplify the set. The present set uses a ganged oscillator and detector circuit because both of these circuits have 100 mmfd padder or band-setting condensers controlled from the front panel.

The oscillator tuning condenser is a double spaced midget condenser of eight plates while the detector condenser has nine plates double spaced. These condensers were made from 100 mmfd Cardwell "Trim-Air" normally spaced midget condensers, similar to those used for hand setting. By winding the oscillator to cover a greater winding space of $1\frac{1}{4}$ inches as against $1\frac{1}{8}$ inches for the detector coil, the oscillator and detector will track throughout the narrow amateur bands. With the number of plates left in these double spaced condensers, the 20-meter band covers about 15 divisions on the airplane type dial and the 40-meter band about 60. Greater spread can be had by removing a plate from each of these condensers. A flexible coupling should be used to gang the oscillator condenser to the front detector condenser so as to eliminate torsion detuning effects on the beat note of a CW station, which always occurs with any dial and condenser mounting.

The antenna system uses a shielded lead-in pair which connects directly to the fixed

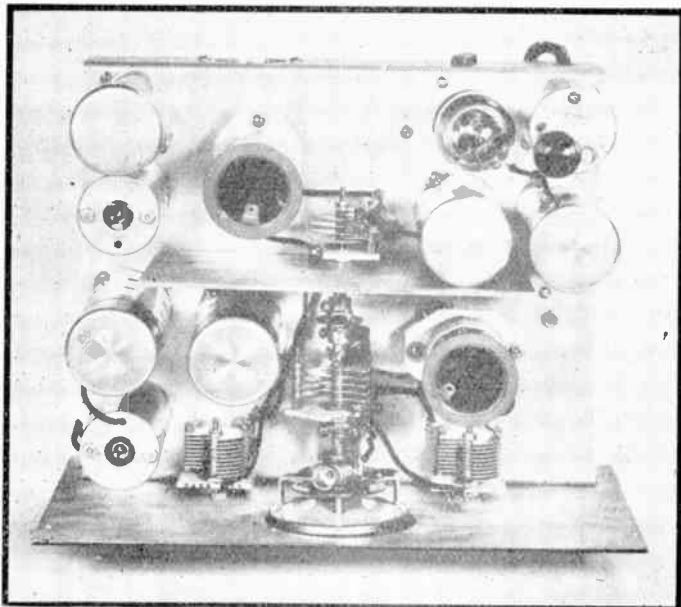

Looking down into the "222". Note shield plate.

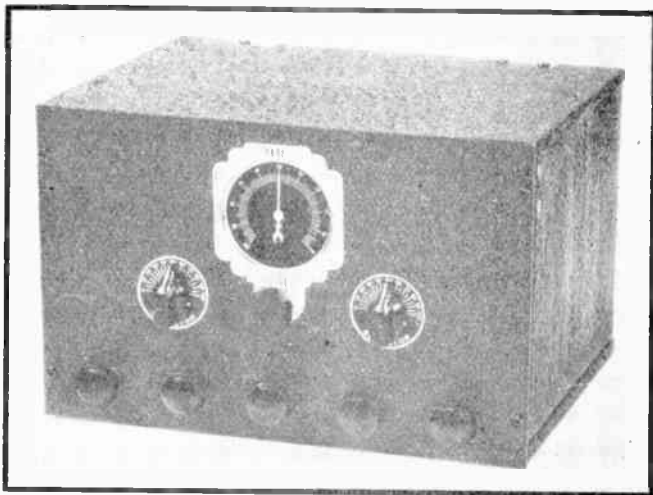

● One set of coils covers both the 20 and 40 meter bands. A separate set of coils is used for 80 meters. The illustrations show the front view and the interior arrangement of parts. The receiver is A.C. operated, but it can also be used with batteries if 6.3 volt tubes are used.

antenna coil underneath the chassis. This eliminates binding posts and unwanted pick-up and presents no complications since the shielded pair can be insulated with tape from the underside of the chassis terminals. The antenna coil consists of 12 close wound

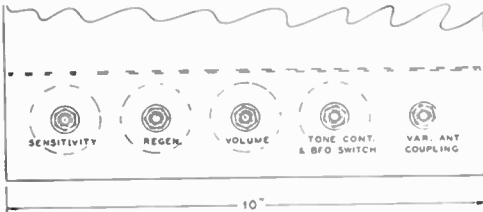

Arrangement of control knobs on lower portion of front panel.

turns of No. 24 DSC on a 1 1/4 inch diameter bakelite tube about 1 1/4 inches long. The sliding coil is of 4 turns close wound of No. 24 DSC on a 1-inch diameter tube. Flexible leads form the remainder of the link coupling device to the isolantite coil

socket above the chassis. Four turns of this same wire were wound on the detector coil about 1/8 inch from the ground end and thus very little capacity coupling exists between the antenna and first detector coil. This 1-inch bakelite tube is controlled from the front panel by means of a plunger action knob over a distance of about an inch. This knob has a 1/4-inch diameter brass rod extending through the front panel and fastened to the 1-inch tubing with a couple of machine screws. The bearing and retaining or pressure spring is simplicity itself, being an ordinary short telephone jack. The rear tip connection acts as a pressure spring against the brass rod and it remains in whatever position it is adjusted to with the knob.

This antenna coupling device is well worth while, since it allows adjustment of the

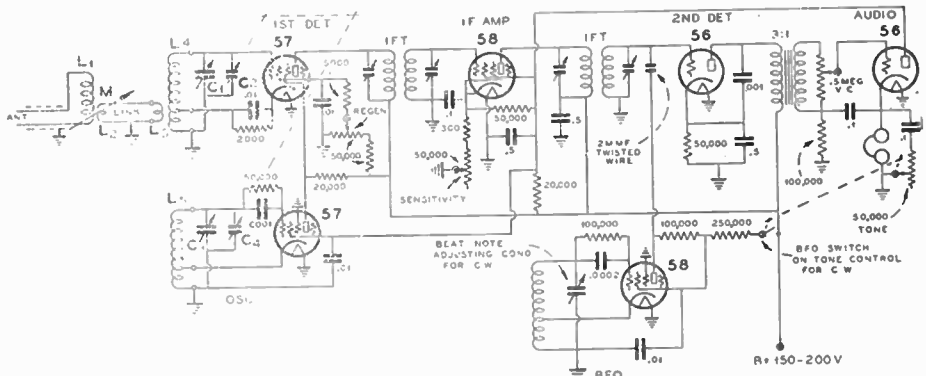

"222" COMMUNICATIONS RECEIVER

Coils L1, L2 and L3 are the same for 20, 40 and 80 meter operation. L1—12 turns, No. 24 DSC wire, close wound, on 1 1/4 in. dia. tubing.

L2—4 turns, No. 24 DSC wire, close wound, on 1-in. dia. tubing. This coil slides into coil L1; the coupling is made variable by sliding L2 into and out of L1.

L3—4 turns, No. 24 DSC wire, wound on 1 1/2-in. dia. tubing, separated 1/8 in. from L4.

For 20 and 40 meters: (same coils used for both bands). L4—11 turns, No. 18 DCC wire, space-wound on 1 1/2-in. dia. tubing, to cover a winding space of 1 1/4 in. long, and tapped at one and one-third turns from bottom.

L5—11 turns, No. 18 DCC wire, space wound on 1 1/2-in. dia. tubing, to cover a winding space of 1 1/4 inches, and tapped at 2 1/2 turns from bottom.

C1—C3—100uufd. midget variable condenser.

C2—9 plate double-spaced midget condenser to give approx. 25uufd.

C4—7 plate double-spaced midget condenser to give approx. 20 uufd.

(Use 8 plates for C2 and 6 plates for C4 if more band-spread is desired).

Condensers C2 and C4 are standard Cardwell 100uufd. "Trim-Air" midgets, with alternate plates removed so as to double-space the plates.

L1, L2, L3 same as for 20 and 40 meter operation.

L4—30 turns, No. 24 DSC wire, wound to cover a space of 1 1/2 in. on a 1 1/2-in. dia. form, with cathode tap taken at one turn from bottom.

L5—26 turns, No. 24 DSC wire, wound to cover a space of 1 3/4 in. on a 1 1/2-in. dia. form, with cathode tap taken at 4 1/4 turns from bottom.

NOTE—The cathode tap on the oscillator coil must not be too high, otherwise image interference will become serious.

TUBES—Instead of using type 56, 57 and 58 tubes, this receiver will give equal satisfaction if the types 6C6, 6D6 and 76 are used for 6.3 volt operation.

160 METER BAND—This receiver will not operate successfully on the 160-meter band unless large variable condensers are used in place of the small midgets. The receiver was primarily designed for 20, 40 and 80-meter operation.

CONDENSER SETTINGS

Band	Oscillator Band-Setting Condenser	Detector Band-Setting Condenser	Coverage on Main Tuning Dial
20 Meters	8°	10°	12° to 15°
40 Meters	80°	95°	50° to 60°
75 Meter Phone Band	45°	50°	25°
80 Meter C.W. Band	50°	55°	100°

resonant antenna coupling so as to obtain optimum value of first detector regeneration. It can be used with any type of antenna and the latter may be tuned to resonance externally and the optimum coupling easily found. The results are very gratifying. The image interference on 40 meters measures 60 DB units down in level from the desired signal, using a signal generator for these measurements. 60 DB means an image reactivity of 1000-to-1, which is extremely good for sets using a good stage of RF. The image measures 50 DB down on 20 meters, which is more than most superheterodyne receivers can even approach at that wavelength. The receiver has practically no image whistles of "phantom" commercial signals in the amateur bands, unless the commercial signal is of very high field intensity. The signal generator gives an audible signal in the headset with an input of 130 DB down from 1 volt, which is less than one microvolt input. This is ample sensitivity, with low internal receiver noise level, to reach down into the atmospheric noise level in any locality.

The receiver is built into a metal cabinet measuring $8\frac{1}{2}$ inches deep, 7 inches high, and 11 inches long. The front panel is 7 inches x 11 inches of No. 12 gauge aluminum. The chassis is also of No. 12 ga. aluminum, bent in the form of a U, two inches deep and $8\frac{1}{4}$ inches wide by 10 inches long. All of the necessary tube socket and dial holes can be punched, or cut out with a circle cutter and drill press. The shield partition between the oscillator and detector is also of No. 12 gauge aluminum, 7 inches long, $4\frac{3}{4}$ inches high with a $\frac{1}{2}$ -inch lip along the bottom for fastening to the chassis with 3 machine screws.

In building this set it is a good plan to take all of the largest parts and set them on the chassis so as to get the proper chassis layout before drilling. The pictures of this set and the plan drawings should enable anyone to duplicate it without trouble. The lower knobs on the front panel from left to right are sensitivity, regeneration, audio volume, tone control and BFO switch combination, and antenna coupling. The upper row: oscillator band setting adjustment with knob and small 0-100 metal escutcheon plate, main tuning control, and last, the detector band setting control and 0-100 division plate. The antenna

leads, power cable plug and telephone jack are at the rear of the chassis with large holes around them through the metal cabinet. The cabinet has a hinged lid. The receiver is simple in its circuit and easily built. It can be, and was, in this case, built and put on the air in two days' time. The circuit line-up is simple if a modulated oscillator is available for lining up the IF amplifier.

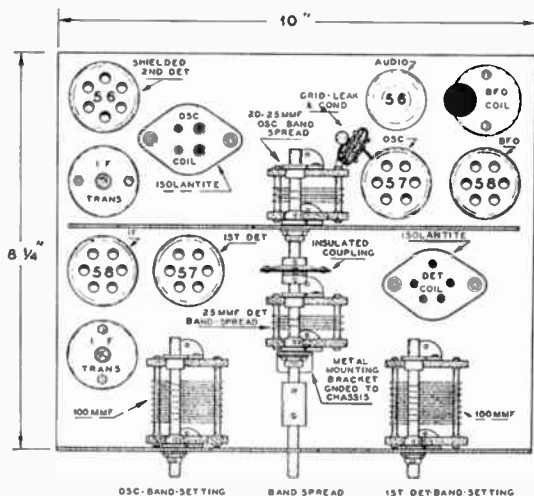

The constructor is advised to use the exact layout of parts, as shown above. All tubes are shielded, other than the type 56 audio tube. Isolantite sockets should be used for the Detector and Oscillator coils.

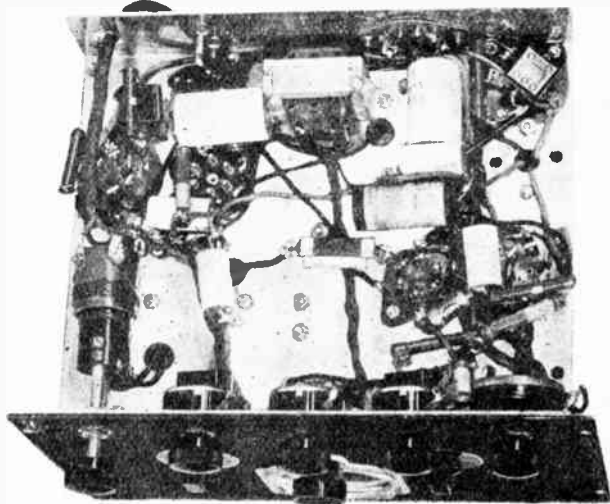

Under-chassis view. Note the variable link-coupling device. It slides into, and out of the antenna coil by means of a plunger which is fitted into a phone jack. The audio transformer is seen at the center rear.

Adding a Stage of R.F. Amplification to the "222" Receiver

The form of RF stage used here is self tuned over a narrow band, which is an ideal condition for amateur reception but would not be satisfactory for an all-wave broadcast receiver. The input circuit uses a resonant RF choke or tuned circuit which has a high L over C ratio. This means real amplification where it is needed and not very great selectivity in this stage. The antenna trimmer condenser will actually tune this stage to resonance any place within the amateur bands. One RF coil or choke is needed for each band, as shown in the coil table. The really beautiful part of this type of RF stage for amateur use is that no special amount of shielding and no three-gang con-

denser is required. No alignment difficulties or circuit reaction are encountered.

The RF chokes can be wound on old burned-out Amperites, such as were used with the 201A tubes to drop their filament voltage from 6 down to 5 volts. There is just a little over 1 inch of winding space on these glass tubes which are about 7/16 inch in diameter. The ends of the wire can be soldered to the end clips and the whole unit plugged into the original clip mounting. This makes a fairly convenient method of changing these RF coils for each amateur band. Another possibility would be the use of burned-out cartridge type fuses, preferably those having glass instead of fibre cylinder walls.

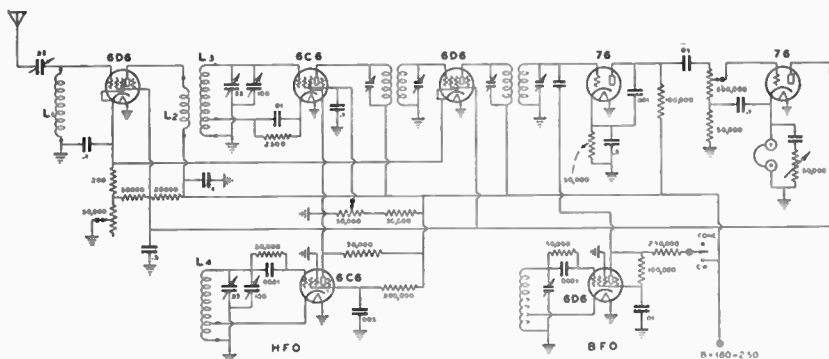

Circuit diagram of the 222 Receiver with RF stage. Data for L1, L2, L3 and L4 given in table below.

Coil Winding Table for Frank C. Jones' 222 Communications Receiver With R.F. Stage				
	L1 (R.F. Grid Coil)	L2 (Plate Winding)	L3 (Detector Coil)	L4 (Oscillator Coil)
For 10 Meters	20 Turns No. 18 DCC Wire. Winding space 1 inch long on a 7/8 inch dia. tube.	3 Turns No. 36 DSC Wire, interwound with L3.	4 1/4 Turns No. 22 DSC Wire, space wound to cover a winding space 1 inch long on a 1 1/2 inch dia. coil form. Tapped at 1/3 turn.	4 Turns No. 22 DSC wire, space wound to cover a winding space 1 inch long on a 1 1/2 inch dia. coil form. Tapped at 1 1/4 turns.
For 20 Meters	35 Turns No. 22 DSC Wire. Winding space 1 inch long on a 7/8 inch dia. tube.	7 Turns No. 36 DSC Wire, interwound with L3.	10 Turns No. 22 DSC Wire, space wound to cover a winding space 1 inch long on a 1 1/2 inch dia. coil form. Tapped at 1/2 turn. . . .	8 3/4 Turns No. 22 DSC wire, space wound over a winding space 1 inch long on a 1 1/2 inch dia. coil form. Tapped at 2 1/4 turns.
For 40 Meters	60 Turns No. 26 Enameled Wire. Winding space 1 inch long on a 7/8 inch dia. tube.	7 Turns No. 36 DSC Wire, interwound with L3.	10 Turns No. 22 DSC Wire, space wound to cover a winding space of 2 inches long on a 1 1/2 inch dia. coil form. Tapped at 1/2 turn.	8 3/4 Turns No. 22 DSC Wire, space wound to cover a winding space 1 inch long on a 1 1/2 inch dia. coil form. Tapped at 2 1/4 turns.
For 80 Meters	160 Turns No. 36 DSC Wire. Scramble wound on a 7/8 inch dia. tube, 1 in. long.	16 Turns No. 36 DSC Wire, interwound with L3.	30 Turns No. 22 DSC Wire over a winding space of 1 3/4 inches long on a 1 1/2 inch dia. coil form. Tapped at 3/4 turn.	26 3/4 Turns No. 22 DSC wire over a winding space of 1 3/4 inches long on a 1 1/2 inch dia. coil form. Tapped at 4 1/4 turns.
For 160 Meters	300 Turns No. 36 DSC Wire. Scramble wound on a 7/8 inch dia. tube, 1 in. long.	30 Turns No. 36 DSC Wire, interwound with L3.	60 Turns No. 28 DSC Wire over a winding space of 1 1/2 inches long on a 1 1/2 inch dia. coil form. Tapped at 1 1/4 turns.	53 Turns, No. 28 DSC wire over a winding space of 1 1/2 inches long on a 1 1/2 inch dia. coil form. Tapped at 7 turns.

The antenna condenser, about 25 mmfd. maximum capacity, should be insulated from the front panel. The antenna is connected to the rotor. Probably a doublet antenna could be used by coupling 10 to 20 turns of wire around the tuned RF choke on a form large enough to slip easily over the choke coil. In this case the antenna condenser should connect to ground in order to resonate the input circuit. The actual resonance curve of a high L over C ratio tuned circuit on 20 or 40, or even 80 meters is wide enough to cover the amateur bands without retuning for each station received. This only holds true where the capacity across the tuned circuit is extremely small and where the coils have a certain amount of resistance to help broaden out the selectivity curves.

The RF stage increases the signal to noise ratio, as shown by tests on the 40-meter band by means of an all-wave signal generator. The image rejection of this set is extremely high when considerable regeneration is used in the first detector. When using as much regeneration as possible the image rejection was 68 DB using a non-resonated input circuit, and nearly 80 DB with a resonant input circuit. One of the most expensive commercially-made all-wave receivers using an RF stage measured only 47 DB image rejection on 40 meters.

A CW Frequency-Meter Monitor

● This CW monitor and frequency meter is quite simple to construct. Being battery-operated, it requires practically no warming-up period. A frequency meter is handy for calibrating a receiver or checking the frequency of a transmitter. If it has a monitor circuit it can be used to check the tone and keying of a CW transmitter. No transmitter should be operated without a monitor to make frequent check-ups.

The Type 19 tube, with its two sets of triode units in the same tube envelope, offers many uses. One unit is used as an oscillator and the other unit as a stage of audio amplification. The Type 19 tube is a stable oscillator and its frequency can be maintained very constant when using batteries, if a good mechanical job of construction is done. The amplification constant and mutual conductance of each unit of the Type 19 tube is high; the filament is of heavy oxide construction. It is perhaps the most rugged of the 2-volt filament series of tubes and thus it is well suited for use in a monitor-frequency meter.

The oscillator is of the simple tickler feedback type using a value of grid leak which gives good stability. Band spread is obtained by means of two condensers, a 100

mmfd. variable which has a screwdriver slot adjustment and locking nut, and a 35 mmfd. variable driven by the large General Radio Co. vernier dial. The secret of a good monitor and frequency meter is in very rugged construction and the use of a large dial which can be read accurately to within one part in 1500, or better. The G. R. dial has 300 divisions and a magnifying glass enables the operator to read scale divisions to a small fraction.

The instrument is built into an aluminum box about 7 inches high, 9 inches long and

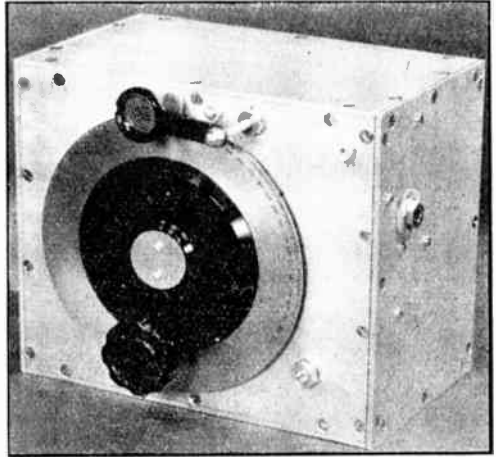

The instrument in its air-tight aluminum case.

6 inches deep. $\frac{3}{8}$ -in. flat aluminum sheets are used, and $\frac{1}{4}$ -in. square rod is used for the corner pieces. Each aluminum sheet is fastened to the square rod along each edge with 3 or 4 machine screws. This construction provides a box of excellent shielding and mechanical strength. A little extra work in building such a box is well spent and results in the difference between a good and often a very poor frequency meter. Aluminum strips of No. 12 gauge, one inch wide, are used to form brackets to hold the two No. 6 dry cells and a portable type 45 volt B battery in place. This same strip is used to provide a bracket for rigidly mounting the 35 mmfd. tuning condenser to the front panel. Since the dial is supported by this condenser rotor, the latter should be of sturdy construction and the bracket should provide at least three points of suspension mounting to the front panel. The coil, jack, and tube socket are mounted horizontally on the end panel and the resistors and fixed condensers are supported by direct connections on the wiring. The jack is a type which has an

extra set of contacts, closing the filament circuit when the telephone plug is inserted into the jack. This eliminates the possibility of forgetting to turn off a filament switch when the unit is not in use.

The second triode unit of the Type 19 tube is used as an audio amplifier in order to provide a good audible beat note signal when the meter is used for monitoring a CW transmitter. Because the two plates are

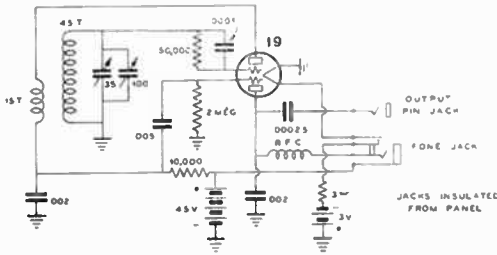

Circuit diagram of frequency meter-monitor

capacitively coupled inside of the tube, it is necessary to provide an RF by-pass of .001 or .002 mfd. from plate to filament, and a good 2½ milli-henry RF choke in series with the telephone jack. The grid resistor of 2 megohms is so high in value that a .005 mfd. mica condenser is large enough for the audio coupling condenser.

A tip jack, insulated from the front panel, is provided in order to allow pick-up of an external signal. A wire from a few inches to a few feet long can then be used as an "antenna". This "antenna" must be coupled very loosely into the oscillator circuit in order that different lengths of external wire will not affect the frequency calibration. This is done by connecting the tip jack through a .00025 insulating condenser to the audio triode plate lead at the socket. The reactance of the .002 mfd. condenser and filament to shielding lead length of about 4 inches provides enough impedance to give a reasonable amount of coupling into the oscillator circuit. There is practically no change in beat note when a wire is lengthened from a few inches to several feet from the tip jack. The intensity merely changes.

Needless to say, all joints should be well soldered and the wiring and parts mounted so as to prevent vibration. The only precaution in connecting up the coil is to see that the tickler is connected in the proper direction in order to give oscillation.

If the instrument is to oscillate over the 80-meter band, and the harmonics used on 10, 20 and 40 meters, the coil should have a secondary inductance of 20 microhenrys. A

winding one-inch long of No. 22 DSC on a one-inch diameter will give this value; or No. 22 Enam. one-inch long on ¾-inch diam. will do the job. The tickler should be wound over the ground end of the main coil with a layer of tape or paper between. About 12 to 15 turns of No. 30 DSC will give the desired result.

If the meter is to be used in the 160-meter band, the coil should be wound with 72 turns of No. 26 Enam. or No. 28 DSC on a one-inch diameter bakelite tube. This coil will have about 80 microhenrys inductance and nearly complete bandsread tuning. In both cases the band setting condenser is used at about two-thirds of its maximum capacity, and once the band is located over the dial range, this condenser should be set with the lock nut.

The meter should be calibrated from standard frequency transmissions which can be picked-up by means of any good short wave receiver. These transmissions are given periodically and are the only convenient method of calibration, unless one has another oscillator and wishes to calibrate from harmonic frequencies of local broadcast stations. Then the extra oscillator should be set to give

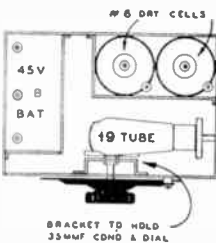
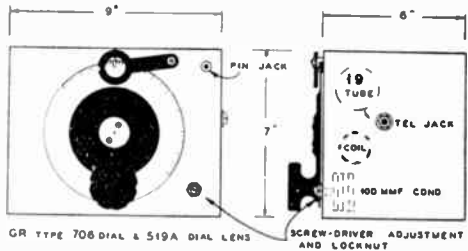

CONSTRUCTIONAL DETAILS

The filament and B batteries are inside the case. The proper location for the coil is shown in the upper right hand illustration.

zero beat with the carriers of the broadcast stations as heard in a BCL receiver, and the harmonics of this oscillator heterodyned to zero beat with the frequency meter. Broadcast stations whose frequencies lie between 1000 and 850 KC are convenient for this purpose, especially those stations that keep their carriers within 10 or 15 cycles of their assigned frequencies.

The "222" Receiver With New Type Crystal Filter and BFO

● Crystal filter circuits are useful for increasing signal-to-noise ratio in superheterodyne receivers. By proper adjustment, the selectivity of a receiver with a crystal filter can be made so great that only one sideband is made audible and an approximate single-signal effect is obtained. Quartz crystals are useful as oscillators or resonators. In the latter case, the "Q" of the circuit is extremely high and thus the selectivity characteristic is much more sharply peaked than when ordinary circuits are used.

A quartz crystal acts as a large inductance, very small capacity and a resistance in series, as in any series-tuned circuit. At resonance, for about 465 KC, the capacity of a few hundredths of one micro-microfarad cancels out the effective inductance of several henries, leaving only a resistance of a few thousand ohms. Slightly off resonance, the reactance of the extremely small capacity and very large inductance is so great that at either side of exact resonance the impedance is great enough to prevent signals passing through. In any quartz crystal filter circuit it is necessary to balance out or neutralize the crystal holder plate-to-plate capacity in order to make the resonance effect really function. In the circuit shown on the facing page this is accomplished by means of a 15 or 25 mmfd. variable condenser and a center-tapped IF tuned circuit.

The plate circuit of the first detector should be tuned for maximum signal gain and the plate coil tuning condenser acts as an effective RF bypass to increase detector efficiency. The center-tapped coil and neutralizing or phasing condenser form a Wheatstone bridge to balance out the crystal holder capacity. At resonance the succeeding tuned IF circuit would be over-coupled to the first detector tuned plate circuit, because effectively there is only a resistance of a few thousand ohms between the "hot" ends of the tuned circuits. This is prevented by means of a small coupling condenser, 3-30 mmfd. in value, in series with the crystal. This allows the use of tuned circuits between the crystal and first IF amplifier grid without loss in signal. By this matching device there is no appreciable loss in the crystal filter when it is cut into the circuit. The noise level drops, because the band passed through the IF amplifier is greatly narrowed down.

With an efficient circuit of this type, only one stage of high gain IF is necessary, which greatly simplifies the construction for an amateur receiver. Any superheterodyne should have as much gain as possible in the front end, and not depend too much upon the IF amplifier for gain. The main function of the IF amplifier is to increase selectivity.

The particular advantage of this crystal

filter is that it can be put into any existing superheterodyne receiver without disturbing the IF amplifier in any way, except to disconnect the detector plate leads.

The new B.F.O.—beat frequency oscillator circuit uses a relaxation type of oscillator. The advantages are in simplicity, since no tickler or cathode tap is necessary in the tuned circuit. This form of circuit is quite stable and the harmonic content is usually less than in an electron-coupled B.F.O. These harmonics are heard in the form of steady carrier signals at various points through the short wave bands, unless complete shielding of the B.F.O. is used. This circuit looks like a dynatron oscillator, yet it is not. It depends upon feedback in phase to the suppressor grid through the condenser C4 of the B.F.O. circuit diagram. The screen grid is more positive than the plate. The plate voltage should be about $+22\frac{1}{2}$ volts, the screen from $+75$ to $+100$, the usual control grid at zero potential and the suppressor grid at about 6 to 10 volts negative with respect to cathode. This is accomplished by means of the resistors shown in the circuit diagram.

The B.F.O. coil L1 and condenser C1 should tune to the IF frequency and should preferably be shielded. An IF coil can be used. A jumble wound coil with a fixed .001 mfd. and semi-variable 70 mmfd. condenser is preferable because this gives a high C to L ratio with less harmonics and greater oscillator stability. Front panel control of the B.F.O. frequency can be obtained by means of C2 which acts as a vernier adjustment for C1. Bending up a corner on a stator plate makes a convenient switch to cut out the B.F.O. for phone reception. The rotor plates of C1 are grounded, thus it can readily be mounted on a metal front panel. Output from the B.F.O. should be taken from the suppressor grid in the form of a short length of hook-up wire with its free end twisted once or twice around the second detector grid lead.

These two new circuits are used in a version of the modified 222 receiver shown in the photographs. This receiver is quite similar to the modified 222 superheterodyne described on page 49, except for the two new circuits. The receiver consists of a stage of semi-tuned RF using plug-in resonant chokes, a regenerative first detector, a single stage of IF, second detector, audio and a B.F.O. The high-frequency oscillator, detector and RF are exactly the same as in the original version, with only minor deviations. It was found that tuning condensers using bakelite instead of isolantite insulation required about $\frac{1}{4}$ more of a turn in the first detector cathode tap of most coils. It was also found desirable to use a separate set of

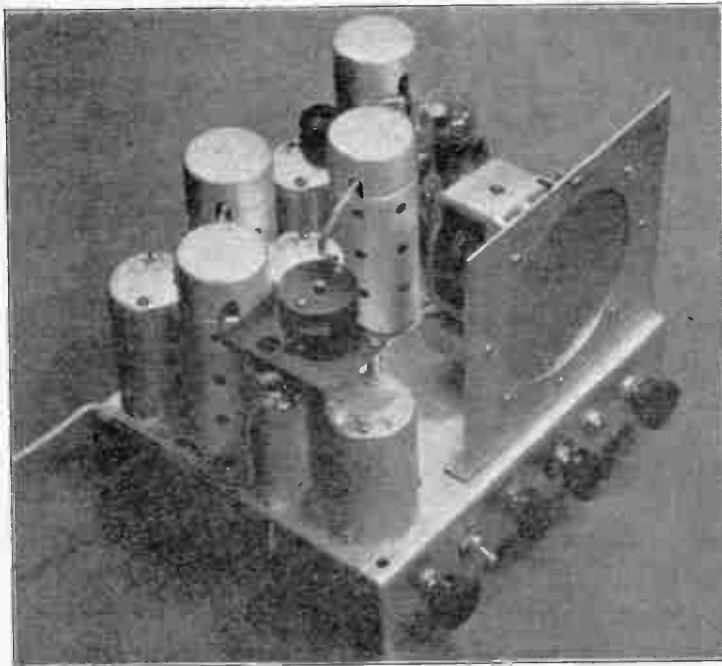

Above: A compact unit incorporating crystal filter, I.F. Amplifier, B.F.O., Detector, Audio and Loud Speaker.

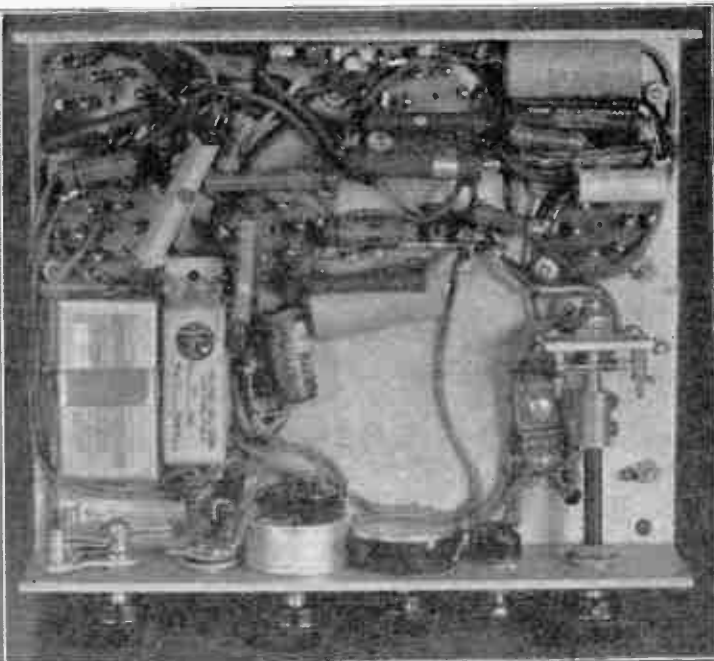

Right: Circuit diagram of the new BFO as developed by RCA and applied to the "222" Receiver by Jones.

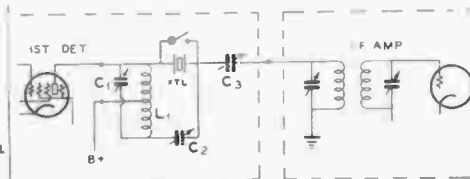
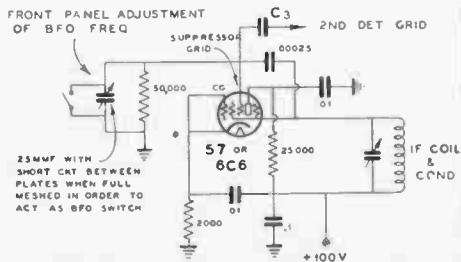

The new Jones Crystal Filter Circuit.

L1—Hammarlund 2.1 mh. choke center-tapped.

C1—8-70 mmfd. mica trimmer (or air cond.)

C2—25 mmfd. var. air cond. (midget)

C3—3-30 mmfd. mica trimmer cond.

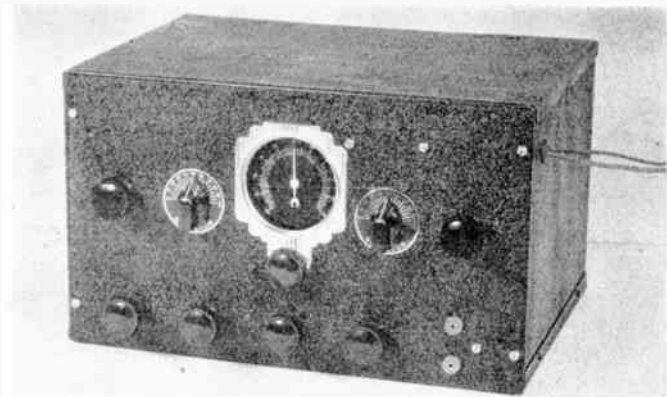

•

The
de-luxe
"222"
Crystal
Filter
Superheterodyne
with
RF stage,
new
BFO
circuit,
new
Crystal
Filter.

•

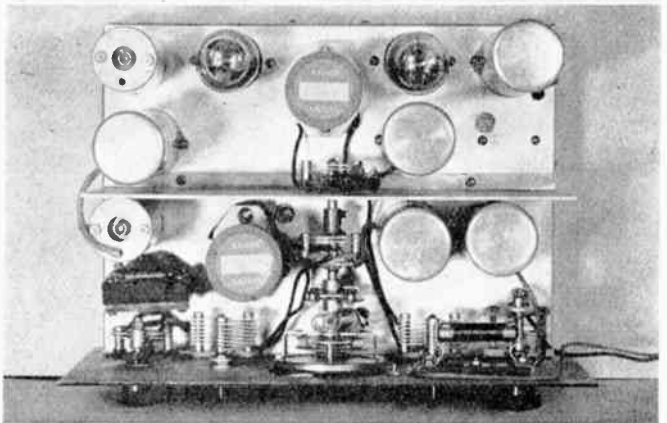
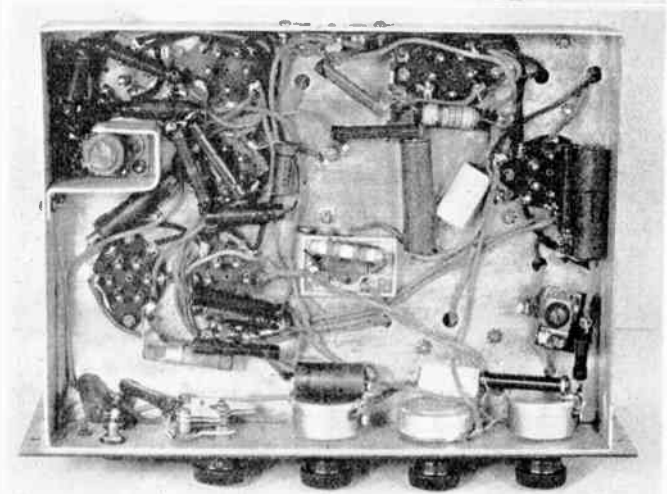

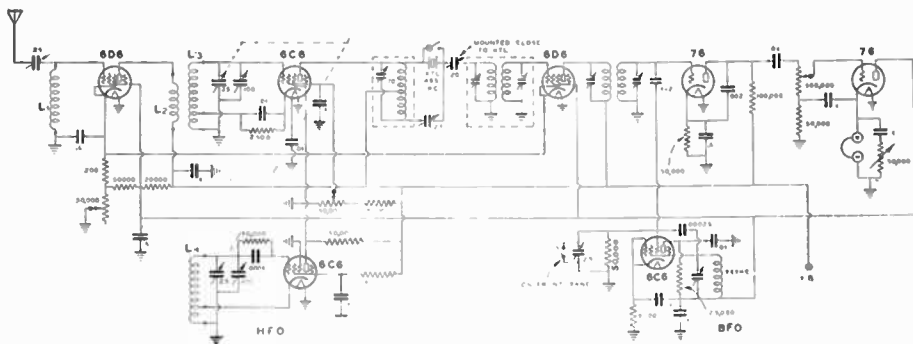

Complete Circuit of the Crystal Filter "222" Receiver. Coil winding data same as for previous models.

coils for 20 meters in order to obtain more band spread. Five turns, one-inch long on the 1½ diameter plug-in coils, proved satisfactory for this band. All of the other coil data is given in the coil table for the "222" Receiver with RF (pages 49, 50).

The crystal filter is made by removing the center universal wound coil of a Hammarlund 2.1 mh. RF choke. This gives a center-tapped plate coil which is tuned by means of a 7-10 mmfd. trimmer condenser. The neutralizing or phasing condenser is a 25 mmfd. variable because the particular crystal holder used had a very large plate-to-plate capacity. Other forms of holders might make a 2 or 3 plate midget condenser preferable. The neutralizing condenser is mounted on the front panel by means of insulating bushings and the crystal is cut in or out by means of plugging the crystal in or out. The phasing condenser has a stator plate bent up so as to short-circuit this condenser at about minimum capacity setting for phone reception. This same idea is used to turn the B.F.O. on or off for CW or phone reception.

The B.F.O. coil is made by removing turns from an old IF coil until it resonates at the desired frequency with its shunt condenser, plus the front panel trimmer condenser capacity.

In lining-up a superheterodyne with a crystal filter it is essential to know the exact frequency of the crystal. The frequency can be most easily found by connecting up the crystal in an oscillator circuit, such as a type 30 tube with 135 volts or more of plate supply. The plate circuit of this oscillator must be tuned to the crystal frequency. When oscillation is obtained, as indicated by a drop in oscillator plate current, the IF amplifier can be aligned to that frequency. Once this is accomplished the crystal can be put back into the receiver. Best single sideband reception on CW reception can be obtained by proper adjustment of the phasing condenser and BFO frequency.

Lack of good single-signal effect can usually be traced to extraneous capacity coupling, lack of proper setting of neutralizing or BFO condensers, or insufficient circuit isolation. In the receiver shown it was found necessary to shield the grid lead to the IF amplifier in order to prevent direct capacitive coupling past the crystal filter. This decreases the undesired signal of R9 to R5 ratio up to R9 to R3 ratio. Even better ratio could probably be obtained by better cathode, screen and plate return lead isolation resistors and condensers.

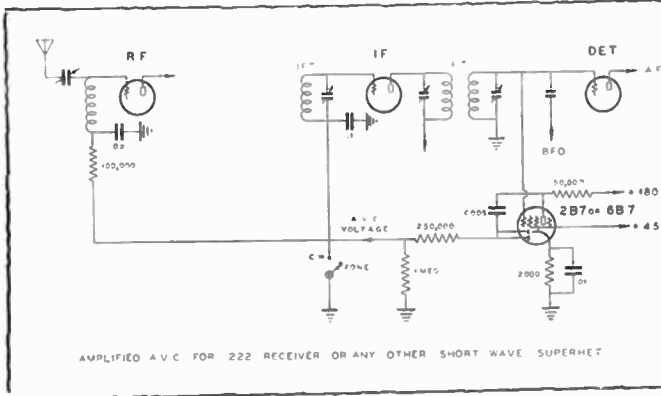

AMPLIFIED AVC FOR 222 RECEIVER OR ANY OTHER SHORT WAVE SUPERHET

AVC FOR THE "222"
The circuit here shown is fairly simple to put into operation in any short-wave superheterodyne receiver. It requires an extra tube but does not affect the selectivity or sensitivity of the receiver on either phone or CW. The input is of nearly infinite impedance and thus it does not load the tuned circuit, such as the usual diode detector does.

Tube Symbols and Bottom Views of Socket Connections

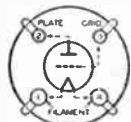

FIG. 1

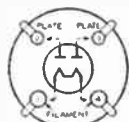

FIG. 2

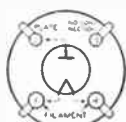

FIG. 3

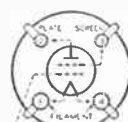

FIG. 4

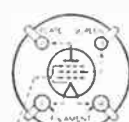

FIG. 4A



FIG. 5



FIG. 6

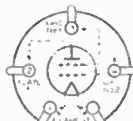

FIG. 7



FIG. 8



FIG. 9



FIG. 9A

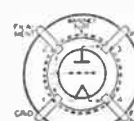

FIG. 10

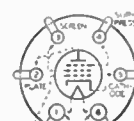

FIG. 11



FIG. 12

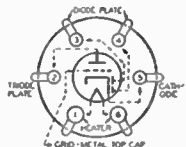

FIG. 13

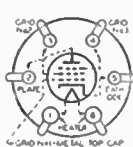

FIG. 14

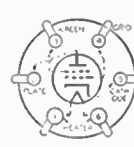

FIG. 15

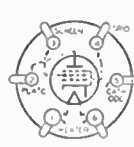

FIG. 15A

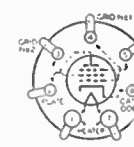

FIG. 18



FIG. 19



FIG. 20

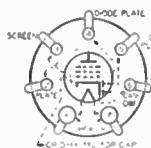

FIG. 21

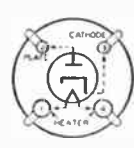

FIG. 22

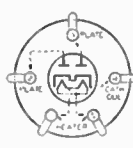

FIG. 23

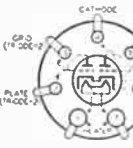

FIG. 24

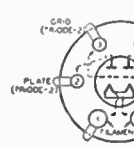

FIG. 25

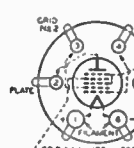

FIG. 26

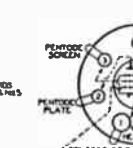

FIG. 27

Tube Characteristics and Socket Connections courtesy RCA Cunningham Radiotron Co., Inc.

Characteristics of Receiving Tubes

(Continued)

TYPE	NAME	BASE	SOCKET CONNECTIONS	DIMENSIONS MAXIMUM OVERALL LENGTH & DIAMETER	CATHODE TYPE #	RATING			USE Values to right give operating conditions and characteristics for indicated typical use	PLATE SUPPLY VOLTS	GRID VOLTS	SCREEN VOLTS	SCREEN MILLI- AMP.	PLATE MILLI- AMP.	A-C PLATE RESISTANCE OHMS	MUTUAL CON- DUCTANCE MICRO- MHMS	VOLTAGE AMPLIFI- CATION FACTOR	LOAD FOR STATED POWER OUTPUT	POWER OUT- PUT WATTS	TYPE				
						FILAMENT OR HEATER		RECTEN													VOLTS	AMPERES	MAX. VOLTS	MAX. VOLTS
						VOLTS	AMPERES	RECTEN																
31	POWER AMPLIFIER TRIODE	SMALL 4-PIN	FIG. 1	4 1/2" x 1 1/4"	D-C FILAMENT	2.0	0.13	180	—	CLASS A AMPLIFIER	125 180	-7.5 -37.0	—	8.0 12.3	4100 3500	925 1050	3.8 3.8	7000 5700	0.185 0.375	31				
32	R.F. AMPLIFIER TETRODE	MEDIUM 4-PIN	FIG. 4	5 3/8" x 1 1/2"	D-C FILAMENT	2.0	0.06	180	67.5	SCREEN GRID R.F. AMPLIFIER	1.5 180	-3.0 -3.0	0.4* 0.4*	1.7 1.2	950000 1200000	646 650	6.10 7.00	—	—	32				
Plate current to be adjusted to 0.2 milliamperes with no signal.																								
33	POWER AMPLIFIER PENTODE	MEDIUM 6-PIN	FIG. 6	4 1/8" x 1 1/4"	D-C FILAMENT	2.0	0.26	180	180	CLASS A AMPLIFIER	180	-18.0	18.0	5.0	22.0	55000	1700	90	6000	1.4	33			
34	SUPER-CONTROL R.F. AMPLIFIER PENTODE	MEDIUM 6-PIN	FIG. 6A	5 3/8" x 1 1/2"	D-C FILAMENT	2.0	0.06	180	67.5	SCREEN GRID R.F. AMPLIFIER	135 180	-3.0 -3.0	1.0 1.0	2.8 2.8	400000 1000000	600 620	360 620	—	—	34				
35	SUPER-CONTROL R.F. AMPLIFIER TETRODE	MEDIUM 5-PIN	FIG. 9	5 3/8" x 1 1/2"	HEATER	2.5	1.75	275	90	SCREEN GRID R.F. AMPLIFIER	180 230	-3.0 -3.0	2.5* 2.5*	6.3 6.3	300000 400000	1020 1050	305 420	—	—	35				
36	R.F. AMPLIFIER TETRODE	SMALL 5-PIN	FIG. 9	4 1/8" x 1 1/4"	HEATER	6.3	0.3	150	90	SCREEN GRID R.F. AMPLIFIER	160 200	-1.5 -3.0	55 90	1.8 1.2*	530000 530000	850 1050	470 525	—	—	36				
Plate current to be adjusted to 0.1 milliamperes with no signal.																								
37	DETECTOR & AMPLIFIER TRIODE	SMALL 5-PIN	FIG. 9	4 1/8" x 1 1/4"	HEATER	6.3	0.3	250	—	CLASS A AMPLIFIER	90 150 230	-6.0 -11.5 -18.0	—	—	2.5 4.3 7.5	11500 10300 6400	800 900 1100	9.2 9.2 9.2	—	37				
Plate current to be adjusted to 0.2 milliamperes with no signal.																								
38	POWER AMPLIFIER PENTODE	SMALL 5-PIN	FIG. 9A	4 1/8" x 1 1/4"	HEATER	6.3	0.3	250	250	CLASS A AMPLIFIER	110 160 210	-7.5 -14.0 -21.0	140 180 230	1.2 2.4 3.6	7.0 11.0 16.0	140000 115000 103000	1050 120 130	15000 11000 10000	0.22 1.00 2.50	38				
39-44	SUPER-CONTROL R.F. AMPLIFIER PENTODE	SMALL 5-PIN	FIG. 9A	4 1/8" x 1 1/4"	HEATER	6.3	0.3	250	90	SCREEN GRID R.F. AMPLIFIER	180 230	-3.0 -3.0	50 1.0	5.6 5.6	230000 160000	360 1050	360 1650	—	—	39-44				

*For Grid-leak Detection—plate volts 45, grid return to + filament or to cathode.
 #Either A. C. or D. C. may be used on filament or heater, except as specifically noted. For use of D. C. on A-C filament types, decrease stated grid volts by 1/2 (approx.) of filament voltage.

*Applied through plate coupling resistor of 250000 ohms or 500-henry choke shunted by 0.25 megohm resistor.
 #Applied through plate coupling resistor of 100000 ohms.

*Maximum.

★For Grid-leak Detection—plate volts 45, grid return to + filament or to cathode.
 #Maximum.

*Applied through plate coupling resistor of 250000 ohms or 500-henry choke shunted by 0.25 megohm resistor.

★For Grid-leak Detection—plate volts 45, grid return to + filament or to cathode.

#Maximum.

*Applied through plate coupling resistor of 250000 ohms or 500-henry choke shunted by 0.25 megohm resistor.

★For Grid-leak Detection—plate volts 45, grid return to + filament or to cathode.

#Maximum.

*Applied through plate coupling resistor of 250000 ohms or 500-henry choke shunted by 0.25 megohm resistor.

★For Grid-leak Detection—plate volts 45, grid return to + filament or to cathode.

#Maximum.

*Applied through plate coupling resistor of 250000 ohms or 500-henry choke shunted by 0.25 megohm resistor.

★For Grid-leak Detection—plate volts 45, grid return to + filament or to cathode.

#Maximum.

*Applied through plate coupling resistor of 250000 ohms or 500-henry choke shunted by 0.25 megohm resistor.

Characteristics of Receiving Tubes
(Continued)

TYPE	NAME	BASE	SOCKET CONNECTIONS	DIMENSIONS MAXIMUM OVERALL LENGTH x DIAMETER	CATHODE TYPE #	RATING				USE Values to right give approximate conditions and characteristics for indicated typical use	PLATE SUPPLY VOLTS	GRID VOLTS #	SCREEN VOLTS	SCREEN MILLI-AMP.	PLATE MILLI-AMP.	A-C PLATE RESISTANCE OHMS	MUTUAL CONDUCTANCE MICRO-MHMS	VOLTAGE AMPLIFICATION FACTOR	LOAD FOR STATED POWER OUTPUT OHMS	POWER OUTPUT WATTS	TYPE
						FILAMENT OR HEATER		PLATE MA. VOLTS	SCREEN MA. VOLTS												
						VOLTS	AMPERES														
58	TRIPLE GRID SUPER-CONTROL AMPLIFIER	SMALL 6-PIN	FIG. 11	4 1/4" x 1 1/4"	HEATER	2.5	1.0	250	100	NIREN GRID R.F. AMPLIFIER MINOR IN SUPERIOR TROODING	250	100	2.0	8.2	800000	1600	1280			58	
											250	100									
59	TRIPLE GRID POWER AMPLIFIER	MEDIUM 7-PIN*	FIG. 16	5 1/2" x 2 1/8"	HEATER	2.5	2.0	250	250	CLASS A AMPLIFIER	250	250	9.0	25.0	40000	2500	100	5000	1.25	50	
											400	—	—	—	—	—	—	—	—		—
71-A	POWER AMPLIFIER TRIODE	MEDIUM 6-PIN	FIG. 9	4 1/2" x 1 1/2"	FILAMENT	5.0	0.25	180	—	CLASS A AMPLIFIER	250	0	—	—	—	—	—	—	—	71-A	
75	DUPLEX DIODE HIGH MU TRIODE	SMALL 6-PIN	FIG. 13	4 1/2" x 1 1/2"	HEATER	6.3	0.3	250	—	TROOD UNIT AS CLASS A AMPLIFIER	250	0	—	—	—	—	—	—	—	75	
76	SUPER TRIODE AMPLIFIER DETECTOR*	SMALL 5-PIN	FIG. 6	4 1/2" x 1 1/2"	HEATER	6.3	0.3	250	—	CLASS A AMPLIFIER	250	—	—	—	—	—	—	—	—	76	
77	TRIPLE GRID DETECTOR AMPLIFIER	SMALL 6-PIN	FIG. 11	4 1/2" x 1 1/2"	HEATER	6.3	0.3	250	100	NIREN GRID R.F. AMPLIFIER	100	60	0.4	1.7	850000	1100	715	—	—	77	
											250	100	0.5	2.3	1500000	1250	1500	—	—		—
78	TRIPLE GRID SUPER CONTROL AMPLIFIER	SMALL 6-PIN	FIG. 11	4 1/2" x 1 1/2"	HEATER	6.3	0.3	250	125	SCREEN GRID R.F. AMPLIFIER	100	75	1.0	4.0	1000000	1275	400	—	—	78	
											250	100	1.7	7.0	800000	1450	1160	—	—		—
79	TWIN TRIODE AMPLIFIER	SMALL 6-PIN	FIG. 19	4 1/2" x 1 1/2"	HEATER	6.3	0.6	250	—	CLASS B AMPLIFIER	185	0	—	—	—	—	—	—	—	79	
											250	0	—	—	—	—	—	—	—		—
85	DUPLEX DIODE	SMALL 6-PIN	FIG. 13	4 1/2" x 1 1/2"	HEATER	6.3	0.3	250	—	TRIODE UNIT AS CLASS A AMPLIFIER	135	—	—	—	—	—	—	—	—	85	
											180	—	—	—	—	—	—	—	—		—
89	TRIPLE GRID POWER AMPLIFIER	SMALL 6-PIN	FIG. 14	4 1/2" x 1 1/2"	HEATER	6.3	0.4	250	250	AS TRIODE** AS PENTODE** CLASS A AMPLIFIER	100	100	1.6	9.5	104000	1280	125	10700	0.23	89	
											180	180	3.0	23.0	80000	1550	125	8000	1.50		—
V-99 X-99	DETECTOR* AMPLIFIER TRIODE	SMALL 4-PIN SMALL 6-PIN	FIG. 10 10	3 1/2" x 1 1/2"	D-C FILAMENT	3.3	0.063	90	—	CLASS A AMPLIFIER	90	—	—	—	2.5	15500	425	6.6	—	V-99 X-99	
112-A	DETECTOR* AMPLIFIER TRIODE	MEDIUM 6-PIN	FIG. 1	4 1/2" x 1 1/2"	D-C FILAMENT	5.0	0.25	180	—	CLASS A AMPLIFIER	90	—	—	—	5.0	5400	1575	8.5	—	112-A	

*For Grid-leak Detection—plate volts 45, grid return to + filament or to cathode.
 **Either A, C, or D, C, may be used on filament or heater, except as specifically noted. For use of D, C, on A-C filament types, decrease stated grid volts by 1/2 (approx.) of filament voltage.
 #Requires different socket from small 7-pin.
 ##Grid #1 = control grid, Grid #2 = screen, Grid #3 tied to cathode.
 ***Grid #1 = control grid, Grids #2 and #3 tied to plate. # Applied through plate coupling resistor of 250000 ohms.
 ****Grids #1 and #2 connected together, Grid #3 tied to plate. **For grid of following tube.

RECTIFIERS

523	FULL-WAVE RECTIFIER	MEDIUM 6-PIN	FIG. 2	5 1/2" x 2 1/8"	FILAMENT	5.0	3.0	—	—	Maximum A-C Voltage per Plate.....	500 Volts, RMS	Maximum D-C Output Current.....	250 Milliamperes	523
1223	HALF-WAVE RECTIFIER	SMALL 4-PIN	FIG. 22	4 1/2" x 1 1/2"	HEATER	12.6	0.3	—	—	Maximum A-C Plate Voltage.....	250 Volts, RMS	Maximum D-C Output Current.....	60 Milliamperes	1223
2525	RECTIFIER-DOUBLER	SMALL 6-PIN	FIG. 9	4 1/2" x 1 1/2"	HEATER	25.0	0.3	—	—	Maximum A-C Voltage per Plate.....	175 Volts, RMS	Maximum D-C Output Current.....	100 Milliamperes	2525
										Maximum A-C Voltage per Plate.....	350 Volts, RMS	Maximum D-C Output Current.....	50 Milliamperes	
1-0*	HALF-WAVE RECTIFIER	SMALL 6-PIN	FIG. 22	4 1/2" x 1 1/2"	HEATER	6.3	0.3	—	—	A-C Voltage per Plate (Volts RMS).....	350 350 350	Maximum D-C Output Current.....	125 Milliamperes	80
										The 350 volt rating applies to filter circuits having an input choke of at least 20 henries.				
80	FULL-WAVE RECTIFIER	MEDIUM 6-PIN	FIG. 2	4 1/2" x 1 1/2"	FILAMENT	5.0	2.0	—	—	Maximum A-C Plate Voltage.....	700 Volts, RMS	Maximum D-C Output Current.....	85 Milliamperes	80
81	HALF-WAVE RECTIFIER	MEDIUM 6-PIN	FIG. 3	6 1/2" x 2 1/8"	FILAMENT	7.5	1.25	—	—	Maximum A-C Voltage per Plate.....	500 Volts, RMS	Maximum Peak Inverse Voltage.....	1400 Volts	82
										Maximum D-C Output Current.....	125 Milliamperes	Maximum Peak Inverse Voltage.....	400 Milliamperes	
82	FULL-WAVE RECTIFIER	MEDIUM 6-PIN	FIG. 2	4 1/2" x 1 1/2"	FILAMENT	2.5	3.0	—	—	Maximum A-C Voltage per Plate.....	500 Volts, RMS	Maximum Peak Inverse Voltage.....	1400 Volts	83
										Maximum D-C Output Current.....	250 Milliamperes	Maximum Peak Inverse Voltage.....	800 Milliamperes	
84 also 622	FULL-WAVE RECTIFIER	SMALL 5-PIN	FIG. 23	4 1/2" x 1 1/2"	HEATER	6.3	0.5	—	—	Maximum A-C Voltage per Plate.....	350 Volts, RMS	Maximum D-C Output Current.....	50 Milliamperes	84 also 622

*Mercury Vapor Type. * Interchangeable with Type 1.

★For Grid-leak Detection—plate volts 45, grid return to + filament or to cathode. □ Grid next to plate tied to plate. ♦Two grids tied together.
 ● Requires different socket from small 7-pin. ✳ Applied through plate coupling resistor of 250000 ohms. **For grid of following tube.

Characteristics of the New Metal Tubes

RCA 6A8 Pentagrid Converter

Heater volt. (AC or DC)	6.3 Volts
Heater current	0.3 Ampere
Plate voltage	250 max. Volts
Screen volt. (Grids 3 & 5)	100 max. Volts
Anode-grid volt. (Grid 2)	200 max. Volts
Control-grid. volt.	—3 min. Volts
Total cathode current	1.4 max. MA
Max. overall length	3 $\frac{1}{8}$ inch
Max. diameter	1 $\frac{3}{8}$ inch
Cap	Miniature
Base	Small octal 8-pin

RCA 6C5 Detector Amplifier Triode

Heater volt. (AC or DC)	6.3 Volts
Heater current	0.3 Ampere
Plate voltage	250 max. Volts
Grid voltage	—8 Volts
Plate current	8 MA
Plate resistance	10,000 Ohms
Amplification factor	20
Mutual conductance	2,000 Micromhos
Max. overall length	2 $\frac{5}{8}$ inch
Max. diameter	1 $\frac{3}{8}$ inch
Base	Small octal 6-pin

RCA 6D5 Power Amplifier Triode

Heater volt. (AC or DC)	6.3 Volts
Heater current	0.7 Ampere
Max. overall length	3 $\frac{1}{4}$ inch
Max. diameter	1 $\frac{3}{8}$ inch
Base	Small octal 6-pin

As Single-Tube Class A Amplifier

Heater voltage	6.3 Volts
Plate voltage	275 max. Volts
Grid voltage	—40 Volts
Plate current	31 MA
Plate resistance	2,250 Ohms
Amplification factor	4.7
Mutual conductance	2,100 Micromhos
Load resistance	7,200 Ohms
Undistorted power output	1.4 Watts

As Push-Pull Class AB Amplifier (2 Tubes)

Heater voltage	6.3 Volts
Plate voltage	300 max. Volts
Grid volt. (fixed bias)	—50 Volts
Plate current (per tube)	23 MA
Load res. (plate to plate)	5,300 Ohms
Power output	5 Watts

RCA 6H6 Twin Diode

Heater voltage	6.3 Volts
Heater current	0.3 Ampere
AC volt. per plate (RMS)	100 max. Volts
DC output current	2 max. MA
Max. overall length	1 $\frac{5}{8}$ inch
Max. diameter	1 $\frac{3}{8}$ inch
Base	Small octal 7-pin

RCA 6J7 Triple-Grid Detector Amplifier

Heater voltage	6.3 Volts
Heater current	0.3 Ampere
Plate voltage	250 max. Volts
Screen volt. (Grid 2)	100* Volts
Grid volt. (Grid 1)	—3 Volts
Suppressor (Grid 3)	Connected to cathode at socket

Plate current	2 MA
Screen current	0.5 MA
Plate resistance	Greater than 1.5 Meg
Amplification factor	Greater than 1,500
Mutual conductance	1,225 Micromhos
Max. overall length	3 $\frac{1}{8}$ inch
Max. diameter	1 $\frac{3}{8}$ inch
Cap	Miniature
Base	Small octal 7-pin

* Maximum screen volts=125

RCA 6K7 Triple-Grid Super-Control

Amplifier

Heater volt. (AC or DC)	6.3 Volts
Heater current	0.3 Ampere
Plate voltage	250 max. Volts
Screen volt. (Grid 2)	100† Volts
Grid volt. (Grid 1)	—3 min. Volts
Suppressor (Grid 3)	Connected to cathode at socket

Plate current	7.0 MA
Screen current	1.7 MA
Plate resistance	0.8 Megohm
Amplification factor	1,160
Mutual conductance	1,450 Micromhos
Grid voltage*	—35 Volts
Grid voltage‡	—42.5 Volts
Max. overall length	3 $\frac{1}{8}$ inch
Max. diameter	1 $\frac{3}{8}$ inch
Cap	Miniature
Base	Small octal 7-pin

* For mutual conductance of 10 micromhos

‡ For mutual conductance of 2 micromhos

† Maximum screen volts = 125

THE NEW RCA METAL TUBES



The illustration shows comparative sizes of glass and metal tubes.

Smaller in size than tubes with glass envelopes, these new tubes will be found in late 1935 model receivers. A power amplifier pentode (RCA-6F6), a pentagrid mixer amplifier and (RCA-6L7) a 400 volt per plate (RMS) full-wave rectifier (RCA-5Z44) were added to the list just as this handbook was put to press.

Receiver Circuit Section

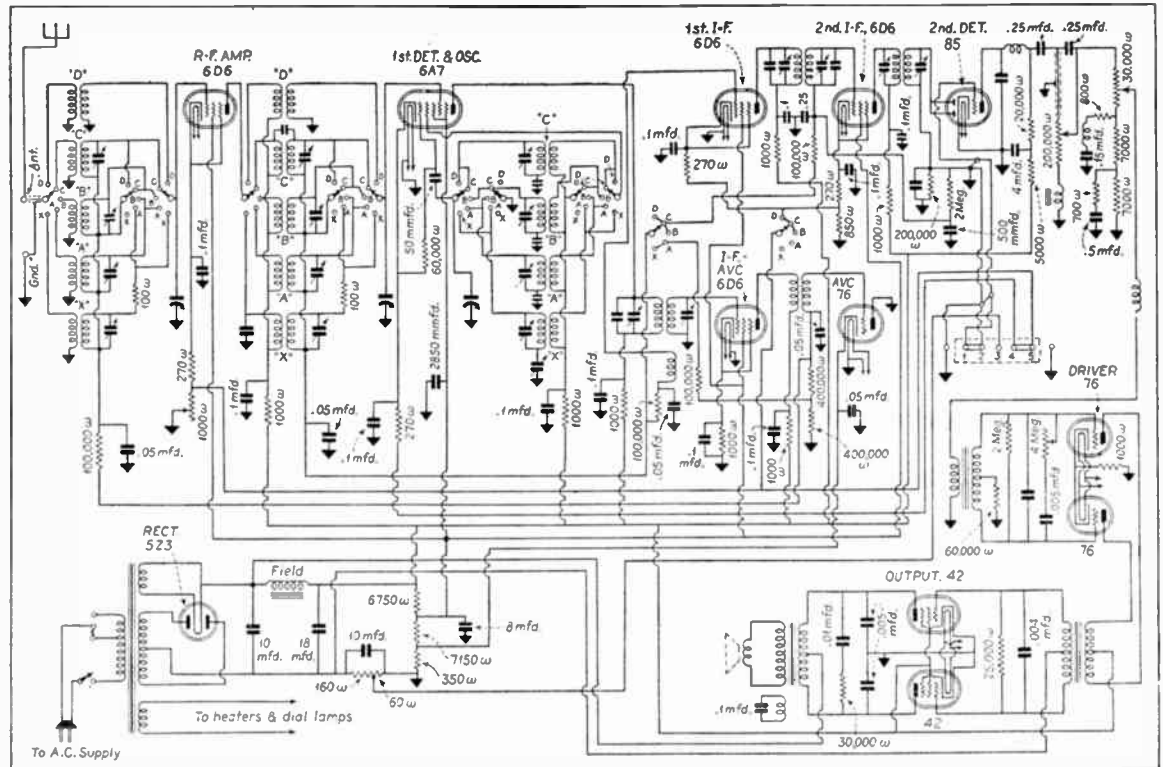

Philco Model 200-X Receiver Circuit Diagram

Courtesy Manson Publishing Co.

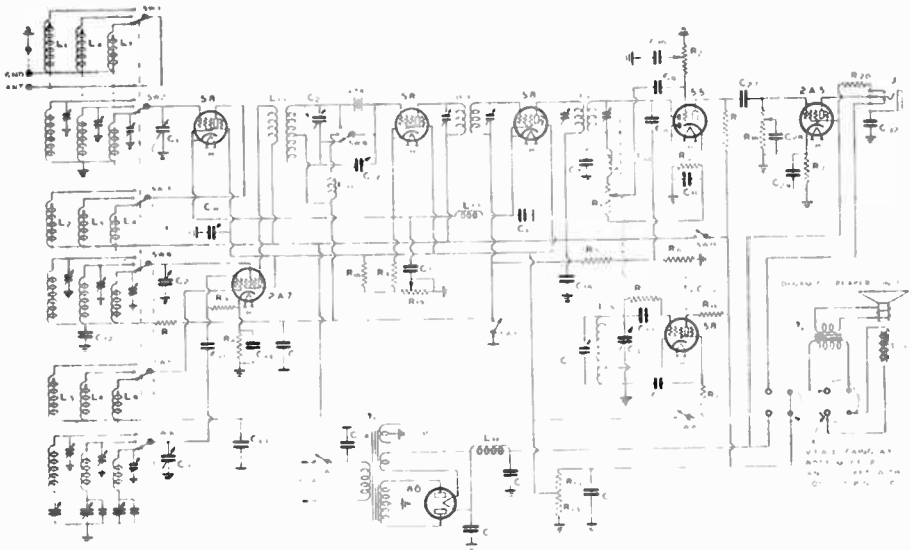

Circuit diagram of the Silver 5C receiver.

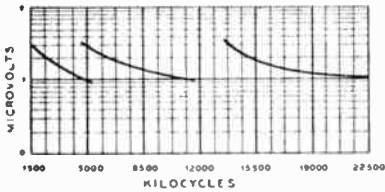

FIG. 5

Sensitivity as measured on a typical 5C receiver. The saw-toothed effect of this curve is due to the fact that it is really 3 curves shown on one sheet indicating the sensitivity of the three separate bands of the receiver. The 3:1 variation observed in each range is due to the variation in L:C ratio over the ranges. The absence of absorption humps, due to deleterious natural periods of adjacent coils is absent in this receiver.

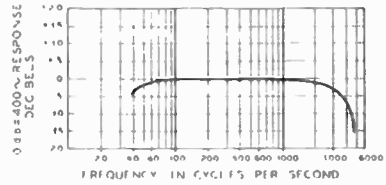

FIG. 7

Fidelity antenna to speaker as measured on a 5C with crystal out. The rising high frequency characteristic of the speaker compensates for the 6 db. drop of 4,000 cycles, which, however, is of no consequence on speech reception, being rather an academic consideration of high quality broadcast receiver design.

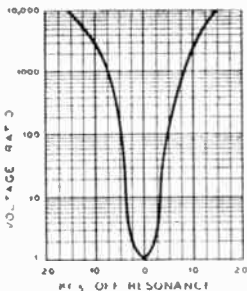

FIG. 6

Selectivity as measured at 6000 kc. This shows the selectivity without crystal at its worst since the adjacent channel contribution of input tuned circuits is negligible at this frequency and the selectivity is essentially that of the i.f. amplifier alone, as in all short wave superheterodynes. The switching in of crystal will narrow this curve to 50 cycles.

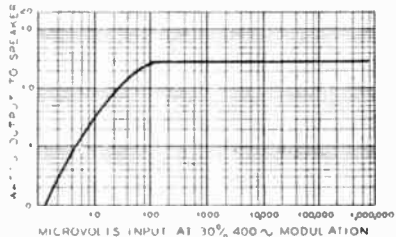
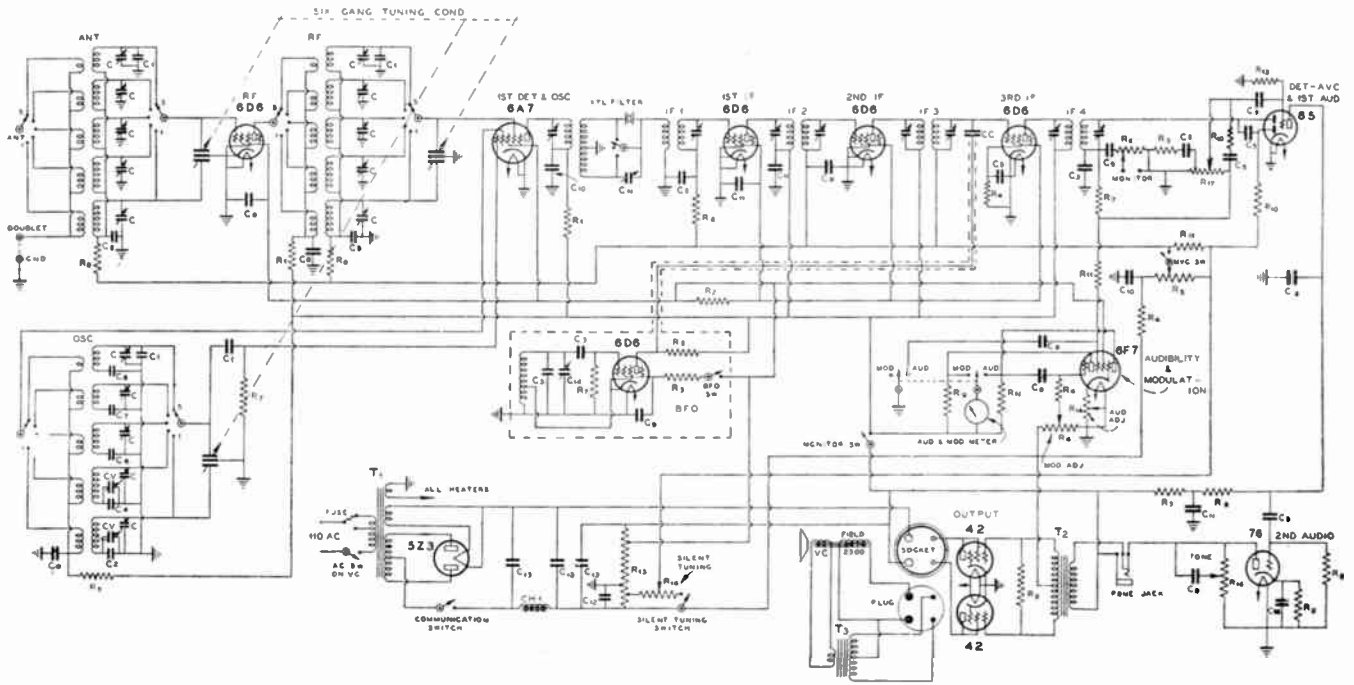
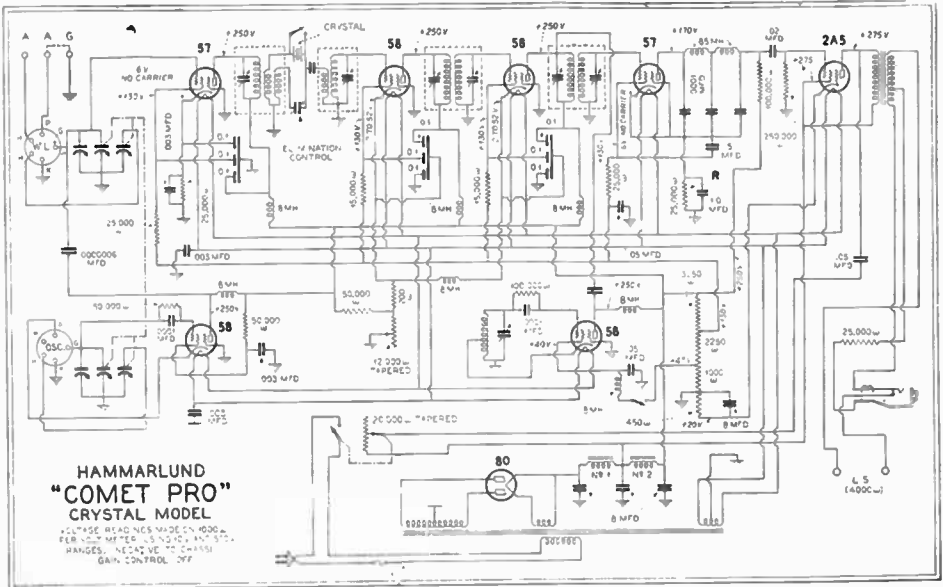

FIG. 8

This curve indicates the automatic volume control action of the receiver, showing how the output rises constantly with increasing signal input up to 100 microvolts and then levels off to the maximum output of three watts. For all practical purposes, as can be seen from the relative increments at the left, the volume may be said to be held constant for all signals of 20 microvolts or stronger since the ear will not accurately discriminate between signals of .6 of a watt and 3 watts, as is best indicated by the sound sensation graduations at the left of the curve.



Complete Circuit Diagram of the Patterson PR-12 Crystal Filter Superheterodyne



The Hammarlund Comet Pro, without R.F. pre-selection, but with crystal filter.

The circuit shown above incorporates a crystal filter which is very effective. Because impedances are matched there is very little loss through the crystal filter. This receiver does not use RF amplification ahead of the detector and its performance can therefore be improved by the use of a separate regenerative pre-selector. At this writing a new receiver by Hammarlund, the "Super Pro" is in the development stage. It uses RF amplification, variable coupling IF trans-

formers, a separate power supply and a number of other modern features.

The circuit below shows the original Patterson PR-10 receiver, also without RF amplification. A standard Patterson pre-selector is available to connect ahead of this receiver. The R-12 circuit, shown elsewhere in these pages, is the more modern version of the Patterson receiver. In the PR-10, as well as in the PR-12, coil-switching is used to change wave bands.

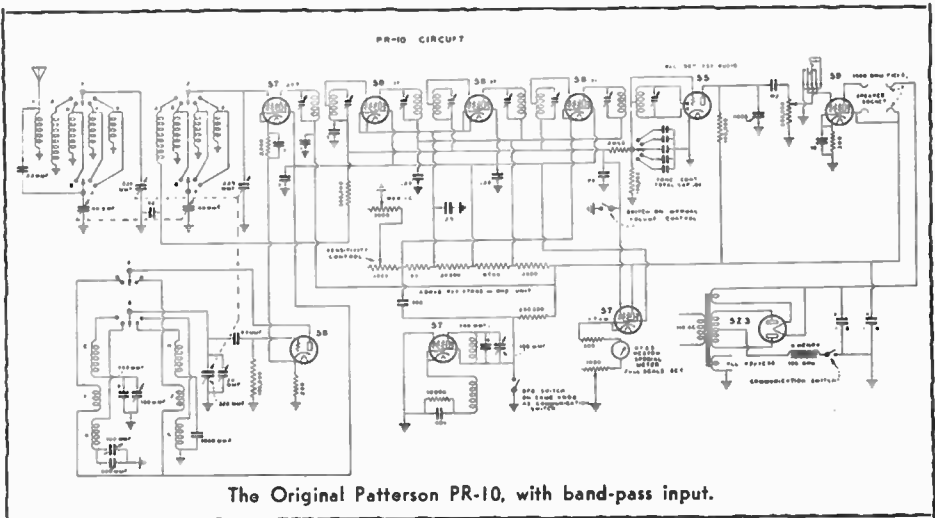

The Original Patterson PR-10, with band-pass input.

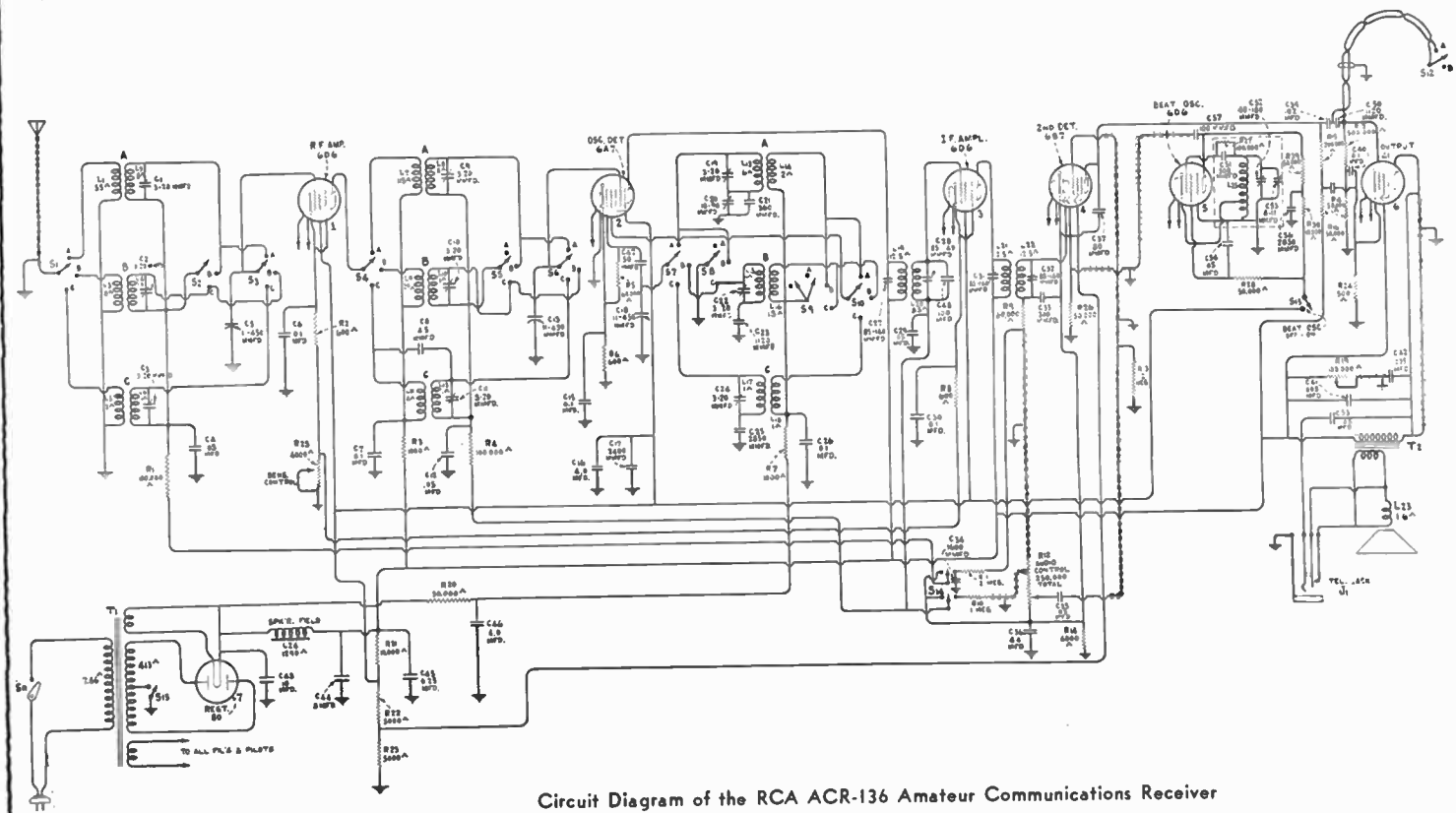

Circuit Diagram of the RCA ACR-136 Amateur Communications Receiver

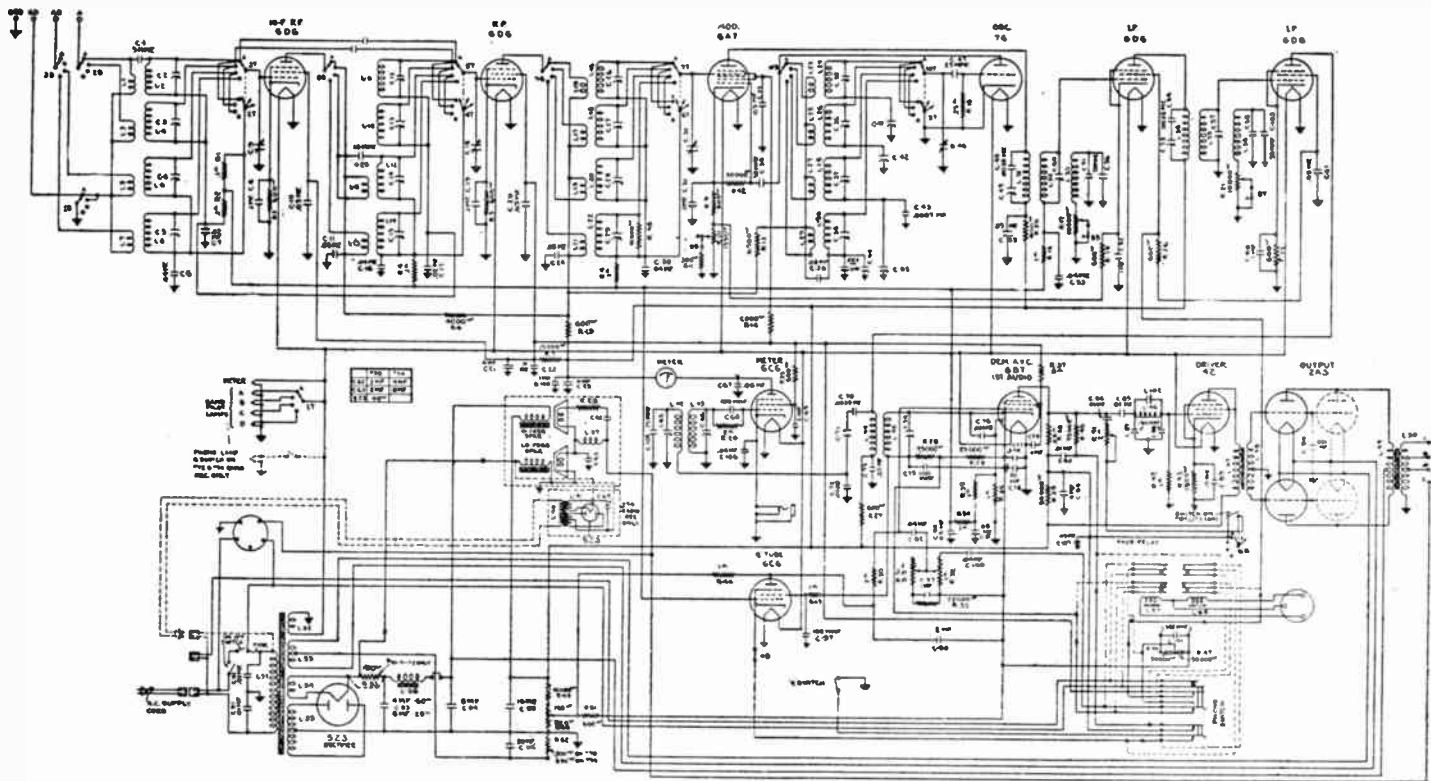

Stromberg-Carlson High Fidelity Broadcast Receiver Circuit. Uses two stages of R.F. preselection, variable selectivity in the I.F. amplifier, wide-range AVC, inter-station noise suppressor, separate H.F. oscillator feeding 6A7 first detector, high fidelity audio channel.

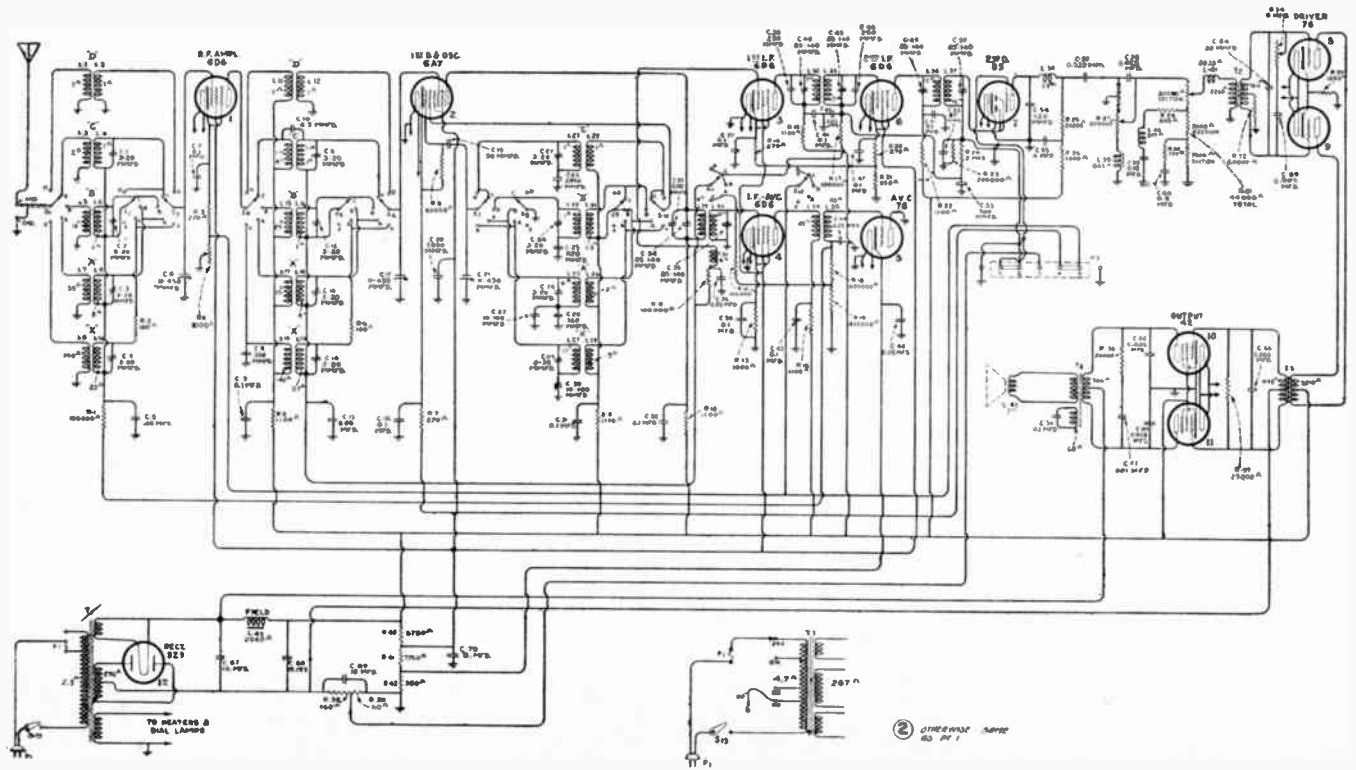

RCA-Victor Twelve-Tube All-Wave Superheterodyne, 150-18,000 K.C., 1935 series.

OTHER PARTS SAME AS SET 1

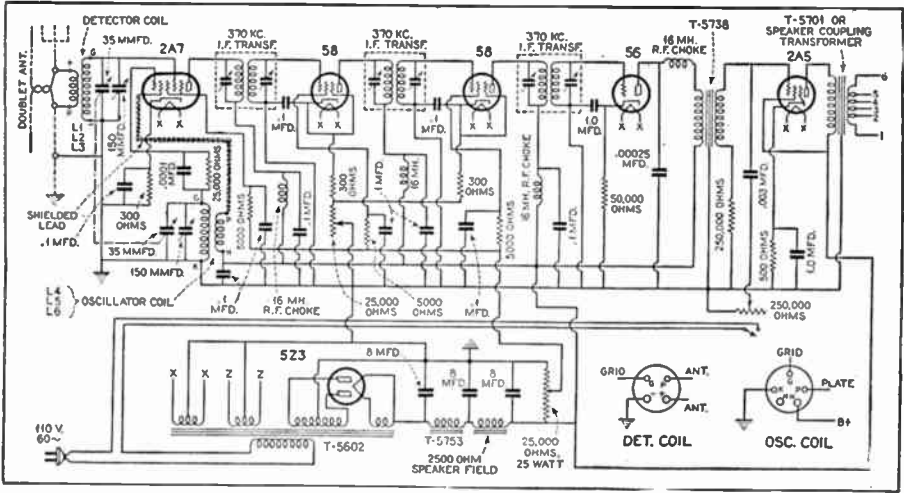

The original 1934 "All-Star" receiver circuit. (Courtesy "Radio News")

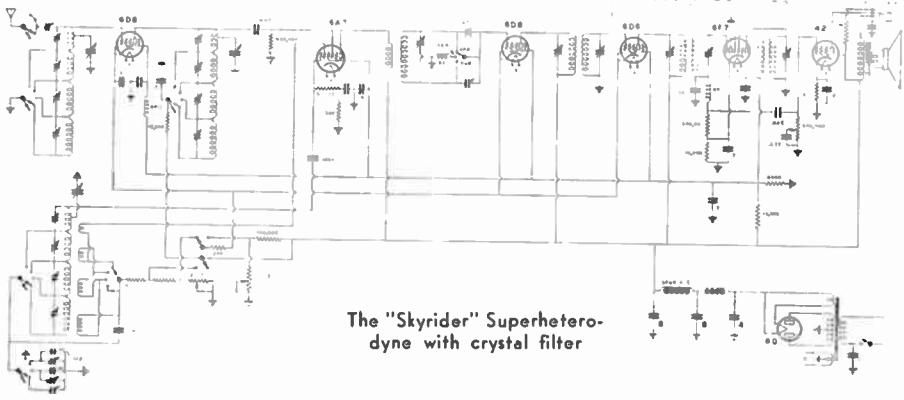

The "Skyrider" Superheterodyne with crystal filter

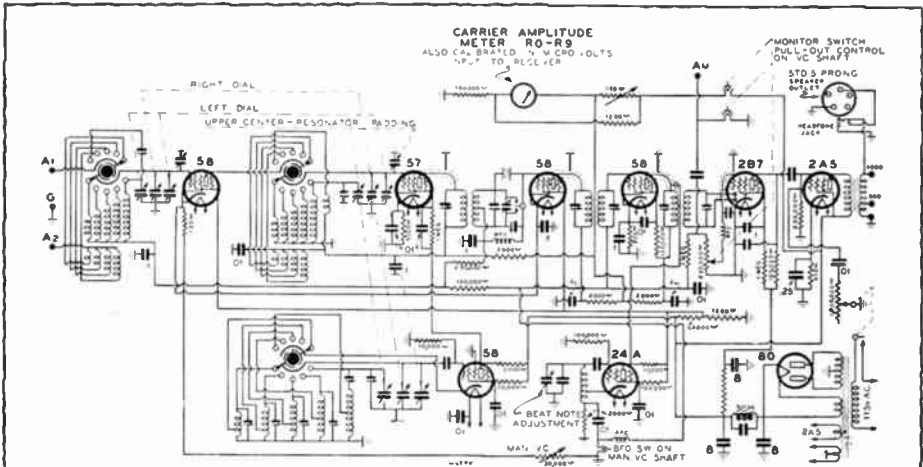

Circuit diagram of the RME-9D crystal filter superheterodyne, 540-22,000 KC.

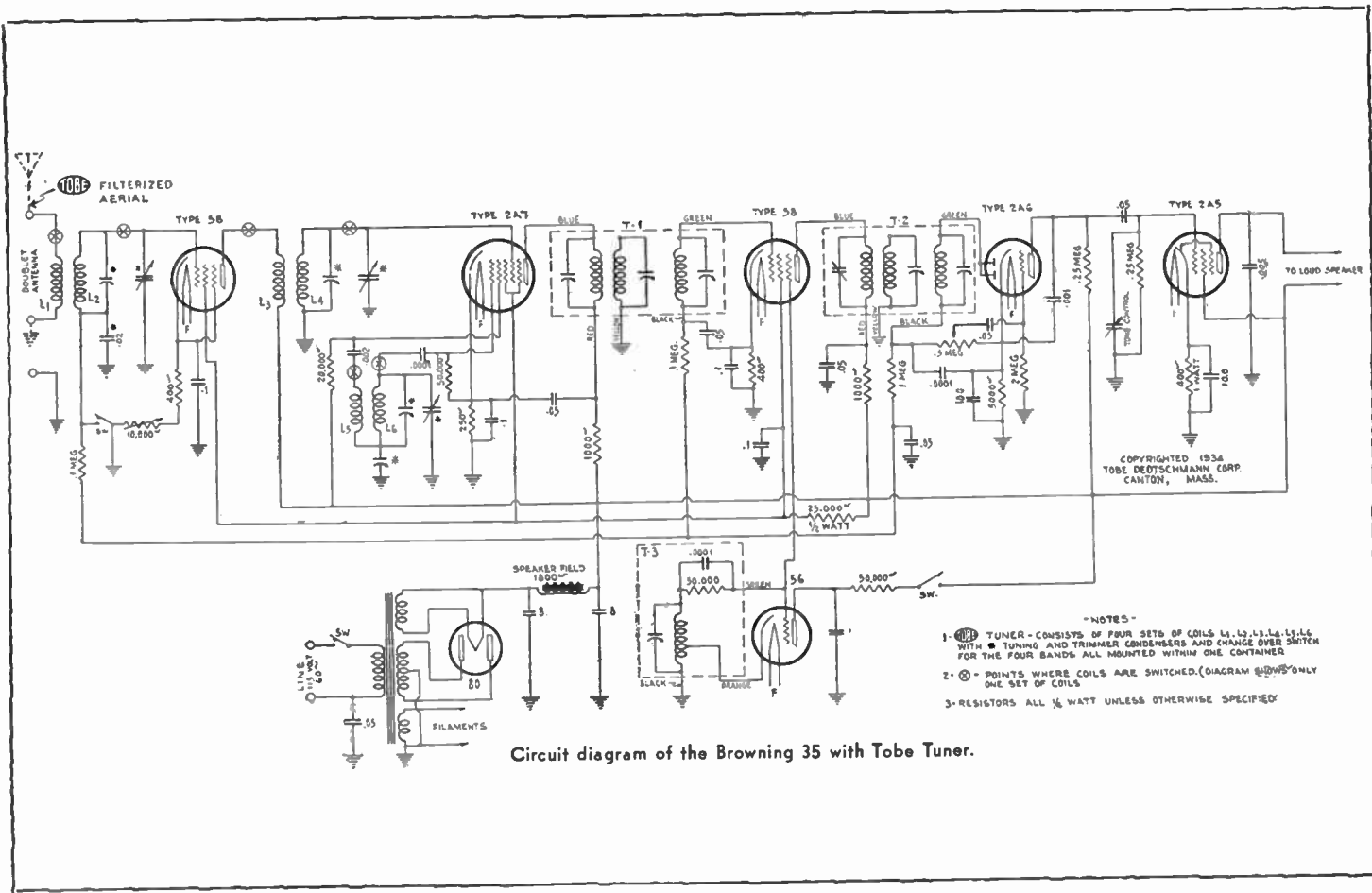

Circuit diagram of the Browning 35 with Tobe Tuner.

COPYRIGHTED 1934
TOBE DEITSCHMANN CORP.
CANTON, MASS.

-NOTES-

1. TUNER - CONSISTS OF FOUR SETS OF COILS L1, L2, L3, L4, L5, L6 WITH TUNING AND TRIMMER CONDENSERS AND CHANGE OVER SWITCH FOR THE FOUR BANDS ALL MOUNTED WITHIN ONE CONTAINER
2. - POINTS WHERE COILS ARE SWITCHED. (DIAGRAM SHOWS ONLY ONE SET OF COILS)
3. RESISTORS ALL 1/4 WATT UNLESS OTHERWISE SPECIFIED

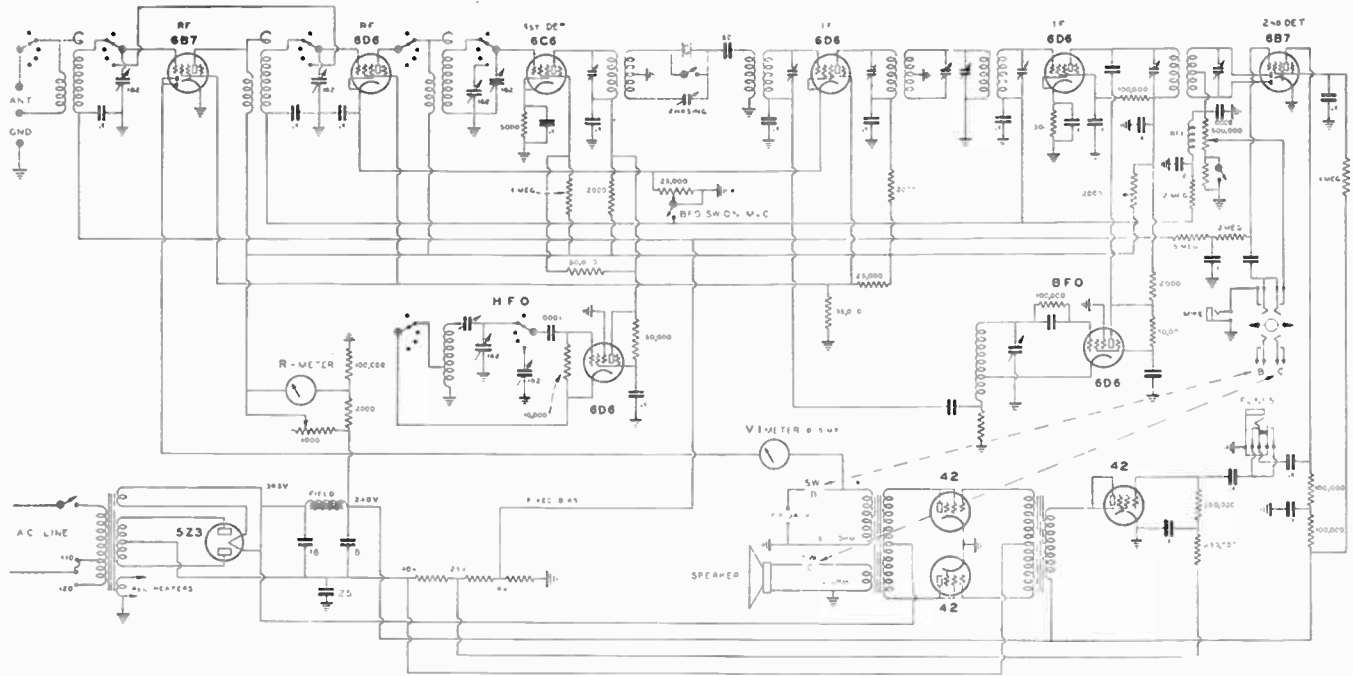

The Breting Amateur and All-Wave Crystal Filter Superheterodyne. It incorporates a speech amplifier for phone or P.A. use. Has percentage modulation indicator and a field strength indicator. Uses high fidelity audio channel and wide-range A.V.C.

Analyzing the Transmitter

● A radio transmitter consists of some form of wave generator, or oscillator, some means of stabilizing the frequency of the oscillator, one or more buffer amplifier stages which serve the dual purpose of amplifying the relatively weak output of the oscillator and isolating the oscillator from the keying or modulation surges usually applied to the final amplifier. With certain types of frequency stabilizing equipment (such as Piezo crystal stabilization), the buffers are also required to multiply the frequency (doubling) because mechanical limitations prevent the stable operation of Piezo crystals at frequencies higher than about 8 megacycles, whereas the final amplifier may be required to operate on much higher frequencies. The various buffers and doublers drive the grid or grids of the tubes used in the final amplifier stage. The final stage functions as a converter of DC plate current into radio frequency alternating current, which is supplied to the radiating portion of the antenna through some form of transmission line.

The Oscillator

Fig. 1 shows the fundamental circuit of a typical transmitter using a 47 crystal oscillator and 46 buffer-doubler. Step by step the function of each portion of the transmitter will be analyzed and comments will be made on the effect of varying the size of each component.

The first component, from left to right, is

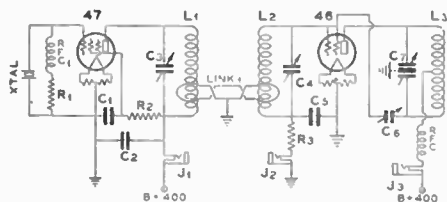

FIG. 1

Pentode Crystal Oscillator Link Coupled to Buffer Stage.

the Piezo crystal. It usually consists of a thin, flat quartz plate whose physical dimensions permit it to resonate mechanically at the frequency of the oscillator. The crystal is mounted between two flat metal plates which rest very lightly on the crystal in order to avoid the damping effect of pressure, which resists mechanical oscillation. Some of the better types of holders use an air gap between the top plate and the crystal so as to avoid even the slightest damping effect. The two metal plates (which, by the way, must be lapped perfectly flat) act as the plates of a condenser, while the flat piece of quartz crystal acts as the dielectric. Thus the me-

chanical vibration of the crystal sets up a voltage across the condenser and, likewise, an AC voltage across the grid circuit. This voltage is supplied by a separate source, such as the oscillator tube and circuit, so that the electrical feedback from the tuned plate circuit will keep the crystal vibrating, or oscillating.

When the crystal is maintained in oscillation it acts as a very sharply tuned series resonant circuit, consisting of high inductance, low capacity and low resistance. The actual frequency is a little higher or lower than exact resonance so as to give an inductive or capacitive reactance depending on the type of oscillator circuit. This type of circuit may be said to have a very high "Q", which is an index of its resistance to changes in resonant frequency with changes in external circuit constants. Thus the crystal acts as a tuned grid circuit whose resonant frequency is fairly free from changes due to varying loads or voltages. Its frequency varies somewhat with the temperature of the plate, but for ordinary amateur use this temperature effect is not bothersome.

The low frequency crystals (up to 4000 KC) usually start easier and give more output than the higher frequency crystals, which are usually somewhat fragile and rather cranky to handle.

The next components in the oscillator circuit are the radio frequency choke, RFC1, and the resistor R1, both of which are connected in series and shunted across the crystal. The purpose of the resistor is to provide a DC return for the grid of the oscillator tube so that the grid may be maintained at a constant DC potential with respect to the filament (or cathode) of the oscillator tube. Because quartz is an insulator, the crystal presents an open circuit to direct current, so an auxiliary path for the DC must be provided. In addition to the DC present on the grid of the tube, there is also present an AC voltage which is caused by the plate-to-grid feedback in the tube. This AC voltage exceeds the DC bias and thus the grid periodically goes slightly positive, with respect to the filament. When the grid is positive it attracts some of the electrons emitted by the filament. Thus it acts as a small half-wave rectifier, which causes a small rectified DC current to flow back through the resistor R1 to the filament. This current is very useful and is utilized to cause a voltage drop across the resistor R1, which becomes the source of DC bias voltage. The purpose of the RF choke, RFC1, permits only DC to flow to ground through the resistor, R1. Any AC grid voltage which escapes in this manner is wasted, and consequently plays no part in swinging the oscillator grid, which is its intended purpose. The size of

R1 is not critical. As it is increased in value, less current flows through it, so the voltage drop across it does not vary appreciably, even though the size of R1 is varied over very wide limits, such as a range of from five to one.

In general, the lower the value of R1 (down to about 10,000 ohms), the higher will be the RF output from the oscillator, although higher values (up to about 50,000 ohms) will permit the crystal to start easier. In fact, only the best crystals will start with a 10,000-ohm resistor, while the cheaper ones require the use of a much higher value of grid leak resistor. In crystal oscillator circuits where harmonic generation is utilized in the crystal stage itself, such as in the Tri-tet, Dow Crystal Doubler and in the Jones All-Band Exciter, a high value of grid leak is used for an altogether different purpose. The distortion in the output of a vacuum tube amplifier increases as the bias is increased, and it is the harmonic distortion which produces the second or fourth harmonic selected by the output tank circuit.

Next we come to the center-tapped resistor across the filament leads. This resistor usually has a value of about 50 ohms, center-tapped, and it is used to divide the DC and RF currents equally across both halves of the filament. If the DC and RF returns are made to only one side of the filament there would be somewhat more 60 cycle AC hum in the output, because one-half of the filament heating voltage is being periodically added to and subtracted from the grid voltage, which effectively modulates it with the hum frequency. If the tube has an indirectly heated cathode, such as a 2A5 or 59, this resistor is not required.

The oscillator tube itself requires little mention. Vacuum tube theory and operation is completely covered elsewhere. However, the ideal crystal oscillator tube should have a high amplification factor, medium-to-low plate resistance, as well as low inter-electrode capacities. The screening does not have to be perfect because some feedback is essential for self-oscillation, but it must be kept to a very low value in order to keep the RF current through the crystal at a minimum. In some transmitting pentodes, such as the RK 20 and the 802, the screening is so perfect that a small external capacity must be used to provide the necessary feedback. This is advantageous in that it allows some adjustment of the feedback so that the best possible compromise between power output and RF current through the crystal can be obtained.

Now we come to the screen by-pass condenser C1. The screen grid, which is next in order after the control grid working out from the filament, is kept at a fairly high positive DC voltage, with respect

to the filament, in order to accelerate the electrons away from the filament on their path to the plate. Thus the screen grid is sometimes called an accelerator grid, especially in the audio pentodes, such as the 47, 2A5 and the 59, because the grids were designed primarily as accelerators and not as screen, or shield grids. The use of audio pentodes in RF circuits was the result of experiments by amateurs because the designers of the tubes had only audio frequency applications in mind when the tubes were originally developed.

At any rate the screen, as we shall call it, must have a positive DC potential applied to it, but it must be grounded with respect to RF. Thus the by-pass condenser C1 readily allows RF to flow to ground, but represents an open circuit to DC. This condenser is usually of a value between .01 ufd. to .006 ufd., although the larger size is preferable. At all points where radio frequency energy is by-passed in an amateur transmitter it is rather important to use non-inductive condensers. Practically all makes of mica condensers are non-inductive, and they are generally used in amateur and commercial transmitters.

The resistance R2 drops the plate voltage to approximately 100 volts necessary for the screen grid circuit. The size of R2 can be of any value between 25,000 ohms and 50,000 ohms because the screen current usually varies enough to offset variations in this resistor, thus varying the drop through the resistor so that the screen voltage is normal. Reducing the value of this resistor increases the screen voltage and slightly increases the output, but at the expense of tube life, and nothing is gained in using more than 100 volts on the screen of a 47, 2A5 or 59 oscillator, no matter what the plate voltage may be.

The condenser C2 provides a means whereby the plate circuit, consisting of the plate of the tube, the plate tank, consisting of L1 and C3 and the filament of the tube, is completed. The RF energy flows all around this circuit and if C2 is omitted the circuit will be "open," which prevents oscillation. This condenser prevents the DC plate voltage from flowing back to ground, except through the inside of the tube, which would be the case if the lower end of L1 is tied directly to the filament. The condenser C2 also establishes the lower end of L1 at ground potential, consequently the rotor of C3 is attached to the RF ground end of L1 so that there will be no troublesome hand capacity when tuning the condenser.

L1 and C3 form a parallel resonant tuned circuit, which has the characteristic of presenting a high resistance to the flow of alternating current whose frequency is that of resonance, and yet presenting a very low impedance to AC at all other frequencies, in-

cluding DC which is AC of zero cycles per second. Thus the DC plate voltage is able to flow through the tank circuit without being impeded, whereas the radio frequency output of the tube encounters a great deal of trouble in flowing back to ground through the same tank circuit. In fact, in its path to ground it is forced to produce many magnetic lines of force which cut the one or two turns of the coupling link and thereby induce, by transformer action, a voltage across the turns. This voltage is transmitted through the transmission line to the other two turns on the other end, whose magnetic lines of force induce another voltage in the grid coil L2. This type of coupling between the plate circuit of the oscillator tube and the grid circuit of the tube it drives, is called Link Coupling. It is by far the most efficient and foolproof method of coupling RF energy from one amplifier stage to another. Because one side of the low impedance link or transmission line is grounded, the coupling is almost entirely inductive, which prevents the capacity across either tank coil from shunting the other tank, permitting lower capacity and higher inductance to be used at each end, with resultant higher efficiency. The grounded link also minimizes interlock between the tuning of the two condensers, C3 and C4, and also prevents a very bothersome type of feedback from stage to stage. Feedback makes exact neutralization difficult.

The Buffer-Doubler

Next we come to the grid circuit of the buffer-doubler stage. We find the tuned tank circuit L2-C4. This circuit is ALWAYS tuned to the same frequency to which the plate tank circuit which feeds it energy is tuned, even if the stage operates as a frequency multiplier, because frequency multiplication always manifests itself in a plate circuit. The resistor R3 acts as the grid leak for the 46 stage and places a DC bias on the grid, due to the rectified grid current which flows through it, and thus causes a voltage drop across it. The size of this resistor is quite variable. Its value is determined by the amount of excitation which is available from the oscillator. Whether the stage is to operate as a straight buffer amplifier or act as a frequency multiplier, or doubler, also determines the value of R3. If the available excitation is low (less than 10 mills of DC grid current, measured at J2) the grid leak can be eliminated and the lower end of L2 is then connected directly to ground. In this case, condenser C5 would also be eliminated. However, more excitation than 10 mills is generally available and thus the grid leak is desirable. Its size is not critical up to 2000 ohms, and values as high as 5000 ohms are sometimes desirable for best doubling efficiency. Many experimenters use a variable carbon resistor for R3.

The grid by-pass condenser C5 provides the radio frequency return so that the grid circuit is completed back to the filament. In other words, the DC grid path goes to ground through R3, while the RF grid path to ground goes through C5, not through R3.

In the first buffer stage maximum power amplification, not maximum plate efficiency, is wanted. You are fortunate if you can obtain twenty watts of RF output from the buffer-doubler stage. The plate dissipation of a 46 is ten watts and only 66 per cent plate efficiency is needed in order to get this output without excessive plate color on the 46. Thus the stage can be operated at 66 per cent efficiency with improved power amplification allowed by medium-low efficiency operation. Unless the stage is used for doubling, the bias must be kept as low as possible, although not less than that DC bias which reduces the plate current to zero when the excitation is removed. Of course, when using grid-leak bias, the bias also drops to zero when the excitation is removed. Measure the bias with a high-resistance voltmeter with the excitation on. The bias can be measured across the resistor R3 and should be about one-twenty-fifth of the plate voltage applied to the 46.

For doubling, the bias should be from twice to three times this value and will vary with individual tubes. Some users of the 46 report good results when doubling with a bias equal to nearly five times cutoff.

Neutralizing

The split-stator tank condenser C7 is shunted across the inductance L3. The combination resonates at either the same frequency as the grid circuit or some multiple of this frequency. This plate tank circuit differs from that of the oscillator in that the RF return to the filament is made through the common rotor of the split-stator tank condenser. The rotor is directly grounded to the filament and thus the extra by-pass condenser (C2 in the oscillator stage) is eliminated. The DC connection to the high voltage is applied to the circuit at the center of the plate tank coil and is fed through the RF choke RFC2 in order to maintain the rotor of C7 as the one and only RF return to ground. The lower end of L3 is connected to the grid of the 46 through condenser C6, which is called the neutralizing condenser. This condenser and the peculiar arrangement of the plate tank circuit is necessary to prevent self-oscillation of the amplifier stage when operating as a buffer amplifier.

As was shown in the oscillator stage, the plate and grid of an ordinary vacuum tube act as the two plates of a small condenser, so that a measurable amount of RF voltage present in the plate circuit is by-passed back to the grid circuit, where it adds to the volt-

ages already present in that circuit in again increasing the amplitude of the RF voltage in the plate circuit. Thus there is a cumulative rise in the AC plate and grid voltages which continues and rises even after the excitation voltage from the oscillator is removed. This condition is called self-oscillation, and the frequency of oscillation is no longer controlled by the quartz crystal. This condition of self-oscillation is to be avoided and it is accomplished by the process of neutralization.

An AC voltage is alternately positive and then negative, with respect to some reference point. Thus if some way is found to feed an AC voltage into the grid circuit of the 46, and if this voltage is equal in amplitude to that fed back through the plate-to-grid capacity of the tube itself, and if the positive peaks of the voltage fed back externally were made to correspond in time to the most negative peaks of the voltage fed back through the tube itself, then the resultant voltage on the grid of the 46 would be zero. This is explained by the fact that the two voltages, equal in amplitude and opposite in phase, completely neutralize each other.

The fundamentals of resonant circuits show that the voltages at the opposite ends of a parallel resonant tank circuit are equal, though opposite in polarity at any given instant, when the center of the coil is the reference point. In the case of the plate tank coil L3 and the condenser C7, the reference point is established at the center of the coil and in the condenser by grounding the split-stator rotor. Thus if the capacity of C6 is equal to the plate-to-grid capacity of the 46 tube, the voltage drop across this condenser will be equal to the voltage drop across the small condenser consisting of the grid and plate of the tube. Then the AC voltage will be balanced out. If this AC voltage is not neutralized it will cause self-oscillation of the 46 tube. It is highly important that a reference point be established at the center of the plate tank so that the AC voltage on each side of center shall be equal, otherwise it is impossible to establish the necessary balance.

Neutralization, in order to prevent self-oscillation, is necessary only when the stage is operated as a straight buffer-amplifier. When the stage is used for doubling there is little tendency for self-oscillation because the plate tank circuit is tuned to a different frequency than that of the grid tank. However, the neutralizing circuit becomes a regeneration circuit and actually aids in doubling, by increasing the grid drive at the output frequency due to the capacity C6. When used in a doubling circuit the capacity of C6 should be greater than the capacity necessary to properly neutralize a stage which operates as a straight amplifier.

The RF power in L3 can be used to excite an antenna by means of any of the diverse

antenna coupling methods, or it can be used to excite another RF amplifier stage by means of a coupling link, similar to Link 1 between the oscillator and the 46 stage.

Mechanical Design And Construction

● It takes more than a good circuit diagram to make a good transmitter. The mechanical layout and the quality of construction are important factors if satisfactory results are to be obtained.

Before the actual construction begins, all of the parts for each stage should be laid out on the breadboard or chassis and moved around until all RF leads are as short and direct as it is possible to make them. Don't worry about making a symmetrical layout if RF leads must be lengthened to do so, because short leads are much more important than the looks of the device after it is finished. Putting all of the tank coils at one end of the breadboard and all of the condensers at the other end may present a fine appearance to the onlooker, but the operator 3000 or more miles away may not hear the signals.

The argument between the merits of breadboards and metal chassis continues day after day. There is probably little difference in the efficiency of the two. A metal chassis looks somewhat better, but it is more difficult to work. Aluminum or copper should be used, if radio frequencies are present. Cadmium or copper plating on steel is often satisfactory.

Breadboards have certain losses because most soft woods are rather poor dielectrics and absorb energy when placed in a strong electrostatic field, such as that which surrounds a transmitter stage. The losses can be minimized by using dry hardwood for the breadboard.

The best solution to the breadboard problem seems to be the use of ordinary white pine, covered with a thin sheet of aluminum or copper. 26 to 30-gauge is heavy enough and it can be securely and neatly fastened by bending it over the edges of the breadboard and tacking it down with small nails. This type of construction allows the use of ordinary woodscrews for mounting coils and condensers and it has the further advantage that the metal acts as a shield, especially when the transmitter is rack-mounted. The metal also keeps the capacity to ground of the various parts of the transmitter constant, which is especially helpful in neutralizing a push-pull stage. Shielding should be used wherever necessary, although all shielding represents a small loss. The best form of shielding is plenty of room between stages. On things that practically all amateurs possess plenty of is room; so do not cramp the

various transmitter stages together. As a matter of fact, now that link coupling has proved superior for coupling from stage to stage, there is absolutely no necessity for putting more than one stage on a single breadboard, because the coupling links between stages can be almost any length up to ten feet. If the transmitter stages are so close together that some kind of interstage shielding is necessary to prevent feedback, it is rarely necessary to completely shield all around a given stage, as in receiver construction. A double baffle about six inches high will usually make even the most cranky amplifier stage settle down to work. The two metal plates which comprise the baffle should be at least a quarter of an inch apart and should not touch each other except where they are connected to the common ground connection, or screwed to the metal chassis. In some cases the double baffle will not be necessary, but it is considered best practice to use this modern method of shielding.

Recently there has been introduced a movement to more or less standardize the size of breadboards and metal chassis. This practice is much to be encouraged. It makes it easy to exchange apparatus among amateurs without necessitating a new rack to mount the new acquisition. In general, the chassis sizes more less follow the standard rack construction originally adopted by the Bell System. The front panel of a standard rack is 19 inches wide and it is some even multiple of one-and-three-quarters inches high. Three common sizes are seven inches high, eight-and-three-quarters inches high, and ten-and-one-half inches high.

The breadboards or chassis, mounted on or behind these front panels, should not be

wider than 17 inches, because that is all the clearance there is between the side members of the standard rack. Most chassis are either eight and one-half inches deep, or twelve inches deep. However, there is less reason for

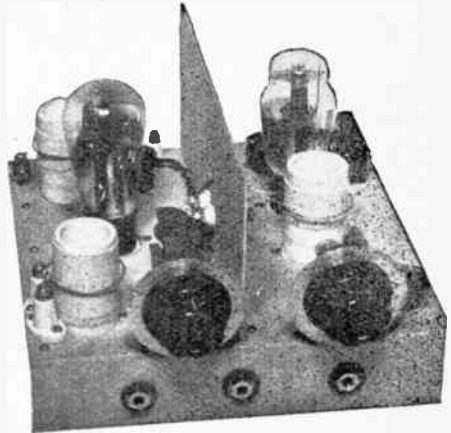

Crystal oscillator link coupled to buffer or doubler stage. 12 gauge aluminum is used. A single aluminum shield is shown between the two stages. Better practice dictates the use of a double shield, with $\frac{1}{4}$ -inch spacing between shields.

standardization of the depth because the only limitation is the strength of the supporting structure.

A neat way in which to lay-out a transmitter is to obtain several pieces of five-ply plywood, each $8\frac{1}{2}$ inches square, and then cover these pieces with 28-gauge aluminum. Each breadboard is of the correct size for a

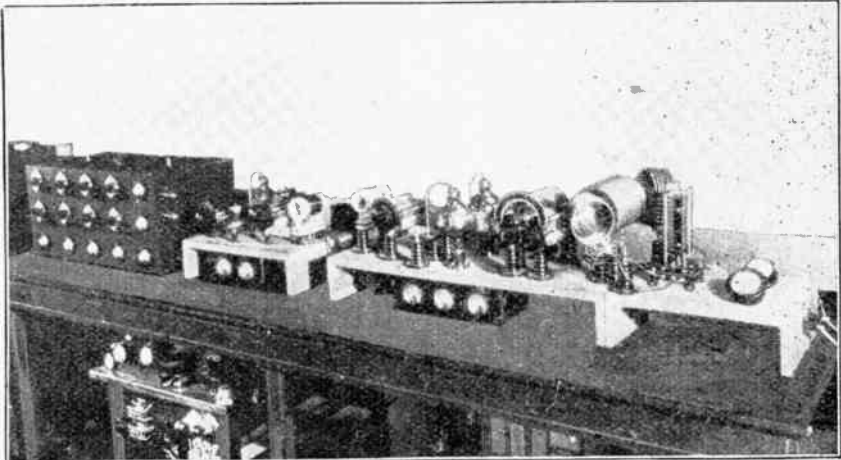

WIZI—A typical modern amateur transmitter mounted on "breadboards."

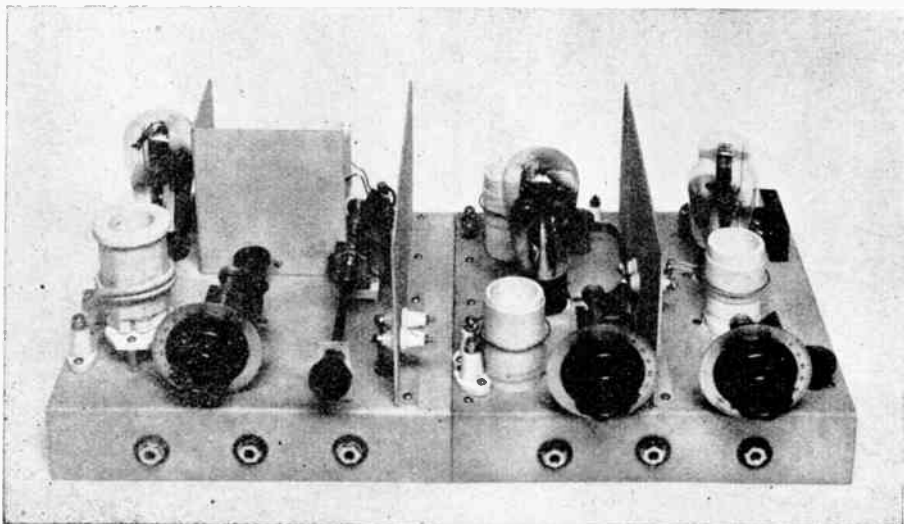

Oscillator, Doubler and Buffer, link coupled. A good example of unit construction.

single low-power stage, and each stage can be quickly removed from the completed transmitter when rebuilding or when changes are necessary. For standard rack mounting, two of these small breadboards can be mounted behind each panel. A plug and jack arrangement for the various power and filament leads can be used so that almost any stage can be taken out and replaced with another right in the middle of a QSO. One arrangement of this kind can use either a 47 oscillator, a Jones exciter or an 865 electron-coupled oscillator stage. The buffer and doubler stages for this particular transmitter use 210s and each stage is exactly alike. Then a 50-watt stage then can replace a stage that uses push-pull 210s.

Nothing in a transmitter should be nailed down. Each coil, condenser, etc., should be fastened solidly to something, but it should never be necessary to stand on your head in order to replace a burnt-out resistor. If each small breadboard can be easily removed from the transmitter, it becomes a real pleasure to change things around until every part of the transmitter is working to perfection.

Not even a radio engineer can lay out such a complicated piece of equipment as a radio transmitter and expect it to work perfectly the first time it is tested. In many cases it is found that there is insufficient excitation to some particular stage. This usually calls for addition of another buffer stage, a simple job if each stage is on its own little breadboard. If the entire rig is solidly nailed down to the top of a table or shelves in a rack, it is practically impossible to add

intermediate stage without first tearing out half the transmitter in order to provide room. It becomes a simple matter to use

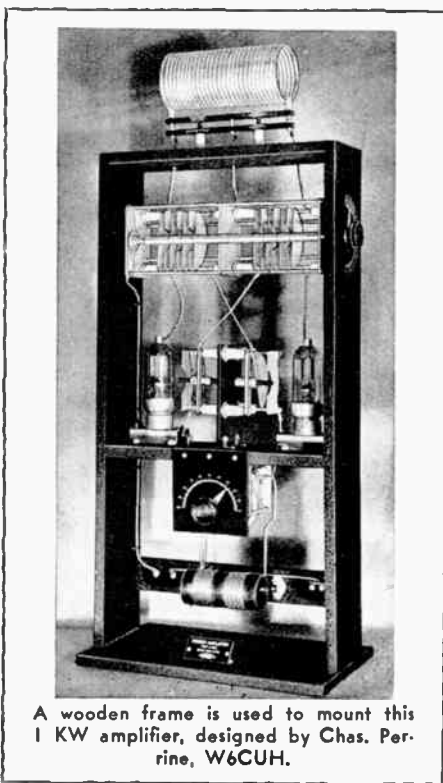

A wooden frame is used to mount this 1 KW amplifier, designed by Chas. Perrine, W6CUH.

additional stages when new circuits or tubes are to be tried out. New tubes and circuits are constantly being invented and the average amateur likes to rebuild about once or twice a year. If each stage is built as a separate unit, very little work is necessary to completely rebuild the transmitter because three-fourths of the old transmitter can be used again in the new. When the operator desires to take a small portable transmitter on a trip, it is quite simple to remove the oscillator stage and one or two buffers. These are then placed in a suitcase with the necessary power supplies and . . . presto, there you have a fine portable transmitter. It is sometimes essential to have a transmitter that can be quickly moved from your present location, which may be in an area where the power had failed, due to a catastrophe, to a new location where power is still available. This process can be quickly carried out if there is nothing in the transmitter that is too big or too heavy to be carried by one man.

When laying out a stage on a particular breadboard or chassis, the grid coil should be placed as far from the plate coil as possible, at least five times the diameter of the plate coil away from it. If the two coils are too close together the stage may sometimes be difficult to neutralize. In some cases, especially in high-power stages, it is desirable to orient the coils so that they are at right angles to each other. In this way the fields around the two coils will have the minimum of interaction between them.

If the tank coils for the lower-power stages are wound on receiving-type plug-in coil forms, they should be of some ceramic material, such as Isolantite. Most amateurs prefer the five-prong type, because it can be used practically everywhere and it is a good idea to have the coils for any one stage fit another stage. Another advantage of the five-prong forms and sockets is that the "Hot", or plate lead can be attached to the prong most widely separated from the other prongs.

Isolantite sockets for tubes and coil forms are desirable. Some of the newer wafer sockets are satisfactory for use in stages that operate with less than 500 volts plate voltage. The newer midget condensers give good re-

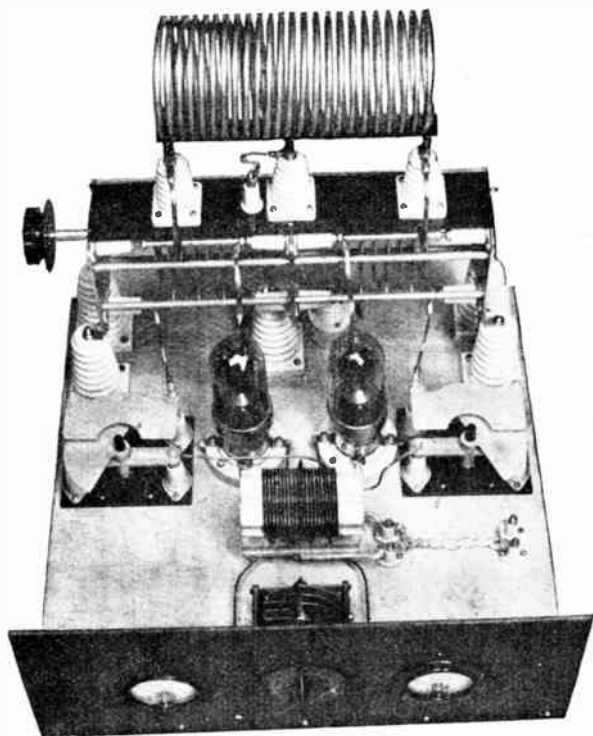

Another 1 KW final amplifier, breadboard construction. Two 354 Gemmatron tubes are used in push-pull. The low grid-to-plate capacity requires extremely low capacity neutralizing condensers. The grid coil is well isolated from the plate coil.

sults when used in the grid and plate circuits of low power stages, but it is a good idea to solder a short pigtail to the rotor, instead of depending on the usually-poor contact between the rotor and condenser frame. A high-resistance joint at this point is very hard to trace because the stage is seemingly OK, yet the power output is lowered. It is always good practice to place a closed-circuit jack in every grid and plate circuit, even though some meters may always be in the circuit. When the stage is removed from the transmitter for test or rebuilding, it is convenient to be able to quickly check the grid current and plate current while the stage is being tested on the workbench.

A fairly-good test for the high-efficiency of a stage is to apply some excitation to the grid circuit and also apply plate voltage to the plate (after neutralizing). Use only grid leak bias, temporarily. With nothing coupled to the plate tank, the plate current should go down well below ten mills. The plate current in a truly-efficient stage should read about one-twentieth of the normal operating plate current, when no load is con-

ected. If the plate mills refuse to drop to where they belong, it is an indication that the tube is either flat or that there is an undesired loss somewhere in the stage. Of course, the excitation should be about normal, as should be the bias. A high plate current with the stage unloaded may also be an indication of a high-resistance joint in either the grid or plate tank circuit. It also may be due to the use of poor materials for the grid and plate coil forms. As soon as the plate tank is detuned from resonance (unloaded) the mills should promptly jump high above the normal operating plate current. In other words, the most efficient stage would show the greatest dip in plate current as the plate tank is tuned through resonance with no load coupled to the plate circuit.

Shunt-Feed and Series-Feed Tank Circuits

In amateur practice, two methods are used to supply plate power to the transmitting tube. One is known as "Shunt-Feed", which delivers the DC from the power supply directly to the plate of the tube. The radio-frequency voltage present on the plate of the tube is prevented from being by-passed back to ground through the power supply by means of a radio-frequency choke which is effectively shunted directly across the plate tank coil. Thus a good test for a radio-frequency choke is to connect it across the tank condenser and press the key. If the presence of the RF choke across the tank condenser materially detunes the circuit from resonance, the choke was not very good. Few RF chokes can withstand this test. One of the disadvantages of shunt-feed is that no choke has infinite impedance, and therefore a finite amount of RF power is lost to ground through the choke. It is especially difficult to design and build a radio-frequency choke which is effective when used on more than one of the amateur bands. These bands are even harmonics of the lowest frequency band, whereas r.f. chokes operate best on the odd harmonics of the lowest frequency for which they are designed. Thus a multi-band choke is only a compromise on all bands and is theoretically perfect on none.

The only advantage of shunt-feeding plate

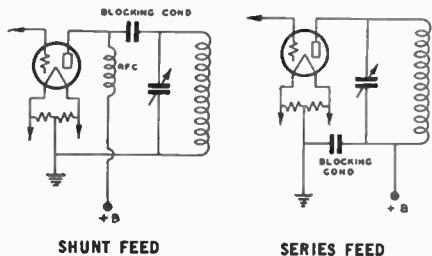

voltage through an RF choke is that it allows the plate tank coil and condenser to operate at ground potential with respect to the DC plate voltage. This condition is sometimes desirable in the design of transmitters in which the connecting leads must be kept at a minimum in order to permit quick band-changing.

Series-Feed applies the DC plate voltage to the bottom, or cold end (middle of the coil in a split-tank circuit) of the plate tank coil. Thus there is no radio-frequency voltage difference between this point and ground, and practically no RF finds its way back into the power supply. In some cases where the grounding of the transmitter is somewhat uncertain, it is advisable to use an RF choke at the ground end of the coil to take care of the slight RF potential difference which sometimes exists between the various portions of the same transmitter. This choke has very little work to do and can be small in size.

Eliminating Key Clicks and Thumps

The transmission of intelligence by means of radiotelegraphy involves the recurrent variation of the RF carrier output between the full "on" and the full "off" position. "Mark" and "Space" are defined by the presence and absence of radiated output, respectively. The carrier wave is usually cut on and off during the keying process by opening and closing the supply circuit which supplies plate power to one or more stages of the transmitter. If the change from the "no output" condition to the "full output" condition occurs too quickly, an undesired key click will be produced. This click will be radiated over a very wide range of frequencies on each side of the carrier frequency and it will cause a particularly annoying form of interference to other radio

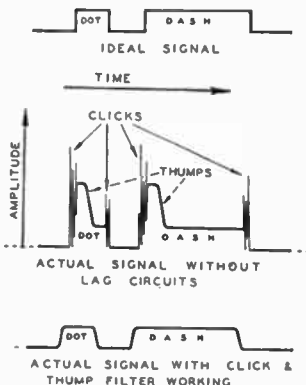

How the three types of CW signals appear on the screen of an Oscilloscope.

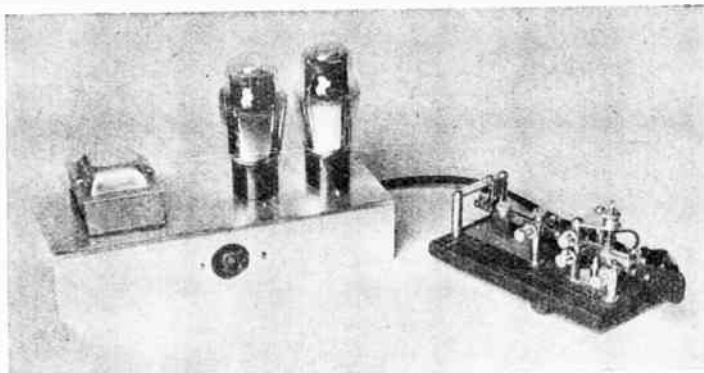

A vacuum-tube keying unit. This system of keying is positive and reliable. High-speed transmission systems use it.

services. Usually these key clicks are only audible over something less than a hundred mile radius, but they occasionally cause interference many thousands of miles away, in certain aggravated cases.

There are two distinct types of key clicks. The most common is that which occurs at the start of the impulse, or when the key is closed. If the voltage builds up too rapidly, a discontinuous wave will be produced and its amplitude may be several hundred times the amplitude of the signal wave. This type of click is usually damped-out by providing some form of time lag in the circuit which forces the DC current to build up relatively slowly. By slowly is meant that the time required for the current from the power supply to go from zero to maximum should be about one-one-hundredth of a second. If the time is less than about one-five-hundredth of a second, annoying clicks will be produced.

The most common form of lag circuit is one that uses a variable series inductance in series with the key, or keying relay. Often no variable inductance is available, but the inductance of any choke coil can be readily varied by connecting a variable resistor across the inductance, as shown in Fig. 6. The required value of inductance depends on several variable factors, such as the amount of current flowing, the plate voltage, the voltage regulation of the source of supply, the characteristics of the filter on the supply, etc. Thus no definite value can be specified in advance. As a matter of fact, in no portion of a radio transmitter can results be forecast with less accuracy than in a keying filter. Eliminating keying interference usually resolves itself into trying every known remedy until one is found that works.

The second type of click is that which occurs at the end of each impulse when the key is opened. This click is a combination

of the spark produced at the key contacts and the sudden change in voltage applied to the radio-frequency amplifier. The use of a series inductance aggravates this type of click. It adds a large inductive back EMF when the circuit is broken and the spark across the keying contacts increases. Ordinarily, the click produced when the key is opened is considerably less bothersome than that produced when the keying contact is closed. However, the use of a series inductance can often eliminate the "make" click, but at the expense of doubling or tripling the amplitude of the "break" click. The latter type of click is best eliminated by connecting a condenser in series with a variable resistor across the keying contacts.

This condenser-resistor circuit represents a compromise between a minimum of clicks and good keying characteristics. The size of the condenser is not particularly critical, anything between $\frac{1}{2}$ microfarad and 2 microfarads is usually quite satisfactory. However, the resistor must be carefully adjusted for best results. If the resistor is too large it will put "tails" on the dots, making the signal difficult to read; the characters of the alphabet will not be clear and distinct. If the resistor is too small, the plate voltage will decay too rapidly and clicks will be produced. A time constant of approximately one-one-hundredth of a second will usually allow satisfactory keying without bothersome clicks, although the really-fast operator who uses an automatic key may find that the dots stand out better if the time constant is reduced to 70-to-80-thousandths of a second.

In order to minimize the harmful effects of this compromise, it is desirable to key in some circuit that draws but little power. The grid-block keying method is useful because the key is required to open a circuit that carries no current at that instant. When

keying the oscillator stage in order to obtain perfect break-in operation, the oscillator screen can be keyed, although the center-tap method of keying the oscillator is also quite satisfactory. Most of the high-power commercial transmitters that key many kilowatts of power at speeds up to 500 words a minute use some variation of the vacuum tube keying system one example of which is shown in Fig. 2.

A click at the "make" means that some form of series inductance must be added in

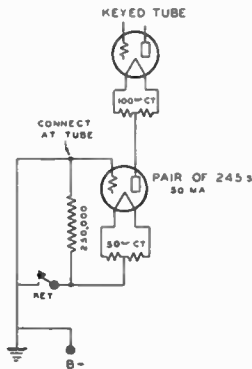

FIG. 2.

Vacuum Tube Keying. This circuit shows one of the more simple vacuum tube keying circuits. Some current flows through the key and this system sometimes produces clicks when the key is opened. Both filament transformers must be insulated from each other and also from ground. This circuit will not completely cut off the plate current to the keyed stage, but will reduce it to a very small value.

the plate circuit or grid circuit of one or more of the amplifiers. A click at the "break" indicates that a capacity should be provided across the circuit keyed in order to enable the voltage in that circuit to decay slowly and evenly. The adjustment of the series resistor is by far the most important in eliminating clicks.

Key Thumps

The deep thump that often causes considerable interference is largely due to the fact that the plate power supply voltage is built up when the key is up, thus causing a sudden surge of output at the instant the key is closed. This surge may have several times the average amplitude of the steady carrier. This thump can only be eliminated by improving the voltage regulation of the power supply so that the voltage with the key up is less than 15 per cent higher than when the key is down and power is being drawn out. The best way to improve the voltage

ORDINARY CENTER TAP KEYING

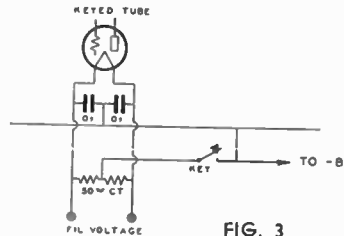

FIG. 3

Ordinary center-tap keying. The center-tap of the filament transformer must not be grounded. As a general rule, the filament transformer which supplies the keyed stage will not be used to supply any of the other stages. The B minus lead from the power supply should be grounded.

regulation is to connect a bleeder resistor across the output of the filter; the bleeder should draw enough load to hold the voltage down when the key is up. The exact value of the bleeder can only be determined by experiment because the inherent regulation of various power supplies varies quite widely.

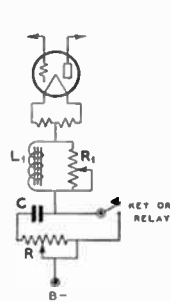

FIG. 5

Conventional center-tap keying with an adjustable key-click filter. This system gives very good results. The actual amount of inductance and capacity in the circuit depends on the amount of current being keyed, and also on the voltage regulation of the plate power supply. L1 should be of a value between 1 and 5 henrys; R1, 20,000 ohms; C, between 1/4 and 2 mfd.; R, 2,000 ohms.

Key Thump Filter

● The usual procedure in designing a circuit arrangement to prevent key thumps and key clicks is to first place in series with the key a sufficient amount of inductance to prevent the too-sudden building-up of oscillations. By selecting the proper value of inductance the desired degree of lag can be introduced. The action of the inductance is satisfactory when the circuit is closed, but when the contact is broken an arc takes place which burns the key contacts. The second step is to place a capacity in shunt with the key to absorb this "inductive kick" and thus prevent the arc at the opening of the circuit. But when the key is again closed, there is a "short" across the charged condenser which gives a spot-welding effect on the key contacts, not to mention interference from impact excitation of associated circuits. To remedy this condition the next step is to put a resistor in series with this condenser in order to pre-

vent a sudden discharge. But this resistor impairs the ability of the condenser to take on a sudden charge, absorbing the self-induced voltage of the inductance at the opening of the key and to some extent defeating the original purpose of the condenser. The best that can come of such an arrangement is a sorry compromise between a small arc at the opening of the key, and a small welding effect on the contacts at the closing

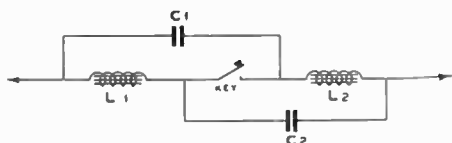

FIG. 7. Key Thump Filter.

of the key. Fig. 7 shows a method for overcoming the difficulty. L1 and L2 are in series with the key and provide the necessary "lag". The "kick" from L1 is cushioned by C2. In turn, L2 prevents C2 from spot-welding the key contacts on discharge. Similarly, the self-induced voltage in L2 at the opening of the circuit is taken care of by C1 and L1 and prevents a sudden discharge of C1. The correct values of L and C can be determined experimentally. The combined capacity of C1 plus C2 should be 1 mfd. or less. The chokes should be of the size generally used in power packs.

Primary Keying

Advantages: Allows the use of grid-leak bias on the keyed stages. Eliminates clicks and safeguards the filter condensers used on the keyed stages. Eliminates the necessity for a high voltage bleeder. Eliminates back-wave 100%, if more than one stage is keyed.

Disadvantages: Requires a heavy current relay that can break an inductive AC circuit. Tends to blink the lights when used on high power. Sometimes creates bad thumps in BCL sets on the same line, caused by 60 cycle AC surges. Makes perfect keying at high speeds difficult due to the tendency of the filter condensers to add tails to the dots.

Center-Tap Keying

Advantages: Allows the use of grid-leak bias on the keyed stage, but separate bias must be used on all succeeding stages. Will follow a "bug" perfectly. Easy to read. High voltage, low current DC relays are relatively cheap.

Disadvantages: Can cause bad key clicks unless a good click filter is used. Can also cause bad thumps unless a rather heavy bleeder is used across the high voltage. The bleeder is also necessary to protect the filter condensers from failure when the key is up.

Keying the Oscillator

This is not a type of keying but a place to key. It justifies special mention because it seems to give the best results, at the present time. (See Fig. 3, Page 96).

Advantages: Allows complete break-in and completely eliminates back-wave. Practically eliminates clicks and thumps and will key at high speed.

Disadvantages: Requires fixed bias supplies for all the amplifier stages. Is apt to chirp, unless the screen voltage for the crystal oscillator tube is provided from a voltage divider, rather than from a series resistor.

Interference Elimination

The Wave Trap

Most of the undesirable interference caused by amateurs in neighboring broadcast receivers is usually due to the fact that the FIRST RF STAGE in the BCL receiver does not possess sufficient selectivity. Thus the high-frequency signal from the amateur transmitter rides through into the grid of the first tube in the BCL receiver. Usually no amount of selectivity beyond this point will eliminate the interference. The powerful amateur signal is so large that it causes detection and cross modulation in the first tube. One method of reducing the amplitude of the high-frequency interfering signal is to place a tuned wave trap in series with the antenna lead to the BCL set. This trap should be tuned for the weakest response to the interfering signal, and it should be placed as close as possible to the antenna post on the BCL receiver. Then make certain that the BCL set has a short, low resistance connection to ground in order to prevent the AC power line from bringing in the interfering signal, in spite of the wave trap.

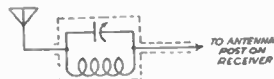

Showing how to connect the wave trap to a BCL set. The device simply consists of an inductance coil tuned by a variable condenser to the transmitter frequency. The condenser can be of any size, from 100 mmf. to 350 mmf. The coil is wound on a 2½-in. diameter form with No. 20 or No. 22 DCC wire. The correct number of turns of wire to wind on the form must be determined by experiment. The following table will serve as a guide:

20 meters.	4 turns	80 meters...	12 turns
40 meters....	7 turns	160 meters...	25-30 turns

Self-Excited Oscillators

● The SEO (self-excited oscillator) is one of the mile-stones in the progress of radio transmitting. When properly designed and operated, it is one of the best forms of frequency generation, for its use permits any desired frequency to be obtained with few adjustments. In amateur band operation this advantage results in selecting "clear spots" in which to operate. But it is a rather dangerous circuit—for beginners, or anyone, for that matter. Few amateurs, especially the beginner, have wavemeters and frequency meters to check the desired frequency with a self excited oscillator. With this thought in mind, beginners should not use the SEO alone until advancement in radio knowledge and practise is obtained.

Good design of the SEO dictates a choice of good parts, solid connections, freedom from vibration, stable power supplies and a bit of common sense.

The fundamental thing to remember about the SEO is that the grid controls the action. The grid not only controls the output, but also the frequency and efficiency of the plate circuit. This means that even though the grid current and voltages may be low as compared to the plate power, plenty of care should be taken with the grid circuit. The plate circuit must not be overlooked. If as much attention is given this portion as to the grid portion, extreme stability in frequency generation will result.

The common types of SEOs are: The Hartley—Fig. 1; The Colpitts—Fig. 2; The TPTG (tuned plate tuned grid)—Fig. 3; The TNT—Fig. 4; and The Electron-Coupled—Fig. 5.

Of the above circuits little need be said, except in reference to the TNT. Its name is correct; it is TNT in the hands of beginners. The beginner wasn't satisfied with the low power, hence the circuit was overloaded to the extent that the grid coil heated every time the key was pressed, with the result that misery was dealt to all who happened to be nearby, or tried to copy the signals. It is not a circuit for the beginner.

SEO circuits can be single tube or two tube (push-pull) affairs. They can be shunt or series fed.

Push-pull is to be recommended over the single-ended circuits, for there is a greater voltage swing, and the even harmonics are eliminated by this push-pull action. The rule to observe in the construction of push-pull sets is symmetry—both mechanical and electrical. Exact electrical and mechanical symmetry cannot be obtained until left-handed and right-handed tubes are manufactured, because the grid and plate prongs of the tubes are reversed on the left-handed

tubes. However, with the exception of the filament leads, a high degree of symmetry can be obtained. The grid leads and plate leads should be the same length respectively. By this is meant that the leads to each inductance from each grid and plate socket connection should be the same length. The condensers can be connected to these leads in almost any manner without disturbing the constants. In many instances in which inductances are mounted on top of the condensers, unequal length of leads may result, even though they appear correct to the eye. Fig. 7 illustrates the fact that even though the grid and plate leads to the condensers are both of equal length, the condenser frames are really making one lead longer than the other. To overcome this difficulty, mount the coils separately with their equal length connection to the sockets, and then connect the condensers to these leads. This might slightly throw off the balance, but odd length condenser leads still constitute capacity—and not inductance. This is illustrated in Fig. 6. A good rule to bear in mind is to keep the condensers at least a coil's diameter away from the coil.

With the above facts in mind, and after much experimenting, a stable SEO was designed. Fig. 8 shows the circuit. It is a push-pull circuit of unique design, insofar as the grid end of it is concerned. The grid coil is not center-tapped. The bias is supplied to the tubes through RF chokes. By using two RF chokes to supply the bias, the extremely high impedance offered by these chokes decreases the percentage of mismatch of the electrical center of the grids in each half, for while the mechanical center-tapping of the grid coil is fairly easy, it may be electrically mismatched, which results in a poor tone when the SEO is operated under a load. In this circuit the grid tank is truly an oscillating device and when its electrical impulses are received 180 degrees out of phase, due to the capacity of the tube that happens to be idle at that moment, it is free to oscillate at its tuned period and its oscillation is not impaired by any center-tap that would usually be mismatched were the coil mechanically center-tapped. In this circuit, a fixed condenser, C2 is in series with the midjet variable tuning. Its purpose is to reduce the voltage breakdown of the variable C1, for since this is a resonance circuit the voltage built up is high.

L1, the grid coil, is constructed with larger wire than would normally be used, and then lacquered to hold the wire solidly, so that temperature change will not appreciably affect its normal inductance. Wire smaller than

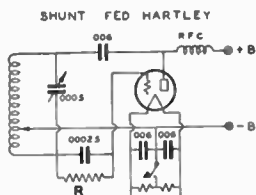

FIG. 1

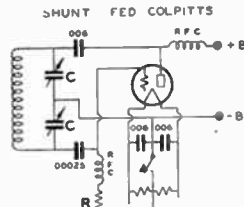

FIG. 2

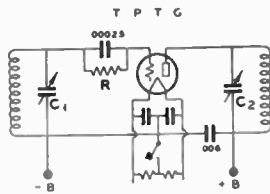

FIG. 3

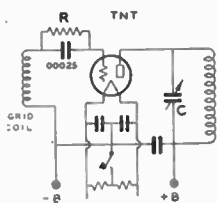

FIG. 4

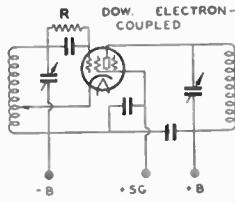

FIG. 5

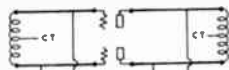

FIG. 6

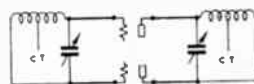

FIG. 7

No. 16 can be used, but it is not recommended. This construction has to do with the input circuit, which really controls the frequency. Since it is solidly built, very little frequency shift will be had. This is one reason for its extreme stability. By applying the same care to the plate circuit, a stable oscillator, having as good stability as the usual overloaded crystal oscillator, is the result.

This circuit can drive an amplifier with ease, doing away with the usual necessary buffers. However, if it is used to control an amplifier whose output is to be 250 watts or more, an "isolator" buffer stage is recommended, coupling this isolator loosely so that no reflected impedance can cause any frequency change to the oscillator.

When this oscillator is coupled to the antenna, the reflected antenna impedance, while loading the oscillator, causes a frequency shift; hence it is necessary to mount the antenna coils solidly and free from vibration, so that once the desired frequency is obtained, there will be no shift. Since the RF current in the plate tank is the same throughout it need only be fed from either end, although there will be a different reflected load to either tube. It is therefore recommended that a split antenna coil be used. If coupled to a Zepp antenna having feeders exactly odd quarter wave in length, there is little difference which side of the antenna coil is fastened to the feeders. If the feeders are of a length between odd quarters, then some RF voltage must also be applied, as well as current, and therefore better results will be obtained by fastening the feeders to the coil ends nearest the tank coil, because

this is the point of highest RF voltage. See Fig. 9.

This circuit is tuned like a TPTG, adjusting the plate tank to resonance as indicated by the low dip on the milliammeter when the desired frequency is reached. When loaded, either by antenna or amplifier, it must be

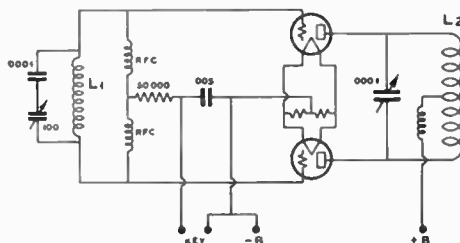

FIG. 8

For 40-Meter operation, L1 has 35 turns of No. 16 wire, wound on a 1/2-inch diameter form. L2 has 14 turns of No. 12 wire, wound on a 2 1/2-inch diameter form.

For 20-meter operation, L1 has 20 turns of No. 16 wire, wound on a 1/2-inch diameter form. L2 has 6 turns of No. 12 wire wound on a 2 1/2-inch diameter form

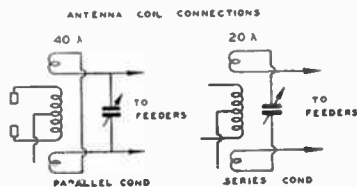

FIG. 9

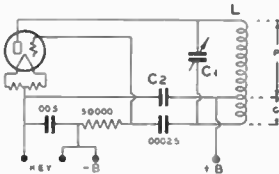

FIG. 10

FIG. 10
 L—For 160 meters. 18 turns, 8½-inch diameter.
 P = 10 turns. G = 8 turns.
 For 80 Meters. 14 turns, 1½-inch diameter.
 P = 8 turns. G = 6 turns.
 C1—For 160 meters .0005 mfd.
 For 80 meters .00035 mfd.
 C2—For 160 meters .005 mfd.
 For 80 meters .002 mfd.

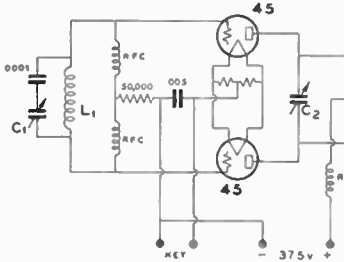
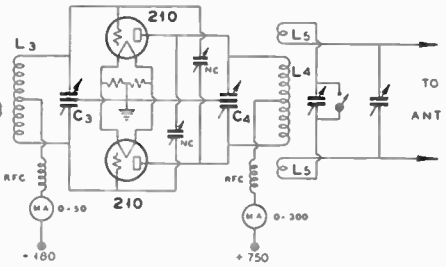

FIG. 11



retuned slightly until the desired frequency is reached for maximum output and frequency stability.

A grid-leak resistor, of high resistance, at

least higher than normally used for type 10 tubes, helps reduce the grid current and causes the tubes to act as a more stable oscillator, giving a much better note. The decrease in

grid current is not detrimental because of the high voltage built up across the grid tank. It is possible, with this circuit, to use mismatched tubes. Experiments have shown that by using one good tube, and one almost dead, the only difference noted was in a decrease in output; the note and frequency stability remained the same as before.

The circuit in Fig. 9 is recommended for frequencies of from 7 megacycles up. For frequencies lower than 7 MC, a single-tube Hartley, shown in Fig. 10, has the same advantages—ease of construction and operation. Because the values given have been found correct, they should not be changed. To tune, merely turn the tank condenser to the desired frequency.

Fig. 11 shows a very good self-excited transmitter using the well designed oscillator circuit, except that the tubes are 45s instead of 10s, and following up with 10s for the amplifier. To tune this transmitter, proceed with the oscillator as previously described. Loosely couple the link, either by increasing its diameter, or cutting down the number of

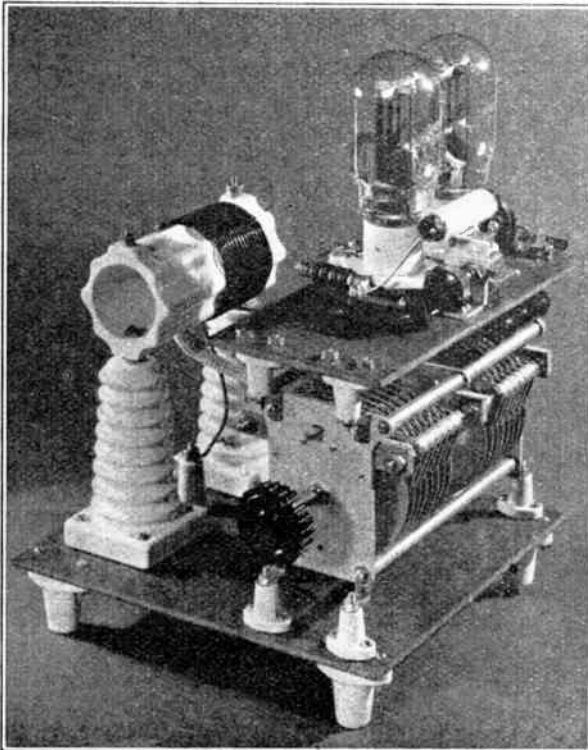

A self-excited oscillator using two type '10 tubes.

turns. However, the loose coupling need only be observed insofar as the frequency change is reflected when the grid circuit of the amplifier is tuned to resonance. Adjust the amplifier grid tank to peak milliamperes, as indicated by a grid meter; then neutralize, with the amplifier plate voltage off. Adjust the neutralizing condensers until there is change of the grid current, as indicated by the pointer on the meter, when the plate tank condenser is rotated through a complete turn. Then apply plate voltage. Adjust the plate tank to low dip of the plate milliammeter, check your frequency again and change the minor adjustments to your pleasure. Then couple the antenna and tune. The antenna coupling recommended is the amount of coupling that will cause the plate current to rise at only one condenser setting. If the coupling is too close, it will be noted that on either side of the correct setting, the plate milliamperes will rise. In other words, the dip in the milliammeter will now be the correct

antenna tuning setting, as will be observed with the antenna meter or some other indicator. However, with the described oscillator, there should be sufficient excitation so that the PP 10s can be biased so that there is no plate current flowing at resonance. Then when loaded by the antenna, the plate current will rise, and the power indicated will be the power taken by the antenna. The transmitter efficiency is therefore increased. However, the operator will probably adjust it to suit himself, but it is well worth while to adjust the bias until the antenna current just starts to drop off. There will be the same output with less power dissipated, hence an increase in efficiency.

This transmitter uses a class C final and the oscillator is keyed for break-in operation.

By closely following the suggested instructions, a very stable self-excited oscillator controlled transmitter will be acquired, and will have the advantages of any desired frequency operation.

Piezo Quartz Crystals, Circuits and Grinding

● Quartz plates are the most widely used for frequency control on frequencies below about 10 megacycles, because of their relative cheapness as compared with tourmaline plates. On the higher frequencies, tourmaline is to be preferred for fundamental frequency control; there is less tendency toward side-tone oscillation which becomes pronounced with quartz plates above 7 megacycles. Also, because of their smaller diameter, and because of their slightly greater thickness for a given frequency, tourmaline crystals are stronger

moved from the resonant frequency. The quartz filter can be likened to a very low "C" tank circuit with an extremely high "Q", which, as a series resonant circuit, has a very sharp selectivity curve.

Circuits and Operation

The conventional crystal oscillator circuit is nothing but a "TNT", or tuned-grid, tuned-plate Armstrong oscillator, with the crystal replacing the grid coil or tank. When the plate tank is tuned to a frequency slightly

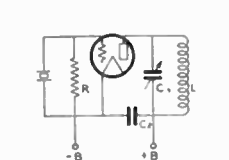

FIG. 1A
CRYSTAL OSCILLATOR,
fundamental circuit using triode
R—20,000 ohms.
C1—.004 mfd.
L—Plate coil.

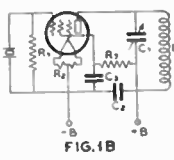

FIG. 1B
PENTODE EXCITER TYPE OSCIL-
LATOR, fundamental circuit
R1—20,000 ohms.
R2—20 ohms.
R3—50,000 ohms.
C2, C3—.004 mfd.

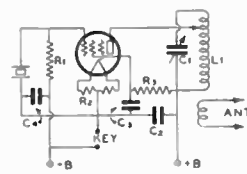

FIG. 2
POWER PENTODE TRANSMITTER
Type Oscillator
R1—20,000 ohms
R2—50,000 ohms
C2-C3-C4—.004 mfd.

mechanically and also present less grinding difficulty.

The resonant effect of piezo plates, besides being utilized for frequency control of transmitters, is made use of in the superheterodyne receiver to pass a very narrow band of frequencies through the intermediate amplifier. Such extreme selectivity is sometimes desirable for CW work when interference is severe. The quartz filter acts as a "selective" radio-frequency filter, with low impedance at its resonant frequency and almost infinite impedance at a frequency only very slightly re-

greater than that of the crystal, the feed-back through the inter-electrode capacity of the tube permits the circuit to oscillate at approximately the resonant frequency of the crystal. Such a circuit, using a regular triode, is shown in Fig. 1-A.

The power output of a crystal oscillator is limited by the amount of radio-frequency current the crystal will pass without heating or danger of cracking. For this reason, greatest output can be obtained from tubes with small grid-plate capacity and high "power sensitivity". In this class fall the

pentodes, such as the 2A5, 59, 42, RK17, and 47, the latter perhaps being the most commonly used. All will work well, there being very little difference in operation or output. Fig. 1-B shows the pentode oscillator circuit.

Greater output for a given crystal current can be obtained by tapping down from the "hot" end of the tank coil for the plate connection to the tube. The efficiency will be reduced, but by using one of the "50-watt" pentodes in this circuit and close coupling to the antenna, over 25 watts can be put directly into the antenna on 80 or 160 meters without exceeding the dissipation rating of the tube. Although the oscillator should run constantly and be isolated from the keyed or modulated stage by at least one "buffer" stage when the transmitter is to be used for telephony or a very clear, distinctive, and piercing note is desired for CW, such a transmitter using a crystal oscillator feeding directly into an antenna will show better frequency stability and greater freedom from "wobulation" than any self-excited transmitter, and will give excellent results on telegraphy. A small, anti-capacity SPST switch can be connected across the crystal and closing it when listening. It is a good plan to put a 100 MA Little-fuse in series with the crystal when used in such a power oscillator, to protect it from accident during the tuning-up process. The transmitter should always first be rather closely coupled to the antenna, and tuned to draw just slightly more than minimum plate mills, before full voltage is applied. The circuit of such a transmitting-type power oscillator is very similar to the exciting-type crystal oscillator, and is shown in Fig. 2. It is fundamentally the same as the oscillator of Fig. 1-B, except for the tap on the tank coil for optimum adjustment of the plate connection.

A single 47 pentode in a crystal oscillator makes a very economical transmitter for use in the 80 and 160-meter bands (See Fig. 2A). With plate voltage around 600, between 12 and 15 watts can be obtained from the tank. As before, the transmitter should be tuned-up and loaded before applying full plate voltage.

Frequency Drift and "Twin Peaks"

Some crystals will oscillate at more than one frequency, and are said to have "twin peaks". This tendency, while more pronounced with certain Y-cut crystals, is also exhibited by many X cuts. X cut crystals are sometimes ground with trick contours to boost the output. If the process is carried too far, the crystal will oscillate at more than one frequency unless precautions are taken with the oscillator circuit to prevent it. The use of a good, space wound, low "C" tank coil will discourage a crystal from oscillating at two frequencies, and at the

same time increase the output. Experiments have shown that the frequency stability is not improved by large tank capacities, which only tend to aggravate the double frequency phe-

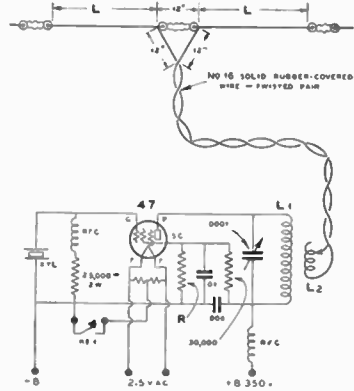
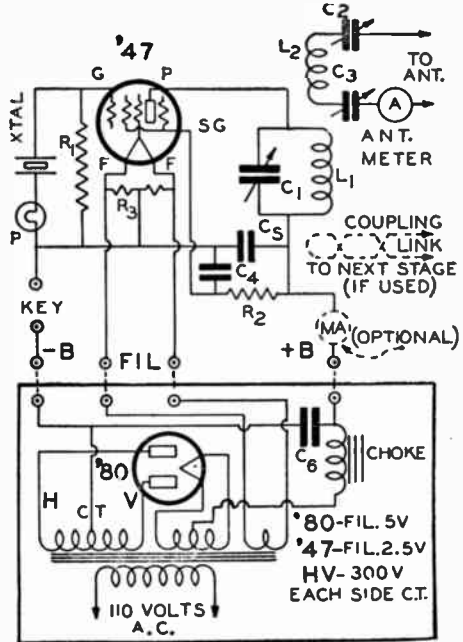

FIG. 2A

A complete one-band crystal oscillator CW transmitter which gives better results than a self-excited oscillator. A doublet antenna with twisted pair feeders is used. L2 is the antenna coupling coil. R is a 50,000 ohm resistor.



Another one-band crystal oscillator CW transmitter and power supply. C4—.01, C5—.002 to .006, C6—8 mfd. 450 v., R1—25,000 ohms, R2—50,000 ohms, R3—20 ohms, CT., C1—100 mmf., C2, C3, 350 mmf., P—type '99 tube (optional) used as oscillator indicator.

nomenon. There is absolutely no reason nor excuse for using a high "C" tank circuit in a crystal oscillator.

Y cut crystals which have been finished with both sides perfectly flat are the worst offenders in regard to twin frequencies, sometimes making it necessary to resort to a special form of clamp holder in addition to an extremely low capacity tank to confine the oscillations to one peak. Y cut crystals, ground as described later in this chapter, will require only the use of a fairly-low "C" tank circuit and no special holder is required in order to prevent double frequency oscillation.

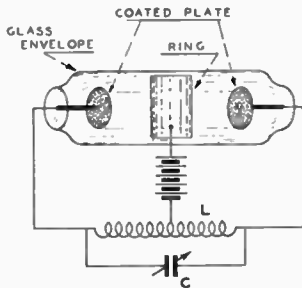

FARNSWORTH "ELECTRON MULTIPLIER"

The cold cathode oscillator-amplifier. This tube amplifies by the fact that every time an electron strikes either of the two coated cathodes it drives off from two to ten additional electrons, due to secondary emission. Some of these additional electrons cross back to the other cathode, causing more secondary emission—and the balance are picked up by the ring-shaped anode. A focusing coil (not shown) carrying one or two amperes of direct current must be mounted around the tube in order to establish the proper division of electrons between the anode and the opposite cathode. The principal advantage of this tube is that a voltage gain of 2000 can be obtained and inherent tube noise is practically eliminated.

An X cut crystal, that has been ground with both sides absolutely flat and parallel, will oscillate at only one peak, but the edges must be free from nicks, the crystal must be finished very accurately, and the top electrode of the holder must not press too heavily against the crystal, if good output is expected. By giving the crystal a special contour, it is possible to get good output without finishing the crystal so accurately, and the output of a crystal ground in such a manner is not appreciably reduced by heavy pressure on the holder electrodes. But, as mentioned before, the crystal will have two peaks if the process is carried too far.

Twin frequencies show up in several ways. Sometimes the crystal will have two frequencies several hundred cycles apart, oscillating on both frequencies at the same time, and

producing an acoustically audible beat note. Other crystals will suddenly jump frequency as the tank tuning condenser is varied past a certain point. Operation with the tank condenser adjusted near the point where the frequency shifts is very unstable, the crystal sometimes going into oscillation on one frequency and sometimes on the other as the plate voltage is cut on and off. Still other crystals will jump frequency only when the temperature is varied over a certain range. And some plates, the worst offenders, will jump frequency with a change either in tank tuning or temperature, and produce an audible beat at the same time, showing actually two pairs of frequencies.

When working close to one edge of a band it is advisable to make sure the crystal will respond to but one frequency in the holder and oscillator in which it is being operated, for a crystal with two peaks can jump out of the band without jumping far enough for the fact to be readily apparent from the meter readings of the transmitter. When working right on the edge, it is also important to choose a crystal that will creep into the band with increase in temperature. X cut crystals have a negative temperature coefficient, Y cuts have a positive temperature coefficient. For this reason an X cut plate is preferable for use just inside the high frequency edge of a band, and a Y cut for the low frequency edge. If it is desired to have the frequency right "smack on" the edge at all times under all conditions of room temperature, some form of temperature control will be required for the crystal. Ovens and constant temperature crystal holders that will maintain the temperature close enough for amateur requirements can now be purchased quite reasonably. Amateurs working close to the edges of the 14 megacycle band should be particularly careful about keeping the crystal at a fairly constant temperature; the frequency shift in kilocycles per degree centigrade goes up in direct proportion to the operating frequency, regardless of whether fundamental or harmonic control is used. This is readily apparent from the fact that when a crystal shifts its frequency by two kilocycles, its second harmonic has shifted four kilocycles. Amateurs not contemplating operation right on the edge of a band need not worry about frequency drift due to changes in room temperature; they will not occur fast enough to make any manipulating or "following" at the receiving end necessary. If a pentode tube is used for the crystal oscillator and run at 300 volts or less, the crystal will not heat enough internally to cause any noticeable frequency drift from that cause, even at 14 megacycles.

When a crystal oscillator is keyed and used as a transmitter on 3.5 or 1.7 megacycles, the creep is not serious even with much higher values of plate input, because of

the keying and the fact that the drift is not multiplied as it would be with harmonic operation of a final amplifier.

Crystals are sometimes cut with their axes between the X and Y axes, to reduce the temperature coefficient. It will be remembered that X cut plates and Y cut plates creep in opposite directions with an increase in temperature, the idea being to cut a crystal at such an angle between the two that the drift is zero. Such crystals do not oscillate as freely as crystals cut on either of the two major oscillating axes, and are often very unstable over certain temperature ranges, either going out of oscillation or jumping frequency.

Many amateurs do not fully appreciate the large effect of the crystal holder on frequency. The frequency of an 80-meter crystal can vary as much as 3 kilocycles in different holders. This is because the electrodes of some of the manufactured holders are far from being flat. The warped electrodes touch the crystal in only two or three spots, forming, in effect, a sort of air-gap holder. Some of the holders have a spring to provide tension on the top electrode, which also has an appreciable effect on the frequency.

The amateur who gives his crystal a scrubbing once a week, or makes a practice of rubbing the top electrode around on the crystal to dislodge any dust that may have worked in between them, may find after a year or so that his frequency has increased a few kilocycles, which would be embarrassing if the crystal were purchased for the purpose of operating right on the high frequency edge of a band. With polished crystals there is less danger of such a condition, but if a crystal is put in a dust-proof holder, as it should be, the crystal need not be touched for months at a time.

When plug-in holders or selector switches are used for changing crystals, three crystals about 3 kilocycles apart can be used with the transmitter tuned up on the "middle" frequency, and either of the other two crystals cut into the circuit without retuning the transmitter. Such an arrangement allows instantaneous frequency change, and is very useful when interference is bad. If a selector switch is used, it should be of low capacity, mounted close to the oscillator tube, and all leads to the crystals made as short as possible.

Buffers

If the transmitter is to be used for telephony, or if a very clear, distinctive, clean and piercing note is desired on CW, the oscillator should be isolated from the final stage by at least one "buffer" stage, and preferably more than one buffer stage should be used for telephony on the higher frequency bands.

To most effectively isolate the crystal stage, the buffer next to the crystal, and better still, all buffer stages, should be run from a power supply separate from one used to supply power to the final stage. For CW, variations in plate supply voltage to the final due to keying of that stage are not impressed upon buffer stages, and on a plate-modulated phone transmitter audio voltage developed across the last filter condenser is not fed back into the buffers if a separate supply is used for the final amplifier. However, if the plate supply to the final of a plate-modulated phone transmitter is not also used to supply voltage to a class B modulator, the same power supply can be used for the buffer or buffer stages if it is first decoupled through a 30 henry choke and a condenser of 2 mfd. or larger. The decoupling filter will at the same time provide additional reduction of power supply hum from those stages.

It has been found that a doubler provides better "buffering" action than a neutralized triode, changes in tank tuning and load impedance having less reaction on the previous stage. Whether or not this would be so with a perfectly shielded and neutralized triode working on the same frequency has not been determined, but such conditions are seldom met in actual practice.

Keying the grid of a tube has practically the same reaction on the oscillator as keying the plate circuit of the preceding stage. The same thing applies to a certain extent to a grid-modulated stage. For that reason, where the grid of the final is either keyed or modulated, it is desirable to have two stages between that stage and the oscillator, although this is not absolutely necessary.

When a pair of No. 14 wires feed the transmitter, and one is keying 800 watts or so of input to the final, the line regulation may be such that considerable variation in plate voltage to the oscillator and buffers occurs while keying. Because of the lag effect of the filter on the power supply to the oscillator, the condition will lend an odd "wobbling" effect to the note, not particularly objectionable, but certainly noticeable on the higher frequency bands. Where one is not interested in securing the ultimate in crystal-clear, bell-like notes, the crystal oscillator can be used to directly excite the final, or in a multi-stage transmitter the oscillator can be keyed along with the other stages to permit break-in operation. Keying the oscillator may give rise to "yoops" on frequencies much above 4000 KC.

For most efficient transfer of energy between capacitively-coupled stages of a multi-stage layout, it is wise to alternate low- μ and high- μ tubes in order to avoid the extreme impedance mis-match which occurs when a tube of high plate impedance is capacitively coupled to a tube of low grid impedance. The use of link coupling be-

tween all stages will automatically provide optimum impedance matching, but requires additional coils and condensers. If it should be necessary for any reason to capacitively couple a high-mu tube to the grid of another high-mu tube, such as an 830-B driving an 03-A, or a 47 driving a 46 or 41, the grid of the driven tube should be clipped down a few turns from the plate end of the driver plate tank. To prevent a form of parasitic oscillation that occurs with such an arrangement when used with conventional tapped-coil neutralizing of the driven stage, split-stator neutralization should be used.

When working on 14 megacycles, especially where plate-modulated phone is being used and considerable excitation is not only desirable but necessary, the problem of getting the greatest amount of 20 meter excitation with the simplest and cheapest outlay of parts is of great importance. Although fundamental control with a tourmaline crystal is probably the most simple, such plates are quite expensive, and such an arrangement is usually prohibitive from the standpoint of cost, especially when it is desired to operate on more than one frequency in the band. It is cheaper to use lower frequency quartz crystals and use special means of frequency multiplication to get down to 20 meters. One such an arrangement, using the Dow oscillator, modified to take a crystal and commonly called the "tritet" makes use of the fact that the output circuit of electron-coupled oscillator is rich in harmonics.

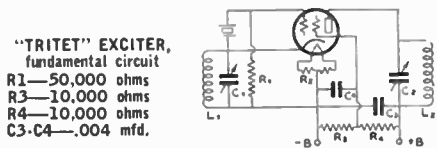

"TRITET" EXCITER,
fundamental circuit
R1—50,000 ohms
R2—10,000 ohms
R3—10,000 ohms
R4—10,000 ohms
C3-C4—.004 mfd.

FIG. 3

Either a 2A5 or 59 can be used in the circuit, the important considerations being to use a high-C cathode tank and a very low-C output tank to get maximum output with minimum heating of the crystal. With tubes of the above mentioned type, it is also important to keep the plate voltage below 350 volts, otherwise the plate current will start to climb after the unit has been in operation a few minutes. The fundamental circuit is shown in Fig. 3. The newer and more modern harmonic oscillator, which gives greater output than the "Tritet", is the Jones Exciter, fully described on page 95.

Fig. 4 shows a circuit using a 53 "twin class B" tube as a combined high-mu triode 40 meter crystal oscillator and high-mu triode doubler. Because of the high value of the grid resistor required for doubling, the oscillator is given a respectable load to work into, in spite of the fact that the circuit is the

equivalent of one high-mu tube capacitively coupled to another. The oscillator coil is wound on a one-inch form, and turns removed one at a time until the circuit goes into oscillation. Further adjustment is then made by merely spacing or compressing the turns until the circuit is stable under operating conditions. No. 22 or 24 DCC wire for the oscillator winding will facilitate the spacing

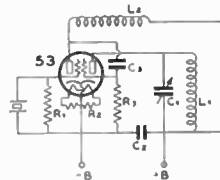

"SIAMESE" EXCITER,
fundamental circuit
C2—.004 mfd.

FIG. 4

adjustment. The doubler tank should be space wound and very low-C, No. 20 enamelled on a two-inch form, making a good coil. It is unnecessary to re-tune the oscillator coil when changing crystals, slight readjustment of the doubler tank condenser being the only change necessary. The grid resistors should be either metallized or of carbon, between 25,000 and 50,000 ohms is the best value. If RF chokes are used in series with the resistors, lower values can be used, with a slight increase in output. The coupling condenser between the oscillator plate and doubler grid should be very small, a few inches of hook-up wire twisted together serving the purpose quite well. The output of the doubler tank should be link coupled to the following stage. This unit allows the crystal to run cooler than the "tritet" formerly described, and gives no trouble from erratic operation as sometimes experienced with the "tritet" under certain conditions. The disadvantage of this "Siamese" circuit is that it is effective only when doubling or tripling, while the Jones Exciter (page 95) will give good output on the fourth, and even higher harmonics.

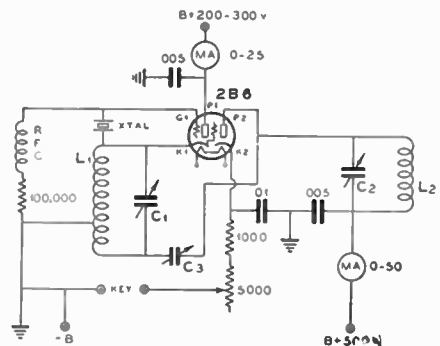

"LES-TET" 2B6 EXCITER

40-Meter Crystals

A 40-meter crystal can be used in the conventional 47 crystal oscillator circuit and link coupled to an 841 doubler running at about 700 volts to excite a 210 to full output with high efficiency on 20 meters, provided the 841 is also link coupled to the 210. On the higher frequencies there is a worthwhile increase in efficiency and output when using the link form of inductive coupling, rather than capacitive coupling. Capacitive coupling is justified at the higher frequencies only for the sake of simplicity where a reduction in efficiency can be tolerated.

When using a 40-meter crystal, special precautions must be taken, and more care given to circuit details than with lower frequency crystals. The use of a suitable holder is of prime importance with 40 meter crystals, many 40 meter crystals refusing to oscillate in any holder except the particular type in which the crystal was designed to operate. Merely because a holder works well with an 80 or 160-meter plate, one should not be led to believe that the holder should work well with a 40-meter crystal.

An excellent holder, one that will work well with most of the 40-meter crystals sold today, can be made by using a silver dime for a top plate, a very fine wire (No. 36 or so) soldered to the dime, and allowed to rest very lightly on the crystal. The silver dime (10-cent piece) should be ground down on one side until it is about .03-in. thick, the fine connecting wire secured with a drop of solder, and the smooth side lapped absolutely flat after the solder has cooled. The bottom electrode must also be lapped absolutely flat, the flatness of the electrodes determining to a large extent the efficiency of the holder. Some 40-meter crystals will work better in the above holder with one side down than with the other side down. The crystal should therefore be reversed in the holder to see if any difference is noted in output or stability. Some 40-meter crystals will show "twin" peaks in the above holder unless used "sunny side up". A 40-meter crystal requires a very light top electrode with no additional spring pressure for maximum output. Spring pressure is not necessary for stability, unless the transmitter is subjected to severe vibration. The faces of a 40-meter crystal are practically flat, and if the surfaces of the holder electrodes are as flat as they should be, the top electrode will not tend to "rock" on the crystal and cause frequency instability.

The electrodes of the holder can be finished on a fresh piece of plate glass with a very fine grade of abrasive. The glass will wear down faster than the metal, but the electrodes can be ground reasonably flat on the side of a wheel or on an oil stone, and not much grinding on glass is necessary.

Unfortunately, not all 40 meter plates on the market will deliver good output even when operated under ideal conditions. It is not enough for a 40-meter crystal to "oscillate"; it must be a free oscillator and stand a reasonable amount of loading without going out of oscillation. Such a crystal must necessarily be ground with a high degree of precision. Most 40-meter crystals are cut a bit under one-inch square, to make them stronger mechanically. This does not seem to affect the output (unless carried too far) and the smaller-than-customary size does not denote an inferior product.

Before placing a 40-meter crystal in its holder, the edges of the crystal should be examined very carefully for nicks. A nick almost invisible to the naked eye will sometimes have an appreciable effect on the output of a 40-meter crystal. If the edges show that they have been chipped, the crystal should be returned to the manufacturer so that the edges can be refinished.

As has been stated, the tank circuit of a crystal oscillator should preferably be low-C on any frequency, but on 40 meters low-C is essential. The coil should not be placed closer than several inches to any shielding, if shielding is used.

While either 25,000 or 50,000 ohms seem to work equally well for the screen dropping resistor on 80 meters, the higher value is preferable with a 40-meter crystal. The grid resistor should also be a bit higher for 40-meter operation; 10,000 ohms is the minimum value for a type 47 tube. Wire-wound resistors can be used without series RF chokes, if the distributed capacity is low and the number of turns of resistance wire is such that the resistor itself acts as an effective RF choke at the operating frequency. The small, manufactured chokes of the sectional-wound, grid-leak mounting type are very effective at 40 meters, and it is a good plan to use one in series with the resistors even if a metallized or carbon resistor is used.

A crystal current that corresponds to 450 plate volts on a type 47 oscillator, loaded and tuned to slightly more than minimum plate mills, is a safe value for continuous operation and will not heat the crystal enough to cause noticeable drift. It is advisable, however, to use a lower value of plate voltage for the preliminary tuning, and to take care that the oscillator does not become detuned or unloaded during regular operation. If sufficient excitation for the next stage can be obtained with lower plate voltage on the oscillator, it should be used in preference to higher voltage because it allows a margin of safety, which is always desirable.

Grinding

Finished crystals are not the expensive luxuries they once were, but many amateurs still prefer to grind their own. Some take



A piece of raw quartz and several unfinished slabs from which oscillating crystal blanks are cut. The best quartz is mined in Brazil.

pride in constructing an entire transmitter, not merely assembling it.

With a little time, patience, and the proper tools and material, any amateur of average ability can finish rough blanks into oscillating plates of good output. It is necessary to observe a few important precautions and to follow instructions carefully.

When ordering blanks, it is well to specify the band in which the crystals are to be operated, as well as the preferred cut, because grinding a 160-meter blank down to 80 meters by hand entails considerable labor. Much time can be saved by procuring blanks that do not run over .008 or .01 inch greater than the calculated finished thickness. This does not apply, however, to 40-meter crystals; it is necessary to purchase a blank considerably thicker in order to be able to grind a flat surface for the reference side, which is of especial importance with 40 meter crystals. A blank only a few thousandths of an inch thicker than a finished 40-meter crystal is too thin to hold a flat surface.

Amateurs who have had no previous grinding experience will do well to first attempt a Y cut 80 or 160 meter crystal. Although it takes no longer to grind an X cut after one has become proficient, X cut crystals must be finished with a greater degree of precision and are therefore best avoided by the novice for the first attempt. By finishing with the proper contour and using a low-C oscillator tank circuit, a Y cut crystal will have but one major frequency response and will have a continuous temperature curve over the normal range of operating temperatures. It is not necessary to resort to a clamp-type holder with heavy pressure (resulting in decreased output)—the trick is in shaping the surfaces. Thus the "X cut versus Y cut"

controversy resolves itself into a question of frequency creep. The temperature coefficient of a Y cut plate is about twice that of an X cut plate (and in the opposite direction), but if the oscillator is run underloaded, as is to be recommended, the drift will be negligible with a crystal of either cut.

The necessary materials and equipment for doing a good job with a minimum of labor and difficulty include a micrometer, several pieces of heavy plate glass, an oil can filled with water, a pan of clean water, several clean towels, a bottle of India ink, a test oscillator, some sort of frequency-measuring device (a calibrated receiver will do), and small quantities of No. 150, No. 280, and No. 400 carborundum. The latter grain is used only in finishing X cut plates, and need not be procured if one intends only to grind Y cuts. Water is used in preference to kerosene, because it is necessary to remove all trace of kerosene each time a crystal is tested in the oscillator. A one-half-inch micrometer, reading to ten-thousandths, is best adapted for thickness measurement, but a one-inch instrument, reading to thousandths, will measure close enough for Y cut plates by estimating to ten-thousandths, and with care can even be used for the lower frequency X cuts if nothing better is available. It is advantageous to grind down the movable face of the micrometer on a wheel so that the tip resembles a cone with a rounded point, rather than the end of a cylinder. This enables one to measure a point on a crystal instead of a section of the crystal. Of course, if the micrometer is a borrowed affair, or is to be later used for shop work, such procedure would be out of the question. Excellent work can be done with a regular, standard micrometer with flat faces.

The test oscillator should be equipped with a plate milliammeter, a dummy load which can be cut out of the circuit, and plug-in inductances so that either low or high "C" can be used in the tank circuit for test purposes. An RF meter in series with the crystal is useful, but not absolutely necessary.

In view of the fact that blanks purchased from reputable manufacturers are almost certain to make good oscillators, it is a waste of time to parallel the faces and test a blank for oscillation before roughing it down. The practice of finishing alternate blanks as cut from the raw quartz makes it possible for a manufacturer to give a reasonable assurance that the blanks he sells will oscillate if properly finished. It is not necessary to pay finished-crystal prices for a tested oscillating blank in order to make sure the blank will make a good oscillator. The rough blanks are cheaper and just about as easy to finish.

Assuming that one has the necessary materials and a 160 or 80 meter Y cut blank which it is desired to convert into a good finished crystal, it is first necessary to finish one side flat, to use as the reference side (some blanks already have the reference side finished and marked). This can be done by rubbing one side around with even pressure on a piece of plate glass that has been smeared with No. 150 Carborundum grain and water until India ink marks which have been placed on the tip of each corner disappear. The crystal is then rinsed in the pan of water and rubbed on another piece of plate glass, covered with No. 280 Carborundum and water, for a half minute or so—care being taken to see that the pressure is fairly even all over the crystal, and that the grinding is being done on the same side. The crystal is then washed, dried, and one corner of the finished side marked with India ink. All subsequent grinding is done on the other side. Using a finer grain of abrasive for finishing Y cut crystals is not advisable, because it does not increase the output but only aggravates the tendency toward twin-frequency peaks. By using a medium grain of carborundum for finishing, and by giving the right contour of the side that is not yet finished, the second peak can be entirely eliminated.

The crystal should now be roughed down with No. 150 grain carborundum until it is .002 or .003 in. thicker than the calculated finished thickness, which will be very close to .022 for 3500 kilocycles, and .0435 for 1750 kilocycles. The finished thickness of a crystal of either cut can be predetermined for a given frequency within fairly close limits by applying the corresponding formula at the end of this chapter. The crystal is next finished down with the No. 280 abrasive to about .0004 in. greater than the calculated thickness (.001 for a 160-meter plate), frequent micrometer readings being taken to

prevent any high or low spots from appearing. The crystal is then put in the oscillator. If its surfaces are reasonably parallel, it should now oscillate. If it oscillates at but one frequency as the tank condenser is varied, it is a most unusual Y cut crystal and is not acting in characteristic fashion. Making sure that it is oscillating at the low-frequency peak, the frequency should be checked to see how closely it is agreeing with the formula. You can now proceed to get rid of the second peak (the higher frequency one) by giving the face you are working on a convex contour. The degree of convexity necessary to give one-frequency operation will vary with different crystals, but in every case the second peak will disappear before the process is carried far enough to affect the output to any great extent. In fact, a moderate curvature will actually increase the output slightly over that of a Y cut crystal that has been ground with both sides perfectly flat.

At this point, the corners should be slightly rounded and the edges finished up. It is best to finish them before putting the final touches on the crystal when attempting to grind the crystal to an exact frequency, because grinding on the edges will sometimes affect the characteristics of the plate. Grinding on the edges has a minor effect on the frequency, and also will sometimes cause a crystal that checks at one frequency to develop a second peak.

The optimum amount of convexity can only be determined for each particular crystal by trial, but it is not critical so long as no spot is higher than the center of the crystal. A contour that has been found suitable for most 80 meter crystals of the Y cut type is as follows: Edges between corners .0001 in. lower than center; corners .0003 to .0005 in. lower than center. For 160 meter crystals the convexity can be slightly greater if necessary to eliminate twin peaks. A piece of glass that has been worn down a bit facilitates grinding a uniform convex contour, but until one has used a piece of glass for roughing-down several crystals it will not be hollowed out enough to do much good. If the glass is nearly flat, pressure on each of the edges and corners—one at a time—will be necessary to get the desired curvature.

A final check for twin frequencies is made by using a tank coil in the test oscillator which requires a bit more capacity to tune to resonance than will ordinarily be used in the transmitter oscillator. No attempt should be made to keep the crystal from oscillating at two frequencies with an extremely high-C tank, because almost any crystal will show a second peak if the oscillator tank is made very high-C. If the "medium-C" tank shows two frequencies, it will be necessary to grind down the tips of the corners until the second one disappears. A soldering iron should then be held near the crystal as the beat note is

oscillator should stand a reasonable amount of loading without going out of oscillation, and it should be stable when loaded.

If the finished crystal gives good output and has only one frequency response, one is then justified in attempting to grind an X cut plate.

The reference side of an X cut blank is ground down with No. 150 and No. 280 grain carborundum in the same manner as a Y cut blank. It is then rubbed around for a half minute on a fresh piece of glass which is covered with No. 400 abrasive and water. It is imperative to use a fresh piece of glass for finishing the reference side of an X cut blank, because an X cut crystal will not give maximum output if either side has the slightest suggestion of a convex curvature. One exception can be made; some manufacturers grind their X cut plates with a special contour which calls for sections of the crystal being very slightly convex, but the amateur with but little grinding experience will do well to keep away from such special trick contours. The output of an X cut plate can be boosted by merely grinding it slightly concave on the finishing side. Paradoxically, while Y cut plates have twin frequencies when the curvature is not great enough, X cut plates exhibit double frequencies only when the curvature is too great. It is necessary, however, to take quite a piece out of the center of an X cut crystal before the second frequency appears, unless a very high-C tank is used in the oscillator. Grinding the center of an 80 meter X cut plate .0001 or .0002 in. low will boost the output without encouraging a second frequency.

After inking the reference side, the blank is roughed down to about .003 or .004 in. over the calculated finished thickness with No. 150 carborundum, and then down a little further with No. 280 grain. The final grinding is done on a little-used piece of glass, covered with No. 400 grain and water. Enough pressure is exerted in the center of the crystal with one finger to bring the center .0001 or .0002 in. lower than the edges and corners. No spot should be lower than the center, otherwise the output will be disappointing. A fresh piece of glass should be used for finishing each X cut crystal. The glass is then still suitable for grinding Y cut plates or roughing-down X cuts. Because 160-meter X cut crystals are too thick to be hollowed out easily by exerting pressure in the center, even if fresh pieces of plate glass are used, it is necessary to finish them on a special piece of convex glass.

Finishing the edges on X cut plates is of greater importance than on Y cuts. An X cut plate with unfinished edges may even refuse to oscillate unless the edges and corners do not vary over .0001 in., or unless about .0005 in. has been hollowed out of the center (which is enough to cause double response

frequencies). A crystal with variation greater than .0001 in. between the different corners and edges may give full output, however, after the edges are finished; for this reason it is important that every last nick be removed from the edges when finishing X cut plates. In any event, unless the crystal has been ground to a very high degree of precision, careful finishing of the edges will boost the output of X cut plates. X cut crystals that refuse to give full output can sometimes be made to oscillate more freely by grinding the edges so that the cross-section of the crystal is reduced. . . that is, to grind so that the dimensions of the crystal along the other axes is changed.

The following hypothetical measurements will serve to show the desired contour as well as the permissible thickness tolerance of an 80 meter X cut plate: Corners, .0318, .0317, .0318, .0318. Edges between corners, .0317, .0317, 0.316, .0317. Center, .0315. A crystal with an ideal contour would have all points in each group the same, with the second group about .00005 (half a ten-thousandth) in. lower than the first, and the center about .00015 lower than the corners. For 40 meter crystals the allowable tolerance for maximum output is greatly reduced. And as their thinness presents additional grinding difficulties, the layman should be discouraged from attempting to grind them. For this reason the grinding of 40 meter plates is not discussed here.

Finished X cut crystals can be tested for output in the same manner as previously described for Y cut plates, but if the crystal has not been made too concave, all references to twin frequencies can be disregarded.

To finish the edges of crystals of either cut, all nicks are first ground out by using the same grade of abrasive as is used to finish the faces, but with slightly less water. To complete the job, the corners and edges are then rounded off a bit.

The India ink reference mark can be removed with a moistened, soft rubber eraser. The plate should be washed with soap and warm water in order to remove any rubber gum which may adhere to the unpolished surfaces of the crystal, if the mark is removed in that manner.

X cut crystals can be polished water-clear with rouge, but the output will not be increased, provided a fine grade of abrasive has been used for the finishing grinding.

Formulae:

$$\begin{array}{l} \text{X cut } T \frac{112.6}{F} \\ \text{Y cut } T \frac{77}{F} \end{array}$$

When T is the thickness in inches, and F is the frequency in kilocycles.

The Jones All-Band Exciter

● Quantitative experiments with various types of quartz crystal oscillator circuits proved the fact that a type 53 or 6A6 tube makes an excellent oscillator and harmonic generator which operates with very little crystal heating. The 53 and 6A6 tubes have two high mu triode tubes in one envelope; the type 53 has a 2.5 volt heater and the 6A6 has a 6.3 volt heater. Their characteristics are quite similar and both tubes should be operated with at least their full rated heater voltage, especially if 300 to 400 volts is applied to the plate circuits.

The best results with a type 53 are obtained when one triode is used as an oscillator and the other as a harmonic doubler or generator. The 53 tube has a high mutual conductance and a high amplification constant; thus it is very well suited for use as a crystal oscillator. Considerable output without need of much grid driving power, which in turn means low RF current through the crystal, results when the 53 tube is used. Low RF current through the crystal results in a minimum of temperature change and, therefore, minimum frequency change. For a given allowable amount of RF crystal current, more output is therefore obtainable than with most of the other oscillator circuits. The 53 or 6A6 tube will give high output with low plate voltage. Its harmonic output is higher with 300 to 400 volt plate supply than a Tritet oscillator having a 500 to 600 volt power supply. This results in economy, since an ordinary BCL power supply is suitable.

The oscillator section works fine when heavily loaded, and also with less crystal RF current. Capacity coupling is used to the other triode section and the latter acts as a very efficient harmonic generator. It has a high mutual conductance and with high RF excitation and bias it becomes a fine doubler or quadrupler. About 5 watts of RF is available from the oscillator section to swing the grid of the doubler section and excellent power efficiency is obtained for the overall tube input to output on any desired harmonic frequency.

Fig. 1 shows the simplest oscillator-doubler circuit, while Fig. 2 shows the same circuit with regeneration in the harmonic section in order to secure reasonable outputs up to the 8th harmonic. Using the circuit of Fig. 1, an output of 5 watts is obtained on 80 meters from an 80 meter crystal, 5 watts on 40 meters and 0.7 watts on 20 meters. These outputs are obtained from a 300 volt power supply with a total cathode current of from 50 to 90 milliamperes, which is about equally divided between the two triode plates. The crystal current is about 37 MA.

With a 160 meter crystal, an output of 3.5 watts on 40 meters is obtained with 320 volt

plate supply at 100 MA DC and a crystal current of 18 MA. An output of .15 watts is obtained on the 8th harmonic on 20 meters with the same approximate values of input.

A 40 meter crystal gives 4 watts output on 20 meters with $E_B=360$ volts, $I_B=80$ MA, $I_X=85$ MA of crystal current. The higher frequency crystals always have greater RF

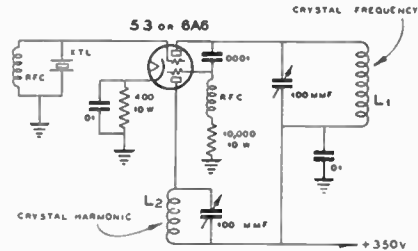

FIG. 1

Jones Exciter for two-band operation.

current and therefore may be desirable to operate on a higher order harmonic in order to minimize crystal heating. Ordinary high loss bakelite coil forms and a cheap grade of widget condensers and wafer sockets were used

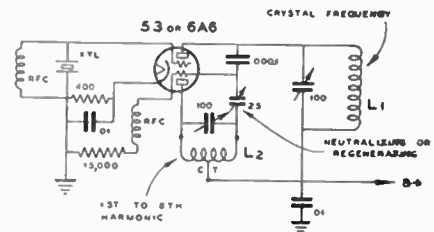

FIG. 2

Jones Regenerative Exciter for all-band operation.

in a laboratory oscillator from which the foregoing data was secured. Undoubtedly, greater output can be obtained if isolantite coil forms, sockets and isolantite insulated condensers are used. The same coils and condensers were used with a pentode and Tritet oscillator circuits so that a fair comparison could be made. The RF output was measured by means of another tuned circuit, link coupled to the output circuit, across which was placed a non-inductive 500 ohm resistor in series with a thermocouple. This form of load gives a fair simulation of the grid circuit of a buffer stage, or output stage, as shown in Fig. 3.

Next a pentode oscillator was set up with a type 59 tube. This gave an output of 1.6 watts on 80 meters from an 80 meter crystal with $E_B=300$ volts, $I_B=27$ MA and $I_X=20$ MA RF. At $E_B=430$ volts, $I_B=38$ and $I_X=25$

All-band Jones Exciter.

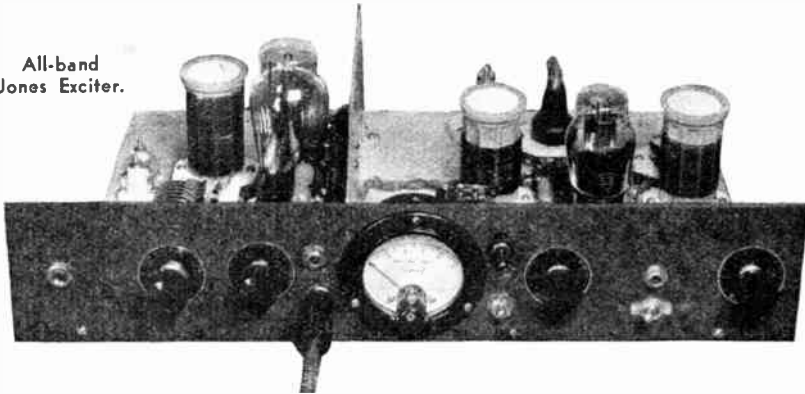

MA, the output was 3.3 watts. The value of I_B included both plate current and screen current, the latter running from 6 to $7\frac{1}{2}$ MA.

The pentode oscillator with a 40 meter xtal gave an output of 3.3 watts with $E_B=380$, $I_B=50$ MA and $I_X=45$ MA RF. The screen voltage was maintained at from 110 to 125 volts in these tests.

A Tritet oscillator was next set-up, using the same 59 tube. At least 3 tubes of each type were tested in each circuit in order to be certain of the results. The Tritet gave an output of 5 watts on 40 meters from an 80 meter crystal with $E_B=400$, $I_B=45$ and $I_X=77$ MA RF. At the same value of plate voltage as used with the 53 tube oscillator, the output was only 2.6 watts with $I_B=50$ and $I_X=57$ MA RF.

With a 40 meter crystal the Tritet gave an output of 0.8 watts on 20 meters at $E_B=320$

volts, $I_B=30$ MA and $I_X=80$ MA and E screen=250. At $E_B=400$, $I_B=43$ MA, $I_{xtal}=70$ MA and $E_{SC}=130$ volts the output was 1.2 watts. Raising the screen voltage to 300 increased the 20 meter output to 2.0 watts but the tube and crystal were both overloaded. It was found that the Tritet oscillator gave very poor results with some crystals which worked fine in a pentode or 53 tube oscillator circuit. This seems to be a common complaint about the Tritet oscillator.

The Tritet with 160 meter crystal gave an output of 1.0 watts on 80 meters at $E_B=390$ volts, $I_B=50$, $E_{SC}=110$ volts and $I_X=18$ MA RF. Its quadrupling output was 0.2 wats on 40 meters at $E_B=400$ volts, $I_B=40$ MA, and $I_X=22$ MA RF. As a quadrupler its output was less than 1/17 of that given by the 53 oscillator-quadrupler,

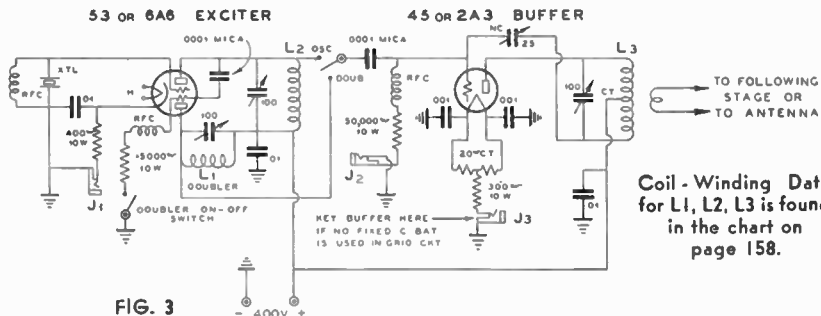

Coil - Winding Data for L1, L2, L3 is found in the chart on page 158.

ALL BAND TRANSMITTER USING JONES EXCITER
20 WATTS OUTPUT - 15 WATTS ON 14 MCS

The circuit shows the Jones Harmonic Oscillator which uses either a 53 (2 1/2 volt) or a 6A3 (6.3 volt) tube in the oscillator circuit. The output from the buffer stage, which uses either a '45 or a 2A3 tube, is 20 watts on 160, 80 and 40 meters; 15 watts on 20 meters. Keying can be accomplished in the oscillator cathode circuit (Jack J1), for preventing key clicks if battery bias is used in the buffer grid circuit. The buffer can be keyed as shown in the above circuit. A single power transformer is all that is required for both the oscillator and buffer stages, but the transformer should have two separate 2 1/2-volt filament windings, one for the oscillator heater, and one for the buffer tube filament. The +B by-pass condensers are .01 mica, 1000 volt rating. The cathode by-pass condenser is a .01, paper or mica. The RF chokes are the conventional small size 2 MH (approx.) receiving type. The 100 mmf. tuning condensers are Star Midgets, receiving type. The neutralizing condenser is a 15 to 25 mmf. Star Midget, double spaced.

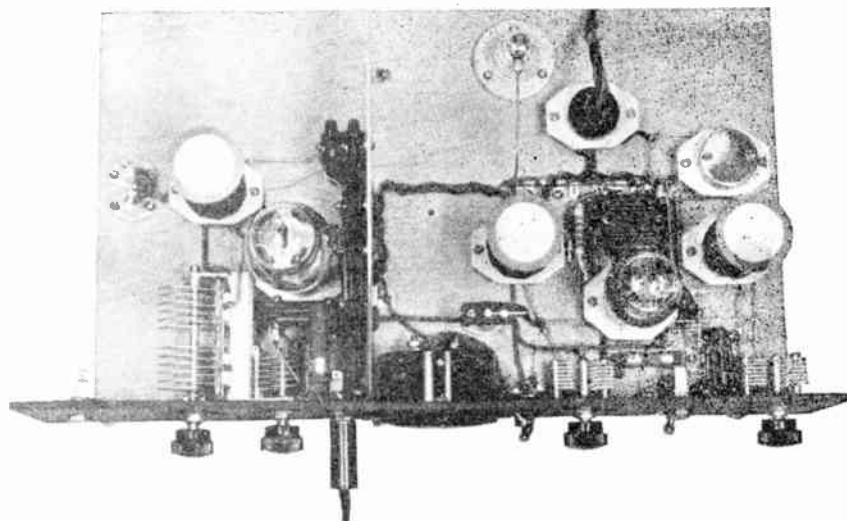

Looking down into the Harmonic Oscillator. An aluminum shield separates the oscillator-doubler from the buffer stage. Reading from left to right, the variable condensers are: buffer plate tank condenser, a double spaced 2-section Hammerlund 35 mmf. per section midget variable, with both stator sections connected in parallel to give 70 mmf. Neutralizing condenser, double spaced Star 25 mmf. Doubler plate tuning condenser, 100 mmf. Star midget. Oscillator plate tuning condenser, 100 mmf. Star Midget.

although its input was over half as much. The input was figured as the plate and screen input in the case of either the pentode or Tritet oscillators.

The 53 harmonic oscillator gave much greater output on the higher harmonics when regeneration was introduced into the second triode. With a 380 volt power supply the total plate current ran from 50 to 75 MA with a 160 meter crystal, and outputs were obtained of 5.0 watts on 160 meters; $7\frac{3}{4}$ watts on 80 meters; 5.5 watts on 40 meters, and 2.0 watts on 20 meters (8th harmonic). This is sufficient output to drive a type 10 buffer stage at moderate output even on 20 meters from a 160 meter crystal and a single 53 or 6A6.

The overall efficiencies of a 53 oscillator and a Tritet, with the best 80 meter crystal tested, gave 23% for the Tritet on 40 meters and 25% for the 53 with regeneration. In quadrupling there is no comparison at all, because the 53 gives over 10 times as much output as a Tritet for the same input.

Regeneration makes the circuit somewhat complicated and adds another adjustment. If doubling only is desired, regeneration is hardly worth using. On the other hand, regeneration is required for the higher-order harmonics, but care should be taken to see that too much feed-back is not introduced, otherwise the circuit can act as an oscillator at the frequency determined by the harmonic triode tuned circuit.

For general use, the simplest form shown in Fig. 1 is desirable. It can be used to drive one or two 45 tubes as a buffer or low-power transmitter. The 45 tube will deliver as high as 20 watts output on 40 meters, using a type 53 tube and an 80 meter crystal. Over 15 watts output can be obtained on 20 meters from a 40 meter crystal when using a single 53 and 45 tube with a 400 volt power supply, capable of supplying about 150 MA. The circuit shown in Fig. 3 is suitable for this purpose.

The simplest test or adjustment of this circuit is to use a single turn of wire and a 6 volt pilot lamp as an indicator of oscillation. The oscillator is first adjusted for maximum output, then the doubler is similarly adjusted. If the doubler section is not used, its grid-leak circuit should be opened in order to remove the load from the oscillator section. The grid leak increases the bias of the harmonic producing triode to a great many times cut-off bias. The 400 ohm cathode resistor provides a fixed bias to both of the triode sections, and also stabilizes it for use on voltages over 300 as plate supply.

The same loop of wire and lamp can be used to neutralize the 45 stage before plate voltage is applied. Adjust the neutralizing condenser so that the lamp does not light up at all at any setting of the 45 tube plate circuit tuning condenser. Self-bias on a 45 or 2A3 stage is desirable if over 300 volts is used for plate supply, in order to prevent the plate current from climbing.

The Proper Tube to Use in a Low-Power R.F. Amplifier

When used as a buffer to isolate the final from the oscillator, the '45 provides better "buffing" action than a '46. Even slight changes in plate voltage or plate load cause a noticeable change in the grid impedance of a '46. When using a '45, changes in the output circuit react but little upon the grid impedance. The difference between the two types of tubes in this respect was brought home strongly when a typical low-powered, 160-meter phone, using a '47 link coupled to a pair of '46s in the final was found to have such a bad case of frequency modulation as to be objectionable. The '46s were replaced with '45s, and the frequency modulation was cut down to a point where it could not be detected by the "zero-beat, beat-oscillator" method.

When its performance as an RF amplifier is compared to that of a '46, the lowly '45, makes the '46 look poor in comparison.

Comparing the two tubes we find the following in favor of the '45:

In spite of the fact that the '45 has a somewhat lower wattage filament, it also has a higher mutual conductance (measured at zero bias) than the '46 (grids tied together and considered as a single grid). The lower mutual conductance of the '46 is largely due to the greater "shadow" effect of the grid(s), which becomes quite appreciable in multiple-grid tubes. Because of its higher mutual conductance, the '45 actually requires fewer WATTS excitation than a '46 to drive it TO A GIVEN OUTPUT WITH A GIVEN EFFICIENCY. Though it takes more VOLTAGE SWING, it can be said that the '45 is the easier to excite, because driving POWER, not voltage, is the criterion of ease of excitation.

The plate impedance of the '46 is several times that of the '45. Thus for a given effi-

ciency in the output circuit (ratio of load impedance to plate impedance), much looser coupling must be used to the plate tank of the '46 (raise the load impedance). Then, to bring the output back up, the plate voltage must be run sky high, and high voltage spells "bad medicine" for '46 tubes. Although the interelectrode spacing and the spacing of the plate lead coming through the

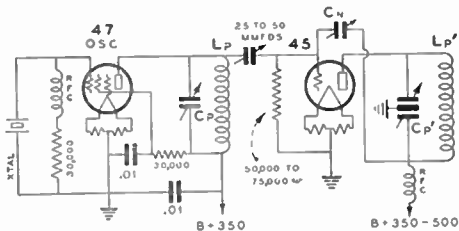

Single 47 to single 45

stem is much greater in the '46, it will not stand any more plate voltage than a '45. The gas content . . . not the spacing . . . limits the plate voltage that can safely be applied to a '46. Oddly enough, many '46s will turn more blue at a given plate voltage and input than a '45 of the same make operated under the same conditions. The '45 permits GREATER EFFICIENCY than is possible with a '46, both adjusted to a given output at a given plate voltage.

Because of its high grid impedance, the '45 can be more advantageously capacity coupled to the preceding stage than a '46 (presuming that it is desired to clip right off the "hot" end of the plate tank of the preceding stage to avoid parasitics). The '46, with its very low grid impedance, requires an extremely small coupling capacity to give the preceding stage a sufficiently high load impedance, and most of the excitation is being wasted. The grid impedance of a '45 offers a very respectable load for most tubes, and the grid of a '45 can be capacity coupled on the lower frequency bands with almost as much efficiency and as great a transfer of energy as can be obtained with link coupling.

The optimum value of grid resistor being very high (between 50,000 and 75,000 ohms for a single tube), it is permissible to dispense with the grid choke in capacity-coupled circuits using a '45. The only precaution necessary is to make sure that the grid resistor is either of the carbon or metal-tapped filament type (non-inductive).

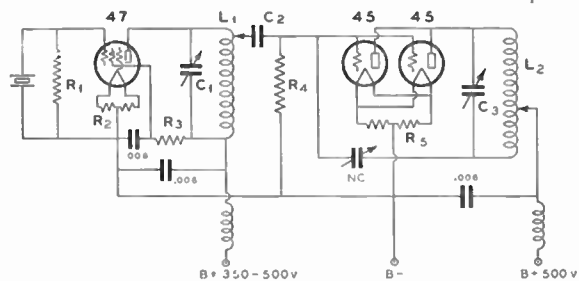

47 oscillator capacitively coupled to a pair of 45s in parallel. Constants: C1—100 mmf.; C2—Preferably a 25-50 mmf. variable; C3—Closely-spaced plates, receiving type condenser; R1—25,000 ohms; R2—Filament C.T. Resistor, 20 ohms; R3—30,000 ohms; R4—Two 75,000 ohms, 2 watt resistors in parallel. No grid choke is required; R5—Center-tapped filament resistor, 50 ohms.

Frequency Multiplication

The quartz crystal is useful only at frequencies below about 8 megacycles and thus it becomes necessary to provide one or more stages of frequency multiplying amplification between a crystal oscillator and a final amplifier which is to operate on a frequency higher than the 8 MC limit. There is distortion, to some extent, in almost every vacuum tube amplifier, and this distortion represents the generation of new frequencies which are integral multiples of the exciting grid frequency. By tuning the plate circuit to the frequency of the desired harmonic frequency, the fundamental and all undesired harmonics are by-passed to ground, and the desired harmonic (usually the second, third or fourth harmonic) is passed on to the grid circuit of the next stage.

For efficient doubling it is essential that the doubler amplifier be adjusted rather carefully. For every tube there is one particular value of grid excitation and grid bias that will give maximum harmonic output; thus it is desirable to provide a means of smoothly adjusting both factors. It will be found that more bias is necessary for plate doubling than for straight class C operation. Pentodes and high mu triodes such as the 53, 46, 59, 841, 203A, RK21 and 838 make good doublers, although there is some question as to whether or not the high mu tubes are better than the medium mu tubes, such as the 210, 211, 852, 50T, 354 and 150T when regeneration is used. Regeneration can be applied to any single-ended doubler stage by using any of the conventional neutralizing circuits. When the plate circuit is tuned to a harmonic of the grid circuit, the neutralizing circuit becomes a feedback circuit.

Push-Push Doubling

The push-push circuit in Fig. 2 differs from most doubler circuits in that doubling is not dependent on distortion, but on the fact that each RF impulse applied to the grid circuit results in two plate current impulses being applied to the plate tank circuit. This is because the grids are excited in push-pull and the plates excite the plate tank in parallel. Thus there are twice as many current impulses in the plate circuit as there are cycles in the grid circuit—in other words, the frequency of the plate tank is twice that of the grid tank.

The simpler forms of the push-push doubler sometimes show a bad tendency to oscillate. The circuit in Fig. 1 is particu-

larly bad in this respect. The circuit in Fig. 2 is much more desirable, particularly if a shielding baffle is provided between the grid tank and the tubes. When using the higher C tubes as push-push doublers it is often desirable to use the KH type of push-push doubler shown in Fig. 3. Oscillation is effectively prevented by neutralizing each tube

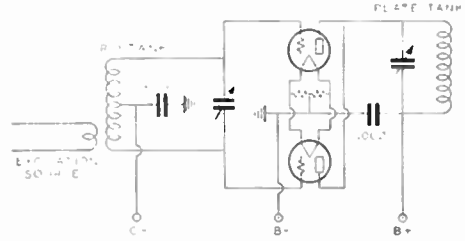

FIG. 1
Wrong Way.

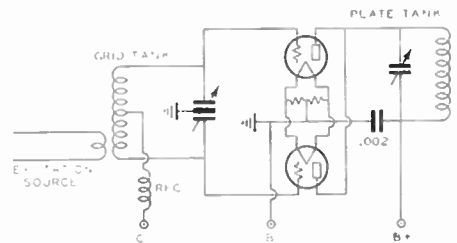

FIG. 2
Right Way.

separately. Fig. 3 shows the standard KH doubler circuit.

The circuits should be neutralized while connected as a regular push-pull amplifier, after which no changes are necessary. Then to increase frequency by a factor of two, change the tank coil of the final to one that will tune to twice the frequency of the grid circuit, and with no load coupled to the final, apply a reduced plate voltage and vary the tank condenser until a pronounced dip in the plate current is found. The final now is ready for operation with a load.

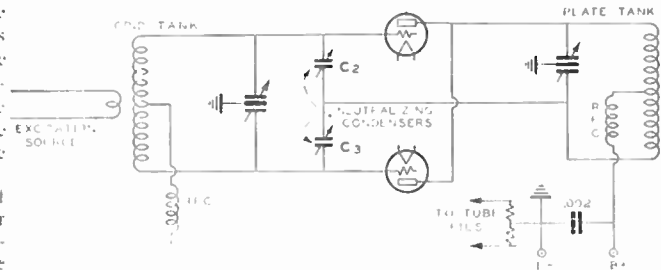

FIG. 3

Neutralizing the RF Amplifier

Neutralization of a radio frequency power amplifier is necessary in order to prevent self-oscillation. Self-oscillation usually occurs in a power amplifier because of the electrostatic energy fed back through the plate-to-grid capacity of the tube itself. The energy in the plate circuit is many times that in the grid circuit and self-oscillation results even if only a small fraction of the plate circuit energy is applied to the grid circuit. The capacity feedback through the tube is neutralized by splitting the plate or grid tank circuit so that the voltages at each end of whichever coil is split are equal, but opposite in polarity, with respect to the center of the split tank, which is at ground po-

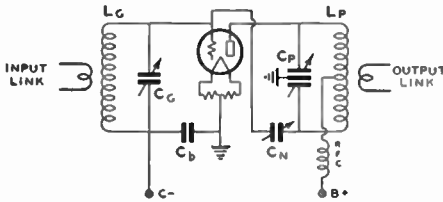

FIG. 1

Plate, or Hazeltine Neutralization.

tential as far as the radio-frequency current is concerned. Both ends of the split tank circuit are then connected to the hot end of the other tank circuit. In other words, when using plate neutralization both ends of the plate tank are connected to the grid of the tube (one end through the tube capacity and the other through an external neutralizing capacity which is exactly equal to the internal tube capacity) See Fig. 1. Thus two feedback voltages are applied to the grid, but because they are equal and opposing, the net voltage is always zero, so that the effective grid voltage (AC) is independent of the RF voltages in the plate circuit.

In the grid-neutralized amplifier (Figs 2, and 3) the grid coil is split . . . the plate coil is not. Thus the high RF plate voltage (AC) is applied simultaneously to both ends of the grid tank. For this reason there can be no potential difference between the two ends of the grid tank, caused by feedback from the plate tank, and the effective net grid voltage is again independent of what is going on in the plate circuit. It will be seen that it is essential that the two capacities which are used to feed back the RF plate voltage to the grid circuit must be exactly equal, if the two voltages are to exactly neutralize each other. Thus the capacity of the neutralizing condenser should almost exactly equal the plate-to-grid capacity of the tube used.

Grid neutralization is always preferable when link coupling is used between stages, because it makes possible the use of cheaper plate tank and neutralizing condensers. Plate neutralization is more desirable when capacitive coupling is used.

How to Neutralize

In a perfectly neutralized RF amplifier there is no coupling from the plate circuit to the grid circuit. By the same token, there

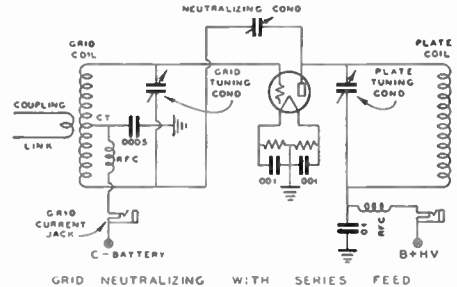

FIG. 2

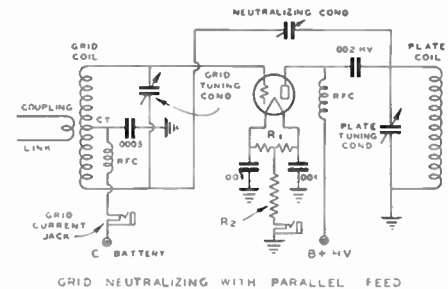

FIG. 3

is no coupling from the grid circuit to the plate circuit. This characteristic is used in adjusting the neutralizing condenser during the neutralizing process. WITH THE PLATE VOLTAGE REMOVED FROM THE STAGE BEING NEUTRALIZED, RF excitation is applied to the grid circuit. Some form of RF indicator, such as a thermo-galvanometer, neon bulb or flashlight globe with a single loop of wire, should then be coupled to the plate circuit. If the amplifier is not neutralized, there will be an indication of RF in the plate tank circuit, when it is tuned to resonance. The neutralizing condenser should be slowly varied until all indications of RF in the plate tank circuit disappear. After each variation of the neutralizing condenser it will be necessary to retune the grid and plate tank circuits in order to restore resonance in both these circuits.

The above process depends on the sensitivity of the RF indicator in the plate tank for perfect neutralization. A neon bulb or

flashlight globe is not particularly sensitive.

A more desirable method is to place a 0-25 ma. DC milliammeter in the DC grid return to the stage which is being neutralized. Apply sufficient RF grid excitation to give a good grid current reading on the milliammeter after tuning the grid circuit for maximum grid current.

If the amplifier stage is not perfectly neutralized, a variation in the DC grid current will be noted when the plate tank condenser is swung through resonance. The neutralizing condenser should be varied slowly until no variation in DC grid current is shown by the milliammeter (in the grid circuit) as the plate tank condenser is tuned through resonance. The grid meter is a very sensitive indicator of perfect neutralization.

If the amplifier which is being neutralized is NOT the final amplifier, another procedure can be followed. A DC grid current meter should be placed in the grid circuit of the stage following the buffer stage which is being neutralized. There should be no plate voltage on either stage. Both the grid and plate circuits of the stage being neutralized should first be tuned to resonance. Then tune the grid circuit of the next stage to resonance. A small grid current reading will be obtained as long as the buffer stage is not neutralized. When the buffer stage is perfectly neutralized, the grid current on the following stage will entirely disappear. The point here is that the grid circuit of the stage which follows the one being neutralized acts as a diode vacuum tube voltmeter and is a very sensitive indicator of RF which is present in the plate tank of the stage being neutralized.

Neutralization of a Push-Pull Stage

The neutralization of a push-pull RF amplifier is accomplished in exactly the same manner as used for neutralizing the single-ended amplifier. The neutralizing condensers are varied in small steps until all indication of RF disappears from the plate tank, or else until there is no variation in DC grid current when the plate tank is tuned through resonance. Both neutralizing condensers should be varied in the same direction, at the same time. In fact, it is sometimes desirable to gang the two neutralizing condensers in order to simplify the adjustment.

Most neutralizing troubles are caused by the RF return from the grid and plate tanks to ground. From the cold end of each tank coil (center of a split coil) there should be a short and direct RF path to the filament center tap of the tube (or tubes). If a split-stator tank condenser is used the rotor should be tied to the center-tap of the filament. If a single-section condenser is used with a split coil, the center of the coil

should be by-passed back to the filament through a mica condenser of from .001 to .006 mfd., the size of the condenser depending on the frequency used; the lower the frequency, the higher capacity of the by-pass condenser. Also, the higher the interelectrode tube capacities, the larger the condenser required in the plate and grid returns.

It is an established fact that the lower C tubes (such as the 800, WE304A, 50T, 852, 150T, 354 and 831) are materially easier to neutralize, particularly at the higher frequencies, than those tubes which have higher interelectrode capacities.

Parasitics

Parasitic oscillations are oscillations at some frequency other than the frequency at which it is desired to amplify. Parasitic oscillations in a radio frequency amplifier can usually be attributed to the stray inductance and capacity in the leads between the tank circuits and the tube elements. The best remedy is to use a low C tube and short, direct leads to the various tank circuits. The leads can be made as short as one or two inches, if the transmitter is properly laid-out. Another type of parasitic oscillation is due to what might be described as super-regeneration. It is evidenced by a series of RAC signals spaced perhaps 10 KC apart over a wide range in the neighborhood of the transmitter frequency. This trouble is particularly common when tubes which must be biased somewhere between three and four times cut-off are used for efficient operation.

Operating Tubes In Parallel

It is often desirable to operate vacuum tubes in parallel at both audio and radio frequencies. This type of operation sometimes introduces parasitic oscillation, which is undesirable. The most common type of parasitic oscillation can be effectively pre-

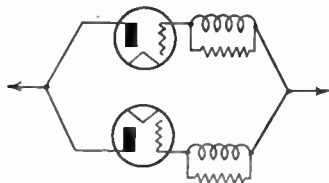

vented by shunting a small RF choke with a carbon resistor of about 50 to 200 ohms. The choke should consist of about 5 to 10 turns of No. 22 enameled wire, wound to a diameter of about one-half inch. The chokes can often be wound around the resistor, which also provides a convenient method of mounting.

Grid Bias

Practically all radio-frequency power amplifiers are operated under conditions such that plate current flows in the form of short, peaked impulses which last for less than one-half of the alternating current cycle. This means that plate current is "Cut-off" during most of the RF cycle and this condition is highly desirable for high efficiency and high power output from small tubes. In order to keep the plate current at zero during most of the RF cycle it is necessary that the control grid of the amplifier tube be kept quite negative with respect to the filament by means of a DC voltage which is termed "negative bias." The AC excitation voltage, which usually comes from the plate circuit of the preceding amplifier stage, periodically overcomes this bias voltage and even makes the grid slightly positive with respect to the filament and therefore causes a short impulse of plate current to flow.

If no grid bias were used, the tube would draw plate current all of the time. This would result in very inefficient operation because the plate would never have an opportunity to cool off.

Cut-Off Bias

Cut-off bias is that value of negative bias which is just sufficient to reduce the plate current to zero. Then, by means of batteries, apply different values of negative bias to the control grid of the tube. If a reading is taken on the plate milliammeter with varying values of negative grid bias on the control grid, it will be found that the plate current decreases as the negative bias is increased. At one point it will be found that the plate current is reduced to zero, and any further increase in negative grid bias has no effect on the plate current which remains at zero. Thus the lowest value of negative grid bias which reduces the plate current to zero is termed "cut-off bias." If the negative bias remains fixed for a moment at the cut-off point, and if the plate voltage is then increased, it will be found that the tube will again draw plate current. With the plate voltage remaining fixed at its newer and higher value, it is found that more negative bias than was used before must be applied to the control grid to again cut off the flow of plate current. Thus the conclusion is reached that there is some definite relationship between the plate voltage and the amount of grid bias necessary to cut-off the plate current. Cut-off bias, therefore, depends on the plate voltage and must be made higher as the plate voltage is increased.

It is not necessary to experiment with bias batteries and different plate voltages in order to determine cut-off bias for a given set of conditions. It can be calculated quite

closely by simply dividing the voltage applied to the plate by the amplification factor of that tube, which may be obtained from any table of tube characteristics. Thus for a 210 tube operating with a plate voltage of 600 volts, cut-off bias is determined by dividing 600 by 8.5 (average amplification factor or μ of a 210), which is approximately 76 volts. When estimating cut-off bias in this manner it is usually desirable to add from 5 per cent to 10 per cent more bias than that calculated, because of the variable μ tendency which is characteristic of all control grids as the cut-off point is approached.

Effect of Bias on Efficiency and Output

The amount of negative grid bias has a very definite effect on plate efficiency and power output. If the plate voltage and RF excitation voltage remain fixed, and if the bias voltage is increased beyond the cut-off point in a radio-frequency power amplifier, the power output and input decline, although

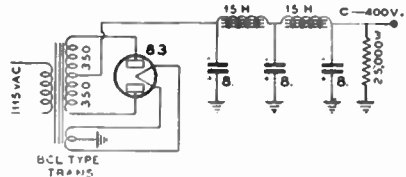

Here is shown a Bias Pack which uses a medium-to-high resistance bleeder. Voltage regulation is usually unimportant in biasing a class C amplifier and thus only enough bleeder is used to protect the filter condensers.

the plate efficiency rises. It is therefore necessary to make a compromise between power output and plate efficiency. The smallest amount of bias that allows the plate of the amplifier tube to run cool should be used beyond the cut-off point. This results in the maximum power output for a given tube, plate voltage, and RF excitation voltage. If it is desired to increase the power output it will be necessary to increase the plate voltage, loosen the antenna coupling, and in many cases increase the radio-frequency excitation voltage. When this is done the bias must be readjusted to the lowest value that allows the plate to remain cool, as previously mentioned. The actual value of this bias, as measured in number of times cut-off bias, will vary from about 1.25 times cut-off in a low-efficiency, high-gain buffer stage to about 4 times cut-off bias in an extremely high efficiency low-gain amplifier, operating with very high plate voltage and RF excitation. The bias voltage and the grid driving power

are closely related and the higher the bias the more grid driving power is necessary to reach a given power output. For tubes of generally-similar characteristics, the one with the highest zero bias mutual conductance (see tube tables) requires the least amount of bias and grid driving power for maximum power output and plate efficiency. As an example of the effect of mutual conductance

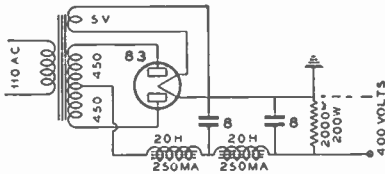

In the Bias Pack shown above, a low-resistance bleeder is used to provide a heavy, continuous current drain in order to stabilize the voltage output. A Bias Pack of this type is suitable for class B audio or class BC Linear Amplifier operation. The ungrounded side is the negative terminal.

on the required bias voltage (and therefore the amount of excitation power necessary) it is found that under a given set of conditions a type 852 must be biased to 3.5 times cut-off and excited with 106 watts of grid driving power in order to obtain 400 watts of radio-frequency power output at 80 per cent plate efficiency. On the other hand, a type 150-T, or 354, which has a considerably higher mutual conductance when used under the same conditions in the same amplifier stage, requires a bias of only 2.1 times cut-off and only 29 watts of grid driving power is necessary to obtain the same 400-watt output at the same plate efficiency (80 per cent).

When a radio-frequency power amplifier is plate modulated, the negative grid bias must be equal to or greater than twice cut-off. This is necessary in order that the peak power output can increase as the square of the plate voltage, which is essential for linear modulation.

Sources of Bias

In general, bias can be supplied from two distinct sources: (1) from within the amplifier circuit itself, due to a voltage drop across either a grid-leak resistor or a cathode bias resistor. (2) From a source external to the amplifier circuit itself, such as batteries or a special rectified AC bias supply pack.

Grid-Leak Bias

Whenever the control grid of an amplifier tube becomes positive with respect to the filament (as it does in all radio-frequency power amplifiers), the positive charge on this grid attracts some of the electrons emitted from the filament. These electrons flow back to the filament through the external DC

grid return and therefore cause a current flow in that circuit. If a resistance is placed in series with the grid return, there will be a voltage drop across that resistor due to the current flowing through it; the end closest to the grid will be negative with respect to the end closest to the filament, thus necessarily causing the grid itself to become negative with respect to the filament. The voltage drop across this grid-leak resistor consists of a varying AC voltage superimposed on a constant value of DC voltage, which DC voltage is proportional to the effective value of the grid current impulses. The AC component is of no concern because it is by-passed by means of a condenser directly back to the filament, and thus by measuring the DC grid current with a DC milliammeter in series with the grid leak, the grid bias can be easily calculated by Ohm's law by multiplying the grid current by the ohmic resistance of the grid leak.

Grid-leak bias is quite flexible and more or less automatically adjusts itself with any variation in RF excitation. The value of grid leak resistor is not particularly critical because the DC grid current usually decreases as the grid-leak resistance increases, thereby keeping the product of the two more or less constant for a given amount of RF excitation. Thus the value of the grid-leak resistance can vary from one-half to two times the optimum value, a ratio of four to one, without materially affecting the negative DC bias voltage actually applied to the grid of the amplifier tube.

Grid-leak bias has certain disadvantages and because the bias voltage is proportional to the RF excitation it cannot be used in grid modulated or linear amplifiers, whose bias must be supplied from a source of good voltage regulation so that the bias voltage is independent of grid current. When grid-leak bias is used alone, it is evident that the bias disappears when the excitation fails, thus allowing dangerously-high values of plate current to flow, with consequent damage to the tube. Therefore it is desirable to augment grid-leak bias with either cathode bias or a separate bias supply in order to keep the plate current within safe limits whenever the excitation fails. The amount of bias supplied in addition to the grid-leak bias should usually approximate cut-off bias so that the plate current will drop to zero if the crystal stage stops oscillating, or if something becomes detuned in any of the other stages.

Cathode Bias

This form of bias utilizes the voltage drop across a resistor in the B-minus lead from the high voltage power supply, caused by the flow of plate current through this resistance. Because the B-minus lead of most high-voltage power supplies is directly grounded, the bias resistor must be placed in the negative side of the DC plate circuit of

the tube itself. The negative side of the DC plate circuit of a vacuum tube amplifier is between the filament center-tap and ground, and a resistor placed between these two points will have the total plate current flowing through it. It will therefore have a voltage drop across the resistor which is equal to the product of the plate current in amperes, times the resistance in ohms. The grounded end of this cathode bias resistor is

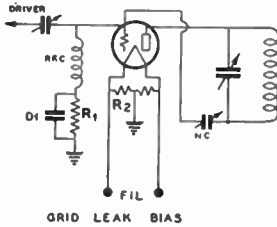

FIG. 1

more negative than the filament end by the amount of voltage drop across the resistor. Therefore, if the DC grid return is brought to the ground end of this resistor, the grid of the amplifier will be negative with respect to the filament.

Cathode bias is probably the safest bias supply known, because the negative bias voltage is a function of the plate current and is largely independent of the RF grid excitation. The plate current, therefore, can never reach a dangerously-high value if the excitation fails. This type of bias is generally unsuitable for class B linear amplifiers, although the use of cathode bias is essential in the newer class BC linear or grid-modulated amplifiers.

This type of bias can be used in a plate-modulated class C amplifier provided a large

COMBINATION BATTERY
& GRID LEAK BIAS

FIG. 2

audio by-pass condenser is connected across the bias resistor in addition to the usual mica radio-frequency by-pass condenser. The principal disadvantage of cathode bias is that the bias voltage must be subtracted from the total power supply voltage in order to obtain the net plate voltage across the amplifier tube. In a high efficiency amplifier stage using a low μ tube and biased to perhaps 3 times cut-off, it may require a 1600-volt power supply to actually realize 1000 volts

on the plate of the amplifier tube, because 600 volts is deducted for negative bias.

Cathode bias is sometimes called automatic bias because variations in plate current automatically change the bias to compensate for these variations.

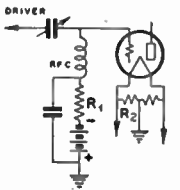
Separate Bias Supplies

Negative grid bias may be supplied from any source of voltage external to the amplifier circuit itself, such as dry batteries or B eliminators. B batteries rarely fail without giving considerable warning to the operator and they represent one of the safest sources of negative bias. However, these batteries wear out rather rapidly due to the charging effect of the DC grid current which causes the voltage as well as the internal resistance of the batteries to rise. After a few months of use, the batteries often become noisy, especially when used for phone work. When charged-up they bulge and leak. It is not unusual to find a 45-volt battery which measures 60 volts after only a month or two of service in the grid circuit of a class

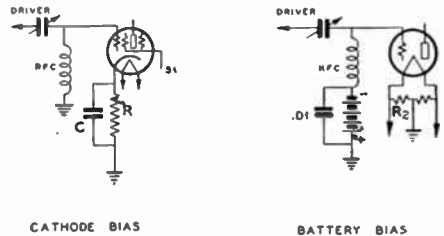

CATHODE BIAS

BATTERY BIAS

FIG. 3

C amplifier. This would be of no particular disadvantage if the 60 volts remained constant, but it usually wavers and fluctuates and often has an adverse effect on the note.

Another form of separate bias supply consists of some form of rectifier and filter system whose positive terminal is grounded and whose negative terminal connects to the DC grid return of the amplifier stage. This bias supply often consists of an ancient B eliminator and is quite satisfactory if certain precautions are observed. If a B eliminator is used to bias a high-power class C stage, some form of relay should be used and controlled by the bias supply so that the plate voltage to the class C amplifier is cut off if the bias supply fails. Most of the older B eliminators and many of the newer types have very poor voltage regulation and trouble is often encountered with interaction when the same eliminator is used to bias two or more separate amplifier stages. Poor voltage regulation merely means high internal resistance in the B eliminator. Any variation in grid current in any one of the amplifier stages will vary the voltage drop across this internal resistance and thereby affect the bias supplied to the other stages of the trans-

mitter. If a B eliminator, or a rectified AC bias supply is used to supply bias to a class B or class BC linear or grid modulated amplifier or to a class B audio amplifier, it is absolutely essential that the DC bias voltage remain constant and independent of the DC grid current. This means that the bias supply must have extremely good voltage regulation. Low resistance transformers and filters, as well as a mercury vapor rectifier tube and a low resistance, high current bleeder should be used to minimize variation in output bias voltage with the changes in grid current which normally occur in these types of amplifiers. If it is desired to adjust the DC voltage output from a bias pack of this type the operator must not tap down on the voltage divider or use a series resistance in either the primary or secondary of the transformer which feeds the bias rectifier. The best method is to either tap the primary of the transformer or an auto-transformer can be used across the 110-volt line to vary the voltage supplied to the bias transformer without effecting the voltage regulation.

More than one of the above bias supplies can be used in series to bias a class C amplifier. In fact, it is highly recommended that a grid leak be used to augment the cut-off value of bias which is best supplied by either cathode bias resistor, batteries or a separate bias pack.

A grid-leak common to more than one class C stage should be avoided, due to tremendous interaction caused by the two different grid currents in the respective stages.

To compute the wattage rating of the resistor, either as a grid leak or to give cathode bias, multiply the square of the current in amperes flowing through the resistor by the resistance in ohms.

Low C and High Efficiency

The difference between the DC plate input and the AC power output is the plate loss; it must be dissipated in the form of heat from the plate of the tube. Because tube cost is almost exactly related to rated plate dissipation, it pays to obtain high plate efficiency as it is then possible to obtain high power output from small tubes. A vacuum tube AC generator has, as have all AC generators, a definite internal resistance to the flow of current. It varies with the applied plate voltage and the grid excitation.

Given a constant voltage generator, the generator efficiency increases as the ratio of impedance mis-match increases—but the power output is maximum when the load impedance is matched to the internal impedance of the generator.

This applies to class A amplifiers. Class C RF amplifiers operate somewhat differently as shown in another chapter, and it is desirable to operate them at high efficiency which involves less of an impedance match between tube and load circuit.

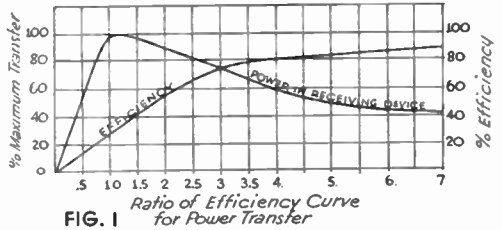

FIG. 1 The comparative percentages of power delivered to a receiving device for various ratios of its resistance to the internal resistance of the supply system and efficiency at which power is supplied to receiving device for same ratios. R_2 equals Resistance of Receiving device. R_1 equals Internal resistance of supply system measured from receiving device terminals.

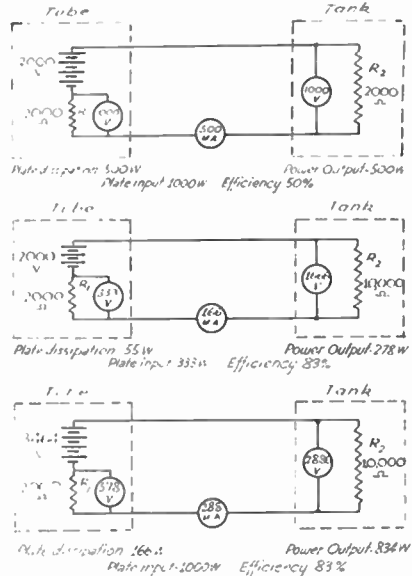

FIG. 2

The Class C RF Amplifier

The most important use for impedance mis-matching is found in the class C radio frequency amplifier, as used in the final amplifier of an amateur transmitter. In order to get the greatest mis-match, use a tube with the lowest dynamic plate impedance, at the highest voltage that the tube insulation and gas content will allow. The high plate voltage also further reduces the internal impedance. Then use all the L and as little C in the plate tank as possible. The antenna coupling should be as loose as it can be, without cutting the input below that desired, and the bias should be around several times cut-off. The excitation, as measured by the DC grid current, should be between 15 and 25% of the DC plate current, and will vary for different types of tubes. In general, the higher the mutual conductance of the amplifier tube, the less excitation power is needed for a given load impedance.

Link Coupling

Advantages of Link Coupling Over Other Types

- (1) Effectively establishes correct impedance relations between grid and plate circuits.
- (2) Permits most efficient operation of circuits wherein low- μ tubes work into, or out of high- μ tubes, and vice-versa.
- (3) Provides a flexible feed line, which may be several feet in length, and which results in efficient operation between stages in "rack type" transmitters in which the stages are spaced quite far apart.
- (4) Permits the use of series-feed in both grid and plate circuits.
- (5) Makes possible maximum power output and attendant lack of "crankiness" when high- or low-frequency crystals are used.
- (6) For a given amount of excitation on the grid of the first buffer, the use of link coupling reduces plate current in the crystal oscillator stage and therefore reduces the RF current through the crystal itself.
- (7) Eliminates the use of taps on coils, with their attendant losses.
- (8) Because of the lack of capacitive coupling effect, neutralization is made easier.

In order to get the maximum transfer of energy from one stage to another it is necessary for the grid impedance of the driven tube be equal to the plate impedance of the driver stage. This match is very seldom obtained with Capacitive Coupling because conditions under which tubes operate vary widely in practice. Theoretically, this mismatch of impedances can be avoided by the expedient

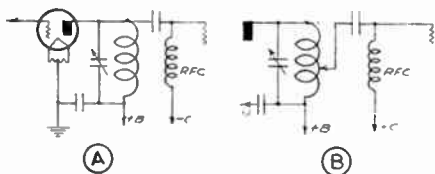

FIG. 1. Capacitive Coupling.

FIG. 1 (A)—Fundamental Capacitive Coupled Circuit. "C" is the capacity-coupling condenser. Aside from the impedance mismatch which results from use of this circuit, the RF choke (RFC) is practically always a source of loss. Thus the circuit possesses two evils, which are eliminated when link coupling is used.

FIG. 1 (B)—A capacitive coupled circuit with the plate coil tapped a few turns down from the plate end. That portion of the plate coil below the point where the tap is taken, acts also as part of an untuned grid in a TNT oscillator, which makes the driven stage oscillate at some parasitic frequency higher than that to which the circuits were meant to be tuned. The parasitic circuit includes the lower portion of the tank coil, the capacitive coupling condenser, the lead to the grid, the by-pass condenser in the negative B circuit and the ground.

of tapping down on the plate tank to obtain the correct match. The "auto-transformer" effect obtained by this method allows a variable adjustment of impedance, either step-up or step-down, depending upon which impedance is higher. This tapping method has the disadvantage of encouraging parasitics, or self-oscillation.

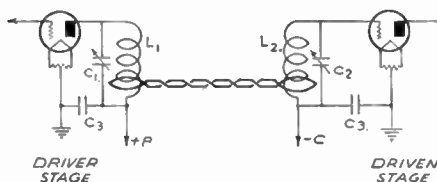

FIG. 2—LINK COUPLING between the driver stage and the driven stage. Although no neutralizing condenser is shown, any of the conventional neutralizing systems can be used. The condensers C1 and C2 which respectively tune the plate coil of the driver stage and the grid coil of the driven stage are both of the same capacity, 50 to 100 mmf. C3 are radio frequency by-pass condensers, their sizes depending upon the frequency used. The higher the frequency the smaller these condensers can be. Usual sizes are .006 mfd. for 160 meters, .005 mfd. for 80 and 40 meters, .001 or smaller for 20 meters. The plate coil of the driver stage (L1) and the grid coil of the driven stage (L2) are identical in size and in number of turns used. Condensers C1 and C2 respectively tune these coils to resonance.

Inductive Coupling

Inductive Coupling consists of transferring energy from the plate circuit of one tube to the grid circuit of another by means of mutual inductance which exists between any two coils whose magnetic fields interlock.

Pure Inductive Coupling, where the grid coil is placed directly alongside the plate coil, has certain disadvantages. The tuning adjustments are very cranky because in order to get enough coupling between the two windings for maximum energy transfer, the grid tuning detunes the plate tuning and it is almost impossible to get both of them right on the peak. Another drawback to straight Inductive Coupling is that which develops when two coils carrying high RF voltage are placed in close proximity to each other. Capacitive Coupling, as well as Pure Inductive Coupling is then introduced, making neutralizing difficult, if not impossible, as well as preventing the use of extremely low-C, which is so desirable in crystal control transmitters.

Link Coupling

Link coupling provides a low impedance transmission line to transfer energy between two isolated tank coils, one of which is the plate tank of the driver stage and the other the grid tank of the driven stage. This low impedance transmission line provides coupling of purely inductive nature, the capacitive loading effect of the coupling loop being negligible. In this way the capacity between the tank coil and the coupling

Complete Circuit Diagram of a Modern Link Coupled Transmitter

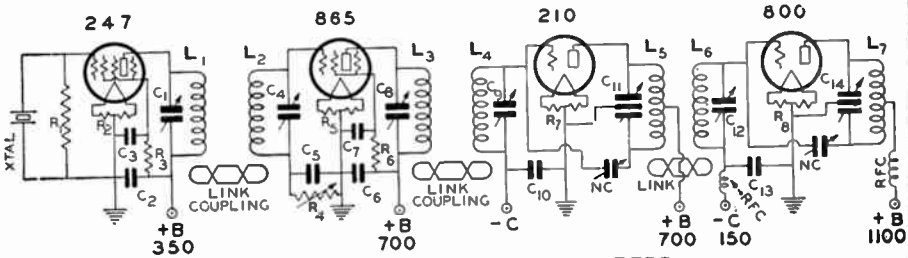

47 - 865 - 210 - 800 TRANSMITTER

List of Parts Required for Modern Link-Coupled Transformer

- C1—50-100 mmf.
- C2, C3—.002 to .006 mfd.
- C4—50-100 mmf.
- C5—.006 mfd.
- C6, C7—.002 to .006 mfd.
- C8—100 mmf.
- C9—100 mmf.
- C11—Split stator V.C., 50 mmf. per section.
- C12—100 mmf.
- C13—.006 mfd.
- C14—Split stator V.C., 50 mmf. per section.
- NC—Neutralizing Condensers.
- R1—10,000 to 50,000 ohms.
- R2—20 ohms, CT.
- R5, R7, R8—100 ohm Electrad Center-Tap Resistors.
- R3—35,000 ohms, 5 to 10 watts.
- R4—0-25,000 ohm. Variable Resistor.
- R6—50,000 ohm, 10 Watt Resistor.
- L1 and L2 are same size; L3 and L4 are same size; L5 and L6 are same size.

loop is not shunted across the tank tuning condenser, which would considerably reduce the L-to-C ratio.

The position of the coupling loops on the tanks in the low power stages is generally non-critical. When working into or out of high-mu tubes, the position of the coupling loop demands more careful attention. Generally speaking, it will be found that the coupling loop on the plate tank of the high-mu tube will have to be placed relatively close to the cold end of the coil. This is the case when using a 47 as a crystal oscillator.

Feed lines, consisting of twisted pairs, can be several feet in length.

The feed line wires can be ordinary rubber covered lamp cord, although the use of a solid conductor with good insulation is recommended.

A reference to the illustrations shows some of the various mechanical arrangements suitable for this type of coupling. In the low power stages, it is recommended that one of the fixed-coupling-loop systems be used. We have shown vertical plug-in coils, wound on the usual Isolantite coil forms, because this type of coil form is ideally suited for the fixed coupling loop. Other systems, some of which are also shown in the sketches, have one coupling loop adjustable from the baseboard. Since this latter system requires the use of two parallel rods several inches long, these rods act as a continuation of the feed line. In conjunction with this system, where the twisted pair feed line is connected to the ends of the rods, an extremely important point arises. The feed line has a very definite

polarity and sometimes, unless the feed line leads are reversed, it is impossible to obtain anything like a normal transfer of energy.

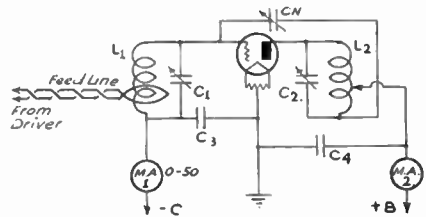

Fig. 3—How To Adjust a Link Coupled Transmitter Stage

TUNE C2 to a point that is known to be off resonance. Place the coupling loop around the center of the plate tank of the driver stage. Place the other loop at the center or toward the cold end of the grid coil L1. Note the reading as indicated by MA1. This operation should be made with the plate voltage disconnected, but with the center-tap of the tube connected to ground (or minus B). Then tune C1 for maximum reading as indicated by MA1. Tune C2 to a point where MA1 takes a decided dip. Set and leave C2 at the point where MA1 shows the lowest reading. With the tap set in the approximate position for correct neutralization on L2, adjust neutralizing condenser NC for the maximum reading on MA1. For each setting of the neutralizing condenser, C1 must be reset to bring the grid current back to maximum. The highest reading of grid current during this compensating adjustment is the point of correct neutralization. When C2 is tuned through resonance no change in grid current should be indicated by MA1. If this meter shows the slightest flicker, the stage is not neutralized and the adjustment must be repeated, but with a different setting for the tap on L2. In this circuit the by-pass condenser from high voltage to ground is essential for complete neutralization. When all adjustments have been satisfactorily made, apply the plate voltage and adjust C2 until MA2 indicates minimum current.

COIL-TURNS TABLE For Link-Coupled Stages

Single-section 100 mmf. variable condenser used for tuning.

- (For low and intermediate power stages)
- 1½-in. Hammarlund Coil Forms.
- 80 Meters—36 turns No. 20 enameled wire, space wound.
- 40 Meters—20 turns of No. 16 or No. 18 enameled wire, space wound.
- 20 Meters—10 turns of No. 16 or No. 18 enameled wire, space wound.
- .001 (100 mmf.) variable condensers are used to tune the above coils.

Link coupling can often be used between stages in a transmitter in a form which will give greater grid swing in each succeeding stage. Some tubes which have a high μ , or the screen grid type, have an extremely low grid impedance, especially under plate loaded conditions. In such cases it is difficult to obtain maximum grid swing or reasonable driver plate load with the usual form of one or two turns in the link coupling loop at each end of the link. The answer to this problem is exceedingly simple. Use one or two turns in the link coupling loop on the driver plate coil and use two to six, or even seven turns at the grid coil when the driven tube is a high μ or screen grid tube. The coupling between the grid coil and the link coil should be as close as possible, such as one winding directly over the other, or interwound. The latter is important for proper impedance matching.

Link coupling will give a certain amount of automatic impedance matching, which can be easily proved by noting that about 50% or more grid swing can be obtained with the usual link coupling over the old form of capacitive coupling between a pair of type 210 tubes. Usually only a small part of this loss in capacitive coupling is due to the grid RF choke, since the latter can be made very effective; consequently the loss is in impedance mismatch when the grid of the following tube is across the entire tuned circuit. Link coupling gives an impedance matching effect because the coupling is usually less than unity or maximum obtainable. The impedance reflected each way is not entirely dependent upon the ratio of tuned coil turns to link coil turns, since the effective coil coupling is relatively loose and resonant circuits are being used. Because the coupling is not unity between the coils, impedance matching takes place . . . providing the ratio of impedances are not too great. When the impedances are greatly different, one being several times that of the other, then link coupling must be used with a little common sense. In short, the low impedance circuit end should have more turns on the link coil and these two coils should be very closely coupled.

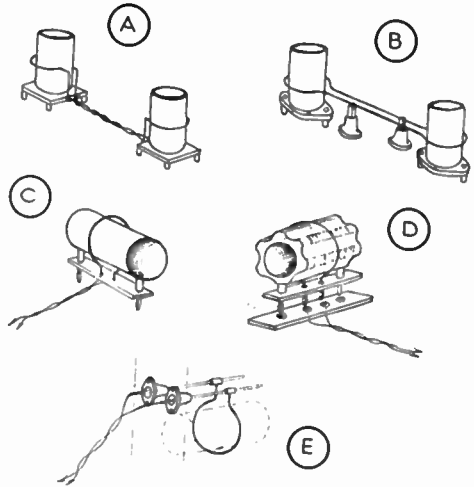

Mechanical Arrangements For Supporting Link Coupling Loops and Twisted Pairs

Two coil forms are used in link coupled arrangements, one coil for the plate, one for the grid. The coupling loop, which is slightly larger in diameter than the outside diameter of the coil winding, is made from a piece of No. 14 rubber covered wire. The loops are held in position by merely soldering the respective ends to the contacts on the sockets into which the coils are plugged. Then a twisted pair, or "transposed feed line" connects the two loops together into a continuous circuit as shown in illustrations (A) and (B).

Some suggested tube combinations

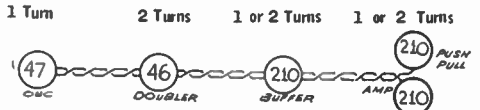

A link-coupled arrangement for high efficiency and high output from small tubes. A 47 (or 53) crystal oscillator, 46 buffer-doubler, 210 buffer and a pair of 210s in the final amplifier running at high plate voltage. The output ranges from 75 to more than 150 watts.

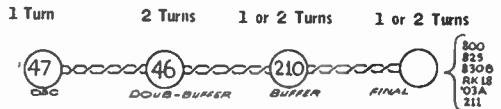

Link coupled medium-power transmitter. A 47 (or 53) crystal oscillator, 46 buffer-doubler, and one of the 40 watt tubes, such as the 800, 825, RK-18, O3A or 211. The output ranges from 50 to 150 watts and more.

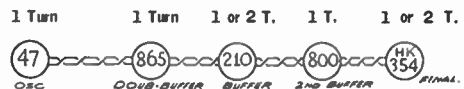

An ideal combination for high power. Link coupling the 47 (or 53) to an 865, doubler-buffer to a 210 buffer to an 800 buffer and, finally, into an HK-354 Gammatron or Eimac 150T. 800 watts has been secured from the use of this combination.

Unity Coupling

Unity Coupling can be used between stages of a transmitter as an aid to eliminate RF choke troubles. It is not as effective as link coupling, yet it does not require an additional tuned circuit. In effect, unity coupling makes the grid RF choke a part of the tuned circuit, because the grid coil is interwound with the plate coil in the coupling unit. Unity coupling can sometimes be used to advantage in transmitters where space is lacking for link coupling. Care should be taken to see that the grid coil interwound turns are spaced sufficiently from the plate coil turns to prevent DC voltage flash-over. For low power operation, the grid coil is often wound

inside of a copper tubing plate coil. The wire for the grid coil should be well insulated.

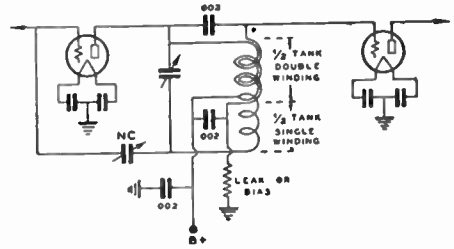

Interstage coupling with grid-leak bias.

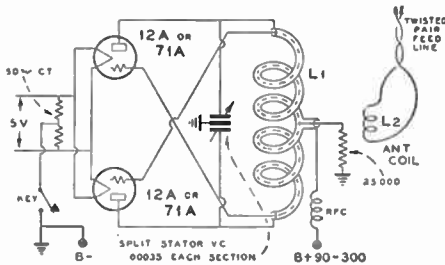

Unity coupled self-excited transmitter for 160 meter portable operation.

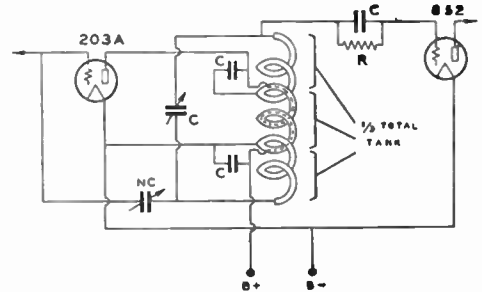

Unity coupling for high power stages.

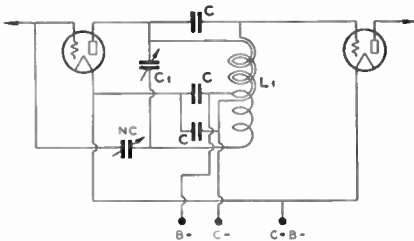

Interstage coupling with fixed grid bias.

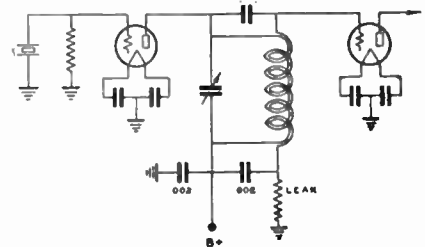

Unity coupling between crystal oscillator and buffer stages.

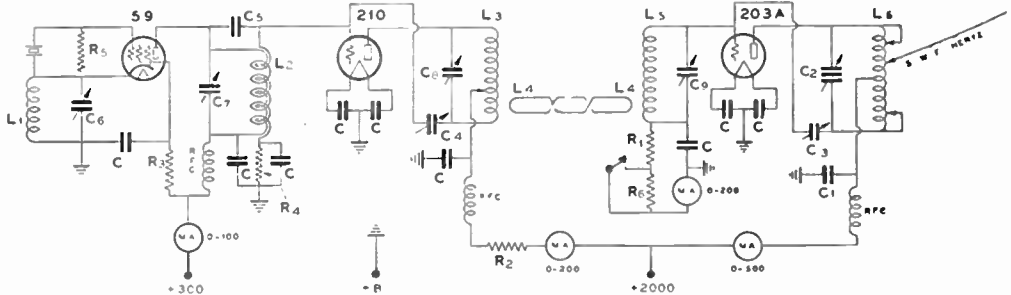

Transmitter circuit with combination unity and link coupling. The final tube may be used as a doubler by increasing the grid leak resistance and tuning the plate circuit to double the grid circuit frequency.

Coil Winding Charts for Copper Tubing Tank Coils

THE values given are a close approximation to your particular requirements in each case, but exact accuracy depends on the circuit arrangement and the length of the leads in the plate circuit of the tube to be used. The two factors mentioned become more important as the frequency increases. Long leads necessitate fewer turns on the coil, but the leads should be long enough to keep the tank condenser separated from the coil by at least the coil diameter.

All the values in the table are for the tubes specified when used as single-ended amplifiers with the neutralization tap near the center of the coil. If placed in the center of the coil, this tap will automatically give fixed neutralization on all bands. For push-pull amplifiers, decrease the number of turns by 25% for any given tube. The reason for this decrease will be apparent upon close comparison of single-ended and push-pull circuits. Just twice as much tube capacity is shunted across the tank in push-pull circuits as when single-ended circuits are used.

In low-C tanks, such as these, the voltage rating of the condenser should be equal to four times the plate voltage on the tube for single-section types, and twice the plate voltage (each section) for split-stator models.

CHART NO. 1. For Coils Tuned With Split-Stator Condenser and Used in Circuits Employing Low-C Tubes, such as 150T, 50T, 354, 852, 800, 825, RK18.

BAND	2" Dia. Coil	3" Dia. Coil	4" Dia. Coil	5" Dia. Coil	6" Dia. Coil	Size of Tuning Condenser
160	N.S.	N.S.	N.S.	N.S.	80 Turns 36" Long 3/8" Tubing	250 Mmf. Each Section for Full Band Coverage.
80	N.S.	N.S.	60 Turns 20" Long 1/4" Tubing	50 Turns 18" Long 1/4" Tubing	40 Turns 18" Long 3/8" Tubing	100 Mmf. Each Section for Full Band Coverage.
40	N.S.	46 Turns 16" Long 1/4" Tubing	34 Turns 12" Long 1/4" Tubing	28 Turns 12" Long 1/4" Tubing	22 Turns 12" Long 1/4" Tubing	35 Mmf. Each Section.
20	32 Turns 15" Long 1/4" Tubing	20 Turns 12" Long 1/4" Tubing	16 Turns 12" Long 1/4" Tubing	14 Turns 12" Long 1/4" Tubing	10 Turns 12" Long 1/4" Tubing	35 Mmf. Each Section.
10	8 Turns 4" Long 1/4" Tubing	6 Turns 4" Long 1/4" Tubing	4 Turns 4" Long 1/4" Tubing	4 Turns 4" Long 1/4" Tubing	3 Turns 4" Long 1/4" Tubing	35 Mmf. Each Section. N.S. Indicates: NOT SATISFACTORY.

CHART NO. 2. For Coils Tuned With Single-Section Condenser and Used in Circuits Employing Low-C Tubes, such as 150T, 50T, 354, 852, 800, 825, RK18.

BAND	2" Dia. Coil	3" Dia. Coil	4" Dia. Coil	5" Dia. Coil	6" Dia. Coil	Size of Tuning Condenser
160	N.S.	N.S.	N.S.	N.S.	60 Turns 36" Long 3/8" Tubing	100 Mmf.
80	N.S.	N.S.	50 Turns 20" Long 1/4" Tubing	40 Turns 18" Long 1/4" Tubing	30 Turns 18" Long 3/8" Tubing	100 Mmf. For Full Band Coverage.
40	N.S.	36 Turns 14" Long 1/4" Tubing	24 Turns 12" Long 1/4" Tubing	20 Turns 12" Long 1/4" Tubing	16 Turns 12" Long 1/4" Tubing	35 Mmf.
20	22 Turns 12" Long 1/4" Tubing	16 Turns 12" Long 1/4" Tubing	12 Turns 12" Long 1/4" Tubing	10 Turns 12" Long 1/4" Tubing	8 Turns 12" Long 1/4" Tubing	35 Mmf.
10	6 Turns 5" Long 1/4" Tubing	4 Turns 5" Long 1/4" Tubing	4 Turns 5" Long 1/4" Tubing	4 Turns 5" Long 1/4" Tubing	2 Turns 5" Long 1/4" Tubing	35 Mmf.

CHART NO. 3. For Coils Tuned With Split-Stator Condenser and Used in Circuits Employing High-C Tubes, Such as 50 Watters, 210, 204A, 849, 212D, 830, 46, RK20.

BAND	2" Dia. Coil	3" Dia. Coil	4" Dia. Coil	5" Dia. Coil	6" Dia. Coil	Size of Tuning Condenser
160	N.S.	N.S.	N.S.	N.S.	72 Turns 36" Long 3/8" Tubing	250 Mmf. Each Section for Full Band Coverage.
80	N.S.	N.S.	54 Turns 16" Long 1/4" Tubing	46 Turns 18" Long 1/4" Tubing	36 Turns 18" Long 3/8" Tubing	100 Mmf. Each Section for Full Band Coverage.
40	N.S.	36 Turns 14" Long 1/4" Tubing	24 Turns 10" Long 1/4" Tubing	20 Turns 10" Long 1/4" Tubing	16 Turns 10" Long 1/4" Tubing	35 Mmf. Each Section.
20	24 Turns 10" Long 1/4" Tubing	16 Turns 10" Long 1/4" Tubing	12 Turns 10" Long 1/4" Tubing	10 Turns 10" Long 1/4" Tubing	8 Turns 10" Long 1/4" Tubing	35 Mmf. Each Section.
10	8 Turns 5" Long 1/4" Tubing	6 Turns 5" Long 1/4" Tubing	4 Turns 5" Long 1/4" Tubing	4 Turns 5" Long 1/4" Tubing	3 Turns 5" Long 1/4" Tubing	35 Mmf. Each Section.

CHART NO. 4. For Coils Tuned With Single-Section Condenser and Used in Circuits Employing High-C Tubes, Such as 50 Watters, 210, 204A, 849, 212D, 830, 46, RK20.

BAND	2" Dia. Coil	3" Dia. Coil	4" Dia. Coil	5" Dia. Coil	6" Dia. Coil	Size of Tuning Condenser
160	N.S.	N.S.	N.S.	N.S.	60 Turns 36" Long 3/4" Tubing	100 Mmf.
80	N.S.	N.S.	50 Turns 20" Long 1/4" Tubing	40 Turns 18" Long 1/4" Tubing	30 Turns 18" Long 3/4" Tubing	100 Mmf. For Full Band Coverage.
40	N.S.	32 Turns 14" Long 1/4" Tubing	22 Turns 12" Long 1/4" Tubing	18 Turns 12" Long 1/4" Tubing	14 Turns 12" Long 1/4" Tubing	35 Mmf.
20	18 Turns 10" Long 1/4" Tubing	14 Turns 10" Long 1/4" Tubing	10 Turns 10" Long 1/4" Tubing	8 Turns 10" Long 1/4" Tubing	6 Turns 10" Long 1/4" Tubing	35 Mmf.
10	4 Turns 5" Long 1/4" Tubing	4 Turns 5" Long 1/4" Tubing	4 Turns 5" Long 1/4" Tubing	4 Turns 5" Long 1/4" Tubing	2 Turns 5" Long 1/4" Tubing	35 Mmf.

Coil Chart for 1 1/2-in. and 2 1/2-in. Dia. Coil Forms.

BAND	1 1/2" Dia. Coil Form	Size of Tuning Condenser	BAND	2 1/2" dia. Coil Form	Size of Tuning Condenser	REMARKS
160	Not Satisfactory		160	46 Turns No. 16 DCC. Close wound	100 MMF. or larger	The winding data shown here is for coils that are tuned with single-section variable condensers. See Chart below for coil winding data when split-stator variable condensers are used.
80	35 Turns No. 22 DCC. Close wound	100 MMF.	80	23 Turns No. 16 DCC. Spaced one dia.	100 MMF.	
40	19 to 21 Turns No. 16 DCC. Spaced one dia.	100 MMF.	40	16 Turns No. 16 DCC. Spaced one dia.	25-35 MMF.	
20	11 to 13 Turns No. 16 DCC. Spaced one dia.	25-35 MMF.	20	8 to 10 Turns No. 16 DCC. Spaced one dia.	25-35 MMF.	
10	5 to 6 Turns No. 16 DCC. Spaced one dia.	25-35 MMF.	10	5 Turns No. 16 DCC. Spaced one dia.	25-35 MMF.	

Coil Winding Chart for 1 1/2-in. and 2 1/2-in. Dia. Coil Forms and Split-Stator V.C.

BAND	1 1/2" Dia. Coil Form	Size of Tuning Condenser	BAND	2 1/2" dia. Coil Form	Size of Tuning Condenser	REMARKS
160	Not Satisfactory		160	59 Turns No. 16 Enameled Close wound. Tap at center.	250 MMF. Each Section (smaller condenser can be used).	The standard Hammarlund 35 mmf. Each section split-stator double-spaced midjet variable condensers are satisfactory. The Cardwell Trim-Air 100 mmf midjets can also be used by merely removing alternate plates from rotor and stator sections and ganging two of these condensers together. The capacity will then be 25 mmf. per section.
80	Not Satisfactory		80	55 to 57 Turns No. 16 DCC. Close wound. Tap at center.	35 MMF. Each Section	
40	35 Turns No. 16 DCC. Close wound. Tap at center.	35 MMF. Each Section	40	29 Turns No. 14 Enameled Space wound. To cover 3 inches.	35 MMF. Each Section	
20	19 Turns No. 16 DCC. Spaced one dia. Tap at center.	35 MMF. Each Section	20	15 Turns No. 14 Enameled Spaced one dia. Tap at center.	35 MMF. Each Section	

"LES-TET" COIL DATA

(See circuit diagram on page 89).

All forms 1 1/8 inches outside diameter.

L1	20 meters	40 meters	80 meters
	same as 40 m. coil, no tap.	15 turns, =18 DCC, spaced 1/16". Tap, 5 turns up from bottom.	24 turns, =18 DCC, close wound. Tap, 8 turns up from bottom.
L2	7 turns =18 DCC, 1/8" spacing. Link coil, 4 turns =22 DCC, close wound, 1/4" from cold end.	15 turns, =18 DCC, spaced 1/16". Link coil, same as for 20 m.	24 turns, =18 DCC, close wound. Link coil, same as for 20 m.

Two-Band Transmitter—Metal Chassis Construction

This transmitter is intended for two-band operation with a single crystal. The latter should be selected with a frequency value between 3500 and 3650 KC, so that the second harmonic falls within the limits of the 7000-7300 KC ("40 meter") band. For straight "80 meter" service, the socket for coil L1 is short-circuited, the 30-turn coil used at L2 and the 25-turn coil at L3 (See coil data table). Tube V1, the 59, then acts as a straight oscillator, the plate tank circuit L2-C2 being tuned to the crystal frequency (or rather a trifle off it, for the sake of stability). The output of this stage is tapped off L2 for amplification by V2, the 210, the plate tank L3-C3 again being tuned to the crystal frequency. The plate-grid capacity of V2 is effectively neutralized by the out-of-phase voltage developed across the bottom of the plate tank coil L3 and impressed on the grid through the neutralizing condenser C6.

For "40 meter" operation, the same crystal is left in, but now the 16-turn coil is used at L1, the 19-turn coil at L2 and the 14-turn coil at L3. The 59 now acts as the well known "Tri-Tet," with the screen-cathode circuit responding to the second harmonic of the crystal, and the plate-cathode circuit further amplifying it, so that a strong 40-meter impulse is available for driving the 210 amplifier, also tuned to the harmonic frequency. This sounds complicated, but the transmitter can be tuned to one frequency and then shifted and retuned to the other frequency in less time than it takes to read this description of the circuit!

COIL TABLE

For 40 Meters:

L1—16 turns No. 20 D.C.C.

L2—19 turns No. 20 D.C.C. tapped at 14th turn

L3—14 turns No. 14 bare or tinned

For 80 Meters:

L2—30 turns No. 20 D.C.C. tapped at 20th turn

L3—25 turns No. 14 bare or tinned

For Both Bands:

L4—25 turns No. 14 bare or tinned, with clip

L1, L2—Use 4-prong Insulux receiving forms, 1 $\frac{3}{4}$ -inch diameter

L3, L4—Use threaded Insulux transmitting forms, 2 $\frac{1}{2}$ -inch diameter

PARTS LIST

C1, C2, C3—140 mmf. Hammarlund midget condensers, with rotors insulated from frame.

C4—500 mmf. variable condenser (Cardwell No. 123B)

C5—220 mmf. variable condenser (Cardwell No. 164B)

C6—50 mmf. double spaced neutralizing condenser (Insuline No. 121)

C6, C7, C8, C9, C10, C11—.005 mf. mica condensers, 1000 volt test (Cornell-Dubilier Type 3)

C12—.005 mf. mica, 2500 volt rating (Cornell-Dubilier Type 4)

C13—.00025 mf. mica, 1000 volt test (Cornell-Dubilier Type 3)

L1, L2—Wound as specified on 1 $\frac{3}{4}$ -in. forms (Insuline No. 952)

L3, L4—Wound as specified on 2 $\frac{1}{4}$ -in. forms (Insuline No. 2650)

R1—50,000-ohm, 2-watt grid leak

R2—10,000-ohm non-inductive grid leak, 100 watts rating (Electrad)

R4—25,000-ohm Truvolt divider, with 2 taps (Electrad No. B-250)

R5—20,000-ohm Truvolt divider, one tap (Electrad No. SD-200)

RF1, RF2—8-mh. chokes

RF3—5-mh. heavy duty choke

J1, J2—Single closed circuit jacks with phone plug

O—100 MA milliammeter, small size

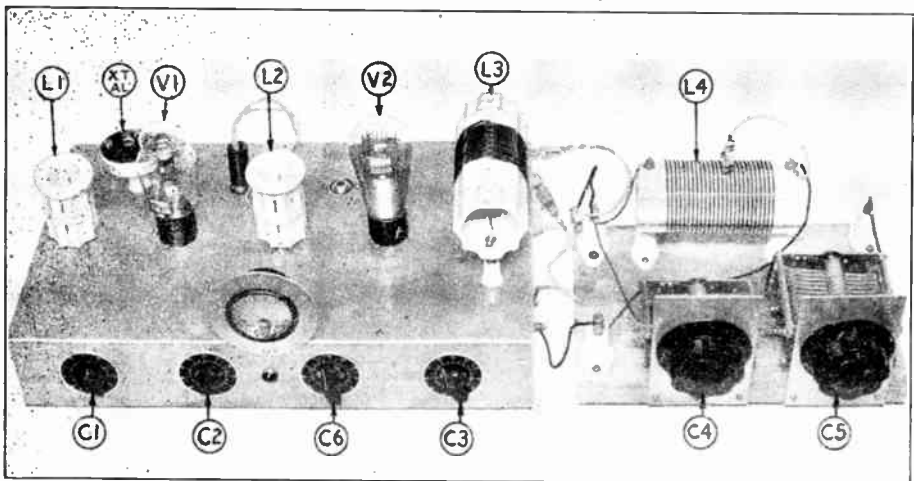

59 Tri-Tet oscillator, 210 amplifier and PI network antenna coupler. The oscillator-amplifier is mounted on a 17-in. x 10-in. x 3-in. metal chassis.

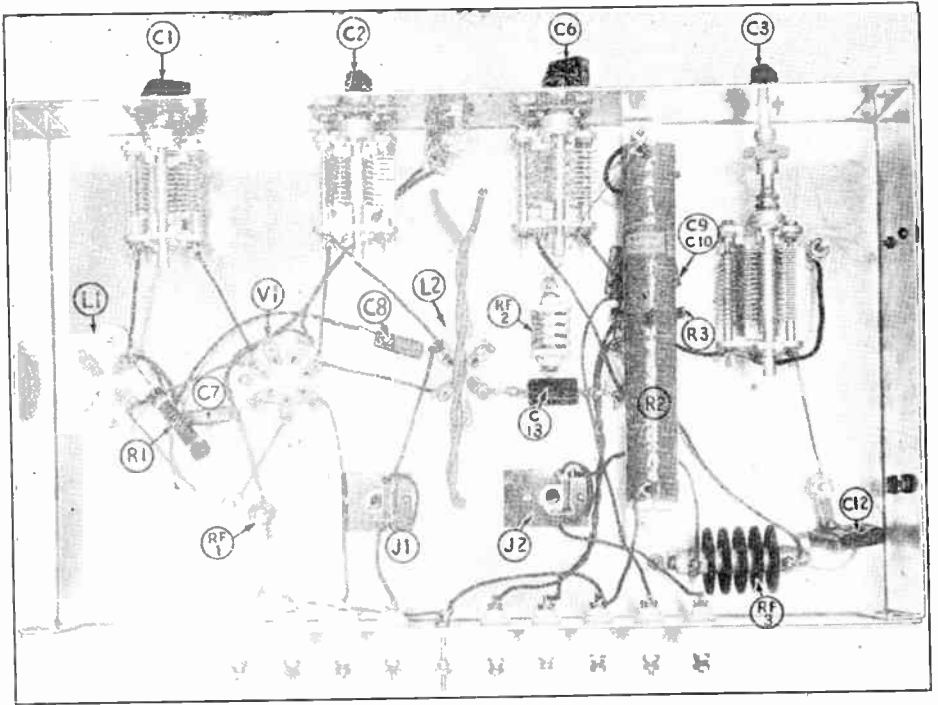

Oscillator and Amplifier Tuning Condensers, as well as the Neutralizing Condenser are all beneath the chassis.

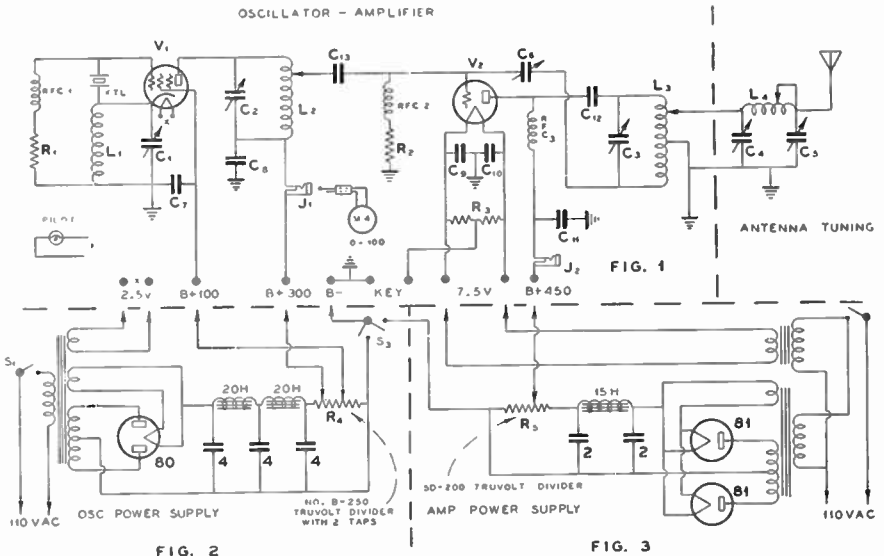

59 Tritet and 210 Amplifier with Collins PI network antenna coupler. See facing page for legend of parts required.

'47 Oscillator and 210 Amplifier Transmitter

THE increasing number of amateurs who are replacing old-time self-excited transmitters with modern crystal control has brought repeated requests for detailed information on the exact number of turns of wire to wind on standard plug-in coil forms for use in the oscillator stage, for the grid tuning coil and for the plate coil of the amplifier. The low-priced midget condensers are also suitable for plate and grid tuning in low-power stages. Standard sizes of these small condensers are 35 mm. and 100 mmf. The 35 mmf. size, double spaced, is suitable for tuning the plate coil in an amplifier stage using a type 210 or even larger tube. It is also ideal for neutralizing such a stage. For the crystal oscillator plate tuning circuit a 100 mmf. variable condenser can be used; it is equally suitable for tuning the grid coil of the first buffer, doubler or amplifier stage.

It has been found from experience that the low-loss Isolantite 1½-inch coil forms give perfect satisfaction in low-power stages, using up to about a 210 or 830 tube. These Isolantite coil forms, when used with Isolantite sockets, make a highly efficient and practical coil assembly. For 20, 40 and 80 meter work it hardly behoves the amateur to use coil forms larger than the 1½-inch standard Isolantite types. For 160 meter work, these same small forms can be used in the oscillator and grid tuning stages, but a larger form (2½-in. dia.) should be used for the amplifier plate coil.

The results secured from a simple 2-tube transmitter, using standard 1½-inch Isolantite coil forms and small midget tuning condensers, were so gratifying that the constructional details are here presented for those who wish to duplicate the transmitter.

From San Francisco it has been possible to work amateurs in Australia and New Zealand on the 80-meter band, using the transmitter here described. The construction of the transmitter is such that additional stages can be added at any future time.

All coil-turns data is shown in the table on page 116. The table is handy for future reference. A turn or two of wire can be added to, or removed from each coil, depending on the particular conditions under which the transmitter will be called upon to operate. However, the winding data is useful because it was computed from coils tuned with small midget condensers.

The illustration shows the breadboard transmitter. The 47 oscillator stage is at the extreme left. The 47 tube has given the best results, by far, of any tube used in straight crystal circuit. For all-band operation, the Jones Exciter with '53 tube should be used. The oscillator stage, from front to rear, consists of a 100 mmf. tuning condenser, plate coil, 47 tube, quartz crystal. The resistors and condensers for the oscillator stage are mounted beneath the baseboard and the board is raised from the operating

table by four standoff insulators. Isolantite sockets are used throughout.

To the right of the oscillator stage is the grid coil, mounted horizontally, and spaced 6 inches between centers from the oscillator coil. Wide spacing is necessary, and the grid coil should be mounted horizontally so as to prevent interaction between the oscillator coil and the grid coil. The horizontal mounting for the grid coil is made simple by merely mounting an Isolantite socket on a supporting block, 2½ by 2½ by 2½ inches. A hole, 1⅝ inch diameter, is cut out of the center of the support so that the grid coil can pass through the support and plug into the socket. The support is screwed to the baseboard. The grid coil tuning condenser is

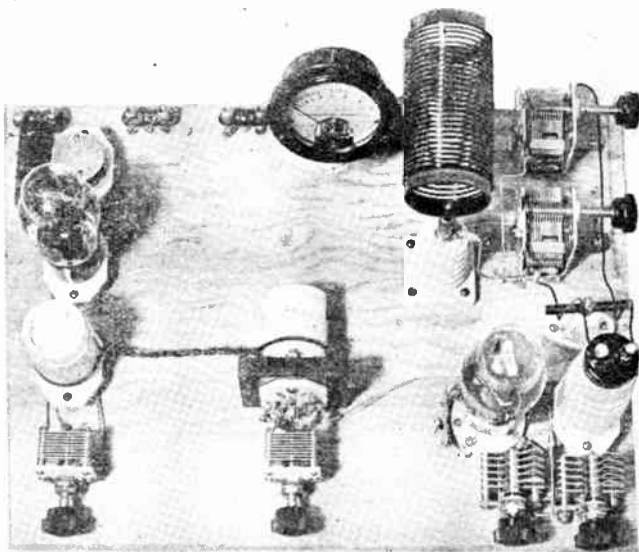

The 47-210 Oscillator-Amplifier Breadboard Transmitter. Note the simple link coupling method between the oscillator plate coil and the grid coil.

directly in front of the grid coil support block. This condenser is a standard 100 mmf. midget variable.

Link coupling is used between the oscillator plate coil and the grid coil. The advantages of this system of coupling have been told previously and are too numerous to mention here. The coupling link is simply a piece of No. 20 (or larger) insulated wire, made into a twisted pair, with a loop at each end. The open ends are soldered together to form a continuous loop. The loops at either end of the coupling link are 1 5/8 inches inside diameter, so that they will slip snugly over the oscillator plate coil and grid coil windings. Variable coupling is not required for the coupling loop. Simply slip the loop over the coils and place them at a point about 1/4 inch (or less) from the LOWER end of each coil. It makes little difference where the loops are placed, as long as they are near the bottom (cold end) of each coil. Place the loops at the very bottom of the coils when first tuning up. Make sure that the "hot" (plate) lead of the oscillator connects to the top turn of the plate coil and also to the stator of the tuning condenser. Likewise, the top connection of the grid coil connects to the grid of the tube in the 210 stage, also to the stator of the grid coil tuning condenser.

The center-tap resistors across the filaments of the 47 and 210 tubes are shown as 20 ohm size. The resistor across the crystal can be anything from 10,000 to 50,000 ohms, although many crystals will not "start" unless 20,000 ohms or more is used.

The 47 tube screen dropping resistor is shown to have a value of 40,000 ohms, although anything from 40,000 to 60,000 ohms will suffice. This resistor should be of 5 or 10 watt size. The screen by-pass condenser and the blocking condenser are shown as .006 mfd. The condenser should be of the mica type. The choke (RFC) should be of good manufacture; a small receiving type Hammarlund choke is satisfactory.

In the 210 amplifier stage, the bias resistor

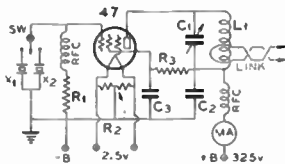

THE CRYSTAL OSCILLATOR

Two crystals can be used, if desired; one for 40 meters, another for 80. A switch "SW" throws in either crystal at will. R1—10,000 to 50,000 ohms. R2—20 ohms, CT. R3—40,000 ohms. C1—100 mmf. C2-C3—.006 mfd. L1—See Coils Turns Table on page 116. X1, X2 are the crystals.

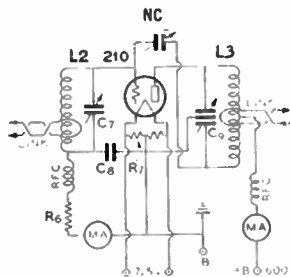

THE 210 AMPLIFIER

Although a split-stator condenser is shown at C9, a single-section condenser can be used in the conventional manner. When a single-section condenser is used, a .006 mfd. condenser is connected between the Positive 600-volt tap (at the RFC) and ground, and the ground connection now shown as going to the rotor of the condenser C9 is eliminated. C7—100 mmf. C8—.006 mfd. C9—35 mmf. midget variable, double spaced. R6—10,000 ohms. R7—100 ohms, CT. L2—Grid Coil. L3—Plate coil for 210 stage. The key is connected in series with the center tap of R7 and the negative "B". To use this 210 stage as a driver for another stage, merely link-couple, as the circuit shows. If the 210 stage is to feed the antenna, place the antenna coil on top of L3, coupled about 1 inch away from it. See Table on Page 116 for Antenna Coil, plate coil and grid coil data for single section condensers.

has a value of 10,000 ohms, 2 watt rating. As in the oscillator stage, the by-pass condensers should be of the mica type. The negative B lead from the oscillator stage is connected to the negative B lead of the amplifier stage. The neutralizing condenser and the plate condenser in the 210 stage are both 35 mmf. double-spaced midgets. These condensers are very low in price and are entirely satisfactory for use in this circuit. The key, for CW transmission, is in series with the center-tap of the filament resistor and the negative B terminal.

If a Zepp antenna is used, a simple coupling coil consisting of from 6 to 13 turns of No. 16 DCC on a 1 1/4-in. bakelite coil form, can be placed directly on top of the plate coil. This antenna coil is tuned with a .00035 mfd. receiving type variable condenser in parallel with the Zepp feeders, or series tuning can be used by placing a .00035 mfd. receiving type condenser in series with each feeder and the respective ends of the antenna coil. Coupling can be varied by placing a hinge on the antenna coil, or it can remain fixed by merely holding the plate and antenna coils in place by means of a cardboard sleeve, slipped into both coil forms.

Another alternative is to use the Collins Impedance Network, as shown in the chapter on antennas. This system permits use of an antenna of any length.

The oscillator is supplied with 300 volts, the 210 stage with 600 volts. Two separate power supplies can be used, although many amateurs prefer a single transformer and a bridge rectifier. The plate current is turned

on after the tube filaments are lighted. A DPDT switch can be inserted in the high voltage leads to the rectifier tubes.

Tuning

THE TUNING PROCESS is simple. Secure a 2½-volt dial light, or a small neon glow lamp. If a dial light is used, connect a 2-inch loop of wire to the terminals of the lamp, soldering one end of the loop to the base connection and the other end to the screw-thread of the lamp. If a neon glow lamp is used, the loop is not needed. Proceed as follows:

Light tube filaments of the 47 and 210 tubes. Turn on the plate voltage for the 47 oscillator tube. Do not connect high voltage to the 210 stage. Hold the lamp near the top of the plate coil. Rotate the oscillator plate condenser until a point is found where the lamp glows brightest. This "peak" of oscillation will not "hold" when the next stage

is tuned. Now slip the coupling link over both the oscillator plate coil and the grid coil. Place the link at the bottom of both coils. Retune the oscillator condenser for brightest glow. Then tune the grid coil condenser until the lamp, when held over the grid coil, glows brightest. If the lamp does not light when held over the grid coil, it is proof that the oscillator stage has stopped oscillating. Retune the oscillator. A setting of both the oscillator condenser and the grid condenser will be found where the lamp glows at about the same brilliancy when held over each coil.

Now place the lamp over the 210 plate coil, with NO plate current connected to the 210 stage, but with the 210 filament lighted. Make sure that the crystal is oscillating. Rotate the 210 plate coil condenser over its entire range. If the tuning lamp lights up, the stage is not neutralized. Keep the lamp over the plate coil of the 210 stage, slowly rotate the neutralizing condenser until a po-

TRANSMITTER COIL WINDING DATA

For '47 Oscillator and 210 Amplifier Using Single Section Condensers

NOTE: L1—Oscillator Plate Coil. L2—Grid Coil. L3—210 Amp. Plate Coil.

160 METERS		TUNING CONDENSER
Note: Coils L1 and L2 wound on 1½" Isolantite Forms.	L1—70 Turns, No. 22 DSC, close wound.	100 mmf.
	L2—70 Turns, No. 22 DSC, close wound.	100 mmf.
	L3—85 Turns, No. 20 DCC, close wound on 2" dia. form, 4" winding space.	35 mmf.
80 METERS		
All 3 Coils Wound on 1½" diameter Isolantite Forms.	L1—35 Turns, No. 22 DCC, close wound.	100 mmf.
	L2—32 Turns, No. 22 DCC, close wound.	100 mmf.
	L3—45 Turns, No. 22 DCC, close wound.	35 mmf.
40 METERS		
All 3 Coils wound on 1½" dia. Isolantite Forms.	L1—19 Turns, No. 20 DSC, space wound, one diameter spacing between turns.	100 mmf.
	L2—Same as L1.	100 mmf.
	L3—24 Turns, No. 16 Enameled, 12 turns to inch.	35 mmf.
ANTENNA COILS		
160 METERS		
For 160 meters a Marconi antenna is well suited. Use the Collins Impedance Matching System. Wind antenna coil with 30 turns No. 12 enameled, on 2½" dia. form, 5 turns to inch.		350 mmf.
80 METERS		
For Zepp Antenna, use coupling coil with 13 turns No. 16 DCC on 1¼" dia. form. If Collins System is used, 80 meter coil is same as 160 meter coil.		350 mmf.
40 METERS		
For Zepp Antenna use antenna coupling coil same as for 80 meters. If Collins System is used, wind only 7 turns on antenna coil. This coil is also satisfactory for 20 meters.		350 mmf.

sition is found where the tuning lamp will not glow over the entire swing of the 210 plate tuning condenser. While neutralizing the stage, it is well to frequently hold the tuning lamp over the oscillator and grid coils to make sure that they are still in resonance. If no indication is found in the lamp when going back over the oscillator, retune the oscillator and grid coil circuits, because different setting of the neutralizing condenser throws the oscillator out of oscillation and the circuits must then be retuned.

When you have found a point on the neutralizing condenser where no glow is indicated in the tuning lamp, no matter where the plate condenser of the 210 stage is set, then the 210 stage is neutralized. Now apply the high voltage to the plate of the 210, press the key, and tune the plate condenser of the 210 until the lamp shows MAXIMUM glow. Connect the antenna to the coupling coil, place this coil over the 210 plate coil, tune the antenna feeder condenser, and retune the 210 plate condenser until maximum indication is had in the antenna RF meter. Your transmitter is then ready for operation.

Summary of Tuning

THE ENTIRE transmitter is tuned to resonance when, and if—a glow is had in the tuning lamp when held over the oscillator plate coil, a glow is had when it is placed over the grid coil, NO GLOW is had when the tuning light is placed over the 210 plate coil, with high voltage disconnected from the 210 stage, no matter where the 210 plate condenser is set.

Watch the antenna RF meter. Slowly retune each condenser until maximum indication is had in the antenna meter when the key is pressed.

Care should be taken not to hold the tuning lamp too close to the coils, else it will burn out. The small neon glow lamps, on the other hand, can be placed in very close proximity to the coils without danger of burn-out when tuning low-power stages.

The newcomer is advised to use the neon glow lamp for tuning, in preference to the $2\frac{1}{2}$ -volt dial light, because it is a more sensitive indicator and will not burn out. These neon lamps cost only about 40 cents, and can be secured from any radio supply house.

If, by chance, the newcomer experiences difficulty in properly tuning the transmitter, he is advised to call on his local radio club for assistance. Fellow amateurs are always willing to be of service. However, if the instructions herein are closely followed, no difficulty should be experienced. In conclu-

sion, it is of paramount importance that a good, standard crystal and holder is used in the oscillator. The emitted note from this little 2-tuber is, literally, a treat to the ear. It is a sharp, pure DC crystal note, in conformity with the rules and regulations of the Federal Communications Commission.

Eliminating the Chirps When Keying the Crystal

● In the conventional pentode crystal oscillator circuit the screen voltage is obtained from the plate power supply by means of a series dropping resistor. When an attempt is made to key in the center-tap of this crystal oscillator circuit, a bothersome chirp is usually found in the note. When the key is up the screen voltage rises to the same value as the plate voltage, which is from 350 to 450 volts. With the key open, no space current flows through the tube and because there is no current through the screen dropping resistor, there is no voltage drop across that resistor. The high voltage is thus applied to the screen. When the key

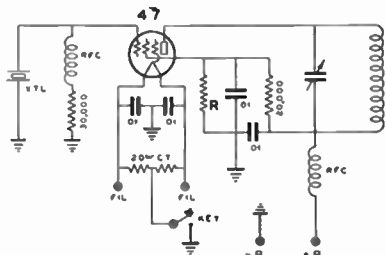

R—5000-10,000 OHMS, (TO GET APPROX 100 VOLTS ON SCREEN)

Circuit Diagram for eliminating chirps when keying the Crystal Oscillator Stage.

is pressed, and space current starts to flow in the tube, the screen current causes a voltage drop across the usual series dropping resistor and the screen voltage then drops back to its normal 100 volts. However, it does not drop back instantaneously; during the time the screen voltage is dropping there is often a very noticeable change in the frequency, which causes the chirp. The chirp can be eliminated by keeping the screen voltage approximately constant, whether the key is up or down. This necessitates the use of a voltage divider, instead of a series dropping resistor as a source of screen voltage, as shown in the circuit above. The value of the resistance R should be chosen so that the voltage on the screen, when the key is down, is 100 volts when measured with a high resistance voltmeter.

High-Power Push-Pull Amplifier and Driver

THE first tube of an ever-increasing group in which Tantalum is used for grid and plate material, in order to obtain a high enough vacuum in which a thoriated filament will operate effectively, was the HK-354 Gammatron. When first introduced, this tube was regarded with a great deal of skepticism by the vast majority of amateurs, due to its many radical features. After a year of widespread use in amateur and commercial stations all over the world, it has been demonstrated that every claim originally made for the tube has been found to be conservative.

Some recent minor changes in the HK-354 are worthy of mention because they make for increased ruggedness and longer life. The redesigned HK-354 Gammatron has approximately the same characteristics as the original 354 and is interchangeable with it. However, it should not be used in a push-pull circuit

amplifier stage in company with one of the earlier types. Minor mechanical changes in the grid and filament structure, which cause but a slight change in characteristics, are of sufficient importance to recommend the use

of two similar tubes in order to obtain a perfect match.

The Nonex glass envelope of the new HK 354 has been enlarged in size to slightly less than 3 inches in diameter. This affords more heat-radiating ability and thus allows the bombarding process to be carried further than when a small size envelope is used.



H-K354 WITH LARGE ENVELOPE

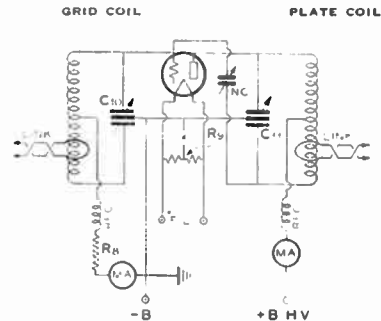

SINGLE HK-354 DRIVER FOR FINAL AMPLIFIER

RFC—Plate Choke, 500 MH., Heavy Duty. RFC—Grid Choke, 125 MA. Receiving Type H.F. R9—100 ohm C.T., 20 watts. R8—10,000 ohms, 100 watt.

C10—Split-Stator, 35 MMF. each section. C11—Split-Stator, 100 MMF. each section, 7500 volts. NC—10 MMF. for HK-354 Tube, or 25 MMF. for 211, 203-A or 830B.

The illustration shows a typical single-ended RF amplifier using an HK-354 Gammatron. Link coupling is used to the grid circuit. The coupling loop has two turns, as shown. This amplifier can be driven by a single type 210, 801 or a pair of type 45 tubes.

The jack at the right, lower front of chassis reads grid current, the jack to the left reads plate current. The neutralizing condenser consists of two heavy aluminum plates, about 2½-in. x 3-in., spaced ⅜-in. and supported on stand-off insulators. The new

low-C tubes (HK354 and EIMAC 150T and 50T) are noted for the unusually heavy plate voltages they will withstand. They are ideally suited for use at very high frequencies and also for dithermy applications.

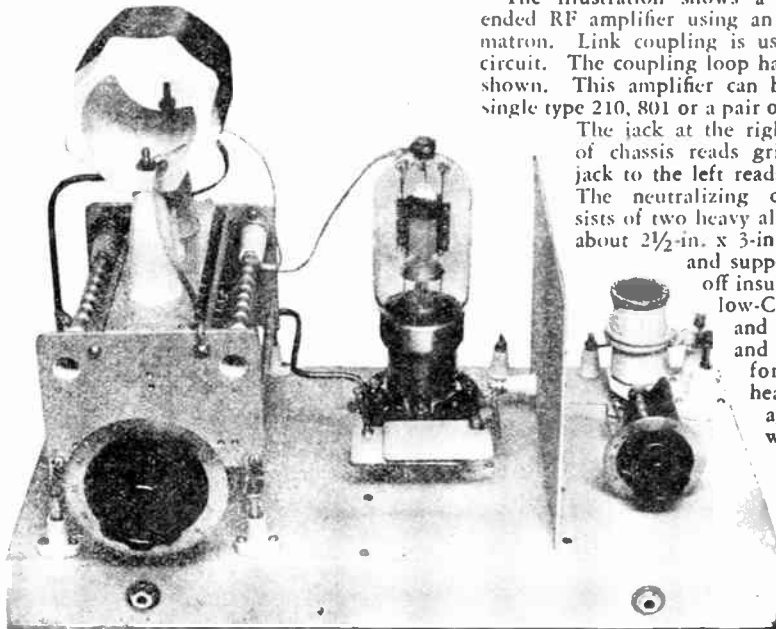

Practical Transmitter Circuits

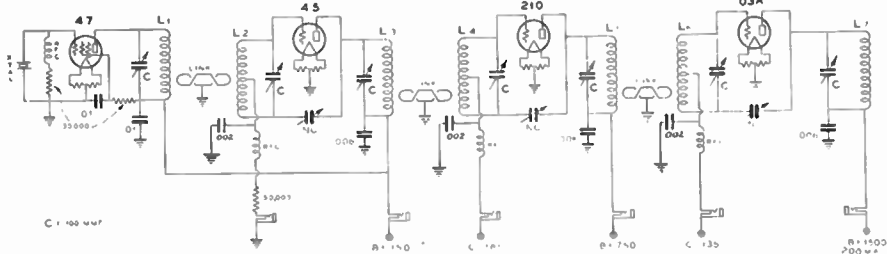

225 WATTS OUTPUT - 300 WATTS INPUT

This transmitter is capable of very good results for CW operation on 160, 80 and 40 meters. For higher frequencies, the low-C tubes are more desirable. If used for phone communication, the plate voltage should be cut down to not over 1250 volts, and the plate current should be held down below 165 MA.

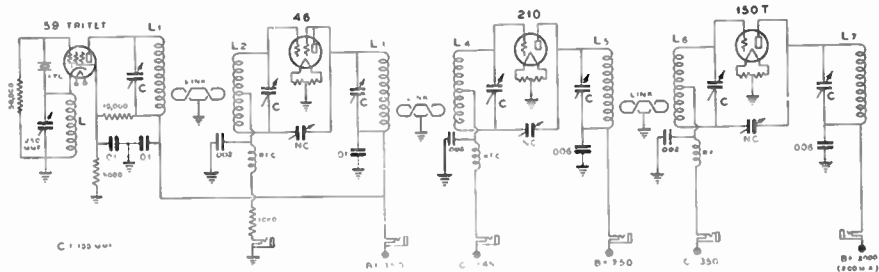

300 WATTS OUTPUT - 400 WATTS INPUT

This transmitter is suitable for either phone or CW on all of the common bands. With a 40 meter crystal it gives good results when multiplying to 10 meters.

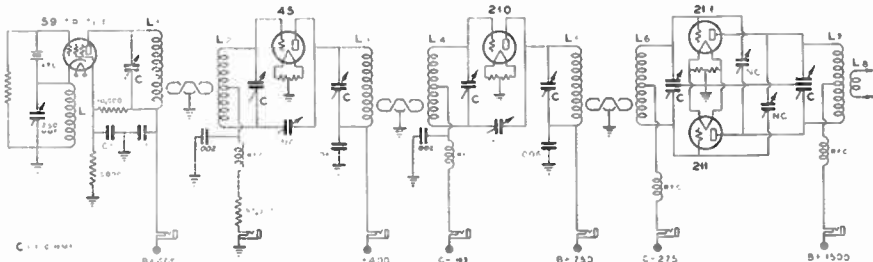

400 WATTS OUTPUT - 500 WATTS INPUT

This line-up is ideal for CW operation below 7500 KC. If used on 14 MC or higher, the input should be cut down to protect the seals in the type 211 tubes. If used for phone operation, the final amplifier should not draw more than 330 MA at 1250 volts. All three of the above transmitters use grid neutralization.

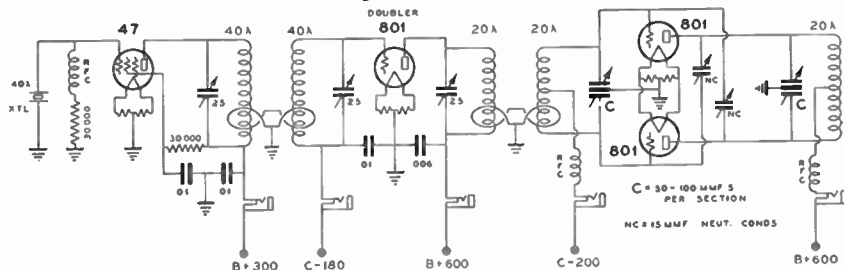

This transmitter is ideal for 20 and 40 meter operation. 100 watts input on 40 meters.

Table of Static Characteristics of Transmitting Tubes

THE purpose of this table is to enable the user of transmitting tubes to quickly select the tube best suited for his particular circuit.

PLATE RESISTANCE IN OHMS—A useful value to know when it becomes necessary to either match or mis-match the impedance of the plate circuit to the load. Plate Resistance of a radio tube is the resistance of the path between cathode and plate to the flow of alternating current.

AMPLIFICATION FACTOR—This indicates the voltage gain of the tube when used as a Voltage Amplifier. It is a very unreliable means of estimating relative power amplification. The principal use of this factor is in determining bias requirements. To obtain cut-off bias, it is simply necessary to divide the plate voltage being used by the amplification factor. The result gives the amount of negative bias voltage necessary to reduce the plate current to zero. Thus, twice cut-off is twice this amount.

MUTUAL CONDUCTANCE—(Micro-Mho)—The mutual conductance of a tube is a yardstick of tube performance which

combines both plate resistance and the amplification factor, and is the ratio of the second to the first. Thus, if a grid voltage change of 10 volts causes a plate current change of 0.01 ampere (10 ma.) with all other voltages constant, the mutual conductance is 0.01 divided by 10, i.e., 0.001 mho. Thus a millionth of a mho, or a micromho, would equal 0.001 mho times a million, or 1000 micromhos.

C_{gp}—This indicates capacity between the grid and plate. It is the capacity which must be neutralized in order to prevent self-oscillation in the conventional RF amplifier. In the screen-grid tubes this capacity is reduced to a very small amount by the screen grid, and neutralizing therefore is not usually necessary.

C_{gf}—This indicates the capacity between the grid and filament. This capacity is shunted across the input circuit of the tube, whether it be a tuned grid tank or the plate tank of the preceding stage. The lower this capacity, the better L/C ratio of the driving tank, and therefore the better the efficiency of the preceding stage, resulting in greater efficiency

from the preceding stage. This capacity is an indication of radio-frequency grid current which sometimes reaches dangerously-high values at the higher frequencies.

C_{pf}—This indicates the capacity between the plate and filament. This capacity is shunted across the plate tank and prevents the use of the extremely low-C which is so desirable for high efficiency.

PLATE DISSIPATION IN WATTS—This indicates the safe value of power which may be dissipated in the form of heat from the plate of the tube. Therefore, the difference between plate input and power output should never exceed this value. This limitation makes it evident that high plate efficiency is much to be desired, because it allows more plate input, and consequently more power output, for a given value of plate dissipation.

BASE—This column gives information on the type of socket to use for a given tube. It also shows if some of the elements are brought out of either the top or side of the glass envelope.

Type	Fil. Volts	Fil. Amps.	Type of Fil.	Plate Res. Ohms	μ Amp. Factor	Trans-conductance μ mhos	C _{gp} $\mu\mu$ fd	C _{gf} $\mu\mu$ fd	C _{pf} $\mu\mu$ fd	Plate Diss. Watts	Base	Comments
45	2.5	1.5	Oxide Coated	1,650	3.5	2,125	8	5	3	10	Med. 4 Pin	Class A or Self Excited Osc.
46	2.5	1.75	Oxide Coated	12,000*	30	2,500				10	Med. 5 Pin	Class B Audio-Doubler-Amplifier
RK100	6.3	.6	Oxide Heater	400	50	1,200	aprx 20			10	6 Pin	Pentode Oscillator-Doubler
59	2.5	2.0	Oxide Heater	11,200*	30	2,700				10	Med. 7 Pin	Class B Audio-Doubler-Triode Osc.
47	2.5	1.75	Oxide Coated	60,000	150	2,500	1.25	8.7	13.2	10	Med. 5 Pin	Pentode Crystal Oscillator
2A5	2.5	1.75	Oxide Heater	100,000	220	2,200				10	Med. 6 Pin	Pentode Crystal Oscillator
RK17	2.5	1.75	Oxide Heater	100,000	220	2,200	1	7.5	16	10	Med. 5 Pin*	High Frequency 2A5
RK23	2.5	2	Oxide Heater	200,000	500	2,500	.04	10	10	12	Med. 7 Pin†	Pentode Oscillator-Doubler
RK25	6.3	.8	Oxide Heater	200,000	500	2,500	.04	10	10	12	Med. 7 Pin†	Pentode Oscillator-Doubler
802	6.3	.9	Oxide Heater			2,250	.15	12	8.5	15	Med. 6 Pin†	Pentode Oscillator-Doubler
2A3	2.5	2.5	Oxide Coated	765	4.2	5,500	13	9	4	15	Med. 4 Pin	Class A or Self Excited Osc.
WE205D	4.5	1.6	Oxide Coated	3,500	7.3	2,080	4.8	5.2	3.3	15	W E 4 Pin	General Purpose Triode
WE271A	5.0	2.0	Oxide Heater	2,800	8.5	3,035	5.3	6.5	3.8	15	W E 5 Pin	General Purpose-Low Hum Level
210	7.5	1.25	Thoriated Tung	5,450	8	1,550	8	5	4	15	Med. 4 Pin	General Purpose
841	7.5	1.25	Thoriated	63,000	30	450	8	5	3	15	Med. 4 Pin	High Mu 210 -Class B Audio-Doubler
842	7.5	1.25	Thoriated	2,500	3	1,200	8	5	4	15	Med. 4 Pin	Low Mu 210—Class A
843	2.5	2.5	Oxide Heater	4,800	7.7	1,600	6	5	5	15	Med. 5 Pin	Resembles 210 -Low Hum Level
844	2.5	2.5	Oxide Heater	125,000	75	600	.07	10	8.5	15	Med. 5 Pin†	Resembles 865—Low Hum Level
865	7.5	2.0	Thoriated	200,000	150	750	.05	10	7.5	15	Med. 4 Pin†	Tetrode-Buffer—Doubler
RK34	6.3	.8	Oxide Heater	5,600	13	2,100	2.7	4.2	2.1	20	7 Pin†	Dual HF Triode
801	7.5	1.25	Thoriated	4,300	8	1,840	6	4.5	1.5	20	Med. 4 Pin	General purpose Triode
250	7.5	1.25	Oxide Coated	1,800	3.8	2,100	9	5	3	25	Med. 4 Pin	Class A or A Prime
WE254B	7.5	3.25	Thoriated	75,000	100	1,330	.085	11.2	5.4	25	Med. 4 Pin†	High Frequency Tetrode
WE252A	5.0	2.0	Oxide Coated	1,800	4	2,222	12	6.5	4	30	Med. 4 Pin	Class A or A Prime

WE268A	5.0	3.25	Thoriated	5,000	5	1,000	2.3	5.4	1.1	30	Med. 4 Pin†	High Frequency Triode
800	7.5	3.25	Thoriated	6,800*	15	2,300	2.5	2.75	1	35	Med. 4 Pin†*	General Purpose—Ultra High Frequency
RK18	7.5	2.5	Thoriated	5,400	18	3,000	5	3.8	2	35	Med. 4 Pin†	General Purpose—High Frequency
RK31	7.5	3	Thoriated				5	4	2	35	4 Pin†	Zero Bias Class B Audio
RK20	7.5	3	Thoriated	500,000	1,500	3,000	.012	11	10	35	Med. 5 Pin†	Pentode Oscillator-Doubler
830	10.0	2.15	Thoriated	4,000	8	2,000	9.9	4.9	2.2	40	Med. 4 Pin	General Purpose Triode
830B	10.0	2.15	Thoriated	8,000	30	3,750				40	Med. 4 Pin†	General Purpose—Class B Audio
50T	5	6	Thoriated	3,300	14	4,000	2	2	.2	50	Med. 4 Pin†§	General Purpose UHF Trio
RK30	7.5	3.25	Thoriated							50	4 Pin†*	Ultra-HF Triode
WE304A	7.5	3.25	Thoriated	4,800	11	2,300	2.5	2	.67	50	Med. 4 Pin†*	General Purpose, Ultra HF
WE211E	10.0	3.0	Oxide Coated	3,500	12	3,425	9	6.3	3.6	65	50 Watt	General Purpose—Audio Only
WE282A	10.0	3.0	Thoriated	70,000	100	1,430	.2	12.2	6.8	70	Med. 4 Pin†	Ultra High Frequency Tetrode
WE242A	10.0	3.25	Thoriated	1,900*	12	6,300	13	6.5	4	100	50 Watt	General Purpose—Below 10 MC.
WE261A	10.0	3.25	Thoriated	1,900*	12	6,300	9	6.5	4	100	50 Watt	General Purpose—Below 15 MC.
WE276A	10.0	3.0	Thoriated	2,000*	12	6,000	9	6	4	100	50 Watt	General Purpose—Below 15 MC.
211	10.0	3.25	Thoriated	1,900*	12	6,300	15	8	7	100	50 Watt	General Purpose—Below 10 MC.
203A	10.0	3.25	Thoriated	5,000*	25	5,200	15	8	7	100	50 Watt	High Mu 211—Below 10 MC.
845	10.0	3.25	Thoriated	1,800	5	3,000	15	8	7	100	50 Watt	Low Mu 211—Class A—Below 10 MC.
WE284A	10.0	3.25	Thoriated	1,900	4.7	2,475	8.2	7	7.8	100	50 Watt	Low Mu 242—Class A—Below 15 MC.
838	10	3.25	Thoriated				8	6.5	5	100	50 Watt	Zero Bias Class B Audio
850	10.0	3.25	Thoriated	200,000	550	2,750	.2	17	26	100	50 Watt*	Tetrode—Below 15 MC.
852	10.0	3.25	Thoriated	6,000*	12	2,000	3	2	1	100	Med. 4 Pin†*	Ultra High Frequency Triode
860	10.0	3.25	Thoriated	180,000	200	1,100	.05	8.5	9	100	Med. 4 Pin†*	High Frequency Tetrode
803	10	3.25	Thoriated							125	Special 5 Pin*	Pentode Oscillator-Doubler
HF200	10	3.25	Thoriated	2,840	12	4,400	9	5.5	3	150	50 Watt†§	H.F. Triode
HK354	5.0	10	Thoriated	2,800	14	5,000	3.7	9	.5	150	50 Watt†	General Purpose—High Frequency
354	5	10	Thoriated	2,800	14	5,000	3.7	9	.5	150	50 Watt†	General Purpose Triode
150T	5	10	Thoriated	2,400	15	5,000	3.2	3	1	150	50 Watt†*	General Purpose Triode
HK357	5	10	Thoriated							150	50 Watt†	Pentode Oscillator-Doubler
F108A	10.0	11.0	Tungsten	8,500*	12	1,400	7	3	2	175	50 Watt†*	Ultra High Frequency Triode
WE212D	14.0	6.0	Oxide Coated	1,600*	16	10,000	19	19	12	200	Spec W E	General Purpose—Below 5 MC.
204A	11.0	3.85	Thoriated	4,700*	24	5,100	17	18	3	250	RCA 250W†	Hi Mu—Below 10 MC.
WE270A	10.0	9.75	Thoriated	1,750	16	9,000	21	18	2	350	Spec W E†	General Purpose—Below 15 MC.
849	11.0	5.0	Thoriated	3,200	19	6,000	33.5	17	3	400	RCA 250W†	General Purpose—Below 10 MC.
831	11.0	10.0	Thoriated	6,450	14.5	2,250	4	3.8	1.5	400	RCA 250W†*	Ultra High Frequency Triode
861	11.0	10.0	Thoriated	143,000	300	2,100	.1	17	13	400	RCA 250W†*	High Frequency Tetrode
500T	5	30	Thoriated		16					500	Eimac 2 Pin†*	General Purpose Triode
F100A	11.0	25.0	Tungsten	7,000	14	2,000	10	4	2	500	Spec FED†*	Ultra High Frequency Triode
HK255	14.0	30	Tungsten	1,000	3	3,000	5	12	7	500	Spec H K†§	Low Mu—Class A—Below 50 MC.
851	11.0	15.5	Thoriated	875*	20	23,000	55	30	7	1750	RCA 250W†	General Purpose—Below 5 MC.
WE251A	10.0	15.9	Thoriated	2,200	10.5	4,770	8	10	6	1000	Spec W E†*	General Purpose—Below 50 MC.
WF279A	10.0	21.0	Thoriated	1,800	10	5,555	18	15	8	1200	Spec W F†*	General Purpose—Below 50 MC.

NOTE:—ALL PLATE RESISTANCE VALUES ARE AVERAGE EXCEPT THOSE MARKED * WHICH ARE MEASURED AT ZERO BIAS AND NORMAL PLATE VOLTAGE.

† Means that the Plate Lead is brought out the top.
 * Means that the Grid Lead is brought out the top.

‡ Means that the Plate Lead is brought out the side.
 § Means that the Grid Lead is brought out the side.

Low-C Tube Amplifier Design

This final amplifier is a good example of the highest form of efficient construction practice. Note the short direct leads to the grid plate terminals of the 150Ts. The two neutralizing condensers are side-mounted directly under the plate tank condenser. This method of mounting permits the use of short leads from each stator of the plate condenser to its associated neutralizing condenser. The grid tank coil is mounted under the chassis which effectively shields it from the plate tank. The grid condenser is above the chassis, mounted directly over the grid terminals and close to the neutralizing condensers. One meter reads plate current and the other reads DC grid current. The entire amplifier is symmetrical with respect to ground. This means that the capacity to ground of each side of the push-pull circuit is equal, an essential feature

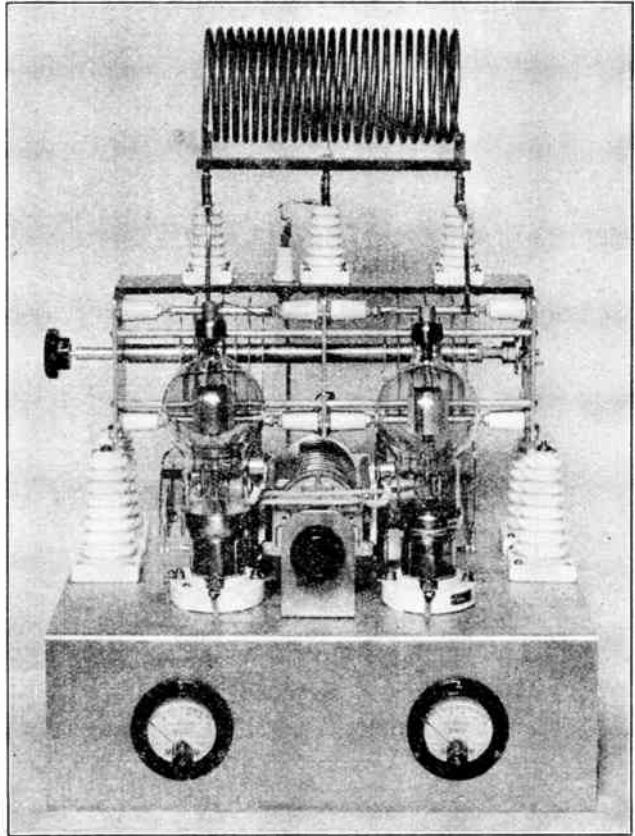

Below: An amplifier using a single 150T driven by a 210 tube (not shown) with 750 volts on the plate. The grid current on the 150T is 40 milliamperes. The unit is mounted on a sand-blasted aluminum chassis. The antenna coil is wound on the same form on which the plate coil is wound, as the picture shows.

for permanent neutralization and to maintain an equal load on both tubes. The use of a metal chassis aids materially to shield the final amplifier from the stages located below it in the mounting rack. A good substitute for a metal chassis is to tack a thin sheet of No. 26 gauge aluminum or copper over an ordinary wooden breadboard.

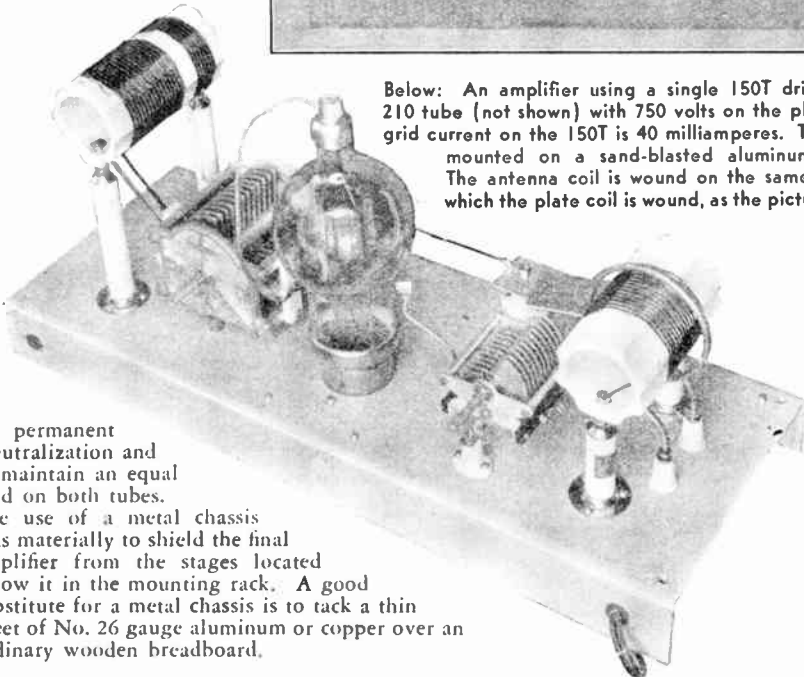

Radiotelephony

THE TRANSMISSION of intelligence from one point to another by means of the human voice is a much more complex process than the transmission of code signals and calls for a somewhat more technical knowledge on the part of the operator.

The average phone transmitter can be divided into three major components: (1) The portion that generates and amplifies the radio frequency carrier wave. (2) The portion that converts the sound waves from the operator's lips into electrical waves and then amplifies these audio frequency waves. (3) The portion of the transmitter that takes the amplified audio frequency voice currents and mixes them (modulation) with the radio frequency carrier waves in such a manner that the power output of the phone transmitter varies in exact accordance with the variations in sound pressure applied to the microphone.

Modulation Fundamentals

IN GENERAL, all communication systems utilize audio frequency waveforms. These can be pure tones and square-topped waves, for use in code transmission, on either land lines or over radio circuits. Or these waveforms can be quite complex, for conveying telephonic speech directly, without translating the intelligence conveyed into the dots and dashes of the telegraphic or radio codes. The range of audio frequencies required to transmit the intelligence varies from a few cycles per second to 10,000 cycles, depending on whether telegraphic or high-quality telephonic speech is used. For amateur purposes, an audio frequency range of from 200 to 2800 cycles per second will provide intelligibility, although fully-natural and pleasing reproduction of the transmitted speech requires a range of from at least 100 cycles to 4000 cycles. True high fidelity reproduction of speech means that all audio frequencies between 80 and 8000 cycles are faithfully reproduced at the receiving point. Whereas this order of fidelity is all too rare in amateur practice, it should nevertheless be encouraged because high fidelity makes an R2 phone signal intelligible. Thus high fidelity is a distinct advantage in working that elusive DX, especially if the receiving operator speaks a foreign language and has difficulty in understanding the particular variety of English you happen to speak.

In the transmission of telegraphic signals over a radio circuit, the carrier is radiated only during the "mark" period. The "space" is obtained and defined by an absence of the carrier. On the other hand, when telephonic communication is used on a radio channel, the carrier remains on between syllables and words. The audio signal

periodically augments and reduces the amplitude of the carrier, but the average amplitude of the carrier remains constant. Certain commercial telephone circuits use a type of modulation, termed "Suppressed Carrier Single Sideband," but it is not very widely used because of the difficulty in obtaining satisfactory speech quality. The principal reason for the difficulties involved in Suppressed Carrier systems lies in the inability to maintain the oscillator in the receiver in exact synchronism with the oscillator in the transmitter.

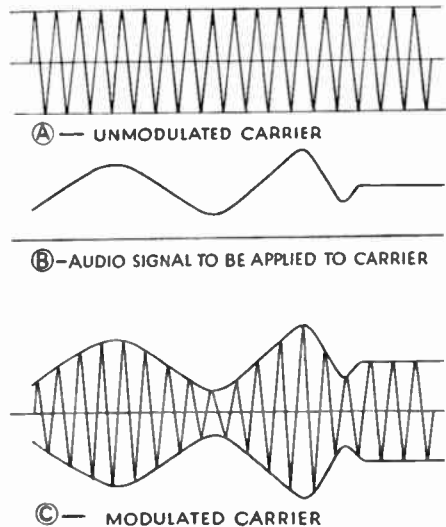

Curve (A) indicates the pure CW wave applied to the grid of the modulated amplifier. Curve (B) shows the audio frequency output of the modulator. Curve (C) shows the combination of the two after being mixed in the modulated amplifier. Note that the average value of the modulated wave is constant.

The Sideband Theory

When a modulated carrier is analyzed, it is found that the original carrier is present, plus two groups of sum and difference frequencies, which have been named the upper and lower sidebands. These sidebands are generated in the transmitter by the familiar heterodyne process, which is commonly used in superheterodyne receivers. Thus one sideband consists of waves whose frequencies equal that of the carrier PLUS that of all the individual audio components, and the other sideband consists of waves whose frequencies equal that of the carrier MINUS all the audio components. In other words, the carrier and the audio signal were HETERODYNED to

gether into a group of BEAT FREQUENCIES by the detecting action of the modulated amplifier.

DETECTION and MODULATION mean much the same. In fact, the detector in the receiver which receives the modulated wave and turns it back into an audio frequency wave which is applied to the loudspeaker, repeats the heterodyne action of the radio-telephone transmitter and completely reverses the process. In the receiving detector (or audio de-modulator, as it is sometimes called) the incoming carrier BEATS with the incoming sidebands and thus the sum (or difference) frequencies between the two become an exact equivalent of the original audio frequency modulating signal, which can now actuate the loudspeaker. When a suppressed carrier system is used a local oscillator must be provided in the receiver in order to re-supply a carrier wave for the incoming sideband (or sidebands, when both are used) to heterodyne with, in order that an audio beat frequency can be obtained to reproduce the signal. It will be seen that the local oscillator must maintain exactly the same frequency as the oscillator used at the transmitter, which was modulated to produce the transmitted sideband. If the frequency of the receiver oscillator drifts slightly, it will not only change the pitch of the fundamental tones in the transmitted speech, but will also shift the frequencies of all the overtones in such a manner that they will no longer be integral harmonics of their associated fundamental tones. The resulting distortion and quality impairment will utterly destroy the intelligibility of the channel. A drift of only a few cycles is sufficient to make most speech absolutely unintelligible, and it is almost impossible to maintain high frequency oscillators sufficiently close together without extensive frequency stabilizing equipment. The carrier takes up practically no room in the frequency spectrum, but each sideband contains all of the audio signal components so that the modulated signal requires a frequency band twice as wide as the highest audio modulating frequency. If the transmitter responds to all audio signals impressed on the microphone between 100 and 4000 cycles per second, then the band width extends 4000 cycles below the carrier and 4000 cycles above the carrier frequency. This 8000 cycle band will cause some interference to any other stations whose sidebands extend into this particular portion of whatever amateur band the transmitter is working in. Almost 90 per cent of the power in the radiated sidebands consists of the lower frequency audio tones below 1500 cycles per second. However, do not labor under the false impression that the 10 per cent above 1500 cycles per second is not important. It tremendously improves the intelligibility and naturalness of the speech,

even though none of the higher frequency sounds contain much power.

Power Distribution in a Modulated Wave

The amplitudes of the sidebands depend on the percentage of modulation; the higher the degree of modulation, the greater the sideband amplitude. It takes POWER to modulate a wave. Power must be expended in altering the amplitude of a wave. When a carrier is 100 per cent modulated by a pure audio tone, the power in each of the two sidebands equals one-quarter of the unmodulated carrier power output. Thus the power in both sidebands equals one-half of the carrier wave and, therefore, complete modulation increases the average power output of the phone transmitter 50 per cent. If a class C radio frequency amplifier is plate modulated, the plate power input must therefore be increased 50 per cent in order to get a 50 per cent increase in output, because the plate efficiency remains constant during modulation. This 50 per cent increase in plate input is obtained from the modulator tubes in the form of AC. It is superimposed on the DC plate input in such a manner that the instantaneous plate voltage (and current) is alternately raised to twice the unmodulated value, and then reduced to zero. In order to swing the plate voltage of the class C amplifier from zero to twice normal, the modulators must alternately supply and absorb power. This involves energy storage during the time the plate voltage is below normal. This energy is stored in the Heising choke, or in the modulation coupling transformer, depending on whether capacitative or inductive coupling is used between the modulators and the modulated amplifier.

One hundred per cent modulation is approached only on the extreme voice peaks. Ordinary voice peaks should rarely be allowed to modulate a phone transmitter more than about 80 per cent, and the average modulation during the time that the operator is actually speaking will barely average 40 per cent. However, 100 per cent modulation CAPABILITY is essential if heterodyne interference with other stations is to be kept at a minimum.

All plate modulated RF amplifiers operate as class C amplifiers. In other words, they are biased to at least twice that value of DC grid bias which would reduce the plate current to zero, at the particular value of DC plate voltage used. This value of grid bias is termed "twice cut-off." Cut-off bias depends on the amplification factor of the tube and the plate voltage used. It is equal to the plate voltage divided by the amplification factor. The plate voltage is usually known, or can easily be measured with a voltmeter. The amplification factor of any tube can be found either in a table of tube characteristics or can be secured from the

tube manufacturer. The grid of the tube must then be heavily excited by a buffer amplifier so that the power output of the stage will rise as the square of the plate voltage without any "dropping off" tendency as the instantaneous plate voltage approaches twice the normal value under modulation. Choose tubes with as high a mutual conductance as possible in order to economize on driving power.

Because the plate input to the class C modulated amplifier increases during modulation, and because the plate efficiency remains constant, it is evident that the plate dissipation of the tube will increase when audio modulation is applied. Therefore, some available plate dissipation must be held in reserve because the heat dissipation must increase up to 50 per cent for complete modulation.

Another reason for operating modulated amplifier tubes below their maximum rating is that the peak plate voltage and the peak plate current are doubled during complete modulation.

Low Level vs. High Level Modulation

THE HIGH LEVEL modulation system (which is most widely used by amateurs) consists of coupling the antenna directly to the modulated class C amplifier, without further amplification of the modulated wave. When a low-power stage is modulated and the modulated output then amplified with one or more linear amplifiers, the method is termed low level modulation."

Each system of modulation has its advantages, each has disadvantages.

A high level modulation system is relatively simple to design and adjust and is probably somewhat cheaper to build, for a given amount of carrier power. The class C modulated amplifier can easily be made 75 per cent efficient and 85 per cent plate efficiency can be secured with proper tubes and fairly high plate voltages. Class B modulators are usually at least 50 per cent efficient and with certain new tubes the plate efficiency can be as high as 72%, which means that small tubes can give high outputs when used as modulators or modulated amplifiers in a high level modulated transmitter. The principal disadvantage in high level modulation is that a relatively large amount of audio power is necessary; in fact, it will generally amount to from 60 to 80 per cent of the RF carrier power output, in watts.

Low level modulation systems apply the modulation to some low power RF amplifier stage and thus very little audio power is necessary to obtain deep modulation. The modulated output from the low power modulated amplifier is then amplified in one or more class B or class BC linear RF amplifiers before being radiated from the antenna. By modulating in a low power stage, all of the troubles of high power audio amplifiers

are avoided. The average power output of a linear RF amplifier must be such that it will increase 50 per cent without distortion, and the peak power output must equal four times the unmodulated value, during complete modulation. The plate input must remain constant and the output can be increased only by increasing the plate efficiency during modulation. Thus the amplifier is least efficient when unmodulated. In order to increase the average power output 50 per cent when amplifying a sine wave modulated carrier, the unmodulated plate efficiency must exactly double. In practice, the unmodulated plate efficiency of a class B linear RF amplifier is only about 30 per cent. Even the newer class BC linear amplifier is only about 40 per cent efficient. Thus the available plate dissipation in the amplifier tube must be 1.5 times the carrier power output, which necessitates large and expensive amplifier tubes compared with the small tubes permissible when high level modulation systems are used.

The principal objection to low level modulation, especially for amateur use, is the critical nature of the adjustments necessary to obtain normal class B or BC plate efficiencies together with linear and symmetrical 100 per cent modulation capability. Some form of well regulated bias supply is also necessary.

Shielding the RF Portion Of a Phone Transmitter

Additional shielding or isolation of the RF portion of the transmitter will often be necessary when going to phone operation as it is essential that all RF be kept out of the speech amplifier in order to eliminate overloading and singing of the audio amplifier. An alternative plan is to use extra-good RF shielding around the speech amplifier equipment. The shielding around the RF portion is less important. It should be remembered that the unwanted coupling between the RF and AF portions of a phone transmitter increase directly with the frequency of operation. In other words, the feedback from a 20-meter transmitter, for a given degree of isolation, is eight times as evident as in a similar 160-meter phone transmitter. Thus about eight times as much shielding and isolation is necessary when operating on 20 meters as on 160 meters. Most of the troubles with RF feedback are caused by poor ground connections. The RF and AF portions of the transmitter should use low resistance SEPARATE grounds. Electricity has a habit of taking not the shortest path, but EVERY available path it can find. Most of it prefers to take the shortest path, but some of it ferrets out every conceivable passage. If one of these many passages happens to lead through a low-level audio circuit, the trouble begins.

Phone Transmitter Components and Their Functions

● The first step in classifying the phone transmitter equipment consists of dividing the transmitter into its three principal parts—(1) The radio-frequency channel, (2) The audio-frequency channel, (3) The power supplies.

(1) The Radio-Frequency Channel

The function of the radio-frequency channel of a phone transmitter is to generate and amplify the radio-frequency alternating current oscillations which are ultimately modulated by the voice impulses and then radiated from the antenna.

(a) **The Oscillator.** The oscillator tube and its associated equipment acts as a low-power AC generator and it is highly important that the frequency of its oscillations be held absolutely constant. All modern phone transmitters utilize a quartz plate which is mechanically resonant in much the same manner as a tuning fork, and which "locks" the oscillator on one particular frequency. The period of vibration of the quartz plate is entirely dependent upon its mechanical dimensions and these dimensions are very rigidly fixed because quartz is a very dense and tough mineral. Slight variations in temperature have an effect upon the mechanical dimensions of the crystal and changes in temperature will therefore cause a resulting change in the natural period of vibration.

However, for amateur use the small amount of frequency drift caused by normal variations in crystal temperature is too minor to warrant consideration. An ordinary crystal can handle approximately one watt of power. Because the average radio-frequency amplifier has a power gain of approximately 10, it is rarely possible to get much more than 10 watts output from the plate circuit of a crystal-controlled oscillator tube.

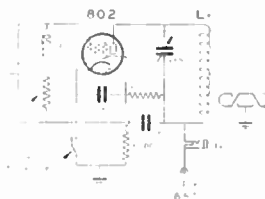

Crystal oscillator using type 802 pentode. At least one stage of buffer amplification must be used between the oscillator and RF amplifier.

While the crystal has a tendency to resist changes in frequency caused by changes in the plate voltage, or other characteristics of the crystal oscillator, it cannot entirely eliminate these changes in frequency. Thus even a crystal oscillator cannot be modulated directly without some undesirable frequency modulation. These wide changes in plate

voltage will have some effect on even the most stable of crystal oscillators, and even modulation of an amplifier which directly follows a crystal oscillator will cause more reaction on the oscillator and on its frequency than is desirable. Thus it is always necessary to put at least one stage of buffer amplification between the crystal oscillator and the radio-frequency amplifier which is modulated by the voice impulses.

Buffer stages are very little different than any other radio-frequency amplifier, and the only special precautions that should be taken are to make certain that the buffer stage is perfectly neutralized and to eliminate, as far as possible, all coupling between its plate circuit and its grid circuit, so that no reaction on the crystal oscillator will result. The real purpose of a buffer stage, as its name implies, is to isolate the oscillator from the modulated amplifier. It is not only permissible to "double" or "triple" the oscillator frequency in a buffer stage, but it is highly desirable to do so. There can be any number of buffer stages in a transmitter. The number is usually dictated by the amount of amplification required to amplify the five to ten watts of oscillator output before applying it to the grid circuit of the modulated amplifier.

The Modulated Amplifier

● Power modulation is used in 95 per cent of all amateur stations. Power modulation is sometimes called Heising Modulation, Plate Modulation, or Power-Supply Modulation. The latter term is perhaps the more strictly accurate. As was previously stated, all forms of plate modulated amplifiers operate "Class C", wherein the negative grid bias is greater than two times that value of bias which would reduce the plate current to zero if the RF grid drive is removed.

The process of plate modulation takes place whenever the plate voltage is varied up and down over its normal value at an audio-frequency rate, the variations being exactly in accord with the voice impulses which strike the diaphragm of the microphone. If the class C RF amplifier is properly biased and driven, the radio frequency AC voltage measured across the plate tank coil will, at all times, be exactly proportional to the instantaneous DC plate voltage. By instantaneous DC plate voltage is meant the sum of the constant DC plate voltage, plus the instantaneous AC voltage which is superimposed on it, and which comes from the modulator tube or tubes. This variation of radio-frequency voltage across the tank coil obviously causes a variation in the power output of that amplifier stage, and if an antenna is coupled to the modulated amplifier the energy which goes

out into the ether in the form of electromagnetic radiations will be varied in exact accordance with the variations in sound pressure applied to the microphone. The RF signal in the detector circuit of a distant receiver, when the carrier is unmodulated, is inaudible—unless a beat-frequency oscillator is turned on. However, as soon as the amplitude (or voltage) of the carrier signal present in the distant receiver is varied, the variation is fed to the audio amplifier of the receiver and is reproduced by the loudspeaker.

In order that the amplitude of the RF output shall be an exact replica of the voice impulses it is essential that there be no regeneration in the class C RF amplifier. This means that the RF amplifier must be perfectly neutralized. Because it takes quite a bit of regeneration to make an amplifier break into self-oscillation, it is usually unsatisfactory to assume that an amplifier is neutralized simply because it does not oscillate. There may not be enough regeneration to allow self-oscillation, but even a small amount of regeneration can seriously disturb the linearity of modulation and thereby cause distortion. The modulation must not only be linear, it must be perfectly symmetrical as well. In other words, the positive and negative peaks of modulation must be equal. This simply means that the carrier output must swing up just as much as it swings down on the immediately succeeding half cycle. Non-symmetrical modulation causes a change in the average amplitude of the modulated wave, which results in carrier shift and serious interference, as well as introducing audio distortion. Interference due to non-symmetrical modulation is very much of the same type as that resulting from over-modulation and is sometimes called "sideband splatter".

Non-symmetrical modulation is sometimes caused by having too little "C" in the plate tank circuit of the modulated amplifier. If there is too much "L" and not enough "C" in the circuit, not enough circulating current will flow in the tank circuit to provide the necessary fly-wheel effect. However, approximately 100 uufds on 160 meters and 12.5 or more uufds on 20 meters will usually provide sufficient fly-wheel effect to avoid this cause of asymmetrical modulation.

Linear Amplifiers

● To avoid distortion, any amplifier which amplifies a wave previously modulated in some preceding stage must produce output wave shapes which are exactly similar, except for size, to the input wave shapes which excite the grid. This type of amplifier is called a "Linear Amplifier", because its output is a linear function of its input. The most common type of linear amplifier is usually biased exactly to cut-off and it is called a "Class B Linear Amplifier."

The principle reason why these amplifiers are not more widely used in amateur stations is because they are quite difficult to adjust and they require a rather expensive amount of tube capacity for their carrier output.

It is desirable to operate a linear amplifier at as high a plate voltage as possible in order to obtain the maximum possible unmodulated plate efficiency. Because the grid current varies with the percentage of modulation, the grid bias of a linear amplifier must be supplied from a separate source, such as batteries or a low-resistance power supply, in order to avoid distortion.

plate input remains constant, regardless of the percentage of modulation. The required variation in power output is caused by a

Linear amplifiers operate as efficiency-modulated devices. This means that the variation in the plate efficiency of the linear amplifier. The plate efficiency is controlled by the RF excitation voltage applied to the grid. The maximum theoretical unmodulated plate efficiency for a class B linear amplifier is 50 per cent, and for a class BC linear amplifier it is 50 per cent. In practice, the unmodulated plate efficiency of a class B linear amplifier rarely exceeds 30 per cent, and for the class BC linear amplifier the upper limit is about 40 per cent.

The modulated output is obtained by varying the instantaneous plate efficiency of the linear amplifier between the limits of zero efficiency and twice the normal unmodulated efficiency. Thus a class B linear amplifier might be 30 per cent efficient during periods of no modulation, and during periods of 100 per cent modulation the instantaneous efficiency would be varying at an audio-frequency rate between zero and 60 per cent. During a period of 100 per cent modulation the AVERAGE plate efficiency increases 50 per cent. Because the average plate efficiency is lowest when unmodulated, the plate loss is highest at that point, and it is therefore evident that all linear amplifiers cool off during modulation. Exactly the opposite occurs in a class C plate-modulated amplifier because its plate loss increases 50 per cent during periods of 100 per cent modulation and also because the plate efficiency of a class C amplifier remains approximately constant during modulation, although the average DC plate input is increased 50 per cent.

Antenna Coupling, Transmission Lines and Antennas

● No phone transmitter is better than its antenna. Although the antenna system is probably the cheapest unit in the entire station, it is usually found that it is given less attention than any of the other equipment. This is unfortunate, because a given amount of money and energy spent on the antenna sys-

tem will cause more of an increase in the signal at some distant point than the same money and energy spent on any other part of the station. The purpose of an antenna is to radiate energy into space. It is desirable to radiate this energy at as low an angle with the horizon as possible, for long distance communication. It is essential that the antenna be as high as possible and it should be free from nearby objects, such as trees, tin roofs, etc. The comparatively recent development of various kinds of low-loss transmission lines no longer makes it necessary to locate the antenna close to the transmitter. Lines as long as 1000 feet are being used and they can have very low losses, which means that the antenna can be placed where it will be most effective. The antenna should be cut to exact length, usually determined by the cut-and-try process, because none of the antenna-length formulae take into consideration the capacity effects which depend upon the height above ground and the conductivity of nearby objects, such as power lines, etc.

The transmission line, which takes the power from the transmitter and feeds it to the antenna, should be designed so that it will have minimum radiation, because radiation from a transmission line almost always represents wasted power.

The means of coupling the line to the plate tank of the final amplifier is very important, because the characteristic impedance of the line (which depends entirely on its mechanical dimensions) must be properly matched to the plate circuit if maximum transfer of energy from tube to line is to be had. By the same token, the far end of the line must terminate in such a manner that the line impedance is matched to the antenna impedance.

The Audio Channel

Microphones

● The function of a microphone is to convert sound energy into electrical energy. In a perfect microphone the electrical output would be an exact replica of the sound input caused by the successive compressions and rarefactions of the air in front of the mouth of the person who speaks into the microphone.

In general, there are three types of microphones in common use. 1. The Resistance Microphone. This includes all types of carbon granule microphones. The electrical output results from the fact that the resistance of a group of carbon particles varies with the mechanical pressure exerted on the particles. A metal diaphragm is usually placed so that its back and forth movement changes the pressure on a pile of carbon particles and varies the microphone battery current which

flows through the microphone. In the case of the double-button carbon microphone there are two groups of carbon particles located in metal buttons, one on each side of the dia-

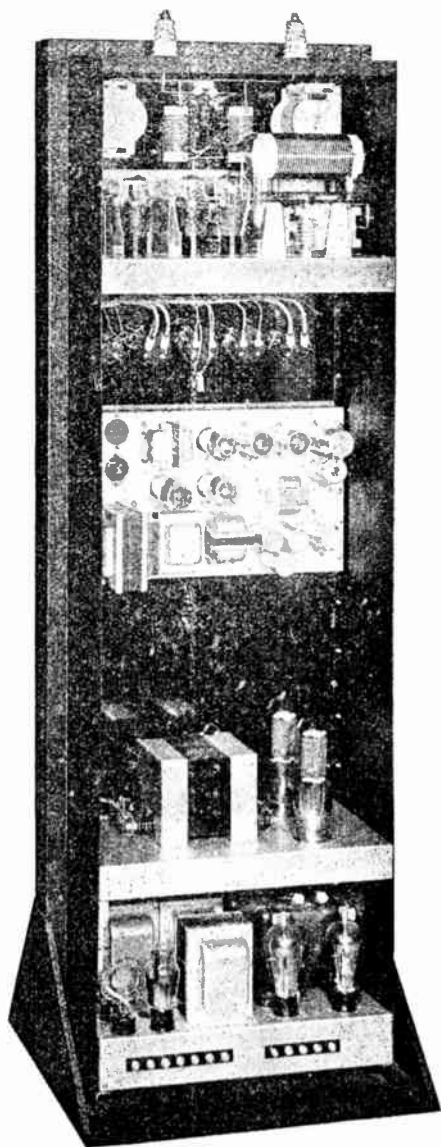

Collins 125 watt phone transmitter, showing PI network coupler on top deck.

phragm. The diaphragm is usually stretched so as to move the mechanical resonance point out of the most important part of the audio frequency range. These two carbon "but-

tons" are connected to a center-tapped primary winding on the microphone coupling transformer so that the buttons are effectively in push-pull. This tends to minimize the even harmonic distortion which is inherent in all carbon microphones.

Resistance, or carbon microphones have a rather high background hiss, due to the button current. They are also incapable of giving wide range frequency response and they also generate more than their quota of harmonic distortion. However, they have the virtue of being relatively cheap and are usually quite rugged, mechanically. They are low impedance devices (200-400 ohms) and require little shielding.

CAPACITIVE MICROPHONES

The Condenser Microphone

● This type of microphone was, until a few years ago, the standard of the broadcast industry, and it is capable of giving all the fidelity that any amateur station can use. It

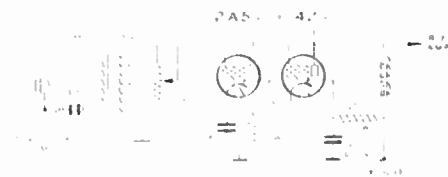

10-Watt Amplifier for use with a single-button microphone.

operates on the principle that any variation in the plate spacing of a small condenser generates an AC voltage across the condenser terminals. A rather-high DC polarizing voltage must be applied between the plates of this condenser in order to secure sufficient output; voltages of from 90 to 180 volts are common. The condenser microphone uses a heavy back plate, in front of which is located a thin "dural" diaphragm which is tightly stretched in order to eliminate resonance. The diaphragm is usually only a few thousandths of an inch thick and the spacing between the diaphragm

and the heavy, insulated back plate is also only a few thousandths of an inch. When sound waves are impressed on the diaphragm it moves back and forth and varies the spacing between it and the back plate. Thus the electrostatic capacity between the

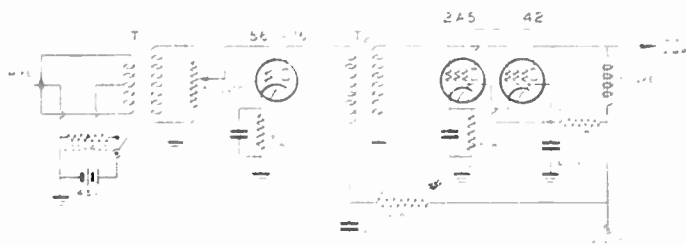

10-Watt Amplifier for use with a double-button microphone.

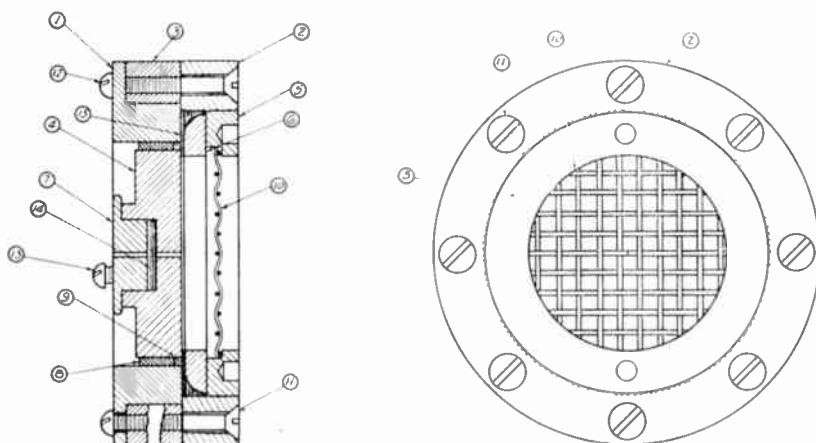

SHOWING HOW A CONDENSER HEAD IS ASSEMBLED

- 1—Back plug. 2—Front half of shell. 3—Rear half of shell. 4—Back plug proper. 5—Tightening ring. 6—Stretching ring. 7—Plug to compensating chamber. 8—Insulation. 9—Sealing compound. 10—Screen. 11—Screws clamping diaphragm. 12—Screws holding rear plug. 13—Rear connection (to grid). 14—Compensating diaphragm. 15—Dural spacer .001 in. thickness.

Condenser Mike Pre-Amplifier

This pre-amplifier is very widely used and has proved highly successful.

All AC leads in shielded cable tied to ground. Tube shelf of copper or metal for inter-shield. Make all grid leads as short as possible. Use good grade of resistors and mica coupling resistors. Power supply must be well filtered. Four-wire shielded cable is used for power leads. As B— is below ground potential, do not ground at that point. Adjust sliders on the 25 watt 1000 ohm Electrad resistor for proper bias voltages, 1.3 v. for 2A6 and 13 v. for 56. Use high resistance voltmeter.

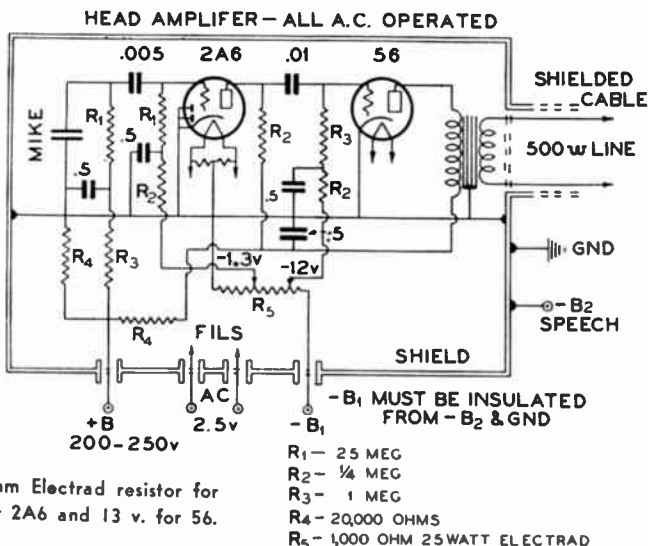

two condenser plates is varied, which impresses an AC voltage on the DC polarizing voltage. This AC voltage is then transferred to the grid of the first audio amplifier through a small blocking condenser which keeps the DC polarizing voltage off the grid of the first audio tube.

The condenser microphone has the advantage that it uses an extremely light diaphragm and thus gives somewhat better high-frequency response than a carbon microphone. There is also no background noise when this type of microphone is used.

The condenser microphone has a disadvantage in that its audio output is quite low, thus a pre-amplifier is necessary to bring its output up to that of the standard 2-button carbon microphone (-50 db). It is a very high impedance generator and must be iso-

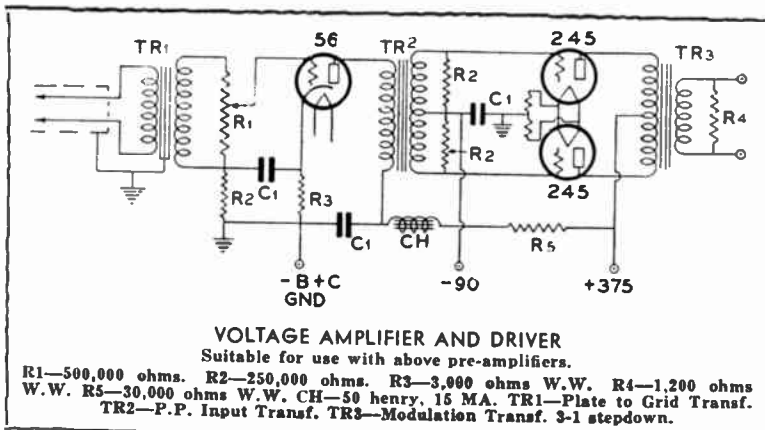
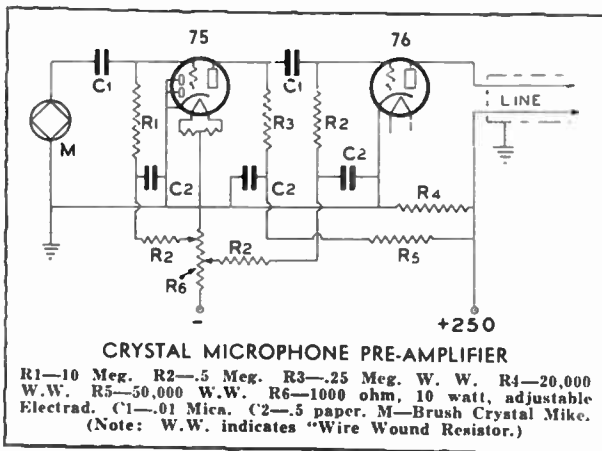

lated from RF and AC fields.

Weather conditions also affect the characteristics of a condenser microphone. It is also a rather delicate type of microphone and will not stand rough handling. It is rather inexpensive, and has somewhat more audio output than the higher fidelity ribbon and dynamic microphones.

THE CRYSTAL MICROPHONE

The Diaphragm Type



Astatic Crystal Microphone

● There are two types of crystal microphones, the diaphragm type and the grill type. Both operate on the Piezo electric principles as defined by Curie. When a dielectric material in a condenser changes its mechanical dimensions or density, a change in capacity occurs. This change in capacity generates a small AC voltage. All crystal microphones use Rochelle salt crystals which act like small condensers. If these crystals are subjected to a bending strain by the pressure of the voice, applied either directly, as in the grill type, or through a diaphragm and lever in the diaphragm type, a voltage is set up across two small pieces of metal foil which are glued to opposite faces of the crystal. The voltage that appears across the two pieces of foil is then applied to the grid of a pre-amplifier tube which amplifies the voltage.

The diaphragm type is the cheapest of crystal microphones. It is usually capable of somewhat better fidelity than the more common types of carbon microphones, although the quality is not quite as good as that secured from the better types of condenser microphones. No polarizing voltage or magnetic field is required, and the audio output is almost as high as that secured from the highly-damped types of two-button carbon microphones. There is no background noise and the fidelity depends upon the care with which the diaphragm has been made and installed.

CONSTANTS FOR CRYSTAL MIKE PRE-AMPLIFIER

- R1—5 meg. R2—50,000 ohms. R3—5,000 ohms. R4—20,000 ohms. R5—1/2 meg. R6—50,000 ohms. R7—2000 ohms. R8—15,000 ohms. C1—.02 mfd. C2—1 mfd. C3—1 mfd. C4—1/4 mfd. C5—1 mfd. C6—1 mfd. C7—1/4 mfd. C8—1 mfd. CH1—CH2—250 Henry, 15 Mil Chokes. T1—Plate-to-Line Transformer.

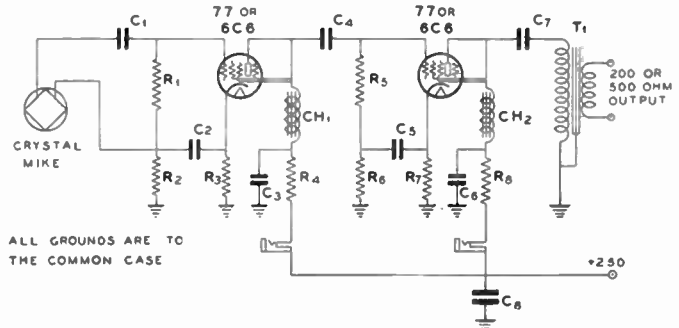

ALL GROUNDS ARE TO THE COMMON CASE

The Grill Type

The grill type of crystal microphone is capable of almost perfect fidelity, when properly built, and uses one or more small sound "cells" connected in series-parallel in order to give high output. The output of the grill type crystal microphone is about equal to that of the lower level moving-coil types, and is somewhat higher than the output of most ribbon microphones. Although the device is a high impedance source of audio voltage, its peculiar condenser characteristic allows the use of a shielded lead which can

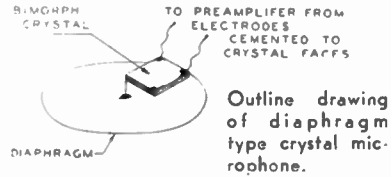

Coupling a crystal microphone to a low-impedance line.

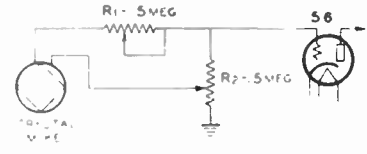

R1—CONTROLS THE HIGH FREQUENCIES
R2—CONTROLS THE LOW FREQUENCIES

Power supply for pre-amplifier

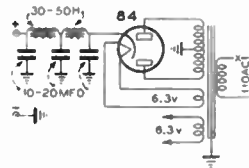

be a hundred feet long between the microphone and its associated preamplifier.

One important advantage of the grill type crystal microphone is that it is less directional than any other type of microphone.

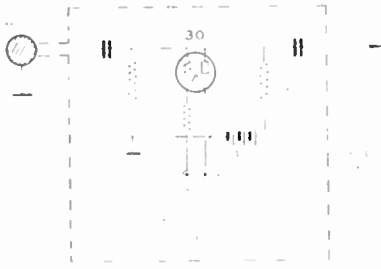

PRE-AMPLIFIER USING 30 TUBE

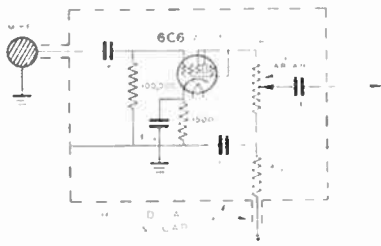

PRE-AMPLIFIER USING 6C6 AS TRIODE

Two circuits showing correct type of pre-amplifier for use with crystal microphone.

These pre-amplifiers can be used for ribbon or dynamic microphones if a suitable input coupling transformer is used.

thus it is suited for almost any microphone location and any kind of mounting can be used.

Crystal microphones are all high impedance generators and have a characteristic impedance of about 5 megohms. For this reason they must be rather well shielded from radio frequency fields.

INDUCTIVE MICROPHONES RIBBON AND MOVING-COIL TYPES

The Ribbon Microphone

● These microphones operate on the principle that the movement of a conductor in a magnetic field induces a voltage in the conductor.

The ribbon microphone utilizes a thin, corrugated metal ribbon, or tape, a few thousandths of an inch in thickness, loosely supported between the poles of a form of horseshoe magnet. As the voice impulses strike the ribbon they cause it to move back and forth in the magnetic field which induces a very small alternating current in the ribbon itself. The two ends of the ribbon are connected to the primary of a coupling transformer which steps-up the voltage output and applies it to the grid of a pre-amplifier tube. The ribbon microphone is very rugged and is of rather simple construction. It is capable of very high quality, when properly built, and is extremely directional. It is actuated by velocity, rather than by pressure, and avoids the high-frequency pressure doubling which impairs the fidelity of most diaphragm types of microphones. It is an extremely low impedance device (less than 1 ohm) and is not affected by radio-frequency fields. Thus it can be used quite close to a radio transmitter, if the pre-amplifier is properly shielded. It has a habit of picking-up a great deal of hum if placed close to an AC 60-cycle line or power transformer, and the low frequencies are unduly emphasized when used for close-talking applications. Its audio output is about the lowest of any type of microphone. It requires the use of a high-gain pre-amplifier to bring its output up to that of the two-button carbon microphone.

THE MOVING COIL OR DYNAMIC MICROPHONE

● This type of microphone operates on the same principle as the ribbon microphone. However, it uses a small coil of wire attached to a diaphragm to generate the audio voltage.

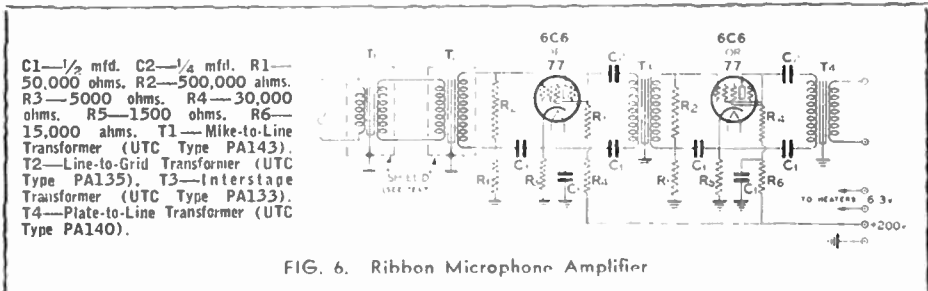

FIG. 6. Ribbon Microphone Amplifier

A permanent magnet supplies the magnetic field in most cases, and the audio output and fidelity are very similar to the output and fidelity of the condenser microphone. The moving coil microphone is a low impedance device and thus it can be located far away from its associated pre-amplifier. The usual impedance of the moving coils is about 30 ohms.

The moving coil microphone is gaining in popularity. It is quite rugged. It has one outstanding advantage over practically all other types of microphones, particularly for broadcast use, in that its characteristics usually stay put. Once equalized, its fidelity remains constant.

Pre-Amplifiers

● It will be seen that practically all of the high fidelity microphones have a very low audio output. Most of the common types of audio amplifiers have been standardized around the two-button carbon microphone and some additional amplification must be provided between the high fidelity microphone and the main voltage amplifier. This amplifier has been named the "pre-amplifier". It usually consists of two stages of resistance or transformer coupled triodes. The overall gain of most pre-amplifiers ranges from 35 to 55 Db, depending on the type of microphone with which it is to be used. 35 to 55 Db represents a voltage amplification of from about 250 to a thousand times. Every phone operator should familiarize himself with the commonly used unit of relative sound intensities, the Decibel, abbreviated Db. It is a very useful unit of sound measurement and materially simplifies all audio amplifier gain problems.

Pre-amplifiers deal with very small audio frequency voltages and it is of the utmost importance that all hum and background noise be eliminated, if good results are to be obtained. Superlative shielding is neces-

sary in order to keep hum pick-up to a minimum, and RF chokes may be necessary in the grid leads if the pre-amplifier is to be operated close to a transmitter. The pre-amplifier should use extra-good filtering in its power supply leads, and it should not be closer than three feet to any choke or transformer which has AC flowing through it.

The heaters can be operated from 6.3 volts AC if care is taken to completely by-pass and shield the filament leads. Otherwise a small storage battery may be necessary if high gain is desired.

Gain controls are rarely used in pre-amplifiers because the control of gain is best left to a potentiometer in the main voltage amplifier.

The Main Voltage Amplifier

● The main voltage amplifier is not very clearly defined in most amateur stations, but it is often combined with the driver stage for the higher-powered modulator. However, it can be defined as that part of the audio channel which starts at a point roughly corresponding to the output level of a damped, high quality two-button carbon microphone. This level is approximately -50 Db below zero level. Throughout this discussion, zero level will be that used by the Bell System, i.e., 6 milliwatts or .006 watts of audio power. Thus -50 Db corresponds to one-one-hundred-thousandth of 6 milliwatts. Thus an audio channel should have a main voltage amplifier capable of amplifying this level of -50 Db to full output. The output of the main voltage amplifier should be about zero level, which indicates that the overall gain should be about 50 Db. Such an amplifier can consist of two stages of 6C6 triodes, transformer coupled.

A gain control should be placed in the grid circuit of the first stage, and it will usually consist of a potentiometer of about 250,000 ohms whose sliding contact connects to the grid of the first stage.

Most Widely Used Main Voltage Amplifier and Audio Driver

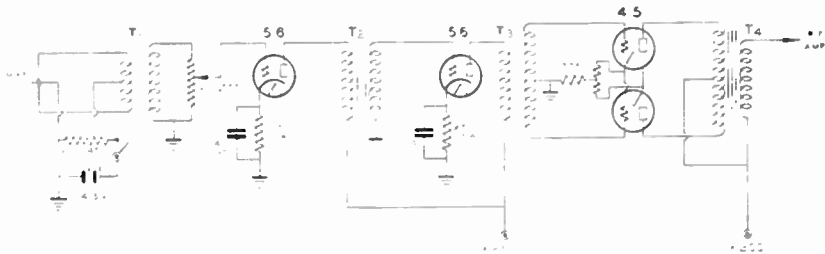

5-Watt Amplifier for use with highly-damped types of carbon microphones.

T1—Mike to grid transformer.

T3—Push-pull input transformer.

T2—Interstage audio transformer.

T4—Push-Pull output transformer.

The main voltage amplifier is used to drive either the driver power amplifier, or, in certain cases, it directly drives the low powered modulator. The main voltage amplifier operates at a considerably higher audio level than a pre-amplifier and thus somewhat less shielding and filtering is necessary to keep the background noise down to where it belongs. However, certain precautions should be taken to see that the first stage is well shielded and filtered; serious hum often results from careless design and construction at this point.

For best audio quality, avoid the use of high ratio audio transformers. They generally involve considerable loss of fidelity in order to obtain high voltage gain. A turns ratio of three-to-one is about all that can be expected, and the better transformers usually have a ratio of about two-to-one.

If pentodes or screen grid tubes are used as audio amplifiers, it is best to use resistance coupling between the multi-grid stage and the following stage. Transformer coupling cannot be used with these high- μ tubes and the use of audio chokes is only permissible when special chokes, particularly designed for this service, are used.

Choke or transformer coupling is capable of giving very high fidelity when used with medium- or low- μ triodes. Use resistance coupling when the higher μ tubes, such as the screen-grid tubes, pentodes or high μ triodes, such as the 75, 2A6 or 40 are used.

THE MODULATOR AND ITS ASSOCIATED DRIVER

If the modulator operates class A, it does not require that its driver supply POWER, it merely supplies VOLTAGE. This is due to the fact that the control grid of a class A audio amplifier, or modulator, is never driven positive, and thus never draws grid current. Thus the driver could be any of the tubes that are used as voltage amplifiers, such as the 6C6, 56, 76 and others. When using an 8-15, 8-49 or 212D as a class A modulator, it is desirable to choose a driver from among the smaller power tubes, such as the 45, 42 (triode), 210, etc. The larger tubes, when used class A, require somewhat more grid voltage swing than can be supplied by the smaller voltage amplifier triodes.

When the modulators are used in push-pull class B or class AB, the driver stage is usually required to supply some grid POWER, and the amount of power required varies widely, depending on plate voltage and power output conditions. Class B modulators

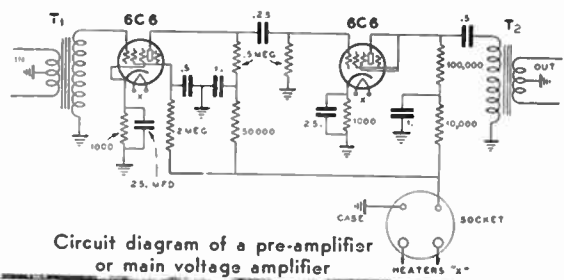

Circuit diagram of a pre-amplifier or main voltage amplifier

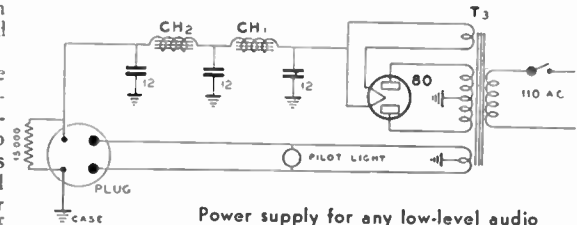

Power supply for any low-level audio amplifier

usually require somewhat more grid driving power than class AB modulators, but class B modulators are often somewhat more economical to build and operate.

For example, class B 46s and class AB 50s have the same maximum undistorted power output of about 25 watts for two tubes. The grids of the 46s require almost two watts of power, whereas the two 50s require only about .1 watt, for the same output. Thus another 46 operating as a low μ triode must be used as a driver for the class B 46s, while push-pull 76s can easily supply the small grid driving power required by the class AB 50s. However, the 46s cost less and also require less plate voltage than the 50s. Offsetting this economy is the fact that the input and output transformers for the class B 46s are usually somewhat more costly than the input and output transformers for the class AB stage using the 50s.

The choice of a modulator tube depends on the DC plate input power drawn by the class C RF amplifier which is to be plate modulated. The maximum undistorted audio power output of the modulator stage must be 50 per cent of the DC input power flowing to the class C amplifier.

Reference to the tube tables will indicate the audio output to be expected from the more common modulator tube combinations, at commonly-found plate voltages. The same table will also suggest satisfactory tubes for use as drivers.

Low power modulators (up to 200 watts of audio power), will usually operate from either a single-ended or a push-pull driver chosen from the following list of commonly used low power drivers:

45, 46 (low μ triode), 59 (low μ triode), 2A3, 71, 42 (triode), 2B6 and 50.

Power Modulation and Efficiency Modulation

Power Modulation

The general classification of power modulation includes all forms of plate modulation because power modulation involves the modulation of the source of power which is converted into RF carrier power by a vacuum tube amplifier. A radio-frequency class C amplifier usually operates under conditions such that the power output varies as the square of the plate voltage. Thus the RF voltage output varies exactly as the plate voltage is varied. Ordinarily, all modulated class C amplifiers operate at a practically constant plate efficiency, but with a peak plate input varying above and below the normal unmodulated value in accordance with the audio-frequency AC supplied by the modulator. The plate efficiency of a plate modulated class C amplifier can be made quite high; 92 per cent has been reached in laboratory amplifiers, although 65 per cent to 85 per cent is more common in modern amateur stations.

A study of the power distribution in a completely modulated wave shows that two-thirds of the total power consists of the carrier, and the other one-third is divided equally between the two sidebands. Thus the average RF power output must be increased 50 per cent for complete 100 per cent modulation, and proportionately less for lower percentages of modulation.

The plate efficiency remains approximately constant during plate, or power modulation, and thus the RF power output can be increased only by increasing the plate input power during modulation. In order to get a 50 per cent increase in average power output during complete modulation, the plate power input must also be increased by 50 per cent. Because the audio frequency modulator, or modulators, are the sole source of this increase in power, it is seen that the maximum undistorted power output of the modulators must be equal to 50 per cent of the constant DC plate input supplied to the unmodulated class C RF amplifier. The modulator, or modulators, must be coupled in the circuit between the source of DC plate power and the class C amplifier in such a way that the peak AC voltage output and peak AC current output of the modulators just equals the unmodulated DC plate voltage and plate current drawn by the class C stage. Under complete modulation, therefore, the constant DC plate input is alternately doubled and neutralized as the audio frequency AC wave goes through its maximum positive and negative values. This shows that the impedance of the load represented by the class C plate circuit and the impedance of the AC power source, which is the modulator tube, or tubes, must be matched to each other if the AC voltages

and currents are to exactly double and then neutralize the constant DC voltage and current, which represents the unmodulated plate input power to the class C amplifier.

Power modulation is by far the most popular method of modulation, largely because it requires few critical adjustments to obtain high audio quality, power output and plate efficiency. It requires rather large modulator tubes, but the development of class B and class AB audio amplifiers has allowed large amounts of audio power to be realized from small tubes. High-efficiency modulators require the use of plate power supplies of good voltage regulation with variations of load current, because class B and class AB modulators do not draw a constant plate current as the audio signal varies. Instead, modulator plate current can vary as much as 1,000 per cent or more, depending on the amplitude of the audio-frequency signal voltage applied to the grid circuit of the modulator. This necessity for better voltage regulation has somewhat increased the cost of the average plate power supply and, in some degree, offsets the economies realized by the use of high modulator plate efficiency. Low resistance power transformers and chokes become necessary, and a swinging input choke is often required to still further improve the voltage regulation of the power supply. This swinging input choke adds but little to the hum filtering but tends to increase the DC output voltage as the load current increases, because the RAC power supply and filter with swinging choke act as a choke input device at low load currents and a condenser input device at high load currents. This compensates for the increased voltage drop in the filter, rectifier and power transformer.

Efficiency Modulation

The average power in an RF wave increases during modulation, up to 50% for complete 100% modulation. This additional power output must be released to the antenna circuit in exact accordance with the variations in sound pressure applied to the microphone. There are two ways in which the power output of a radio-frequency amplifier can be increased. First, the plate input power can be increased, keeping the efficiency of conversion into AC RF power constant, in which case the RF power output must faithfully follow any variation in plate power input. This method was previously described and is termed POWER MODULATION. Second, the plate input can be left constant and the EFFICIENCY OF CONVERSION can be varied at an audio frequency rate, which will also result in the desired increase in RF power output. While the average power output only increases 50% during complete 100% modula-

tion, the peak power output alternately swings from normal to four times normal, then down to zero and back to normal during each audio frequency cycle. Thus the instantaneous plate efficiency, in an efficiency modulated amplifier, must vary between zero and twice the unmodulated efficiency if complete modulation is desired.

The average plate efficiency must increase 50 per cent, during complete modulation of an efficiency modulated RF amplifier, and the peak plate efficiency can never exceed 100%. Thus the unmodulated plate efficiency must be something less than 50% in all efficiency-modulated devices.

Efficiency modulated amplifiers include practically all forms of grid modulated amplifiers, whether they are modulated by variable excitation, in which case they are usually termed Liner Amplifiers, or whether they are modulated by variable grid bias, in which case they are called Grid Bias Modulated Amplifiers.

Grid Bias Modulation

When the axis of the AC grid excitation voltage is shifted by the audio frequency modulating voltage, it is termed grid bias modulation. If the control grid of the modulated tube draws any DC grid current, then enough audio must be supplied from the modulator tube to modulate this DC grid current. Usually this current is quite small in comparison to the DC plate current and a real economy of required audio power can be effected by using grid-bias modulation instead of plate-power modulation. Under certain conditions, the vacuum tube amplifier can be operated so that the control grid draws no DC current, even when most positive, so that the modulator tube need supply no power at all in order to effect deep modulation, as the effective grid impedance is, in that case, infinite. Usually it is poor economy to operate a radio-frequency amplifier control grid wholly on the negative side of zero bias because the efficiency of plate power conversion is then usually quite low, unless high plate voltages are used, together with a tube of exceptionally high mutual conductance. Thus most grid-bias modulated amplifiers operate so that some DC grid current is drawn, at least on the peaks of modulation.

The Linear Amplifier

In the Linear Amplifier the DC bias is kept constant and the amplitude of RF grid excitation is varied at an audio rate. The excitation is varied by merely modulating in some preceding amplifier stage, by means of either power modulation or some form of efficiency modulation. The maximum possible power output and plate efficiency of a linear amplifier, for a given tube and given plate circuit conditions, is exactly the same as for a similar grid bias modulated amplifier. It is usually more economical

to modulate the DC grid bias than to use an already-modulated RF wave to obtain the modulation of the final power converter stage, because power modulation of a buffer stage always requires the use of more audio power than would be required to grid-bias modulate the final stage directly. No coupling device can be 100 per cent efficient, especially at radio frequencies, so that in general at least twice as much audio power is necessary to effect grid-excitation modulation as would be necessary to effect grid-bias modulation at that same stage.

A linear amplifier or a grid-bias modulated amplifier can be operated, with conventional tubes and power supplies, under conditions that allow unmodulated plate efficiencies in the neighborhood of 35 to 40%. To obtain such high unmodulated efficiencies it is necessary to utilize fixed bias equal to "cut-off", plus enough cathode resistor bias to cut the time of plate current flow to that desired. This is the class BC system of operation. The total amount of bias will usually be approximately equal to the bias that would be used on that same amplifier stage operated as a Class C amplifier at the same values of plate voltage and load resistance in the plate circuit (antenna coupling).

Screen Grid Modulation

Practically all screen-grid tetrodes and pentodes built at the present time are incapable of complete and linear 100% modulation when the AC modulating voltage is applied to the DC screen voltage. Western Electric has had some success in modulating the screen-grids of two cascaded RF amplifier stages.

It is theoretically possible to design a screen-grid pentode which will allow perfect and complete modulation to be effected by cascade screen voltage modulation, but such a tube has not been built to date and even if such tubes were available, the use of two cascaded efficiency modulated stages would be generally uneconomical as well as highly critical in adjustment.

Suppressor Grid Modulation

Suppressor-grid modulation is used quite extensively among amateurs in the United States. If some means can be found to increase the unmodulated plate efficiency to around 40%, suppressor-grid modulation should become very widely used because it is probably the least critical modulation method of any, insofar as adjustment goes.

Summary of Efficiency Modulation

In all known efficiency-modulation systems, the plate power input must remain constant, if linear modulation is desired. The unmodulated plate efficiency could be about doubled if it were possible to make some form of grid-modulated amplifier release its own additional plate input from the DC plate supply source, during modulation.

In general, efficiency modulation is characterized by the fact that it is rather difficult to adjust, especially without an oscilloscope, and there is some question as to whether it is cheaper to use a large tube running at 35 to 40% plate efficiency and a minimum of audio equipment, or to use a small, high-efficiency class C amplifier stage together with extensive modulator and power supply equipment.

There are many good points to each side of the argument, and as modern efficiency modulation is still rather new to the majority of phone amateurs, it has not had an opportunity to really prove what it can do.

Design Factors For Class AB Amplifiers

Class AB Audio Considerations

The best load impedance for class AB tubes is somewhat difficult to calculate accurately. As in Class B, for a limited grid voltage the output power will be greatest when a plate load is chosen such that the product of plate voltage swing and plate current swing is a maximum. For maximum power with minimum distortion, the load resistance will decrease as the driver power is increased. In other words, with greater driving power, the plate current swing on the output tube can be increased and greater power output will consequently be developed across a lower load. This again is governed by the peak current which the plate supply can deliver. It is also not desirable to use a low load resistance if the plate supply regulation is bad. All these factors are of more or less importance depending upon the magnitude of values in the particular design. However, a general method of determining load impedance for push pull tubes can be used where the grids are not driven very positive. Fig. 3 shows this as applied to the 845 tubes. The published plate characteristic curve must be obtained and an operating voltage E_b selected. A vertical is erected at $.6E_b$ and the $E_c = 0$ line is extended to meet it. A line is then

drawn from this point of intersection to our point E_b . The slope of this line multiplied by 4 is the proper plate to plate load. In the example drawn, this load is equal to

$$\frac{1250 - 750}{400} \times 4 = 5000 \text{ ohms.}$$

If the grids are driven sufficiently positive to make the normal output about four times that of a single Class A amplifier using the same tube, this value of load impedance

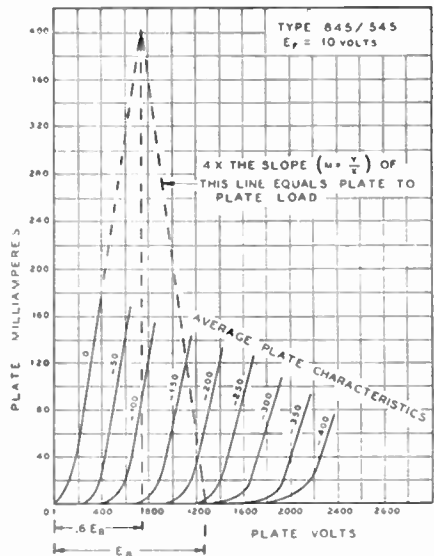

FIG. 3 Method of Graphically Computing Proper Load Impedance (see text)

should be reduced by about 20%. If the plate supply regulation is better than 10%, this load impedance can be reduced another 5%. In the case shown, this would mean an effective plate load of 3750 ohms. The recommended RCA value is approximately this value.

The calculation of maximum power output

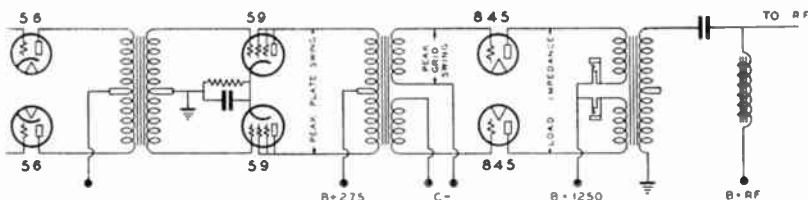

FIG. 2 A-Prime 845s used for High-Level Plate Modulation

is also not difficult. The output is equal to

$$\text{Power} = \frac{\text{Max. plate current} \times \text{plate voltage}}{5}$$

as shown in Fig. 3 this gives

$$\frac{.40 \times 1250}{5} = 100 \text{ watts}$$

If the above notes are summarized, it is seen that AB amplification is a system lying between Class A and Class B. High biased near cut-off. Not all tubes are suitable for AB operation. Those most commonly used in this manner are the 42, 245, 2A3, 250, 845, WE 283A, 212D and E, 849.

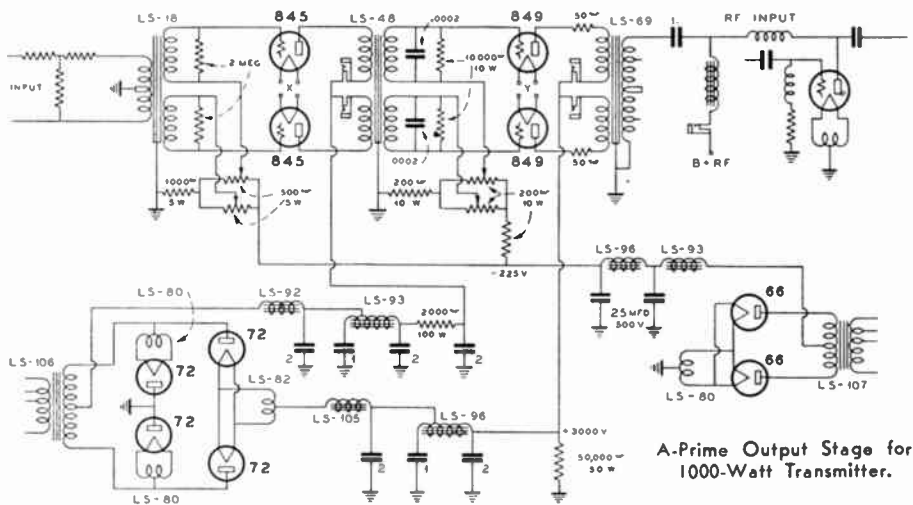

A-Prime Output Stage for 1000-Watt Transmitter.

FIG. 5.

The 849 bias should be adjusted so that the no-signal plate current is 40 MA. per tube for Class A-Prime operation, or 10 MA. per tube for Class B operation. Other constants are not altered.

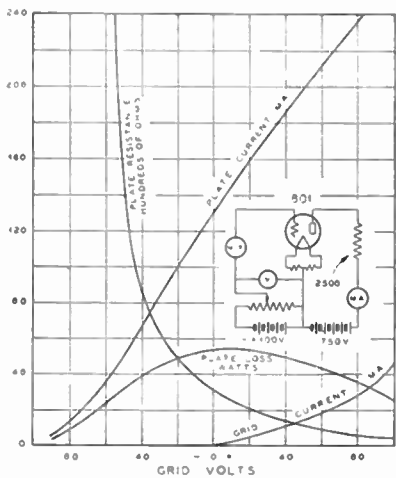

Dynamic characteristics of the 801 tube.

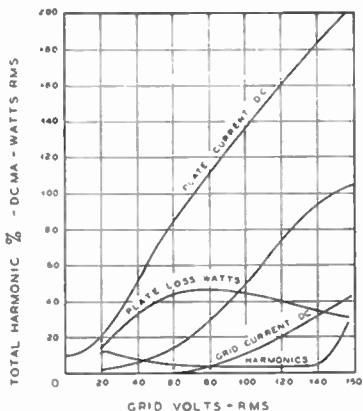

Characteristics of a class B amplifier using push-pull 801s.

Class B Audio Considerations

Certain precautions must be kept in mind for high quality Class B results, and it will not be amiss to outline them briefly.

(1) The driver stage must be able to supply about two or three times the actual power required to drive the grids of the Class B stage. This reserve of power is necessary in order that the driving voltage shall have good regulation under the variations in load represented by the Class B grids. In general, the driver output should be from 5 per cent to 15 per cent of the output of the Class B stage itself.

(2) The Class B input transformer should have sufficient step-down so that the driver load impedance never goes below the plate resistance of the driver tube, when the Class B grids are most positive. It follows that less step-down is necessary when using Class B tubes with a high grid impedance. By the same token, the choice of a driver tube with a low plate impedance, such as the 45, 50, 2A3, 2B6 and 42 triode, is necessary for minimum step-down ratios.

(3) The load impedance into which the class B stage works must be fairly high in comparison with the plate impedance of the class B tubes. The actual value of load impedance is not especially critical, and for practically all common tubes it can be between 5,000 and 20,000 ohms plate to plate. It is well to keep in mind just what happens when the

essential that they receive exactly the same driving voltage and that they each draw the same plate current in the resting condition. No two tubes will maintain their characteristics for any length of time and it is essential that individual bias adjustments be provided so that the stage can be balanced. This precaution is only applicable with other than the zero-bias tubes, which include the 46, 59, 19, 49, 89, 53, 79, NCB, RK31 and 838.

(5) The plate power supply must have good voltage regulation because the plate current varies quite widely with the grid drive. Any variation in plate voltage with changes in plate current will cause amplitude (harmonic) distortion, and is to be avoided. Low resistance windings on the power transformer and filter chokes are essential. The use of a saturated, or swinging input choke helps to keep the output voltage constant with variations in current, because this type of choke provides choke input with a small load and condenser input as the load increases. Thus the output voltage tends to rise slightly as the load increases. This offsets the drop due to the unavoidable resistance in the transformer and choke windings. Mercury vapor rectifiers have an inherent voltage drop that is independent, to a great extent, of the load current, and thus cause no sacrifice of regulation, as is the case with thermionic rectifiers.

(6) With certain tubes, notably some makes of 210's, 203A's, 211's 800's, 204A's

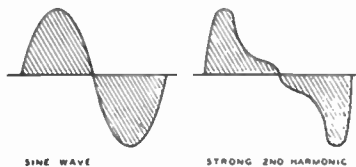

SINE WAVE

FIG. 1

STRONG 2ND HARMONIC

FIG. 2

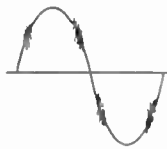

FIG. 3

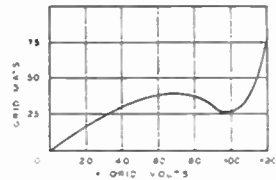

FIG. 4

plate load impedance of a Class B stage is varied. As long as the load impedance exceeds the static plate resistance of the tube, an increase in load impedance improves the quality by reducing the harmonic distortion. It also reduces the power output, for a given grid excitation. Therefore more excitation is required for the same power output, with higher loads. The plate efficiency also increases as the load impedance is increased, so that more output can be obtained, for a fixed plate loss, by merely increasing the grid drive. However, as the load impedance and the grid drive is increased, it is necessary to raise the plate voltage in order to prevent the maximum grid voltage from exceeding the minimum plate voltage, at the peaks of grid drive.

(4) The two halves of the circuit must be accurately matched. Because each Class B tube works for only half the cycle, it is es-

and 849's, it is essential to take precautions against super-regenerative dynatron distortion. See Fig. 3. That imposing description simply means that the stage starts to oscillate on the peaks with a rasping effect which absolutely wrecks the quality. This tendency toward oscillation is caused by a Dynatron kink in the grid characteristics of the tube and can only be swamped-out by the use of 50-ohm parasitic resistors in each grid lead, combined with 5000 to 20,000 ohms shunted across each half of the input transformer secondary. Sometimes it even becomes necessary to shunt each side of the primary of the output transformer with a .001 ufd. condenser.

It is common practice to consider the average or effective audio power necessary to modulate 100 per cent, but the peak audio power is the correct factor to consider. When the peak audio voltage and power reaches a value equal to the DC input voltage and

power on the modulated amplifier, 100 per cent modulation is obtained. The average audio power at this point is of a value that is not known unless the wave form of the audio is known. The wave forms of voice or music are very complex and the effective power in them is much less than in a sine wave of equal peak voltage, although the peak voltage and peak power are the same. DC current meters read average values and it is difficult to determine when the peak current has reached the correct value for 100 per cent modulation, the average values for voice and music being lower than for a constant sine wave input. The average audio power with a sine wave of constant amplitude necessary to modulate a carrier 100 per cent is 50 per cent of the DC input to the Class C amplifier. But, with voice or music, the average audio power necessary is considerably less.

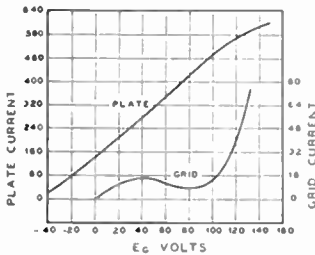

203A Operating Characteristics

The shaded areas of Fig. 1 and Fig. 2 show the average power in two different wave forms of equal peak voltage and power. Fig. 1 shows the power in a pure sine wave with no harmonics. Fig. 2 shows the power in a wave of the same fundamental frequency with a strong second harmonic. The aggregate or combined peak power of the wave is equal to that of Fig. 1, but the average power over the entire cycle is much less.

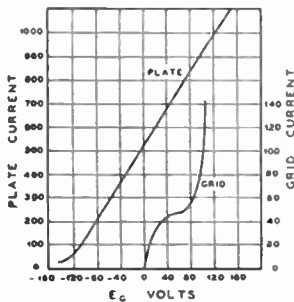

849 Operating Characteristics

This shows that it is possible to get much more out of the same tubes with normal voice than with a constant tone input. As long as amplifier is to be used for voice or music, and the peak power should not be more than

a definite amount, it can be secured from tubes of much lower rated capacity.

The filament or cathode of a tube will deliver a certain maximum number of electrons per unit of time, which will cause a definite plate current to flow, regardless of how positive the grid voltage may be. This is called "saturation plate current" and is the value of plate current that should flow, on the peak audio swing, to obtain maximum output. Exciting the amplifier to a point beyond the point of saturation will cause distortion due to the flattening-out of the audio peaks because the plate current cannot rise beyond this value. By increasing the plate voltage and the load impedance, the power output can be increased and the limiting factor is the insulation of the tube terminals and the stem seal. Tubes with the plate-lead out the top are ideal because the plate voltage can be increased to a high value and higher power output can thus be obtained.

The grid voltage grid current characteristic of a tube is the most important insofar as the quality or fidelity of the Class B amplifier is concerned. When the grid goes positive, grid current flows, and if this curve is a straight line, little trouble will be caused, but such is not the case. As the grid becomes more positive, the grid current rises more rapidly until finally the grid current curve becomes almost vertical. Some tubes have a negative grid current slope such as shown in Fig. 4. This gives rise to transient oscillation of the dynatron variety and occurs only during a portion of the audio cycle. These parasitic oscillations cause a sort of hash, or fuzz, to appear on the output. They can be analyzed only with the aid of a cathode-ray oscillograph. The string type oscillograph is too slow to respond to the high frequency of the oscillation, but on the cathode-ray type the oscillations show up as a blur on the wave form, as shown in Fig. 3. The 203-A tube usually produces this effect. It can be reduced by a small capacity (.0001 MF) from grid to ground of both tubes, or by neutralization such as is used in any push-pull RF amplifier. Off-hand it would seem that a tube of high amplification factor would be the best tube for Class B work, due to the lower value of excitation voltage necessary, but actually more power is required to excite a pair of 203As to 200 watts output than a pair of 211s. The grid current rises to a higher value and there is a greater grid loss in the 203-A type than in the 211. Of course, the C bias supply for the lower mu type tubes must be given consideration. Owing to the much lower grid current surges, the C bias supply can be taken care of with a small power supply using an 83 rectifier, whereas if a C bias supply were to be used on 203-As it would have to maintain about 30 volts at current changes as high as 75 MA. Practically the same power output can

be obtained with any of the 50 watt type tubes, such as 203-A, 211, 845, provided the proper excitation is applied. The high μ types require lower excitation voltage, but better voltage regulation of the driver output is needed. The low μ types require more excitation voltage, but because of lower grid current the source does not need such good regulation. The tubes of medium μ are usually the best, all points considered.

The Transformers

Without transformers of proper design a Class B amplifier can produce many kinds of audio distortion. The input transformer must deliver perfect quality to the Class B grids, even though the grids are drawing current all the way from zero to maximum during any one audio cycle. The grids of the Class B tubes offer a load that fluctuates all the way from infinity down to several hundred ohms. This means that the input transformer must supply to them a perfect reproduction of the signal without distortion, even though the load is varying.

The driver must be capable of delivering sufficient power to maintain the grid voltage swing with the grid current of the Class B tubes flowing through the secondary of the input transformer; furthermore the secondary should have very low DC resistance so that the bias on the Class B tubes does not vary appreciably with the grid current. This fault is common with most input transformers. All of these points must be maintained with a fair degree of constancy over the entire frequency range. This seems like a big order, and it is.

The coils must be designed so that the primary has identical relationship with both halves of the secondary. The capacity, and the leakage reactance, must be the same for the primary and each secondary. If these precautions are not taken, the wave form of the voltage supplied to the Class B grids is not the same for each grid and distortion of the wave form occurs, giving rise to harmonic generation.

The input transformer should have a step-down ratio of such a value that the signal voltage applied to the Class B grids is just sufficient to give required output. This improves the regulation of the driver output voltage.

The same coil design considerations hold true for the output transformer, for coil symmetry.

The output transformer is much more simple in design because it works into a load of constant impedance, and the secondary is delivering both halves of the audio cycle to the same load.

The DC resistance of the primary should be very low so that the voltage drop is not great when the saturation plate current value is considered. For instance, a plate current

in one-half of the primary of 500 MA and a primary DC resistance of 250 ohms (which is not uncommon in commercial transformers of this type), would cause a 125 volt drop in the signal voltage. The wire size may have been large enough to handle 500 MA without melting, and as long as the peak current was only there for a small fraction of a cycle the wire would not heat, but what about the wave form? A Class B output transformer should show little rise in temperature in operation and the wire size should be at least 1500 circular mills per amp., based on the peak plate current.

Most output transformers are designed to carry the current of the modulated stage, but this practice is not advisable if the best quality is to be had.

When the secondary is made to handle such high current, a large air gap in the core is necessary to prevent core saturation. This, in turn, necessitates increasing the number of turns on the coils, which increases the DC resistance, the leakage inductance, and the distributed capacity, to a point where good frequency response over the audio spectrum is hard to get. When the secondary carries no DC, the core can be assembled without an air gap, resulting in much better quality and greater power output.

It is very important, however, when this practice is followed, that the tubes have like characteristics and are adjusted to identical static plate currents. The output of a single tube working Class B consists essentially of a fundamental and a series of even harmonics, chiefly the second harmonic. If two tubes are properly balanced in a push-pull circuit, the output will be free from even harmonic distortion. A correctly designed output transformer has a core of such dimensions that the flux density at peak plate current will be close to the upper bend of the B & H curve, in other words, close to saturation. Unless this is done, the incremental permeability will fall to a very low value for low percentage modulation, with a resulting loss of low frequencies. The unbalanced plate current will swing the iron through different ranges of flux density on alternate half cycles, producing high amplitude harmonics. These harmonics can produce severe over-modulation and cause the carrier to splatter over a wide frequency band, even though the fundamental frequency is modulating less than 100 per cent.

Because it is desirable to get the peak audio power output necessary to modulate a given DC power input to a Class C amplifier, and because this power cannot be measured with the meters usually available, it becomes necessary to calculate the peak power output (without distortion). DC current meters read average current. Thermo-Couple

AC current meters read effective current, or the equivalent heating power of a DC current. With a pure sine wave input of constant amplitude, the AC current divided by

$$\frac{\pi}{2\sqrt{2}} \text{ or } 1.11, \text{ if no distortion is present. If}$$

the factor is more than 1.11, it proves that harmonic distortion is present. If the factor is less than 1.11, the wave form is flat-topped. A factor of 1 (one) would represent a square wave. The effective power output with a pure sine wave input is equal to the plate current, as read on a thermo-ammeter, squared times the load impedance and the peak power is exactly double this value. Also, the peak power is equal to the square of the peak-plate current times the load impedance, so the effective current to peak current can be converted by multiplying by $\sqrt{2}$ or 1.41; under the stated conditions the peak power output can therefore be estimated with a fair degree of accuracy. As an example let us estimate the modulating capabilities of a pair of the new 801 type carbon plate tubes.

Ep	Ip	Watts Loss	Grid Voltage
750	.004	3	-90
700	.020	14	-68
600	.058	34.8	-38
500	.097	48.5	-9
465	.110	51.1	0
400	.135	54	+20
300	.175	52.5	+44
200	.214	42.8	+70
150	.230	34.5	+85
110	.250	27.5	+100

Data on Class B 801

In a Class B circuit only one tube conducts at a time, so it is assumed that one tube is supplying all the power during $\frac{1}{2}$ cycle and the other tube is supplying no power during that half cycle. The rated safe plate loss averaged over any audio frequency cycle is 20 watts, and this value is conservative. Considering that either tube is supplying no power one-half of the time, the plate loss can be increased to double the rated value during the half cycle it is working. This would mean an average loss during the half cycle of 40 watts. The maximum loss does not occur at maximum plate current but usually near zero grid voltage, so that the plate voltage, plate current curves of the tube must be consulted to determine the average plate loss. The average plate loss of the 801 is computed from the curves supplied by the manufacturer. The plate supply voltage is 750 V. and the peak or maximum plate current is 250

MA. The plate losses for the different grid voltages are given below:

Average loss 36.2 over $\frac{1}{2}$ cycle or 18.1 watt loss over the whole cycle. This leaves a fair margin of safety below the rated 20 watt dissipation. Using the equation:

$I_p \text{ Max}^2 R_L = PO \text{ max}$, R_L equals load impedance and $I_p \text{ Max}^2$ equals peak plate current. With the peak plate current of .250A and a load of 2500 ohms, the result is 156.2 peak watts, or an effective power of 78.1 watts, which will modulate a DC input to a Class C amplifier of 156.2 watts.

This output is possible with a pure sine wave input of constant amplitude and with the tubes operating below rated plate loss. Consequently, with normal voice or music input, the average or effective power being less than with constant sine wave input, the peak power can be increased to a value where the average plate loss is equal to the rated value.

It must be understood that when operating tubes under these conditions the input to the amplifier should be normal speech or music, not sustained tones of appreciable duration and high amplitude, which would cause an average plate loss above the rated value.

Impedance Matching

Contrary to general belief, the plate-to-plate load impedance of a class B audio stage is not particularly critical, unless the last possible watt of output power from a given pair of tubes is desired. This is rarely the case and considerable mismatch can be tolerated at only a slight sacrifice in power output.

It is also unfortunate that most output transformers are classified in terms of plate-to-plate impedance, instead of in impedance ratios. Many operators believe that a 10,000 ohm transformer represents a 10,000 ohm load on the tubes regardless of what is connected across the secondary winding of the transformer. It should be emphasized that an output transformer is merely a device to transform a given secondary load impedance into the desired reflected primary impedance into which the tubes work. If a given transformer reflects a plate-to-plate load of 10,000 ohms when a 4,000 ohm load resistance is connected across its secondary, the reflected plate-to-plate load will vary in exact proportion to the variations in secondary load. Thus if the secondary load is increased from 4,000 ohms to 6,000 ohms, the reflected primary resistance will go up to 15,000 ohms plate-to-plate. The load resistance across the secondary of a class B output transformer equals the plate voltage in volts, divided by the plate current in amperes of the class C amplifier that is being modulated. When in doubt it is better to run the modulators into a load that is too high rather than one which is too low.

Modernized 25 Watt Phone Designed For Type 46 Tubes

• The circuit shown below represents a modernized version of a standard type of phone transmitter using class B modulation. The carrier output is 25 watts and the transmitter will give a good account of itself on either 75 or 160 meters. It is not recommended for operation in the 20 meter band unless a separate doubler stage is added between the buffer and the final amplifier.

The crystal amplifier is entirely conventional and uses a type 47 pentode as the oscillator tube, which gives good output and stability. The oscillator is link coupled to a 46 buffer stage which utilizes grid neutralization. The buffer is link coupled to the grid circuit of the final amplifier, which uses two 46s in parallel as a class C plate modulated amplifier. Grid-leak bias is used throughout the radio frequency portion of the transmitter. Grid neutralization is used on the final amplifier in order to simplify the special antenna coupler. The theory of this antenna coupler is similar to the Collins PI network, but represents a combination of plate tank and antenna coupler which is an obvious step toward simplification.

The 350 mmf. condenser in the antenna coupler is used to match the coupler to the antenna, and the 150 mmf. condenser is used to restore resonance in the tank circuit.

The speech amplifier is somewhat unconventional in the driver stage for the class B modulators. It has been found that most of

the distortion which occurs from using 46s as class B modulators originates in the driver and in the class B input transformer. A 46 operating as a low-mu triode has not quite enough audio output to properly drive the grids of class B 46s, especially if a cheap class B input transformer is used. Thus a special form of direct-coupled circuit, using a 56 and a 46 driver, is provided to overcome this difficulty. A 46 connected as a low-mu triode has an audio output of less than 2 watts, whereas the 46 driver shown in the circuit diagram has an audio output in excess of 7 watts. Obviously, the 7 watts is not used to drive the grids of the 46 modulators, but with this amount of power in reserve the fidelity is materially improved and a very objectionable source of distortion is eliminated. The audio channel is designed to work out of a highly-damped carbon microphone, such as the Western Electric 387W, and thus provides enough gain for practically any other kind of carbon microphone. If a ribbon, crystal, condenser or dynamic microphone is to be used with this transmitter, one or more stages of pre-amplification will probably be required ahead of the first 56 tube.

The plate current to every stage in this transmitter should remain constant under modulation, with the exception of the 46s used as modulators, and the 46 audio driver.

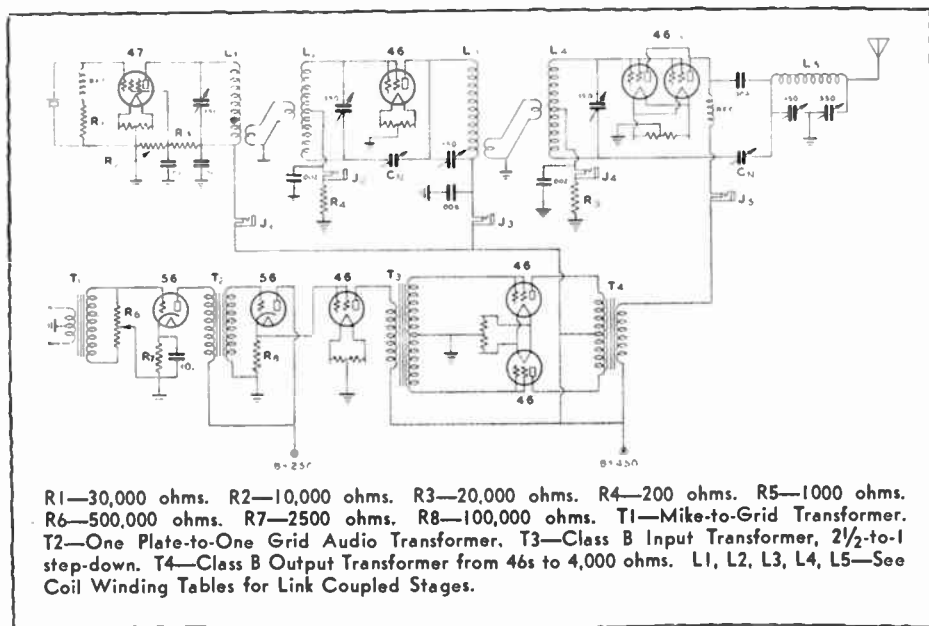

Simple 160 Meter Phone For Newcomers

The simple 160 meter phone should preferably use a crystal oscillator stage and a buffer amplifier with either one or two type 45 tubes. A single plate supply will operate the entire transmitter, as the circuit diagram shows.

The transformer should be rated at 100 volts each side of center-tap, at 175 MA. It must have two separate 2½-volt filament windings, if it has but one 2½ volt winding a separate 2½ volt filament transformer can be added. The 45 tubes in the final amplifier must not operate from the same filament winding that lights the filament of the 47 oscillator and audio tubes. An 83V rectifier tube is used. This is a comparatively new tube. It uses a

cathode heater. Two 8 mfd. 600 working volt condensers are required. Make sure that they will stand 600 volts. The choke is a 200 MA, 20 to 30 henry size. The power unit should deliver 100 volts at the output terminals when the transmitter is in operation.

The Audio Amplifier

The audio system is simple. A 57 tube drives two 2A5's in parallel. These tubes are in the low-price group. A crystal microphone can be connected to the input, or any other type of good microphone can be used.

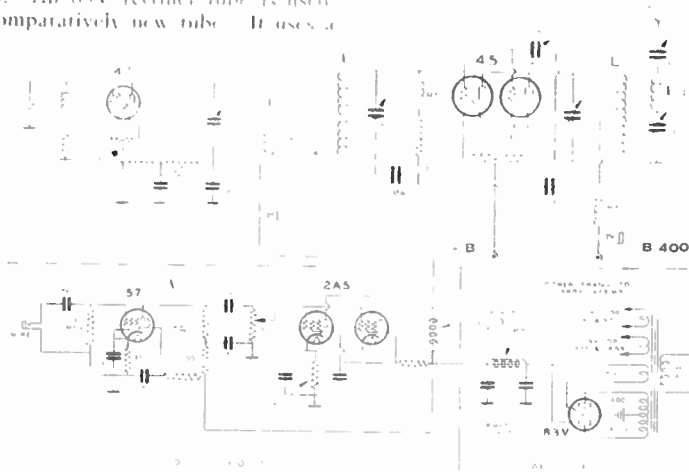

Circuit Diagram of the Entire Transmitter.

The coil tables for link coupling (shown elsewhere in these pages) give the correct number of turns for L1, L2, L3, and L4.

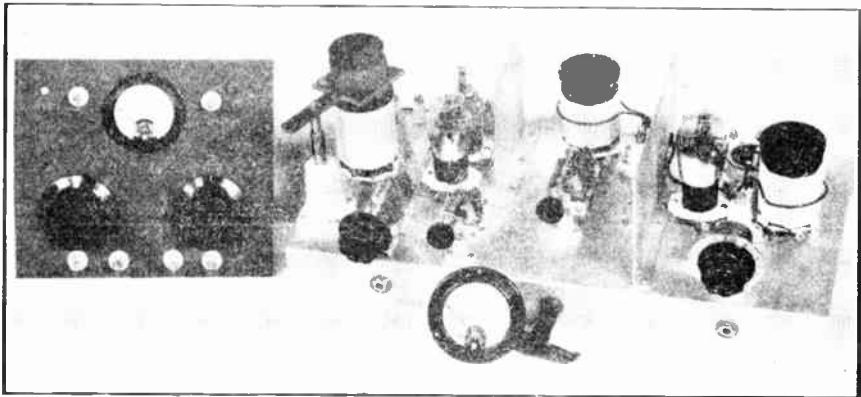

47 Oscillator, Link-Coupled to a pair of 45s in parallel. Antenna Condensers and RF Ammeter are Mounted on the Panel at Left.

Table Showing Audio Output of Modulator Tubes

	Audio Power	Type of Tube	Class	Driver Tube
Plate Volts 400	4 watts	1—2A5 or 42	A	56, 57, etc.
	4 W.	1—250	A	56, 27, 12A, etc.
	25 W.	2—46s or 59s or 53s. PP.	B	PP 45s
	40 W.	4—46s in push-pull Par.	B	PP 2A3s
Plate Volts 450	4.6 W.	1—250	A	56 or equiv.
	15 W.	2—250s in push-pull	A	56 or equiv.
	30 W.	2—46s, etc., push-pull	B	PP 45s
	50 W.	4—46s, etc., push-pull Par.	B	PP 2A3s
Plate Volts 500	5 W.	1—250	A	56 or equiv.
	7.5 W.	1—845 or WE284A	A	210 or 45
	35 W.	2—210s or 841s. PP.	B	PP 45s
Plate Volts 600	4.5 W.	1—WE211D or E	A	210 or 45
	8 W.	1—845 or WE284A	A	210 or 45
	30 W.	2—250s. PP.	AB	45 or 250
	40 W.	2—210s or 841s. PP.	B	PP 45s
Plate Volts 750	5.5 W.	1—RK18 or WE211E	A	56 or equiv.
	6.25 W.	1—211 or WE242A	A	56 or equiv.
	10 W.	1—845	A	210 or 45
	15 W.	1—WE284A	A	210 or 45
	50 W.	2—210s or 841s. PP	R	PP 2A3s
	70 W.	2—RK18s or 801s	B	PP 2A3s
	75 W.	2—WE211D or E, push-pull	R	PP 2A3s
	90 W.	2—50Ts, push-pull	B	PP 2A3s
Plate Volts 1000	8.5 W.	1—RK18	A	56 or equiv.
	10 W.	1—354 or 150T	A	210 or 45
	10 W.	1—211 or WE242A	A	210 or 45
	15 W.	1—845	A	210 or 45
	25 W.	1—WE284A	A	210 or 45
	40 W.	2—830s in push-pull	AB	PP 45s
	100 W.	2—800s, push-pull	B	PP 2A3s
	100 W.	2—WE211D or E, push-pull	B	PP 2A3s
	150 W.	2—50Ts	B	PP 2A3s
	175 W.	2—WE284As or 845s	AB	PP 2A3s
Plate Volts 1250	18 W.	1—211 or WE242A	A	210 or 250
	30 W.	1—845	A	210 or 250
	30 W.	1—WE284A	A	210 or 250
	106 W.	2—800s in push-pull	B	PP 2A3s
	125 W.	2—WE284As in PP.	AB	PP 2A3s
	175 W.	2—50Ts	B	PP 2A3s
	200 W.	2—211s or WE242As. PP	B	PP 2A3s
	225 W.	2—203As or 838s	B	PP 250s
	225 W.	2—845s in push-pull	AR	PP 2A3s
	275 W.	2—150Ts or 354s	B	PP 2A3s
Plate Volts 1500	35 W.	1—WE212D	A	210 or 250
	75 W.	1—HK255	A	203A or 211
	165 W.	2—50Ts. PP.	B	PP 2A3s
	240 W.	2—845s, push-pull	AB	PP 2A3s
	350 W.	2—WE212Ds in push-pull	AB	PP 250s
	350 W.	2—150Ts or 354s	B	PP 2A3s or 250s
Plate Volts 1750	37.5 W.	1—HK255	A	203A or 211
	400 W.	2—354s or 150Ts	B	PP 250s
	400 W.	2—WE212Ds in push-pull	B	PP 845 or equal
Plate Volts 2000	35 W.	1—354 or 150T	A	210 or 45
	40 W.	1—204A	A	210 or 45
	60 W.	1—849	A	210 or 45
	100 W.	2—354s or 150Ts or Push-Pull	A	210 or 45
	100 W.	1—851	A	210 or 45
	100 W.	1—HK255	A	203A or 211
	500 W.	2—354s or 150Ts, push-pull	B	PP 250s
	500 W.	2—204As in push-pull	B	PP 845 or equal
Plate Volts 2500	600 W.	2—849s in push-pull	B	PP 845 or equal
	600 W.	2—849s in push-pull	R	PP 845 or equal
	600 W.	2—150Ts or 354s in push-pull	B	PP 250s or equal
	750 W.	2—WE270As, push-pull	B	PP 845 or equal

47-46-210 Phone—25 to 50 Watt Carrier

This is a standard low-power transmitter for operation on 160, 75 or 20 meters. It is extremely simple to construct. The c.w. portion of the transmitter should be built first. Particular attention should be paid to see that the 46 and 210 stages both neutralize perfectly. The audio channel should then be built and tested by applying radio program material to the input. A speaker or a pair of headphones should be tapped across the output load resistor R13. The audio modulation

should not be applied to the plate supply of the class C 210 stage until both portions of the transmitter are working 100%. The plate currents as read at the various plate current jacks should all remain absolutely constant during modulation, with the exception of the modulator plate current read at jack J6. The speech amplifier has ample gain to work out of the average double-button carbon microphone. If any of the low-level microphones are used, a pre-amplifier should be added and its output coupled to T1.

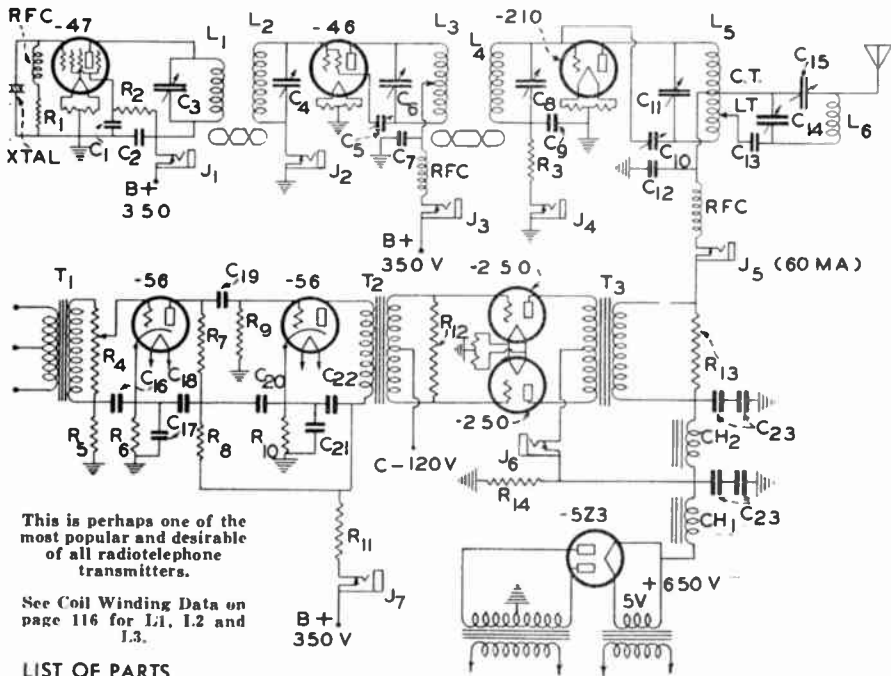

This is perhaps one of the most popular and desirable of all radiotelephone transmitters.

See Coil Winding Data on page 116 for L1, L2 and L3.

LIST OF PARTS

- R1—Oscillator grid leak, 10,000 to 50,000 ohms. Smaller the better, 2 watt.
 R2—Screen dropping resistor, 30,000 ohms, 2 watt.
 R3—Final grid leak, 15,000 ohms, 25 watt.
 R4—Volume control, 200,000 ohms, tapered potentiometer.
 R5—Grid decoupling, 100,000 ohms, metallized.
 R6—56 bias resistor, 2500 ohms, 2 watt.
 R7—Shunt feed, 100,000 ohms, 5 watt.
 R8—Plate decoupling, 10,000 ohms, 5 watt.
 R9—Grid load, 500,000 ohms, metallized.
 R10—56 cathode bias, 2500 ohms, 2 watt.
 R11—Isolating, 5,000 ohms, 5 watt.
 R12—Grid load, 200,000 ohms, metallized.
 R13—Load stabilizer, 100,000 ohms, 10 watt.
 R14—Bleeder, 30,000 ohms, 100 watt.
 C1—.001 ufd.
 C2—Same as C1.
 C3—50 ufd. midget variable.
 C4—Same as C3.
 C5—Same as C3.
 C6—Same as C3.
 C7—.001 ufd. same as C1.
 C8—Same as C3.
 C9—Same as C1.

- C10—.35 ufd. variable neutralizing, 2000 V. breakdown.
 C11—50 ufd. variable tank, 2000 V. breakdown.
 C12—.006 fixed, 2500 V. breakdown. Mica.
 C13—.006 ufd. 2500 V. same as C12.
 C14—350 ufd. variable. (Good BC cond.)
 C15—Same as C14.
 C16—Anything from 1/2 to 2 ufd.
 C17—Same as C16.
 C18—Same as C16.
 C19—Same as C1.
 C20—Same as C16.
 C21—Same as C16.
 C22—Same as C16.
 C23—Filter conds., each 16 ufd., 350 volts, making 8 ufd., 700 V. in series.
 T1—Mike to grid transformer.
 T2—Plate to push-pull grids.
 T3—Class A prime output, 1.25 to 1 stepdown.
 CH1—First filter choke, 15 henries 200 MA. Low resistance. Can be swinging choke.
 CH2—30 henries or more at 75 MA. Two power transformers necessary. One 650 to 800 volts center-tapped BC type. One 1200 to 1400 volts center-tapped, @ 200 MA. Must have good voltage regulation.

Circuit Diagram and Constants for RK-20 Phone

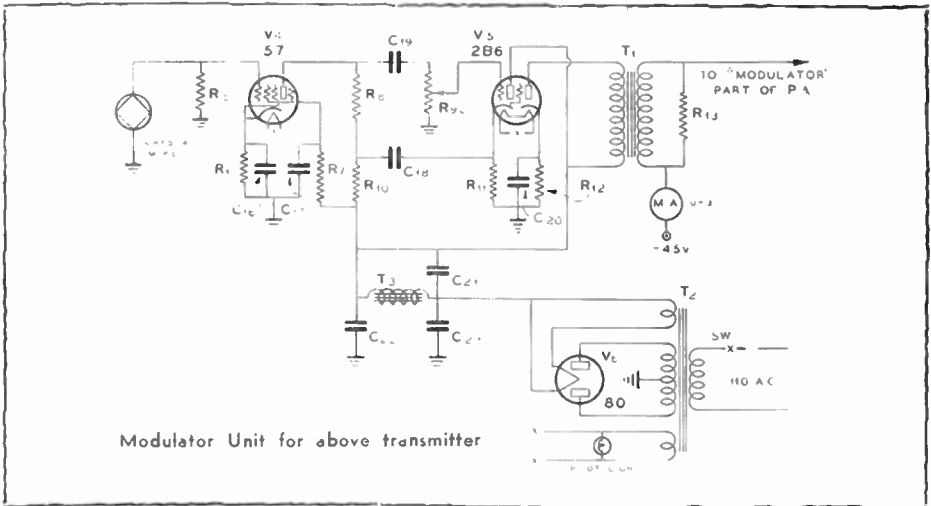
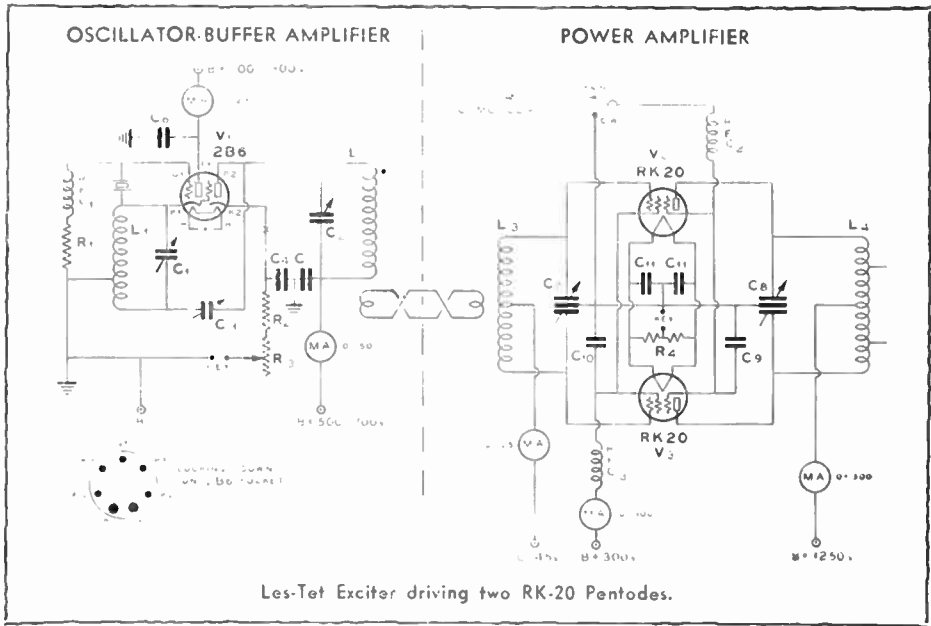

Parts List—Oscillator & Amplifier

C1—100 mf.; C2—100 mmf.; C3—25 mmf.; C4—01 mf.; C5—.005 mf.; C6—.005 mf.; C7—130 mmf. each section (split sections); C8—70 mmf. each section (split sections); C9—.002 mf.; C10—.002 mf.; C11—.002 mf.; C12—.001 mf.; C-13—.001 mf.; C-14—480 mmf.; C15—220 mmf.; L1—Oscillator inductor ("plate" coil); L2—Amplifier inductor (plate tank); L3—Power amplifier grid inductor; L4—Power amplifier plate tank; L5, L6—Antenna impedance matching inductors; R1—100,000 ohms; R2—1000 ohms; R3—5000 ohms; R4—75 ohms, center tapped; RF1, RF2, RF3—2.5 millihenry r.f. chokes.

Parts List—Modulator Unit

C16—5 mf.; C17—.5 mf.; C18—.5 mf.; C19—.1 mf.; C20—25 mf.; C21—.1 mf.; C22—8 mf.; C23—4 mf.; R5—5 megohms; R6—5000 ohms; R7—2 megohms; R8—250,000 ohms; R9—1 megohm potentiometer; R10—100,000 ohms; R11—10,000 ohms; R12—750 ohms; R13—10,000 ohms; T1—Modulation transformer; T2—Power supply transformer; T3—30 henry filter choke.

Circuit Diagram for Capacitively Coupled 75-80 Meter Phone-CW Transmitter

This phone transmitter is a completely AC operated unit which has a carrier output of not less than 50 watts and which may be modulated 100%. It is mounted in a steel frame 17 inches wide, 50 inches high and 19 inches deep.

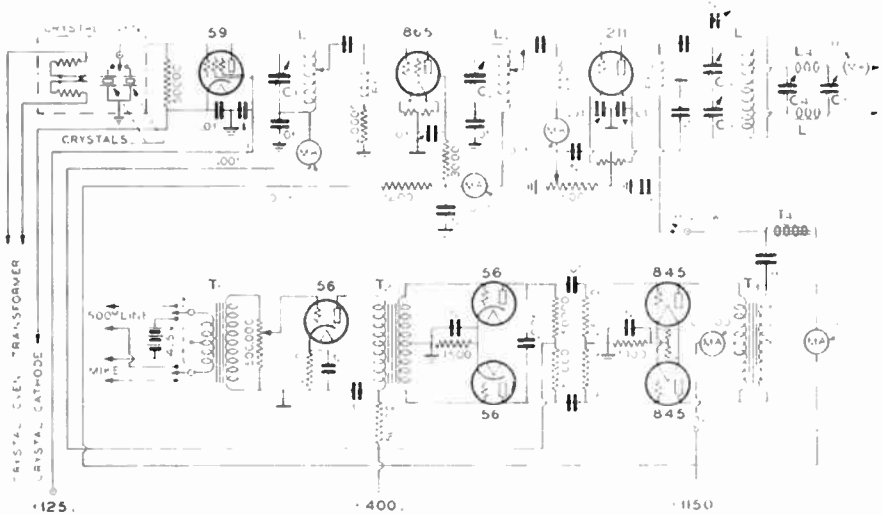

Circuit Diagram for 50-Watt Class A Radio Telephone.

- C1—75 mmf. C2—75 mmf.
- C3—220 mmf., each section, Split-Stator.
- C4-C5—350 mmf. each.

Coil Winding Data for 75-80 Meter Operation:

- L1—35 turns, No. 20 DCC wire on 1 1/2-inch dia. form, close wound.
- L2—22 turns, No. 16 Enameled, 14 turns per inch, on 2 1/2-inch dia. form.

- L3—22 turns, No. 10 Enameled, 6 turns per inch, on 3 1/2-inch dia. form, with antenna coil taps 1/4 down from each end.
- L4-L5—Each 15 turns, No. 12 Enameled, 12 turns per inch, on 2-inch dia. forms.
- T1—Mike transformer.
- T2—Push-pull input transformer.
- T3—Class AB (A-Prime) output transformer.
- T4—Modulation choke. 200 MA @ 30 henrys.

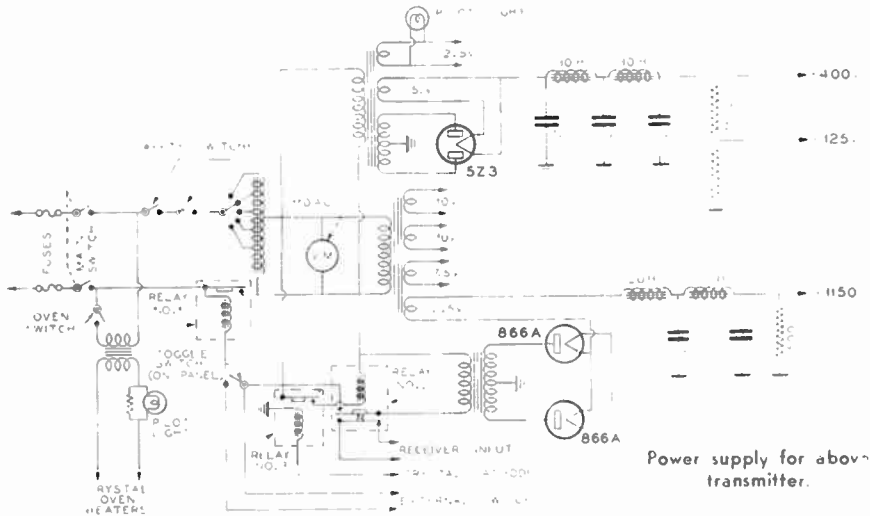

Power supply for above transmitter.

Economical 1000 Watt Phone

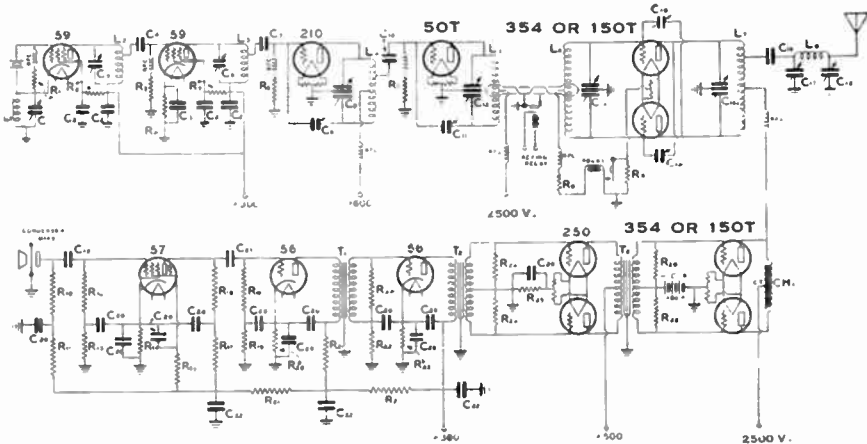

- C1—140 mmf. Hammarlund Condenser.
- C2—.01 mfd. C3—50 mmf. Hammarlund.
- C4—.00025. C5—.0001. C6—50 mmf. Hammarlund.
- C7—.00025. C8—22 mmf. Neutralizing.
- C9—100 mmf. split stator. C10—.00025.
- C11—15 mmf. neutralizing. C12—100 mmf. split stator.
- C13—100 mmf. split stator. C14—15 mmf. neutralizing.
- C15—100 mmf. split stator. C16—.001.
- C17—250 mmf. C18—250 mmf. C19—.001.
- C20—1 mfd. C21—.01 mfd. C22—8mfd.
- R1, R2, R3, R5, R17, R19—50,000 ohms.
- R4—1000 ohms. R6, R7—15,000 ohms.

- R8—25,000 ohms.
- R10—10 megohms.
- R12— $\frac{1}{2}$ megohm.
- R14—750 ohms.
- R16— $\frac{1}{4}$ megohm.
- R20—2500 ohms.
- R22— $\frac{1}{4}$ megohm.
- R24—1 megohm.
- R26—10,000 ohms.
- T1—Triode Plate to Grid.
- T2—Push-Pull Input. T3—Class B Input, 1:1 for 354's; 2:1 for 357's.
- Ch—Class B Output Choke, 92 henries.
- R9—1500 ohms.
- R11—5 megohms.
- R13— $\frac{1}{4}$ megohm.
- R15— $\frac{1}{2}$ megohm.
- R18— $\frac{1}{2}$ megohm.
- R21—20,000 ohms.
- R23—2500 ohms.
- R25—750 ohms.

Suppressor-Grid Modulated Phone Transmitter Using Type 802 Tube

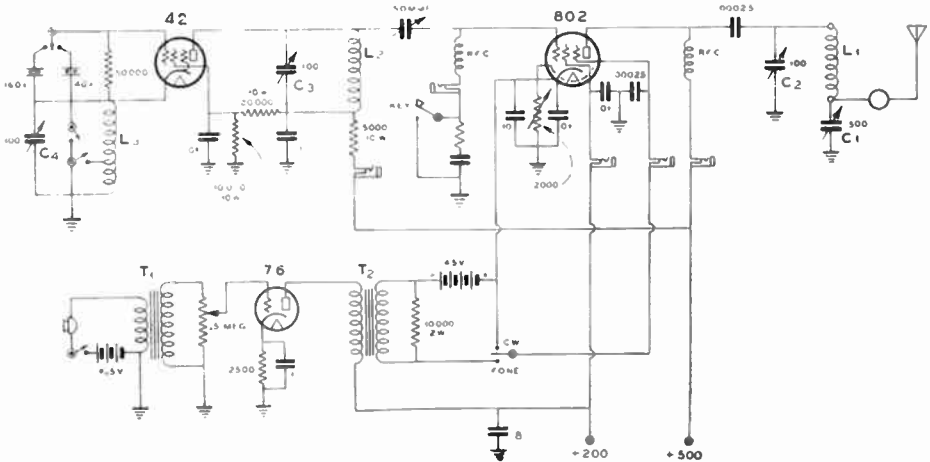

Simple phone, suppressor-grid modulated, using an 802 in the RF amplifier. 10 watts of carrier power can be secured. By changing crystals this 160 meter CW transmitter.

The New 125 Watt Pentode in a Modern 50-Watt Phone

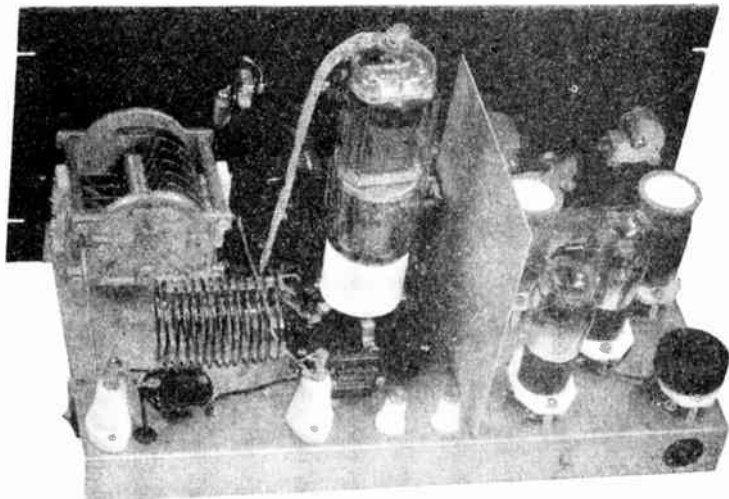

The complete R.F. portion is mounted on a single chassis.

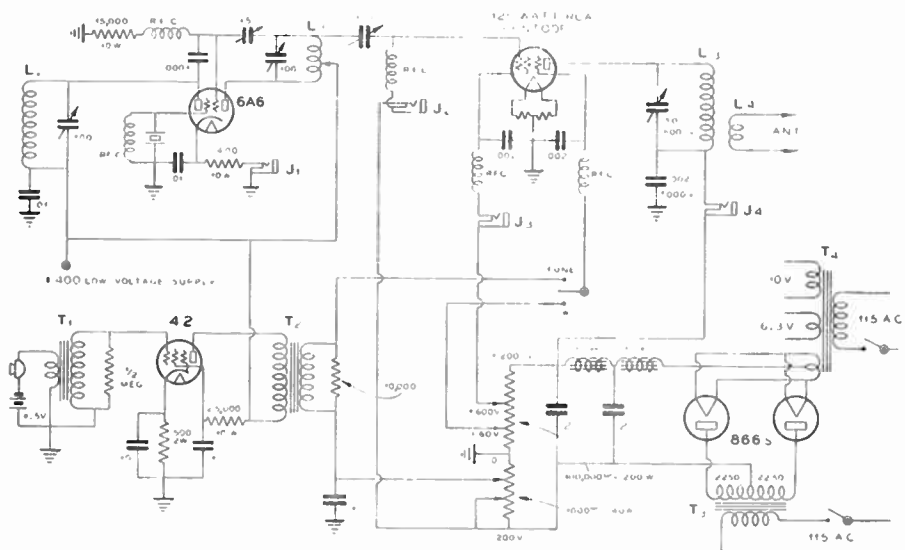

Suppressor-grid modulated phone using 125 watt pentode. A 53 or 6A6 is used as driver and the suppressor grid of the 125 watt pentode is modulated by a type 42 or 2A5 tube. The output is 200 watts for c.w. and 50 watts for phone operation. The 42 or 2A5 plate transformer T2 is a regular small class B input transformer with a 10,000 ohm load resistor across the secondary. T1 is the microphone transformer. The oscillator uses the Jones exciter circuit. Coil winding data for 20 meters: L1 (40 meters) $14\frac{1}{2}$ turns of No. 18 DSC on $1\frac{1}{2}$ " dia. form, space wound to cover $1\frac{1}{2}$ " winding space. The doubler coil L2 is wound with 8 turns of No. 18DSC on a $1\frac{1}{2}$ " dia. form, space wound to cover 1" winding space. L3 (20 meters) 10 turns of $3/16$ " copper tubing, $1\frac{3}{4}$ " diameter, $2\frac{1}{2}$ " long. The variable grid coupling condenser is changed to one of 35 mmf. capacity for 20 meter operation. For 40 meters, 100 mmf. is used, as shown in the circuit diagram.

125 watt pentode characteristics: Fil. 10 volts. Fil. current 3.25 amps. DC plate voltage 2000 max. Plate dissipation 125 watts. D.C. screen voltage 600 max. Suppressor voltage +60 max. Screen dissipation 20-30 watts, max.

PRACTICAL GRID-BIAS MODULATION

● The fundamental circuit of a bias modulated amplifier is shown in Fig. 2.

A given amount of carrier power costs just about as much when obtained from a bias modulated transmitter as when obtained from a high level plate modulated transmitter. At certain power levels, plate modulation may be more economical, while at some other power level, bias modulation may have a slight advantage. This is because certain tube combinations happen to work out just right for one or the other of the two systems of modulation.

The outstanding feature of a bias modulated transmitter is the fact that very little audio gear is required, in comparison to a plate modulated transmitter of the same

The reason for the amplitude, or harmonic distortion, in the other systems lies in the fact that the average value of the plate current is not proportional to the peak value of the plate current, during modulation. As the grid swings more positive (during modulation), plate current flows during a longer time interval, and as the grid goes more negative, plate current flows for a shorter time interval than when the bias is unmodulated. For distortionless modulation it is essential that the interval during which plate current flows shall remain constant, regardless of the percentage of modulation. This condition is fulfilled only when the fixed bias is exactly equal to the cut-off value. However, while fixed cut-off bias is entirely workable for a class B linear amplifier, which is amplifying a wave which was modulated in some preceding stage, it cannot be used in a

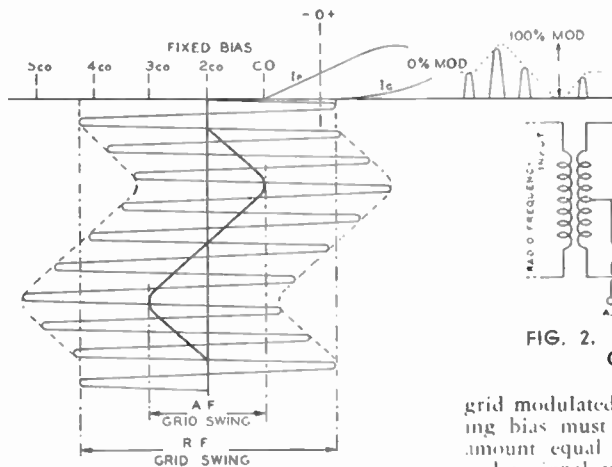

FIG. 1
Graphic representation of class BC bias modulation.

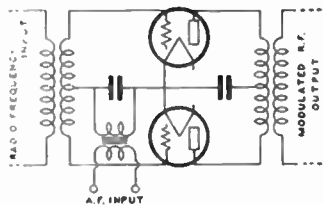

FIG. 2. Fundamental Circuit of Grid Modulation

power output. This feature is particularly valuable to a man who spends a good part of his operating time on CW. Instead of having over half the transmitter idle, as when working CW with a plate modulated phone, less than 10 per cent of the equipment is idle when the bias modulated transmitter is used for CW telegraphic communication.

Several different types of grid bias modulation systems have been brought forward in the past few years, but only one bias modulation system has proved itself to be capable of complete, linear and symmetrical modulation. This is the Hawkins class BC bias modulation system, which is characterized by a constant angle of plate current flow. See Fig. 1. The best practical test of linearity for any bias modulated amplifier is to see that the average plate current remains absolutely constant for all percentages of modulation up to 100 per cent. The class BC amplifier is the only one, at the present time, which fulfills this requirement.

grid modulated amplifier because the operating bias must always exceed cut-off by an amount equal or greater than one-half the audio signal voltage, in order to keep the negative halves of the RF excitation cycles from crossing the cut-off point during modulation.

Fundamentals of Grid-Bias Modulation

Grid modulation is characterized by the fact that very little audio power is necessary to modulate the grid bias of an RF amplifier. However, the complexity of adjustment in the older systems has prevented about 99% of those attempting it from obtaining satisfactory results. Usually terrific distortion and overmodulation followed most attempts to obtain the combination of 100% modulation capability and high plate efficiency.

When audio modulation is used the radio-frequency carrier has two sidebands which carry the transmitted intelligence. Mathematics shows that one-third of the power in a completely modulated signal is contained in the two sidebands, while the other two-thirds consists of the carrier. Thus the problem which faces the builder of a phone trans-

mitter is to increase the power output of the transmitter, during modulation, up to a maximum of 50% for complete modulation. This additional power must be released in exact accordance with the variations in sound pressure which the operator's voice impresses on the microphone.

Plate modulation of a class C amplifier takes this additional power in the form of AC and adds it to the normal DC plate input to the modulated amplifier, which is operated under such conditions that its power output varies directly with the plate input. This AC power is supplied by the audio output of the modulator tubes and therefore we arrive at the conclusion that the power output of the modulators must be equal to one-half of the DC watts input to the class C modulated amplifier. Thus the real function of the modulator tube, or tubes, in a plate modulated phone, is to release power from the power supply for use in the modulated amplifier, so that its power output may be increased during modulation.

Where, then, does the power come from that increases the carrier output when the bias-modulated amplifier is modulated? Let us digress here and consider the fundamental nature of a vacuum tube amplifier. It might be defined as a device which converts DC (plate power) into AC (RF output) power. This conversion process is never 100% efficient and the difference between the plate input and the power output is dissipated from the plate of the tube in the form of heat. The efficiency of a vacuum tube amplifier depends on a number of things and varies widely for different types of amplifiers. If a given amplifier is, for example, 25% efficient under a given set of conditions, it will have a certain power output. Now, without changing the DC plate input to the amplifier, let us change some of its operating conditions so that its average plate efficiency rises 50%. This can be done by swinging the instantaneous plate efficiency between zero efficiency and twice the unmodulated value of plate efficiency.

If we now measure the power output we will find that when we increased the average plate efficiency, keeping the plate input constant, the power output is one-and-one-half times what it was before. Thus if we can find some way to cause the plate efficiency to increase 50%, we can obtain the 50% increase in average output that we need for complete modulation. Under certain conditions the grid bias voltage affords this means of varying the plate efficiency of the amplifier.

Therefore **ALL GRID MODULATION SYSTEMS, WHETHER THEY USE THE CONTROL-GRID, SCREEN-GRID OR SUPPRESSOR-GRID FOR THE AUDIO CONTROL, OPERATE WITH CONSTANT PLATE INPUT AND VARIABLE EFFICIENCY.**

In class BC amplification (see Figs. 1 & 2) the fixed bias is equal to cut-off bias. This bias should usually be supplied from batteries. Additional bias approximately equal to the fixed battery bias is obtained from a cathode bias resistor connected in the conventional manner. The extra bias supplied by the voltage drop through this resistor is proportional to the plate current and therefore to the grid voltage. When the ratio of grid voltage to this excess bias voltage is a constant, a condition arises where the plate current impulses all flow for the same time interval, regardless of their peak amplitude.

In the older bias modulation systems the distortion increases almost directly as the ratio of fixed bias to cut-off bias. This limits any attempt to increase the plate efficiencies by using higher values of bias and driving voltage. However, in class BC the total bias may be as high as desired in the search for a higher plate efficiency and the absolute value of the total bias, and therefore the driving voltage is dictated by the usual class C amplifier considerations. A limiting factor in class BC is the voltage drop across the cathode resistor which represents a growing waste of perfectly good plate volts, as the bias is increased. There is no objection to driving the grid of the class BC amplifier to positive saturation, although extremely high values of grid current will cause some slight distortion because the grid current flows through the cathode resistor. Therefore the plate voltage should be as high as the tube insulation and gas content will allow, so that positive saturation will be as close to the zero bias line as possible.

The best tubes to use as class BC amplifiers are those of medium μ , such as the 210, 211, 800, RK18, 242A, 852, 50T, HK354, and 150T. The high μ tubes, such as the 841, 203A, 830B, 46, 838 and the screen-grid tubes have an advantage in that a smaller cathode resistor can be used because less bias is necessary to reach any given number of times cut-off. However, the high plate impedance of these tubes makes their use undesirable because it is hard to get a linear dynamic characteristic. This limits the undistorted power output.

The low μ tubes, such as the 245, 2A3, 845 or HK255 have the most linear characteristic, but the cathode bias resistor must be so large in order to get enough bias for efficient operation that a terrific waste of plate voltage results. However, if there are no limitations to the plate voltage available, the low μ tubes will give slightly better results than the medium μ tubes. Perhaps the best single index of merit is grid-plate transconductance, although this factor of tube merit is measured under such widely varying

conditions that direct comparisons should be made with caution, except for tubes of the same general type.

Designing the Bias Modulated Amplifier

It is impossible to present a table showing exact operating characteristics at all possible plate voltages with the many tubes that can be used; thus it is desirable to describe some of the relationships which exist in the class BC amplifier circuit so that the constructor can easily calculate the unknown factors from those factors which he knows in advance. It should be remembered that the unmodulated plate efficiency of a class BC amplifier is approximately 40%. During complete modulation the average plate efficiency goes up to 60%. The limitation on the output of all bias modulated amplifiers is the available plate dissipation of the tube (or tubes) used in the amplifier. The following three factors are known:

- (1) E_B = DC plate supply voltage, in volts.
- (2) $W_{PLATE\ LOSS}$ = Rated plate dissipation of tube used, in watts.
- (3) μ = Amplification factor of tube used.

The tube factors can be determined from tube tables and the plate supply voltage with a high-voltage voltmeter. From these three known factors the constructor must be able to determine in advance all of the unknown factors, in order to allow the amplifier to operate properly. This is the only bias modulation system which allows the unknown factors (shown below) to be accurately determined in advance; all other bias modulation systems require extensive experimentation in order to realize optimum conditions of operation. Due to the complex variable factors involved in a bias modulated amplifier it is extremely unsatisfactory to depend on guesswork in order to realize complete linear and symmetrical modulation capability. The unknown factors which are to be determined from the three known factors, shown above, are:

- (4) W_{INPUT} = AC plate input power, in watts.
- (5) W_{OUTPUT} = RF unmodulated carrier output, in watts.
- (6) I_P = DC plate current, amperes.
- (7) E_{CCO} = DC battery bias equal to theoretical cut-off, in volts. ($1/2$ total bias).
- (8) R_K = Cathode bias resistance, in ohms.

The unknown factors shown above require little explanation. They simply describe the conditions under which the class BC amplifier will operate when properly adjusted. E_{CCO} , which equals that amount of DC bias equal to theoretical cut-off at the plate voltage used, is the battery bias which must be used, and is also equal to the voltage drop across the cathode bias resistor. The following formulas define the unknown factors in terms of the known factors.

$$(9) W_{INPUT} = 1.66 W_{PLATE\ LOSS}$$

$$(10) W_{OUTPUT} = .66 W_{PLATE\ LOSS}$$

$$(11) I_P = \frac{1.66 W_{PLATE\ LOSS} (1 + \mu)}{\mu E_B}$$

$$(12) E_{CCO} = \frac{E_B}{1 + \mu}$$

$$(13) R_K = \frac{E_B^2 \mu}{1.66 W_{PLATE\ LOSS} (1 + \mu)^2}$$

The above formulas are all based on 40% plate efficiency; this efficiency will easily be realized from any tube operated at, or above its rated plate voltage. The class BC amplifier requires somewhat closer antenna coupling than is commonly used in CW transmitters.

Particular attention should be called to the fact that the class BC amplifier makes an exceptionally good linear radio-frequency amplifier for amplifying a previously modulated wave. It is capable of somewhat better linearity and plate efficiency than the conventional class B linear amplifier. The class BC linear amplifier is a modulation-gaining linear amplifier because it doubles the percentage modulation of the excitation wave. Thus the amplifier which precedes the class BC linear amplifier (when twice cut-off bias is used on the class BC linear) must not be modulated more than 50% if over-modulation of the output wave is to be avoided. When the exciting wave is modulated 50%, the output wave delivered to the antenna is exactly 100% modulated. In certain cases this permits a distinct economy of audio power to be realized in modulating the preceding stage. 50% modulation of a given plate modulated class C stage only requires one-fourth of the audio power necessary for 100% modulation.

All of the above formulas hold true for operation as a class BC linear amplifier.

Table of Data for Class BC Amplifier Operation

Tube Type	RF Unmodulated Carrier Power		Plate Loss W	μ
	Input W	Output W		
210	25	10	15	8.3
801	33	13	20	8.5
800	60	25	35	15
50T	83	33	50	13
211-242A	166	66	100	12
852	166	66	100	12
354	250	100	150	13
150T	250	100	150	13
212D	333	133	200	16
204A	416	166	250	24
270A	500	200	300	16
849	583	233	350	19
851	1000	400	600	20
251A	1250	500	750	10.5

The Smallest Economical Bias-Modulated Transmitter

● In this transmitter the grid bias on the final stage is varied at an audio frequency by means of a low-power modulator. A 57 tube is used as a speech amplifier from a crystal microphone, driving a 2A5 pentode for modulating a type 211 tube. An audio swing of less than 200 volts is all that is required for complete modulation, while with plate circuit modulation a swing of at least four times as much would be necessary for a carrier of 50 watts.

For grid modulation, the RF excitation is much less than for CW or plate modulation, and in most cases the fixed battery C bias is set to cutoff. In this form the fixed bias is set for cutoff and self-bias from a cathode resistor is used to give additional bias of 150 to 200 volts.

Using only a fixed bias equal to cutoff, and a self-bias to take care of the audio swing in addition, the usual grid modulation distortion is greatly reduced and higher efficiency is obtainable. It is called class "BC" because it operates in a manner similar to an ordinary class B RF amplifier, but is biased fully class C, to twice cut-off. The amount of cathode bias is not critical but the fixed battery bias must be equal to theoretical cut-off, which is net plate voltage divided by the amplification factor of the tube. This class BC system is simple to adjust.

For phone use the RF excitation must be reduced until only a few milliamperes of grid current flow. Furthermore, the antenna load must be slightly greater than is normal for CW operation.

The oscillator and buffer stages are similar to those described under "The Jones Harmonic Oscillator." Either the fundamental or second harmonic of the 53 tube is used to drive a 2A3 or 45 tube buffer stage.

The latter gives from 14 to 18 watts for driving the grid of the final 211 stage. This is needed for CW operation at the plate voltage available. For phone operation this is too much driving power, and part of it can be "swamped-out" by means of a 100-watt lamp shunted across the link circuit and the remainder reduced by slightly detuning either the 211 grid circuit or the crystal oscillator circuit. The second harmonic is needed for operation in the 20-meter band. It also allows operation on 40 meters from an 80-meter crystal. The output from the 2A3 neutralized buffer stage is about the same for either fundamental or second harmonic operation of the crystal oscillator.

The final stage has a very effective method for coupling to either a single wire fed Hertz

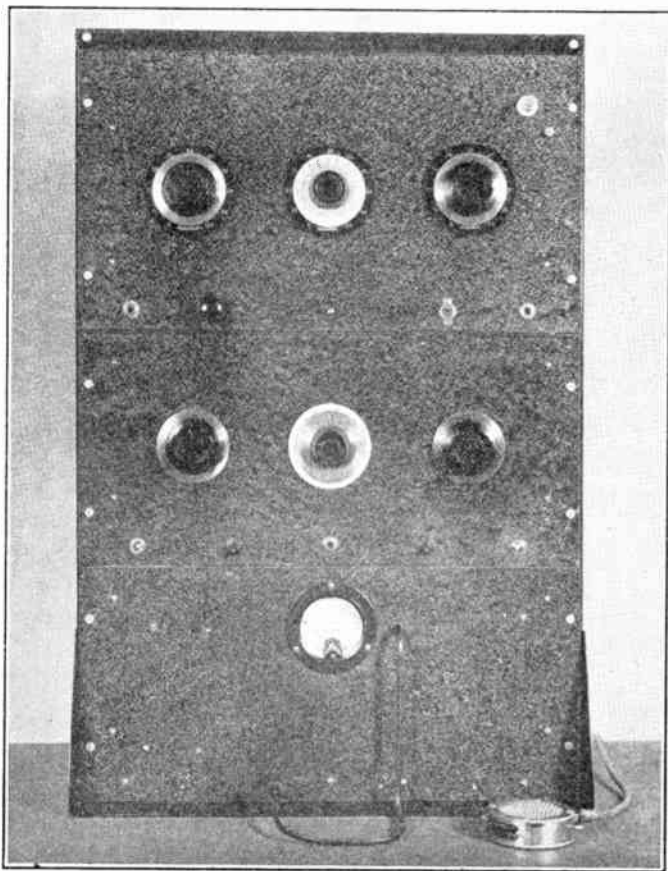

The complete phone in a 3-section standard relay rack. The bottom section holds the power supply; the center section holds the oscillator-doubler-buffer stages; the upper section holds the final amplifier, modulator and antenna tuning network.

antenna or an end fed Fuchs antenna. It is similar to the Collins antenna tuning system, but unlike the Collins system there are no losses introduced by an additional tuned circuit. The condenser C1 provides a low impedance path for harmonics and the inductance acts as an RF choke; therefore there are practically no harmonics across the antenna coupling condenser C2, or C2 and C3. The fundamental frequency has its proper impedance drop across the antenna condenser for matching from 2000 down to 50 ohms, or so. The antenna is easily matched with this system and usually more actual power gets into the antenna than when other systems are used. It is possible to use nearly any length of end fed antenna and get results not obtainable with other antenna coupling systems.

It is rather difficult to feed into a Zepp antenna with this system. The load on the final amplifier is not heavy enough to properly load it for grid modulation. By tuning the feeders separately to resonance and by the connection of C3 (a 1000 volt mica condenser across C2) Zepp feeders will give satisfactory results. A well spaced receiving condenser, rated at 1000 volts, is sufficient for C2 but C1 should be rated at 2500 volts in order to keep from breaking down on RF peaks. With the power supply used (1800 volts) the output is about 60 watts carrier output for phone, and over 200 watts for CW operation. It is conservatively rated as a 50-watt phone and 150-watt CW transmitter. Keying is conveniently accomplished in the cathode of the crystal oscillator because all stages are biased beyond cut-off and the tuned circuits between antenna and crystal stage tend to eliminate key clicks, which are spurious side bands.

Constructional Details

This transmitter can be conveniently built into a table mounting type relay rack as illustrated. The power supply is built into the lower deck on a 10-in. x 17-in. x 1½-in. chassis pan, behind an 8¾-in. x 19-in. front panel. This chassis rests directly on the base and the heavy power equipment does not put a strain on the front panel. Most of the inter-connections between panels are by means of 5 conductor patch cords, using tube sockets at the rear of each chassis for plug-in receptacles.

The power deck holds the high voltage transformer which should be rated at 1500 volts RMS each side of center-tap and capable of supplying at least 200 MA of DC load out of the filter. The filter consists of two 2 mfd. 2000 volt condensers connected across the 15 to 20 henry 250 MA filter choke. This gives sufficient filtering for phone use because the load current is only 100 MA for grid modulation. The heavy antenna load probably helps prevent hum modulation in the form of plate modulation.

All decks are made the same size, 10-in. x 17-in. x 1½-in., and the second or middle deck also mounts behind an 8¾-in. x 19-in. relay rack panel. This deck contains the low voltage rectifier, 83v, and filter system, and the crystal harmonic oscillator and buffer stage. The tuning controls are brought out through insulated couplings to dials on the front panel. The buffer stage is neutralized by means of a screwdriver adjustment through a hole in the front panel. An aluminum shield is placed between the crystal and buffer stages to minimize RF feedback. The tube, coil, and crystal sockets are arranged for convenience around the midjet tuning condensers. Since isolantite sockets are used, ¼-in. diameter holes are made under each socket for the wiring, most of which is under each deck. Ordinary good radio hook-up wire is satisfactory for wiring this deck. All high voltage leads are made with small flexible wire, insulated for 10,000 volts breakdown.

The top deck mounts behind a 10½-in. x 19-in. front panel and holds the modulator system and final RF stage. The entire modulator system occupies a space about 2-in. x 6-in. The grid circuit of the 211 tube is link coupled to the 2A3 buffer stage. An aluminum shield is placed between the grid and plate circuits of the 211 stage in order to insure ease of neutralization. Grid neutralization is used and functions perfectly, neutralizing fully as easily and as well as plate neutralization. The plate and antenna condensers are mounted on the front panel; the rotors of the condensers are grounded. The grid and neutralizing condensers must be mounted on insulators. The three controls on the top panel are arranged to be symmetrical with those on the middle deck in order to give a pleasing appearance.

The current measuring jacks are mounted on the front panels without insulators; however, the two grid current measuring jacks are insulated from the panel because they must be connected-up in an opposite manner to that used for cathode circuit jacks. It is desirable to use a 0-25 MA meter for grid current measurements. Either a 0-200 or 0-300 MA meter is suitable for the other measurements.

The speech amplifier should have the input leads shielded so as to prevent audio and RF feedback. The resistors and condensers can be mounted beneath the upper deck by means of terminal strips. If a small modulation transformer is used, it is desirable to balance-out the DC in the primary winding, as shown. This loading resistor also provides a needed load on the pentode modulator because the grid impedance of the 211 is not constant. This transformer is a small universal type class B transformer, originally designed for either input or output use with several taps. A number of manu-

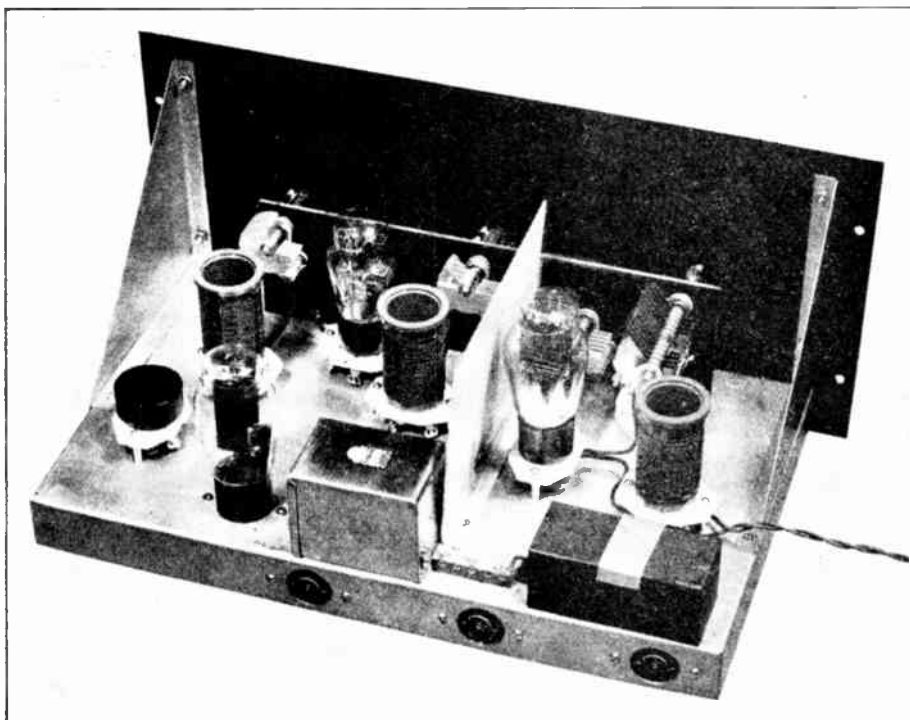

The Jones Exciter and the buffer stage. Note that the tuning condensers are mounted on a long bakelite strip. The condenser shafts are insulated from the front metal panel. At the rear of this unit, to the left, is the 83V rectifier tube and alongside of it is the power supply choke for the low-voltage supply. The filter condenser bank is at the extreme right.

facturers have such a transformer on the market. This transformer circuit arrangement greatly improves the audio frequency characteristic of small transformers.

The total speech amplification is only great enough for close-speaking operation with a crystal microphone. One possible source of distortion or "downward" modulation swing is in the modulation transformer. If this transformer saturates, it causes trouble. Usually a 2-to-1 impedance step-down ratio from the 2A5 plate to 211 grid is satisfactory in this transformer.

T1 is not very critical and practically any audio transformer capable of handling 2 watts of power, plus 25 A of DC in the secondary and with a 2 to 1 step-down ratio can be used. Most of the conventional class B input transformers give good results.

Circuit Adjustments

Under no load, the high voltage supply should deliver nearly 2000 volts, because condenser input is used. The low voltage supply should deliver 400 volts under load of about 160 MA.

The output of the crystal oscillator should light-up a 6-volt pilot lamp in series with a single loop of wire, when it is coupled to either the oscillator or doubler coils. The lamp also provides a convenient indicator for neutralizing the buffer and final amplifier circuits. Plate voltage can be removed from these circuits by plugging-in an open-circuit plug in the cathode circuits. It is advisable to shut off the high voltage supply when neutralizing the final, because an open-plug would probably arc across.

The link coupling and preceding tuning adjustments should be made so as to obtain maximum grid current in the 211 tube. Without plate voltage, this grid current should be between 30 and 40 MA. Under load this current will be less, because the cathode resistor builds up additional bias due to the plate current.

Neutralizing the final amplifier is simple if a tapped coil is used instead of a split-stator condenser in the grid circuit. Neutralizing on 20 meters is somewhat more difficult than on other bands, but even the old 211 tubes seem to neutralize well on 20 meters.

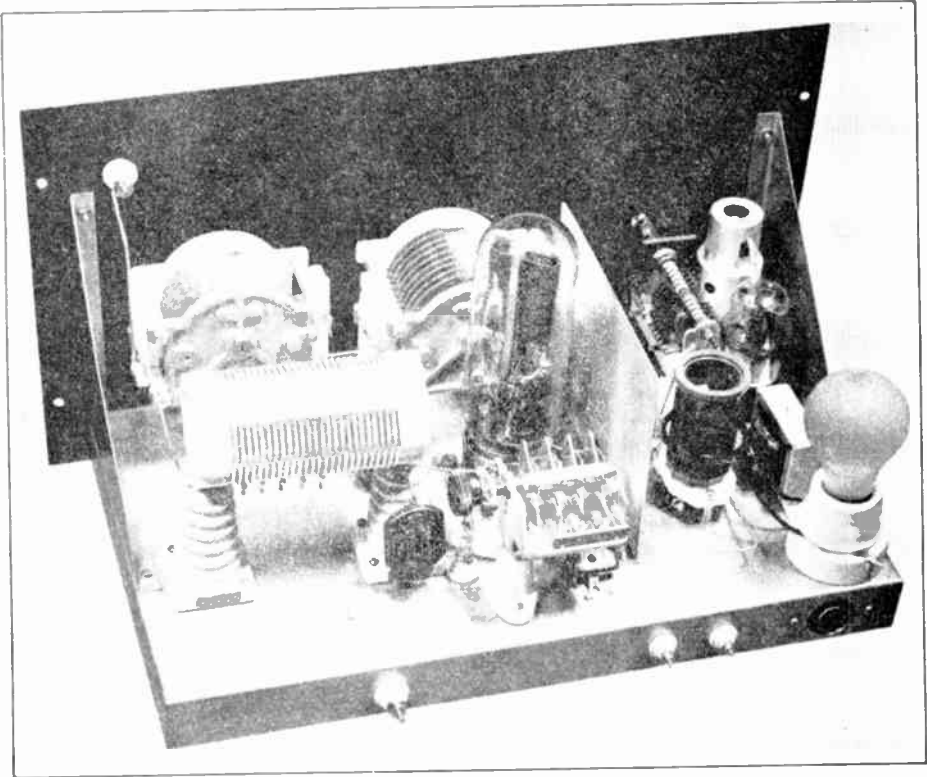

The Final Amplifier and the simplified PI Antenna Network. To the extreme right is seen the 57 tube (shielded) and the 2A5 tube, these two tubes constituting the entire audio channel. The small modulation transformer is seen alongside the grid coil. The grid tuning condenser is mounted on a bakelite support and the condenser shaft is insulated from the front metal panel. The 100 (or 200) watt lamp bulb is in shunt with the coupling link, although this lamp may not always be required. The coupling link around the grid coil has two turns, 2 inches in diameter.

The antenna circuit should be adjusted simultaneously with the plate condenser C1 in order to remain in resonance, as denoted by minimum plate current. Never disconnect the antenna or dummy antenna load unless the plate voltage is reduced to not over 1000 or 1200 volts, because C2 will flash-over on RF peaks. For CW operation, use all of the available grid excitation and adjust the antenna condenser C2 until maximum output with normal plate current is obtained. C1 should always be set for resonance, or lowest plate current. For CW operation the plate current should be in the neighborhood of about 200 milliamperes.

The adjustment for phone is simple—turn on the modulator filament switch—increase the antenna current to maximum, even though the plate current is high—then reduce the grid RF excitation until only a few grid mills flow.

If the load is proper, the plate current will run about 100 MA with an 1800 volt sup-

ply. Since a cathode bias resistor of 1500 to 1700 ohms is used, the actual plate voltage is only about 1600 volts. This gives 160 watts input. At 40% unmodulated plate efficiency there is about 60 watts of carrier output, and 100 watts of plate loss. Note that the tube cools off during modulation and if completely modulated with a tone, the input will remain at 160 watts. The R.F. output will increase to 90 watts, and the plate dissipation will drop to 70 watts.

The flashlight lamp and single turn of wire, or an antenna RF meter, should be used to make sure that upward modulation is being secured when the microphone is whistled into. The antenna current should rise about 22% on a steady tone. When talking, the antenna current should rise not more than 10% as with any plate modulated phone when operated within the 100% modulation limitation. If downward or insufficient modulation is obtained, it is usually an indication that too much RF excitation is being used. The grid

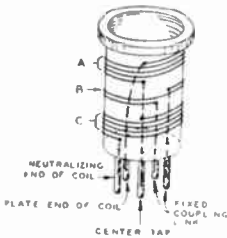

Showing how the buffer plate coil is wound. 5-prong Hammarlund forms are used. The link coupling loop portion of the winding has two turns, in the center of the form. A and C are the two halves of the plate coil winding. B is the two-turn coupling loop, L4 and L5.

The Buffer Plate Coil for any band is center-tapped. At the center of the buffer plate coil winding, this winding is spread apart so that a 2-turn coupling loop can be wound directly in the center of the coil. This is a fixed coupling loop and the connections are brought to two of the prongs on the coil form base. The link coupling loop of two turns on each of these buffer plate coils does not require a variable adjustment. The same size wire is used for winding the two-turn coupling loop as is used for winding the coils proper. On the 160-meter buffer plate coil this 2-turn loop is close wound with the other winding. On the 80-meter buffer coil this 2-turn loop is separated by $\frac{1}{16}$ -in. from both sides of the coil winding proper. On the 40-meter buffer plate coil the loop is separated by $\frac{1}{8}$ -in.; on the 20-meter buffer plate coil the separation is $\frac{1}{4}$ -in.

Coil-Winding Table For Grid-Modulated Phone

NOTE—5-Prong $\frac{1}{2}$ -in. Dia. Coil Forms Used Throughout, Except for 211 Amplifier Plate Coil.

Band	OSCILLATOR COIL L1	DOUBLER Plate Coil L2	BUFFER PLATE COIL L3	211 GRID COIL L6	211 PLATE COIL L7
160 Meters	68 turns, No. 22 DSC, close wound on $\frac{1}{2}$ -in. dia. form. Winding space occupies $2\frac{1}{8}$ -in.	NONE	78 turns, No. 22 DSC, close wound on $\frac{1}{2}$ -in. dia. form. Winding space occupies $2\frac{1}{4}$ -in. tap to be taken at center of winding. Also a 2-turn winding is to be wound in center of coil for coupling link. See drawing of coil form for data.	77 turns, No. 22 DSC, close wound on $\frac{1}{2}$ -in. dia. form, center-tapped. Winding space occupies $2\frac{1}{4}$ -in.	51 turns, No. 14 enameled wire, wound on $2\frac{1}{2}$ -in. dia. ceramic or bakelite form. Winding space occupies $3\frac{5}{8}$ -in.
80 Meters	27 turns, No. 22 DSC on $\frac{1}{2}$ -inch dia. form. Space for doubling wound to cover $\frac{1}{2}$ -inch windingspace.	Same coil as 80 meter oscillator coil from 160 meter oscillator.	45 turns, No. 22 DSC, close wound on $\frac{1}{2}$ -in. dia. form, center-tapped. Winding space occupies $1\frac{7}{8}$ -in. A 2-turn coupling link is wound in center, same as for 160 meter coil.	44 turns, No. 22 DSC, wound on $\frac{1}{2}$ -in. dia. form, center-tapped. Winding space occupies 2-in.	26 turns, No. 12 bare wire, space wound, on $2\frac{1}{2}$ -in. dia. form to cover a winding space of $3\frac{1}{2}$ -in.
40 Meters	13 turns, No. 18 DCC on $\frac{1}{2}$ -inch dia. form. Space for doubling wound to cover winding space of $\frac{1}{2}$ -inch.	Same coil as 40 meter oscillator coil from 80 meter oscillator.	22 turns, No. 18 DCC on $\frac{1}{2}$ -in. dia. form, center-tapped. Winding space occupies $1\frac{3}{4}$ -in. A 2-turn coupling link is wound in center, same as for above buffer coil.	22 turns, No. 18 DCC, wound on $\frac{1}{2}$ -in. dia. form, center-tapped. Winding space occupies $1\frac{1}{2}$ -in.	12 turns, No. 12 bare wire, space wound on $2\frac{1}{2}$ -in. dia. form to cover a winding space of $1\frac{1}{2}$ -in.
20 Meters	Use 40 meter oscillator coil.	7 turns, No. 18 DCC on $\frac{1}{2}$ -inch dia. form. Space wound to cover a winding space of $1\frac{3}{8}$ -inch.	12 turns, No. 18 DCC on $\frac{1}{2}$ -in. dia. form, center-tapped. Winding space occupies $1\frac{3}{4}$ -in. A 2-turn coupling link is wound in center. Same as for above coil.	10 turns, No. 18 DCC on $\frac{1}{2}$ -in. dia. form, center-tapped. Winding space occupies $1\frac{3}{8}$ -in.	5 turns, No. 12 bare wire, space wound on $2\frac{1}{2}$ -in. dia. form, to cover a winding space of $\frac{3}{4}$ -in.

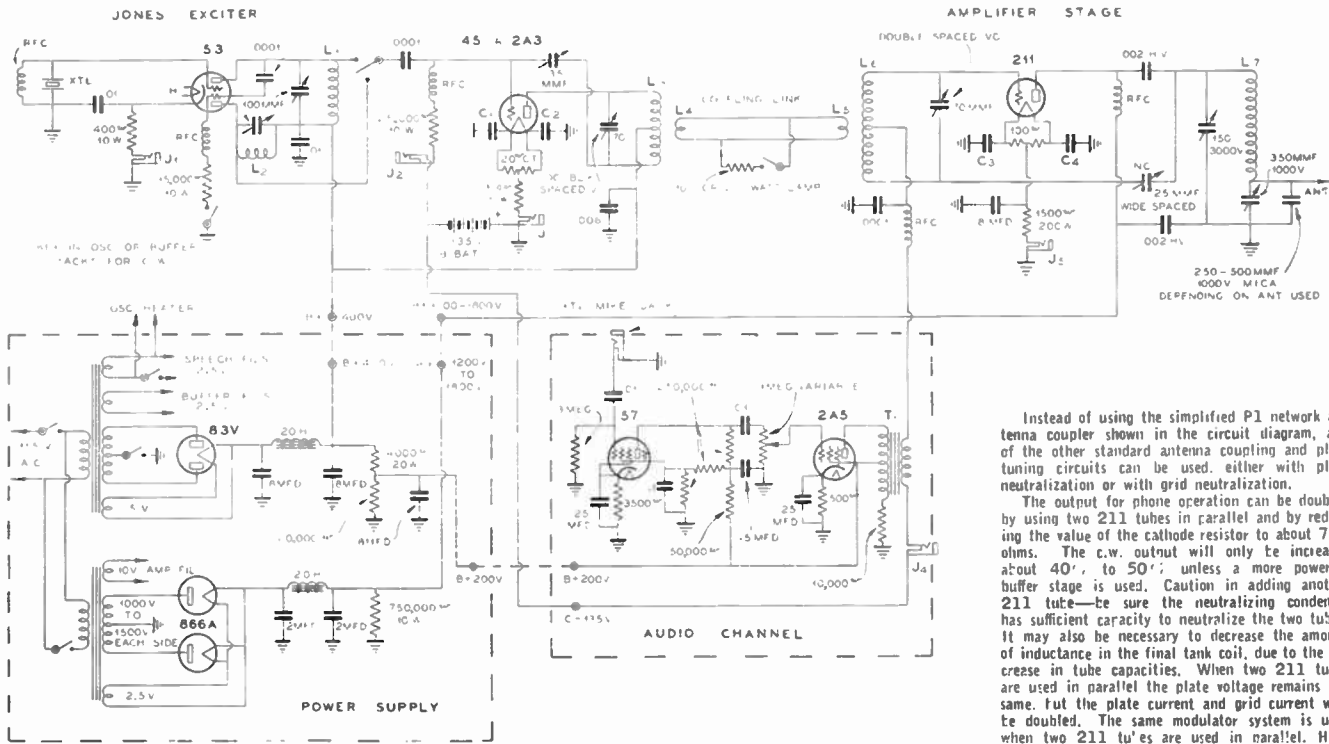

L3 and L4 each have two turns in the coupling loop. Condensers C1, C2, C3 and C4 are .001 or larger, fixed mica type, 1000 volt rating.

Instead of using the simplified P1 network antenna coupler shown in the circuit diagram, any of the other standard antenna coupling and plate tuning circuits can be used, either with plate neutralization or with grid neutralization.

The output for phone operation can be doubled by using two 211 tubes in parallel and by reducing the value of the cathode resistor to about 750 ohms. The c.w. output will only be increased about 40% to 50% unless a more powerful buffer stage is used. Caution in adding another 211 tube—be sure the neutralizing condenser has sufficient capacity to neutralize the two tubes. It may also be necessary to decrease the amount of inductance in the final tank coil, due to the increase in tube capacities. When two 211 tubes are used in parallel the plate voltage remains the same, but the plate current and grid current will be doubled. The same modulator system is used when two 211 tubes are used in parallel. High MU tubes, such as the 03A, 838 and 830B do not give good results when used as used as grid-modulated amplifiers.

and plate current meters should stand still on modulation, except for a very slight upward kick on overmodulation peaks.

For phone operation, a 100 watt lamp is connected across the coupling link between the buffer and the final amplifier. The purpose of this lamp is to stabilize the load on the buffer during modulation, which improves the regulation of the R.F. excitation voltage. This is necessary because the instantaneous grid current on the final amplifier varies with modulation. This lamp introduces no losses when phone operation is used because the buffer supplies considerably more excitation than is required. In fact, the grid circuit of the final amplifier must be detuned to still further reduce the excitation.

Thus by reducing the RF excitation by screwing the 100 or 200 watt lamp into the receptacle across the link coupling circuit, and by slight grid current detuning, the carrier is reduced from a 150 or 200 watts on CW to 50 or 60 watts on phone. Normally a good CW antenna load will be sufficient for phone operation and thus only one adjustment is needed—reduce the grid RF excitation until good upward antenna current swing is obtained when the microphone is whistled into.

For phone operation the CW key can be used for push-to-talk control, or the low volt-

age power supply center-tap switch can be used.

The external C battery of 135 volts is correct for a total applied plate voltage of 1800 volts. The correct value is obtained by dividing the plate-to-cathode voltage under load by the amplification constant of the tube. This is about 12 for a 211 tube. In using a 852, 50T, 150T, or 354 Gammatron, the same procedure should be used.

Several points should be emphasized in the construction of this transmitter. If a 1500 volt power transformer is used, condenser input type of filter is necessary in order to obtain at least 1700 volts DC for maximum output. For c.w. operation the 2A3 tube must deliver sufficient excitation to the final stage so that the grid current will be about 20 mills under load. This grid current can be increased by increasing the number of turns in the coupling link (within limits) or by increasing the plate supply voltage on the 2A3, to not use more than 500 volts. The grid blocking condenser in the 211 stage should have a rating of 2,500 volts DC working voltage. The filament by-pass condensers on the 211 tube should be .001 or larger, 1000 volt rating mica type. These condensers enable the filament of the tube to reach r.f. ground potential and these condensers are essential for complete neutralization.

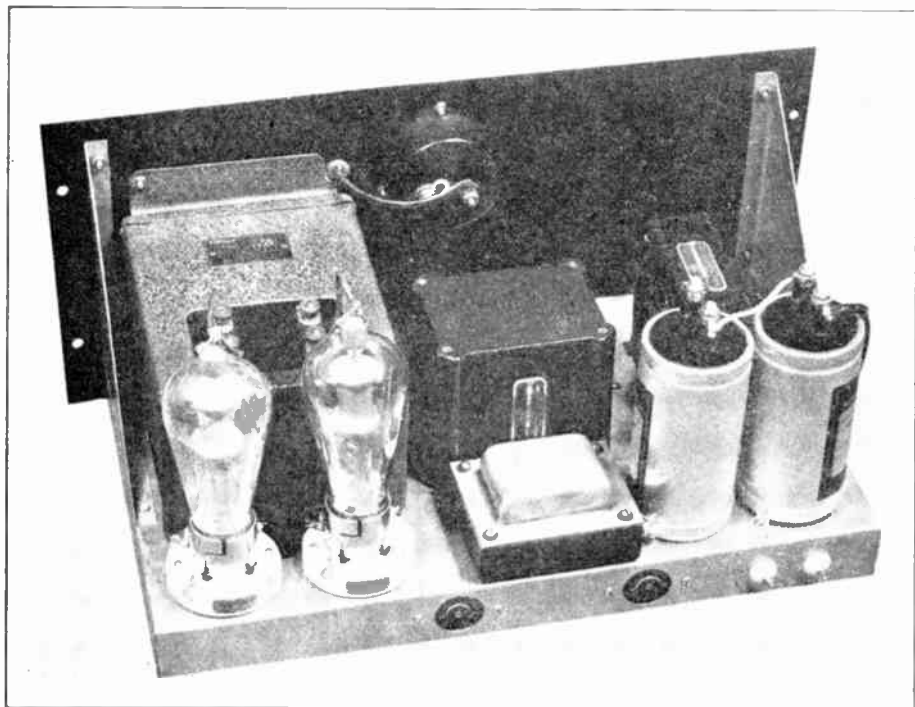

High and low voltage transformers, H.V. choke and H.V. condensers are mounted on the lower deck.

Controlled Carrier Modulation

The first known use of controlled carrier modulation was in 1923 when Jones and others experimented with an overbiased class A audio amplifier as the grid-leak for a radio frequency oscillator. These earlier systems suffered from the generation of extraneous sidebands, as well as producing excessive audio distortion. The first known use of modern carrier control wherein the audio and syllabic modulations are separated from each other was in 1931 when WOCJ used controlled carrier in order to reduce BCL interference. A year or two later the General Electric Co. tested controlled carrier experimentally at WGY, using Thyatron and other forms of control.

Two major effects are obtained through the

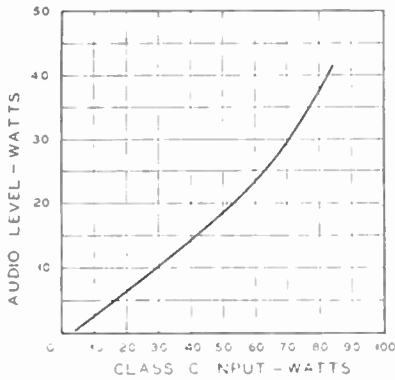

Class C input vs. Audio level in a Controlled Carrier Transmitter.

use of controlled carrier modulation; high percentage modulation is obtained at all levels, and the average carrier varies in magnitude with the audio output. These characteristics effect a number of improvements:

(a) Greater DX possibilities for the amateur, or greater blanket coverage for the broadcast station. This is caused by the high percentage modulation at low levels. As the integrated audio output of a transmitter rarely exceeds 10 per cent of its rated maximum output, this becomes a very important point. The theoretical side of this phase of controlled carrier modulation indicates that it is possible for a small station using this system to obtain the same coverage as a station many, many times larger and with less interference.

(b) Increased tube economy. Due to the fact that the Class C input is low for the major part of the time, an effect similar to Class B is obtained, permitting much higher output from a given tube arrangement.

(c) Reduction in interference. This is of extreme importance to both the amateur and

the broadcast station. Because the carrier level is low for the major portion of the time, interference and "monkey chatter" is reduced. To the broadcast field this means a definite step toward high fidelity, as the high frequency range of radio receivers could

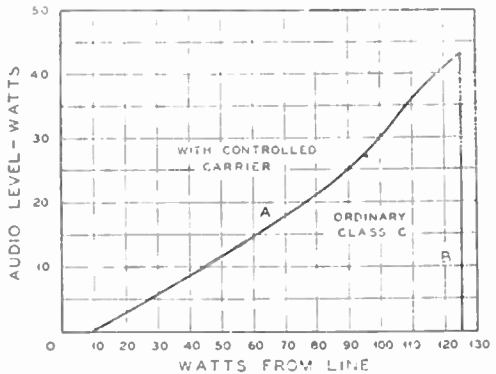

Comparison Between Ordinary Class C and Controlled Carrier Class C as Referred to the Variation of Power Consumption from the Line vs. Audio Power.

be extended without the present background noise caused by monkey chatter. To the amateur this means a much less crowded ether.

(d) Due to the low power taken by the final for the major part of the time, there is a definite reduction in power consumption. If the tubes are not operated too hard, an increase in tube life is obtained.

(e) Higher fidelity is possible from the broadcast station from the standpoint of volume range. One of the factors controlling volume range from a transmitter is the fact

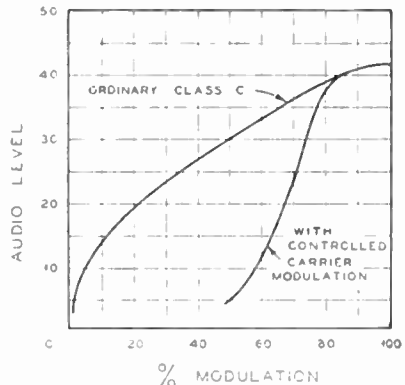

Percentage of Modulation in Ordinary and Controlled Carrier Transmitters at Various Audio Levels

that when the audio level drops very low, the modulation percentage decreases as the square of this audio drops in level. This results in poor and possibly no reception at the receiving end. A higher percentage modulation at low levels would tend to overcome this difficulty, and permit the transmission of wider audio volume ranges.

(f) If high power output is required, the

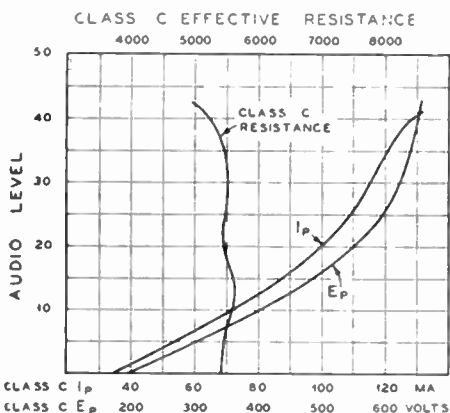

Relation of class C operating characteristics to modulator level in controlled carrier transmitter.

controlled Class C can be fed into a Class B linear. The power rating of output tubes operated in this manner is practically quadrupled. The tubes operate efficiently to begin with, due to Class B operation. To this is added the fact that the plate dissipation from the Class B tubes is almost negligible at no signal input. As the audio level varies, the Class C input is varied and this varying input being applied to a Class B linear stage permits the plate power input of the linear stage to vary over a wide range. A further benefit of this system is the fact that modulation need not be done at very high level. A 500 watt station need only have 50 watts or less of audio output. This modulates a corresponding class C tube which drives the 500 watt Class B linear. If still further power is desired, the Class B linear can be fed into another Class B linear.

Class B Series Control Using Same Tubes For Audio and Syllabic Modulation

Numerous systems of controlling the average input and carrier output of a class C plate modulated amplifier have been developed and successfully applied to high-frequency phone transmitters.

One of the earliest systems uses the variation in average plate-to-cathode resistance of a class B audio stage to series-modulate the class C stage. The audio output of the class B audio amplifier is then fed through the conventional class B output transformer

into the plate circuit of the controlled and plate-modulated class C amplifier.

This system is quite simple, although it has two disadvantages. The resistance of the plate to cathode path of the class C stage is in series with the B plus high voltage lead to the modulators, which is the equivalent of placing a 5,000 ohm resistance in the B plus lead. This materially affects the voltage regulation of the DC plate voltage supplied to the modulators, with some consequent audio distortion. This variation of the plate voltage applied to the class B modulators also causes the "cut-off" bias point to move around as the audio signal varies. If anything but a zero bias modulator tube were used, this would mean that the modulators would be operating class C part of the time, which is not conducive to high fidelity.

The other disadvantage is that the plate voltage across the modulators, in the resting condition, must be about twice the operating plate voltage, which means that lower than normal operating plate voltages must be used because there are no zero bias modulator tubes available which will stand plate voltages of twice the normal operating voltage. Consequently the maximum power output must be cut down below that which the same tube capacity could deliver in the conventional system of constant carrier modulation.

Thyatron Control

Another system of controlled carrier modulation of a class C amplifier uses grid controlled rectifiers in the plate power supply. These grid controlled mercury vapor rectifiers allow a simple means of controlling the DC plate voltage at syllabic frequencies.

For high power operation this system is extremely useful because, if applied to a three-phase power supply, the lag can be practically eliminated, because a three-phase power supply requires extremely little hum filtering.

Variactor Control

Another simple and effective system is the one developed by I. A. Mitchell. It uses the variation in DC plate current drawn by a class B audio amplifier (the modulators), to control the saturation of a dropping reactor in series with the primary of the class C amplifier plate power supply. As the DC drawn by the modulators increases, the reactor core becomes more saturated, which reduces its AC resistance and allows more current to flow in the primary circuit of the class C plate power supply. This increased current, which corresponds to raising the primary voltage, increases the DC plate voltage and thus causes the input and average carrier output of the class C stage to increase with modulation.

Here the basis for control is the fact that the modulator plate current in a class B amplifier varies practically linearly with the power output. This plate current is used to saturate a control reactor which in turn controls the plate supply of the class C final. If a class A modulator is used, other means of ob-

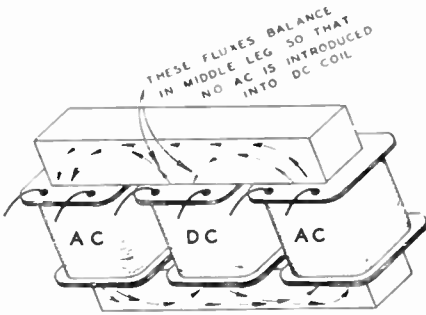

FIG. 1. Appearance of Saturable Reactor.

taining this control current are possible. Fig. 1 illustrates the general nature of a saturable reactor. A shell type laminated core of somewhat different proportions than that in an ordinary transformer is used for the magnetic circuit. Three coils are placed on the respective legs of this core, the outer two be-

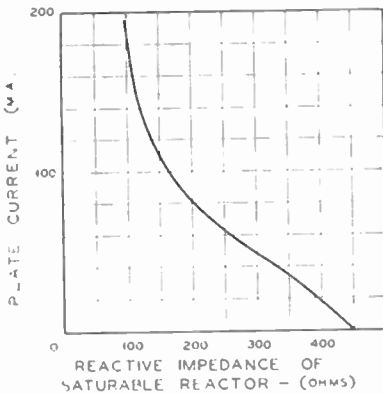
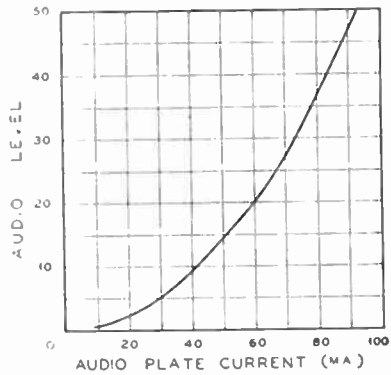

FIG. 2. This Curve Shows the Change in Reactance of AC Coils in a Saturable Reactor as the DC Is Increased.

ing connected in series with the AC line and so related in polarity that their respective magnetic fluxes are in accordance with the arrows shown. It is seen that the MMFs of the two AC magnetic circuits are opposite in direction in the middle leg and tend to neutralize each other. If the coils and magnetic circuit are perfectly balanced, these fluxes will be perfectly balanced and no AC flux will traverse the middle leg of the

laminations. The control coil is placed on this middle leg and the plate current of the Class B modulator is passed through it. All radio men are familiar with the fact that as the DC current is increased in a filter choke, its inductance decreases. Exactly the same effect is produced here, except that by proper design a fairly linear relation and a wide range in inductance can be obtained. Fig. 2 illustrates this relation of saturating DC to AC impedance in the experimental reactor used in the transmitter previously referred to. The linearity of this curve can be increased still further.

The saturable reactor is placed in series with the primary of the final plate transformer. It is seen from Fig. 2 that with no



Relation of plate current to watts in a typical class B amplifier.

audio signal (minimum DC) the reactance of this reactor is quite high (450 ohms). This effects a great voltage drop to the primary of the plate transformer, as the effective impedance of this primary is quite low. However, as the saturating DC is increased, the reactance is decreased, and the consequent voltage drop is decreased. The primary voltage rises in accordance with this, and with proper design reaches almost maximum at normal maximum audio output. Even with the reactor practically saturated, a small reactance and consequent voltage drop exists. To compensate for this, an autotransformer is used on the line side of the reactor which increases the total impressed voltage. This autotransformer does not have to be used if the plate transformer primary is wound or tapped for the reduced voltage obtained after the reactor drop. In either case, this voltage drop does not represent a power or efficiency loss, because the drop is almost entirely reactive and results primarily in a change of power factor; i.e., only the ratio of VA/watts increases.

Fig. 3 illustrates a complete controlled carrier audio amplifier for variactor control. 70

watts of audio is obtained from four 46s in class B, without excessive distortion. This output is used to plate modulate a pair of 801s in controlled class C with 140 watts maximum controlled class C input.

Fig. 5 shows the complete electrical circuit of this audio unit. A number of unusual circuit features are incorporated in this amplifier. The input transformer is of the Varitone type. As is well known, the intelligibility of speech is not affected appreciably if the frequencies below 300 and above 3000 are cut off. However, if these frequencies are cut off, a considerable decrease in the average power is produced.

The first tube in the audio amplifier is a 57, triode connected, and resistance coupled to another 57, triode connected. This second tube is transformer coupled to a pair of 2A3s which in turn drive the four 46 output tubes. It is well to note here the fact that 2A3 tubes are far superior to most other tubes for use as class B drivers.

While using 2A3s and a proper input transformer gives plenty of driving power for the Class B tubes, there is one further limitation to high power output with low distortion, namely, plate supply regulation. No standard plate supply has perfect regulation, particularly at maximum audio peaks when the plate current of class B tubes runs extremely high. A novel adaptation of the variator can be used to compensate or over-compensate for this regulation. A small auto-transformer and variator is applied to the primary of the audio amplifier power transformer. This is so arranged that the plate current of the Class B tubes saturates the series reactor and

increases the power transformer secondary voltages as the plate current is increased. This compensation is arranged in the transmitter shown so that a 5 per cent increase in plate voltage is effected at the Class B plates at maximum output. In addition, at these peak powers the filament voltage is somewhat increased so that additional filament emission is obtained to take care of the peak plate current. An increase of at least 25 per cent in power rating has been checked so far. The result is that two simultaneous effects take place, tending to increase the power handling ability and reduce the distortion. The plate voltage is maintained constant and the filament emission is increased at peaks so that distortion due to emission saturation is minimized. Furthermore, the tendency for motorboating and degeneration caused by the plate voltage on the first stages varying with output is eliminated. This combined autotransformer and variator for Class B audio is quite compact. For the 70 watt transmitter shown, the size of the complete control unit is only 1 1/2 in. x 3 in. x 6 in.

The balance of the audio circuit is more or less standard. Four 46s in the audio output are matched to a transformer having a tapped output winding. A plate milliammeter is supplied to check level. To reduce the initial plate current, a 4 1/2 V. C. battery is used into the 46 grids. On the panel shown in Fig. 3, the control to the right is volume; to the left, frequency range. The switch controls the power supply and a bull's eye is provided. The mike plugs into the jack on the left. The rectifier and low level tubes

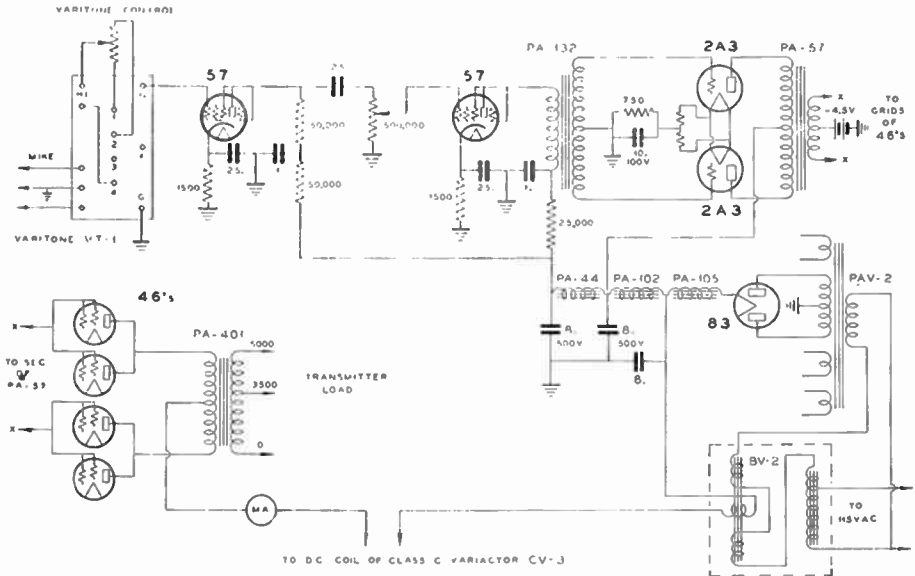

FIG. 3. Complete Circuit of the Audio Channel of a Variator Controlled Transmitter.

are at the back of the chassis and the driver and output tubes at the front. The Class B variactor unit is underneath the audio chassis. No autotransformer is used for the variactor circuit for the RF because the class C plate transformer has an 85 volt tap. This variactor unit is mounted under the RF deck. The transmitter was built to operate on 20 meters with the view in mind that if it operates on 20 meters first it will be OK for the other bands later. An examination of the circuit in Fig. 5 illustrates the more or less conventional layout of the rig. A 2A5 is used as the oscillator and

its tuned plate circuit is properly balance coupled to a pair of 2A5s with the grids in push-pull and the plates paralleled. These tubes are in tur necoupled to a pair of 801s or carbon plate 210s in the permanently neutralized final stage. The interesting details of the transmitter may be noted as follows:

1. Once neutralized the transmitter needs no further attention until it is necessary to change tubes.

2. By opening switch marked SW1, the buffer stage is automatically neutralized when that stage is being operated as a straight-through buffer. When being used as a plate doubler, the switch is thrown on.

3. For operation on 1.75 MC, 3.5 MC, 7 MC, and 14MC, only two crystals are necessary, one being a 1.75 MC and the other a 7 MC.

4. The 50 mmfd. condenser in the grid circuit is a very small one and is mounted in the coil form which has a mounting pillar inside of it. It is adjusted for maximum output consistent with stable operation of the crystal oscillator.

5. The switches in the plate circuits

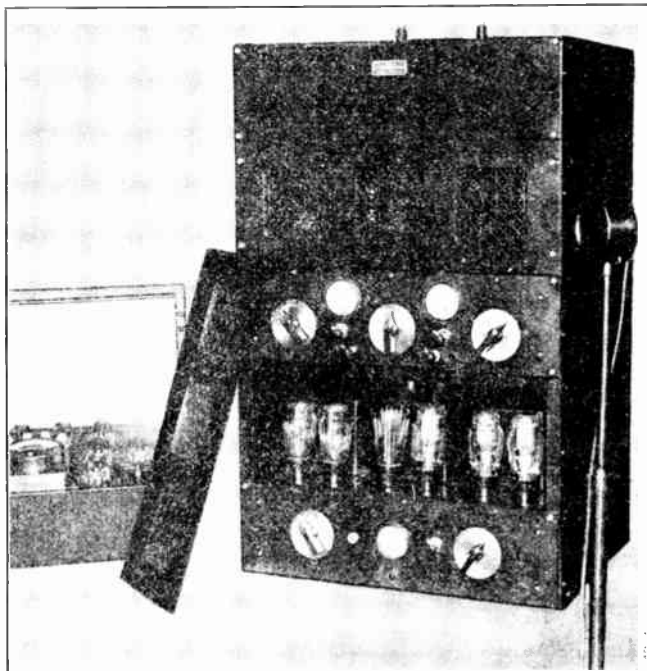

FIG. 4. The complete controlled carrier transmitter.

of the buffer and final are used to read the grid mills and are also useful in neutralizing the stage.

6. The milliammeters are placed in the cathode circuits to minimize the danger to the operator and meter. When the plate switch is open the meter of that stage reads the grid mills, and when closed it reads both grid and plate mills combined.

7. The low voltage power supply is also used to supply C bias voltage to the final stage. The condenser across the C bias voltage is used to prevent demodulation.

8. The grid coils are wound on the same form as the Plate coils on the "cold" side of the plate winding.

9. The windings L2 and L4 are somewhat critical. Slight variations from the table shown in Fig. 6 may effect improvement in some cases. All coils except L5 are wound on Hammarlund SWF coil forms. Coil L5 is wound on a 2-inch diameter form. The 1.75 MC coils L2 and L4 are also tuned by a 100 mmfd. coil fitting condenser APC 100. For all other bands

coil L2 need only be tuned by a 50 mmfd. type APC 50.

10. By interlocking SW2 and SW3 no plate power can be applied until the filaments are first lighted.

The construction of this RF unit is symmetrical in all details and is matched in appearance with the audio unit previously described. While all controls are brought out to the panel, the construction is such that the tubes and crystal are readily accessible. The three main controls are from left to right: Class C tank condenser—buffer tun-

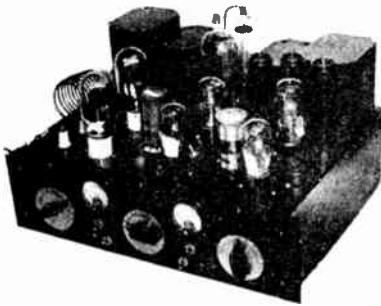

Front view of U.T.C. RF Unit.

FIG. 6. Coil Data.

Coil	1.75 MC	3.5 MC	7 MC	14 MC
L1	55 T	30 T	18 T	6 T
Space	1/4"	5/16"	5/16"	3/8"
L2	26 en.	18 en.	12 T	6 T
L3	50 T	25 T	15 T	6 T
Space	1/8"	1/4"	1/4"	3/8"
L4	80 T	60 T	28 T	11 T
L5	44 T	26 T	16 T	8 T
	#14	#12	1/8" tube	1/8" tube

ing condenser—oscillator condenser. The switches include the main filament switch—low plate voltage supply—high voltage plate supply—2A5 filament. One pilot light is provided to indicate that the filament and low voltage is on and another to indicate that the high voltage supply is on. The switch used to change from controlled to standard carrier is also on the front panel, but is not shown in the photograph. The meter at the left checks class C plate or grid mills. The meter at the right is used to check buffer

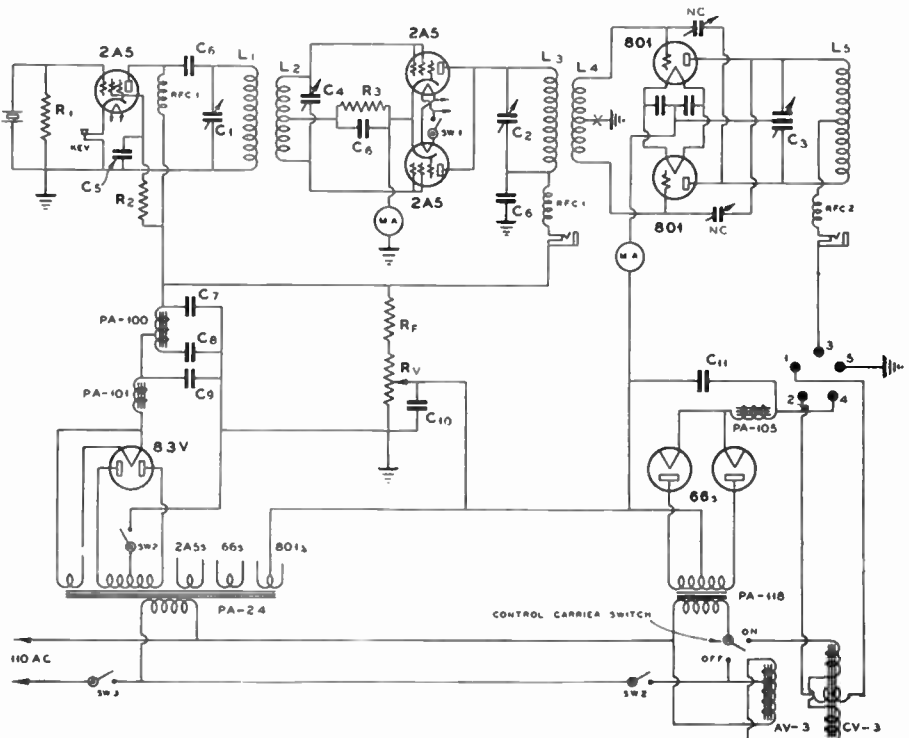

FIG. 5. Circuit of Controlled Carrier RF Unit Using Variactor Control. The Jones exciter can be used in place of the 2A5 oscillator and push-pull 2A5 buffer.

plate and grid mills. A jack is provided at the rear to plug in a key for code transmission or to read the oscillator plate current.

Fig. 7 shows the comparison between the perfect theoretical controlled carrier condition whereby 100 per cent modulation would be obtained at all levels and the actual characteristics with variactor control. The curve shown is that of a variactor for a 250-watt class C input transmitter. The practical curve shown is such that if the reactor is arranged for 100 per cent modulation at maximum level, it is not possible to overmodulate at lower levels, but high percentage modulation is obtained at all levels.

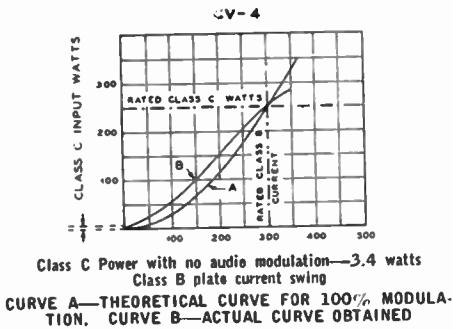

FIG. 7. Ideal and practical controlled carrier curves.

Miscellaneous Series Control Circuits

The latest improvement on the original series-control system is shown in Figs. 8, 9 and 10. In these circuits the control is separated from the modulation, and separate tubes are used for each function. This eliminates any compromises in regard to the operation of the modulators and any type of audio modulation can be used, class A, B or class AB, single-ended or push-pull. All three circuits show single-ended class A modulation because it is simple and economical for low power use. It is also somewhat simpler to adjust for good fidelity.

Half Wave Series Control

Fig. 8 is a simplified circuit which shows that the syllabic control tube's plate-to-cathode path is in series with the negative lead, or center-tap lead, to the class C modulated amplifier. Thus it resembles very closely a conventional keying tube, and that is practically what it is. Instead of merely keying "on" and "off", it keys up and down in accordance with the average power of each syllable in the speech. On the loud syllables the resistance of the control tube is reduced, which places most of the plate voltage across the class C tube, raising its carrier output. Of course, the DC plate voltage to the class C amplifier is simultaneously being modulated by the audio out-

put of the modulators, which is shown coming through the output transformer at the right, although choke modulation could have been shown just as easily. Thus it should be remembered that the carrier is really being modulated twice, once by the syllabic control and once by the audio signal. These two modulations do not get mixed, because they differ widely in frequency. The audio modulation components usually are in the frequency range between about 80 and 8,000 cycles, while the control modulation frequencies are in the range between zero cycles and about 20 cycles per second.

The circuit of Fig. 8 shows only one control tube, and while this is entirely workable, there are some advantages in the use of two tubes.

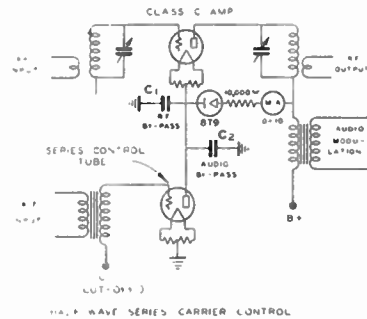

FIG. 8.

Full Wave Series Control

Fig. 10 shows the use of two tubes as the control elements, in what looks like the conventional push-push doubler circuit. That is just what it is, although a better term for this use of these tubes would be "Full-Wave Rectification". As these tubes are biased close to cut-off, they act as detectors, or rectifiers, because they turn the AC audio voltage into a varying DC voltage which alternately increases or decreases the DC voltage drop across the control tubes. Vary-

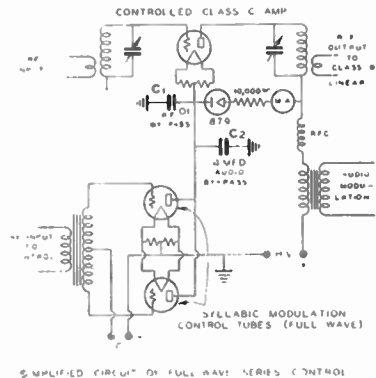

FIG. 10

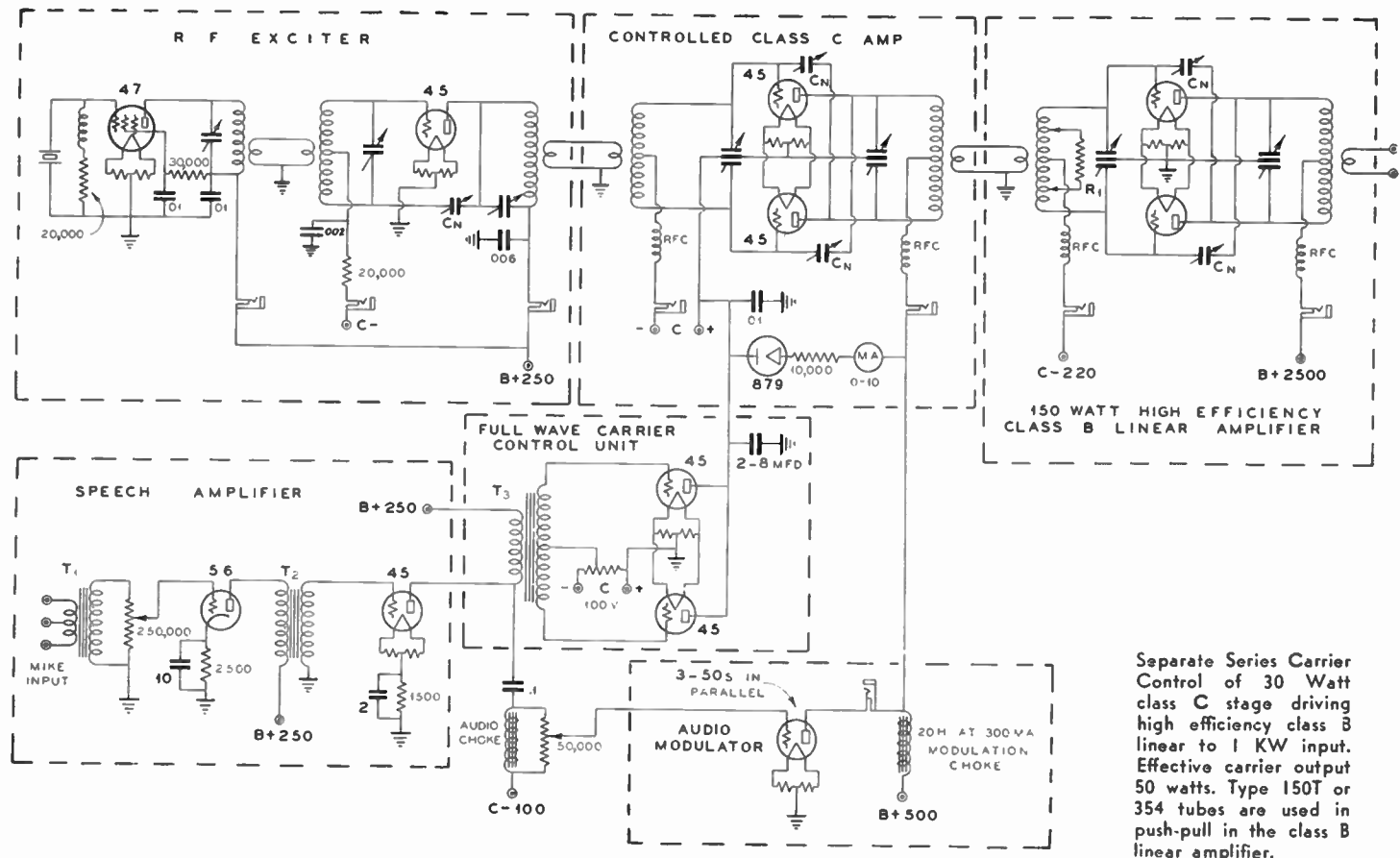

FIG. 9

Separate Series Carrier Control of 30 Watt class C stage driving high efficiency class B linear to 1 KW input. Effective carrier output 50 watts. Type 150T or 354 tubes are used in push-pull in the class B linear amplifier.

ing this voltage drop naturally varies the current through every part of the series circuit, and thus varies the power input and output of the class C stage.

The important advantage of the full wave circuit shown in Fig. 10 (and Fig. 9) is that less capacity is required in the audio bypass between the control plate and ground, which reduces the lag inherent in all carrier control circuits. It corresponds exactly to the hum filtering and primary keying problem in any CW transmitter. It is well known that full-wave, high voltage rectifiers require less hum filtering and thus can follow primary keying with less lag than if half-wave rectification is used. The full-wave control circuit shown applies a DC impulse to the controlled circuit twice each audio cycle, instead of just once per cycle.

An Overmodulation Indicator

The 879 rectifier tube shown in these circuit may puzzle the reader, but its use is extremely important if trouble is to be avoided. This tube, with its associated resistor and meter, is an overmodulation indicator. It indicates only overmodulation on the negative peaks, which are the ones in which we are most interested, because the negative peaks cause most of the undesired interference which can be attributed to overmodulation. It works by reason of the fact that when a class C stage is overmodulated on the negative peaks, the plate voltage has been swung BELOW zero. In other words, the negative AC audio voltage exceeds the positive DC plate voltage so that the plate of the class C amplifier becomes negative with respect to its filament, which, of course, has no effect on the power output, as it can only go to zero and no lower. When the plate of the class C stage goes negative, with respect to its filament, it means that the filament of the 879 rectifier tube goes negative with respect to its plate. In other words, the PLATE OF THE 879 HAS BECOME POSITIVE WITH RESPECT TO ITS FILAMENT. This is the condition for passage of current through any rectifier tube, which allows the meter in series with the 10,000 ohm load resistor to indicate overmodulation. It is very easy to overmodulate a carrier controlled class C amplifier and overmodulation is quite difficult to detect unless this indicator or a cathode-ray oscilloscope is used. The 879 is the small, high-voltage thermionic rectifier designed originally for cathode ray tube circuits and can stand peak voltages of 2,000 volts without danger of breakdown. In low voltage carrier controlled circuits it is possible to use an 80 or 81 rectifier, as long as the peak voltages present do not cause the tube to arc over. This overmodulation indicator also acts as overmodulation minimizer because it throws a load across the modulator output as soon as the over-

modulation occurs. It has no effect whatever on the circuit as long as the class C stage is not overmodulated.

Adjusting Controlled Carrier Transmitters

The first step in adjusting a controlled carrier transmitter is to properly modulate the class C stage with the carrier control disconnected. In other words, the plate voltage on the class C stage should be fixed at the maximum obtainable when the carrier control is turned on. Neutralization, RF excitation and grid bias should be correct for conventional modulation and there should be no wiggle of the plate milliammeter during audio modulation. After the class C stage and the audio modulators are working properly the carrier control can be turned on. Some means should be provided to vary the carrier control, or syllabic modulation, in relation to the audio modulation. Fig. A

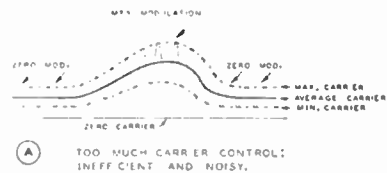

shows what happens when there is too much carrier control. The DC plate voltage on the class C stage swings up much farther than required by the amount of audio modulation present. The only disadvantage involved here is that unnecessary heterodyne interference is created, and a class B linear amplifier following the class C stage will operate inefficiently because the average percentage of audio modulation of the carrier is not high enough. It should be remembered that class B linear amplifiers are efficient only at high percentages of modulation.

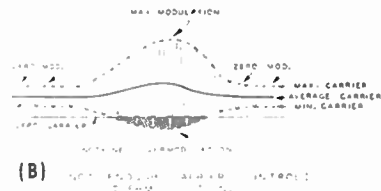
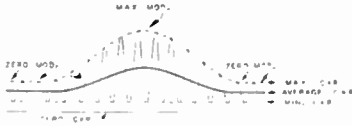

Fig. B shows what happens when there is not enough syllabic control over the carrier. In other words, the average carrier power has become less than twice the maximum sideband power, which represents overmodulation. The shaded area under the zero line represents an absolute absence of RF output which causes bad sideband splatter and undesirable interference. This negative overmodulation can only be detected by means of the overmodulation indicator which uses a rectifier tube, as shown in Fig. 10. The

remedy is to increase the carrier control, or else reduce the audio modulation.

Fig. C shows perfect carrier control. The minimum carrier level remains constant and



(C) PERFECT CARRIER CONTROL. NOTE: PRACTICALLY CONSTANT MIN. CARRIER.

This trouble can usually be traced to the use of too much capacity in the syllabic filter.

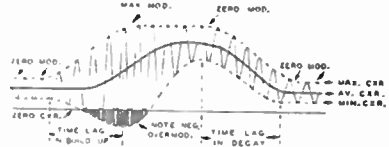

(D) SATISFACTORY DEGREE OF CARRIER CONTROL BUT BAD TIME LAG IN CONTROL; OVERMODULATION AND LOW EFFICIENCY.

the carrier control has just enough effect to keep the average carrier power a little over twice that of the audio sideband power. Of course, the wave shown in Fig. C has been idealized somewhat, because no audio wave encountered in practice would be as smooth as the one shown. However, it is desirable to keep the minimum carrier value as low and as constant as possible without letting the negative peaks cross the zero line (overmodulation).

Fig. D shows a satisfactory degree of carrier control; however, the bad time delay (or lag) in the filter circuit, which separates the audio component from the syllabic component, delayed the rise in the carrier until considerably after the audio modulation had become effective. Thus the carrier is overmodulated at the start of the syllable, and undermodulated at the end of the syllable.

Series Control Using a DC Amplifier

Fig. 11 shows the circuit of part of a phone transmitter in which carrier control is used in part of a push-pull 210 stage, which drives a class B final amplifier with 1 KW input on peaks. The effective carrier power output of this transmitter is 500 watts. The carrier control is exercised by the use of two 250s in parallel. These tubes are in series with the B minus return of the class C 210 stage. Thus the resistance of the 250s determines the DC plate input to the 210s. The audio modulation is applied to the 210s in the conventional manner by the two 250s running class AB in push-pull. When no audio is present, the paralleled 250s in the cathode return of the 210 stage are biased nearly to cut-off with the batteries shown. Thus there is little input and output from the 210 stage,

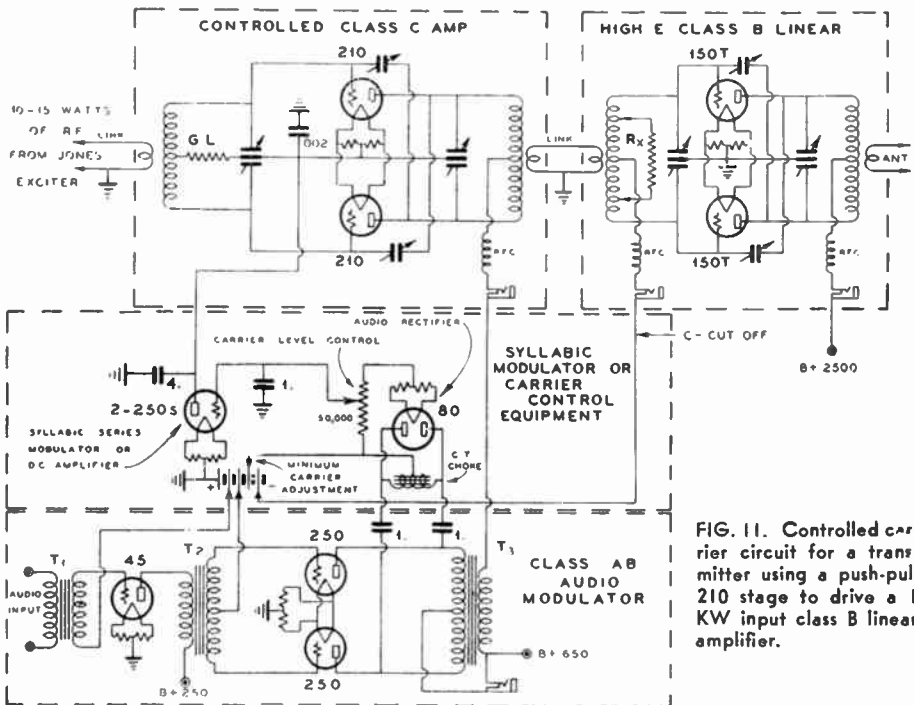

FIG. 11. Controlled carrier circuit for a transmitter using a push-pull 210 stage to drive a 1 KW input class B linear amplifier.

and very little carrier is radiated. When an audio signal comes along, part of it is bypassed from the plate circuit of the audio modulators to the plates of an 80 rectifier. This 80 rectifier converts the audio into pulsating DC which is then filtered through the 1 mfd. condenser shown, after which the remaining syllabic DC component is applied to the grids of the 250 control tubes in the proper polarity to buck out part or all of the battery bias. This reduces the resistance of the plate-to-cathode path of the 250 control tubes, thus permitting more DC plate current to flow through the class C stage, thereby raising the carrier input and output. The 250 control tubes act only as DC amplifiers. The 4 mfd. condenser connected from plate to ground on the 250 control tubes filters out any of the remaining audio component from the plate circuit of the parallel 250s, but the more important purpose of this condenser is to complete the audio modulation circuit back to ground. The principal filtering out of the audio component from the syllabic modulation control circuit takes place in the 1 mfd. condenser connected from the grids of the control amplifier to ground. The 50,000 ohm potentiometer which acts as a load on the 80 rectifier circuit allows an adjustment of the carrier control relative to the audio modulation. The minimum value of the carrier output is adjusted with the bias tap on the battery, as shown. The control circuit takes about 5 per cent or 10 per cent of the audio power output of the audio modulators. The filament winding of the 80 rectifier must be insulated from ground.

The High Efficiency Class B Linear Amplifier

● It will be evident that carrier control of a class C stage is not particularly economical, when calculated on a basis of watts per dollar of EFFECTIVE carrier. There is some slight saving in the tube capacity required for a given carrier plus sideband output from the class C modulated amplifier because the filaments and plates of the modulated amplifier get a much-needed rest between words and sentences. However, this

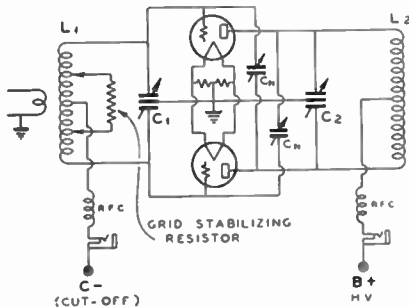

FIG. 12. Circuit diagram of a linear amplifier.

Table of Effective Equivalent Carrier Power Output

Obtainable with controlled carrier linear amplifier.

Tube Type	Conventional Linear Carrier	Equivalent Carrier from Controlled Linear
210	7½W (max)	15 to 20 Watts
800	15	30 to 40 Watts
830B	15	50
50T	25	75
211	40	75
852	30	90
354	75	200
150T	75	250
212D	100	140
204A	100	200
849	175	333
851	350	666
251A	400	800

Note that the relationship between ordinary class B linear carrier output and the controlled equivalent carrier is not constant for all of the above tubes. The limiting factor is not the same in all cases. In some tubes the filament emission limits the output. In other cases secondary emission or plate dissipation limits the output. The above table is for one tube. For push-pull linear amplifiers multiply the above outputs by two.

saving is only a small fraction of the total transmitter cost. The audio modulators and power supplies are not changed, as far as cost per watt is concerned. In some of the best carrier control systems the addition of control reactors or series control tubes more than offsets the savings to be realized from the reduction in class C tube capacity. The advantage of cutting down break-in cross-talk and distant heterodyne interference is worth the extra cost and complication inherent in most carrier control systems if a class B linear amplifier follows the carrier controlled class C stage. The addition of a fairly conventional class B linear RF amplifier to the carrier controlled transmitter allows really surprising economies to take place, when figured on a basis of watts per dollar.

It is well known that the ordinary class B RF linear amplifier is rather undesirable for general amateur use because it is very inefficient when unmodulated (assuming conventional constant carrier modulation). A large amount of plate dissipation capability must be provided in the tubes used in the linear amplifier; at least two watts of dissipation ability for each watt of carrier output.

Thus a 100-watt linear amplifier usually requires about 300 to 400 watts of DC plate input, of which from 200 to 300 watts must

be dissipated in the form of heat from the plates of the tubes.

In the controlled carrier system the picture is quite different because the DC INPUT TO THE LINEAR VARIES WITH THE SYLLABIC MODULATION AND IS QUITE LOW WHEN THE TRANSMITTER IS UNMODULATED. This means that the EFFECTIVE CARRIER OUTPUT of a given tube used as a linear amplifier in a controlled carrier system can be from two to four times the carrier output from the same tube when used as a conventional constant carrier class B linear amplifier. Thus the EFFECTIVE EQUIVALENT carrier output that can be obtained from any given tube when operating as a controlled carrier linear rather closely approaches the carrier output that can be obtained from the same tube when used as a high level, or plate modulated class C amplifier.

The maximum EFFECTIVE carrier output that it is possible to obtain from any tube can be estimated by taking two-thirds of the class B audio output of that same tube. This is derived from the fact that at 100 per cent modulation the output from any phone transmitter consists of two-thirds carrier and one-third sideband power. Thus three-thirds equals the maximum safe power output when biased to cut-off, and this amount will about equal the maximum class B AUDIO output from the same tube, because most class B RF amplifiers can be made at least as efficient as a class B audio amplifier.

Thus about 15 watts of effective carrier output can be obtained from a single 210 tube. A 50T has an effective carrier output of about 75 watts and a 150T has a maximum effective carrier output of better than 250 watts. These linear amplifier outputs are better than four times the output from conventional linear amplifiers.

The circuit of such a class B linear amplifier is shown in Fig. 11 and is conventional in every respect. The linear amplifier can consist of either a single-ended stage, or a push-pull stage, because the harmonic distortion inherent in all class B amplifiers is of little importance at radio frequencies. There is no difference in the audio quality which can be obtained from either type of linear ampli-

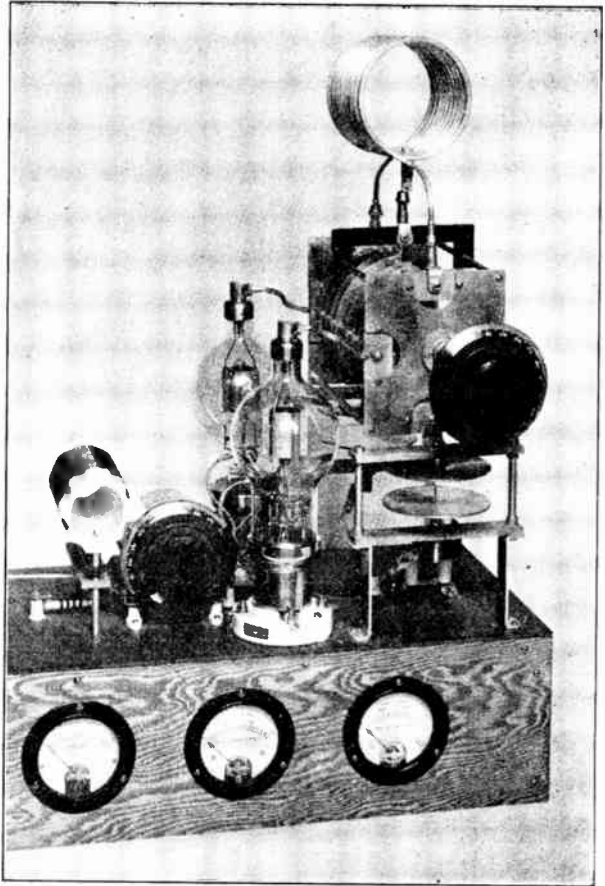

FIG. 6. A typical high-efficiency 1 KW linear amplifier.

fier. The linear amplifier should be biased slightly below cut-off, for best linearity. This point is the same as that recommended for the same tube operating as a class B audio amplifier. In fact, in many respects the amplifier acts just like a class B audio amplifier and thus might be said to be modulating itself. The DC plate current in the resting condition (no modulation present) is usually quite low, and is dictated by the minimum value of carrier output from the controlled class C stage.

In one case, a final linear amplifier drew about 150 watts of plate input, unmodulated, and the input rose to slightly better than one KW on the voice peaks, at which time the output consisted of close to 750 watts of RF power. This was determined by tone modulation. The class C modulated amplifier was nearly 100 per cent modulated at that point, which indicated that about 500 of the 750 watts of RF output consists of EFFEC-

TIVE CARRIER and the other 250 watts consists of audio sideband power. EFFECTIVE CARRIER means that amount of steady carrier power which would just equal twice the maximum sideband power available. This amplifier consisted of a pair of 150Ts in push-pull, operating at 2500 volts plate voltage. At this output the tubes operated within ratings and remained cool. The modulated class C stage had about 20 to 30 watts of effective carrier output, a portion of which was dissipated in a 5,000 ohm stabilizing resistor tapped across the grid tank of the class B linear amplifier.

The adjustment of the linear amplifier is simplicity itself. The class C modulated stage is adjusted by means of some kind of audio oscillator whose output is fed through the speech amplifier and whose output is varied either by an output control on the oscillator, or else by the gain control on the speech amplifier.

The grid circuit of the linear amplifier should be coupled to the class C modulated stage (with no plate voltage on the linear) and tuned to resonance. The output of the audio oscillator should then be increased until the plate current of the class C amplifier is about one-half the peak which it would be expected to reach if it were operating as a conventional class C amplifier. In the transmitter shown in Fig. 11 the peak class C plate current is 100 MA, so that the 50 per cent point is 50 MA. The exact amount is not critical because this is just a starting point. The linear amplifier is now neutralized in the conventional manner. With the plate voltage still disconnected from the linear amplifier, the load stabilizing resistance Rx is tapped across part of the grid tank. The resistor is tapped across more and more turns until the plate current to the class C stage is increased by one-half, due to increased loading. The coupling link is then adjusted to reduce coupling until the plate current to the class C stage is back to the 50 MA starting point. The point to remember is that the resistor should dissipate about one-third of the RF output from the class C modulated amplifier. After each adjustment of the loading resistor Rx it will be necessary to retune the grid tank because even the best of the non-inductive loading resistors have quite a detuning effect. With some tubes used in the class B linear amplifier 5,000 ohms will be too large, in which case about 2,000 ohms will usually be satisfactory, particularly when 203As or 852s are used. When the resistor is consuming about one-third of the power output of the modulated amplifier, plate voltage can be applied to the linear amplifier. Tune the plate tank to resonance and couple the antenna. Then increase the tone from the audio oscillator to a point just below where the overmodulation indicator (the 879 and associated milli-

ammeter) starts to kick up, showing negative overmodulation. Then simply adjust the antenna coupling for maximum power output in the antenna circuit.

The only adjustment on which anyone can go wrong is that of the load stabilizing resistor in the grid circuit of the linear. This will vary widely with different transmitters because it depends on several variable factors, including the minimum grid impedance of the linear, the L to C ratio in the grid tank and the amount of excitation available from the modulated amplifier. All the other adjustments are for maximum power output. Be sure, however, that the class C stage is not overmodulated when making adjustments. It is very easy to go wrong unless some form of negative overmodulation indicator is available. Conventional peak vacuum tube voltmeters fall down in measuring percentage of modulation on a controlled carrier transmitter because there is no fixed value of unmodulated carrier to refer to. Thus either an oscilloscope or the overmodulation detector should be used.

The linear amplifier should, by all means, draw grid current on voice peaks. This is the only way to get real plate efficiency out of the linear. The grid current drawn by any tube combination used in the linear amplifier should just about equal the DC grid current drawn by a similar class B audio amplifier operated at the same plate voltage.

The power gain through the linear will depend quite widely on the tubes used and on the plate voltage. A gain of about 12 can usually be expected, although it is a good idea to play safe and provide a surplus. The surplus, if any occurs, can be burned-up in the load stabilizing resistor, with a consequent increase in linearity.

The plate current drawn by the linear amplifier varies between the no signal condition and the maximum audio signal condition in exact accordance with the ratio between minimum and maximum class C modulated amplifier power output and thus it will be seen that the high voltage power supply must have rather good voltage regulation in order to avoid voltage variations as the load varies. However, the variations in load current will usually be materially less than in a similar class B audio stage, because the input and output of the linear amplifier do not go down to zero in the resting condition. Choke input to the filter of the high voltage supply, with some inductance swing in the choke, will effectively prevent undue voltage variation with modulation.

The really important economies that can be effected through the use of the controlled carrier, plus linear amplifier, should interest everyone. 35 watts of equivalent carrier power from a pair of 210s operating as linears is real economy.

The Antenna

● An antenna consists of any electrical conductor which is capable of radiating radio waves. Its effectiveness depends upon certain electrical laws. Usually an antenna consists of one or more copper wires, strung up as high as possible above the ground.

Any such system which is efficient for transmitting is also good for receiving, if properly insulated. It is easier to understand what an antenna does if one refers to transmission and then shows the similarity for reception purposes.

A wire connected to some source of oscillating electrical energy will radiate electromagnetic waves. Alternating, or oscillating electrical power in any wire will cause electric and magnetic fields of varying intensity around the wire. Near the wire this field is called the induction field and this energy alternates out and back to the antenna. Some of this field escapes or leaves the antenna entirely and forms the radiation field energy which is urged outward through space and travels at the speed of light. It is similar to light waves, but of very much lower frequency.

These electromagnetic waves are sent out in all directions and any wire above earth is capable of absorbing energy from them. Weak electrical oscillations are generated in the wire by the passing waves and this electrical energy may be used to operate a radio receiving set in the form of incoming signals.

At this point an antenna can be compared to any tuned circuit. Its capacity and inductance is distributed, instead of being lumped as in a tuning condenser and coil; however, the effect is similar. Resonance can be obtained and the inductive reactance will cancel the capacitive reactance so that the only impedance left to limit the flow of alternating or oscillating current, is the resistance of the circuit. If an antenna is resonant to the passing radio waves, the electrical current generated in the wire will be much greater than in a non-resonant antenna which offers added inductive or capacitive reactance to the flow of that current. This simply means greater desired signal-to-noise-ratio in the output of the radio receiver which is used to amplify the weak signal current flowing in the antenna.

The antenna may consist of a wire of any length, insulated, connecting through the radio receiver, to ground, or to another wire acting as a counterpoise. When ground is used, it acts as a mirror to the aerial wire and so completes the circuit. Any tuned circuit for resonance must be some multiple of half-wavelengths long, in the form of lumped or distributed capacities and inductances. The electromagnetic wave in space has a certain wavelength depending upon its frequency. A

straight wire for resonance to that frequency will be electrically a half wave long, which is nearly that physically, too. It is physically about 5 per cent shorter than a half wave because it is impossible to get a wire of zero diameter and no end supporting insulators.

If a ground connection is used, the antenna can be only a quarter, or some odd

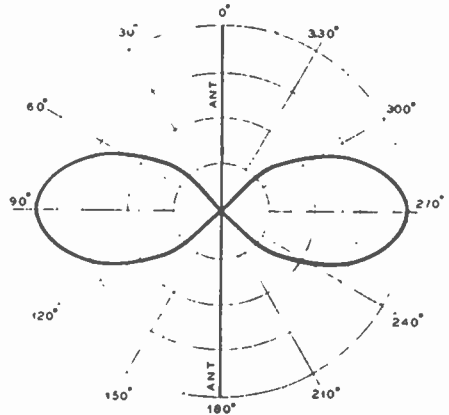

FIG. 1. Top view—the half wave horizontal antenna

multiple of quarter wavelengths long electrically, since the ground acts as a mirror to furnish a quarter wave and give a half wave or multiple of half waves for resonance. A very short wire can be used and loaded-up to a quarter wave, electrically, by means of a loading coil. Naturally it will not have as strong an induced current as a longer and higher resonant antenna since the passing radio waves only meet the small obstruction. This is one of the reasons why short-wave commercial stations use large "curtains" or directional antennas; the received signal is proportional to the amount of antenna wire exposed to the radio waves. It is, of course, necessary to connect up the antenna units so that the signal currents will be in phase and additive at the receiver.

Increasing the antenna length beyond an electrical half wave causes a drop in signal pick-up due to non-resonance, until resonance is again obtained at a full wavelength or some other multiple of half waves. If the radio wave approaches a half wave antenna from a direction at right angles to the wire, the induced current will be a maximum. In the case of a full wave antenna, the wave would induce currents in the two half wave sections which would be out of phase, and the receiver would get no current variations in the form of signals. If some of the wave

front approaches from a direction not at right angles to the wire, the resultant current would give a signal in the receiver. At certain angles, the signal resulting would be actually greater than if only a half wave antenna was used. These angles are at 54° in the form of a four-leaf clover. A half wave antenna, such as shown in Fig. 1, has a maximum response in the form of a figure "8" at right angles to the wire direction. Adding more and more half wavelengths to the antenna tends to bring the four-leaf effect closer to the end directions of the long wire, and additional response loops of smaller values are added outwardly at approximately right angles to the wire.

A vertical antenna is non directional in giving equal response to any direction, but

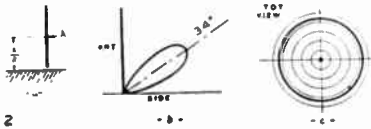

FIG. 2

Full wave antenna gives maximum radiation upward at an angle of 34 degrees from the horizon.

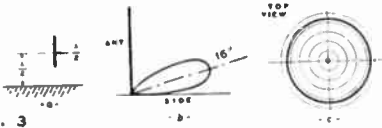

FIG. 3

Half wave antenna, same height as full wave antenna in Fig. 2. Here the radiation is known as 16-degree "low angle" radiation.

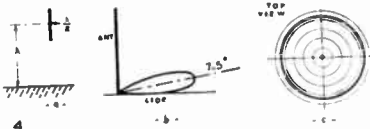

FIG. 4

Increasing height of antenna above ground lowers angle of radiation to 7.5 degrees, as shown.

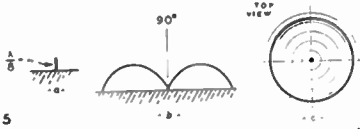

FIG. 5

Short vertical antenna, grounded, gives very low angle radiation.

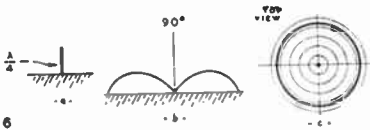

FIG. 6

Quarter wave grounded antenna concentrates more of the radiation at a low angle than the $\frac{1}{8}$ th wave antenna does.

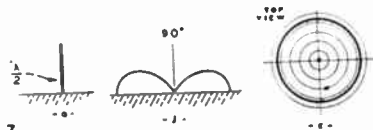

FIG. 7

Grounded half wave antenna.

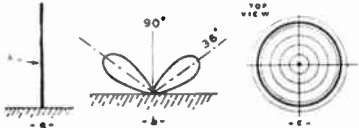

FIG. 8

Full wave grounded antenna.



FIG. 9

Horizontal antenna, half wave above ground. This is the best height for horizontal antenna for general use.

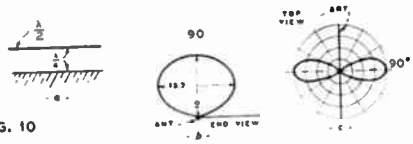

FIG. 10

Horizontal antenna, quarter wave above ground.



FIG. 11

Horizontal antenna, $\frac{3}{4}$ wave high, radiates mainly upward.

its effectiveness can be controlled for angle radiation by its height above ground. An outgoing radio wave is sent out in all directions and the earth tends to reflect it upward as it goes out. Fortunately the Heavyside layer acts as a reflector and radio waves are reflected back toward earth at distant points. This means that long distance signals may be coming down across the antenna wire at either a high or low angle with respect to the horizon. By having the antenna at certain heights above the ground, it is acting as a mirror or reflector and the response to incoming waves of various angles can be made greater. This is brought out in the various curves of radiation patterns given in the figures shown. A careful study of these figures will help anyone desiring to visualize an antenna system and methods for improving it.

Antennas for Receiving

The RCA World-Wide Antenna System was developed with two important objects in mind. First, a system was desired which reduced the effects of man-made static. Second, a maximum of signal pick-up over the entire short-wave spectrum was wanted.

THE only principle which has been successfully employed for the reduction of man-made static is to locate the antenna in a comparatively noise free area and to employ a lead-in of such a type that pickup on the lead-in is eliminated. To place the antenna in a noise free location is a unique problem for each installation. However, the type of lead-in is an important design problem. There are two general types—the shielded lead-in and the balanced transposed line. The shielded line is unsuitable for high frequencies because to be effective, the shielding must be grounded every few feet with short ground wires. This is obviously impossible in most installations.

The balanced line, however, is eminently suitable for many reasons. When used in conjunction with a well-designed transformer at the set pickup on the line is almost completely eliminated. No grounding is necessary. Losses are lower than in a shielded line.

In designing the line the space between the wires and the size of the wires is important. The farther apart they are, and the smaller they are, the higher is the characteristic impedance of the line. If a line is terminated at each end with its characteristic impedance, its transmission is nearly constant at all frequencies. However, when the terminating impedances are widely different from the proper value, the transmission varies greatly with frequency, the curve passing through a series of peaks and valleys corresponding to resonance points in the line.

For the RCA World-Wide Antenna System a line having 180 ohms impedance was chosen because this value is about the average input impedance of most short wave receivers and because it is about the average impedance of

varying in efficiency two or three to one. The line length was adjusted experimentally by throwing short lengths in and out of the circuit, until a length was found such that a transmission peak occurred at each of the important short wave broadcasting bands.

Mechanically, the line consists of a rubber covered twisted pair with stranded tinned copper wire for each conductor. After exhaustive tests special submarine cable rubber was specified for insulation of the transmission line due to its low losses and high natural rubber content. The life of this transmission line is materially increased by the use of this high quality rubber insulation. While twisted pair was indicated to produce a line of the proper impedance, it is also important that the wires be close together with frequent transpositions to avoid picking up out of phase signals.

In order to keep the losses low when the line is wet, it is important that no cotton be used as insulation. Even when a cotton wrap is well impregnated, the impregnating material soon evaporates away and moisture then gets in, increasing the line losses.

IT IS very important to note that the noise eliminating feature of the system depends entirely on the design of the transformer which couples the line to the set. The purpose of this transformer is to eliminate in-phase signals while transmitting out-of-phase signals. The expression "in-phase" means that the voltages of the two sides of the line go positive together and then go negative together. Obviously, this type of signal will produce no current in the primary of the transformer, it simply changes its potential. "Out of phase" signals are those which cause one side of the line to go negative when the other goes positive and then the reverse. This type of signal does produce primary current. The mere presence of a transformer does not eliminate the in-phase signals, (or

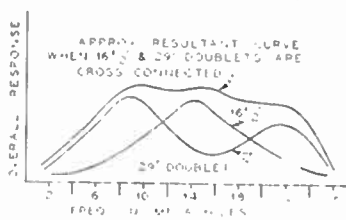

FIG. 1

the double doublet antenna over the short wave frequency spectrum.

Because the antenna does not represent an impedance exactly equal to the line impedance at all frequencies, the transmission curve does have a series of minor peaks and valleys,

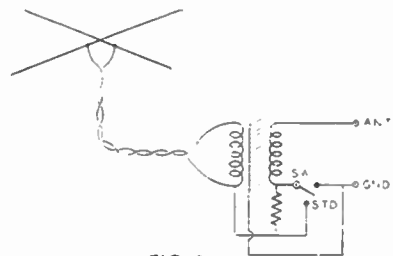

FIG. 2

noise) because if there is capacity coupling, the noise will be transmitted to the set through that capacity.

In the transformer under discussion a special and highly efficient static shield is used, completely eliminating capacity coupling. As

a result, the in-phase signals and noise picked up by the line are eliminated while the out of phase signals picked up by the antenna are transmitted to the receiver.

The circuit diagram of the complete antenna system is shown in Fig. 2.

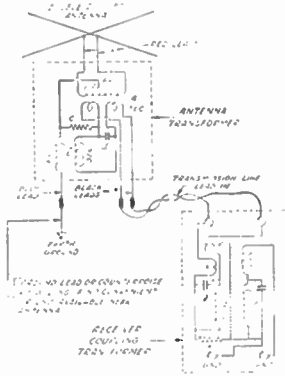

Improved RCA world-wide antenna system. This newest method replaces the one shown in Fig. 3.

WHEN choosing a noise-free area to locate the "Double Doublet" antenna it is well to keep in mind the generally accepted theory that the strength of noise interference varies inversely as the square of the distance from the source of noise.

The receiver coupling transformer of the system eliminates automobile ignition noise completely. This can best be explained by the following paragraphs and illustrated by referring to Fig. 3.

"S" represents a signal generator such as a source of auto ignition noise. (a) repre-

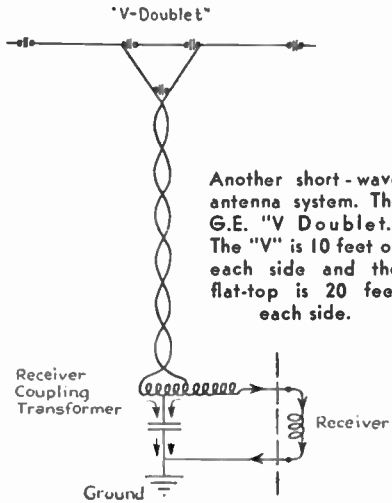

sents the capacity coupling from "S" to the transmission line. (b) represents the capacity coupling from "S" to the power supply line. (h) represents the capacity coupling from one side of the power supply line to the metal chassis. (f) represents the capacity coupling from "S" to actual earth ground.

(A) The noise voltage that would be induced by capacity coupling (a) into the transmission line would correspond to an "IN-PHASE" signal and therefore would be coupled or fed through to the secondary of

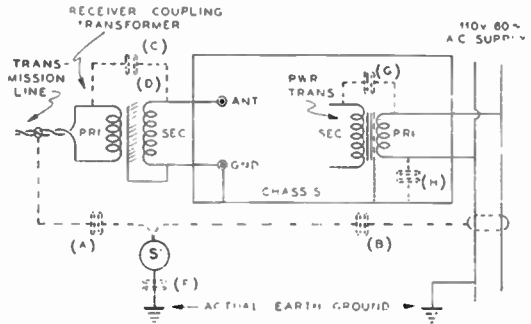

FIG. 3

the receiver coupling transformer by the capacity (c) if this capacity (c) were not eliminated by the special and highly efficient electrostatic shield (d). If it were not for shield (d) a noise voltage would be developed across "ANT" & "GND" of the receiver due to a completed circuit from "GND" to chassis frame through "h" to the power supply line which is usually grounded on one side and thence back to "S" through (f).

(B) The noise voltage that would be induced by capacity coupling (b) causes current to flow through the power transformer and develop a noise voltage from ground to the chassis through capacity (h). If no receiver coupling transformer was used this voltage would occur across ("ANT" and "GND") the input terminals of the receiver and hence cause noise. When the RCA World Wide Antenna System is used including the receiver coupling transformer this voltage occurs between the primary and the electrostatic shield, since capacity (c) has been eliminated.

However, this does not produce primary current. Therefore this noise voltage does not induce a voltage in the transformer secondary.

(C) The electrostatic shield provided with most power transformers serves to offset the capacity coupling (g) and thus prevents the introduction of RF noise voltages into the voltage supply of the receiver directly.

No doubt the above reasons (A) and (B) contribute to very real improvement in signal to noise ratio to be had with this system on auto ignition interference.

Transmitting Antennas and Coupling Systems

THE final amplifier of a transmitter is a power converter. It converts direct current supplied by the high voltage power supply into high-frequency alternating current. All of the other stages in the transmitter serve only to control the final amplifier and none of the power generated in the stages which precede the final amplifier reaches the station listening to you. In other words, the final amplifier is a relay, controlled by the crystal oscillator through the following stages of RF amplification.

A final amplifier can be highly efficient as a power converter but all efforts in this direction are wasted unless the power is effectively radiated into the ether in the form of electromagnetic waves. The antenna is simply a resonant circuit and from one standpoint has exceptionally high losses. In fact, all of the power that reaches the antenna is dissipated from it in what can be, strictly speaking, a loss. Whenever a loss occurs in a circuit carrying high-frequency alternating current, the power dissipated is not destroyed; it is merely wasted by either generating heat or passing off to ground. An efficient antenna, on the other hand, can neither generate a material amount of heat nor effectively transfer power to a ground connection. The energy lost by the antenna creates electromagnetic disturbances in the ether which are called radio waves. This loss of power by means of radiation is caused by reflection losses due to the tremendously-high impedance mismatch which occurs at the end of any antenna. This mismatch of impedances at the ends of an antenna is highly desirable because it radiates power.

It is highly important that the power released in the final amplifier be transferred as effectively as possible to the antenna. Losses in the coupling device between the final amplifier and the antenna represent an undesired waste, because very little of the power dissipated in these losses ever produces a signal in a distant receiver.

A successful coupling device is one which must do three things well. (1) It must be matched in impedance to the final amplifier at the station end. (2) It must be matched in impedance to the antenna at the antenna end. (3) It must have negligible losses in itself and must not radiate.

Any resonant circuit, of which the plate tank of a final amplifier is an example, has a rather high impedance (AC resistance) across the two ends of the tank circuit. Across the two center turns of this same tank circuit the impedance is very low, and the impedance increases as taps are taken out and away from the center point of the tank coil. One of the fundamental electrical laws states that maximum power transfer

from one electrical circuit to another occurs when the impedance of the source of power is exactly equal to the impedance of the receiver of power. Thus it follows that the coupling device (which may be any one of various transmission lines or feeders) receives power from the final amplifier most effectively when tapped across just enough turns of the final tank coil so that the impedance across that portion of the tank is equal to the impedance at the station end of the coupling device.

Similarly, an antenna, which is a tuned resonant circuit, varies in impedance along its length. Thus the coupling device should connect to the antenna at a point or points where the impedance of the antenna matches the impedance of the coupling device. If the impedances at the station end and at the antenna are not properly matched, power is lost either through radiation from the feeders, which radiation is not effective, or else by loss to ground due to voltages induced in surrounding objects which absorb power, such as house wiring, tin roofs, plumbing and water pipes, etc.

There are many sources of loss in the coupling device. For example, consider the Zepp feeder system. If the spacing between feeders is too great the standing waves on those feeders do not properly cancel each other. If the spacing is too small there is excessive heating of the feeder separators and a tendency for them to arc-over. The best compromise for Zepp feeder spacing is about 6 inches. Ceramic feeder separators which resist the absorption of moisture should be used. Other common sources of loss in all types of coupling devices include sharp bends, which have a reflection loss and thus radiate, wire of improper size for the

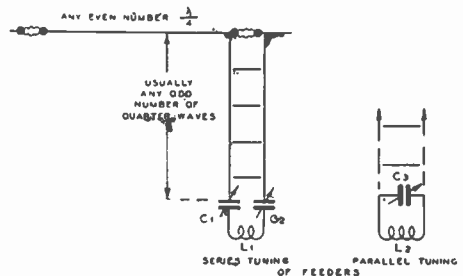

Series tuning of Zepp feeders is used to reduce the electrical length of the resonant system which consists of the two feeders and the pick-up coil. Parallel tuning is used to increase the electrical length of the resonant system and thus feeders of almost any length can be resonated on practically any frequency by one or the other of these two tuning methods.

feeder separation, more capacity to ground from one side of the feeders than the other, and high resistance unsoldered joints.

Coupling Devices: Resonant Lines

The common example of a resonant coupling device is by means of conventional Zepp feeders which, strictly speaking, are not feeders at all, but a part of the antenna proper. The portion of the antenna called the Zepp feeders simply consists of an additional length of antenna which is folded back upon itself in such a way that the standing waves on the two feeders neutralize each other and thus prevent the feeder portion of the antenna from radiating. The first fundamental of Zepp antenna operation is that the flat-top portion which does the actual radiating must be cut to within 10% for the frequency used. No amount of tuning of the folded portion (feeders) of the antenna can properly compensate for a flat-top which is more than approximately 10% too long or too short. The electric length of a flat-top can be checked by hauling down the feeders and disconnecting the antenna from its feeder, and then hauling the feeders up again. With the feeders hauled up (and the antenna disconnected from them) turn on the transmitter and tune the feeders to resonance. Turn off the transmitter, but without changing the feeder tuning condensers, connect the antenna to its associated feeder in the usual manner. Now turn the transmitter on again and if the flat-top portion of the antenna is cut to proper length no re-tuning of the feeder condensers will be necessary to establish resonance. In other words, the point of resonance should be at the same setting of the feeder tuning condensers, whether the flat-top is connected or not. If the capacity of the feeder tuning condensers must be increased in order to establish resonance, the flat-top portion of the antenna is too short. If the capacity must be reduced, the flat-top portion is too long.

Whereas a Zepp coupling system is useful, due largely to its simplicity and ease of adjustment, it is definitely less efficient than the more-modern non-resonant transmission lines such as the Jones Twisted Pair Feeders, Johnson Q Feeders and the One- or Two-Wire Matched Impedance Lines, because the Zepp system actually brings a portion of the antenna into the operating room. Theoretically, Zepp feeders do not radiate but as a matter of fact the perfect Zepp feeder exists only "on paper."

Another type of Zepp feeder is one which is attached to the center of the antenna, instead of to one end. This differs from the more common voltage fed type in that it connects to a low impedance point on the antenna instead of a high impedance point. For this

reason, it is sometimes called a "Current Fed Zepp," or a doublet, whereas the more-common type is known as the Voltage-Fed antenna. If the flat-top portion of the antenna is any odd number of half wavelengths long, it will be found that at the end of each half-wave section there is a voltage loop, which simply means that at these points there exists a high impedance and thus voltage feed may be attached at these points.

Zepp Feeder Lengths

All Zepp feeders must resonate by themselves to the radiated frequency. The term "Zepp feeders" includes the coupling coil and coupling condensers and thus the electrical length of the two feeders and the coupling inductance and capacity must be some multiple of one-half wavelength in length.

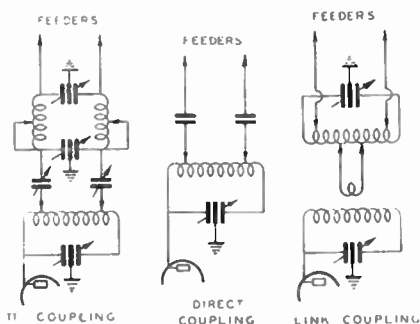

Three methods of coupling the antenna load into the final amplifier. The PI coupling and link coupling circuits can be used with either resonant or non-resonant feeders, whereas the direct coupling circuit can only be used with non-resonant lines.

Therefore each feeder with its associated half of the coupling reactance must be some odd multiple of one-quarter wave in electrical length. If the mechanical length of the two feeders is either longer or shorter than the proper length to produce resonance, the proper amount of electrical length can either be added or subtracted by means of coils and condensers. Thus when Zepp feeders are tuned, merely their electrical length is varied.

In order to transfer energy to the feeders a small coil is usually placed at the station end in inductive relation to the plate tank coil of the final amplifier. The presence of this coil adds electrical length to the feeders. If the electrical length of the feeders, plus the electrical length of this coupling coil is less than one-quarter wave greater than any multiple of one-half wave, then series condensers must be used to shorten the electrical length of the feeders sufficiently to establish resonance. If, on the other hand,

the electrical length of the feeders and the coupling coil is more than one-quarter wave too long, or less than one-quarter wave too short (which is the same thing), a condenser shunted across the coupling coil must be used in order to bring the electrical length back to a multiple of one-half wavelength. Fig. 1 is a table for converting frequency into the mechanical equivalent of full wave, half wave and quarter wave. From this table it can be quickly determined whether the feeders are longer or shorter than a multiple of one-half wave. The length of the two feeders should be added together; for example, the shortest feeders whose mechanical length would approximate one-half wave at 40 meters would each be 33 ft. in length.

For 5 meters one quarter wave is 4 feet
 For 10 meters one quarter wave is 8 feet
 For 20 meters one quarter wave is 16 feet
 For 40 meters one quarter wave is 33 feet
 For 80 meters one quarter wave is 66 feet
 For 160 meters one quarter wave is 132 feet

Fig. 1—Zepp Feeder Lengths
(Each Wire)

LENGTH OF FEEDERS	Type of Feeder Tuning to Use
Up to One Quarter Wave	Parallel Tuning
Between One and Two Quarter Waves	Series Tuning
Between Two and Three Quarter Waves	Parallel Tuning
Between Three and Four Quarter Waves	Series Tuning
Between Four and Five Quarter Waves	Parallel Tuning
Between Five and Six Quarter Waves	Series Tuning

Many amateurs commonly use Zepp feeders whose total length is an odd multiple of quarter waves long. They then bring the total electrical length of the feeder system, which includes the coupling coil and tuning condensers, up to resonance by adding the extra one-quarter wave by means of the coupling coil and tuning condensers.

Not all Zepp feeders use a coupling coil and tuning condensers. A short-circuiting bar across the two feeders at the lower end can be used to complete the circuit. In this type of construction the feeders are tuned by sliding this bar up and down along the feeders until resonance is established. The final amplifier of the transmitter is then coupled to the feeders by means of a non-resonant, low impedance transmission line which is clipped onto the two feeders slightly above the shorting bar, depending upon the impedance of the transmission line. It

should be evident that the impedance across the feeders is lowest at the shorting bar and is highest at the end where the antenna is connected to the feeder. Thus the impedance of a non-resonant transmission line which is delivering power to this type of Zepp feeder can be matched by merely sliding the clips up and down along the feeders until the standing waves disappear from the non-resonant line. If a neon tube is held against the non-resonant line its brilliancy should not vary as it is moved along the line. This form of Zepp feeder is quite widely used by the commercial communications companies in coupling a non-resonant line to a directional antenna array. The commercial people minimize the losses inherent in all resonant transmission lines by keeping them well up in the air and away from house wiring, tin roofs, etc., and by using high-grade separators and by proper tuning and balancing.

The principal advantage of the Zepp feeder system is that no matter how inefficiently it may be built it will still draw power from the final amplifier, although it may effectively radiate only a small fraction of the power delivered to it. Thus many operators make the mistake of thinking that because a Zepp system draws a lot of power out of the final amplifier and gives the greatest meter indication of RF amperes, it is a better system. Other forms of coupling usually refuse to draw power from the final amplifier unless the radiating portion of the antenna is actually radiating. Many amateurs assume that the non-resonant transmission line is faulty and difficult to adjust because the final amplifier can not be made to draw enough plate current, whereas all that is wrong is that the antenna is not of the proper length to draw power from the transmission line. In other words, an effective non-resonant transmission line ordinarily will not draw power from the transmitter unless it can deliver it to the antenna.

Length of Flat-Top Portion For Zepp Feeders

Contrary to accepted beliefs, the flat-top portion of a Zepp antenna is NOT critical as to length. The Zepp feeder tuning system in the radio room will take care of variations of approximately 10 per cent in the flat-top portion. Thus the following table of flat-top lengths is suitable for operation on any frequency in the band listed in the table:

FOR HALF WAVE ZEPPE FLAT-TOPS	
BAND	LENGTH OF FLAT-TOP
160 Meters	250 feet
80 "	125 feet
42 "	66 feet
20 "	33 feet
10 "	16½ feet
5 "	8 feet

How to Calculate the Length of Any Half Wave Radiator

The antenna used with any type of non-resonant feeder systems must be cut to EXACT LENGTH, subject to slight modification due to presence of nearby objects. For all practical purposes the antenna can be cut to the calculated length and the wire used should be of a kind which will not stretch. Knowing the frequency at which the antenna is to operate, this figure can be converted into wavelengths by dividing it by 300,000,000. The wavelength thus given in meters should be multiplied by 1.56 to give the actual length of a half wave antenna in feet. As a typical example, assume a frequency of 7,200 KC for the transmitter:

$$\frac{300,000}{7,200} = 41.7 \text{ Meters}$$

41.7 × 1.56 = 65 feet. Thus the length of the flat-top is 65 feet and the feeder should be attached 14 per cent of this value, or 9 ft. 1 inch off either side of center of the flat-top, in case a single wire or two wire matched impedance feeder is used. If a twisted pair feeder is used, about one foot should be cut out of the center of the flat-top and a one-foot triangle formed out to the twisted pair feeder. Two small insulators complete the "V" termination of the twisted pair feeders, as illustrated on page 193 (Frank Jones Twisted Pair Feed Line System).

Non-Resonant Transmission Lines

The essential difference between a non-resonant transmission line and the Zepp feeder system is that the non-resonant lines, when properly constructed, have no standing waves on them, and the impedance of the line is the same at both ends, whereas the impedance of Zepp feeders varies uniformly from a low impedance at the transmitter end to a very high impedance at the flat-top end.

The impedance of most non-resonant lines is usually under 800 ohms and is as low as 70 ohms in certain types of twisted-pair lines. In any circuit carrying power, the voltage across the circuit rises as the square-root of the impedance. Thus a low impedance line has a very small voltage across it and insulation becomes a minor factor. Because the line is not resonant there is no circulating current flowing through it, and thus allows the use of smaller wire than that used for a Zepp feeder system. This is not always true of the low impedance lines but holds true for average lines. Because the non-resonant line radiates a negligible amount of power it can be run indoors and close to water pipes and other conductors without losses, which sometimes is necessary when the flat-top portion of the antenna is at a considerable distance from the transmitter.

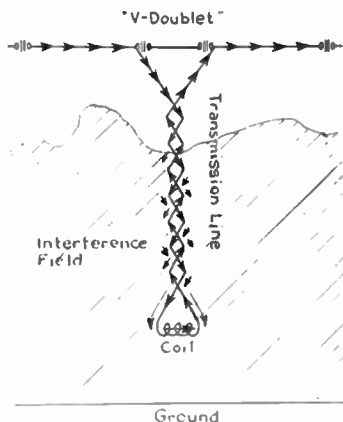

TRANSPPOSITION OF FEED LINE

This method reduces noise pick-up.

The arrows on the wires show the signal path and the arrows on the outside of the transmission line show the interference currents. The latter do not set up a potential across the wires.

Single-Wire Fed Hertz

The most common type of non-resonant line is the single-wire matched impedance line. It consists of a single wire (and phantom ground return) clipped on the antenna at a point approximately 14 per cent of one-half wave away from any voltage node. In a half wave antenna the voltage node happens to be at the center, and thus the feeder is clipped on the antenna 14 per cent of the total length away from the center. There is some controversy as to the exact point of attachment because it varies slightly with frequency, size of the feeder wire and height of the antenna above ground. Best results can be obtained by moving the point of attachment about four inches at a time around this 14 per cent point until the standing waves disappear, as indicated by a neon bulb held against the feeder and moved along it over a distance of one-quarter wave.

It is highly important that a good ground be used with a single-wire feed line because the single-wire line is in reality a two-wire

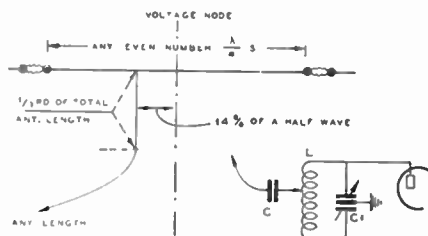

Single-wire fed Hertz antenna and method of coupling to the final amplifier.

line, the second wire of which is a phantom return through ground, which is in effect connected to the exact center of the antenna in the case of a one-half-wave flat-top. Because a perfect ground is never obtained in practice, the single-wire feed line has somewhat higher losses than the better two-wire types of lines. It is highly important that the single-wire feeder is at a right angle to the flat-top radiator which it feeds for a distance of at least one-third of the length of the antenna in order to avoid pick-up from the magnetic field surrounding the antenna, which would cause the presence of standing waves on the feeder. One of the characteristics of all non-resonant lines is that they can be made practically any length, within reason, and have been successfully built 1000 feet long.

Two-Wire Non-Resonant Transmission Line

This type of transmission line is also called the Two-Wire Matched Impedance Transmission Line. As was previously stated, all non-resonant transmission lines are aperiodic and therefore have no standing waves on them. However, they have distributed inductance and capacity which depends on the size of the wires and their spacing. These factors determine the characteristic, or surge impedance of the line. This characteristic line impedance is the impedance that must be matched to the antenna at the far end and to

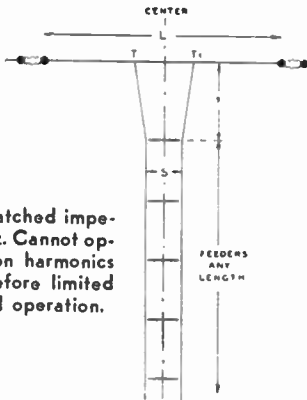

Two-wire matched impedance Hertz. Cannot operate well on harmonics and is therefore limited to one-band operation.

the transmitter at the near end, if the maximum power transfer is to be realized. It is quite simple to compute the surge impedance of any two-wire line.

$$Z = 276 \log \frac{b}{a}$$

where Z is the surge impedance, a is the radius of the wire and b is the distance between the two wires, a and b may be expressed in any units, but the same units should be chosen for the two dimensions

because we are interested only in the ratio between the two. It was also previously mentioned that the impedance of an antenna depends upon the points between which measurement is made and varies from a low value at a voltage node (center of a one-half-wave antenna) to a very high value at the voltage loops or ends of an antenna.

The line, therefore, must be tapped on the antenna at points whose impedance is equal to the impedance of the line. With the ordinary type of two-wire matched impedance line it is necessary to fan-out the feeders at the far end in order to evenly increase or transform the feeder impedance so that it matches the antenna. The details of this matching process between a 600-ohm line and a one-half-wave antenna are figured as follows:

$$L \text{ (in meters)} = \frac{492,000}{F} \times K$$

or

$$L \text{ (in feet)} = \frac{150,000}{F} \times K$$

- L equals antenna length
- F equals frequency in kilocycles
- K equals .96 for frequencies below 3000 KC
- K equals .95 between 3000 and 28,000 KC
- K equals .94 above 28,000 KC.

The portion of the antenna between the two taps T, T1 where the feeders connect is computed as follows:

$$T, T1 \text{ (in feet)} = \frac{492,000}{F} \times K'$$

or

$$T, T1 \text{ (in meters)} = \frac{150,000}{F} \times K'$$

- K' equals .25 below 3000 KC
- K' equals .24 between 3000 and 28,000 KC
- K' equals .23 for frequencies above 28,000 KC

The fanned Y portion is computed as follows:

$$Y \text{ (in feet)} = \frac{147,600}{F}$$

or

$$Y \text{ (in meters)} = \frac{45,000}{F}$$

The feeder spacing S for a 600-ohm transmission line is computed approximately as follows:

$$S = 150 \times r$$

where S is the center-to-center distance between the feeders and r is the radius of the wires. These should be expressed in the same units, whether inches or millimeters.

The spacing of the feeders is rather critical and the line should be kept taut. Each side of the line should be of the same length and symmetrical with respect to ground. As

with the single-wire line, it should be at right angles to the antenna proper for a distance at least equal to one-third of the antenna length. Any bends in the feed line should be gradual because sharp bends cause reflection loss and undesired radiation.

The characteristic impedance of the two-wire line must be matched to the plate circuit of the final amplifier. This can be done by tapping the line on each side of the center of the plate tank coil until the final amplifier operates efficiently at the desired DC input. In most final amplifiers the feeders will be tapped about one-quarter or one-third of the way out from the center-tap of the coil. Because tank circuit impedances vary widely, depending on tubes and plate voltages, it is impossible to definitely determine this point in advance. Some form of blocking condensers should be used in the feeders to isolate the DC plate voltage from the antenna and line.

The familiar Collins Pi network provides a convenient and exact matching device to most effectively couple a two-wire line to a single-ended or push-pull final amplifier.

There is no necessity for the use of transposition blocks if the antenna to which the two-wire line is connected is used for transmission only. In fact, the transposition blocks introduce a certain amount of loss due to the radiation from the sharp bends in the wires. However, certain types of transposition blocks minimize this difficulty and cause only a minor loss in efficiency.

Twisted-Pair Non-Resonant Line

This type of transmission line (see page 193) and the Johnson Q Feeders are probably the two lowest-loss feeder systems commonly used by amateurs. The losses in the Twisted-Pair Feeders are exceptionally low, largely because the small spacing between the wires causes the line to have a very low characteristic impedance. Normally such a transposition line has an impedance in the neighborhood of 175 ohms. This means that for a given amount of power the voltage between the two wires is very low and thus insulation and dielectric losses can be kept to a minimum. Ordinary stranded lamp cord should be avoided because of high losses, but single-conductor rubber covered No. 12 to No. 18 (twisted) will usually be satisfactory. We recommend the special twisted-pair manufactured by RCA in conjunction with their double-doublet all-wave antenna kit, because this wire uses a special low-loss high-frequency insulation and can handle up to a kilowatt of power without trouble. The impedance of a twisted-pair line is approximately twice the center impedance of a one-half-wave antenna and should be fanned out for approximately the last foot of its length where it taps on the antenna, across the center insulators. The taps are about a foot

apart on the antenna, making an equilateral triangle of approximately one foot on each side out of the two feeders and the center portion of the antenna. This type of transmission line has so little radiation that it can be carried around a room or up through a light well without material losses. As a matter of fact, when used with a roto-beam antenna it can be carried down through the pipe which supports the flat-top portion of the rotatable doublet without any sacrifice of efficiency.

The End-Fed Hertz Antenna

● This type of antenna can be used to advantage in locations where there is no objection to bringing the antenna proper right into the radio room. (See Figs. 1 and 2). If some isolation is desired, L1 and C1 can be placed atop a pole and a link-coupled feed line can be used to couple L1 to L2. This antenna is also useful when it is impossible to obtain a good ground connection, a common trouble at high frequencies when the transmitter is located three or more stories above the ground, which makes it rather difficult to eliminate standing waves from a ground connection. No ground should ever be used with an end-fed antenna because the ground tends to make it act as a Marconi antenna.

There are only two types of end-fed antennas, (1) Voltage Fed, (2) Current Fed.

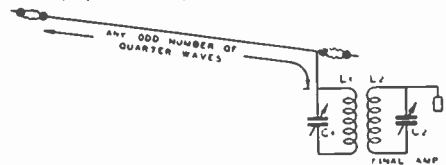

END FED CURRENT FED HERTZ ANTENNA

FIG. 1.

Voltage Fed simply means that power is fed to the antenna at a point of high impedance, such as the end of a half wave or full wave Hertz. Current Fed means that the power is fed to the antenna at a point of low impedance, such as the center of a half wave antenna, or the near end of an antenna whose length is any odd number of quarter wave lengths.

Figs. 1 and 2 look alike, yet there is a great difference in the two. The radiating portion of the antenna in Fig. 1 has high

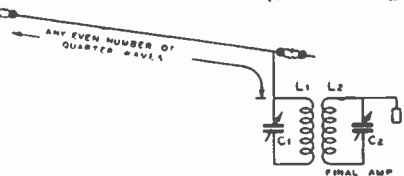

END FED VOLTAGE FED HERTZ ANTENNA

FIG. 2.

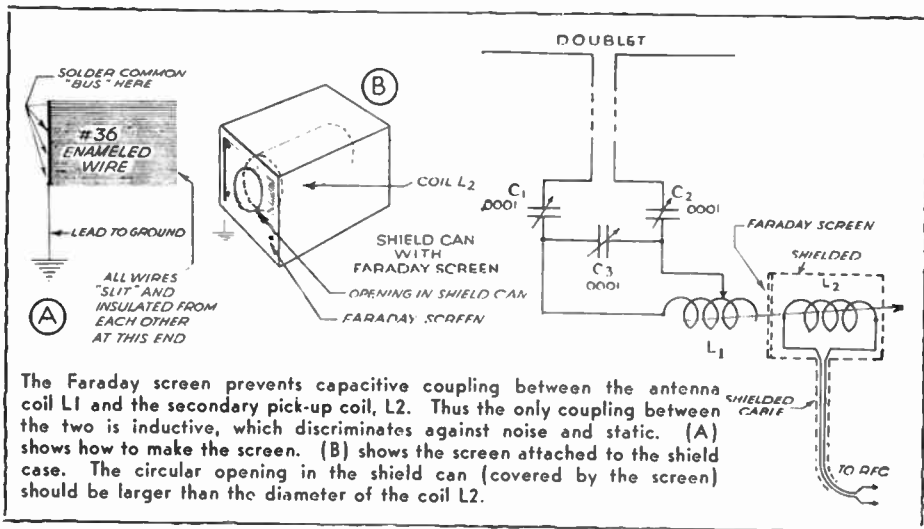

voltage present at both ends and the coil. L1 and condenser C1 resonate to the transmitter frequency. In Fig. 2 there is high voltage at the far end of the radiating portion of the antenna, very little voltage is present where the antenna connects to the top of L1. At that point there is largely current, although a high voltage point will be found at the bottom of L1. L1 in Fig. 2 will have about

half as many turns as L1 in Fig. 1 for the same transmitter frequency, and L1, C1 in Fig. 2 will ordinarily be tuned to approximately twice the transmitter-frequency.

COLLINS PI NETWORK
(See Figs. 1 to 3C)

This Collins PI network is placed between the final amplifier tank circuit and the load, whether it be single or two-wire, resonant or non-resonant transmission lines, or the end of an antenna itself. It affords a very flexible means of transforming impedances where non-resonant lines are used and of balancing out inductive or capacitive reactances when coupling to a resonant feeder system or to an antenna proper. Its principal advantage is that it practically eliminates any impedance mismatch between the transmission line (or end-fed antenna) and the plate tank of the final amplifier. It cannot correct a mismatch between the transmission line and the antenna and is of no great value where everything is perfectly matched by either inductive or direct coupling. The single-wire type of Collins pi network is particularly useful when a portable transmitter is used.

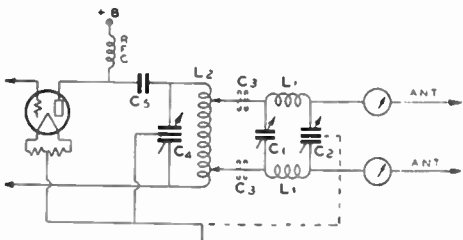
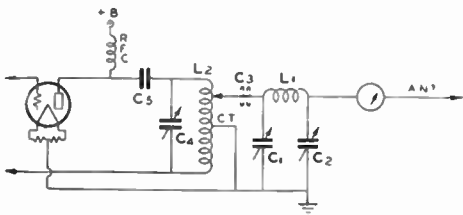

Two-wire feed line from single-ended amplifier—split-stator plate tuning and optional split-stator used at C2. Shunt feed.

Many amateurs have asked how to utilize the Collins pi network between a push-pull final and a single wire fed antenna. Some simply tie the pi net to one side of center and let it go at that, but they usually find that the load on the tubes becomes unbalanced when this is done, causing one tube to heat more than the other, and also causing neutralizing troubles as well as generating even harmonics.

The circuit shown in Fig. 1 evenly loads each side of the push-pull stage and only causes a very slight capacity unbalance, which is too minor to affect the neutralization of

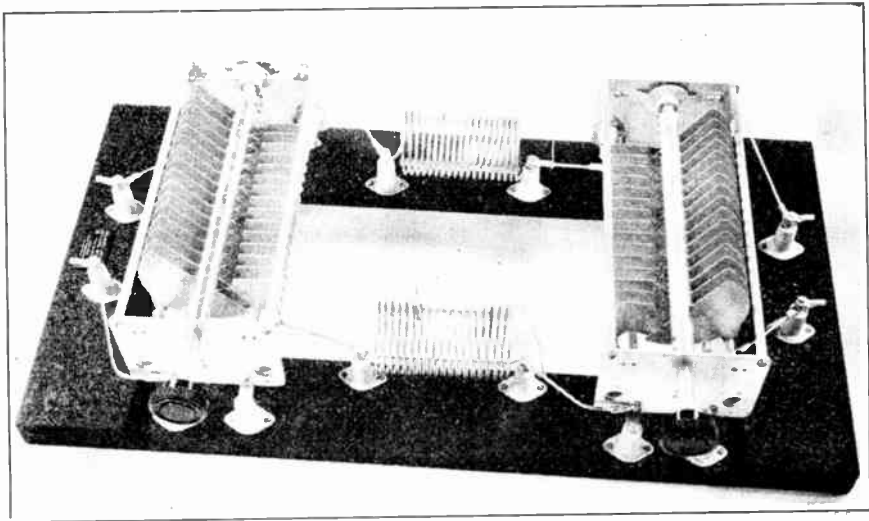

Pi network antenna coupler for high-power transmitter.

the stage. C1 is the conventional plate tank condenser of the push-pull stage and is shown as a split-stator, although its use is not essen-

tial to the antenna coupling system. L1 is the regular tank coil. L2 has about one-third as many turns as L1 and is exceptionally

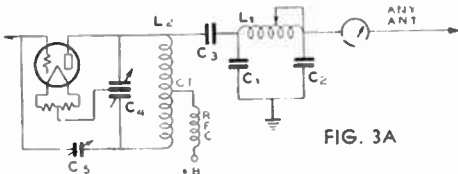

FIG. 3A

Single-wire feed from end of low impedance output tube tank. Split-stator tuning and series feed. C1 and C2 should be variable.

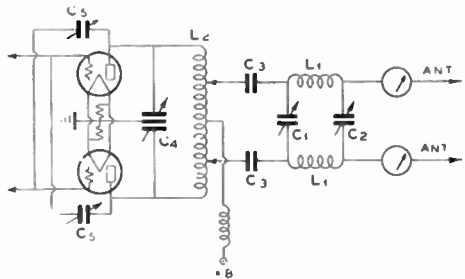

FIG. 3B

Coupling a two-wire line to a push-pull final amplifier. Use of single-wire line out of a push-pull final through a PI network is not recommended.

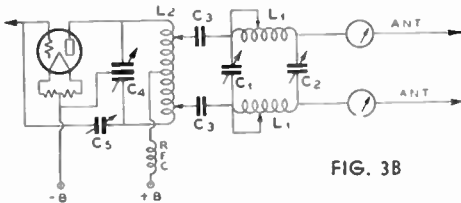

FIG. 3B

Two-wire line from single-ended amplifier. Split-stator tuning and series feed.

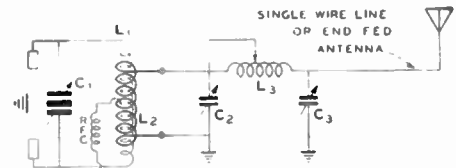

FIG. 4

How to couple a single wire antenna or feed line to a push-pull final amplifier.

L1 and L2 should be interwound in order to load both tubes equally in a push-pull amplifier. L2—1/3 Tank Turns, interwound or otherwise very closely coupled.

L3—Standard Collins coil.
C2-C3—.00035 mfd. each.

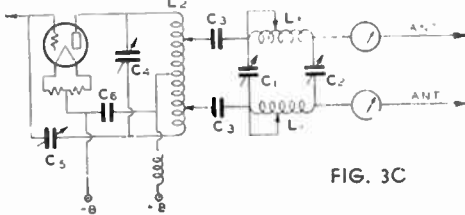

FIG. 3C

Same as Fig. 3B, but with single-section tuning condenser.

closely coupled to it. It may be wound inside or outside of the plate tank, although the inter-wound coil shown is to be preferred. It is impossible to obtain close enough coupling by placing L1 and L2 end to end, as is done with most Zepp and other inductive antenna coupling systems.

C, C3 and L3 are the conventional single-ended components of the Collins pi network and their constants are unaffected by the presence of the coupling coil L2.

How to Adjust the PI Network

The PI network acts as a low-pass filter which does not cause an appreciable loss to the fundamental emitted frequency, yet practically eliminates radiation of harmonics. It is illegal to radiate harmonics and for this reason the PI network is of value. For high power operation the spacing of the plates in the tuning condensers should be wide enough to withstand several thousand volts when coupling to certain types of antennas. Normally, the condensers used in this network when it is coupled to transmitters with no more than 100 watts output should have sufficient plate spacing to withstand at least 1000 volts.

The plate tank of the final amplifier should first be tuned to resonance with the PI network disconnected from the final amplifier. The final amplifier must not be retuned thereafter. Then connect the PI network to the final amplifier and to the antenna. Tune the two variable condensers in the PI circuit until maximum antenna current (or feeder current) is obtained at normal values of final amplifier plate current. The PI network condenser which is closest to the final amplifier is used to obtain resonance in the PI network for any particular setting of the load matching condenser (the one nearest the antenna). The amount of inductance in the PI network coils must be determined by experiment, in order to obtain best results.

Choosing a Suitable Antenna For Your Particular Location

Several types of antennas will give satisfactory results in a given location. In brief, the suggestions here offered will be of help to the experimenter in choosing a good antenna for his particular location.

For those who reside in densely populated areas, such as apartment house districts, hotels, etc., a satisfactory antenna for operation from 80 meters down, would be a half wave antenna with either single wire feed or Zepp feeders. If the transmitter is located on the top floor it is often possible to use an end fed half, or full wave antenna. For 160 meter phone operation a quarter wave (from 75 to 132 ft.) antenna and a one or two wire counterpoise is desirable. If the radio room is on the lower floor of an apartment house, hotel,

etc., and if one-band operation only is desired, the problem merely resolves itself into the use of a twisted-pair r.f. feeder to a half wave doublet antenna. This twisted pair (as used in the Jones antenna) reduces the losses in transmission and the feeders can be run close to walls, down light-wells, around corners, etc., without appreciable effect on performance. If more than one-band operation is desired, two antennas with twisted-pair feeders should be used, one for each band, because a half wave doublet antenna with twisted-pair feeders operates successfully only on one band.

For the operator who desires to work on both the 75 meter and 20 meter phone bands from a single antenna, a satisfactory compromise is to use a very long antenna, operated on one of its harmonics, with end feed at the transmitter. Some multiple of half wavelengths is the proper antenna length to use.

For the operator who desires to use only the 20 meter band, either a vertical half wave antenna or two separate horizontal antennas, placed at right angles to each other, with some form of two-wire feeder, will be satisfactory.

160-Meter Coupling Systems

A simplified Pi coupling system is shown in Figure 1, below. An ordinary single wire antenna can be used and its length can be from 50 to 130 feet long for 160 meter operation. The antenna length is not critical. A good ground is essential for satisfactory operation. Several pipes driven into the earth and spaced a few feet apart and connected together will make a good ground system. Connection to the pipes should be made by means of a ground clamp. The ordinary water pipe system used in the home is not a very satisfactory ground for 160 meter operation because it can cause interference with neighboring BCL receivers. The 150 mmf. and the 500 mmf. variable condensers are effectively in series, through the common chassis ground connection. The advantages of this arrangement are: (1)—There is no DC on the tuning condensers and the condensers will not flash-over on modulation peaks. (2)—There is freedom from filter and rectifier trouble; (3)—Closer spaced tuning condensers can be used; (4)—Ample leeway for tuning the cir-

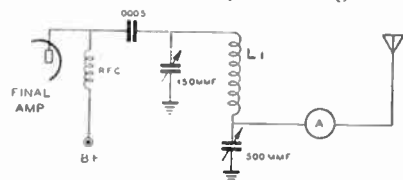
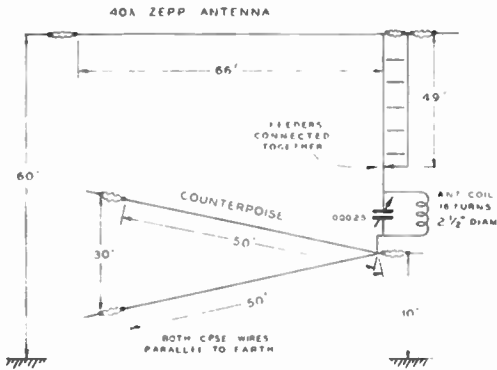

FIG. 1. A simplified antenna coupling system. The 500 mmf. condenser is an ordinary receiving type variable condenser; the 150 mmf. condenser is of the high-voltage type.

How to Use a 40 Meter Zepp Fed Hertz on 160 Meters



The illustration shows a 40 meter Zepp fed Hertz antenna for operation in the 160 meter band. A counterpoise, about 10 feet above earth, completes the circuit to ground and makes a Marconi, or quarter wave grounded antenna out of the combination. The Zepp feeders are connected together and attached to the tuning condenser and to one end of the antenna coupling coil, as shown. The other end of the coupling coil connects to the counterpoise. If the feeders are not of the same length as those shown in the diagram, the number of turns on the coupling coil must be changed in order to establish resonance. The coupling coil should be loosely coupled to the tank circuit of the transmitter. For

40 meter operation, the Zepp feeders are adjusted in the usual manner with the coil and condensers, and the counterpoise is not used.

cut because large variable condensers are used. The plate coil (L1) consists of 60 turns on No. 20 DCC wire, close wound, on a 2-inch diameter form, tapped at the 10th, 50th and 60th turn.

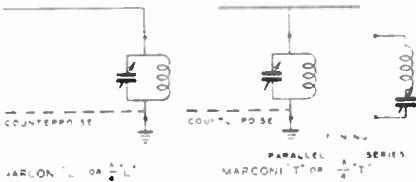

FIG. 3

FIG. 4

Fig. 3 shows the common Inverted-L Marconi Antenna using parallel tuning of the pick-up coil. Fig. 4 shows the same antenna in a T form, instead of an Inverted-L. Practically all 160 meter antennas are of the quarter wave type, as are practically all of the

antennas used in the broadcast band for either transmission or reception. A good ground is essential, and a counterpoise is simply one or more wires close to the ground. These wires have a high capacity to ground. The length of a counterpoise is not critical and is usually made about one-half the length of the flat top portion of the antenna. While the counterpoise is placed close to the ground, yet insulated from the ground, it should preferably run parallel to the antenna. If the counterpoise is not run parallel to the antenna, ground currents will flow, which will cause losses in such places where sand or dry soil is found.

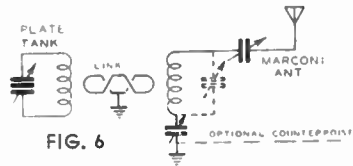
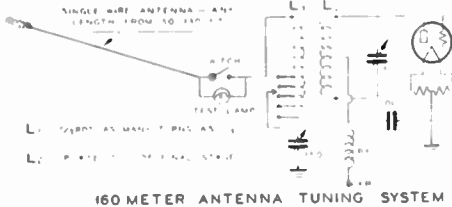

FIG. 6

FOR 160 METER OPERATION

Link-coupling the plate tank to a 160 meter Marconi antenna.



160 METER ANTENNA TUNING SYSTEM

FIG. 5. The circuit shows the use of a tuning lamp in series with the antenna and a shorting switch for bridging the lamp after the antenna is tuned. A better method is to merely wrap a turn or two of wire around the lead-in wire and connect the ends of the loop to the lamp. The lamp can then be left permanently in the circuit.

Figs. 5 and 6 show other methods for adjusting and coupling quarter wave, or Marconi antennas. The choice depends largely on the individual location. It is always desirable to keep the lead-in and the coupling coil as far away from house wiring and metal objects in order to minimize losses. Fig. 6 shows a feeder system which can be used to isolate the lead-in and the coupling coil from the transmitter and metallic objects. The system shown in Fig. 6 has probably the lowest losses. Any of the grounds shown can be replaced by a counterpoise.

Summary of Antennas and Tuning-Up Procedure

● A Hertz antenna is most widely used for frequencies above 3,000 KC because its physical dimensions become so large as to be awkward at lower frequencies. A Hertz antenna is usually characterized by the fact that the radiating portion of the antenna is any even number of quarter waves in length and has voltage present at both ends. All Doublets are Hertz antennas. Practically all antennas that use Zepp feeders are Hertz antennas. The principal advantage of the Hertz antenna is in that it uses no ground connection and therefore its loss resistance is usually lower than is the case when the usual grounded antenna, such as the Marconi type is used. It should be remembered that the "Doublet" is not an antenna—it is a feeder system.

The Marconi antenna is generally used for frequencies below 3,000 KC. However, it is also used for 5-meter operation, especially mobile work, in the form of a quarter wave rod which is grounded at its lower end. The smallest half wave antenna which can be used on 5 meters is approximately 8 feet long and is sometimes too bulky when used for portable or mobile work.

The effectiveness of a Marconi antenna depends, to a great extent, on its height above the ground and the use of a low resistance ground connection. Where a low resistance ground is not available, a counterpoise is used. All Marconi antennas are a quarter wave in electrical length, measured between ground and the far end of the antenna. The electrical length can be adjusted by a tuning condenser either in shunt or in series with the coupling coil. A shunt condenser increases the electrical length, and a series condenser decreases the electrical length of the antenna system. If the Marconi antenna is cut so that its electrical length is exactly one quarter wave at the transmitted frequency, the coupling coil and tuning condensers can be eliminated and some form of single wire feed line can be used to transfer energy from the transmitter to the antenna. Strictly speaking, all antennas are Hertz antennas.

Summary of Feeders

● A feeder is a device which "pipes" energy from the transmitter to the radiating portion of the antenna with as few "leaks" as possible. The less the feeder radiation the better, because feeder radiation is not effective in producing a signal at a distant point.

Resonant Feeders

Practically all resonant feeders can be classified as Zepp feeders. Strictly speaking, they are not feeders at all, but merely rep-

resent a portion of the antenna which is folded back upon itself in such a way that the radiation from that portion of the antenna is minimized.

All Zepp, or resonant feeders must be tuned to resonance. They can be used for either voltage or current feed to the radiating portion of the antenna. Zepp feeders are very inefficient but they have the advantage that they are fool-proof and can always be depended upon to draw plenty of power out of a final amplifier. The feeders may not transfer all of this power to the antenna, but at least they draw the power out of the final tank circuit, which is more than an improperly designed non-resonant feeder system will do.

Non-Resonant Lines

There are two principal types of non-resonant transmission lines. (1) The single-wire matched impedance feed line. This type of line, while more efficient than the resonant type of line, has somewhat higher losses than some of the types to be described later. Its principal advantage is that it is simple to adjust and easy to build and it permits operation on more than one amateur band.

(2) Two-wire matched impedance feed line. This type of transmission line includes the Jones Twisted Pair Line and the Johnson "Q" System, as well as the Fanned-Y type of two-wire line which has improperly been given the general name "Two-Wire Matched-Impedance Feed-Line". This Fanned-Y type of line is rather difficult to adjust, although it gives very good results. It will not operate well on harmonics. The Jones Twisted Pair Line has the lowest radiation and voltage loss. The line can be run around corners, through walls and close to metal objects with little loss.

Its only competitor in this respect is the concentric-tube type of two-wire line, which is extremely expensive to construct. The Johnson "Q" uses a special quarter wave matching transformer to couple a more or less conventional 200 or 600 ohm two-wire line to the 72 ohm impedance which exists at the center of a half wave Hertz antenna. This matching transformer consists of two parallel aluminum tubes, each a quarter wave in length.

Feederless Antennas. All types of end-fed antennas do not generally utilize feed lines and can therefore be termed "directly excited antennas". They are useful because they are tunable from the radio room and can be built in less time that practically any other type. Their main disadvantage lies in the fact that the antenna is brought directly into the radio room; therefore a material portion of the radiation is lost in the radio room and its immediate metallic surroundings.

Directive Effects

● The directive properties of antenna systems are almost entirely dependent upon the length of the radiating portion of the antenna, its height above ground and its slope. A short antenna (up to a half wave long) radiates most of its energy in a sort of a doughnut-shaped pattern at right angles to the antenna wire. As the length of the wire is increased beyond a half wave, the doughnut changes into two cones, one at each end of the antenna. As the length is further increased, the four principal lobes of radiation more and more closely shoot the radiation off toward each end of the antenna. Therefore a short antenna can be considered to be a broadside radiator, while a long antenna is an end-fire radiator. The method of feeding the antenna has little to do with the radiation pattern, as long as the feeders are operating properly. However, when the feeders themselves radiate, the radiation pattern becomes quite distorted.

All antennas are resonant tank circuits and consist of distributed inductance, capacity and resistance. In order to radiate properly, they must resonate at the transmitted frequency. The best test for resonance is shown when the antenna acts as a pure resistance and reflects no reactance back into the transmission line or transmitter.

The Johnson Q

This type of feeder system is a special form of current-fed Zepp feeders tied on the end of a non-resonant transmission line. It was shown that the Zepp system can be quite satisfactory provided the feeders are properly constructed and are suspended in the clear and not located near house wiring or grounded metallic conductors. The Johnson Q system suspends its special low-loss resonant Zepp feeders directly from the center of the antenna and then feeds the lower end of those Zepp feeders by means of an aperiodic, or non-resonant low-impedance line from the transmitter. If the manufacturer's recommended dimensions for this system are followed closely, the losses can be held at a very low value.

This is not a Zepp system. The antenna coil should not be tuned because the system must be non-resonant for proper operation.

A Field Strength Test Set

A field strength meter is a very useful instrument for determining maximum efficiency from a transmitting set and antenna. It actually gives an indication of the power in the antenna and thus it is more reliable for reading values of r.f. current in the antenna or feeders. A method for using the field strength

meter is to connect a short antenna wire to the coil, L1, as shown in the circuit diagram shown here.

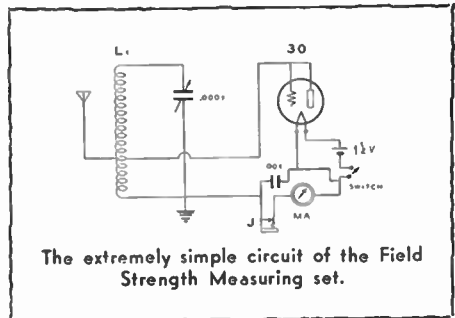

The extremely simple circuit of the Field Strength Measuring set.

Circuit diagram of Field Strength Test Set, a most useful and practical piece of equipment. It is far better to rely on this test set for measuring RF current in the antenna than to resort to the use of the conventional RF thermo-ammeter in the antenna circuit. L1 is an ordinary receiving type plug-in coil, 1½-in. dia. Here is the coil-winding data: For 80 and 160 meters—Wind 63 turns of No. 22 DCC or DSC, close wound; tap at 20 turns from the bottom end of the winding. For 40 and 20 meters—Wind 12 turns, space wound to occupy a winding space of ¾-in.; tap at 4th turn from bottom. For 5 and 10 meters—Wind 2 turns, spaced ½-in. apart, and tap at the exact center. The test set and battery must be encased in a shield can.

Coil L1 is a standard plug-in coil, wound like an ordinary short-wave receiver coil, but with the tap for the antenna taken at a point ¼rd the way up from the bottom end of the winding. This coil is tuned with a midget variable condenser of about 100 mmf. The tube used in this field strength meter is a type 30 (2 volt filament) with the plate and grid of the tube tied together. The MA meter is a 0-1 MA DC milliammeter.

To make field strength measurements, the instrument is placed either in the radio room or somewhere in the yard. An antenna a few feet above ground is entirely suitable for use with this instrument. The transmitting system is tuned for maximum reading on the milliammeter. The field strength meter should be tuned to resonance with the transmitter frequency. This meter is also useful as a phone monitor, or as a check for key clicks. For these purposes an ordinary headset is plugged into the telephone jack, J. The type 30 tube acts as a diode and it provides sufficient emission from a single 1½ volt dry cell to actuate the meter, or a headset at low volume. The diode is only connected across part of the tuned circuit and thus the actual sensitivity is considerably higher than the usual connection where the diode is connected across the entire tuned circuit.

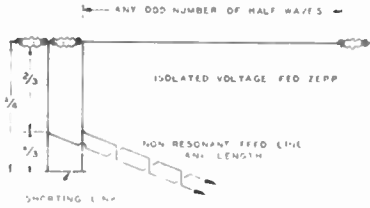

System for matching a non-resonant long RF feeder to the antenna by means of a quarter wave resonant stub line. The location of the non-resonant feed line taps on the quarter wave stub should be adjusted for equal currents each side of the connection to the stub. For transmitting, the non-resonant line should not be transposed. It should have no standing waves; i.e., unequal values of current along the line. The quarter wave stub should have the shorting link adjusted for exact resonance at the desired transmitting frequency.

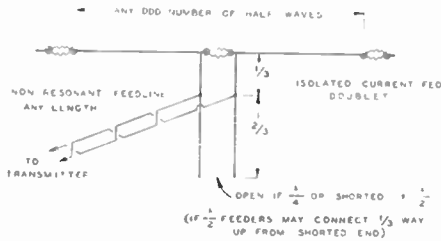

This system is similar to the one shown above, and the adjustments are made in like manner. The length of the stub (or building-out portion) is critical. The flat-top, plus the building-out section, must be in exact resonance with the transmitting frequency. The transposed non-resonant line reduces noise pick-up if the antenna is used for receiving, but it introduces irregularities when the system is used for transmitting.

Bringing the Antenna Into the Radio Room

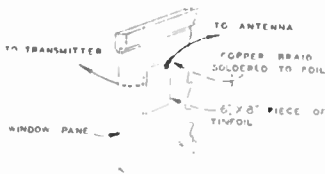

Method for use with receiving antenna or low-power transmitter lead-in. A sheet of tin foil on each side of the window pane acts as a condenser of low impedance.

Angle Radiation

Short-wave signals are reflected or refracted back to earth from ionized layers of atmosphere surrounding the earth. If the main portion of the transmitted wave can be directed at certain angles, the signals at the desired distant points will be received at good intensity, even when the transmitter uses relatively low power.

The angle at which the wave should be directed for best results depends upon the distance and direction desired. For extremely long distances a low angle should normally be used—or an extremely high angle above the earth's horizon. Intermediate angles will tend to shorten the skip distances.

The length of the antenna, direction and distance above ground all affect the angle of maximum radiation. Short antennas of the usual half wave type send out a wave broad-side, shaped something like a doughnut—at right angles to the wire—and the lower half is reflected in or out of phase, upwards, by the ground acting as a mirror. Most of the energy is reflected upwards at very high angle radiation with a half wave horizontal antenna if the antenna height above ground is between a quarter and a half wave. By tilting one end, more energy is sent out in the downward tilt direction.

Long antennas operated at a harmonic tend to give low angle radiation. An analogy can be made with an ordinary garden hose and nozzle, considering the radiation from one end of a harmonic antenna. As the nozzle is turned on from the fine spray position, the cone of water has less angle and is more concentrated. A second or third harmonic antenna is like the fine spray position, while a long one (6 or 8 wave-lengths long), shoots most of the signal out in a sharper narrow cone, having a radiation much greater at its maximum than a half wave or full wave antenna.

A vertical quarter or half antenna sends out a low angle wave which is good for long distance work, but its maximum is less than a very long horizontal antenna, correctly pointed. The vertical antenna sends out equally well in all directions and thus the energy available in a certain direction is much less than from a concentrated beam, such as given by one of the long "lobes" of radiation from a long horizontal antenna.

Careful antenna design will enable a low power signal to get out as well as a high power signal at certain distant points. These points change with the time of day, season and other conditions affecting the Heavside layer or layers.

Antenna and Feeder Adjustment

● The Zepp antenna, with the flat top a half wave long and the resonant feeders odd multiples of quarter wavelengths, is widely used by amateurs. For exact adjustment the flat top should be disconnected and the two-wire feeders tuned for maximum antenna meter current. The flat top can then be connected to one feeder, and if the antenna tuning condensers must then be reset for maximum current, the flat top is not electrically a half wave long. For this form of exact tuning, it is best to first make the flat top portion a few feet longer than the value in feet given by "1.56-times-the-wavelength-in-meters", or other formula used. This flat top can then be pruned a few inches at a time until resonance is obtained—as indicated when the feeder tuning condensers will be at the same setting with the tap either connected or disconnected. It is often desirable to check this effect after an antenna has been up (and stretched) for some time. After the correct length has been determined, the flat top connection to one of the feeders should be soldered in order to preserve a good electrical connection.

When the antenna is clear of nearby objects by a quarter or even an eighth wave in distance, it is usually not necessary to do any pruning because the theoretical length given by simple formulas is generally correct. The reader is again referred to the table on page 180. Exact "pruning" of the Zepp flat-top is not necessary for general amateur operation.

Tuning-up a doublet antenna where resonant feeder wires are connected at the center of the flat top portion, is similar to the method used in tuning-up Zepp feeders. The feeders must be some multiple of half-waves in length, electrically. This can be accomplished by using shunt tuning for feeders less than some multiple of half waves, or series tuning in case the feeders are longer than some multiple of half waves. This same reasoning applies to Zepp feeders, except that some odd multiple of quarter waves is used, such as 33 to 99 feet for a 10 meter antenna which might be 66 feet long in the flat top portion.

It is difficult to adjust the single wire feeder of the average amateur antenna. Usually it is connected about 1/7 (one-seventh) of the total antenna flat top length away from the center of the top section. The top is usually a half wave. If small RF meters are available, they can be connected at points far apart (a quarter wave) in the feeder, and the feeder tuning and antenna connection point moved along until the feeder current is as nearly constant in value as can be obtained throughout the length of the feeder.

The two wire feeder, non-resonant type, should be adjusted in the same manner. If the

power output of the final stage is 50 watts or more, and if bare copper wire feeders are used, the RF milliammeter can be shunted across about 15 inches of one feeder, as shown in the illustration, and the unit moved along one or the other feeder. This method is very useful when adjusting long single or two wire "non-resonant" feeders. Standing waves with variation in line current is an indication of reflection losses and thus the line current should be made as near constant as possible.

A Marconi antenna for 160 meter operation can be adjusted by using series tuning

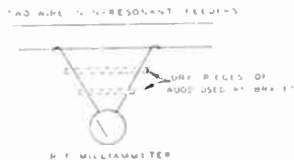

When bare copper wire is used for non-resonant feeders the impedance matching adjustments can be checked by measuring the current along the line, as shown above.

to ground or counterpoise. This calls for the use of an antenna loading coil, tapped, and a series condenser of from .00025 to .0005 mfd. maximum. Resonance can be obtained by switching taps and varying the condenser until the antenna loads the final stage plate current to its normal values. If this value is more or less than the rating of the tube, the coupling between the loading coil and the final tank coil should be decreased or increased.

Another form of antenna and feeder arrangement is the use of a short quarter or half wave resonant feeder connected to the end of a half wave antenna, or into the center. A quarter wave feeder is like a Zepp type and a non-resonant feeder connects about one-third of the way up the resonant feeder. The lower end of the quarter wave feeder is shorted, if it is connected to the end of the antenna, or left open if connected into the center. In the latter case, a half wave section can be used and the free end shorted. The previously mentioned method of eliminating standing waves in the non-resonant portion can be used. With a 600 ohm non-resonant line, the mismatch will not be serious if the resonant quarter wave section is tapped at 1/3rd of its length from the shorted end, or from the antenna in the event the latter is center fed.

In all cases of non-resonant lines an antenna matching system should be used, such as the Collins system, or the simpler method (shown on page 186) of two tuning condensers and a tapped plate coil connected as a low pass filter.

Link Coupling the Final To the Antenna

● Link coupling is used in amateur transmitters because of increased output obtained in any stage of the transmitter. One place for its use is in coupling between the final amplifier tank circuit and the antenna. It is highly desirable to use some form of tuned circuit when coupling the antenna to the final tank circuit. For example, the feeders of a Zepp antenna must be tuned, and link coupling can often be used to simplify the mechanical problems involved. Another case is for a single wire feeder to a Hertz antenna; here the feeder circuit should have an additional tuned circuit in order to minimize harmonic radiation.

In the case of coupling a Zepp antenna, the usual arrangement makes use of two

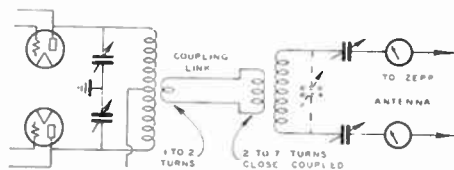

FIG. 1

coils at either end of the final tank circuit in order to obtain a balanced condition. This is an awkward method for varying the coupling and it is sometimes difficult to arrive at the proper number of turns in the coupling coils with respect to the shunt or series tuning condensers. By using link coupling the antenna tuning parts can be located at some convenient point several feet away from the transmitter. More output can usually be obtained if impedance matching is correct. Proper impedance matching is better accomplished when the coupling coils are removed from the plate coil field. The coupling coils are usually wound with heavy copper tubing and thus there is an excess amount of metal with eddy current loss in the field of the plate coil. The use of a two to three inch diameter plate coil of No. 10 or No. 12 wire, space wound, will in such cases give higher efficiency for low C circuits than the use of heavy copper tubing coils, even at inputs as high as a kilowatt. The Zepp tuned coil should be of copper tubing if high power is used because the antenna current runs into high values.

The link coupling circuit should consist of No. 14 or No. 12 rubber covered wire, twisted or paralleled, usually with a one turn loop at the plate coil end and two or more turns in the loop at the antenna coil end. Since only inductive coupling is desired, the

link coils should be wound tightly over the RF voltage node points of the coils, providing only sufficient insulation to withstand the plate voltage used. The number of coupling turns used depends upon the closeness of coupling and the ratio of impedances. The antenna current is low and therefore its link coil should have more turns, closer coupled, than the plate coil. This system is shown in Fig. 1. If a single ended final amplifier is used, such as in Fig. 2, the link coil should be at the RF ground potential end and sometimes it is necessary to use two turns to obtain sufficiently close coupling. It is difficult to obtain proper impedance matching with link coupling unless the link coils are very closely coupled to their tuned coils when the impedances of the tuned circuits are widely different.

Fig. 2 shows a method for link coupling to either a single wire fed Hertz antenna

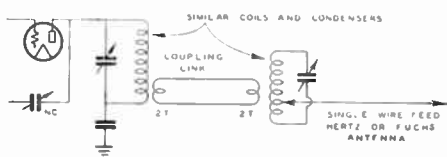
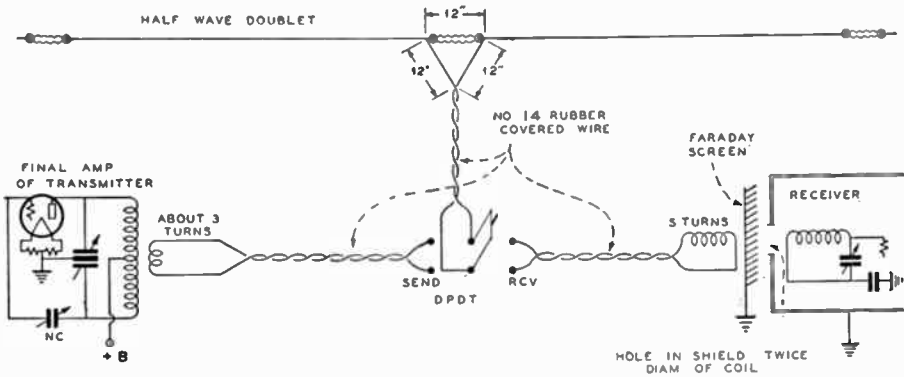

FIG. 2

or to a Fuchs antenna. The latter is often brought into the station operating room. The system shown allows the antenna coupling circuit to be located near the lead-in point and link coupling is used to the transmitter final amplifier. The additional tuned circuit allows impedances to be matched and greatly reduces harmonic radiation. This circuit, when properly adjusted, reflects a pure resistive load on the tube circuit, even for moderate variations of antenna characteristics, such as that due to vibration in the wind. For this reason it should be especially useful with a self-excited oscillator system, when such circuits are used for certain special reasons.

The adjustment of the circuit in Fig. 2 is simple because the impedances can be made nearly equal. One to two turns in the link coils is sufficient. The latter should be located at the RF voltage nodes of the coils. The antenna or antenna feeder should be tapped-up far enough so that normal load is pulled in the final amplifier tube when both tuned circuits are exactly in resonance. A simple field strength meter is very useful in obtaining maximum power into the antenna. This maximum power is obtained when the link coupling, antenna tap and tuned circuit losses are all correct and as low as possible.



FRANK JONES TWISTED PAIR FEED LINE SYSTEM

The Frank Jones feeder system is highly efficient in operation, yet economical and simple in construction. Quick change-over from send-to-receive is accomplished by means of a double-pole-double-throw switch. The feed line consists of a twisted pair of No. 14 solid rubber-covered wire, if a medium-power transmitter is used. No. 16 rubber-covered wire can be used for low-power transmitters. Lamp cord should not be used for the feeders. Each half of the flat-top portion of the doublet antenna should be one-quarter wave long. The feeders can be of any convenient length. Coupling the feeders to a push-pull final amplifier is accomplished in the same manner as for a single-ended amplifier. The feeders must be "fanned" where they connect to the flat-top portion of the antenna, as the diagram shows. A Faraday Screen for use with any type of short-wave receiver is described elsewhere in these pages. The feed line is non-resonant and therefore it should not be tuned, either by series or parallel condensers.

Dummy Antennas

When a transmitter is being tested, it is often desirable to utilize a dummy antenna instead of the radiating antenna in order to more accurately determine power outputs, as well as to prevent interference with other stations when the transmitter is being tested.

A dummy antenna usually consists of a resonant tank circuit whose condenser and coil are selected so as to resonate at the frequency at which the transmitter operates. This tank circuit is coupled to the transmitter either by direct coupling, capacitive coupling, or inductive coupling. Link coupling is the more desirable, because it affords a convenient means for varying the degree of coupling between the plate tank of the transmitter and the load tank of the antenna. In order to dissipate power, some resistance must be coupled into the dummy antenna load tank. A convenient method is one in which one or more electric lamp bulbs are connected in series and the bulbs then tapped across various turns of the tank coil until the final amplifier draws the proper plate input from its power supply.

The resistance of electric lamp bulbs varies widely with the filament temperature of the lamps; therefore it is difficult to determine

accurately the power output of the transmitter by means of the I^2R Law, because R is a variable factor. An approximate estimate of power output can be made by determining the brilliancy of the lamp bulbs when work-

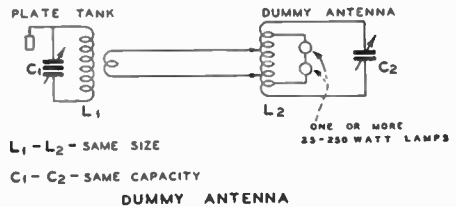

ing as a dummy antenna, as compared with the brilliancy of the same bulbs when connected to a source of 60 cycle voltage. This voltage and current for this given degree of brilliancy can be accurately measured at 60 cycles, but it cannot be accurately measured at radio frequencies. In other words, the power consumed in lighting the lamp to a given degree of brilliancy is the same whether the power is radio-frequency energy or power derived from the 110-volt, 60-cycle power line.

5-Meter Antenna Systems

THE subject of five meter antennas has always been of interest because the results obtained with these miniature systems sometimes can be useful in the design of lower frequency antennas. More and more interest will be shown in 5 meter antenna design as this band becomes more popular for amateur use and as television progresses.

In the transmission and reception of 5 meter signals the direct, or ground wave is used. At longer wavelengths a skywave is utilized and thus great distances are possible by means of reflections from the Heaviside layer. The five meter signals usually seem to penetrate this layer with little reflection back to earth and therefore it is necessary to depend upon the direct wave. The earth is a good reflector for short waves and it is necessary for the transmitting and receiving stations to be within visual range of each other. A hill on the earth's curvature is enough of a "mirror" or reflector to literally bend or push the five meter signals upward to a much greater extent than at longer wavelengths. For this reason an airplane can go from 100 to 200 miles away from a transmitter and still receive five meter signals if it can climb to a high enough altitude.

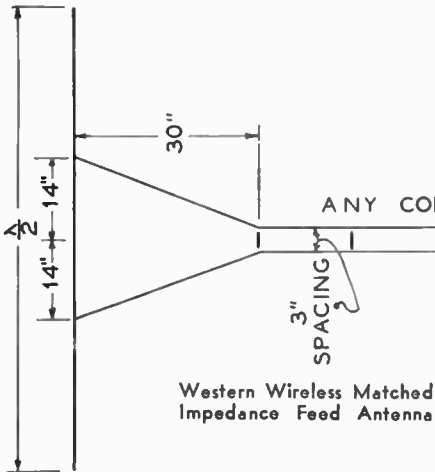
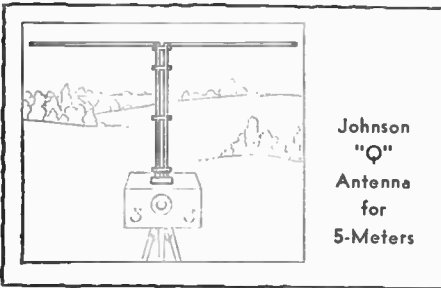

The point to be emphasized in the preceding paragraph is that as much height should be used as possible at both the transmitter and receiving antennas. Since the direct wave is used, an antenna should be used which has a low angle of radiation both for transmission and reception. Vertical polarization has been proven to be much more effective than horizontal polarization and thus vertical antennas are indicated if they are of the simple half-wave type.

Half-wave antennas have been used very successfully because their radiation pattern is a figure 8 with the greatest radiation parallel to the earth. In this case the wave is transmitted at a low angle with respect to the earth, since it acts as a reflector tending to bend the wave front up away from the ground. There is less tendency for upward bend with vertical polarization, otherwise a half-wave horizontal antenna would be just as effective. Of course, the horizontal antenna would have to have its axis perpendicular to the receiving station in order to get maximum effect from the figure 8 radiation pattern, and it would have to be at least a wavelength above ground. Our 20 and 40 meter antennas are usually less than a half-wavelength above ground, therefore the earth acts as an antenna reflector wire and shoots the wave upward at what is termed "high angle radiation."

For transmission an effective antenna is a

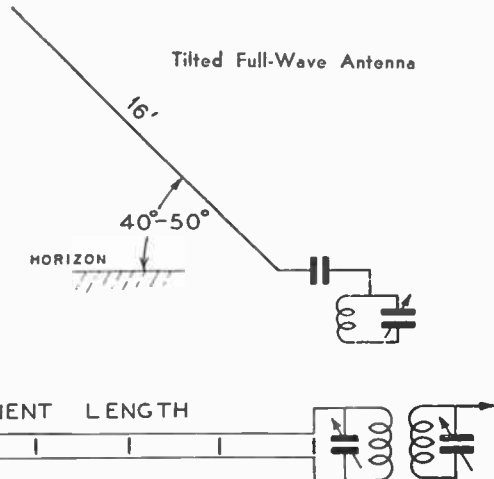

half-wave vertical wire using a two wire matched impedance line. This line can be a pair of No. 18 wires spaced 2 or 3 inches, fanned out in a Y at the antenna end in order to be terminated properly. Each wire can be connected about 13 to 14 inches each side of center of the antenna, and at the transmitter end, terminated across a parallel tuned cir-

cuit which is coupled to the oscillator or amplifier tank circuit. This type of line can be spaced with dowel rod and string spacers, or transposition blocks could probably be used.

In some locations a directional antenna can be used for both transmitting and receiving with a gain of several D.B. units. The simplest form uses parasitic reflectors or directors or combinations of the two. Reflector wires are longer than the antenna and are placed a quarter-wave behind the antenna and a half-wave away if used on the sides of the antenna. Director wires are different in that they are always placed in a straight line in front of the antenna at spacings of $\frac{3}{8}$ wavelength from it and each succeeding director. The beam can be made very sharp if enough director wires are used, and back or side radiation can be minimized by the use of reflector wires which also increase the intensity in the desired direction. These spacings are $6\frac{1}{2}$ feet for director wires, for an average 5 meter antenna resonant at the middle of the amateur band, $4\frac{1}{2}$ feet back and $8\frac{1}{2}$ feet at each side of reflector wires. The following chart gives the proper lengths for these antenna, allowing for end effects:

Wave-length	Freq. MC	Antenna Length	Director Length	Reflector Length
5.0	56	8' 4"	7' 7"	8' 7"
5.17	58	8' 1"	7' 4"	8' 4"
5.36	60	7' 9"	7' 1"	8' 1"
10.65	28.2	16' 8"	15' 2"	17' 1"

A SURPRISINGLY good receiving antenna consists of an eight foot wire with its lower end coupled through a very small capacity to the grid circuit of the receiver. This type works well in any type of building not constructed with too much steel and "chicken wire", such as used in stucco coated exteriors. Moving this antenna a few feet in a room will often increase the signal several fold due to reflective or directive effects of nearby objects, such as house wiring. If most of this antenna wire can be vertical, or nearly so, very good results are usually obtained.

A good transmitting antenna always makes a good receiving antenna, but for purposes of two-way phone operation, or for a person interested in receiving only, other forms of antennas are useful, such as the one described above. Another more effective five meter antenna is the Franklin type which consists of a number of half wave sections with a resonant circuit between each section.

The Franklin antenna is very interesting in that the received signal can be at least doubled with a three section wire 24 feet long with two tuned circuits cut in at 8 ft. intervals. These tuned circuits can be 6 turns of No. 10 or 12 wire on $\frac{5}{8}$ inch diameter with a little spacing between turns and tuned by a three

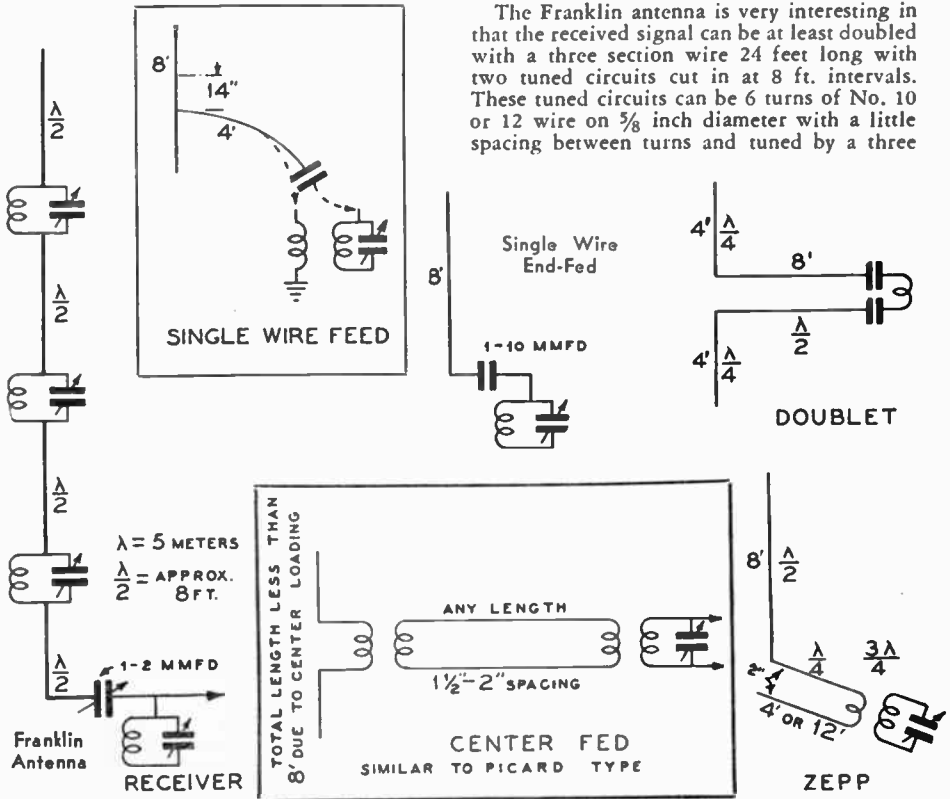

or four plate midget tuning condenser. These coils can be soldered directly across the condenser terminals and the eight foot antenna sections also soldered on these connections. These circuits are easily tuned to five meters by previous adjustment when the coil and condenser are coupled like a wavemeter to a transmitter or receiver circuit. With an outside antenna, these tuned trap circuits should be protected against moisture. Any number of sections can be used in order to increase the effective height above ground.

The purpose of these tuned circuits is to prevent phase reversal of standing waves of voltage and current in an antenna of several half wavelengths. These "phasing coils" reverse the phase without themselves radiating to any extent; the desired effect of a number of antennas all radiating in phase is obtained.

A full-wave antenna, 16 feet long, without a phasing coil and condenser trap circuit has a radiation pattern like a shamrock, or four leaf clover, without much energy going out at right angles to the antenna. This radiation pattern should have a maximum in a direction parallel to the earth for five meter transmission or reception, so a 16 foot antenna can be used if it is tilted at an angle of 40 or 50 degrees toward or away from the desired directions. It should be more effective if tilted towards the desired direction since its upper "loop" would be used parallel to the earth, and because the upper loop would be useful, the effective height would be greater.

Any form of antenna can be used for five meter work, even a wire several hundred feet long, but best results are obtained if the antenna is designed only for five meter use. The vertical half-wave antennas mounted on roof tops with two wire matched RF feeders, or the simple Franklin antennas are by far the best for non-directional transmission and reception.

Directional Antennas

THE VALUE of directional transmitting antennas is that they can be made to radiate most of their power in one direction rather than broadcasting this energy in all possible directions. The result is equivalent to increasing the effective power of the transmitting station by an amount which can be made as much as 100 or more times. From the point of view of amateur transmission a gain of 50 means that 100 watts properly directed would be equivalent to 5 KW on an ordinary half-wave antenna. The disadvantage of the directivity, of course, is that stations in other than the favored direction receive extremely poor signals (i.e., the 100 watt transmitter might be no more effective in an undesired direction than a 5-watt non-directional transmitter).

The first thing to consider about directional antennas is the type and amount of directivity desirable. Experience with com-

mercial directional antennas has shown very definitely that it is possible to have too much directivity, since the waves do not always travel along the same path in reaching the receiver, and that the amount of directivity in the vertical and horizontal planes which can be tolerated is quite different. In general, it is found that the waves travel very closely along the great circle path to the receiver, and that very sharp directivity can be used in the horizontal plane. When it comes to directivity in the vertical plane, however, the situation is somewhat different, as it appears that the best angle above the horizon varies from time to time. Experience indicates that the main beam should be directed at an angle not lower than 10 to 12 degrees and not higher than 25 to 30 degrees, and that the vertical directivity should not be too sharp.

Although many types of directivity antennas have been devised, the present trend is towards a few relatively simple types involving a small number of long wires, rather than a large number of small antennas. The best examples of these are the horizontal V, used by RCA, and the horizontal diamond, developed by the Bell system. Antennas of these types are shown in Figs. 1 and 2. It will be noted that both of these antenna systems involve relatively simple structures which are correspondingly simple to build and easy to tune.

The principal factor controlling the design of the V antenna is the angle between the wires. This is determined by the length of the wire according to the relation shown in Fig. 3, and is relatively critical. The amount of directivity obtainable is greater the longer the wires, and commercial antennas of this type are commonly made about eight wavelengths long. A reasonable directivity can be expected, however, for lengths of two to four wavelengths. A number of feeding systems may be employed, of which perhaps the simplest is to make each wire an odd number of quarter-wavelengths long (as, for example, $3\frac{3}{4}$) and then use a resonant transmission line having a current maximum at the junction of antenna and line. The tuning-up process is then just as simple as any current-fed antenna system. If voltage-feed is desired the wires should be an even number of quarter-wavelengths long (as, for example, $3\frac{1}{2}$).

A single V antenna is bi-directional. The back end radiation can be redirected forward by a reflecting antenna similar to the radiating antenna but located an odd number of quarter-wavelengths behind and faced so that the two antennas are supplied with current 90° out of phase. The exact details of accomplishing this result are somewhat involved and should not be undertaken unless one has had some experience with problems of this sort.

The diamond antenna operates in a manner considerably different from the usual antenna employed by amateurs. This antenna is non-resonant and possesses a current distribution which dies away uniformly from the input corner to the terminating resistance. As a result of this behavior, the diamond antenna is not critical with respect to frequency and can be used without any change of adjustment over a frequency range of at least 2 to 1. The antenna is, furthermore, uni-directional, since the terminating resistance eliminates the radiation which would otherwise take place in the backward direction. These properties make the diamond antenna desirable from many points of view. It can, for example, be used at 20 meters in the daytime and 40 meters at night without any change. In constructing a diamond an-

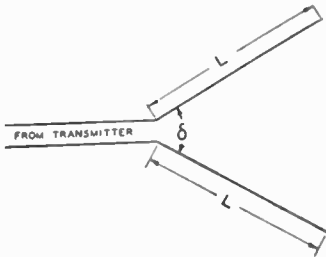

FIG. 1

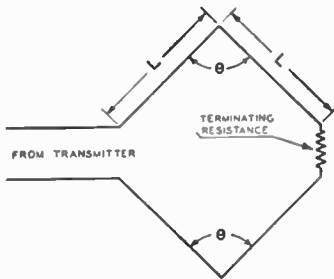

FIG. 2

tenna the proper thing to keep in mind is the angle θ which is related to the length of the legs as shown in Fig. 4. The terminating resistance should then be given the value which eliminates the resonances along the line and will be in the order of 800 ohms. The antenna also offers a resistance load of about 800 ohms to the transmission line.

The vertical directivity of horizontal antennas such as have been described depends primarily upon the height of the antenna above ground rather than upon other characteristics of the antenna. This is because the

ground reflects the energy radiated in its direction and this reflected energy combines with the main energy either to reinforce or to cause cancellation, depending upon the vertical angle. The higher the antenna the lower (i.e., the nearer the horizontal) will

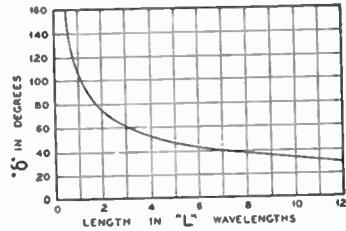

FIG. 3

These charts courtesy of Prof. F. E. Terman.

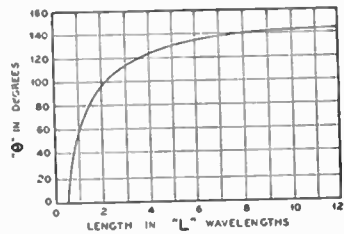

FIG. 4

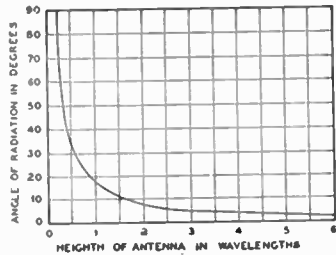

FIG. 5

the reflected energy reinforce the directly radiated energy with the result that the higher the antenna above ground the closer to the horizontal will be the radiation. This is shown in Fig. 5 from which it is seen that if the height is one wavelength then the bulk of energy will be directed at a vertical angle of approximately 16°, while if the height is one-half wavelength, the angle will be 30°. Horizontal antennas should therefore never be less than 1/2 wavelength above the ground if they are to be used for long distance communication.

5-Meter Tuned Diamond Antenna

A TUNED Diamond Antenna has given better results than the Diamond Antenna with a resistor at the far end. By carefully tuning each side of the Diamond Antenna, the resistor can be eliminated.

For the sake of convenience, take the approximate center of the Five Meter Band, namely, 5.172 meters, as a basis for the working arrangements and discussions. Experimentally, the figure, 1.56 has proved to be a reliable one. Multiply 1.56 x the wave length, and the correct half wave length can be found without much experimentation. However, the type of surrounding objects all enter into consideration, so if anyone is anxious to have a fine, good working diamond antenna, the following procedure should be carried out.



FIG. 1

Each side of the Diamond (Fig. 1) should be one full wave length, namely 16 feet 2 inches. The angle in the case shown, that is, for one wave length a side, is 121 degrees.

If more space is available the diamond shown in Fig. 2 can be used, where each side is two wave lengths, or 32 feet 4 inches. In this case the angle must be 87 degrees. The

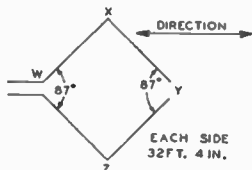
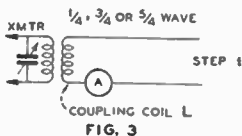

FIG. 2

arrow at the top of the diagram shows the direction of wave propagation and also the direction of best reception.

The antenna shown in Fig. 2 will give a stronger wave in the direction indicated, as compared with the antenna in Fig. 1.



The first step in tuning of the antenna is shown in Fig. 3, namely, a quarter wave feeder. A five-meter quarter-wave feeder is only four feet and one-half inch long, so any mul-

tiples of four feet, one-half inch, can be used.

For instance, the odd multiples would be

- 4 ft. 1/2 inch.
- 12 ft. 1 1/2 inches
- 20 ft. 2 1/2 inches
- 28 ft. 3 1/2 inches
- 36 ft. 4 1/2 inches, etc.

The most convenient feeder length can then be chosen and the transmitter coupled to the Antenna Coupling Coil as shown in Fig. 3.

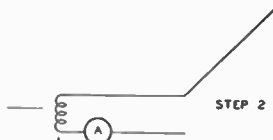

FIG. 4

A glow lamp can be placed in the antenna at "A" or a small ammeter, sufficient to give a reading while the transmitter is on low power, can also be used. Be sure the transmitter is on low power, otherwise the ammeter will burn out.

Move the clips back and forth on coupling coil "L" until resonance is secured with the transmitter set at the required wave length, which in this case is 5.172 meters.

Then lower the feeders, attach one side of the diamond, say 32 ft. 4 inches, hoist the feeders with the 32 ft. 4 inch side on it, and repeat the process. If the clip on coupling coil "L" comes out on the same turn, then the 32 ft. 4 inch section is right. If more turns have to be used, then the 32 ft. portion should be made longer. If less turns have to be used, then cut off a few inches of the 32 ft. wire until it reaches maximum resonance at the same point as it did in Fig. 3.

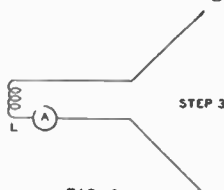

FIG. 5

In Fig. 5 is shown two sides of the Diamond. The tuning process is repeated here. In this case, both of the sides should be the same length.

Fig. 6 shows the completed diamond. It should likewise check-out just the same as did the coupling Coil "L" near the previous stages. We now have a completed Diamond. The angle shown by the curved arrow should remain at 87 degrees throughout the test. When completed, this antenna will radiate very strongly in both the directions shown by

the arrow and, will also receive strongly from those directions.

If one of the directions is not wanted, then

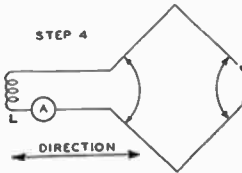

FIG. 6

the back wave can be cut off by inserting the resistor in the open end, as shown in Fig. 7. This resistor should be non-inductive of wattage equal to $\frac{1}{2}$ the transmitter output and should have a value from 600 to 800 ohms. The tuning process can also be re-

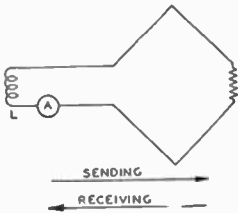

FIG. 7

peated in this case, and it will be found to remain the same, although the resistor takes the definite resonance point out of the tuning and cancels the back wave. We then find the direction of transmission as shown on the single-ended arrow, and likewise receiving is started from the direction on the receiving arrow.

If the antenna is slanted so that, for example in Fig. 2, "W" is higher than "Y", then the signals will be stronger towards the direction of "Y", i.e., away from "W".

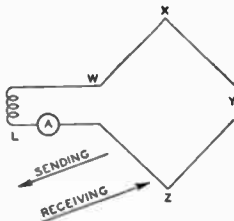

FIG. 8

If "Y" is made higher than "W", the reverse is true, i.e., signals will be stronger towards "W" and away from "Y".

The reverse is true for receiving, namely, the same direction in which transmission is strongest is the direction from which best reception is secured.

If the two edges "X" and "Z" cannot be

made the same height no serious difficulty will be encountered. However, in this case there will be a sort of angular change. For instance, if "X" and "Y" are higher than "W" and "Z", the direction of transmission will be as shown in Fig. 8, but by raising any one of the four corners, a stronger signal can be sent away from any one of the four raised corners.

If it is desired to radiate in an exactly horizontal position, the chart shown by Professor Terman in these pages should be consulted. His Fig. 5 shows the angle of radiation in degrees, depending upon the height of the antenna in wave lengths. Take a specific case, for example. If 36 feet $4\frac{1}{2}$ inch feeders are used, this length would be

THE information in this article, while primarily intended for 5-meter operation, is likewise applicable to 20 and 40 meter work. For 20 meter operation, multiply the dimensions by 4, for 40 meter operation, multiply the dimensions by 8. The factor 1.56 can still be used to work on the exact frequency of the crystal in use. Final tuning adjustments are the same as for 5 meter work.

Use of Professor Terman's chart for angle radiation will also enable you to utilize desired skip effects. Because the average 40 and 20 meter Diamond antennas for amateur work will not be very high above the ground level, in terms of wavelength, they are at their best when tipped; the low portion of the Diamond is pointed in the direction of the distant stations which the operator desires to work.

The back-wave radiation from a Diamond is wasted, or absorbed by the resistor, but the remaining signal strength is so greatly increased that no consideration need be given to the waste from back-wave radiation.

approximately two wavelengths, and two wavelengths would be 32 ft. 4 inches off the ground. The angle of radiation is 7 degrees, as shown in Professor Terman's chart. If the antenna is slanted 6 degrees the angle of radiation would be exactly horizontal.

The Diamond Antenna puts consistently more energy into the air than any other type of antenna. It is larger and requires a little more space than other types of antennas. For a 5-meter antenna the space required is not large, and even the antenna shown in Fig. 2 can be put in the average location. The ideal condition would be to have two or three antennas placed at opposite ends of the property, so that directional transmission could take place in any desired direction.

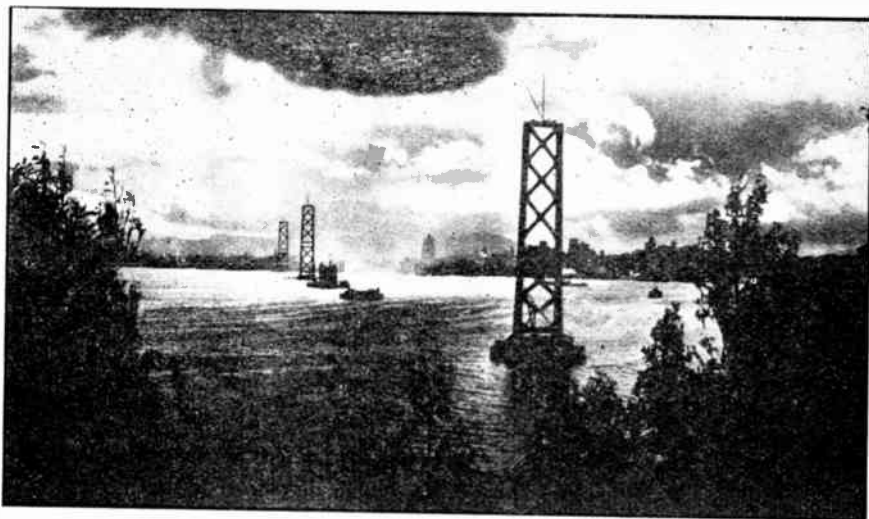

A large number of 5-Meter Transceivers are in constant operation as an aid in building the giant San Francisco Bay Bridge.

Technique and Principles of Ultra-High Frequency Communication

THE following information collected after many years of specializing in this particular field, while perhaps not new to all, will supply practical hints and ideas to many experimenters. The information is divided under separate headings.

I. Transmission Characteristics

ULTRA-HIGH frequency transmission of radio energy below approximately 7.5 meters or 40 megacycles has a field all its own. Its field of use is restricted to a great number of purposes where local communication is required, due to the fact that the wave does not return to the earth by reflection from the mirror-like Heavside Layer. On very rare occasions it is possible that this takes place for brief intervals but such transmission is of no value.

Because of this fact several advantages are gained for its local uses. The so-called ground radiation only is utilized and no fading or variation in signal strength occurs. The range of transmission may be governed by the elevation of the transmitting antenna and to some extent by the transmitter power. It is limited to a distance somewhat in excess of the radius of the horizon as seen from the transmitting antenna when the receiving points are at ground level and to a distance somewhat in excess of the combined horizon distances when both transmitter and receiver antenna are elevated.

Waves at these frequencies travel in optical paths like light and behave exactly according to the theories for light rays. Their wave lengths, however, are still millions of times greater than the wave lengths of light. For this reason the path of these waves is not a straight line joining the two points on the earth. Light waves bend in passing from one point to another very slightly, this effect becomes more and more pronounced as the wave length increases. In the ultra-high frequency bands this effect has become so pronounced that the optical path is no longer approximately straight but is curved along a line which is the circumference of a circle about 4 times the radius of the earth. This is due to refraction caused by the earth's atmosphere and its exact curvature is dependent upon the variation of density of the air with altitude. Since this changes from time to time the range beyond the true horizon may vary. One result which has been observed by us many times is the gradual increase in range or in the signal between two points after the sun goes down and darkness approaches. The reason is that the density of the atmosphere near the earth's surface increases as the temperature falls, this results in the optical path through the air becoming more curved so that it remains closer to the earth after passing the true horizon. In one case we have observed where the two stations were beyond the light horizon no signal at

all was obtained during the day. Soon after the sun went down the signal began to come through and by the time it was dark a very reliable signal was received. Over another circuit 40 miles long the straight line of sight enters the ground at two miles from one station and six miles from the other. Both stations using 15 watts of antenna power are always in reliable two-way phone communication but the signal strength always improves at night. Between two such points 40 miles apart, if all the intervening space were at sea level, the earth curvature causes the surface to rise approximately 260 feet. In other words, over the ocean towers nearly 260 feet high would be required at each end to be visible to one another. A circuit over this path on 5 meters would require towers nowhere near this high on account of the increased curvature of the radio optical path. Over land the ground elevations above sea level are added to this curvature "bump" and result in increased attenuation, and of course become serious if the elevations of ground are great near the mid-point of the path.

The "light horizon" in miles from an elevated antenna location can be found by taking the square root of the height in feet of the antenna above sea level and multiplying it by 1.23. For instance if the antenna is 100 feet above sea level the horizon is 12.3 miles (the square root of 100 is 10 which multiplied by 1.23 gives 12.3 miles). The "radio horizon" is greater and the multiplying factor is approximately 1.4 instead of 1.23. In other words, communication is reliable over sea or over land at sea level for a distance approximately 20% greater than the light horizon.

The topography of the intervening terrain modifies this picture to a great extent. A fair picture of whether transmission is possible or not can be had by using the "Haigis Method". A circle is drawn passing through the two station locations with a radius of 60 inches. Elevations taken from a contour map are plotted on this circle along extended radii with a scale of $\frac{1}{8}$ -in. equalling 10 feet in elevation. If a circle whose radius is 240 inches is drawn passing through both antenna locations and does not pass through any of the elevated points between, transmission is assured, provided, of course, that the transmitters have sufficient power. If this line passes through one or more peaks on the way, transmission is usually still possible but each one increases the attenuation to some extent.

When one station is located in the shadow of a high hill other facts enter into the problem due to reflection and diffraction which make individual problems in themselves and they usually are solved by changes of antenna location, which may amount to only a few feet. These effects also come into play in all transmissions but it is the writer's opinion after extensive tests that refraction plays the most important role.

For estimating short distance circuits such as occur in a city and its immediate surroundings, if reasonably flat, a fair estimate of range can be obtained by use of the above formula tempered with good judgment as regards height of antenna necessary to overcome local obstacles such as tall buildings (which offer considerable attenuation) and intervening hills.

The power required is astoundingly small. Using a Transmitter-Receiver putting about .5 watt in the antenna there is no difficulty in contacting the amateurs within a range of from 6 to 15 miles in the Philadelphia area. This area is, of course, quite flat with no elevations of any account. With 15 watts power the 40 mile circuit described above is reliable.

One reason for the low power requirement is due to the fact that fully resonant antenna can be used. A highly efficient transfer of power into radiation is possible in such a system as compared to one where loading coils are necessary to bring the antenna to resonance. It is well to remember, also, that within the area to the horizon more power produces higher field intensity and that at points in this area where, due to obstacles, the signal is weak, more power will remedy the situation.

In free space, from an airplane where line of sight exists, power of the order of .5 watt is often sufficient for ranges up to 100 miles although greater power is required for the return circuit to produce a strong signal intensity at the plane. This is necessary so as to overcome the exceedingly high surrounding noise level through which the signal must be intelligible. With a plane flying at 1500 feet the "radio line of sight" is between 50 and 55 miles. Using .5 watt antenna power the attenuation is such that reliable communication using a sensitive super-regenerative receiver is just possible to the ground. By the reciprocal law .5 watt at the ground station will produce the same signal strength at the plane but this would not be reliable on account of the plane noise. By actual test to a balloon these statements were proven.

2. Receivers for Ultra-High Frequencies

THE super-regenerative type of receiver is in some form almost universally used for reception. Peculiarly and in contrast to the difficulties encountered in designing equipment to meet the requirements of higher and higher frequencies in the last few years, super-regenerative detection becomes less and less critical.

To explain, simply, exactly how this form of detection takes place is not a simple matter but some of its characteristics are easy to visualize. As it is used for phone and tone telegraph reception, the detector oscillates intermittently at a frequency above audibility (20 to 25 thousand cycles). In such an intermittently oscillating circuit, an incoming

signal will build up to an enormous value depending only on the grid swing possible with the type of tube used. When no signal is present the tube and circuit noises are built up by this action until they produce the extremely high noise or rush level so familiar to those using this type of detection. It is well to remember that this noise is the result of extreme sensitivity and that it is not an inherent phenomenon of super-regenerative action but would be and is present in any form of detection of equal sensitivity.

The noise is made up partly of the "Shot Effect" due to the irregularity of electron emission from the filament and partly due to the noises of the currents flowing in the tank circuits and leads. The part due to the emission can be eliminated to some extent by using tubes having filaments from which the electrons are emitted more regularly. Pure tungsten filaments seem best, next the thoriated type, then oxide-coated, and finally the heater type. There is little difference between the thoriated and oxide-coated type, but quite a large jump in noise takes place between the oxide type and heater type, not so much in the loudness of the noise but rather in the smoothness.

When a signal comes on, it will automatically reduce the sensitivity of the tube, and consequently the background noise by an amount depending on the strength of the incoming carrier. A weak signal well modulated can be heard through the noise even though it is only slightly reduced. A strong signal will completely remove all background noise. We consider a signal perfectly reliable if the background noise is reduced by 6 db. or more. Insofar as detecting action goes, the super-regenerative receiver behaves like a receiver with automatic volume control, the super-regenerative detector being inherently 100% automatic in controlling volume.

One particular disadvantage lies in the selectivity of such a detector. It is extremely

broad due to the time-delay principle employed in building up the signal. It builds up in the circuit to its maximum value during the non-oscillating periods, and this action greatly reduces the selectivity. Another disadvantage is due to the radiation from the detector. When receiving, the detector oscillates intermittently and, of course, radiates a signal fully modulated by the quenching frequency. Another receiver operating within receiving range of the radiating receiver's carrier, picks it up and the beat notes between the quenching frequencies of the two receivers cause very serious interference. This may happen over quite large distances (a mile or more). The more sensitive a detector of this type is the more radiation it has and consequently the more trouble it makes. It makes little difference whether it be of the self-quenched oscillator type or of the type where the oscillator is intermittently stopped by a separate quenching tube. The self-quenched type is the more sensitive if constructed properly, since the stop and start of the oscillation period can be made sharper. This gives the signal more time to build up.

It is possible to use a RF amplifier as a blocking tube between the detector and antenna, and to really get some gain but it is not an easy job to do it. Even the best screened grid tubes at ultra-high frequency allow considerable energy to be by-passed in the wrong direction. Then again the power cable to the set is usually of sufficient length to act as a fairly efficient antenna. Choke coils in the individual leads do little good since the spurious capacities to the set at the cable entrance are sufficient to allow considerable RF power to pass to the cable.

The chief advantage of this type of receiver, namely its extreme sensitivity, should be an incentive to the experimenter and engineer alike in developing improvements to remove its disadvantages. Little intensive study has been made of this method and the writer believes that big strides can be made with it.

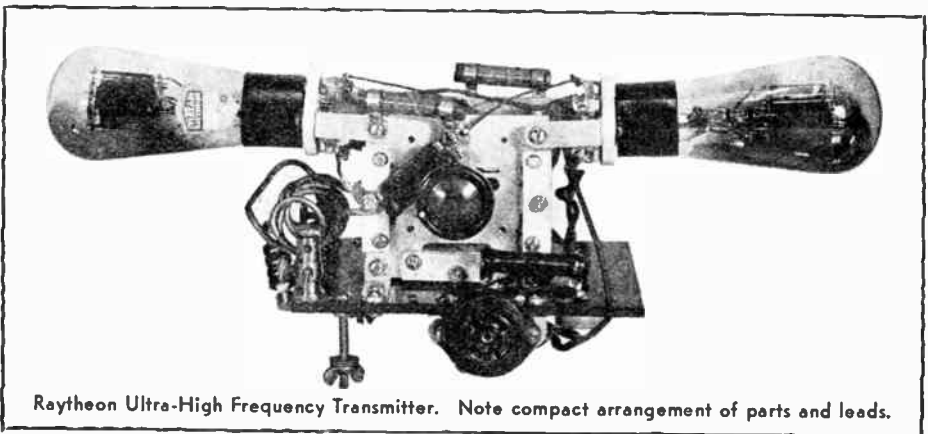

Raytheon Ultra-High Frequency Transmitter. Note compact arrangement of parts and leads.

The superheterodyne receiver for these frequencies will also find use in this field and will soon supersede the super-regenerative type. Until such time as the transmitters in general use have better frequency stability, there is little to be gained by its use. There are many difficulties in the design of such a receiver, but it is well to bear in mind that, if the sensitivity is increased to approach that of the super-regenerative type, there will be an equal amount of tube noise, if the receiver is not properly designed.

3. Transmitters

ALMOST any type of circuit will oscillate quite efficiently at frequencies down to 70 or 75 megacycles, if a few simple precautions are observed. By far the most popular type has been the tuned grid tuned plate type in push-pull arrangement. At the highest frequencies this has a distinct advantage, since the tube capacities are in series across the tank circuit, but at frequencies up to 60 megacycles, there is little choice between it and the same circuit single ended, other than the increased power result-

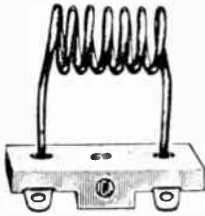

Conventional 5-Meter Inductance.
The illustration is actual size.

ing from two tubes. In designing any circuits for these frequencies, short leads are very essential. It is hard to believe that a straight piece of wire a few inches in length has sufficient inductance to offer any impedance but it is nevertheless true (an inductance of one microhenry offers a reactance of 400 ohms at 60 megacycles). For this reason the tank circuits should be connected to the tube elements by as short leads as possible. The design of ultra-high frequency equipment is as much mechanical as electrical, and the test "bread board" set-up cannot be transformed to a different layout in the finished set with equal success. The practice of some large laboratories of segregating electrical development and mechanical design in engineering radio equipment has not produced very satisfactory results in the ultra-high frequency field.

By and large the greatest number of transmitters operating in the amateur band are made up of directly modulated oscillators. In most sections of the country the frequency instability resulting from this does not cause any great interference. The time is rapidly

approaching where this order of things will change. The master oscillator, power amplifier type should be the present goal of the amateur. With it will come an improvement it is well to mention. Frequency modulation occurs when the oscillator is modulated and becomes very noticeable when the percentage of modulation is high. Many side bands are produced and the energy is spread over them all instead of being concentrated in the two which are present when the carrier frequency is constant. This results in a weaker detected signal spread over quite a wide band. When detected in a super-regenerative receiver, the signal can be heard spread over a large proportion of the silent region. If a good M.O.P.A. transmitter is used, the voice is observed quite sharply in the center of the carrier, and since the side band power is concentrated at one point, the signal is louder for the same modulation percentage, and consequently greater range may be expected. In addition the amplifier may be modulated to 100%. In the M.O.P.A. transmitter it is well to note that the oscillator should be designed with proper circuit constants so that, as far as possible, frequency stability is assured even though the supply voltages may vary slightly. A sufficiently powerful oscillator is also a good thing in order that the coupling between it and the amplifier can be reduced sufficiently to prevent reaction of the modulated amplifier on it. Tubes of the same size in both oscillator and power amplifier have been found to be satisfactory.

Class B modulators are perfectly satisfactory and economy dictates their use. For the smaller units a single power supply for the entire equipment can be used if care is taken to insure extremely good regulation. For the larger units the Class B modulator should have its own power supply to prevent any frequency fluctuations of the oscillator due to the voltage drop in the supply when modulating. The oscillator and power amplifier may be supplied from a second unit quite satisfactorily, or three units may be used, the oscillator then having its own supply.

A well-designed 5 watt transmitter should be quite satisfactory for all amateur purposes. Increased power accomplishes little in extending the signal beyond the horizon, and, except in those cases where the location is shadowed, will produce sufficient signal strength within the horizon radius.

A word here about the gain to be expected from increased power. Little is gained by just doubling the power. The signal strength is increased by only 3 db, and this is just noticeable. For this reason power increases are generally made in multiples of 10, which give 10 db. gain for each step. In other words, if your location is so shadowed that 5 watts is unsatisfactory, little improvement will be noted unless a jump to a 50 watt carrier is made.

4. Antenna and Transmission Lines

THE antenna almost universally used for fixed stations is the vertical half wave dipole. A horizontal dipole is directional at right angles to its axis and it exhibits this characteristic very noticeably in free space and to a less degree where local reflections caused by buildings and hills change its pattern. A wave radiated from a horizontal dipole is polarized in such a way that it must also be received on a horizontal dipole so that the experimenter wishing to operate with stations in all directions from him, using vertical dipoles, must do so himself if results at all satisfactory are expected.

In the 56 to 60 megacycle band a rod one-half inch in diameter is resonant if cut to approximately 93% of the actual half wavelength of the frequency used. Since it has a high radiation resistance, (74 ohms), its resonance curve is very broad and its length is not very critical. A rod cut for 58 megacycles can be operated quite satisfactorily anywhere in the 56 to 60 megacycle band. It should be mounted as high and as free from all surroundings as possible. The supports for it should be near the middle rather than at the ends where voltage maxima exist, to reduce losses. If possible, it should be supported by brackets holding it away from the mast by 2 feet. The upper portion of the mast extending beyond the lower end of the dipole should be of wood, but the rest can be of metal. Guys should be attached at a point below the lower end of the rod. We have found little to be gained by breaking up the guys with insulators at these frequencies.

The antenna may be supplied with power from the transmitter by a transmission line, either of the matched impedance type or of the resonant tuned type. In either case some method must be used to determine when the antenna is at resonance. The writer believes this problem is the most difficult one confronting the ultra-high frequency experimenter. The direct method where thermocouple meters are inserted in the antenna is the most reliable, since definite assurance of radiation is thereby obtained.

Before taking up the transmission line let us consider some of the electrical characteristics of the half wave dipole. If the rod were cut in two at the middle and its impedance measured, it would be found to have a resistance of about 74 ohms, if it is several wavelengths above the ground. Near the ground this value may be anything from 10 to 100 ohms, but above one wavelength it never goes below 65 ohms or over 80. Due to this change, the method often used of making adjustment first, and then raising the antenna, is not a good one.

Now an antenna, even though it is a straight rod, has inductance and the two opposite ends have capacity to each other. As a rough approximation, the antenna can be considered

as a coil shunted by a condenser similar to the tank circuit of an oscillator with 74 ohms of resistance inserted in series with the coil, to represent the radiation resistance of the antenna. If the tank circuit or antenna were tuned to say 60 megacycles, and the coil (or antenna) cut in the middle and the impedance measured, the resistance would be 74 ohms. If we don't cut the coil (or antenna), but simply measure the value of impedance across one turn (between two points equal distance from the center of the antenna) the impedance will be higher and will increase the farther out we go, until when we measure across the entire tank circuit (between the ends of the rod) we measure a very high impedance. For a well-designed tank circuit this may be 10,000 ohms or more, for the antenna it is of the order of 13,000 ohms.

Now, to transfer the maximum amount of power from one circuit to another the impedance must match fairly closely. A mismatch of 2 to 1 is not very serious but we, of course, endeavor to match correctly.

A two-wire transmission line made up of two No. 14 bare copper wires spaced 2 inches apart has an impedance of approximately 500 ohms and if we want to match this to an antenna the simplest way is to attach it at two points equidistant from the center where our measurements show the impedance of the rod to be 500 ohms. The points at which this occurs are spaced 24% of a half wave length apart. As an example suppose we wish to set up a matched impedance antenna for 58 MC. The wave length is 5.17 meters or 203.5 inches. One-half wave length is 101.8 inches. The $\frac{1}{2}$ -inch diameter rod is cut 93% or 94.5 inches long. The tap-offs are made so that the points are 24% of the actual $\frac{1}{2}$ wave length apart or 24% of 101.8 inches which equals 24.4 inches or 12.2 inches each side of center.

The line made up as indicated above is spread out from a point about 24 inches away and at right angles to the rod and attached. It may be run for any length to the transmitter. If the match were perfect there would be no standing waves on the wires and a neon light will show the same brilliancy when touched at any point of either wire. Such a perfect match is seldom obtained in practice and standing waves exist to some degree in most installations. The goal to strive for is to make them a minimum by changing the line length a few inches at a time, noting for each length the transmitter setting for minimum standing waves. A position will finally be found for the transmitter setting and length which is best.

This type of line is best connected directly to the tank circuit through fixed blocking condensers and no series or parallel tuning of the line is needed.

If four thermo-couple instruments are available having the same range this process

can be simplified by connecting one in series with each line at the set and one in each line at a point approximately one quarter wave length away. Adjustment can then be made as indicated above until all four meters are made to read as near alike as possible.

A further and conclusive proof of correct adjustment can be had, if convenience permits, by placing a meter in each outer leg of the antenna itself at the tap-off point. Adjustment of the length of the line as indicated above until these meters read alike and maximum, together with tests of standing waves on the feeder line, make certain that best adjustment has been reached.

In this type of installation the use of a meter at the center of the antenna is not recommended as this meter will show a large reading when standing waves are present on the line which then acts as a Lecher Wire system and delivers no energy to the outer ends of the antenna which do practically all of the radiating. The line should be installed to clear surrounding objects by at least 10 inches and where bends are made they should be of as large a radius as possible.

There is on the market a form of matching transformer consisting of a coil which is connected to the matched impedance line and which has taps at 74 ohm points to which the antenna can be connected by cutting it at its center. There is no advantage in this method over the one described above and it is undoubtedly not as efficient.

There are two other methods of matching which should be mentioned because of their adaptability in certain installations. They both make use of a length of transmission line as a transformer. If a section of transmission line $\frac{1}{4}$ wave length long at the frequency we desire to operate is shorted by a jumper at one end and the antenna is attached to one wire at the other end, points can be found along these lines where the impedance is 500 ohms. To these points equidistant from the jumper the line is attached. This quarter wave transformer can be hung directly beneath the antenna rod and may be convenient to use in some cases, although no better results will be obtained than when the antenna itself is used for the matching.

The same principle can be employed by connecting a $\frac{1}{2}$ wave length of line to the center of the antenna, shorting the far end. In this case two 500 ohm points can be found which are approximately the same distance from the antenna end and the shorted end. The line can be attached at either point and standing waves eliminated.

These $\frac{1}{4}$ and $\frac{1}{2}$ wave line transformers are usually used in setting up directional arrays and are here described so that those caring to experiment may do so. The most all round practical type of matched impedance antenna is that described first in this section.

Nothing yet has been said about concen-

tric tube lines where the two conductors are formed of pipe or tubing and arranged one inside the other. This type of line is more difficult and expensive to construct but has many advantages, one being that the energy is all confined inside the outer tube, the line itself cannot radiate, the outer tube may be grounded at any point along its length or even buried in the ground with no loss in efficiency.

Two wire lines cannot be constructed which have a very low impedance. For 6 inch spacing the impedance is 628 ohms, for 4 inch spacing 578 ohms, for two inch spacing 495 ohms, for 1 inch 413 ohms and when the wires are spaced only .1 inch or are practically in contact the impedance is 137 ohms. This drastic change of 60 times in the spacing has reduced the impedance to only 137 ohms from 628 or by a factor of 4.5. It can be seen from these figures that the wire spacing of a two wire line is not very critical and that variations in the spacing, unavoidable in construction, will have little effect.

A concentric tube line can easily be constructed to have much lower impedances. If the ratio of the outer diameter of the inner conductor (which may be either solid or tubing) to the inner diameter of the outer tubing is 3.44 the line will have an impedance of 74 ohms independent of the size of pipe and will form a matched impedance system into the center of a dipole, the outer tube to one side and the inner to the other. A line made of $\frac{3}{8}$ -inch outside diameter tubing having $\frac{1}{32}$ -inch wall for the outer sheath and No. 4 B & S copper wire for the inside meets these specifications very closely. Thin bakelite spacers can be used at intervals to hold the inner conductor in place.

Such types of line as applied to ultra-high frequency uses are more particularly adaptable to mobile automobile and plane installations since they can be bent to conform with the car body or plane fuselage much easier than an open wire line.

For such mobile installations another type of antenna is often more convenient to install. A quarter wave rod is used extending upward through the car roof or through the fuselage in the rear of the plane. The metal framework of the car or plane is used as a counterpoise, extra foil, metal screen, or wires being added around the base of the rod if necessary. This antenna is really a $\frac{1}{4}$ wave Marconi Type radiator and shows an impedance between its base and the surrounding counterpoise of 37 ohms, half that of a dipole or $\frac{1}{2}$ wave antenna. A concentric tube line can be made to feed this type, the ratio of diameters to make the line 37 ohms being 1.86. Using $\frac{3}{8}$ -inch o.d. pipe with $\frac{1}{32}$ -inch wall the inner conductor will be .367-inch outside diameter. The use of $\frac{3}{8}$ -inch o.d. tubing is satisfactory.

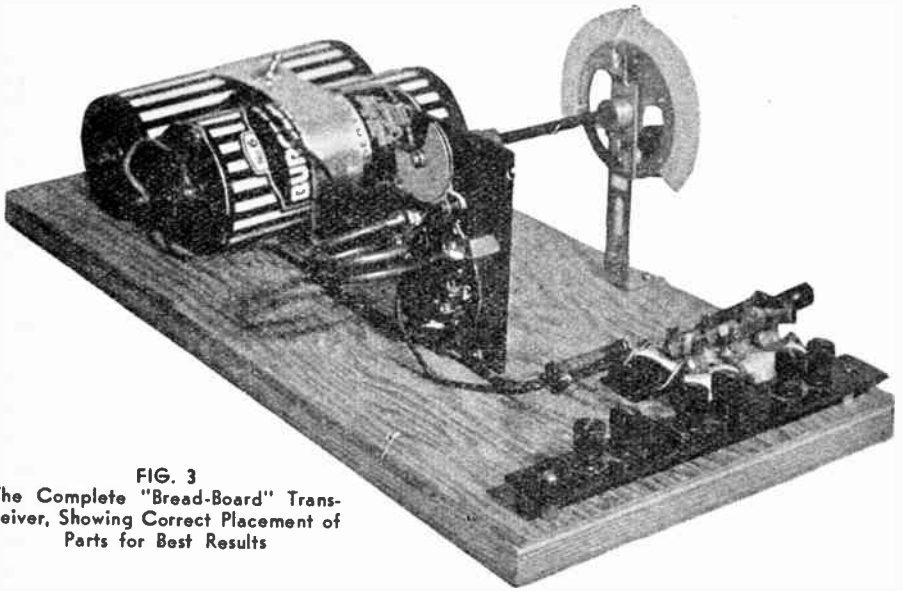

FIG. 3
The Complete "Bread-Board" Transceiver, Showing Correct Placement of Parts for Best Results

Frank Jones One-Tube 5-Meter Transceiver

Introduction

THE five meter amateur phone band offers an interesting field for the newcomer and experimenter. This band is not too crowded; in fact it is unoccupied in most communities, and yet the necessary equipment is simple to construct and costs far less than that needed for operation in any of the other amateur bands.

The five meter signals are useful over relatively short distances . . . usually not over five to ten miles. Greater distances are possible under favorable conditions, and two-way phone communication has been conducted over distances up to 150 miles. The low wavelengths are of such a high frequency that only the direct wave is used, since the Heaviside layer seldom reflects these frequencies back to earth, as is done on longer wavelengths. Herein lies one of the advantages of this band, since no interference is created beyond a range determined by the apparent curvature of the earth and the elevation of the transmitting station. This means that hundreds of communities can make full use of this band without the overcrowding effects and great amount of interference which fills up the other amateur bands.

Another advantage of this band is that very low-power transmitters can be used. This results in a decided saving to one's pocket-book. The receivers are also simple and economical to build. The low-power receiving type tubes can be used for both trans-

mitting and receiving, and a great deal of fun can be had where friends in a neighborhood wish to make tests and talk to each other. Even to an old-time "CW" amateur, there is a thrill in using phone, although the other station may be only a few houses away.

Greater power, such as can be had from type 210 or 800 tubes operated in m.o.p.a. or crystal controlled circuits, has its place and is a future step to those really interested in the amateur game. The complication of such circuits and the peculiarities of adjustments calls for considerable experience. The advantages of such circuits on five meters are freedom from frequency modulation, ability to put the signals into small valleys or behind small hills, and a personal satisfaction of transmitter accomplishment. This field is more for the advanced experimenter, or for ultra-short wave police and television stations.

Five Meter Circuit Analysis

FIVE meter circuits can be compared with the circuits used in broadcast or short-wave sets. The functions are similar—an antenna is needed to pick up the signals and provide electrical energy which can be detected, amplified, and made audible in a headset or loudspeaker. The transmitter must have some form of oscillator, a method of modulating the carrier signal, an antenna to radiate it and, of course, a microphone to change the voice or sound energy into electrical energy. The functions of capacity, in-

ductance and resistance are exactly the same as in any other longer-wave radio circuit. The difference lies in the size of the inductances and capacities used in the radio frequency circuits. For example, a broadcast receiver coil can be made by winding 30 to 40 feet of wire on a coil, tuned by a large variable condenser having 15 to 20 plates. For five meters, a foot of wire or tubing, wound into a coil, is usually ample when tuned by a midget two or three plate condenser. Theoretically, the vacuum tubes should be smaller for greater efficiency; however some types of commercially available tubes are suitable.

A typical five meter receiver circuit is

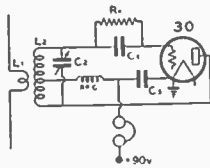

FIG 1

shown in Fig. 1. The five meter wave cuts through the antenna and induces an electric current in it. This oscillating current induces another into L2 if L1 and L2 are near each other. L2 may be of from one to ten turns, depending upon the diameter of the turns. For example, the set herein described has 2 turns, 2 inches in diameter. The inductance L2 is tuned to resonance by means of C2 in order to make the receiver responsive to the desired wavelength within the five meter band. The reactance of L2 and C2 are opposite in phase, or cancel each other, leaving only the resistance in the tuned circuit at resonance to limit the value of induced current. Thus a relatively large value of induced current flows through the inductance and around through the tuning condenser C2 and its shunt capacities, due to the wiring and tube. The voltage across either the inductance or capacity depends upon the reactance of that particular element, consequently the actual voltage across the input to the detector tube is increased enormously by resonance. This tube is a voltage operated device; the greater the signal voltage, the greater the audio signal across the telephone receivers.

Since the field intensity at the receiving antenna is in terms of microvolts or millionths of a volt, due to the use of low-powered transmitters and wave attenuation, the receiver must have a great deal of amplification. The most practical way to accomplish this is by means of extreme regeneration, or what is called "super-regeneration". Regeneration consists of feeding part of the signal voltage in the plate circuit back into the grid circuit and thus obtaining an amplifying action. This

effect can be continued with increased amplification until the tube breaks into continuous oscillation, which ruins the detection characteristic of the tube. Super-regeneration consists of a means of increasing the tube regeneration until it goes into oscillation, then automatically backing it off into a non-oscillating condition. This action continues at some frequency which is above the audible values in the range of from 15,000 to 200,000 times per second. This super-regeneration amplifies a weak signal many thousand times. This effect is especially applicable to the five

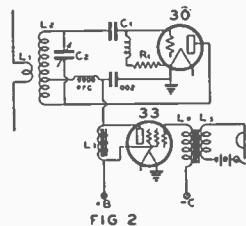

FIG 2

meter band, and at present is the most practical method for obtaining the necessary sensitivity to weak signals.

The circuit shown in Fig. 1 is a good oscillator, but proper proportions of R1, C1, C3 and the plate supply voltage allow the super-regenerative effect to take place. R1 and C1 cause a blocking action which throws the detector in and out of oscillation at a high rate of frequency. R1 can be returned to filament or to +B as shown, depending upon its value, but for less overloading and distortion effect on strong five meter signals the connection shown is highly desirable. C3 must be large enough to by-pass the high super-regenerative surges back to filament, but not large enough to short-circuit the audio frequencies in a modulated signal which must be impressed across the telephone receivers or audio amplifier. Common values for R1 are from 1/4 to 2 megohms, C1 of .00025 mfd. and .006 mfd. for C3.

In Fig. 2 is shown a five meter transmitter such as is used in many present day low-power sets. The microphone causes a variation of current through L5 due to sound waves from one's voice striking the diaphragm, and thus varying the resistance. L5 is coupled closely to L4 by means of an iron core which is permissible because only audio frequencies are being used at this point. L4 and L5 are the two coils of a microphone transformer. Usually the coil L4 has 15 or 20 times as many turns as L5, resulting in that same proportionate increase of voltage and decrease of current. Since no resonance to any particular audio frequency is desired (which would result in distortion, because it would be amplified more than the other audio frequencies),

no tuned circuit is used in either the plate or grid circuit of this modulator tube. The modulator tube amplifies the audio voltage across its grid circuit, and applies it across the modulation choke L3 which offers a high reactance to audio frequencies. This voltage adds and subtracts, over its cycle, to the steady DC plate voltage which supplies the oscillator. For example, if there is a 90-volt sine wave AC peak voltage across the choke L3 due to the action of the microphone, this voltage will add to and subtract from the DC supply, which may be 180 volts of B battery. This means that over the audio cycle the actual plate voltage on the oscillator is varying from 90 up to 270 volts, even though a DC supply of only 180 volts of B battery is used. The power output of the oscillator varies with the plate voltage and thus a signal of varying amplitude is impressed on the antenna. This variation is in accordance with the microphone input. The carrier signal may be modulated in accordance with one's voice.

The oscillator in Fig. 2 is quite similar to the one shown in Fig. 1 but it uses a lower value of grid leak. The lower value of R1 allows steady oscillation to take place, and energy can be fed to the antenna system through the coupling between L2 and L1. Capacitive coupling can be used instead of inductive coupling with equal results.

Antennas

For either transmitting or receiving, the antenna should be as high above ground as possible. A half-wave antenna coupled directly to the set, either by a very small capacity at the end to the grid or by means of a small coil as shown in Fig. 1, will work satisfactorily but greater distance can be attained by using a high antenna. This usually means some form of RF feeders, such as shown in June (1934) "RADIO". Even an ordinary broadcast or short-wave receiving antenna may be used on five meters because of the harmonic effect. Such an antenna was used successfully to talk over a distance of ten to twelve miles between San Francisco and Oakland, using the small combination transmitter and receiver shown in Fig. 4.

Wavelength or Frequency Determination

SOME means of adjustment of the transmitters and receivers must be made in order to operate within the amateur five meter band of from 56 to 60 megacycles. This band is over four times as wide as the whole American broadcast band, yet it covers only a third of a meter in this range. In localities where there is some five meter activity a frequency check can be given by other amateurs who have calibrated frequency meters or receivers. Otherwise one must use a cali-

brated frequency meter, or wavemeter, in order to be certain of legal operation. Parallel or Lecher wire systems may also be used for measurement to within an accuracy of about 1%.

Parallel wires suitable for this purpose can be strung between two supports from 35 to 40 feet apart. Bare wire, No. 18 to 14 gauge, should be used with a spacing of

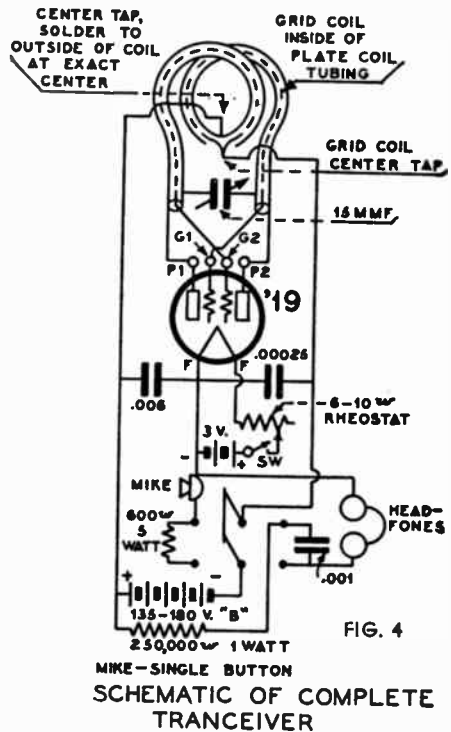

This is the Circuit for the Transceiver Shown in the Picture (Fig. 3)

about three inches between wires. Resonance indication is obtained by coupling the oscillator coil to the closed loop end of the parallel wires, and then sliding a short-circuiting copper link along the wires. An indication can be obtained by means of a milliammeter in the oscillator grid or plate circuit, or more preferably by means of a variation of RF current. This can be done by means of a small turn of wire connected in series with a 6-volt radio dial light or RF thermogalvanometer and coupled to the oscillator coil along with the parallel wire loop. A decided change of current will be had when the short-circuiting link of wire is across some half-wave point on the parallel wires. Sliding this link along between the first and second points of indication, and careful measurement with a scale or tape measure, will give

the wavelength of the oscillator. This distance should be between 16.40 and 17.55 feet for oscillation in the amateur band of from 56 to 60 megacycles, which is from 20 or 25 feet of parallel wires. This length can be used and a small variable condenser connected across the loop end, about 3 inches from it, in order to bring the first indication point up to within 2 or 3 feet of the loop end. The second indicated point will still be 16.4 to 17.55 feet from the first for proper operation. A little absorption-type wavemeter can be conveniently calibrated from this set-up and a very accurate check obtained from a harmonic calibration from a known frequency quartz crystal oscillator.

Combination One Tube Transmitter-Receiver

FOR the newcomer in the five meter band, the set shown in Fig. 4 is about as simple as one can possibly build, consistent with worthwhile results. It puts out a well-modulated, strong signal as a transmitter and func-

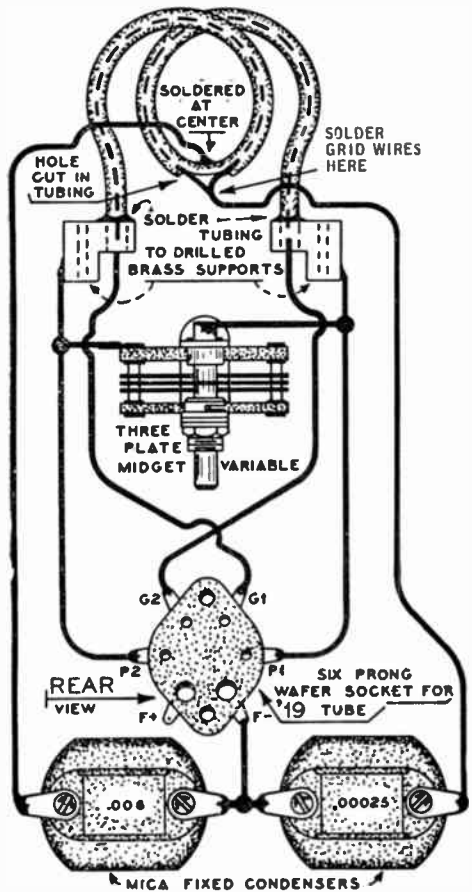
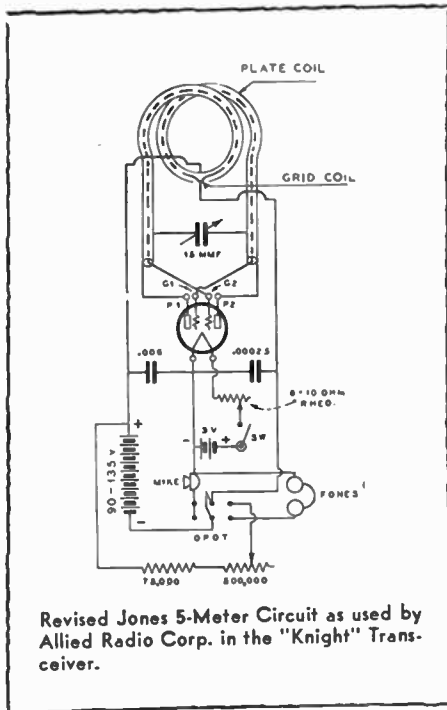

Pictorial of the RF Portion of Fig. 4. The plate coil is a two-turn loop of 1/4-in. diameter copper tubing. The grid coil (push-back insulated wire) is woven into the copper tubing and a center-tap of the grid coil brought out through a hole in the tubing as shown above.

tions as a sensitive super-regenerative detector in the receive position.

This circuit uses a type 19 two-volt filament tube as a push-pull oscillator and detector. As an oscillator or transmitter, grid circuit modulation is used because of the extreme simplicity. The microphone, an ordi-

nary single button telephone transmitter, is in the negative B battery lead and the voltage drop and variation of voltage is used as grid bias. There is a steady voltage drop across the resistance of the microphone and when it is spoken into. The variation of resistance causes a variable grid bias on the oscillator. The 19 tube is a "high mu", or high amplification type of tube and a fixed bias type rather than a grid-leak oscillator circuit is used in order to simplify the modulation circuit. This tube is really two "high mu" triode tubes in one envelope. It can readily be used in a push-pull oscillator circuit.

Unity coupling is used because the set must stay on the same frequency in both transmit and receive positions. Tuned grid-tuned

plate, or TNT oscillator circuits require a compensator on one of the switch positions, which adds complication to the circuit. Unity coupling is obtained by running the grid coil inside of the plate coil. Two turns are used in order to conserve space and coil external field, and also to give short leads to the bypass condensers C2 and C3.

In the receive position, the microphone is cut out of the negative B battery lead and a pair of telephone receivers cut in. The grid return is also switched-over to a quarter megohm grid leak in order to obtain blocking-

socket grid terminals. The tuning condenser mounts near the tube socket and thus the leads to the condenser are only an inch long. A bakelite extension to the dial shaft is necessary in order to eliminate hand capacity effects.

For convenience the two B battery leads, microphone and headset connections are brought out to six binding posts. Either 135 or 180 volts of B batteries or a small B eliminator may be used. The plate current is from 5 to 50 milliamperes on transmit, and about 5 on the receive position. Most headsets work better when the 5 MA plate current flows through them; a reversal of the phone tips often increases sensitivity.

The transmitter should illuminate a 6-volt dial light when the latter is coupled to the

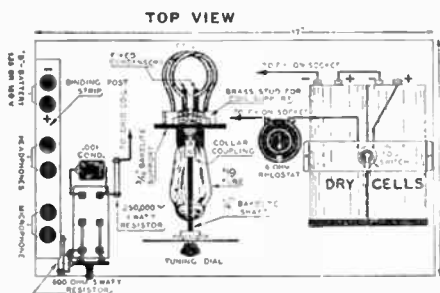

Looking Down on the Assembled Transceiver

grid super-regeneration. The grid leak returns to +B in order to give better results, as previously mentioned.

Unless one has had considerable experience with five meter circuits, it is suggested that the exact layout shown in the picture of the "breadboard" set and circuit of Fig. 4 be followed. Sometimes the misplacement of a single lead or condenser by as little as a half inch will ruin the operation of a five meter set. A straight piece of wire one inch long has a very appreciable inductance and capacitance on these ultra-high frequencies.

The oscillator coil consists of a small coil of $\frac{3}{8}$ -in. or $\frac{1}{4}$ -in. soft copper tubing with a well-insulated piece of rubber or cambric covered wire woven through it for the grid coil. The copper tubing coil consists of 1½ turns, two inches inside diameter, with a center-tap on both coils. The grid coil center-tap can most easily be made by cutting a small slot (about $\frac{1}{2}$ -in. long) in the copper tubing, at the center of this plate coil. The grid coil can be threaded through the tubing in two sections with the center connection soldered together in a small "pig-tail" connection about $\frac{1}{4}$ -in. clear of the copper tube center opening. The ends of the plate coil tubing can be fastened into small brass end blocks or soldered directly to the two plate terminals on the 19 tube socket. The ends of this coil extend down about an inch, or slightly less, in order to keep the coil center-taps clear of the other tube socket terminals. The two inside, or grid leads cross over to opposite

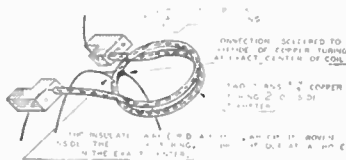

Showing How to Make the Plate Coil, with Grid Winding Inside of Plate Coil

oscillator coil by means of a two-inch turn of wire soldered to the lamp terminals. A single turn with lamp is a very useful oscillation indicator for any transmitter, since it is fairly sensitive. Modulation can be roughly checked by this same means.

The receiver should give a hissing sound when it is functioning properly. A good five meter signal always reduces or eliminates the background hiss. The antenna can be most conveniently coupled to the set by means of a clip on the copper tube inductance. This clip should be set near the center tap, but as far away from it as possible to still get the super-regenerative hiss over the tuning dial range. Usually the clip will be not over an inch along the inductance from the center-tap. Any wire can be used as an aerial, even values up to several hundred feet in length. For most local work a four-foot wire or rod can be used, connected to the oscillator by means of the clip mentioned. For better results a wire 12 feet long is recommended; it gives a quarter-plus-a-half-wave antenna. The 4-foot section acts as a quarter-wave antenna with the set and batteries acting as a ground or counterpoise. Probably an aluminum plate about the size of the breadboard and underneath it should aid in this effect, if it is connected to one of the 19 tube filament terminals by means of a short lead.

Trouble shooting the set is fairly simple. For the newcomer or beginner, the polarity and voltages of the A and B batteries should

be checked. The values of the resistors and mica by-pass condensers are important. The filament rheostat should be set so as to give 2 volts across the 19 tube filaments. Good soldered joints should be made throughout and all RF leads made as short and direct as possible. The 19 tube should be a good one and a check can be made by inserting a milliammeter in series with the B battery. It should read from 50 to 60 milliamperes when transmitting, and drop to about 10 or 15 when not oscillating, such as when touching a plate or grid terminal with the antenna or one's finger.

For receiving, the plate current should read about 5 milliamperes.

If it is possible to obtain a high-level single button mike of about 200 ohms resistance, the 600 ohm plate resistor R2 can be eliminated and more power output obtained without excessive plate current. This resistor holds the plate voltage to about 100 to 120 volts, since the mike used had only about 20 ohms resistance with rather low grid bias voltage.

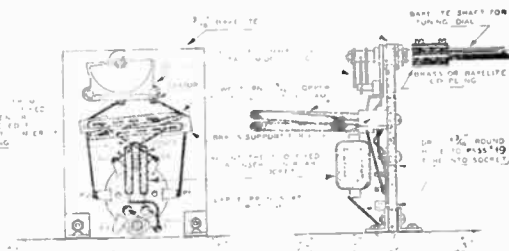

Rear and Side Views of the RF Portion—Note Short Connections

The set has worked very satisfactorily over distances of ten miles, without either location being more than 50 feet above ground.

Super-Regeneration Simplified

SUPER-REGENERATION is used in nearly all receivers operating on wavelengths between 3 and 10 meters because of its extremely high sensitivity. Radio frequency amplification and present day superheterodyne circuits are coming into prominence for 5-meter operation, but super-regeneration provides a practical method of receiving weak signals.

An ordinary detector circuit can be made a great many times more sensitive and selective by the use of regeneration. This consists of using some form of circuit in which part of the plate circuit RF signal is fed back to the grid circuit, and since the tube acts as an amplifier as well as detector, the signal is increased. This feed-back voltage or effect can be carried to the point of self-oscillation with increasing amplification on weak input signals. Beyond the point of oscillation, the quality on voice or music is ruined and the sensitivity begins to drop, due to less efficient detection.

If the feedback effect could be carried on long enough, the only limit to the final signal strength would be the overloading point of the detector. Super-regeneration is a method of carrying this feedback past the point of self-oscillation without ruining the detector audio quality. This is done by allowing the tube to oscillate, then damping-out the oscillation a great many times per second. Usually this is done at such a fast rate that the damping oscillations are above audibility.

This damping or quenching effect can be accomplished in a number of different ways.

Sometimes a regular oscillation circuit working in the range of from 20,000 to 200,000 cycles per second is used as a means of controlling the ultra-high frequency oscillations. The latter takes place in the detector circuit so the other low frequency (sometimes called interruption frequency) oscillator can feed a little energy into the detector grid or plate circuit. The most common method is to couple the two tube plate circuits together for a form of Heising or plate modulation. In this case, the interruption frequency varies the detector plate voltage enough so that this tube spills in and out of oscillation at a rate determined by the interruption frequency. This same detector tube can also be used as an interruption frequency oscillator by putting the tuned circuits for the latter into the detector circuit.

Another form of super-regeneration makes use of a blocking grid leak-condenser action so that no extra tube or low frequency coils are necessary. Such a circuit functions as an ordinary oscillator in which the grid leak is too high to allow the electrons on the grid to leak off at a rate to give constant value of grid bias voltage. This causes a change in average bias and stops the oscillation because the plate current is decreased and the mutual conductance of the tube drops. If the circuit constants are correct, including a fairly high decrement in the detector tuned circuit, the blocking action takes place at an inaudible rate and super-regeneration is accomplished. The decrement of even a low-loss five meter circuit is sufficiently high to allow this circuit to function well.

(Continued on page 243)

The Single-Tube 35-19 Jones Transceiver

● There is a demand for the simplest possible circuit which is suitable for phone transmitting and receiving on five meters. Simple circuits, such as this 1935 model of the original 19 tube transceiver described on page 206 are not as good as two or three tube sets. However, for the beginner, or for extreme portability, this new type 19 single tube set has its place.

The circuit has been so simplified that the number of parts in the set is a minimum. This makes it easy for the newcomer to the 5 meter band to get on the air on phone. The type 19 tube acts as a modulated oscillator for transmitting and as a super-regenerative detector and audio amplifier for receiving. The change from transmit to receive is accomplished by means of a single-pole, or On-and-Off snap switch.

The set acts as a transmitter when the switch is on the closed ("on") position, performing the following functions: (1) The tuned circuit causes 5 meter oscillations in one of the triode units of the 19 tube. (2)

The oscillations are radiated either by an 8 ft. antenna connected directly to the antenna post, or by means of a one or two wire matched impedance RF feeder line. (3) The tuned circuit is capacitively coupled to the antenna by means of a trimmer condenser coupling capacity. Normally the adjusting screw is taken out in order to obtain lower capacity. This capacity may be varied by bending the movable plate.

Modulation is obtained by the old familiar method of loop modulation. The microphone is connected in series with 3 or 4 turns of wire, coupled to the oscillator coil. When the mike is spoken into, its resistance varies and the current through it and the loop pick-up coil varies, thus giving modulation. The system is an absorption method and consequently the output usually drops when the mike is spoken into. However, by proper adjustment of the loop coil coupling, a fair amount of understandable modulation is obtained. This coupling is critical and should be as close as is possible

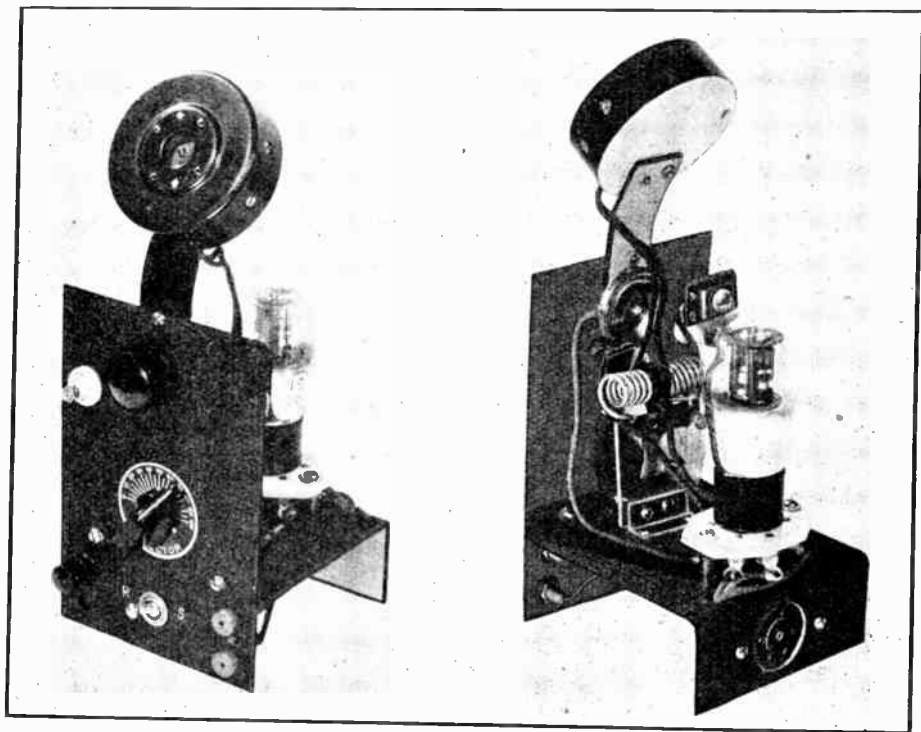

Front and Rear Views of the ultra compact 35-19 Transceiver. The microphone is secured directly to the front panel. A mouth-piece can be attached to the mike. A toggle switch is used to change from send to receive. The rear view illustration does not show very clearly how the mike couplink loop is placed between the two coils, L1 and L2 (see circuit diagram). This mike loop coil is merely suspended between the two coils; it is made of insulated push-back wire, the loop is self-supporting and its coupling is easily varied. The RF choke is barely visible in the photo. It is supported on the bakelite support piece which holds the tuning condenser.

to use and still maintain super-regeneration while receiving. More satisfactory modulation is obtained this way than in the grid modulation method used in the set described on page 206. The mike should preferably be mounted on the transceiver in order to keep the leads short.

The 19 tube is a good oscillator and the carrier is greater than can be obtained from a type 30 tube. The oscillator circuit shown has proved to be much more efficient than the unity coupled circuit shown on page 208. Super-regeneration can be obtained with somewhat less than 80 volts with this circuit, while the one shown on page 208 required at least 135 and often 180 volts of B battery. Super-regeneration gives a high degree of sensitivity for 5 meter reception and is used exclusively in the more simple 5 meter receiving circuits. This set will function with only 90 volts of B battery, but the power output is only about half that obtained with 135 volts. The antenna coupling can be greater with the latter value of voltage without pulling the detector out of super-regeneration, denoted by a loud hiss when not receiving a signal.

The second triode unit of the 19 tube is used as an audio amplifier when receiving. The oscillator section merely super-regenerates and only the grid circuit rectified signal is used across the grid of the other triode unit. This simplifies the circuit and gives ample volume for headset operation. The headset or telephone receivers should be of the high impedance type, any value from

1,000 to 5,000 ohms. When transmitting, this triode unit acts as a monitor, giving sidetone of the speech in the headset. A person can tell easily whether the mike is functioning properly because the modulation should be audible in the telephone receivers in the send position. Receive position of the switch should give a strong hiss, unless the tuning circuit is adjusted to a carrier of some other transmitter or oscillator. Too-close coupling of the microphone loop coil will pull the detector out of super regeneration.

The tuned circuit consists of a two plate tuning condenser, two similar coils and a small mica grid-blocking condenser. The

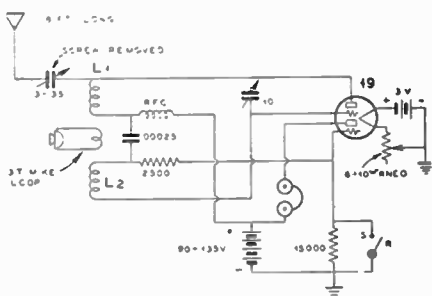

CIRCUIT DIAGRAM OF THE 35-19 TRANSCEIVER

Coils L1 and L2 each have 6 turns of No. 12 or No. 14 bare copper wire, 1/2-in. diameter, 3/4-in. long. The Mike Loop Coil has 3 turns of insulated push-back wire, 1/2-in. diameter, placed between coils L1 and L2. The RF Choke Coil has 50 turns of No. 22 DSC wire, 3/6-in. diameter, air supported.

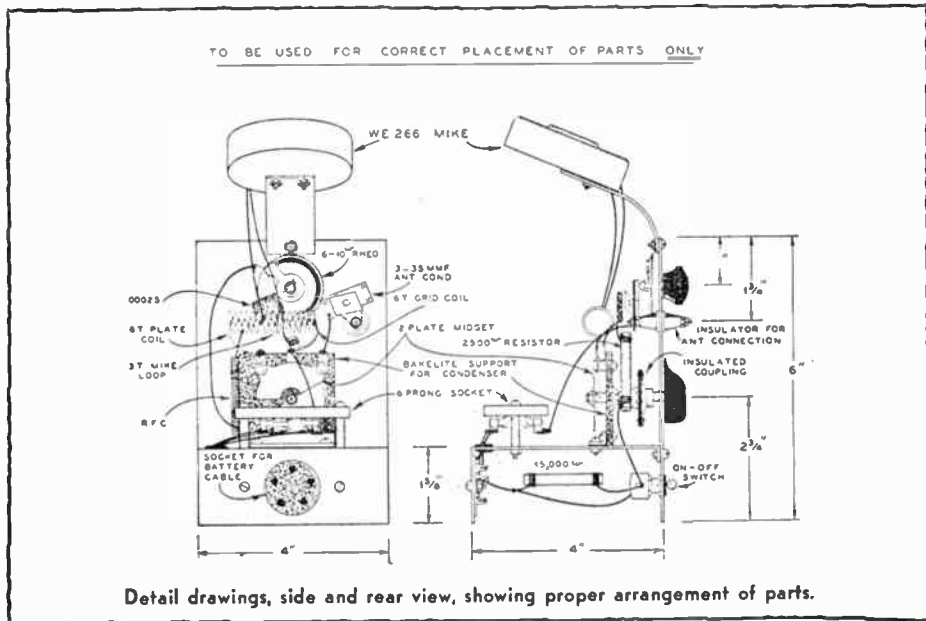

latter, plus the grid leak, causes super-regeneration in the receive position. When transmitting, the receiver grid leak is shorted-out and only the 2,500 ohm grid leak is left in the circuit. The two coils can be wound with No. 12 or No. 14 copper wire on a $\frac{3}{8}$ inch rod as a winding form. The turns are removed and spaced to occupy about $\frac{3}{4}$ inch to 1 inch length for each coil. These two coils make a continuous winding with the mica condenser in the center and the tuning condenser across the outside. The latter must have an insulated coupling on its shaft in order to prevent hand-capacity and short circuit to the metal front panel.

The radio-frequency choke consists of about 50 turns of No. 22 DSC wire, $\frac{3}{16}$ inch in diameter. This coil is made by winding the wire on a $\frac{3}{16}$ inch diameter rod and slipping the coil off when enough turns are wound. The coil is rigid enough so that its two ends will hold it in place, as shown in the diagrams.

The filament rheostat should only be turned up high enough to cause good super-regeneration when receiving with a reasonable amount of antenna coupling capacity. If no super-regeneration is obtained, and if the circuit has been carefully checked, the trouble may be in a faulty tube. Connections to the batteries are important for correct polarity. Too much antenna coupling may cause trouble and first adjustments should be made without an antenna. All connections should be soldered and the leads kept as short as possible. The two plate tuning condenser can be made by removing one plate from a standard 3-plate midget condenser available on the market. If the grid condenser is too small in actual capacity due to incorrect rating, super-regeneration may not be obtained.

It should be remembered that any transmitter radiates receiver whistles strongly over a distance of a mile or two and thus consideration in its operation should be given to other nearby amateurs. In transmitting, a strong carrier will be radiated and the only trouble one is likely to have is in obtaining sufficient modulation of a good character. The two important adjustments are the coupling between coils and the filament rheostat setting.

For 5 meter work the antenna should be a half wave vertical rod or wire about 8 feet long. It should be as high as possible. In some cases it may be necessary to use a RF feeder. A simple feeder is a single wire attached to the 8 foot antenna, 14 inches below its center. This wire can be any length up to a hundred feet and should run off for at least 3 or 4 feet at right angles to the antenna. A two wire feeder is more efficient; in this case one wire connects to the antenna

post and the other to the aluminum chassis.

In adjusting the transmitter it is desirable to have another receiver nearby in order to monitor the speech. This circuit is so simple that two sets can easily be built for duplex operation, using one as a receiver and the other only as a transmitter. A 6.3 volt pilot lamp is a useful tool for testing this

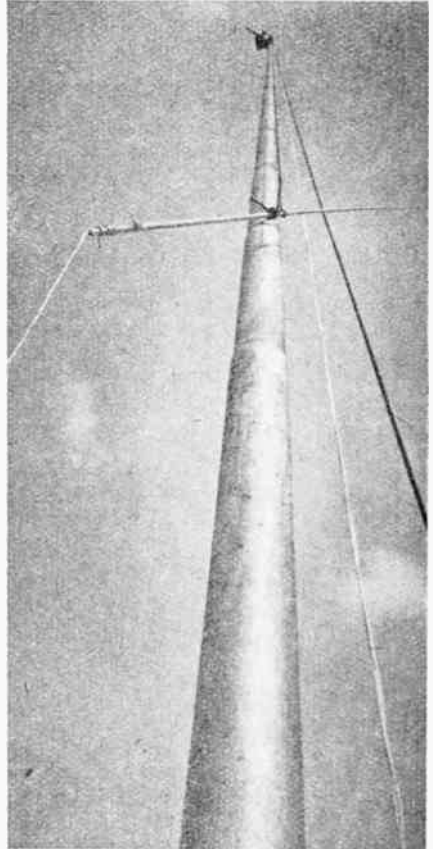

Method of suspending 5-Meter Antenna for New Jersey Police System.

set. A single turn of wire about an inch in diameter enables this lamp to be coupled to the oscillator coil. It should light up when testing the transmitter; when the mike is spoken into loudly, the lamp should become somewhat dimmer. Too-loose coupling will give no modulation and too high coupling will cause the transmitter to stop oscillating due to excessive absorption modulation. A low resistance single button microphone should be used.

The Simplest 5-Meter Super-Heterodyne

● A simple superheterodyne which anyone can easily build in a few hours has recently been developed for use on the short wave bands below ten meters. The circuit is not at all complicated and no special parts or alignments are necessary in order to put one of these sets on the 5 meter band. The receiver is much more sensitive than a super-regenerative type and has none of the usual loud hiss so common in the latter type.

Briefly, the circuit consists of an autodyne first detector, a "tuned" resistance coupled two stage I. F. amplifier, and a second detector. Four tubes give real results on five meters. It tunes easily because the I. F. amplifier passes a wide band of frequencies. The parts cost very little more than those needed for a super-regenerative receiver. This super does not radiate nearly as much as a super-regenerative set. Several of these receivers can be used in a neighborhood without causing interference with each other because it is not likely that the oscillating first detectors would be tuned to the same frequency within 5 KC even when all sets are tuned to the same station. The tubes are oscillating weakly, anyway, and only on one frequency to which the circuit is tuned, instead of over a band of 100 to 200 KC as in a super-regenerative detector.

The first detector tunes like a regenerative, oscillating detector used for 40 meter CW reception. That is, there are two points very close together on the dial where each station will be heard. In this receiver these points are so close together that the dial is merely set to either side of the exact center of any station by about a half degree or so at which points the quality is best, and the signal loudest, due to its being heterodyned properly into the IF amplifier. The first detector uses a RF choke in series with the cathode to obtain oscillation because this is simpler than finding the exact point on the tuned circuit for the cathode tap, as in the usual electron coupled oscillator. This form of oscillator gives good stability even on 5 meters.

The IF amplifier is the really interesting part of this receiver. It gives good amplification over the band of frequencies desired, from 10 KC to a little over 100 KC, and is quite stable. The secret is in using the proper values of resistors and condensers to obtain this resonance characteristic. By using low values of grid resistors, $\frac{1}{4}$ megohms, and small coupling condensers, .0001 mfd., the response to audio frequencies is practically nil. There is no tendency to motor-boat since it is such a poor audio amplifier. This also prevents the rectified audio signal component in the first detector from being amplified all the way through the receiver.

This value of coupling condenser (.0001 mfd.) and a grid leak of $\frac{1}{4}$ megohm does not tend to attenuate the higher frequencies such, as for example, 50 KC. This means that the first detector can be of the autodyne type and act as its own oscillator. By having it oscillate weakly, the tube is in its most sensitive condition, which accounts for the excellent signal to noise ratio obtained in this receiver. It also eliminates the need of tracking two tuned circuits, such as used in most superheterodyne receivers.

The relatively low values of plate resistors of 50,000 ohms tend to even-out the amplification of the IF amplifier for the range of 50 to 100 KC in order to be able to receive modulated oscillators. Probably 98% of the phone transmitters on 5 meters use modulated oscillators, so it is necessary to have a receiver tuned broadly enough to receive these signals. Even if all transmitters were temperature and crystal controlled types, it would still be desirable to have the IF amplifier broadly tuned in order to take care of oscillator drift in the receiver. Two stages of moderate gain per stage give more than enough amplification to bring up the man-made noise level into audibility in the output of the second detector. Automobile ignition is the worst offender, although neon signs and other electrical appliances cause plenty of interference up to a hundred feet or so from where the receiver is located.

Volume control is obtained by means of variable cathode bias on the IF amplifier because variable mu tubes are used. Tubes such as the 6C6 or 57 would give too much audio rectification or detection, with resultant distortion and cross-talk, if variable bias were used. In one experimental circuit these tubes were used and the volume control was connected as a variable potentiometer for grid input variations on the second IF stage, just as in an ordinary audio amplifier. Variable mu tubes such as 6D6 or 58 are better and allow the use of cathode bias adjustment for volume control.

The second detector consists of a grid-leak type which is satisfactory for this purpose and gives comfortable volume in a pair of headphones. The .01 condenser across the phones by-passes the I.F. component and increases detector output and efficiency. If loudspeaker output is desired, the detector could be connected through an audio transformer to a pentode power tube. The loudspeaker should be mounted in a separate case or cabinet in order to prevent microphonic feedback on strong carrier signals. For this reason, if an AC power pack and loudspeaker is to be used, the power audio stage may as well be built into the loudspeaker unit. The way the receiver is now

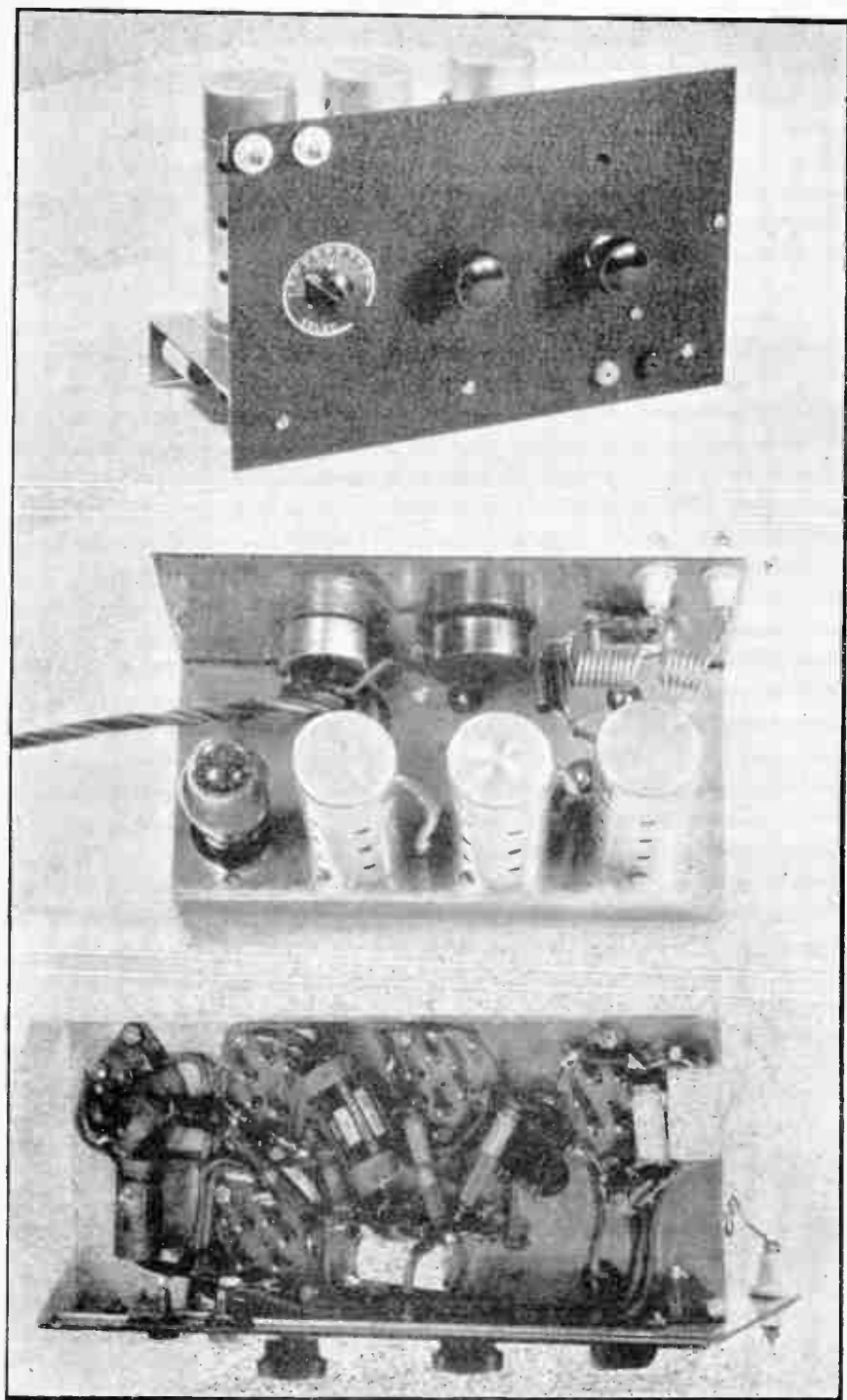

Three Views of the 4-Tube 5-Meter Super. It is the Acme of Simplicity

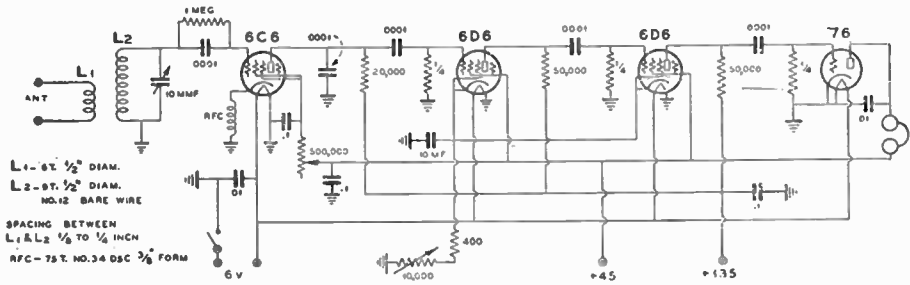

The Extremely Simple Circuit Diagram of the 5-Meter Super.

designed it can be used with batteries for portable use, or from an AC power pack at home. If an AC supply is used, the -15 volt tap should be by-passed with 8 mfd. and this voltage maintained at about 40 or 50 volts so as to prevent the screen voltage from exceeding the effective plate voltage on the IF resistance-coupled amplifier. The B voltage is not critical and can be of any value up to 250 volts.

The grid leads on the IF amplifier are shielded to prevent capacitive coupling and a tendency to oscillate on high IF frequencies. This shielding also tends to limit the response of the amplifier to very high intermediate frequencies.

The ground connections in the first detector circuit should be grouped as much as possible. The heater circuit should be grounded on one side at this point and the other side of the heaters by-passed to ground with a small .01 mfd. paper condenser. All leads should be kept short; thus it is desirable to solder the coil to the midget tuning condenser lugs. Pin jacks could be used so as to use plug-in coils for 2 $\frac{1}{2}$, 2, 7 $\frac{1}{2}$ and 10 meter bands.

The 10 mmfd. tuning condenser has its rotor grounded to the metal front panel and thus there is no mechanical difficulty of insulated shafts and mountings to worry about. This 10 mmfd. condenser can be made by breaking off one plate of a three plate standard midget condenser. The antenna uses inductive coupling in order to use a balanced two-wire feeder to an 8 ft. vertical antenna mounted on the roof. In some locations a Faraday screen would be desirable between the two coils to minimize capacitive pick-up from the feeders. A great deal of auto ignition interference is picked up in the down leads from the antenna and this can be balanced out if no capacitive coupling is allowed to reach the first detector circuit.

The cathode RF choke is not critical and the one shown is suitable for use at from 2 to 10 meters. It consists of about 75 turns of No. 34 DSC wire wound on a $\frac{3}{8}$ inch diameter bakelite rod. The ends are soldered to two pieces of bare wire which are run

through holes near the ends of the rod and then twisted together to give an effective soldering lug for external connection. A suitable RF choke for 5 meter operation only, can be made by winding 50 turns of No. 22DSC wire on a $\frac{1}{4}$ inch form, slipping it off and let it be self-supporting by the connections to the two ends.

When first testing this receiver, the regeneration control should be turned up high enough to insure good oscillation in the first detector. The IF volume control should be turned on full if 180 volt B supply is used, or back just slightly if 135 volts is used. Auto ignition will be heard if an indoor antenna of any convenient length is used—provided cars are passing within a block or so. Below the point of oscillation in the first detector the auto ignition and other noises drop out. It will be found that sensitivity is greatest when the detector is oscillating weakly but on very strong signals, stronger oscillation is desirable to prevent overloading distortion. Coupling between the antenna coil and first detector coil should be adjusted for best weak signal reception, although this is not critical. Too much coupling to a resonant antenna will pull the detector out of oscillation. It will be found that every 5 meter signal will have two points close together where the audio quality is clear, since an autodyne first detector is used.

In building this receiver, good .0001 midget mica condensers and good quality resistors should be used. A noisy resistor or leaky coupling condenser will cause plenty of noise, especially if it is in the first detector or first IF stage. In one receiver built in our laboratory, a noisy plate resistor in the first IF stage caused trouble until it was replaced. Several of these circuits have been wired-up and tested. The IF units have always performed satisfactorily and there is no alignment of tuned circuits to worry about. $\pm 10\%$ accuracy of values of condensers and resistors has proven satisfactory.

It will be noted that the screen and suppressor grids of the first detector are con-

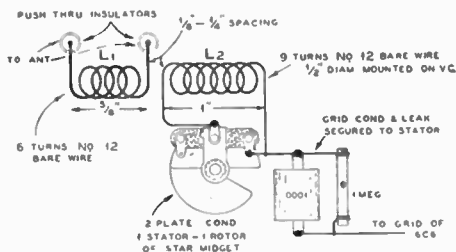

Simplified Sketch Showing Coil Winding Data.

nected together. This gives smoother regeneration effects and better conversion gain for 5 meter work. The screen by-pass was made as large as .1 mfd. in order to prevent noise from variation of the regeneration control. Needless to say, this condenser, as well as the heater .01 mfd. by-pass, should be non-inductively wound in order to act as a by-pass for 5 meter purposes.

Compact 5-Meter Automobile Set

● The circuit and set here shown were designed for use in an automobile where a carrier output of about two to three watts is desired. Class A modulation, driven quite hard, is used to modulate one of the new 6A6 tube oscillators. The ordinary transmitter has insufficient power output to transmit over flat country from a moving car, such as is necessary for some types of amateur work or police operations.

The receiver has a stage of tuned RF in order to give a slight increase of sensitivity and to prevent radiation from the super-regenerative detector. The latter uses a 6A6 tube in order to reduce the number of tubes in the set because the 6A6 can also be used as the first stage of audio amplification. The 42 tube modulator acts as the second stage of audio for loudspeaker reception when the send-receive switch is on receive position. The 6A6 detector has another advantage in that it will take a strong signal without audio distortion to better value than a 37 or 76 super-regenerative detector. The second triode unit in the 6A6 acts as a high μ resistance-coupled audio stage. The mike transformer gives a step-up ratio in receive position for the audio amplifier. This additional audio gain is not usually needed but the center-tap also prevents the 6A6 plate circuit and 100,000 ohm resistor from loading the modulator down too much in the transmit position. If the 6A6 plate is connected across the entire secondary of the mike transformer it would be necessary to

have an additional switch to cut this load off while transmitting.

The tuned RF uses a resonant grid coil. The latter resonates with the tube and antenna coupling capacities to the low frequency end of the amateur band, or preferably just outside of the band if the transmitter is to be used near that end of the band. This stage must be detuned by 2 megacycles, from the transmitter, if no power is to be absorbed from the transmitter. It was found that if the usual condenser and coil arrangement was used, some power would be absorbed up to 3 MC off resonance. By using a very low C, semi-tuned circuit, the RF

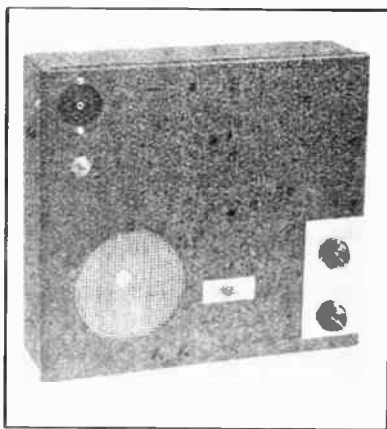

The container for this 5-meter auto set is only 3 inches deep and will easily find a place for itself in almost any car.

gain is fairly good over the entire amateur band—about two points on the "R" scale over that of a receiver with an untuned RF stage. This grid coil is made by winding 18 turns of No. 22 DSC wire on a quarter-inch diameter rod to cover a length of $\frac{3}{4}$ inch. The coil is slipped off the rod and supported by its ends soldered to a pair of soldering lugs. Once its correct length is determined it can be coated along one side with Duco cement to be sure that it will retain its proper inductance.

The semi-variable coupling condensers, marked 3-30 mmfd in the circuit, can be the small compression type condensers with mica spacers. The one on the transmitter (for maximum frequency stability), should be an air spaced plate variable condenser with screwdriver slot adjustment. The main oscillator tuning condenser can be either dial or screwdriver slot controlled. Since this circuit uses a TNT circuit with resonant untuned grid coil, it will give maximum results over only about two MC. The 15 turn coil specified is for use around 58 to 60 MC.

This set is to be used with a dynamotor

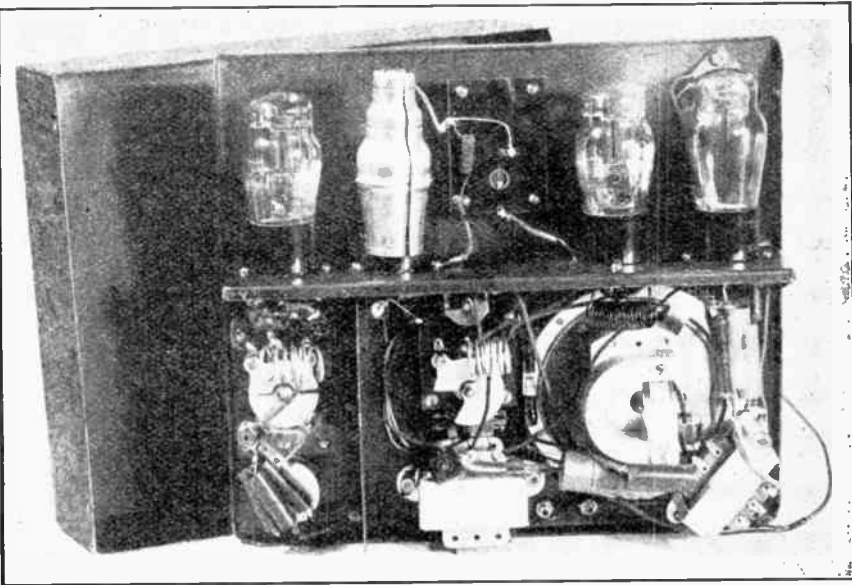

Interior view of the 5-meter auto set. There is a shield partition between the coils. The four tubes are all on one shelf.

for power supply from the car 6-volt battery. A microphone filter is built into the dynamotor and consists of a 100 ohm resistor and a 20 mfd 25 volt electrolytic condenser. The latter provides a return path for the voice frequencies, while the 100 ohm resistor acts as an impedance to noise from the common battery supply. The circuit is shown for use in a car with "plus" terminal grounded to the car frame. If the negative terminal is grounded, this 20 mfd electrolytic condenser would have to be reversed in polarity. 5-meter RF chokes would be necessary at the dynamotor to prevent excessive receiver noise.

A built-in five-inch magnetic loudspeaker is incorporated so as to eliminate the need of wearing a telephone headset while driving. As can be seen from the pictures, the set was built into a very narrow steel can for the purpose of mounting it on the under side of the car roof. The outside dimensions of this can are 3-in. by 11-in. by 12-in. and the back cover fastens by screws to ribs in the car roof. The set can be mounted in back of the windshield, where the send-receive switch and controls will be convenient to the driver's right hand. This also puts the loudspeaker in a good position. The mike is a W.E. 266 watchcase type, which can be gripped in the right hand and still leave one's

forefinger and thumb free for use in switching or tuning the set. This eliminates the need of a remote control tuning and volume control, as well as a send-receive relay.

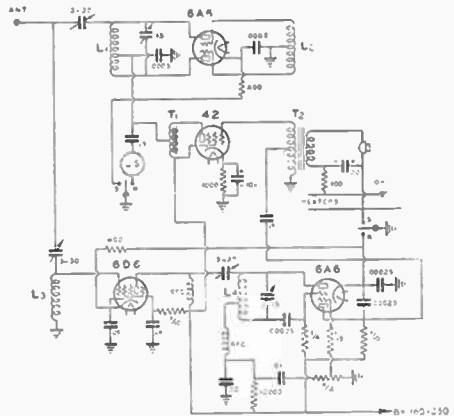

CIRCUIT DIAGRAM

- L1—6 turns, No. 12 wire, 5/8-in. dia., 3/4-in. long.
- L2—15 turns, No. 14 wire, 1/2-in. dia., 1 1/2-in. long.
- L3—18 turns, No. 22 DSC wire, 3/4-in. long, 1/4-in. dia.
- L4—6 turns, No. 12 wire, 5/8-in. dia., 1 1/4-in. long.
- T1—Center-tap 30 henry choke, 100 MA rating.
- T2—Mike transformer with secondary center-tapped.
- RFC—60 turns No. 30 DSC wire, 3/8-in. dia.
- Send-Receive Switch is a D.P.D.T.

Measuring the Wave at 5-Meters

A GREAT many notions have had to be modified since the time when amateurs first took an interest in five meter operation. Chief of these is the idea that harmonics are satisfactory for calibration of wave and frequency meters used on this band. True, the band is nicely located with relation to our other amateur bands so that excellent harmonics can be produced and effectively used as indicators, but how many amateurs will agree which is the fourth harmonic of 14,000 KC when they are endeavoring to place their transmitter in operation within the band? Not many. But if they could measure the wave with a common yardstick and be absolutely certain that they were accurate at 5 meters, if there would be little argument.

Turning back the pages of scientific history we come across the old Lecher wire system described in every high school textbook on Physics, but little understood by the average amateur. This method of measuring a min-

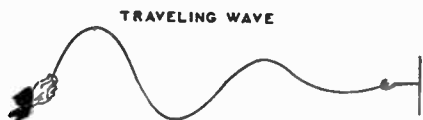

FIG. 1

ute wave is much simpler than checking harmonics with a wavemeter. Moreover, the transmitted wave can be measured with surprising accuracy.

By way of explanation, suppose that you tie a rope to the garage and start shaking the free end up and down. As soon as you have found the correct rate for your hand, waves start to run along the rope toward the garage as shown in Fig. 1. As soon as these

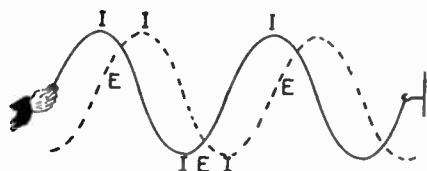

FIG. 2—Points I move up and down while points E stand still

waves are reflected back to your hand there is set up a system of standing waves that does not seem to move at all, as shown in Fig. 2.

Now this same thing is done in an antenna every time we send. Generally an antenna has only a $\frac{1}{4}$ wave on it, i.e., current at the bottom and voltage at the top. In the event that a counterpoise is used we have a $\frac{1}{2}$ wave with current at the antenna inductance and

voltage at the ends of both the antenna and the counterpoise.

Working the antenna at a harmonic will result in several places in between the ends where voltage will show up as illustrated in Fig. 2. While the rope showed up only the vertical or up and down wave, the electrical system consists of two waves, a voltage and a current wave. And whenever there is current present there is little voltage as shown in Fig. 3, but note that there is voltage at the far end of the antenna. In fact, it can be laid down as a general rule that there cannot ever be any current at the end of the antenna, therefore voltage must always be present.

Assuming, therefore, that we stick to the voltage wave and stop worrying about the current wave, let us stretch a pair of wires as shown in Fig. 4. This system, which will be similar to a one wire antenna and one wire

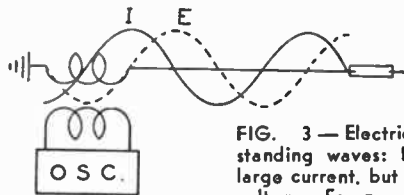

FIG. 3—Electrical standing waves: I= large current, but no voltage. E= no current, but large voltage

counterpoise, should be 21 feet long and the wires should be separated about 8 inches for best results. Turn on the oscillator and tune the antenna system just built until the neon tube at the far end glows brightly.

When this point has been reached, reson-

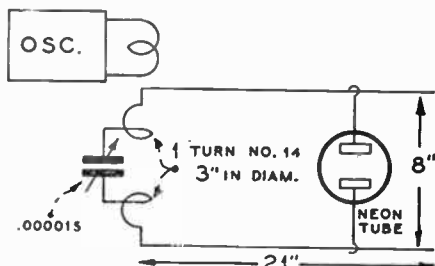

FIG. 4—C1=.000015 mfd. L1=1 turn, No. 14 wire, 3-in. diameter

ance has been reached between the oscillator and dummy radiator system. But what is the frequency? To find this, slide the neon tube along the wires toward the oscillator, pushing it with a newspaper or other long insulator. Be sure to keep your own body as far away from the entire system as possible. After the tube goes out keep on pushing it along slowly until it lights up again. This

operation is the most critical of all and should be done carefully in order to avoid any error. Find where the bulb lights brightest and leave it there! This point is identified as the center of a 1/2 wave and it is now only necessary to find the ends of this 1/2 wave. To do this find the place where a short-circuiting bridge between the two wires has no effect. When such a place has been found it is evident that there can be no voltage at that point, therefore we have found the end of the 1/2 wave.

To construct the short-circuiting bridges, two of which are needed, cut a straight stiff wire 10 inches long and bend it so that one-half inch on each end is bent at right angles to the nine inch sliding portion of the bridge as shown in Fig. 4. Now lay one of these across the two wires and start sliding it back and forth until a place is found where the tube will still light. This adjustment can be made within 1/5 to 1/4 inch to five meters. Now take the second bridge and do the same thing on the other side of the neon tube.

With these two bridges in place and the neon tube still glowing you can be certain

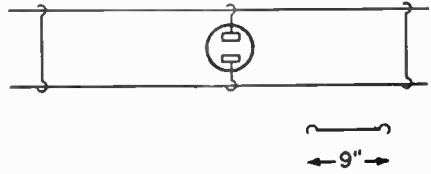

FIG. 5

that the two bridges are just 1/2 wavelength apart. The distance between the two should now be measured with a yardstick, multiplied by two, reduced from inches to meters and the result is the wavelength of the oscillator. For example, we find that the two bridges are just 106 inches apart:

106 in. x 2 = 212 in. = wavelength in inches.

Since 39.37 inches equals one meter then,

$$39.37 / 212 = 5.384 \text{ meters}$$

With such a system as this it is quite possible to obtain a number of very reliable points easily, and by the usual means calibrate a first class five meter (or lower) wavemeter.

Circuit Diagrams of Factory-Built 5-Meter Sets

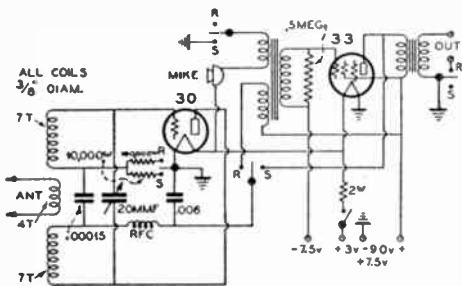

HARVEY RADIO LABORATORIES 5 METER TRANSCEIVER 2 VOLT MODEL

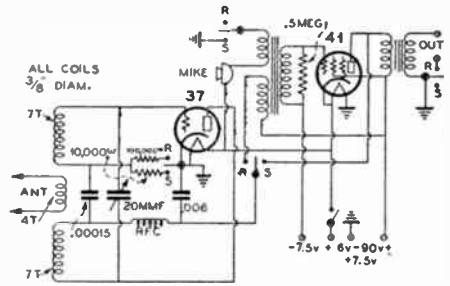

HARVEY RADIO LABORATORIES 5 METER TRANSCEIVER 6 VOLT MODEL

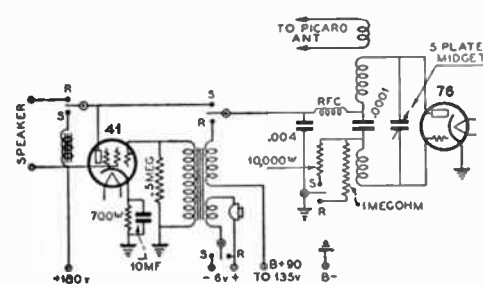

Chauncey Wing's Sons, Transceiver.

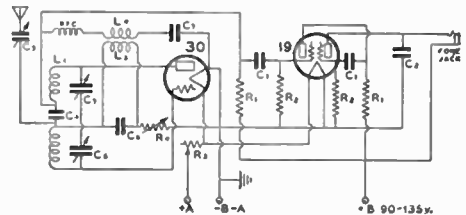

Circuit Diagram of 2-Tube Hart Receiver

C1—0.1 mfd. C2—.001 mfd. C3—.00002 mfd. variable. C4—.0001 mfd. fixed. C5—.0001 mfd. variable. C6—.002 mfd. C7—.004 mfd. R1—0.1 megohm. R2—0.5 megohm. R3—20 ohm rheostat.

Frank Jones 5-10 Transceiver

FIVE or ten meter phone work offers an interesting possibility for tests between cars, or between a car on a mountain side and some city in the distance below. Requests for a powerful transceiver have been made and the circuit shown should fulfill this need. Some sets of this type have been in service for several months on the construction work of the great San Francisco-Oakland Bay bridge and have always put out a good strong signal of excellent intelligibility.

The power output ranges from about one watt carrier at 160 volts plate supply to about three watts at 250 volts. These powers are suitable for use in cities or level forests of from two to six miles on five meters. These same sets will transmit and receive up to any

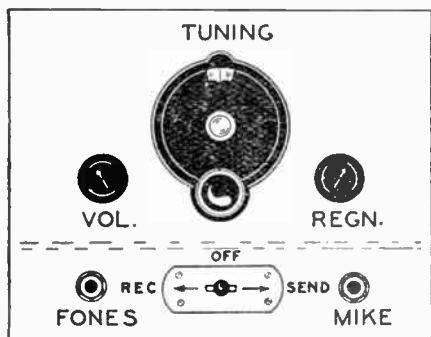

Front View of Transceiver

visual distance (a hundred miles or more) between mountain sides. On 10 meters the absorption and reflection by buildings and small hills is much less and the short distance ranges are greatly increased. Occasionally a 10 meter signal may come in from a point 500 to 800 miles away on days which are particularly suitable for this frequency. This form of receiver is quite sensitive since it is an efficient super-regenerative circuit on the receive position. It also emits bad interference since it is a grid-leak type of super-regenerator. However, this form of detection has proven very satisfactory when using type 41, 42 or 2A5 pentode tubes from a standpoint of good sensitivity and ability to detect, without undue distortion, weak or extremely strong signals. The latter effect is obtained by returning the grid leak to a high positive potential which makes it act more nearly like an AVC receiver than any other form of super-regenerator.

High sensitivity is obtained by relatively tight coupling to a resonant antenna and oper-

ation of the super-regenerative detector at a moderate value of actual plate potential and grid bias, followed by a high gain audio stage. Too many super-regenerative sets give too much noise and too little signal because of improper circuit constants and too little audio amplification following the detector.

The circuit consists of two tubes such as the type 42 six volt pentode power tube. A four pole double throw anti-capacity or spring leaf switch is used to either transmit or receive with six volt power supply being shut off in the center, or off position of the switch. A tuning control, volume control, and receiver super-regeneration control are also provided since the adjustment of the latter minimizes receiver radiation. In the receive position, one tube acts as a super-regenerative detector and the other as an audio amplifier. In the transmit position, the actual plate voltage on the former tube is increased greatly and a low value of grid leak makes it into a powerful oscillator. The audio amplifier becomes the modulator and the headset is cut off and the single button mike cut on in the transmit position.

The transmitting oscillator draws relatively high plate current on these short wavelengths and best results are obtained when the modulator has a step-down output transformer or choke for coupling. A center-tapped output transformer or a center-tapped 30 or 40 henry choke works very nicely and gives a high percentage of modulation as compared to the usual Heising choke coupling to the oscillator. This choke carries the combined oscillator and modulator plate current so it should be one having a suitable air gap if good speech quality is desired.

The mike transformer can be any single button-to-grid type of transformer. The volume control for receiving allows any volume range desired on the receive position but has no effect on the transmitter except to act as a fixed resistor load across the mike transformer secondary, thereby improving the audio quality.

The regeneration control is desirable since the relative feedback is greater on 10 meters than on 5 meters and it can also be set at a value near the breaking-off point of super-regeneration. This minimizes receiver radiation. This variable resistor should be capable of carrying two or three milliamperes of detector plate current and serves as a resistance coupling to the audio amplifier. This resistance coupling drops the plate voltage on receive position.

The values of condensers and resistors shown in the detector circuit are quite important for proper super-regeneration, especially the plate return and grid blocking condensers. The leads from the tuning condenser to the tube should be as short as possible, not

5 & 10 TRANSCEIVER

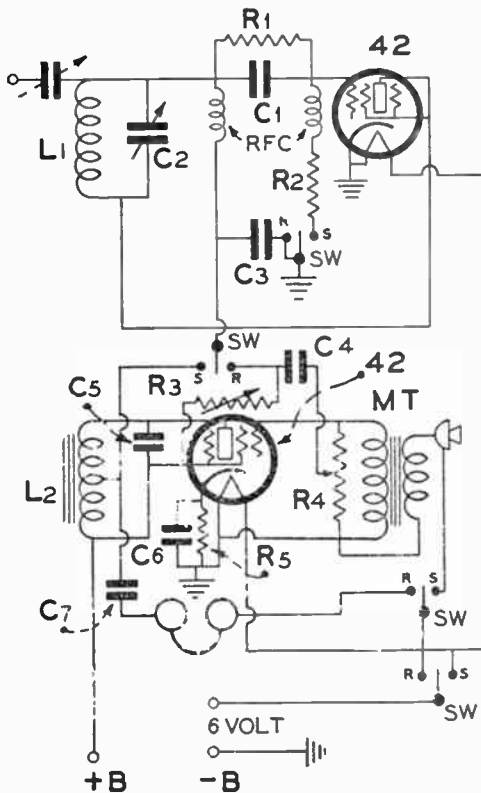

- L1—56 MC-6T No. 12— $\frac{3}{8}$ -in. diam. spaced $\frac{1}{8}$ -in. between turns. 28 MC-12T No. 12— $\frac{3}{8}$ -in. diam. spaced $\frac{1}{2}$ -in. between turns.
- L2—Center-tapped choke.
- R1—1 Megohm.
- R2—5000w 1 Watt.
- R3—50,000w.
- R4—250,000w POT.
- R5—600w 1 Watt.
- SW—4 Pdt. center is "off".
- C1—.00025
- C2—15 Mmfd.
- C3—.006
- C4—.1 Mfd.
- C5—.006
- C6—10 Mfd.
- C7—.5 Mfd.

over two inches at the most. The plug-in coil should have its two pin jacks mounted very close to the tuning condenser terminals, preferably on the same piece of bakelite or hard-rubber sub-panel. This coil should be at least $\frac{3}{4}$ of an inch away from any metal shields. The tuning condenser must have an insulating coupling in its shaft connection to the tuning dial. The complete receiver should be enclosed in a metal cabinet with a metal front panel for shielding and prevention of hand capacity. The antenna coupling condenser can be two right angle brackets about $\frac{1}{8}$ inch apart and $\frac{5}{8}$ inches square. A slot

should be cut in the mounting screw hole of one of these brackets in order to have a slight variation of coupling in order to adjust it to a point where the receiver has a tendency to pull out of super-regeneration with the regeneration control set at about half way position. This condenser should also be mounted on the tuning condenser vertical subpanel.

The tubes can be mounted on a metal or bakelite horizontal subpanel with the tuning condenser and coil above and the send-receive

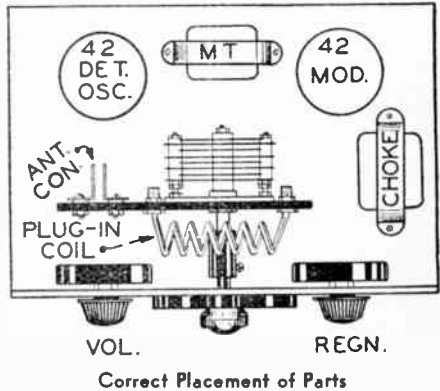

switch below. The RF chokes should be mounted beneath this subpanel near the grid condenser and grid terminal of the oscillator socket. The chokes which have proven most satisfactory for both 10 and 5 meters, are made by winding No. 30 DSC wire for $1\frac{1}{4}$ inches on a $\frac{3}{8}$ inch diameter bakelite rod. These chokes can be mounted by means of a short 6-32 machine screw which does not extend into the RF choke winding itself. The chokes should be dipped in clear lacquer or coil "dope" and dried before using.

An 8 mfd. electrolytic condenser is shown connected across the B plate supply as most dynamotors or B eliminators are not well filtered. Even with B battery power supply this condenser is useful because it prevents a sort of fringe howl in the receiver when the batteries become old and have high internal resistance. The 10 mfd. electrolytic by-pass condenser across the 2 watt 600 ohm cathode resistor can be of the 25 volt type. For coupling into a single wire feeder a condenser spacing of about $\frac{1}{16}$ to $\frac{1}{8}$ inch is usually correct. An antenna that has given excellent results in a car, is a quarter wave rod mounted on one of the front fenders with a stud bolt. The fender acts as the ground plate to which the bottom of the quarter wave rod should make good electrical contact. The single wire feeder should then be connected to a sliding clamping ring for final coupling adjustment. This point is always about one-fourth of the way up from the base of the rod.

The Frank C. Jacobs 5-Meter Transceiver

THE push-pull oscillator, class B modulator transceivers herein described have a power output of from 10 to 50 times that of the conventional transceiver employing type 30 and 33 tubes. The use of highly efficient tubes and circuits makes possible an output comparable to that of a medium-powered transmitter. The transceiver chassis and cases are made of crackle-finished steel, are 10 by 7 by 5 inches, and weigh from 7½ to 9½ pounds, depending on type. The front panel and chassis are a welded unit which fits into the hinged top cabinet. Special models with speaker grill and battery or generator compartment follow the same chassis design.

Twin triodes are the foundation of the Jacobs transceivers. Their use makes possible short leads so important at ultra-high frequencies, and simplifies the problem of realizing high output power. These tubes are available in three styles, the 19 for 2-volt operation, the 53 for 2.5-volt, and the 79 and 6A6 for 6 volts. The 19, 53 and 6A6 are peculiarly adaptable to 5-meter oscillators, having all plate and grid leads in the base. The 79 has one grid terminal in the cap, making symmetrical push-pull connections awkward.

The Jacobs transceivers use twin triodes as oscillators and twin triodes as class B modulators; which, with a class A driver, make the equivalent of a five-tube transceiver, although employing only three tubes. The oscillator tube socket and unity coupled ½-inch copper inductance are mounted above the chassis on a bakelite platform. Plate and grid leads are brought directly to the socket prongs, making all RF components symmetrical and keeping them out of the field of other circuits.

The audio frequency circuits are confined to the region below the chassis subpanel. No wiring other than the plate, grid and filament leads to the oscillator circuit come above the base.

When the send-receive knob is thrown to the receive position the RF panel assembly becomes a push-pull super-regenerative detector feeding into a special primary winding on the microphone transformer. After

being amplified by the driver and class B amplifier tubes, sufficient energy is developed to operate a loudspeaker. The 19-A transceiver delivers 2.1 watts U.O.P. to a speaker, greater power than that of many broadcast receivers; and the 53 (or 6A6) gives a maximum undistorted power of 10 watts.

Throwing the knob to "Transmit" changes the RF assembly into a high-powered oscillator circuit and connects the microphone to its transformer.

The 19-A transceiver may be used either as a portable or as a mobile station. Filament voltages of 2 or 6 volts from No. 6 dry cells may be employed. When four No. 6 dry cells

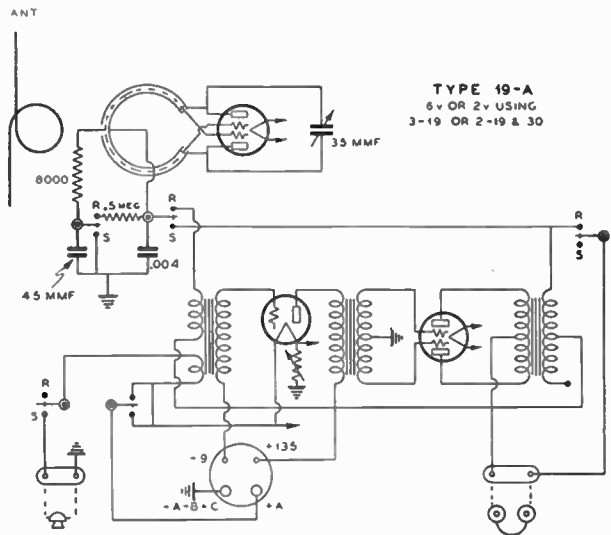

are employed the current draw is only 0.25 amperes, three 19s being employed with filaments in series. Battery life is approximately 130 hours. A rheostat to compensate for the deterioration of dry cells is incorporated. Access is had by means of a slotted shaft in the rear of the cabinet; out of the way of playful hands. At a plate voltage of 135 the transceiver consumes 20 m.a. on reception and 50 m.a. on transmission. On extreme modulation peaks 75 m.a. is drawn. Either an automobile B-eliminator or B batteries may be used.

The Type 53-A is made for mobile or AC operation. In the former role the filaments are wired for connection to a 6-volt storage battery, while in the latter the filaments are heated from a 2.5-volt source.

A Separate 5-Meter Transmitter and Receiver

THE greatly increased popularity of the 5 meter amateur band has resulted in the use of transceivers, i.e., a combination of transmitter and receiver. These transceivers have some disadvantages if very many of them are used in one locality at any one time. The receiver portion radiates strongly and the radiation can be heard nearly as far as the transmitter itself, in some cases. The

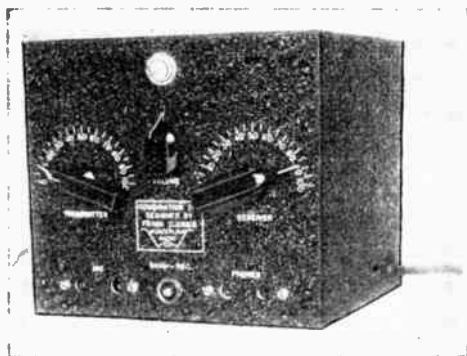

Wunderlich TR model in metal case.

transmitter is tuned to the same frequency as the receiver; it crowds-up all of the stations on one frequency. Some transceivers possess the annoying feature of not transmitting on the exact frequency of the receiver. Thus two similar sets will chase each other right across the band . . . sometimes even beyond the band during a QSO. The power output is low because the antenna coupling



Under-chassis view.

must be very loose in order to prevent pulling the detector out of super-regeneration.

As more 5 meter sets come into use, some means for overcoming these faults must be found. At the same time, the cost of con-

struction must not increase appreciably. The circuit diagram shows a 5 meter set which has several advantages over the usual transceiver. It can be built into a 7-inch square case.

This circuit is the result of considerable experimenting and it has several interesting features. The transmit-receive switch can be an ordinary single-pole-double-throw snap switch, instead of the usual 4-PDT switch. The receiver has a separate tuning control and thus the transmitter can be left on one fixed frequency. The antenna coupling can be greatly increased, with the result that for a given plate voltage the power into the antenna is doubled or tripled.

The receiver portion uses a stage of radio-frequency amplification. It does not radiate appreciably if the transmitter section is shielded from the receiver. By using a res-



Arrangement of coils, tubes and transformer.

onant antenna the grid circuit is tuned somewhat, and the plate circuit is coupled to the super-regenerative detector by means of a small mica-type trimmer condenser of about 25 mmfd. maximum capacity. The RF gain in this stage is practically nil but it serves to prevent radiation from the receiver and permits the use of a very satisfactory method of coupling to a resonant antenna without the usual "pulling effect" on the detector.

The detector circuit uses a type 76 tube which super-regenerates nicely at low plate voltages. This permits the use of resistance coupling to the modulator or amplifier tube. The grid leak of the detector returns to $+B$ voltage in order to obtain less distortion on strong 5 meter signals. The sensitivity, when this method is used, is the same as when the grid leak returns to $-B$, but a much better automatic volume control effect is obtained.

The modulator tube is a 41 which, in combination with a center-tap output choke, will

modulate the 71A oscillator nicely with better quality than the usual modulation choke arrangement. This tube also serves as the audio amplifier for reception.

The transmitter section uses a 71A oscillator because this tube is quite effective at moderate plate potentials on 5 meters. The 71A tube heats quickly and the send-receive switching arrangement acts fairly rapidly. A 12A tube is also quite efficient, but the lower value of grid-leak for the 12A necessitates the use of an RF choke in series. The grid-leak value for a 71A is so high (100,000 ohms), that no grid RF choke is needed.

The send-receive switch is only a SPDT switch but it performs several functions. In the transmitting position it turns on the 71A filament and allows the oscillator to function; it also turns on the microphone current; cuts the head-set off, opens the cathode circuit of the RF tube so that it will not load-up the transmitter, and opens up the detector cathode circuit so that it will not super-regenerate and modulate the transmitter. In the receive position all the functions are reversed. In order to keep the side-tone low while transmitting, the cathode by-pass condensers must be small, .0001 condensers are satisfactory.

The circuit diagram gives nearly all of the circuit constants. The 5 meter coils are made of No. 12 wire, space-wound on $\frac{1}{2}$ -in. form, 5 turns, center-tapped. The tuning condensers can be 15 mmfd. midgets, such as those used in the receiver. It is possible to

use a center-tapped loudspeaker output transformers for the modulator choke and mike transformer shown in the diagram.

The transmitter output into a 500 ohm resistor should run between 1 and 2 watts with 135 to 180 volts plate supply. The output will increase rapidly with higher plate voltage. However, about 230 to 250 volts is all that a 71A tube will handle for any period of time as a 5 meter oscillator. The method of coupling to an antenna depends upon the type of feeders used. A convenient method is to use two 1-inch square plates with about $\frac{1}{8}$ -in. spacing as an antenna coupling condenser. With this arrangement either a single-wire feeder or two-wire matched impedance feed can be used to the antenna. A two-wire feeder will function satisfactorily by connecting one feeder to the chassis and the other to the coupling condensers. For automobile use, a single-wire feeder is quite convenient; the antenna being a 4 ft. quarter-wave rod. The lower end of this rod should be grounded to the car body or bumper, and the feeder attached about 12 to 14 inches above the grounded end.

The RF tube coupling condenser to the detector should be adjusted so that the detector will just super-regenerate well with the plate voltage supply used. Best sensitivity is thus secured. Care should be taken to keep all RF tube by-pass condenser grounds to one point, preferably very close to the socket. The RF chokes can be made by winding No. 34 DSC wire for about 1 inch on a $\frac{3}{8}$ -inch bakelite or dowel rod.

5-Meter Transmitter and Receiver Circuit

This is not a Transceiver, but a 5-meter unit known as a Transmitter-Receiver. More widespread use of this type of equipment will aid in solving some of the problems of 5-meter congestion in localities where many 5-meter sets are in operation. The circuit here shown in the model "TR" Wunderlich. Coils L1 and L2 are made of No. 12 wire, space wound, $\frac{1}{2}$ inch diameter, 5 turns, center-tapped.

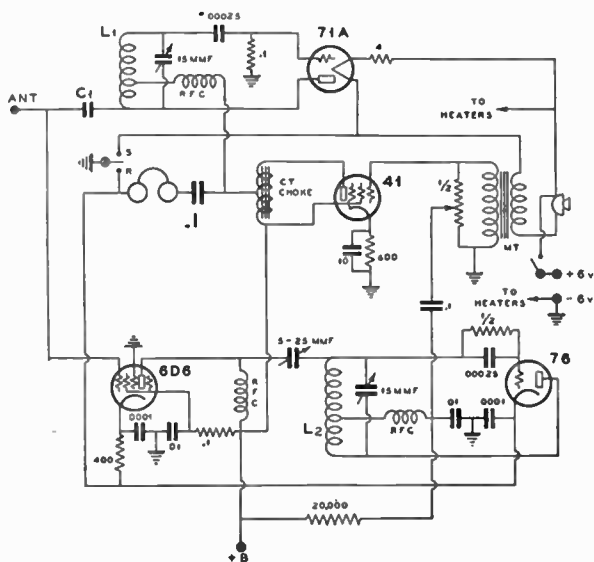

Jacobs' Duplex Transmitter-Receiver

THE Radio Transceiver Laboratories Type 53-6A6 Duplex Unit employs a radio-phone transmitter similar to that of the Jacobs' 53-6A6 Transceiver. Like the transceiver, it employs twin-triodes, unity coupling and class B modulation; but in addition, the TR unit has a separate four-tube super-regenerative receiver and a dynamic speaker. Receiver radiation interference is eliminated and duplex operation is thus made possible. Duplex, or break-in operation is two-way transmission and reception, similar to that of a land telephone circuit. The operator talks and listens without throwing a switch. He can interrupt the conversation at will, or "break-in". A panel switch knob is provided for turning off the transmitter when listening on the transmitting frequency.

Transmitter and receiver are separate units, completely shielded from each other, and each has its own power supply socket. The unit can be installed with individual power supplies for transmitter and receiver, or both may be connected to the same power source. Supply cables should be shielded to prevent receiver radiation. The entire duplex unit is housed in a black crackle finished steel case, 10x14x5-in. and is provided with ventilating holes and two handles. The latter may be used for securing a strap for carrying or for fastenings in mobile use.

The receiver employs a super-regenerative detector of the indirectly heated cathode type.

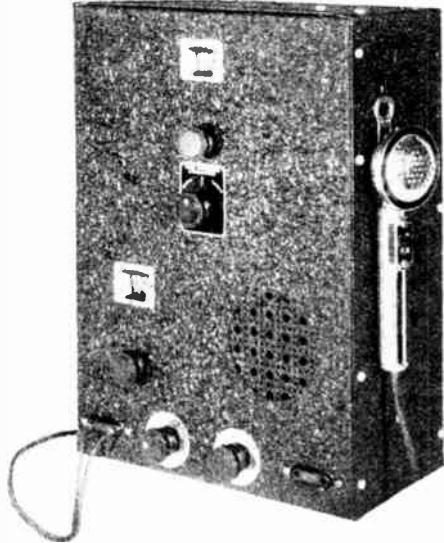

Exterior View of Radio Transceiver Laboratories Duplex Transmitter Receiver

26 OR 56 MC AMATEUR BAND - OR 37 MC EXPERIMENTAL BAND
TYPE TR 53-6A6 DUPLEX TRANSMITTER-RECEIVER
2.5V OR 6.3V FIL

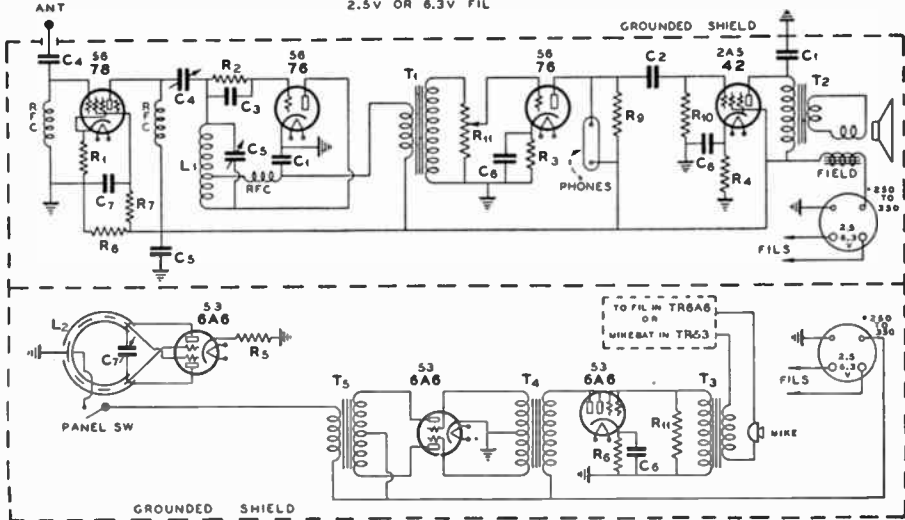

- R1—400 ohms. R2—1/4 megohm. R3—2700 ohms. R4—500 ohms, 2 watt. R5—500 ohms, 2 watt. R6—1000 ohms. R7—50,000 ohms. R8—40,000 ohms. R9—100,000 ohms. R10—250,000 ohms. R11—500,000 ohms. RFC—50 turns No. 30 DSC on 3/8-in. dowel. C1—.004 ufd. C2—.05 ufd. C3—.00025 ufd. C4—35 ufd. C5—1 ufd, 450 v. C6—5 ufd, 25 v. C7—15 ufd Cardwell. L1—9 turns No. 12, 3/8-in. dia. (60 MC) spaced thickness of wire and tapped at 6 turns. L2—2 turns, 3/8-in. copper tubing, 2-in. dia., with piece of No. 19 Corlac 1300 v. insulated solid wire threaded through for Grid Coil (60MC). T1—3:1 Audio Trans. T2—Pentode Output Trans. T3—Mfc. Trans. T4—Class B Input, UTC HB1 or NS29. T5—Class B Output, UTC HBM or NS33.

I.C.A. 5-Meter Transceiver Kits

THESE are many experimenters interested in five-meter work who would much rather build a set than buy an assembled unit, because of the pleasure they get out of building it.

Home constructors who have been waiting for some firm to recognize their requirements in this regard will be interested in three new transceiver kits recently brought out by the Insuline Corporation of America, New York. These kits are really complete, down to the last nut and soldering lug.

All three sets use the same steel cabinet, which is finished in black crackle enamel. The box measures only 6 1/4 inches long, 5 inches high and 3 3/8 inches deep and the completed outfits weigh only 4 pounds, less batteries. The two-volt model, for operation on dry cells, uses a 30 and a 33. The six-volt model, for storage battery use, particularly in a car, uses a 37 and a 41. The AC model uses either a 37 and a 41 or a 56 and a 2A5.

The diagrams of all three models are shown herewith, with the electrical values of all parts indicated. The same fundamental RF-AF circuit is used in all cases, with minor differences occasioned by the nature of the power supply.

The circuit is very simple, but many people are confused by the dual functioning of the tubes.

Consider Fig. 1, which shows the 2-volt model. If the transmit-receive switch is pushed to the "receive" position, the 30 acts as a self-quenching super-regenerative detector. It is called "self-quenching" because it supplies its own low-frequency oscillations,

which in other types of circuits are produced by a separate tube. The oscillation at low frequency is a function of the grid leak value, in this case 250,000 ohms.

The signals received by the detector are led through the switch to the upper primary

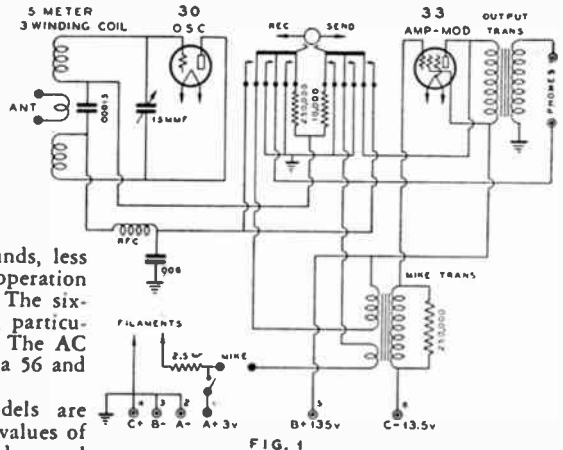

FIG. 1

of a special double-primary transformer, which in the receive position of the switch acts as a perfectly normal AF amplifying transformer. The secondary goes to the 33 output tube, and the amplified signal finally reaches the earphones through an output transformer.

If the switch is pushed to the "transmit" side, the same tubes and parts act altogether differently. With a 10,000 ohm grid leak in the circuit, the 30 tube becomes a straightforward RF oscillator, the frequency of its output depending of course on the setting of the 15 mfd. midget tuning condenser. The lower primary of the special transformer is cut into the microphone circuit, and the transformer becomes a modulating transformer. Likewise, the 33 tube, which is still connected to the secondary of the latter, becomes a regular Heising modulator and modulates the RF output of the 30 oscillator with the speech picked up by the hand microphone attached to the transceiver. The phone circuit is opened in the "transmit" position, so the primary of the output transformer functions as a straight audio choke. The principle of Heising modulation has been used for years and is well known.

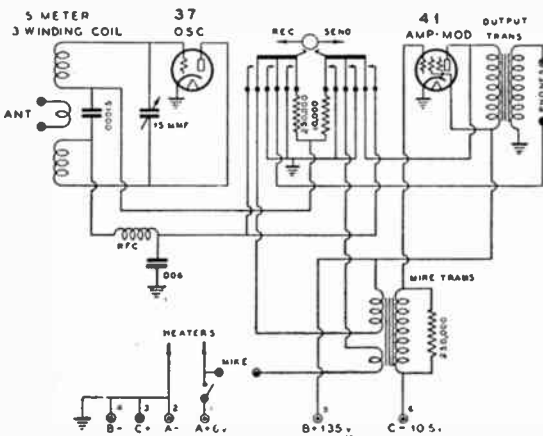

FIG. 2

There is nothing at all complicated about the receiving and transmitting operations; all they require is manipulation of the change-over switch and the single tuning knob.

The latter has two holes in the top for stand-off insulators that carry the antenna connections, and an opening in the back for the binding post strip. Detailed assembly directions and picture wiring diagrams are supplied with the kits. Anyone who can handle a screw-driver, soldering iron and pair of pliers can put together a complete outfit in a single evening.

The two small binding posts on the top of the case, which connect to a small coupling winding between the sections of the oscillator coil, permit the use of various types of antenna. For portable operation probably the simplest aerial is a four-foot length of copper, brass or aluminum rod or tubing fastened directly to one post, with the other left free or grounded. Tuned feeders connecting to a half-wave Hertz antenna may also be used, in accordance with all the principles that govern antenna construction and operation on the lower frequencies. The various methods for connecting the filament circuit, depending upon the

type of tubes used, is shown in Fig. 4. The 37-76 oscillator tube and the 41 amplifier-modulator tube can be operated with the

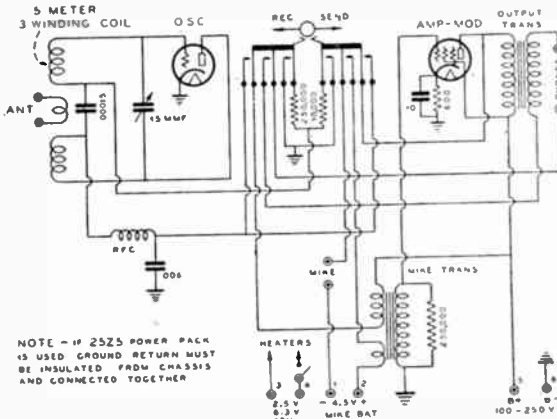

FIG. 3

During receiving, the transceiver produces a steady, rushing noise in the earphones. However, when a carrier wave is tuned in, the noise disappears and the voice comes through clearly. This peculiar operation is characteristic of super-regenerative receivers.

The mechanical placement of the parts in the I.C.A. transceivers is arranged so that the wiring leads are as short and direct as possible. The photograph shows the simplicity of the low-cost model. The layout is symmetrical. The 15 mmf. midget condenser

HEATER CONNECTIONS FOR A C MODEL

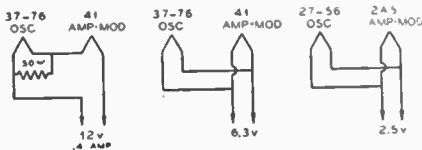

FIG. 4

occupies the center of the front panel, with the change-over switch above it and the split winding tuning coil below and behind it. Just behind the binding post strip are the audio transformers. The various small resistors and condensers are mounted by their own terminal wires, all the connections being short and direct.

The carrying case is made of two pieces: an L-shaped front and bottom, and a complete



The I.C.A. Kit in its Metal Cabinet.

filaments connected in series if a 12-volt battery is used. A number of the popular makes of automobiles use a 12-volt storage battery. A 50 ohm resistor is connected across the filament terminals of the oscillator tube, as shown. This resistor should be of the heavy-duty small wire-wound type.

3-Tube Unity-Coupled 5-Meter Transceiver

ONE of the most interesting pieces of apparatus in amateur radio is the five-meter "transceiver," which gets its name from the fact that it is a combination transmitter and receiver using the same tubes and accessories for both purposes. A recent ruling of the Federal Communications Commission permitting mobile as well as portable operation on five meters has greatly accelerated amateur activity along these lines, and amateurs everywhere are deserting the hopelessly crowded 20, 40 and 80 meter bands to find considerable pleasure on the shorter wave.

Five meters offers many opportunities because one can pack a complete outfit into a box about the size of a typewriter case and set it up for operation in a few seconds. A 5-meter set can be operated in a car in motion, and dozens of different "hams" can be contacted as you drive from one town to another. Five-meter "field days" held on Saturdays or Sundays, are getting to be regular affairs in amateur circles.

In recognition of this growing acclaim of five meters, there has been designed a three-tube transceiver which has proved exceptionally successful, and can be purchased complete for a price that would have been considered low a few years ago for just an ordinary power pack.

A single case, made of steel finished in durable black crackle, and measuring 15¼ inches high, 8 inches wide and 7 inches deep, houses the complete outfit, which is known as the Lafayette Transceiver. Why steel and not aluminum for a portable job? you may ask. It was found that steel stands the punishment of portable service better than aluminum, and its extra weight pays for itself in durability.

As shown in the illustrations, the case is formed on four sides and has removable front and back panels. A man-sized carrying handle is fastened to the top. The upper half of the box is occupied by the transceiver proper, the lower by all the required filament, plate and microphone batteries. A decorative plate for the front panel carries three controls and two jacks; the former are the main tuning knob, in the upper center, volume control, lower left, and receive-transmit throwover switch, lower right. The jacks are for earphones and a small hand microphone.

The knobs are of the new pointer type and look very distinctive. A plain knob and not a vernier dial is used for the tuning condenser (C1 in the diagram) because the tuning is not critical and a knob permits quick scanning of the entire five-meter band.

The three tubes in the Lafayette Transceiver actually do the work of five, and this accounts to some degree for the effectiveness

of this little outfit. The diagram shows all of the connections in detail.

Transceiver hookups always look confusing at first sight, but this particular one is really easy to understand if you follow it through carefully. Tubes V1 and V3 are both

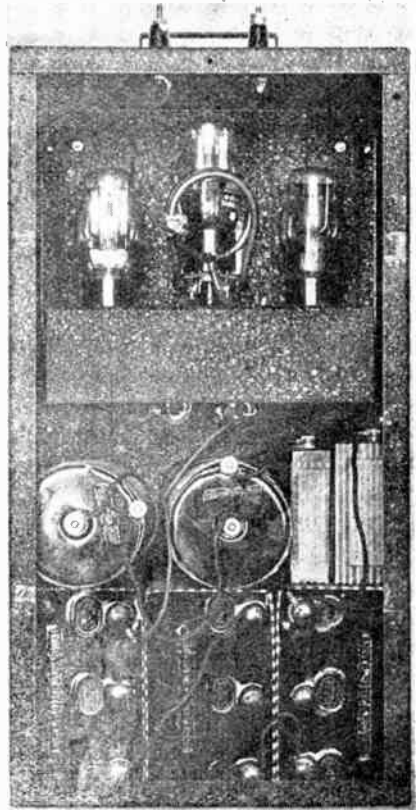

Interior view of Transceiver, showing unity-coupled coil and battery compartment.

type 19 double triodes, V2 a type 30. The four switches marked S are all part of a single four-pole, two-position unit; the points marked T represent the transmit position; the points R the receive position. The variable resistor R1, which acts as volume control, is combined with the filament switch SW. C1, R1 and S are the only variable instruments in the whole transceiver.

The coil marked L2 looks a bit peculiar. It consists of two turns of ¼-inch copper tubing about 2 inches in diameter, with a split length of insulated flexible wire inside. The tubing acts as the plate coil, the wire as the grid coil, of a simple push-pull oscilla-

tor. The close coupling between the two coils makes this a powerful oscillator indeed. Tuning condenser C1 (a 15 mmfd. midget) is connected across the ends of the plate or "tank" coil and to the plates of V1, with a center tap for plate voltage. The grid coil connects to the corresponding grids and is similarly tapped.

Let us throw the changeover switch to the receive position and see what happens. Tube V1 now acts as a self-quenching super-regenerative detector, with C4-R3 as the grid condenser-leak combination. Transformer T1, with primary P1 functioning, acts as an ordinary amplifying transformer, working into V2 as first audio stage. V2 in turn feeds into T2 and V3, which act together as a complete class B audio output stage, the output transformer T3 operating the earphones.

Now switch to the transmit position, and the same parts act altogether differently. V1 becomes a push-pull oscillator. Primary P2 of transformer T1 is cut in, and T1 becomes a microphone coupling transformer. The secondary of T3 is switched from the phones to the plates of V3, so T3 is now the modulation transformer.

In the receive position, R1 is a volume control on the received signals. In the transmit position, it is a mike gain control.

The whole idea works out perfectly, with the tubes performing their dual functions just as efficiently as if the receiver and transmitter were separate units.

Two binding posts are provided on the top of the case for antenna or feeder connections. Best results are obtained with a quarter-wave antenna, consisting of a four-foot length of aluminum tubing, fitted at one end with a threaded brass insert that screws directly to one of the stand-off insulators. An eight-foot, half-wave antenna has also been

found good. The four-foot tube is convenient because it is shorter. It is especially valuable when used on a car in motion, because it whips around less.

For power supply, dry batteries are used throughout. Two standard No. 6 dry cells light the filaments. Three 45-volt B batteries energize the plates. A 7½-volt C battery furnishes bias for V2. A separate 4½-volt C battery is used for microphone current, one of the switch sections opening this circuit when the transceiver is in the receive position. A single set of batteries withstood two months of experimental service, and still seem to be all right.

As for actual results, the five-meter band is full of surprises, the right kind of surprises. Although these waves are supposed to be of the quasi-optical type, and a receiver and a transmitter may be practically within sight of each other for communication, this set has worked more than ten miles "blind" between 100 Sixth avenue, New York, and some of the outlying sections of the city. Some of the contacts were made with stations apparently blanketed by steel buildings. In fact, one QSO was accomplished with this transceiver on the fifth floor of a 17-story steel building, and the other station about three miles uptown! One of the beautiful features about a transceiver like this is that you can pick it up and move on, if one location isn't so good, and if another looks better.

The owner of a car can spend whole months running around with this transceiver. To look up the address of some five-meter amateur, drive around the corner from him and then "QSO him" over the air. The strength of the received signals is not always an indication of the transmitter's location.

Parts List for the Lafayette Transceiver

- C1—15 mmf. midget.
- C2—.002 mfd. mica.
- C3—.002 mfd. mica.
- C4—.00025 mfd. mica.
- C5—.004 mfd. mica.
- C6—.00005 mfd. mica.
- R1—1 megohm.
- R2—5000 ohms.
- R3—200,000 ohms.
- R4—1.5 ohms.
- L1—Tank coil as described.
- T1—Special Lafayette double primary transformer.
- T2, T3—Class C AF transformers.
- V1, V3—Type 19 tubes.
- V2—Type 30 tube.

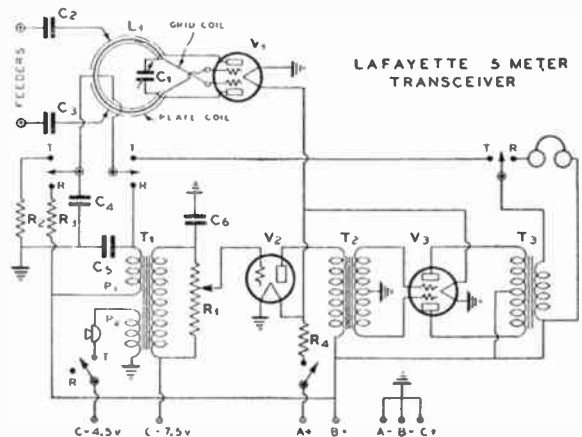

8-TUBE 5-METER SUPERHETERODYNE

● The writer, in common with other 5-meter experimenters, has always had better luck with super-regenerative receivers than with any other type on the 5-meter band. An analysis of the situation brought out some interesting points, so another superheterodyne receiver was built and the results have been very gratifying. The sensitivity and selectivity of this receiver is better than any super-regenerative receiver ever tested.

For present day purposes, a receiver must tune broadly enough to cover from 50 to 100 KC band width in order to receive

line voltage. This means that the IF amplifier should be broad enough in its tuning to take care of this oscillator drift. The car transmitters are also liable to drift; therefore the IF amplifier should be broad.

Most 5-meter superhets have lots of noise and very little signal. The trouble usually lies in too much IF gain and not enough RF gain ahead of the mixer tube. A straight RF amplifier will provide some gain, but regeneration is the real answer. Regeneration at the IF frequency does no good, but it can be used in either the RF stage or in the de-

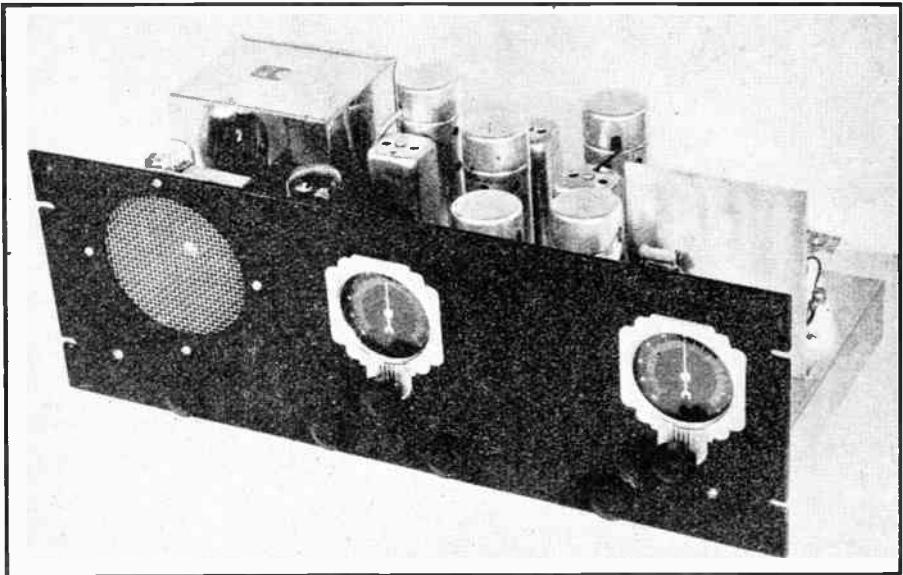

● The front panel presents a symmetrical and pleasing arrangement. The loud-speaker is protected with a metal grille. Illuminated Crowe airplane tuning dials add beauty to the job. The panel is of standard relay rack size. The 6.3 volt series tubes are used; the receiver can be operated from batteries or A.C.

the usual modulated oscillator transmitter signals. Very few stations use crystal or MOPA controlled sets and thus a special IF amplifier was built using a short wave about 110 meters for the intermediate frequency. This, with close coil coupling, gave a nice band width and the superheterodyne therefore becomes really practical for present day service.

A superheterodyne receiver for police 8-meter work should also tune broadly, since even with MOPA or crystal control in the car sets, the main station must have a standby service without constant retuning. The ordinary first oscillator in the superheterodyne will drift from 20 to 80 KC as its temperature changes and with variations of

detector grid circuit. Both methods were tried and best results were obtained by using regeneration in the detector circuit, since antenna resonance has no effect of dead spots in the regeneration control. Better weak signal response from a signal generator was obtained by using first detector cathode tap regeneration than when the same method was used for the RF tube.

The RF stage provides a little additional gain where it is really needed, reduces image interference, and removes antenna resonance absorption spots from the regenerative circuit. This combination brings in 5-meter signals that are inaudible on super-regenerative sets using a stage of TRF. The same

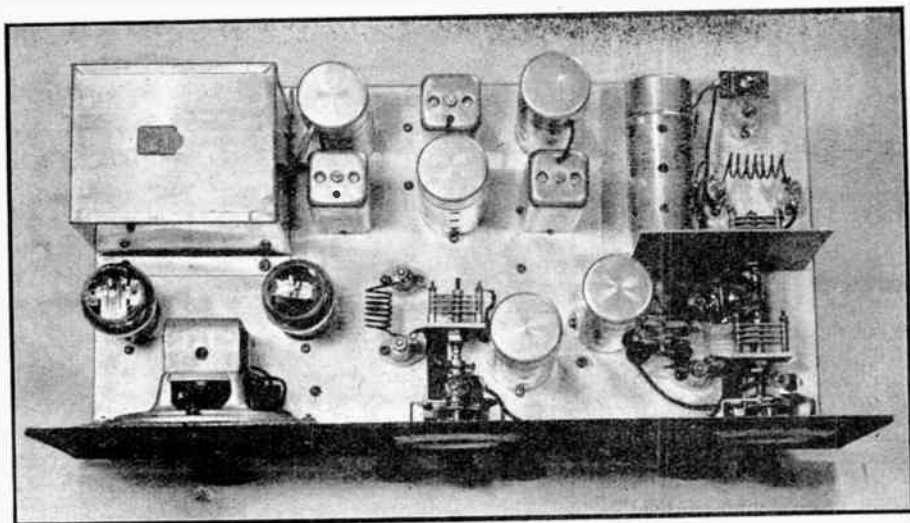

● Looking down into the 5-meter Super. The RF coil is mounted horizontally to permit the use of very short leads. An aluminum shield isolates the RF stage from the detector. The inductances are mounted on porcelain stand-off insulators. The power transformer is at the left rear of the chassis. It is the new UTC Niklshield unit, with 6.3 volt filament winding.

results were obtained in comparing it with an ordinary transceiver set.

The image interference is minimized because of regeneration and two pre-selection tuned circuits. The IF frequency being about 2.7 megacycles, the image is 5.4 MC away from the desired signal. This means no image interference from other amateur signals in the 5-meter band of from 56 to 60 MC.

AVC was included in this set to prevent overload on strong local signals. To provide maximum sensitivity, delayed AVC was used and this voltage applied to the grids of the two IF stages only. An audio volume control is used to maintain the desired amount of loudspeaker volume. The sensitivity control, a 50,000 ohm IF cathode variable resistor, could have been made 5,000 or 10,000 ohms with a slotted shaft for screwdriver adjustment only, since the usual field strength of 5-meter transmitters is quite low.

Examination of the circuit will show that the RF and detector circuits are quite similar to those used in longer wave sets. These two circuits are tuned by a gang condenser made from ordinary midget condensers. The condensers were originally 100 mmfd type and later were double spaced and only 7 plates left in each condenser. Double spacing helps on 5 meters since the condensers are less microphonic when the loudspeaker is being operated at good room volume. Trimming the detector and RF stage is accomplished by means of the semi-variable coupling condensers from the antenna to

grid, and plate to grid of the respective stages. The coils are made of No. 14 wire so the inductances can be varied by slightly altering the turn spacing. No attempt was made to track the oscillator with the other two circuits, although this could probably be accomplished. Regeneration makes the detector tuning about as sharp as that of the oscillator.

The second detector and audio power stage is quite similar to that used in some broadcast receivers. Delayed AVC is obtained by using one of the diode plates biased with respect to the cathode. The signal must be of a certain amplitude before any negative AVC voltage is generated for AVC control. The audio frequency is taken from the other diode plate without any bias, since the latter would cause audio distortion. The high mu triode section of the 75 tube is used as a regular resistance coupled audio stage giving a gain of about 40 to 50. A type 42 pentode increases the signal to loudspeaker volume.

A tone control is provided to reduce automobile ignition interference which is quite serious when using a superheterodyne receiver in most locations. A high half-wave receiving antenna, transposed two wire feeders and an electrostatic shield should reduce this trouble. The antenna coupling condenser should then be connected across the tuning condenser and a Faraday electrostatic shield placed between the tuned grid coil and tuned antenna feeder coil. Most of the auto QRM is picked up in the down leads and is transferred beautifully by even

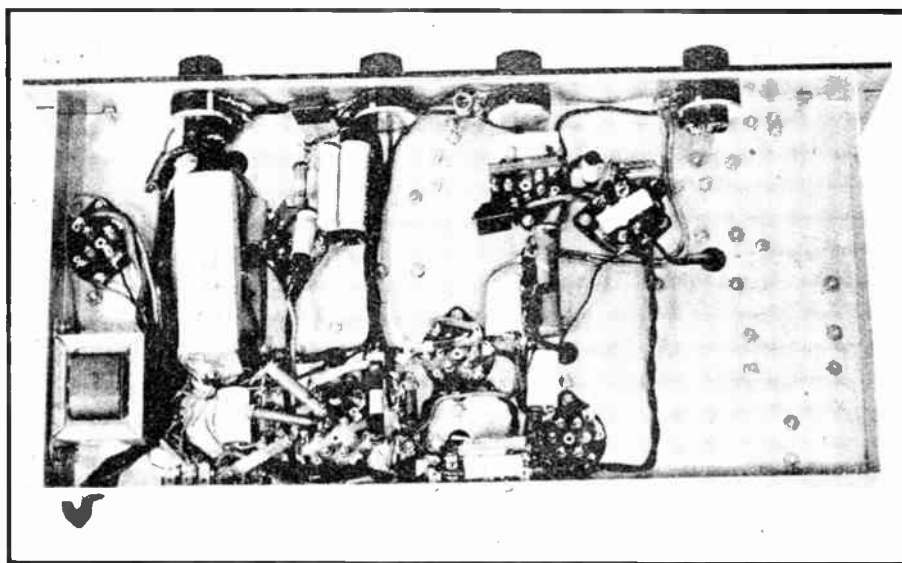

Under-chassis view, showing proper location for filter choke and condensers.

the slightest bit of capacity coupling. The receiver should be mounted in a relay rack with a metal dust cover, or in a metal cabinet if used on a table or desk. Too much emphasis cannot be placed on the need of using an efficient, noise-reducing type of receiving antenna.

Several oscillator circuits were tried and best results were had from a 76 tube instead of the usual electron coupled 6C6 or screen grid tubes. A form of electron coupling is used to the mixer tube because the suppressor grid is used for that purpose. This puts the suppressor grid at a positive potential of about 100 or so, since it ties directly to the oscillator plate. However, this seems to give better conversion gain in a regenerative detector than any other system tried. Invariably, comparisons between capacity coupling or any other form and this method, gave the latter the edge by about two or three times in sensitivity.

The receiver is mounted on a 7 x 19 x $\frac{3}{8}$ -inch aluminum panel for relay rack mounting. The holes for the loudspeaker opening and the two airplane type dials can be cut by means of a flying bar cutter. The chassis was made of No. 14 gauge aluminum because it is easily drilled and does not require plating. The chassis measures 9 x 17 $\frac{1}{2}$ x 1 $\frac{3}{4}$ inches. The pictures of the set give a good idea of the general layout of the parts. The signal comes in at the grid of the horizontally-mounted RF tube, through the first detector, two IF stages, second detector and power

audio stage. The power equipment and loudspeaker are mounted at one end and the RF portion at the other. The IF amplifier occupies the rear middle portion and the high frequency oscillator the front middle portion. The oscillator tuning condenser must have an insulating coupling to the dial because this circuit is "hot" at both ends of the I.C. circuit.

The two radio frequency chokes are made by winding about an inch of winding length of No. 31 DSC on a $\frac{3}{8}$ -inch diameter bakelite rod. All of the coils are made of No. 14 wire, space wound on a half-inch diameter. These coils are mounted on small stand-off insulators near the tuning condenser terminals and they can be changed in a few minutes, if the receiver is to be used on some other short wave band.

The RF tube is mounted horizontally so as to obtain a short plate lead to the detector grid circuit. All of the RF stage bypass leads are very short and return to the common ground point on the RF partition shield. By making this point at the tuning condenser rotor connection, interlock between the RF and detector circuits is avoided. Short leads are necessary in 5-meter work because an extra inch of wire adds quite an appreciable value of inductance.

The IF amplifier uses about 2.7 MC as its frequency. The transformers are home-made affairs, using the parts of regular IF transformers. Those used in this set were wound on $\frac{3}{8}$ -inch diameter tubes. The

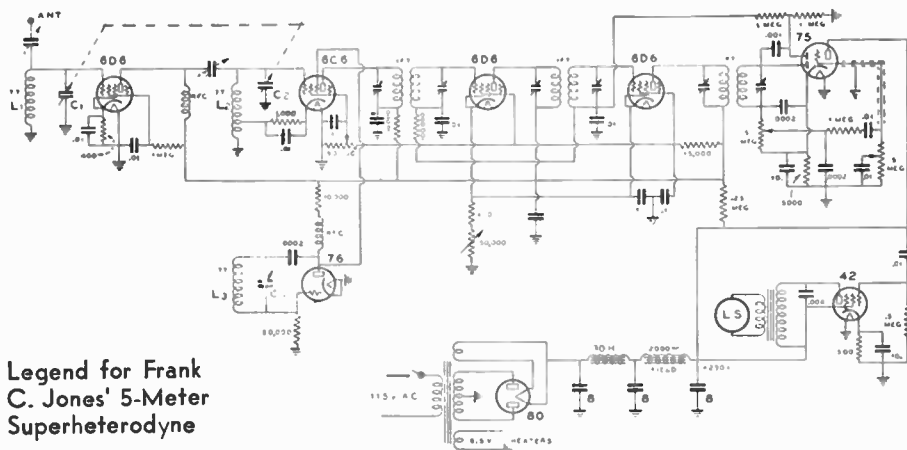

**Legend for Frank
C. Jones' 5-Meter
Superheterodyne**

L1 and L2—Each $1\frac{1}{2}$ in. long, 7 turns, No. 14 enameled wire, $\frac{1}{2}$ in. dia. L3—1 in. long, 7 turns, No. 14 enameled wire, $\frac{1}{2}$ -in. dia.

C1, C2, C3—100uufd. double-spaced variable condensers, with only 7 of the original plates remaining. Maximum capacity of these re-built condensers to be about 18uufd.

I.F. Transformers tuned to approximately 2,000 KC.

450 KC litz coils were removed and two windings each of 120 turns of No. 34 DSC wire put on in jumble fashion to cover a winding length of $\frac{3}{8}$ -inch. $\frac{1}{8}$ -inch spacing was used between adjacent coil edges. These windings, tuned with the mica trimmers of the original transformer, cover from approximately 100 to 120 meters. If one lives very close to a 120 meter police station it would be desirable to use about 100 turns and tune the transformers to about 90 or 100 meters. The first transformers tested used litz wire and were made by pulling off 40 feet of wire from each coil and closing up the coupling until adjacent coils were $\frac{1}{4}$ -inch apart. The IF frequency was adjusted to 1550 KC, but the selectivity was a little too great and the image interference was troublesome. The higher frequency of 2700 KC or 2.7 MC proved to be best. So far no trouble has developed due to IF amplifier pick-up from the antenna circuit on 110 meters. This is minimized by the use of the RF preselector stages and shielding.

The IF amplifier should be lined-up by means of a modulated oscillator of the all-wave type. Starting from the second detector circuit, each stage should be aligned by coupling to the oscillator, then a recheck made of the overall amplifier by coupling the oscillator into the first detector grid circuit. The latter should connect temporarily through a 1000 ohm resistor to ground instead of to its LC circuit, while aligning this IF amplifier.

Alignment of the RF and detector stages is fairly simple. The detector coupling condenser should be adjusted until its capacity is low enough to allow the first detector to break into oscillation when the regeneration control is on full at both ends of the tuning range. The RF antenna coupling, or trimmer condenser, should be adjusted together with slight coil turn respacing until the noise level is highest throughout the band. There is usually enough noise from auto ignition to accomplish this, although a harmonic signal from a modulated all-wave oscillator is much superior for this purpose.

An interesting test was made with a signal generator and a small radiating antenna. A regular receiving antenna was first connected to a good super-regenerative receiver and the signal attenuated in the generator until it was just barely noticeable in the high background noise of this form of receiver. The super-regenerative was then replaced with the superheterodyne receiver and this same signal gave loudspeaker volume without the background noise of the other set. The absence of background hiss is especially pleasant when comparing the two sets for loudspeaker operation. When the auto ignition noise level is low, the 5-meter signals roll in and out without any fuss or change of hiss level, making it difficult to tell an R9 signal from an R6 signal. If the local flashing sign or auto ignition QRM is high, the 5-meter signal strength can be judged by the amount that it overrides the noise level.



Ideal A.C. Operated 5-Meter Amateur Receiver

Ultra-short wave superheterodyne receivers can be made quite sensitive by the use of extreme regeneration, and can even be made broad enough in tuning to serve for standby operation. However, these sets are apparently much more sensitive to neon sign and auto ignition interference than super-regenerative sets. The fact remains that a good "stiff" super-regenerative receiver gives a good signal-to-noise ratio for average, moderate-strength signals. By a "stiff" super is meant one in which the detector is super-regenerating quite strongly.

This latter condition makes for bad receiver radiation unless a radio-frequency stage is used to couple the antenna to the detector. The actual gain in the RF stage is relatively small, being from 1 to 8, as against several thousand in the detector circuit. Its main use is in preventing radiation, which is terrific when the detector is even coupled loosely to an antenna.

The RF tube can be coupled to the detector in several ways; one is shown in this

receiver circuit. This method permits an adjustable amount of coupling and consequently does not load the detector input circuit too much. The RF signal completes its path through the internal capacities of the detector tube, and external circuit to ground capacities. Either an RF choke input can be used with a resonant receiving antenna, or a small semi-fixed tuned input circuit can be used.

Since an RF stage is used, any super-regenerative detector circuit could be utilized. The receiver here shown uses a blocking grid-leak detector system in which the grid leak return is to a high positive potential. When the detector is coupled directly to an antenna, this particular type of circuit radiates about three times as much as the more usual form using a separate IF oscillator.

The sensitivity of the usual form of blocking grid-leak with ground or cathode return is about the same as in this circuit in which the grid leak return is to $+B$ voltage. However, the detector overloading effect is greatly reduced when receiving strong signals and, in general, the tone quality is much better. The action is similar in effect to a receiver with automatic volume control, so that nearly all signals are received at the same volume and only an audio volume control is necessary.

The detector consists of a regular Colpitts oscillator circuit in which the internal capacities of the tube act as the voltage dividing elements and hence produce oscillation. The grid leak is of such a high value that even with a

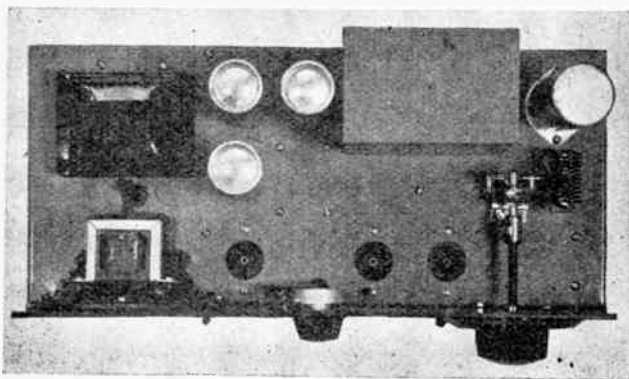

The RF Stage is in the small shield can at right

positive return it still builds up a negative voltage, due to grid current. The circuit decrement and values of grid leak and condenser, and plate return by-pass to cathode are such as to cause a blocking action, producing super-regeneration and the familiar loud hissing sound when no signals are being received.

THIS circuit seems to function as an ordinary oscillator in which the grid leak is too high in value to allow the electrons on the grid to leak off at a rate which would give a constant value of grid voltage. This causes a change of average bias and stops oscillation because the plate current is decreased and the mutual conductance of the tube drops. The grid leak and condenser values and circuit decrement determine the rate and discharge, or number of cycles-per-second that this occurs; in this case an inaudible rate. Apparently the plate circuit must maintain a fairly low impedance path to cathode at this inaudible frequency because the plate by-pass should be at least .002 mfd., whereas .006 mfd. seems none too large. With either resistive or transformer coupling to the audio amplifier, no super-regeneration

will take place without a fairly large plate-to-cathode return by-pass condenser. In the circuit shown, this by-pass condenser has no effect on the RF portion, since it is on the low RF potential side of the RF choke.

TWO stages of audio amplification are used in order to insure more than ample volume under all conditions of reception. In some locations local noise is high, and a loud signal is required in order to make it intelligible. Many ultra-high frequency transmitters are of the modulated oscillator type which have a strong carrier signal with moderate or weak values of modulation. A strong carrier will eliminate the super-regenerative hiss or roar, but the actual voice signal will be weak unless plenty of audio amplification is used. Since a high value of audio amplification is available, it is necessary to use a well-filtered power supply, as shown in the circuit diagram. The pentode power tube, used as an output amplifier, provides ample power for the small dynamic loudspeaker. Head-set operation is possible by means of the switch which cuts-in either the headset and the first audio amplifier, or both stages and loudspeaker.

A super-regenerative detector tunes very

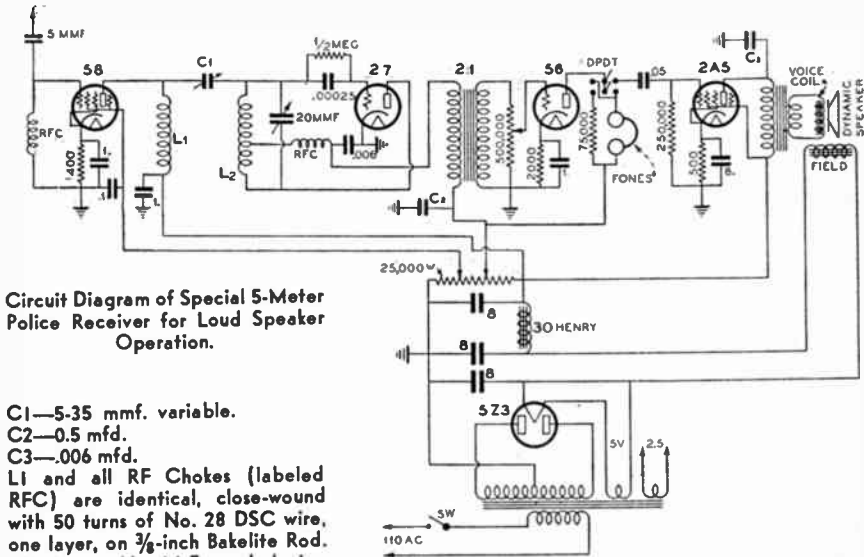

Circuit Diagram of Special 5-Meter Police Receiver for Loud Speaker Operation.

- C1—5-35 mmf. variable.
- C2—.05 mfd.
- C3—.006 mfd.
- L1 and all RF Chokes (labeled RFC) are identical, close-wound with 50 turns of No. 28 DSC wire, one layer, on 3/8-inch Bakelite Rod.
- L2—6 turns No. 14 Enamelled wire, 3/8-inch dia., spaced one diameter, and self-supporting. A tap is taken on L2 at 2 turns from the bottom (plate side of L2 which connects to the '27 Tube).

The Transformer between the plate of the 2A5 and the Voice Coil of the Dynamic Speaker is an 8000-10 step-down of any standard make.

The Field Coil of the Speaker (which acts as one filter choke) can be made the output choke, instead of input choke as shown, if hum develops.

Plate Voltages should be adjusted as follows: To L1 and to Step-down Output Transformer, 250 volts. To Interstage Transformer (between '27 and '56 tube) and to Fones, 120 volts. To Screen of '57 RF Tube, 90 volts.

broadly, normally covering a band of at least 100 KC. It is thus satisfactory for standby operation when receiving modulated oscillator transmitters or mopa transmitters in which there is a carrier frequency drift due to temperature changes. This broad tuning effect is readily explained when it is realized that the detector circuit is oscillating periodically over a wide band of frequencies, usually from 60 to 200 KC in width. An ordinary 6 or 7 meter oscillator will vary its frequency 30 to 100 KC when its DC plate voltage is varied 50%. A super-regenerative detector is an oscillator which has its plate voltage, or grid voltage, varied over much wider limits. As it goes in and out of oscillation (super-regeneration effect) a great many thousand times per second, it also varies its high frequency oscillation period, which gives the broad tuning effect. This is a decided asset in some cases, such as the purpose for which this receiver was designed.

5-Meter M-O-P-A Companion Transmitter For Receiver Described Above

THE trend in ultra-high frequency equipment shows a tendency toward some form of master-oscillator, power amplifier combination. The reason is obvious; an increasing number of commercial, police and others are finding the ultra-high frequencies useful for their needs. The broad modulated oscillator type of transmitter must eventually give way to some form of driven amplifier circuits so that high percentage modulation with its attendant effectiveness can be utilized. Crystal control is far from impossible but it still presents so many complications that its use is hardly justified.

The advent of the new RCA 801 served as a stimulus for the construction of the transmitter here described. The 801 is driven by a '45. Although the internal capacities of the '45 tube leave much to be desired, it nevertheless makes an excellent oscillator for a five-meter transmitter and it is capable of delivering enough output to satisfactorily drive the 801.

The entire unit, which includes oscillator, amplifier, modulator and two power supplies, is housed on a deck 6 inches high, 12 inches deep and 17 inches long. The front panel is standard, 10½ by 19 inches, relay rack size, since the unit is designed to fit into a standard relay rack with its associated receiver mounted on the lower panel of the rack. As the photograph shows, none of the main tuning controls come out to the panel; instead they are accessible through the screened door opening out from the panel. The importance of short direct leads can hardly be stressed too strongly. The leads are made shorter by not attempting to line up the

various controls on the panel, and thus the added convenience in tuning is sacrificed for the sake of added efficiency.

Fig. 1 shows the complete circuit diagram. The oscillator is inductively coupled to the amplifier. A regular tuned circuit is used in the grid of the amplifier in order to provide a voltage step-up as well as to enable the use of series-grid-feed, which eliminates the necessity for an RF choke. Peculiarly enough, RF chokes are quite efficient at five meters and shunt feed is often used. The best choke is none too good, hence the use of series feed.

The amplifier stage is not unlike that used for any of the lower frequencies; the essential difference is in the use of small condensers (low C being used throughout, except in the oscillator), and the use of small diameter inductances. Isolantite sockets are used for both oscillator and amplifier to lessen the loss, which is always appreciable at these frequencies. Shunt-plate-feed is desirable in the amplifier in order to keep the DC off the tank coil, and in the transmitter here described shunt-feed made for correct neutralization. In practice, either inductive or conductive coupling to the antenna is used. Both systems have their advantages, as well as their disadvantages. Inductive coupling was used because of its flexibility and ease of handling.

Good quality of reproduction, as well as a high percentage of modulation was demanded and, therefore, the audio system was designed to conform to these requirements.

Because the transmitter has a 20-watt carrier, it was necessary to use class B audio in order to provide the necessary 10 or 12 watts of audio to give 100 per cent modulation. If properly designed and good transformers are used, the 53 makes a good class B tube. As the circuit shows, one 53 is used as a push-pull, class B tube, and another 53 with both sets of elements in parallel is used for the driver tube. The crystal microphone was approximately 60DB down and it was found a stage of 56 was not enough to bring the level of the mike up to a satisfactory value. Consequently, a 57 high-gain amplifier was used. When a 57 is used, all circuits must be well by-passed and under no circumstances should less than 12 mikes be used in the cathode resistor by-pass. If a smaller condenser is used, degeneration and subsequent loss of the low frequencies will result.

The O-100 milliammeter is connected permanently in the positive high voltage of the class B amplifier. This meter is helpful in determining correct setting of the gain control and assures the operator that the modulator and speech amplifier stages are working properly. An O-1 meter in conjunction with a Yaxley, two-section, six-position, rotary switch indicates oscillator plate current, am-

plifier grid current and amplifier plate current. Each meter position has its own shunt so that a low range reading is possible for the grid current reading, a medium range for the oscillator plate current and a 0-100 range for the amplifier plate current. Alternate switch points are used on the rotary switch so as to avoid the possibility of arcing when the switch is rotated. The use of individual shunts has a further advantage in that it makes all circuits complete when the meter is not in use.

Both power supplies, associated chokes and filters are mounted beneath the chassis. One power supply furnishes power for the speech amplifier and modulator and the other supplies power for the oscillator and amplifier. The use of two power supplies is almost necessary to provide the regulation for good class B operation. The high voltage for the amplifier is fed directly through the secondary of the output transformer, instead of through a choke-condenser arrangement. This method is satisfactory because the output transformer is well designed and the secondary is easily capable of passing the amplifier plate current. The secondary is designed to work into an 8000 ohm load. While this may seem somewhat higher than the usual secondary load, it works out to best advantage since the class C amplifier presents this load with a plate voltage of 400 volts and a plate

$$\text{current of } 600 \text{ milliamperes. } \frac{400}{.060} = 8000$$

ohms, while $400 \times .060 = 24$ watts, the correct input. There is nothing particularly sacred in exactly matching the class C load to the modulator since small amounts of mismatch change the modulator output but slightly.

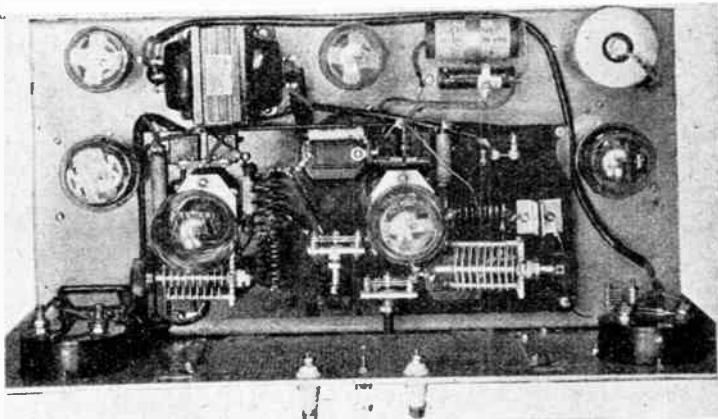

Looking down on the RF portion. The arrangement of the inductances L1 and L2 is plainly shown. The tuning condensers are wide-spaced Cardwell midgets. The R.F. tubes sockets (Isolantite) are raised well above the chassis.

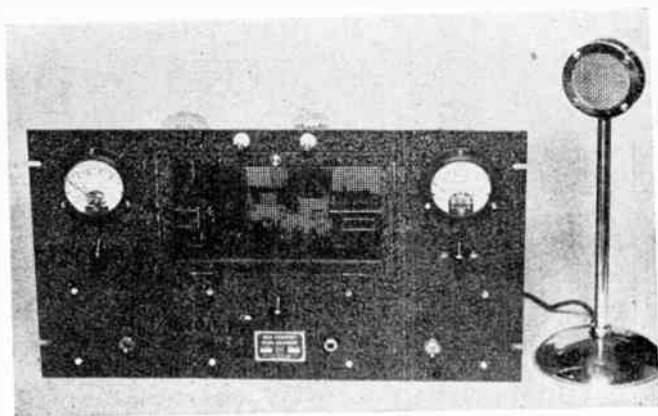

There are no tuning controls on the front panel of this 5-meter MOPA. All tuning adjustments are made by opening the small screen doors on the front panel. Symmetry gives way to efficiency.

This transmitter is completely AC operated; no battery is required for the microphone since this device generates its own voltage. A small amount of fixed bias is necessary as a safety measure for the amplifier stage and this bias was obtained by means of the automatic resistor method. The resistor in the center-tap circuit is arbitrarily adjusted with the plate current set to the working value by the antenna load, and the drop across it is then measured with a voltmeter. This resistance is so adjusted as to have approximately 25 volts drop across it. The voltage drop is then measured across the grid leak and the two bias voltages are added in order to obtain the effective bias on the tube. The values of these two resistors are

changed until the correct bias is obtained. The amount of drop across the cathode resistor should be kept to the smallest possible value so as to keep the plate current within safe limits, should the excitation fail. The bias for class C operation is determined with small error by the formula:

$$\frac{\mu}{\text{Plate voltage}} \times 2$$

On the final adjustment, the sum of the two biases should equal this amount. During the course of this adjustment it is well to bear in mind the fact that changes in the bias will likewise change the plate current and consequently the load resistance which the class C stage offers to the modulator. It is necessary to keep the plate current fairly constant during adjustment, by simply changing the antenna coupling.

In tuning the transmitter, the following procedure is used: First the oscillator should be set to the desired frequency

by use of a frequency meter. The plate voltage on the final amplifier should be disconnected during the course of the preliminary adjustment. The milliammeter is now switched over to read grid current, and the grid tank condenser is adjusted for maximum reading. The final amplifier condenser is then tuned to resonance, as indicated by a dip in the grid current. Bring the grid current back to an optimum value, which will still be below its former value, and then adjust the neutralizing condenser until the grid current remains constant when the final amplifier tank is tuned through resonance. Plate voltage should then be applied to the final and the milliammeter switched into the amplifier plate circuit. The plate current should then be tuned for a minimum reading, by adjusting the final tank condenser.

The quality of voice from this transmitter leaves little to be desired. It speaks for the advantages of the driven amplifier type of ultra-high frequency equipment.

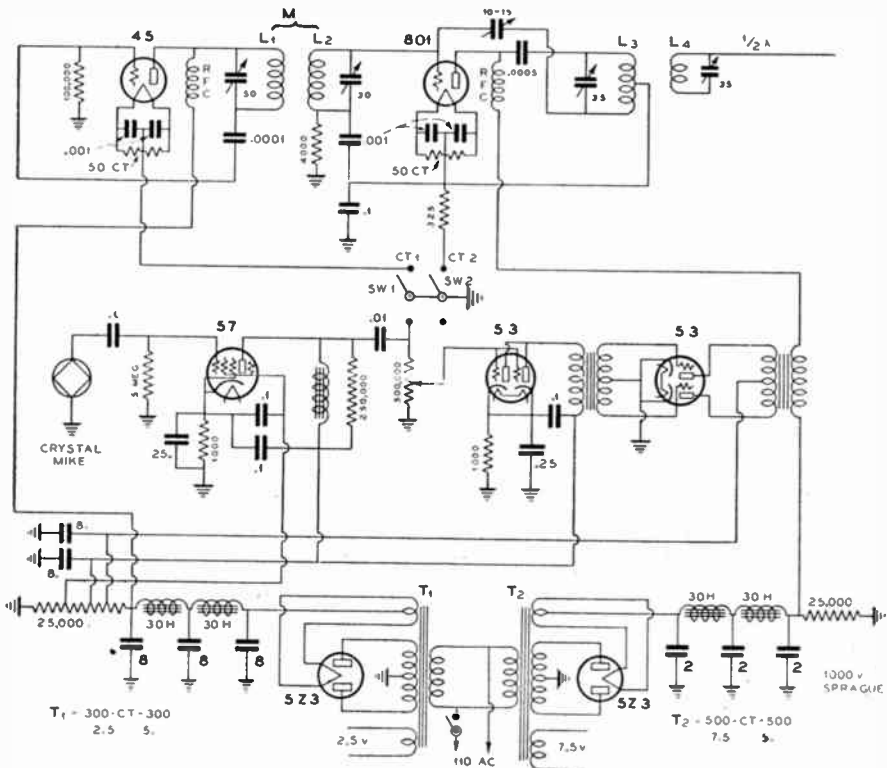

Complete RF, Speech and Power Supply Circuit Diagram of 5-Meter M-O-P-A.

Coil-Winding Data for 5-Meter Operation: L1—6 turns, No. 12 enameled wire, spaced one inch between turns and wound on a 1-inch diameter form. L2—4 turns, No. 12 enameled wire, self-supporting, air-spaced between turns, 1-inch diameter. This coil is placed 1 inch away from L1. L3, L4—6 turns, No. 12 enameled wire, spaced 1/8-inch between turns on 1-inch dia. form.

Frank C. Jones 5-200 Meter Amateur Receiver

THIS new receiver was designed to meet several requirements which have always seemed desirable. In the first place, few amateurs are able to make use of more than one or two of the short-wave bands which are at their disposal, thus missing a great deal of pleasure. Amateur activity on the different bands from 5 to 175 meters varies with the seasons of the year, and also to a great extent on the so-called "11 year cycle" period. A desirable set would be one that is simple to operate and could be used satisfactorily on any and all of the six amateur bands from 5 to 175 meters.

The above requirements are met in a new receiver herein described. Since this receiver functions on all of the bands, it is more uni-

than it is worth, unless precautions are taken. A volume or sensitivity control is necessary to prevent strong signals or key clicks from overloading and locking up the regenerative detector. Variation of this control always has a slight effect on the tuning of the detector. The actual signal selectivity of a T.R.F. stage is about nil; in general an RF stage is liable to be undesirable and in most locations it is unnecessary.

A really good regenerative detector has a gain of several thousand times on weak signals and thus a gain of 5 or 10 through an RF stage is usually unnecessary, unless the noise level is exceedingly low. Raising the RF gain usually means automatically reducing

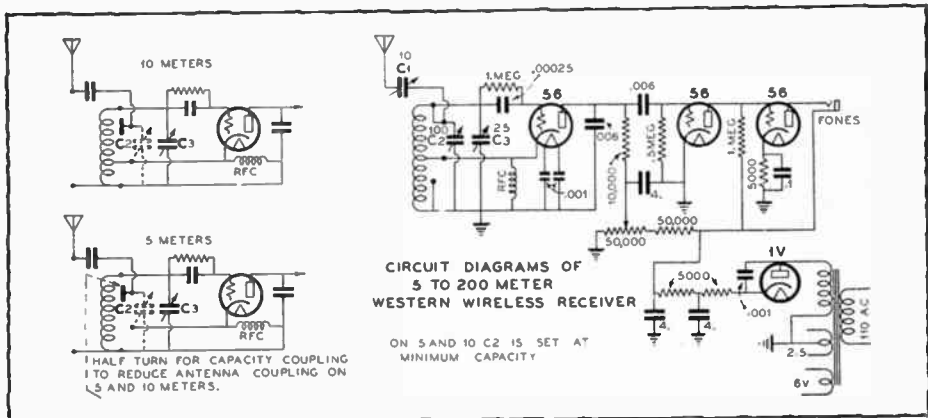

versal in its applications for amateur use. It is possible to QSY to any amateur band by means of plug-in coils, one per band. The circuit is such that either regeneration or super-regeneration can be used on the 5 and 10-meter bands, and regeneration on the 20, 40, 80, and 160-meter bands. Bandspeed tuning is available on any of the bands, or between bands from 10 to 200 meters, since the tuning coverage is complete.

In designing a receiver for use on all of these bands, there are several considerations involved. A super-heterodyne set, with or without a quartz crystal filter, is usually desirable in the 40 and 80-meter bands because of its superior selectivity. T.R.F. sets can be used on the longer wavelengths to obtain more sensitivity, and they give slightly greater selectivity than can be obtained with a plain regenerative detector. However, on 5 and 10 meters the gain of an RF amplifier is practically nil; usually true even on 20 meters. On 40 and 80 meters a T.R.F. (tuned-radio-frequency) stage can be more troublesome

the detector sensitivity, so there is nothing gained. A good regenerative detector can be made to super-regenerate and thus give a great increase in sensitivity on 5 and 10-meter phone signals. A good regenerative detector can make a poorly-designed superheterodyne appear "sick" when it comes to receiving weak CW signals on 10 and even 20 meters. It will give a super a good race even on 40 and 80 meters, and many DX records are made with regenerative-detector sets. The fellows that really hear those foreign DX stations in most cases depend on practice and ear sensitivity to weak signals, rather than the use of a multi-tube receiver with high noise level and loudspeaker output.

Another desirable feature is complete AC operation of the receiver; that is, no batteries of any kind to worry about. AC operation means special precautions must be taken to eliminate AC hum, and to eliminate variation of signal strength or CW beat note when fluctuations occur in the AC line supply. Elimination of AC hum means good filtering

and careful placement of transformers and chokes. In this receiver no audio transformers or filter chokes are used, and the current drain is low enough so that a very effective resistance filter can be used. It proved to be more satisfactory than any other type, even a screen-grid tube. Analysis of a screen-grid tube detector showed that in the usual form of electron-coupled detector there is a triode tube detector coupled electronically to the tetrode audio amplifier part of the tube. In other words, the reason for the supposed superiority of a grid-leak type screen-grid detector was in the fact that there is more audio amplification in the tube itself. In grid leak detection, the detection is in the grid circuit and the tube acts also as an audio amplifier. The screen-grid type gives more audio amplification and possibly slightly better detection efficiency than a type 27 or 37 triode tube.

Practical tests seem to show that the type 56 tube has a better grid-leak detection efficiency than even a screen-grid tube, but not as much audio amplification. This condition was easily remedied by using an additional resistance-coupled 56 audio amplifier. The detector circuit is rather novel in that the plate is grounded by a .006 mfd. condenser and the cathode is tapped part way up the grid coil, as in an electron-coupled oscillator. This type of oscillator gives a much more uniform regenerative control over a large tuning range than the more usual form of a separate plate tickler winding. It also adapts itself readily to 5 and 10-meter super-regeneration. The tuning condenser rotors are at ground potential, even on 5 meters, which is desirable both electrically and mechanically.

From about 13 meters up to 200 meters, the plug-in coil connections are such that the cathode tap gives regeneration . . . not super-regeneration, and the 100 mmfd tuning condenser, C2 is shunted across the band-spread tuning condenser C3. The latter is the main tuning control, and C2 is set at whatever band is desired within the coil range. The use of C2 allows the reception of commercial CW or phone stations between any of the amateur bands with, of course, vernier tuning by means of C3. By proportioning the coil turns properly, C2 is set for the amateur bands so that C3 tunes nearly over the whole scale to cover the band. Since nearly the whole 100 mmfd of C2 is used on the 20 and 40-meter bands, the detector circuit is fairly high C, which has certain advantages. The detector stability is much better than with high L (inductance) and low C so that pure CW notes sound pure and not wobbly. The detector oscillation is stabilized so that a strong signal does not tend to pull the tube into zero beat, as with low C circuits. This effect is the familiar "detector locking effect" and is nearly absent in this

receiver. By disconnecting the antenna lead it is possible to use the set as an actual monitor even on a powerful transmitter.

On 5 and 10 meters the plug-in coils automatically disconnect the padding condenser C2 and reduce the coupling to the antenna. C2 should be set at zero or minimum capacity. The antenna coupling has to be very loose on these bands. Thus there is an additional series capacity to the grid end of the coil; the result is practically no hum at all, even with the set and power pack enclosed in a small cast aluminum cabinet 6-in. x 7-in. x 9-in.

The receiver consists of a regenerative detector, two low-gain audio stages and power pack. The detector uses a type 56 tube. On 5 meters the coil has no cathode tap, the tube capacities giving the necessary feedback for super-regeneration. The small radio-frequency choke from cathode to ground provides a path for the plate current and grid-leak returns. On the 10 meter and higher wavelengths, the cathode tap shorts out the radio-frequency choke and thus there are no troublesome resonant effects from this source.

Grid-leak type of super-regeneration is used because of its simplicity and the ease of obtaining efficient regeneration or super-regeneration on either 5 or 10 meters by means of the regeneration control. Super-regeneration is obtained by means of high RF feedback, which condition is brought about by the selection of proper values of grid condenser and leak and plate by-pass condenser. The type 56 tube functions extremely well in this circuit at moderate values of plate voltage; 19 volts at 5 meters in one instance. Type 27 or 37 tubes haven't a high enough amplification constant, apparently, to function well in this circuit at 5 meters, unless plate voltage in excess of 100 is used. In this form of super-regeneration the feedback control R1 should only be advanced sufficiently to obtain a loud hiss, not a howling whistle on 5 and 10 meters. On good phone signals the carrier signal reduces the hiss or roar to practically zero.

Resistance coupling is used between the detector and first audio tube to prevent fringe howl. The latter usually takes place if the plate load of a regenerative tube is inductive, such as with transformer coupling, but doesn't if it is resistive. The second audio tube is direct coupled to the first because of its simplicity. With this form of direct coupling, variations of tubes, etc., seem to have no effect, as it is possible to use a 27 and a 56, or two 27 tubes, or an old and a new tube. Variation of plate voltage over wide limits has no appreciable effect either, since the values of the resistors and operating characteristics of the tubes are chosen to overcome such well known effects of direct coup-

ling. These two audio tubes drew less than 5 milliamperes at 100 volts from the plate supply. This form of audio amplifier is efficient, simple and free from fringe howl effects, and has the proper amount of audio gain for headset operation from the detector circuit.

Still another novel feature, and a very practical one, is the use of a resistor type power pack filter. The total plate current drain is less than 10 milliamperes, consequently small 5000 ohm resistors can be used in place of two iron-cored filter chokes. This effects a savings in cost and space, since the power transformer doesn't have to be placed at a definite distance from an audio transformer or filter chokes. The inductive reactance of a 30 henry choke at 60 cycles (half wave rectifier) is only 1130 ohms, so this resistive filter of three 5000 ohm resistors provides better filtering than three filter chokes in the same circuit. With resistance and direct audio coupling, the filtering must be good.

The 4 mfd. condenser across the regeneration control quiets this control in operation and also aids in AC hum filtering in the detector plate circuit, where it is most needed. The resistor input from the rectifier and .001 mfd. condenser from cathode to plate of the rectifier eliminates the usual "tunable hum" problem so often encountered in AC operation of short-wave receivers.

The performance and sensitivity to weak signals has made even old-timers enthusiastic about the receiver in tests around San Francisco bay. Since it covers the whole short-wave spectrum in use at present, it makes an excellent standby receiver for persons wishing to listen-in on some exploring expedition or short-wave phone or CW stations outside of the amateur bands. Without an antenna it can be used as a good monitor for either a phone or CW transmitter to check the quality of the output signal.

An ordinary aerial can be used for reception on all short-wave bands or a doublet receiving antenna can be utilized. In the lat-

ter case the doublet should preferably be tuned by a shunt tuned circuit with the antenna and ground leads from the set connected across the doubler tuning circuit.

Coil Winding Data for Frank Jones' 5-200 Meter Receiver

Coils forms are 1 1/4-in. outside diameter. 7 forms are required. Either 4 or 5 prong forms can be used.

5-Meter Coil—2 turns, No. 22 bare copper wire, space-wound to cover a space of 3/4-in. Then wind 1/2 turn of No. 22 DCC wire alongside the top turn of the bare wire winding, this 1/2 turn being the grid coil, used as the coupling capacity.

10-Meter Coil—7 turns, No. 22 bare copper wire, space-wound to cover a space of 3/4-in. Then wind one turn of No. 22 DCC wire alongside the top turn of the bare wire winding; this is the coupling coil. Also a tap is taken from the bare wire coil, 1 1/2 turns up from bottom of the winding. This is the cathode tap.

20-Meter Coil—6 turns, No. 22 bare copper wire, space-wound to cover a space of 3/4-in., with cathode tap taken at one-half turn on bottom turn. This, and other coils for 40, 60, 80 and 160 meters requires no coupling coil winding.

40-Meter Coil—10 turns, No. 22 DCC, slightly space-wound to cover a space of 3/4-in. Cathode tap taken at 1/2 turn on bottom turn.

60-Meter Coil—17 1/2 turns, No. 22 DCC, close wound; Cathode tap taken at 1 1/4 turns up from bottom turn.

80-Meter Coil—34 turns, No. 22 DCC, close wound; Cathode tap taken at 1 1/4 turns up from bottom turn.

160-Meter Coil—65 turns, No. 28 SCC or SSC, close wound; Cathode tap taken at 1 1/2 turns up from bottom turn.

Super-Regeneration

(Continued from page 211)

Super-regeneration will amplify a weak signal many thousands of times, while a radio-frequency amplifier will only amplify it about five times at five meters.

Unlike ordinary regeneration, super-regeneration always broadens the tuning, or gives much less selectivity. Any of these sets tune so that they cover at least 100 KC at any point on the tuning condenser. This is easily explained when comparing it to a transmitting five meter oscillator. Decreasing or increasing the DC plate voltage 60%

usually varies the oscillator frequency from 60 to 200 KC.

The hiss or rushing sound (which is somewhat similar to static) audible in a super-regenerative set is mostly due to thermal and contact circuit noise. The detector is in an extremely sensitive operating condition when no signal is present, thus this noise is greatly amplified and made audible in the headset or loud-speaker. A carrier signal automatically reduces this amplification or sensitivity and apparently knocks down the background noise. A strong signal will always completely eliminate this super-regenerative hiss or roar.

"Jayenay" 5-Meter Stabilized Transmitter

DUE TO THE optical limitations on distant communication on the short wavelengths below ten meters, it is evident that interference will be a problem only in and around a metropolitan area. In the country, QRM will be practically unknown. However, in and near the larger

Fig. 2 shows a speech amplifier which may be used to modulate the transmitter shown in Fig. 1. It will completely modulate a twenty-five watt input to the power amplifier and provides enough gain to give full output when excited by a damped two-button carbon microphone.

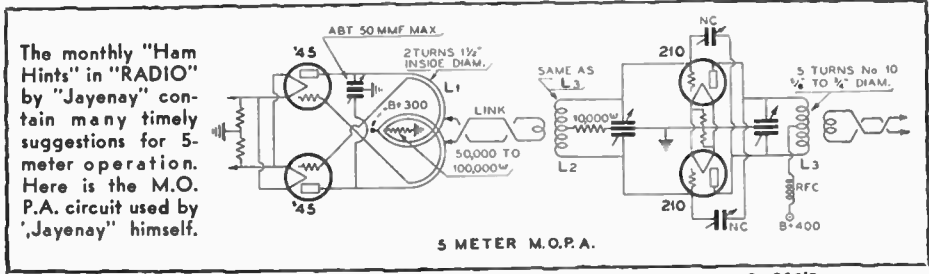

cities, QRM is bound to become troublesome, especially if the practice of modulating self excited oscillators is continued. Modulated oscillators were abandoned years ago on the lower frequencies (longer waves) because of the inability to obtain a high percentage of modulation with frequency stability.

Thus, some form of oscillator-amplifier transmitter will undoubtedly become standard practice as activity on the higher frequencies increases. In Fig. 1 is shown a simple MOPA transmitter which uses a pair of push-pull 45's as unity-coupled oscillators and a pair of neutralized 210's in push-pull in the power amplifier. The oscillator is designed for maximum stability, while the final amplifier is designed for maximum output. These two characteristics never go together in the same stage. You can have either stability or high output, but rarely both, because entirely different operating conditions are necessary for the two characteristics. The oscillator uses relatively high C in the tank circuit so that changes in tube capacity and plate resistance will have the least possible effect on the frequency of oscillation. On the other hand, the amplifier stage should have as little tuning capacity as possible in order to avoid losses.

The oscillator grid coil is wound inside of the copper tubing which forms the plate coil, and the grid coil must be connected properly, if satisfactory operation is desired. The ends of the grid coil connect to the grid of the tube whose plate is connected to the OPPOSITE end of the plate coil. The stage will oscillate weakly if the grid coil is improperly phased, but will be very unstable.

The coupling link between the two stages is tapped across about a third of a turn of the plate coil of the oscillator, and helps to isolate the oscillator from the amplifier.

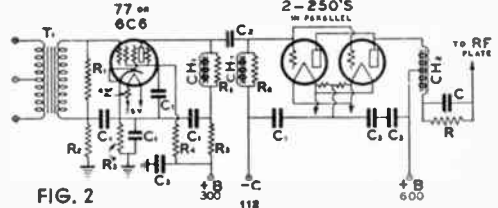

AUDIO CHANNEL FOR 5-METER PHONE
 R1—250,000 ohms, 2 watt; R2—100,000 ohms, 2 watt; R3—500 ohms, 5 watt; R4—500,000 ohms, 2 watt; R5—50,000 ohms, 5 watt; R6—300,000 ohms, 2 watt; C1—1 ufd., 400 volts; C2—.01 ufd.; C3—8 ufd., 450 volts; T1—Line or mike to grid transformer; CH1—400 henry audio choke; CH2—Tapped modulation choke, 25 to 40 henries at 75 MA.

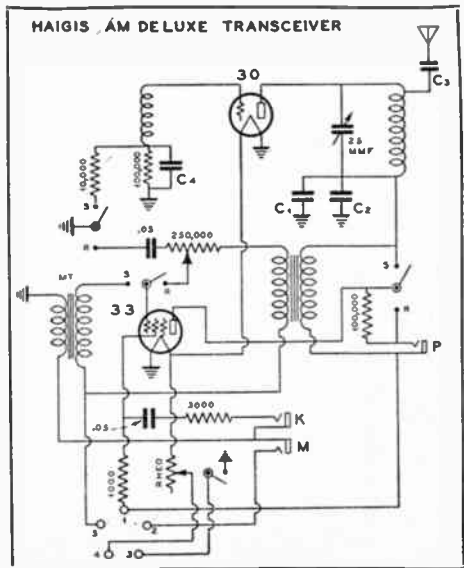

A Modern Link-Coupled Phone

IT CAN easily be imagined that the much neglected ten-meter band will become increasingly popular during the winter months. The new regulations allowing the use of phone on a portion of this band, coupled with the fact that DX conditions appear to be unusually favorable, would seem to give strength to such an assumption. However, there are a number of requirements that must be complied with, if good phone communication reasonably free from QRM, is to be enjoyed.

A comparison of the five and ten-meter bands may possibly serve to illustrate this point. This comparison is probably timely, due to the fact that the amateurs on five have already acquired a degree of proficiency in the operation of ultra high frequency equipment. It is logical to assume that these men will be among the first to migrate to this new and virgin phone territory. The first point to observe is that the ten-meter phone band is only about one-eighth as wide as that of its higher frequency neighbor. (The whole five-meter band is open to phone but only 500 kc. on ten meters.) The extreme width of the former band and the difficulty of obtaining easy frequency stabilization probably justify the use of self-excited, modulated oscillators. The quasi-optical effect is also a further justification for their use because stations even short distances away are at times unable to hear one another. On ten, the story is somewhat different. Stations within a ten-mile radius (and probably even greater) are able to carry on communication at any time, day or night. This

greater ground wave range and the potential DX possibilities further add to the interference problem. It rather goes without saying then, that the use of self-excited, modulated oscillators and their attendant broadness (due to frequency modulation) are definitely out.

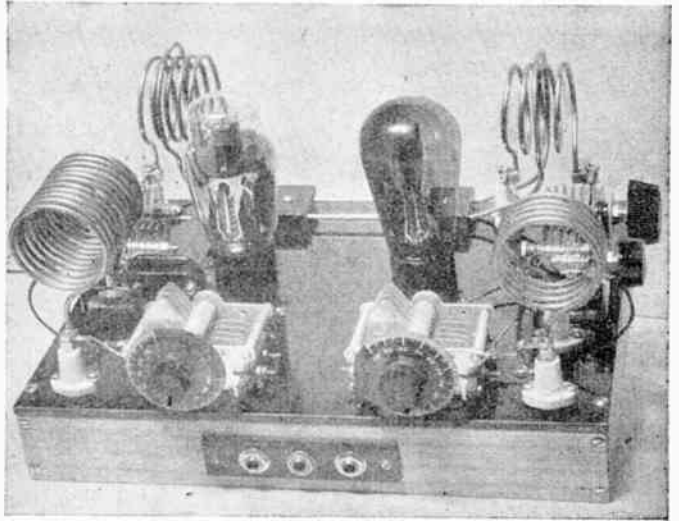
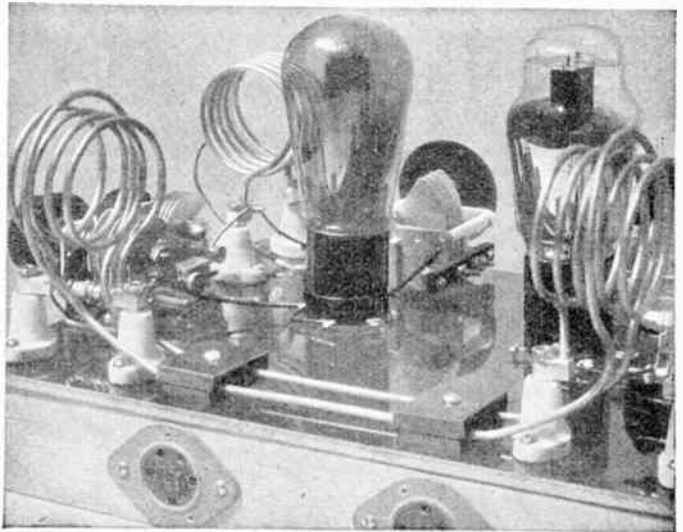

Fig. 1—Front View of Transmitter.



Rear View, Showing Coil Supports and Coupling Arrangement.

All of which leads to the crux of the whole matter—frequency stabilization.

Probably the best method of achieving frequency stabilization is by the use of crystal control. This method should present no particular difficulty to the 20-meter phone men who have all the necessary equipment, with the possible exception of another frequency doubler; but it is a hard nut to crack for the 5-meter experimenters, most of whom have only self-excited sets. However, crystal control isn't the only answer. Its runner-up, the Electron Coupled Oscillator, is a very able substitute.

The property of an electron coupled oscillator to deliver high harmonic output makes its use particularly feasible for ten-meter work. By taking advantage of this peculiarity (or is it a blessing?) it becomes possible to operate the grid circuit, which largely determines the frequency drift, on a lower frequency where its action is apt to be more stable. Then, by doubling in the plate circuit, there is developed a nice, steady signal on the band where it is wanted. This, incidentally, eliminates doublers and their attendant apparatus — and evils. Having decided on the type of oscillator we wish to use, the next thing to consider is the choice of a suitable tube.

There are on the market at the present time several tubes that are suitable as elec-

tron coupled oscillators; among these, the 59, 2A5, 57, and 2-1A are the best bets. The 59 was selected over the others because of its ability to deliver larger output. It was found, though, that the 59s made by different companies varied greatly in their ability to perform the required task, some refusing to operate at all after running about five minutes. This should not be a deterrent, however, because tubes made by the leading manufacturers were found to be entirely satisfactory. Now, having disposed of the oscillator tube, the next step is to decide what the amplifier tube is to be.

It is hardly good practice to attempt to select the amplifier tube without first considering the carrier power desired and the percentage of modulation we intend to use. In fact, it is much more important that we first consider what modulator tube to use. We will worry about the amplifier later. For 100% modulation it is necessary to have half as much audio power as we have carrier. There are very few audio tubes in the low price class that can furnish more than about three watts of reasonably undistorted output. This means, simply, that we cannot allow our r.f. carrier to be higher than six watts, if we want to come even close to doing a good,

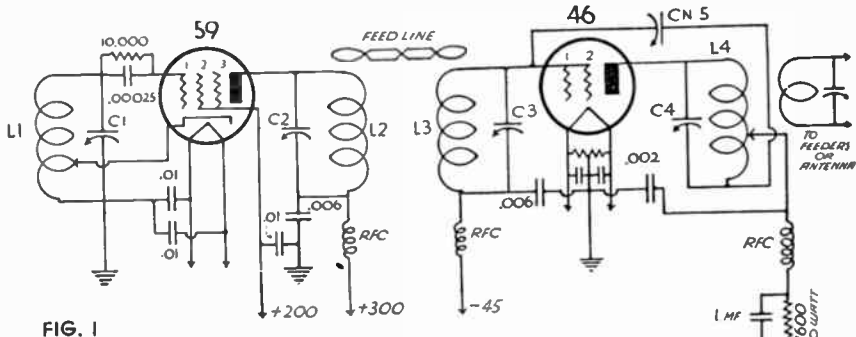

FIG. 1

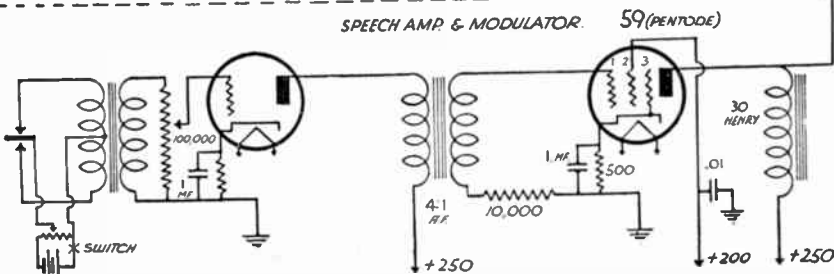

Fig. 2—Circuit Diagram, Showing All Values, for 10-Meter Phone.

- A Type 56 is used as speech amplifier.
- L1—9 turns, 2-in. dia., 1/4-in. copper tubing.
- L2, L3, L4—4 turns each, 2-in. dia., 1/4-in. copper tubing.
- C1, C4—13 plate condensers, with alternate plates removed. Cardwell Type 405-B.
- C2, C3—100 mmfd. Midget Variables with alternate plates removed.
- CN5—5 plate Midget, single spaced.
- RFC—Radio Frequency Chokes, No. 36 D.C.C. wire, 1/4-in. form, winding space 2 1/2-in. long, single layer of wire.

high percentage job of modulating. The 59, as a pentode, will deliver three watts and has the further advantage that it can be driven directly by a good high gain single button mike, no speech amplifier being necessary. In the case of a double button mike (almost a necessary refinement) a stage of speech is needed, a 56 being used for this purpose. The speech amplifier should be used even with the single button mike because it insures sufficient swing to the modulator and allows a finer adjustment of that swing, an essential factor in a distortionless Class A amplifier. By limiting the carrier to six watts the selection of the final RF tube becomes a very simple matter. A 46 was used because, with the two grids tied together, the tube works very near to cutoff, thereby requiring only a small amount of bias to operate the tube as a Class C amplifier. It has the further advantages of being easily capable of standing the modulation peaks (24 watts) and being an easy tube to excite. It is conceivable that some slight amount of amplitude distortion is likely to be present, due to the fact that no buffer tube is used to build up the excitation. This distortion, however, should be limited to a very small amount if the oscillator is adjusted for maximum output.

Fig. 1 shows the RF portion of the outfit. It incorporates some features not usually considered. Where the oscillator is self-excited (as it is in this case), the utmost care must be taken to avoid any mechanical vibration. No matter how stable the oscillator may be, the whole system can be ruined by mechanical vibration. With this fact in mind, extreme care was taken to make all leads as short and direct as possible, without recourse to the fancy bends and twirls sometimes used. The tubing on the inductances is heavy enough to do justice to a well loaded 210 with about ten times the input used on the 46. A special mechanical arrangement was used to anchor the coupling loops and the feed line between the oscillator plate tank and the amplifier grid tank. All midjet condensers are double-spaced to lessen the likelihood of change in capacity, due to vibration. The coils were not made plug-in but were fastened permanently to the stand-off insulators. In the case of the oscillator coil it would probably be advisable to mount a hard rubber strip across the top to lessen the tendency for this coil to start vibrating. The ten-meter coils have so few turns that no trouble is experienced from this source. The outfit is tuned in the conventional manner, the only precaution being that the tap on the oscillator coil (cathode) has a great effect on the harmonic output, and consequent excitation to the amplifier stage. Three turns from the ground end was found to be the best position in this unit, though this will probably vary in other arrangements. The three jacks shown on the

front baseboard are, respectively, C bias lead of final, Center-tap of final (to insert key in case of CW), and High Voltage lead of final. The meter can be plugged into the C bias lead to determine the correct adjustment of the excitation from the oscillator, and the grid meter can further be used to neutralize in the conventional manner. No trouble was experienced in neutralizing, though it might be well to point out that the high voltage clip on the final will go more toward the center of the coil than is usual in other tubes.

For the benefit of those who don't like to figure, it might be stated that the proper value of load resistance the Class C amplifier offers to the modulator is obtained at 30 mills at 200 volts (6666 ohms—close enough to the value of load resistance for maximum output from the 59, i.e., 6000 ohms.) These values of current and voltage when multiplied give the required input of six watts. See Fig. 2 for proper value of drop resistor and other details.

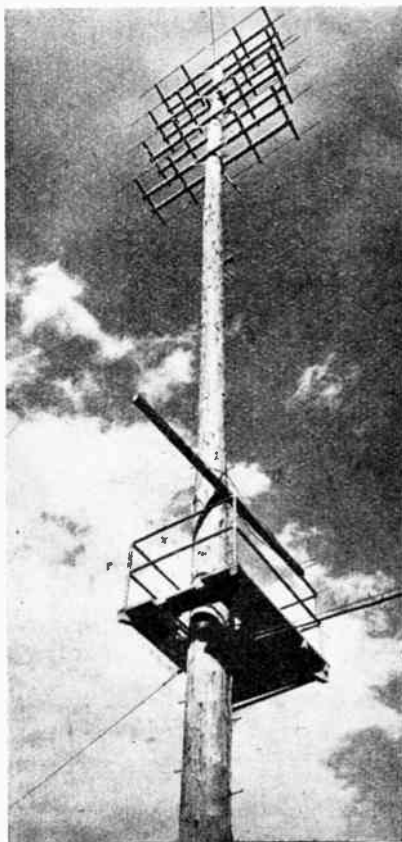

Elaborate High-Frequency Antenna System used by Bell Telephone Engineers.

400-Watt Carrier 5-Meter Final

HERETOFORE it has been difficult to obtain stable operation on five meters with the higher-power tubes, due to various reasons. Among them are: (1) High inter-electrode capacity in certain types of tubes, (2) The necessity for long leads from grid to plate, (3) The refusal of practically all of the common tubes to amplify at a reasonably low plate voltage on 5 meters. A tube that will not amplify properly will not oscillate without excessive grid losses, (4) A rugged grid and grid lead is essential because of the high radio-frequency grid current that flows at 60 MC, even in the low capacity tubes.

THE tantalum grid used in the 354, 50T or 150T led us to believe that it could be the answer to the high-power 5-meter problem. Experiments confirmed this belief and exceeded our fondest expectations, especially on the score of plate efficiency, which is usually so hard to obtain at 5 meters. Efficiencies of 35% in oscillators or class C amplifiers have been as high as one could realize in the "pre-354 era". We realized a plate efficiency of over 55% when using the conventional TNT oscillator circuit shown in Fig. 1. By substituting about 5 feet of No. 14 wire, as in

Fig. 2, for about \$10 worth of tank coil and condenser, the efficiency promptly jumped to over 66% and 400 watts of (measured) output was obtained with only 600 watts input, instead of 700 watts necessary when the conventional plate tank circuit was used.

The tank circuit in Fig. 2 is nothing but a pair of Lecher wires suspended vertically from the plate caps of the tubes, and held in position by the aid of an ordinary piece of wrapping string. The transmission line to the Johnson "Q" antenna was clipped on the Lecher wires at a point approximately 2 inches each side from the RF choke through which plate voltage is supplied.

As an example of how theory can be confounded by practice, the first Lecher wires consisted of $\frac{1}{4}$ inch copper tubing; the tubing became warm under operation and the efficiency was a little better than when the conventional tank circuit was used.

It has been said—"If a conductor heats up, use a larger conductor". So half-inch copper tubing was tried. This became distinctly hot and the efficiency dropped materially. Becoming slightly puzzled, we used some one and one-quarter-inch copper tubing and dared the efficiency to stay down. This large tubing became very hot. At this point we realized that we were headed in the wrong direction, so we tried $\frac{1}{8}$ -inch copper tubing. Everything cooled-off at once and the efficiency jumped 'way up, which proved we were on the right track. No. 16 enameled wire proved ideal and did not even become warm with 600 watts input. It was finally decided that the excess metal in the field of the "tank" caused these excessive losses.

The exceptionally high "Q" of this "tank" improved the frequency stability of the oscillator to a marked degree, always welcomed at 5 meters. We intend to try this "tank" on 10 and 20 meters at an early date. Who knows but that our Zepp feeders may yet prove to be the perfect tank coil? Comments from readers who are inclined to conduct such experiments are solicited.

The breadboard is covered with a thin sheet of aluminum, tacked at the edges of the board to hold it in place. Try this on your own breadboard transmitters, on any band, because it often straightens-out that stage which refuses to neutralize, due to improved grounding and shielding.

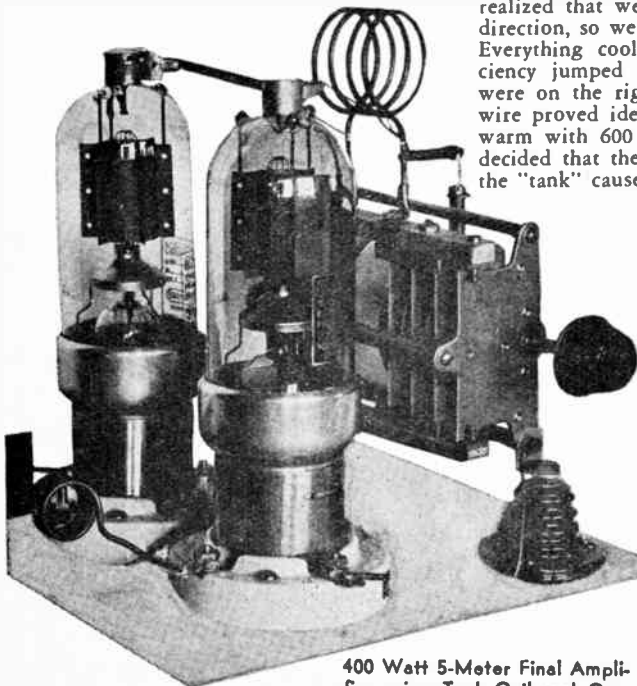

400 Watt 5-Meter Final Amplifier using Tank Coil and Condenser. Equally satisfactory results were secured when Lecher Wires replaced the coil and condenser. The tubes are HK-354s.

Sheet copper is just as good as aluminum and has the further advantage that solder will stick to it. This shield also reduces dielectric losses in a breadboard, often quite high, unless the wood is very dry. It may interest the reader

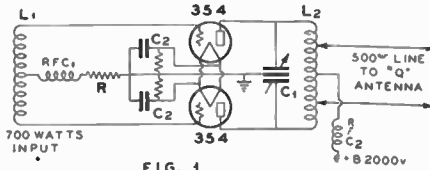

FIG. 1

Circuit Diagram of High-Power 5-Meter Transmitter.

- L1—5 turns, No. 10 wire, 3/4-in. diameter.
- L2—4 turns, 1/8-in. tubing, 1 1/2-in. diameter.
- C1—40 mmf. per section, 3000 volt condenser.
- C2—.001 mfd., low voltage condenser.
- R—10,000 ohms, 100 watt.
- RFC1, RFC2—50 turns, No. 28 DSC on 3/16-in. Bakelite Rod.

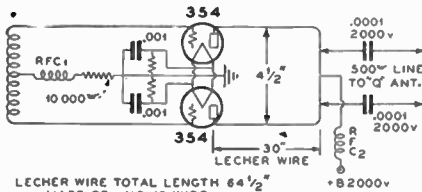
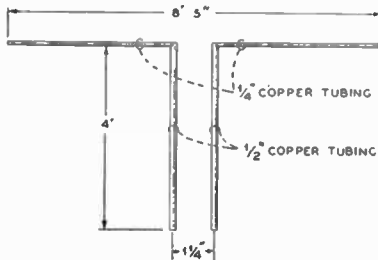

FIG. 2

Antenna tap at 3/8 turn each side of center.

to know that some breadboards can become distinctly warm when subjected to a strong electrostatic field, as in the final amplifier of a high-power transmitter, because of the poor dielectric nature of soft woods.

The remainder of the circuit is conventional TNT practice and the frequency is determined by the length of the tank which, as is shown in Fig. 3, is a single loop of wire. A similar tank was used in the grid circuit but proved unsatisfactory. The 300 watts of audio power necessary to modulate this oscillator was obtained from another pair of 354s in class B, running at 1000 volts.



TRANSMISSION LINE NO.14 WIRE SPACED 2" WITH JOHNSON BLOCKS

FIG. 3

A Resonant-Line Transmitter

THE conventional 5-meter transmitter or receiver is limited in several respects by the tube interelectrode capacity. The high-C oscillators, the high-efficiency output tanks, the link-couplers, and other elements so well used on the lower frequencies, are of small help at 56 MC.

It is fortunate, then, that at the frequencies where ordinary lumped tank circuits begin to lose their utility, resonant lines begin to have dimensions within reason. For resonant lines can be used to simulate an inductance, capacity, tank circuit, or what-not.

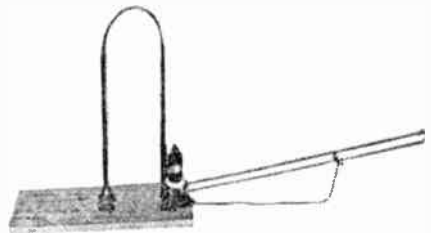

A '53 tube and some No. 12 wire makes an excellent 60 MC Transmitter

In the photo, and in the circuit of Fig. 1 is shown a 5-meter rig using a '53 tube and some No. 12 copper wire and not much else. The simplicity approaches the ultimate, yet the transmitter puts out a more stable signal, and a stronger signal at less plate input than the more usual types. The No. 12 wire is the output tank, the grid coupling condensers, the transmission feed line, and the wave-meter.

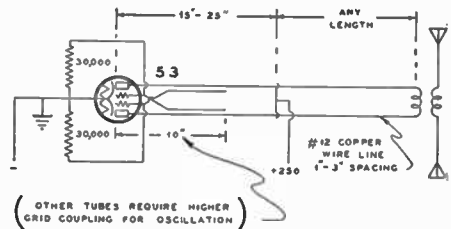

FIG. 4—THE SIMPLEST 5 METER TRANSMITTER

In the layout of Fig. 1, the portion of the line to the left of the shorting bridge is the oscillator tank. The grid coupling wires are spaced from and tied to the plate wires by knotted string, fixed in place with a drop of paraffin or rosin. Tuning of the oscillator is done by sliding the shorting bridge. The portion of the line to the right of the bridge is a non-resonant transmission line, properly terminated on the antenna by the usual Y-spread, Pickard or Johnson scheme. The

transmission line is coupled to the oscillator by the impedance in the shorting bridge.

To check the wavelength, the feeders can be opened up at the antenna and a flashlight-lamp bridge slid out along the transmission line, till it lights at maximum. The distance in meters from the oscillator bridge to the lamp bridge is one-half the oscillator wavelength. This, of course, is nothing more than the usual Lecher wire set-up.

If 5-meter work palls for awhile, and 10-meters wants a try, all that is necessary is to slide the oscillator bridge on out the line, and couple up a 10-meter radiator.

A short-circuited transmission line less than a quarter-wave long presents an inductive reactance at the open end. When connected to a vacuum tube, the electrode capacity in combination with the line inductance forms a tank circuit. The losses of the tank inductance can be made comparable to or smaller than those of the low frequency tanks.

An open-circuited line less than a quarter-wave long has a capacitive reactance. The

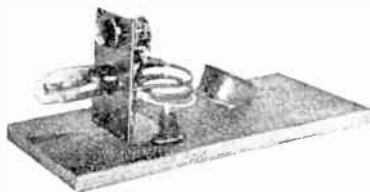

The unity-coupled '53 tube on 60 MC used for comparison

transmitter arrangement in Fig. 2 uses a line very nearly one-quarter wave long for the grid tank. The open-circuit portion to the left of the grid connections is a capacity, and the shorted portion to the right is an inductance. The effective capacity can be made of the order of 100 to 200 mmfd.—impossible to use in the ordinary lumped condenser—and the oscillator performance compares to that of the high-C on lower frequencies. The output is somewhat lower, and the note is more stable. The oscillations persist over only a small range of the plate line tuning.

In using the quarter-wave line as a high-C grid tank, sometimes inductive coupling exists to the plate tank, and the performance can be improved by reversing the grid connections. The grids should be tied in about 5 or 10% of the conductor length from the shorted end.

A point which perhaps should be brought out is that a high-Q circuit does not necessarily make a stable oscillator. By Q is meant the usual definition, $\omega L/R$. Assume a tank circuit is at hand with a Q of infinity—i.e., its resistance is zero. Even though this be in the grid circuit of an oscillator tube, the frequency would still hop around as long as the effective tube input capacity varied.

What is more important, as regards frequency stability, is the arrangement of the frequency determining circuit, in order that tube capacity shall have small effect. In a parallel tuned circuit, the tank capacity must be large—such as in the high-C method; or, in a series tuned circuit, the tank capacity must be small—as in the equivalent circuit of a quartz crystal.

A long resonant line is an excellent means of stabilizing ultra-high frequency oscillators. Any shorted line less than an odd and more than an even quarter-wavelength long presents inductive reactance at the open

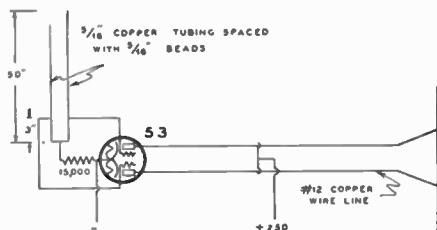
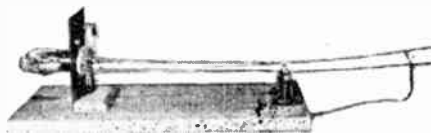

FIG. 2—A HIGH-C 5 METER OSCILLATOR

end, and will form an oscillator tank against the grid capacity. Imagine a very long line used in the grid tank. If the tube capacity tries to create a frequency change of, say, .01%, each quarter-wavelength along the line would have to change .01%, and would shift the last quarter-wave the total accumulated difference. As a result, only a very slight frequency shift will make large changes in the line input reactance, which will offset the tube variation. RCA used a 10-wavelength line on a 40-KW oscillator with average measured frequency stability as good as with crystal.

Actual full-size long line control for the amateur is hardly practical. However, even a $1\frac{1}{8}$ wavelength (225 inches of No. 12 spaced $\frac{3}{16}$ -inch with Isolantite beads and string) grid tank on a 5-meter modulated oscillator gave noticeable improvement. Where other



Fixed tune high-C oscillator with tuned-line plate tank

carriers, as received weakly on an autodyne detector would completely disappear under modulation, the line-controlled carrier did not wobble more than 10 KC, roughly.

These paragraphs are given mainly as something to break the ice. It should not take much amateur experimenting to develop some very practical methods with resonant lines.

The 955 "Acorn" One-Half-Meter Tube

IF ALL the physical dimensions of a conventional vacuum tube are proportionately reduced, the inter-electrode capacities can be tremendously reduced without causing an appreciable change in the electrical characteristics of the tube itself. In spite of its small size, the tube has a low plate resistance, 12,500 ohms, and a high amplification factor of 25 with the resulting high mutual conductance of 2,000 micromhos. Mutual conductance is a fairly-accurate yardstick of tube performance, and regardless of the compromises which have been made to enable this tube to operate as a regenerative

cellent characteristics, this tube will come into prominence for 5 meter work, although it is in the high frequency field that such a tube will really prove its merit. Although a number of the present tube types will oscillate at around 2 or 3 meters, the 955 is the only tube that will operate in the conventional manner as low as $\frac{1}{2}$ meter.

With the B-K type of oscillator used by many experimenters for operation at frequencies below one meter, a number of difficulties limit the effectiveness of such oscillators. In the B-K circuit the grid must run positive, while the plate is negative. The power input to the tube is consequently greatly limited by the low heat dissipation of the average grid. With these limitations in mind it is easy to see why the conventional type of oscillator is much to be preferred.

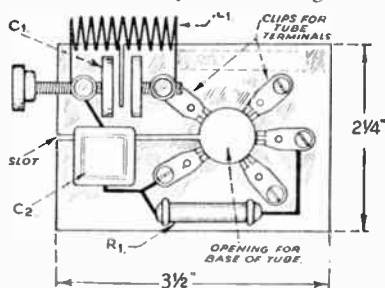

Plan view of transmitter.

oscillator at a wavelength of only 20 inches, the mutual conductance is higher than any of the conventional general purpose triodes, such as the 56 and 76.

In order to keep the capacities low, no base is used on this tube. The leads to the grid, plate and indirectly-heated 6.3 volt cathode come directly out of the glass envelope, and are widely separated. No attempt should be made to solder to these wires because soldering usually results in breaking the glass envelope.

With very low internal capacities and ex-

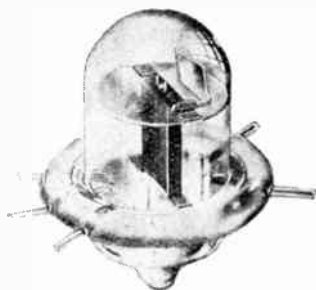

Here are the characteristics of the 955:

Heater voltage.....	6.3 volts
Heater current.....	0.16 amp.
Max. plate voltage.....	180 volts
Grid voltage.....	-5 volts
Max. plate current.....	4.5 MA
Mutual conductance.....	2000 micromhos
Amplification factor.....	25
Plate resistance.....	12,500 ohms

RCA 955—CIRCUIT DIAGRAM AND SUGGESTED LAYOUT

L1—8 turns, $\frac{1}{2}$ -in. outside diameter, No. 18 wire, spaced $\frac{1}{4}$ -in. between turns.

C1—Tuning condenser; 2 circular brass plates, $\frac{3}{4}$ -in. in diameter; 10/32 thread on adjusting screws.

C2—.00025 mica condenser, postage stamp type.

R1—15,000 ohms, 1 watt carbon resistor.

RFC— $\frac{1}{4}$ -in. bakelite rod wound $1\frac{1}{2}$ -in. with No. 32 DCC wire.

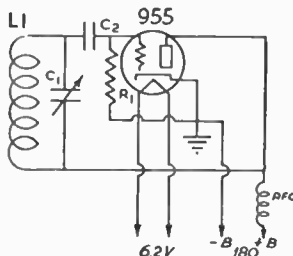

Circuit diagram of transmitter using RCA 955 tube.

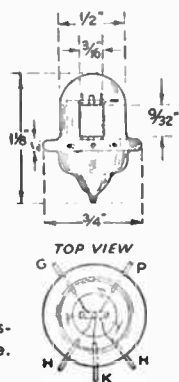

3/4-Meter Transceiver Using the 955 "Acorn" Tube

A PRACTICAL 3/4-meter transceiver is here described. The circuits shown are not the ultimate in design, by any stretch of the imagination. However, the sets work satisfactorily, both as transmitters and receivers. Undoubtedly much more output for a given input can be obtained if the grid excitation could be adjusted properly, such as by the use of a semi-variable grid condenser and proper location

of that condenser in the LC circuit. Some experimenters report much greater output by means of these adjustments. In the circuit shown, the similarity to the usual 5 meter transceiver is quite apparent. The transmitting oscillator is modulated by a type 41 tube with a single-button mike input. On the receive position, the oscillator becomes a blocking grid-leak type of super-regenerative detector, and the 41 modulator tube becomes an audio amplifier driving a small magnetic loudspeaker to moderate volume on fairly-strong signals. The switching circuit is similar to that used in most 5 meter transceivers. It changes the grid-leak value so as to obtain either ordinary oscillation or super-regeneration. It also switches the input and output circuits of the audio tube and turns on or off the microphone current and heater circuits.

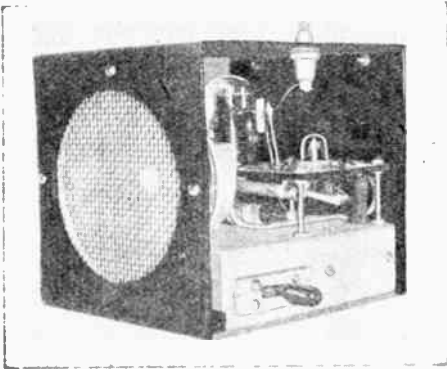

The 3/4-Meter Transceiver in metal case. A midjet loud speaker is built-in. The RCA-955 "Acorn" tube is plainly visible.

The new RCA type 955 "acorn" tube was used because its extremely small elements and capacities allow it to function satisfactorily on wavelengths below one meter. Its power output is quite low as an oscillator and thus a beam antenna should be used. The antennas used for the first tests with these sets consisted of short lengths of No. 10 wire, thrust through tight-fitting holes along a 3/8-inch diameter wooden dowel rod. The antenna was a wire 13 3/4-in. long with a reflector 14 1/4-in. long and two directors 13-in. long. The antenna wire was spaced a quarter-wave ahead of the reflector wire, which amounted to about 7-in. (3/8 of a wavelength spacing between the antenna and director and between the two director wires was used). This amounted to about 10 1/2-in. spacing. This antenna was not very directional because there were no reflector wires on either side of the antenna and a great many more director wires should have been used. By using really-good directional antenna systems, the apparent low power of the transmitters can be increased so that it should

of that condenser in the LC circuit. Some experimenters report much greater output by means of these adjustments.

In the circuit shown, the similarity to the usual 5 meter transceiver is quite apparent. The transmitting oscillator is modulated by

3/4-Meter Circuit

The RF Choke consists of about 25 turns of No. 22 DSC wire, wound on a 1/4-inch diameter form. T1 and T2 are Output transformers. Those used in the Transceiver here shown are of the 2A5 P.P. Output type.

Although the circuit diagram shows a number of separate switches, for the sake of simplicity, a 4-pole-double-throw anti-capacity switch will serve the same purpose.

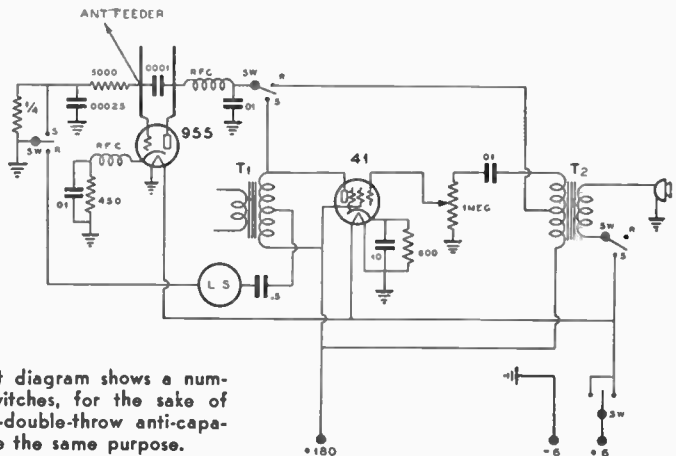

be possible to communicate over air line distances of several miles.

The RCA 955 tube is inclined to be microphonic and it also has a tendency to "run away", similar to the action which takes place with an overloaded type 46 tube. It is necessary to keep the plate and grid currents within the limits recommended by the tube manufacturer. One way to prevent the tube from creeping-up in plate current is to use cathode bias and a fairly low value of grid leak. Then as the plate current starts to climb, the grid bias increases and tends to

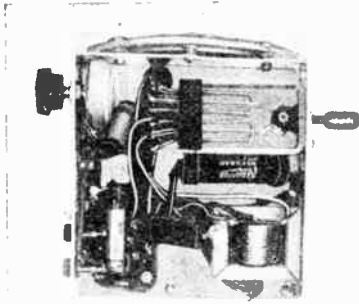

Under-chassis view, showing correct location for mounting the 4PDT anti-capacity switch and the output transformer.

reduce the plate current. The use of this method seems to solve the problem of tube life.

To obtain oscillation in these particular sets, it was necessary to use a cathode RF choke. The 450 ohm cathode resistor prevented super-regeneration until it was bypassed with a .01 mfd. condenser. This condenser bypasses the super-regenerative hiss frequency, although it would probably have been equally satisfactory to return the plate by-pass .01 mfd. condenser to the lower end of the cathode RF choke instead of to ground. The number of turns in the RF chokes seems to be somewhat critical. A variation of from 10 or 15 turns causes trouble. This is probably due to the high RF impedance of the path back to the nodal point of the tube and LC circuit. It is difficult to bypass effectively at these frequencies and thus a few experiments with RF choke turns, location of leads and chokes, and contact resistance of the tube clips will remedy this source of trouble. Oscillation should always be checked by means of a plate circuit milliammeter. The plate current should never exceed about 7 milliamperes on the transmit position, if one expects more than a few minutes of tube life.

The oscillating circuit consists of the tube capacities and a parallel wire LC circuit. At $\frac{3}{4}$ meters the parallel wire length is slightly over an inch in length and is made by soldering a pair of No. 14 bare copper wires to the tube grid and plate clips. The parallel wire bridge consists of the .0001 grid condenser.

Antenna coupling can be accomplished by connecting the antenna feeder to some point along the parallel wires, or preferably by

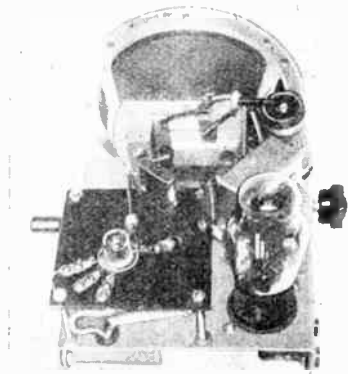

Showing how the RCA-955 "Acorn" tube is mounted on a Bakelite sub-base which is isolated from the metal chassis deck.

inductive coupling. The usual two-wire feeder would undoubtedly be better than the single-wire feeder used in these first tests. The latter was connected to the antenna 2 inches off center. A two-wire feeder can be made of No. 24 or 26 wire, spaced about an inch and tapped across the center of the antenna in the usual Y connection. The antenna coils are wound directly over the plate coil; they use the same number of turns as the plate coil.

The modulator control is the key to the left of the panel. The toggle switch to the right controls the incoming power. The two flashlight cells alongside the microphone transformer are for the microphone supply. The control in the center is the volume control, mounted directly between the two meters. The meter in the plate circuit of the class B stage reads the current, which should be 60-65 milliamperes for full modulation. The arrangement shown here is the only one that gave the minimum amount of hum.

IN ACTION:

This transmitter has been operating for several months in a congested area on the three phone bands and has done very well, considering the great number of higher-power stations on the air most of the time. The antenna used is 132 feet long, with a

.0005 condenser in series for tuning. The reports given with the antenna four feet off of the ground were as good as when it was 40 feet in the air, for local operation.

Standard RCA Circuits and Constants For 955 Tube

ULTRA-HIGH-FREQUENCY HARTLEY OSCILLATOR

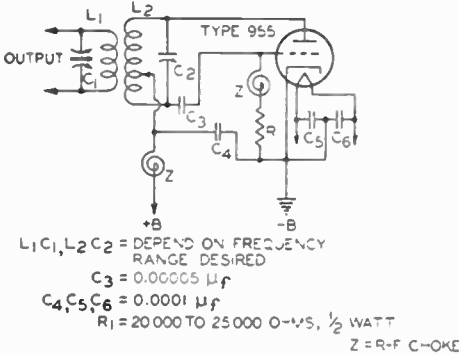

PUSH-PULL OSCILLATOR TUNED-PLATE TUNED-GRID TYPE

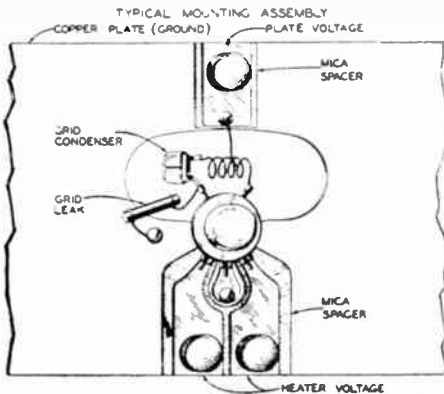
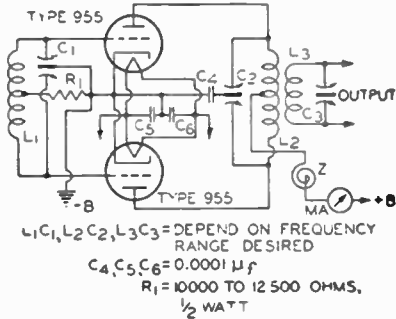

Five-Meter Filter Circuits

One of the major problems of five-meter auto radio is a suitable plate voltage supply. B-batteries are cumbersome and expensive, if often replaced. A small B-eliminator or dynamotor, operating from the car 6-volt battery, is the solution to this problem. The eliminator or dynamotor occupies but little space and the device can be made to supply from 150 to 300 volts of DC voltage.

However, most amateurs who have tried these systems have experienced trouble from a hash of noise in either the transmitter or receiver, or both. Additional audio filter in +B leads seem to be of little help. The trouble is caused by RF disturbances which get into both the A and B leads to the 5 meter set.

RF disturbances can be confined to the dynamotor or vibrator eliminator itself by means of simple RF chokes. The circuit in Fig. A has worked satisfactorily when used in connection with various dynamotors. The 8 mfd condenser acts as an audio filter and low impedance by-pass for the audio or modulator return circuits. The RF choke in the +B leads prevents RF from running up this lead to the set. All RF chokes should be mounted as close to the power supply unit as possible.

The RF chokes in the 6 volt leads must be made of heavy enough wire to carry the continuous load of this unit, which may be from 2 to 10 amperes, depending upon its rated power input and load. Usually No. 12 enameled wire, close wound on a 3/8-in. dowel rod for a length of about 2-in., will be suitable for these 6-volt lead chokes. The plate RF choke should have more turns of fine wire, such as No. 32 to No. 34 DSC on a 3/8-in. diameter rod, for about a 1-in. length. This number of turns in the larger chokes would make them unreasonably bulky, so an effective compromise is made to keep the size fairly small.

Occasionally a 1/2 mfd. condenser must be connected from the hot side of the battery at the dynamotor terminal to some particular spot on the dynamotor frame or housing.

The circuit shown in Fig. D has often been used to remove the hash from a 5 meter transmitter when using a dynamotor power supply, or to prevent the clicking noise from a vibrator supply unit. Sometimes these units will be quiet enough for use on a receiver of the super-regenerative type but they will introduce noise in the transmitter due to lack of mike circuit filtering. A simple filter consists of a 20 to 50 mfd. 25-volt electrolytic condenser to complete the voice frequency circuit, and a 100 to 200 ohm 1-watt resistor in the hot side of the 6-volt supply. Care must be taken to see that the polarity of the electrolytic condenser is correct; its

negative side is toward the negative 6-volt supply, and the positive terminal toward the positive 6-volt supply lead. Either the negative or positive terminal of car batteries is

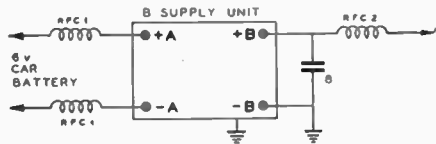

FIG. A

RFC1—25 turns No. 12 wire on 1/2 to 5/8 inch dia. form.

RFC2—75 turns No. 32 to 34 DSC wire on 1/4 inch dia. dowel or bakelite rod.

Either positive-A or negative-A battery terminal of car can be grounded.

grounded to the car frame; thus it is always necessary to first check the polarity.

The circuits of Fig. B and Fig. C are useful in preventing noise from getting into either the transmitter or receiver. The resistor-type filter cannot be used here, since the current drain through it would be too

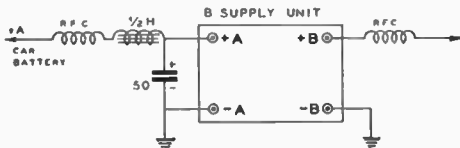

FIG. B

great. A low resistance choke of from 0.1 to 1/2 henry inductance, and small fraction of an ohm of resistance, is somewhat a problem, but it can be solved. Some small dynamotors are equipped with such a choke, but usually without the 50 mfd. condenser or RF chokes. If no audio filter is furnished with the dynamotor, at least an 8 mfd. electrolytic

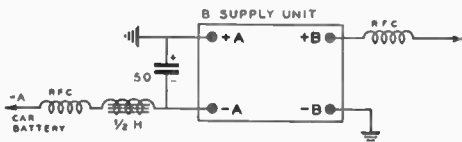

FIG. C

condenser must be connected across the plate supply, either in the 5 meter set or at the power supply terminals.

Fig. B and Fig. C are somewhat similar and are given in order to show the change of connections necessary when the car battery is grounded to -6 in one case, and +6 in the other.

The RF filters should be mounted close to the dynamotor or eliminator in order to

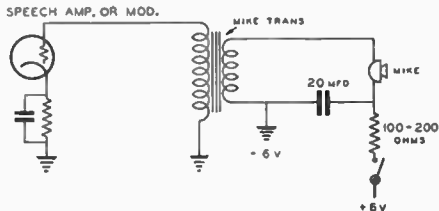

FIG. D

be effective. Ample space can be found inside the dynamotor container for these RF chokes. If not, the chokes should be mounted rigidly in a metal can adjacent to the unit. Needless to say, the 6-volt supply to the 5 meter set should come from the battery side of the RF filters.

It is always good practice to run the power leads directly to the car battery in order to avoid car ignition noises. The usual resistor-type spark plug and distributor suppressors will kill 5 meter interference. The conventional by-pass condenser at the car generator is advisable. Fortunately, the car ignition system noise is easily minimized, but the broadcast type RF choke type suppressors will not work on 5 meters. These suppressors are usually layer-wound and they are useless at high frequencies.

2 1/2 and Five-Meter Doublet Antenna

The new factory-made telescope type 2 1/2 and 5-meter Doublet Antenna is a good solution to the antenna problems encountered in ultra-high frequency transmission and reception. It has always been the desire of the



amateur to obtain the maximum efficiency from each piece of equipment used. Tests conducted within the last few months prove that successful high frequency transmission depends to a great extent on the type of antenna system employed. In most cases, 5 meter antennas were made by the cut and try method and it took hours to "tailor" the antenna for the particular transmitter or receiver. With this new antenna with its special force type locking devices, it is a simple matter to obtain the proper length and this is important—maintain these adjustments for long periods of time.

The Jones "Economy" Transceiver

● This transceiver is easy to build and uses a very simple circuit. It is a combination receiver and phone transmitter for operation in the five-meter band. It uses one type 19 and one type 33 tube. Power is secured from 135 volts of B battery, 13½ volts of C battery and three dry cell batteries for filament supply. The filaments of the two tubes are connected in series. The total "A" battery drain is about ¼ ampere.

A type 19 tube makes an excellent 5-meter super-regenerative detector when connected as shown in the circuit diagram. The sensitivity is better than that of many other tubes and the output is sufficient for headset operation. One section of the 19 tube acts as a super-regenerative oscillator and the other section acts as the detector. When receiving, the oscillator section has a ½ mfd. condenser shunted from plate to ground, thus preventing this triode section from acting as a grid-leak detector audio amplifier section. The other section, previously called "detector", is in reality the audio amplifier section.

This circuit eliminates the need of a 4-pole-double-throw switch for changing from transmit to receive, and vice versa. The change-over switch is only a single-pole-double-throw type, with the moving arm grounded. This switch can be of the type shown or a small snap type toggle switch can be used. When receiving, this switch short circuits practically all of the modulator output and provides a low impedance path for the detector plate circuit. When transmitting, the grid leak is lowered in value so as to obtain steady, strong carrier output and the modulator (the type 33 tube) is allowed to function.

The 33 tube is used only as a modulator and requires no reflexing with additional contacts on the send-receive switch. The mike transformer is one of the conventional small single-button mike to grid transformers. The output choke is center-tapped, although this is not absolutely necessary. A medium size push-pull output transformer to loudspeaker is satisfactory for this use; the small secondary winding is left open. This transformer should be large enough to carry 40 or 50 milliamperes without saturation. The rating can be roughly checked by using a single turn of wire connected to a 6-volt dial pilot lamp coupled to the oscillator coil. It should light up more brilliantly when the mike is spoken into. Lack of sufficient variation of intensity when modulating can often be traced to saturation of the modulation choke. A piece of writing paper, slipped into the air gap along the butt joint of this choke,

will usually cure this trouble. Many builders of the original Jones 42-42 transceiver complained of low percentage modulation, whereas a good center-tapped choke would have been the solution of this difficulty.

The filaments of the 19 and 33 tubes are in series; therefore the correct polarity of the

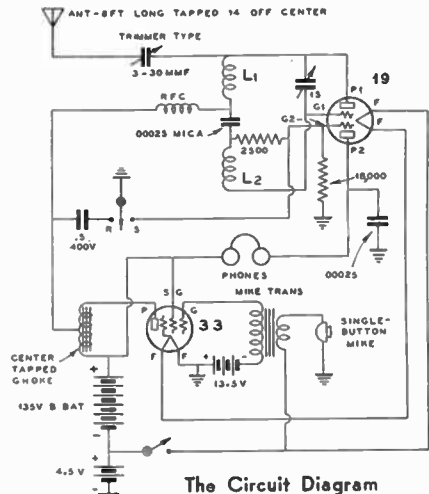

L1, L2—Each 4 turns No. 14 wire, ½ inch dia., air supported, spaced diameter of wire.

L3—R.F. choke of 50 turns of No. 22 DSC wire, on ¼ inch dia., air supported.

filament battery is important. It should be connected as shown, in order to obtain a 2-volt negative bias for the type 19 tube. This 4½ volt battery provides ample voltage for most single-button microphones. In the usual 3 volt transceivers, many microphones are not sensitive enough to fully modulate the transmitter.

The RF choke consists of about 50 turns of No. 22 DSC wire, wound on a ¼ inch dowel rod, and then slipped off the rod. This coil is supported from the oscillator coil to a small hole in the bakelite subpanel which holds the tuning condenser. The 2500 ohm grid leak is mounted in a similar manner on the other edge of the bakelite panel. The two oscillator coils of about 4 to 4½ turns, ½ inch diameter, are mounted on the tuning condenser and the mica condenser is soldered across the inside ends of the two coils. The turns are spaced one diameter of the wire. A two or three plate midget condenser has sufficient capacity for tuning over the 5-meter band. The grid and plate leads to the oscillator section of the

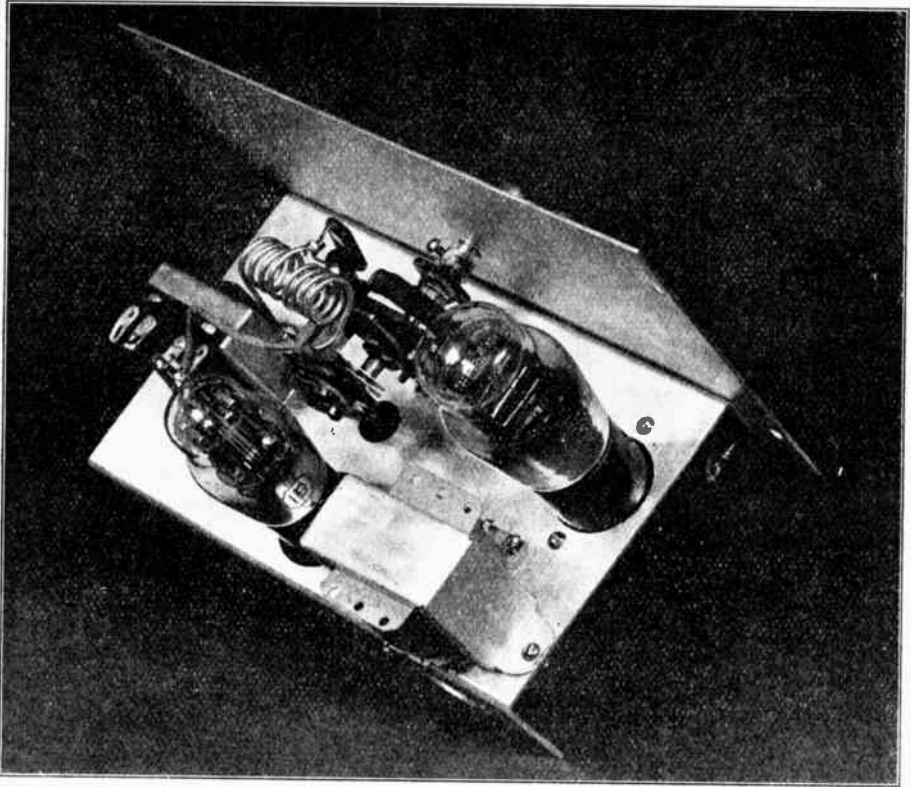

Looking into the Economy Transceiver. The correct arrangement of parts is clearly shown.

19 tube should be as short as possible. The other leads are not important and can be run under the chassis from point to point.

The antenna coupling condenser should be a 3-30 mfd. adjustable trimmer condenser. Normally this condenser will be set so that the two plates are about $\frac{1}{16}$ to $\frac{1}{8}$ inch apart. This is much more coupling than can be used with a 30 tube oscillator. Measurement with a thermocouple and 500 ohm dummy antenna load indicated from $2\frac{1}{2}$ to 5 times as much carrier output. The plate current is about twice as much for the 19 tube oscillator. The result is approximately $\frac{1}{2}$ watt of output into a two-wire 500 ohm antenna feeder with 135 volt B supply, which is a very respectable output on 5 meters. The receiver is quite sensitive for headset operation. If loudspeaker reception is desired, an additional stage of audio amplification would be necessary. It should be remembered that all transceivers radiate bad interference in the receive position and therefore they are always a nuisance to other amateurs in a congested area.

The set can be built on an aluminum chassis about 5-in. x 8-in. as illustrated, or a wooden

baseboard can be used. The front panel should be of metal, about $6\frac{1}{2}$ x 8-in., in order to prevent hand-capacity when operating of the set. It is convenient to use an extra tube socket for a plug and cable battery connection system. Because the front panel is of metal it is necessary to use an insulated coupling between the dial and the tuning condenser shaft. Either bakelite wafer or isolantite sockets are suitable for use in this circuit. Tip jacks or a plug and phone jack can be used for the headphones and microphone connections through the front panel. It is necessary to insulate both sides of the headphone connections from the front panel.

In testing the set, the transmitter should light up a flashlight lamp, as previously mentioned, and modulate the lamp upwards in brilliancy. In the receive position, a fairly strong hiss should be audible in the headphones when no 5-meter signals are being received. Too much capacity in the coupling condenser will prevent this super-regeneration.

Nearly any kind of an antenna can be used. A four-foot rod will work fairly well over very short distances.

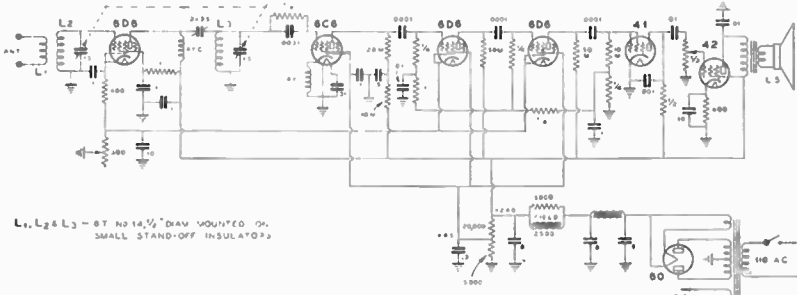

L₁, L₂ & L₃ - BT NO 14, 1/2" DIAM MOUNTED ON SMALL STAND-OFF INSULATOR

Circuit Diagram of Jones Commercial 5-Meter Superheterodyne. This is a better circuit than the one shown on page 235 and should preferably be used.

Allied "Knight" Transceiver

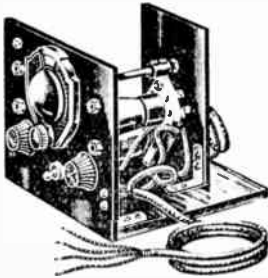

"Knight" Transceiver—Compact Model.

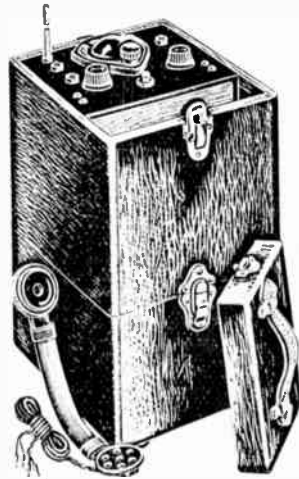

"Knight" Transceiver in carrying case with battery compartment.

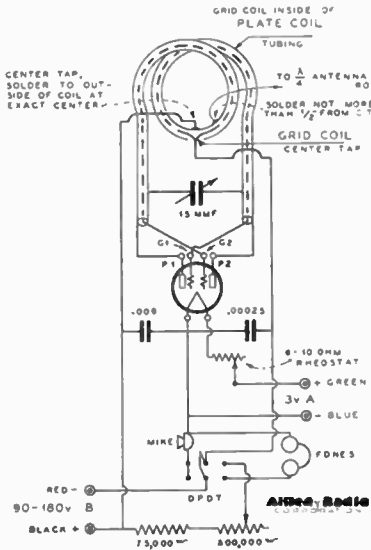

Improved Allied "Knight" Transceiver Circuit. See page 206 for complete data on design and operation.

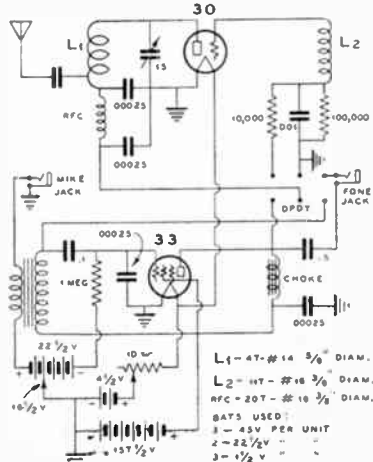

The Haigis Portophone Model PF-1, showing resistor, condenser and coil constants.

The RCA-954 Acorn Pentode

● The new RCA-954 acorn type pentode tube has just made its appearance and experimenters can now have a real screen grid tube for ultra-short wave receivers. This new tube is the same size as the 955 triode acorn tube and fits the same socket. The plate and control grid connections are brought out through the two tips and thus these elements can be easily shielded from each other. The heater and cathode leads are brought out along the edges in a manner

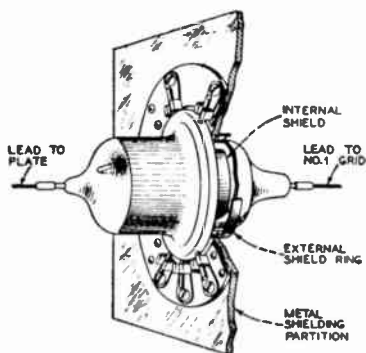

1. Terminal Mounting Template

similar to that of the 955 tube. In the 954 tube the screen and suppressor grids are brought out at the same points as the plate and grid leads of the 955.

From the tentative characteristics of this new tube it can be seen that the input and output capacities are only a small fraction of the 6C6 or 57 tube. It therefore becomes very useful as an RF amplifier for wavelengths below 10 meters. In properly designed circuits it is said to give a gain of 3 at one meter, and 10 or more at 5 meters. Except for its extremely small size it is quite similar to a 57 or 6C6 tube in its other characteristics and may be used as a detector, RF amplifier, AF amplifier or as a triode tube. The latter use is made in a special vacuum tube voltmeter since the tube is so small and the input capacity so low that it can be used for RF measurements. In this case the tube is mounted on flexible leads so that the tube connects directly across the circuit under measurement.

In shielding this tube for RF measurement, the control grid end of the tube is inserted through a hole in a metal plate so that the metal edge of the hole is in close proximity to the internal shield. It may be desirable to provide a small metal collar on

the baffle hole in order to increase the shielding effect.

RF grounding should be by means of small condensers, right at the tube terminals. For very high frequencies flat ribbon leads to the clips should be used. These leads should be insulated from the metal shield plate by means of mica spacers. These connections then act as by-pass condensers. In RF amplifiers, the tuned grid and plate return by-pass leads should be made to a common point in order to avoid RF interaction.

As an audio amplifier the tube may be used with 250 volt plate supply; screen voltage, 50 volts; control grid voltage, 2.1 volts; suppressor connected to cathode; plate load resistor, 250,000 ohms; and plate current of 0.5 MA. With a 1 megohm grid leak, a voltage amplification of approximately 100 can be obtained.

For detection, the grid bias can be obtained by means of a resistor of between 20,000 and 50,000 ohms.

The 954 tube should be ideal for amateur 2½ and 5 meter receivers using super-regenerative detector circuits. As a RF amplifier, it would not only prevent receiver radiation but would also give a decided increase of receiver sensitivity. It should also work out satisfactorily as an autodyne first detector in the ultra-short wave superheterodyne receivers which use "resistance coupled" IF amplifiers.

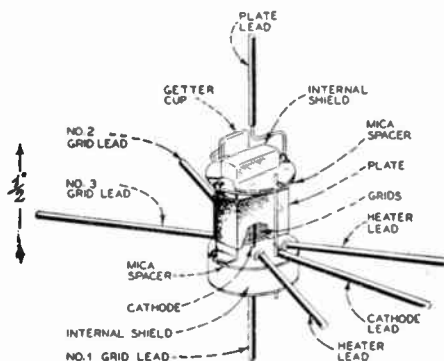

2. Internal Structure

CHARACTERISTICS PENTODE CONNECTION

Heater Voltage (AC or DC)	6.3	Volts
Heater Current	0.15	Ampere
Direct Interelectrode Capacitances:		
Control-Grid to Plate (with shield baffle)	0.007 max.	uuf
Input	3	uuf
Output	3	uuf

Transformer Design

A COMMON problem in radio and allied work is to determine how a transformer can be built to supply certain power requirements for a particular job, or how to calculate the windings needed to fit a certain transformer core which is already on hand. These problems can be solved by a small amount of calculation. There is a certain personal satisfaction and pride in building such a device.

The most important factor in determining the size of any transformer is the amount of core material available. The electrical rating, as well as the physical size, is determined almost entirely by the size of the core. The core material is also important, but the present practice is to use high-grade silicon steel sheet. It will be assumed that this type of material is to be used in all construction herein described. Soft sheet iron, or stovepipe iron is sometimes used, but transformers made from such materials will have about 50 to 60% of the power rating, pound for pound of core, as those made from silicon steel. The core size determines the performance of a transformer because the entire energy used in the transformer (except small amounts of energy used-up in resistance losses in the primary) must be converted from electrical energy in the primary winding to magnetic energy in the core, and re-converted into electrical energy in the secondary. The amount of core material determines quite definitely the power that any transformer will handle.

Transformer cores are usually designed so that if the losses per cubic inch of core material are determined, these losses can be used as a basis for calculating the rating of the transformer. These losses exist in watts, and are divided between the eddy current loss and the hysteresis loss. The eddy current loss is the loss due to the lines of force moving across the core, just as if it were a conductor, and setting-up currents in it. Induced currents of this type are very undesirable and they are merely wasted in heating the core, which then tends to heat the windings, increase the resistance of the coils and reduce the overall power handling ability of the transformer. To reduce such losses, transformer cores are made of thin sheets, usually about No. 29 gauge. These sheets are insulated from each other by a coat of thin varnish, shellac, or japan, or by the iron oxide "scale" which forms on the sheets during the manufacturing process, and which forms a good insulator between sheets.

"Hysteresis" means "to lag", and hysteresis in an iron core means that the magnetic flux in the core lags behind the magnetizing force

that produces it, which is, of course, the primary supply. Because all transformers operate on alternating current, the core is subjected to a continuous magnetizing and demagnetizing force, due to the alternating effect of the AC field. This force heats the iron, due to molecular friction caused by the iron molecules changing back and forth as the magnetizing flux changes. The higher the field strength, the greater the heat produced. A condition can be reached where a further increase in magnetizing flux does not produce a corresponding increase in the flux density. This is called "saturation" and is a condition which would cause considerable heat in a core. In practice it has been found that all core material must be operated with the magnetic flux well below saturation.

Core losses manifest themselves as heat and these losses are the determining factor in transformer rating. They are spoken of as "total core loss", generally used as a single figure, and for common use a core loss of from 0.75 watts to 2.5 watts per pound of core material can be assumed for 60 cycles. The lower figure is for the better grades of thin sheet, while the higher loss is for the heavier grades. About 1 watt per pound is a very satisfactory rating for usual grades of material. This rating is also dependent on the manner in which the transformer is built and mounted, and the ease with which the heat is carried off from the core. Transformers with higher losses can be used for intermittent service.

The transformer core loss can be assumed to be from about 5% to 10% of the total rating for small transformers. Thus if the core loss is known, the rating of the transformer can be easily determined. If the figure of 1 watt per pound is assumed, the problem becomes still simpler. To determine the rating of a transformer, weigh the core. If the core weighs 10 pounds (for example) the transformer will handle from 100 to 200 watts. Such a transformer core can be assumed to have about 150 watts nominal rating. If the weighing of the core is inconvenient, the weight can be calculated from the cubic contents, or volume. Sheet steel core laminations (or laminae) usually weigh approximately $\frac{3}{4}$ lb. per cubic inch, and from this it is easy to calculate the approximate weight.

Transformer cores are usually made of two types; the "shell" type and the "core" type. The shell type has a center leg which accommodates the windings, and this is twice the cross sectional area of the side legs. The core type is made of strips built up into a hollow box-like affair of uniform cross sec-

tion. For the shell type core the area is taken as the square section of the center leg, in this case $2\frac{1}{4}$ -in. x $4\frac{1}{2}$ -in., and in the core type, the area is taken as the section of 1 leg, and is also $2\frac{1}{4}$ -in. x $4\frac{1}{2}$ -in., or an actual core area in both cases of 10.1 square inches, which is large enough for a comparatively large transformer.

To determine the number of turns for a given voltage, the following formula is used:

$$E = \frac{4.44 N B A T}{100,000,000}$$

E =: the volts of the circuit

N =: the cycles of the circuit

B =: the number of magnetic lines per square inch of the magnetic circuit

A =: the number of square inches of the magnetic circuit

T =: the number of turns

The proper value for B usually is the stumbling block, but it has been found by long experience that for small transformers, and for ordinary grades of sheet iron, such as are now being considered, we may safely use, B = 75,000 for 25 cycle transformers, and 50,000 for 50 or 60 cycle transformers.

First we rewrite our equation in this form:

$$T = \frac{E \times 100,000,000}{4.44 \times N \times B \times A}, \text{ and since we know}$$

N and B, we may write:

$$T = \frac{100,000,000}{4.44 \times 60 \times 50,000} \times \frac{E}{A}$$

from which

$$T = 7.5 \times \frac{E}{A}$$

That is, for a transformer to be used on a 60 cycle circuit, we can get the proper number of turns for the primary coil by multiplying the house-circuit volts by 7.5 and dividing this product by the number of square inches cross-section of the magnetic circuit.

On a 25 cycle circuit, the 7.5 becomes 12, and on a 50 cycle circuit it becomes 9; which makes that simple expression good for any power circuit likely to be used.

One example will illustrate:

Let us assume we have a core that we wish to use on a 115 volt, 60 cycle circuit for two tubes, each of which takes 1000 volts on the plate and 15 volts on the filament, to be used in a self-rectifying circuit on both half waves. The core measures $2\frac{1}{4}$ x $4\frac{1}{2}$ inches;

hence $T = \frac{7.5 \times 115}{2.25 \times 4.5} = 85$ (to the nearest turn), and the volts per turn = $\frac{115}{85} = 1.353$ which is the same for all coils.

Method of Measuring Magnetic Cross Section

Now the secondary coil must have two windings in series, each to give 1000 volts, and with a middle tap. Then the secondary turns will be $\frac{2000}{1.353} = 1478$ with a tap taken out at the 739th turn.

The filament coil must have two similar windings, each to give 15 volts and with a middle tap. Its turns then will be $\frac{30}{1.353} = 22$

with a tap taken out at the 11th turn.

For two 50 watt tubes, such as are assumed for this example, the primary current will be about 6 amperes. Allowing 1500 c.m. per ampere, the primary wire should be No. 10; and the filament winding may be the same size for a 6 ampere filament current when the filaments are in series. If they are connected in parallel, the wire should be No. 8 and the number of turns should be 11, with the middle tap at $5\frac{1}{2}$ turn (for ground connection).

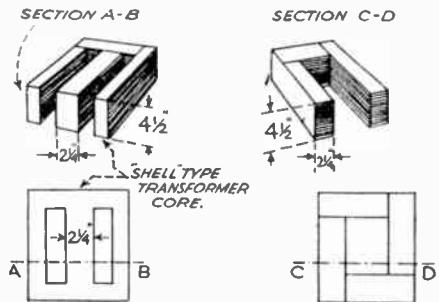

The size of wire on the plate coils may be No. 20 or No. 22.

So, if you want to determine how much iron to pile up for a core, remember that about 1 to 1.5 volts per turn is a conservative range. For trial assume 1.25 volts per turn. Then by transforming our first equation we have,

$$A = 7.5 \times \frac{E}{V} \text{ or, the area required is } 7.5$$

times the volts per turn; in this case $7.5 \times 1.25 = 9.38$ sq. in.

The magnetic cross section must be measured at right angles to the laminations that are enclosed by the coil; the center leg when the core is built up around the coil; and either leg where the core is built up inside the coil, i.e., between the arrows in the sketches shown above.

It should also be kept in mind that there is a copper, or resistance loss in all transformers. This is caused by the passage of the current through the windings, and is commonly spoken of as the "IR" loss. It manifests itself directly as heat, and varies as the load is varied; the heavier the load, the more heat

developed. This heat, as well as other heat losses, must be removed, or the transformer will burn up. Most transformers are so arranged that both the core and windings can radiate heat into the surrounding air, and thus cool themselves. Large transformers are mounted in oil, for cooling, and also for the purpose of increasing the insulation value.

In any transformer, the voltage ratio is directly proportional to the turns ratio. This means that if the transformer is to have 110 volts input, and 250 turns for the primary, and if the output is to be 1100 volts, 2500 turns will be needed. This may be expressed as:

$$\frac{E_p}{E_s} = \frac{T_p}{T_s}$$

It is often more convenient to take the figure obtained for the primary winding, and by dividing by the supply voltage the number of turns per volt is calculated. This accomplished, the number of turns for any given voltage can be calculated by simple multiplication. This figure is given in detail for all transformers which are described in the table on page 264.

Radio transformers are generally of small size. The matter of power factor can therefore be disregarded, more especially because they work into an almost-purely resistive load. In the design of radio transformers, the power factor can safely be assumed as unity, in which case the apparent watts and the actual watts are the same. Admittedly this is not always a correct assumption, but it will suffice for common use.

In determining the size of wire to be used in any transformer, the size depends upon the amperage to be handled. For a current of 1 ampere for continuous use, at least 1000 circular mils per ampere must be allowed. For transformers which have poor ventilation, or intermittent heavy load service, or where price is not the first consideration, 1500 circular mils per ampere is very desirable practice. Suppose we have a transformer rated at 100 watts primary load on 110 volts. The amperage will then be:

$$I = \frac{W}{V} = \frac{100}{110} = 0.90 \text{ amperes,}$$

and if the assumption is 1000 circular mils per ampere, we find that this will require 1000 x 0.90, or 900 circular mils. The wire table shows that No. 20 wire for 1022 mils, is entirely satisfactory. If we desire to use 1500 circular mils, we will require 1500 x 0.90, or 1350 mils, which corresponds to a No. 19 wire, approximately. The difference seems small, yet it is large enough to reduce heating and to improve overall performance. Assume that we have a 600 volt, 100 MA high-voltage secondary, a 5 amp., 5 volt secondary, and a 2.5 volt, 7.5 ampere secondary. Hence we have 60 watts load on the high voltage secondary, 15 watts on the 5 volt

filament winding and 16 watts on the 2.5 volt secondary, a total of 91 watts. The core and copper loss is 10 watts. The wire sizes for the secondaries would be: 100 mils current, No. 30 wire, 5 amps, at 5 volts, No. 15 wire; No. 11 wire for the 7.5 ampere secondary.

For high voltage secondary windings, a small percentage should be allowed to overcome the resistance of the small wire used, so that the output voltage will be as high as anticipated. The figures given in the table include this percentage which is added to the theoretical ratio of turns, and consequently the number of turns shown in the table can be accepted as the actual number of turns to be wound on the core of any given transformer.

Allowance should always be made for the insulation and size of windings. Good insulation should be provided between the core and the windings, and also between each winding and between turns. Numerous materials are satisfactory for this purpose; varnished paper of cloth, called "empire" cloth or paper, is very satisfactory, although costly. Good bond paper is a satisfactory insulator for small transformer windings. Insulation between primary and secondary and to the core must be exceptionally good, as well as the insulation between the various windings. Thin mica, or "micanite" sheet, is very good. Thin fibre, commonly called "fish paper", is also satisfactory. Bristol Board, or strong, thin cardboard can be used. In all cases, the completed coil should be impregnated with insulating varnish, and either dried in air or baked. The use of common varnishes or shellac is unsatisfactory because these materials usually contain moisture. Air-drying insulating varnish is satisfactory; baking varnish can be used, but the fumes given off are inflammable and often explosive. Care should be taken in using them. The use of collodion, or banana oil lacquer is positively dangerous; in the event of a short or burnout in the transformer, a serious fire can result.

If it is desired to wind a transformer on a given core, it is much better to calculate the actual space required for the windings and then see if there is enough available space on the core. If this is not done, it is sometimes embarrassing to find that only about half the turns needed can actually be wound on a core, when the work is about three-quarters finished. Always allow from 15 to 40% more space than is actually needed. The winding of transformers by hand is a space-consuming process. Unless the builder is an experienced coil winder, there is every chance that a sizable portion of the space will be used-up by insulation, etc., not sufficient space remaining for the winding. Calculate the cubical space needed for the total number of turns, and allow from 15 to 40% additional space in the core "window." Thereby much time and labor will be saved.

Gauge No. & S.W.G.	CROSS SECTIONAL AREA			TURNS PER LINEAR INCH						TURNS PER SQUARE INCH						FT. PER POUND			RES PER 1000 FT.	CARRYING CAPACITY			
	Dia. in Mils.	Cir. Mils.	Sq. Inches	CCC.	SCC.	SSC.	Enam.	Enam. and SCC.	Enam. and SSC.	CCC.	SCC.	SSC.	Enam.	Enam. and SCC.	Enam. and SSC.	CCC.	SCC.	Bare	Copper	1000 CM Per Amp.	1500 CM Per Amp.		
0000	460.0	211600	.1662															1.561	.8199	211.6	160.7		
000	409.6	167800	.1318															1.968	.8629	167.8	111.3		
00	364.8	133100	.1045															2.462	.8793	133.1	86.9		
0	324.9	105500	.08289															3.126	1.060	105.5	70.3		
1	289.3	83690	.06573															3.847	1.260	83.7	55.7		
2	257.6	66370	.05213															4.977	1.592	66.4	44.1		
3	229.4	52640	.04136															6.276	2.004	52.6	35.0		
4	204.3	41760	.03278															7.914	2.336	41.7	27.7		
5	181.9	33100	.02600															9.986	3.192	33.1	22.0		
6	162.0	26250	.02052				5.44	5.60										12.558	4.028	26.3	17.5		
7	144.3	20820	.01615				6.08	6.33										13.87	5.060	20.8	13.8		
8	128.5	16510	.01297				6.80	6.94										19.6	19.9	20.01	6.105	16.5	11.0
9	114.4	13090	.01028				7.64	7.68										24.6	25.1	25.23	8.077	13.1	8.7
10	101.9	10340	.008155				8.51	8.55										30.9	31.6	31.82	1.018	10.4	6.9
11	90.74	8234	.006467				9.58	9.60										38.9	39.8	40.12	1.284	8.2	5.5
12	80.81	6530	.005129	10.62	10.80	11.8	12.1	12.1	11.4	11.8	121	136	139	116	146	130	139	48.9	50.2	50.59	1.619	6.5	4.4
13	71.96	5178	.004067	11.88	12.06	13.2	13.5	13.5	12.8	13.2	153	173	183	163	183	162	173	61.5	63.2	63.80	2.042	8.2	3.5
14	64.09	4107	.003225	13.10	13.45	14.7	15.1	15.2	14.2	14.7	187	213	216	229	239	201	216	77.3	79.6	80.44	2.575	4.1	2.7
15	57.07	3257	.002558	14.68	14.90	16.4	16.9	17.0	15.8	16.5	229	264	268	287	290	250	271	97.3	100	101.4	3.247	3.3	2.2
16	50.82	2583	.002028	16.40	17.20	18.2	18.9	18.7	17.6	18.4	280	327	333	358	350	309	338	119	126	127.9	4.094	2.6	1.7
17	45.26	2018	.001609	18.10	18.80	20.3	21.2	21.4	19.5	20.5	340	406	412	448	458	381	421	150	155	161.3	5.163	2.0	1.3
18	40.30	1624	.001276	20.00	21.00	22.6	23.0	24.0	21.7	22.9	412	498	510	559	575	469	526	188	196	203.4	6.510	1.6	1.1
19	35.9	1248	.001012	21.83	23.60	25.4	26.8	27.2	24.2	25.8	508	629	644	715	739	587	665	237	247	256.3	8.210	1.3	.86
20	31.96	1022	.0008023	23.91	26.40	27.8	29.5	30.1	26.5	28.4	596	722	773	867	904	701	805	308	311	323.4	10.35	1.0	.68
21	28.46	810.1	.0006383	26.20	29.70	30.8	32.8	33.6	29.6	31.5	712	849	919	1078	1129	878	991	370	369	407.8	13.85	.81	.54
22	25.35	642.4	.0005046	28.58	32.00	34.1	36.6	37.7	32.7	35.0	859	1161	1181	1337	1419	1071	1227	461	491	514.8	16.46	.64	.43
23	22.57	509.5	.0004002	31.12	34.30	37.6	40.7	42.3	36.1	38.8	1030	1418	1418	1616	1708	1308	1518	581	624	648.4	20.76	.51	.34
24	20.10	401.0	.0003173	33.60	37.70	41.5	45.3	47.2	39.7	43.1	1266	1722	1722	2018	2225	1575	1858	745	778	817.7	26.17	.41	.27
25	17.90	320.4	.0002517	36.20	41.50	45.7	50.3	52.9	43.7	47.9	1591	2245	2265	2555	2900	1907	2249	903	958	1031	33.00	.32	.21
26	15.91	244.8	.0001996	39.00	45.30	50.2	55.7	58.0	47.8	52.8	1745	2515	2515	3108	3484	2281	2768	1118	1188	1300	41.62	.25	.17
27	14.20	201.5	.0001583	42.60	49.40	55.0	61.7	65.8	52.1	58.1	2029	3019	3019	3811	4328	2713	3381	1122	1533	1629	52.48	.20	.13
28	12.61	158.8	.0001255	45.50	51.60	60.1	68.3	73.9	57.0	64.4	2317	3611	3611	4668	5456	3250	4141	1759	1903	2067	66.17	.16	.11
29	11.26	126.7	.00009853	49.00	58.00	65.5	75.4	82.2	61.9	70.8	2696	4291	4291	5688	6761	3830	4908	2307	2461	2607	83.44	.13	.084
30	10.03	100.5	.00007891	51.10	61.40	71.3	83.1	92.3	67.4	77.9	3076	5081	5081	6911	8527	4517	6075	2534	2893	3267	105.20	.10	.067
31	8.928	79.70	.00006260	56.80	69.00	77.3	91.6	103.0	72.8	85.3	3619	5911	5981	8389	10568	5305	7267	2768	3183	4145	132.70	.079	.053
32	7.950	63.21	.00004964	60.20	75.00	83.7	101.0	116.0	79.1	93.9	3931	7003	7003	10101	13363	6250	8819	3137	4414	5227	167.30	.063	.042
33	7.060	50.13	.00003937	61.30	81.00	93.0	110.0	130.0	85.6	103.0	4194	8113	8113	12130	16952	7326	10672	4697	5688	6591	211.00	.050	.033
34	6.302	39.73	.00003122	64.60	87.60	97.0	120.0	145.0	91.7	112.0	4543	9187	9187	14199	20987	8403	12610	6168	6200	8310	266.00	.039	.026
35	5.615	31.52	.00002176	73.00	91.20	104.0	131.0	164.0	98.8	123.0	5791	10847	10817	17217	26745	9766	15186	6737	8293	10150	335.00	.023	.021
36	5.000	25.00	.00001961	78.50	101.00	111.0	143.0	182.0	105.0	133.0	5917	12316	12316	20008	30051	11080	17777	7877	9846	13210	423.00	.025	.017
37	4.473	19.83	.00001557	84.00	104.00	115.0	155.0	206.0	113.0	146.0	6152	13996	13996	21015	40766	12758	21295	9389	11636	16660	533.40	.020	.013
38	3.965	15.72	.00001235	89.10	115.00	126.0	169.0	235.0	120.0	157.0	6974	15763	15763	26108	54990	14291	24685	10666	13418	21010	672.60	.016	.010
39	3.493	12.47	.000009793	95.00	122.00	131.0	181.0	261.0	128.0	172.0	7521	17630	17630	32609	68120	16308	28412	11907	14286	26580	818.10	.012	.008
40	3.134	9.848	.000007766	102.50	130.00	140.0	191.0	290.0	131.0	181.0	8615	19589	19589	37779	81288	18481	32727	11222	24381	33110	1069.00	.009	.006
41	2.800	7.811	.000006160	112.00	153.00													17920	30610	42130	1323.00	.008	.005
42	2.491	6.220	.000004885	121.00	168.00													22600	38700	53100	1667.00	.006	.004
43	2.221	4.933	.000003873	140.00	192.00													28410	48600	66970	2102.00	.005	.003
44	1.978	3.910	.000003073	153.00	210.00													35950	61400	84600	2655.00	.004	.0025

COPPER WIRE TABLE

Filter Chokes

● A choke is a coil of high inductance. It offers an extremely high impedance to alternating current, or to current which is substantially alternating, such as the pulsating DC obtained from the output of a rectifier.

Choke coils are used in power supplies as part of the complete filter system in order to produce substantially "pure" direct current from the pulsating current which is obtained from the rectifier. The size of a choke should be such that the current flowing does not cause too great a voltage drop due to the Ohmic resistance of the choke. At the same time sufficient inductance must be maintained to provide ample smoothing of the rectified current.

Smoothing Chokes

The function of a smoothing choke is to discriminate as much as possible between the AC ripple which is present and the desired average DC that is to be delivered to the output. Its air gap should be large enough so that the inductance of the choke does not vary materially over the normal range of load current drawn from the power supply.

Swinging Choke

In certain radio circuits the DC power drawn by a vacuum tube amplifier can vary widely. Class B audio amplifiers are good examples of this type of amplifier. The plate current drawn by a class B audio amplifier can vary a thousand per cent, or more. It is desirable to keep the DC output voltage applied to the plates of the amplifier as constant as possible, and the voltage should be independent of the current drawn from the power supply. The output voltage from a given power supply is always higher when a condenser input filter is used than when choke input to the filter is used. When the input choke is of the swinging variety it means that the inductance of the choke varies widely with the load current drawn from the power supply. Thus at low load currents the inductance of the swinging choke is high and the filter acts as a choke input filter, with a relatively low output voltage. When the load current increases, the inductance of the swinging choke decreases and the filter circuit begins to act more and more like a condenser input filter. This causes the output voltage to rise somewhat, although the rise is usually adjusted so that it just offsets the voltage drop caused by the transformer and choke resistance, plus the drop across the rectifier tubes. A swinging choke does not have much smoothing effect, but it is valuable in improving the voltage regulation of the power supply. The use of a swinging choke is desirable in a CW transmitter in order to reduce the keying thumps which occur when condenser input is used.

Design and Construction of Chokes

A choke is made up from a silicon steel core which consists of a number of thin sheets of steel, similar to a transformer core, but wound with only a single winding. The size of the core and the number of turns of wire, together with the air-gap which must be provided to prevent the core from saturating, are the factors which determine the inductance of a choke. The relative sizes of the core and the coil determine the amount of DC which can flow through the choke without reducing the inductance to an undesirably low value due to magnetization.

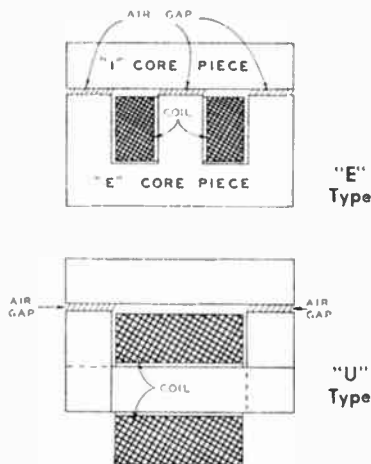

Two types of Choke Coil Construction. The air gap is approximately 1/32 inch. The gap can be filled with non-magnetic material, such as brass copper, bakelite, fibre or hard-wood, in order to maintain accurate and uniform spacing.

The same core material which is used in ordinary radio transformers, and which can be obtained from burned out transformers of almost any kind, usually furnishes a cheap and very satisfactory source of core material.

Insulation

In the construction of a choke the winding should be insulated from the core with a sufficient quantity of insulating material so that the highest peak voltages which are to be experienced in service will not break down the insulation. It is good practice to operate the chokes with the cores grounded. The choke should be in the negative high voltage lead, in order to minimize breakdown. If a breadboard is used for mounting the choke, the core need not be grounded. In some cases where extremely objectionable hum is experienced it may be desirable to completely shield and ground the choke.

Choke Table for Transmitter Power Supply Units

Current M.A.	Wire Size	No. Turns	Lbs. Wire	Approx. Core (Area)	Air Gap	Wt. Core
200	No. 27	2000	1.5	1½" x 1½"	3/32"	4 lbs.
250	No. 26	2000	1.75	1½" x 2"	3/32"	5 lbs.
300	No. 25	2250	2	2" x 2"	1/8"	6 lbs.
400	No. 24	2250	3	2" x 2½"	1/8"	7 lbs.
500	No. 23	2500	4	2½" x 2½"	1/8"	10 lbs.
750	No. 21	3000	6	2½" x 3"	1/8"	14 lbs.
1000	No. 20	3000	7.5	3" x 3"	1/8"	18 lbs.

NOTES: These are approximations based on high-grade silicon steel cores, with total airgaps as given. Airgaps indicated are *total* of all gaps.

The use of standard "E" and "I" laminations is recommended. If strips are used, and if an ordinary square core is used, the number of turns should be increased about 25%. Choke coils built as per the above table will have an approximate inductance of 10 to 15 henrys. Because considerable differences occur due to winding variations, allowable flux densities of cores, etc., the exact inductance cannot be stated; these chokes will, however, give satisfactory service in radio transmitter power supply systems.

The wire used is based on 1000 circular mils per ampere; this will cause some heating on long runs, and if the chokes are to be used continuously, as in a radio telephone station in continuous service, it is good practice to use the next size larger choke shown for such loads.

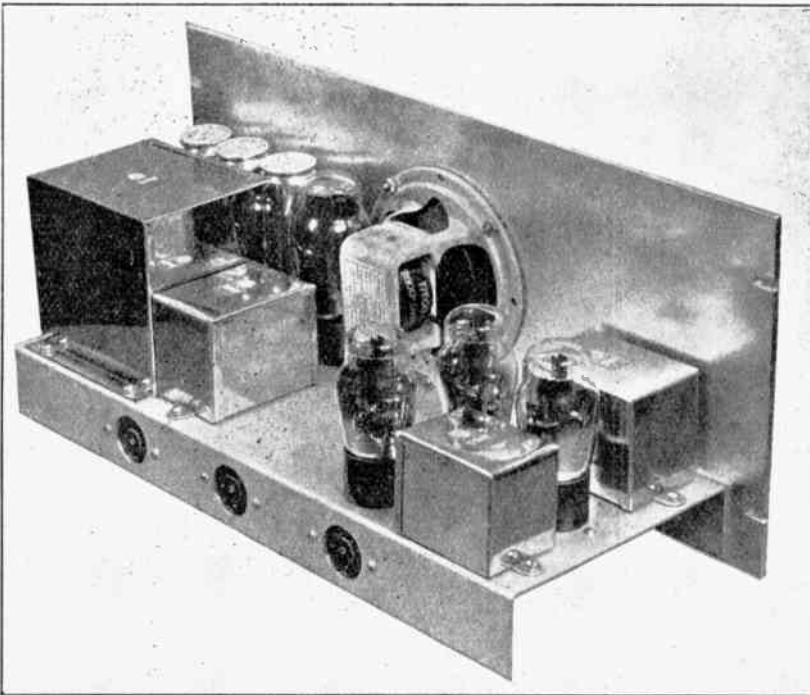

A well-designed power supply and audio amplifier in which the new Niklshield Chokes and Transformers are used.

Rectifiers and Filters

● A source of high voltage direct current must be applied to the plate of a vacuum tube in order that the tube can function as an amplifier. The power is usually obtained from the AC mains. It is then transformed, rectified and filtered in order to produce direct current. Alternating current electricity is not a constant flow of electricity but consists of electricity which flows for a short period of time in one direction, then reverses its polarity and flows for an equal period in the opposite direction. Thus a frequency of 60 cycles indicates that the polarity completely reverses itself 60 times per second. Alternating current electricity is the only kind of electricity which can be either stepped-up or stepped-down by means of a transformer. Such a condition is desirable for electric lighting or power circuits. In order to apply alternating current usefully to a transmitter or receiver, this alternating current must first be stepped-up through a suitable transformer, and then changed from alternating current into direct current. This change is accomplished by the process known as rectification. In order to accomplish this change from alternating current into direct current, a "one-way-gate" is used, through which electricity can pass in only one direction. This "gate" is the rectifier tube. Electrons can only flow from filament to plate, and not from plate to filament in the rectifier tube. Thus, during the portion of the AC cycle when the plate is positive with respect to the filament, current flows through the tube; but on the next half cycle, when the current tries to reverse its direction, it finds the "gate" closed, and there is no flow of current.

This "gate" is technically known as the half-wave rectifier. The tube passes one-half of the wave and blocks the other half; thus current flows for half the time and drops to zero the other half of the time. This causes a very uneven voltage output, because it varies from zero to maximum 60 times per second, even though it is now direct current and flows only in one direction. It should more strictly be called "pulsating direct current."

In order to minimize the pulsations, and in order to make the current flow more continuous, a "full wave" rectifier is used. A full wave rectifier consists of two "gates", each gate connected to one end of the secondary of the power transformer. The center tap of this transformer is usually grounded. Thus when one end of the transformer is going through the most positive part of the cycle, with respect to the center-tap, the other end of the transformer is most negative. Therefore, when one gate is conducting, the other gate is closed; then, one-half cycle later, the other gate conducts while the first one is

closed. The output of these two gates is connected together, usually through a common rectifier tube filament circuit, and thus the gates alternately supply current to the output circuit which is connected between the filament winding of the tube or tubes that are acting as the gate, and the center-tap of the high voltage transformer. The rectifier filaments are always of positive polarity.

Thus we have a direct current pulsation every half cycle or 120 times per second instead of one pulsation for each cycle; therefore the variation in output voltage is much less. However, the pure direct current required for the amplifier tube is not yet available, so that some form of a low-pass filter must be placed between the rectifier and the load.

A low-pass filter is a device which selects and passes certain types of electric currents and rejects and by-passes other unwanted types. It should be remembered that a pulsating DC voltage might be considered to be a pure DC voltage which has a somewhat smaller alternating voltage superimposed on it. In other words, the combination of the two voltages is, in every way, exactly similar to the pulsating DC voltage output of the rectifier.

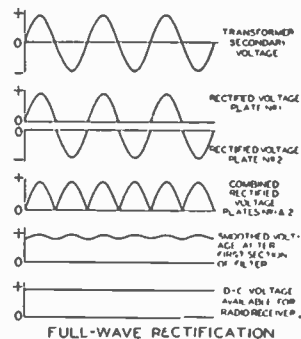

FIG. 1. Showing effects of rectification and filtering of an AC current.

All filters and filter operations are designed to select and reject alternating currents. The characteristic of the alternating current which enables the filter to select it or reject it is its FREQUENCY. A low-pass filter offers little obstruction to alternating currents of low frequency, but materially impedes the flow of alternating currents of high frequency. DC can also be considered as AC of zero frequency, and thus it is an infinitely low frequency, and passes straight on through a low-pass filter to the load with little or no obstruction. On the other hand, the pulsations, or ripple consists of an

alternating current, usually of a frequency of about 120 cycles per second, and it is this alternating current which the low-pass filter prevents from reaching the load where it would make its presence known as a HUM. A low-pass filter usually consists of two elements; an inductance, or choke coil, in series with the load, and one or more capacities (filter condensers) shunted across the load. An inductance or choke coil is a device which resists any change in the current that flows through it, and it offers a relatively high resistance to the flow of a varying current. The more variations there are per second, the more resistance it offers to the flow. Because it is in series with the load, the AC component (or ripple) flows through it only with great difficulty.

On the other hand, a capacity (or condenser) is a device which has exactly the opposite action to that of a choke. It offers a relatively low impedance to the flow of alternating or pulsating current and yet represents a very high or often an infinite resistance to the flow of direct current.

Thus the two currents, the direct current and the AC ripple superimposed upon it, leave the output of the rectifier together and arrive at the input of the filter. At this point each component has the choice of two paths which it can follow: (1) it can travel through the choke coil, to the load, and back to ground through the load which consists of the plate circuit of the amplifier tube; (2) or, if it chooses, it can go directly to ground through the filter condenser, which is usually shunted across both the input and output of the filter.

Electricity always follows the path of least resistance. It was previously stated that the choke offers little resistance to the flow of DC, while the condenser offers high resistance to DC. Thus the DC will choose to go through the choke and back to ground through the load, serving the useful function of attracting electrons from the filament over to the plate of the amplifier tube on its way. The AC component, or ripple, on the other hand, faces a high resistance in the choke, but a very easy path back to ground, where it seeks to go, through the condenser. It also chooses the path of lowest resistance, and consequently is by-passed directly to ground. The choke prevents the AC ripple from reaching the plate circuit of the amplifier tube, where it would cause undesirable hum.

The amount of permissible hum, or ripple, depends on the load. For amateur radio telegraph service more hum can be permitted than for telephone, and for crystal controlled transmitters of high frequency stability, the ripple can be much higher than for other types, the self-excited oscillator circuit requiring the most filter in a transmitter. Inductance and capacity combined as indicated

comprise the filter system, and because there is direct current which must flow, the arrangement must be such that there is as little resistance as possible introduced in the circuit, because this resistance causes a loss and a waste of voltage. The common types of filter circuits are indicated in Fig. 2.

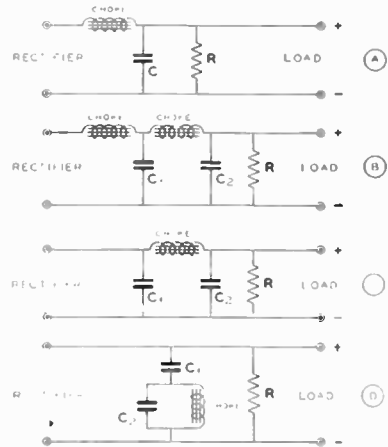

FIG. 2. Common types of filter circuits.

The first three, a, b and c, indicate parallel types of filters, and d indicates the resonant filter connected across the supply line direct from the rectifier. The parallel types are often called "brute force" filters, because they have so much inductance and capacity that they "force" the pulsating current to become direct; actually, they are adjusted to such a low frequency that any stray alternating current is suppressed, and eliminated, no matter what its frequency happens to be. These filters usually work out satisfactorily with almost any haphazard values of inductance and capacity (usually of large size), and require practically no exact or precise adjustments. They are very effective and popular and they are used in many types of transmitters and receivers. They are, however, rather bulky and require large values of capacity and inductance for successful operation. The resonant type choke requires much less equipment, yet more accurate adjustment. Its use is generally limited to high power equipment, or to installations where proper equipment is available to make sure they are operating effectively. For the usual simple amateur installation, the brute force filter in some of its many forms will usually be simpler and easier to handle.

For amateur use, the ripple voltage should not exceed about 1 per cent for radio telephone service, in the audio and preliminary amplifier stages of the transmitters. If crystal control is used the power supply to the final stage (which is usually separate) should have no more than 3 per cent ripple,

and preferably it should be much less than that. Elaborate tables and formulae have been published, showing how to calculate the values of L and C for a filter system, but unfortunately these formulae usually fall down because they are based on the assumption that inductance and capacity measurements can be made by the amateur, which is not the case. This is still further complicated by the fact that the values of L, the chokes, or inductances, may vary widely during load conditions, when direct current is flowing through them. Probably the simplest way for the amateur to determine the ripple voltage is to measure it with a voltmeter, and from reliable reports from distant stations, as to whether or not the "carrier" is pure DC.

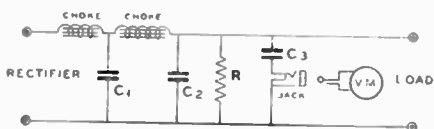

FIG. 3

Fig. 3 shows a simple way to measure ripple with the aid of a spare condenser (C3) of about $\frac{1}{4}$ to 1 mfd. and a high-resistance copper oxide alternating current voltmeter. To make the measurement, connect the apparatus as shown. **AFTER THE TRANSMITTER IS IN OPERATION**, insert the voltmeter plug in the jack and read the voltage. This will be the approximate RMS ripple voltage (approximate because it may be altered by wave shape, and condenser capacity to a certain extent). Be sure to **REMOVE THE VOLTMETER** from the circuit before turning off the plate current. If the meter is left in circuit when the transmitter is started or stopped, the rush of current caused by the condenser charging or discharging may burn out or damage the meter. **BE SURE** to connect the meter jack into the negative or low potential side of the condenser. **REMEMBER—CONTACT WITH THE HIGH VOLTAGE CAN CAUSE A FATAL SHOCK!**

Generally, a filter system which uses a CHOKER input as shown in Fig. 2-b is advisable, especially with mercury vapor tubes. The choke absorbs energy, similar to a fly-wheel. Due to the high inductance it resists any change in the current flowing through it. The choke coil selected should be large enough so that it will carry the maximum direct current load without heating, and without losing too much inductance. Any coil wound on an iron or steel core has a certain amount of inductance, determined by the size of the core and the size and number of turns of wire wound on the core. The direct current which is impressed on it

magnetizes the core, and this reduces the value of the inductance. It is quite possible to raise the direct current up to magnetic saturation, in which case the core will cease to exist magnetically, and the effect will be that of a pure resistance. Closed magnetic circuits of steel or iron will saturate quite easily. All cores on properly designed chokes are fitted with a break in the magnetic circuit. Usually this is in the form of a piece of fibre, bakelite or other material which is inserted between the ends of the laminations; any method of breaking the magnetic continuity will usually suffice. This gap is commonly called an "air gap", but for mechanical reasons it is easier to use a non-magnetic substance, instead of air as the spacing. Magnetic saturation can be avoided in chokes by liberal design, and by the use of plenty of copper and iron. Iron core material is usually cheaper and easier to obtain than a large number of turns of wire; therefore the larger the core, the better, within limits of reason, of course.

Choke coils can be easily built, because they contain but a single winding. Care should be taken in their insulation, because choke coils must often stand the full plate voltage, plus the "peak", or 1.4 times output voltage which is delivered from the rectifier system.

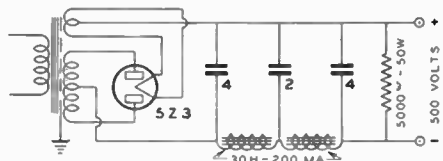

Standard full-wave rectifier using 5Z3 tube. This tube handles more current than the 80.

The other portion of the "filter" is the capacity, or "condenser". Condensers are generally of two types, "paper" and "electrolytic." Paper condensers consist of 2 strips of tinfoil, separated by high-voltage-test waxed paper, and are available in capacities up to about 2 mfd. for voltages up to about 5000 volts. The electrolytic types are available in several voltage ranges of about 450 to 600 volts maximum, per section, usually 8 mfd. capacity. These condensers depend for their action on the fact that pure aluminum, when immersed in a suitable electrolyte, usually sodium borate or a similar solution, forms a very thin film of oxide on the surface. This film, which is apparently of molecular dimensions, forms the dielectric of the condenser. Because the capacity of any condenser is inversely proportional to the thickness of the dielectric, and directly proportional to the dielectric constant, it will be seen that the very thin film of dielectric will give remarkably high capacities for extremely small areas of aluminum.

Electrolytic condensers usually cost from one-third to one-fourth that of paper condensers, and they occupy about one-sixth to one-eighth the amount of space required for the same capacity in a paper condenser. The two commercial types are the "wet" and "dry" electrolytics. The wet types are simply a specially shaped aluminum foil electrode enclosed in, and insulated from, a metal can or container, and filled with the proper solution. This type, while effective, is more expensive and less satisfactory than the dry type. The latter is made of two strips of aluminum sheet, usually "formed" before assembly, by an electrolytic process in a solution, and separated by paper or cloth impregnated with a jelly which contains the proper solution, the entire unit then being enclosed in a proper container and sealed, usually in 8 mfd. units or multiples thereof.

Electrolytic condensers have the following disadvantages: single units cannot be made for operation at more than about 450 volts; they draw an appreciable current while in service, usually in the order of a few milliamperes, and they usually break down after a few years of service.

In order to use them on voltages higher than about 350 to 400, it is necessary to connect several condensers in series, or in series parallel, in order to obtain increased capacity. Under these conditions it is sometimes necessary to connect an equalizing resistor across each condenser, as shown in Fig. 4.

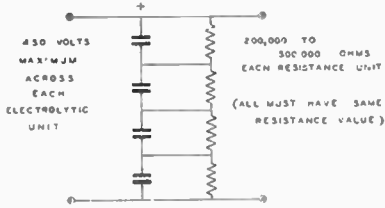
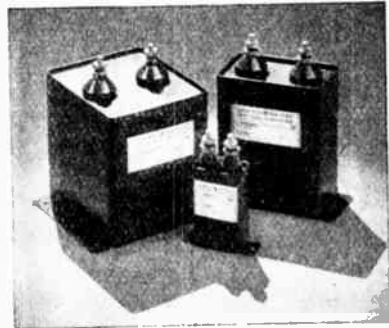

FIG. 4. Electrolytic condensers connected in series, plus to minus, should have one watt, 500,000 ohm resistors connected across each condenser in order to equalize the leakage and prevent excessive strain on any one section of condenser.

Some types of paper condensers are impregnated with wax, some with oil, especially the higher voltage types. The oil type is usually more satisfactory, although more expensive than the ordinary paper or wax impregnated types. Paper condensers are rated for "flash" and "normal operating voltage" test ratings; the first refers to a test, usually about twice to three times the normal operating voltage of the condenser, and is only a manufacturers' test rating. The normal operating voltage, or working voltage, is the maximum voltage the condensers will be called upon to stand in service; it is usually

the square root of two, or 1.4 times the direct current voltage. For reasons of safety, it is good practice to use condensers of at least 1.5 times the normal working or operating direct current voltage as read on the output voltmeter across the filter terminals.

All mercury vapor tubes are rated by their "maximum peak" plate current and "maximum inverse peak" voltage. The maximum plate current is for a pair of tubes, or as otherwise explained in detail in tube data sheets, which accompany tubes when packed.



Heavy duty, high-voltage, oil-filled transmitting condensers, ideally suited for amateur and commercial filters. The popular size is the 2 mfd. unit, rated at 2000 working volts. For operation at 4,000 working volts two of these 2 mfd. units can be connected in series, but the resultant capacity of the two will be only 1 mfd. On the other hand, if two of these 2 mfd. units are connected in parallel, the resultant capacity is 4 mfd. at 2000 working volts. For operation at 4000 working volts, a total capacity of 2 mfd. would require the use of four of these 2 mfd. 2000 volt units connected in series-parallel.

The maximum inverse peak voltage depends for its value on the peculiar qualities of alternating currents, where the usual type

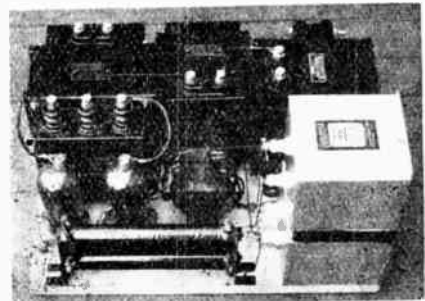

High-voltage full-wave power supply using 866 or 866A rectifier tubes.

of thermo-couple, dynamometer, or similar common type of meters actually give the "square root of mean square", or "RMS"

value of the current, or voltage in a circuit. This means that ordinary meters read the effective current or voltage, or that which would cause the same heating effect by an equivalent direct current. In an AC circuit the maximum, or peak voltage or current is usually the square root of two, or 1.41 times that indicated by the meter reading. In other words, in an AC circuit, with say 100 volts indicated, the actual peak voltage is 141 volts. In a simple half wave rectifier system, therefore, with 1000 RMS volts across the transformer secondary, there will be 1410 volts peak voltage, and a single half wave rectifier tube would have this voltage impressed on it, either positively when the current flows, or "inverse" when the current does not flow. The inverse peak may be twice this value if condenser input filter is used in a half-wave rectifier. If a full wave system is used with a center-tapped transformer, the voltage across the entire secondary will be twice that of a similar half wave system, or 2000 volts, using the above example. The maximum peak inverse voltage across each tube when not conducting (negative half of the cycle) will be 2000×1.41 , or 2820 volts. Obviously, care must be taken in the choice of rectifier tubes and associated equipment, because it is the peak voltage which breaks down the insulation and causes failure.

In the rectifier output circuit the two half-waves combine to form pulsating direct current, and the peaks of this current are also 1.41 times the indicated, or average value. This means that all units, such as condensers, etc., must be arranged to withstand this voltage.

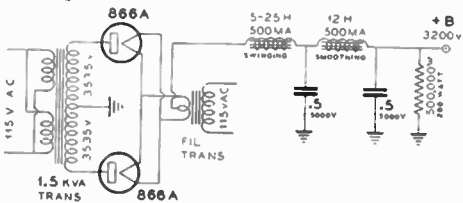

Power supply for CW operation. Smaller filter condensers can be used, as shown.

The voltage regulation of a rectifier and filter system must be given careful attention in the design of a power supply. It depends on the selection of a power transformer of substantial size and a reasonable overload capacity; the secondary should be of low resistance, and the transformer so designed that the voltage will not drop appreciably when the secondary load is increased. The selection of the proper chokes, of low resistance and high inductance and of low saturation, all contribute to the maintenance of good regulation in the power supply unit. The use of the so-called "swinging choke", which changes its inductance with the varia-

tion in load, is also a help in this direction.

A heavy duty resistor should be connected across the filter output so as to draw an appreciable load. This "bleeder" resistor should normally draw about 10 per cent of the full load current, and it really places a load on the system so that a chance open circuit will not allow the condensers to build up to the full 1.4 times the normal voltage, which would obviously be a considerable strain on the entire system. A resistor of this type should be wire-wound, preferably of the 50 or higher watt heat dissipation size. This resistor also helps keep the voltage constant, and to prevent chirpy signals when keying a CW telegraph transmitter.

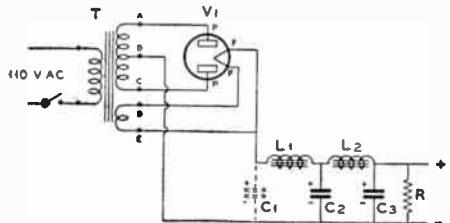

If C1 is used in the circuit, the filter is known as "Condenser Input". If C1 is omitted, the filter is known as "Choke Input."

A further method of obtaining good voltage regulation is to use choke input to the filter. This is essential for all types of circuits using mercury vapor tubes. If a condenser is connected directly across the output of a mercury vapor rectifier system (except in some forms of voltage doublers where a condenser is necessary) the condenser will draw nearly the peak 1.4 times the normal current from the rectifier at all times, and will also reduce the output voltage considerably; thus the regulation will be poorer. Except in small units, using vacuum type rectifiers, the use of choke input to filters is strongly recommended, both for increased tube and condenser life, and for the better regulation. The use of a fuse in the power supply system may save a tube, condenser, or other piece of equipment, which costs many times as much as the fuse. It is desirable to mount the chokes in positions of minimum inductive field of the power transformer.

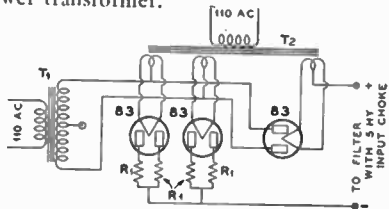

Bridge rectifier suitable for 1000 volt supply. R1 are equalizing resistors, 100 ohms each, 10 w.

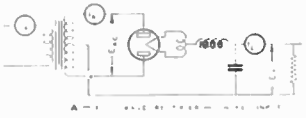

EDC - 435 V
IDC - 100 MA
EAC - 1100 V
IAC - 71 MA
IPRI - .6 MA

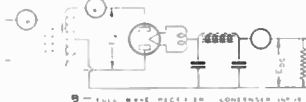

EDC - 675 V
IDC - 100 MA
EAC - 1100 V
IAC - 103 MA
IPRI - .9 MA

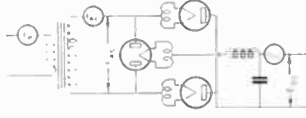

EDC - 860 V
IDC - 100 MA
EAC - 1100 V
IAC - 96 MA
IPRI - 1.1 A

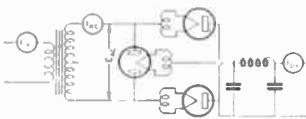

EDC - 1200 V
IDC - 100 MA
EAC - 1100 V
IAC - 148 MA
IPRI - 1.65 A

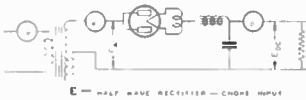

EDC - 480 V
IDC - 100 MA
EAC - 550 V
IAC - 120 MA
IPRI - .9 A



EDC - 580 V
IDC - 100 MA
EAC - 550 V
IAC - 190 MA
IPRI - 1.45 A

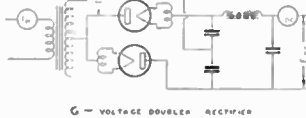

EDC - 1080 V
IDC - 100 MA
EAC - 550 V
IAC - 310 MA
IPRI - 1.55 A

Typical voltage and current readings in various types of power supplies.

Plate Supply Circuits and Ratings

● Inasmuch as practically all amateur transmitter plate supplies use mercury vapor rectifier tubes, the data here compiled will concern this type of tube only. Tubes of this type are rated on the basis of peak inverse voltage (the maximum voltage permissible in a direction opposite to the normal rectified current flow), and peak plate current. On the basis of sine wave input the peak inverse voltage can generally be taken as 1.4 x the RMS AC voltage from the transformer.

Condenser Input

Where a filter circuit is used having condenser input, the peak plate current per tube in a full wave circuit may rise to values as great as four times the DC load current de-

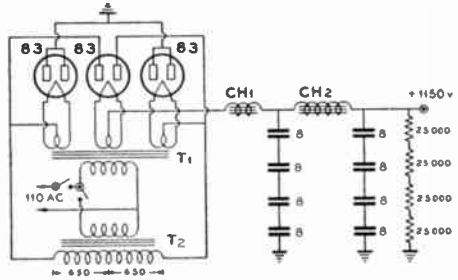

Bridge rectifier using inexpensive parts. 1150 volts at 250 MA. Ordinary 8 mfd. 450 WV electrolytic condensers are used, connected in series, as shown.

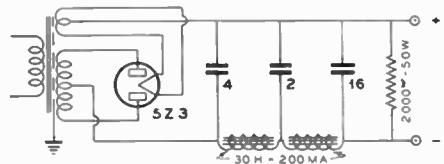

C-BIAS FOR FONE WHEN FINAL AMP USED AS A LINEAR

pending on the value of input capacitance. This naturally results in poor tube economy. In the case of 866 tubes for example, the peak plate current of .6 amperes might be reached when the DC obtained is only .15 amp. A second factor which limits the use of condenser input filters for amateur work is the poor regulation obtained in such circuits.

Choke Input

Where a filter circuit is used having choke input, the peak plate current per tube in a full wave circuit will generally run about 50% greater than the DC. If a saturated reactor is used, this peak current will be increased as the load current is increased to as high as 2 1/2 times the DC.

With the knowledge of the peak inverse

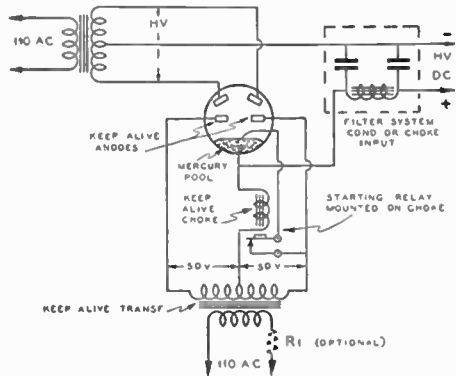

2C MULTI-ARC
Circuit diagram showing Multi-Arc starting, Keep-Alive Circuit and filter supply.

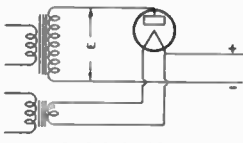

SINGLE PHASE HALF WAVE
FIG. 1

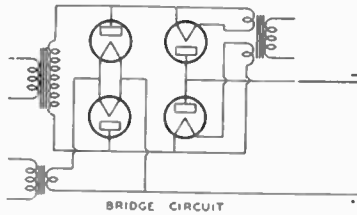

BRIDGE CIRCUIT
FIG. 4

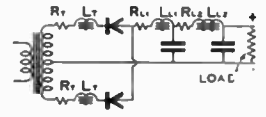

SIMPLIFIED FORM FIG. 7
FIG. 8

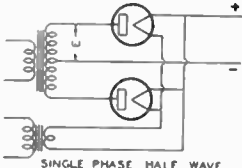

SINGLE PHASE FULL WAVE
FIG. 2

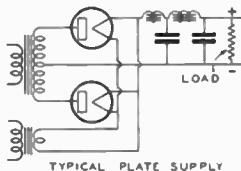

TYPICAL PLATE SUPPLY
FIG. 7

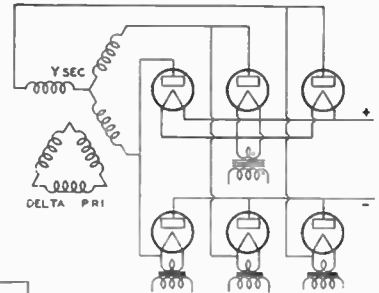

FULL WAVE THREE PHASE
FIG. 6

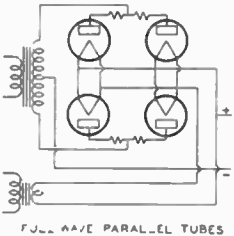

FULL WAVE PARALLEL TUBES
FIG. 3

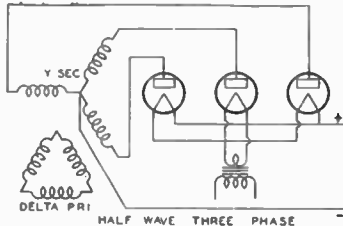

HALF WAVE THREE PHASE
FIG. 5

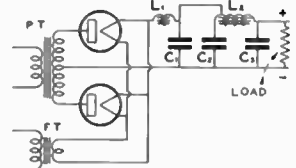

FIG. 9

voltage and peak plate current of rectifier tubes, it is apparent that the proper tube or tubes and associated components can be readily determined for any plate supply output. These values for the tubes generally used by the amateur are enumerated below:

Tube Type	Peak Inverse Volts	Peak Plate Cur.
82	1,400 volts	.40 A.
85	1,400 volts	.80 A.
66	7,500 volts	.6 A.
66A	10,000 volts	.60 A.
72	7,500 volts	2.5 A.
72A	10,000 volts	2.5 A.
869	20,000 volts	5 A.

Standard Rectifier Circuits

Figs. 1 to 6 illustrate typical rectifier circuits applicable to amateur use. The single phase half wave circuit of Fig. 1 is not very popular due to the fact that the ripple is of greater magnitude and being of lower frequency than other systems is more difficult to filter. With choke input, the DC voltage will be approximately .45 that of the RMS voltage E. Fig. 2 illustrates the full wave single phase circuit which is most commonly used and with which every amateur is familiar. Fig. 3 is identical in nature with Fig. 2, except that four tubes (more if de-

sired) are used to obtain higher current output. The resistors shown in the plates of these tubes are highly essential. Otherwise one tube will generally take most of the load with the natural result that the tube life is greatly decreased. If a drop of about six volts is obtained across these resistors, stability will be obtained. Fig. 4 illustrates a bridge circuit. While this circuit involves four tubes, it has the great advantage that high DC voltages can be obtained without expensive (high peak inverse voltage) tubes and with low voltage transformers. In many cases where full wave rectification has been used it is desired to increase the DC voltage; it is possible to use the entire secondary output of the plate transformer, and with rectifier tubes in bridge connection, twice the DC voltage will be obtainable. Of course, this halves the current output due to the transformer current carrying limitations. Figs. 5 and 6 are similar in nature to Fig. 2, except that they are applied to three phase circuits. In the circuit of Fig. 5, each tube carries current for one-third of a cycle. The circuit of Fig. 6 is very commonly used for high power transmitters where three phase power supply is available, due to the high DC voltage which is obtainable. This circuit has the added advantage in that the ripple frequency is high, be-

ing six times the supply frequency, allowing easy filtering.

Analyzing these rectifier circuits, we obtain the values indicated below as the maximum operating and output values for any of the tubes described:

Fig. No.	Transf. volts E	DC output volts at input to filter	Dc output current
1	.7 x peak inv. voltage	.45 x E	1.33 x peak plate current
2	.35 x peak inv. voltage	.9 x E	.66 x peak plate current
3	.35 x peak inv. voltage	.9 x E	1.32 x peak plate current
4	.7 x peak inv. voltage	.9 x E	.66 x peak plate current
5	.43 x peak inv. voltage	1.12 x E	.83 x peak plate current
6	.43 x peak inv. voltage	2.25 x E	1.0 x peak plate current

As an example, if we apply these figures to the 866 tube, we find that in a full wave circuit, (Fig. 2), the maximum transformer voltage E each side of center-tap is .35 x 7500 or 2650 volts. This gives us a DC voltage at the input to filter of 2650 x .9 or 2400 volts. The maximum DC output is .66 times the peak plate current of .6 amperes, or 400 MA. Naturally, voltages and currents lower than these values can be used. Where a saturated input reactor is used, the allowable DC is reduced.

However, as these saturated reactors are normally used in conjunction with a class B amplifier load, the high DC and peak plate currents are normally of short duration, reducing the tube life by an amount which is not excessive.

Predetermining DC Voltage

Actually, in practice, the DC voltage in which we are interested is that out of the filter. If we examine our complete circuit closely (Fig. 7), we find that it can be reduced to the simpler form of Fig. 8. Here we have the ratio of transformation such that E volts are induced in the transformer secondary. From the theoretical DC output which is .9 x E, we must subtract all the voltage drops, which include the drop across Rt (the transformer resistance), across Lt (the transformer leakage reactance), across V (the tube drop), across RL1 and RL2 (the choke resistances). If the transformer regulation is known, a value of E can be obtained which already incorporates the transformer losses. The DC output is then (.9 x E) minus 15 (the normal voltage drop across a mercury vapor tube), minus 1Dc x (RL1 plus RL2). This gives a definite means of predetermining the DC output voltage from a rectifier using a choke input filter.

High-Frequency Measuring Equipment

Modulated Oscillator

● There are numerous forms of modulated oscillators. Those which use an output attenuator, self-contained power supply, and a separate modulator tube are to be preferred. However, for ordinary use around an amateur's station or laboratory, or to align some friend's broadcast receiver, a simple modulated oscillator is satisfactory.

Two types use a single tube for the combined purpose of oscillator and modulator. In Fig. 1 on page 276 is shown a circuit using either a 199, or preferably a 30 tube. This oscillator uses a blocking grid action to obtain modulation at an audio frequency such as 500 to 1000 cycles. The tone can be adjusted to suit the individual taste by changing either the grid leak or grid condenser. Adjustment of the filament rheostat will also vary the tone and this allows adjustment over the tuning range of the variable condenser. The other type is shown in Fig. 2 and it uses an electron-coupled oscillator with an AC plate and screen supply. Modulation is obtained from the AC plate voltage which gives a 60-cycle tone.

The oscillator shown in Fig. 1 can be built into a metal box with room for a portable 45-volt battery and a couple of No. 6 dry cells. This box can be about 5 inches deep, 10 inches long and 7 inches high, as shown in the sketch of a proposed layout.

A two-gang broadcast receiver type condenser will serve nicely by connecting the sections in parallel. The wiring diagram is simple and the only thing to worry about is the correct polarity of the tickler winding to obtain oscillation. The coil can be an old broadcast receiver coil where the primary (tickler in this case) has 20 or 30 turns.

The other AC operated oscillator could be built into a metal can about 8 inches long, 6 inches high, and 4 or 5 inches deep. An old bell-ringing transformer or a filament transformer is used to heat the filament of the electron-coupled oscillator. The condenser is the same as previously described. A 10 millihenry RF choke and an output attenuator can be used in this circuit to obtain variable output. The cathode winding must have an optimum value of turns to obtain the correct amount of modulation from the AC plate supply. It would probably be desirable to wind a special coil with taps every five turns from the lower end in order to find the best tap in the actual oscillator set. This coil should have about 120 turns of No. 30 DSC wire on 1¼-inch tubing. Small mica condensers isolate the can and output circuit from the 110-volt AC circuit. The only disadvantage is in the very low frequency of the modulation.

Calibration of either of these oscillators can be accomplished by means of a broadcast receiver. The high frequency range of the

oscillator down to 550 KC can be calibrated by means of picking it up in a calibrated receiver or by beat note reception of known frequency broadcast stations and the oscillator signal. The upper range can be calibrated roughly by extending the curve, or more accurately by using the second harmonic which will be audible in the broadcast range in the receiver. Dividing this reading in each case will give the fundamental frequency of the oscillator. The latter should tune up to about 350 KC, which makes it useful to line up 450 KC superheterodyne receivers.

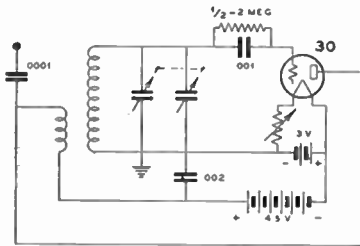
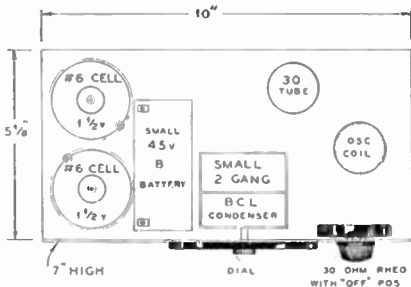

FIG. 1

Circuit diagram of Modulated Oscillator with type 30 tube for battery operation.



Parts layout for battery model.

If a careful calibration of the fundamental frequency is made on the oscillator, the harmonics may be used to locate short wave stations, either amateur or broadcast. For example, if the short wave station is listed at 6.01 megacycles, the oscillator can be set at $1502\frac{1}{2}$, 1202, $1001\frac{2}{3}$, 857 KC, etc., which will all give harmonics on 6.01 MC. By checking at least two fundamental points, one can be sure of which harmonic is heard in the short wave receiver. The fundamental of $1502\frac{1}{2}$ has a harmonic on $4\frac{1}{2}$ MC which might cause a mistake to be made, but swinging the oscillator over to 1202, the next fundamental having a 6.01 MC harmonic would give no harmonic at $4\frac{1}{2}$ MC.

The frequency of a quartz crystal to be used in a single signal receiver can be found fairly closely by setting the quartz plate on, or leaning it against the grid of the oscillator. At resonance the oscillator

will suddenly change, as listened to in a broadcast receiver tuned to the oscillator second harmonic. This test means manipulation of both the oscillator and BCL receiver,

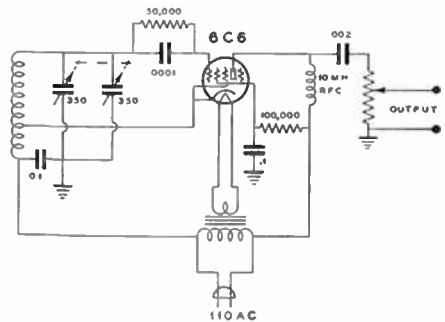
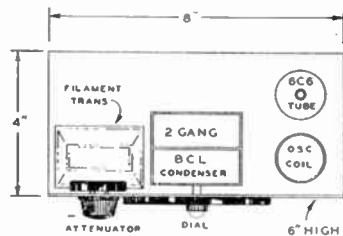

FIG. 2

Circuit diagram of A.C. oscillator.



Parts layout for A.C. oscillator.

but once the crystal frequency is found, the IF amplifier in the single signal receiver can be lined up to that frequency by means of the oscillator.

Lining up an IF amplifier should always begin at the grid of the tube preceding the last stage of IF transformer. After that transformer is aligned (by ear or output meter), the next preceding stage can be lined up using less coupling to the grid of the next preceding stage. Always work with a fairly weak signal, because many sets have AVC which would cause trouble with a strong signal peaking, unless a meter is used.

Cathode-Ray Oscilloscope

● The high vacuum cathode-ray tube is in many respects like a high vacuum amplifier tube. No special technique is required in installing and operating the tube other than that normally used in the handling of high vacuum amplifier tubes. The cathode is indirectly heated, like an AC amplifier tube, from the winding of a transformer and is operated at rated voltage without any adjustments. The currents to the electrodes of the electron gun usually total 0.1 or 0.2

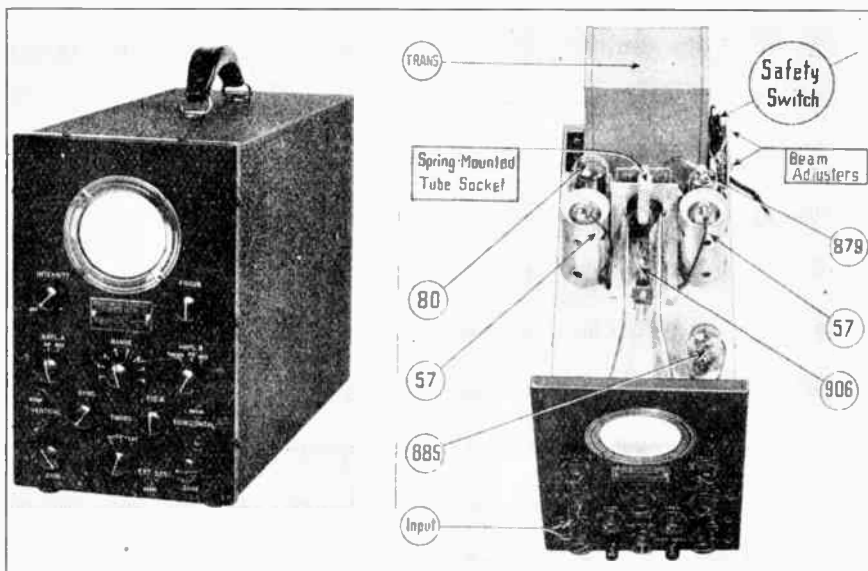

RAC Type TMV-122B Cathode-Ray Oscilloscope.

milliamperes or less so that the current in the voltage divider may be as low as about one milliamperes. Under these conditions, the ripple in the rectified voltage is small and a condenser of 0.5 to 2.0 microfarads supplies adequate filtering. The DC power required is low so that a small transformer with proper insulation for the high voltage can be used. A few one watt carbon resistors and potentiometers serve as the voltage divider. A half-wave rectifier or a voltage-doubler rectifier circuit is suitable. The rectified DC voltage is approximately equal to the peak of the AC voltage for the half-wave circuit or twice this value for the voltage doubler circuit. The rectifier tube carries only a small current but must withstand a peak inverse voltage of twice the peak AC voltage of the transformer.

The control electrode is normally operated with a bias voltage negative with respect to the cathode. It is used for controlling the beam current and hence the brilliancy of the fluorescent pattern. Usually, the control electrode voltage is made adjustable by means of a potentiometer tap in the voltage divider in order to permit a range of voltage from zero to a voltage sufficiently negative to cut off the beam current completely.

When the tube has an accelerating electrode, it is normally connected to a fixed tap on the voltage divider corresponding to rated voltage.

The focusing electrode (anode 1) is used to focus the beam current to a sharply defined spot on the screen. The voltage of this electrode is usually equal to approximately $\frac{1}{2}$

of the voltage on anode 2. A range of adjustment upward to about $\frac{1}{3}$ of the voltage on anode 2 is usually allowed.

When the brilliancy of the fluorescent pattern is adjusted, considerable defocusing sometimes results due to the regulation of the high-resistance voltage divider. This is readily corrected by adjusting the focusing voltage, or it may be eliminated, if desired, by increasing the current in the voltage divider.

If a range of anode voltages is required, a potentiometer on the line voltage side of the high voltage transformer will change the voltage on all electrodes simultaneously. This method will keep the pattern approximately in focus. Proper location or shielding of the tube is advisable in order to avoid the influence of stray electric and magnetic fields.

Sweep Circuits and Auxiliary Apparatus

In order that the wave form of phenomena producing a vertical deflection may be viewed, a horizontal deflection is applied to sweep across the screen at a uniform rate. The linear time sweep may traverse the screen only once when observing a nonrecurrent wave form or it may be arranged to be returned rapidly to its starting position and to repeat the linear time sweep.

When the frequency of the wave form being observed is a multiple of the repetition frequency of the linear time sweep, the wave form remains stationary on the screen. The number of cycles of the wave form appear-

ing throughout the sweep on the screen shows the ratio of the frequency of the wave form to the frequency of the linear sweep voltage. Thus, a sweep frequency of 3,000 cycles per second shows 4 cycles of a 12,000 cycles per second wave form.

A linear time-sweep generator with good linearity, short-return sweep time, good frequency stability, and adjustable in frequency from very low frequencies to the upper audio frequency range, is available with present tubes. The type RCA-885 gas filled triode tube was especially designed for this service. With suitable circuits, a sweep of 200 volts amplitude (or by special arrangements, 400 volts amplitude) can be obtained. The linear time sweep is generated by charging a condenser at a constant current rate. The constant current characteristic of the plate circuit of a pentode amplifier tube is used preferably as the constant-current controlling device. A diode operated at low filament voltage to produce saturation may also be used for this purpose. Another means consists in using only a small portion of the initial charging curve of the condenser. Since the exponential charging characteristic of a condenser is initially linear, the use of a high resistance in series with the condenser and a high charging voltage will permit an appreciable amount of voltage across the condenser before it departs appreciably from linearity. Either the charging or the discharging voltage of the condenser may be arranged to produce the linear time sweep. The return sweep occurs on discharge or charge according to the circuit arrangement. The time constant of the circuit causing the return sweep should be low with respect to the time of the sweep. Generally, the arrangement is used in which the condenser charging produces the linear time sweep and the discharge the return sweep. Any one of these methods properly employed is capable of a high degree of linearity.

The return sweep occurring on the discharge of the condenser may be accomplished electrically by a gas filled triode or in certain applications it may be done mechanically by a rotating contact, a tuning fork, or other means. The gas filled triode permits a large frequency range and locked synchronization with the wave form being observed. Synchronization is locked by means of a small amount of wave form voltage coupled to the grid circuit of the gas filled triode. The mechanical method either controls the phenomena being observed and is, therefore, self-synchronized, or it provides a standard with which the frequency of the wave form can be compared.

Other time bases are used for various applications. A 60 cycle per second wave of

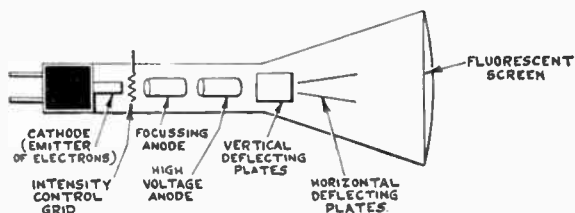

Elementary Diagram of Cathode Ray Tube.

approximately sine-shape voltage from the power line is often useful as a sweep voltage. When the amplitude is made large enough to cause the end portions to sweep beyond the limits of the screen, the central portion is nearly linear. If the frequency of the wave form being observed is a multiple of 60 cycles per second, the wave form will appear stationary on the screen and will have an approximately linear time distribution. Since the sweep and the return sweep of the 60 cycle per second voltage are the same, the wave form is spread twice across the screen. One method for preventing confusion of the wave form pattern consists in applying some of the 60 cycle per second voltage with a 90 degree phase shift to the deflection in the vertical direction. The result is that the sweep and the return sweep appear as 2 separate lines on the screen, since the 60 cycle per second voltages sweep out an elongated ellipse instead of a line. Another method consists in making the return sweep invisible by applying some of the 60 cycles per second voltage with a 90 degree phase shift to the brilliancy control electrode. The beam current is cut off during the return sweep by the negative half of the 60 cycles per second voltage. Where exact linearity is not necessary, this 60-cycle sweep method is convenient. Since there are a large number of 60 cycle intervals over the audio frequency range, a stationary wave form is readily obtained. The wave forms of different frequencies can be spread to convenient proportions by increasing the 60 cycles per second sweep voltage within the limits permissible in the deflecting circuits of the cathode ray tube.

A circular time base is often useful for frequency comparisons. In general, an ellipse results with axes parallel to the deflecting directions when voltages of the same frequency but with a 90 degree phase relation are applied to the deflecting plates. When the deflection amplitudes in the 2 directions are equal, the ellipse becomes a circle. The voltage with a 90 degree phase relation is readily obtained by means of a condenser and resistance. If the voltage source supplying the circular time base is changed rapidly from zero to a maximum, the successive circles produced by each cycle are swept into a spiral.

The spiral affords a convenient time sweep of known variable velocity and of considerable length on the screen.

Other auxiliary apparatus used frequently are amplifiers and current transformers. Resistance coupled amplifiers are most useful when uniform response over a wide frequency range is needed. For extremely low frequencies and DC voltages, directly coupled amplifiers are used. For high frequencies where a wide range is needed, resistance coupled amplifiers having screen grid or pentode tubes and low plate-load resistances are used. The resistance coupled amplifier is used to amplify voltages to the proper level for applying them to electrostatic deflecting plates or electromagnetic deflecting coils. If a low resistance is introduced into a circuit where current is to be observed, a small voltage drop in the resistance is produced which may be amplified to a level suitable for deflecting the cathode ray beam.

Current transformers provide a means for converting current into voltage suitable for direct connection to the electrostatic deflection plates. When a uniform response over a frequency range is desired, the primary of the current transformer is connected across a low resistance in the circuit in which the current to be observed flows. The inductance in the frequency range used will be large with respect to the resistance. The voltage developed across the primary is stepped up by the turn ratio of the transformer, the secondary of which is connected to the deflection plates. For example, with a turn ratio of 100 to 1 and the primary shunted with 10 ohms, a current of 10 milliamperes will produce 10 volts on the secondary or a peak-to-peak amplitude of about 0.5 inch on the screen of a cathode ray tube operated at 1,000 volts.

Applications of Cathode Ray Tubes

It is impractical in a discussion of this length to more than hint at some of the possible applications for cathode ray tubes. Fundamentally, the cathode ray tube may be regarded as an electron pointer or the movement of an uncalibrated electrical indicating device. The calibrating scales and circuit are provided by the user to suit his particular type of measuring or indicating apparatus.

One of the simplest uses of the cathode ray tube is the measurement of voltage. This is most conveniently done with the electrostatic deflection type of tube. The displacement of the spot on the screen is directly proportional to the applied voltage. When a DC voltage is applied, the polarity as well as the magnitude is indicated by the displacement of the spot. When an alternating voltage is applied, the spot sweeps back and forth with an amplitude proportional to the

peak-to-peak value of the applied voltage. For example, a 10-volt root-mean-square sine wave produces a sweep with an amplitude equal to 28 volts. At frequencies above 8 cycles per second, the sweep of the spot appears as a line, due to the persistence of vision. There is no error due to frequency until extremely high radio frequencies are reached. Overvoltage on the deflecting plates, which is not excessive, merely sweeps the spot off the screen. Thus, the cathode ray tube, being rugged, having a high impedance, and being independent of frequency, is useful as a peak voltmeter.

Since the electron beam can respond to several deflecting fields simultaneously or in rapid succession, the cathode ray tube can be used for time or frequency comparisons. The feature of being able to combine in the cathode ray tube the effects of 2 or even more factors makes it possible to obtain graphical results directly on the screen.

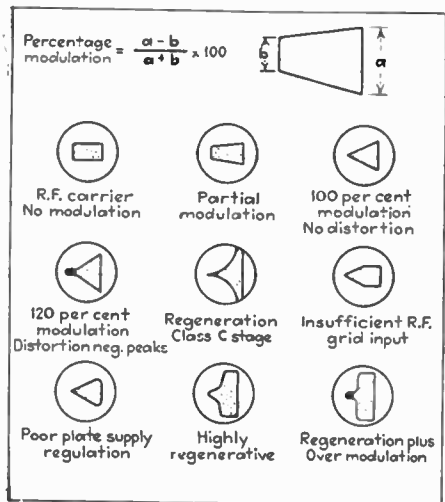

Oscilloscope chart, showing typical trapezoidal readings of a phone transmitter when sweep circuit is not used.
—Courtesy "Electronics"

The high voltage anode of the Cathode Ray Tube requires 1,000 volts DC for proper operation. Also DC voltages are required for the amplifier. The RCA-879 rectifier is used in a half-wave rectifying circuit for providing the necessary anode voltage for the RCA-906. The 80, connected in a full-wave rectifying circuit, provides plate and grid voltages for the two 57 amplifiers. While a single transformer is used for both rectifiers, individual filter circuits are provided. The transformer is oversized to prevent stray magnetic leakage that would otherwise affect the operation of the Cathode Ray Tube.

How To Build a Vacuum-Tube Voltmeter

• A vacuum tube voltmeter has many uses in an amateur or service laboratory. It can be used to measure AC voltages of any frequency from 30 cycles up, through the audio range, and also the RF frequency ranges. It is also useful for determining the audio response of an amplifier, a radio receiver, the gain of an audio or radio frequency amplifier. It can even be used to measure percentage of modulation of a phone transmitter or to run the frequency characteristic of the latter. A simple full-wave linear rectifier, when used with the peak voltmeter here described, can be used to measure both the "up" and "down" sides of a modulated carrier signal.

This vacuum tube voltmeter uses a peak voltage rectifier of the diode type and a DC amplifier to enable the use of a 0-1 milliammeter for reading low voltages. The diode type has several advantages over the plate rectifier type. It is linear, not square law. Thus the meter scale can be direct reading. The diode measures peak voltage if the D.C. load is at least a megohm. This load can be divided-up into a resistance divider for multi-range use. That is, the voltmeter can be used to cover from a small fraction of a volt to over a hundred volts by means of a multiplier switch which will not affect the input circuit. An ordinary milliammeter can be used instead of the costly microammeter, such as is used in the less sensitive plate rectifier type. Its one disadvantage is that it acts as a slight load on the circuit across which it is connected.

The circuit consists of two type 30 tubes connected as shown. One tube acts as a

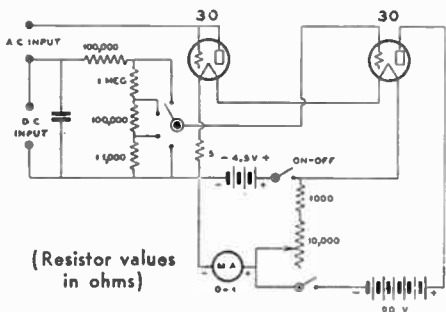

diode peak rectifier and the other as a simple, foolproof, DC amplifier. The latter by itself, through an extra binding post on the panel, acts as a DC voltmeter over the range of from a fraction of a volt up to 100 volts. This DC connection draws less than 0.1 ma load for 100 volts impressed, and in the one volt range the load drawn is less than a microampere. This makes it useful in

measuring DC voltages where no appreciable load can be allowed, such as the voltage developed by AVC in a radio receiver.

In the particular meter here illustrated, the resistances, tubes and battery voltages are such that for practical purposes the scale is direct reading. The multiplier can be marked 1, 10, and 100 and the scale deflection multiplied by those values for either DC or RMS voltage. The error is not over 6%. For actual peak values of AC voltage the scale reading must be multiplied by 1.4. Over a period of time this form of voltmeter should not be relied upon for better than $\pm 10\%$ accuracy because of tube and battery age. For any individual set of measurements a calibration can be made, although generally the relative ratio of voltages is the important thing. The voltmeter is accurate for this purpose.

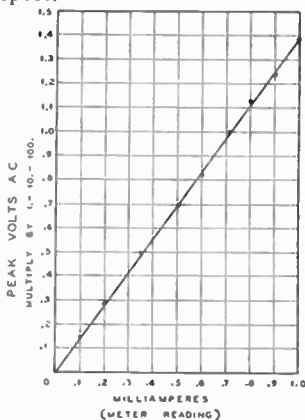

Vacuum Tube Voltmeter Chart

The 10,000 ohm resistor should be set so as to put the metal needle to zero when there is no impressed AC voltage. This resistor makes use of the 4½ volt A battery as a bucking battery to balance out the steady current drawn by the DC amplifier from the 90 volt B battery. This tube should operate as a linear amplifier in order to keep the calibration linear, or direct reading on the meter scale.

The 5 ohm filament resistor provides about a quarter volt negative bias on the diode to prevent current from flowing in the multiplier resistors when no AC voltage is impressed. This makes the 10,000 ohm resistor control setting practically constant for any step on the multiplier.

Needless to say, the polarity of the batteries and the milliammeter should be exactly as shown. If any trouble is had from inability to set the meter to exactly zero with the variable 10,000 ohm resistor, a vernier adjustment can be added by putting a 200 ohm variable resistor in series with the 10,000 ohm resistor. The battery switch

should preferably be a DPST switch in order to open-up the plate circuit at the same time the filament and bucking battery circuit is opened. A 1000 ohm resistor in series with the 10,000 ohm variable resistor limits the current drawn from the bucking battery so as to prevent meter burn-out if this control is advanced too far for a short time.

A bakelite front panel is used to simplify insulation problems. It measures 5x8x3/16 inches and is mounted at right angles to a wooden baseboard. The latter holds the tubes and batteries, as shown. The aluminum cover is 5x9 inches and serves to protect the instrument from dust and breakage.

In using this VT voltmeter it is necessary to have a DC path through the circuit under measurement. Most circuit measurements provide such a path, although occasionally a path must be provided by means of the secondary of an audio transformer for audio frequency measurements, or an RF

choke for RF measurements. In such cases, the choke should shunt the AC input binding posts. The DC path resistance of the circuit under measurement can be as high as 50,000 ohms without affecting the calibration of the VT voltmeter.

This meter is useful in lining-up a radio receiver. It can be connected across the last IF coil or across the audio amplifier, and a modulated oscillator used as a signal generator. It is possible to check either stage of a receiver in order to locate trouble. The uses of such an instrument in connection with audio amplifiers has been covered thoroughly in most all radio books and it can easily be the most useful piece of equipment in an experimenter's possession.

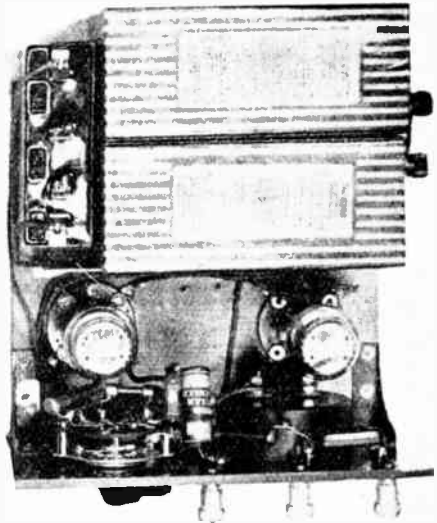
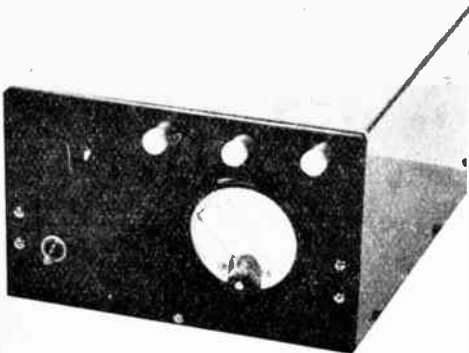

Views of the Completed Vacuum Tube Voltmeter.

"PEAK" LINEAR DETECTION MONITOR

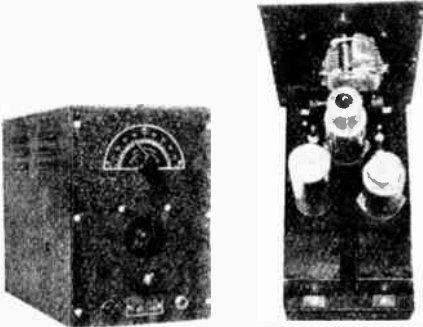

Exterior and interior views of the Peak Linear Detection Monitor.

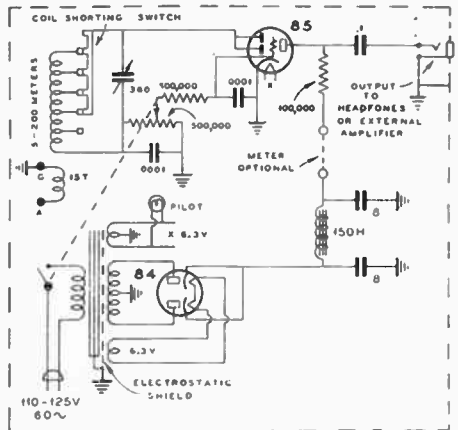

PEAK M2 AMATEUR LINEAR DETECTION MONITOR

Amateur Regulations

● The Federal Communications Commission at Washington, D. C., regulates the affairs of radio communication under the jurisdiction of the U. S. in every form. It licenses all stations and operators. District offices are maintained in many principal cities of the U. S. Write to, or call at the FCC office nearest you for such information as you desire. Frequency bands and call letters are assigned by the FCC. This Commission has the power to revoke or suspend licenses. Anyone who violates the provisions of the Radio Act or the Rulings of the FCC is subject to penalty.

Applicants for amateur class A or class B license are examined at one of the inspection offices of the FCC, or at some other place where examinations are given, at various times. The inspecting officer gives the applicant the code test. If the applicant passes the code test he is given a written examination on the theory and operation of an amateur station and matters pertaining to radio laws and regulations. The examination papers are sent to Washington. If the applicant is successful, he is given a combined station-operator license card and is assigned a call letter for his station. The station-operator license is good for 3 years. If the applicant fails to pass the examination he cannot be re-examined until 90 days has elapsed from the date on which he failed in his previous examination. If the applicant lives more than 125 miles air-line from the nearest FCC inspection office he can be examined for a class C amateur license by a duly-licensed radio amateur in his vicinity. This amateur gives the applicant the code test and a written examination. The written examination is taken in the presence of a witness who certifies that the questions were answered without assistance. Those who are examined at a radio inspection office are given a class B license, if they are successful in the examination. Examination for a class A license can be applied for after the operator has held a class B license for one year or more.

There is no age limit for amateurs. Only American citizens can own and operate amateur stations in the U. S.

A person who desires an operator license, but not a station license, can secure the same, but he cannot secure a station license without an operator license. The holders of a commercial license must also hold an amateur operator license in order to be permitted to operate an amateur station.

If the property on which a station is to be located is controlled by an alien it is unlawful to operate a station on that property.

Portable Operation

Before a portable station is put into operation advance notice of the location of such operation must be sent to the inspector in charge of the district in which portable operation is to take place. Notice shall include the approximate location of the proposed portable station. If operation is continued for more than 30 days, additional notices must be sent every 30 days. This does not apply to operation above 56,000 KC. Every time the operator of a portable station signs his call he must indicate (by the letters "BT") that it is a portable station, giving the number of the amateur call area in which he is operating. Portable operation requires keeping an accurate log. The operator-station license must accompany a portable station.

Classes of Amateur Operator Licenses

Amateur operator licenses are divided into three classes—A, B, and C. The class A license entitles the operator to certain privileges not enjoyed by holders of the other classes of license. The unlimited operation of a phone station in all of the assigned amateur phone territory is a privilege enjoyed by the holder of a class A operator license. Only those with class A operator licenses can operate phone stations in the 3,900-4,000 KC and 14,500-14,250 KC bands. However,

the holder of a class A license can also operate in any other amateur band. Those who hold class B or C amateur operator licenses (both classes are identical insofar as privileges are concerned) can operate radiotelephone stations only in the following bands:

1,800-2,000 KC
28,000-28,500 KC
56,000-100,000 KC
and above 100,000 KC.

Holders of class C licenses are subject to appear at an examining point for a supplementary written examination, if directed to do so by a representative of the FCC.

Examining officers do not correct the examination papers of an applicant for license; these papers are placed into a sealed envelope by the applicant . . . he hands this envelope to the examining officer and the examination papers are then mailed to Washington.

License Renewals

Renewals should be applied for at least 60 days before a license expires and the holder of the license must have communicated by amateur radio with at least three other amateur stations within 90 days preceding the date of application for license renewal.

Amateur Bands

The frequency limits of the amateur bands are as follows:

1,715-2,000 KC
7,000-7,300 KC
14,000-14,400 KC
28,000-30,000 KC
56,000-60,000 KC
and above 110,000 KC.

Bands for Radiotelephony

Any licensed amateur can operate a radiotelephone station in any of the following bands:

1,800-2,000 KC
28,000-28,500 KC
56,000-60,000 KC
above 110,000 KC.

Type A-2 Emission, or tone-modulated radiotelephony can be used in the following bands:

28,000-30,000 KC
56,000-60,000 KC
above 110,000 KC.

Adequately filtered DC plate supply is required for operation in the following bands:

1,715-2,000 KC
3,500-4,000 KC
7,000-7,300 KC
14,000-14,400 KC.

Type of Emissions

Type A-1—PURE DC telegraphy.
Type A-2—TONE-MODULATED telegraphy.
Type A-3—TELEPHONY.
Type A-4—TELEVISION-FACSIMILE.

General Information

Any licensee receiving notice of violation of radio laws shall reply to said notice in writing to the FCC at Washington.

Requests for special call-letters will not be considered.

The person manipulating the telegraph key of an amateur station must be a duly licensed operator.

Tests can be conducted by amateurs if such tests do not interfere with services of other stations.

The original license shall be posted in the station or kept in the personal possession of the operator on duty, except when it has been mailed to an office of the FCC for endorsement or change before the date of its expiration.

Amateur stations must not be used to handle messages for pecuniary interests, direct or indirect, paid or promised.

Amateur transmissions must be free from harmonics. Loosely-coupled circuits must be used,

or devices that will result in giving equivalent effects to minimize keying impacts, clicks, harmonics and parasitics.

1 KW power input to the stage which feeds the antenna is the maximum permissible power for amateur operation.

Amateur operators must transmit their assigned call letters at the end of each transmission, or at least once during each 15 minutes of operation. If an amateur transmitter causes general interference with reception of broadcast signals in receivers of modern design, that amateur station shall not operate during the hours from 8 p.m., to 10:30 p.m., local time, and on Sundays from 10:30 a.m. until 1 p.m., local time, upon such frequency or frequencies as cause such interference.

Each licensee of an amateur station must keep an accurate LOG of station operation, name of person operating the transmitter, with statement as to the nature of transmission. The call letters of the station, the input power to the stage which feeds the antenna, the frequency band used, the location of the station if portable operation is used, must all be entered in the station LOG. A copy of each message sent and received must be kept on file for at least one year. This information must be available on request by authorized representatives of the Government of the United States. The station may be operated only to the extent provided by the class of privileges for which the operator's license is endorsed.

Distress Signals

The International Distress Signal is (three dots, three dashes, three dots). The distress signal is NOT SOS, it is an easily-recognized group of characters of three dots, three dashes, three dots. For radiotelephony distress calls the signal is MAYDAY. All communications must cease when a distress call is heard. Communication must not be resumed until it has been definitely determined that all is clear again. When you hear a distress call notify the nearest source from which aid can be secured.

Other Important Laws and Regulations

It is unlawful to send fraudulent signals of distress or communications relating thereto; to maliciously interfere with any other radio communications. Distress calls have precedence over all others. Minimum power must be used to effect reliable communication. The use of profane language is prohibited. The contents or meaning of a message must be kept secret, except to an authorized agency which takes part in the forwarding of the message, or to the addressee or his agent, or upon the demand of a court of competent jurisdiction or authority.

Secrecy provisions do not apply to broadcasts for public use, or to distress calls. In the event of a national emergency the station can be ordered closed.

Third-party messages cannot be transmitted by amateur stations unless special arrangements have been made between the governments of the countries concerned. Amateur stations cannot be used to broadcast entertainment. In the event of an emergency an amateur station is permitted to communicate with stations other than amateur.

"AR" denotes the end of a message. "SK" denotes the end of a communication.

Penalties

The penalty for violating the provisions of the Communications Act of 1934 is \$10,000, or imprisonment not to exceed two years, or both, for each offense. The operator's license is liable to suspension for 2 years if a conviction is secured. The station license can also be revoked.

For violation of any of the regulations of the Federal Communications Commission a fine not to exceed \$500 can be imposed for each day of such offense. If the convicted person is a licensed operator his license can be suspended for a period not to exceed 2 years. The station license can also be revoked. The penalty for not keeping a station log is the same as related above. For malicious interference with distress communications the maximum penalty of \$10,000 and 2 years

can be imposed. For malicious interference with other than distress communications the license can be suspended for up to 2 years. An amateur who accepts material compensation for any services rendered by his station is subject to a fine of not more than \$500 for each day of such offense. His license can also be suspended for as long as 2 years.

Radio Symbols

The following symbols are commonly used in radio work and many of these symbols are used in the pages of this book:

- EF Filament (or heater) terminal voltage
- EP Average plate voltage (DC)
- IP Average plate current (DC)
- E_p AC component of plate voltage (effective value)
- I_p AC component of plate current (effective value)
- EC Average grid voltage (DC)
- I_G Average grid current (DC)
- E_G AC component of grid voltage (effective value)
- I_G AC component of grid current (effective value)
- E_{FF} Filament (or heater) supply voltage
- E_{RB} Plate supply voltage (DC)
- E_{GC} Grid supply voltage (DC)
- U Amplification factor
- r_p Plate resistance
- g_M Grid plate transconductance (also mutual conductance, g_{M1})
- r_p Plate load resistance
- Z_p Plate load impedance
- DC Direct Current (as adjective)
- AC Alternating Current (as adjective)
- RMS Root Mean Square
- U.P.O. Undistorted power output
- C_{GK} Grid-cathode (or filament) capacitance
- C_{PK} Plate-cathode (or filament) capacitance
- C_{GIP} Effective grid-plate capacitance in a tetrode (cathode [or filament] and screen grounded)
- C_{G1(k+g2)} Direct interelectrode capacitance of grid to cathode (or filament) and screen
- C_{p(k+g2)} Direct interelectrode capacitance of plate to cathode (or filament) and screen

Conversion Table

Factors for conversion, alphabetically arranged.		
MULTIPLY	BY	TO GET
Amperes	× 1,000,000,000,000	micromicroamperes
Amperes	× 1,000,000	microamperes
Amperes	× 1,000	milliamperes
Cycles	× .000,001	megacycles
Cycles	× .001	kilocycles
Farads	× 1,000,000,000,000	micromicrofarads
Farads	× 1,000,000	microfarads
Henrys	× 1,000,000	microhenrys
Henrys	× 1,000	millihenrys
Kilocycles	× 1,000	cycles
Kilovolts	× 1,000	volts
Kilowatts	× 1,000	watts
Megacycles	× 1,000,000	cycles
Mhos	× 1,000,000	micromhos
Microamperes	× .000,001	amperes
Microfarads	× .000,001	farads
Microhenrys	× .000,001	henrys
Micromhos	× .000,001	mhos
Micro-ohms	× .000,001	ohms
Microvolts	× .000,001	volts
Microwatts	× .000,001	watts
Micromicrofarads	× .000,000,000,001	farads
Milliamperes	× .001	amperes
Millihenrys	× .001	henrys
Millimhos	× .001	mhos
Milliohms	× .001	ohms
Millivolts	× .001	volts
Milliwatts	× .001	watts
Ohms	× 1,000,000,000,000	micromicro-ohms
Ohms	× 1,000,000,000	micro-ohms
Volts	× 1,000,000	microvolts
Volts	× 1,000	millivolts
Watts	× 1,000,000	microwatts
Watts	× 1,000	milliwatts
Watts	× .001	kilowatts

Courtesy RCA Mfg. Co.

Q SIGNALS

Abbreviation **Question**

QRA—What is the name of your station?
 QRB—What is your approximate distance from my station?
 QRC—By what private company (or Government administration) are the accounts for charges of your station liquidated?
 QRD—Where are you going and where do you come from?
 QRE—Will you indicate to me my exact frequency (or wavelength) in kc. (or m.)?
 QRH—Does my frequency (or wavelength) vary?
 QRI—Is my note steady?
 QRJ—Are you receiving me badly? Are my signals weak?
 QRK—Are you receiving me well? Are my signals good?
 QRL—Are you busy?
 QRM—Are you being interfered with?
 QRN—Are you bothered by static?
 QRO—Shall I increase power?
 QRP—Shall I decrease power?
 QRQ—Shall I send faster?
 QRS—Shall I send slower?
 QRT—Shall I stop sending?
 QRU—Have you something for me?
 QRV—Are you ready?
 QRW—Shall I tell you are calling him on kc. (or m.)?
 QRX—Shall I wait? When will you call me again?
 QRY—Which is my turn?
 QRZ—Who is calling me?
 QSA—What is the strength of my signals (1 to 5)?
 QSB—Does the strength of my signals vary?
 QSD—Is my keying accurate? Are my signals distinct?
 QSG—Shall I transmit telegrams (or one telegram) at once?
 QSJ—What is the charge per word for including your interior telegraph charge?
 QSK—Shall I continue the transmission of all my traffic? I can use break-in operation
 QSL—Can you give me acknowledgment of receipt?
 QSM—Shall I repeat the last telegram I sent to you?
 QSO—Can you communicate with directly (or through)?
 QSP—Will you relay to free of charge?
 QSR—Has the distress call from been attended to?
 QSU—Shall I transmit (or reply) on kc. (or m.) and/or with waves of type A1, A2, A3, or B?
 QSV—Shall I transmit a series of VVV ?
 QSW—Do you wish to transmit on kc (or m.) and/or with waves of type A1, A2, A3 or B?
 QSX—Do you wish to hear (call signal) on kc. (or m.)?
 QSY—Shall I change to transmission on kc. (or m.) without changing the type of wave? or Shall I change to transmission on another wave?
 QSZ—Shall I send word or group twice?
 QTA—Shall I cancel telegram number as if it had not been sent?
 QTB—Do you agree with my word count?
 QTC—How many telegrams have you sent?
 QTE—What is my true bearing relative you? or What is my true bearing relative to (call signal)? or What is the true bearing of (call signal) to ?
 QTF—Will you give me the position of my station based on bearings taken by radiocompass stations you control?
 QTG—Will you transmit your call signal for fifty seconds, ending with a dash of ten seconds, on kc. (or m.) so that I can take your radiocompass bearing?
 QTH—What is your position in latitude and longitude (or according to any other indication)?
 QTI—What is your true course?
 QTJ—What is your speed?
 QTM—Send radio signals and submarine sound signals so that I can determine my bearing and my distance
 QTO—Are you leaving the dock (or the port)?
 QTP—Are you going to enter the dock (or the port)?
 QTQ—Can you communicate with my station by means of the International Signal Code?
 QTR—What is the correct time?
 QTU—What are the working hours of your station?
 QUA—Have you any news of (call signal of mobile station)?
 QUB—Can you give me, in this order, information concerning: visibility, height of clouds, and ground wind for (place of observation)?
 QUC—What is the last message received by you from (call signal of mobile station)?
 QUD—Have you received the urgency signal made by (call signal of mobile station)?
 QUE—Have you received the distress signal made by (call signal of mobile station)?
 QUG—Are you going to be forced to alight at sea (or on land)?
 QUH—Will you give me the barometric pressure at sea level?
 QUI—Will you give me the true head to follow, with no wind, for directing me to come to you?
 The signal series of OA, OB, OC, OD, OE and

Answer

The name of my station is
 The approximate distance between our stations is
 The accounts for charges of my station are liquidated by the private company, (or by the government administration).
 I am going to and I am coming from
 Your exact frequency in kc. (or wavelength in m.) is
 Your frequency (or wavelength) varies.
 Your note varies.
 I can not receive you. Your signals are too weak.
 I receive you well. Your signals are good.
 I am busy (or I am busy with). Please do not interfere.
 I am being interfered with
 I am bothered by static.
 Increase power.
 Decrease power.
 Send faster.
 Send slower.
 Stop sending.
 I have nothing for you.
 I am ready.
 Please tell I am calling him on kc. (or m.)
 Wait (or Wait until I have finished communicating with)
 I shall call you at o'clock (or soon).
 Your turn is number (or after every other call).
 You are called by
 The strength of your signals is (1 to 5).
 The strength of your signals varies.
 Your keying is inaccurate. Your signals are bad.
 Transmit telegrams (or one telegram) at once.
 The charge per word for is francs, including my interior telegraph charge.
 Continue the transmission of all your traffic. I shall break you if necessary.
 I give you acknowledgment of receipt.
 Repeat the last telegram you sent to me.
 I can communicate with directly (or through).
 I will relay to free of charge.
 The distress call received from has been attended to by
 Transmit (or Reply) on kc. (or m.) and/or with waves of type A1, A2, A3 or B.
 Transmit a series of VVV
 I am going to transmit (or I shall transmit) on kc. (or m.) and/or with waves of type A1, A2, A3 or B.
 I hear (call signal) on kc. (or m.)
 Change to transmission on kc. (or m.) without changing the type of wave, or
 Change to transmission on another wave.
 Send each word or group twice.
 Cancel telegram number as if it had not been sent.
 I do not agree with your word count; I herewith repeat the first letter of each word and the first figure of each number.
 I have telegrams for you (or for).
 Your true bearing relative to me is degrees, or
 Your true bearing relative to (call signal) is degrees at o'clock, or (call signal) relative to (call signal) is degree of o'clock.
 The position of your station as based on radiocompass stations that I control is latitude longitude.
 I am going to transmit my call signal for forty seconds, ending with a dash of ten seconds, on kc. (or m.) so that you can take my radiocompass bearing.
 My position is latitude, longitude (or according to any other indication).
 My true course is degrees.
 My speed is knots (or kilometers) per hour.
 I am sending radio signals and submarine signals so that you can determine my bearing and your distance.
 I am going to leave the dock (or the port).
 I am going to enter the dock (or the port).
 I am going to communicate with your station by means of the International Signal Code.
 The correct time is
 The working hours of my station are from to
 The news of (call signal of mobile station) is following: are the weather details requested:
 The last message received by me from (call signal of mobile station) is
 I have received the urgency signal made by (call signal of mobile station) at o'clock.
 I have received the distress signal made by at o'clock.
 I am going to be forced to alight at sea (or on land) at (place).
 The barometric pressure at sea level is (units).
 The true head to follow, with no wind, for directing you to come to me, is from degrees at o'clock.
 OA, OB, OC, OD, OE and OF are reserved for special aeronautical codes.

Common Word Abbreviations

ABT about
AHD ahead
AHR another
AMT amount
ANI any
AY any
BD bad
BK break
BUG speed key
BT but
BN been
B4 before
BI by
BCUZ because
BTWN between
BTR better
BRT brought
BIZ business
CK check
CN can
CUD could
CUL see u later
CUM come
CNT can't
C see
CW continuous wave
DE from
DLD delivered
DX distance
DNT don't
DA day
DH dead-head
DC direct current
ES and
EI that is
FB fine business
FM from
FR for
FRK frequency
GA go ahead
GM good morning
GN good night
GT get, got
GG going
GND ground
HA laughter
HI laughter-high
HR hear—here
HW how
HV have
HF high frequency
HLO hello
HM him
HP high power
HQ headquarters
I "ok"
IC I see
K go ahead
LID poor operator
LFT left
LIL little
LST last
LTR letter
MI my
MA milliamp.
MSG message

MILL typewriter
MST must
MNI many
MI my
MG motor-generator
MK make
MO more
ND nothing doing
NG no good
NL night letter
NR no more
NW number
OB old boy
OL old lady
OM old man
OP operator
OT ought
OW old woman
PLS please
PSE please
PTput put
PX press
R ok

RCD received
RT right
RI radio inspector
SA say
SM some
SS single signal
SIG signal
SINE sign
SUM some
SEZ says
SINE op's initials
STICK pencil
SKED schedule
TFC traffic
TKS thanks
TNX thanks
TK take
TMW tomorrow
TNK think
TR there
TS this
U you
UR yours
UD it would

UL you'll
TT that
V from
VB very bad
VT vacuum tube
VY very
WA word after
WB word before
WD would
WF word following
WK work
WL will—would
WN when
WL wavelength
WT what
WX weather
X interference
XMTR transmitter
YF wife
YL young lady
YR your
PT put
73 regards
88 love and kisses

THE CONTINENTAL CODE LETTERS

A	● ■■■	N	■■■ ●
B	■■■ ● ● ●	O	■■■ ■■■ ■■■
C	■■■ ● ■■■ ●	P	● ■■■ ■■■ ●
D	■■■ ● ●	Q	■■■ ■■■ ● ■■■
E	●	R	● ■■■ ●
F	● ● ■■■ ●	S	● ● ●
G	■■■ ■■■ ●	T	■■■
H	● ● ● ●	U	● ● ■■■
I	● ●	V	● ● ● ■■■
J	● ■■■ ■■■ ■■■	W	● ■■■ ■■■
K	■■■ ● ■■■	X	■■■ ● ● ■■■
L	● ■■■ ● ●	Y	■■■ ● ■■■ ■■■
M	■■■ ■■■	Z	■■■ ■■■ ● ●

NUMERALS

1	● ■■■ ■■■ ■■■ ■■■	6	■■■ ● ● ● ● ●
2	● ● ■■■ ■■■ ■■■	7	■■■ ■■■ ● ● ● ●
3	● ● ● ■■■ ■■■	8	■■■ ■■■ ■■■ ● ●
4	● ● ● ● ■■■	9	■■■ ■■■ ■■■ ■■■ ●
5	● ● ● ● ●	0	■■■ ■■■ ■■■ ■■■ ■■■

READABILITY—SIGNAL STRENGTH REPORTS

The "QSA-R" System

A short-cut method which indicates signal strength from 1 to 5. 1 indicates the hardest signal to copy, 5 the easiest to copy. The "R" portion indicates signal STRENGTH, from R1 to R9, R1 being the weakest, R9 the loudest. Thus

QSA-1, R1 would denote the most difficult signal to read, and the WEAKEST signal, as well. QSA-5, R-9 would denote the EASIEST signal to copy, plus the MAXIMUM signal strength.

THE "R-S-T" SYSTEM

READABILITY:
 1—Not readable
 2—Barely indistinguishable
 3—Readable with difficulty
 4—Easily readable
 5—Perfectly readable

SIGNAL STRENGTH:
 1—Very faint
 2—Weak
 3—Fair
 4—Good
 5—Powerful

STONE:
 1—Very rough
 2—Rough AC note
 3—Fairly rough AC
 4—Rather rough AC
 5—Musical—fairly good

6—Modulated, slight whistle
 7—Nearly DC note
 8—Good DC note
 9—Perfectly-pure DC note

EIMAC

TRANSMITTING TUBES

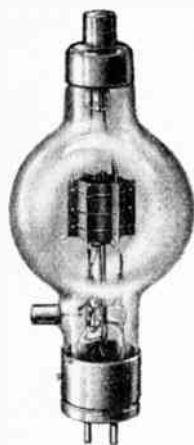

EIMAC 50T

MORE—

.....Power Output

.....Plate Efficiency

.....Power Gain

.....Ruggedness

.....Flexibility

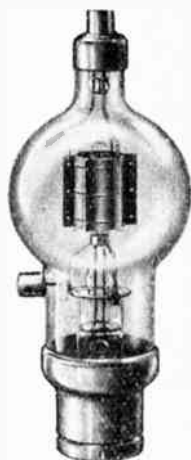

EIMAC 150T

UNSURPASSED

EIMAC TUBES are standard equipment in many of the world's outstanding DX Stations. These tubes are used in preference to all others because they are the only tubes designed to meet the extraordinary demands of amateur operation. Tubes used in commercial stations are rarely overloaded; for this reason tubes designed for commercial use do not have the safety factor which characterizes all EIMAC Tubes.

"Compare and Reflect"

The EIMAC organization maintains a tube application engineering service for the benefit of all amateurs . . . whether EIMAC users or not. Send your problems to us.

The best dealers have EIMAC Tubes in stock. Write us for characteristics and application notes. We will give you the name of the dealer nearest you.

EITEL-McCULLOUGH, INC.
SAN BRUNO CALIFORNIA



**New
Low-
Loss
COILS
and COIL
FORMS**

**More Stations!
Sharper Tuning!
Louder Signals!**

USERS say that these low-priced Hammarlund Coils out-perform any others at any price. "XP-53", the remarkable new low-loss Hammarlund dielectric is one reason. Many other exclusive features. No artificial coloring to cause losses. Set of four 15-250 meter coils (4 or 6 prongs), \$3.00 and \$3.75 respectively. One extra coil covers 250-560 meters. Coil Forms (4, 5 or 6 prongs), 35c and 40c each. 40% discount to experimenters.

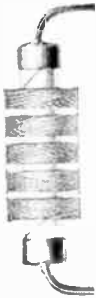

**Smallest, Lightest
R. F. CHOKE**

Tinned copper leads extend straight from end caps. Sufficient to support choke. Makes for neater wiring. Minimum distributed capacity. No other choke like it. Priced so low it can be used freely in all detector plate circuits, B+ and grid leads. 75c each, less 40% to experimenters.

COMET "PRO" Receiver
Still the World Sensation

Preferred by leading amateurs, professionals, air and steamship lines, broadcasting networks, armies and navies. Four models: with or without Automatic Volume Control or Crystal Filter.

Write Dept. PRH for
FREE new 1935 Catalog

HAMMARLUND MFG. CO.

424-438 W. 33rd St. New York, N. Y.



**I.C.A. Quality Apparatus
for 5 Meter Work**

Amateurs and Experimenters always insist upon I.C.A. when seeking **QUALITY** and **DEPENDABILITY**. Our 5 M. Kits and parts maintain this standard and insure satisfaction. The list prices shown below are subject to a discount of 40% when purchased through your jobber . . . or send order direct naming jobber and we will see that you are supplied.

5 M. Transceiver Kits

Choice of 3 models: 2 volt, 6 volt or A.C. model. Easy to build, complete instructions, diagrams. List prices (respectively)

\$19.50, \$19.25
\$19.75



Coils for 5 Meter

**Transceivers
(QST Specifications)**

Interruption Frequency
Oscillator with 4 lugs.

List price \$1.00. 5 Me-

ter RF Choke with two mounting feet. List price 60c. 5 Meter Dual mounting base. List price 75c. Complete as above with blue print. List price, **\$2.25.**

NEW 1935 CATALOG

Send 10c stamps or coin to cover cost of handling and mailing big new 1935 catalog listing hundreds of parts and accessories as well as our complete line of receiver kits. Supply limited. Send now to avoid disappointment!

INSULINE CORP. OF AMERICA
23-25 Park Place, Dept. Y-15 New York, N. Y.

**TO THE READERS
of this
HANDBOOK**

THOSE who do not desire to cut the coupon from the Allied Radio Corporation's advertisement on the outside back cover of this handbook will find the coupon at the bottom of this advertisement a more convenient way in which to order a copy of the latest Allied catalog. You will not deface your copy of the handbook if you use the coupon which is repeated here.

Mail This Coupon Today

-----COUPON-----

ALLIED RADIO CORPORATION
Dept. J1
833 W. Jackson Boulevard, Chicago, Ill.
Send me your new **FREE** catalog.

Name _____
Address _____
City _____ State _____

INDEX

Page		Page		Page	
Abbreviations	286	Crystals, Quartz,		International Prefixes	285
Acorn Pentodes	260	Grinding	90	Key	4
Alternating Current	12	Current Flow	8	Key Chirps	117
Amateur Frequencies	16	Charts—		Key Clicks	81
Amateur Regulations	283	Audio and Modula-		Keying	80
Ampere	8	tor Table	145	Keying Systems	82
Amplification		Characteristics of		Laws (Amateur)	283
Theories	13-21	Tubes	56, 121, 145	License Examina-	
Amplifier, Class A		Choke Coil Winding	267	tions	283
Prime or Class		Coil Data		Linear Amplifiers	136-171
AB	137	Receiver	28-30-44	Linear Detection	
Amplifiers, Audio	21-139	Metal Tube		Monitor	282
Amplifiers, Class A,		Characteristics	60	Linear Rectifier	282
B, C	21-139	Power Supplies	273	Link Coupling	
Amplifiers, Class		Resistor Color		Antenna	192
BC	21-151-153	Code	9	Logs	284
Audio Coupling	27	Transformer Wind-		Magnetic Flux	10
Amplifiers, RF	73-122	ing	261	Magnetism	9
Angle Radiation	190	Transmitting Tube		Measurements	
Antennas—		Table	121	Test Sets	275-276-281
Center Fed	195	Tube Socket		Frequency	51
Diamond	199	Connections	56	Monitor	51
Directional	189-199	Wire Table	265	Mercury Vapor	
Doublet	195	Detection	21-25-27	Rectifiers	268
Dummy	193	Directional		Microphones—	
Feeder Systems	191	Antennas	195-197-199	Amplifiers	129-130
Field Strength Test	189	Doubling Frequency	99	Capacitive	129
5-Meter Types	195	Duplex Power Supply		Condenser	129
Franklin	195	Units	274	Crystal	131
G. E. "V" Doublet	181	Economy Transceiver	257	Dynamic	132
Hertz	181	Efficiency Modulation	136	General	128
Jones	193	Electrical Units and		Inductive	132
Johnson	189-194	Fundamentals	7-9	Modernized 25-Watt	
Loading Coils	187	Electricity	7	Phone	143
Marconi	187	Electromagnetism	9	Modulated Oscillator	275
Matched Impedance	182	Electromotive Force	9	Modulation	135-161
Pi Network	184	Electron Flow	8	Modulator, The	134
Picard	195	Exciter Units—		Modulator Tube	
Simplified Pi	186	Tritet	89	Tables	145
Single Wire	181	Jones	96	Multipliers	
Theory	16	Les-Tet	89	(Frequency)	99
Tuning	188	Stamess	89	Mutual Inductance	10
Twisted Pair	193	Faraday Screen	43-184	Negative and Posi-	
Zepp	187	Feeder Systems,		tive Polarity	7
Band-Spreading	29	Antenna	180-190	Neutralizing	100-117
Beat Frequencies	26	Filter Chokes	266	Ohm	8
Beginner's Instruc-		Filter Units	268	Ohm's Law	8
tions	4	Five-Band Exciter		Oscillation	22
Bias	104	Units	95	Oscillator—	
Bleeders	272	Flux Density	10	Beat Frequency	52
Break-In Operation	96	Formulas—		Crystal	85
Bridge Rectifiers	272	Alternating Current	12	Jones Exciter	96
Buffers	88	Antennas	16	Modulated	275
Buzzer Practice	4	Capacitive		Self-Excited	82
Calculations—		Reactance	12	Tritet	89
Antennas	16	Coupled Circuits	15	Overmodulation Indi-	
Capacity	14	Electric Power	9	cator	169
Impedance	12	Impedance	12	Parallel Circuits	8
Inductance	13	Inductance	13	Parasitics	101
Resistance	9	Inductive Reactance	11	Pentode—High Power	150
Cathode-Ray Oscillo-		Inertia	9	Percentage Modula-	
scope	276	Ohm's Law	8	tion	136
Characteristics,		Parallel Resonance	14	Permeability	10
Tubes, Theory	20	Resistor Code	9	Phone Operation	123
Choke Table	267	Series Resonance	14	Phone Wavelengths	16
Chokes, Filter	266	Transformers	11	Plate Modulation	157
Circuits, Cathode-		Frequency Doubling	99	Plate Resistance	13
Ray Oscilloscope	277	Grid Bias	104	Plate Transformers	261
Circuits, Monitors	23-74	Grid Detection	22	Potential	8
Circuits, Power Sup-		Grid Modulation	135-151	Power Amplifier	73-122
plies, Filters	272-274	Grid Neutralization	100	Power Distribution	124
Circuits, Self-Ex-		Hartley Circuit	83	Power Factor	12
cited Oscillators	82	Heaviside Layer	13	Power Supply	
Clickless Keying	78	Hertz Antenna	74	Design	261-268
Code Practice	4	Heterodyne	26	Pre-Amplifier	133
Collins Pi Network	185	Impedance	12	Pre-Selector	38
Condenser Ratings	273	Impedance Matching	142	Push-Pull Amplifier	77
Condenser Theory	268-270	Impregnation	263	Push-Pull Oscillator	83
Continental Code	286	Intermediate Ampli-		Q Signals	285
Controlled Carrier		fier	36	Quartz Crystals	34-85
Modulation	161	Inductance	13	Radiation	13
Coupled Circuits	11-15	Induction	10	Radio Laws	283
Coupling, Antenna	186	Inductive Reactance		Radio Symbols	284
Crystal Control	85-95	Interference Elimina-		Radiotelephony	126
Crystals, Quartz	85	tion	81	Reactance	11
				Reedability	286
				Receiver Circuits	42-64
				Receiver Coils	28-30
				Rectification	268
				Regeneration	22
				Regulations, Amateur	283
				Reluctance	10
				Resistance	8
				RK-20 Phone	147
				Resonance	14
				Screen Grid Modula-	
				tion	136
				Secrecy of Messages	284
				Selectivity	13
				Security Carrier Control	167
				Shielding	125
				Skin Effect	24
				Skip Distance	13
				Speech Ampli-	
				fiers	129-130-131
				Superheterodynes	26-45
				Super-regeneration	211
				Suppressor Grid	
				Modulation	136
				Sweep Circuit	278
				Symbols	281
				Tables—	
				Conversion	284
				Choke Design	267
				Copper Wire	265
				Modulator Tubes	145
				Receiving Tubes	56-60
				Resistor Color Code	9
				Symbols	284
				Transformers	264
				Transmitting Tubes	120
				Tube Character-	
				istics	64
				Thump Filters	80
				Transceivers	207
				Transconductance	13
				Transformer Design	11-261
				Transformer Winding	
				Table	264
				Tritet Oscillator	89-95
				Tube Tables	121
				Tuned Circuits	14
				Tuning, Transmitters	116
				Ultra-High Frequency—	
				Antennas	194
				Economy Trans-	
				ceiver	257
				Filter Circuits	255
				5-10 Transceiver	223
				Haigis Portophone	259
				Harvey	221
				I. C. A.	228
				Jacobs	224-227
				Knight Transceiver	259
				Lafayette	231
				Resonant Line	250
				Receivers	206 to 280
				3 $\frac{1}{2}$ Meters	253
				Theory	200
				Transmitters	206 to 280
				Unity Coupling	109
				Vacuum Tubes	
				Amplifier	18
				Detector	18
				Tables	59
				Theory	17
				Vacuum Tube Volt-	
				meter	261
				Volt	8
				Voltage Amplifier	133
				Voltage Feed	179-183
				Voltage Regulation	29
				Wave Measuring	220
				Wave Propagation	13
				Wavelength-Frequency	
				Conversion	285
				Wire Table	265
				Wave Trap	81
				Zepp Feeders	180

Make No Mistake

There Is *No Finer
Condenser Than a*

CARDWELL!

As the name Packard is to the automobile, Baldwin to the locomotive, Westinghouse to the air brake, so for a decade and more has the name CARDWELL been associated with the finest and most efficient condensers. You join a distinguished company—the biggest names in Amateur and Commercial Radio—when you choose a CARDWELL for *your* job. Some outstanding and popular models are shown and described below.

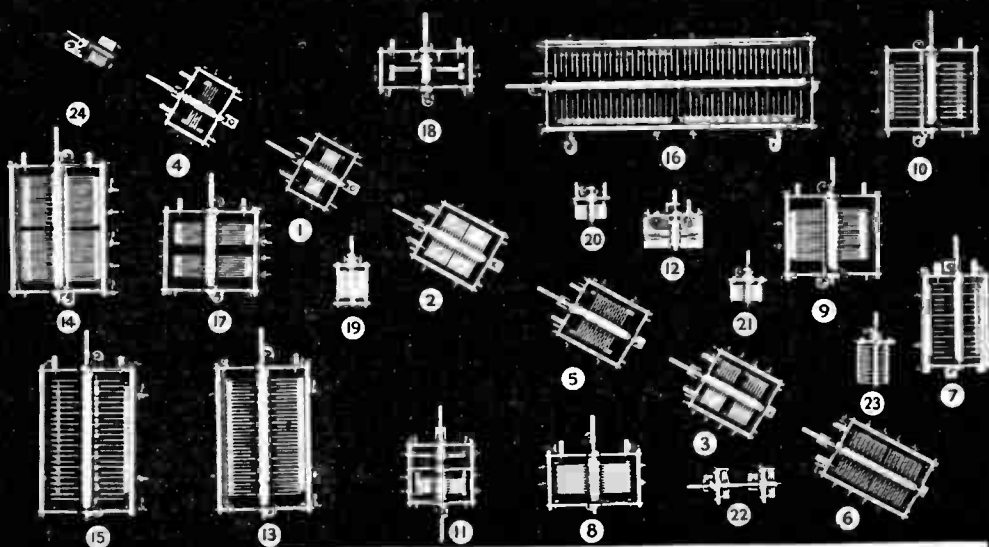

There is a Cardwell for every tube and purpose

- | | |
|--|---|
| <p>(2) 407-B Split Stator "Midway"—150 mmfd. per section—for 56 m.c. portable phone, etc.</p> <p>(6) 413-B Split Stator "Midway"—70 mmfd. per section—for High Frequency push-pull amplifier Tank Circuit.</p> <p>(7) 415-B "Midway"—34 mmfd., 6000 V.—Especially designed for neutralizing 50 watt modulated stages.</p> <p>(9) 164-B "Standard"—220 mmfd., 3000 V.—The most economical medium-power QUALITY transmitting condenser on the market.</p> <p>(10) 513-B "Standard"—Neutralizer for 204A's non-modulated. 511-B "Standard" (not shown)—Neutralizer for 203A and 211A.</p> | <p>(12) 519—Neutralizer for RK-18, 852 and 825 tubes. 519-B (Not shown)—Neutralizer for 830 tubes.</p> <p>(13) 520-B "Standard"—250 mmfd., 4500 V.—Tank Tuning condenser up to and including 852's non-modulated.</p> <p>(14) 157-B "Standard" (Split)—210 mmfd. per section—For tuning 100 Watt push-pull amplifiers.</p> <p>(15) T-183 "Standard"—110 mmfd., 6000 V.—Suitable for 852 modulated amplifiers.</p> <p>(16) DT-183 "Standard" (Split)—110 mmfd. per section—For push-pull 852's, etc.</p> <p>(17) 197-B "Standard" (Split)—80 mmfd. per section—For push-pull, medium power low C circuits.</p> |
|--|---|

THERE ARE MANY MORE CARDWELLS!

Send for literature describing the entire Cardwell line

The Allen D. Cardwell Mfg. Corporation

88 PROSPECT STREET, BROOKLYN, N. Y.

"THE STANDARD OF COMPARISON"

LOOK TO C-D IN 1935

THE WORLD'S MOST COMPLETE CONDENSER LINE

Just twenty-five years ago, Cornell-Dubilier began the manufacture of quality condensers. Today, thousands of appreciative hams and servicemen make their final choice—Cornell-Dubilier. The largest condenser organization in the world offers to them a capacitor of every type for every purpose.

FOR INSTANCE

Type 9 manufactured of finest selected mica and foil Moulded at a predetermined constant pressure to insure accurate capacities and low leakage

Type TD Special oil. High voltage capacitor Aluminum container hermetically sealed. Cubic volume reduced more than 70% compared with present types on market High porcelain insulators afford ample protection against high voltage surges.

Type 86 Mica Capacitor — recommended for amateur plate blocking grid and tank condenser applications. Ceramic casing insulates condenser from interfering ground capacity as obtained in the metal cased capacitor

Type TA Oil impregnated high voltage condenser Non-inflammable, all fire hazards eliminated Can be operated at high ambient temperatures. Weight reduction of 50% from former types

Write to W2AFS for
technical information.

MAIL THIS COUPON

W2AFS
4385 Bronx Boulevard
New York, U. S. A.

Gentlemen Please send me free information about the world's most complete condenser line

NAME

ADDRESS

CITY

**LEADERS—
FOR 25
YEARS**



**CORNELL-
DUBILIER
CORPORATION**
4385 BRONX BLVD.
NEW YORK, U. S. A.

McMurdo Silver Announces

THE FINEST PROFESSIONAL RECEIVER OF ALL TIME . . .

SILVER MASTERPIECE IV_a

The Super-fine Phone Receiver!

- No Inherent Circuit Noise
- Controllable Selectivity
- Plenty of Band Spread
- One Half Microvolt Sensitivity
- Complete Flexibility

Out of the experience of over twenty-three years . . . that built all the receivers for W9USA at the World's Fair, that built the all wave receivers for Admiral Byrd, that has produced the famous 5B and 5C now doing their stuff in thousands of ham shacks, in government service, at engineering universities the world over . . . now comes the MASTERPIECE IV_a, the superlatively flexible professional receiver. It has so many totally new and unduplicated features that it takes the 32-page Blue Book to explain them all, but here are a few:

No Inherent Noise. Not over 20 milliwatts inherent receiver noise when "wide open" at $\frac{1}{2}$ microvolt absolute sensitivity on all bands, means good readable signals where they are now lost in set noise or not even heard.

Controllable Selectivity. From sharp enough to give single signal C.W. to amply sharp to cut through crowded phone bands, to broad enough for standby, all controlled by the fidelity and two tone knobs.

Band Spread. One large 4" accurately calibrated air-planned, with accurately re-logging geared band spread pointer on inside 0-200 division, 360 degree, scale. Spread on 160 meter amateur band 540 degrees, 80 meter, 280 degrees, 40 meter 130 degrees, 20 meter 80 degrees, and ten meter 180 degrees.

Range. 140 to 410 kc. (2150 to 732 meters) and 530 to 32,000 kc. (568 to 9.4 meters) covers all five amateur bands, short wave and regular

broadcast and long wave commercial, all at maximum sensitivity and selectivity.

Two Tuned R.F. Stages On All Bands. Perfect image selectivity even at 20 meters and inherent noise so low you'll think the set is dead until Aussies and Zedders roar in R9. All r.f. oscillator and i.f. circuits use permanent air condensers—only one compression trimmer in 33!

High Fidelity. It's there—30 to 9000 cycles and 15 watts undistorted output thru matched Jensen speaker. Not only is it the perfect amateur receiver, but a wow of a high-fidelity all wave broadcast receiver as well.

Control Flexibility. All controls are calibrated so you know exactly what you're doing, and can duplicate adjustments from day to day. Tuning meter with calibrated sensitivity control is perfect R-meter, allowing exact measurement of received signal strength.

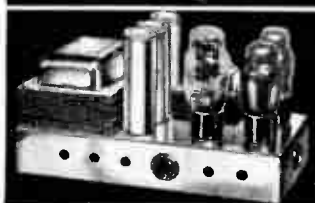
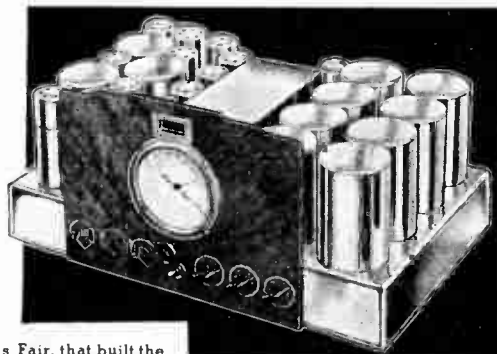

10 DAY FREE TRIAL
The Silver MASTERPIECE IV_a, like the 5C, is just so good that it's the only amateur receiver offered to you on a 10 day free trial basis. You can test it, make it do its tricks, and if you don't like it 100%, you can return it undamaged and get your money back instantly. With this wide-open guarantee, we get less than one-half of one percent back—so they **must** be good.

When you install a Silver MASTERPIECE IV_a on your operating desk, your receiver worries are over for years to come, for it's so far ahead of contemporary design that once you operate it, you'll only be able to say "man, what a receiver!"

These champion of champion receivers are being delivered right now—you can get one at once, without waiting until next year, and the price complete with 15 watt power amplifier and matched high fidelity speaker, is less than you could buy the parts for.

MAIL COUPON FOR FREE BOOK

Send the coupon or a postcard for the complete story—even if you don't buy a Silver MASTERPIECE IV_a, the 32-page Blue Book will at least tell you what to look for in fine receivers.

McMURDO SILVER CORPORATION Division of
G.P.H., Inc.

3366 N. Paulina St., Chicago, U. S. A.

McMURDO SILVER CORPORATION
3366 N. Paulina St., Chicago, U.S.A.

Send Free "Blue Book" with complete specifications of Silver MASTERPIECE IV_a, and details of FREE TRIAL OFFER.

Name.....
Address.....
City..... State.....

R115

TRANSMITTING EQUIPMENT for the AMATEUR WHO WANTS VALUE FOR HIS MONEY

Here is a collection of outstanding NEW Developments, hard to get parts and accessories as well as standard merchandise that will save money for Hams everywhere.

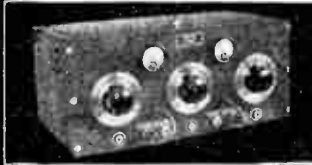

Left: Lafayette 100 watt C.W. & 30 watt phone described in *Radio*, November, 1934. Most economical.

Left: Lafayette 30 watt type P46 Transmitter. \$49.50. Utilizing Les-tet Oscillator Buffer or Doubler with 46's in parallel.

Right: Lafayette '19' Transceiver described in *Radio*, October, 1934. Power output about 10 times that of similar units. Price \$17.95. Write for details.

Right: Companion unit for P46 X'mtr described above. Modulate 60 watts of R.F. input. For use with crystal microphone, the overall gain being 110 Db. flat. Price \$39.50.

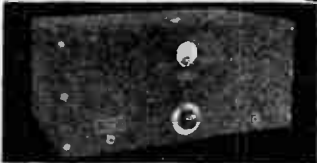

19" RELAY RACKS

Made of hi grade steel—not scrap. Black crystalline finish that will last a lifetime. Entirely new and exceptionally good looking. Drilled every $\frac{3}{16}$ ".

Steel Rack Panels 19" Long

Stock No.	Width	Cost
HXY22160	7"	\$.78
HXY22161	8"	.95
HXY22162	10 $\frac{1}{2}$ "	1.15
HXY22163	12 $\frac{1}{4}$ "	1.35
HXY22164	14"	1.55
HXY22165	15 $\frac{3}{4}$ "	1.75
HXY22166	17 $\frac{1}{2}$ "	1.95
HXY22167	19 $\frac{1}{4}$ "	2.10
HXY22168	21"	2.40

PEAK PRESELECTOR

and Preamplifier will boost those R1 signs to 9. Predates and modernizes your present receiver. Immediate delivery. No. HXN13760...\$19.80



TRUTEST CRYSTALS

Accurately ground to .1 of 1%. We will immediately ship frequency nearest to that ordered—or to your specified frequency within 2 days without extra charge. All Xtals are 1-in. square and are guaranteed power oscillators. X or Y cut

40 meter band No. HXN13989	\$3.75
80 and 160 meter band No. HXN13988	\$2.75
AT cut Drift less than 10 cycles per degree per megacycle. 80 and 160 meter band. No. HXN13535	\$3.25
AT cut Drift less than 4 cycles per degree per megacycle. 80 and 160 meter band. No. HXN13536	\$5.00
40 meter band to order only. No. HXN13537	\$8.50

INDICATOR PLATE

Black background, aluminum figures, marked CW-Phone Switch. PXH9918, each15c



TRANSFORMERS

A complete line of these in stock:

UNITED TRANSFORMERS
THORDARSON TRANSFORMERS
TRUTEST TRANSFORMERS

THE NEW NATIONAL HRO

Receiver in stock. Complete with coils, less tubes, speaker and power supply.

HXN13771 \$139.50



NATIONAL COIL FORMS

Type XR 10A, steatite; 2 $\frac{1}{2}$ x5"; 26 turns. No. HXN14347	\$.90
Type XR 12A, steatite; 4x6 $\frac{1}{2}$ "; 28 turns. No. HXN14348	\$1.35
Type XR 20, steatite; 4, 5 or 6 prongs. No. HXN14349	\$.21



NEW RCA ACR-136

In stock. Get details of this remarkable receiver. Price complete with tubes. Nothing else to buy.

HXN13814 \$69.50

Latest RCA OSCILLOGRAPH

Ready for immediate delivery. Complete with tubes. No. HXN13943\$84.50

CIRCULAR PLATES



Black background, aluminum figures, 1-in. diam. $\frac{7}{16}$ -in. hole. Marked: Mike-Phone, Cell Disc; Adjust-Cell Voltage; On-Off. PXH9899, each.....10c

EIMAC TUBES

at the best prices! We are sole Distributors for Atlanta and South Eastern States.

TRUTEST TRANSFORMERS FILAMENT TRANSFORMERS

Primary 115 Volts A.C. 50/60 Cycles	
OT-1 2 $\frac{1}{2}$ V.C.T. 20 A; 2500 V. insulation OT mtg.	\$1.50
OT-2 7 $\frac{1}{2}$ V.C.T. 6.5 A; 2500 V. insulation OT mtg.	\$1.75
OT-3 10 V.C.T. 6 $\frac{1}{2}$ A; 2500 V. insulation OT mtg.	\$2.00
OT-4 6.3 V.C.T. 5 A; 5 V.C.T. 6A; 2500 V. insulation OT mtg.	\$2.00
OT-5 2 $\frac{1}{2}$ V.C.T. 12 A; 5000 V. insulation OT mtg.	\$1.75
OT-6 5 V.C.T. 3 A; 5 V.C.T. 3 A; 5 V.C.T. 6 A; 2500 V. insulation OT mtg.	\$2.00
OT-7 Three 7 $\frac{1}{2}$ V.C.T. 2 $\frac{1}{2}$ Amp. windings; 2500 V. insulation OT mtg.	\$2.00

SMOOTHING CHOKES

VS-1 12 Henry, 200 MA; D.C. resistance 140 ohms. VS mtg.	\$2.50
DS-30 12 Henry, 300 MA; D.C. resistance 105 ohms. DS mtg.	\$3.75
DS-50 12 Henry, 500 MA; D.C. resistance 70 ohms. DS mtg.	\$6.50

INPUT SWINGING CHOKES

VS-2 5/25 Henry, 200 MA; D.C. resistance 140 ohms. VS mtg.	\$2.50
DS-40 5/25 Henry, 300 MA; D.C. resistance 105 ohms. DS mtg.	\$3.75
DS-60 5/25 Henry, 500 MA; D.C. resistance 70 ohms. DS mtg.	\$6.50

PLATE TRANSFORMERS

Primary 115 Volts A.C. 50/60 Cycles	
DS-4 800 each side of center at 150 MA; DS mtg.	\$3.75
DS-5 800 each side of center at 250 MA; DS mtg.	\$5.50
PA-111X 750 or 900 each side of center at 350 MA; PA mtg.	\$ 8.50
PA-112X 1250 or 1400 each side of center at 500 MA; PA mtg.	\$16.00
PA-113X 1600 or 2000 each side of center at 400 MA; PA mtg.	\$21.75
PA-114X 2500 or 3000 each side of center at 500 MA; UST mtg.	\$32.50
PA-116X 1250 or 1400 each side of center at 200 MA; PA mtg.	\$10.00

WHOLESALE RADIO SERVICE COMPANY,

100 Sixth Avenue, Dept. H-35, New York, N. Y.

- Send me the order I have described in enclosed letter.
- Send me your new 136-page BARGAIN BOOK 56-c.

Name.....
Address.....
City..... State.....

WHOLESALE RADIO SERVICE Co.

NEW YORK, N.Y. - 100 Sixth Avenue

ATLANTA, GA. 430 W. Peachtree St.

NEWARK, N.J. 219 Central Ave.



The Most Complete Line of Transformers on the Market

Assure Yourself of Matched and Balanced Performance by Purchasing All of Your Units From One Manufacturer.

The equipment described in this Handbook was designed and constructed by the engineering staff of "RADIO". UTC transformers and chokes were used in the original laboratory models.

Specify UTC when buying your transformers and chokes and assure yourself of duplicating the performance which the Handbook equipment will give when the correct power equipment is used.

In order to simplify your problem of choosing the proper transformer or choke for the feature articles described in this book, use the UTC Reference Chart on this page.

For Plate Power Supplies

PLATE TRANSFORMER UM-4X, 325 volts at 100 MA, net price \$2.40, is ideally suited for use in any of the small 2, 3, or 4 tube receivers described in this handbook.

PLATE TRANSFORMER UP-T1, 375 volts at 125 MA, at \$3.30 net, or NS-51 at \$5.40 net, or UH-3 at \$3.00 net are correct for use in receivers which employ a heavy-duty plate transformer.

FOR EXCITER UNITS, such as the Jones All-Band Exciter, or the Tritet, used as a driver for a buffer stage, the proper plate transformer to use is UP-T1, \$3.30 net, or NS-51, \$5.40 net, or UH-3, \$3.00 net. These transformers deliver 375 volts at 125 MA.

FOR BUFFER STAGES using 210, 801, 802, RK25, RK34, etc., the proper plate transformer to use is UP-T4, at \$5.40 net, or PA-110, at \$6.00 net, or LS-75 at \$18.00 net.

For a HIGH POWER BUFFER OR AMPLIFIER using 203A, 211, 242A, 800, 50T, 830B, use PA-112X at \$19.20 net, or LS-76 at \$27.00 net.

For a HIGH POWER AMPLIFIER using 354, 50T, 150T or 852, the proper transformer is PA-113X at \$26.10 net.

For a 1 K.W. FINAL AMPLIFIER using 150T, 354, 50T, 204A or 852, the proper transformer is PA-114X at \$39.00 net.

FILAMENT TRANSFORMERS

2½ volts, 10A—Use FT-5 at \$1.05 net, or PA 29 at \$3.75 net.

2½ volts, 12A—Use NS-47 at \$1.35 net.

2½ volts, 10A, 5000 V—Use DS-15 at \$4.80 net, or VS12 at \$2.70 net.

5 volts, 20A, 7000 V—For 872, 872A, 150T, 354, 50T, use DS-16 at \$4.50 net.

5 volts, 20A, 10,000 V—Use PA-121 for 872, 872A, etc., at \$8.40 net, or DS-17 at \$6.00 net.

Two 5 volt, 3 AMP. windings and one 5 volt, 6 AMP. winding, for (2500 volt insulation) 83, 83V or 5Z3 tubes in bridge circuits, use OT-6 at \$2.40 net, or VS-15 at \$3.00 net.

6.3 volts, 3A—Use NS-46 at \$1.35 net, or OT-4 at \$2.40 net.

7.5 volts—Use VS-13 at \$2.70 net, OT-2 at \$2.10 net, OT-7 at \$2.40 net or FT-7 at \$1.05 net.

10 volts, 6½A—Use PA-124 at \$7.20 net, DS-13 at \$6.90 net, VS-14 at \$3.00 net, OT-3 at \$2.40 net, or LS 84 at \$9.00 net.

11 volts, 10A—Use DS-14 at \$5.10 net, or PA-126 at \$12.00 net.

UTC COMPONENTS ARE WIDELY USED IN

BROADCAST STATIONS
in speech channels; plate, bias and filament supplies and equalizers, etc.

TELEVISION STATIONS
in wide range cathode ray picture frequency amplifiers, etc.

LABORATORIES
in voltage regulators; filters; oscillators; bridges; etc.

UNITED TRANSFORMER CORP.

72-78 SPRING STREET

NEW YORK, N. Y., U. S. A.

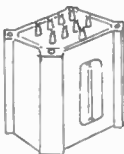
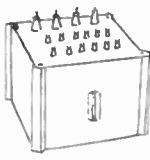
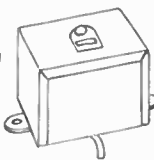
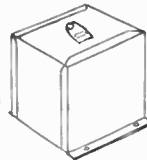
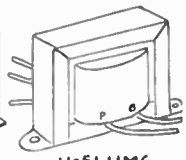
HIGH VOLTAGE
MOUNTINGLS
MTG.L.S.
MTG.NS.-12, 29, 40
TYPESNS-50;51
TYPESU-51, UM6,
U-19, FT, 3
TYPES



There is a U.T.C. Transformer for Every Transmitter, Receiver, Transceiver, Test Set or Power Supply Described in This Handbook. The Engineering Staff of "RADIO" Specifies U.T.C. for Better Results.

CHOKES

SWINGING CHOKES

5/25 h. 200 MA—VS-2, \$3.00 net. PA-103, \$4.80 net. LS-97, \$9.00 net.
5/25 h. 500 MA—PA-109, \$12.00 net. DS-60, \$7.80 net.

SMOOTHING CHOKES

10 h. 200 MA—VS-1, \$3.00 net. PA-102, \$4.80 net. PA-40, \$2.70 net.
10 h. 500 MA—PA-108, \$12.00 net. DS-50, \$7.80 net.

CHOKES FOR RECEIVING SET POWER SUPPLIES—30 h. at 100 MA—PA-44, \$2.40 net.

20 h. at 90 MA—NS-39, \$1.50 net.

UTC Units for Low Level Audio Channels

Line or Mike to Grid
LS-10—\$9.00 net.
PA-134—\$3.90 net.
NS-5—\$1.50 net.
UMG—\$0.96 net.

Audio Interstage
LS-20—\$6.00 net.
PA-131—\$2.70 net.
NS-1—\$1.41 net.
U-31—\$1.08 net.

Push-Pull Input
LS-21—\$7.80 net.

PA-132—\$3.00 net.
NS-2—\$1.50 net.
U-32—\$1.14 net.

Push-Pull Interstage
LS-22—\$13.20 net.
PA-133—\$3.60 net.
NS-3—\$1.65 net.

Tube-to-Line
LS-51—\$9.00 net.
PA-140—\$3.90 net.
NS-26—\$1.80 net.
HA-113—\$7.50 net.

High-Level Audio Input Transformers

Input transformer for Class AB 2A3s, 45s, 42s and 2A5s range in price from \$2.10 net to \$13.20 net, depending on the quality of unit desired. Write for catalog giving specifications of these units.

Class B Input Transformers

For 46s, 59s, at prices of from \$1.65 net to \$9.00 net. For 800s, 830Bs, 50Ts, etc., from \$4.50 net to \$9.00 net.
For 150Ts, 354s, 204As, etc., from \$7.50 net to \$21.00 net.
For 203As, 211s, etc., from \$6.00 net to \$12.00 net.

High Level Audio Output Transformers

Class AB Output for 2A3s, 45s, 42s or 2A5s from \$3.00 net to \$9.00 net.
Class B Output for 46s, 59s, from \$2.10 to \$12.00 net. 800s, 830Bs, 50Ts, etc., from \$12.00 net to \$42.00 net.
203As, 211s, etc., from \$19.50 net to \$42.00 net. 150Ts, 354s, 204As, etc., from \$48.00 net to \$120.00 net.

For Any Suppressor-Grid, Screen Grid or Control-Grid Modulated Phone.

Single 45, etc., to 4,000 or 2,000 ohms, use type NS-22 at \$1.65 net.
Single 42 pentode, etc., to 4,000 or 2,000 ohms, use type NS-23 at \$1.65 net. For push-pull 45s, etc., to 4,000 or 2,000 ohms, use type NS-24 at \$1.95 net.

For Transceivers

Single plate or mike to 1 Grid—UPMG, \$1.20 net. Universal Modulation Choke-Transformer—USO, \$1.20 net.

Highly-Shielded Ribbon Mike Transformers

Ribbon to Line—HA-109, \$7.50 net. LS-31, \$9.00 net. Line to Pre-Amplifier Grid—HA-100, \$7.50 net. LS-10, \$9.00 net. Ribbon Mike to Grid—HA-102, \$7.50 net. LS-16, \$12.00 net.

UNIVERSAL MODULATION OUTPUT CHOKES

Type	List Price	Net to Hams
HUC-20—Will handle 20 watts audio power. Can be used with class B 46s, 59s, 53, 6A6, 79, etc., or class A 2A3s, class A prime 42s, 45s, etc.	\$ 7.00	\$ 4.20
HUC-50—Will handle 50 watts audio power. Suitable for use with class B 210s, 801s, 830s, 841s, push-pull parallel 46s or 59s, push-pull parallel 45s A prime, push-pull parallel 2A3s.	12.50	7.50
HUC-100—Will handle 100 watts audio power. Suitable for use with class B 800s, 211Es, A prime 284s, 845s, etc.	20.00	12.00
HUC-200—Will handle 200 watts audio power. Suitable for use with class B 203s, 830Bs, HK-354s, EIMAC 50Ts, push-pull parallel 845s, prime, etc.	32.50	19.50
HUC-500—Will handle 500 watts audio power. Suitable for use with class B 204s, HK-354s, EIMAC 150Ts, A prime 212Ds, A prime 849s, etc.	80.00	48.00

UNITED TRANSFORMER CORP.

72-78 SPRING STREET

NEW YORK, N. Y., U. S. A.

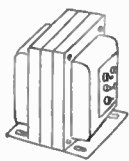

DS MTG.

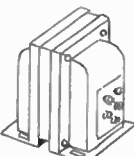

VS MTG.

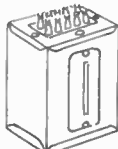

HIPERM

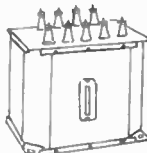

PA MTG.

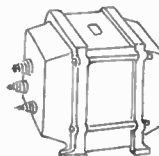

PA MTG.



VT.1



Variactor Controlled Carrier Modulation Acclaimed the Greatest Forward Step in Radiotelephony Completely Described in This Handbook

Phone Men who have switched over to Variactor Controlled Carrier Modulation agree it is the most economical and practical, least critical and simplest of any system of Controlled Carrier Modulation in use.

THE UTC SYSTEM OF VARIACTOR CONTROLLED CARRIER MODULATION:

- ★ Increases DX coverage many times over.
- ★ Allows power consumption savings of 50% or over.
- ★ Almost doubles Class C tube ratings and will double to quadruple Class B Linear Tube ratings.
- ★ Reduces interference between stations tremendously.
- ★ Increases tube life and power efficiency.

Using the UTC Variactor CCM System the changeover from standard carrier to controlled carrier can be accomplished in less than an hour.

The Essential Variactor Unit Required for Controlled Carrier Modulation Is Now Available in Six Types to Take Care of Transmitters From 25 to 800 Watts Output.

CV VARIACTORS FOR CONTROLLED CARRIER CLASS C

	List Price	Net to Hams
CV-1 25 to 50 watts maximum input controlled class C.....	\$ 7.50	\$ 4.50
CV-2 50 to 100 watts maximum input controlled class C.....	10.00	6.00
CV-3 100 to 170 watts maximum input controlled class C.....	15.00	9.00
CV-4 170 to 300 watts maximum input controlled class C.....	20.00	12.00
CV-5 300 to 500 watts maximum input controlled class C.....	25.00	15.00
CV-6 500 to 800 watts maximum input controlled class C.....	33.00	19.80

AV AUTOTRANSFORMERS FOR CV VARIACTORS—115/170 VOLTS AC

	List	Net		List	Net
AV-1 for use with CV-1.....	\$ 5.00	\$3.00	AV-4 for use with CV-4.....	9.00	5.40
AV-2 for use with CV-2.....	6.00	3.60	AV-5 for use with CV-5.....	12.00	7.20
AV-3 for use with CV-3.....	7.00	4.20	AV-6 for use with CV-6.....	15.00	9.00

CV VARIACTORS are suitable for obtaining controlled carrier on any transmitter using high level plate modulation. For existing equipment the corresponding AV autotransformer must be used with the CV VARIACTOR.

United Transformer Corporation
72-78 Spring Street
New York, N. Y., U. S. A.