

RADIO

ESTABLISHED 1917

A-267

NOW Expanded in Scope...
all phases of practical radio, electronics, sound, police, airline, practical design, f.m., u.h.f., construction, basic theory and instruction—SEE PAGE 34a

25c

- THIS MONTH**
- CATHODE-RAY OSCILLOSCOPES
 - SIMPLE AIR-RAID RADIO ALARM
 - NOTES ON U.H.F. PROPAGATION
 - PANORAMIC RADIO CONVERTER

Technical Radio
and Electronics



March 1942

NUMBER 267

25c IN U.S.A.

2 Reasons Why-

TAYLOR 866/866A's* HAVE
LONGER LIFE AND

HIGHER RATINGS



ACTUAL
SIZE

1

The shield and anode of Taylor's 866/866A are made of pure Svea metal which eliminates any possibility of filament poisoning due to loose carbon.

2

The cathode of the Taylor 866/866A is a multi-strand (mesh) filament which has approximately twice the emitting area of the ribbon type.

* For the past 3 years, Taylor's 866 has had the ratings of an 866A. See QST advertisement—April 1939.

Only \$1.50
OVER 125,000 SOLD!

SEE YOUR PARTS DISTRIBUTOR
TODAY FOR TAYLOR TUBES

"More Watts Per Dollar"

RATING

| | |
|----------------------------------|--------|
| Fil. Volts | 2.5 |
| Fil. Amps. | 5.0 |
| Max. Inverse Peak Plate Volts .. | 10.000 |
| Average Plate Amp. | 0.25 |
| Peak Plate Amp. | 1.0 |

Taylor HEAVY **CUSTOM BUILT** DUTY Tubes

TAYLOR TUBES, INC., 2341 WABANSIA AVE., CHICAGO, ILL.

SX-28 MAKES POSSIBLE

Exacting Tests!



Model SX-28, fifteen
tubes. Six bands.
Covers from 550 kc.
to 42 mc \$179.50.

ONE of the uses of the Model SX-28 in defense industries is the checking of crystals for the British Air Ministry in the plant of Aircraft Accessories Corporation at Kansas City. Crystal checking is an exacting operation and we are justly proud that the Model SX-28 was selected to do this important job. It is a great tribute to the engineering skill which is incorporated in every Hallicrafters communications receiver.

the hallicrafters co.
CHICAGO, U. S. A.

Keep Communications Open

Past ●
Present
and
● **Prophetic**

Amateur Operation

We hear so many conflicting reports in regard to amateur operation during the emergency that it is difficult to ascertain the exact status of the amateur at the present time. But Perry Ferrell mentions in a last minute note at the end of his UHF column that something definite is being done about the amateur situation. We hope that it won't be long before the DCB will be able to give us definite information on which amateurs will be allowed to operate in conjunction with local defense outfits, what frequencies will be authorized, and what areas will be set aside for this type of operation.

Tubes and Transmitters

We all know, possibly from sad experience, that thoriated filament transmitting tubes deteriorate from long disuse. Now that the amateurs are off the air there will be a lot of beloved bottles in low frequency transmitters that will be actively in a condition of disuse. The best way to remedy this situation would be, of course, to operate the transmitter for a few hours each month into a *shielded* dummy antenna. But since shielded dummy antennas are difficult to build, and since the transmitter itself would also have to be entirely shielded, with no radiation from the control or power leads, it is not recommended that the transmitter be operated in its normal manner, even though into a shielded dummy. Even the smallest signal radiated by the transmitter, though the rig were operating into a dummy, would very quickly be detected by one of the dozens of monitoring stations and would constitute a serious violation of the order.

Since the matter is thus complicated by the fact that the transmitter itself cannot be operated to keep the tubes in operating condition, we have written to the various tube manufacturers to find out the best method, in their opinion, of forestalling deterioration.

Many publications seem to be offering or commenting upon various different systems for keeping a strong signal (for emergency instructions, morale maintenance, etc.) at the receiving antenna of the populace during an air raid. Several of these systems for delivering a signal which cannot be used as a beacon to enemy bombers have merit. One in particular, as used by the British, consists of synchronizing all transmitters in a given large area on the same frequency with the same program. It is then impossible for a bomber to get a bearing on any particular station, due to the interference from other stations on the same frequency, until the plane is just a few miles from the station. The interceptor command can then by shutting down only stations within a certain distance of the plane or squadron, keep any particular station from serving as a beacon. But service to the listeners on this official frequency will be maintained by the composite signal from the balance of the transmitters even though the one near them may be shut down.

This system is an ingenious, though complicated, arrangement for maintaining uninterrupted broadcasting on a comparatively small area such as the British Isles. But the arrangement, due to various electronic and geographic difficulties, would not be practical for the very large area of the United States with its extreme variation in population density. It might be practical, though, for comparatively large sized subdivisions of the U.S.A.

Another suggestion is to install a very high powered broadcast transmitter, operating on a comparatively low broadcast frequency for greatest daytime coverage, somewhere in the middle west, perhaps at Denver, and operate this station as the official station for the west coast area. This arrangement would certainly give satisfactory reception at night over a large radius, and bearings taken on the station would be very unreliable due to the admixture of the sky wave and ground wave. The difficulty of taking bearings would probably be increased by systematically varying the polarization of the wave.

'Scopes

Beginning with this issue is a series of articles dealing with the theory, design, and construction of the cathode-ray oscilloscope. With the increased use of oscilloscopes in all types of radio and electronic work, including that concerned with National defense and the war effort, a knowledge of the theory and operation of the 'scope will be an asset to any radioman, and, for that matter, indirectly of value to the Government. Be sure to study these articles carefully.

RADIO

the worldwide authority . . .

Published by
EDITORS and
ENGINEERS, Ltd.

Home offices: 1300 Fenwood Road, Santa Barbara, California

Telephone: Santa Barbara 4242
Bell System teletype: 5 BAP 7390
Cables: EDITORSLTD SANTABARBACALIF

March • 1942

The publishers assume no responsibility for statements made herein by contributors and correspondents, nor does publication indicate approval

No. 267

Table of Contents

Cover—Control position of the WGEA-WGEO transmitter. Photo by GE.

ARTICLES

| | |
|--|----|
| Notes on U.H.F. Propagation— <i>Perry Ferrell, Jr.</i> | 6 |
| The Cathode-Ray Oscilloscope Part I— <i>Jay Boyl, W6FRM</i> | 9 |
| A Vacuum-Tube Voltmeter— <i>A. K. McLaren</i> | 13 |
| Panoramic Radio Exception— <i>J. R. Popkin-Curman, W2LNP</i> | 15 |
| Q & A Study Guide, Second Installment | 19 |

MISCELLANEOUS FEATURES

| | |
|-----------------------------|----|
| Past, Present and Prophetic | 4 |
| Marketplace | 65 |
| Advertising Index | 66 |

DEPARTMENTS

| | | | |
|---|----|--|----|
| Police Department: Kinks on Noise Elimination— <i>H. W. Evitts, W6GQX</i> | 24 | <i>Smith, W6BCX</i> | 28 |
| Sound Department: Sound Effects with Home Movies— <i>Ray E'eborn</i> | 26 | U.H.F. | 30 |
| Incidental Music for Recorded Sketches— <i>Siegmond A. E. Bätz</i> | 27 | Yarn of the Month | 34 |
| The Amateur Newcomer: A Code Practice Oscillator or Keating Monitor— <i>W. W.</i> | | With the Experimenters: A Simple Radio Air-Raid Alarm— <i>Glenn Earl Whitham, W1HSM</i> | 36 |
| | | Directly Calibrated Audio Oscillator— <i>C. Harold Campbell, W2IP</i> | 36 |
| | | New Books and Catalogs | 38 |

CORRESPONDENCE and ORDERS should be sent only to our home offices. MANUSCRIPTS, if unsolicited and unaccompanied, will be destroyed unless accompanied by a stamped, self-addressed envelope.

ADVERTISING copy and cuts fully mounted and verified should be sent to "Radio" Production Office, 417 E. Beardsley St., Office and duplicate copy and insertion order to Santa Barbara, where advertisement will run until home office ruling says to approve or reject.

SUBSCRIPTION RATES (in U. S. funds) are \$4.00 or \$3.50 yearly in U.S.A. (plus tax in Illinois), 10 Canada (inclusive of current taxes), Pan-American countries, and Spain, \$5.00 per year and foreign elsewhere, \$1.00 per year additional (sent once yearly, back issues are not included in subscriptions).

IF YOU MOVE, notify us in advance; we cannot replace copies sent to your old address. Notice must be received by the 5th of the month preceding the cover date of last issue so as to be in new address.

PUBLISHED monthly except August and September, and OCTOBER 1942 by Editors and Engineers, Ltd., 1300 Fenwood Road, Santa Barbara, Calif. REGISTERED as second-class matter July 16, 1922 as Radio Engineers, under the Act of March 3, 1879. Acceptance for mailing at special rate of postage provided for in Act of October 3, 1917. Authorized circulation of 50,000 copies. All rights reserved. TITLE REGISTRATION U. S. Patent Office, 1942-12-17, 17, 18.

The Editors of "Radio"

EDITOR

R. L. DAWLEY, W4DHG

ASSOCIATE EDITORS

W. W. SMITH, W6BCX

K. V. R. LANSINGH, W4QX

J. E. BEARDSLEY, W8UYA/4

Contributing Editors

H. BECKER, W4GD

J. CONKLIN, W5SLG/3

Editorial and Technical Assistants

J. H. ROTHMAN, W4SD

B. A. ONTIVEROS, W6PF

Published by Editors and Engineers Ltd.

K. V. R. Lansingh, Publisher

Editorial Director, W. W. Smith

A. McMullen, Treasurer

Circulation Manager, A. M. Wilson

J. A. Thompson

Advertising and Sales Promotion Manager

J. E. Beardsley

Production Managers

W. Wadsworth

Notes On

U. H. F. PROPAGATION

By PERRY FERRELL, Jr.*

In the rush to the ultra-high frequencies during the past year or so there has been suddenly brought upon the progressive u.h.f. men an immense influx of theories regarding u.h.f. propagation. These theories have been numerous, and they have been singularly new—so new that their scope has had a tendency not to clarify, but to contradict and confuse.

This regrettable situation has counteracted the real usefulness of these theories in maintaining the great strides forward at the present time. So in an effort to stabilize the theories of 5 meter dx by sporadic E and auroral reflections, this paper has been prepared. As it is recognized that these subjects will remain extremely controversial, it must be emphasized that this is not a digest of the writer's personal opinions, but is indicative of a consensus of opinions among the u.h.f. propagation theorists.

Extending Sporadic E Skip

During the summers of 1940-41 sporadic E skip signals were heard and worked at distances between 1300 and 1650 miles. Conklin³ has shown us that the normal skip distance of E_s reflections is between 400 and 1250 miles, assuming a virtual height of 110 km. and wave angles of reception and transmission of 17 and 3 degrees above the horizon for the respective distances. It is admitted that two-hop skip is possible on these paths and it may at first appear to be the answer itself to the propagation of these signals. However, the reflective index of the E layer is a proposition of quantity in terms of free electrons per cubic centimeter (14×10^9 making 5-meter dx possible). Ionospheric measurements taken during these outbursts at no time indicated any readings higher than 18×10^9 . For a two-hop skip to 1600 miles

the E layer density² must at least approach 25×10^9 . Therefore the only logical deduction remaining is indicative of extending the single hop skip by some complementary phenomenon.

Conklin³ and Wilson⁴ conclude that the extension of the E_s skip is caused by the refraction of these signals by tropospheric air boundary bending (T.A.B.B.) local to either the receiving or transmitting positions. Wilson even goes so far as to prove theoretically that distances up to 1850 miles could be covered if T.A.B.B. were in evidence at both of the positions simultaneously. Wilson furthered his detailed account (figure 1) to show that the inversion area must be located just beyond the maximum skip so that the wave-path is practically at horizontal incidence with the actual refraction taking place perhaps 50 to 100 miles further along the near tangent wave-path.

Conklin, meanwhile, states that possibly this

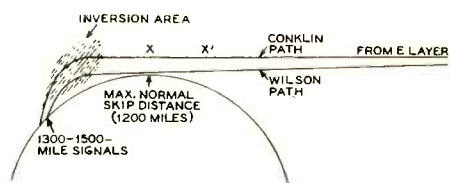

Figure 1. Greatly exaggerated diagram showing paths for extending 56-Mc. sporadic E skip. Note the amount of atmosphere the signal must traverse to reach a suitable bending "front." If front were located at either X or X' the skip would be shortened to somewhat less than maximum.

² 45×10^9 free electrons was reached during the outburst of June 5th, 1938.

³E. H. Conklin, U.H.F. Column, March, 1941 RADIO.

⁴Melvin S. Wilson, "5 Meter Wave Paths." QST, August, 1941, p. 23.

*107 East Bayview Ave., Pleasantville, N. J.

¹E. H. Conklin, "That 5 and 10 Meter Skip." RADIO, February, 1941, p. 40.

A TYPICAL IONOSPHERE STORM

This is a simplified, but an actual conception of how sunspots cause radio fadeouts and ionosphere and magnetic disturbances. In the photoheliograph of the sun (figure 4), made at 11:55 A.M. p.s.t. on February 27th, 1941 by the Mt. Wilson Observatory, note the sunspot group moving up to the meridian formed by the imaginary line between the two inset poles.

This corresponds to position "A" in figure 3 as we look down upon the plane of the earth's orbit in space.

Since the sun and the earth both move in the same direction, i.e., using the surface of the sun and the direction of the earth in its orbit (the ratio of speeds being about 13:1), position "B" must be realized at 10:22 A.M. e.s.t. by the sunspot for the beam of ultra-violet light to cause the sudden radio fadeout. The fadeout affects only those stations in the sunlit portion of the hemisphere and is seen as a break in the horizontal intensity of the earth's magnetic component on the Cheltenham magnetogram trace (Eight minutes is lost for the transmission of the light from sun to earth, making the record read 10:30 A.M., e.s.t.).

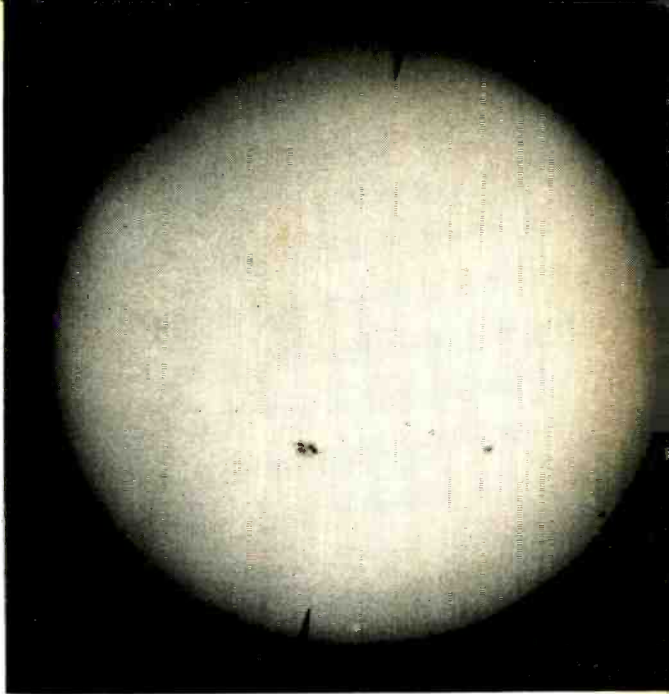
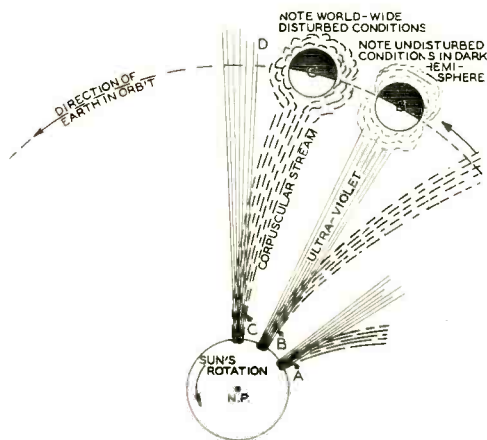

Figure 4.

Figure 3.



Ejected from the same sunspot group (at "B") is the highly electrified corpuscular stream, which having a much slower radical velocity than the ultra-violet light is seen sweeping in solar space in a revolving garden hose effect. We may see now in the magnetogram trace how 12 hours and 28 minutes (from "B" later this stream was caught up in the earth's magnetic field ("C") and the severe ionosphere storm of March 1st, 1941 began. In the exaggerated drawing note that the sunspot and the earth have both moved along and the "beam of ultra-violet light" is pointing out into empty space ("D", also at "A").

Figure 5.

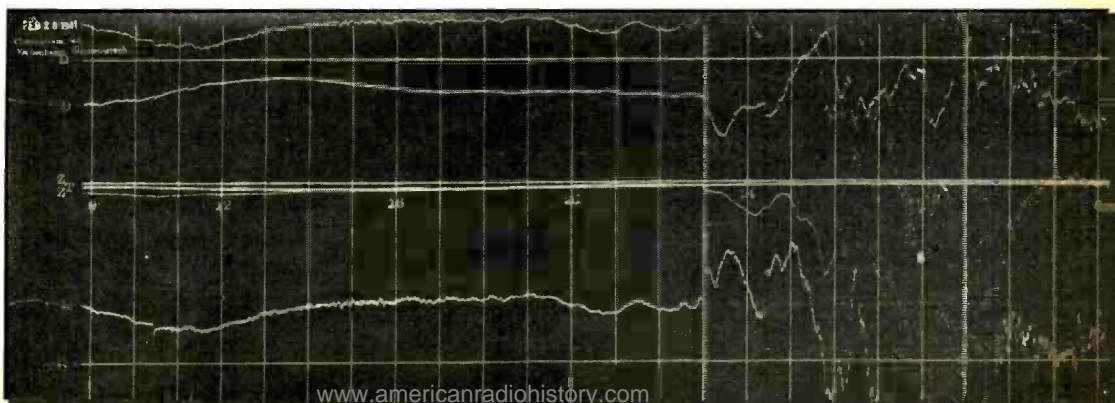

may happen or, in fact (figure 2), the wave-path may be sufficiently above the earth's surface so as not to be cancelled out by ground reflections. Actually the only difference between the two theories is the height of the E_s reflected signal above its tangency.

We realize from previous experiences that T.A.B.B. is the refraction of the u.h.f. signal through very definite stratified air masses⁸, and that T.A.B.B. in these cases refracts the signal downward making it audible to positions beyond the normal horizon. T.A.B.B. is also

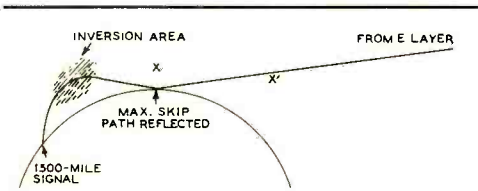

Figure 2. The reflected path may in this case cover the same extension of skip distance as diagrammed in figure 1. Inversion at X would strengthen the reflection and possibly reduce phase interference. Inversion at X' would shorten the path again but would still allow a portion of the signal to be reflected.

known to have a definite degree of vertical localization⁹. The number of reported cases where extended E_s skip signals *have* been heard does not seem to justify the theories of Messrs. Conklin and Wilson, since at such low receiving angles of wave arrival, the signal would traverse 50 to 125 miles of atmosphere where a suitable bending front could be located. Likewise, where the downward descent of the wave-path has already been formed, the signal would undoubtedly, upon encountering the slightest T.A.B.B., be refracted so as to shorten the skip even to a degree of being less than the normal or maximum as the case may be. It is difficult to visualize a signal entering the atmosphere and first being refracted more or less parallel to the plane of the earth's surface and, after travelling 100 or so miles, being again refracted only this time downward to the surface and the receiving positions.

The majority of the extended E_s skip signals which have been received bore a quality similar to that which dx men, at one time at least, fondly called a "10,000 mile flutter." This is the peculiar fade of a radio signal which has been reflected by the earth back into the ionosphere a number of times while in transit.

The reflecting ability of the earth's surface

at ultra-high frequencies is quite good. Therefore it seems possible that the signal could be reflected by it, at the optimum skip distance, back towards the ionosphere, the angles of reflection and incidence being equal (they would be between 3 and 5 degrees). This wave-path could then be intercepted by a tropospheric discontinuity and returned again to earth at normal T.A.B.B. distances. Naturally, complementary conditions may permit a varying quantity of the direct wave-path signal to come through and cause the "fluttering" fade. Or one type of transmission, either direct or reflected path, may predominate and make the signal practically free of severe phase fading. But it would appear that the more probable wave-path was that of the reflection.

THE VERTICAL AURORAL LAYER AND ITS RELATIONSHIP TO E_s

From the limited amount of data now in our hands it is possible to conclude that there exist two distinct types of E_s : one being the normal summertime E_s , and the other, sporadic E layer ionization recorded during severe ionosphere storms.

From this we noted that the E_s layer existing during these magnetic disturbances is undoubtedly closer akin to aurora than many of us believe. On some occasions in cycles of auroral recurrences, aurora has been progressively followed in a few hours by excellent E_s conditions. At this time, however, the dividing line between the two is unknown and we have not advanced to the stage where predictions safely can be made. However, normal E_s is extremely prevalent in the polar regions and nearly absent in the equatorial zone,⁹ while the band of maximum intensity closely follows that of aurora, being about 23 degrees from the geomagnetic pole.

The lateral structure of E_s during ionosphere storms is patchy and consists of irregular steps or sudden bursts of high and low ionization, spread checkerboard fashion over an extremely wide area. This we recognize as differing from the normal E_s , which is a more or less sharp boundary (i.e., uniform layer) covering a comparatively smaller area and is considerably more stable in density.

In the theory of the Lorentz Polarization-Correction for radio waves⁷ it is proposed that the E layer is itself composed of two well defined layers. This is complementary with ionosphere soundings, as they indicate E_s is a reflecting media. The lower boundaries are

[Continued on Page 45]

⁸Perry Ferrell, Jr., "The Coincidence of U.H.F. Fading." RADIO, April, 1941, p. 9.

⁹Berkner and Wells, "Abnormal Ionization of the E Region." Terr. Mag., March, 1937, p. 73.

The Cathode-Ray OSCILLOSCOPE

By JAY BOYD,* W6PRM

A series of articles covering the theory, practical design and application of this most useful instrument.

PART I—THEORY OF THE CATHODE-RAY OSCILLOSCOPE

Of all the apparatus at our disposal there is none so versatile as the cathode-ray oscilloscope. By its use we may observe, compare or record any instantaneous changes or conditions taking place in any of our radio, sound or other electrical circuits.

The oscilloscope¹ is to the radio engineer what the X-ray or fluoroscope is to the medical profession. By its use we can look at its fluorescent screen and see just what electrical effects are occurring in any part of the circuit to which it is connected.

So is there any wonder its use is daily becoming more popular, and that it is now considered a "must" item of any laboratory or service shop?

What Is the Cathode-Ray Oscilloscope?

The heart of the instrument is the cathode-ray tube. This is a special type of high-vacuum tube, shaped like a funnel, containing an electron gun, usually two pairs of deflecting plates, and a coated screen at the front of the tube where the image or pattern is viewed.

In operation, the heated cathode releases a cloud of free electrons. These are drawn through the electron gun which accelerates their velocity and focuses them into a tiny stream. As these electrons strike the coated surface of the viewing screen, a fluorescent glow is produced, lasting for a fraction of a second.

It is a property of emitted electrons that they will be attracted or repelled by any positively or negatively charged bodies in their proximity. Located between the electron gun and viewing screen will be found two sets of flat deflecting plates, arranged so the electron stream must pass between them.

Placing an electrical charge on these plates will cause the beam to move up or down, or to either side, making visible a graph of whatever action is taking place within the circuit under inspection.

In addition to the cathode-ray tube there is a special type of "saw-tooth" timing oscillator for providing the horizontal deflection, as required by the majority of applications. But this is quite simple! In most commercial oscilloscopes we will find two amplifiers, labeled "ver-

*2468 Lyric Avenue, Los Angeles.

¹There is some difference of opinion as to whether the instruments in question should be termed "oscilloscopes" or "oscillographs." Webster's New International Dictionary defines: "os'cil-lo-graph—an instrument for recording or indicating alternating current waveforms or other electrical oscillations, usually consisting of a galvanometer with a strong field; specifically, such a galvanometer for recording acoustic phenomena transformed to electrical energy upon a sensitized film," and: "os-cil'lo-scope—an instrument for showing visually the changes in a varying current." (Italics are the writer's.)

It also gives: "Cathode-ray oscillograph—an

oscillograph in which the moving element is a pencil of cathode rays."

It would seem, then, that if the instrument is primarily a recording device, it is properly an oscillograph, while if used generally for visual observation, it is an oscilloscope, regardless of whether the moving element is a galvanometer or cathode ray. The absence of a definition for "cathode-ray oscilloscope" is probably due to the newness of our modern instruments.

Neither the manufacturers of such instruments nor the engineers who use them are in agreement as to the proper terminology. But in one respect they all agree. It's a doggone handy thing to have around!



FIGURE 1
THE X-RAY SHOWS
PICTURE LIKE THIS



FIGURE 2
THE CATHODE-RAY OSCILLOSCOPE PRODUCES
GRAPHS OF ELECTRICAL PHENOMENA

tical" and "horizontal," along with their respective gain controls, and switches for cutting them in or out of the circuit as desired. And then there is a power supply—usually a dual sort of affair. And that's about all there is to the instrument.

Put these five units—cathode-ray tube, sawtooth oscillator, horizontal and vertical amplifiers and power supply into a suitable cabinet and there you have a complete, self-contained cathode-ray oscilloscope. A block diagram of this assembly will be found in figure 3.

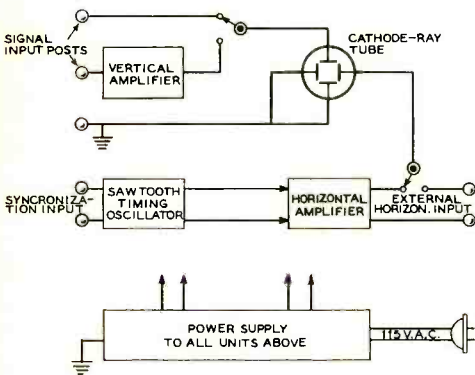

Figure 3. Block Diagram of a typical cathode-ray oscilloscope.

Applications Are Many and Varied

It would be impossible to list all the applications for which the cathode-ray oscilloscope may be used to advantage. Its users are always finding new roles for it to play.

But before telling some of its more popular uses, let's consider its workings in a little more detail. We mentioned that the "movable element" is the electron stream. The mass of these electrons is so infinitesimally small that, for all our practical purposes, their weight and mass may be entirely ignored. The diversion of this stream, or beam, from its normal course may be effected at the highest radio frequencies without the sluggishness which would be the case if a mechanical vibrating element were used,

however small it might be. Therefore, the beam will faithfully follow excitation of any frequency and produce a true graph upon the viewing screen.

Now let's consider some of the cathode-ray oscilloscope's more popular uses.

Audio amplifier checking—We may observe and correct waveforms, tube overloads and consequent distortion, feedback, unwanted oscillations of audio or radio frequencies, power supply hum, inductive pickup, check and measure gain per stage, frequency response, check phase-inversion circuits or load impedances.

The effect of any changes may be observed when "cleaning up" or "flattening out" a newly-built amplifier which, to the critical ear, will sound only as good as it looks on the oscilloscope.

Transmitter checking—The oscilloscope is the most satisfactory instrument known for checking the performance of radiophone transmitters. Besides checking the entire audio system from microphone to modulation transformer, we can also adjust the transmitter for the much desired hundred per cent modulation, check neutralization, lack or excess of grid drive, over- or under-biasing of amplifier, linearity of modulation, overloaded speech or modulator tubes. Modulation transformers may be properly matched to the r.f. load. The source of hum modulation or r.f. feedback may be more easily found and corrected.

Or, in short, if the phone transmitter is "ailing," the 'scope will certainly show up its faults. These checks are made by observing either the modulation envelope, audio waveform, or trapezoidal patterns, and sometimes by the elliptic or cat's eye pattern.

Receiver checking and alignment—Besides being useful for stage by stage checking of receiver circuits, the cathode-ray oscilloscope offers the most accurate means known for correctly aligning tuned circuits, and particularly the intermediate frequency channels of super-heterodynes. Performance of demodulator and audio systems of the receiver may also be easily checked.

Study of power circuits—Alternating current waveforms are shown as a "graph" upon the screen and their various relations may be studied, measured and analyzed. Transients and surges may be inspected, as well as operation of relays, circuit breakers, fuses, etc.

Large-screen oscilloscopes are ideal for classroom demonstrations of all sorts of electrical and radio phenomena.

The automotive and aviation industries have made frequent use of oscilloscopes in their studies of vibration, noise, combustion pressures, ignition systems, etc.

One special type of cathode-ray oscilloscope,

the cardiograph (or 'scope) is used by doctors and hospitals for the study of heart conditions.

Another special type of instrument is used by orchestra directors for the exact tuning of musical instruments.

The Story of Cathode Rays

Now that we have covered a rough outline of the instrument and its many uses, let's turn back the pages of history for a brief look at its forbears. Not that it is necessary in order to understand the 'scope. But because its history is so interesting, and because we will more greatly appreciate the instrument when we remember the earlier apparatus.

The production of electron streams, which he named "cathode rays," was first discovered by Sir William Crookes about 1874, while experimenting with Geissler tubes. These are simply vacuum tubes having electrodes in either end and containing small amounts of rarefied gases, which glow, something like our present-day neon tubes, when high voltages are applied to the electrodes.

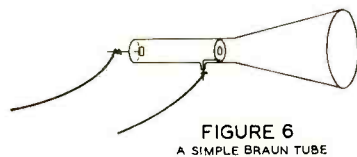
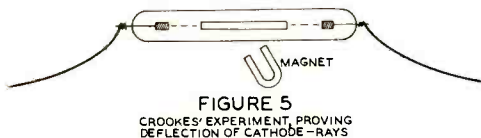
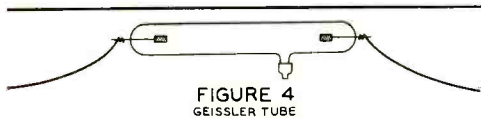

He noticed that if these were pumped to a very high vacuum, the gaseous glow would disappear and then the inside walls of the glass tube would show brilliant fluorescent effects.

It was also found that these free electrons always left the cathode at right angles to its flat surface, and that if this cathode were made concave they could be focused into a highly concentrated beam, having enough energy to fuse platinum foil inserted at this focal point within the tube. There was much controversy over the question of whether the cathode ray was an ether wave, as invisible light, or a stream of material particles flowing between the cathode and anode.

Sir J. J. Thomson, about 1892, determined that these cathode rays were, in reality, a stream of free electrons and proved that they might be deflected by a magnetic or electrostatic field. In his experiment he placed a strip of mica, coated with zinc sulphide, within the tube, parallel to the electron stream. Placing a magnet near the tube deflected the beam. As the electrons ricocheted along the screen, their path was made visible by the fluorescent glow thus produced. This experiment laid the foundation for our modern cathode-ray tubes.

Here we may diverge a moment to be reminded of another important discovery, for which the cathode ray was directly responsible. A German physicist, Wilhelm Konrad Röntgen, in 1895, made the discovery that whenever cathode rays fell upon the walls of the tube or any obstacle within, and especially the platinum anode, a form of invisible radiation, capable of passing through many opaque objects, was produced. He had discovered the X-ray!

It should be noted here that the cathode ray differs from the X-ray in that the former is simply a stream of free electrons, while the latter is similar to our radio and light waves, only much, much shorter.

And now back to our story. About 1894 a Frenchman, Hess, suggested using the cathode ray as the writing stylus for tracing curves of electrical phenomena. Then K. F. Braun of Germany designed and applied a cathode-ray oscillograph for this purpose as early as 1897.

This and all former tubes used a cold cathode, electron emission being effected by means of high vacuum and potentials of anywhere up to 100,000 volts. With such high potentials, the electrons attained velocities of about one-half the speed of light.

A few years later, Dufour in France and Sir J. J. Thomson and A. B. Wood in England built oscillographs of this pattern. They stood several feet in height, being made of iron and shaped like an upturned funnel, with the cathode at the top. They were equipped with a door for insertion of the six photographic plates and two fluorescent screens which were carried on a revolving drum. A glass window permitted viewing as well as photographing the phenomena under study.

After loading the plate-holders and pumping the vacuum for awhile, these pioneer physicists were ready to photograph a few patterns, which usually consisted of a single trace across the screen. But in spite of this laborious method, some very fine oscillograms were produced, particularly of radio wave trains.

So just remember that, the next time you think it is a little trouble to hook up your modern and highly developed oscilloscope!

Modern Cathode-Ray Tubes

In 1905 Wehnelt found that by using a hot cathode operation at very low voltages was practical but the filament life of the tube was a short one. Western Electric brought out their type 224, hot-cathode tube about 1921. This tube contained a small amount of argon gas, which, along with a critical adjustment of filament temperature, caused the electrons to gather into a concentrated stream. An improved cathode structure increased the filament life to several hundred hours.

In the earlier 1930's, Manfred von Ardenne in Europe and R.C.A., Dumont, Farnsworth and others in America began experimenting with cathode-ray tubes for television. This resulted in development of the excellent series of hot-cathode, high-vacuum tubes now available for either oscilloscopic or television use.

These tubes all focus by adjustment of voltages on certain elements of the electron gun, and, containing no gas, have a very long life.

Theory of the Tube

Having covered a rough outline of cathode-ray tubes and oscilloscopes, let us now examine the individual components in greater detail.

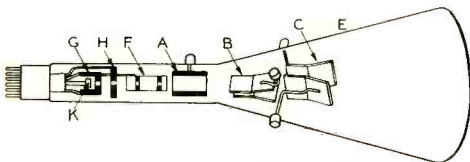

Figure 7. A typical cathode-ray tube.

The "innards" of a typical cathode-ray tube are shown in figure 7. These comprise the cathode K which releases free electrons when heated by the filament within the cathode sleeve. This cathode is surrounded by a cylinder G, which has a small hole in its front for the passage of the electron stream. Although this element is not a wire screen as our usual grid, it is known by that name because its action is similar; that is, the purpose of controlling the cathode stream by a variation of its negative potential.

Next in line is found the first accelerating anode, H, being simply a disk having another small hole in its center. In some tubes this element is connected within the tube to a second cylindrical accelerating anode, A, both these elements operating at the full potential of the tube. In the tube sketched the first accelerating

electrode connects to a base pin and operates at reduced voltage.

Between these elements is found a sleeve, F, containing two more small disks, these also having small holes in their centers. This is known as the focusing electrode.

The electrodes just described comprise the electron gun, which produces free electrons and focuses them into a slender, concentrated stream, for projection onto the viewing screen.

A comprehensive explanation of the electron action in this process of focusing involves a study of what is known as "electron optics," so called because the electron stream obeys many common optical laws.²

We will simply state here that when the focusing electrode voltage is adjusted to approximately one-fifth that of the accelerating electrodes, a very fine beam of electrons will find a focal point on the viewing screen.

Since the tube manufacturers have designed their tubes so as to focus properly, all we have to worry about is the inclusion of a potentiometer in our circuit for making this adjustment, and another potentiometer for adjusting the grid voltage to the value necessary for producing the desired brilliance of pattern.

Deflecting the Beam

Up to this point we have covered only the production and focusing of the beam. This, of course, must be deflected from its normal course so as to strike any part of the viewing screen if a pattern is to be produced. As previously stated, either a magnetic or electrostatic field will attract or repel the beam from its normal course.

Some tubes, particularly a few of the larger ones meant for television use, are designed for magnetic deflection and do not contain the electrostatic deflection plates found in all the smaller tubes used in cathode-ray oscilloscopes. Beam deflection in tubes of the former type is accomplished by means of electromagnets, usually made in the form of a yoke, which slip over the neck of the tube.

The only point in mentioning electromagnetic deflection here is to impress upon the reader that the beam is easily deflected by magnetic fields, since this may be the source of much annoyance if the tube is not kept clear of all power transformer and filter choke fields.

Electrostatic Deflection

Referring back to figure 7, we will find, between the electron gun and viewing screen, two

[Continued on Page 40]

²"Electron Optics in Television," by I. G. Maloff and D. W. Epstein.

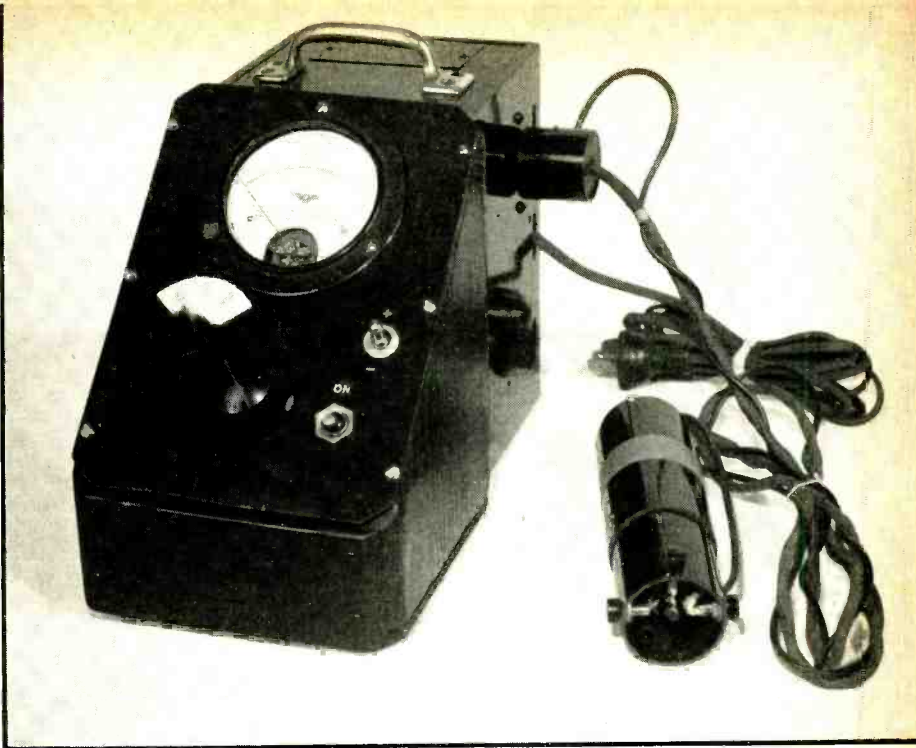

The complete vacuum-tube voltmeter. The power supply, meter, and multiplier resistors are housed in the combination metal and wood box with the handle. The 24-A v.t.v.m. tube is mounted inside the probe which can be seen alongside the cabinet.

A Vacuum-Tube Voltmeter

By A. K. McLAREN*

A description of a simplified v.t.v.m. which lends itself to home construction from components on hand. Precision multiplier resistors are not required.

A vacuum-tube voltmeter is a necessary instrument for the amateur or serviceman who wishes to measure a.c. and d.c. voltages in high impedance circuits. Vacuum-tube voltmeters may be purchased which may or may not be accurate at all frequencies and which may or may not load the circuits under test. The majority of manufactured units are a compromise between cost and range, accuracy, and a host of other things that enter into the design and manufacture of the instruments.

The design specifications and information given herein are for the construction of a simple vacuum-tube voltmeter of the probe

type which may be made very accurate on d.c. voltages and fairly accurate on a.c. and r.f. voltages, subject to the compromises before mentioned. Thus there may be some loss of accuracy on a.c. below 60 cycles and in measuring voltages on low-power r.f. circuits. However, the unit will be found quite accurate enough for all practical purposes.

As to the cost, it will be less than \$10 depending upon the type and manufacture of the meter used and on the type of cabinet employed. A 0-1 d.c. milliammeter having a multivoltmeter scale is used. The one employed in the unit described had a 0-6, 0-12, 0-120, and 0-300 volt scale; a meter having a different multivoltmeter scale may be used

*213 South 16th Street, St. Joseph, Mo.

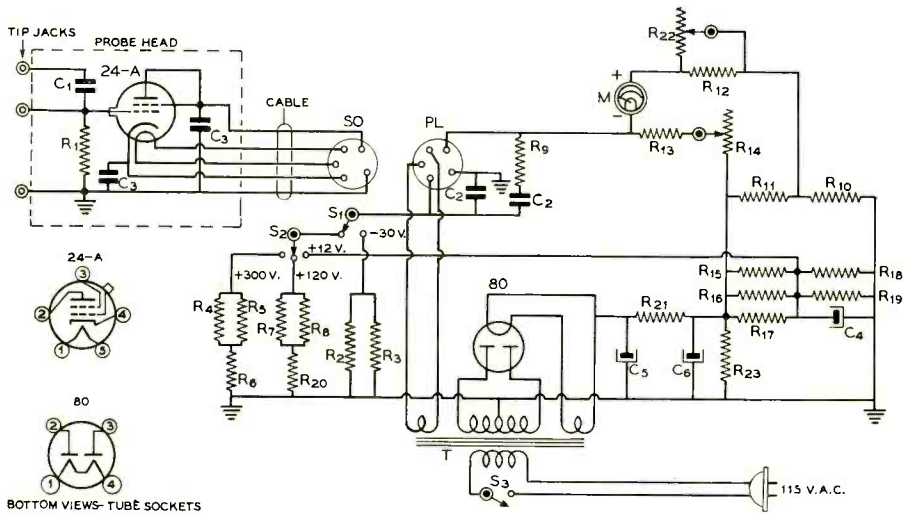

Wiring diagram of the degenerative-feedback probe-type v.f.v.m.

| | | | |
|--|---------------------------------------|---|--|
| C ₁ —0.01- μ d. mica | R ₉ —20,000 ohms, 1 watt | R ₁₁ —100,000-ohm potentiometer | R ₂₃ —50,000 ohms, 10 watts |
| C ₂ —1.0- μ d. 600-volt tubular | R ₁₀ —2.0 megohms, 1 watt | M—0-1 d.c. milliammeter | |
| C ₃ —0.0001- μ d. mica | R ₁₁ —250,000 ohms, 1 watt | T—700 c.t. 40 ma., 5 v. 2 a., 2.5 v. 3 a. | |
| C ₄ —40- μ d. 150-volt electrolytic | R ₁₂ —25,000 ohms, 1 watt | S ₁ —S.p.d.t. plus or minus voltage switch range | |
| C ₅ , C ₆ —8- μ d. 450-volt electrolytic | R ₁₃ —200,000 ohms, 1 watt | S ₂ —S.p. 3 t. positive voltage range switch | |
| R ₁ —5.0 megohms, 1 watt | R ₁₄ —40,000 ohms, 1 watt | S ₃ —S.p.s.t. a.c. line switch | |
| R ₂ —100,000 ohms, 1 watt | R ₁₅ —200,000 ohms, 1 watt | | |
| | R ₁₆ —400,000 ohms, 1 watt | | |
| | R ₁₇ —3500 ohms, 1 watt | | |
| | R ₁₈ —2000 ohms, 1 watt | | |
| | R ₁₉ —4000 ohms, 1 watt | | |

but will require changes in the resistor values employed.

Power Supply

The power supply used is standard throughout. It uses a midget power transformer capable of putting out 350 volts d.c. under normal load, plus a conventional brute-force filter. Line voltage changes have little effect on the accuracy as the meter may be set to zero for any line voltage changes; due to the design of the circuit this adjustment compensates for any line voltage change. Dropping the line voltage to 75 volts results in a 0.2-v. difference in accuracy on the 6-volt range.

Construction

The first thing to do is build the power supply complete with bleeders and mount it in the enclosure so that the probe tube cable can be plugged in. The probe tube should be mounted

in bakelite tubing just sufficiently large to accommodate the tube, the two 100 μ f.d. condensers, and the 0.01- μ f.d. condenser. These three should be small mica condensers. If bakelite tubing can be secured in two sizes which telescope together it will be easier to make connections.

Insulated tip-jacks may be used for the probe contacts. In making adjustments the test cords should be removed from the jacks while resetting the meter to zero. It is not necessary nor desirable to short the contacts in calibrating to zero. Also, the negative of the power supply should be grounded to a good ground. An actual ground is best as water-pipes may pick up a.c. and affect the zero reset.

Care must be used if the meter is operated without a ground and the switch is set on the low-voltage scale. Touching the hand to the probe will cause the meter to fly off scale due to body pickup.

[Continued on Page 59]

PANORAMIC RADIO RECEPTION

By J. R. POPKIN-CLURMAN,* W2LNP

By means of a new and interesting device it is possible to observe visually just what is going on in any 100-kc. channel in the radio spectrum. The device also has other important applications.

Panoramic reception is the simultaneous visual reception of several radio signalling stations whose frequencies are distributed over a continuous portion of the frequency spectrum. This is in contrast to the usual aural reception which is confined to a narrow band and usually means the reception of more than one station simultaneously only when very closely spaced in frequency.

Figure 1 shows a portion of the spectrum as seen by means of Panoramic reception. All of the spectrum that normally would be heard is indicated in the space between the dotted lines. With a Panoramic adapter it is possible to combine simultaneous narrow-band aural reception with Panoramic visual reception.

The significance of such a development becomes immediately apparent in the application of Panoramic reception for monitoring of the air. Since with Panoramic reception it is possible to "see" a much wider band of frequencies than that obtained normally with the conventional aural receiver, more effective supervision of the band is possible.

For example, with a conventional aural receiver having a selectivity of 10 kc. the operator can hear only the signals within this pass band. A Panoramic adapter added to this receiver makes visible (without in any way affecting the ordinary operation of the receiver) all signals present in a bandwidth of 100 kc. Thus, the portion of the spectrum observable at any one time is increased ten times. The probability of intercepting stations operating only short periods of time is increased by this factor. Furthermore, the Panoramic adapter shows signals which, although meaningless when heard in an ordinary receiver, might reveal themselves as a

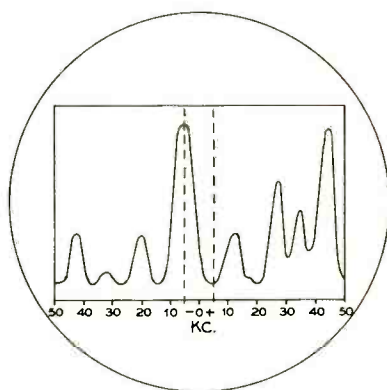

Figure 1. Sample trace as seen on the screen of the tube showing a 100-kc. frequency range containing eight signals of varying intensity.

secret communication system employing frequency or phase modulation, or operation on separated frequencies.

Wide portions of the spectrum can be covered far more rapidly with Panoramic adapters than is possible with ordinary receivers.

In order not to miss any of the signals which pass the relatively narrow "gate" or pass band of the ordinary receiver, the operator must tune slowly. Covering 100 kc. of the spectrum under observation in five seconds, he will pass through a 10 kc. channel in one-half second.

Even at this slow rate of tuning, signals which are in a deep slow fade or which for the moment are covered with QRN are liable to be missed. This is also true of c.w. stations which have their keys up during the time the ordinary receiver is passing through their particular frequencies.

A receiver equipped for Panoramic reception by means of a Panoramic adapter will be able

*Engineer, Panoramic Radio Corp., New York, N.Y.



Figure 2A. Front view of a commercially manufactured version of the panoramic radio spectro-scope.

to keep each point in the spectrum under constant surveillance for a full five seconds, assuming the same speed of tuning.

In a short time an operator becomes accustomed to using the visual method of watching the band. He then can tune more quickly, with greater certainty and with less concentration and nervous tension. Hence, the increased effectiveness of the monitoring facilities.

Standby or "watch" reception can be obtained without the attendance of an operator by connecting a crystal speaker to the output of the adapter. Any signal appearing in the band under observation will give an audible warning automatically. The band being watched can have any desired bandwidth up to 50 kc. above and below the channel selected.

Panoramic reception is also helpful in combatting the amateur interference problem. Show me the amateur who, in the past, hasn't wished for some more tools with which to combat QRM. By using Panoramic reception it is possible to see the character, frequency and relative amplitude of the interference without tuning the receiver to it. Optimum adjustment of the crystal filter is greatly facilitated. If one possesses a rotary beam, the relative signal strength changes are immediately apparent and it is easily seen which position is best for maximum desired-to-undesired signal ratio.

Since the Panoramic adapter shows every signal as a deflection on a cathode ray screen, the clear channels (now too plentiful) would be instantly seen.

The Panoramic adapter easily can be arranged for taking rapid bearings on two or more stations simultaneously. This ability is not limited to strong stations, since the adapter will show recognizable deflections of signals which otherwise might be obscured by noise. Separation of signals which are badly hetero-

dyned can be accomplished by the adapter, allowing "fixes" to be obtained under conditions of severe interference. The null and maximum methods both can be used effectively.

CHARACTERISTICS AND OPERATION OF THE PANORAMIC RADIO-SPECTROSCOPE ADAPTER

The Panoramic Radio-Spectroscopy Adapter (shown in figures 2A and 2B) is so named be-

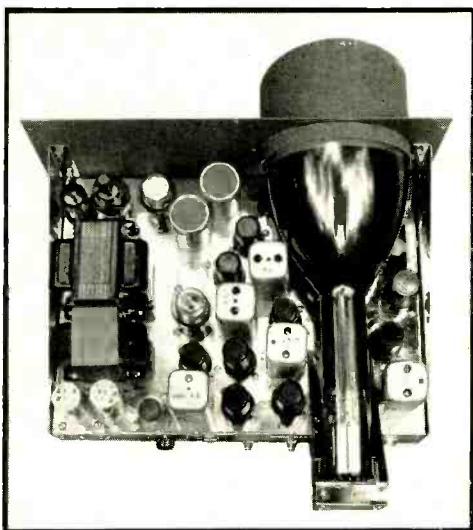

Figure 2B. Interior view of the Panoramic Converter.

cause of its ability to convert signals in a given radio spectrum into oscilloscope deflections, showing their frequency, signal strength, type of modulation, fading and frequency stability as well as any interference present. The adapter to be described operates in conjunction with an ordinary radio receiver of the superheterodyne type which has an intermediate frequency between 450 and 480 kc.

The adapter is connected to the receiver's mixer or converter tube through an input cable which has an isolating resistance to prevent detuning of the receiver's i.f. Upon connecting the adapter to the receiver the operator instantly can see all the characteristics of signals present within 50 kc. on either side of the frequency to which the operator is listening. The width of the band is adjustable up to a maximum of 100 kc. As the operator tunes the receiver this band moves, so that its center frequency is that to which the receiver is re-

sponding in the normal manner. The operator hears only that signal which appears in the exact center of the cathode ray screen.

How Panoramic Reception Is Made Possible

The block diagram of the Panoramic Spectroscope Adapter is given in figure 3. The input stage (A) of the Panoramic adapter is connected to the plate of the mixer of an ordinary superheterodyne receiver, whose i.f. is tuned somewhere in the range of 450-480 kc. This input stage A is, in effect, an r.f. amplifying stage, which has a bandpass characteristic 100 kc. wide, or 50 kc. on each side of a mean frequency which is tunable over the range of 450 to 480 kc.

The bandpass characteristics of the input stage A are such as to amplify signals 40 kc. on each side of the assumed 455 kc. mean frequency F. (See figure 4.) This tends to compensate for the selectivity of the tuned r.f. stage and tuned plate circuit of the receiver with which the adapter must operate, so as to allow reception of signals over the band of 100 kc.

The compensation cannot be perfect for all frequencies. Most receivers are much more selective on the lower frequency ranges than on the higher ones and the above ratio of peak to center bandpass amplification will give partial compensation on the low frequency range of such a receiver, gradually improving until perfect compensation is reached at a given frequency. There will be over-compensation, however, on higher frequency ranges. Figure 5 shows a family of curves representing the variation of amplitude of a given signal as it passes from one extremity to the other on the screen, covering a 100-kc. tuning range at various frequencies, through a hypothetical radio receiver. In this figure, curves 1, 2 and 3 show various degrees of partial compensation, curve 4 (heavy line) shows complete compensation, curves 5, 6 and 7 show various degrees of over-compensation.

By again referring to figure 3, it is seen that the signals received and amplified through the input stage A are fed into the converter stage B, where they are mixed with the signals from oscillator C. This oscillator is periodically and automatically varying in frequency up to 50 kc. above and below a fixed mean frequency F_0 . The oscillator's center frequency can be adjusted between 350 and 380 kc. and is made to correspond to the particular set with which the adapter is intended to operate, or in our case, 355 kc. Since the last i.f. is 100 kc., the oscillator frequency is equal to the receiver's intermediate frequency (F_1) less 100 kc.

The periodic frequency sweep of the oscilla-

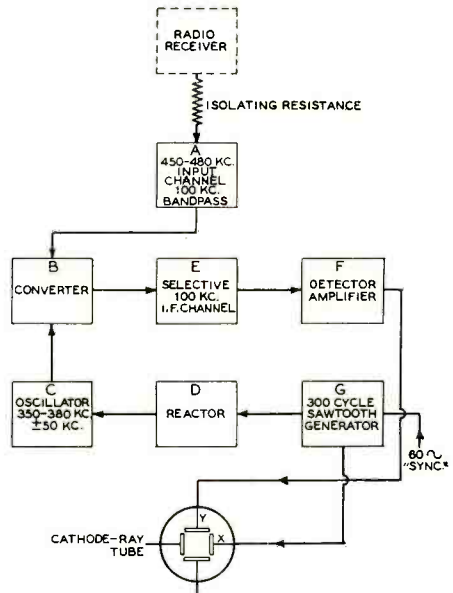
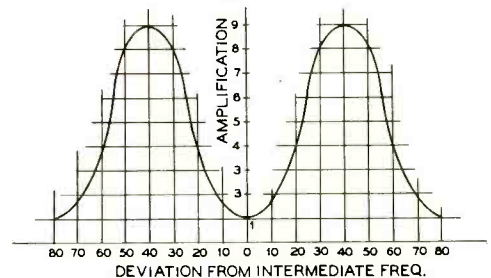

Figure 3. Block diagram of the panoramic radio spectroscope.

tor C is effected by electronic means. A reactor tube (D) is connected to this oscillator through proper phase shifting circuits in such a manner as to become an equivalent inductance in parallel with the oscillator tank. By varying a controlling voltage applied to the grid of this tube, the inductive reactance between the plate and cathode changes in such a manner as to vary the frequency of the oscillator proportionally to that voltage. Such a controlling voltage variation is applied periodically, thirty times per second, by feeding into the reactor tube part of the output of the sawtooth voltage (figure 6A) which, starting from zero volts, rises linearly (proportionally to time) up to

Figure 4. Band-pass characteristic of "A" in figure 3.



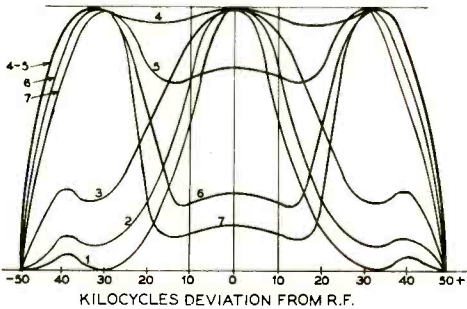

Figure 5. R.f. input characteristics at converter input "B" (in figure 3).

maximum value $+e$ within $1/60$ second, then drops to $-e$ practically instantaneously, and then rises again linearly, within $1/60$ second to zero voltage. This represents a complete cycle lasting $1/30$ second.

The oscillator frequency varies in the same manner (see figure 6B). When the sawtooth voltage is equal to zero, the oscillator frequency is at its mean frequency F_0 ; as the sawtooth voltage rises to its maximum positive voltage ($+e$) the oscillator frequency rises to its maximum frequency of $F_0 + 50$ kc. As the sawtooth voltage instantaneously drops to maximum negative voltage ($-e$), the oscillator frequency instantaneously drops to $F_0 - 50$ kc. and as the voltage again rises to zero volts, the oscillator frequency increases to the mean frequency F_0 .

It can be seen, therefore, that the maximum limits of frequency sweep are determined by the peak sawtooth voltage applied to the reactor tube. If only half of the above peak voltages are applied to the reactor tube, the oscillator will vary over a band only half as wide. In other words, the total bandwidth of the oscillator frequency sweep is proportional to the sawtooth voltage applied.

This process is the same as that normally producing f.m. signals with a reactance tube,

except that a sawtooth wave is used instead of voice or sine wave modulation. Referring again to figure 3, it is seen that the variable frequency signal output of the oscillator C and the mixed signals of various frequencies coming from input A are mixed in the converter B. The output of this converter is passed into channel \bar{E} .

This channel is sharply tuned to 100 kc. and will successively select and amplify each of the signals coming through the input A, at a given time only. To be specific: each signal will pass through E *only* during the moment when the difference between the signal frequency and the oscillator frequency is 100 kc.

When the variable oscillator frequency value F_{0x} passes through the specific value F_0 (355 kc.), the variable signal frequency value F_{1x} becomes the specific value F_1 (455 kc.). However, the signals F_1 are those which are produced in the radio receiver mixer, when tuned to a given signal of frequency F_s , generally readable on its dial. Therefore, it can be said that when the oscillator of the adapter passes through its mean value F_0 (355 kc.) we shall see the signals to which the radio receiver is tuned and which are audible in its phones or speaker. By the same reasoning, it can be seen that when the oscillator frequency becomes $F_0 + 50$ kc. (405 kc.) we shall see signals 50 kc. higher in frequency, and when the oscillator frequency becomes $F_0 - 50$ kc. (305 kc.) we shall see signals 50 kc. lower in frequency.

After amplifying the successively received signals they are fed into a detector and a video-amplifier. They are then applied to the Y-plates (vertical deflection plates) of a cathode ray tube.

Part of the output of the sawtooth voltage generator is fed to the X-plates (horizontal deflection plates) of the cathode ray tube. Before doing so, however, the cathode ray spot is positioned by means of a horizontal positioning control, on the center of the screen. Upon applying sawtooth voltage, the spot will sweep the screen equally on each side of the zero mark. If the amplitude of this voltage is properly adjusted the spot will reach the extreme right of the screen scale, corresponding to calibration point $+50$ kc., when the sawtooth voltage reaches maximum positive voltage, at which time any signals perceived on the cathode ray screen must correspond to the maximum frequency value $F_s + 50$ kc. The spot will be at the extreme left when the sawtooth voltage reaches maximum negative voltage and when the signals perceived on the screen correspond to the maximum frequency $F_s - 50$ kc. The spot will pass through the center of the screen marked O when the signal received

[Continued on Page 46]

Figure 6.

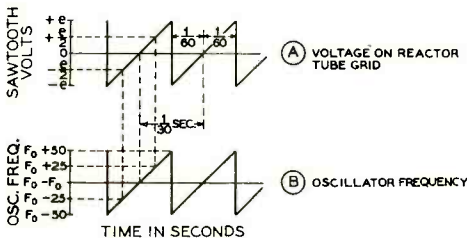

Q. & A. STUDY GUIDE

Covering Radio

Theory and Practice

(CONTINUED FROM LAST MONTH)

CONDUCTED BY W. W. SMITH

CORRECTION: In last month's installment appeared a typographical error in the answer to question 19. The formula for power stored in a condenser is $W = \frac{1}{2}CE^2$, and *not* $W = \frac{1}{2}E^2$.

ELEMENT 2

(Second Installment)

(136) Describe the characteristics of a vacuum tube operating as a class A amplifier.

The tube is biased and excited to operate over the linear portion of the characteristic curve, and plate current flows for the entire excitation cycle. The efficiency is greatest at maximum excitation, but is low in any case.

(137) Describe the characteristics of a vacuum tube operating as a class B amplifier.

A class B amplifier is biased to cutoff. The positive side of each excitation cycle is reproduced, but this gives only half-wave pulses in the plate circuit. When the tube is properly loaded, the output r.f. voltage varies linearly with excitation voltage over the positive half cycle.

The missing half cycle is supplied by the fly-wheel effect (Q) of the plate tank circuit in a class B r.f. amplifier, and by another tube (to permit push-pull operation) in a class B a.f. amplifier. Efficiency and plate current are proportional to the excitation voltage.

(138) During what portion of the excitation voltage cycle does plate current flow when a tube is used as a class B amplifier?

Plate current flows for approximately 180 de-

grees of the excitation cycle except at very low signal levels. (The tube normally is biased to "projected" cutoff rather than actual cutoff.)

(139) Does a properly operated class A audio amplifier produce serious modification of the input wave form?

No. Refer to answer 136.

(140) What is the meaning of the term "maximum plate dissipation"?

This is the maximum permissible amount of heat which the plate of the tube can dissipate safely. It is equal to the d.c. plate input multiplied by the efficiency of the stage.

(141) What is meant by a "blocked grid"?

A blocked grid is a grid which has sufficient negative bias to cut off all plate current flow.

(142) What is meant by the "load" on a vacuum tube?

The load on a vacuum tube is the impedance into which it works.

(143) What circuit and vacuum tube factors influence the voltage gain of a triode audio frequency amplifier stage?

The voltage gain of a triode audio frequency amplifier stage is affected by the amplification factor of the tube; the primary inductance of the coupling transformer if used; the turns ratio of the coupling transformer if used; the value of the plate resistor, coupling condenser, and following grid resistor if the stage is resistance coupled; the plate resistance of the tube; and the operating potentials supplied to the tube.

Some of these factors have but little effect upon the amplification over wide limits, while others have very great effect. Some of them, such as the primary inductance of the transformer or the capacity of the coupling condenser, are interdepend-

ent upon the frequency of operation, while others, such as the amplification factor, have nothing to do with frequency.

(144) What is the purpose of a bias voltage on the grid of an audio frequency amplifier tube?

The purpose of the bias on the control grid is to locate the operating axis at the desired point on the characteristic curve.

The purpose of bias on other grids (in a multi-element tube) is to permit each of these grids to perform its function most effectively.

(145) What is the primary purpose of a screen grid in a vacuum tube?

The primary purpose of the screen grid is to raise the amplification factor of a tube and (in the case of tubes for r.f. service) to permit amplifier operation without need for neutralization.

(146) What is the primary purpose of a suppressor grid in a multi-element vacuum tube?

The primary purpose of a suppressor grid is to minimize the flow of electrons from the plate to screen by secondary emission when the plate voltage is low in proportion to the screen voltage.

(147) What is the meaning of the term "plate saturation"?

There are two conditions of "plate saturation." One is where all the electrons the cathode is capable of emitting are attracted to the plate, and raising the plate voltage or lowering the negative grid bias will not cause an increase in plate current. The other condition is where the control grid is more positive than the plate or screen, and making the grid more positive does not result in an increase in plate current.

(148) What is the most desirable factor in the choice of a vacuum tube to be used as a voltage amplifier?

A high amplification factor, as a coupling transformer then is not necessary in order to obtain high amplification.

(149) What is the principal advantage of a tetrode over a triode as a radio frequency amplifier?

The tetrode does not require neutralization if the tube is thoroughly shielded and the amplifier properly constructed.

(150) What is the principal advantage of the tetrode as compared to the triode, when used in a radio receiver?

High gain, multi-stage r.f. amplifiers are more easily built using screen grid tubes. (Refer to answer 149.)

(151) What is the principal advantage in the use of a diode detector instead of a grid leak type detector?

The diode will handle a high signal level without distortion, while a grid leak type detector will not.

(152) Draw a grid voltage vs. plate current characteristic curve of a vacuum tube and indicate the operating points for class A, class B, and class C amplifier operation.

Refer to diagram 152. There are two modes of class A operation, one in which the grid never is allowed to go positive and one in which the grid is driven positive. The former is designated as A_1 in the chart and the latter as A_2 .

With a pentode or beam tetrode, the operating point is half way between cutoff and zero bias for class A_1 operation, or midway along the straight portion of the curve for class A_2 operation.

With a triode, maximum undistorted output is obtained not with the bias at the midway point, but slightly more negative. The exact optimum bias is dependent upon the load impedance. For a triode operating class A_1 into a load impedance equal to twice the plate resistance of the tube, the bias normally is made about 0.6 or 0.65 times cutoff. This bias permits maximum undistorted output under these conditions.

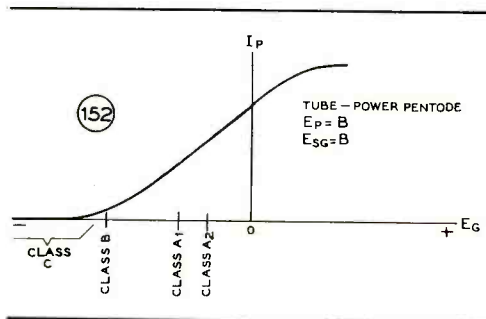

(153) What operating conditions determine that a tube is being used as a "power detector"?

The tube is biased approximately to cutoff, usually by a heavily bypassed cathode resistor but sometimes by a battery or drop across a common power supply resistor.

The cathode resistor is chosen so as to give the desired bias with a signal of average strength.

(154) Why is it desirable to use alternating current supply for vacuum tubes?

It is cheaper (unless the a.c. has to be obtained from d.c.), more convenient, and prolongs the life of directly heated cathode types by equalizing the average emission from the two halves of the filament. The latter is particularly true when the filament voltage is an appreciable portion of the cutoff bias and heavy plate current is being drawn.

(155) Why is it advisable to periodically reverse the polarity of the filament potential of high power vacuum tubes when a d.c. filament supply is used?

This ties up with Q. & A. number 154. When the filament voltage is an appreciable portion of cutoff bias, then there will be considerably more emission from one end of the filament than from the other, as the operating grid potential with respect to any point on the filament is determined not only by the C bias, but also by the voltage drop across the filament.

A periodic reversal of polarity tends to even up the wear on the filament.

(156) Why is it important to maintain transmitting tube filaments at recommended voltages?

If the rated filament voltage is exceeded only slightly, the life of the tube is considerably shortened. If the filament voltage is low, the tube will not operate properly.

Thoriated tungsten filament tubes can be damaged by running the filament voltage too low as well as too high, particularly when run at high plate input.

(157) How may certain vacuum tube filaments be reactivated?

Thoriated tungsten filament tubes which have lost emission often can be reactivated successfully by "flashing" and "cooking" the filament with all other voltages disconnected. A voltage much higher than normal is applied for a short period, then a voltage slightly higher than normal is applied for a long period. The best treatment for a particular type tube can be obtained from the manufacturer, as some tubes require different treatment from others.

(158) When an alternating current filament supply is used, why is a filament center-tap usually provided for the vacuum tube plate and grid return circuits?

A center tap connection minimizes hum resulting from the alternating potential gradient along the filament. This alternating potential is applied to both the grid and plate circuits, and is much greater when no center tap connection is used.

It should be observed that a center tap connection does not completely eliminate the difficulty; but it does greatly reduce it, especially when the tube is biased class A.

When no center tap is used, the ripple introduced by filament voltage modulation of the bias and plate voltage is of the same frequency as the supply voltage frequency. But when a center tap connection is employed, the ripple frequency is doubled and greatly reduced.

(159) What type of vacuum tube filaments may be reactivated?

Only thoriated tungsten filament tubes may be reactivated successfully.

(160) Explain the operation of a grid leak type detector.

The negative bias and therefore the plate current of a grid leak type detector is dependent upon the r.f. signal voltage. This is true because the r.f. signal voltage develops a bias across the grid leak as a result of the rectifying action of the grid. At low signal levels the grid may be considered as a non-linear impedance, while at high signal levels it may be considered as a half-wave rectifier. In either case rectification takes place, and bias is developed across the grid leak in the manner of a diode peak rectifier.

If the grid condenser is made sufficiently small in value, the bias developed across the grid leak by the r.f. voltage applied to the grid can follow a.f. variations in the amplitude of the r.f. voltage. Thus the modulation envelope of a modulated carrier is reproduced in the plate circuit of the detector.

The action of a grid leak detector is quite similar to that of a diode detector which is direct coupled to an a.f. amplifier.

(161) List and explain the characteristics of a "square law" type of vacuum tube detector.

A true square-law detector delivers an output voltage which is proportional to the square of the input voltage. Such a detector is not suited to the distortionless detection of double sideband modulated signals unless the modulation percentage is quite low. However, such a detector gives distortionless detection of single sideband modulated waves (heterodyne detection).

The square law detector does not generate high order harmonics of the carrier frequency, and is useful in certain applications for this reason. The square law detector is not as efficient as a linear detector.

(Note: The foregoing applies to the usual square-law detector in which the tube operates on the curved portion of the characteristic curve, with both positive and negative half-cycles producing an effect upon the plate current. A variable μ tube biased to cutoff is sometimes referred to as a "square law detector," but this is a special case, in which negative half cycles of the excitation voltage have no effect upon the plate current and the rectification efficiency is high.)

(162) Explain the operation of a diode type of detector.

The diode type detector is simply a peak rectifier which has a time constant sufficient to wipe out the carrier frequency but not the modulating frequency. The voltage across the load resistor follows the peak r.f. voltage applied to the detector, in a linear manner. Therefore the voltage across the load resistor is a replica of the modulation envelope of the modulated carrier applied to the detector.

(163) Explain the operation of a "power" or "plate rectification" type of vacuum tube detector.

Assuming that a relatively large signal is applied to the grid, plate current flows only on the positive half-cycles of the excitation voltage. If the tube has a linear characteristic curve, it will be seen that the pulses appearing in the plate circuit will be exactly the same as those appearing across the load resistor in a half wave diode detector. The advantage of the power detector is that the tube supplies some gain and does not load the preceding circuit.

The plate resistor is bypassed for r.f. but not a.f., and therefore the a.f. component or modulation envelope is recovered and passed through the a.f. amplifier.

(164) Is a "grid leak" type of detector more or less sensitive than a "power" detector (plate rectification)? Why?

The grid leak type is more sensitive, meaning that it will produce more a.f. output from a *weak* signal that is modulated. On a strong signal (almost sufficient to block the detector) there is little difference.

There is a common misconception that a grid leak type detector is more sensitive than a power detector because of the fact that the grid leak type is a "square law" detector. This is not true. A square law characteristic does *not* favor weak signals; the rectification efficiency is low. Besides, when properly designed, *both* a grid leak detector and a power detector are square law detectors on *weak signals*, and linear detectors on moderately strong signals.

The grid leak detector is the more sensitive because the transconductance of the tube is greater near zero bias than it is on the elbow of the characteristic curve near cutoff bias, and because the curvature (equivalent to rectification efficiency) is greater at zero bias.

(165) Describe what is meant by a "class A amplifier."

A class A amplifier is one which is so biased, loaded, and excited that the output is an undistorted replica of the waveform applied to the grid. The plate current as read on a d.c. meter does not change with excitation voltage.

A class A_1 amplifier is operated so that the grid never is driven positive. In a class A_2 amplifier somewhat less bias is used and the grid is driven positive on peaks. In neither type of operation is the plate current cut off over any portion of the excitation cycle.

(166) What are the characteristics of a class A audio amplifier?

A class A amplifier produces very little distortion of the signal, but the amplifier draws a continuous input, whether excited or not, of at least three times the maximum undistorted output power. (See also answer 165.)

(167) What are the advantages of operating two tubes in push pull rather than in parallel for an audio frequency amplifier?

The direct current flowing to the two tubes through the output coupling transformer or choke will buck when the two tubes are operated in push pull, reducing a tendency towards core saturation and permitting use of a much smaller core.

Even-harmonic distortion is cancelled out in the push pull arrangement. This permits the tubes to be biased higher than for class A operation, with a substantial increase in maximum undistorted output power and plate circuit efficiency, and a decrease in the resting plate current.

(168) What will be the effect of incorrect grid bias in a class A audio amplifier?

In any case the maximum undistorted output will be reduced. The plate current will be either higher or lower than the value existing with correct bias, and may be so high as to damage the tube by excessive plate dissipation.

(169) Why is an audio transformer seldom used in the plate circuit of a tetrode used as an audio frequency amplifier?

The term "audio frequency amplifier" means a voltage amplifier, as contrasted to an "audio frequency power amplifier."

With a voltage amplifier tetrode it is possible to obtain a high value of voltage gain with resistance coupling, which provides better frequency response and is cheaper than transformer coupling.

(170) What is the purpose of a bias voltage for the grid of a vacuum tube?

The bias voltage sets the operating point for the tube. (Refer to answer 144.)

(171) Why are tubes, operated as class C amplifiers, not suited for audio frequency amplification?

In a Class C amplifier, plate current flows for substantially less than one half each input cycle. Therefore, even though two tubes were operated in push pull, there would be serious distortion in the output waveform unless the stage worked into a tuned tank circuit. As audio frequency amplifiers as commonly used must pass a wide band of frequencies, a tuned output tank is impracticable. Therefore, class C audio amplification is impracticable.

(172) Draw a circuit of a "frequency doubler" and explain its operation.

(Refer to diagram 110.) For high efficiency, the control grid would be biased sufficiently high that each excitation pulse would be approximately 90 degrees. The effective excitation on the grid then would be substantially the same as though the tube were biased class B and excited at twice frequency *with every other excitation pulse missing*. If the plate tank is tuned to twice the resonant frequency of the grid tank and has sufficient Q, the "flywheel effect" will sustain oscillation during each "missing" excitation pulse and operation will be very much the same as for a class B amplifier operating "straight through."

(173) For what purpose is a "doubler" amplifier stage used?

A doubler stage is used when it is desired to obtain antenna power on an even multiple of the oscillator frequency. Oftentimes it is impracticable or undesirable to design the oscillator to operate on the same frequency as the final amplifier, particularly when a quartz crystal is used and the transmitter is to operate above 5000 kc.

(174) What would be the effect, in a class C modulated amplifier using grid leak bias only, of a loss of excitation?

Loss of excitation would result in loss of negative bias, and the tube would be running at zero bias. Unless the plate voltage were lower than the rated value, or the static plate resistance of the tube high (such as in so called "zero bias" tubes), the plate dissipation probably would be excessive. With tubes having low plate resistance the plate current might even exceed the normal operating value, in which case the tube (or tubes) would be saved from damage if a suitable fuse or overload relay were connected in series with the d.c. plate current.

The fact that the tube is being modulated has little to do with the case, though the change in plate current to the modulated stage when excita-

tion was removed would result in a change in load impedance on the modulator tubes.

(175) What effect upon the vacuum tube plate current will be noted as the plate circuit resonant frequency of an r.f. amplifier is varied?

There will be a dip in the plate current as the tank is tuned through resonance. If the loaded Q of the tank is high, then the plate current will be minimum exactly at resonance. The more heavily the amplifier tube is loaded, the greater will be the minimum d.c. plate current.

(176) What type of oscillator or amplifier is best suited for use in a frequency meter? Describe the desirable characteristics.

When the power supply is not voltage regulated, an electron coupled oscillator is desirable, because the oscillator constants can be so proportioned that the oscillation frequency is substantially independent of plate voltage. The electron coupled oscillator also provides isolation of the oscillator tank from the output circuit, being equivalent in this respect to an ordinary triode oscillator with a buffer amplifier stage.

A frequency meter should contain an oscillator which is virtually immune to mechanical vibration, does not drift in frequency with change in ambient temperature, does not change frequency with change in line or battery voltage, and does not require an excessively long time to "settle down" after being turned on. It should be followed by a buffer amplifier (or amplifiers) which eliminates all reaction of the output circuit upon the oscillator frequency.

(177) Describe what is meant by "link coupling" and for what purpose(s) is it used?

Link coupling is an "indirect" form of inductive coupling between two tank circuits. The two tank circuits are coupled by means of a low impedance transmission line. It is useful whenever it is desirable to provide inductive coupling between two tank circuits which are separated physically some distance, or where direct inductive coupling would be impracticable from a mechanical standpoint.

Link coupling is most commonly used between amplifier stages in a transmitter, and between a final amplifier and antenna tuning tank.

(178) What factors may cause low plate current in a vacuum tube amplifier?

Low plate voltage, excessive bias, insufficient loading, insufficient excitation (when fixed bias is used), or loss of filament emission may cause low plate current.

(179) Given the following electron tube constants: E_p 1000 volts, I_p 150 ma., I_c 10 ma., and grid leak 5000 ohms, what would be the value of d.c. grid bias voltage?

The bias is developed by the d.c. grid current flowing through the grid leak. If no other source of bias were employed, the total grid bias would be equal to the grid leak resistance times the grid current (in amperes). This application of Ohm's law gives 50 volts of bias.

The plate voltage and plate current would not enter into the calculations.

(180) Explain how you would determine the value of cathode bias resistance necessary to provide correct grid bias for any particular amplifier.

The first thing to determine is the required amount of bias for the desired class of operation at the plate voltage employed. This can be taken from the manufacturer's data sheets. It should be borne in mind, however, that the actual plate voltage will be the plate supply voltage (under load) less the cathode bias voltage.

Having determined the required bias voltage, this value is divided by the total space current (not just plate current) that should obtain under the desired operating condition. The answer will be the correct value of cathode resistor, as we are dividing the desired voltage drop across it by the total d.c. current flowing through it.

TO BE CONTINUED

• • •

Nostalgic Note

Mr. Darrell Froom, of Santa Maria, California comes forth with a solution to the difficulty experienced in providing air raid warning sirens which can be heard everywhere under all conditions.

Coupled to the siren or used in conjunction with it would be a good old rotary gap—one with plenty of fire—coupled to an aperiodic radiator broadly tuned to the center of the broadcast band.

The first half minute of the siren blast would be augmented by a little "old fashioned" r.f. Receivers tuned to any local station would be warned of the raid; so blanketing of the spark signal by a powerful local would not be anything to worry about. Those listening to out-of-town stations would not have the benefit of so many microvolts, and the "alarm signal" undoubtedly would ride in over Glenn Miller, if not actually smother him. Interference to other services would be minimized by limiting the r.f. alarm signal to one single "whooooooooooooo."

If the gap were allowed to pick up speed gradually and coast to a stop, to simulate the note of a siren, it would be unlikely that the noise would be mistaken for electric shaver QRM. However, should this possibility exist, the signal could be keyed slowly with letter "V."

And we'll bet that somebody will write in to say that if the rotary gap he operated "back when" were used, the regular acoustical siren would no longer be required.

POLICE DEPARTMENT ♦ ♦ ♦

SOME KINKS ON NOISE ELIMINATION

By H. W. BRITAIN,* W6OQX

Police departments usually are located in or near the heart of the city and any receivers used there are apt to pick up excessive noise. There is nothing more annoying than the crackle and popping of a receiver when trying to carry on a conversation, either on the telephone or in person. Some of this noise can be eliminated by elevating antennas well above everything in the neighborhood and feeding with concentric or twisted pair line. Putting suppressors on all automatic signs, calculating machines, electric motors, etc., in the neighborhood is a sure cure, but in many metropolitan areas this is practically a hopeless task, and the expense so great as to make it prohibitive in some cases.

After a careful study of all possibilities for eliminating some or all of the noise, each of the following was tried and the results tabulated for the benefit of others who might profit by them. The first, of course, is the installation of a good doublet antenna with concentric line feed to the receiver. There are so many satisfactory variations of this type that no recommendation as to make, construction, length, or height will be made here. Choose the type that suits your particular requirements and get it as far away from the main source of the noise as possible.

The important thing is to get as much signal pickup as possible with the least noise. The amount of noise pickup is not as important as the signal to noise ratio. A slight increase in noise can be tolerated if the signal is several times as loud.

When contemplating the purchase of a new receiver one is able to find just about anything in the way of modern improvement, but for those of us who have old receivers and have to use them, much can be done to cut down noise between calls by the installation of a squelch or "Q" circuit. Offhand this seems to be quite complicated, but in many cases a squelch can be

installed without the addition of many new parts and tubes. With the unlimited choice of tubes on the market no trouble should be encountered in choosing the proper tube layout to suit the particular situation.

Any high μ triode is suitable for a squelch circuit. Tubes such as the 6Q7, 6SQ7, 6SF5, 75, 2A6 or any tube having a μ of 60 to 100 works well. The Q tube depends on the rectified carrier to operate it, and a tube having too low a μ will require too much voltage to operate it. (Refer to figures 2 and 3.) This type Q circuit requires three sets of tube elements to operate: two complete and separate triodes and one diode. The diode acts as second detector, the first triode unit as a d.c. voltage amplifier and the second triode unit as audio amplifier.

This combination can be made up in several ways, such as with a 6H6, 6F5, 6F5; a 6H6, 7F7; or a 6SQ7, 6SF5. There will be no difference in the operation or results. In most cases a tube will have to be added to the receiver. If there is no room on the chassis it often can be mounted under the chassis, or else elevated above the chassis. After the incorporation of a Q circuit it sometimes is found that the noise is of such magnitude that the squelch will not squelch. There is a limit to the amount of unwanted noise a squelch will keep out, the limit of its action being when the noise is almost as loud as the weakest signal that must be received.

Some control over the "threshold" on the squelch, the value at which it operates, can be had by adjustment of the tap on R_0 . However, an attempt to obtain very much threshold adjustment by this means will result in improper bias on the audio tube and consequent distortion on loud signals.

Greater control over the threshold may be had, when necessary, by incorporating a 1 megohm potentiometer to reduce the amount of voltage supplied to the squelch tube by whatever amount needed. The input to the squelch tube can be cut down until it just will operate

*Radio Supervisor, Santa Barbara Police Dept., Santa Barbara, California.

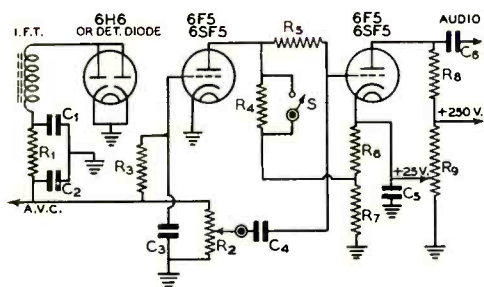

Figure 1

Squelch circuit suitable for use on any standard communications receiver. The output of the a.f. voltage amplifier (the second tube) is more than sufficient to drive an output pentode.

- | | |
|--|---|
| R ₁ —25,000 ohms, 1/2 watt | (to cut squelch in or out) |
| R ₂ —500,000 ohm pot., a.f. gain taper | C ₁ —.0001 μfd. mica |
| R ₃ , R ₁ , R ₅ —1 megohm, 1/2 watt | C ₂ —.0001 μfd. mica |
| R ₆ —750 ohms, 1/2 watt | C ₃ —.01 μfd. tubular |
| R ₇ —10,000 ohms, 1/2 watt | C ₄ —.01 μfd. tubular |
| R ₈ —250,000 ohms, 1 watt | C ₅ —10 μfd. 50 v. electrolytic |
| R ₉ —Regular divider in receiver | C ₆ —To suit following grid resistor |
| S—S.p.s.t. toggle switch | |

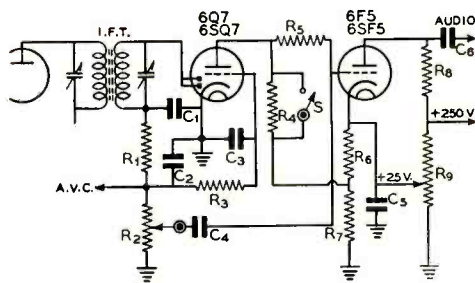

Figure 2

This circuit is essentially the same as that of figure 1 except that a dual purpose tube has been employed in order to minimize the number of socket holes. For constants, refer to figure 1.

ance of from 2 to 3 times the rated impedance of the voice coil. The voice coil is connected to the movable arm and one end. This arrangement will give a smooth, "spread out" control of the volume over a range of about 10 or 12 db, which is sufficient if the receiver a.v.c. meets the requirements previously specified.

[Continued on Page 57]

positively on the weakest signal to be received. With this adjustment the squelch is not likely to be triggered off by noise pulses, unless of course the noise is as loud as the weaker signals.

If your location is a city hall, courthouse or other large building, receivers can be installed in some room near the top of the building away from much of the noise, with the voice leads running to a remote speaker installed in the operating room. It is somewhat of a problem to control the volume over a wide range in a three- to five-ohm voice lead; so two transformers are used: a voice coil to 500 ohm line and 500 ohms to voice coil. (See figure 3A.) A 500-ohm L pad is inserted between these two transformers and the volume can be controlled very smoothly at the speaker. The volume on the receiver is set just a little past comfortable volume, giving some to spare.

If the a.v.c. of the receiver works exceptionally well, and holds the audio volume constant within a few decibels even on the weakest signal that will "untie" the squelch, then a simpler arrangement can be used.

The speaker is fed via a twisted pair from the voice coil winding on the transformer, the 500-ohm line and transformers being dispensed with. This is perfectly satisfactory so long as the leads are at least no. 16 for distances up to 150 feet or no. 14 for distances up to 250 feet.

Volume is controlled at the speaker by placing across the line a wire wound potentiometer (inexpensive linear-taper type) having a resist-

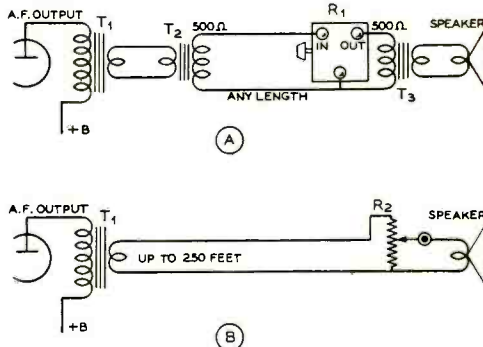

Figure 3

The arrangement shown at A is for remote operation where the speaker must be more than 250 ft. from the receiver, or where smooth a.f. gain control over a range exceeding 12 db is necessary at the speaker. The arrangement at B will be found satisfactory in most cases. A plate to 500 ohm line transformer may be substituted for T₁ and T₂ if desired, but as T₁ already is part of the set, no saving in transformers is realized. The substitution of a single transformer for T₁ and T₂ will cut down insertion loss, however.

- | | |
|--|--|
| T ₁ —Regular plate to voice coil transformer | R ₂ —Wire wound potentiometer (no taper) having resistance equal to 2 or 3 times the rated impedance of the speaker voice coil. |
| T ₂ , T ₃ —500 ohms and voice coil | |
| R ₁ —Constant impedance attenuator pad (500 ohms) | |

Sound

RECORDING AND REPRODUCTION

SOUND EFFECTS FOR LAUGHS WITH HOME MOVIES

By RAY ERLBORN*

More and more home movie enthusiasts are using home recording units to add sound to their eight and sixteen millimeter films. Here is a method for synchronizing humorous sound effects to these home movies!

With this method it is not necessary to "splice" the entire reel. When recording the sound effects, just record one sound at a time and leave a small space on the record between each recorded cut. Sound effects recorded in this manner may be "cued" into the picture by the operator. He simply watches the screen and when it comes time for the effect, he sets

*Sound Effects Engineer for the Al Pearce Program, Columbia Broadcasting System



the needle on the record in the first groove of the "band" cut with the desired effect.

To eliminate the possibility of choosing the wrong cut, a label can be pasted in the center of the record, listing the different sounds and the order in which they appear on the record.

When dubbing sound effects to films, it is not necessary to make the sound authentic *if the film is meant to be a comedy*. The sound effects men in radio have learned that laughs can be provoked by bringing a horse to a stop with a screeching sound like the squealing of brakes, or making an auto sound like a cement mixer (Jack Benny's Maxwell, for instance), or in many other ways.

Suppose you had a picture of some member of the family floating on his back in a swimming pool, kicking his feet vigorously as he demonstrates his backstroke to the family. It should get a laugh if the sound of an outboard motor were heard during this scene. To get this sound effect you needn't record an outboard motor. Get a fair sized piece of thin cardboard and hold it firmly in both hands, close to the microphone. As you bend it back and forth rhythmically, the sound of an outboard motor will be recorded on the disc. (A little experimenting will show how to get the desired sound.)

On one Al Pearce program, when Elmer Blurt bit into one of Mrs. Newbride's biscuits, the sound you heard was the "effects" man chewing a couple of Life Savers close to the mike. Other humorous chewing effects can be made with celery or carrots.

When cueing sound effects, don't forget "comedy timing." Many times a slight pause

[Continued on Page 58]

Ray Erlenborn, sound effects engineer for Al Pearce and his Gang, on the alert for his cue.

Incidental Music

FOR RECORDED SKETCHES

By SIEGMUND A. E. BETZ*

Amateurs who make radio-script type records can easily have professional-sounding incidental music for backgrounds or transitions. It is possible to have the Minneapolis Symphony Orchestra play just the right bit, or Nelson Eddy hum just the right snatch of song, for your home-recorded sketch!

A rather special technique is required, however, for direct use of full-length professional recordings (yes, it's done with records!) as incidental sound or music is difficult. The few bars of Beethoven's Fifth Symphony that will provide just the right atmosphere for the lovers' quarrel are to be found, perhaps, about an inch and a half from the center of the disk.

About an inch and a half! To use these few measures the amateur sound-effects man must be ready to place the pick-up at exactly the right moment on exactly the right place. An error in judgment of two or three grooves may bring in strains of an entirely different mood, inappropriate to the sketch. He must also control volume so that the music may be "sneaked" in and faded out properly. If the incidental music for the sketch draws upon several selections, he must be able to make quick, noiseless shifts while recording is going on. Under these circumstances, making a smooth scene with incidental music or theme song is almost impossible.

A professional sound effects man has the benefit of a highly accurate, mechanical "spotting device" which enables him to pick out any portion of a commercial or prepared effects record without danger of missing by more than one groove. However, these "spotting" contraptions are precision equipment, and besides being expensive, are not very satisfactory unless used with a professional type recorder of the type employing lathe feed.

All this trouble can be eliminated by the preparation of an *intermediate record* to be used especially with the script in question. Such a record consists of a blank on which are cut, *in proper sequence*, the musical bits that

are to be used in the sketch; these sections of re-recorded music are separated by *bands of uncut surface*.

Preparation is comparatively easy. The desired music is found on the professional record; its *approximate* limits are carefully noted. (Since the final recording will be, so far as the incidental music goes, a *re-re-cording*, it is important for the best results that the original professional record be as new as possible.) The microphone is placed close to the speaker of the phonograph or is replaced with the "dubbing" pickup. Volume control of the recorder is set near zero.

Both turntables are started at about the same time. The pickup is set to play several grooves before the desired theme. As this appears in the music, recorder volume is increased, and when the time for the fade-out comes, it is decreased to zero again. After a few dead grooves, the cutting head is raised.

The resultant recording will consist of several dead grooves, followed by music sneaking in and reaching a climax which is held as long as desired, and which in turn is followed by a decrescendo and several dead grooves again. At least a quarter of an inch of surface should be left uncut between the section just completed and the next one. Several such bits of incidental music can easily be put on one side of even a small blank.

Use of the intermediate record containing such pre-arranged music is simple. The record can be played at constant volume, since crescendo and diminuendo are taken care of as it is made. The dead grooves at the beginning and end of each section facilitate timing and prevent sudden blasts of background. Rehearsal time will be less than half that required when the background music is taken directly from professional records.

Experimenting with the method will suggest a number of variations. For instance, sound effects can be run in with the music, in certain cases. "Crashes" and sudden crescendos can be produced by proper manipulation of the recorder volume control.

*2413 Ohio Avenue, Cincinnati, Ohio.

The Amateur Newcomer

A Code Practice Oscillator or Keying Monitor

By W. W. SMITH,* W6BCX

Two versions of this device are described: one which is designed specifically for use as a code practice oscillator, the other for use either as code practice oscillator or as a keying monitor. As a monitor, it will show up a rough or chirpy note.

The first of the two units to be described is merely a simplification of the second, and is for those who are interested in a code practice oscillator but have no use for a keying monitor. The second is a modified version of the combination code practice oscillator and r.f. driven keying monitor described by the author in the November, 1940 issue of RADIO.

The new version is substantially the same except for the addition of volume and pitch controls, and provision for making the unit independent of batteries when used as a code practice oscillator. A desire to make the original version as simple as practicable resulted in the omission of these features. However, the incorporation of these refinements is very much worthwhile, particularly when the device is to be used exclusively as a code practice oscillator.

Describing the simpler unit first, the code practice oscillator of figure 1 consists of a single-tube feedback oscillator in which the necessary phase shift in feedback voltage is supplied by the center tapped output transformer, T, and by the grid-leak-condenser combination C₂ and R₂-R₃. The oscillation frequency can be made higher than the "natural" period of the transformer by so proportioning the grid condenser and leak that phase shift takes place at the "natural" frequency of T. At some higher frequency the combined phase shift will be favorable for

oscillation.

This permits a simple method of varying the oscillation frequency. The grid leak is made variable and C₂ and C₁ are so chosen that varying the grid leak permits a wide change in frequency with strong, stable oscillations over the whole range. The correct "outside" terminal of the tapered potentiometer must be used or else most of the frequency change will occur at one end of the pot.

The rectifier section of the tube is employed as a half-wave power supply rectifier. The resistor R₄ and electrolytic capacitor C₄ provide sufficient filtering to give a note with negligible power frequency ripple.

This type of oscillator is rich in harmonics, which results in a note that is pleasant to copy, a note which does not tire the ear as quickly as does a pure sine tone.

Volume is adjusted by means of the low resistance potentiometer R₁. This potentiometer should have a resistance of between 2 and 3 times the voice coil impedance of the speaker used, a value of about 15 ohms being satisfactory for most speakers. By using the right value of resistance, smooth control of volume is obtained over a wide range, without crowding much of the range over a small portion of the shaft rotation. As a small amount of power is wasted in the potentiometer even at full volume, a simple series rheostat would appear to be preferable. However, a rheostat would not be practical unless it had a semi-log taper, and such rheostats are not commonly available in low resistance values. The amount

*RADIO.

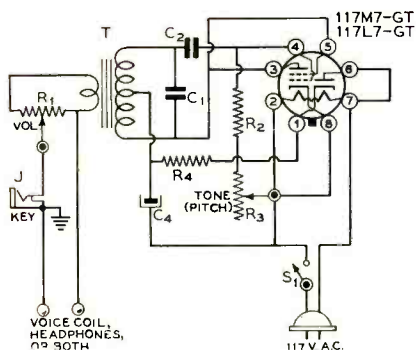

Figure 1. Schematic diagram of a.c.-d.c. code practice oscillator.

- R₁—Wire wound potentiometer, resistance equal to 2 or 3 times the rated voice coil impedance of the p.m. speaker used.
- R₂—50,000 ohms, 1/2 watt
- R₃—500,000 ohm pot., a.f. taper. Observe correct polarity (see text)
- R₄—1000 ohms, 1 watt
- C₁—0.1 μfd. paper tubular
- C₂—0.1 μfd. paper tubular
- C₃—40 μfd. 150 v. electrolytic
- J—Closed circuit jack
- S₁—Toggle switch (on-off)
- T—Small p.p. output to voice coil, 8000-10,000 ohms tot. pri. with speaker used.

of power lost in R₁ when used as shown is hardly enough to produce a noticeable difference in volume, and as the output is sufficient to make plenty of noise, the loss is nothing to worry about.

Keying is done in the output lead. This provides very clean keying with no clicks. Up to several dozen pairs of high impedance headphones may be connected in parallel across the output terminals along with the speaker voice coil. With high impedance phones of moderate sensitivity the volume will be just about right if the voice coil impedance is between 4 and 8 ohms. At normal room volume for the speaker, the earphone volume will correspond to what most operators consider to be normal earphone volume.

If the speaker is disconnected, the volume control no longer will work properly for earphones; most of the "control" will be at the low volume settings. However, as the volume ordinarily will be run pretty well towards full on for earphones, this may not be serious. If it is, a resistor equal to the voice coil impedance of the speaker or to about half R₁ may be substituted for the speaker when it is desired to silence the speaker for earphone operation.

The load into which the tube works is not particularly critical, but if too high or too low, the maximum output will be reduced a bit. If much lower than it should be for optimum operation, oscillation may not be obtained over the full range of R₁.

Transformer T should be chosen (or so adjusted if of the variable ratio type) so that the voice coil reflects an impedance of between 8000 and 10,000 ohms across the whole primary. Because of the shunting resistance of R₁, the load resistance will be somewhat less than this when R₁ is turned full on, or about 6000-7000 ohms. This value of load will give best output; but as previously mentioned, it is not serious if the load is a little lower or higher.

Keying in the output circuit also protects the operator from possible shock, often a hazard when keying an "a.c.-d.c." oscillator in the grid, plate, or power circuit.

Combination Unit

To use the oscillator as a carrier-driven keying monitor requires the addition of only a d.p.d.t. switch and a couple of bypass con-
 [Continued on Page 51]

Figure 2. Combination unit, can be used either as code practice oscillator or as a c.w. monitor.

- C₃—0.1 μfd. paper tubular.
 - C₅—0.003 μfd. mica
 - S₂—D.p.d.t. switch
- Other constants same as for fig. 1.

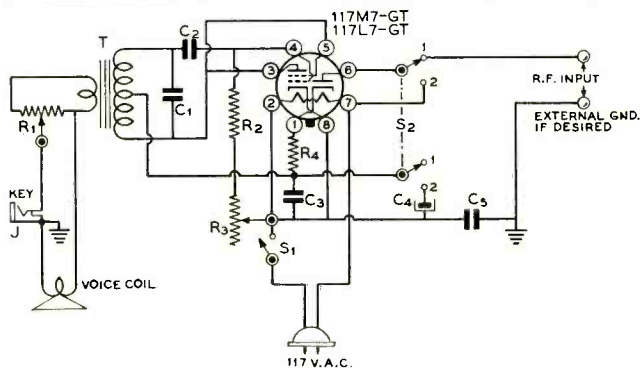



By PERRY FERRELL, Jr.*

Undoubtedly we have all heard it said from time to time that after this war is over the radio markets will spring alive with many new and unthought-of pieces of apparatus that will just about make the life of a radio amateur a rather ideal one. This particular thought was driven home at the recent I. R. E. convention in New York City, where the single exhibit to draw the greatest attention was the demonstration of simultaneous aural and panoramic radio reception.

Panoramic reception, as the name implies and is misleading at the same instant, shows upon a cathode ray tube screen exactly what is taking place along a specific radio band.

Imagine it! Calling CQ to a dead band and just shutting down the audio and parking near a favorite frequency or riding slowly over the band—actually looking for a signal—as even the weakest signal your receiver can push above the noise level can be seen on the screen.

The Panoramic Radio Spectroscope is really a second complete self-contained, self-powered conversion unit tied in with your present 5-meter dxers' i.f. (providing it is a 450-480 kcs. model). This variable bandwidth i.f. has 10 kc., 20 kc., 50 kc. or 100 kc. pass and feeds the cathode ray tube leaving only two controls, viz., horizontal and vertical ray positions, to be handled by the operator. Once set, however, the unit is completely automatic, the sweeps being set at the various bandpasses with no effect whatsoever on the original receiver. The sweep may be cut off completely and the modulation on the received carrier examined. Noise levels may also be measured and signals less than 3 kilocycles apart can be resolved.

Such an instrument today has a wide variety of uses and may allow a monitoring operator to cover the radio spectrum twenty times faster than by listening alone.

*107 East Bayview Ave., Pleasantville, N.J. Send contributions to Mrs. Josephine Conklin, W9SLG-W3JUX, 300 Wilson Lane, Bethesda, Maryland.

It is certainly unfortunate that at this time of National Defense, local petty politics have the strength and backing to interfere with the return of a portion of the radio amateurs to the u.h.f. bands. It is impossible to feel anything but grievance towards this malicious and unwarranted act of prejudice and false security. From across the continent reports have drifted in one by one, each stating that, "We have our equipment in good order and are ready to go back on, but local politics has things pretty well wound up."

From Washington no word of importance is forthcoming and no one seems likely to take the responsibility of saying, "Go ahead!" In some instances this is justifiable, for we only need one or two bad cases of impromptu acting and our portion of the OCD setup ends forever. Yet, handled correctly and efficiently, there are many brighter aspects.

Ours, at present, is a waiting game, but don't waste time; be prepared, get some degree of organization working, for, who knows, we will probably be called upon at the very last moment!

Out in Tucson, Arizona, W6OVK writes, "Have been tied up with organization of the local u.h.f. boys for 112-Mc. OCD work, and it sure calls for a lot of meetings and letter writing, etc. We now have 32 in the unit here and all are working on their gear and about 16 have rigs ready to go. Greatest difficulty has been providing emergency power supplies, but with help of the local radio service men we hope to have them all self-powered very shortly. . . . We feel pretty proud of Tucson for its size and feel that when this emergency is over our earnest efforts to provide emergency communications for the city and vicinity will not have been wasted."

Alan R. Eurich, of W7HFZ/WHFZ and W10XDA fame, writes that, "Since our low frequency bands are not so hot for state-wide defense communication for various obvious reasons, we hope to get an u.h.f. net working where a 100-mile hop is standard. But, although this looks fairly difficult, we do have some pretty nice hills out here with a nice little hump over by Bozeman, where several of the boys are, that runs up to over 11,000 feet. If those Arizona Desert Rats can do it, we can too. I am starting out with a 100-foot tower here."

Just so everything isn't out in the mountains and plains, Walt Smith, W3UT, in Atlantic City, N. J., is lining up the lower Jersey shore boys. Walt says, "We had about ten fellows working out fine on 112-Mc. before the shut down and I believe we can stretch a net to cover 60 miles of open coastline. We are meeting once a week, on Wednesdays, in a local trade school."

Back out to u.h.f. minded Arizona again, Clyde Criswell, W6QLZ, says, "We were just getting going good when we were taken off, but we are still building up reserve rigs, just in case."

Speaking of rigs, W3HOH of Bernardsville, N. J., finally drops us a line about his 112-Mc. setup. Ken seems to have been using his 56-Mc. exciter unit, then an HK24 doubler, HK24 buffer and a pair of HK24's in the final. The 112-Mc. buffer wasn't really necessary but provided ample grid drive for a pair of 35T's that could be substituted for the HK24's if higher power was needed. A 40-watt carrier seemed to work out good enough and the 35T's were never used.

W8PK has about 70 watts crystal controlled on 112-Mc. and was working out to W8AFQ's push-pull 7A4's with R9 signals.

Alan, W7HFZ, wants to try some really high power with an HK357 and quarter wave concentric lines in the grid and plate. The unheard of HK357 is a pentode he picked up in his travels and was never officially put on the market. It rates at 4000 volts and 200 ma. with typical Gammatron construction insuring low inter-electrode capacities.

W6QLZ was intrigued by the Grammer horse-shoe transmitter in a recent QST for 112-Mc. operation. Clyde couldn't quite swallow the 18 watts input for only a watt or two of carrier. After much experimenting, a 7C5 instead of the 6V6GT was found to have considerable more efficiency. The final result was a 7 watt carrier modulated by 7A4-7C5 and steady enough to be read on a good 112-Mc. super-het. Clyde has a pair of T-40's ready for 112-Mc. now.

DX

Scene: A busy street corner. Enter two hams from opposite directions, both u.h.f. men. Says party of first part upon spying party of second part:

"Well, old man, did ya hear that W6 on 5 last night?"

"Heh, heh!" says party of second part hurrying off, thinking quietly, "Poor Joe, he never did act right since he thought he heard that K6 last summer. Oh well."

Exits Joe, "... never could take a joke. Bet his draft number's up."

Wonder how many times in the last several months that scene has been reenacted? Plenty, I'll bet.

Guess 1941 wasn't such a bad DX-ing year after all, now the boys have time to put pen to paper and let us know all about it. Jim Brannin, 6OVK, says that on the last Sunday,

56 Mc. DX HONOR ROLL

| Call | D | S | Call | D | S |
|-------|---|----|-------|---|----|
| W5AJG | 9 | 38 | W4FLH | 7 | 18 |
| W5HTZ | 9 | 29 | W5CSU | 7 | |
| W8CIR | 9 | 35 | W5EHM | 7 | |
| W8RKE | 9 | | W6OVK | 7 | 23 |
| W9AHZ | 9 | 16 | W8CVQ | 7 | |
| W9AKF | 9 | | W8PK | 7 | 17 |
| W9AQO | 9 | 25 | W8RUE | 7 | 21 |
| W9CBJ | 9 | 31 | W9BJV | 7 | 15 |
| W9CLH | 9 | 23 | W9GGH | 7 | |
| W9GHW | 9 | | W9IZQ | 7 | 14 |
| W9CJS | 9 | 22 | W9PKD | 7 | 13 |
| W9LLM | 9 | 17 | W9SQE | 7 | 22 |
| W9NYV | 9 | | W9WWH | 7 | 26 |
| W9PK | 9 | 25 | W9ZUL | 7 | 18 |
| W9QCY | 9 | 25 | | | |
| W9USH | 9 | 18 | WILLL | 6 | 24 |
| W9USI | 9 | 24 | WILSN | 6 | 18 |
| W9WAL | 9 | | WICLH | 6 | 13 |
| W9YKX | 9 | 30 | WIJFF | 6 | 11 |
| W9ZHB | 9 | 43 | WIKHL | 6 | 11 |
| W9ZJB | 9 | 31 | WIJJR | 6 | 17 |
| W9ZQC | 9 | 26 | W2KLZ | 6 | |
| | | | W2LAH | 6 | |
| WIDEI | 8 | 20 | W5VV | 6 | 18 |
| WIEYM | 8 | 20 | W8LKD | 6 | 11 |
| WIHDQ | 8 | 31 | W8NKK | 6 | 16 |
| WISI | 8 | | W8OJF | 6 | |
| W2BYM | 8 | 30 | W8PKJ | 6 | 12 |
| W2GHV | 8 | 24 | W9NY | 6 | 13 |
| W3AIR | 8 | 24 | W9CJS | 6 | |
| W3BZJ | 8 | 27 | W9JPB | 6 | 10 |
| W3RL | 8 | 29 | | | |
| W5AFX | 8 | | WIGJZ | 5 | 15 |
| W5DXW | 8 | 21 | WIHXE | 5 | 18 |
| W6QLZ | 8 | 23 | WIJMT | 5 | 9 |
| W8JLQ | 8 | | WIJNX | 5 | 12 |
| W8QDU | 8 | 25 | WIJRY | 5 | |
| W8QOS | 8 | 17 | WILFI | 5 | |
| W8VO | 8 | | W2LAL | 5 | 11 |
| W9ARN | 8 | 17 | W3CGV | 5 | 10 |
| W9EET | 8 | 15 | W3EIS | 5 | 11 |
| W9VHG | 8 | | W3GLV | 5 | |
| W9VWU | 8 | 16 | W3HJT | 5 | |
| | | | W4EQM | 5 | 8 |
| W2AMJ | 7 | 22 | W6DNS | 5 | |
| W2JCY | 7 | | W6KTJ | 5 | |
| W2MO | 7 | 25 | W6QAP | 5 | 14 |
| W3VYF | 7 | 22 | W6SLO | 5 | 19 |
| W3EZM | 7 | 24 | W8EGQ | 5 | 10 |
| W3HJO | 7 | | W8KWL | 5 | 13 |
| W3HOH | 7 | 17 | W8NOR | 5 | 16 |
| W4DRZ | 7 | 22 | W8OPO | 5 | 8 |
| W4EDD | 7 | | W8RVT | 5 | 7 |
| W4FBH | 7 | 17 | W8TGJ | 5 | 9 |
| W4FKN | 7 | 16 | W9UOG | 5 | 8 |

Note: D—Districts; S—States.

6SLO and 6OVK were working portable W6QLZ/6 Campwood, Arizona, at 210 miles.

Meanwhile over in Silver City, New Mexico, W9BKM/5 was hearing Clyde Q5 and R3 to 4 on his new super-het. Ray took out for a peak 40 miles away, but his 8 watts just wouldn't stretch through. Of course, the distance may have had something to do with that, but it was only about 330 miles. Clyde, by the way, was using his JRA-3 with an HY615 and co-axial vertical. A sway-back rhombic proved to be a disappointment and vertical polarization was used throughout. The boys feel pretty bad as they are positive they could have made a 500 or so mile record of it in several more weeks of trying.

W8PK wants his 7 districts and 17 states put on record, which we are very glad to do. Wish the rest of the gang would drop us a card on their latest for the Honor Roll. Let's see just what we did do in 1941!

W3HOH adds to the 112-Mc. roll with W1LZB at 220 miles and W1BJE at 205. Ken's total of 430 different stations last year doesn't back the rumor that he wasn't on the air very often and no one could work him. His present receiver is a two tube "955" acorn job in front of a Meissner FM receiver. Antenna is a 112-Mc. extended double zepp. Airplane contacts by 3HOH were fairly successful, but didn't compare with home station records.

Antennas

W6QLZ comments on the W8JLQ 3 db gain in stacking two QLZ beams saying, "I have been using the same stacked beam idea here for the past 2½ years and it is about 12 db better than the single array. If Howard had shortened his top elements to allow for transit time between the two arrays and hasn't tried fanning the phasing wires, as some have, the results would be better. Fanning the phasing sections only reflects current and, in most cases, the feeders radiate considerably themselves. All eight elements should be connected by phase sections for the best balance, instead of just the radiators. The tower and superstructure have plenty to do with distorted wave patterns besides."

Miscellany

Another comment we have been receiving consistently of late, has been concerning the expected changes in the general outline of the ultra-high frequency during the next year or so. It was surprising to many to see the apparent ease with which commercial and military installations were turning to the extremes in the u.h.f. band. One hundred megacycles, three hundred, five hundred, a thousand megacycles

seem to fairly pass by as though they had been meters instead of thousands of kilocycles. Naturally, there is an immense trend towards the u.h.f., but the exceptions we hear about are not the rule.

The radio amateur who delved into the mysteries of the u.h.f. has not wasted his time, for just as the above comments were received, so did this writer recently learn with considerable surprise that simple transmission phenomena which these same amateurs had encountered and overcome a year or so ago, were today causing anxiety among other ranks. As in the last war, the men who make radio a profession are finding that the men who make radio a hobby in many instances are a step or two ahead of them. We are unfortunately, and fortunately too, at a restriction of self-censorship; yet there is no reason to lose interest, for there is opportunity for all in experimenting with receivers and antennas for practical FM home reception. FM is more than the dominating factor on the u.h.f.; it *is* the u.h.f. Be it proposed, that the radio amateur turn a portion of his interest to learning and experimenting with the background of FM, before it is too late.

Starting with this column, we shall endeavor to present a little each month about their transmitters, a little about new receivers, a little about the new antennas we see going up around us and all the comments we receive on extended ground wave or skip dx. This broadcast band of 42 to 50 Mc. is adjacent to our own 56 Mc. and the effects on one can be felt on the other.

Who would be first with a little dx note, but Editor Dawley, who says, "Incidentally, I was hearing W45CM of Columbus, Ohio, from about 3:30 until 5:00 in the afternoon of December 27th, Saturday. They were fading very badly, but about every five minutes or so they would come up to good signal strength and hold for maybe 15 seconds. The quality was excellent on these short peaks." A quick analysis would indicate F layer transmission; however, the late afternoon time of reception and the excellent fidelity would point towards a double hop sporadic E skip signal. We hear again from that December peak.

Major Armstrong, when questioned by this writer some weeks ago, said he believed FM might not be feasible for sky-wave transmission where a number of wave-paths could be utilized at the same time. But it was pointed out that sporadic E skip signals bore the original quality in every case he had heard of or that had been reported to him.

In the study of "aurora dx," some interesting comments were made by Dr. Gartlein of Cor-

nell University during the recent meeting of the American Association of Variable Star Observers at Harvard University. Dr. Gartlein, who ranks with Professors Stormer and Segard in the study of aurora, mentioned that: Aurora is usually long in longitude and narrow in latitude and the variations in auroral heights is a direct correlation with atmospheric pressure, which may change the effective heights as much as 50 per cent. Following a particularly brilliant display, the greatest probability of recurrence is for the following night; next, in about 54 days, and thirdly, in about 28 days. Although April and September have the largest number of displays, this has nothing to do with the seasons, or the severity of the disturbance. Dr. Gartlein said he began observing the September aurora at midnight September 17th, although it did not attract general attention till the following evening. The 19th and 20th went without any auroral signs, but on the 21st the disturbance really ended with several arcs seen in the northern sky. This seems to substantiate the belief that we missed plenty of periods when aurora DX was possible.

The 28-Mc. band during November in Great Britain was considered the poorest yet, with signals identified on only eight days. W's were logged on November 3, 5, 8, 9, 11, 23 and 26, and a few weak stations on the 4th and 12th. November 3rd was the best day with all districts but 6 and 7 being reported. On November 26th, BRS3893 logged W7AUU and W7IDO, but no W6's. The most unusual signal was that of K6HJZ heard by BRS3003 at 17:20 Gmt on the 3rd. G4MR heard K4ESH and KB4HBX on the 9th, while K4HVQ and K4DDH were reported on the 8th. As usual, LQB4/LSA2 on 27.4 Mc. was heard on 20 days.

Well, this nearly closes our second column and so far we've had little direct contact with our readers and in a sense we have been writing blindly. The situation is one which we hope all will appreciate. The military service and governmental agencies have weeded out over 50 per cent of our regular reporters, but they still remain among the most ardent readers. Therefore, it is up to the rest of us to make this a newsy column; what do you say, gang? Drop us a card on your honor roll standing, what dx you worked last year and didn't have time to write us about, what kind of rig you ended up with, are you doing anything with FM, etc.

Question and Answer Department

Q. We have been quite interested in forming a 200-kc. net over the local light lines if we must stay off altogether. What do you think about that?

2 1/2 METER HONOR ROLL

ELEVATED LOCATIONS

| Stations | Miles |
|----------------------------|-------|
| W2MPY/1-W1JFF | 325 |
| W2MPY/1-W1BHL | 295 |
| W6KIN/6-W6BJI/6 (airplane) | 255 |
| W6QZA-MKS | 215 |
| W6QLZ/6-W6SLO-OVK | 210 |
| W6BKZ-QZA | 209 |
| W6QZA-OIN | 201 |
| W6BCX-OIN | 201 |
| W3BZJ-W1HDQ (crossband) | 200 |
| W6FVK-BIP | 190 |
| W6LSC-NNN | 190 |
| W6OXQ-NNN | 190 |
| W1JYI/6-W6NNN | 190 |
| W3HOH-W1HDQ | 175 |
| W6NJJ-NJW | 175 |

HOME LOCATIONS

| Stations | Miles |
|-----------------------|-------|
| W2BYM-W1LZB | 230 |
| W2FJQ-W1LZB | 220 |
| W3HOH-W1LZB | 220 |
| W2OEN-W1LZB | 218 |
| W1MON-W2LAU | 203 |
| W1LZB-W2ADW | 200 |
| W1LZB-W2NCG | 200 |
| W3HOH-W1BJE | 200 |
| W3HOH-W1JWB | 190 |
| W3HOH-W1LPO | 190 |
| W6ECP-W6NNN | 190 |
| W6NNN-W6OIN | 185 |
| W1JFF-W1MEP | 145 |
| W8CVQ-QDU (crossband) | 130 |
| W3BZJ-W1MRF | 130 |
| W6QLZ-OVK (crossband) | 107 |
| W1J-W2LAU | 105 |
| W3BZJ-W1LAS | 105 |
| W2OEN-W2LH | 100 |
| W2OEN-W2HZR/8 | 100 |

1 1/4 METER HONOR ROLL

ELEVATED LOCATIONS

| Stations | Miles |
|-----------------------|-------|
| W6IOJ-LFN | 135 |
| W1AJJ-COO (crossband) | 93 |

A. Of course, we assume you understand the limitations of this type of communication. Then, too, there is the real question of whether it would be worth while and has any material value, because the telephone will serve practically the same purpose and in emergencies the electric circuit is just as likely to go out as the telephone. On the other hand there is the question of legality; certainly this will bear investigating. Although there are no restrictions on

[Continued on Page 51]

YARN of the MONTH

ATLANTIC CROSSING

There was a slight lull in the conversation in the "Static Room," as we used to call the waiting room down on Duane Street where we brass pounders used to put in time while awaiting a berth, or, possessing one of the same, would await our turn before turning in our abstracts and reports on completion of a trip.

The buzzer, connected to a key on the superintendent's desk and used to summon us into the holy of holies, had just zinged out my name in Mr. Edwards' precise fist.

I had been on the beach for several months, working for the New York Edison Company, but the urge to get back to sea finally got too much for me, and I had come down to see what Marconi might have to offer a good (?) operator. I had heard rumors that, due to war conditions and other things, the rates of pay were being upped, which Lord knows they needed to be, and also that some operators were not quite so anxious to ride the waves, war conditions being as they were at that time.

"Glad to see you back, Wilkins," said Edwards, on my entrance. "We have a good berth for you, in case you are interested." I had seen some of his "good berths" before on several occasions, and so was prone to take this with rather more than a grain of salt, but when he went on to say that the tanker "John D. Archbold" was in need of a chief operator, I was more than pleased, as I knew her to be a good ship, and I always had liked the tankers. Clean, good food and plenty of it, lots of time at sea and good paydays.

"She's laying over at Bayonne and due to sail within twenty-four hours. Standard Oil takes out an insurance policy for your dependents and agrees to pay for your belongings in case you should lose 'em. Hundred and twenty-five per. Shall I sign you up?"

"What goes on here?" says I. "It sounds as if you might expect it to be my last trip, or some'pn." After some hemming and hawing, I finally got it out of him that the last ship to attempt the voyage we were about to embark on had been spurlos versenkt, or whatever the words they used at that time. At any rate they had never heard anything from her after she hit the hot corner of the Atlantic.

At any rate, I decided it was just as well to take a whack at the job and proceeded to get everything signed up airtight, packed my tooth brush and other suit and headed for the wilds of Bayonne.

I found the "Archbold" to be a first class ship, and for the most part the officers and men distinctly above the average. The junior op was brand new, but a swell kid who did a good job and handled himself like a man throughout the voyage.

The radio equipment wasn't anything to rave about, even in that era. As I remember it now the transmitter was one of those old Marconi 120 cycle synchronous jobs—I always did love to hear those babies whine—remember WHA and WSY? The receiver was about the average for that kind of a ship. If you could find a good spot on the carborundum and conditions were right otherwise it was sometimes possible to hear VCE (Cape Race) and GLD (Land's End) on the same night. You could even almost copy NAA half way across on good nights. But the emergency equipment—Ah, that was the pay-off. It consisted of a Marconi ten-inch spark coil run by three small "accumulators" which sat underneath the operating desk. They were a dinky looking power supply, but, thank God, they were reliable.

In order to get this rock-crusher in action, it was necessary to disconnect the regular power transformer and clip the secondary leads of the coil on the "oscillation transformer," using the same condensers and tuning equipment as on the regular transmitter. Also the same gap was used, but it had to be turned to minimum clearance if you valued your life and your leyden jars, of which I think there was one spare.

Due to some delay we were sent down to a Texas port while waiting for our regular cargo destined for France. It makes the Standard Oil Company very unhappy, to put it mildly, to have one of their big ships just lying around and not doing anything.

It was on the trip back north that we got the word that all Hell had busted loose and that Uncle had decided to install a couple of nice five inch guns on our deck before we

By G. C. WILKINS

All Special SUBSCRIPTION OFFERS

Withdrawn As of
APRIL 15, 1942

● Due to the probability of changes in subscription rates to result from RADIO'S new policy and expanded scope, all outstanding special and reduced rate subscription offers are hereby withdrawn effective April 15, 1942.

If you are not a subscriber at present take advantage of our special introductory 5-issues-for-\$1 offer (U.S.A. only) on the adjacent order envelope now, today, before you forget.

The new RADIO more than ever is an ideal gift for that son, husband, father, or "boy friend" in the service.



If you are currently a subscriber you may extend your subscription now at current rates shown on page 5.

THE EDITORS OF "RADIO"

In Keeping With The Times

ANNOUNCE that RADIO'S scope effective at once will be still further expanded to keep pace with the expansion of our readers' radio interests resulting from national defense and war stimulus. Analytical readers may already have noted this tendency in recent issues.

In its larger field RADIO will even more than formerly be able to run the best of everything in practical radio, sound, and electronics from semi-popular and general to practical engineering and design and including of course as much as possible under current conditions of the type of material for which it has become famous.

M. L. MUHLEMAN

[formerly Managing Editor, "Radio News"; Editorial Director, "Radio Engineering", "Communications and Broadcast Engineering", and "Service"; Radio Editor, "Aviation Engineering"; Radio Editor, "Scientific American"; Editor, "All-Wave Radio"; at present, Editor, "Radio Service Dealer"]

will be general editor of the new RADIO. Our former editors, reluctantly released to the national program, will contribute as much as their new duties will permit, while reasonable payments to independent authors assure RADIO of its share of the "cream of the crop".

A bigger magazine, of course.
Next issue in about sixty days.

Watch For It

WE PROMISE YOU A PLEASANT SURPRISE

would be allowed to head for European water.

Accordingly we put in at Philadelphia, where the guns were mounted and a Naval gun crew put aboard. They were a swell bunch of boys; always up to some devilment, but right on the job.

After the Navy got through with this little chore we proceeded back to Bayonne where, in not a whole lot longer than it takes to tell it, we had taken on about ten thousand tons of perfectly good aviation gas. At the same time stores were being loaded and we were soon on our way to sunny Frawnce, Rouen to be exact.

I was practically a wreck from all the work I didn't have to do. Of course we kept a constant watch, and copied all press and weather, warnings of all kinds and that stuff, but we were under strict and I do mean *strict* orders not to start up the transmitter or hit a key except in case of disaster and then only under direct orders from the Master.

The Naval crew held almost daily target practice on boxes, barrels, etc., thrown over the side, and they really looked plenty good. We had the usual number of scares as most anything in the water looks like a periscope under conditions like this.

However, the voyage across was rather uneventful. The only casualty as I remember was one night when the ship was rolling pretty badly when I was copying press on one of those typewriters with a carriage about three feet long. The roll of the ship would throw the carriage before I was ready, and the copy was some'n awful. Finally I put the mill on a chair and headed the carriage fore and aft as the pitching wasn't so bad, and about that time a heavy one hit us and landed that fifty pound mill right on top of me. Seriously though, we didn't see or hear much in our vicinity until we were within five or six hundred miles of the coast of France. Then the distress calls commenced to roll in with dreadful regularity. Every afternoon just about sundown seemed to be the worst time. Apparently the subs would spot a ship and maneuver themselves so they would be in the sun in regard to the ship, then let 'em have it.

All we could do, in fact all we were supposed to do if and when we heard an SOS from submarine attack was to report the position to the bridge. It was up to the Captain to keep away from the position of these sinkings.

To get on with the yarn, we arrived safely in France, enjoyed the very beautiful trip up the Seine to Rouen, enjoyed a trip to Paris, etc., etc. France was still France in those days.

Our return trip was something else—and how! We departed from Le Havre with a small convoy, sailing at dark just before they locked the harbor up for the night. I remember that the tide had turned three or four times while we were lying at anchor awaiting the rest of

the convoy, and each time it turned it had swung the ship. We had two anchors out and those anchor chains were a mess. We just about missed the convoy on account of those blasted anchor cahins.

We were sailing without lights, and whether by plan or accident, I have never known, we were out there all by ourselves when daylight came. We got through the day all right and I was enjoying an afternoon nap when I heard what seemed to be a lot of commotion in the companion way outside my quarters. Investigation showed that the lookouts had sighted a submarine away up ahead of us and right on our course, going in the same direction as we were. The gun crew claimed he was out of range so there seemed nothing for us to do but steer a zig-zag course and continue on our way.

This continued for some time when one of the crew on the bridge let out a yell and pointed aft. Wow! here comes a torpedo right for the engineroom. The ship was swinging when the thing was sighted, but not in time. The torpedo hit directly in the engine room, killing the three men on duty at the time.

The subs were apparently hunting in pairs; one running awash ahead for a decoy while the other sneaked in from behind. The explosion disabled the rear gun and blew the starboard after lifeboat clear over the ship. The stern immediately settled to the surface of the water, but worst of all, with disabled engines we could not maneuver the ship to bring the forward gun into play, and thus were helpless.

By this time it was easy to see that the "Archbold" was going to require either another torpedo or some shots from the sub's deck guns before she would sink. Being in ballast, and having so many different tanks only partially full of water ballast, several tanks would have to be struck before she could go down.

I was standing by the shack when all this took place so proceeded to get my old coil hooked up and ready for action. The Old Man came boiling out of the chart house with his shore-going suit on—straw hat and all. He went by the shack on the fly, and I finally called him to see if he wanted an SOS sent and if so how about a position report. "Hell yes, we want an SOS," says he, and in about thirty seconds the mate handed me the dope. By that time I had made a few experimental signals and everything seemed ok, so I let her go. I had sent the whole thing once and was repeating it when someone tapped me on the shoulder. On looking around, I found to my surprise it was the Chief Steward, and he wanted, of all things, a cigarette! After sending all the dope three or four times, I switched over gingerly to the receiving position. Oh Boy! Who should

[Continued on Page 56]

With the Experimenter

A SIMPLE RADIO AIR RAID ALARM

By GLENN EARL WHITHAM,* WIHSM

The need for a simple and reliable air raid alarm for business establishments and private homes has become evident in the light of events of the past several weeks. It is the purpose of this article to describe a simple system that can be used in any location which is within the primary service area of a broadcast station operating on a 24 hour schedule. This includes practically all vital defense areas.

On order of the interceptor command of a given area all broadcast stations in that area must cease transmission. There are a number of ways in which an alarm signal may be controlled by a radio receiver so that the alarm will operate when the input signal to the receiver is removed. Such a system obviously constitutes an efficient air raid alarm.

If a receiver has an automatic volume control system there is usually a sufficient increase in the plate current of one of the r.f. or i.f. tubes to close a relay in the plate circuit of the tube when a strong input signal is removed. The circuit of such a system is given in figure 1. When the receiver has no a.v.c. system the two tube control system of figure 2 may be connected to the receiver at the point marked X. As long as the input signal is present a portion of it will be rectified by the 6H6 and used as negative bias for the 6C5. However, when the input signal is removed the bias on the 6C5 will also be removed causing the plate current of the 6C5 to increase, thus making the relay close. More sensitive control can be had, if necessary, by using an 1852 in place of the 6C5.

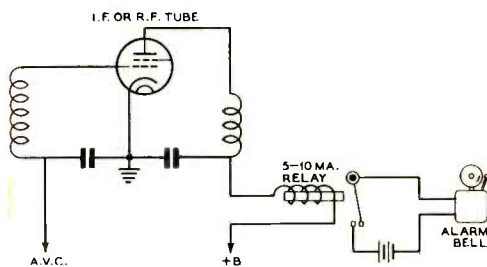

Figure 1

Assurance against false alarms caused by accidental breakdown of the transmitter or receiver can be obtained if there are two nearby stations operating on a 24 hour schedule. Two receivers, each tuned to a different station, may be connected to relays in the manner described above, and the relay control terminals connected in series. Thus, the alarm will not operate unless both stations leave the air. The all clear signal is given when either station returns to the air causing the warning bells to stop ringing.

DIRECTLY-CALIBRATED AUDIO OSCILLATOR

By C. HAROLD CAMPBELL,* W2IP

Being one of those who constructed the Directly Calibrated Audio Oscillator, described by W. F. Davis, W5GHU, in the July 1940 RADIO, may I suggest a slight modification which to me seems well worth the slight extra cost and

[Continued on Page 55]

*179 Beach St., Wollaston, Mass.

*486 East 5th Street, Mt. Vernon, N.Y.

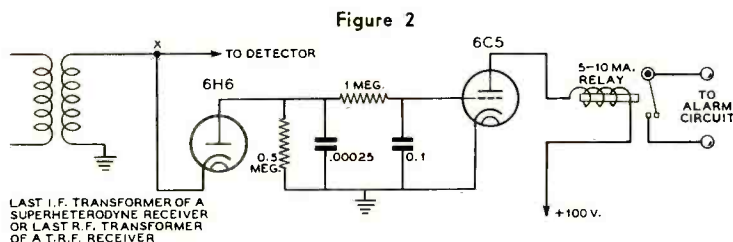

Figure 2

LAST I.F. TRANSFORMER OF A SUPERHETERODYNE RECEIVER OR LAST R.F. TRANSFORMER OF A T.R.F. RECEIVER

Centralab The Quality Line

From Resistor, Capacitor and Inductor to Control Switches, Centralab has a complete line of electronic components. These are made to the highest standards and are available in quantities to suit your needs. Centralab products are made to the highest standards and are available in quantities to suit your needs.

STANDARD 1/2 WATT
MIDGET 1/4 WATT
SPECIAL 1/2 WATT
AXIAL LEAD 1/2 WATT
RESISTORS

CONDENSATORS
INDUCTORS
CONTROL SWITCHES

CENTRALAB Div. of Globe-Union Inc., Milwaukee, Wis.

SEND FOR CATALOG NO. 22

For Every Need in EVERY Emergency

Centralab AXIAL LEAD RESISTORS

These resistors are the only ones which are getting every "heat" these modern resistors are getting these resistors are made to suit every emergency need. They are made to the highest standards and are available in quantities to suit your needs. Centralab products are made to the highest standards and are available in quantities to suit your needs.

CENTRALAB Div. of Globe-Union Inc., Milwaukee, Wis.

Complete NET only \$10.56

**Always THE RIGHT
REPLACEMENT CONTROL
WITH THIS CENTRALAB
PORTABLE
Switch Kit**

CENTRALAB Div. of Globe-Union Inc., Milwaukee, Wis.

Answering the Call

A—STANDARD
These resistors are the only ones which are getting every "heat" these modern resistors are getting these resistors are made to suit every emergency need. They are made to the highest standards and are available in quantities to suit your needs. Centralab products are made to the highest standards and are available in quantities to suit your needs.

B—MIDGET
These resistors are the only ones which are getting every "heat" these modern resistors are getting these resistors are made to suit every emergency need. They are made to the highest standards and are available in quantities to suit your needs. Centralab products are made to the highest standards and are available in quantities to suit your needs.

C—ELF
These resistors are the only ones which are getting every "heat" these modern resistors are getting these resistors are made to suit every emergency need. They are made to the highest standards and are available in quantities to suit your needs. Centralab products are made to the highest standards and are available in quantities to suit your needs.

Centralab RADIOHMS

CENTRALAB Div. of Globe-Union Inc., Milwaukee, Wis.

41 PASSES in REVIEW

The history of CENTRALAB can be read in its advertisements down through the years. New developments . . . the result of research and pioneering . . . keep Centralab constantly in the vanguard.

Today . . . research alone is not enough . . . the demands of the present emergency call for an "ALL OUT" program of production. In '42 CENTRALAB will not fail to maintain its record. In '42 as in '22 and '32 . . . always "SPECIFY CENTRALAB".

CENTRALAB Div. of Globe-Union Inc., Milwaukee, Wis.

STILL No compromise QUALITY!

CENTRALAB Div. of Globe-Union Inc., Milwaukee, Wis.

Plotting the Curve of Progress

Our Men Centralab are not so much as you would suppose. They are men who are working hard to make the world a better place. They are men who are working hard to make the world a better place. They are men who are working hard to make the world a better place.

CENTRALAB Div. of Globe-Union Inc., Milwaukee, Wis.

Centralab RADIOHMS

There's a BIG Centralab SWITCH

More and more people are turning to Centralab for their switch needs. Centralab switches are made to the highest standards and are available in quantities to suit your needs. Centralab products are made to the highest standards and are available in quantities to suit your needs.

CENTRALAB Div. of Globe-Union Inc., Milwaukee, Wis.

RESISTORS CAPACITORS

CENTRALAB Div. of Globe-Union Inc., Milwaukee, Wis.



Want a Better Receiver?

Receivers are scarce. But we have a large complete stock of Hallicrafters, Hammarlund, National, Howard, RME at lowest net wholesale prices. Order from us for immediate delivery. We will help you get the best receiver for your use. We will cooperate with you to see that you are 100% satisfied.

YOU get 10 day trial. No sale unless you are satisfied.

YOU get best trade-in for your receiver. We want trade-in receivers. Tell us what you have to trade.

YOU get best 6% terms financed by us so you can buy with less cost, no red tape, quicker delivery.

Write, wire, phone, or visit us anytime about any receiver, transmitter, tubes, meters, 2½ meter equipment, radio supplies of any sort. We are on the job 24 hours a day, 365 days a year. Your inquiries invited. It will pay you to buy from W9ARA.

If you live in the western states, write my brother:

TED HENRY

HENRY RADIO SHOP
2335 Westwood Blvd.
West Los Angeles, Calif.



"World's Largest Distributor of Communications Receivers"

NEW BOOKS and catalogs

HANDBOOK OF CHEMISTRY AND PHYSICS, 25th edition. Edited by Charles D. Hodgman. Published by Chemical Rubber Publishing Company, 2310 Superior Avenue, Cleveland, Ohio. 2521 pages, 7½ by 4¾ inches; price in U.S.A. of fabric-bound edition, \$3.50.

The new and revised 25th edition of this well-known reference handbook has just been released for distribution. To those who are not familiar with previous editions, the book is a compilation of many hundreds of reference tables, charts, engineering formulas, and listings under these five general headings: Mathematical Tables; Properties and Physical Constants; General Chemical Tables, Specific Gravity and Properties of Matter; Heat and Hygrometry, Sound, Electricity and Magnetism, and Light; and Quantities and Units, Conversion Tables, and Miscellaneous Tables.

Although the book is devoted to a wide range of subjects other than radio and electricity, convenient availability of the additional information on such subjects as plastics, physical and chemical constants, and conversion tables will certainly prove valuable once the acquaintance of this handbook has been made. All in all, the book will certainly prove a valuable addition to the reference library of an active radioman or practicing radio engineer.

To those who are familiar with previous editions of the work, the table of Amino Acids has been revised, a table of Natural Secants and Cosecants has been added, additional Conversion Tables have been added, and the sections on Symbols and Abbreviations, and Properties of Commercial Plastics have been revised and brought up to date. Many other tables have also been revised and a great number of minor changes have been made throughout the volume.

New 16-Page Catalog on Ohmite Stock Items

A new, up-to-date, 16-page Catalog listing over a thousand stock items in Rheostats, Resistors, Tap Switches, Chokes and Attenuators has been issued by the Ohmite Manufacturing Company, Chicago.

This new Catalog 18 is especially useful today for quick reference by engineers, maintenance men, purchasing agents, servicemen, jobbers, and amateurs. It gives illustrations, descriptions, ratings, prices and other helpful information on the wide range of Ohmite stock types and sizes. There are close control vitreous enameled rheostats ranging from 25 watts to 1000 watts, Dividohm adjustable resistors from 10 watts to 200 watts, and fixed resistors from 1 watt to 200 watts, all in many resistance values. Two types of tap switches and a wide variety of power line and r.f. plate chokes are listed. There are also many other items of general interest.

A free copy of the new Catalog 18 may be obtained by writing to the Ohmite Manufacturing Company, Dept. 1N, 4835 Flournoy Street, Chicago, Illinois.

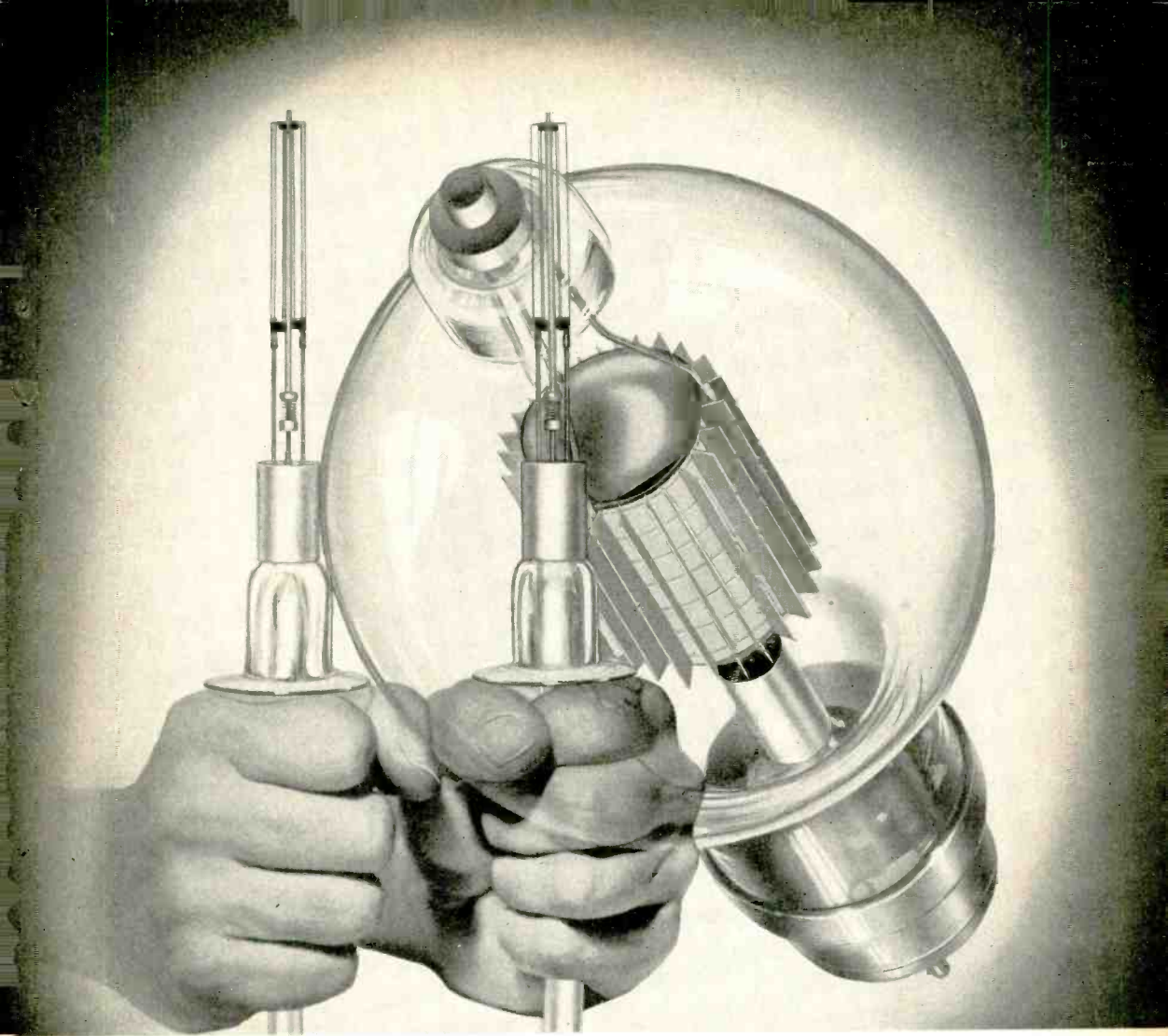

How Important is a Filament?

It's a well known fact that the vacuum tube is the heart of radio communications, but it is important to remember that the filament is the heart of the vacuum tube! Thus, the efficiency with which these tiny strands of tungsten wire perform may mean the difference between success and failure of the tube itself...victory and defeat for tanks or battleships... life and death for millions of people.

You can't always tell by appearance whether a filament is efficient or not. The two assemblies shown above look exactly alike but when put to the test one may not do its job. Into the production of filament for Eimac tubes has gone much research and experimentation. Among the many special instruments designed and perfected by Eimac to insure perfect filaments, none is more interesting than the electron microscope which virtually gives a moving picture of how a filament works under actual operating conditions.

Behind every Eimac tube is the assurance that its

filament will function at top efficiency. Contributing factors to this efficiency are: Tantalum plates and grids and the super-vacuum which removes all contaminating gas particles. All these factors and more are what make it possible for Eimac tubes to carry the unconditional guarantee against emission failure caused by gas released internally.

Eimac's unusual performance capabilities are receiving enthusiastic acceptance in all branches of the service . . . ARMY, NAVY and the AIR CORPS

Follow the leaders to

Eimac
TUBES

Eitel-McCullough, Inc.
San Bruno, California

• • • • • for the
practical radioman

These technical books belong on your shelf. They represent the latest, most authoritative information available on radio theory, practice, and service.

For western readers, we stock the more popular of these items and can usually make immediate direct shipment.

For eastern readers, we can have any of these items sent direct to you from eastern warehouses.

- **RADIO OPERATING QUESTIONS AND ANSWERS** by Nilson and Hornung. Getting your operator's license made easier. 415 pages, **\$2.50.**
- **THE "RADIO" HANDBOOK** by the Editors of Radio, 8th ed., 640 pages, leading practical handbook. **\$1.75.**
- **RADIO ENGINEERING HANDBOOK**, 3rd ed., leading and largest compilation of radio data. 945 pages, **\$5.00.**
- **RADIO ENGINEERING**, by Prof. F. E. Terman, the authoritative general text. 688 pages, **\$5.50.**
- **ELECTRONICS** by Millman and Seely. Electronic principles covered completely. 699 pages, **\$5.00.**
- **PRINCIPLES OF ELECTRON TUBES**, by Reich, especially non-communication aspects. 397 pages, **\$3.50.**
- **PRACTICAL RADIO COMMUNICATION** by Nilson and Hornung. Excellent school and home-study text. 754 pages, **\$5.00.**

Send your order today. We can furnish nearly any book in radio, electronic, and allied fields and invite your order.

Book Department

EDITORS AND ENGINEERS, Ltd.
Box 1350 Santa Barbara, Calif.

RADIO

Cathode-Ray Oscilloscope

[Continued from Page 12]

pairs of flat electrodes which we know as deflector plates. An outside connection, similar to a grid cap on receiving tubes, is brought out from each plate in the tube sketched. However, in the case of smaller tubes for oscilloscopic use, these terminals are connected to pins in the tube's base. Also, it should be mentioned, one plate of each pair is tied together inside the tubes and then connected to the accelerating electrodes, A and H, making actually four electrodes tied to this common pin. These electrodes are operated at ground potential, which is the *positive* terminal of the high-voltage power supply in oscilloscope practice. The two remaining free plates, then, are used for application of the voltages under test.

It will be noted that each pair of plates is mounted at right angles to the other set. Placing a positive voltage on either free plate will divert the beam toward that plate and a negative charge will likewise repel the beam, as shown in figure 8.

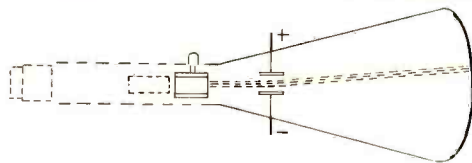

Figure 8. A positive charge attracts the electron beam, deflecting it toward the charge.

If the top plate of the set nearest the electron gun is made alternately positive and negative, as by connection to an alternating current potential, the beam will move up and down. As the electrons strike the screen a momentary fluorescent glow is produced.

Characteristics of Cathode-Ray Tubes

As with other types of vacuum tubes, cathode-ray tubes are designed to operate with certain specified voltages, although they are quite tolerant in this respect. The 902, for instance, is rated for 400- to 600-volt anode potential, but will focus with good brilliance at considerably less voltage.

In changing the anode voltage, however, the deflection sensitivity, spot diameter or line width, and maximum brilliance will be affected.

• • •

The higher the anode voltage, the smaller is the spot diameter or line width, the greater is the brilliance of trace, and the *lower* is the tube sensitivity.



for
**POLICE,
 AVIATION,
 RELAY-BROADCAST**

stations, the Micrometer Frequency Meter will monitor one or a dozen transmitters, on any frequencies up to 56 mc., with accuracy 0.01%. Two models, priced \$110.00 and \$165.00, net. Write for details.

LAMPKIN LABORATORIES
 — Bradenton, Fla. —

On the list of strategic materials the government is trying to accumulate reserves of are many strange names. How many of these have you heard of: tragacanth, dragons blood, abaca, kapok, karaya, sisal, henequen, damur, kauri, vetivert, and ylangylang?—*Obmite News*

FLUORESCENT LIGHTING

BUY DIRECT—from Factory at Distributors Prices
 COMPLETE LINE—for Industrial and Home Use. 100%
 —G.E. Parts and Lamps. Descriptive, illustrated circular
 —FREE.

F-2016 **McGEE RADIO COMPANY**
 Kansas City, Mo.

Add to the growing list of applications for plastics the use of extruded plastic threads for making window screens. This type of screen never needs painting and it is reported that the cost will be close to that of the copper type.—*Obmite News*

New... Handy

Write for Catalog

UNIVERSAL REPLACEMENT Capacitors

SOLAR MFG. CORP., Bayonne, N. J.

RADIO

In answer to the demands of television a screen giving a white line can be had in certain tube types. These make possible black-and-white pictures for the television audience.

Cathode-Ray Tube Circuits

Having covered the various elements inside the tube, as well as their functions, let us now consider a typical circuit in which they are used, as shown in figure 9.

The tube is shown schematically, with both the control grid and focusing electrodes shown by the usual grid symbols, as is customary in cathode-ray tube circuits. The potentiometers, R_1 and R_2 , control the intensity (brilliance) and

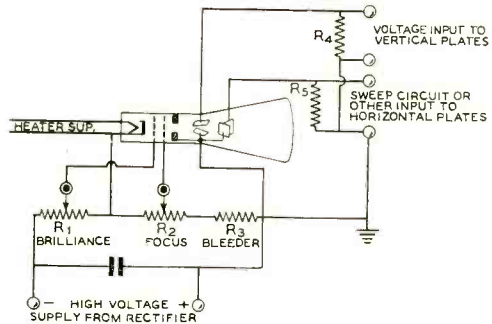

Figure 9. Typical cathode-ray tube circuit.

focusing of the beam. R_3 simply completes the bleeder circuit.

Mention has been made of the two "free" deflector plates where test voltages are connected. Actually, they are connected to ground through resistors of from one to ten megohms. These resistors would not be needed if all circuits under test provided a ground return path. But with such high values, the input signals will not be affected. If allowed to "float" entirely free, these plates would soon accumulate enough electrons to give them a negative charge and shift the beam completely off the screen.

The heater supply is connected to a transformer which furnishes 2.5 or 6.3 volts to the filament, depending on tube type. In the smaller tubes the cathode is connected to one side of the filament, within the tube.

The high-voltage leads are connected to the rectifier output of the power supply. It should be noted, though, that the *positive* lead is grounded, which is contrary to receiver practice.

Sweep Circuits

What is the "sweep circuit" and how does it function? This is one of the first puzzling

questions of those to whom the oscilloscope is new. We are all familiar with those graphs which engineers use to show the relation of one function to another. Take the old familiar sine wave, for example, a graph of which appears in figure 10.

To the left we find a vertical line representing instantaneous voltage values. At the bottom is found a notation of the time in which these changes take place, being $1/60$ of a second in this case.

Now we will see how this same curve would be plotted on the cathode-ray screen. Facing

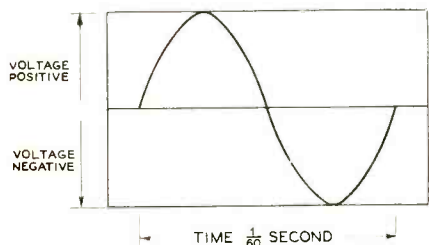

Figure 10. Graph of a single sinusoidal wave.

the front of the tube would be seen the four deflecting plates if the screen were removed, and we would see the electron stream as a tiny dot if it were visible.

The secondary of a transformer is here connected to the vertical plates so the beam will be moved up and down in accordance with the voltage. The voltmeter will read the r.m.s. voltage across the secondary, but the beam will follow the *instantaneous* potential. With no voltage on the horizontal plates, a fine vertical line will appear on the screen. Since this line represents the voltage changes from minimum to maximum, it is possible to measure the peak voltage directly with a ruler placed on the screen, provided the oscilloscope's sensitivity has been previously determined.

Examining the remaining apparatus we find a battery with its center cell grounded and its positive and negative terminals connected across a potentiometer P, the slider arm A of which goes to the free horizontal plate. It is plain, then, that the beam will be moved to the right or left, depending upon the arm position.

This latter member is connected to a lever which follows the contour of a cam, C, being turned by a synchronous motor operating from the line under test.

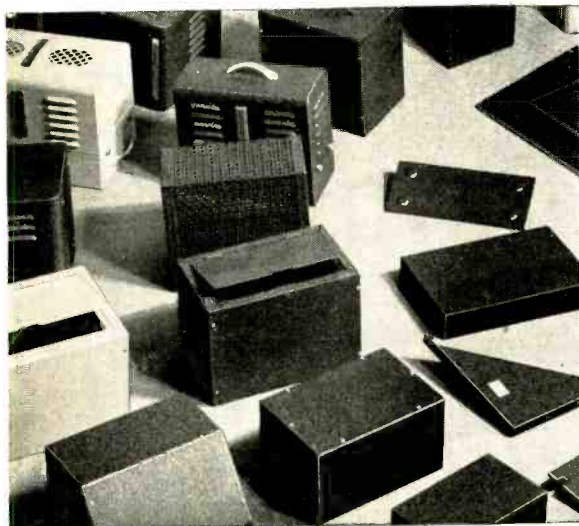

Your jobber will be pleased to furnish your requirements for BUD Cabinets, Racks, Panels and Chassis.

**USE THESE
BUD
METAL CABINETS
To Protect
Your Equipment**

BUD Metal Cabinets are "tops" in appearance, durability and protection. There are many types ideally suited for housing your UHF emergency equipment. You will be pleased with their sturdy construction and handsome, finished appearance that will withstand the most strenuous service.

BUD RADIO, INC.

CLEVELAND, OHIO



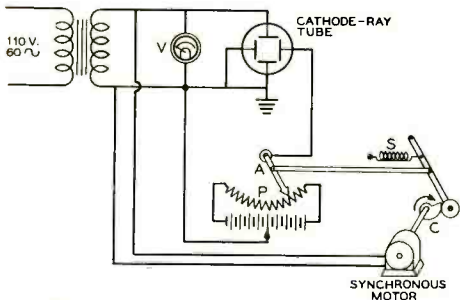

Figure 11. Mechanical sweep circuit.

As the cam revolves, the slider arm will be drawn from left to right at a uniform rate and the electron beam will follow simultaneously. As the maximum lobe on the cam turns by its follower, the lever L and slider A are instantly snapped back to the left position by the spring S, and the sweep cycle starts all over again.

It will be apparent that during this cycle the beam has been deflected vertically by the voltage under inspection, and horizontally by the sweep circuit mechanism. If the cam is geared to the synchronous motor so as to revolve 60 times per second the beam will trace a pattern upon the screen similar to figure 10.

In one second's time the beam will traverse the screen 60 times, making a trace each time. But since the sweep mechanism moves in perfect synchronism, each trace will cover the exact position on the screen as did all preceding traces. Instead of seeing a moving pattern, then, the electrical wave appears to be "stopped in its tracks," permitting study as long as desired.

The above applies, of course, only if the phenomena is recurrent (and the sweep synchronized) but this condition holds true for most electrical phenomena in which we are interested.

Any transient surges occurring during this study will register as a deviation from the normal waveform, and appear as a fine line, diverting from the true waveform. They will glow for an instant, and then disappear.

While such a mechanism as above described might work at very low frequencies, it is quite evident that a better means must be found for sweeping the beam at frequencies varying from 15 to 10,000 cycles per second, or more.

The Relaxation Oscillator

While there are several types of electronic oscillators that will perform the function of producing a linear sweep, the relaxation oscillator is the simplest and most adaptable to our work. This type oscillator is used in all present-day commercial oscilloscopes.

It is also known as the "saw-tooth" oscillator, linear timing axis, grid-glow or thyratron oscillator, and perhaps another name or two. Its action is quite simple, but because it may be unfamiliar to some, will be described in detail.

Evolution of the Linear Timing Circuit

We have seen from the mechanical arrangement just described that a sweep oscillator must move the beam at a uniform rate in one direction and return to its starting point instantaneously. It is quite apparent, then, that our usual sine-wave oscillators are not suitable for this particular job.

The problem is to develop a suitable voltage for horizontally deflecting the beam and then to provide a means for instantly reducing this voltage to zero.

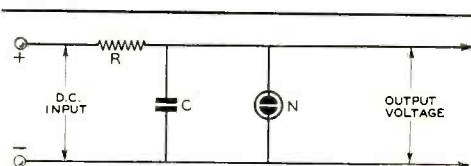

Figure 12. Simple neon oscillator.

A simple neon oscillator is shown in figure 12. Current from the d.c. input circuit, flowing through resistor R, charges condenser C. The neon bulb N, has no effect until its flashing voltage (50 or 60 volts) is reached. At this point, gas within the bulb ionizes, rendering the bulb a conductor, and instantly discharges condenser C as if it were a short circuit.

When the voltage across condenser C becomes reduced to almost zero, the neon gas de-ionizes, suddenly restoring the bulb to its former status of an insulator. Here another cycle of operation begins as condenser C begins "filling up" with another charge.

The frequency of operation is determined by the time required for charging condenser C. By selection of proper capacity values, and by making R variable, oscillation of any frequency from a few cycles up to many thousand may be obtained.

While extremely simple, this oscillator has three major faults which must be corrected before it can be used in a first-class oscilloscope.

First; its output, which will be slightly less than the neon bulb's flashing potential, is not sufficient to swing the electron beam completely across the screen.

Second; its frequency is not easily synchronized to the signal frequency. And third; as the condenser becomes more and more charged, its charging rate decreases, hence the output volt-

[Continued on Page 62]

Notes on U.H.F.

[Continued from Page 8]

always very sharp and there is no sudden rise in the virtual height as the frequency is increased. On the underside is a layer, probably very thin, of ions. Above this ionic E and separated from it by perhaps one to three kilometers is an electronic E layer. The dissociation between the two is so well marked that it appears possible that factors may originate from entirely different sources that would, independent of each other, produce an E layer of sufficient density to reflect 56 megacycle signals. Yet, even with our modern ionosphere sounding equipment, we would not be able to recognize which of the two layers is actually doing the reflecting.

It is now being recognized that the radio amateur, solely and upon his own initiative, has somewhat revised our modern ionosphere theory to apply to the unusual signals obtained during severe magnetic and ionosphere disturbances. Basically, we have assumed a vertical ionosphere layer. This in itself is slightly ambiguous, since our present deductions make this layer appear to be the remnants of the D, E and F₁ layers, which, on coming in contact with a wall of electrified particles arriving from inter-solar space, are swept upward from their normal heights and are finally dissolved in the region ordinarily occupied by the F₂ and G layers. One may now see that this layer is not actually vertical in respect to the plane of the earth's surface below it or to the normal ionosphere, but has assumed an angular tilt of 30° to 60°.

This turbulent and boiling ionization spreads as waves or curtains from the vortex formed by the earth's magnetic poles. Wilson sees this curtain as being very unstable, thereby causing the assorted reflected wavepaths to combine and cancel on the receiving antenna. The rapid reenforcement and dispersement of amplitude, since fading depends upon frequency (amplitude modulated signals), will cause the different side-band frequencies contained in the modulation envelope to fade independently of each other, causing a garble, or extreme selective fading.

To this writer it appears difficult to analyze a reflecting media as grossly irregular as seen by Wilson which would produce the erratic auroral fading noted on a modulated carrier. But to diffuse the audio quality to the extreme of that noted during actual auroral reflections also seems somewhat impossible.

Since reflection at a specific u.h.f. will require a definite amount of electronic density

⁷Booker and Berkner, *Terr. Mag.*, Dec., 1938, p. 427.

(remembering that this is reflection and not refraction of the u.h.f. wave) and noting again the sporadic brilliance of aurora and its accentric movement across the heavens, we find it not difficult to visualize a shifting plane of density at the above mentioned angular tilt sufficient to reflect 56 megacycle signals. Such an imaginary plane would be capable of exercising motion in any normal direction at an amazing speed; i.e., reflection may occur at one specific point in the ionosphere only to have the signal reflected a second later 1 or 2 degrees away in longitude. The rapid ionization and recombination of the free electrons and ions during the boiling of the ionosphere causes the reflecting plane to assume motion and would therefore continually alter the length of the various wave-paths of the radiated signals. Such movements and their effect on frequency are better known to the physicist as "Doppler's Displacement." (Doppler's effect on an unmodulated f.m. carrier is to produce first a high pitched hiss alternating on about a 20-second cycle with a low hum. The displacement or shifting of the audio band first up and then down in frequency causes the distorted quality.)

TO BE CONTINUED

REMEMBER...

HYTRON

gives you

Record U-H-F Performance



Peace-time amateur operation on the ultra-highs has proved that Hytron offers you the best in efficiency, economy, and satisfaction for your U-H-F equipment.

Now, for emergency communications, for radio locators, for a host of other uses, Hytron submits as part of its contribution to VICTORY, those electronic magicians of the ultra-highs, those national favorites, the HY75, HY114B, and HY615.

**HYTRONIC
LABORATORIES**



**A DIVISION OF THE
HYTRON CORP.**

25 N. DERBY ST.
SALEM, MASS.

MANUFACTURERS OF RADIO TUBES SINCE 1921

Panoramic Reception

(Continued from Page 18)

on the receiver is of F_s kc. This will hold true no matter what the actual frequency of F_s is.

Interpreting What Is Seen on the Adapter's Screen

The screen of the adapter is calibrated for center frequency and has markers 10 kc. apart on the screen up to 50 kc. above and below the center frequency. If it is remembered that the adapter shows a deflection for each segment of radio frequency appearing at a frequency or group of frequencies, it will be easy to understand what is seen. Naturally the adapter can show only signals which can be received by the receiver. If the receiver tracks poorly, is insensitive or has poor image rejection, erroneous or unsatisfactory results must be expected.

A constant carrier appears as an inverted V deflection of definite amplitude. Relative amplitudes of different constant carriers will vary in proportion to their signal strengths. A voice or music modulated carrier causes the deflection to vary rapidly in amplitude, depending

upon the percentage of modulation and the frequency modulating the carrier.

In double sideband transmission (most used still), the sidebands appear on each side of the carrier if their modulation frequencies are 2000 cycles or higher. The higher the modulation frequencies the farther away from the carrier are the sideband deflections. Frequencies lower than 2000 cycles can be separated from the carrier if the frequency deviation of the oscillator (C, figure 3) is reduced.

Single sideband modulation appears as two carriers of slightly different frequencies. This may be likened to the phenomenon of beats in aural reception. Incidentally, two signals which heterodyne each other may appear as one signal on the screen of the adapter if they are close enough together in frequency. The waxing and waning of the "beats" will evidence itself by changes in the amplitude of the deflection. If the frequency deviation of the oscillator is reduced as above, the two signals will be seen to separate.

A frequency modulated carrier evidences itself by the deflection "wobbling" back and forth along the frequency axis of the screen. The adapter was a great device for showing up some of the 112-Mc. boys.

YOUR REFERENCE BOOK BUYING GUIDE AND MASTER FILE

Gives This Important Data

Contained within the hard covers of this 800-page MASTER BOOK are the listings of the products of 90% of all Radio Parts and Equipment Manufacturers in the industry. In it you will find many thousands of items, such as electronic devices, transmitting and receiving sets, public address equipment, speakers, tubes, antennas, transformers, condensers, replacement parts, meters, laboratory test equipment, relays, plugs, coils, wire, and numerous other radio components. Thousands of clear illustrations with descriptions and specifications. Yes, this is your "MUST HAVE BOOK."

Saves Time—Saves Money

WHERE, WHAT AND HOW MUCH: Such information is instantly at your fingertips. This valuable RADIO MASTER eliminates the maintenance of bulky files. It is completely indexed for speedy reference.

If you buy, sell or specify, you will find the RADIO MASTER an indispensable and handy book to have around at all times.

NINTH EDITION IT'S A MASTERPIECE

Took 6 years and thousands of dollars to develop to its present size—yet it costs you only **\$2.50**

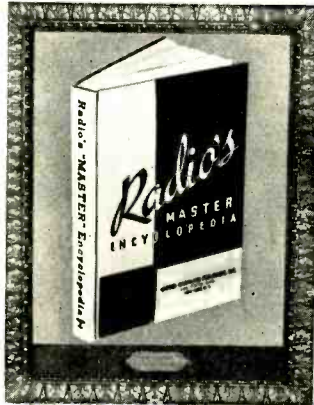

MONEY BACK GUARANTEE

Order your copy today—look it over. You will find it to be an excellent investment; if not, return it to us in five days for full refund. We prepay transportation charges if remittance accompanies order.

THE ONLY OFFICIAL RADIO & EQUIPMENT MASTER CATALOG

Compiled in co-operation with and approved by the Radio Manufacturers Group as the industry's official source book.

Who Uses It?

- Broadcasting Stations
- Department Stores
- Electrical Engineers
- Exporters
- Foreign Governments
- Industrial Plants
- Mail Order Houses
- Mechanical Engineers
- Newspaper Publishers
- Police Departments
- Purchasing Agents
- Radio Distributors
- Radio Service Organizations
- Radio Salesmen and Buyers
- Radio Parts Manufacturers
- Radio Set Manufacturers
- Radio Sales Agents
- Students and Experimenters
- Technical Libraries
- Telephone Companies
- Telegraph Companies
- Universities & Schools
- U.S. Military, Naval and Aircraft Depts.

UNITED CATALOG PUBLISHERS, Inc.
106-110 LAFAYETTE STREET, NEW YORK, N. Y., U.S.A.

A speech or music modulated f.m. signal appears as a multiplicity of deflections appearing over a variable bandwidth. During periods of silence the single carrier corresponding to the center frequency appears. The convolutions depend upon the modulating frequencies and the variable bandwidth upon the percentage of modulation (percent of deviation for 100% modulation). This makes the adapter quite useful (with a few changes) as an f.m. monitor.

A c.w. signal appears and disappears in step with the keying of the transmitter. During the moments when the signal is off, the frequency sweep axis closes at the base of the signal. A radio operator used to reading c.w. signals on phones can, with a little practice, read such signals directly off the screen. In very rapidly keyed signals the deflection and the axis are seen simultaneously.

An i.c.w. signal appears like a c.w. signal of periodically varying amplitude. If the modulation rate is high, sidebands will appear as explained above.

Signal QRM, or two signals which are so close in frequency as to cause aural interference (beat), may appear on the screen as a single deflection, varying in amplitude similarly to a modulated signal. As the frequency separation is decreased, visible slow beats will be seen. As the frequency separation is increased, the deflection appears as if modulated on one side only. Further increase in frequency will cause a "break" in the apex of the deflection. By reducing the sweep width of the adapter, the respective deflection will gradually separate.

Transient disturbances, generally received as noises in the receiver, are of two types: periodic and random transients.

Periodic transients, such as produced by automobile ignition, motors, vibrators, buzzers, etc., appear as signals moving along the frequency sweep axis in one direction or another. Thus, an automobile which is accelerating will produce a set of deflections which may move first in one direction, slow down, stop, and then move in an opposite direction. This is caused by the fact that the adapter is sweeping at a fixed rate (30 times per second), whereas the transient occurs at a variable rate. The images stop on the screen when there is synchronism between the two. If the transient disturbance is synchronized with the 60-cycle line the "noise" appears as a fixed signal, which, however, does not move on the screen when the receiver is tuned, but only varies in amplitude. Such deflections may appear like amplitude modulated signals or like steady carriers.

Random transients, such as "static," appear as irregular deflections and flashes along the whole frequency sweep axis.

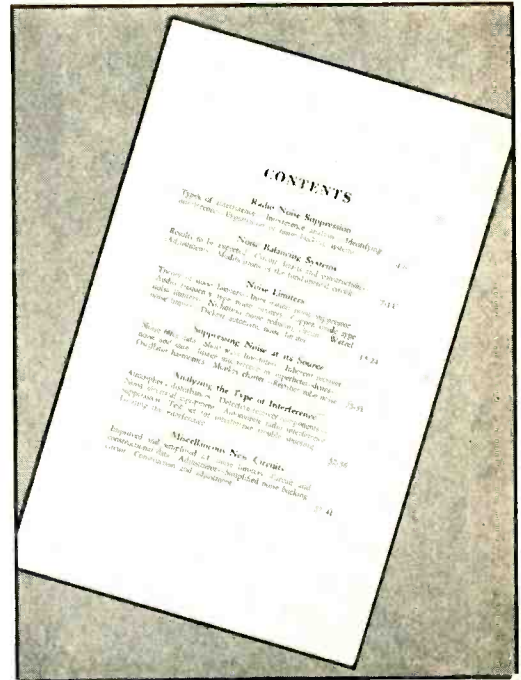

If you have troubles . . .

Trouble getting that signal through the hash of extraneous noises, one of the chapters described above may be the happy solution.

If noise elimination is not practicable, one of the noise limiting circuits illustrated and described will often save the signal for you. Examine a copy today at your radio dealer—or order from us today.

35c in U.S.A. (postpaid) Elsewhere 40c.

THE EDITORS OF **RADIO** 1300 Kenwood Road, Santa Barbara CALIFORNIA

OTHER USES OF THE ADAPTER Receiver Checkup and Alignment

The Panoramic radio adapter provides an excellent and very accurate method of checking up the alignment of radio receivers. If the adapter has been properly adjusted for a given i.f. frequency, and if the r.f. stages of a radio receiver are properly aligned, any signal deflection moving from one end of the screen to the other will pass through amplitude variations which must be symmetrical with respect to the zero mark. If, however, any deflection appears of greater amplitude on one side than on the other, this indicates that the r.f. stage, or stages, of that receiver are improperly tuned at that particular point of its receiving range. An experienced operator will be able to judge very rapidly what adjustments must be made for proper tracking and aligning.

Reduced sensitivity or complete insensitivity at certain frequencies may sometimes be due to reduced power of the receiver's oscillator, or to its failure to oscillate. This can be easily checked with another receiver and a Panoramic adapter, by tuning that receiver to the frequency of the oscillator and checking its amplitude over its entire range. This operation

provides also a very excellent method of checking up the tracking of the oscillator over the entire range of any given band.

Transmitter Adjustments

The Panoramic adapter will be very useful in many ways around a transmitter. Frequency adjustments of an e.c.o. with respect to a standard frequency are easily and quickly made. The operator easily can adjust his transmitter frequency at any desired frequency difference from a given standard or station. Rapid checks can be made as to frequency.

Spurious oscillations caused by improper neutralization can be detected quite readily.

The percentage of modulation of a transmitter can be checked best by reducing the sweep width of the adapter to zero. The frequency sweep axis will then move vertically according to percentage of modulation.

The Panoramic adapter serving as a visual strength indicator can be used for taking field strength measurements around the transmitter. It can then be used in conjunction with a standard signal generator tuned to a slightly different frequency, to measure the variations of field strength for determining antenna radiation patterns.

All in One Book—Yours for 35¢

Complete . . . Concise . . . Easy to Understand . . . all the information you need to get on the air. Includes diagrams and photos of a simple transmitter and receiver that can be built at a very low figure. Get your copy of this valuable little book today.

[Outside Continental
USA, 40c postpaid]

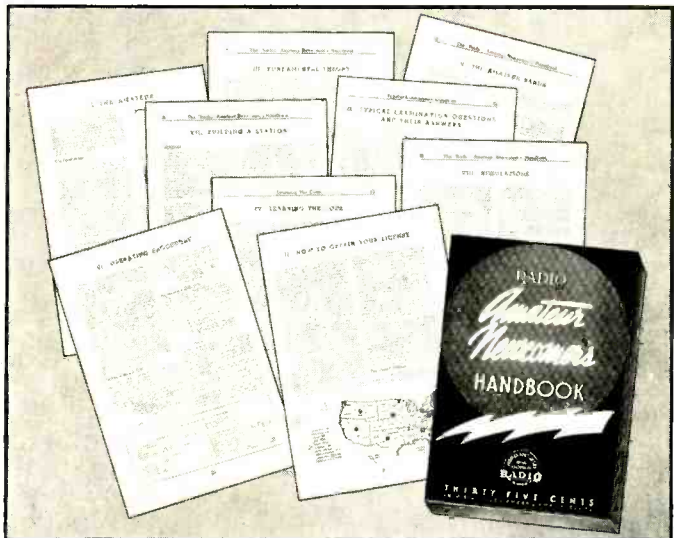

THE EDITORS OF **RADIO**

CORPORATE NAME: EDITORS AND ENGINEERS, LTD.

technical publishers

1300 KENWOOD ROAD, SANTA BARBARA, CALIFORNIA

Electrical Tests

The Panoramic radio adapter is well suited for carrying out many rapid tests for production or control of materials. Being a frequency measuring, or comparing device, the test methods are based on the generation of a signal frequency and comparing that frequency to one or several standard frequencies. If the generated frequency is lower, or higher, than the standard, within certain given tolerances, the product tested does not possess the desired electrical characteristics.

Such tests can be well applied to ganged, identical elements for checking up tracking, such as variable condensers, i.f. transformer, etc. The sections of a variable condenser can thus be rapidly checked point by point and properly balanced for identical capacity.

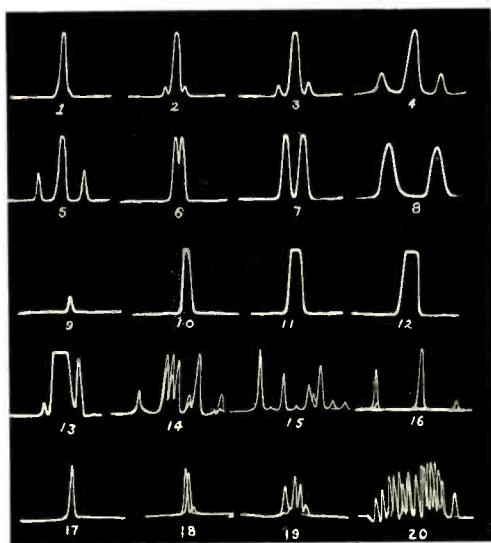

Figure 7. Characteristic Oscillograms

- A. Modulation Sidebands Versus Sweep Width
1. Signal modulated at 3000 cycles. Sweep width 100 kc. The sidebands are too close to the fundamental to be resolved. Some irregularity at the base is the only indication of their presence.
 2. Same signal as in 1. Sweep width reduced to 70 kc. The resolution is better and the sidebands are clearly separated on each side of the carrier.
 3. Same signal as in 1. Sweep width reduced to 50 kc. The sidebands separate still more. The amplitude of the deflection has increased. Slight amount of overload is apparent by the flattening of the apex of the deflection.
 4. Same signal as in 1. Sweep width reduced to 25 k.c. The sidebands are still farther away. (The gain of the adapter was somewhat reduced, to avoid overload.)
- B. Resolution Versus Sweep Width
5. Signal modulated at 15,000 cycles, sweep width 100 k.c. The sidebands are quite distinct from the carrier.
 6. Two carriers 5 k.c. apart at full sweep width of 100 kc.
 7. Same carriers as in 6 with sweep width reduced to 50 kc.
 8. Same signals as 6 and 7 with sweep width reduced to 20 kc. (Gain slightly reduced to avoid overload.)
- C. Deflection Amplitude Versus Signal Strength (100 kc. sweep width, no a.v.c. control, fixed gain control)
9. 10 microvolt signal.
 10. 100 microvolt signal. Limiting amplitude has been reached.
 11. 1000 microvolt signal. Base widens up. Limiting action causes square top.
 12. 10,000 microvolt signal. Small spurious signal visible on the left.
 13. 100,000 microvolt signal. The deflection breaks up into three portions: one central portion flattened on the top and two "harmonic spurious."
- D. Example of Actual Receiving Conditions
14. 14-Mc. amateur phone band as it used to be. About six modulated phone stations are visible.
 15. A portion of the broadcast band. Stations are distributed at every 10 kc.
 16. Three c.w. stations. Due to the rapid keying the deflections appear closed at the bottom. On the left side a "key click" appears.
- E. F.M. Signals (100 Kc. Sweep Width)
17. Carrier during period of silence.
 18. Very little modulation.
 19. Increased modulation.
 20. Heavy modulation.

First Aid Fast

Of interest from the standpoint of safety first are the following facts: statistics show that in cases of electrical shock, 90% of those shocked were brought back to life when resuscitation was started within one minute while only 10% were saved when there was a delay of only six minutes.—*Obmite News*

**Defense
Radio Development
Service**

The services of our engineering and technical staff are available on a limited basis to west coast defense contractors who need additional circuit or equipment development work done outside their own plants in the radio or electronics fields.

We do not have facilities available for quantity production or basic research.

Write, stating your problem in detail, to

**Editors and Engineers, Ltd.
Santa Barbara California**

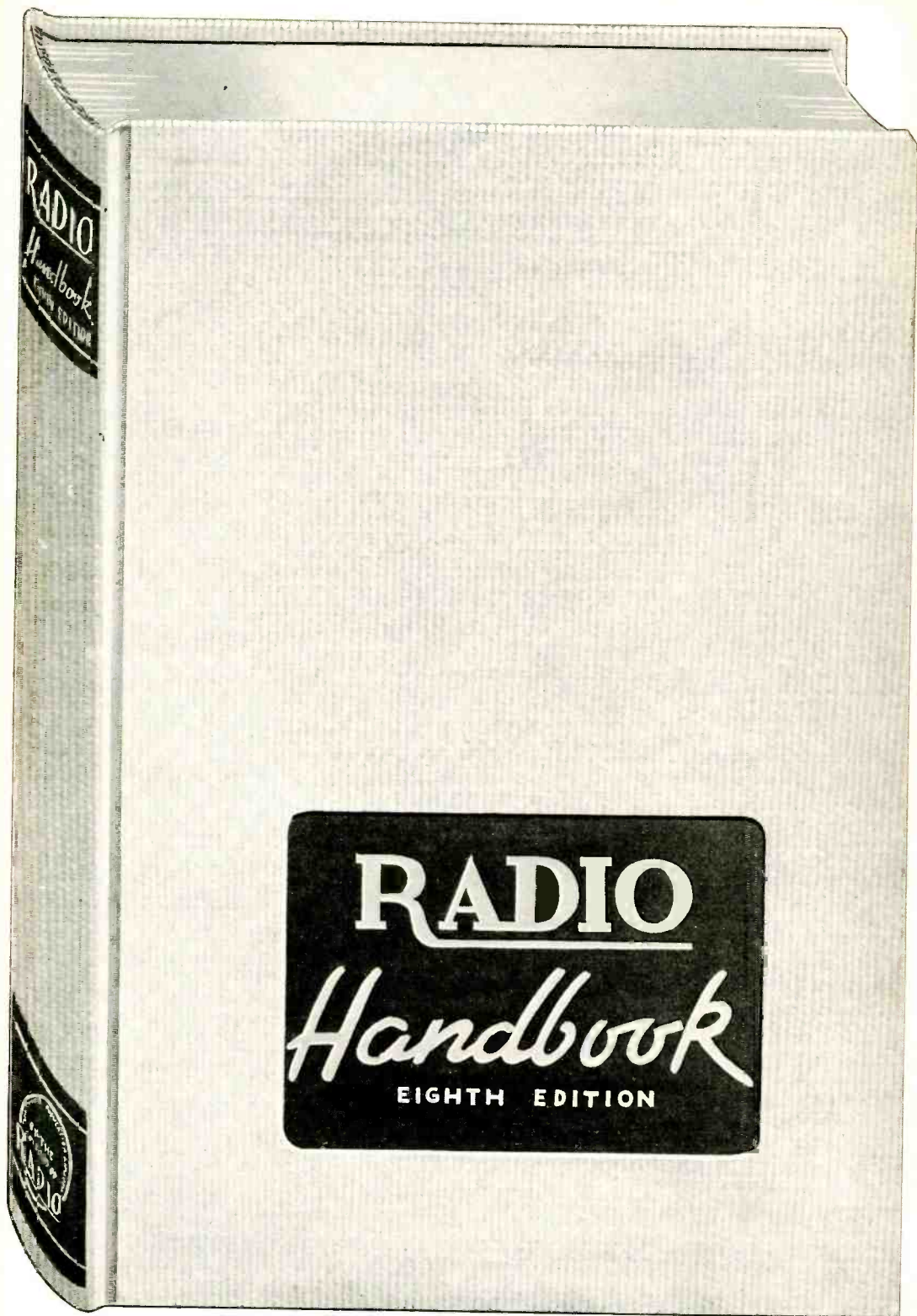

\$1.75 AT YOUR DEALER'S

• 50 •

The Amateur Newcomer

[Continued from Page 29]

U.H.F. Department

[Continued from Page 33]

densers. The circuit is shown in figure 4.

The filter condenser, C_4 , has so much storage capacity that the oscillator will not follow keying; so a smaller condenser, C_3 , serves as r.f. and audio bypass when the device is driven from r.f. instead of a.c.

The r.f. carrier voltage, which is rectified and filtered to furnish plate voltage to the oscillator, is picked up from the final amplifier plate coil by a few turns of heavily insulated wire and fed to the monitor by means of a twisted pair or coaxial line. If the carrier is free from ripple, the plate voltage supplied the tone oscillator also will be free from ripple. However, if the carrier contains ripple, the plate voltage to the tone oscillator also will contain ripple, as the time constant of the bypass condenser C_3 is small enough to let the ripple through with little attenuation. Any ripple in the carrier that is sufficient to produce audible power supply modulation when the signal is heard on a regular receiver will produce audible hum modulation in the keying monitor.

Likewise any keying lag (yoops, tails, etc.) will be apparent, because the strength (and to a slight extent, the pitch) of the monitor signal is determined by the plate voltage, which in turn is determined by the strength of the carrier.

Probably the main advantage of this monitor over one of the heterodyne type is that it is not necessary to retune the monitor each time the transmitter frequency is changed.

The coupling of the r.f. pickup coil is adjusted so that with the monitor volume control full on, the signal is about as loud as with the switch S_2 on "a.c." The volume then can be reduced to the desired level. The r.f. power robbed from the final amplifier will be about 3 watts under these conditions. When the transmitter power is 25 watts or more, this amount of loss can be ignored. However, the loss can be reduced somewhat when full volume is not required, simply by leaving the volume control full on and reducing volume by backing off on the coupling to the final amplifier tank.

Any good p.m. type speaker having a voice coil impedance of from 4 to 8 ohms will be found satisfactory. The speaker should preferably be of at least the 5 inch size, as the "pee wee" type p.m. speakers are rather inefficient, and will not deliver nearly as much volume for a given applied power.

using this inter-phone within your residence, talking across or around town might prove a little unsavory to the local power companies. Better wait for 112 or 224 Mc. permission.

Q. I believe I was misled in buying an FM receiver. Now we are off the air I've had plenty of time to listen in, and believe me, reception is perfect, but what programs! There are none of our favorites. Everytime we want to hear anything good we must switch on the old broadcast band blooper. What's the idea?

A. Well, that particular complaint is very common, so we'll take the time to answer it here. In starting FM on it's merry way the FCC first blew hot then cold in allowing a very nice band for FM broadcasting and then allowing commercialism. Since FM stations are a commercial proposition they must therefore originate a very high proportion of their program within their own studios. Also, the FCC considers a network a monopoly now, and to double the number of stations broadcasting the same program would practically give them a nervous breakdown. Into this mess go the station owners who would lose money on two stations with the same program, instead of two stations carrying different programs.

* * * * *

At the last minute as this column is written, word comes from Washington that the new reactivating regulations will remove all political fingers! Because of the discouraging conditions involved in the random issuing of permits by the previous system, rumor has it that the DCB is stepping in and will/has requested the FCC to create a special status for experienced u.h.f. operators. The entire situation is changing and improving rapidly.

• • •

W. T. Caswell, Jr. W5BB

Dx men the world over will be grieved to hear of the passing of W. T. ("Bill") Caswell, Jr., W5BB, of Austin, Texas. Caswell was a captain in the Texas Defense Guard and in recent months had been instructor for NYA classes in radio work. He died of a heart ailment on January 26, 1942.

• • •

"V" for Victory Cross-Word Puzzle

This month's cross-word puzzle, conceived in the spirit of the times, features the "V for Victory" theme. The puzzle was submitted by Richard L. Bridges, W6PMU, of Los Angeles. Watch for the correctly answered puzzle next month.

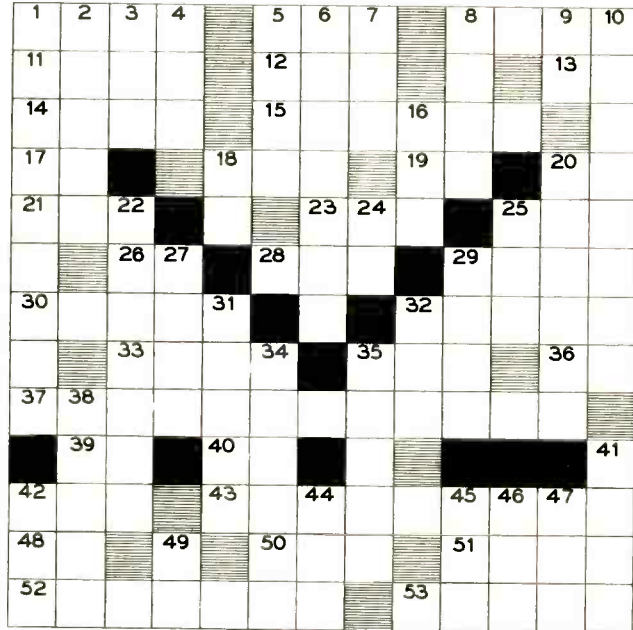

DOWN

ACROSS

- | | |
|---|--|
| <ol style="list-style-type: none"> 1. Capacitor. 2. Type of rounded convex molding. 3. Group of coactive stations. 4. Point of the compass. 5. Counterweight used in physics. 6. Doctrine contending the universe to be composed of minute particles. 7. Combining form meaning "foot." 8. Negative voltage applied to amplifier grids. 9. New Hampshire (abbr.). 10. Oscillator with "negative resistance" characteristic. 16. When you hear this in the rig, pull the switches and grab it. 18. Go ahead. 20. Positive ion (abbr.). 22. This polygon has nine sides, nine angles. 24. Fifth part of a nickel (abbr.). 25. Resistive circuit used in mixing. | <ol style="list-style-type: none"> 27. Transmission of a speech-modulated carrier. 29. Scrambled vowels ("u" excluded). 31. Maximum horizontal projectile distance (ballistics). 32. Legal exclamation of annoyance for fone men. 34. Bisector of a triangle. 35. Middle part of a ship. 38. Work, measured in terms of its heat equivalent. 41. First transmitter stage (abbr.). 42. Triumphant ejaculation upon catching neighborhood children uprooting antenna poles. 44. National Recovery Administration. 45. Symbols of Ohm's Law. 46. Electrified particle. 47. Symbols for: number of turns; time, in seconds; current, in amperes. |
| <ol style="list-style-type: none"> 1. Speaker component. 5. Variable position on a resistor. 8. Group of frequencies. 11. Device for maintenance of constant crystal temperature. 12. Suffix for naming certain salts and esters. 13. Inductance unit (abbr.). 14. Quality of a c.w. signal. 15. Surveyor's assistant. 17. One-tenth liter (abbr.). 18. Precious stone. 19. And. 20. Audio system for group consumption. (abbr.). 21. Great geological time unit. 23. Type of transmission. 25. Instrument used in volume control (abbr.). 26. Preposition. 28. Amateur signal reporting system. 29. Symbols for: electric field intensity, | <ol style="list-style-type: none"> gain, switch, resistance. 30. XE title of courtesy. 32. Three guesses on this one. 33. Indo-Chinese kingdom. 35. This is pitched widely. 36. Switch position. 37. Condition in which a portion of circuit output is applied, in phase, to the input. 39. Symbol for output load resistance (letter and subscript). 40. Good. 42. Another time. 43. Developer of the theory of Relativity (possess.). 48. Put some of these together, and you'll have a good laugh. 50. Skill of performance. 51. Reserve Officer's Training Corp. (abbr.). 52. Device used as a radiator. 53. Xmtr stage preceding antenna. |

What's New

IN RADIO

HEWLETT-PACKARD V.T.V.M.

The Hewlett-Packard Company, 481 Page Mill Road, Palo Alto, Calif., have announced a new vacuum-tube voltmeter with which measurements of radio frequencies up to one megacycle are made as easily as d.c. measurements can be made with the usual multi-meter. The new Model 400A has a frequency range from 10 c.p.s. to 1 megacycle, making the above type of measurement possible. Nine voltage ranges are provided with full scale sensitivity from 0.03 volts to 300 volts. The voltage scale is linear and a decibel scale based on 600 ohms and 1 milliwatt is provided.

This instrument is excellent for all types of audio frequency work. It is particularly valuable at the present time for carrier current, television, and supersonic measurements, and for measurements throughout the broadcast field.

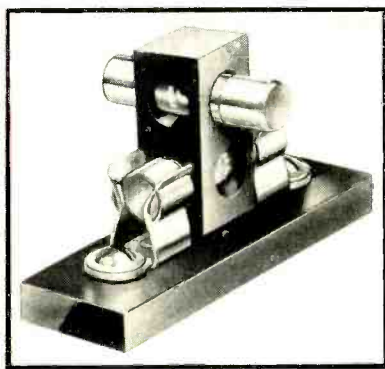

QUICK FUSE-CHANGING IN CLOSE QUARTERS—NEW LITTELFUSE UNIT

An entirely new convenience for changing fuses in close quarters—replacing a blown fuse in a twinkling—and giving notice on inspection that another spare is required, are features compactly embodied in a Spare Fuse Holder & Puller combined, just announced by Littelfuse, Incorporated, 4797 Ravenswood Ave., Chicago.

These new devices are applicable to all 4AG and 5AG fuses. The fuse in circuit goes through one end of the soft rubber rectangular Littelfuse Holder, between the clips. Above,



and at right angle, is an opening in the Holder for the spare fuse. When inserted, the caps of the spare fuse project beyond the Holder affording an easy grip for two fingers.

When the fuse in circuit blows, all the operator has to do is to pull and reverse the Littelfuse Holder. This puts the spare fuse in circuit and brings the blown fuse on top in the same position that the spare was in before. The change is easily made in a moment.

One end of the Littelfuse Holder & Puller is painted red. Until a fuse change is necessary, the red end is underneath, out of sight. When a reverse is made, putting the spare fuse in circuit, the red end is brought into full view on top. To an inspector or service man this red signal instantly indicates that a fuse has blown and that another spare is required. If the end is black both the fuse in circuit and the spare are still serviceable. Fuses are easily removed and replaced.

"Windows" in the Spare Fuse Holder & Puller keep the elements of both fuses in view at all times.

The device is made in two sizes—No. 1422 ($\frac{1}{2}$ " x $\frac{1}{2}$ " x 1-5/16" long) for 4AG fuses, and No. 1378 ($\frac{3}{8}$ " x $\frac{5}{8}$ " x $1\frac{3}{8}$ " long) for 5AG fuses.

[Continued on Next Page]

What's New

[Continued from Preceding Page]

GAMMATRON HIGH-VACUUM RECTIFIERS

Heintz and Kaufman, Ltd., South San Francisco, Calif., have recently announced a series of four high-vacuum rectifiers to meet the expanding needs of the electronic industry. All are designed for high voltage rectification, the largest rated at a peak inverse voltage of 150,000 volts. These tubes will be suitable for a wide range of new applications since they are not affected by temperature extremes and no warm-up period is required.

The smallest of the four, the Gammatron 253 is rated at 1500 ma. peak plate current and 15,000 inverse peak volts. The next three are equipped with pure tungsten filaments, in contrast to the thoriated tungsten filament in the 253, and all bear the characteristic number 953 followed by a letter. The 953-B is rated at 30,000 inverse peak volts and 80 ma. peak plate current. The 953-D ratings are 75,000 volts inverse peak and 120 ma. peak current, while the ratings of the 953-E are 400 ma. peak plate current at 150,000 inverse peak plate volts.

Full data may be obtained from H&K.

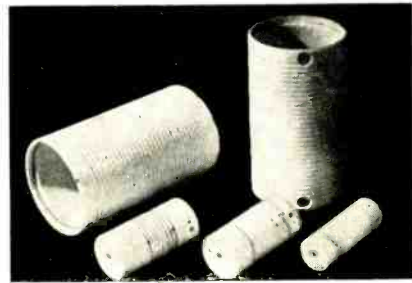

CROLITE PRECISION COIL FORMS

The production of precise coil forms in Crolite, combining mechanical and electrical characteristics meeting the most rigid specifications, is one of the many National Defense activities in the recently enlarged plant of Henry L. Crowley & Co., Inc., in West Orange, N.J. These coil forms range from a fraction of an inch to several inches in diameter, are helically grooved to take different sized wires and winding pitches, and have a plurality of different holes accurately positioned for winding taps as well as threaded holes for mounting screws. Various Crolite "bodies" or formulae are uti-

[Continued on Page 60]

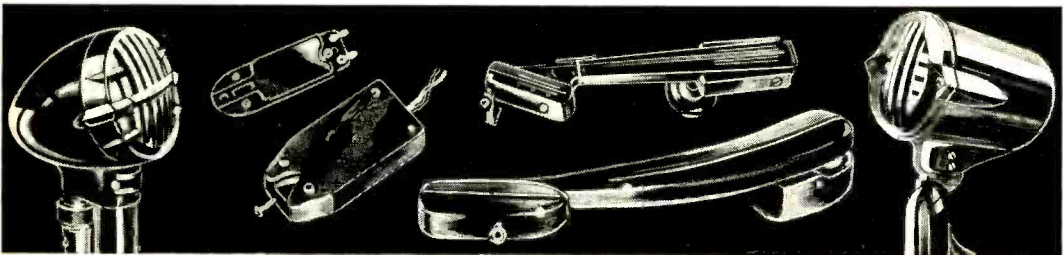

Research and Development GO ON!

Notwithstanding the uncertainty of present day conditions, Astatic continues its laboratory and field research in the development of products for a market of the future. Astatic Microphones, Pickups, Cartridges, Recording Heads, and Accessories have played an important role in the evolution of today's radio and sound equipment. Astatic looks forward to even greater accomplishments in the days ahead.

ASTATIC

THE ASTATIC CORPORATION

YOUNGSTOWN, OHIO

Licensed Under Brush Development Co. Patents

In Canada: Canadian Astatic Ltd. Toronto, Ontario

With the Experimenter

[Continued from Page 36]

The oscillator was built after the author's description and several different makes and styles of 2-gang potentiometers were tried. Not being entirely satisfied with the results, a 2-gang 11-point rotary switch was installed in place of the potentiometers and fixed resistors were soldered between the points of the rotary switch. This gave eleven different frequencies spaced evenly over the dial and without difficulty from backlash.

The frequency range of 60 to 6000 cycles was most suitable for my needs so the eleven points cover 60, 100, 200, 500, 800, 1000, 2000, 3000, 4000, 5000, and 6000 cycles. This range could be changed of course by using different values of resistors. The accompanying circuit diagram shows the particular values used in my oscillator. A good commercial a.f. oscillator was available for calibrating the oscillator so the frequencies given are quite accurate. Half-watt resistors are used and it will be noticed that most of them are of standard values. The 900, 1300, and 2300 will have to be made by connecting two resistors in parallel or series or by selecting them from a group of resistors having a 10 per cent tolerance in the closest value. All other constants remain the same as in Mr. Davis' original article.

• • •

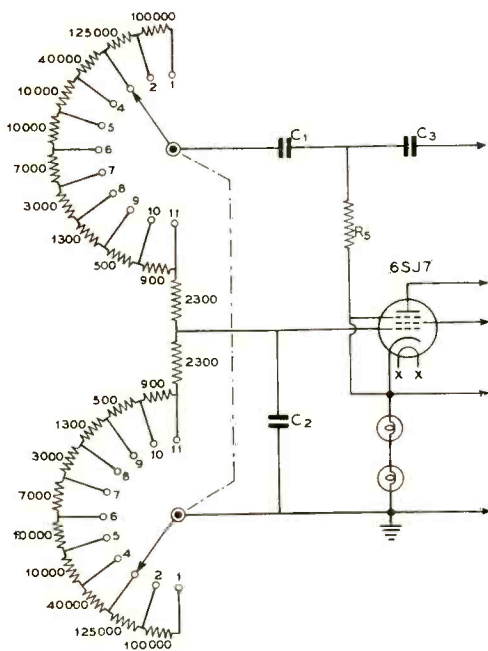

OUT OF THE
Present Emergency



will come

Better Products

For A New Amateur Radio

AMATEUR Radio as we have known it, is now a thing of the past. While cessation of operation was a matter of law, all amateurs willingly gave up their hobby to favor the interests of their country.

When victory again brings peace to our shores, there is no question that amateur activities will be renewed with greater enthusiasm than ever before. The present emergency conditions are already pointing the way to this new amateur radio. Intensive research and development work, increased production facilities and stringent Government specifications are all working together for better amateur radio components in the future.

Bliley is producing crystal units in constantly increasing numbers for all National Defense requirements. Today's war-time experience will result in better Bliley Crystal Units for tomorrow's greater Amateur Radio.

BLILEY ELECTRIC CO.
UNION STATION BUILDING ERIE, PA.

Yarn of the Month

[Continued from Page 35]

I hear rebroadcasting our position and condition but GLD, so I pulled the switch for the last time and got out of there.

The Old Man was bawling for me to come on. Two boats had shoved off and were on their way. The sub had come to the surface and their commander had given orders for us to leave the ship at once. About this time the Chief Mate got the brilliant idea that I should duck back in the chart room and rescue his "ticket," and I was just silly enough to do it. Incidentally I also got the ones belonging to the other deck officers, and stopped by the shack and rescued my own as well as all of my log sheets, which turned out to be of some importance later.

The Heinies were getting pretty impatient by this time and we lost no more time in sliding down the falls and putting some space between ourselves and the poor old "Archbold."

About six or seven shells were required to sink her and with a mighty WHOOSH and a dull explosion, she stuck her nose up in the air and sank.

The sea was not rough when viewed from the deck of a ship, but in a lifeboat it was something else again. The first two boats to get away were some distance from us but all going in the same general direction.

In a very short time, it seemed, we saw the smoke from some vessel approaching us and our hopes rose immediately. They fell just about as quickly when we discovered that the submarine, which we thought had left the place, showed up just astern of us. To top this off the surface vessel which we had seen approaching us started to shell our lifeboat and was getting our range slowly but surely. We tried to correct his mistaken idea that we were a sub, but he kept it up until you could almost see the man working the gun. It was a small freighter which had been bought in the United States and was being brought to France by a French crew.

They steamed up quite close to us and someone hailed us from the bridge wanting to know if we wished to be picked up. Our Old Man replied that we did not, and informed the freighter's Captain that the submarine was right back of us. Just about that time the sub sent a torpedo at the freighter and apparently only missed her stern by three feet. The freighter took out of there and by some hook or crook escaped.

It soon commenced to get dark, and the submarine was now fully on the surface, evidently charging batteries, and getting a little fresh air. They stayed a fair distance from us and

apparently were waiting for the next vessel foolish enough to try to pick us up.

They had not long to wait. We soon saw some small vessel approaching at a rapid rate and from her cut it was easy to see she was a fighting ship of some kind. The sub submerged again and we tried to devise some way to warn the oncoming ship of her presence. There was no flashlight in the boat (Eveready please note) but the regular lifeboat lantern seemed to be in working order, so I got in the bow of the boat with the sub dead astern of us. Then by shielding the lantern with my jacket and covering and uncovering the lantern with my cap I had a make-shift Morse light. Ever try sending code that way? It's not so easy. At any rate I flashed or tried to flash "Submarine right astern, watch for him." The ship came right back with her Morse light "R OK COME ON ABOARD." (Much to my surprise. I didn't think anyone could read that stuff.)

She turned out to be the converted French Yacht "Engageante" a trim little craft that only drew about six feet of water, a fact that probably saved all of our lives in the next few moments, for as we were climbing over the side, the sub fired a torpedo which passed completely under our lifeboat and the sub-chaser. BOY! that thing really sizzled. At the same moment the "Engageante" opened up on the sub with their deck gun right over our heads, and started getting under way in order to drop some depth charges. I doubt if they got the sub, but by that time it was hard to tell.

We cruised about for a day or so before they landed us at Brest, and in the meanwhile I had to struggle with my French as the Skipper of the little craft was trying to get as much information from my log sheets as possible. One of our survivors was a large nondescript dog of very uncertain parentage but unexcelled awkwardness, which we had picked up in France. The crew took such a liking to him (we had named him "Bum") that we let them take him for a mascot.

Our Old Man finally made arrangements through our Consul to get us down to Bordeaux whence we sailed for New York after about a week's wait. We came home in style though on the French liner "Espagne," arriving in New York on July Fourth. Did we celebrate the Fourth? What do you think?

• • •

Persons interested in ground conductivity of the United States are invited to consult such a map in the Commission's "Standards of Good Engineering Practice Concerning Standard Broadcast Stations," which is obtainable from the Superintendent of Documents, Washington, D. C., at a cost of 30 cents a copy.

Police Department

[Continued from Page 25]

If the speaker isn't already of the p.m. type, it is best to substitute a p.m. of the same voice coil impedance. Otherwise it would be necessary to provide a field supply at the speaker in order to avoid running high voltage leads between the speaker and receiver.

Placing the receiver much closer to the antenna in this manner greatly reduces the loss in the antenna transmission line, because a much shorter length may be used. And besides, lamp fixture wire (for the a.f. line) is a lot cheaper than low loss coaxial cable.

Another advantage of having receivers remote to the operating rooms is that if they are of the tunable type, they are away from dial twisters and "tuner-inners." Also, in some cases room is at a premium, and the removal of two or three receivers from a room alleviates crowding of apparatus which cannot be operated remotely.

There is one new source of radio noise which has given much trouble: the fluorescent light. It is no easy matter to eliminate the hash from one of these lights. The noise from one tube seems to be as bad as from a whole battery of them. After trying nearly everything in the book it was found that a pair of chokes in the lines *right at the light*, with condensers across the lines going to ground, was the only procedure that would help at all. (See figure 4.) If the filter is placed at the end of a long wire running to a fluorescent light, the cord radiates the hash before it gets to the filters; so the filter must be as close to the source of noise as possible. There are several types of commercial filters available, but not many are designed to be made part of the lamp installation.

Nearly all kinds of interference emanating from electric motors can be eliminated by the insertion of a conventional line filter as close to the motor as possible.

Ignition noise from traffic probably is the most aggravating kind of interference to combat when the receiver is located in a traffic area. A noise silencer is of prime importance in combating this interference. Those receivers which do not have one can be helped some by a makeshift silencer consisting of a neon bulb, with the resistor removed, connected from plate to screen of the output stage (assuming single pentode output). This will also help in cases of excessive static or electrical disturbances where the pulses are of short duration. A more elaborate silencer will be required in the more stubborn cases.

Sometimes one of the things mentioned here will do much toward ending noise and sometimes all of them will do very little; but any-

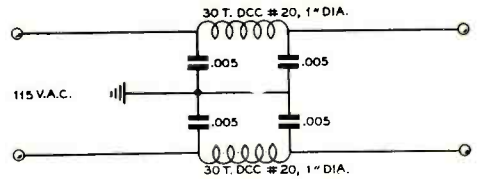

Figure 4
Fluorescent light filter. To be most effective, it should be placed right at the light. No. 20 wire will be heavy enough for anything up to 100 watts.

thing that may help at all is worth a trial. One thing, however, is to be borne in mind whenever a project like this is begun; that is, noise can be eliminated at its source much easier than it can be kept out of an antenna. If the sources are *not too numerous*, and are accessible, it is simpler to operate upon the noise at the various sources.

• • •

**"GHOST" SIGNALS ON 9-METER
POLICE BAND**

By **GEORGE W. ALLEN,* WIMSD**

Recently the radio operators of this station have been annoyed by a peculiar type of interference on the 9-meter police band. This interference made itself known by opening the squelch on the high-frequency receiver. The unknown carrier had apparently the same strength as one of the more distant mobile units, with the result that in some instances it was almost impossible to understand what the operator of the mobile unit was saying. However, there was no audible beat between the strange carrier and that of the car transmitter, and the use of an all-wave signal generator tuned from the i.f. of 456 kc. up through the entire spectrum to above the input frequency of the receiver did not produce an audible beat.

As a last resort the writer built up a super-regenerative detector operating on the 9-meter band and coupled to it the regular receiving antenna. Exactly on the car frequency was heard the characteristic squeal of another super-regen. It was also noticed that the super-regenerating detector had the same effect on the h.f. receiver only to a greater degree, due, no doubt, to the close proximity.

By applying the process of elimination to the possible listeners to this frequency, it was decided that it must be one of the local garage proprietors, who in this area, as no doubt in many others, are addicted to the practice of

*Radio Operator, East Providence, R. I., Police Department.

listening on the police frequencies with the idea of being on the scene of automobile accidents with their wreckers as soon as possible.

Following this line of reasoning a trip was made to several of the garages in the neighborhood. In the last one visited the well-known hiss of a super-regenerative receiver was apparent upon entering the establishment.

It is thought that the report of this experience may be of assistance to others who may run up against this type of interference.

• • •

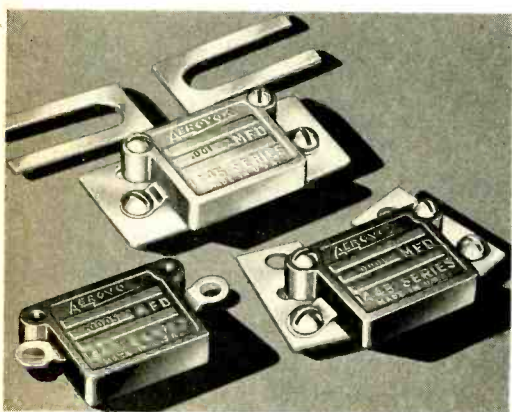

Meter-shunting MICA CAPACITORS

Some two dozen molded-in bakelite types to choose from.

Meter-shunting capacitors with adjustable brackets. Wider choice of mountings, terminals, dimensions, voltages.

Capacitors also available in XM (yellow) low-loss bakelite for UHF work, at slight price increase over usual brown bakelite.

Also stack-mounting; bakelite-case; cast-aluminum case; metal-case, and other types, heretofore made only on special order.

• When it comes to those more special mica capacitors, you can always depend on the Aerovox line because it provides the *greater* choice. Especially since Aerovox communications-grade transmitting capacitors, heretofore made only to order, are now available to "hams" and experimenters.

Ask Your Jobber . . .

Ask him to show you these meter-mounting and other types of molded-in-bakelite micas. Ask to see his data on communications-type or extra-heavy-duty transmitting capacitors. Or write us direct.



Sound Department

[Continued from Page 26]

before bringing in the effect will build up the laugh. As an illustration, suppose we are filming a short sequence concerning the Community Chest drive. A title flashes on the screen reading, "The Rich Mr. Moneybags makes a donation to the Community Chest." We see a pompous gentleman, smoking a fat cigar, enter a curtained booth and draw the curtains behind him. There is a pause for "comedy timing" and then we hear the sound of a small coin being dropped in a tin cup. This sequence inevitably gets a laugh from the audience.

Using the method described for cueing in sound effects will not give split-second synchronization, but various expedients may be used to avoid this difficulty. If we have a scene where someone is coming to call at a home, we show him approaching the door and raising his arm, ready to knock. Then we cut to the interior of the home and show a lady seated in a chair reading. As the operator cues in the sound of the knock we see the lady raise her eyes from the book as though hearing the knock, and the illusion is complete. In other words, by keeping our sound effects "offstage," absolute synchronization is not necessary.

Here are a few offstage sound effects that should get laughs: We see two lovers seated at a table. A man at a nearby table winks at the girl. The boy gets mad and motions the fellow to step into the next room. As they close the door behind them, we "pan" to the girl's face. She puts her fingers in her ears as the sound of a terrific battle is heard.

Here again the sound effects man would take liberties and burlesque the sound of the fight. You might hear loud ripping of cloth, breaking of glass, birds twittering, etc.

In another scene, a guest might ask for some iced tea. The host brings in a large pitcher of iced tea, enough for ten men. The host is amazed to see his guest lift the whole pitcher to his lips. We then cut to a close-up of the host, whose eyes are as big as saucers as we hear the sound of gallons of water being emptied from a jug.

And don't forget, those of you who have dual turntables. One table can be used for background music which is faded down each time a sound effect is cued in!

• • •

Massachusetts hams William K. Snow (W1MUF) and William J. White (W1MUG) ought to know each other.

A Vacuum-Tube Voltmeter

[Continued from Page 14]

Since most good resistors manufactured nowadays are quite inexpensive it is well to have a couple of each value, as slight individual variations may give just the value needed.

Any multiscale meter may be used by figuring out different values for the resistors from the values given for this meter—up to 300 volts. Scales above this value should not be used because (with a power supply of 350 volts) values higher than 300 volts applied to the grid of the tube will run into the upper bend of the tube's characteristic curve and the response will not be linear.

It might be better to make first adjustments on the medium range. This range does not use a bleeder and the only adjustments will be on the cathode resistor and the meter series resistor R_{12} . A power supply furnishing this voltage with a potentiometer for adjustments will be necessary. Batteries are best for this supply if available.

An accurate a.c.-d.c. voltmeter should be used for calibrating and should be left connected while readings are taken with the vacuum-tube voltmeter. The conventional meter will load the circuit, hence the voltage will rise if it is disconnected to take a reading with the v.t.v.m. The a.c. voltage scale is different from the d.c. scale. A separate scale may be drawn up to correspond to the d.c. divisions of the meter scale or may be put directly on the upper side of the d.c. scale. A 60-cycle a.c. supply is used for calibrating. This calibration is used for future a.f. and r.f. voltage testing.

A 24-A-type tube is used with the screen-grid and plate tied together. Use of this tube results in some frequency discrimination at the high frequencies. A different tube might be used but then the values of the components may be quite a bit different from the ones given. Also, a tube must be used that will stand the 2.5 or 3 ma. of plate current which is required with a meter of this sensitivity.

Safety

The network consisting of C_2 and R_9 serves to prevent the meter from slamming the pin when the prods are removed from the circuit during measurement of high voltages. When the test prod is removed from a high voltage circuit, condenser C_2 connected from cathode to ground on the 24-A discharges through the cathode resistor and holds the tube at cut-off. This would cause the bucking voltage to slam the meter back past zero were it not for the counter action of C_2 and R_9 . When turning on the power it is best to set the range switch in the high-voltage position.

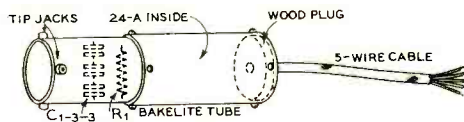

Semi-schematic of the probe housing for the 24-A v.t.v.m. tube.

The switch S_1 is used for switching from positive to negative. The meter is read from full-scale down for negative voltages. It is calibrated the same as for positive voltages.

S_1 is a single-pole double-throw switch and is connected so as to shift the cathode to the common terminal of S_2 , a single-pole 3-position switch. A reversing switch might be used for reversing the meter to make it read upward on negative voltages, but is not necessary. The negative range is 30 volts. Input for a.c. voltages is through condenser C_1 .

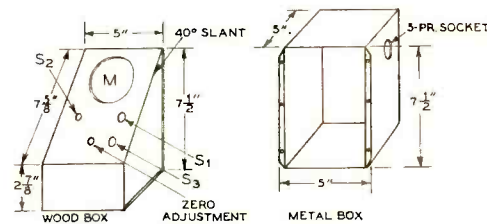

Drawing of the combination wood and metal box which houses the instrument.

A metal panel should be used for mounting the meter and switches. The panel should be grounded to the negative of the power supply.

In the photo the positive range switch is to the left. The center knob is for zero-adjustment, the lower toggle switch is the 110-volt power switch and the one at upper right is for switching from negative to positive. To the right is the prod vacuum tube in its bakelite tubing case. The prod cable is plugged into the side of the meter and power supply case.

A terminal board of good insulating material with plenty of lugs for connecting resistors, condensers and switches should be secured. If the instrument is to be used as a d.c. meter only or in connection with a separate rectifier such as was described on page 40 in the November issue of RADIO, then the condensers C_2 of which there are two, the 40- μ fd. condenser C_4 and R_9 may all be eliminated. If it is used thus the 24-A tube may be placed inside the cabinet. The tube should be well shielded under these conditions.

[Continued on Page 61]

What's New

[Continued from Page 54]

Dear RADIO:

Kindly send me the items listed below for which I enclose \$..... in payment.



- "Radio" (five issues)
- "Radio" (one year)
- "Radio" (two years)
- "Radio" (three years)
- "Radio" Handbook
- "Radio" Amateur Newcomer's Handbook
- "Radio" Noise Reduction Handbook
- W.A.Z. Map (6 great circle maps)

Name

Call

Address

Note: All shipments are prepaid by us. Current editions are always supplied unless previous or future editions are requested in the original order. California and Illinois customers: please add sales tax.

266

THE EDITORS OF **RADIO** 1300 Kenwood Road, Santa Barbara CALIFORNIA

lized in meeting the radio characteristics required at different operating frequencies, particularly in the ultra-high-frequency spectrum.

NEW SHURE "556"

SUPER-CARDIOID BROADCAST MICROPHONE

A new "Super-Cardioid" Broadcast Dynamic Microphone is announced by Shure Brothers, "Microphone Headquarters," Chicago. This new Series "556" introduces a "Super Cardioid polar pattern that is twice as unidirectional as the Cardioid, from the standpoint of receiving front sounds and rejecting rear sounds, yet has wide-angle front pick-up. Decreases pick-up of reverberation energy and random noise 73%. The axial polar pattern is symmetrical at all frequencies.

Improved "Ultra" wide-range frequency response from 40 to 10,000 cycles assures full reproduction of music, crisp reproduction of speech.

The new Microphone is functional in design and beautifully modern in appearance. Compact, sturdy construction makes it easy to handle in the studio or to take along on remotes.

For full details, write to Shure Brothers, 225 W. Huron Street, Chicago, Illinois.

SYLVANIA ANNOUNCES A NEW TUBE CHARACTERISTICS SHEET

A new Renewal Tube Characteristics Sheet was released today by the commercial engineering department of the Hygrade Sylvania Corporation. Original distribution was made by inserting it in the current *SYLVANIA NEWS* just out.

A new type format distinguishes this Characteristics Sheet from previous editions. Each tube type is horizontally ruled off so that any particular characteristic desired can be seen at a glance.

It is a twelve page booklet and contains not only average tube characteristics, but also panel lamp characteristics and tube and base diagrams. It is available free, but, in view of paper shortages, we request that radio servicemen and service departments of radio shops order for bare requirements only and give a single copy the greatest possible use.

• • •

The new giant cyclotron, or "atom smasher" now being constructed at the University of Southern California is expected to produce a beam whose voltage will range from 100,000,000 to perhaps 300,000,000. The beam from the largest cyclotron now operating penetrates in air about five feet; the beam of the new instrument will penetrate 140 feet.

The Ohmite News.

Vacuum-Tube Voltmeter

[Continued from Page 59]

Ranges

Any meter range may be used for preliminary testing for linearity. It is best to bring out leads from the terminal board so that connections can be made to the resistors as the different ranges are adjusted. All condensers should be connected before any adjustments are made. The meter, together with the 0.4-megohm resistor and the 3,500-ohm resistor which furnishes the bucking voltage, the 2,000- and 4,000-ohm resistors and the 0.1-megohm variable control (Centralab recommended) should also be connected. Of course the other resistors for the range being adjusted should also be connected.

The power should then be turned on. If you are using the 12-volt scale it should be possible to adjust the meter to approximately center scale and also to reduce it to below zero. In any case, with no test cords connected set the meter to zero. Connect test leads and apply 3 or 4 volts positive to the grid of the tube. Then apply voltage to bring the meter near full-scale. If the meter reads high (according to the voltage scale) the cathode resistance must be increased.

If the meter reads about right at the low end of the scale, and runs high at the high end, resistor R_{12} in series with the meter must be increased. However, once the value of this resistor is found, it will not have to be changed for the other ranges.

By using the variable resistor R_{22} alone and adjusting for linearity and then using an ohmmeter to measure the approximate value required, some time may be saved. However R_{12} should be of such value as to allow the variable resistor R_{22} to be set near its mid point as this resistor is used to adjust the instrument for any changes in tube characteristics or changes in value of resistors.

Calibration

The important part of the adjustment process is the calibration. It will be noticed that the 12-volt range uses a bleeder in series with the cathode resistor. In making adjustments you will find that decreasing the value of the bleeder will make the meter read higher, and vice versa. Also, decreasing the cathode resistance will lower the range of the meter; that is, the voltage required to swing the meter to full-scale will be less.

Different values of resistors should be tried in these positions until you get somewhere near the correct values. You will find that these

values are very critical, but by paralleling or placing resistors in series the correct values can be obtained. The values shown were arrived at by this means and different resistors may require other values of parallel resistors to obtain the same result. In case of the 12-volt ranges shown, the 60,000-ohm resistor is the main resistor and should be a 5 or 10-watt wire-wound unit. The other resistors used are all of the 1-watt insulated type.

• • •

Now—a really high-powered—

RADIO ENGINEERING LIBRARY

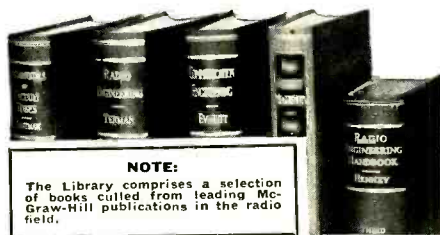

NOTE:

The Library comprises a selection of books culled from leading McGraw-Hill publications in the radio field.

- especially selected by radio specialists of McGraw-Hill publications
- to give most complete, dependable coverage of facts needed by all whose fields are grounded on radio fundamentals
- available at a special price and terms

These books cover circuit phenomena, tube theory, networks, measurements, and other subjects—give specialized treatments of all fields of practical design and application. They are books of recognized position in the literature—books you will refer to and be referred to often. If you are a practical designer, researcher or engineer in any field based on radio, you want these books for the help they give in hundreds of problems throughout the whole field of radio engineering.

5 volumes, 3319 pages, 2289 Illustrations

1. Eastman's FUNDAMENTALS OF VACUUM TUBES
2. Terman's RADIO ENGINEERING
3. Everitt's COMMUNICATION ENGINEERING
4. Hund's HIGH FREQUENCY MEASUREMENTS
5. Henney's RADIO ENGINEERING HANDBOOK

10 days' examination. Easy terms. Special price under this offer less than books bought separately. Add these standard works to your library now; pay small monthly installments, while you use the books.

.....SEND THIS ON-APPROVAL COUPON.....
McGraw-Hill Book Co., 330 W. 42nd Street, N.Y.C.

Send me Radio Engineering Library, 5 vols., for 10 days' examination on approval. In 10 days I will send \$3.00, plus few cents postage, and \$3.00 monthly till \$24.00 is paid, or return books postpaid. (We pay postage on orders accompanied by remittance of first installment.)

Name

Address

City and State

Position

Company R-3-42
 (Books sent on approval in U. S. and Canada only.)

Cathode-Ray Oscilloscope

[Continued from Page 44]

age does not increase linearly with respect to time.

Now, what to do about it! The first fault, insufficient output, is overcome simply by hooking on a stage of amplification.

Fault number two is remedied by changing to a thyratron tube, this being a more or less glorified version of the neon bulb. It looks just like a 76 but behaves differently.

A simple thyratron oscillator circuit is shown in figure 13. Instead of the neon bulb is a type 884 or 885 gas-triode (thyratron), which has a heater, cathode and plate—but has a little inert gas mixed with its vacuum content. Its action is quite similar to the neon bulb, except that its flashing voltage may be set to any predetermined value by application of proper grid bias potential E_c .

Two more resistors, R_1 and R_2 , have been added to the circuit. The former simply limits the maximum charging rate, while the latter prevents C_1 from discharging more rapidly than the little tube will stand.

It is a characteristic of type 884 and 885

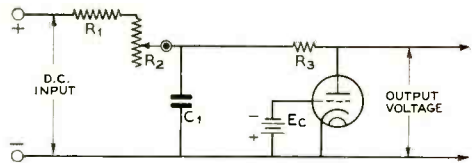

Figure 13. Simple gas-triode (thyratron) oscillator circuit.

tubes, that discharge will occur whenever the plate potential reaches about seven times the negative grid bias value. Since we will amplify the output voltage anyway, we can fix the flashing voltage at about 20 volts by biasing the grid to about -3 volts. This gives plentiful output and makes the saw-tooth wave linear in the bargain, the explanation of which will follow.

We have already mentioned that a condenser takes its charge in exponential fashion. The curved and dotted line in figure 14 shows this charging characteristic. The condenser starts charging fast but slows down as its potential approaches that of the charging voltage.

If such tank condenser is "flashed" when about half full its charging curve will be

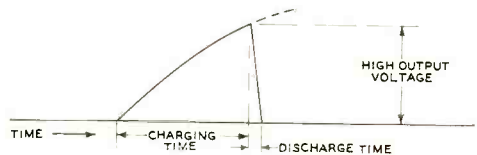

Figure 14. Effect of operating at a high flashing voltage.



Figure 15. Obtaining sweep-circuit linearity by means of a low flashing voltage.

"rounded" like the solid line. Such a curve will make the pretty patterns on our cathode-ray screen rather distorted.

However, if the thyratron is set for a low flashing voltage—that is, only five or ten per cent of the d.c. charging voltage, this charging curve will be essentially linear, as shown in figure 15. Here we flash the condenser before its curve starts bending to any appreciable extent.³

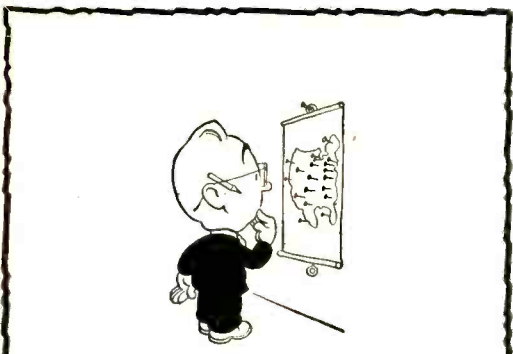

Look, chum: Radio's WAZ World Map (defining the forty DX zones under the WAZ plan) will lick all your map problems—it's literally all there. Besides, there are those five great circle maps so you can determine distance and direction to any point in the world! How about it? Only 35 cents, post-paid anywhere.

THE EDITORS OF **RADIO** 1300 Kenwood Road, Santa Barbara CALIFORNIA

Synchronization

And now, about synchronization. We stated that the flashing voltage was determined by the thyatron's grid bias. If a small potential—less than a volt being required—is fed back from the signal under inspection to this thyatron grid, the tube will flash, always at the instant a certain signal voltage is reached.

A potentiometer, R_1 , in figure 17 provides control of the synchronizing potential. This voltage is usually taken from the signal voltage on the free vertical deflection plate, but in some cases from the signal, itself, and occasionally from the 60-cycle line.

Something should be said of the polarity of output, both from the tank condenser C , and the complete sweep circuit, with amplifier. Referring to the first portion of figure 16 will be found the "saw-tooth" waveform across the

as will be seen in the last portion of figure 16. This phase reversal is of no real importance, though. If the cathode-ray tube is mounted so

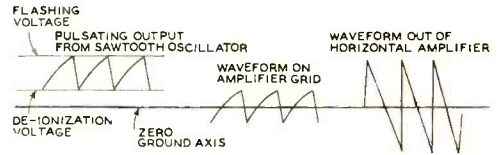

Figure 16. Pulsating oscillator output becomes a.c. on output side of coupling condenser.

the free horizontal plate is at one's left, the sweep cycle will begin at that side, travel to the right, and then snap back to start the cycle all
 [Continued on Page 66]

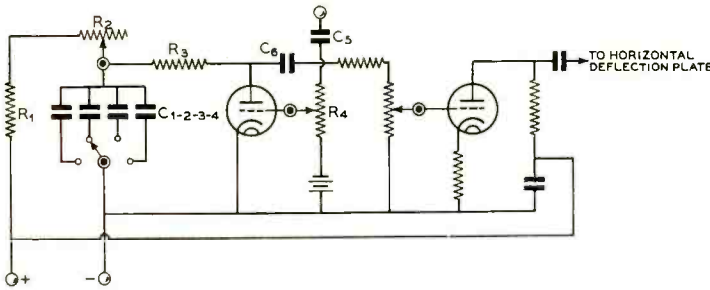

Figure 17. Complete sweep circuit, consisting of sawtooth oscillator and horizontal amplifier.

tank condenser. This voltage varies from a few volts above ground to the flashing potential of the thyatron. Note that this voltage is *always positive*. The waveform is a saw-tooth pulse, rather than an alternating current wave, at this point. However, the oscillator is coupled to the horizontal amplifier grid through a coupling condenser C_6 . Here on the amplifier grid we will find the same saw-tooth characteristic. But the amplitude is now divided half above and half below our ground line of zero potential.

Now after amplifying this wave, we find that the amplifier has shifted its phase 180 degrees,

³Another method of obtaining a linear output voltage is frequently found in television receiver designs, and in some of the older oscilloscopes. Instead of flashing the thyatron at a low potential, this method flashes at a much higher value; that is, two or three hundred volts, thereby eliminating the amplifier. By substituting a pentode tube for the current limiting resistor R , current flow to the tank condenser is limited to a constant rate. This method, however, is just as complicated as the low-flash-and-amplify method and is not nearly so flexible. Also, with the low-flashing circuit, the amplifier is also available for amplification of external signals, if desired, making it much more suitable for oscilloscope use.

MAILING LISTS

GET OUR FREE REFERENCE BOOK and MAILING LIST CATALOG FREE

Gives counts and prices on accurate guaranteed mailing lists of all classes of business enterprises in the U. S. Wholesalers—Retailers—Manufacturers by classification and state. Also hundreds of selections of individuals such as professional men, auto owners, income lists, etc.

Write today for your copy

R. L. POLK & CO.
 Polk Bldg.—Detroit, Mich.
 Branches in Principal Cities
 World's Largest City Directory Publishers
 Mailing List Compilers, Business Statistics, Producers of Direct Mail Advertising.

To keep abreast of
rapid developments,

Read "RADIO"

the outstanding
publication in the field

Not a staff-written magazine, RADIO solicits its editorial material from all independent investigators and experimenters, assuring you of unbiased information.

A trial will convince you of the value and merit of this publication.



Special Introductory Rate: Send us \$1.00 and we will enter your name on the subscription list for the next five issues (no back numbers).

"RADIO" is published monthly, except August and September.

Full year, **\$2.50** in U.S.A.

THE EDITORS OF
RADIO *technical publishers*

1300 Kenwood Road, Santa Barbara
CALIFORNIA

The Marketplace

Classified Advertising

(a) Commercial rate 10c per word, cash with order; minimum, \$1.00. Capitals: 13c per word. For consecutive advertising, 15% discount for 3d, 4th, and 5th insertions; 25% thereafter. Break in continuity restores full rate. Copy may be changed as often as desired.

(b) Non-commercial rate: 5c per word, cash with order; minimum, 50c. Available only to licensed amateurs not trading for profit; our judgment as to character of advertisement must be accepted as final.

(c) Closing date (for classified forms only): 25th of month; e.g., forms for April issue, published in March, close February 25th.

(d) No display permitted except capitals.

(e) Used, reclaimed, defective, surplus, and like material must be so described.

(f) Ads not relating to radio or radiomen are acceptable but will be grouped separately.

(g) No commissions nor further discounts allowed. No proofs, free copies, nor reprints sent.

(h) Send all Marketplace ads direct to Santa Barbara accompanied by remittance in full.

WANTED—Factory built 500 watt and 1000 watt input transformers with no home modifications. 160 meter coils, condensers necessary. Send description including make, model, age, weight delivered, price to Art Sowle, W6CW, Supervisor State Police Radio, Box 890, Reno, Nevada.

COMPLETE PHONE TRANSMITTER, in cabinet, very conservatively rated at 150 watts carrier, excellent fidelity. Originally designed for amateur bands from 3500 to 30,000 kc., but with few coil alterations will work on any frequency between 2000 and 33,000 kc. Makes excellent police transmitter. Described on page 357 of 1942 **RADIO HANDBOOK**. Price, less tubes, crystal and microphone, \$200.00 f.o.b. Editors & Engineers, Ltd., Santa Barbara.

WANTED—Bargain in transmitters, receivers and parts, etc.; also laboratory apparatus, etc. What have you? W5KD, 215 N.W. 19th St., Oklahoma City, Okla.

WE CAN make immediate delivery of Hallicrafters, Hammarlund, National, Howard, RME receivers and other radio supplies. You get lowest prices, best 6% terms (financed by us), best trade-in, ten day trial. Write, telegraph, telephone. Henry Radio Shop, Butler Mo., and 2335 Westwood Blvd., West Los Angeles, Calif.

KATOLIGHT—350 watt model JR35, 110 volts a.c. or 6 volts at 20 amps. d.c. Ignition completely shielded, including special plug. Self-starting with 6 volt battery (not included). Used very little; both gas engine and generator in excellent shape. Price \$50 f.o.b. Editors & Engineers, Lt., Santa Barbara, Calif.

RECONDITIONED guaranteed communications receivers and transmitters. All makes and models cheap. Free trial. Terms. List free. Henry Radio Shop, Butler, Mo.

RADIO HEADQUARTERS—tremendously large stock of receivers (over 200 on hand), transmitters—all sizes—transceivers—over five different models, radio parts of all kinds. Write to Leo, W9GFQ, for that Big Bargain Catalog and reconditioned receiver list today. Wholesale Radio Laboratories, Council Bluffs, Iowa.

TRANSMITTER COMPONENTS—Some new, some used, but in perfect condition. Too many to list. First come, first served. Write your needs and we will quote when can supply. Editors & Engineers, Ltd., Santa Barbara, Calif.

WANTED—Used communications receivers. We pay cash. Get our offer. Code machines rented and sold. We have large stock of bugs, keys, oscillators, all code teaching equipment. Order anything from us. Henry Radio Shop, Butler, Mo.

METAL CABINETS, racks, panels, chassis, specials. R. H. Lynch, 970 Camulos St., Los Angeles, Calif.

WANTED—Test equipment, transmitting parts. Holstein, 246 E. 148th, N. Y. C.

HAVE several reconditioned guaranteed JRA3, 400 Watt A.C. light plants at \$45, ideal for amateurs. Write Katolight, Inc., Mankato, Minnesota.



RADIO
CATALOG NO. 58
164 PAGES
SETS-PARTS
SUPPLIES
FLUORESCENT
Burstein Applebee Co.

BIG FREE CATALOG

EVERYTHING IN RADIO

Sets, parts, supplies, public address systems, amateur equipment, testers, kits and fluorescent lighting at lowest prices. Huge stocks, bought months ago . . . ready for shipment the same day your order is received. The Defense Program is making big demands on our industry but because of our advance buying we are able to fill your orders promptly and efficiently.

PACKED WITH VALUES!

BURSTEIN-APPLEBEE COMPANY
1012-14 MCGEE STREET, KANSAS CITY, MO.

Cathode-Ray Oscilloscope

[Continued from Page 63]

over again. Our cathode-ray screen graphs will be correctly plotted from left to right, in relation to time.

About Amplifiers

In small commercial oscilloscopes one usually finds one vertical and one horizontal amplifier. The larger models, using five-inch tubes or larger, are usually equipped with two vertical amplifiers.

The vertical amplifier simply builds up the

signal under test to sufficient amplitude to deflect the electron beam to the desired degree.

The chief purpose of the horizontal amplifier is to amplify the saw-tooth timing wave, as previously described, largely in the interest of linearity.

There is nothing unusual about either of these amplifiers, except that they should operate with as little distortion and have as flat a frequency characteristic as can be obtained.

A flexible switching arrangement is always provided to make the oscilloscope as versatile as possible.

Commercial Oscilloscopes

Since we have covered the theory of the oscilloscope, let's examine a typical commercial job. As one would expect, we find two potentiometers for controlling the brilliance and focus of the cathode-ray tube. The a.c. line switch is usually connected to the brilliance control.

Two more potentiometers, for centering the beam on the screen, or lowering it for certain work, are found. Instead of returning the free deflector plates to ground, as shown in the fundamental cathode-ray tube circuit, these plates are returned to the slider of these centering controls. The two ends then "straddle" a portion of both the positive and negative high-voltage bleeders, as will be described more fully in the next chapter.

The free vertical deflector plate may be switched either to the output of the vertical amplifier, or to a binding post for directly connecting signals of high amplitude.

The horizontal selector switch connects the free horizontal plate either to the output of the horizontal amplifier or to a binding post for external signals, this being used particularly for producing trapezoidal patterns.

The vertical amplifier grid remains connected to the saw-tooth oscillator most of the time, but a switch is provided so it may be connected to an external binding post for amplification of signals, whenever such occasion arises.

There are four controls for the saw-tooth oscillator; that is, rough frequency in four or more steps; fine frequency control to obtain any frequency between these steps, and the synchronizing potentiometer. The fourth control is a synchronous selector switch, permitting the use of internal signal, external signal, or 60-cycle line for a synchronizing source. This synchronous selector switch is sometimes associated with the horizontal selector switch, making one less knob on the control panel.

In the next chapter, which will appear in the April issue of RADIO, design of the oscilloscope will be discussed. Enough data will be given so that the reader may build a one-, two-, or three-inch oscilloscope to fit his needs.

Advertising Index

| | |
|---|-----------|
| Aerovox Corp. | 58 |
| Astatic Corp., The..... | 54 |
| Bliley Electric Co. | 55 |
| Bud Radio, Inc. | 43 |
| Burstein-Applebee Co. | 65 |
| Centralab | 37 |
| Eitel-McCullough, Inc | 39 |
| Hallicrafters Co., The | 3 |
| Henry Radio Shop | 38 |
| Hytronic Laboratories..... | 45 |
| Johnson Co., E. F. | IV Cover |
| Lampkin Laboratories | 42 |
| Mallory & Co., Inc., P. R. | 41 |
| McGee Radio Co..... | 42 |
| McGraw-Hill Book Co. | 61 |
| National Co. | III Cover |
| Polk & Co., R. L. | 63 |
| RADIO | 64 |
| RADIO— <i>Amateur Newcomer's Handbook</i> | 48 |
| RADIO— <i>Books</i> | 40 |
| RADIO— <i>Engineering</i> | 49 |
| RADIO— <i>Handbook</i> | 50 |
| RADIO— <i>Noise Reduction Handbook</i> | 47 |
| RADIO— <i>Publications</i> | 60 |
| RADIO <i>WAZ World Map</i> | 62 |
| Solar Manufacturing Corp..... | 42 |
| Taylor Tubes, Inc..... | II Cover |
| United Catalog Publishers, Inc. | 46 |



S **EMPER FIDELIS**

When the going is tough and there is a man's job to be done, old friends of proven dependability are doubly welcome.

NATIONAL COMPANY, INC., MALDEN, MASS.



JOHNSON *for tube sockets*

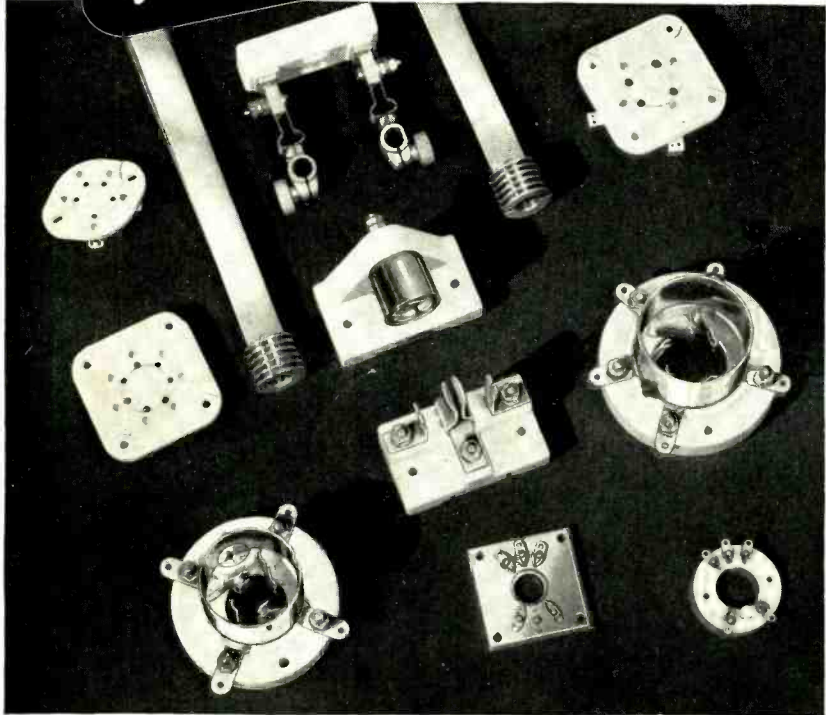

| SOCKET | FOR |
|--------|----------|
| 209 | 5 watt |
| 210 | 5 watt |
| 211 | 50 watt |
| 212 | RCA 833 |
| 213 | 152TL |
| 214 | 1500TH |
| 215 | 250 watt |
| 216 | 204A |
| 217 | 7 prong |
| 224 | 4 prong |
| 225 | 5 prong |
| 226 | 6 prong |
| 227 | 7 prong |
| 228 | 8 prong |
| 235 | Acorn |
| 237 | RCA 813 |
| 245 | Acorn |
| 247 | RCA 829 |

If it's a tube socket, the chances are that Johnson makes it. Listed above are some of the more common types manufactured regularly in large quantities, and available from your Jobber. Others are supplied on special order or to the customer's specifications.

In the illustration will be noticed some of the old familiar stand-bys. Also illustrated is the 212 for RCA 833 and the 245 with built in by-pass condensers for the Acorn tube. When you buy a tube socket be sure to look for the name Johnson. It's your guarantee of quality.

ASK FOR
YOUR NEW
CATALOG
967K



E. F. JOHNSON CO.

WASECA, MINNESOTA

EXPORT: 25 WARREN ST., NEW YORK, N. Y.

"MANUFACTURERS OF RADIO TRANSMITTING EQUIPMENT"