

RADIO

ESTABLISHED 1917

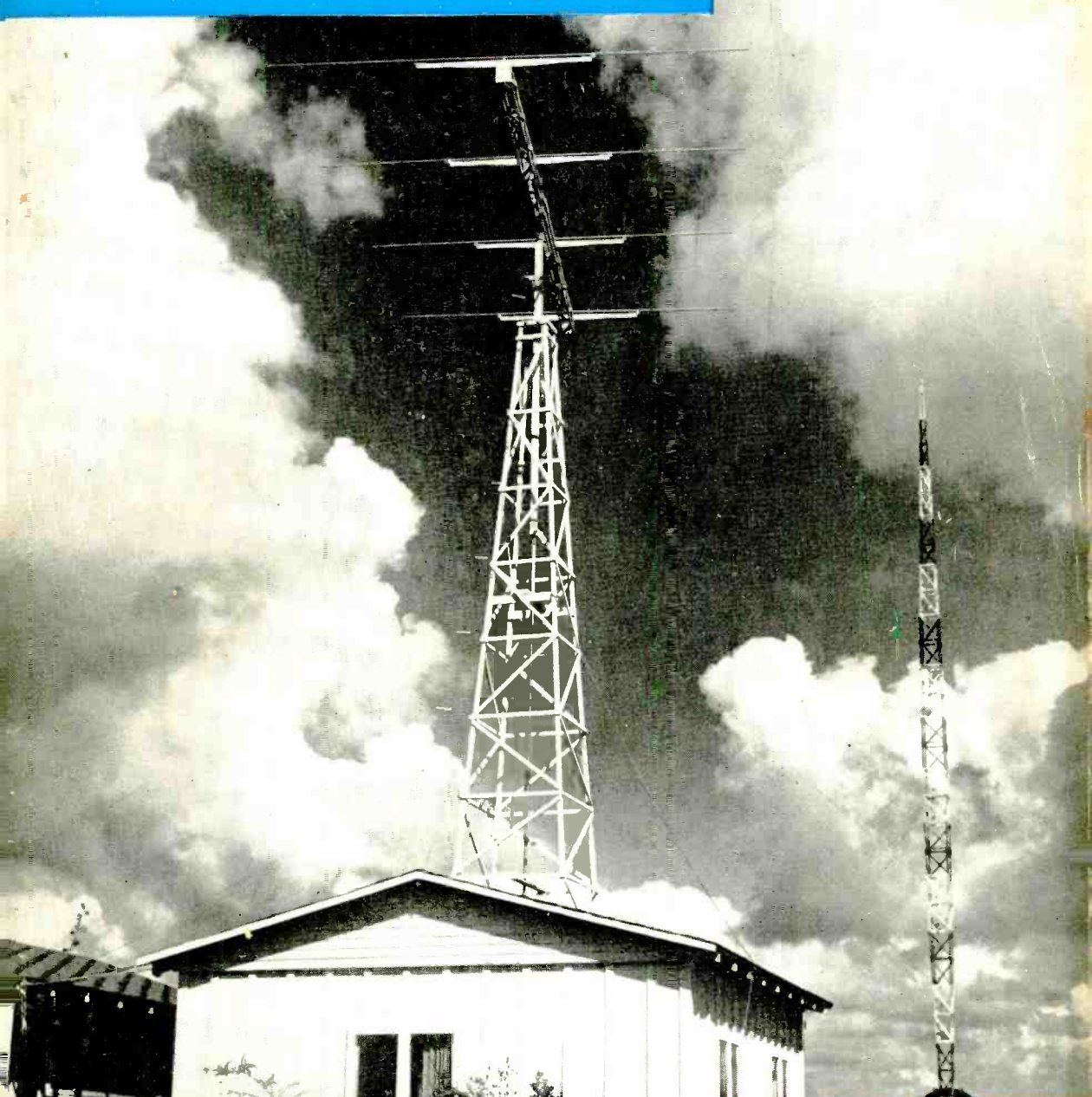

THIS MONTH

- SHORT RADIATORS ON LOW FREQUENCIES
- PORTABLES FOR EMERGENCY SERVICE
- CUSTOM EQUALIZER FOR PHONO PICKUPS
- TRANSMITTER INTERFERENCE ELIMINATION

Technical Radio
and Electronics



November 1941

NUMBER 263

30c IN U. S. A.

HYTRON GIVES YOU

RECORD PERFORMANCE

HY75—112 MC—335 miles*
HY615—224 MC—135 miles

HY615 proved its record-making capabilities back in August, 1940, when used by W6IOJ and W6LFN to set a still-unbroken 224-MC record. HY615 tubes, used in simple transceivers, settled once and for all that efficiency, not size or price, is what counts in U-H-F tubes.

HY75 now smashes to the front with a brand-new record. On August 21, 1941, at 8:38 p.m., just one year after the HY615 shattered all 224-MC records, W2MPY, working 112-MC portable on Mount Katahdin, Maine, raised W1JFF, at Newport, R. I.! This breath-taking, 335-mile QSO was made with an HY75.

*Reception over 400 miles on 112 MC with an HY75 is reported on page 54 of Oct. QST.

YOUR LOGICAL CONCLUSION: YOU too need these outstandingly efficient and remarkably low-priced tubes, which HYTRON alone offers you, for your own U-H-F gear.

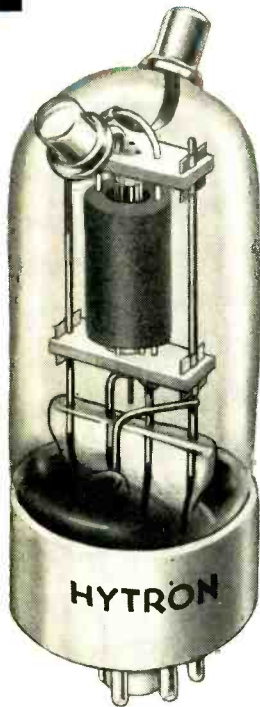

HY75—\$3.95 net

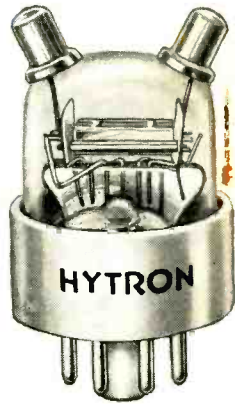

HY615—\$2.25 net

NEW UNSELFISH-EXCITED CIRCUIT

Hytron is proud to have given the amateur these mighty mites, but it is concerned at the QRM these little magicians are creating as detectors in these transceivers which are piling up almost unbelievable performances. Consequently, it is happy to announce that its Chief Engineer, Dick Briggs, W1BVL, has devised a solution to this transceiver problem, a solution which will permit the retention of the desirable simplicity, portability, and economy of the transceiver, but which will greatly reduce the QRM caused by these miniature power-houses, the HY615 and the HY75, when used as oscillating detectors.

Let's put the HYTRON pygmies to work in this new circuit, and give the other fellow some of this much-discussed leibnstraum (living-space).

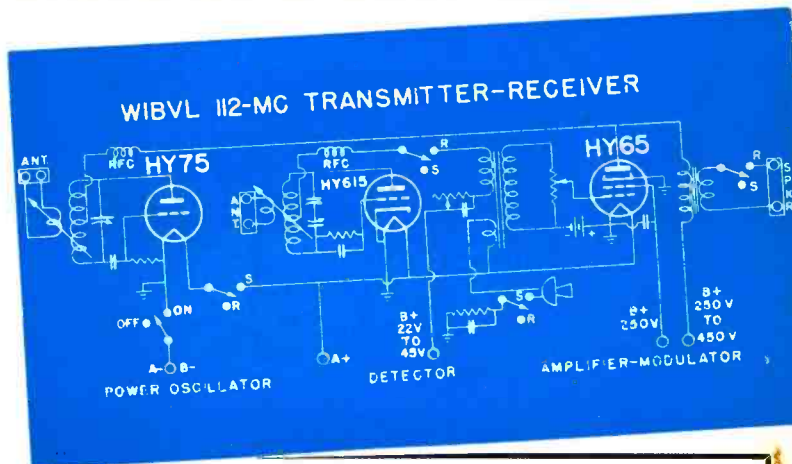

HIGHLIGHTS

1. Radiation from the receiver is markedly reduced.
2. The receiving circuit and its antenna coupling can be designed and adjusted for optimum performance.
3. The oscillator circuit and its antenna coupling can be arranged for maximum power output and efficiency, without a compromise for concomitant receiver performance.
4. Retuning is eliminated when changing between transmitting and receiving.
5. Filament power is conserved by appropriate switching of the HY75 instant-heating filament.
6. The cost is very slightly more than that of a conventional transceiver.



HYTRONIC LABORATORIES

23 New Darby St., Salem, Mass.

MANUFACTURERS OF RADIO TUBES SINCE 1921

A DIVISION OF
HYTRON CORP.

ARMY COOKS

Stir up

GOOD
RECEPTION!



IN the Army, the Navy, or wherever you are you can stir up good reception with a Hallicrafters Sky Traveler. Here is a portable that has been designed for real communications performance. Nine tubes, 1.4 volt tubes used throughout. 4 bands, covers 550 kc. to 30.5 mc. electrical bandspread, self-contained collapsible antenna extends to nearly 3 feet, battery life prolonged through a self-contained charging circuit,

automatic noise limiter, an RF stage used on all bands, sensitivity below two microvolts on all bands, high gain antenna coupling circuit for maximum antenna energy transfer, permeability tuned RF and IF circuits. The Sky Traveler has all the essential controls, operates on either 110/125 volts AC or DC or from its self-contained batteries. Cabinet dimensions 7"x8½"x12¼". Model S-29 The Sky Traveler \$69.50.

the hallicrafters co.
CHICAGO, U. S. A.

USED BY 33 GOVERNMENTS ★ SOLD IN 89 COUNTRIES

Published monthly except August and September by Editors and Engineers, Ltd., 1300 Kenwood Road, Santa Barbara, Calif. Entered as second-class matter Sept. 26, 1938, at Santa Barbara, Calif., under the Act of March 3, 1879. Additional entry at Mt. Morris, Ill.

Ready for You

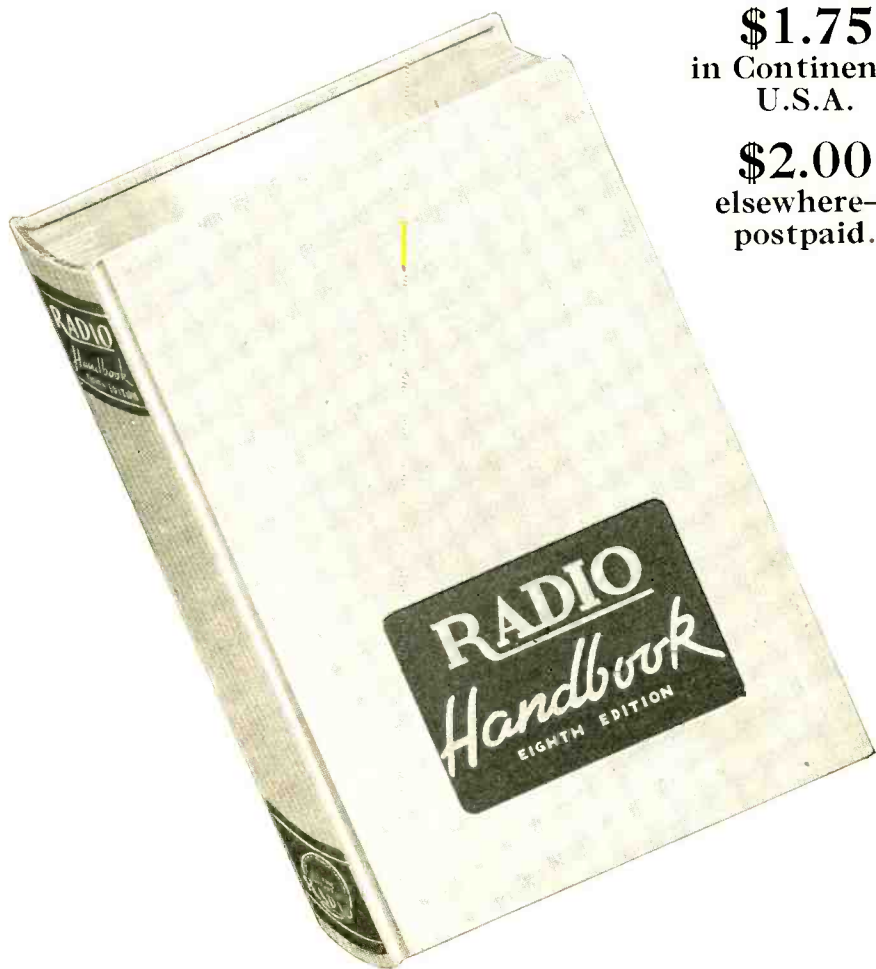

\$1.75
in Continental
U.S.A.

\$2.00
elsewhere—
postpaid.

Over 600 pages—profusely illustrated. This book is truly the radio engineer's, the short wave technician's, and the amateur's own handbook. Written to give you the information you want. See it at your dealer's today!

THE EDITORS OF

RADIO

CORPORATE NAME: EDITORS AND ENGINEERS, LTD.

technical  *publishers*

1300 KENWOOD ROAD, SANTA BARBARA, CALIFORNIA

At your dealer's . . .

The 1942 "RADIO" HANDBOOK

- This book is now ready for your inspection at your nearest radio dealer's. Get ready to be flabbergasted—about its size, content, and beautiful binding—about its thorough coverage of the short wave radio field—about its thorough and complete technical data sections.
- Get ready to BUY your copy right away. Never before has such a Handbook been made available at such an outstandingly low price. Similar books—of like quality, excellence, and fine library appearance—seldom sell below \$5.00 a copy. This book, however, costs you only \$1.75 a copy!
- If your favorite dealer does not have this book in stock, simply send us your check for \$1.75 and your copy will be mailed immediately, postpaid. Please send us your dealer's name, also.

THE EDITORS OF

RADIO

CORPORATE NAME: EDITORS AND ENGINEERS, LTD.

technical  *publishers*

1300 KENWOOD ROAD, SANTA BARBARA, CALIFORNIA

Past

Present

and

Prophetic

Live and Let Live

To avoid the distinction of being the only radio magazine in the country not editorializing on the *Digest's* recent survey of servicemen, perhaps we had better risk sticking our necks out by adding a few comments. We don't wish to become embroiled in the controversy, and most certainly won't speculate on the probable accuracy of the survey, the fairness of the method used, or the propriety of such an article in a magazine such as *Reader's Digest*.

The point is that the author of the report recommended that the set owner secure the advice of a friendly amateur as protection against unscrupulous or overly-enterprising servicemen.

We are afraid that many amateurs will be inclined to be a little hard on these men who have to make their living "making it play again." Neglecting those amateurs who happen to be servicemen by trade, it is hard for an amateur to realize why a serviceman should get \$3 for a job which takes only maybe an hour, a job which many an amateur would be willing to do for a neighbor gratis, just for the love of it. Also, we are afraid that many amateurs will hold the entire fraternity of servicemen responsible for the practice of a few in blaming every case of unlocatable interference upon radio amateurs rather than admit inability to track it down.

As we said before, while we don't like to speculate on the probable percentage of shysters in the servicing profession, there definitely are *some* who are not beyond treating the customer as a sucker to be bled for all he is worth. The point we would like to make is that it just isn't sportsmanlike to make it tough on honest repairmen just because there happen to be dishonest repairmen. It's tough enough already on the honest ones.

Maybe that's why some of them succumb to temptation.

Non-Premium Hams

Amateur radio and operators get a nice send-off in the October *Harper's* in an article by Carl Dreher and Zeh Bouck. All except the "in-mates" of the 160-meter band, who are classed as a bunch of dopes.

Well, perhaps *all* the sidebands on 160 don't emanate from the lips of mental giants. Which prompts the observation that there is no one so indignant over having the 160-meter gang referred to as a bunch of drips as is the phone amateur who recently flunked his class A. And no one so imperiously contemptuous of the "160-meter goons" as the recipient of a brand new unrestricted ticket.

Priorities

It still is uncertain just how tough the parts situation is going to get for amateurs and experimenters. It is a foregone conclusion that some parts will not be obtainable and some will be hard to get. But just how bad the situation ultimately will get and just which parts will be affected cannot be predicted at this time.

This brings up the question of construction articles in RADIO. Naturally we do not wish to run construction articles on apparatus containing components which only a few of our readers have or can obtain. But neither do we wish to go to the other extreme and start showing nothing but "junkbox specials" made from homemade and salvaged b.c. receiver parts while a good selection of store-bought components still is generally available.

We shall do our best to suit construction articles to the current availability of parts, but will depend a lot upon our readers to let us know whether at any particular time we should bear down more on makeshift parts or more on manufactured parts, and to let us know *which* parts fall in which category.

It might be well to point out to our prospective contributors that "academic" and "non-construction" articles will be more and more welcome as time goes on. These include antenna articles, new circuits, practical theory, and so on. Articles on methods of *improving existing equipment*, how to utilize converted or makeshift parts, how to repair equipment when regular replacement parts are not available,—all will be given "priority" when the editors do their monthly winnowing.

Police Department?

In this issue are several kinks that should be of interest to police radio technicians. Whether we attempt to continue or increase the dosage will depend upon the response to the material in this issue. If it is continued as a regular feature, the material probably will be grouped together each month in a "police department."

RADIO

the worldwide authority . . .

Published by
EDITORS and
ENGINEERS, Ltd.

Home offices: 1300 Kenwood Road, Santa Barbara, California

Telephone: Santa Barbara 4242
Bril System teletyp: S BAR 7390
Cable: EDITORSLTD SAN BARBARACALIF

November • 1941

The publishers assume no responsibility for statements made herein by contributors and correspondents, nor does publication indicate approval

No. 263

Table of Contents

Cover—The shack, 28-Mc. four-element rotary, 100-foot tower, and an interesting group of clouds at W6JRM, La Mesa, California.

ARTICLES

300-Watt R. F. Section for V.F.O. Operation— <i>K. H. Rothman, W6KFK</i>	8
A Parallel T for Amateur Use— <i>C. F. Sheaffer</i>	12
An Emergency-Service Portable Station— <i>James H. Hlywa, W6QDG</i>	16
A Custom Equalizer for Any Phonograph— <i>W. W. Smith</i>	21
Tuning Short Radiators on Low Frequencies— <i>C. B. Stanley, W7BOG</i>	24
Sweepstakes Exciter— <i>P. K. Onnigian, W6QEU</i>	26
Transmitter Interference Elimination— <i>Howard C. Lawrence, Jr., W3LXL</i>	30
A Portable Emergency Transmitter for Home or Field Use— <i>Everett G. Taylor, W8NAF</i>	32
Design and Operating Data for Condenser Input Filters— <i>Curtis W. Lampson</i>	35
Police Radio Kinks— <i>"Copper" Sparks</i>	37
A Probe Type Rectifier for the D.C. Voltmeter— <i>A. K. McLaven</i>	40
A Dual-Service Transceiver— <i>Orin C. Levis, Jr., W6DZK</i>	42
A Counterweighted Antenna Tower— <i>J. M. Fraser</i>	44
Simplified Transmitter Control— <i>Richard Whitehorn, W9EMA/3</i>	46
56 Mc. "Potgut" Oscillator— <i>Leroy May, W5AJG</i>	48
Series Tank Frequency-Multiplier Circuits— <i>Arthur L. Munzig, W6BY</i>	49

MISCELLANEOUS FEATURES

Past, Present and Prophetic	6	Buyer's Guide	97
The Marketplace	95	Advertising Index	98
Crossword Puzzle	62		

DEPARTMENTS

The Amateur Newcomer: Simplicity in the Speech Amplifier— <i>Ray L. Dawley, W6DHG</i>	52	U. H. F. Transmission Line— <i>Ellsworth O. Dumas, W8LE</i>	92
U. H. F.	55	What's New in Radio	68
Yarn of the Month	61	Postscripts and Announcements	70
With The Experimenter: Another Final— <i>M. H. Link, W6OHU</i>	64	New Tubes	72
		New Books and Catalogs	74

CORRESPONDENCE and ORDERS should be sent only to our home office. MANUSCRIPTS, if unsolicited and unusable, will be destroyed unless accompanied by a stamped, self-addressed envelope.

ADVERTISING copy and rates (fully mounted and marked) should be sent to "Radio" Production Office, 417 S. Dearborn St., Chicago; send duplicate copy and insertion order to Santa Barbara, as no advertisement will run unless home office telegraphs its approval thereof.

SUBSCRIPTION RATES (in U. S. funds): Two years \$4.00, or \$2.50 yearly in U.S.A. (plus \$1.00 in Illinois). To Canada (inclusive of current rates), Pan-American countries, and Spain, \$0.50 per year additional. Elsewhere, \$1.00 per year additional. Ten issues yearly; back issues are not included in subscriptions.

IF YOU MOVE, notify us in advance; we cannot replace copies sent to your old address. Notice must be received by the 5th of the month preceding the cover date of first issue to go to the new address.

PUBLISHED monthly in June, August and September (and COPYRIGHTED, 1941, by Editors and Engineers, Ltd., 1300 Kenwood Road, Santa Barbara, Calif.) ENTERED as second-class matter June 26, 1927 at Santa Barbara, Calif., under the Act of March 3, 1879. Accepted for mailing at special rate of \$1.00 per copy provided for in Act of October 3, 1917. POSTAGE WILL BE PAID BY ADDRESSEE. THIS REGISTRATION IS IN FULL COMPLIANCE WITH THE ACT OF MARCH 3, 1879. PRINTED IN U. S. A.

The Editors of "Radio"

EDITORIAL DIRECTOR
W. W. SMITH
W 6 B C X

EDITOR
R. L. DAWLEY
W 4 E H C

ASSOCIATE EDITORS
R. L. NORTON, W6CEM
K. V. R. LANSINGH, W6QX
J. E. BEARDSLEY, W8UYA/W6

Contributing Editor
H. BECKER, W6QD

Editorial and Technical Assistants
J. H. BORTHMAN, W6KFO
B. A. ONTVEROS, W6FFF

Business Staff

K. V. R. Lansingh, Publisher Circulation Manager: **N. Castille**
J. A. Thompson Advertising and Sales Promotion Manager:
J. E. Beardsley Production Managers: **W. Wadsworth**

300-WATT R. F. SECTION

for V. F. O. Operation

By K. H. ROTHMAN,* W6KFQ

A two-stage transmitter r.f. section primarily designed for v.f.o. operation—with bandswitching exciter and a vacuum-tube circuit included.

This transmitter r.f. section was designed and built as another piece of equipment to go in the same rack and to operate in conjunction with the r.f. section described on page 30 of the March, 1941, RADIO. At that time it was decided to build two r.f. sections, but to use the same modulator and power supplies, so that it would be possible to change from one band to another in the least possible time—and with the least amount of equipment tied up in the process.

The r.f. section which was described in the earlier article is the high-frequency r.f.

portion, while the original intent was to make this—the other—r.f. section the low-frequency job. The high-frequency transmitter covers the 7- to 30-Mc. range, so it was originally figured that this transmitter would only have to cover the 80 and 160 bands. But in the interest of greater flexibility, and to allow for possible breakdowns and alterations, it was finally decided to have the second r.f. section cover as great a range as was convenient.

Since excitation is a problem only on the 10-meter band, and since the primary range of this r.f. section is from 160 through 20, it was decided to use bandswitching coil turrets in the exciter stage grid and plate circuits. Hence, it

*Laboratorian, RADIO.

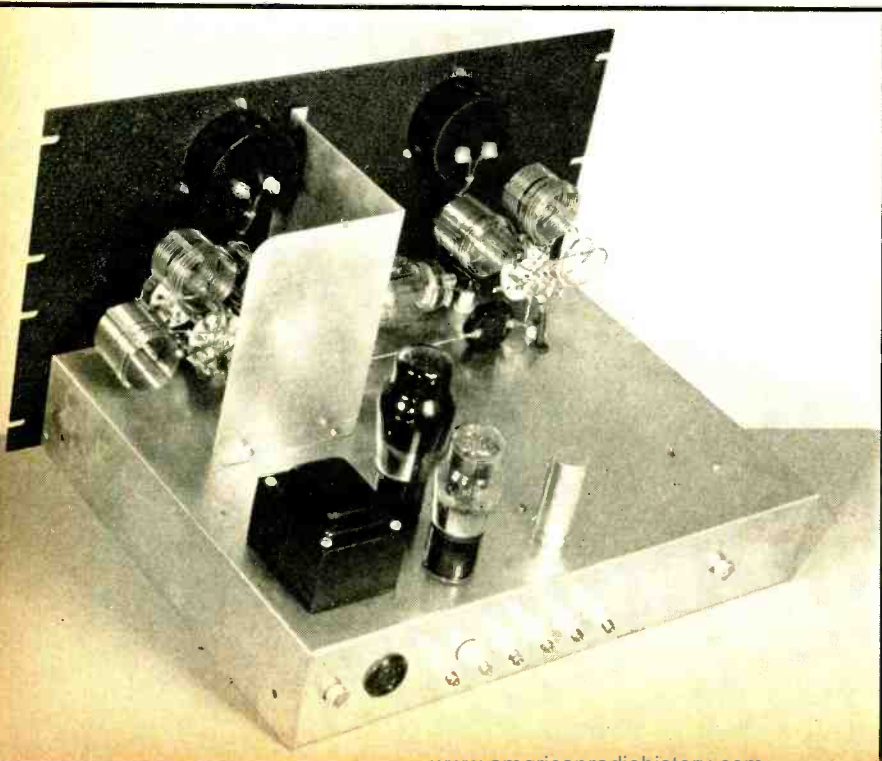
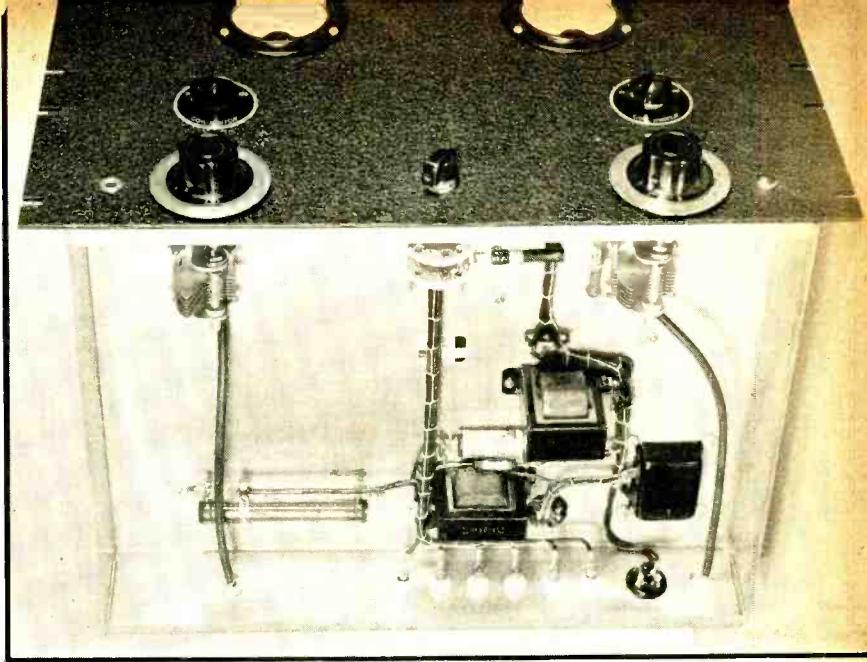

Figure 1. Under-chassis view of the exciter deck. The ceramic rotary switch in the center of the front drop of the chassis controls the distribution of plate potentials to the two alternate r.f. sections of the transmitter—this one and the one previously described.

Figure 2. Rear view of the exciter deck of the transmitter. Note the bent shield which encloses the grid end of the 807. The bias pack and keyer tube is on the rear of the chassis.



is only necessary to change coils in the final stage and in the v.f.o. when changing bands.

Since this r.f. section is also to be used for c.w., a keying tube and bias pack for the final were included on the exciter chassis. Also, in regard to power supply and modulator switching, the 110 power and v.f.o. input lines are switched from one r.f. section to the other in the high-frequency rig; the various plate supply voltages are switched in this r.f. section.

The Exciter—Layout and Construction

When it was finally decided what was needed in the exciter the parts were broken out of their boxes and placed here and there on the chassis. Finally a layout was arrived at which just made room for the meters above and to one side of the coil turrets and which still left the panel symmetrical. Both the final and the exciter are built upon 13" x 17" x 3" chassis, with 10½" standard 19" wide panels. The tuning condensers were mounted under the chassis on insulators. One side of each condenser was supported by a small cone insulator, and the other side by a small feed-through insulator. The feed-through insulator on the frame of the grid condenser feeds the cold end of the grid turret with grid bias. An additional feed-through is close by which connects to the stator of the grid condenser on one side of the chassis and to the grid side of the turret on the other side.

A similar arrangement was used in the plate circuit of the 807. The feed-through on the frame of the plate condenser goes to plate voltage and the other side of the condenser is supported by a small cone insulator. Then the

hot side of the plate circuit is fed through in the same way as in the grid circuit. This method of mounting and feed was found to be a good way to get the r.f. through the chassis with as little loss as possible. Since there is already a sizeable amount of loss in the coil turrets it was necessary to keep all other losses as low as possible.

As the top view of the exciter shows, the 807 tube was placed in a horizontal position with a shield between the grid and plate circuits to keep coupling to a minimum. The 807 socket is mounted on the shield in such a position that the grid and plate of the tube line up with the appropriate positions on the coil turret. An additional small hole was drilled in the shield just to one side of the socket. Then a bolt was put through this hole and solder lugs were placed on either side of the shield. All ground returns for the 807 stage were made to this point.

Bias Pack and Keying Circuit

The other gear on the exciter deck comprises the vacuum-tube keying circuit and the bias pack. A 6A3 was chosen as the keying tube since this type can pass a good deal of plate current and since it also has a low plate resistance. The grid of the 6A3 is returned to the negative side of the bias pack through a 250,000-ohm resistor. When the key is up, the bias voltage put out by the pack is ample to cut off plate current through the 6A3 completely. When the key is closed the grid of the 6A3 is grounded, but the action of the bias supply is not disturbed since the resistance of R_b is so high that very little current is taken from the supply. Notice also that the filament

of the 6A3 is lighted from a transformer that is separate from the filament supply to the 807. The transformer for the bias pack has a 6.3-volt winding which supplies the filament voltage to the 807. The bias pack itself is quite conventional and needs no explanation.

The Final Amplifier

After the 807 exciter had been completed, a similar layout job was necessary for the push-pull T-40 final. Components were placed here and there until the layout shown in the photographs was obtained. Here, again, the

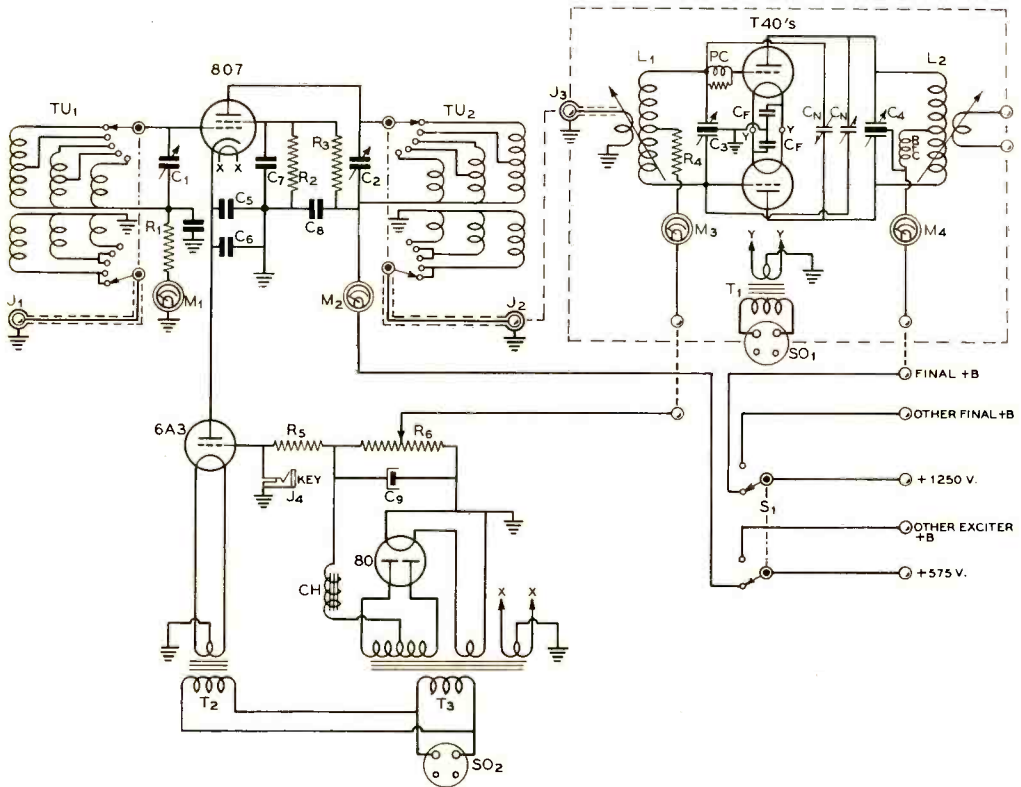

WIRING DIAGRAM OF THE 300-WATT V.F.O. AMPLIFIER

C_1 —100- μ fd. midget variable
 C_2 —100- μ fd. midget variable
 C_3 —140- μ fd. per section split stator midget variable
 C_4 —200- μ fd. per section split stator midget variable
 C_5 —0.03- μ fd. 600-volt mica
 C_6 —0.1- μ fd. 600-volt tubular
 C_7 —0.03- μ fd. 600 volt mica

C_8 —0.005- μ fd. 1000-volt mica
 C_9 —4- μ fd. 450-volt electrolytic
 C_{10} —0.003- μ fd. 600-volt mica
 C_{11} —Neutralizing condenser
 807 grid return condenser — .005- μ fd. 600-volt mica
 R_1, R_2 —50,000 ohms, 2 watts
 R_3 —15,000 ohms, 10 watts

R_4 —200 ohms, 10 watts
 R_5 —250,000 ohms, 2 watts
 R_6 —8,000 ohms, 50 watts
 RFC—2.5 mh.
 S_1 —D.p.d.t. rotary switch
 SO_1, SO_2 —4-prong socket
 J_1, J_2, J_3 —Single contact connector
 J_4 —Single circuit closing jack

L_1 —Grid coil
 L_2 —Plate coil
 T_1 —7.5 v. 8 a., c.t.
 T_2 —6.3 v. 3 a., c.t.
 T_3 —700 v. 70 ma., c.t., 5 v. 3 a., 6.3 v. 2.5 a., c.t.
 M_1 —0-25 ma.
 M_2 —0-150 ma.
 M_3 —0-100 ma.
 M_4 —0-300 ma.
 TU_1 —Grid circuit tuning unit
 TU_2 —Plate circuit tuning unit
 CH—10 hy., 65 ma.

Figure 3. Top view of the final amplifier chassis of the transmitter. Note the pulleys and dial cable which drive the plate tank condenser.

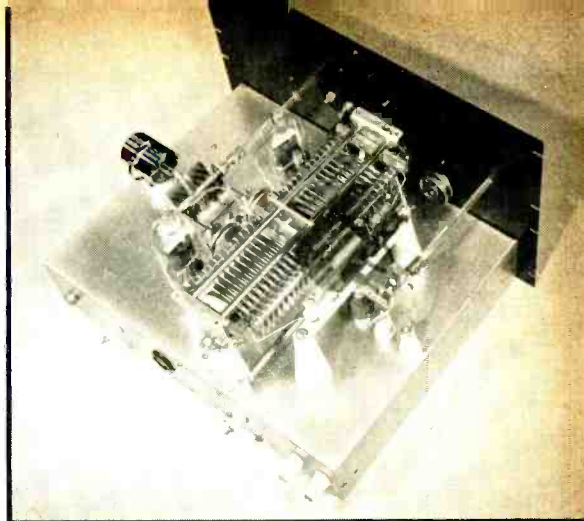

meters presented a mounting problem. It was found to be impossible to lay out a good looking and symmetrical panel with short leads in the actual amplifier without using some sort of offset drive to the final amplifier plate tank condenser. So the pulley and dial cable arrangement shown in the photographs was employed so that the grid tuning condenser could be mounted flat on the chassis and yet have the plate condenser dial line up with the one on the grid condenser.

It was decided that it would be desirable to have the control on the variable link coupling to the antenna brought out to the front panel. So a very small knob was used so as not to upset the symmetrical appearance of the panel.

Since individual filament transformers are used on each of the decks of the transmitter, interconnecting cables for the 110-volt supply must be used. Four-pronged sockets with appropriate plugs are used throughout on these cables. Feed-through insulators were used for

all the d.c. voltage leads, and concentric-cable microphone connectors were used for all excitation leads.

The plate circuit r.f. choke for the T-40's is mounted on a very small feed-through insulator and placed directly under the final plate coil. In this way the choke is made self-supporting. The neutralizing leads are crossed between the plate tank condenser and the two neutralizing condensers.

The coils shown in the photograph are for the 160-meter band. On close inspection it is possible to see the corner of a small mica condenser on the 160 grid coil. The grid condenser is $140\mu\text{fd.}$ per section but even so does not have sufficient capacity to tune the commercially manufactured coil to the band. So it was necessary to place a pair of $.0001\text{-}\mu\text{fd.}$ mica condensers in series across the coil. Needless to say, these mica condensers must be of the highest quality if they are to withstand the r.f. current which flows in this circuit.

[Continued on Page 84]

Figure 4. Underchassis view of the push-pull final amplifier. The single parasitic choke in series with one of the grid leads can be seen in this photograph.

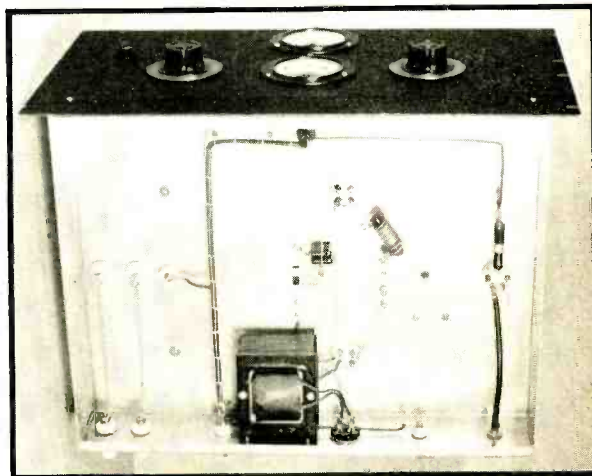

A PARALLEL T

for Amateur Use

By C. F. SHEAFFER*

The Parallel T, or Twin T, as you prefer, is the name given to a radio frequency impedance measuring set which has recently been designed by engineers Sinclair and Tuttle, of the General Radio Company. The names are very descriptive, for, basically, the device consists of two specially designed T networks connected in parallel, and though they cannot strictly be called twins, they are required to bear a certain design relationship in order to permit independent measurement of the resistance and reactance.

The purpose of this article is to describe the design of a parallel T, a modification of the G.R. device, which is easily constructed and calibrated, and therefore adaptable to amateur use. The amateur is seldom interested in making precise measurements, but most usually is interested only in making certain that his transmitter is properly tuned and loaded and that there are no standing waves on the transmission line. Also, one of the principal interests of the amateur is experimentation, and hence the availability of a simple means of measuring r.f. impedance opens new possibilities for experimental work of a highly interesting and educational nature.

The theory of parallel and bridged networks and the development of the circuit design described herein, has been disclosed in other writings, and will not be discussed in detail. The operation of these null devices is based on the fact that when two networks are connected in parallel, the receiving-end voltage goes through a null when the sum of the transfer admittances of the two networks goes through zero. Since, if they are con-

nected in parallel, they have the same voltage source, this is the same as saying a null occurs when the received currents are equal and opposite in phase. The design of these devices, therefore, resolves into the selection of pairs of networks which shift the phase in the proper directions and under the desired conditions.

The schematic diagram and a list of circuit values are given in figure 1. The conditions for balance, or a null, may be obtained by adding the admittances of the two T's and equating to zero. The two resulting equations for balance are:

$$L_p = 1/(2C + C^2/C_1 + C_0)\omega^2 \quad (1)$$

$$R_p = 1/R(1 + C_2/C_1)C^2\omega^2 \quad (2)$$

L_p and R_p are the required parallel inductance and resistance for producing the null.

L_p = Total inductive effect at 3,4, including the coil, condenser, and unknown.

R_p = Total resistive effect at 3,4, including the shunt R_{p0} and the unknown parallel resistive component.

$$B_p = BC_0 + B_{L0} + B_x \quad (3)$$

$$G_p = G_{p0} + G_x \quad (4)$$

Where G_p and B_p are the total admittance and susceptance at 3,4.

The conditions required for reactive balance can therefore be met by adjustment of C_{p0} , and the adjustment for resistive balance may be made by adjustment of either C or C_2 . The point of interest is that the resistive requirements for balance are independent of C_{p0} and the reactive requirements independent of C. This permits C_2 to be used for measurement of the parallel resistive component of the unknown impedance, and in the device of figure 1, the dial of this condenser is calibrated directly to read this resistance.

*KTUL, Tulsa, Okla.

Making an Impedance Measurement

Measurements of unknown impedance are made in the following manner: The parallel T is set up as indicated in the diagram, and with nothing connected to the unknown terminals, 3,4, an initial balance is made at the frequency at which the measurement is desired. This is done by adjustment of C in conjunction with C_{p0} , with C_2 set at zero capacity, or resistance reading $R=00$. The unknown impedance is then connected and a re-balance obtained, this time by adjustment of C_2 in conjunction with the standard condenser, C_{p0} . The unknown parallel reactive component is then: $X_x = 1/\omega \Delta C_{p0}$, where ΔC_{p0} is the change in capacity of the standard condenser between initial and measurement balance. The parallel resistive component is read directly from the scale of C_2 .

The chief point of difference in operation of the parallel T of figure 1 and the G.R. instrument is in the means whereby the initial balance is obtained. In the G.R. device, initial balance is made by adjustment of a condenser in parallel with C_2 provided for this

purpose. When the balance is made in this manner, the conductance, or resistance scale calibrated on C_2 becomes a function of the frequency and will be true only at the frequency of calibration. In designing the instrument of figure 1, it was thought that the use of the device would be simplified by providing means for making the initial balance by adjustment of C, the twin condenser. This automatically compensates for frequency change and thereby renders valid the resistance calibration for all frequencies.

Construction of the Unit

It is the simplicity of construction and its ability to operate over a wide range of frequency, which makes the parallel T so well adaptable to amateur uses. Most amateurs will have on hand a considerable amount of the apparatus required for its construction. There are a few precautions which should be taken in laying out the mechanical design: The signal and detector terminals should be separated by considerable space on the panel front. The only stray capacities which

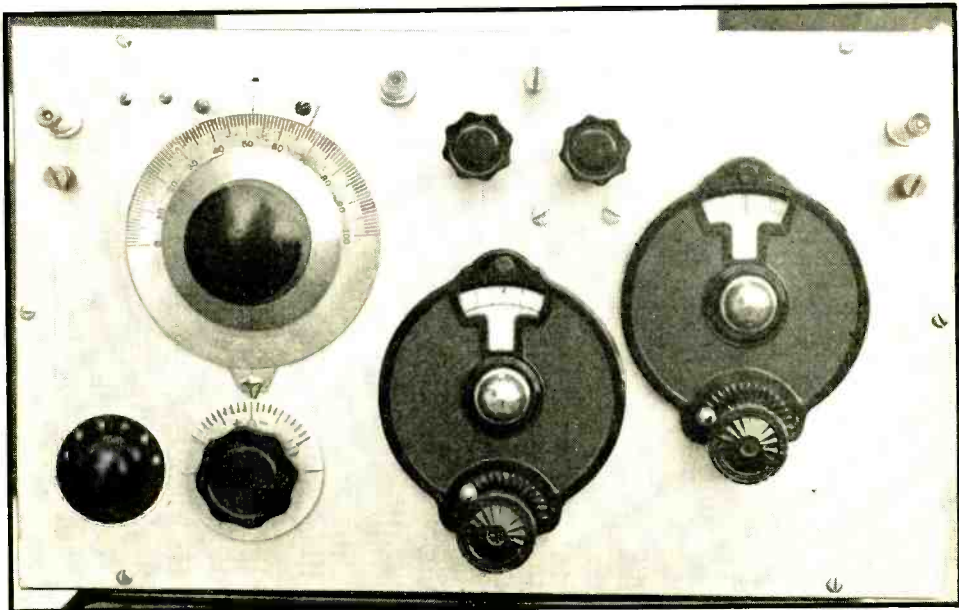

Front view of the homemade parallel T impedance measuring network. The oscillator input is connected to the feed-through and binding post on the top left of the panel. The unknown is connected to the binding post and feed-through at the top of the panel, and the receiver is connected to the pair of terminals on the top right hand edge of the panel. The tuning controls are from left to right: First the top row of three; the calibrated tuning capacity C_{p0} , vernier for fine adjustment of C, condenser C for making the initial balance. The bottom row of four; coil switch, a vernier for C_{p0} , an auxiliary condenser connected in parallel with C_2 and used for measuring high resistances, (this condenser is not included in the described design, but may be added if deemed desirable) and the condenser for measuring parallel resistance C_2 .

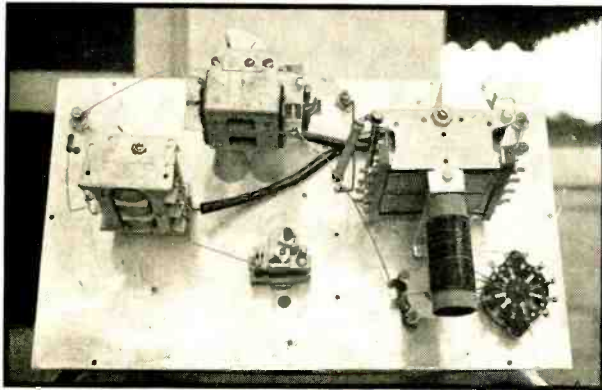

Behind-the-panel view of the test set.

do harm are those between 3 and 7, 1 and 5, and 5 and 7. It is well to shield the two condensers C_2 and C_{p0} from each other. Other capacities can be made sufficiently small by placement of parts.

Calibrating the Instrument

The calibration of C_2 is accomplished by checking the null adjustment of a group of fixed carbon resistors of various known values and then drawing a graph of dial reading vs. resistance. A paper dial may then be cut and a scale of resistance values transcribed on it.

The standard condenser, C_{p0} , is calibrated as follows: A small fixed condenser of known value is used as a comparison standard. The parallel T is set up and an initial balance obtained at some frequency, say 2000 kilocycles. A large variable condenser is connected across the measuring terminals, and with the small fixed condenser also connected, the dial of C_{p0} is set in the zero capacity position. A re-balance is then made by adjustment of the variable padding condenser. The next step is to disconnect the comparison standard and re-balance with C_{p0} . The change in the dial reading of this condenser is then equal to the value of the fixed standard. The dial reading is logged and the above procedure repeated, this time leaving the dial of C_{p0} set at the logged position. This procedure is continued, each time logging the setting of the dial, until the full scale has been covered. By this means a group of dial readings are obtained which represent capacity changes equal to value of the comparison standard. If finer divisions are desired, a graph may be drawn from these. The dial may be cut from a sheet of white paper. A protractor may be used for mark-

ing the lines representing the various values on the dial, but since, ordinarily, the dial scale used in obtaining the graph will be 0-100, this will require multiplying the values on the graph by 1.8.

We shall now consider, briefly, a few of the uses of the parallel T.

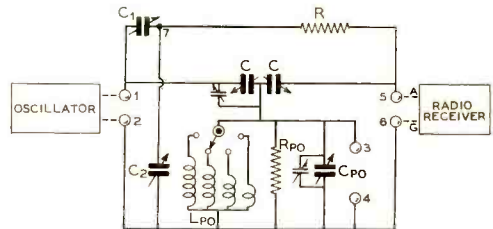

Figure 1. Wiring diagram of the parallel T impedance measuring network

C —Two-gang variable condenser, tapered capacity, 150 $\mu\text{mfd.}$ per section

C_1 —50- $\mu\text{mfd.}$ midget variable set at about $\frac{3}{4}$ capacity

C_2 —Two-gang variable condenser, tapered capacity, 500 $\mu\text{mfd.}$ each section, in parallel

C_{p0} —1000- $\mu\text{mfd.}$ variable, straight-line capacity

R_{p0} —500-ohm carbon resistor.

R —500-ohm carbon resistor

L_{p0} —Four coils, as follows: 20 turns on 1-inch form, 15 turns on $\frac{3}{4}$ -inch form, 10 turns on $\frac{1}{2}$ -inch form, 3 turns on $\frac{1}{2}$ -inch form.

A vernier condenser of approximately 15 $\mu\text{mfd.}$ is connected in parallel with one of the sections of 50 $\mu\text{mfd.}$ A vernier of 50 $\mu\text{mfd.}$ is connected in parallel with C_{p0} and is calibrated to read plus or minus 20 $\mu\text{mfd.}$

MEASUREMENT OF INDUCTANCE AND CAPACITY

Adjust the T to an initial balance at some frequency, preferably one near that at which the coil will be used. Note the setting of the standard condenser, then connect the coil to the unknown terminals and re-balance. The change in the capacity of the standard condenser is the amount of capacity required to resonate the coil at the frequency of measurement, and the inductance is given by:

$$L_x = 1/\omega^2 \Delta C_{p0}$$

Any adjustment of C_2 required to get the measure-balance is an indication of the coil's resistance, and the coil Q is given by:

$Q = R_x/\omega L_x$, where R_x is the resistance reading given by C_2 . The change in capacity noted on the standard condenser, when measuring an inductive reactance will always be positive, while the change will be in a negative direction when measuring a condenser. Capacity measurements are simple, since the unknown capacity is indicated directly by the change in the standard.

MEASURING THE CHARACTERISTIC IMPEDANCE OF TRANSMISSION LINES

Unbalanced lines may be measured directly with the parallel T as follows: Estimate the frequency at which the line will be a quarter wave in length, or an odd number of quarters. Next, place a non-inductive resistor of known value, and of a value approximating the expected value of the characteristic impedance, across the end of the line. Set up the parallel T for measurement at the estimated frequency and measure into the line viewing the resistor R_r . The characteristic impedance is then given by:

$Z_0 = \sqrt{Z_s R_r}$, where Z_s is measured input impedance.

The characteristic impedance of a line will not vary to any great extent with the frequency, and if the frequency of measurement is not too far from the operating frequency, the accuracy will be sufficient. As a further check, however, the T may be set up on the operating frequency and the line terminated in the measured value of the characteristic impedance. If the measured value holds for the operating frequency, the input impedance will be equal to that of the termination.

Measurements on balanced lines are somewhat more complex, because of the necessity of providing a balanced circuit from which to measure. Such measurements are usually made through a specially designed transformer, the secondary winding of which is balanced to ground. One method makes use of the device

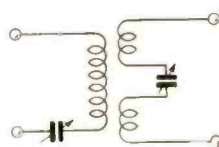

Figure 2. Tuned radio frequency transformer for making measurements of the characteristics of the balanced r.f. transmission lines.

shown in figure 2. It can be shown that a transformer acts like a quarter-wave network, if its primary and secondary are individually tuned to series resonance. Under these conditions the impedance inverts about the axis of the mutual impedance. The input impedance of a transformer is given by:

$$Z_i = R_p + jX_p + X_m^2/(R_s + jX_s) = R_p + R_s X_m^2 / (R_s^2 + X_s^2) + j(X_p - X_m^2/(R_s^2 + X_s^2) + \dots) \quad (5)$$

If X_p and X_s are made zero by series tuning, (5) reduces to:

$$R_i = R_p + X_m^2/R_s \quad (6)$$

R_p is the primary coil resistance and R_s is the total resistance in series with the secondary including the coil resistance.

The procedure for measuring into a balanced line with the tuned transformer is as follows: Adjust the primary to series resonance at the desired frequency with the secondary open; adjust the secondary to series resonance with the primary open. These adjustments may be made with use of a non-inductive series resistor containing enough resistance to permit the resistance reading to fall on the scale of C_2 . Next, select a few premeasured non-inductive resistors of values varying from 50 to 500 ohms and measure their reflected values through the tuned transformer. A graph may then be drawn of measured value vs. resistor value covering the above-mentioned range. We may then refer to the graph for determining the value of resistance connected across the balanced secondary. If there is a reactive component in the unknown impedance, it can be eliminated by adjustment of the secondary tuning condenser, and if it is necessary to know its value, it can be found by measuring into the secondary. Under these conditions the series components will be determined. It is, perhaps, of passing interest to note in connection with the resistance graph and equation (6), that if the resistance of the two coupled coils are negligibly small, the mutual reactance of the transformer is given by the intersection of the graph plot and a 45 degree line drawn from the graph axis.

ANTENNA MEASUREMENTS

Measurements on vertical antennas can be made direct, but most amateur antennas are of

[Continued on Page 90]

An Emergency Service

PORTABLE STATION

By JAMES H. HLYWA,*
W6QDG

A description of a complete 'phone-c.w. station, including a superheterodyne receiver, designed both for regular station operation from the a.c. line and for emergency service from a 6-volt storage battery.

It has long been the desire of most radio-men to have a portable station that is complete in regard to having both a good 'phone-c.w. transmitter and a superhet receiver, that is flexible in regard to full-power operation both from a 110-volt a.c. line or a storage battery, and that is truly portable to the extent of being contained in one box with a handle on top. The recent emphasis placed upon the need of such equipment by National Defense has greatly intensified the quest for a satisfactory design.

Here is a piece of equipment that is the result of several years' work and numerous experiments and tests under all conditions of operation. In the course of two years' operation both as a portable and as a regular station, no alterations or parts replacements have been required.

The entire unit is mounted in a waterproof case 9 x 14 x 16 inches and consists of the following:

*404 Ogden, Cochrell Hill, Dallas, Texas.

Transmitter—Crystal controlled with but a single coil to tune the entire rig and load it up to any antenna (2 feet or more in length) to full output on any frequency from 1.75 to 30 Mc. The transmitter operates with 30 watts input on c.w., 20 watts on 'phone with 100 per cent plate and screen modulation.

Public address system—The modulator of the transmitter may be used as a 10-watt public address system with inputs for crystal or dynamic microphone or phonograph pick-up. The output may be fed into a larger speaker than that in the unit, or into a cutting head.

Receiver—Simple plug-in coil superheterodyne which uses the speech channel of the transmitter as the audio amplifier. A small speaker is built into the cabinet for use when the station is on the receive position.

Power supply—The entire unit can be operated with full power output from a built-in power supply which runs either from 110 a.c. or a 6-volt storage battery.

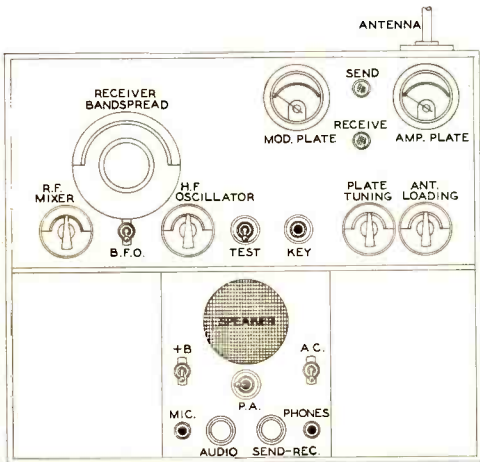

Layout drawing of the front of the transmitter-receiver showing the location of the various controls.

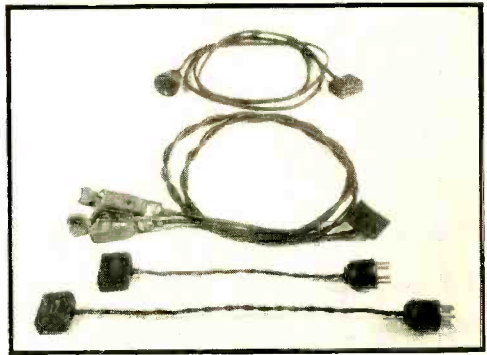

The four cables used with the transmitter-receiver. The two in front are the same ones shown with the power supply modulator deck. The large cable in the center of the photograph is plugged into the power supply deck for operation of the unit from a 6-volt storage battery. The cable in back is plugged in for operation from a 110-volt a.c. line.

The Transmitter

The transmitter r.f. section consists of only two stages: the crystal oscillator and the modulated amplifier. The crystal stage itself uses the Pierce circuit and either a 6L6 or a 6F6 tube may be used. With the circuit constants shown, any good crystal up to 14 Mc. will give ample output with reasonably low crystal current. The final stage uses a 6L6 as a plate and screen modulated beam tube. The final amplifier runs at about 60 ma. combined plate and screen current for 20 watts input on 'phone. For c.w. operation the final amplifier current may be run up to about 90 ma.

Antenna Coupling

As will be noticed by inspection of the circuit diagram, there is only one coil in the transmitter. This is the plug-in coil in the pi-network antenna coupler. The pi-network antenna coupler was used primarily to facilitate coupling the output of the transmitter into the 8-foot collapsible-rod antenna which plugs into the top of the cabinet. Experience with the coupler has shown that the coupling device will load up an antenna from 2 feet in length to 135 feet or more to a full 30 watts input, on any frequency above 1700 kc.

Tuning procedure for the pi-antenna network is as follows: The antenna loading con-

General view of both shelves of the unit. The transmitter-receiver deck is in the rear and the power supply and modulator deck is in front.

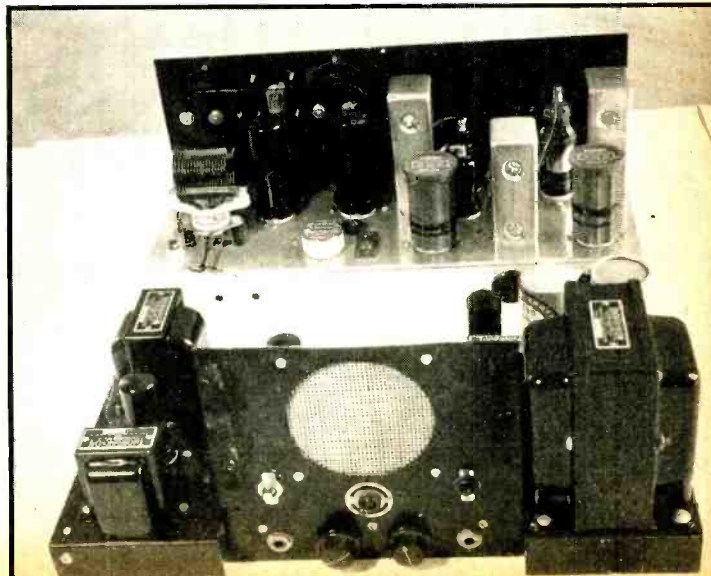

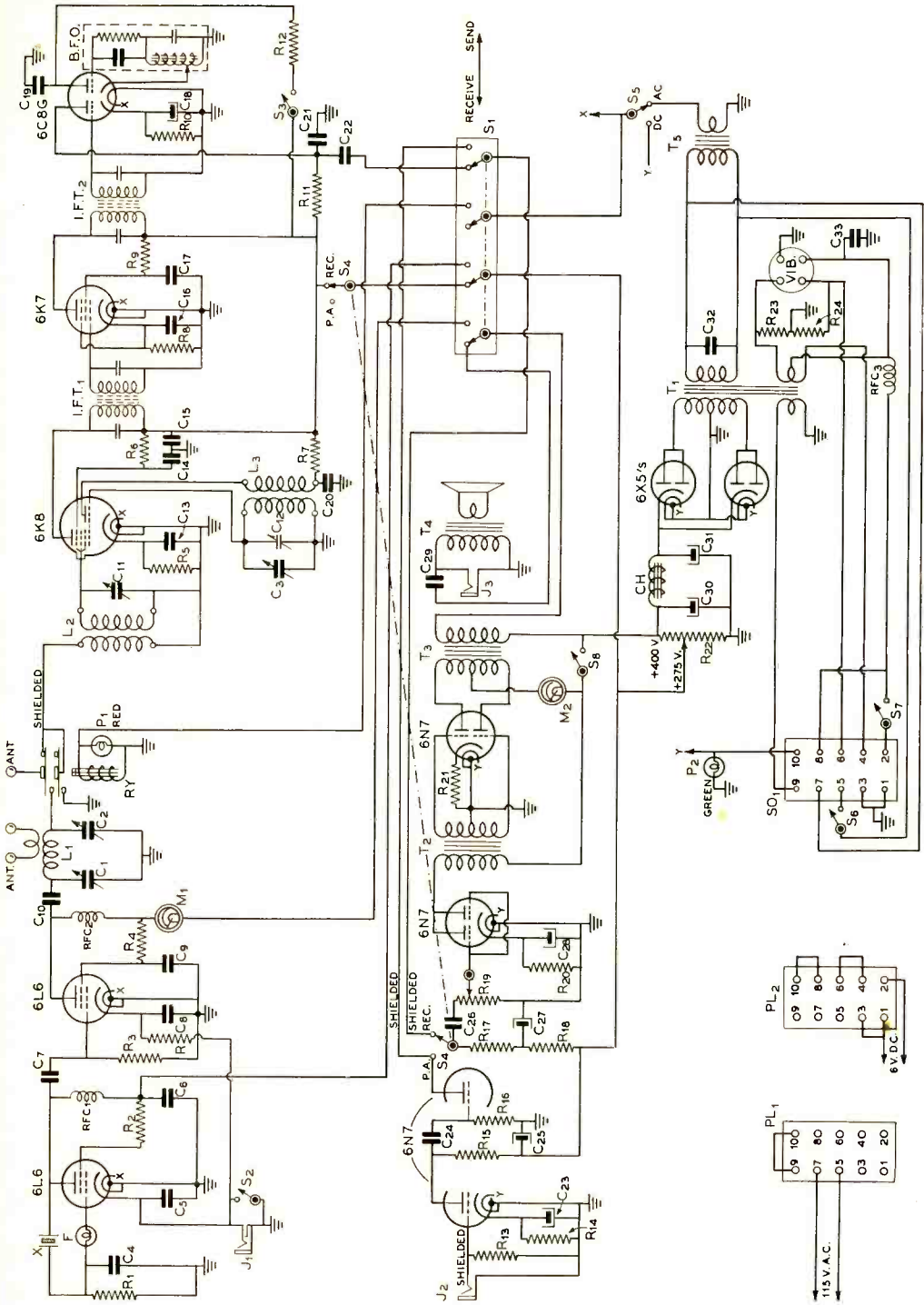

WIRING DIAGRAM OF THE PORTABLE-EMERGENCY TRANSMITTER-RECEIVER.

C ₁ , C ₂ —140- μ f.d. midget variables	C ₂₈ —10- μ f.d. 25-volt electrolytic	R ₁₀ —100,000 ohms, 1/2 watt	J ₁ —Keying jack
C ₃ —Oscillator band-spread condenser (main tuning control) 20- μ f.d. midget variable	C ₂₉ —0.1- μ f.d. 400-volt tubular	R ₁₁ —500,000 ohms, 1/2 watt	J ₂ —Microphone jack
C ₄ —0.0025- μ f.d. mica	C ₃₀ —12- μ f.d. 450-volt electrolytic	R ₁₂ —50,000 ohms, 1/2 watt	J ₃ —Jack for external speaker or recorder
C ₅ —0.01- μ f.d. 400-volt tubular	C ₃₁ —8- μ f.d. 600-volt paper	R ₁₃ —20,000 ohms, 1/2 watt	T ₁ —6.3 volts from vibrator or 110 a.c. to: 350 v. d.c. to filter, 6.3 v. 4.75 a. for filaments
C ₆ —0.002- μ f.d. mica	C ₃₂ —0.05- μ f.d. 400-volt tubular	R ₁₄ —500,000-ohm potentiometer	T ₂ —6N7 to 6N7 class b driver transformer
C ₇ —0.001- μ f.d. mica	C ₃₃ —0.5- μ f.d. 200-volt tubular	R ₂₀ —1000 ohms, 1/2 watt	T ₃ —6N7 class B to 5000-ohm load
C ₈ —0.01- μ f.d. 400-volt tubular	R—250 ohms, 10 watts	R ₂₁ —100 ohms, 10 watts	T ₄ —Output transformer to speaker
C ₉ , C ₁₀ —0.002- μ f.d. mica	R ₁ —30,000 ohms, 1 watt	R ₂₂ —50,000-ohm 25-watt bleeder	T ₅ —6.3 v. 2.5 a. filament transformer
C ₁₁ —120- μ f.d. det. tuning	R ₂ —50,000 ohms, 2 watts	R ₂₃ , R ₂₄ —100 ohms, 1/2 watt	PL ₁ —Cable plug for 110 a.c. operation
C ₁₂ —100- μ f.d. oscillator bandset	R ₃ —100,000 ohms, 2 watts	X—Crystal for operating frequency	PL ₂ —Cable plug for 6.3 d.c. operation
C ₁₃ , C ₁₄ , C ₁₅ , C ₁₆ , C ₁₇ —0.1- μ f.d. 400-volt tubular	3 ₁ —20,000 ohms, 10 watts	F—6.3-volt 150-ma. pilot	SO ₁ —Receptacle for power plugs
C ₁₈ —10- μ f.d. 25-volt electrolytic	R ₄ —300 ohms, 1/2 watt	RFC ₁ , RFC ₂ —2 1/2-mh. 125-ma. chokes	VIB—Special 10-ampere vibrator
C ₁₉ —0.002- μ f.d. mica	R ₅ —50,000 ohms, 1/2 watt	RFC ₃ —40 t. no. 14 enam., 5/8" dia.	S ₁ —4 p.d.t. rotary send-receive switch
C ₂₀ —0.01- μ f.d. 400-volt tubular	R ₆ —50,000 ohms, 1 watt	M ₁ —0-200 d.c. milliammeter	S ₂ —S.p.s.t. test switch
C ₂₁ —0.002- μ f.d. mica	R ₇ —350 ohms, 1/2 watt	M ₂ —0-100 d.c. milliammeter	S ₃ —S.p.s.t. b.f.o. switch
C ₂₂ —0.01- μ f.d. 400-volt tubular	R ₈ —100,000 ohms, 1/2 watt	P ₁ , P ₂ —6.3-volt pilot lamps	S ₄ —D.p.s.t. rcvr.-p.a. switch
C ₂₃ —10- μ f.d. 25-volt tubular	R ₉ —30,000 ohms, 1/2 watt	RY—6.3-volt a.c.-d.c. d.p.d.t. relay	S ₅ —A.c.-d.c. filament switch
C ₂₄ —0.05- μ f.d. 400-volt tubular	R ₁₁ —75,000 ohms, 1 watt	Coils—Suitable for band operated	S ₆ —S.p.s.t. on-off switch for a.c.
C ₂₅ —8- μ f.d. 450-volt electrolytic	R ₁₂ —50,000 ohms, 1/2 watt	IFT ₁ , ₂ —465-kc. high-gain i.f.'s	S ₇ —S.p.s.t. on-off switch for d.c.
C ₂₆ —0.1- μ f.d. 400-volt tubular	R ₁₃ —2 megohms, 1/2 watt	BFO—465-kc. tapped b.f.o. trans.	S ₈ —Speech ampl. off switch for c.w.
C ₂₇ —8- μ f.d. 450-volt electrolytic	R ₁₄ —2500 ohms, 1/2 watt		

denser C₂ is tuned to maximum capacity. The plate condenser C₁ is tuned to resonance by noting the r.f. amplifier plate current. This condition gives minimum antenna loading. The antenna condenser is then turned toward minimum capacity until proper loading is evidenced by the amplifier plate milliammeter. As the loading is increased, the plate condenser must be retuned slightly to keep the final in resonance, as is shown by the dip on the milliammeter. There is also a link on the amplifier coil which may be used to couple the output of the transmitter to a standard antenna tuner or to excite a following stage. To shift bands, merely insert the proper crystal and the antenna network coil for the desired band. The transmitter will double with approximately 30 per cent decrease in power output.

Keying is accomplished by breaking simultaneously the cathode circuits of the oscillator and amplifier. There are no key clicks, thumps, or chirps.

The Modulator

The final r.f. stage of the transmitter is modulated by a 6N7 in class B. This tube is capable of about 10 watts undistorted audio output. This amount of audio will modulate 20 watts input to the final without noticeable distortion. As can be seen in the schematic, the modulator is a normal class B system with the exception of the resistor R₁₀. This resistor helps keep the peak current down and does not seem to affect the output of the modulator. For full 100 per cent modulation the modulator plate current will reach 60 to



Rear view of the transmitter-receiver deck of the portable station. The two-tube r.f. section of the transmitter is mounted to the left of the center of the chassis; the receiver portion is mounted to the right of the chassis center line.

65 milliamperes on voice peaks. No-signal plate current is about 35 ma.

With a crystal or dynamic microphone of normal output (-50 db), the gain control is set to $\frac{1}{3}$ maximum to modulate fully the 20 watts input to the final. There is more than ample audio power. The modulation transformer is rated at 15 watts and will carry 100 ma. in the secondary, so this component also operates at a good safety factor. As can be seen in the circuit, this transformer is switched to the r.f. amplifier when transmitting and the transmitter is modulated. But when the send-receive switch is set back to the receiver position the modulation transformer is shifted to the loudspeaker and 'phone circuit, and the audio equipment acts as an audio amplifier for the received signal.

The Driver

The driver is also a 6N7 wired in parallel, with its grid circuit resistance coupled to the speech amplifier. The grid input circuit of the driver is coupled to the speech amplifier through a d.p.d.t. switch. This switch is used to connect up the speech amplifier in such a way that it can act as a public address system or as the audio amplifier of the receiver when the r.f. section is turned off. The in-

put of the driver also goes to the send-receive switch, and when transmitting the driver is coupled to the speech amplifier and microphone. However, upon receiving, the input of the driver is coupled to the output of the receiver through a condenser. When receiving, the amplifier gives more than enough volume on any signal picked up. The gain control sets the microphone gain to the modulator when transmitting, and on receiving is used as a volume control for the receiver. All leads running to the send-receive switch, p.a. switch, and the receiver output are shielded. There is no trace of hum whatsoever in the entire equipment.

The Speech Amplifier

The speech input amplifier consists of a 6N7, using both triodes in a cascade circuit. Despite the fact that the audio components are very close mounted, there is absolutely no trouble from hum or feedback. The circuit of the speech amplifier is normal. The only unusual thing found by the author is that the value of the grid resistor in the second triode section must be kept below 100,000 ohms, otherwise motorboating may result. The grid resistor across the microphone

[Continued on Page 82]

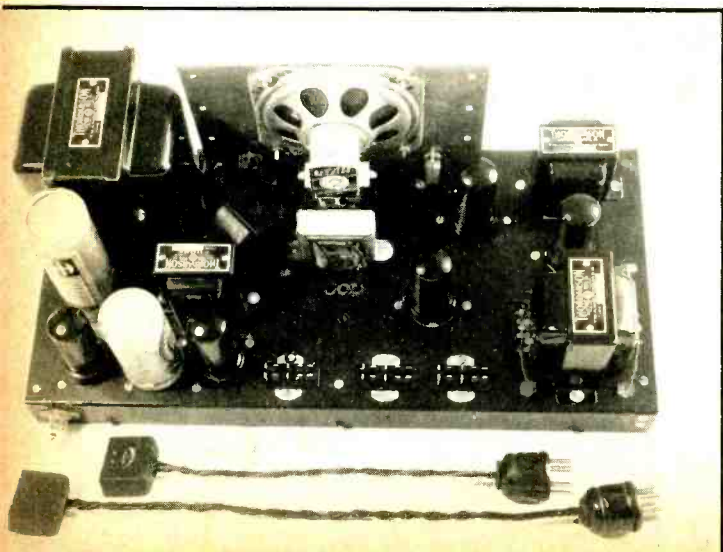

Looking down upon the power supply and modulator deck. The a.c. or 6-volt d.c. power supply is mounted along the left side of the chassis and the modulator occupies the right hand portion. The two cables which connect this deck to the upper one which houses the transmitter r.f. portion and the tuner of the receiver are shown in front of the deck.

Figure 1. Illustrating construction of the universal phono equalizer and scratch reducer.



A CUSTOM EQUALIZER *for Any Phonograph*

By W. W. SMITH*

A device which may be connected to any electrical phonograph to give any combination of bass boost, treble boost, or scratch suppression, immediately and easily adjustable to suit the characteristics of a particular record and the taste of the listener. Both treble boost and scratch suppression may be employed simultaneously to provide maximum attenuation of scratch with minimum loss of brilliance.

Ever since the advent of the phonograph, engineers have been trying to figure out a way to get rid of needle scratch without sacrificing "brilliance." But unfortunately, it is impossible to eliminate or attenuate the needle scratch falling within a certain frequency range without eliminating or attenuating the recorded musical tones or overtones falling in the same range of frequencies.

The old idea that the scratch "resonated" at some particular frequency, making it subject to selective elimination by a tuned rejection filter, has long since been disproved, and the resonant "scratch filter" has disappeared from the scene.

However, the desire to reduce needle scratch to a value which is not objectionable while at the same time preserving the brilliance of the record has *not* disappeared from the scene. This does not apply to "acetate"

*RADIO.

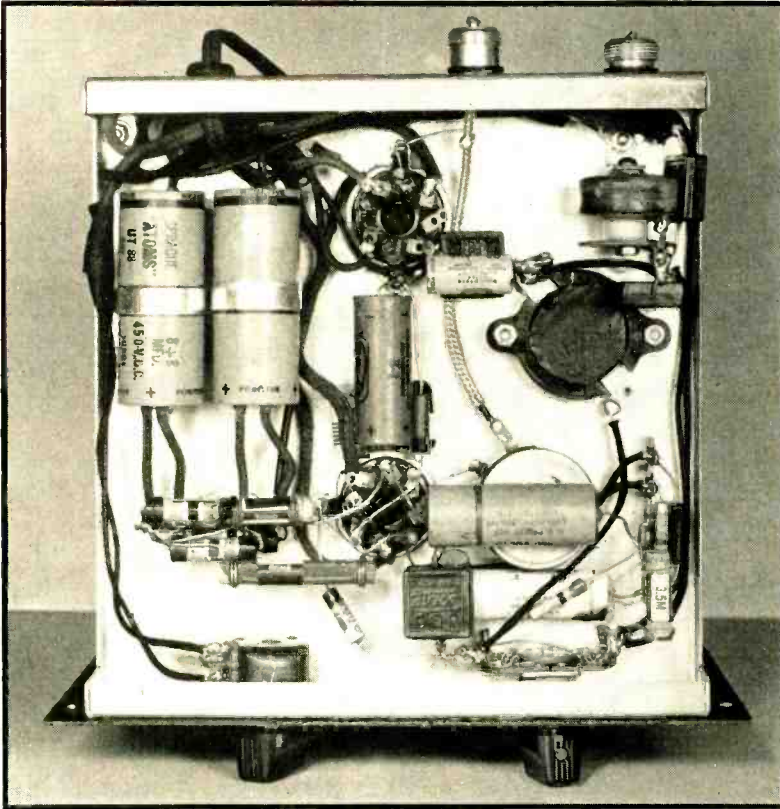

Figure 2. Under chassis view of the universal phono equalizer, showing layout of parts. To avoid serious change in inductance, the choke L_2 is mounted at right angles to the iron chassis by means of an angle bracket and screw, both of brass.

instantaneous recordings or to Vinylite transcription pressings, both of which have very low scratch level, but rather to the ordinary commercial "shellac" pressing. The noise level of the shellac pressing has been reduced in recent years by improved manufacturing technique, particularly on the higher priced pressings, but nevertheless it is still an annoying factor.

While the surface noise level varies with different records, the frequency characteristic of the surface noise is substantially the same for all shellac pressings.

The intensity of the scratch noise increases progressively with frequency. It does not peak at any particular frequency, but becomes greater with increase in frequency, right on out to the frequency limit of conventional reproducing apparatus.

An attempt to reduce the scratch by means of a "slope filter" (the usual "tone control") or an unequalized crystal pickup, either of

which will result in an attenuation approaching 6 db per octave at those frequencies contributing substantially to the surface noise, results in a proportionate loss in brilliance.

At least one record manufacturer has attempted to offset this loss in brilliance by boosting the highs when recording, thus assuming that they will be restored to their right proportion when played back by a corresponding attenuation. Such records are cut about midway between constant velocity and constant amplitude above the "turnover" frequency. But apparently attempts to cut the record constant amplitude at all frequencies has not proved practical because of the tendency of the heavier pickups to "wear off" the highs on such a record after but a few playings. Perhaps when the majority of the pickups in use are of the "featherweight" variety having both low pressure and low needle point impedance, record manufacturers may be able to cut their records at constant amplitude; but while so many

of the heavier pickups are in use the practice is not practical.

The most practical method of minimizing needle scratch without producing an objectionable loss in brilliance takes advantage of the fact that our ear plays us tricks. By supplying an abundance of highs between 2500 and 5000 cycles and chopping the response off sharply at 5000 cycles, the record will *appear* not to be lacking in highs except to a hypercritical listener or on an "A-B" test. Actually it is an illusion, because the eliminated overtones above 5000 cycles have appreciable effect upon the timbre of the music. However, by slightly boosting the highs below the cutoff frequency, our ear is fooled into thinking it sounds pretty good, and even the most critical music lover will almost invariably prefer the synthetic brilliance to the full-strength scratch on an old or worn pressing.

This is the method used by many broadcast stations for playing commercial shellac

pressings, and the reason why it often is difficult to tell, when listening to a radio that is not "super high fidelity," whether a selection is from a record or being rendered by live talent.

The device illustrated in the accompanying photographs and diagrammed in figure 3 contains a sharp cutoff 5000-cycle low-pass filter which may be cut in or out at the flip of a switch. It also contains a bass boost and treble boost, so as to permit "custom tailoring" of the response to suit the individual. Either no boost, bass boost, treble boost, or bass and treble boost together may be had by throwing the selector switch to the proper position.

The bass boost will be found particularly pleasing when an unequalized magnetic pickup is employed, and the high boost when an unequalized crystal pickup is employed. (An unequalized magnetic pickup is deficient in bass and an unequalized crystal pickup is defi-

[Continued on Page 74]

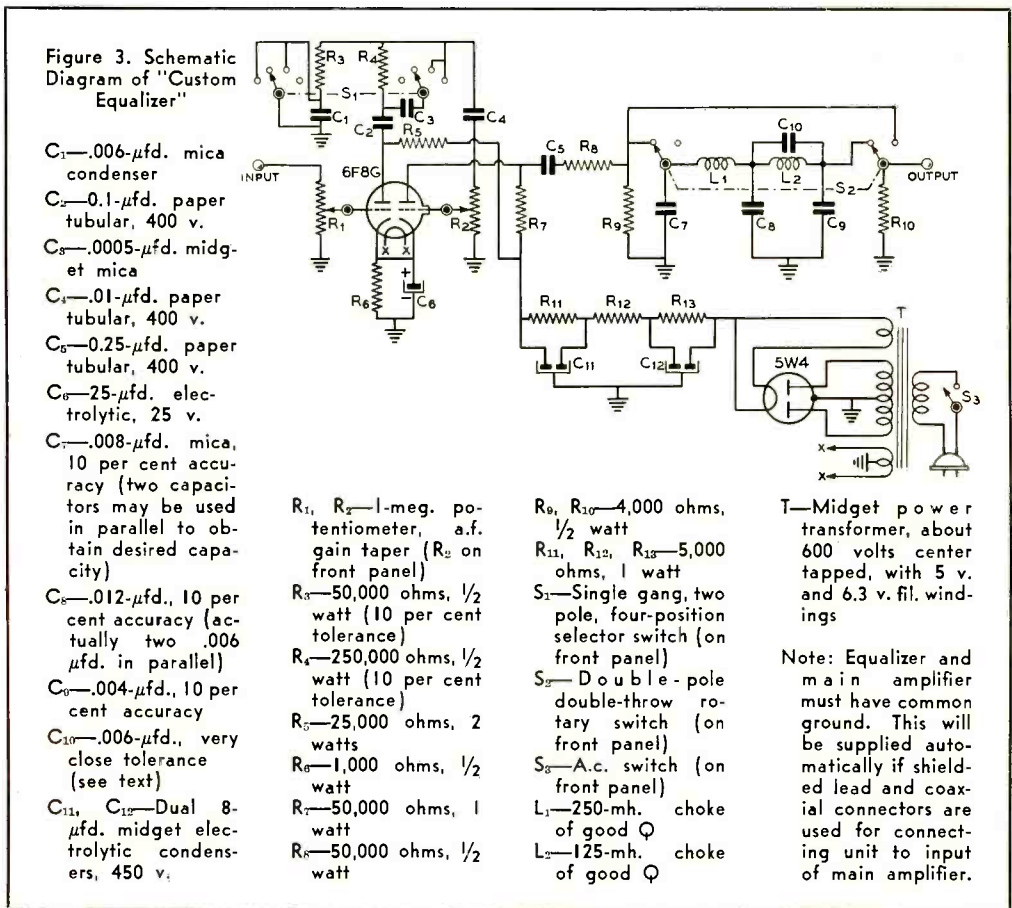

TUNING SHORT RADIATORS ON LOW FREQUENCIES

By C. B. STANLEY,* W7BOG

The problem of obtaining good radiation efficiency from a short fishpole-type antenna on the lower police frequencies has long been a serious one. In this article Mr. Stanley analyzes the poor results obtained from conventional installations and discusses a new design which has proven to give excellent results.

The restricted height of antennas for medium-high-frequency mobile operation has been one of the most serious objections to the use of these frequencies for this type of service by many state and government agencies. It is felt that the use of medium-high frequencies for this type of service has many advantages over the ultra-high frequencies, particularly if the terrain is unfavorable for elevated receiver locations and the distances to be covered are great.

The need for an effective two-way system, providing fifty mile coverage for the mobile units of an existing one-way system operating over rugged mountain terrain, has resulted in the development of an extremely efficient method of antenna tuning which eliminates one of the serious objections to medium-high-frequency mobile operation.

The first radiator tested was a conventional nine-foot whip antenna, loaded to a quarter wave by means of a parallel-resonant circuit at the base of the antenna. This provided a service area of about ten miles radius using a transmitter operating on a frequency of 1706 kilocycles with a power input of fifty watts. A top-loaded radiator, approximately the same height, extended the range to twenty-five miles. Although this was a decided improvement, the radiator was expensive and mechanically cumbersome, so the straight whip was set up again and many different coupling circuits were tried in order to determine which one was the most

effective. The results of these tests indicated that the coverage could be extended to forty miles or more by properly tuning the whip antenna.

The Coupling Circuit

It was found that with a parallel-resonant circuit at the base of the antenna, the antenna current increased as the L/C ratio of the loading circuit was increased, reaching a maximum value when the only capacitance across the coil was that of the antenna plus the stray capacitance of the circuit. In effect, the antenna was caused to become the capacitive leg of the parallel-resonant circuit, with the circulating current in the tank circuit appearing between the radiator and ground.

The circulating current in a parallel-resonant circuit is approximately equal to the line current multiplied by the Q of the circuit. It may be seen that it is possible to increase the antenna current to a much higher value by this method than by coupling the antenna to the transmitter with an impedance-matching network. In the latter case, the antenna would present a high impedance to the network; the antenna current would be low, and the voltage high.

If the base-loading circuit were tuned by means of a parallel condenser, the circulating current would divide between the parallel condenser and the antenna in proportion to their respective capacitances to ground. The current distribution of such a circuit is shown in figure 1. Here the circulating current may be very

* Asst. Radio Technician, Oregon State Highway Dept.

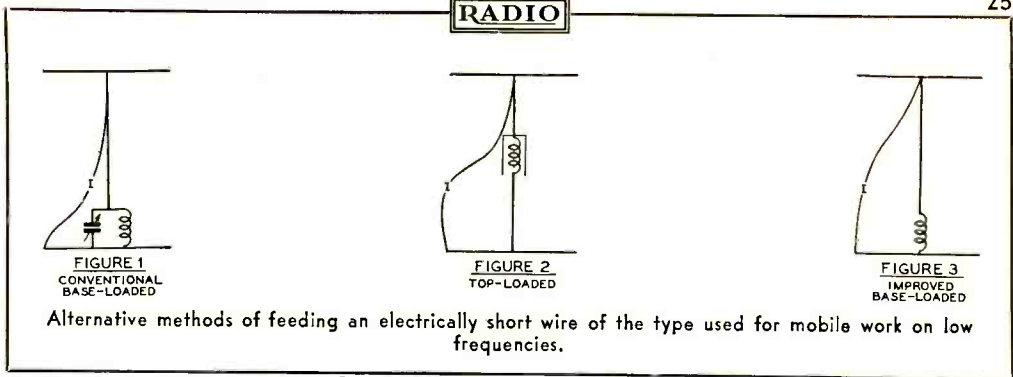

high, yet the antenna current is low. The top-loaded radiator (figure 2) has a high value of current over approximately one-half its height. The current in the improved circuit (figure 3) is high throughout the length of the antenna, being distributed directly as the capacitance of the antenna to ground, yet the voltage is also high.

The Mounting

Since it is desirable that all of the current in the capacitive leg of the circuit appear in the radiator, a low-capacitance mounting must be provided at the base of the antenna. One of the most effective mountings tried was one in which the base of the antenna was brazed to the brass rod of a Pyrex feed-through insulator, with a two-point brace brazed to the antenna about two feet from the base and fastened to the car body with ceramic cone insulators. This provided a mechanically rigid, yet low-capacitance mounting for the whip, the capacitance of the entire antenna from the top of the coil to ground being approximately sixty micro-microfarads.

The circuit Q should be made as high as possible without the addition of parallel capacitance. Short-circuiting the turns of a coil greatly reduces the Q of a tuned circuit, and, since open-end losses occur when the tuning is done by moving a tap along the coil, the tuning of the circuit must be accomplished by actually cutting the turns of the coil until the point of resonance is reached. The coil should preferably be unshielded in order to minimize eddy-current losses and the introduction of stray capacitance.

The coil should be wound on a ribbed transmitting-type coil form with enamelled wire not smaller than No. 16. The bottom of the coil is connected to a low-resistance ground and the transmitter is connected to the circuit by means of a link tapped up the coil from the ground end. The capacitance across the link winding must be kept low, since it is a part of the resonant antenna circuit.

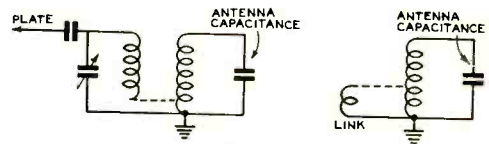

FIGURE 4

Alternative methods of coupling the transmitter output to the base of the antenna.

Tuning

A simple diode field strength meter is invaluable in the tuning operation. If the antenna length is adjustable, it should be shortened a few inches before the tuning procedure is started. The coil should be wound to be resonant with a parallel capacitance of 25 or 30 $\mu\text{mfd.}$ before the antenna is connected. The parallel condenser should then be replaced with the antenna and the turns cut one at a time until the point of resonance is approached, as indicated by an increase in the diode current of the field strength meter. At this point, it is important that the exact operating conditions be established and that the operator move away from the antenna when taking a reading. As soon as the resonance peak has been passed and the diode current starts to decrease, the coil can be permanently mounted and the antenna extended to its full length to bring the circuit back to the point of exact resonance.

The current at the base of the antenna used in the tests was 1.20 amperes with a transmitter power input of 50 watts. The maximum current at the base of the top-loaded radiator was 0.5 amperes. Tests made over a period of six months showed an increase in field strength of 3 db for the improved system over that of the top-loaded radiator. Plotted field-strength contours show the average signal strength to be S9 at a distance of 18 miles from the receiver and S6 at 34 miles. Forty miles is considered to be the consistent working distance, although solid contacts have been made up to sixty miles in the daytime.

SWEEPSTAKES EXCITER

By P. K. ONNIGIAN,* W6QEU

A truly all-band v.f.o.—power output is available by selection through a single bandswitch on all bands from 160 through 5 meters.

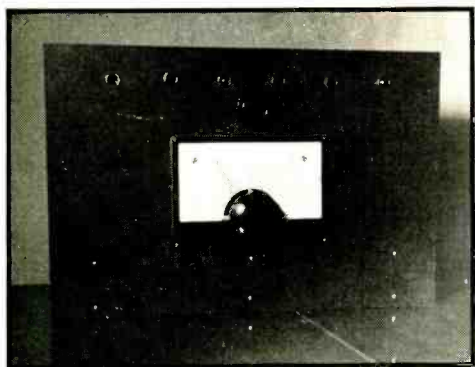

Front view of the six-band exciter. Note the row of dial lamps which indicate the band on which the exciter is delivering power.

During the past few years many articles have been written about variable frequency oscillators and exciters. It is the purpose of this article to describe an exciter that is built around the author's interpretation of the best points of the various exciters that have appeared in various radio publications during the last two years. It was decided that this unit was to be used to excite the regular transmitter and not to be used as a low power transmitter, although it may be used for such purposes. Therefore, no attention was given to obtaining large output power. This exciter will be used to drive a beam power stage in our regular transmitter (an 807), therefore the low power output is more than sufficient to drive it. The following advantages are claimed for this exciter:

1. Fool-proof band switching. No coils to change.
2. Individual band in use indicator and scale for the band in use.

3. No retuning of stages in the exciter for any frequency in any band.
4. Only two controls. One for the band and the other, (the dial) for QSYing.
5. Output brought out in a low impedance line, thus permitting the unit to be placed on the operating table or wherever convenient.
6. Frequency stability. Drift compensation is used, resulting in excellent stability even on the higher frequency bands.
7. Output on any one of six bands.
8. Simple to construct. No tricky circuits or adjustments to be made.
9. Economical. Total cost, about \$35.

The Circuit

An electron coupled oscillator with the cathode above ground was decided upon, using the single-ended tube, 6SJ7. The oscillator operates in the 160-meter band thus avoiding any possibility of nearby h.c.l. interference in the broadcast band. The plate circuit of the oscillator is untuned, there being ample voltage swing for the following stage. This also removes all traces of interlocking which may arise when the plate circuit is tuned. The range covered by the oscillator is 1750 to 2050 k.c. with a little overlap. The heater leads of the 6SJ7 are by-passed right at the socket to prevent a hum which was found to be present before this was done.

The usual precautions should be taken in building this oscillator as any other. The importance of stiff wiring and short direct leads cannot be too highly stressed. The tuning condenser is mounted against the side of the chassis and therefore eliminates movements when the dial is rotated. All the oscillator bypass condensers are mounted right around the socket with stiff wire to prevent vibration. All this results in an oscillator which will not chirp, squack or squeal when the cat walks into the room!

*Rt. 4, Box 350, Fresno, California.

The oscillator is followed by the 6SK7 as a class A amplifier-buffer. This stage does not draw any grid current. The only load on the oscillator is the impedance represented by the coupling condenser C_c and the grid resistor R_g , of the buffer stage. This figure roughly to be 20,000 ohms for the 160-meter band, which is comparatively light loading. It can, therefore, readily be seen that the load on the oscillator is of a substantially constant nature, thus adding further to the stability. The buffer stage is biased near class A by using self bias. The plate circuit of the buffer stage is untuned and uses an r.f. choke to give it a reasonable value of impedance to work into.

The doubler stages are all conventional except for the fact that the 160-80-40 meter stages are compensated for frequency changes. The plate tank circuits in these stages have resistances inserted in them to flatten the normally sharp frequency response. Let's see how this works. The "sharpness" of resonance, or selectivity, is a quantity which indicates the fractional change in current for a given fractional change in either capacity or inductance at resonance. The sharpness of resonance thus defined is equal to the ratio of the inductive (or capacitive) reactance to the d.c. resistance. It should be noted that as the value of resistance is made less, the resonance curve becomes sharper and that as the resistance is increased, the curve becomes flatter. That's the purpose of the non-inductive carbon resistors in the plate circuits of the first three doubler stages. The amount of "dullness" resistance depends on the amount of "flattening" desired. They are omitted in the last three stages because their use is not warranted. The width of the higher frequency amateur bands is small in respect to the band frequency.

The 20- and 10-meter stages have radio frequency chokes in their grid circuits, to prevent absorption of the grid drive. A radio

frequency choke in the grid of the 5-meter stage was omitted, because with it the stage was being over-driven.

The cathode of the 20-meter stage is bypassed at the socket to prevent degeneration which was found to exist without it. No trouble was experienced from this cause in the other stages.

The plate circuits of all except the 160-meter stages are tuned to twice the grid frequency of that stage. The 160-meter stage is operated on the same frequency as is impressed on the grid. Consequently, more power is obtained from this stage but is used up in the "flattening" resistor. This stage is not neutralized because there isn't a tuned circuit in its grid circuit, consequently oscillations are not likely to occur.

All output stages are biased to one-half cutoff bias by means of the bias tap in the power supply. This is done so that during the key up position large amounts of current will not be drawn (40 milliamperes per tube without excitation and bias, making 240 milliamperes for the output stages).

Bandswitching

Switching is the main feature of this exciter. Pushbuttons were the original idea, but after looking through all the catalogs at our disposal and visiting several radio service shops, no pushbutton assembly was found that could do the switching that we wanted. Until the day we locate a pushbutton assembly that can do the trick, we'll use the present band switch. The switch used is a 4-circuit, 2-gang, one to six position switch, with minor changes. The switch was disassembled and a runner ring was soldered to the switching disc. This permits shorting of the cathodes of the output stages as the switch is advanced. One circuit is used for the band-in-use indicator. This

Rear view of the exciter chassis. Note that the power supply is on the extreme rear.



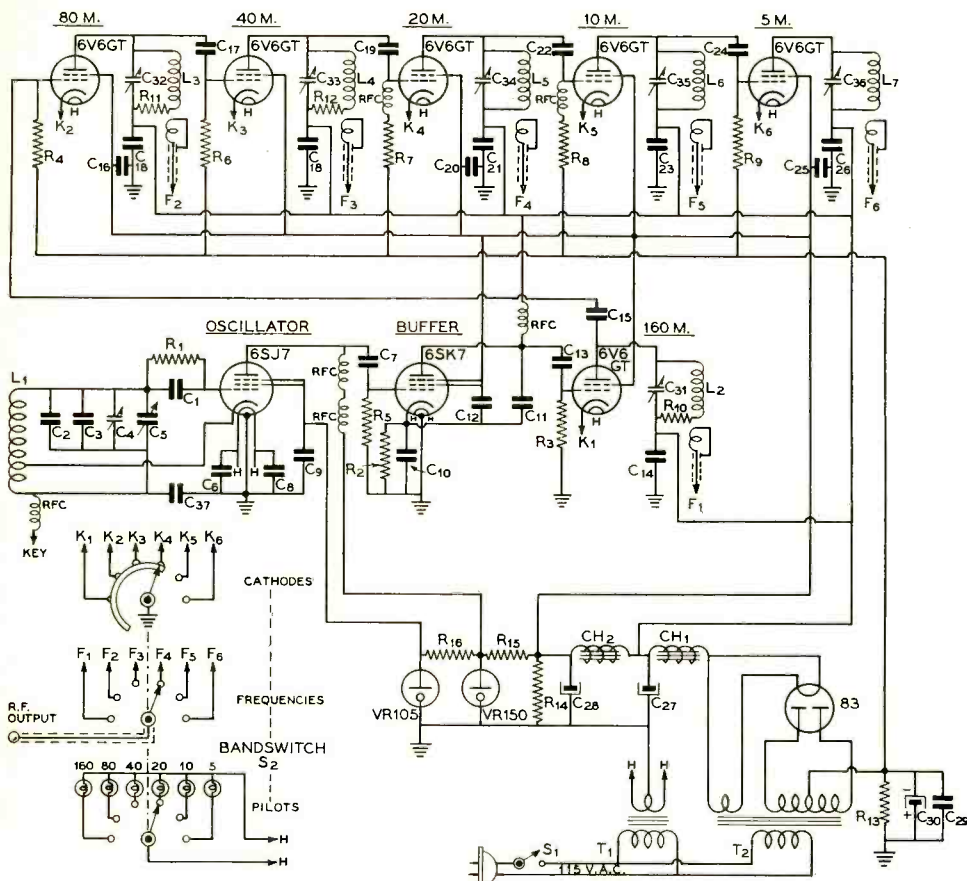

WIRING DIAGRAM OF THE "SWEEPSTAKES" EXCITER.

- | | | | |
|---|---|--------------------------------------|--|
| C ₁ —.0001- μ fd. mica | C ₁₈ , C ₂₀ , C ₂₁ , C ₂₃ , C ₂₅ , | R ₁₄ —50,000 ohms, 10 | tapped 9 turns from |
| C ₂ —.000035- μ fd. compen- | C ₂₆ —0.01- μ fd. 600- | watts | bottom for cathode |
| sating cond. | volt tubular | R ₁₅ —3,000 ohms, 10 | L ₇ —42 turns no. 26 |
| C ₃ —.0004- μ fd. low- | C ₂₇ , C ₂₈ —16- μ fd. 475- | watts | enam. on 1/4" |
| drift silvered mica | volt electrolytics | R ₁₆ —1,500 ohms, 10 | form, closewound |
| C ₄ —.00028- μ fd. mica | C ₂₉ —.002- μ fd. midget | watts | L ₃ —21 turns no. 26 |
| padder | mica | RFC—2 1/2-mh. r. f. | enam. on 1/4" |
| C ₅ —.00015- μ fd. tun- | C ₃₀ —20- μ fd. 150-volt | chokes | form, closewound |
| ing variable | electrolytic | T ₁ —6.3-volt 6-amp. fil. | L ₄ —12 turns no. 26 |
| C ₆ —0.01- μ fd. 600-volt | C ₃₁ -C ₃₅ —Mica or air | trans. | enam. on 1/4" |
| tubular | padders | T ₂ —Power transformer | form, closewound |
| C ₇ —.0001- μ fd. mica | R ₁ —20,000 ohms, 1/2 | 250 to 325 d.c. volts | L ₅ —6 turns no. 26 |
| C ₈ , C ₉ , C ₁₀ , C ₁₁ , C ₁₂ — | watt | at 250 ma. with rec- | enam. on 1/4" |
| 0.01- μ fd. 600-volt | R ₂ —400 ohms, 1 watt | tifier winding | form, spaced to 1" |
| tubular | R ₃ , R ₄ —100,000 ohms, | CH ₁ —5-20 hy. 250-ma. | L ₆ —6 turns no. 20 |
| C ₁₃ —.0001- μ fd. mid- | 1 watt | swinging choke | enam. on 3/4" polysty- |
| get mica | R ₅ —20,000 ohms, 1/2 | CH ₂ —12-hy. 250-ma. | rene form, close- |
| C ₁₄ —0.01- μ fd. 600-volt | watt | filter choke | wound |
| tubular | R ₆ , R ₇ , R ₈ , R ₉ —100,000 | S ₁ —S.p.s.t. a.c. line | L ₇ —4 turns no. 20 |
| C ₁₅ —.0001- μ fd. midget | ohms, 1 watt | switch | enam. on 3/4" polysty- |
| mica | R ₁₀ —75 ohms, 1 watt | S ₂ —Two-deck 4-circuit | rene form, spaced |
| C ₁₆ —0.01- μ fd. 600-volt | R ₁₁ —50 ohms, 1 watt | 6-position rotary | to 1/2" |
| tubular | R ₁₂ —25 ohms, 1 watt | switch | F ₁ -F ₆ —2-turn link on |
| C ₁₇ , C ₁₉ , C ₂₂ , C ₂₄ — | R ₁₃ —150 ohms, 10 | L ₁ —28 turns no. 26 | cold end of all out- |
| .0001- μ fd. midget | watts | enam. on 3/4" poly- | put coils |
| mica | | styrene coil form, | |

Underchassis view showing the individual compartments for the oscillator and the various doubler stages.

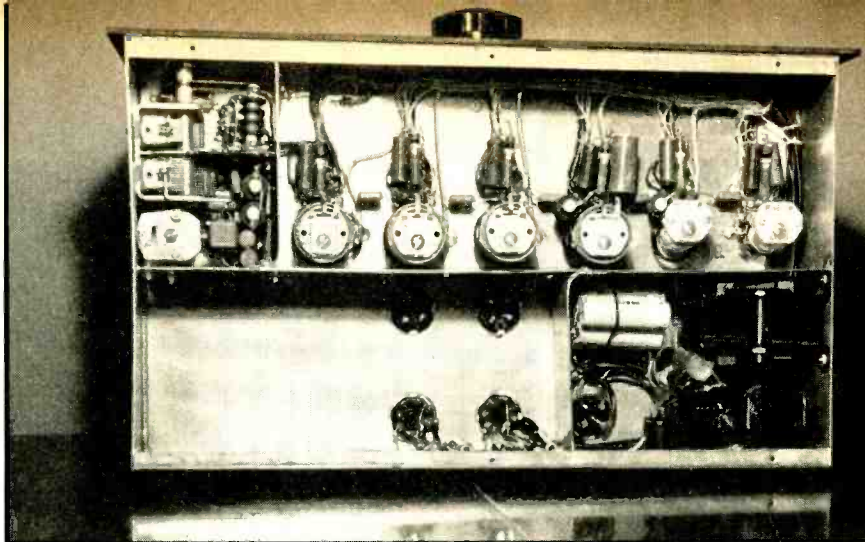

lights the proper panel light. The lights used are 6-8 volt, 150 milliamperes, (brown bead) to prevent arcing.

The output of the various stages is brought to the switch by means of link coupling. The link circuits are then switched and taken back to the terminal strip, all with shielded cable. Ordinary pushback wire was used first, but was found to have excessive losses, probably due to the stray coupling. Each coil has a 2-turn link wound on the cold end and soldered to a 2-lug soldering terminal strip. The fourth circuit of the switch is not used.

Shielding

Two factors that greatly improve the stability of any variable frequency oscillator are electrical shielding and mechanical stability. This exciter is no exception. As can be seen in the photographs, the chassis is divided into five compartments completely shielding each section of the exciter. The oscillator stage and all of its condensers, resistors and tuning condenser are all mounted in one compartment, completely shielding the oscillator section from the rest of the exciter.

The 6SK7 is shielded in like manner. The output stages, however, are not shielded so thoroughly, because they are not tuned to the same frequency. The power supply is also separated from the rest of the stages, though more for mechanical stability and to prevent vibration at 60 and 120 cycles than for electrical shielding. There is also an additional compartment which at the present time is housing the voltage regulator tubes but will house a small speech amplifier for modulation of the unit on 5 meters. All shielding material is heavy cadmium-plated steel.

Keying

Keying is accomplished in the cathode circuit of the oscillator. The combination of RFC,

and C_a aids in filtering. This circuit has excellent keying characteristics and no further filtering is necessary. The keying circuit has only about 12 milliamperes flowing through it, therefore the "sparking" does not induce any radiation to speak of. The keying lead is brought out to the back of the chassis through a shielded lead. A connection is also brought out to the terminal strip at the back of the chassis to permit "spotting" of the oscillator. This leaves the output stages "in the air" and accurate spotting is made possible.

Vacuum tube keying was tried but was unsuccessful because of the small keying current involved. The oscillator continued to oscillate due to the very small leakage current through the keyer tubes. The oscillator will oscillate with as little as 6 volts. That is the reason for the two empty sockets on the chassis. The present type of keying is entirely satisfactory.

Power Supply

There is nothing new in this power supply except that a few problems are presented. First, with all the output stages in operation the load on the power supply is approximately 250 milliamperes. Therefore the power supply components must be capable of handling this load. The rectifier used is an 83, which handles the load very nicely and also helps in the voltage regulation because the voltage drop across it is nearly constant regardless of the load. Choke input is used because the rectifier tube is of the mercury vapor type. The 100-ohm, 10-watt resistor in the power supply is used to provide a bias voltage of approximately 15 volts to the output stages. Though the voltage varies due to the load through the resistor, this variation does not have any harmful effects. Voltage regulation is used for the oscillator screen and plate voltages. A separate transformer is used for the filaments.

[Continued on page 93]

TRANSMITTER INTERFERENCE ELIMINATION

By HOWARD C. LAWRENCE, JR., * W3IXL

A practical discussion of tried-and-proven methods for the elimination of transmitter interference from communications receivers located adjacent to the interfering transmitters.

In amateur and in commercial radio station operation, it is often desirable that a receiver remain in operation while a transmitter is on the air. It may be that two transmitters are being used simultaneously, or that one frequency is being monitored continuously while another is being worked. One of the difficulties with such operation is that the field of one transmitter affects the receiver used with the other transmitter, either blocking it completely or reducing the sensitivity and causing interference that makes it difficult to copy weak signals.

In large scale commercial operation, it is often possible to locate the receiver at a distance from the transmitter where the field strength is relatively low. In amateur operation and some commercial operation, this practice is not possible. Instead, it is necessary to use receivers that are unaffected by strong fields at frequencies other than those to which they are tuned.

One way of going about making a receiver unaffected by these strong fields is to set it up in a field similar to that in which it will operate and then to eliminate the sources of trouble one at a time.

If the receiver is to be used always in one particular location, the interference investigation may be started with the receiver in its normal position. If a general cure that will be good in a large number of locations is desired, it is well to place the receiver in a very strong field set up by running a wire from the transmitter over the receiver and terminating this wire in such a way that there is a good strong field at the point at which the receiver is lo-

cated. It is usually desirable to modulate the transmitter with a constant tone, even when all c.w. operation of the transmitter is expected. It is much easier to trace down a source of interference with tone modulation on the carrier than it is to try to hold a constant beat with the receiver beat-frequency oscillator. Also, radio frequency that enters the audio stages of a receiver often will not show up until it is keyed or modulated.

If possible, some sort of indicator should be provided so that one can tell when the interference has been reduced and by approximately how much. If the receiver has an "S" level indicator, it may be used as the output meter. If it has not, a copper-oxide rectifier-type meter will be satisfactory. Vacuum-tube voltmeters are not satisfactory for this sort of work because they often pick up radio frequency energy and give readings which are not indicative of what is going on in the receiver. The exact way of going about eliminating the interference will depend to some extent upon the particular receiver. As an aid, some of the causes of such interference that have been experienced are outlined below in the hope that they will serve as a guide for similar work.

Methods

There are two general methods of operation: One is to attempt to prevent the radio frequency energy from entering the receiver case; the other is to attempt to deal with the affected circuits directly. Often it is necessary, or most convenient, to use a combination of these two methods.

Keeping the radio frequency energy from entering the receiver case is sometimes the simplest method. As a preliminary step in in-

*308 Ninth Avenue, Haddon Heights, New Jersey.

investigating the possibilities of this method, all wires and other equipment not absolutely essential to the operation of the receiver should be removed. This makes it easier to locate any remaining sources of interference. Then, as these parts are replaced one at a time, any interference introduced by one of them may be corrected.

If the receiver is of the single unit type in which the receiver, power supply, and speaker are enclosed in one case, the only things that can be removed are the antenna, ground, and earphones, if they are used. The antenna terminal should be connected to chassis ground with the shortest possible lead. If there are remote control wires, pre-selector or similar apparatus associated with the receiver, they also should be removed. With all such external equipment removed, any signal then present in the output of the receiver enters either through the case or on the power line. An indication of the importance of the signal entering by way of the power line may be had by coupling some of the output of the transmitter into the power line, which may be done by bringing the receiver power cord near the transmitting antenna. A filter consisting of a radio-frequency choke and by-passes at the receiver end will usually eliminate this source of signal. (Figure 1). To be most effective, this filter should be mounted in a shield box at the point where the lead enters the receiver case. If there is no room within the case, this shield box may be fastened to the outside. It is particularly important that this filter shield be fastened to the case of the receiver, and not to the chassis. The power leads should enter through small holes in opposite ends of the filter box, to keep the input and output of the filter as far apart as possible. Leads on the by-passes should be short. The size of the chokes and capacitors will depend largely on the frequency of the interfering signal.

Interference Through the Case

Energy entering through the case of the receiver may be found by holding a source of radio frequency signal near various parts of the case. With the receiver in a strong field, it is often only necessary to point a finger at various parts of the case to locate the trouble. If the receiver is removable from the case, all joints in the case should be tight fitting. To be most effective, the receiver case should have no holes in it. Radio frequency energy will find its way into even small ventilating holes. If there is a large hole for the loudspeaker, a metal grill may provide satisfactory shielding. In some cases, it may be necessary to place a metal box around the speaker and to cover

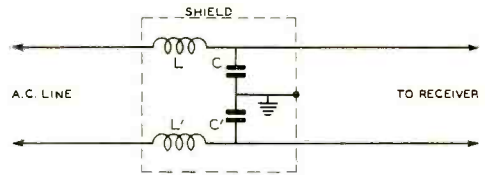

The inductances L and L' will vary somewhat with the frequency to be eliminated, as will the capacitors C and C' . Often Ohmite Z-1 chokes (u.h.f. type) and 0.01- μ fd. tubular paper capacitors will be satisfactory. Care should be taken to see that the input and output ends of the filter are well separated.

up all ventilating holes. Meter holes holding bakelite-cased meters will allow strong signals to enter the receiver. The remedy is to put a metal shield over the back of the meter, or use a metal-cased meter. Fortunately, this source is of importance only in the case of a very strong field.

Signals will enter a receiver on the shafts of controls that are not grounded at the point where they enter the receiver case. This is particularly true of ultra-high frequency interference. In several cases it has been found that a tuning shaft grounded two or three inches behind the front panel will radiate signal inside the case of a receiver when the operator's hand is on the tuning knob. The correction for this source of interference is to ground the shaft to the case, at the point at which it enters, with a small wiper on the tuning shaft. This same trouble is occasionally found with range switch and volume control shafts, although they are less important because the hand of the operator is not normally on them when a signal is being tuned.

Some Remedies

Any cables that enter the receiver should have their shields grounded to the receiver cabinet at the point where they enter. In bad cases it may be necessary to bypass the individual wires to ground where they enter, and, in extreme cases, to provide radio-frequency chokes for each lead. If radio-frequency chokes are needed, they should be enclosed in a shield box similar to that recommended for the power cable filter.

Earphone jacks often require shields around them, and filters between them and the rest of the circuits.

After other causes of interference have been eliminated, an antenna may be connected to the receiver. If it is found that a signal is coming

[Continued on page 93]



A PORTABLE EMERGENCY TRANSMITTER

For Home or Field Use

By EVERETT G. TAYLOR,* W8NAF

An efficient and straightforward 20-watt unit that is suitable for either 110-volt a.c. or 6-volt d.c. operation.

A portable-emergency transmitter is a prime requisite for operation in field day contests, and is a comforting piece of apparatus to have around.

The first important detail is size vs. power. We may have a watt in hand or a kilowatt in a trailer. By compromising between these two extremes we wind up with a very useful twenty-watt rig on a 5 x 10 x 3-inch chassis. Twenty watts seems to be a logical compromise, as this order of power often has proved sufficient to be reliable.

The particular transmitter to be described uses a 7A4 Pierce oscillator and a 7C5 amplifier. The 7C5 could have been used alone, but in view of the fact that an oscillator by itself will not have as good efficiency or stability as an oscillator and amplifier combination, we used the latter. Two-band operation is highly desirable, and with a single tube this would mean an extra control for the cathode

of the tri-tet oscillator, the latter being the obvious choice for a single tube oscillator.

The screen connection in the oscillator socket is connected to the plate. This permits use of any loctal triode or pentode in this socket, which means that only one tube need be carried as spare for the r.f. end of the rig, this tube being a 7C5.

Construction

The entire rig is housed in a small, manufactured "amplifier foundation" cabinet which contains the chassis mentioned before. Referring to the illustrations, the switch on the front right side is for the a.c. The other one is a d.p.d.t. rated at 6 amps. to change from 110 volts a.c. to 6 volts d.c. The tuning condenser nearest the center is for the antenna loading and the other key one is for the main tuning. The midget key jack is mounted on the back drop along with the antenna and input voltage connections.

*611 West Vine St., Mt. Vernon, Ohio

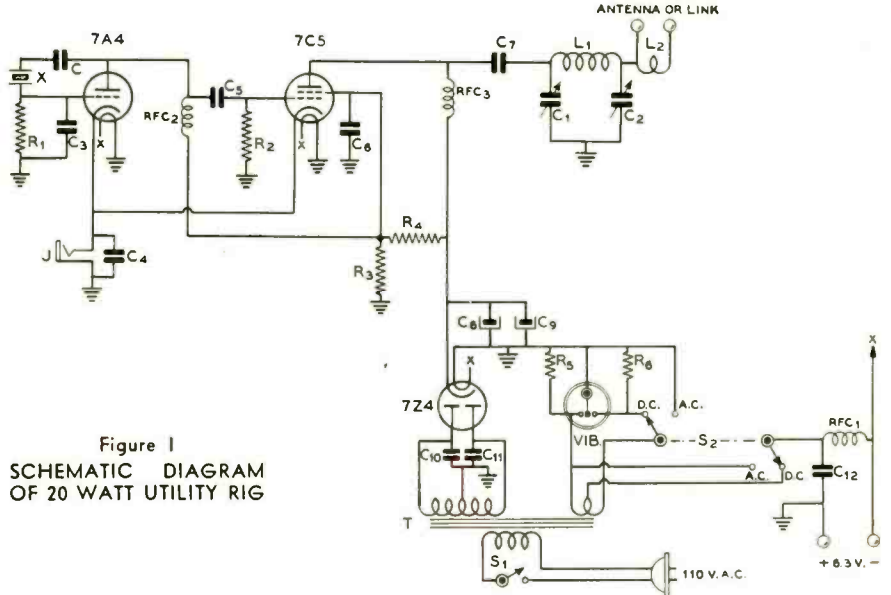

Figure 1
SCHEMATIC DIAGRAM
OF 20 WATT UTILITY RIG

C—75- μ fd. or more, mica
 C₁, C₂—140- μ fd. midget variable
 C₃—50 or 75- μ fd. midget mica, whichever works best
 C₄—.003- μ fd. mica
 C₅—75- μ fd. midget mica

C₆, C₇—.003- μ fd. mica
 C₈, C₉—One, dual 10- μ fd. electrolytic unit, 450 v.
 C₁₀, C₁₁—.02- μ fd. 1200 working volts
 C₁₂—0.5- μ fd., 200 v.
 R₁, R₂—50,000 ohms, 1/2 watt
 R₃—20,000 ohms, 10 watts

R₄—5,000 ohms, 10 watts
 R₅, R₆—50 ohms, 1/2 watt
 RFC₁—See text
 RFC₂, RFC₃—2.5 mh. r.f. chokes
 T—Small power transformer, about 70 ma., with 5 and 6.3 volt windings and high voltage

winding of 300 to 375 v. each side c.t.
 S₁—S.p.s.t. toggle switch
 S₂—D.p.d.t. switch to stand 110 v.
 VIB—Full wave vibrator (not self-rectifying type)
 L₁, L₂—See coil table

The 20 watt r.f. unit with its self-contained 6-110 volt power supply. The dust cover is removed to show layout of parts.

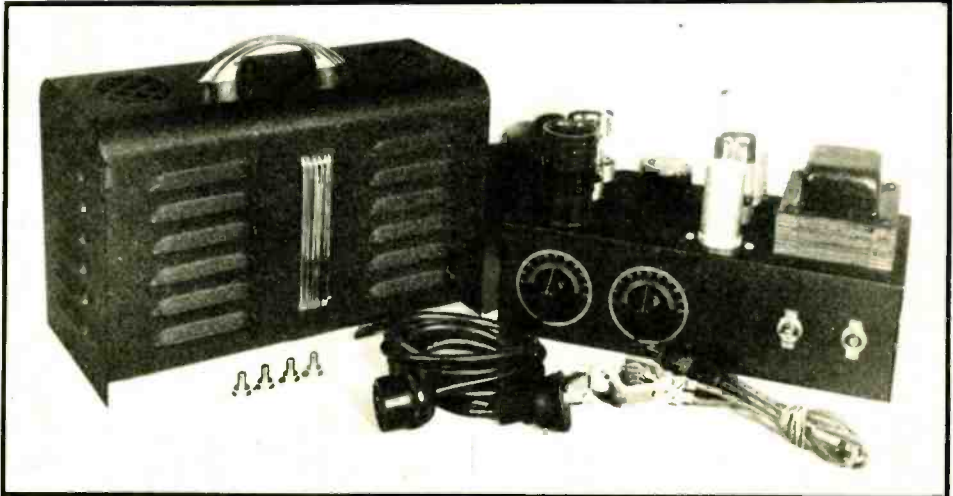

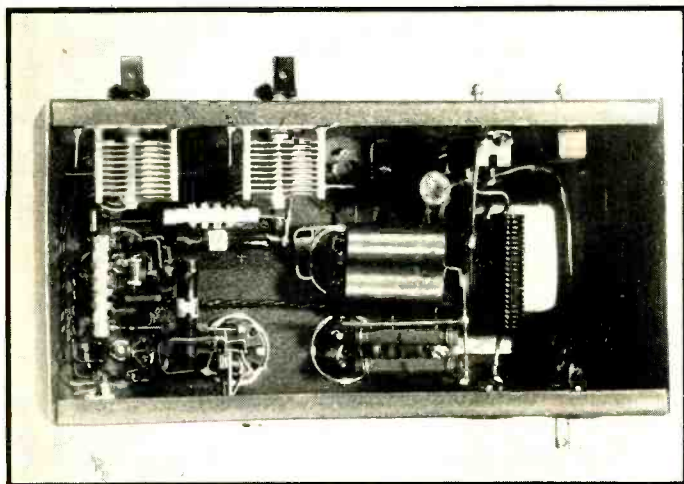

Under chassis view, showing compact arrangement of parts.

One side of the antenna link is connected to the hot side of the coil. By doing this we may feed almost any type of antenna, or link couple to an amplifier when the rig is used as an exciter at the home location. In the latter service, C_2 is shorted out.

At the time the photos were taken no bottom plate was had due to the present scarcity of radio parts. As it always happens, the next day it came. This should be used, as it entirely eliminates the hash radiated by the vibrator and also reduces chances of shock from the transmitter.

Another safety measure is to have the a.c. switch off when operating on battery, as it breaks the 110 v. circuit in the primary. By using parallel feed to the plate of the 7C5, the d.c. voltage is kept off the coil, further preventing chances of "getting bit" by the B voltage.

A 75- μ fd. condenser is inserted between the crystal and the plate of the 7A4 to keep the d.c. potential off the crystal and to prevent the possibility of the operator's getting bit when changing it. This condenser does not necessarily need be this particular value; any size mica condenser from 50- μ fd. up will be o.k. The output of the 7A4 is sufficient to fully excite the 7C5, the grid current on the latter being on the order of 3 ma.

The power transformer is rated at 375 volts at 70 ma. and has 6.3 and 5 volt windings, the latter not being used. The 7Z4 was used in preference to the more commonly used 7Y4 as it will pass more current. The cost is the same as the latter and the connections are also alike for both, so it seemed good logic to use the former. The dual 10- μ fd. filter condenser was found to be sufficient capacity

to give a T9X signal even without a choke.

The vibrator has 50-ohm, 1-watt Centralab resistors from each contact to the ground. It is very imperative to use them as it reduces the spark across the contacts. These, along with the buffer condensers and the 0.5- μ fd. condenser after the "A" choke tend to minimize the hash that would be radiated from the vibrator supply. The choke consists of 22 turns of no. 12 enamel wire $\frac{3}{8}$ -inch in diameter. By carefully studying the circuit diagram it can be seen how a d.p.d.t. switch may be used to change the filaments and vibrator from a.c. to d.c. or vice versa. Be sure to remove the vibrator from the rig when operating on a.c., as the contacts will not take a.c.

The use of a regular 110-volt power transformer as a vibrator transformer is not exactly the best of practice, as a transformer must be specially designed for most efficient use with a vibrator and long vibrator life. However, with the transformer shown, the efficiency is reasonably good, and the life of the vibrator is still long enough to permit a lot of portable operation. While such an arrangement might not be advisable in an auto set, where the vibrator must run day in and day out, it is perfectly feasible when the vibrator is used only occasionally.

COIL DATA

All coils are wound on $1\frac{1}{4}$ -inch dia. forms with no. 18 enamelled wire. Link is simply a continuation of the main winding, 2 turns for all coils.

20 meters: 8 turns spaced diameter of wire.

40 meters: 14 turns close-wound.

80 meters: 26 turns close-wound.

Design and Operating Data for CONDENSER INPUT FILTERS

By CURTIS W. LAMPSON*

The recent "cooking out" and subsequent failure of a small power transformer operating apparently within its rating in a conventional power supply, led, after some unfriendly remarks about the manufacturer, to an investigation of the actual operating conditions imposed upon the transformer. The rectifier was a conventional full-wave type with center-tapped secondary transformer and a double rectifier tube. This led into a "pi" network filter with an input condenser, a fairly large choke, and an output condenser, similar to that used by hundreds of amateurs. The input condenser was rather large in order to improve the regulation characteristic up to full load (See figure 1).

The heating of the windings of a transformer due to copper losses is proportional to the square of the r.m.s. current in the winding, so in order to establish the heating conditions in the transformer winding it is necessary to know the r.m.s. current as a function of the d.c. output current. A search of the available literature brought to light very little on the current and voltage relationships in a rectifier with a condenser-input filter, although plenty of information is available concerning the choke input rectifier system. One handbook had no more to say than that the rectifier with condenser input is complex in operation. With this scarcity of readily available information it seemed worth while to make an analysis of this important rectifier system with a view toward making the results generally applicable to the usual rectifier system used by amateurs.

*Assistant Professor of Physics, University of Richmond, Virginia.

Analysis

The analysis is made for an ideal rectifier system with certain mathematical approximations to reduce the computational labor to reasonable limits. These approximations are believed to be close enough to permit an accuracy of five or ten per cent in the results as applied to an actual rectifier. This accuracy is entirely reasonable for any purpose except precision work or design of extremely large units.

The assumptions as to the nature of the rectifier are as follows: (1) The reactance and resistance of the transformer are negligible as far as their influence on the shape of the current wave is concerned, (2) the rectifier itself has negligible resistance, which is closely true for mercury vapor tubes and is a reasonable approximation for high vacuum tubes, (3) the rectifier tubes do not reach saturation during a current peak, (4) the choke is large enough to insure a substantially constant flow of current away from the input condenser. The last two assumptions are closely fulfilled in the usual rectifier.

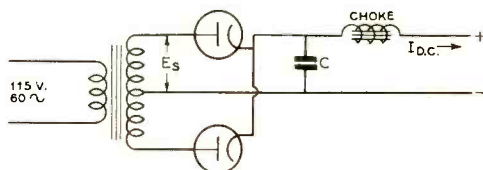

Figure 1. Circuit diagram of a full-wave rectifier with condenser input.

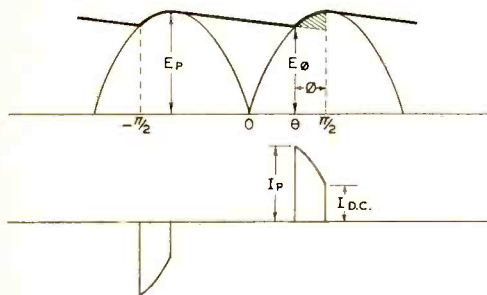

Figure 2. Voltage wave applied to the input condenser. The heavy line represents the voltage across the condenser as a function of time. The light line of the rectified sine wave represents the voltage applied to the condenser from the rectifier. When the applied voltage equals the voltage of the condenser, charging current starts to flow into the condenser as shown in the bottom diagram. The flow of current away from the condenser is considered to be constant.

The operating conditions are depicted in figure 2 where (a) shows the voltage on the input condenser during a cycle and (b) shows the corresponding current through one-half the secondary winding of the transformer. The condenser is considered to be fully charged at the angle $-\pi/2$, the peak of the voltage wave, and to discharge uniformly to a voltage E_c at which point in the cycle the voltage of the next half wave is equal to the condenser volt-

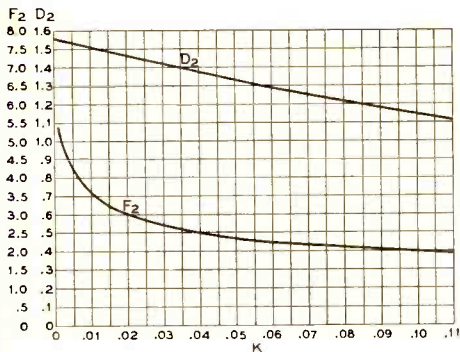

Figure 4. Curves comparing the output voltage and transformer current of a rectifier with condenser input to a rectifier with choke input. The factor D is the ratio of the output voltage with condenser input to the output voltage with choke input. The factor F is the ratio of the r.m.s. transformer current with condenser input to that with choke input. The parameter K is the same as for figure 3 and is explained in the text.

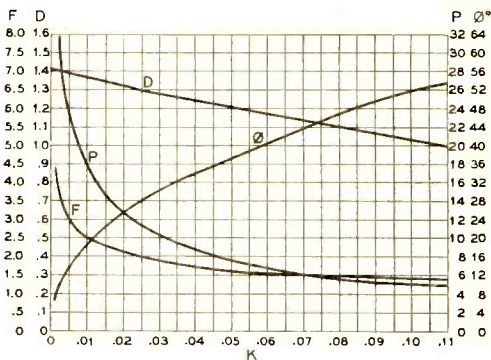

Figure 3. Curves illustrating the performance of a condenser input rectifier. The four curves give D, F, P, and O as a function of K, the rectifier parameter. The factor D gives the ratio of output voltage to the transformer voltage to midtap, the factor F is the ratio of the transformer r.m.s. current to the d.c. output current, the factor P is the ratio of the peak tube current to the d.c. output current, and the quantity O is the angle of conduction in degrees. The parameter K against which these curves are plotted is the ratio of the d.c. output current in milliamperes to the product of input capacity in microfarads and the r.m.s. transformer secondary voltage to midtap as explained in the text.

age, and charging commences. Current flows for an angular interval Φ until the crest of the voltage wave is reached at $+\pi/2$. The current pulse during this time is as shown in the figure with its maximum at the beginning of the pulse and dropping to a value I, the d.c. current, in a regular manner before dropping abruptly to zero. The wave shape of the current pulse is a section of a cosine curve. Since the average value of the current pulse must be equal to the output current I, it is qualitatively seen that circuit conditions that restrict the flow of current to a small angle must result in high peak currents and correspondingly high r.m.s. currents in the windings of the transformer. Large values of the input condenser produce these current conditions, although producing at the same time an improved regulation.

It became apparent during the analysis that the operation of the rectifier depended on just three readily ascertained factors. These are the d.c. output current of the rectifier, the capacity of the input condenser, and the r.m.s. voltage to center tap of the transformer as indicated in figure 1. These three factors, which may vary widely for any individual rectifier, were combined to form a parameter K so that the

[Continued on Page 76]

POLICE RADIO KINKS

By "COPPER" SPARKS

INEXPENSIVE BAWL-OUT

The use of "bawl-out" traffic cars is quite common in the larger cities as a means of educating the public by calling their attention to traffic mistakes when observed.

Such cars are generally equipped with a 10 to 15 watt public address amplifier and one or more speakers. Not only can the car be used for general traffic work, but the loud speaker installation is invaluable for handling crowds at public gatherings or for controlling spectators at the scene of fires or accidents.

If two way radio is already installed or contemplated, it is unnecessary to use a separate amplifier, however. Since the modulator commonly used in a car transmitter is capable of delivering 10 watts or more of audio power, it can be made to do double duty at very little additional expense.

The idea of having such a system on *every* car has many things to recommend it. Whenever an officer stops a vehicle to "shake it down" or halts a known "hot car," he is taking his life in his hands the minute he leaves the protection of his own car. By staying in the patrol car and directing the occupants of the other vehicle through his loudspeaker, he immediately has the advantage. Their failure to obey a command to vacate the car is cause for extreme caution. This is particularly true in the case of cars manned by but one officer.

It is impossible to calculate the number of officers' lives which might have been saved by this simple expedient.

To add a loudspeaker to an existing two-way radio installation requires but three parts: a relay, an output transformer and a loudspeaker assembly.

Figure 1 illustrates the necessary conversion of a single-ended class A or AB modulator and figure 2 that of a push-pull class AB or class B stage. In both cases, operation of a dashboard toggle switch transfers the output of the modulator from the r.f. amplifier to the loud-

speaker and kills the r.f. section by breaking B plus. The same mike and speech amplifier as used for the transmitter is then used for the safety horn.

The single-ended modulator will require a d.p.d.t., 6-volt d.c. relay, while the push-pull modulator requires a 3 p.d.t. relay. In both cases an additional output transformer is incorporated to match the loudspeaker to the tubes used. An accurate match is not required, though it is best not to have too much mismatch.

In either case, a 2-wire (preferably shielded) cable connects the modulator to the speaker. A volume control is unnecessary, since the volume can be varied simply by talking at different levels or at a different distance from the microphone.

While the speaker or horn may be mounted on the roof of the car, few police departments would care for this type of mounting; so it is better to use one of the standard weatherproof horns and mount it on the front of the car. An even better plan is to mount a 6- or 8-inch *high power* permanent magnet dynamic in a small box having speaker cloth over its face for weather protection and place the assembly behind the radiator grill where it is out of sight. Almost all cars manufactured in the last few years have sufficient space available between the grill and radiator proper. It is possible to get a 6- or 8-inch 15-watt speaker which is highly efficient.

Although the speaker in this position is subject to heat from the radiator, experience with such mountings indicates a life expectancy of up to two years, during which period its replacement cost will have been saved many times over.

Departments already using loudspeakers on their patrol cars claim it is the greatest advancement in police radio since the adoption of two-way radio communication. We predict it will become a universal item on all radio equipped cars within a very short time.

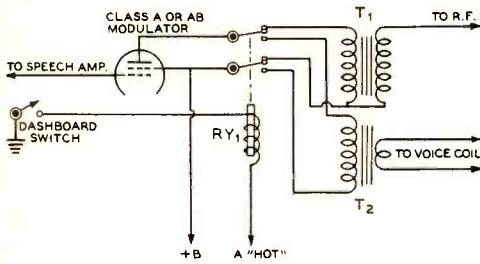

Figure 1. Method of connecting single ended modulator (usually a 6L6) for bawl-out use without incurring loss of two transformers in circuit simultaneously.

RY₁—D.p.d.t. relay for 6 volts d.c.

T₁—Regular modulator transformer

T₂—Tube to voice coil, capable of handling both direct current and audio frequency power of modulator

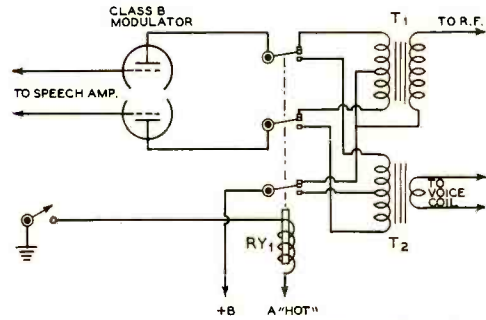

Figure 2. Method of connecting push pull modulator for bawl-out use.

RY₁—Three pole double-throw relay for 6 volts d.c.

T₁—Regular modulation transformer

T₂—Husky push-pull tubes to voice coil transformer, capable of handling modulator output

REMOTE VOLUME CONTROL

It is often deemed preferable to mount fixed-frequency patrol-car receivers in the trunk and feed their output to a loudspeaker either on the dash or header in the drivers compartment.

This makes the receiver easily accessible for tuning or servicing and permits the use of the transmitting antenna as a receiving antenna without the losses incidental in a long lead to the engine bulkhead for that type of mounting.

The difficulty in placing the receiver in the trunk is to provide means of controlling the volume from the forward part of the car. Most commercially manufactured police receivers of both medium- and ultra-high frequency types, control their volume with a potentiometer in the second detector or first a.f. Any attempt to run these leads to the dash is doomed to failure.

Figures 3 and 4 illustrate methods of accomplishing volume control in a remotely located receiver, using a minimum number of parts. *The speaker line in each case carries no d.c.*

The regular receiver volume control is set at a predetermined point. Since all sets have good a.v.c., this is satisfactory.

In the case of figure 3, one side of the plate-to-voice-coil transformer in the receiver is grounded and the other side run through a wire to the loudspeaker. A 50-ohm potentiometer connected between this line and ground, with the movable arm attaching to one side of the voice coil, permits proper control.

Figure 4 illustrates an alternative method using high impedance coupling, in which a plate-to-voice-coil transformer is incorporated in the speaker. A 0.5- μ fd. or larger paper

condenser is connected to the plate of the last audio tube to feed the output to the speaker. A 10-hy. choke may be used at the receiver in place of the transformer shown, if desired.

In both cases, if a jack "outlet" is installed in the receiver to connect the output to the speaker line, a service speaker may be used for adjustments in the trunk. A magnetic speaker is required for checking in figure 4 unless the old voice coil leads are brought to a socket or jack, in which event a permanent magnet dynamic may be plugged in, allowing simultaneous operation of both the regular and test speakers. This cannot be done if a choke is substituted for the transformer at the set.

The regular volume control on the receiver is set for maximum desired volume within the required service or patrol range from the transmitter, and the drivers volume control will then hold it down to whatever level he desires.

INCREASING ANTENNA SENSITIVITY

The advent of the "turret top" sounded the death knell of the roof antenna formerly used with medium-frequency car receivers. All the substitutes so far devised fall far short of the pickup of the older types. Fortunately, due to newer tubes, better circuits and more efficient components, this is not so noticeable until one attaches a receiver to a good old fashioned roof antenna, when the difference is amazing.

In police or similar fixed-frequency work, where mobile reception of a single station is desired, it is possible to tune the antenna to give increased pickup and range.

Figure 5A shows the usual input circuit of

the radio frequency or first detector stage of a receiver using conventional antenna coupling. This is the universal method of coupling car antennas to the set.

Figure 5B illustrates a simple conversion of this circuit which provides for tuning of the antenna to the frequency it is desired to receive and providing greatest possible voltage transfer to the grid of the input tube.

The change is accomplished by disconnecting the regular tuning condenser from the grid circuit, removing the antenna coil and replacing it with a permeability tuned coil of suitable inductance. The inductance required for resonance will depend upon the length of the antenna, the shunt capacity of the shielded antenna lead-in, and other factors. The shielded lead-in should be of the low-capacity type and be as short as possible.

This is shown in figure 6. While the idea is simple, the results are excellent.

A 2 pole, double throw switch disconnects the antenna from the antenna coil of the receiver and connects it to a "short wave" coil, through a series tuning condenser. At the same time the second set of contacts remove the grid of the first detector from the regular broadcast coil and connect it to the short wave coil. This switching is equivalent to cutting out the radio frequency stage and feeding the signal directly into the first detector. It is then merely necessary to tune the regular dial of the receiver until a harmonic of the oscillator beats with the incoming police signal at a difference frequency equal to the intermediate frequency. For the 2400 kc. channels, this will be around the center of the broadcast band. Several spots are invariably found

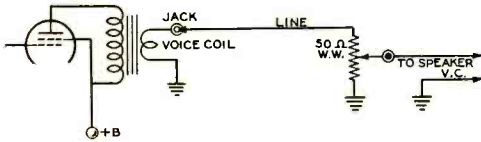

Figure 3. Simple method of remote volume control for any car receiver. This permits mounting of receiver in trunk.

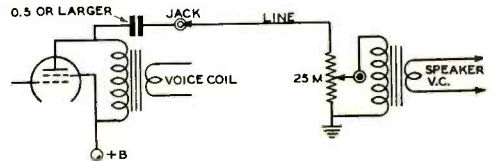

Figure 4. Alternative method of connecting remote speaker.

A circuit such as this does not have the selectivity of the usual arrangement, but does have the advantage of excellent sensitivity. It is particularly adaptable to locations where there are no high-power stations on the image response frequency. It has been tested for more than five years on both motorcycle and car receivers and it invariably gives from two to four times the signal input that can be obtained from an "untuned" antenna.

SIMPLE POLICE CONVERTER

It sometimes happens that one desires to receive police calls on either a fixed or mobile broadcast receiver which does not cover any short-wave bands.

If the police transmitter operates on medium frequencies, any superheterodyne may be converted for reception of a single station locally, by installing but three parts which in no way interfere with its use as a broadcast set.

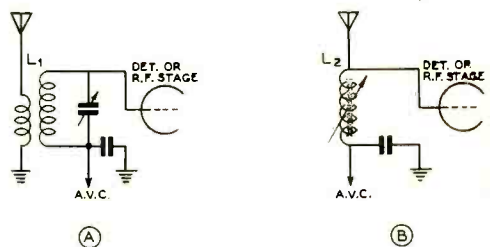
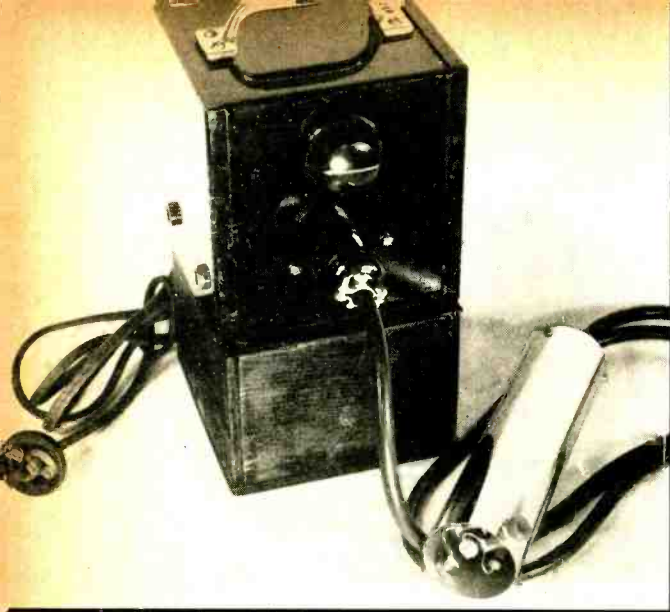

Figure 5. Regular antenna input (A) and converted circuit (B) which provides increased gain. The permeability tuned coil is resonated to the station frequency.

where the signal can be heard and it is only a matter of picking the loudest setting for future tuning.

Since the r.f. stage is removed from the

[Continued on Page 72]



Assembled view of the equipment. The knob is the zero reset control, and the tip jacks on the side are for connecting the indicating d.c. meter.

A Probe Type Rectifier For the D. C. Voltmeter

By A. K. McLAREN*

To measure a.c. voltages with a vacuum tube or high resistance d.c. voltmeter requires some kind of a rectifier. And to measure high frequency voltages a rectifier built into the test probe is generally necessary in order to shorten the leads between the meter and the circuit under test.

The probe type rectifier described here can be built for about \$5 or \$6, and will measure voltages of any frequency between 60 cycles and 30 megacycles. The entire unit is very simple, and no machine work is required on the probe itself.

Using this rectifier with a d.c. vacuum tube voltmeter or high resistance d.c. voltmeter makes the complete instrument a peak-reading device, since, for voltages above about 12 volts condenser C₁ charges up to a voltage only slightly less than the peak value of the a.c. voltage being measured. In the range from zero to 3 volts the meter reads r.m.s. values, varying from that to peak values at about 12 volts. To convert the r.m.s. readings to

peak values it is merely necessary to multiply by 1.414; multiplying by a factor of .707 converts peak readings to r.m.s. values.

Construction

The rectifier tube and its associated equipment (parts within the dotted lines in the diagram) are mounted in a piece of brass tubing $1\frac{3}{4}$ inches in diameter and 7 inches long. The heater transformer and zero adjustment circuit components are mounted in the metal can, which measures $4\frac{1}{2} \times 5 \times 5$ inches.

The socket for the 75 tube is of the wafer type, trimmed just to fit inside the brass tube. To hold it in place in the tube two pieces of $1\frac{3}{4}$ -inch bakelite tubing 2 inches long are needed. These have a small strip cut out lengthwise to allow them to be squeezed together to fit into the brass tube.

To assemble the probe unit the input jacks are first mounted near one end of the brass tube, diametrically opposed to each other. One jack is grounded to the tube; the other is insulated from it. R₁ is connected between the

*213 So. 16th St., St. Joseph, Mo.

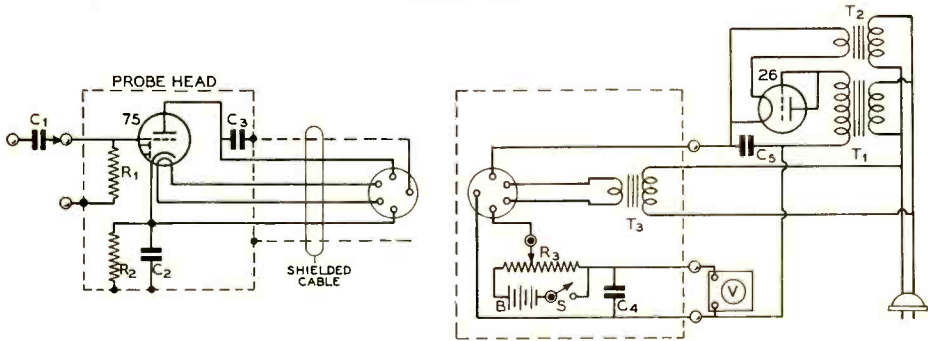

WIRING DIAGRAM OF THE PROBE RECTIFIER

- | | | | |
|---|---|--|--|
| C_1 —0.01- μ fd. mica | tubular | S —A.c. switch on R_3 | V —Multirange d.c. voltmeter, either electronic or high resistance d'Arsonval type |
| C_2, C_3 —100- μ fd. mica | R_1, R_2 —10 megohms, $\frac{1}{2}$ watt | T_1 —Audio transformer, 3 to 1 ratio | |
| C_4 —0.25- μ fd. 600-volt tubular | R_3 —25000-ohm potentiometer, with switch | T_2, T_3 —Output transformers | |
| C_5 —0.1- μ fd. 600-volt tubular | | | |

two jacks. R_3 , C_2 and C_3 are connected to the socket and the 75 tube is inserted. Then one of the bakelite tubes is pushed just inside the bottom of the brass tube, and the tube and socket are pushed in after it, until the top cap on the tube is about even with the end of the brass tube. The second bakelite tube is then inserted below the socket.

Care should be exercised to see that none of the leads to the tube socket short together or to the brass tube. It is well to place spaghetti tubing on these leads. A short jumper is connected between the grid cap of the tube and the insulated jack. The 4-wire shielded cable is wired to the socket, and then an end from a wooden magnet wire spool is used

to close the bottom end of the tube and held in place with small wood screws. A 5-prong plug terminates the other end of the cable. The cable shield serves as the ground return and is connected to the number 3 terminal of the plug.

The zero adjusting potentiometer, R_3 , and the cable socket are mounted on the front of the metal case, and the two insulated tip jacks for connecting the voltmeter are located on the side of the case. C_1 is connected between these two jacks. The B+ jack is at the rear of the case. In the interior view it is partly obscured by one of the leads. In this same view can also be seen the 4.5-volt battery and the heater

[Continued on Page 78]

Interior construction. The wooden box on the left contains the power supply and the metal box on the right contains the components associated with the rectifier, including its heater transformer.

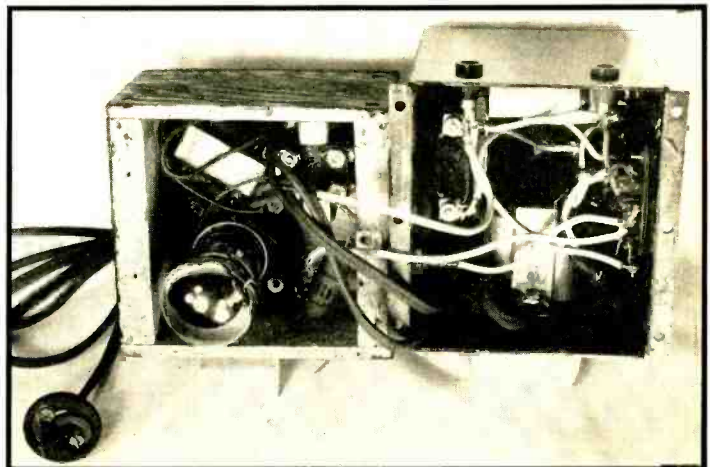

A DUAL-SERVICE TRANSCIEIVER

By ORIN C. LEVIS, Jr.,* W6DZK

A description of a simple method of altering the popular "Battery Operated Transceiver" described in the March, 1940, RADIO for operation on either batteries, 6 volts with vibrapack, or 110 volts a.c. The alterations are simple, and the unit operates equally well on either of the three types of power supply.

The continued popularity of the little self-contained 112-Mc. transceiver¹, described last year in RADIO, led me to attempt some alterations designed to increase its versatility, as well as to provide for a threatened shortage of small A-B battery packs.

The alterations to be described make provision for:

1. Self-contained battery operation, as originally designed.

2. Six-volt d.c. vibrapack or genemotor operation, giving more power output than the dry batteries.

3. A.c. line operation from a 110-volt power pack for regular home usage. Essentially, the changes are simple. When operating either on 110-volt power pack, or 6-volt vibrapack, a 6AF5-G replaces the 1G4-G and a 6K6-G replaces the 1Q5-GT. The number 8 pin on the 6.3-volt tubes is connected to the cathode, and since this pin is not used on the 1.4-volt tubes, the cathode wiring may be installed permanently at the sockets. All other socket connections remain the same.

The filament and plate power leads are brought out in a cable to a 4-prong male plug, and the battery leads are brought out to a 4-prong female plug. When these plugs are connected together, and the 1.4-volt tubes are in the sockets, the transceiver operates as it originally was designed. When 110-volt a.c. or 6-volt vibrapack operation is desired, the battery plug is pulled out and left dangling, and a 4-prong female plug on the powerpack cord is connected to the filament and plate circuit plug. Of course the 1.4-volt tubes must be replaced with the corresponding 6.3-volt tubes.

On the circuit diagram, it will be noted that the microphone voltage is obtained from the A battery in the A-B pack, regardless of the source of the B voltage. It was found desirable to add an additional 1.5 volts of microphone voltage in order to provide sufficient gain for the higher plate voltage; so a small flashlight cell was wired in series with the mike transformer. This cell may

¹Smith, "2.5-Meter Transceiver," RADIO, March 1940, page 11. Also RADIO HANDBOOK, 7th Edition.

*2432 Oregon Avenue, Long Beach, California.

be mounted underneath the chassis by means of a small metal strap. The "off-on" switch on the panel controls only the mike voltage when using a.c. or vibrapack power supplies.

The plate voltage on the 6.3-volt tubes should not exceed 200 volts, because regeneration control then becomes erratic, and also the screen of the 6K6G may run red hot. Some trial and error adjustment of the plate voltage at this time will result in the obtaining of optimum operating conditions.

Changing from 1.4- to 6.3-volt tubes shifts the 112-Mc. band slightly on the dial, but in most cases both ends of the band may be reached without alteration of the parallel lines.

Two small feed-through insulators with jacks for banana plugs were mounted on the end of the cabinet, above the tuning condenser.

A hair-pin coupling loop may be plugged into these jacks, thus providing an input for a 2-wire spaced transmission line from a high antenna, when used as a home receiver or transmitter. This coupling loop should be removed when using the rod antenna coupled to the oscillator grid.

As for results, the "amended" rig has been very satisfactory in all three methods of operation. No difficulties were encountered, and no reduction in efficiency was noted when operated with the 1.4-volt tubes. When using the 110-volt powerpack at home, for receiving, the audio output is sufficient to permit the use of a speaker, and also a resistance-capacity bridge ("Hetrofil") to reduce the superregenerative hiss on weaker signals.

Acknowledgment should be made here to W6IT for the original suggestion of the idea.

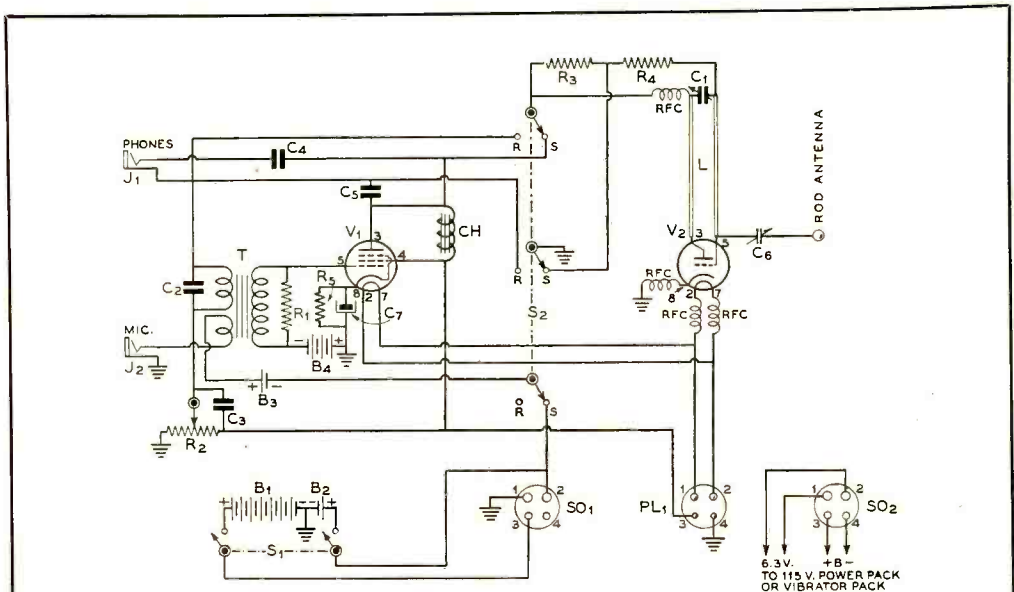

WIRING DIAGRAM OF THE DUAL-SERVICE TRANSCEIVER.

- C₁—100- μ fd. midget variable
- C₂—.001- μ fd. midget mica
- C₃, C₄—0.1- μ fd. 400-volt tubular
- C₅—0.01- μ fd. 400-volt tubular
- C₆—3-30 μ fd. mica trimmer
- C₇—10- μ fd. 25-volt electrolytic

- R₁—100,000 ohms, 1/2 watt
- R₂—100,000-ohm potentiometer
- R₃—1.0 megohm, 1/2 watt
- R₄—25,000 ohms, 1/2 watt
- R₅—350 ohms, 1 watt
- CH—7 to 10 hy., 50 ma. choke
- T—Dual mike and audio transformer

- S₁—D.p.s.t. toggle switch
- S₂—Four-pole double-throw rotary switch
- RFC—U.h.f. type, not over 1 ohm resistance
- V₁—1Q5-GT or 6K6-G
- V₂—1G4-G or 6AF5-G
- B₁, B₂—90-volt and 1.5-volt pack
- B₃—1.5-volt flashlight cell

- B₄—Midget 4.5-volt C battery
- SO₁—Socket for battery operation
- SO₂—Socket for a.c. line or vibrapack operation
- PL₁—Power plug from transceiver
- J₁—Open circuit phone jack
- J₂—Open circuit microphone jack

A Counterweighted ANTENNA TOWER

By J. M. FRASER*

A description of a type of counterweighted antenna tower which is easily lowered and which returns to a vertical position by action of the weighted bottom when antenna adjustments have been completed. A tower of this type is especially convenient as a support for a rotary type array upon which adjustments are frequently made.

After having read numerous articles on the various types of towers for beam antennas, especially those for the rotary type for 10 and 20 meters, the writer finally decided to make the one described. It was in use until the time all Canadian amateurs were put off the air. It has been found to be just about all that is desired for a 10-meter rotary antenna and has stood up in storms and adverse weather of all kinds.

Unlike most other towers, it erects itself when properly balanced and it has to be pulled down! That is the one thing about it which is odd for an amateur antenna tower. No lift-

ing "bees" or cranes for this one, you just keep putting the proper amount of dirt, sand or concrete in the box at the bottom and presto! up she goes. And no guy wires either!

Now for the dimensions. First of all, the sides are made of two-inch plank. Starting at the bottom they are about 12 inches wide with a gradual taper to about 4 inches at the top, the plank having to be cut to the proper width before being spliced together. A piece of 2" x 12" is used for the bottom section. It is left the full 12 inches at the bottom but is tapered to about 10 inches at the top. The second or middle section is made of 2" x 10" and is tapered to nearly 6½ inches at the top, while the top section is made from 2" x 8"

*Box 95, Binscarth, Man., Canada.

and is cut the full length, as the 8 inches at the bottom is too wide. It tapers to about 4 inches at the top. The splices are nailed and clinched, or bolted, whichever is preferred. They are given a good overlap at the joints, each splice being about 8 feet long. The splices are set on the inside to make a neater looking job from the outside.

When both sides are made rigid and finished up like the one shown in the drawing, they are laid out on the ground in their proper positions ready for nailing together. First of all, a small tie-piece is put on the top to hold the small ends together. This is later removed when the bases and top proper are put on. Next, the bottom is nailed together. Inch boards, any handy width, can be used so long as they fit together nicely. Eight-inch ones were used here. Both sides and the bottom are nailed up solid, as this is the box where the weight is placed. Leave the top of this box part open.

Now put on the cross braces as shown in the drawing. Ten of these are used, with two more short ones at the top which go straight across. Of the ten, five are put on each side, being put on in pairs opposite each other to form an X. These braces are made of 1" x 4" and are nailed on. Now before we go any further, a nine-foot long bar or pipe, about two inches in diameter, must be secured for the axle on which the tower mounts. Holes for this axle are then drilled through the two sides of the tower as shown.

Before we can put the tower up we must have the posts on which it stands. These are procured from your local telephone or power company. The used poles they usually have are just about right. They need to be 10" or 12" in diameter and about 12 feet or more long, as they are put in the ground almost as far as they are above it. Don't forget to put the same size holes 6 inches from the top of each pole as those you put in the sides of the tower for the axle. The pipe must go through them, and it is most awkward drilling these holes after the poles are in the ground! The posts are better set in concrete, but if they are well packed with dirt and stones when put in you may get by nicely without the cement.

Now to finish the top. This will depend on the type of antenna you are going to use. There are so many different types of mounting that this point is left to the builder's discretion to fit the type of antenna he desires to put on the tower.

After the top is finished, a rope is made fast near the top as shown in the drawing. We are now ready to mount the tower up on the posts. Get the axle ready and put it through one post. Then, with some help if

needed, lift the bottom of the tower until the holes in the sides come in line with those in the posts. Now drive the bar or axle through both holes in the tower and through the other post. Be careful of the top while doing this so as not to damage it in any way.

Now go back to the top and raise it up ten feet or so and support it on a ladder so it will remain there. Then begin putting the sand, dirt, or concrete in the box compartment at the base of the tower. Keep filling this until you get sufficient weight here to swing the top of the tower upwards. Then add a little more to help stabilize the tower when erect.

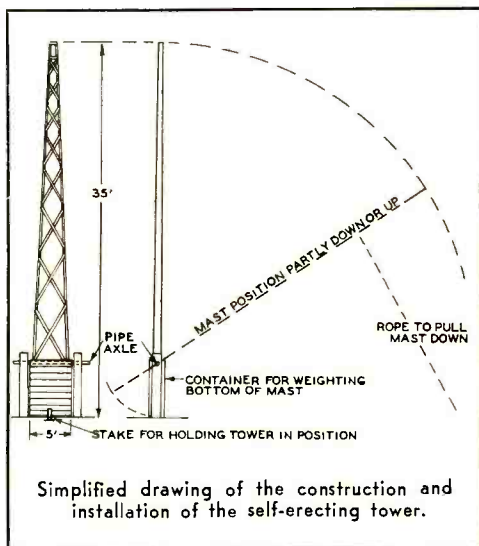

The result of all this should be a tower that can be pulled down at will, and that will go up itself any time. The rope should be attached to something when the tower is pulled down or else it will go up again when the rope is released. A peg in the ground is good for this. A peg is also placed in the ground at the base of the tower on the opposite side from which it turns out when you bring it down. And if you intend to leave it up for any time it is a good idea to peg both sides tight to eliminate any tendency to sway. It is also most advisable to give the wood two or three coats of good paint. A coat of paint not only protects the wood but also adds greatly to the tower's appearance.

The total cost of this tower to the builder amounted to only \$14.00. When you consider the return in satisfaction it seems a very fine investment indeed.

SIMPLIFIED TRANSMITTER CONTROL

By RICHARD WHITEHORN,* W9EMA/3

A one-tube control circuit which accomplishes break-in, push to talk or to key, automatic time delay in warm up, and automatic holdover between characters when on c.w.

It is appreciated by many amateurs that a simple and effective method of transmitter control is one of the greatest aids to enjoyable operation of an amateur station.

The writer has seen c.w. stations where the change from transmitting to receiving involved the operation of three or four switches scattered in various parts of the shack. And he has also seen some of the more elaborate "talk to talk" systems that have been devised. The system described in this article represents an attempt at the design of a simple and effective method of transmitter control.

To get down to brass tacks, there are a number of operations involved in the operation of an effectively controlled transmitter. They are:

1. There must be a master switch—a switch that makes the transmitter, all of it, dead when this switch is operated.

2. Some provision must be made so that high voltage will be applied to the plates of mercury vapor rectifiers only after the fila-

ments have been well heated.

3. The high voltage plate supplies should be dead when the station is not actually transmitting.

4. The switching from transmitting to receiving should be as simple as possible.

5. In the last analysis, the control of the transmitter should lie in the transmitting instrument, the key or microphone.

Now to consider these operations. The first is very easily accomplished with a switch placed in the main 110-volt lead to the transmitter. This should be a heavy, manually operated switch placed in a conspicuous position.

The second and third should be automatic and may very easily be combined.

The third and fourth are really a definition of break-in operation.

Concerning the fifth, with regard to phone operation the writer has found that "push to talk" is the most satisfactory solution. The "talk to talk" method is much too complicated and involved for most amateurs. If a s.p.d.t. switch that has a dead center position, a momentary, and a holding contact is used as the control the operation is nearly perfection.

*307 Overhill Road, Baltimore, Maryland.

Operation

If you will examine figure 1 you will find that the last four operations have been combined in this circuit. When the key or "push to talk" control (which has been inserted in the oscillator circuit) is operated, RY₁ will be actuated short circuiting C, thus removing the bias from the tube and actuating RY₂. This opens the receiver B- lead, killing the receiver, and actuates RY₃ which turns on the high voltage plate supply. The transmitter is then in operation.

When the key is lifted, RY₁ will open and C will charge through R₂ at a rate determined by the position of the tap on R₁. When C is charged to the cut-off bias of the tube RY₂ will change over, turning on the receiver and killing the h.v. plate supply. If the key is pressed again before C is charged to cut-off, the transmitter will remain in operation and the receiver will stay off. With the values given in figure 1 the charging rate of C can be adjusted so that the transmitter will stay on for any keying speeds from 5-6 words per minute up.

Because of the insertion of R₃ in the heater lead to the control tube, the cathode will not reach operating temperature until the rectifier filaments in the transmitter are up to their operating temperature. The plate voltage for the control tube should be obtained from a tap on the bleeder of one of the low voltage power supplies which are turned on by the master switch. The position of this tap will have some effect on the time which will be required for this circuit to go into operation.

S is provided so that the delay can be removed for phone operation.

Here at W9EMA the control system, the low voltage power supplies, and the bias pack are all combined on one chassis. RY₁ is connected in series with the screen of an 807 buffer which is biased to cut-off. No current flows to the 807 unless the key is pressed. This makes the screen actually the keyed circuit. RY₂ is connected in the primary leads of the pole transformer that serves as the plate transformer in the 1100-2200 volt supply for the RK-20-A buffer and the T-125 final.

With this circuit in operation all that is necessary to operate the station is to turn on the main switches to the transmitter and receiver and commence keying. At W9EMA there is an antenna changeover relay with the coil connected across the h.v. primary. If you go on c.w. with S open it sounds like a boiler factory or a reasonable facsimile thereof.

Operation with this setup is a pleasure. You have only to listen and send. Break-in is a delight, and it is possible to jump through the holes in the QRM with the greatest of ease.

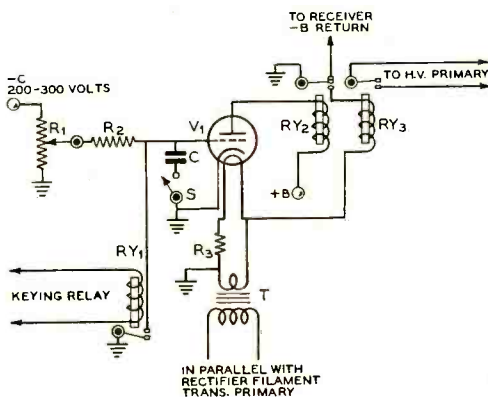

Figure 1. Wiring diagram of the all-purpose transmitter control circuit.

- | | |
|---|--|
| C—0.25- μ fd. 400-volt tubular | T—Filament transformer or spare filament winding of appropriate voltage for V ₁ |
| R ₁ —1.0-megohm potentiometer | V ₁ —Any modern heater triode (6C5, 6J5, 76, 56, etc.) |
| R ₂ —2.0 megohms, 1 watt | RY ₁ —2500-ohm s.p.s.t. relay |
| R ₃ —1.5 to 2 ohms, 10 watts—with a 0.3-ampere heater as in the 6C5, 6J5, etc. | RY ₂ —5000-ohm s.p.d.t. relay |
| S—S.p.s.t. toggle switch | RY ₃ —6.3-volt a.c. s.p.s.t. power relay |

Modern Radio Bows to Ancient Equipment

On September 18th all along the eastern seaboard radio services were subjected to a bombardment of interference due to powerful sunspots and magnetic storms. Experience has shown that such storms have the greatest effect upon high-frequency east-west radio channels. So to maintain international communications RCA engineers resorted to the old long-wave alternators at Rocky Point, L. I. There are similar alternators in London, Sweden, and Germany, which are maintained for use in such emergencies.

Another temporary means utilized in keeping the radio channels to Europe open was to route communications to Buenos Aires, where they were automatically relayed to London, thereby making the transmissions follow a more north-south path, and getting them out of the path of the storm.



Recent photograph of the author making a frequency measurement upon the potgut.

56-Mc. "POTGUT" OSCILLATOR

By LEROY MAY, W5AJG

This equipment was originally intended as a 56-Mc. r.f. amplifier, but neutralization difficulties and parasitics were present in large gobs. Really, if the thing was so vigorous in oscillatory capabilities why not control the infernal gadget and adapt it to a "pot" oscillator affair. This was done, and in its new role, there was produced one of the smoothest and most efficient 56-Mc. oscillators yet encountered.

It all started when the writer located a nice spot high on a windy hill overlooking White Rock Lake. This would be an ideal spot for picnics, etc., and it seemed a good idea to back the 25-watt mobile rig up to the monster and operate in tandem. As above mentioned, difficulties developed and its use as an amplifier was abolished.

Basically, the tank construction is approximately $\frac{3}{8}$ wave in diameter and $\frac{5}{16}$ wave in height. While complete details can not be divulged of the inner structure at this time, it can be said that it is a mechanical variable power pot oscillator, whose capability runs from zero level down to 750 watts negative. In other words, extended negative peak modulation is utilized to its fullest extent and all positive or real components are virtually eliminated.

Physical vibration was very pronounced on early test and it was mandatory to install the

potgut oscillator on a cement base and securely bolt it down, after which the enormous center agitation behaved beautifully.

The picture clearly shows the outside construction and the instrument held by the writer is a miniature pot-type absorption wavemeter. The 56-Mc. half-wave antenna may be seen and is coaxially fed to a matching section from the main pot. This method of antenna feed worked most admirably and quite fulfills the condition "R plus j zero," which in so many cases is difficult to obtain on the ultra-high frequencies.

The round cylindrical projection seen at the lower left of the main tank was used as an input mesh circuit to couple the output of the mobile rig to the inner fins of the potgut for operation as an r.f. amplifier.

Not visible in the picture is a pair of wires taped temporarily to the antenna and running in a horizontal plane. This was a sampling loop which ran to a portable phase monitor and was discarded after final determination of phase angle. In passing, it might be stated the phase lag was something terrific on the initial run, and silly as it may seem, the trouble was corrected after removal of a dead water snake entwined in the co-axial matching stub. Said snake had apparently ambled up from the lake a few wave-lengths away.

[Continued on Page 89]

Series Tank

FREQUENCY - MULTIPLIER CIRCUITS

By ARTHUR L. MUNZIG,* W6BY

Frequency multipliers are universally used in commercial and amateur transmitters to obtain outputs on frequencies higher than the fundamental cut of the crystal. It is more convenient as well as more economical in multi-band transmitters to have all crystals ground for the low frequencies. There is less heating at comparatively high crystal stage plate voltages with a corresponding decrease in frequency drift and an increase in output.

In practice, the frequency multiplier is inefficient on harmonics higher than the second. Hence, the second harmonic multiplier or doubler is in most common use. The usual practice is to double the frequency with each stage. While greater multiplications than this can be obtained, the output falls off rapidly when higher multiplications are attempted.

While it is possible to obtain efficiencies from a doubler stage comparable to that of straight-through amplifiers, the grid bias must be at least five times cut-off and the d.c. grid current should be the normal rated value for the tube in use, *providing that this value can be obtained from the preceding stage*. However, this requires a tremendous amount of driving power which is not normally practical. It is the purpose of this article to present a group of circuits in which frequency multiplications are accomplished with plate circuit efficiencies that compare with straight-through amplification.

In figure 1 is shown an oscillator-doubler circuit with two triodes that is commonly used in amateur practice. Efficiencies of from 40 to 50 per cent are rarely possible except in well designed stages using low-loss components. The essential components of the circuit are a plate inductance L_1 resonating at the crystal frequency and coupled capacitively to the grid of the doubler tube, and a second inductance L_2 in the doubler plate circuit resonating at twice

the crystal frequency. The grid input and plate output circuits of the doubler tube being at widely different frequencies, no neutralization is necessary.

Adding another doubler tube to the circuit would be essentially the same as that in figure 1, whether capacitive coupling or a grid coil were used.

Referring to figure 2, it will be seen that another inductance L_2 has been connected in series with the plate inductance L_1 . This inductance is tuned to twice the frequency of L_1 , and the grid coupling condenser C_2 is connected to a matching point on the coil. Now an entirely different condition exists in the doubler grid input circuit; the doubler grid and plate circuits are in resonance. Instead of being a low efficiency doubler circuit, it now resembles a straight class C amplifier. Of course the value of the bias resistor R_2 will have to be changed for correct class C operation and the stage neutralized.

The optimum point at which the coupling condenser C_2 taps on the inductance L_2 will de-

*4870 Hart Drive, San Diego, Calif.

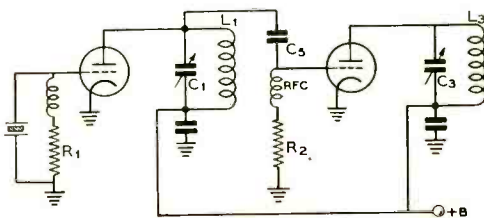

Figure 1. Conventional crystal oscillator and frequency doubler, using two triodes.

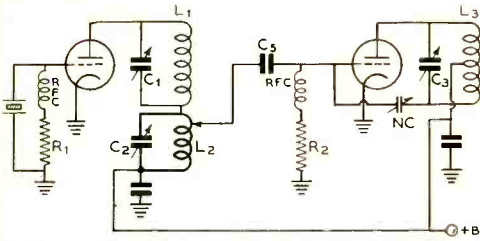

Figure 2. Series tank coil doubler circuit, with following r.f. amplifier stage. L_1 and L_2 are the seriesed coils—see text for discussion.

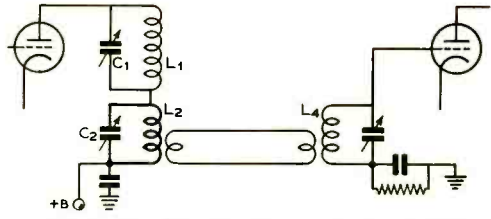

Figure 3. Showing the method of link coupling a grid coil to the series-tank system of Figure 2. Unity coupling could also be used.

pend on several factors: the type of tube used, the input impedance and capacitance, the value of the coupling condenser, etc. So many factors are involved in determining the point at which the tap should be made, that this point is best found by trial and error. It is commonly known that the impedance between two tapped points on a coil will be to the total impedance as the square of the turns between the tapped points. In other words, if the coil is tapped in the center the impedance to the tap point will be $(\frac{1}{2})^2$ or one-fourth the total parallel impedance of the circuit. It has been found in practice, however, that the point at which the tap is made is not critical in most cases.

Providing suitable L/C ratios are used, the tanks resonating on bands other than that in use will offer negligible impedance at the operating frequency. In effect, then, only the desired tank is in the circuit. The one precaution to be observed is that the L/C ratio should not be too high. In other words, if each tank consists of mostly coil and little condenser, the impedance on other bands may be great enough to affect the operation of the circuit.

In figure 3 is shown a method of link coupling a load circuit to the series tanks of figure 2. An additional coil L_4 and tuning condenser are necessary for the following grid circuit but

[Continued on Page 80]

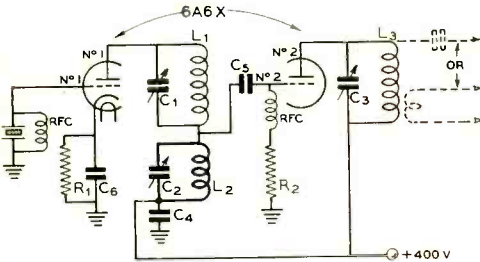

Figure 4. Either 6A6, 6N7-G, RK-34, or 53 can be used in this circuit. See text.

- C_1 —100- μ fd. mid-g et variable
- C_2, C_3 — 50- μ fd. mid-g et variable
- C_4 —.005- μ fd. mica
- C_5 —.00015- μ fd. mica
- C_6 —.001- μ fd. tubular
- R_1 —400 ohms, 10 watts
- R_2 —50,000 ohms, 2 watts
- RFC — 2½-mh. r.f. chokes
- L_1, L_2 — Wound on same form, see text and coil table
- L_3 —See coil table

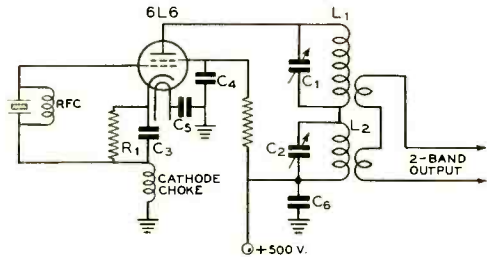
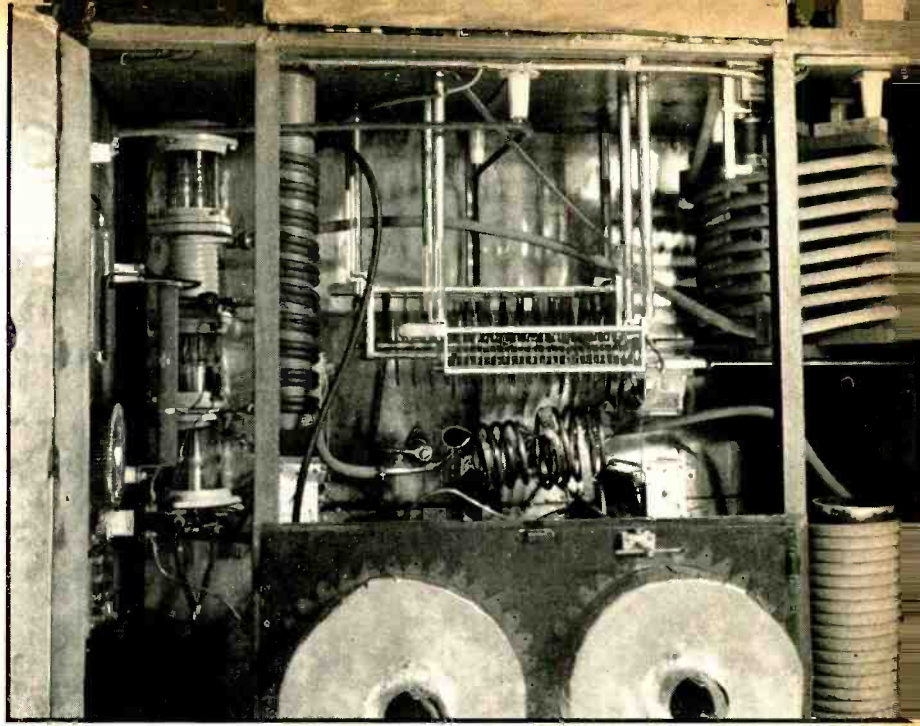

Figure 5. Using the 6L6-G as an oscillator-doubler-quadrupler. If the cathode choke is shorted out and L_1 - C_1 resonates at the crystal frequency, output is obtained on the fundamental and second harmonic frequencies.

- C_1 —100- μ fd. mid-g et variable
- C_2 —50- μ fd. mid-g et variable
- C_3 —.00004- μ fd. mica
- C_4, C_5 —.001- μ fd. tubular
- C_6 —0.002- μ fd. mica
- R_1 —500 ohms, 10 watts
- R_2 —20,000 ohms, 10 watts
- L_1, L_2 — Series tank coils. See text and coil table
- Cathode choke—See coil table



- Looking into the 5-kilowatt water-cooled oscillator (about 7 Mc.) used as a power source to the accelerator electrodes of the Stanford University cyclotron.

DEPARTMENTS

- **U. H. F.**
- **The Amateur Newcomer**
- **Yarn of the Month**
- **With the Experimenter**
- **What's New in Radio**
- **Postscripts and Announcements**
- **New Books and Catalogues**

The Amateur Newcomer

SIMPLICITY IN THE SPEECH AMPLIFIER

By RAY L. DAWLEY,* W6DHG

When the newcomer undertakes the construction of his first speech amplifier he is often overwhelmed by the diversity of opinion as to just what is required in the speech system. He has probably read an article which recommended three transformer-coupled stages with fixed bias on the output grids and having 16.03 db of feedback from the output back to the driver stage. Then another article says that excellent quality may be obtained by operating an F-set into a pair of 6L6 grids.

These different opinions, plus the suggestions of "experienced" friends, are more than likely to leave the newcomer more in a fog than before he sought outside opinion. So it was decided to write this article with the above problem in mind. The speech system

illustrated and diagrammed and described herein is designed to serve as the solution to the problem for the average beginning phone amateur.

Microphone

In the first place, any phone station must naturally have a microphone. Past experience has indicated that by far the most satisfactory type of microphone for all ordinary amateur installations is the diaphragm-type crystal. These microphones are comparatively rugged, require no complicated speech input system, and have high enough output voltage that an excessive amount of gain in the speech amplifier is not required. The only disadvantages of the crystal type are that they cannot withstand either extremely hot or extremely moist climates. Hence, the crystal

*Editor, RADIO

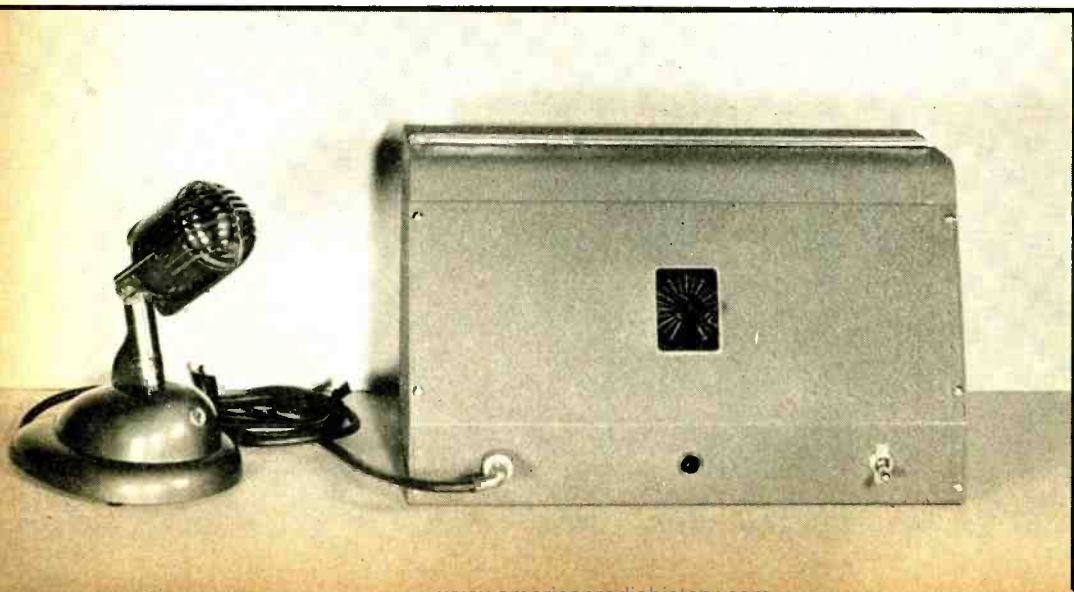

Rear view of the chassis of the speech amplifier. The squeezing of the components in front caused by the sloping panel can clearly be seen. The four-prong male socket is for the cable plug to the transmitter.

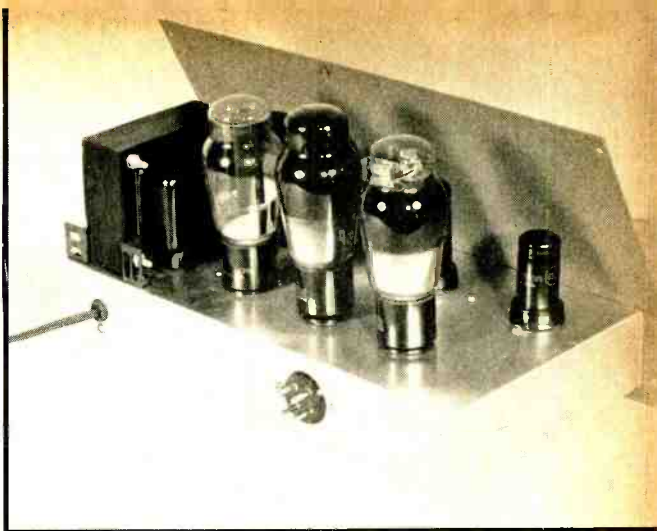

type should never be used for an automobile installation where the car might stand out in the sun with the microphone inside.

There are two types of microphones which can withstand the climatic conditions which make the crystal unusable. These are the carbon and the dynamic types. Both these types require an input transformer between the microphone itself and the grid of the first tube. But the majority of amateurs in this country will have no trouble at all with the crystal type, provided they take the most elementary precautions. So the speech amplifier to be described was built for crystal microphone input.

Design of the Amplifier

The majority of amateurs building speech amplifier at the present time, or for that matter redesigning their present amplifiers, will be using either class B plate modulation or class C grid modulation. In either case a speech amplifier with push-pull triodes in the output and having 6 to 10 watts of output power will be a satisfactory solution to the problem. So it seems that our speech system should start out with a high-output diaphragm-type crystal microphone, and end up in a pair of push-pull triodes with 6 to 10 watts output.

The speech amplifier shown was designed to fulfill these requirements with a minimum of components and with a minimum of expense. It consists merely of a high-gain pentode input stage, a self-balancing phase inverter, a push-pull triode output stage, and a simple power supply.

There are absolutely no complications to the design, as may quickly be seen by inspection of the circuit diagram. The volume control was placed in the grid of the 6N7 rather than in the grid of the first tube for two reasons: First, when the control is in the position shown it allows R_1 to be con-

nected in series from the microphone lead to the input grid, thus allowing this resistor to act as an effective r.f. filter. Second, there is less chance of noise arising from the volume control if it is placed in a comparatively low-gain position.

It will be noticed that the output transformer for the 6A3's has not been placed on the speech amplifier chassis. Rather, the plates of the tubes and the plate voltage lead have been brought out to a cable connector for use with an external transformer. Experience has shown that there is less chance for parasitic oscillations and spurious r.f. pickup in the grids of a class B modulator when the driver transformer is located immediately adjacent to the grids of the tubes. The same is true, though to a more limited extent, in regard to the modulation transformer for grid modulation.

Layout

The amplifier is housed in a small inexpensive sloping-front cabinet which has a neat chrome trim strip across the top. The panel has been laid out with a minimum of controls. On the left is the shorting-type microphone plug, in the center is the red pilot light which is wired in parallel with the filaments of the tubes to indicate when the amplifier is operating, and on the right is the amplifier on-off switch. The volume control is placed in the center of the sloping front of the cabinet.

Construction of the Unit

To the beginner in metal-chassis construction, the construction of a unit of this type entails several new mechanical problems. The solution of these problems can be considerably simplified if the constructor will follow the detailed constructional instructions given in the following paragraphs.

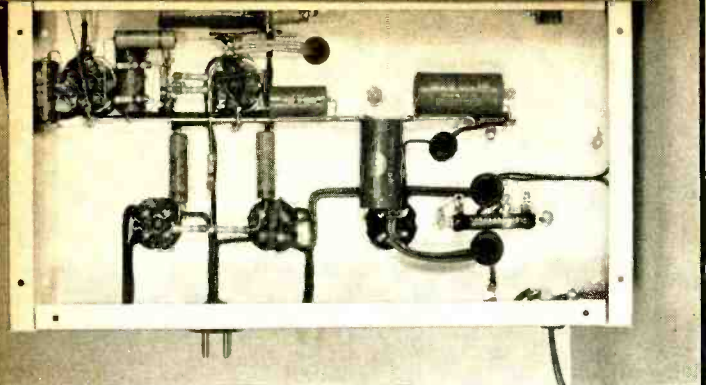

Under the chassis. The use of a common ground bus, even in a speech amplifier, makes wiring easier and makes a neater appearing construction job.

In building a unit where it is desired to maintain a neat appearance after the unit is completed, the wrapping paper should be left on the chassis. This is done so that all pencil lines used in the layout will be on the paper and not on the chassis. The first thing to do is to determine where the holes are to be on the panel. Then spot the holes through with a small drill. After that, place the chassis in the box, screw the panel onto

the box, and then move the chassis until it is evenly centered inside the cabinet. Hold the chassis with one hand, and with the other hand and a pencil mark holes through the panel onto the paper of the chassis. Now remove the panel from the cabinet and drill the holes in the chassis.

The mounting bolts should then be placed through the panel and the chassis, slitting

[Continued on Page 72]

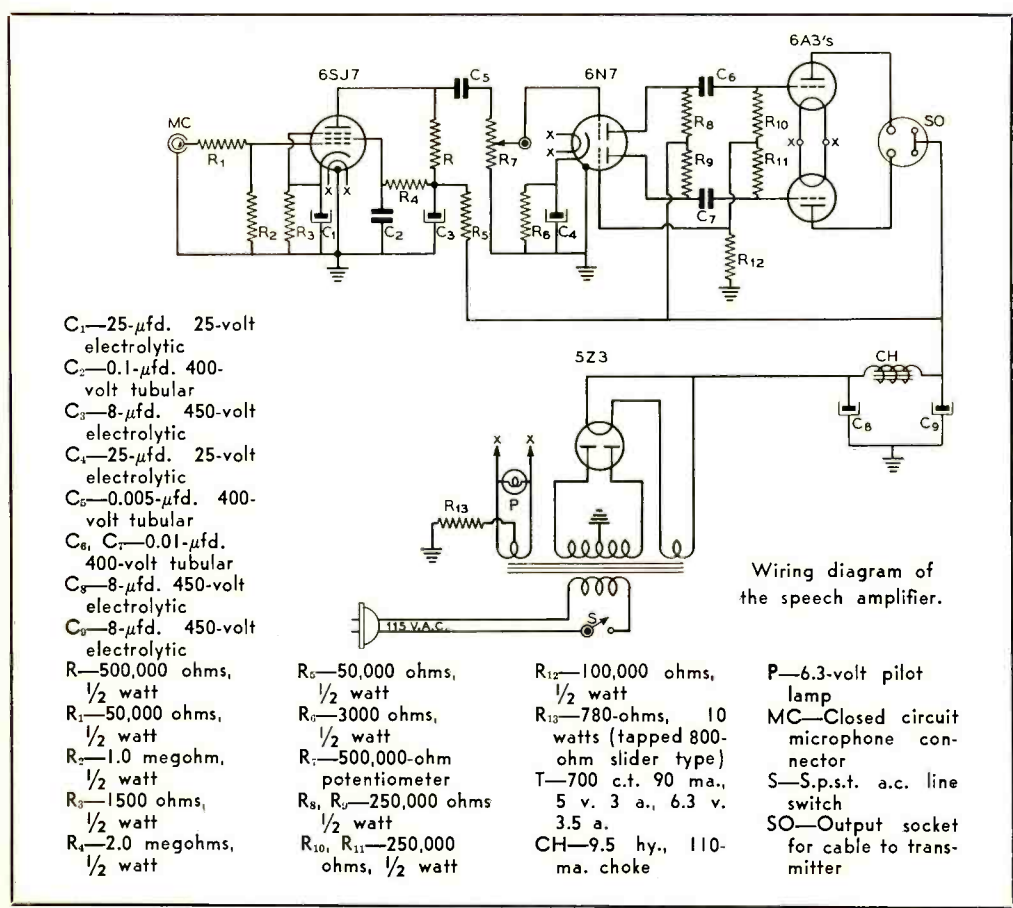



By JOSEPHINE CONKLIN,* W9SLG/3

Can it be true? Can you even imagine it? Jim Brannin, W6OVK, says that many of the fellows who have not yet worked five meters—including several K6's—seem to think that the ground wave dx being worked nearly everywhere in the country is similar to the poor-quality ten meter bounce-back signals that have been encountered in recent years. These bounce-back signals are discussed in detail in the RADIO HANDBOOK as well as in several past issues of RADIO. Usually the signals have a "rain barrel" sound, or what W9QDA calls a "wha wha" fade. They are worked often with all beams pointed southeast in the morning or southwest in the afternoon even to contact stations one or two hundred miles away in the skip zone and in another direction.

Such a condition does not appear to be especially likely to occur on five meters, at least before the next sunspot peak in about 1948. On the other hand, some real low atmosphere bending dx on ten meters should be possible with beams pointed right at each other, just like on five meters and $2\frac{1}{2}$.

So if you fellows find that the winter openings on ten are starting to be more spotty later on (the 28 megacycle band opened for W6-W3 work in mid-September), do not overlook using the ten meter rig for 200-300 mile ground wave contacts, especially on c.w. until the circuit becomes firmly established and good phone signals can be squeezed out of the equipment. Of course, another thing you can do is to put the rig down on 56 megacycles and see how much fun it is to squeeze some dx out of it. If the receiver question bothers you, build a converter using the new 9001-2-3 tubes.

The Big Aurora

On September 19, the chains had trouble in the morning with a magnetic storm which disturbed the overseas news broadcasts. That evening, the east got a beautiful aurora display which was seen as far south as Georgia—and

*300 Wilson Lane, Bethesda, Maryland

one report states that it was seen in Florida. It was unusually good in Finland and other European points, so it was quite widely spread. There has not been time for any reports of five meter aurora-type dx to reach us as this is written. The storm may have been too severe to bring about a five meter opening, although Ninth District 28 megacycle signals were getting into Washington, mostly with the usual modulation and noise background.

Recent Skip Openings

As this issue goes to press, few reports of five meter skip openings are at hand to add to those appearing in RADIO for October. W9PK was able to raise W4FVW on September first and W5AJG EHM on the second. One report appears to have been omitted last month—a July 16 contact between W9AQQ and W7IFL. W6OVK thinks that the band folded up for dx earlier this year than last in Arizona, while ten meters had not yet opened for dx by September 8. W6QLZ says that five meters during May and June were the best ever for him with about twice as many openings as previously, but July was poor. Bill Conklin's earliest records show relatively poor openings in August up to the 16th, and only a few scattered openings, especially in September, after that date in later years. Watch out for the December splurge, however, if there is anything to a recent study made of the seasonal character of the Sporadic-E layer.

A message from K1GNN states that he has not been on five meters for several years and not on any band since April when he moved. No reason not to try it in the dx next summer, OM. It is too bad that the W3OR contact was with a bootlegger, but such is life. K7GNN received letters from the Army, Navy, F.C.C., QST and RADIO. We can account for several of those letters but wonder—and wonder—why the F.C.C. is interested. Somebody around Philadelphia is likely to get his neck chopped off if he tries that stuff again.

Joe Addison, W9PKD, wonders why he does not hear W4 and W5 stations. One reason probably is that he is just outside of one-hop range of the Miami stations and too close to most of the W5's. Another is that W4EDD is talking of moving his family and rig up to Washington to be W4EDD/3 for six months or so. The furnished house right next door on Wilson Lane can be had, provided that a suitable arrangement can be made for use of a kilowatt or so, a beam, and a receiver on the ultra-highs.

Indicators and Ideas

One of the most intriguing subjects to your columnist is that of "band opening indicators." A reasonably good degree of success has been

had by using ten meter short skip to indicate possible five meter openings, just as twenty was used years ago to predict ten meter openings. This method is not always accurate, for several reasons, but it is helpful. Sometimes five meter dx has been raised when both five and ten appeared dead. Now that there are many signals between 30 and 56 megacycles, considerably better indicators are available for those who can tune them in.

Here in Washington, an Empire State Building transmitter just under 56 megacycles is used as a perfect indicator of low atmosphere bending conditions to New York City. W4FKN and W6QAP have both pointed out that some of the f.m. transmitters are more accurate indicators of five meter openings than are 28 megacycle amateurs—something which is in line with the reasoning because the frequency is closer to 56 megacycles.

A question has been raised by W6OVK about the effect of difference in altitude on skip dx. It would appear that the altitude of the station would not of itself be particularly important although the ground conditions at the point of ground reflection of the signals can be very important. If a signal arrives at an antenna from a direction ten degrees above the horizontal, then another wave will arrive at the antenna from an angle below the horizon that, in the case of level ground, will be ten degrees also. It is easy to see about where a signal will have its ground reflection if you sit on the top of the mast and consider various directions and arrival angles. If the level ground that reflects the signal is lower or higher, then the angle is still the same but the point of reflection is farther or nearer. If the land is tilted or irregular, the situation is much more complex. A hill-top location like W1HDQ or W8CIR may involve a reflection on slanting ground that is particularly favorable to very low angle transmission or reception, giving these stations a great advantage in working extreme one-hop dx. This advantage need not be associated with height alone, but rather with the ground conditions at some distance from the station.

A rapid fluttering fade on one-hop signals has almost always been noticed by W6QLZ and W6OVK when two-hop east coast signals come through. This is expected on the lower frequencies where signals may arrive over several paths involving a different number of hops between the ionosphere and ground. The arriving signals interfere with each other to cause fading. If the sporadic-E layer is a continuous sheet rather than spotty, more intense ionization may permit both one-hop and two-hop reception from stations within 1250 miles or so, with possible severe flutter or fade. The flutter

could be caused by irregularities or motion in the layer at the point of reflection of a one-hop signal, but it might always be considered as an indicator of possible intense ionization that may spread enough to bring in two-hop signals.

Another thing that Jim out at W6OVK brings up is the connection between clouds and skip dx. He has tabulated skip and clouds, indicating that best dx during this past summer, especially on two hops, often was heard on days when high cloud formations are seen. He calls them cirrus, not of the flaky or mackerel type but of the feather edge or horse tail variety—known to many as cirro-stratus clouds. These clouds seem to appear a day early and last through the opening.

There may be something to this cloud thing, but several generalities can be kept in mind. Aside from the daily correlation that Jim has made, the season for skip and for certain types of weather may be the same. A few years ago in some parts of the country, it looked just as good that thunderstorms accompany openings. The openings are due to a layer that may be 300 to 600 miles away for one-hop signals and again as far as 1800 miles for two hops, so any connection between skip and weather is likely to be the operation of one cause on two separate things rather than a direct cause and effect relationship. The Sporadic-E layer is some 65 miles up, whereas the clouds are below 10 miles.

Such a discussion is likely to be like the one last month on the front steps between W1DEI W3RL W9ZJB W9BNX about such things as whether the Sporadic-E layer is flat or like a lot of balls of cotton. To the uninitiated, the talk would have sounded like the medieval argument about how many angels could stand on the point of a pin—if they could.

Ground Wave Work

Five meter work on ground wave or low atmosphere bending has been good during the past summer. Vince Dawson, W9ZJB/W3JSL, stopped in at W8CIR to work W8JLQ (horizontal) near Toledo and W3HWN in Harrisburg (vertical). His opinion is that many five meter stations have been doing work of this sort so often that they make no attempt to report it. Such appears to be the case. Bill Conklin found CIR's log full of dx of this kind.

Around Washington, W3FJ/3 IIS GGR/3 GIO CGV have been heard by W1HDQ, and W3HXI has worked him a number of times using only 6L6's.

In Detroit, W8KQC mentioned making contacts with W8CIR when only W8QDU in town could hear Ed, mainly using the crystal filter

to assure a good signal-to-noise ratio. W8QDU and CVQ in Michigan are reported to be using horizontal antennas of the rotary beam variety.

W9QCY in Fort Wayne has used both a horizontal beam and a vertical doubler with good results. W3HWN and W2BYM have been running comparative tests between verticals and horizontals. W3HWN has a four-element horizontal 30 feet high and a vertical extended double zepp 70 feet high. It is reported that the low horizontal beams have been 3 or 4 R's better.

W9PK near Chicago got his 25th state in a low atmosphere bending contact with W9RBK



Full length view of the 86-foot light-weight mast in use at W9QCY to support his three-element quarter wave spaced rotary.

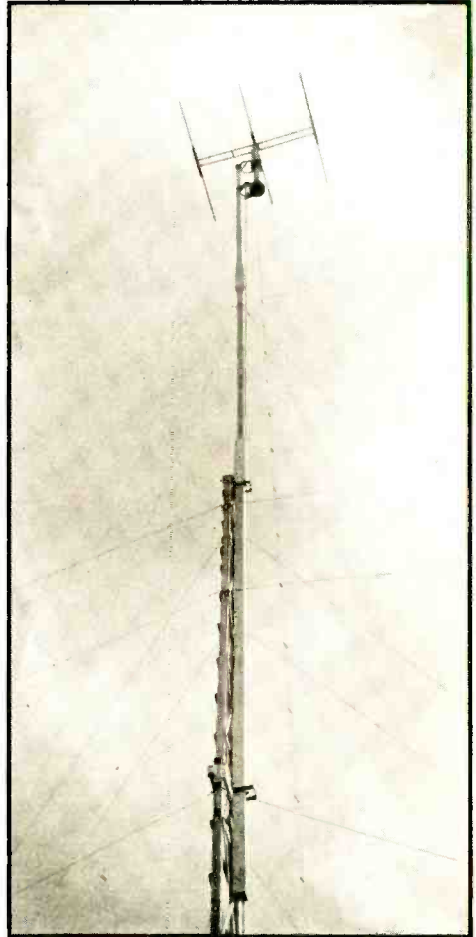

A closer view of the quarter wave spaced rotary atop W9QCY's 86-foot mast. The array is fed with an open-wire line and Q bars.

in Newport, Kentucky, said to be more than 300 miles. This is really stepping out, with nobody on a mountain. WSBPQ in Cincinnati was also hearing PK during the contact. PK says that the August relay was good from W9YDC in Omaha to W8CIR in Pennsylvania. It appears that the mountains were too much for W8CIR and W3HWN to bridge this time.

A report of a contact between W9YKX in Woodbine and W9IFB at Iowa City, 235 miles away, during the summer was omitted from the last issue of RADIO. IFB should make a nice additional contact for the Iowa-Illinois gang.

The active Chicago area five meter stations now include W9FBX VZP EGQ (Gary) IWX

AEH EWE KFK IQ OMX RRX LLM and more stations farther out, such as W9CLH PK PQH.

There is five meter interest in Richmond and Norfolk, Virginia, which might develop suffi-

ciently to make a relay possible from Maine to North Carolina.

Antennas and Polarization

Ed Doherr, W8CIR, is still happy with his solution to the horizontal-vertical question. He uses both types at the same time, and works stations using either polarization. In fact, a test with W8QXV near Akron, 75 miles away, indicated a 2R gain when they both used two antennas.

This column has long wondered about tilting an antenna sideways 45 degrees so that it will be satisfactory for both kinds of work. CIR's stunt probably has the same result. The only risk is that the other fellow may use one antenna tilted the other way or two so connected that there is no signal, in which case everyone would be right back to where they started. But in the meantime, a few stations with tilted or double antennas may enjoy contacts with everyone, even at the theoretical expense of 3 db due to the useless signal in the "wrong" antenna, or its equivalent in the tilted antenna.

It does not take W9QCY long to put a mast up to a great height. His new job looks something like ladder construction half way up its 86 feet, with a well-guyed mast above. The antenna at the top is a three-element quarter wave spaced rotary horizontal array fed with Q bars. Glenn, how about complete construction and erection details on that mast?

W9YKX tuned his twelve-element array by adjusting three elements (antenna, reflector, director) and then using the same lengths for the remaining elements. The effect of one set of elements on another, however, may cause detuning; and the greater capacity of the lower elements to ground may make it desirable for the lower ones to be shorter.

W3HQP in Falls Church, Virginia, ran across an account in *Nature* for October 7, 1939, about some English tests of horizontal and vertical polarization on 3 meters in which vertical antennas appeared better for working short distances when hills intervene. The item is quoted below:

"When ultra-short waves are propagated over hills with long ridge formation . . . we have always noted that the shadow behind the ridges is always appreciably deeper for horizontally polarized than for vertically polarized waves . . .

"For a fixed transmitter position situated on a plateau about 600 feet from the edge of a slope some 400 feet in overall height, measurements of the vertical and horizontal electric fields were made at a series of positions on the slope, the transmitting aerial being

56 Mc. DX HONOR ROLL

Call	D	S	Call	D	S
W5AJG	9	38	W4FKN	7	16
W5HTZ	9	29	W4FLH	7	18
W8CIR	9	35	W5CSU	7	
W8RKE	9		W5EHM	7	
W9AHZ	9	16	W6OVK	7	23
W9AKF	9		W8CVQ	7	
W9AQQ	9	25	W8OKC	7	12
W9CLH	9	23	W8PK	7	9
W9GHW	9		W8RUE	7	18
W9GJS	9	22	W9BJV	7	15
W9NYV	9		W9GGH	7	
W9PK	9	25	W9IZO	7	14
W9QCY	9	25	W9PKD	7	13
W9USH	9	18	W9SQE	7	22
W9USI	9	24	W9WWH	7	26
W9WAL	9		W9ZUL	7	18
W9YKX	9	22	WILL	6	24
W9ZHB	9	43	WICLH	6	13
W9ZJB	9	31	WIJFF	6	11
W9ZQC	9	26	WIKHL	6	11
WIDEI	8	20	WIJJR	6	17
WIEYM	8	20	W2KLZ	6	
WIHDQ	8	31	W2LAH	6	
WISI	8		W5VV	6	18
W2BYM	8	27	W8LKD	6	11
W2GHV	8	24	W8NKJ	6	16
W3AIR	8	24	W8OJF	6	
W3BZJ	8	27	W8PKJ	6	12
W3RL	8	29	W9NY	6	13
W5AFX	8		W9CJS	6	
W5DXW	8	21	W1GJZ	5	15
W6QLZ	8	23	W1HXE	5	18
W8JLQ	8		W1JMT	5	9
W8QDU	8	25	W1JNX	5	12
W8QQS	8	17	W1JRY	5	
W8VO	8		W1LFI	5	
W9ARN	8	17	W2LAL	5	11
W9CBJ	8		W3CGV	5	10
W9EET	8	15	W3EIS	5	11
W9VHG	8		W3GLV	5	
W9VWU	8	16	W3HJT	5	
			W4EQM	5	8
W2AMJ	7	22	W6DNS	5	
W2JCY	7		W6KTJ	5	
W2MO	7	25	W6QAP	5	14
W3YF	7	22	W6SLO	5	19
W3EZM	7	24	W8EGQ	5	10
W3HJO	7		W8NOR	5	16
W3HOH	7	17	W8OPO	5	8
W4DRZ	7	22	W8RVT	5	7
W4EDD	7		W8TGJ	5	9
W4FBH	7	17	W9UOG	5	8

Note: D—Districts; S—States.

oriented according to the type of polarization under observation at the receiver.

"Near the top of the ridge the vertical and horizontal fields were approximately equal, but on moving the receiver down the hill into the shadow, the vertical field increased relative to the horizontal field."

Near the bottom of the slope the vertical field was about 2.5 times stronger than the horizontal field. Incidentally, U.S. publications have reported other tests which were made with signal strength recorders over a period of time. One most interesting one was in the *IRE Proceedings* about January, 1940. Another was W9BOE's more recent paper on the diffraction over a ridge, appearing in the same journal. It is apparent that individual tests should not be taken as too conclusive, inasmuch as fading varies at times, and conditions at the place of the test may not be representative of conditions at other places.

Receivers

According to W6OVK, W6SLO has built a new superhet of the fancy variety using the new 9000 series of button tubes put out by RCA and Ken-Rad. It is arranged for a.m. and f.m., and has plug-in coils for 10, 5 and 2½. What, no pipes? OVK is going to give it a test on W6QLZ's 56- and 112-megacycle signals over the mountains soon.

W8LE in Scottville, Michigan, tried one of W9YKX's five meter converters described last June in RADIO. He writes, "I would like to put in my little word and state that if more of the amateur fraternity would busy themselves and construct one of these converters, they would be greatly surprised at the difference between the conventional and coaxial-tuned job. I have just finished mine and would like to state that it is easily three to four times as sensitive as the ordinary circuit using 956 r.f., 954 mixer, and 955 oscillator."

Dumas goes on to say that he put a condenser from the plate lead to the inner conductor at the hot end of the plate line, which improved tracking. Also, he removed the ground from the center of the antenna hairpin coupling coil which improved the gain in his case. He put small postage-stamp condensers in series with the feeders and across the coil for best results. When the feeders are not perfectly balanced, the ground connection on the hairpin should be omitted; however, if the antenna is working as a beam should, the ground connection will act like a Faraday screen and by-pass to ground the noise pick-up on the feeders. If there are even partial standing waves on the feeders, tuning may improve the coupling very materially.

2 1/2 METER HONOR ROLL

ELEVATED LOCATIONS

Stations	Miles
W2MPY/1-W1JFF	325
W2MPY/1-W1BHL	295
W6KIN/6-W6BJI/6 (airplane)	255
W6QZA-MKS	215
W6BKZ-QZA	209
W6QZA-OIN	201
W6BCX-OIN	201
W3BZJ-W1HDQ (crossband)	200
W6FVK-BIP	190
W6LSC-NNN	190
W6OXQ-NNN	190
W1JYI/6-W6NNN	190
W3HOH-W1HDQ	175
W6NJJ-NJW	175
W1DMV/6-W6HJT (airplane)	165
W9WYX-VTK	160
W6KIN/6-W6OMC/6	140
W6ADM-NJJ	130
W6IOJ-OIN	120
W2LBK-W1HDQ	118
W6BCX-IOJ	100
W6NCP-OIN	98
W1KXK-MNK/1	81
W6IOJ-OIN	80
W6CPY-IOJ	80

HOME LOCATIONS

Stations	Miles
W1MON-W2LAU	203
W1LZB-W2ADW	200
W1LZB-W2NCG	200
W6ECP-W6NNN	190
W6NNN-W6OIN	185
W2BYM-W1LZB	160
W2FJQ-W1LZB	140
W8CVQ-QDU (crossband)	130
W3BZJ-W1MRF	130
W6QLZ-OKV (crossband)	107
W1IJ-W2LAU	105
W3BZJ-W1LAS	105
W2ADW-W2LAU	96
W1LPO-W1KLJ	92
W1HBD-W1XW (1935)	90
W1JFF-W1IJ	85
W1JFF-W2KPB	80
W2LBK-W1IJ	76
W2LBK-W3BZJ	76
W1MWN-W2LAU	75
W1SS-BBM	74
W1KXK-IZY	73
W1MRF-W2LAU	68
W2OEN-W1LAS/2	57
W2GPO-LAU	50

1 1/4 METER HONOR ROLL

ELEVATED LOCATIONS

Stations	Miles
W6IOJ-LFN	135
W1AJJ-COO (crossband)	93

A case of regeneration in a concentric line converter at W9YKX was cured by putting a small condenser between the grid lead that goes through the inner conductor, and the hot end of the inner conductor (similar to W8LE's case above, but referring to the grid bias lead rather than the plate supply lead). The gain went down as the regeneration ceased, and so did the sharp resonance, inasmuch as the tube's input conductance was then placed across the line, but the signal-to-set-noise ratio remained about the same, and weak signals came through as before when the receiver gain was readjusted. In a test with a commercial converter, YKX's line-tuned job was 5R louder and the noise was 2R louder. When the r.f. gain in the receiver was set at the point where set noise was the same, the YKX converter was 3R better, all of it an improvement in signal-to-set-noise ratio.

Miscellany

Our reporters tell us that Ed Grabill, W9ZHB, was the winner at the Hamfester's jamboree, coming off with an HT-6 transmitter. Well, do you think that he will go on 80 or 160 now, instead of ten and five?

W8KQC suggests a rehash article bringing into one place the whole story on signal-to-set-noise ratio in u.h.f. receivers, and another on coaxial lines, Q, and whatnot as applied to ultra-high equipment. Some of this is in the RADIO HANDBOOK, although much more could be said if space permitted.

Several of the gang have asked what Robbie, W4EDD, is doing here in Washington. He is representing Communications Company, W4AEO's (remember his Pierce Oscillator circuit article in RADIO?) outfit in Coral Gables, Florida, and other companies. W5VV is a Captain in the Army Air Corps doing radio work of an administrative type. Dr. Harner Selvidge, W9BOE, is spending part of his time on NDRC radio work. W3AIR is with W3DBC at NDRC. W6DNS is reported to have left Washington, as are a lot of hams who were sent to various foreign countries as Naval attachées to handle the communications at U.S. embassies. W3FPL has moved over to the Radio Branch, Bureau of Ships, to work with W9BNX, W9ZJB/W3JSL, and numerous other officers and civilians in the Navy Department. W2TP is second in command of the Army's message center.

Have you ever gone on a trip wanting to call on a few hams without being able to locate them on arrival? Bill has just about decided to build up a card file containing telephone numbers and addresses, both for home and work, of numerous hams who have written to

us. We may take a trip to New England some weekend in a month or two, which may bring the card file idea to a head.

Above 112 Megacycles

This has been a good year for low atmosphere bending on 112 megacycles too, with many new records set up. Very few details of the August work have reached us as we go to press, however. Vin Ulrich of Hytron wired us about the use of an HY75 and MRT-3 Abbott transceiver in the distant contacts between W2MPY/1 on Mt. Katahdin, Maine, with W1JFF in Rhode Island, about 325 miles according to the report, and with W1BHL in Massachusetts, said to be 295 miles away, in the latter part of August. Also, there was some fine work between W1LZB in Boston and two New Jersey stations, W2BYM and W2FJQ, both over 200 miles. Several stations on 2½ around Philadelphia heard W1HDQ, and W3HOH worked him.

W6NNN of Santa Barbara worked W6OIN at his home location in San Diego on July 19, 20, and September 5. This is 185 miles. NNN has also worked W6LSC OXQ JYI/6 on Mt. Soledad near San Diego, and W6ECP who is about 160 miles away in Oceanside. He was using 20 watts into an HY75 modulated with a 6L6; the receiver used an HY615, 6C5, and 6F6. The antenna is a vertical W8JK which was only 20 feet high at the time but it has been raised to 50 feet.

W6OVK QLZ continue their 56-112 cross-band work. Weaker signals have been blamed on QLZ's beam by one and on hot weather by the other. However, the consistent work at 107 miles over a mountain range goes on.

General Activity

W6CLV says that W6RBQ is a new San Francisco 112-megacycle station. W6QUY has been using a push-pull rig in Salinas. W6LUM in Salinas worked W6NAL forty miles away in Carmel with a transceiver and single wire off-center fed rod. W6FTA in Fresno was reported to be about ready for the band.

In Baltimore, W3HDZ worked W3CGF 18 miles away using 30 watts into an RK34 at each end. The QSO was heard by W3IFW JPX BTQ 25 miles away. HDZ says that this is not much, but the boys will probably be trying for W1HDQ next. Anyhow, W3BZJ and some others should be good pickings, too.

Some u.h.f. rigs are placed along the Pennsylvania Turnpike for communication between garages and the like. Bill stopped at one to

[Continued on Page 87]

YARN *of the* MONTH

ENCOUNTER AT SEA

His Majesty's cutter, the *Pinafore*, looked unusually businesslike that morning as its small, sleek hull knifed its way through the blue waters north of Timor. There was deadliness in its every trim line, from the wireless antenna to the slender cannon fore and aft.

Radioman McCaskill, a raw recruit from Queensland, moved up beside Captain Durham at the rail. There was a strange excitement tingling within him at the newness of his first chase.

Captain Durham studied the distant schooner carefully through his binoculars. She was carrying full sail, and glittered dazzling white against the blue sky and bluer waters.

"What do you make of her, sir?" asked McCaskill with a burst of enthusiastic curiosity.

Durham shook his head slightly and dropped the glasses to his chest. "She looks like a quite ordinary trading ship," he said, "except for that bright new paint job. I don't see any sort of wireless rigging, however."

McCaskill reminded him hopefully: "This is the area our radio bearings fixed that tipster ship, sir. Don't you think she could be a disguised trader that tips off the pocket ships on our cargo vessels?"

Durham rubbed his grizzled chin. "You might be right, son. It never occurred to me that it might be an ordinary island shuttler." He raised up the glasses once more. "She's a pretty vessel, duralumin mast and shipshape rigging. Traders aren't usually that fancy."

He turned toward beaming young McCaskill. "We'll take a look at her," he said, then hesitated a moment. "Better keep glued to the receiver, son, just in case."

McCaskill saluted briskly and went into the wireless room, full of suspense.

He stopped thoughtfully for a moment and contemplated the neat high-frequency transmit-

ter and the equally neat long-wave job. Then his attention turned to the regenerative receiver. It was a beautiful thing, something he would like to have at his ham shack back in Queensland. He fingered its dials caressingly for an instant, then disconnected the battery leads and stowed the receiver carefully into a gear locker.

A moment's search unearthed an old three-circuit tuner with a carborundum detector and two-step amplifier, which he placed gingerly on the operating shelf. After a few moments making various connections and adjusting the dry-cell current through the crystal, the telephones hissed consolingly.

McCaskill sat down with a grin and began tuning each of the switching ranges, listening intently. Naturally enough, there were only a few signals to be heard on the shorter wavelengths—none on the longer waves. After a moment of slight indecision he concentrated on the thirty to two hundred meter range, trying meanwhile to fight off the clamoring desire to go along with the boarding party.

After a while of hearing nothing among the crisp rustle of static he noticed the sudden cessation of the engines' throb and knew that they were alongside their quarry.

The schooner had heaved to the wind, its crew glaring sullenly at the *Pinafore*. Captain Durham picked three seamen at random and ordered a boat lowered.

A huge man in white cotton stood erect on the schooner's starboard deck and watched the proceedings with a twisted smile. Captain Durham yelled at him across the intervening gap of water. "Get ready to take us aboard!" he called. "Prepare for searching party!"

The man in cotton did not move. Captain Durham gave out orders to the gunners and

[Continued on Page 88]

By THE OLD TIMER

RADIO CROSSWORD PUZZLE

Just for the novelty of it, RADIO this month presents a crossword puzzle with the majority of the key words taken from the radio field. If you like them, fine—maybe we can even make one a frequent feature; if you don't they don't take up very much space. This one was sent in by Arthur Mattes, W3JD. We'll publish the correctly filled-in puzzle next month.

ACROSS

- 1. Symbol for plate material of 852 tube.
- 5. Class of amplifier operated over linear portion of curve.
- 6. Draw from (voltage divider).
- 9. Frequency modulation (abbr.).
- 11. Tube to stabilize voltage (abbr.).
- 13. Type condenser used in band-spread tuning.

- 17. Common plated finish for radio components.
- 21. Symbol for tellurium.
- 22. The reflector in a beam antenna is placed to the ... of the radiator.
- 24. International distress call.
- 25. This must be done when hearing 24 across.
- 26. Action of an antenna.
- 30. Direct transmission (abbr.).
- 31. High-powered U. S. Naval Station.
- 33. Early type of c.w. transmitter.
- 35. Ship's noon position.
- 36. Variable resistor (abbr.).
- 37. Intermittent transmission (abbr.).
- 38. Flow of r.f. energy from a transmitter.
- 39. Convert d.c. into r.f. or a.c.
- 43. Thousand cycles (pl.).
- 44. Wife of 67 down.
- 45. Divide by (algebra).
- 46. Signal reporting system.
- 47. Filter noise (abbr.).
- 48. Component of beam antenna.

1	2		3		4		5		6	7	8		9	10		11	12
	13	14			15		16		17			18			19		
20		21				22	23				24						
25	26			27		28				29		30				31	32
	33		34		35		36									37	
	38								39			40		41	42		
	43				44						45						
46				47			48	49		50						51	
						52		53				54	55	56			57
	58		59		60		61			62		63					
64			65						66								67
	68	69			70	71						72			73	74	
	75		76	77							78			79			
	80						81	82			83						
	84						85			86		87			88		
89				90			91			92					93		94
			95		96		97							98			
		99	100				101			102		103				104	
105						106				107						108	

- | | | | |
|--|---|--|--|
| 51. Symbol for rubidium. | 84. Symbol for nickel. | 41. Coil - condenser circuit (abbr.). | sections of transformers. |
| 53. And (ham jargon). | 85. Communication voice (ham jargon). | 42. Atom (abbr.). | 76. Special type of rectifier circuit (abbr.). |
| 54. Unit of energy. | 87. Symbol for plate material of 250TH, 354, and 806. | 46. Rotating mechanism (abbr.). | 77. Inductance unit (abbr.). |
| 57. Variable polarity current (abbr.). | 88. Low-level amplifier. | 47. Deliver power to a load. | 78. C.w. signal quality. |
| 58. Name given originally to this here radio. | 89. Screen-grid modulation (abbr.). | 49. Some amateurs use a . . . tet oscillator. | 79. Arriving at dock or port. |
| 62. Filter for passing a given band of frequencies. | 90. Resonant line (abbr.). | 50. Period of time. | 81. Transformers in stages between first and second detector (abbr.). |
| 64. Local FCC radio representative. | 91. Regeneration coils. | 52. Symbol for cerium. | 82. Usually heard on amateur phone bands. |
| 65. Prefix of message sent in code. | 93. Request. | 55. Revolutions per minute (abbr. pl.). | 86. Excitation keying lag (abbr.). |
| 66. Symbol for selenium. | 95. Filed (abbr.). | 56. Start sending (code). | 89. Necessary equipment at any amateur station. |
| 68. No more traffic (ham jargon). | 97. Unit of a battery. | 58. Coils of a transformer (singular). | 90. Radiation meter. (abbr.). |
| 70. Function of stages following crystal oscillator. | 98. Electrostaticshield between grid and plate of tube (abbr.). | 59. Resistance coupled (abbr.). | 92. Low-loss dielectric (abbr.). |
| 72. Rotten sending (abbr.). | 99. Gauge. | 60. Units of a lead-acid battery. | 94. Legal limit of input to amateur station final amplifier. |
| 73. ARRL communications officer. | 102. Desires. | 61. Element placed between screen grid and plate. | 96. Double. |
| 75. Function of tapped bleeder resistor. | 105. Common name for high frequency (abbr.). | 62. Band-edge frequency (abbr.). | 98. Regret (ham jargon). |
| 78. Negative. | 106. The OM's who manipulate the key at an amateur station. | 63. Nothing doing (ham jargon). | 100. Electrical engineering degree (abbr.). |
| 79. Leaving dock or port. | 107. Class of amplifier with operating angle of 180°. | 66. Noise limiter. | 101. Prefix of message on which sender pays for reply. |
| 80. Type of interstage coupling. | 108. Final stage in a transmitter. | 67. Spouse of no. 44 across. | 103. Symbol for erbium. |
| 83. Turning unit beam of antennas. | | 69. Legal required power to carry on satisfactory contact. | 104. Marine wireless abbr. for 15 to 18 and 45 to 48 minutes after the hour periods. |

DOWN

- | | |
|---|--|
| 2. One of the names hams call each other (ham jargon). | 16. Try (ham jargon). |
| 3. 67°, 30", by the compass. | 17. Electron emitters in vacuum tubes. |
| 4. Symbol for neon. | 18. Varied in accordance with a particular waveform. |
| 6. Amateurs in third call area. | 19. Signal checker. |
| 7. End of message (code). | 20. General call. |
| 8. Polarity which attracts electrons (abbr.). | 23. Human link in radio reception. |
| 9. Sending ability. | 26. X-mitter frames. |
| 10. Amplification factor. | 28. What the tube plate did to the power supply current. |
| 12. Amateur transmitters (ham jargon). | 29. System of communications. |
| 14. Action of a magnet on a piece of iron. | 32. Type of beam antennas. |
| 15. Licensed sending and receiving equipment at a given location. | 34. Condenser ratings (abbr.). |
| | 40. Intermediate frequency noise (abbr.). |

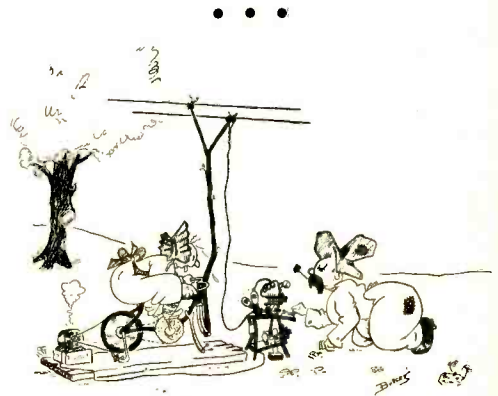

"Step it Maw! Zeke says we're QSB."

With The Experimenter

ANOTHER FINAL

By M. H. LINK,* W6OHU

The writer certainly does not presume the amplifier described to be the ultimate in design. Rather, it was evolved of parts at hand. But it is felt that compactness, symmetry, and shortness of leads have been attained to an unusual degree by this particular arrangement of components.

The tank condenser, a National TMC-100D, for the plate circuit of the tubes is mounted on three 1½-inch pillar insulators. The pies of the r.f. choke are remounted on the middle pillar for compactness, with the top pie connected directly to the frame of the tank condenser.

*3646 Lemon Avenue, Long Beach, Calif.

The r.f. ground return is through a 5000-volt .002- μ fd. mica condenser. The same lug bolt that supports this condenser goes through the chassis to the lug of the grid tank condenser, permitting an extremely short common ground lead. To allow for satisfactory Q in the plate tank circuit on the lower frequencies, provision has been made for plugging a fixed air padder condenser across the main tuning condenser.

The grid coil jack strip is mounted on ¼-inch pillars screwed to a cross bar bolted between the condenser stators. This mounting arrangement allows ½-inch leads to the grids of the two tubes. The grid r.f. choke seen in the photo is not really necessary as the wire-

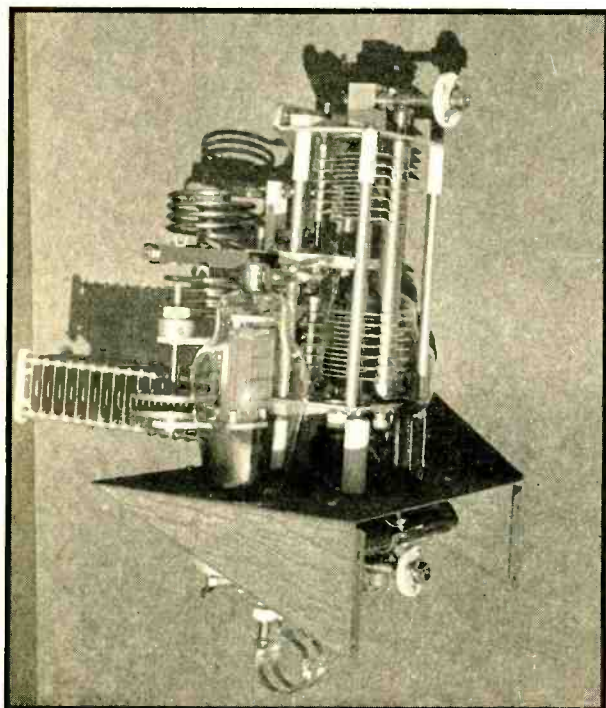

Side three-quarter view of the amplifier. Note that the plate tank condenser is driven through a pair of bevel gears so that the control shaft may be at right angles to the axis of the tuning condenser. The accessory plug-in padder capacitor for low-frequency operation can be seen extending out the back of the stage.



“No it ain’t a rainmaker—Hank has to watercool his antenna since he put in his new GL-810’s”

HANK’S OM merely means that with GL-810’s you put plenty of soup in your antenna. The skywire will fairly sing with your signal.

GL-810’s are used as the final amplifiers in the G-E 250-watt frequency-modulation broadcast transmitter because of their low cost, and high efficiency and stability at high frequencies.

GL-810’s are easy to drive, easy to neutralize, excellent for a-f or r-f service.

Look ’em over at your dealer’s or write for complete dope (just ask for Bulletin GET-755A).

GL-810 TRANSMITTING TRIODE . . . Net \$13.50

Class B Audio—2 tubes

Ample output to plate-modulate a 1-kw rig; driving power, 13 watts.

Class C 'Phone—Plate Modulated*

Input, per pair 900 watts
 Driving power, per pair 17 watts

Class C Telegraph*

Input, per pair—1000 watts, *conservatively* operated; driving power, 24 watts.

*Intermittent Commercial and Amateur Service



FREE!

DATA BOOK ON RECEIVING TUBES

It’s different: 24 pgs., 8½ x 11. Includes tube dimensions, base connection diagrams, and interchangeability chart. It lies flat; the type is easy to read; technical information is in easy-to-get tabular form. Also

- GEA-3315B on G-E Transmitting Tubes
- GEA-2021B on G-E Pyranol Capacitors

General Electric, Section A 161-27.
 Schenectady, N. Y. Please send me free the items checked.

Name _____
 Address _____
 City _____ State _____

GENERAL  ELECTRIC

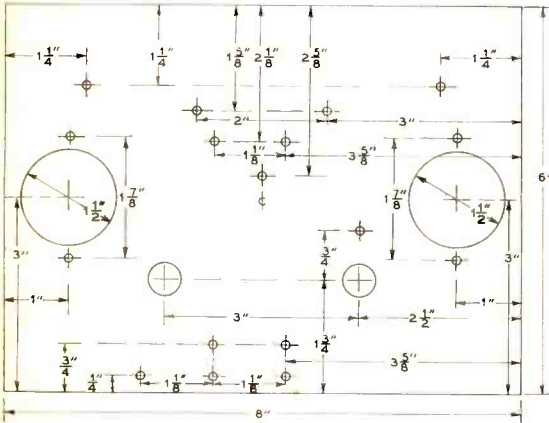

Schematic diagram of the chassis of the unit-type amplifier.

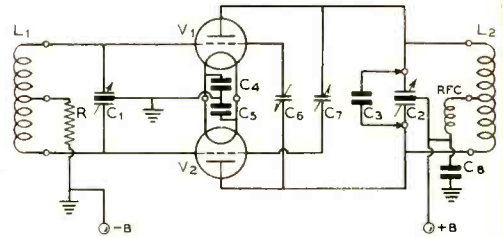

Wiring diagram of the amplifier.

- | | |
|---|--|
| C_1 —100- μ fd. per section .024" spacing | C_7 —.002- μ fd. 500-volt mica |
| C_2 —100- μ fd. per section .077" spacing | R —5000 ohms, 25 watts, slider type |
| C_3 —Fixed air cond. 100- μ fd. .144" spacing | RFC —4.3-mh. 600-ma. r.f. choke |
| C_4, C_5 —.002- μ fd. mica | L_1, L_2 —Plug-in coils for band in use |
| C_6, C_7 —Feed-through plate-type neutralizing condensers | V_1, V_2 —812's, HY-51A's, T-40's, 35T's, or HK-54's |

wound grid resistor is sufficient choking.

The drive arrangement for the plate tank condenser uses a pair of $\frac{1}{2}$ -inch Boston Gear Co. bevel gears. It may be considered easier to use a flexible shaft instead, but gears are more positive and permit closer spacing of the controls. The ceramic coupling *must* be used, as the condenser shaft is hot to d.c. The plates

for mounting the tank jack strip and fixed capacitor would better be made of $\frac{3}{16}$ -inch insulating material than of metal. (Incidentally, the photo is in error in showing the fixed air padder in place with the ten-meter coils in use. But at the time the photo was taken only those coils were immediately available.)

[Continued on Page 92]

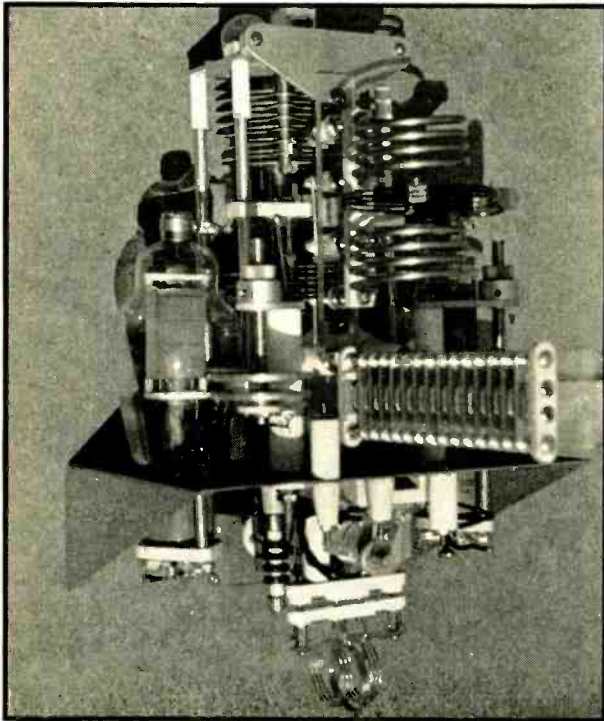

Rear view of the unit-type amplifier. Note the manner of mounting the bracket for supporting the plate tank coil. The plug-in padder condenser is used only on the 80 and 160 bands.

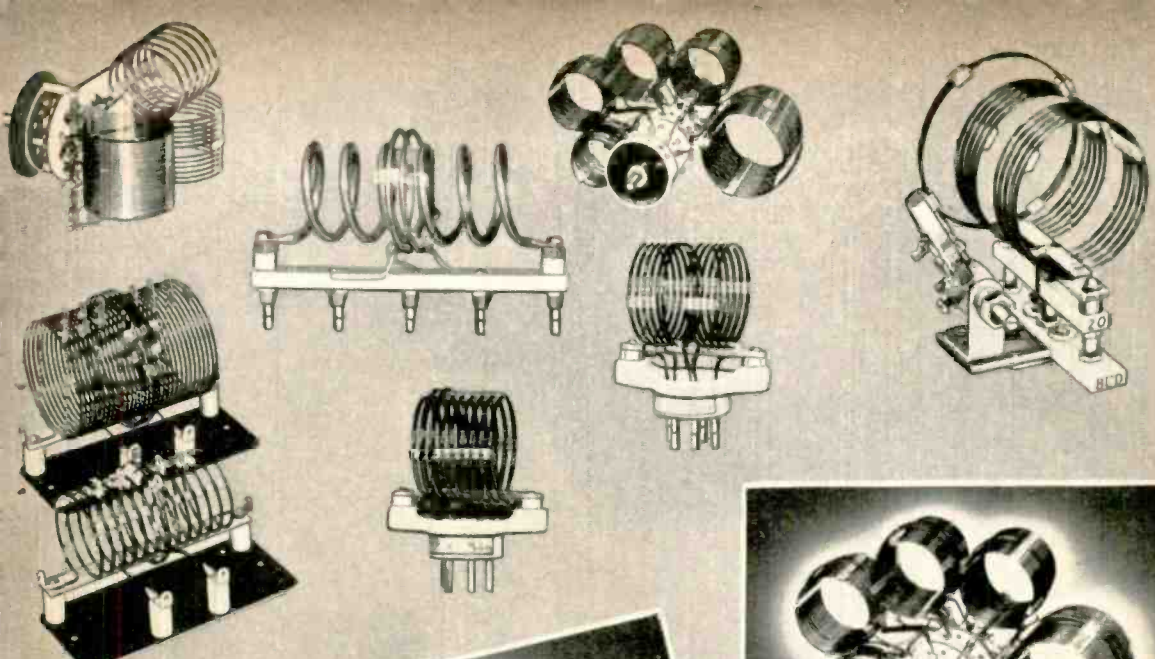

BANDSWITCH ASSEMBLIES

• BUD Bandswitch Assemblies are made in four 50 Watt types and three 100 Watt types. All are designed to give plug-in coil efficiency with front-of-panel band changing convenience.



ADJUSTABLE LINK COILS

• Made in 150, 500, and 1000 Watt ratings. Plug-in coils available for all bands from 10 to 160 Meters.



OSCILLATOR AND BUFFER COILS

• Distinguished by their rugged construction and convenient plug-in base. Conservatively rated at 50 watts.

BUD "AIR-WOUND" COILS

No matter what your inductance requirements may be, you can be sure they will be adequately filled if you make your selections from the complete line of BUD "Air-Wound" Coils.

There are fixed and adjustable link coils in ratings from 50 watts to 1 K.W.; band switch assemblies in 50 and 100 watt capacities; and antenna coils for any type of antenna matching network.

The careful design and rugged construction found in all BUD Coils are contributing factors to their unusual efficiency in operation. Your jobber will be pleased to serve your needs.

What's New

IN RADIO

RCA ALL-WAY SPEAKER BAFFLE

A loudspeaker baffle of entirely new design, projecting sound uniformly over a 360° area through five evenly spaced apertures arranged in a horizontal plane, has been announced by the RCA Manufacturing Co., Inc., for use in paging and announcing in industrial plants.

One of the unique features of this baffle, which operates from a single loudspeaker mechanism, is its construction of non-metallic non-vibratory acoustic material especially developed for this purpose. Its use releases a large quantity of aluminum, originally specified for the unit, for National Defense.

The new baffle distributes sound pressure uniformly throughout a radius of 50 feet, and the directive effect concentrates projected sound over the entire floor area. It is designed for operation with 5-, 10-, 12-, or 15-watt loudspeaker mechanisms, all of which are interchangeable. The dimensions are: 20" high, and 20" deep.

IMPROVED RELAYS

Bulletin 106 relays, manufactured by Ward Leonard Electric Company of Mount Vernon, New York, have been improved in construction details and materials. They are now furnished with molded bakelite bases, providing greater protection against absorption of moisture,

higher insulating qualities, increased mechanical strength, and lighter weight.

All double-pole relays now have rubber insulated lead wires. On double-pole, double-throw relays the contacts carried by the bakelite arm are now secured by a spun over riveting operation that requires no facing and thereby eliminates open end grain contact.

ENLARGED QUARTERS FOR ACA

The Amplifier Co. of America, New York, has recently increased its factory space at 17 West 20th Street. The enlarged facilities for manufacturing transformers, electronic equipment, and amplifiers triples the production space, and greatly expands the company's facilities to take care of increased requirements for ACA products in industry and National Defense.

NEW SOLAR Elim-O-Stat

The latest addition to the line of Elim-O-Stats, manufactured by the Solar Manufacturing Corporation, Bayonne, New Jersey, is the type AFL. It is specifically designed to eliminate radio interference created by fluorescent lighting equipment. It is supplied in a small, narrow metal case for channel mounting.

BOB HENRY OPENS WEST COAST BRANCH

Bob Henry, W9ARA, announces the opening of a West Coast Branch Office of Henry Radio Shop, Butler, Missouri. The new office, located at 2335 Westwood Blvd., West Los Angeles, California, will be under the management of Bob's brother, Ted Henry W9AYG. The same liberal policies which have made the Butler, Missouri, shop so well known among amateurs will be in effect at the Los Angeles branch. Ted can be reached at the address given almost twenty-four hours a day and seven days a week by telephone, telegraph, or letter.

• • •

The first professional oscillographer we have heard of is a woman at the Bell Labs.

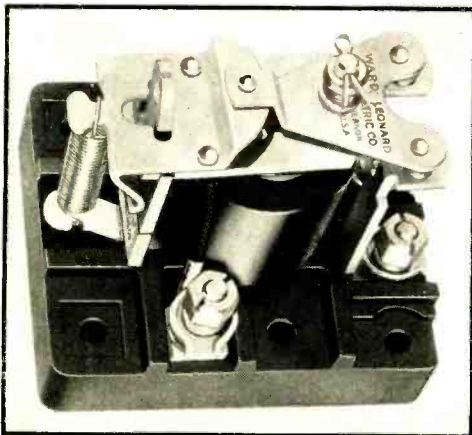

The world's largest stock of Amateur Receivers is at Your Service

Wholesale
Distributors

HENRY RADIO SHOP
Butler, Missouri
211 North Main Phone 395

PURCHASE ORDER
6-26-41
No 2558

Ordered from Hallicrafters
Ship Via rail freight

Quantity	Part No.	Description
40	S19R	
40	S20R	
20	SX-24	less
20	SX-25	
20	SX-28	
10	PM-23	spe
2	R-12	speake
2	R-8	"

Ship to me bill me

CLASS OF SERVICE
This is a full-rate telegram or Cablegram unless otherwise specified. Charges in foreign countries are to be paid by a valid check or postal note or remittance to the address.

WESTERN UNION
CHICAGO ILL JUN 30 1111A

BOB HENRY, HENRY RADIO SHOP
BUTLER, MO

ACKNOWLEDGING YOUR LATEST ORDER ONE HUNDRED FORTY RECEIVERS AND FOURTEEN SPEAKERS. CONGRATULATIONS ON BIG JOB YOU ARE DOING.

W J HALLIGAN PRES THE HAL LICRAFTERS CO.

DAI JUN 30 PM 12 04

The "world's largest stock" means IMMEDIATE DELIVERY of your short-wave receiver. No waiting when you deal personally with Bob Henry. In addition you get a liberal trade-in allowance on your old receiver . . . easy, rock bottom or "charge account" terms . . . and a ten-day free trial! Write me—I will help you get the best receiver and I will cooperate with you to see that you are 100% satisfied. I guarantee you can't buy your equipment for less or on better terms anywhere else.



Bob Henry
W9ARA
BUTLER, MISSOURI
"WORLD'S LARGEST DISTRIBUTOR
OF AMATEUR RECEIVERS"

POSTSCRIPTS...

and Announcements

CRYSTAL GRINDERS NOTE

We are in receipt of an urgent request from a government department for the names and addresses of everyone who has in the past or currently does grind quartz crystals. If you have done this type of work please send the following information by airmail to RADIO, 1300 Kenwood Road, Santa Barbara, California:

NAME, ADDRESS, TYPE OF WORK DONE AND EXPERIENCE IN ALLIED FIELDS, KIND OF EQUIPMENT ON HAND, WORK BEING DONE AT THE PRESENT TIME, WHETHER YOU CAN DO SUPERVISORY WORK, WHETHER YOU CAN DO PART TIME OR FULL TIME WORK.

We will insure that all information you send will be kept in confidence, and that it will be sent to the proper government agency immediately.

Withdrawal of Frequencies From Amateur Service.

ORDER

At a meeting of the Federal Communications Commission held in its offices in Washington, D. C. on the 22nd day of August, 1941;

The Commission having under consideration its Rules governing Amateur Radio Stations and Operators with particular reference to the matter of temporary withdrawal of certain frequencies from the amateur service; and

IT APPEARING that a hearing on the above-entitled matter was held on August 18, 1941, at which time an opportunity was afforded any party affected thereby to protest

the temporary withdrawal of these frequencies and no protest was made at said hearing; and

IT FURTHER APPEARING from the evidence submitted at the hearing in this proceeding that the temporary withdrawal of such frequencies from the Amateur Service for the training of military airplane pilots will serve the public interest, convenience and necessity; therefore,

IT IS ORDERED that Sections 12.111 and 12.115 of Part 12 of the Rules and Regulations of the Commission, insofar as they pertain to the continental limits of the United States, BE, AND THEY ARE HEREBY, SUSPENDED UNTIL FURTHER ORDER OF THE COMMISSION;

IT IS FURTHER ORDERED that the following Temporary Rules Governing Amateur Radio Stations be effective during the period of the suspension of the foregoing sections;

Temporary Rule 12.111

Frequencies for exclusive use of amateur stations.—The following bands of frequencies are allocated exclusively for use by amateur stations subject to change with respect to 3650-3800 kilocycles and 3900-3950 kilocycles upon further order of the Commission:

1750 to	2050 kilocycles
3500 to	3800 kilocycles
3900 to	4000 kilocycles
7000 to	7300 kilocycles
14000 to	14400 kilocycles
28000 to	30000 kilocycles
56000 to	60000 kilocycles
112000 to	116000 kilocycles
224000 to	230000 kilocycles
400000 to	401000 kilocycles

Provided, however, that amateur licensees located in the states of Maine, New Hampshire, Vermont, Massachusetts, Rhode Island, Connecticut, New York, New Jersey, Pennsylvania, Delaware, Maryland, District of Columbia, Ohio, Michigan, Indiana, Illinois, Wisconsin, Minnesota, Iowa, North Dakota, South Dakota, Wyoming, Montana, Idaho, Oregon, and Washington, may use the frequencies in the band 3800-3900 kilocycles for Type A-1 emission during the period between two hours after local sunrise and two hours before local sunset subject to the condition that no interference is caused to government operation on these frequencies. The privilege conferred by this proviso with respect to any amateur or to the amateurs within any area may be terminated at any time without advance notice or hearing should interference develop.

Temporary Rule 12.115

Additional bands for types of emission using amplitude modulation.—The following bands of frequencies are allocated for use by amateur stations using additional types

[Continued on Page 86]

A Ham Who Knows Good Tubes—

Bill Guimont, W9JID, W. A. S.
on 160 Meters in 20 Hours
with TAYLOR TUBES in his Rig.



HISTORY REPEATS—

Once more, Taylor Tubes have played their part in another outstanding achievement. Whether it be a W. A. S. party or just plain every day contact work, discerning amateurs know that the dependability, high efficiency and greater safety factors of Taylor Tubes give their rigs the power and punch needed for good clear signals.

The *plus* features built into every Taylor Tube result in greatly increased *safety factors*, longer life and better all 'round performance. The Taylor margin of extra safety is backed up by Taylor's famous "More Watts Per Dollar" policy.

STILL LEADING IN SALES

And for the new rig, Taylor's T40-TZ40 and 866 Jr. are a hard combination to beat.

"MORE WATTS PER DOLLAR"

Taylor HEAVY CUSTOM BUILT DUTY **Tubes**

TAYLOR TUBES, INC., 2341 WABANSIA AVE., CHICAGO, ILL.

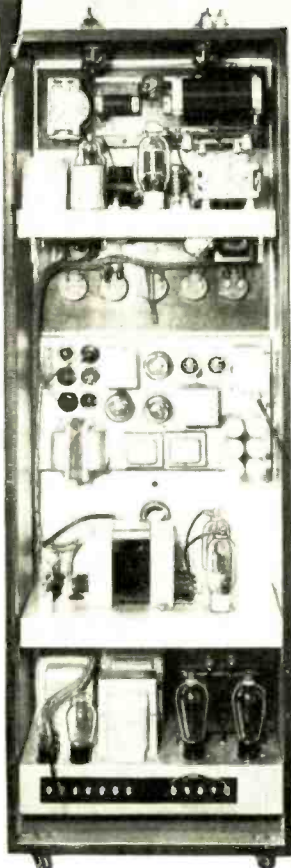

Proud of his record and proud of his rig, Bill Guimont, AMERICAN AIRLINES RADIO OPERATOR, knows the vital part that good tubes play in amateur communications. He knows too, that quality can't be sacrificed when there's a job to do. For dependability and top-notch performance, Bill has relied on Taylor Tubes for nearly 10 years. Again, "On the Air" proof of Taylor superiority has been confirmed.



NEW TUBES

Two new receiving tubes have just been announced by RCA. Designated as the 6SH7 and the 12SH7, they are high-frequency amplifier pentodes of the sharp cut-off type in single-ended metal envelopes. They are not recommended for high-gain audio amplifier applications, as undesirable hum may be encountered. The cathode is brought out to both pins 3 and 5.

GL-8009

This new transmitting tube, especially designed for high-frequency applications, has just been announced by the General Electric Company. It is a water-cooled tube similar to the GL-880, but has a six-pole terminal mount, and can be used as a class B modulator, an r.f. amplifier, and an oscillator.

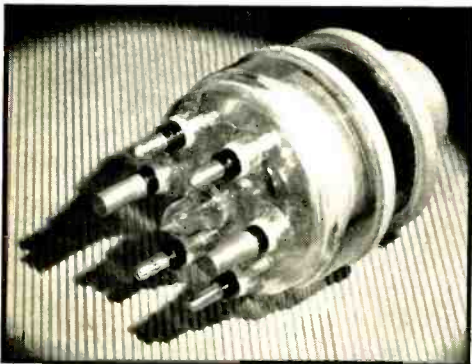

The design of the terminal mount connections and the introverted anode minimize lead inductance. While designed primarily for television service the tube is suitable for any high-frequency application. It can be used up to 25 Mc. at maximum ratings, and up to 100 Mc. with reduced ratings. The plate voltage rating is 10,500 volts at a plate current of 6 amperes, class C telegraph service.

Police Radio Kinks

[Continued from Page 39]

circuit, one would expect a marked decrease in sensitivity. However, this does not occur as much as might be expected. If a suitable permeability-tuned coil is available for L, then condenser C may be omitted with a slight increase in sensitivity.

A value of 75 $\mu\text{fd.}$ should suffice for C when used. Once the setting of this is found, it will be unnecessary to retune it over a long period of time unless the antenna is changed or reception of a different station is desired. The proper "short wave" coil to use is one

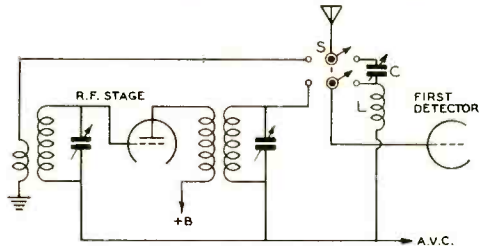

Figure 6. This "tubeless" converter provides excellent reception of a local medium-frequency station. Condenser C should be about 75 $\mu\text{fd.}$, and the coil of such inductance that by itself it resonates at the operating frequency with about 50 $\mu\text{fd.}$ of shunt capacity.

which will hit the desired frequency with the same 75- $\mu\text{fd.}$ condenser across it in the usual shunt-tuned manner and tuned to about half capacity.

A tubeless converter such as this is particularly applicable to car receivers. If the set uses multiple push-button tuning or the consecutive "single push button" type, one channel may be tuned to the desired spot where the police station comes in.

The Amateur Newcomer

[Continued from Page 54]

the paper on the chassis enough to allow room to place the nuts on the bolts. With the panel bolted to the chassis, place the components on the chassis and move them around until a suitable arrangement is obtained. Then their positions should be marked, using a square-type steel rule to assist in keeping the layout symmetrical and neat. After all the holes are marked, take the parts off and counter punch all the holes through the paper. Now put a small drill in the drill press and center-drill all the holes with the small drill. The next step is to put in the larger drills and make each hole the size that is needed. When cutting the tube socket holes, the paper is again slit in the bottom to allow enough room to get the bottom part of the Greenlee chassis punch through. At all times take care never to touch the chassis, as the finger prints will show up later as dirty discolored spots.

The next step in the procedure is to tear

[Continued on Page 96]

JOHNSON

..for Dependability

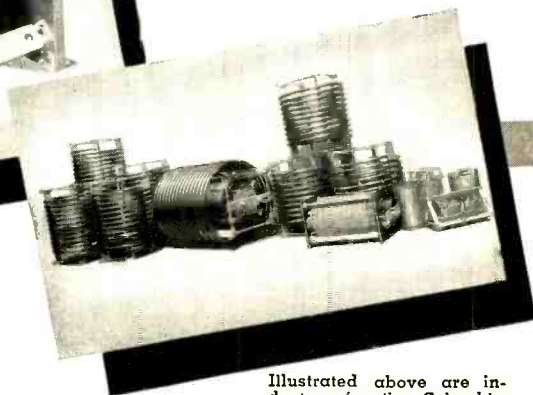
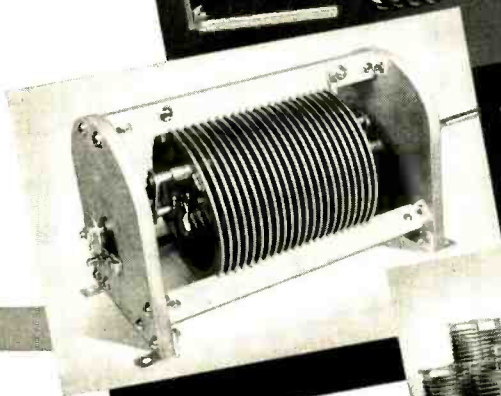
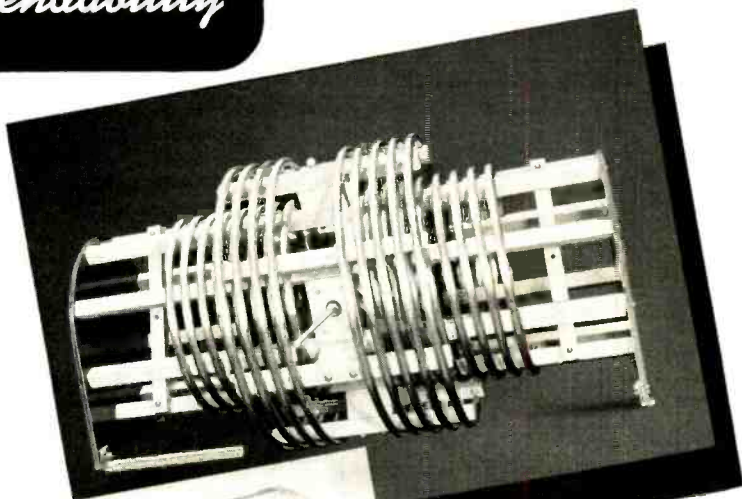

Not every application demands an inductor rated at 50 KW, but the same Engineering skill and precision workmanship may be found in all Johnson Products. Where dependability is of paramount importance, those who know specify Johnson, whether it is a standard stock part or an especially Engineered and manufactured component. Ask your favorite Jobber about Johnson Quality.

Illustrated above are inductors for the Columbia Broadcasting System and the National Broadcasting Company for 50 KW applications. In the upper photo insulation is Alsimag 196 and in the lower two Myclex is used.

**ASK FOR THE NEW
CATALOG 967K**



E. F. JOHNSON CO

WASECA, MINNESOTA

EXPORT, 25 WARREN ST., NEW YORK, N. Y.

"MANUFACTURERS OF RADIO TRANSMITTING EQUIPMENT"

NEW BOOKS

and catalogs

1942 Allied Catalog

Allied Radio Corporation, 833 W. Jackson Blvd., Chicago, Ill., announces their new 212-page 1942 catalog. It contains complete sections of interest to dealers, servicemen, PA men, amateurs and experimenters. One section is devoted to fluorescent lighting and equipment. All merchandise is carefully arranged and precisely indexed for speedy reference. A copy may be had free of charge by addressing the company.

GE Mycalex Booklet

The plastics department of the General Electric Company, Pittsfield, Mass., has issued a 10-page booklet, illustrated with photographs and charts, explaining the nature, properties, advantages and applications of GE Mycalex. It was announced recently that GE had perfected a technique for the molding of Mycalex by the injection process, thereby broadening the field of its usefulness by permitting the production of more intricate shapes.

A Custom Equalizer for Any Phonograph

[Continued from Page 23]

cient in highs when playing a commercial shellac pressing.) However, some who like lots of bass may desire to use the bass boost on certain records even when using a crystal pickup, assuming that motor hum and turntable rumble do not then become objectionable.

The unit has been constructed as a self-powered auxiliary device which may be connected to existing equipment without calling for alteration of the equipment. In the usual case it simply is inserted between the phono pickup and the amplifier to which the pickup was connected. However, if it is desired to make the equalizer an integral part of an amplifier, one need simply omit the power supply. The 6F8-G requires only 0.6 amp. of heater power and a few ma. of plate current.

The affair is a "gainless amplifier," having a gain of approximately 1 at the middle audio frequencies. In other words, it is assumed that the amplifier with which the device is used already has sufficient gain. To make the unit truly versatile, potentiometer R_1 was included to permit any value of input voltage without

danger of overlooking the first tube. This potentiometer is mounted behind the panel, close to the tube socket, and when once adjusted for a given setup is left alone; volume over a normal range is then controlled from the front panel by means of R_2 .

If the input to the unit never exceeds 4 volts (peak), then the potentiometer R_1 may be replaced by a 1-megohm $\frac{1}{2}$ -watt resistor. The newer lightweight crystal pickups will not deliver sufficient peak voltage to overload the first section of the 6F8G, and in a permanent installation where such a pickup is used, the resistor may be substituted for the potentiometer.

Referring to the diagram, figure 3, the various positions of the selector switch S_1 are as follows, going clockwise around the four contacts of each section: 1) Non-operative, no boost. 2) Bass boost. 3) Treble boost. 4) Both bass and treble boost.

The low-pass filter, which is cut in and out by means of S_2 , is a composite affair, consisting of a full K section and an M derived section with M equal to 0.5. This combination gives both sharp cutoff and good attenuation at frequencies well removed from the pass band. The design of the filter was dictated to a considerable extent by what inexpensive chokes with a suitable order of inductance were readily available. Both chokes should have a moderately high (though not necessarily extremely high) value of Q at the frequencies with which we are concerned.

The first choke, L_1 , consists of a Hammarlund type RFC-250 choke of 250 mh. inductance. The second choke, L_2 , consists of a Meissner type 19-6848 unshielded, iron core choke of 125 mh. Both chokes are mounted so that the iron chassis will have a minimum of effect upon the inductance. The values of C_7 , C_8 , and C_9 should be within 10 per cent. (Condensers of this tolerance are standard items with several manufacturers; others claim only 20 per cent accuracy.) The value of C_{10} is quite critical. Preferably it should be chosen from several random .006- μ f. condensers by actual trial. It should resonate with L_2 at a frequency of approximately 6000 cycles when L_2 is mounted on the chassis. If equipment is not available for checking the resonant frequency, the best one can do is to purchase a .006- μ f. condenser of 5 per cent tolerance.

Construction

The unit illustrated is housed in a 7 x 7 x 8 inch cabinet. However, the device could be made somewhat more compact if desired. As the input and output leads may be of any reasonable length (provided low capacity cable is used for the input lead), the device may be placed anywhere in the room.

An idea of the construction may be had from the illustrations. The layout of parts is not critical, and may be changed to suit the

You can step up Efficiency with

OHMITE PARTS

THE high efficiency you get with Ohmite parts can make a lot of difference in the performance of your rig. That's why it pays to use the 10 watt or 20 watt wire wound vitreous enameled Brown Devils, the 10 watt adjustable Dividohm resistors, the 2½ or 5 Meter R.F. Plate Chokes shown here, and the many other well-known Ohmite units. They're all veterans of service in amateur, commercial and defense communications. Available, of course, in many sizes and values to meet your exact needs. *Get them at your Jobber!*

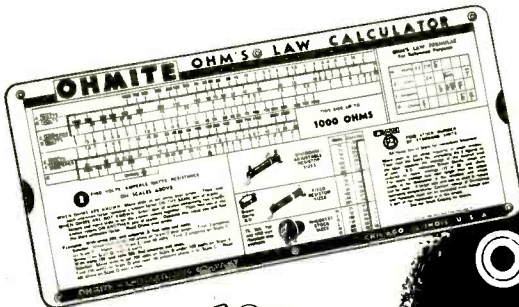
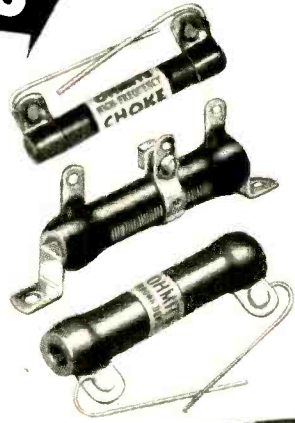

YOU can use
this handy new

OHMITE
Ohm's Law Calculator

ONLY 10¢ to cover
handling cost

**Solves any Ohm's Law Problem
with One Setting of the Slide**

Figures amperes, watts, volts, ohms—quickly, easily. Does not require any slide rule knowledge. All values are direct reading. Scales on both sides cover the range of currents, resistances, wattages and voltages commonly used in radio and commercial work. Size only 4½" x 9". *At your Jobber, or Send the Coupon today!*

OHMITE MANUFACTURING CO.
4867 Flournoy Street, Chicago, U.S.A.

10c in coin enclosed.
Send Ohm's Law Calculator

Name

Address

City State.....

Radio—Nov. '41

Be Right with **OHMITE**
RHEOSTATS · RESISTORS · TAP SWITCHES

constructor so long as care is taken to keep high impedance a.f. leads away from high voltage a.c. leads. A metal envelope rectifier, with shell grounded, helps to minimize hum pickup from electrostatic coupling between the high voltage a.c. and the high impedance audio leads. For the same reason the input lead to R_1 is shielded.

A 6SN7-GT may be substituted for the 6F8-G if desired, as this single-ended tube is electrically equivalent to the 6F8-G. However, the double-ended 6F8-G was chosen because with the particular construction employed a shorter grid lead to the second triode section was obtainable with a 6F8-G.

Design and Operating Data for Condenser Input Filters

[Continued from Page 36]

results of the analysis could be readily applied to any rectifier system. The results of the analysis are plotted in terms of the parameter K . K is defined by the following simple equation:

$$K = \frac{I_{ma.}}{C \mu ra. E_s} \quad (1) \text{ where } I_{ma.} = \text{D.c. output current of the rectifier in milliamperes}$$

$C \mu ra.$ = Capacity of the input condenser in microfarads

E_s = R.m.s. voltage to midtap of the secondary of the transformer

The curves plotted in Figure 3 give the factors in the following equations which determine: the output voltage, the r.m.s. current in the transformer secondary, the peak currents through the rectifier tubes, and the conduction angle Φ , in terms of the parameter K .

$$E_{dc} = D E_s \quad (2) \text{ where } E_{dc} = \text{D.c. output voltage of the rectifier neglecting the drop in the choke}$$

$$I_s = F I_{a.c.} \quad (3) \text{ where } E_s = \text{A.c. voltage to midtap of the transformer}$$

$$I_p = P I_{a.c.} \quad (4) \text{ } I_{a.c.} = \text{D.c. output current of the rectifier}$$

I_s = R.m.s. current in the transformer secondary

I_p = Peak current in the rectifier tubes

The curves plotted in figure 3 give the factors in milliamperes.

The factors D , F , and P are plotted in terms of the parameter K . The fourth curve gives Φ , the angle of current flow, as a function of K .

The angle Φ is plotted because the results of the analysis were directly given in terms of Φ , and were then transferred to the graph in terms of K . Two sets of curves are given, one showing these factors as indicated (figure 33) and the second set of curves (figure 4) giving the ratio of E_{dc} and I_s for a condenser input rectifier to E_{dc} and I_s for the same rectifier system with choke input instead of condenser input. This second set of curves may be interesting to the amateur wishing to compare the relative voltages and transformer currents for the same rectifier except with different types of input filters.

Discussion of Curves

Some discussion of the curves of figure 3 may be interesting in order to bring out the points shown by these curves. The curve marked D is substantially a universal regulation curve for any condenser input rectifier since it shows the output voltage as a function of K , and K itself is directly proportional to the output current. The output voltage for any output current can be obtained by first computing K for that output current, finding the value of D corresponding to that of K on the curve and then multiplying this value of D by the transformer secondary voltage to midtap. The curve F is illuminating in that it shows the increased heating effect on the transformer caused by the high momentary currents drawn by a condenser input rectifier. In a choke input rectifier the transformer secondary r.m.s. current is .707 $I_{d.c.}$, but in the condenser input rectifier the r.m.s. secondary currents may be three to four times the d.c. output current if a large condenser is used in the input. The clue to the failure of the transformer discussed in the first paragraph is obtained from this curve. It was found that the transformer was overloaded by a factor of about three, even though only rated d.c. output current was being drawn. A mental apology to the manufacturer was in order when this fact had been determined. It behooves the amateur to consider whether or not the transformer has a current rating sufficient to support the increased current drawn from the windings when operating into a condenser input filter.

The winding current for any output current can be found from curve F , and if the rating of the transformer is approximately equal to this value of current, the increased voltage afforded by a condenser input filter can be enjoyed without excessive transformer heating. It may be in some cases that a transformer of lower rating but higher voltage may be cheaper. The curve for P , the peak factor, may influence the choice of a rectifier tube, although tube handbooks do not as a rule give saturation currents for the various small rectifier tubes. The

HOT STUFF!

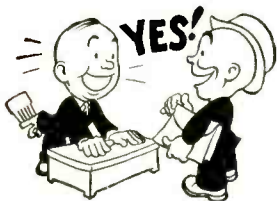

“NO! Is that a fact! Hot stuff?”

“Yessir! Really **HOT STUFF** coming up in the next issue of Radio.”

“Maybe I’d better plan to get a copy. Where can I be SURE of getting one?”

“What! Aren’t you a regular subscriber? Say, ehum, you’d better send in your order right away. \$2.50 a year—or if you want to procrastinate, send only \$1.00* for the next five issues. That’ll get you the big January Yearbook number, too!”

“Okay. Where do I send it?”

“Just send it to the Circulation Manager, Editors & Engineers, Ltd., 1300 Kenwood Road, Santa Barbara. They’ll fix you up pronto.”

***Trial offer for new subscribers only.**

THE EDITORS OF

RADIO

CORPORATE NAME: EDITORS AND ENGINEERS, LTD.

technical  *publishers*

1300 KENWOOD ROAD, SANTA BARBARA, CALIFORNIA

saturation currents are usually some two or three times higher than the maximum output currents given in the tube manuals for the various rectifier tubes. For purposes of comparison it may be stated that the peak current for a choke input filter is the same as the output d.c. current. This presupposes a large input choke, but is only slightly increased for the smallest d.c. chokes used in amateur filters.

It is hoped that these curves will show some of the facts concerning condenser input rectifier systems without any great labor of computation or complex equations. They should fill a gap in the amateur's literature on rectifiers, and give some basis for the design of amateur power supplies.

Probe Type Rectifier

[Continued from Page 41]

transformer. In mounting the battery it should be insulated from the case with strips of bakelite. The transformer is an old output transformer which has a secondary voltage of about 5 volts when the primary is supplied with 110 volts. It should have good insulation. 5 volts is low for a 75 tube, but it is sufficient for this application.

Power Supply

Any source of d.c. plate voltage can be used, but the voltage must always be considerably higher than the voltage being measured. The power supply shown in the illustrations can be built at little cost, consisting almost entirely of parts which can be salvaged from the junk box.

An old output transformer is used as a filament transformer, and a 3-to-1 audio transformer acts as a high voltage source. The rectifier tube is a type 26, but it could be almost any type, since only about 1 milliampere of current is drawn from the supply, even when using a 1000-ohm-per-volt meter. A 0.1- μ fd. condenser is all the filter that is required. The d.c. plate voltage available for the rectifier is 350 volts.

The transformers must be insulated to stand the voltages applied and obtained when used as power transformers. To calculate the voltages that will be obtained the following formulas are given: $E_p/E_s = N_p/N_s$; $E_p^2/E_s^2 = Z_p/Z_s$; $N_p^2/N_s^2 = Z_p/Z_s$. E_p , N_p and Z_p are the primary voltage, turns, and impedance, respectively. E_s , N_s and Z_s are, correspondingly, the secondary voltage, turns, and impedance, respectively. Generally, either the turns ratio or the impedance ratio of audio and output

transformers is given by the manufacturer. Of course, a single midget-type power transformer can be used in place of the three transformers in this unit, greatly simplifying the power supply.

The power supply is mounted in the wooden box shown in the interior view, upon which the metal case is fastened. If an external power supply is used, the negative terminal should be grounded to prevent a.c. pickup from affecting the readings.

Operation

Blocking condenser C_1 is required whenever there is a d.c. component in the voltage to be measured. For convenience, a phone tip may be soldered to one terminal of the condenser, to permit plugging it into the grid input jack.

The input capacity is 6 μ fd. without the blocking condenser, and 8 μ fd. with it in the circuit. By reducing the plate voltage to 45 volts the grid resistor may be disconnected and the input capacity reduced to about 3 μ fd. In this case the input resistance is increased to a value approaching infinity for d.c. voltages. If the grid circuit is opened when the plate voltage exceeds about 45 volts the tube will block. As ordinarily used with the grid leak connected, plate voltages up to approximately 350 volts may be used. A plate voltage of 350 volts will allow a.c. voltages up to at least 250 volts r.m.s. to be measured.

The combination of R_3 and the 4.5-volt battery serves to compensate for zero-signal plate current. The d.c. voltmeter should be adjusted to zero first with the rectifier disconnected, and then the rectifier is connected and the zero readjusted by means of R_3 .

The rectifier circuit offers some protection to the meter with which it is used, but all ordinary precautions should still be observed. The range switch on the d.c. meter selects the ranges, just as when it is used without the rectifier.

Negative voltages as high as approximately -15 volts may be measured by connecting an external battery in series with the output of the rectifier and the voltmeter. About 15 volts will be required to cause the meter to read full scale when a 1000-ohm-per-volt meter is used. Voltages are then read from full scale downward.

• • •

The use of high-frequency iron cores in r.f. and i.f. coils is helping to alleviate the aluminum shortage in the radio industry. By the use of specially designed self-shielding cores it has been found possible to eliminate the aluminum shields so long thought necessary.

SMOOTH FREQUENCY RESPONSE

FOR either amateur or public address requirements, Astatic's new **N-Series Crystal Microphones** assure exceptionally smooth frequency response and grand all-around performance. These models are made with Astatic's swivel joint, tilting head for adjustment of microphone to semi-directional as well as directional position, adding to its practicability and effective method of acoustic feedback control. Concentric cable connector facilitates quick interchange of cable. **Model N-30** is a hi-fidelity, wide range microphone, 30 to 10,000 cycles, substantially flat and free from peaks. Output level—52 db below one volt per bar. **Model N-80**, voice range microphone, output level—49 db below one volt per bar, with rising response to 3,500 cycles, provides efficient speech characteristics to increase intelligibility.

Standard equipment includes 25-ft. low capacity, closely shielded rubber covered cable with spring protector.



**MODEL
N-30
WIDE
RANGE**

•
**MODEL
N-80
VOICE
RANGE**

•
**LIST
PRICE
\$17.50**



CONVENIENT SWITCH ADAPTOR

When so ordered, at little extra cost, a convenient On-Off Switch, as shown in accompanying illustration, may be had with either model in the N-Series Microphones. This is known as Type "S" Switch Adaptor, the purpose of which is to short the microphone circuit in "off" position.

Model N-30S or N-80S, complete with Type "S" Switch, as illustrated, **List Price \$20.00**

In addition, Astatic Microphones **T-3, WR-20, WR-40, D-104** and **K-2** may be ordered equipped with the Type "S" Switch. This switch is **NOT SOLD SEPARATELY.**

ASTATIC

THE ASTATIC CORPORATION

YOUNGSTOWN, OHIO

Licensed Under Brush
Development Co. Patents

In Canada:
Canadian Astatic Ltd.
Toronto, Ontario

Frequency-Multiplier Circuits

[Continued from Page 50]

more ideal matching conditions are obtained.

A number of circuits in which the series tank system can be applied will occur to the circuit student. In figure 4 the series tank method is applied to a twin-triode tube, such as the 6A6, 6N7G, 53, etc. The circuit essentials are a coil and condenser (L_1, C_1) tuned to the crystal frequency and a *series tank* (L_2, C_2) tuned to twice the crystal frequency, coupled by C_3 to the grid of the second triode section of the tube. The output plate circuit (L_3, C_3) resonates at four times the crystal frequency, and gives an output comparing favorably to that of just a single doubling operation. As an example a 7000-kc. crystal will quadruple to 28 Mc. with an output equal if not greater than can be ob-

tained with a 14-Mc. crystal in a single doubling operation with its necessary lower voltage precautions. This quadrupler circuit requires no extra parts over conventional crystal oscillator circuits, has higher output, and the advantage of using a low-frequency crystal. The circuit values are given under the diagram (figure 4) and in the coil table.

There are a number of isolantite base twin triode tubes on the market, such as the 6A6-X, 6N7G-X, RK34, etc. These types are preferable to molded bakelite base types, especially at ultra-high frequencies. Appreciable outputs can be had at $2\frac{1}{2}$ meters if another twin triode, similar to the RK34, is coupled to the output of the circuit in figure 4 when using a 40-meter crystal. Both sections then function as separate frequency multipliers, the first section at 5 meters and the second at $2\frac{1}{2}$ meters. To get appreciable outputs at these frequencies, it is obviously necessary to use low-loss parts throughout.

It is convenient in the *series tank system* to wind both coils (L_1, L_2) on the same form. Winding data are given in the coil table. By the use of plug-in coil forms a number of band combinations can be obtained.

In figure 5 is shown another adaptation of the series tank system to an oscillator circuit (a take-off from the tri-tet) developed by W. W. Smith, W6BCX. The essentials of the circuit are a crystal operating at the fundamental frequency, a plate coil (L_1) doubler and a *series tank coil* (L_2) quadrupler. If the cathode choke is shorted out and L_1 resonates at crystal frequency, outputs are obtained on the fundamental and doubler frequencies. All the circuit constants are the same as the original specifications. Cathode choke and coil data are given in the coil table. This circuit gives good outputs on two bands simultaneously.

• • •

Boogie Woogie C.W.

Belgian colonial forces in the Belgian Congo have been using native radio operators as a method of highly effective secret communication. Captured Italian officers confess that their communications and cipher officers are at a complete loss to make sense out of the "swing" code used by the natives. They are not stumped by a bad case of "Lake Erie Swing" or "Banana Boat Roll," but when the native operators limber up and start beating out their Boogie Woogie code at eight to the bar and forty w.p.m., the Italians can do nothing but tear their hair.

Natives that can read and write can be taught the code in five or six months. The swing comes natural.

COIL TABLE

For 160-meter Crystal:

L_1, L_2 —Series tank coils. Wound on same form. Use 5-prong form $1\frac{1}{2}$ in. dia. Separate the two windings $\frac{1}{4}$ inch.
 L_1 —65 turns no. 24 d.c.c.; close wound.
 L_2 —32 turns no. 22 enam.; space dia. of wire.

For 80-meter Crystal:

L_1, L_2 —Series tank coils. Wound on same form. Use 5-prong coil form similar to Hammarlund SWF-5. Separate the two windings $\frac{1}{4}$ inch.
 L_1 —32 turns no. 18 enam.; space dia. of wire.
 L_2 —16 turns no. 18 enam.; space slightly more than dia. wire.

For 40-meter Crystal:

L_1, L_2 —Series tank coils; same type form and separation as above.
 L_1 —16 turns no. 18 enam.; spaced to $\frac{1}{2}$ form.
 L_2 —8 turns no. 18 enam.; spaced to balance of form.

Constants for L_3

80-meters—32 turns no. 18 enam.; 4-prong coil form (SWF-4); spaced to 2 inches.
 40-meters—16 turns no. 18 enam.; same form as above; spaced to 2 inches.
 20-meters—8 turns no. 18 enam.; low-loss 4-prong coil form similar to Amphenol no. 24-4P; spaced to $1\frac{1}{2}$ inches.
 10-meters—4 turns no. 16 enam.; low-loss form as above; spaced to $1\frac{1}{2}$ inches.

Cathode Choke

160-meter—80 turns no. 24 D.C.C.; close wound on 1 inch dia. bakelite tubing.
 80-meter—40 turns no. 24 D.C.C.; close wound on 1 inch dia. bakelite tubing.
 40-meter—20 turns no. 22 D.C.C.; spaced dia. of wire on 1 inch dia. bakelite tubing.

Centralab

CRL

The Quality Line

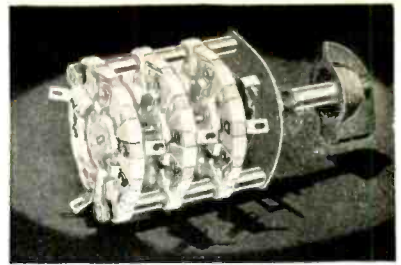

SELECTOR SWITCH

Available in an almost infinite variety of combinations . . . in bakelite or steatite . . . in single or multiple gang . . . from two to eleven positions on any one switch . . . also available for use in amateur transmitters.

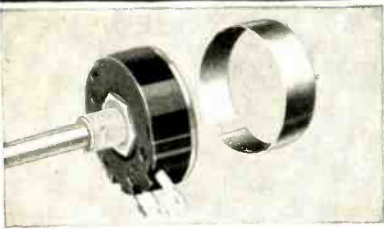

STANDARD RADIOHM

Wall type resistor. Exclusive non-rubbing contact band. 1 3/8" diameter x 9/16" deep. Available single, twin or triple, plain or tapped . . . with S.P.S.T., I.P.S.T. or S.P.D.T.

Hams, Servicemen, Experimenters and Manufacturers appreciate the utter dependability of Centralab products. Since 1922 more than a hundred million radio parts bespeak the universal acceptance accorded Centralab products. Send for catalog if your jobber cannot supply you.

CENTRALAB
Div. of Globe-Union Inc.
MILWAUKEE

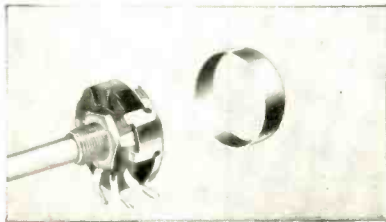

MIDGET RADIOHM

Companion to "standard" . . . small size but large control efficiency. Available single, dual or triple . . . plain or one, two or three taps . . . with S.P.S.T., S.P.D.T., or D.P.S.T. Moulded bakelite case, 1 1/8" diameter, 1/4" metal shaft 3 3/8" long.

WIRE WOUND RADIOHMS

In values from 2 to 10,000 ohms . . . insulated construction . . . 3 watts . . . universal shaft for all replacements . . . regular Radiohm switch covers may be attached . . . in linear curve only . . .



ATTACHABLE SWITCH COVERS

For standard and wirewound resistors (Radiohms) as well as Midget and Elf Radiohms . . . S.P.S.T. . . . S.P.D.T. . . . D.P.S.T. . . . four point . . . S.P.D.T. (operates at clockwise position) and S.P.S.T. with Dummy Lug.

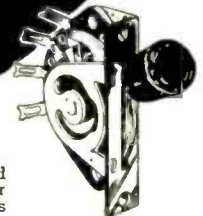

LEVER ACTION SWITCH

Used singly or in groups . . . for broadcasting, receiving, public address, test instruments and industrial uses. Available in any one of ten different combinations including positive and spring return action.

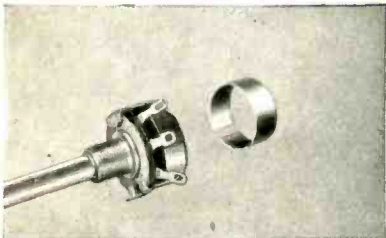

ELF RADIOHM

Smaller but also features the long, straight resistor strip. Available plain or tapped with S.P.S.T. switch . . . with or without dummy lug. Bakelite case 57/64" diameter, 17/32" deep (less switch) 25/32" deep with switch.

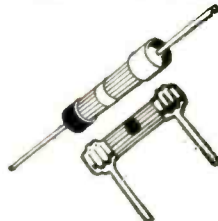

AXIAL LEAD RESISTORS

Body is insulated by inert ceramic jacket . . . proof against vibration and humidity . . . will withstand five times rated load without permanent change. In two sizes . . . RMA coded . . . 1/2 watt at 1/8" x 5/8" and 1 watt at 1/4" x 1" . . . Also supplied in conventional RADIAL LEAD Style . . . 1/2 watt - 1 watt or 2 watt.



CERAMIC TRIMMER CONDENSER

where greater stability than ordinary types is required. Supplied with neg. temp. coefficient of .006 MMF/MMF/C°. With or without mounting brackets.

CERAMIC CAPACITOR

Small "special purpose" for h.f. circuits where temperature compensation, low power factor, or absolute permanence are important. 1000 V.D.C. leakage resistance more than 10,000 meg. Power factor less than 1%.



SEND FOR CATALOG NO. 23

Emergency Service Portable Station

[Continued from Page 20]

jack and plug is shielded, as is also the grid lead. A single toggle switch in the plate voltage lead to the speech equipment cuts the plate voltage on the amplifier if desired when higher output is desired on c.w. This switch is optional, but advisable if much c.w. operation is contemplated.

The Receiver

The receiver is a simple super-heterodyne using a 6K8 mixer, 6K7 amplifier (i.f., 465 kc.), and a 6C8-G as combined second detector and beat oscillator. A satisfactory single signal effect is obtained by adjusting the pitch on the b.f.o. transformer to one side of the center of the i.f. The receiver is lined up in the normal fashion, using a signal generator or a signal picked up on the air.

The antenna lead to the receiver is shielded and runs to the antenna relay. When transmitting, the antenna is shifted to the transmitter and the input of the receiver is grounded. The output of the receiver is then fed into the driver of the speech amplifier for audio amplification, as can be seen in the circuit diagram.

The coils may be wound to suit the builder. The receiver works surprisingly well up to 15,000 kc., but images become more prevalent above 9,000 kc. Below 9,000 kc., the receiver will match any good super using 5 or 6 tubes.

Foreign broadcasts may be picked up with more than ample volume on 31 to 49 meters when using only an 8-foot rod for the antenna. When an outside antenna is used, the volume on foreign stations is enormous. The speaker is a permanent magnet type; the audio quality sounds excellent to the ear. Incidentally, the first detector tuning condenser is not ganged to the high frequency oscillator condenser, but is trimmed separately and used also as an r.f. gain control on strong signals.

The Dual Power Supply

Under all ordinary conditions the power supply runs from 110 volts a.c. as does any other power supply. But the power transformer is a special Thordarson with two primary windings, one for 110 and the other for 6 volts from a vibrator. The power output is the same in either case. The vibrator is a 10-ampere one, Radiart Type 4253A. All leads leading to the vibrator should be as heavy as possible to reduce voltage drop. In our case the cable going to the battery is number 10 stranded wire. This size seems to carry the current without any appreciable drop.

Jones male and female 10-point plugs and sockets are used for the cables connecting the lower unit to the upper unit, also to shift from a.c. to 6 volts d.c. operation. To shift, merely pull out the a.c. cable going to the socket and plug in the 6-volt cable which connects to the battery. Polarity is optional. Then change S₃ to the battery side. This shifts the remainder of the filaments to the battery circuit. Since the filament current necessary on a.c. operation is more than the power transformer is capable of handling, an additional filament transformer is wired into the circuit as shown. The filter is small, consisting of only one choke and condenser input, to obtain higher plate voltage. However, the regulation of the power supply is quite good. The filter is ample and there is no trace of hum in the receiver, amplifier stages, or transmitter.

The Send-Receive Switch

The transmit-receive switch is a rotary type made by Mallory and is a four-point double-throw type. Any switch of the same type can be used. When this switch is thrown to receive, the plate voltage is shifted to the receiver, the receiver is connected to the driver, and the modulation transformer is shifted to the speaker. When the switch is put in the send position, it shifts the plate voltage to the transmitter, shifts the modulation transformer to the r.f. amplifier, connects the driver to the speech amplifier, and kicks in the antenna relay, shifting the antenna to the transmitter.

The only other switch is the checking switch on the front panel, which closes the keying circuit for tuning-up purposes.

Operation

Every section of the portable is simple in design and operates without trick circuits. This indeed is a valuable feature of a piece of equipment which must be capable of emergency service under all sorts of difficult conditions. The results obtained with the equipment on the extensible fishpole antenna were quite surprising, considering the fact that the unit is small enough to be carried anywhere and that no antenna poles or additional equipment other than an a.c. line or storage battery is required. The following data give a rough idea of the operating capability of the equipment under different operating conditions:

Phone, 4-Mc. band—8-foot rod for transmitting and receiving antenna range 15 miles in daytime, R7 to R9 signals. 40-foot antenna, daytime range 50 miles, R7 to R9 signals. 132-foot antenna, nighttime range 300 miles, R7 to R9 signals.

C.w., 7-Mc. band—8-foot rod nighttime range, 400 miles, R7 signals. 100-foot antenna, 3000-mile range, R6 to R8 signals.

off. Then, when excitation was applied, there was plenty of grid current.

When the plate voltage was applied to the T-40's and their plate circuit dipped, the minimum plate current on 20 meters was about 30 ma. Loading the amplifier to 200 ma. with 1250 applied volts gave full brilliancy in a 200-watt lamp. But when the key was plugged into the keying jack the amplifier went wild and the plate milliammeter hit the pin. However, the output of the 807 fell to zero, indicating that the trouble was in the final and not in the exciter.

Parasitic Treatment

After the spurious oscillation had been traced to the final amplifier, it was next necessary to determine whether it was a low-frequency or high-frequency parasitic. Since previous experience had indicated that using an r.f. choke in the grid return of an r.f. amplifier was very conducive to low-frequency parasitics, a 10-watt 200-ohm resistor had been used in this position. Hence it was felt that the likelihood of the existence of a low-frequency parasitic was small.

A lowered plate voltage was placed on the final for a few seconds. There was a good sized spark on the plate caps of the tubes, but the spark died out toward the tank condenser. This meant that it was a u.h.f. parasitic with which we must contend, if there was a standing wave on so short a section of wire as that between the plate cap and the tuning condenser. So an Ohmite parasitic choke was placed first in one plate lead and then in the other, in the two neutralizing leads, and then in series with one of the grid leads as shown in the circuit diagram. Leaving the choke in this position greatly reduced the intensity of the parasitic but did not eliminate it entirely. Then the by-pass condenser that was originally from the rotor side of the plate r.f. choke to ground was removed. This completely eliminated the trouble.

The transmitter was then checked again with the key open in the exciter. The plate current on the final went down to about 30 ma. but there was no sign of any type of parasitic oscillation. The bias voltage from the bias pack was increased a slight amount and the plate current then fell to zero with the key up. The final stage normally runs from 50 to 60 ma. of grid current on all bands from 20 through 160 with full operating load of 240 ma. at 1250 volts on the plates of the T-40's.

• • •

It is possible to compare resistance, capacitance, and inductance to WWV standard frequency signals.

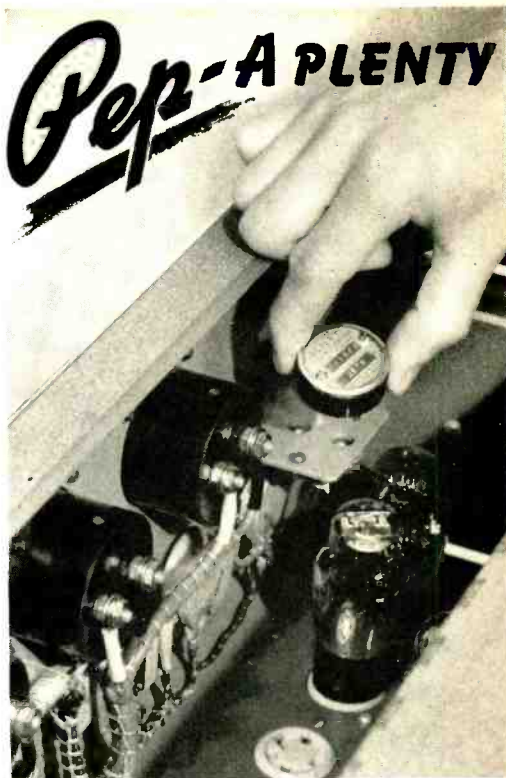

BLILEY CRYSTALS

THE signals of this transmitter are going to go places and do things. The sharp, clean-cut note, packed with punch, will be under the full supervision of the Bliley Crystal Unit being plugged in the socket.

Bliley Crystals have a way of getting the best out of any transmitter. Activity, keying, power-output, and dependability—characteristics that are necessary for above-the-average transmission—are deliberately developed to the highest practical degree.

If it's pep you want (and who doesn't), plug a Bliley Crystal in your transmitter. Your distributor has Circular A-8 giving complete descriptive data on Bliley Crystal Units for the various amateur bands.

BLILEY ELECTRIC CO.
UNION STATION BUILDING ERIE, PA.

Postscripts and Announcements

[Continued from Page 70]

of emission as shown:

1750 to	1900 kilocycles	A-4
1900 to	2050 kilocycles	A-3
7250 to	7300 kilocycles	A-3
28100 to	30000 kilocycles	A-3
56000 to	60000 kilocycles	A-2 A-3 A-4
112000 to	116000 kilocycles	A-2 A-3 A-4 A-5
224000 to	230000 kilocycles	A-2 A-3 A-4 A-5
400000 to	401000 kilocycles	A-2 A-3 A-4 A-5

This order shall take effect on the 20th day of December, 1941; *Provided, however,* That should need therefor arise, the commission may, by subsequent order, advance the effective date hereof to a date prior to December 20, 1941, but not less than thirty (30) days from the date of this action.

Minnesota Radio Association Convention

The annual convention of the Minnesota Radio Association is to be held on Sunday, November 2, 1941, in Rochester, Minnesota. This year the convention is to be held under the

auspices of the Rochester Radio Club of Rochester, Minn. Complete information concerning the convention may be obtained by writing to Mr. Francis C. Kramer, W9DEL, St. Charles, Minnesota.

Latest Additions to the OMRC

The applications for membership in the Old Men's Radio Club are coming in more slowly, now probably due to the fact that most of the older hams are already registered. But a few who have become 50 years old lately are coming in, in scattered numbers, from time to time.

- The following old timers have signed lately:
- W1BKE, Jan. 29, 1879.
 - W1KHT, March 28, 1886.
 - W1AS, Sept. 10, 1891.
 - W6QFH, Jan. 3, 1891.
 - W7BAQ, March 2, 1891.
 - W9RGX, Jan. 7, 1891.
 - W9VGC, Nov. 16, 1889.

We will have a get-together of the OMRC at the State Hamfest at Boston, on the 18th of October, at the Hotel Bradford. We would like to have all OMRC members present at that time. It will be announced from the platform.

[Continued on Page 94]

**YOUR REFERENCE BOOK
BUYING GUIDE
AND MASTER FILE**

Gives This Important Data

Contained within the hard covers of this 800-page MASTER BOOK are the listings of the products of 90% of all Radio Parts and Equipment Manufacturers in the industry. In it you will find many thousands of items, such as electronic devices, transmitting and receiving sets, public address equipment, speakers, tubes, antennas, transformers, condensers, replacement parts, meters, laboratory test equipment, relays, plugs, coils, wire, and numerous other radio components. Thousands of clear illustrations with descriptions and specifications. Yes, this is your "MUST HAVE BOOK."

Saves Time—Saves Money

WHERE, WHAT AND HOW MUCH: Such information is instantly at your fingertips. This valuable RADIO MASTER eliminates the maintenance of bulky files. It is completely indexed for speedy reference.

If you buy, sell or specify, you will find the RADIO MASTER an indispensable and handy book to have around at all times.

**NINTH EDITION
IT'S A MASTERPIECE**

Took 6 years and thousands of dollars to develop to its present size—yet it costs you only **\$2.50**

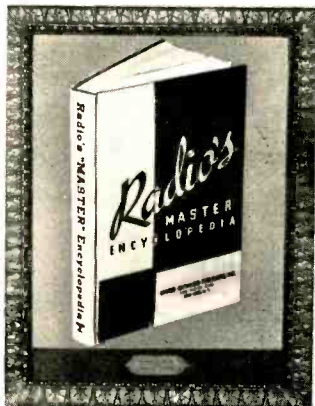

**MONEY BACK
GUARANTEE**

Order your copy today—look it over. You will find it to be an excellent investment; if not, return it to us in five days for full refund. We prepay transportation charges if remittance accompanies order.

**THE ONLY OFFICIAL
RADIO & EQUIPMENT
MASTER CATALOG**

Compiled in co-operation with and approved by the Radio Manufacturers Group as the industry's official source book.

Who Uses It?

- Broadcasting Stations
- Department Stores
- Electrical Engineers
- Exporters
- Foreign Governments
- Industrial Plants
- Mail Order Houses
- Mechanical Engineers
- Newspaper Publishers
- Police Departments
- Purchasing Agents
- Radio Distributors
- Radio Service Organizations
- Radio Salesmen and Buyers
- Radio Parts Manufacturers
- Radio Set Manufacturers
- Radio Sales Agents
- Students and Experimenters
- Technical Libraries
- Telephone Companies
- Telegraph Companies
- Universities & Schools
- U.S. Military, Naval and Aircraft Depts.

UNITED CATALOG PUBLISHERS, Inc.
106-110 LAFAYETTE STREET, NEW YORK, N. Y., U.S.A.

Eimac #51

Eimac 304T

4 TRIODES IN 1

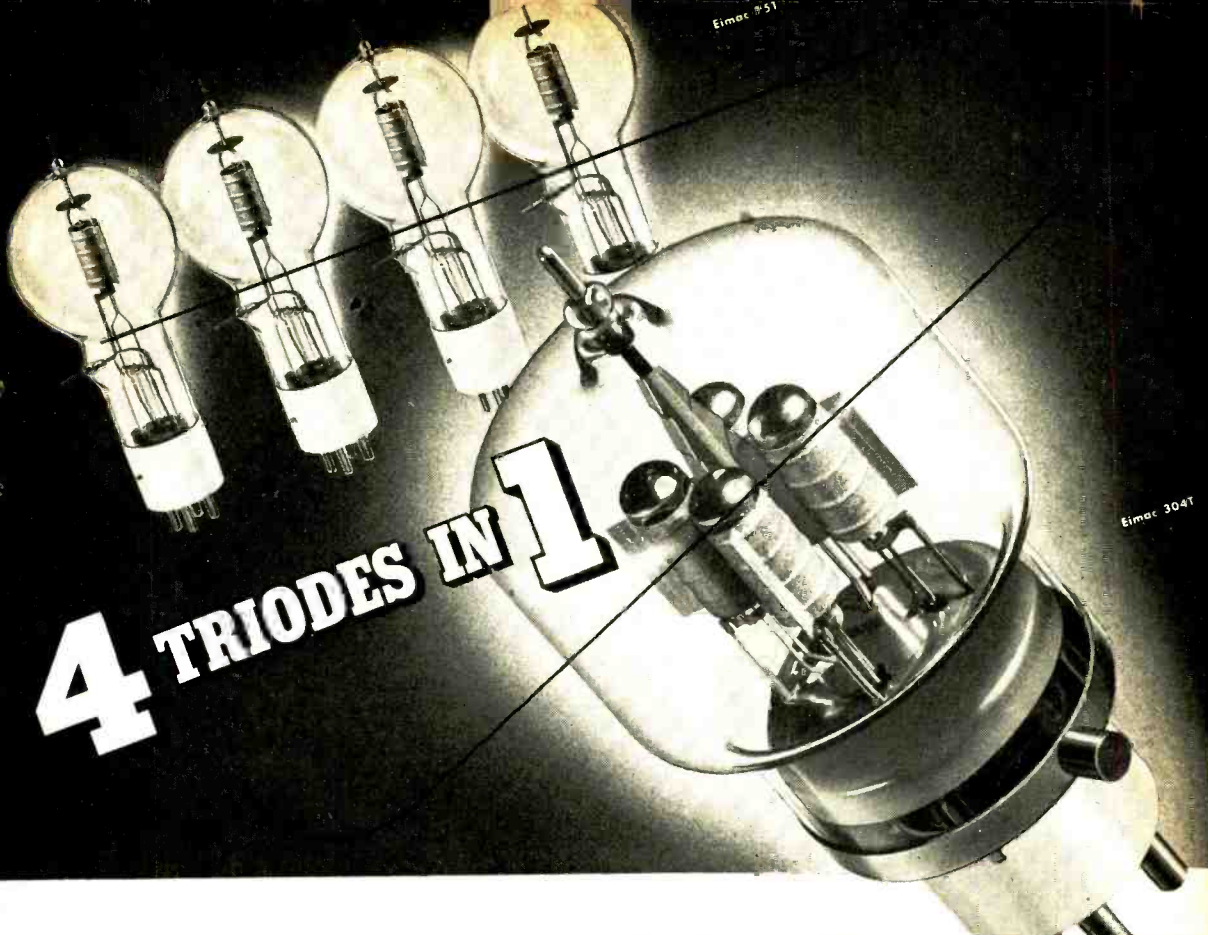

LOW VOLTAGE TUBE...LOW INTERNAL RESISTANCE with a 10 to 1 safety factor

More than a year ago, Eimac announced these Multi-Unit tubes to the industry under the statement "A Revolutionary Change in Vacuum Tube Design." They were developed in the Eimac laboratories for the precise purpose of providing a high power, low voltage (1000 to 2500 volts) tube having an extremely low internal resistance which would operate efficiently up to 200 megacycles. In actual operation Eimac 304T tubes are seeing service with as much as 20,000 volts on the plates...10 times the rated voltage. Where else is there a tube offering such a safety factor? It's just typical of Eimac's leadership... another reason why Eimac tubes are to be found in the key sockets of most of the important radio transmitters throughout the world.

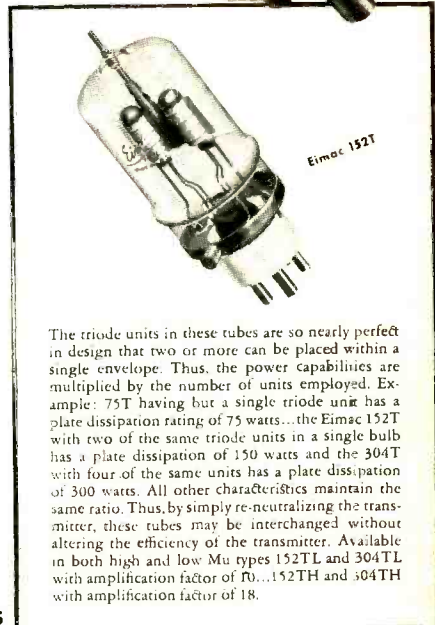

The triode units in these tubes are so nearly perfect in design that two or more can be placed within a single envelope. Thus, the power capabilities are multiplied by the number of units employed. Example: 75T having but a single triode unit has a plate dissipation rating of 75 watts...the Eimac 152T with two of the same triode units in a single bulb has a plate dissipation of 150 watts and the 304T with four of the same units has a plate dissipation of 300 watts. All other characteristics maintain the same ratio. Thus, by simply re-neutralizing the transmitter, these tubes may be interchanged without altering the efficiency of the transmitter. Available in both high and low Mu types 152TL and 304TL with amplification factor of 10...152TH and 304TH with amplification factor of 18.

FOLLOW THE LEADERS TO



Eitel-McCullough, Inc. San Bruno, California

EIMAC REPRESENTATIVES

California, Nevada
HERB BECKER, 1530 W.
104th St., Los Angeles, Cal.
N. Y., N. J., Penn., Md., Del.,
Dist. of Col., Maine, N. H.,
R. I., Conn., Mass.
ADOLPH SCHWARTZ,
14726 Elm Ave., Flushing,
New York.

Wash., Ore., Idaho, Mont.
GENERAL SALES CO.,
Verner O. Jensen, 2605-07
Second Ave., Seattle, Wash.

Colo., Wyo., New Mexico,
Arizona, Utah
RICHARD A. HYDE, 4253
Quitman St., Denver, Colo.

Chicago, Illinois, Wisconsin
G. G. RYAN, 549 W
Washington Blvd., Chicago,
Ill.

N. Caro., S. Caro., Georgia,
Tenn., Flor., Ala., Miss.
JAMES MILLAR, 316 Ninth
St. N. E., Atlanta, Georgia.

Texas, La., Okla., Ark.
J. EARL SMITH, 2821 Live
Oak St., Dallas, Texas.

Ohio, Mich., Ky., Ind., Minn.,
Mo., Kan., Neb., Iowa
PEEL SALES ENGINEER-
ING CO., E. R. Peel, 154
E. Erie St., Chicago, Ill.

Export Agents: FRAZAR & CO., LTD. • 301 Clay Street, San Francisco, Calif.

The Spotlight's on Radio and Radio's AMATEUR NEWCOMER HANDBOOK



The quickest, most thorough and clearest way to the understanding of short wave radio is through the pages of Radio's Amateur Newcomer Handbook. Its pages sparkle with clear, concise explanations of radio phenomena; with discussions of radio theory and amateur radio practice.

Learn the code; learn how to build your own short wave receiver and transmitter; learn how to operate your station with full cognizance of standard operating rules and procedures.

All these facts, plus hints on how to answer the license examination, are fully covered in this amazing little book.

Order at your dealer today—or direct from us.

35c in U.S.A. Postpaid Elsewhere 40c

THE EDITORS OF
RADIO 1300 Kenwood Road, Santa Barbara
CALIFORNIA

RADIO

300-Watt V.F.O. Amplifier

[Continued from Page 11]

Tuning Up

After the units were built and checked for wiring they were put on the test bench and the various power supplies connected. The filaments were lighted and the excitation applied to the 807 from the v.f.o., with no plate voltage on the 807. The grid current was satisfactory (about 10 ma.) so the proper plate coil was selected with the turret and the plate voltage applied to the 807. The plate current was dipped, and then the grid condenser on the final was resonated. Then the final stage is neutralized. It may be necessary to remove the plate voltage lead to the stage in order to obtain perfect neutralization. Also, it is advisable to neutralize the amplifier on the 14-Mc. band since the adjustment is then more likely to hold accurately on the lower frequency bands.

At this time it was noticed that the grid current on the 807 had dropped considerably. In the original circuit the grid return of the 807, as well as that of the final stage, went to the bias pack. When the grid current of the final amplifier went through the bias pack it developed an excessive amount of bias on the 807. So the value of grid leak on the 807 was increased and the resistor was returned to ground instead of to the bias pack. With this grid circuit arrangement the 807 grid current ran too high, and it was also noticed that the grid tuning condenser tuned quite broadly. These two conditions indicated that the coupling to the v.f.o. was somewhat too tight. So the number of link turns on the turret was reduced by cutting one of the leads and sliding the lead over to the next turn. With the reduced amount of coupling the grid circuit tuned sharply and the grid current on the 807 fell off to a reasonable value.

After taking the fixed bias from the 807 grid circuit it was wondered whether or not the plate current on the tube would be excessive without excitation. With the v.f.o. turned off it was discovered that the 807 drew just 40 ma.—a perfectly safe value. The reasonable value of plate current on the tube without excitation was due primarily to the cathode bias developed across the 6A3 keying tube in the 807 cathode return.

Then back to the final. It was noted that the grid current was quite low even after the variable grid link had been adjusted to the optimum value of coupling. A check of the bias voltage showed that the potential of the pack was soaring, due to the grid current of the final. The voltage was reduced so that with no excitation the tubes were just at cut-

U. H. F.

[Continued from Page 60]

investigate and lost a finger-nail in the car door. Vince Dawson found a 2½ meter ham rig in one of the toll houses, but he went on to W3HWN without finding out whose it was.

W6PQQ and W9BKM/6 on Signal Peak worked W6TVU/6, W6KTJ and W6QLZ around Phoenix, the latter being 90 miles away. PQQ used one of those Smith transceivers described in the March, 1940, issue of RADIO. He had ½ watt input to a 1G4G, which is 180 miles per watt.

2½ Meter Rigs

W8CIR has 250 watts crystal controlled on 2½, which should be a contribution to possible dx to someone at a distance from Pittsburgh.

W9IOD in Elmhurst, Illinois, is building a 112-megacycle superhet to use on schedules this winter with W8CVQ in Kalamazoo. IOD uses crystal control and horizontal antenna.

W6QLZ put up a vertical Yagi but replaced it with three half waves colinear, with reflectors, giving him 12 db gain over a half wave, he says. It is reported that this came down in favor of an 8 element vertically polarized array. W6OVK has been unable to hear Clyde's signals on vertical antennas. Only an extended double zepp has been used by Jim, who will replace it with something else before deciding that *only* horizontal polarization can get over the 107 miles and the mountains between these two stations. OVK has a horizontal antenna with 51" reflector, 48.75" radiator, 47" first director and 46.75" second director. The 1½" line is fanned out for 18" and is jumped across 13" of the radiator. Jim says that the first director is much hotter than the antenna, with the second director and antenna checking about the same in voltage and current. He uses it on 113.5 megacycles where it is reported to have an 8R front-to-rear ratio. A new 2½ and 1¼ meter mobile rig at W6QLZ uses HY615's modulated with a 6V6. The receiver uses 9003 r.f. and 955 detector (he could have used the 9002 triode for the detector if he had it) plus audio. Clyde found that he got more output but less stability from a coil compared with rods, the reduced output apparently resulting from the radiation from the shorting bar; this can be reduced by spacing the rods closer.

W3IUN in Washington is reported to have a crystal controlled 829 on 2½, and a good location. He does not hear those who hear him quite a way out. A goodly share of the other stations in town have broad wobbled signals on the band as yet.

Goodbye until next month; don't forget to send in the news, photographs, hints and kinks.

HALF A SEC OLD MAN...I'LL SHOOT UP TO 160 METERS



Work them wherever you get through best . . . as easy as tuning a receiver!

P. R. MALLORY & CO. INC.
MALLORY

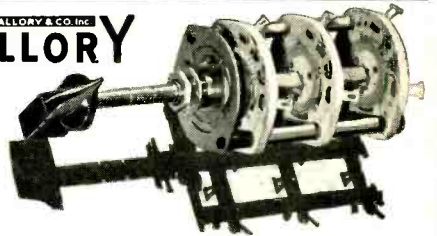

HamBand Switches

Band switching is easy when you use Mallory HamBand switches. Type 160C is designed especially for amateur service. It affords many exclusive, high efficiency features and assures long satisfactory life. Enjoy all the benefits of amateur radio transmission by making your rig flexible. Write for Form Y-646 which gives complete technical details.

P. R. MALLORY & CO. INC.
MALLORY

PUSH BUTTON
Switches for
Many Purposes

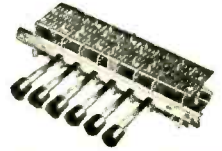

For meter switching and many other purposes, Mallory Push Button Switch Type 2190 offers a great many desirable features. Multiple circuits may be read with a single meter by merely pushing a button. In each case the other circuits remain closed and uninterrupted.

P. R. MALLORY & CO., Inc.
INDIANAPOLIS INDIANA
Cable Address—PELMALLO

Use

P. R. MALLORY & CO. INC.
MALLORY
APPROVED
PRECISION PRODUCTS

Yarn of the Month
[Continued from Page 61]

mate, then took his three men to the heaving boat at the side. The gunners trained their guns menacingly and seamen took up their stations with pistols and tommy guns.

Inside, McCaskill could hear all this and even see the schooner's shiny mast swinging rhythmically to and fro. With determination he continued his watch on the receiver.

When the *Pinafore's* boat reached the schooner's side, the man in white threw Cap-

tain Durham a rope and stood mockingly by as he and the three men forced their awkward ascent up the plunging vessel's side.

Durham was angered by the man's inconsiderateness. "Haven't you a ladder on this tub?" he asked scornfully, not waiting for an answer. "Show us below!"

The search below revealed precisely nothing. There was only a cargo of copra, some left-over bargaining goods, sailors' gear, and a cat with a litter of kittens. No sign of a wireless layout or firearms. Seemingly no hidden compartments.

Durham returned to the deck and scrutinized the rigging carefully. There were no wires up there; nothing but rope and sails flapping idly in the breeze.

The air seemed very still. Only the creaking of ropes taut in their blocks and the restless slap of water against the hull disturbed the silence. The man in cotton, with his men gathered quietly behind him, smiled blandly. "You see we have nothing to conceal," he said suavely.

Durham still felt a little suspicious. The man was quite fair, but so were many of the English; flaxen hair and blue eyes did not necessarily brand the man as German. His English was perfect, too. So Durham began an apology.

In the radio room McCaskill sat up in sudden discovery. A shrill steady whistle, certainly very close, was rasping into the telephones. He tuned across it carefully, noting the ease with which the buzzer picked it out of the static. Then it abruptly shifted frequency. McCaskill followed it closely as it swept across the dial.

There could be no doubt of it: it was the detector of a regenerative receiver close by, being tuned carefully across the band. He tore the telephones from his head and rushed out onto the deck, waving his arms frantically at Captain Durham, now descending to the *Pinafore's* boat.

"There's a radio on that ship!" McCaskill yelled, "I know it! I can hear it!"

Durham looked up startledly. A murmur of excitement broke from the crew, and the men on the schooner stirred uneasily.

Durham was puzzled. He yelled back across the water questioningly. "But you must be mistaken. We found nothing!"

McCaskill waved his arms in desperation toward the shiny duralumin mast. "There's your aerial!" he yelled hoarsely. "That metal mast!"

After the man in white and his crew had been taken prisoner, and the schooner had been commandeered, Captain Durham congratulated McCaskill warmly.

"But tell me," he said, "how you fathomed the existence of their wireless. It was hid-

[Continued on Page 91]

ELECTRONIC PROBLEMS

**quickly
accurately
SOLVED**

with the help of latest data on electronic devices, developments, theory—given in this new book.



**Just Published
ELECTRONICS**

By J. Millman and S. Seely
Dept., Elec. Engineering, C.C.N.Y.

699 pages
illustrated, \$5.00

COORDINATING the physical theory of electronics and the theory of operation of electronic devices, this book systematically presents a lucid and well-rounded explanation of basic electronic principles together with their applications to many problems in electrical engineering and physics. General considerations of both vacuum and gas filled electronic devices are included.

Theoretical and practical aspects of electronics are treated side by side with the point of view of either the physicist or the engineer predominating, depending upon which is the more appropriate for the particular topic under survey.

The many diagrams, sketches, photographs, curves plotted from laboratory data, oscillograms, and the numerous illustrative examples make possible an especially clear understanding of how the theory is applied to specific problems.

UP-TO-THE-MINUTE

Based on present-day developments, considerable attention is given to material that is of commercial importance, including television pick-up devices, secondary emission multipliers, cold cathode gas triodes, vapor and fluorescent lighting, controlled rectifiers, modern photocells, etc., etc.

FOR 10 DAYS' FREE EXAMINATION SEND COUPON

McGraw-Hill Book Co., Inc., 330 W. 42 St., N. Y.

Send me Millman and Seely—*Electronics* for 10 days' examination on approval. In 10 days I will send \$5.00 plus few cents postage or return book postpaid. (Postage paid on orders accompanied by remittance.)

Name

Address

City and State

Position

Company R. 11-41

(Books sent on approval in U. S. and Canada only.)

"Potgut" Oscillator

[Continued from Page 48]

Field strength measurements are now being undertaken and preliminary results are most encouraging. One disadvantage is that the device was erected a few miles from the home location in rich black soil, which, although practically perfect for ground conductivity, makes for awkwardness during the rainy season as far as continuous tests go. Another drawback was that "picnickers" thought it a huge ashcan and invariably attempted to deposit things into it, which did it no good fast. A small supply of padlocks eliminated this complaint.

Originally, the first model was set up in the backyard at W5AJG, but after only a few days testing, the xyl (W5JKM) emphatically avowed that it turned the wash a "tattle-tale gray" and pressure was brought for its subsequent removal. Of course, this was all tish and nonsense, and firm negotiations are now under way for its transfer back to the original site. (Failing this, the potgut will be controlled by a 400-Mc. circuit from the permanent QTH.)

Anyone desiring further details on the oscillator would be advised to take it easy and forget about the whole thing for the time being.

• • •

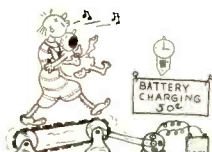

BE PRACTICAL—EARN WHILE YOU LEARN!

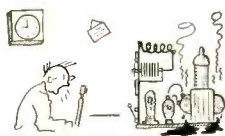

SET SKEDS FOR FEEDING TIME—BOTTLE WARMERS COST MONEY!

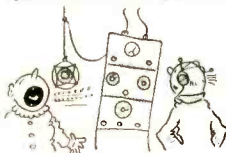

CHECK THE RIG OFTEN WITH FULL RANGE AUDIO



BE A PAL (WHEN THE XYL DEMANDS)



EXCESSIVE LOW ANGLE RADIATION IS VERY COMMON



IN SOME CASES THE ONLY SOLUTION IS A TOP LOADED ANTENNA

Bringing Up the Junior Op.

MEMO TO:

All Signal-Shifter Users

NOW is the time to complete the exciter of your transmitter!



By adding the "SIGNAL SPOTTER"

Your Signal Shifter was the best investment you ever made for the improvement of your station! It's ability to place a T9X signal on any frequency is worth real dough! It's still mighty convenient, tho, to switch back to spot-frequency operation with crystal control—for "band-edge" operation, Army and Navy networks, traffic skeds, etc. The Signal Spotter provides excitation on four fixed frequencies; has sockets for four mounted crystals, selected by a switch on the panel. Connects to the Signal Shifter by handy cable in rear and matches it perfectly in size and finish. Don't wait until it's too late—see your Jobber TODAY!

SIGNAL SPOTTER, Complete with tubes, Model 9-1044. Amateur Net . . . \$24.75

Write for Free Complete Catalog!

Dept. A-11



A Parallel T for Amateur Use

[Continued from Page 15]

You CAN do something about all that racket---

If you want to reduce those extraneous noises—bring out signals previously unintelligible—if you want to check most forms of radio noise at their source then this book is for you.

Describes the most frequent types and sources of noise and tells how to eliminate them. When elimination is not practicable, then you can modify your equipment with one of the several noise-limiting and noise-balancing circuits described.



All operations are described thoroughly—the theory as well as constructional details and methods of application.

Get your copy today at your local radio parts dealer. If he doesn't have it in stock, order direct from us.

35c in U.S.A. Postpaid 40c elsewhere

THE EDITORS OF **RADIO** 1300 Kenwood Road, Santa Barbara CALIFORNIA

the horizontal type and will necessitate the use of the tuned transformer. Careful use of the parallel T will go a long way toward taking the guesswork out of matching up the antenna and transmission line. The impedance measuring set can be set up at the transmitter end of the transmission line, and the antenna impedance transforming device adjusted until the measured impedance is equal to the characteristic impedance of the line.

With reference to experimentation, a great many things can be learned about the characteristics of filters and networks which are not always too apparent from text book studies, and the truths grasped will add greatly to the student's understanding of what he reads.

The parallel T measures parallel components, and if it is desired to know the series components, they must be derived by formula.

$$Z_s = R_x + jX_x = R_x X_x^2 / (R_x^2 + X_x^2) + jR_x^2 X_x / (R_x^2 + X_x^2) \quad (7)$$

where the subscript x denotes parallel components, and y the series components. It should be noted that if either of the parallel components is infinite, the corresponding series component is zero, furthermore the remaining parallel and series components are equal.

Bibliography

- "Bridged T and Parallel T Null Circuits," W. N. Tuttle, *Proceedings I.R.E.*, Jan. 1940.
- "Impedance Measurements at 30 Mc.," D. B. Sinclair, *Proceedings I.R.E.*, July 1940.

• • •

The narrowest ham band (160) is twenty times smaller than the widest (1 1/4).



"I told you the hidden transmitter wasn't a water-cooled job."

Yarn of the Month

[Continued from Page 88]

den superbly, and I must say your shrewdness was uncanny!"

"Well, sir," McCaskill explained, "of course they wouldn't operate their transmitter with us in sight, but I had another chance to depend on. I reasoned that the mast could be used for a radiator, and as a marconi with its height it was logical to expect the wavelength used to be somewhere around one hundred meters—an excellent spot for the type communication required to communicate with the pocket raider. As a Hertz, it would enable them to work on about fifty meters or twenty-five meters, permitting them to work around the world."

It was deep for the Captain, and he knitted his brows with a proudly perplexed smile.

"A receiver," McCaskill said, "can be heard for a short distance exactly like a transmitter. I assumed that they would be in tune constantly, probably on the lower frequency, and hence would be detectable."

McCaskill knew his explanation meant very little, grinned, and went on. "I knew too that our own receiver might give us away in the same manner, giving the operator time to turn off his receiver before I could make certain. So I dragged out the old crystal detector, which couldn't possibly have given us away, and the rest was inevitable."

Captain Durham sighed with relief as McCaskill finished. "Mr. McCaskill," he said, "with your knowledge you should be on a capital ship. I shall see to it that you receive a hearty recommendation for promotion and proper stationing!"

McCaskill felt a strange weakness in his knees at Captain Durham's words. All he could say in reply was, "Thank you, sir. Thank you!"

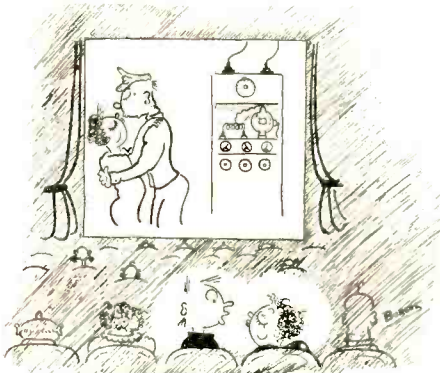

"I tried the same hookup and got a pink slip."

How Many Milliampere per Bird?

Puzzled by unorthodox increases in the plate current of the final amplifier at WMRC, Walter Neal Pike, an engineer on the staff, investigated and found the cause to be a flock of English sparrows "parked" on the station's transmission line.

Twenty sparrows caused an increase of 20 milliamperes. Therefore: one sparrow—one milliampere increase. Since no salt was available, the current increase per gram of sparrow meat was not obtained.



Individually
TESTED!

Paper tubulars in colorful yellow, black and red label wrappers.

Heavily waxed jackets and generous wax-sealed ends for protection against moisture.

Conservative voltage ratings for longest service life.

In 400, 600, 1000 and 1600 v. D.C.W.

In popular capacities from .001 to 1.0 mfd.

Also other paper condenser types such as metal-can wax-filled paper units, oil-filled can types, oil-filled paper tubulars, bakelite-case paper units, high-voltage oil-filled transmitting capacitors, etc.

• Yes, even these inexpensive paper tubulars by Aerovox are individually tested. And we mean *individually* tested—not a percentage test nor a spot check, but each and every paper tubular is tested.

That's true of every Aerovox condenser whether it be a ten-dollar transmitting capacitor or a ten-cent paper tubular. Each and every Aerovox condenser is thus pre-tested for your convenience, your rig's performance, your pocket-book.



Ask Your Jobber . . .

Ask for these individually-tested Aerovox condensers, so that you can build with confidence. Ask for our latest catalog—or write us direct.



With the Experimenter

[Continued from Page 66]

U.H.F. TRANSMISSION LINE

By **ELLSWORTH O. DUMAS, ***
W8LE

The accompanying diagram illustrates a low-impedance transmission line worked out primarily for use on the 56- and 112-Mc. bands. The line is comparatively easy to construct, has very little radiation from its length, and is quite low in characteristic impedance (the facilities for making a determination of the actual value of impedance are not available). A transmission line of this type has proven to give an unusually good transfer of energy to a 3-element or 4-element close-spaced array when coupled as shown in the drawing.

The feeder spreaders are cut from 3/8-inch diameter polystyrene rod, each spreader being about 2 3/4 inches long. Then the four clearance holes for the No. 12 enamelled wire which makes up the line are drilled. The outer wires

*Scottville, Michigan

are spaced 2 1/4 inches, and the inner wires are spaced 3/8-inch in from the outer ones. Then both ends of the spreaders are tapped to take a 6-32 set screw which is to hold the outside wires taut.

The spreaders should be spaced about every foot or so to keep the wires in their places along the entire line. If the feeder length is

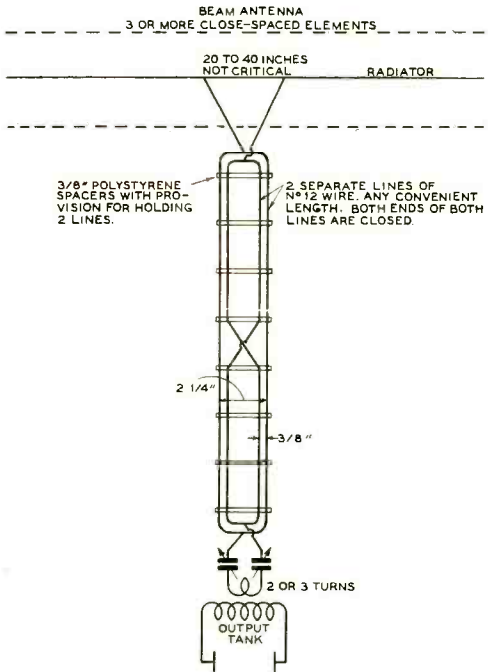

Low-impedance low-radiation u.h.f. transmission line.

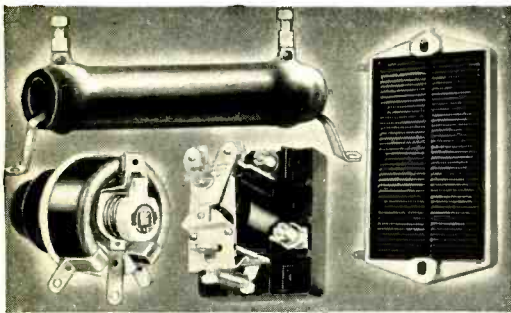

Relays • Resistors • Rheostats

The oldest and most complete line on the market for service and amateur use. Proven dependability and conservative ratings. You are not experimenting when you install Ward Leonard items . . . you know they are right.

WARD LEONARD ELECTRIC COMPANY

43 South Street, Mount Vernon, N. Y.
Please send me Circular 507 covering Relays, Resistors and Rheostats.

Name

Street

City and State

Call Signal

more than a half wave it is advisable to transpose the inner set of wires about in the center as indicated on the drawing. Although quite a lot of elbow grease is required in drilling and tapping all the spreaders, and in threading the spreaders on the wires, the reduction in undesired radiation loss caused by the close spacing of the wires in the line makes the labor entailed seem well worthwhile.

• • •

An interesting new application of electronic technique in the automobile and internal combustion engine industry is the new method of dynamically balancing crankshafts. A vibration pickup is mechanically coupled to the rotating shaft. The output of this pickup is coupled through suitable amplifying and controlling devices to a special lathe which takes off just enough metal in the proper spot to eliminate the vibration in the rotating shaft.

Transmitter Interference Elimination

[Continued from Page 31]

in on the antenna, a parallel tuned trap mounted in a shielded box screwed to the back of the receiver case may eliminate the trouble. If several transmitter frequencies are being used, several filters may be placed in series and tuned to each of the interfering frequencies. If the interfering transmitters operate at a much higher frequency than that to which the receivers are tuned, as is the case where separate receivers are used in the ultra-high and medium-frequency ranges, it may be possible to install a low-pass filter in the antenna lead. An efficient form of such a filter, and one which will not reduce the sensitivity of the receiver appreciably, is a small radio-frequency choke, such as the Ohmite Z-1, in series with the antenna.

If it proves too difficult to prevent the signal from entering the receiver case, it will be necessary to attempt to eliminate the signal at the point which it affects. The affected point may often be located by removing the tubes, one at a time, starting at the antenna end of the circuit. When removal of a tube reduces the interference, it indicates that circuits associated with that tube are causing some of the trouble. Additional shielding on some of the tubes or coils may be needed. Replacement of glass tubes with the single-ended metal equivalent often provides better shielding. This is particularly true of low-level stages, either audio or radio frequency. It may be necessary to shield some of the wiring to prevent its picking up signal that can be fed to some portion of the circuit in which rectification may occur.

Other Helps

Small radio-frequency bypasses on the plates and grids of the audio tubes may help reduce the interference. They should be close to the points affected. If grid-leak bias is used on some of the audio tubes, as is done in lower price receivers, it may be helpful to install smaller grid resistors and bias cells to reduce rectification in these circuits. Radio-frequency chokes in series with leads to affected tubes are often useful. To be most effective, these chokes also should be close to the points affected.

When one serious point of interference is corrected others will show up. However, a systematic investigation of a receiver and elimination of one point at a time will make possible complete elimination of interference from signals at frequencies other than those to which the receiver is tuned. This has been proved possible by the reduction of interference in receivers placed in a field of over 30 volts

per meter. With 150 volts of unwanted radio frequency at the receiver antenna terminal it has been possible to reduce the unwanted signal to a point below the no-signal noise level of the receiver.

Sweepstakes Exciter

[Continued from Page 29]

Two voltage regulator tubes are used to obtain good voltage regulation. Some variation may be needed in the values of the resistances used in conjunction with these tubes if the supply voltage is other than that shown.

The voltage in this power supply was 250 after filter. This is ample for most needs but if higher output is desired, a higher voltage power supply should be used. With 325 volts, the output may be increased as much as 75%.

Construction

Everyone has his pet method of constructing and wiring equipment, but here are a few pointers that will make this particular unit easier to build. First, all parts are laid out on the chassis and panel and mounted. The heaters were wired in first. The power supply was completed and tested. Then the voltage regulator tubes and then the oscillator was wired and tested for oscillations and band coverage. This should be from 1745 to 2050 kilocycles. Next, the buffer stage was wired and tested for output.

It must be noted that the shield must be placed in last and that wiring must be so grouped as to permit the shield to go into the chassis. In our case, all the wiring was grouped and laced before the shield was put in.

Getting back to the wiring, the cathodes of the output stages were color coded and taken out of the chassis to the top of the panel and then to the bandswitch. Then the screens of the output stages were wired in. The number 6 pin on the octal sockets of the output is used as a tie lug for the coil, plate voltage and the padder condenser lead, and also for the plate by-pass condensers. The by-passes on the plates and screens are staggered, that is, the plate on the 160-meter stage is by-passed while the screen is not and on the 80-meter stage the screen is by-passed while the plate is not, and so on. This holds true except that on the 20-meter stage both screen and plate are by-passed.

Shielded wire is used for all the link leads which are taken to the band switch and for the switched output. This switched output is taken with shielded wire to the back of the chassis and to the terminal strip. The grid coupling condensers and grid resistors were wired in last.

The 6 volts from the filament circuit was taken to the switch where it is used to light the correct panel light indicator. All the contacts on the switch were color coded with plastic enamel paint, which is used to touch up plastic radio cabinets. This makes the wiring easy.

Having had the oscillator lined up to the proper coverage and the buffer stage in working order, we are ready to go ahead in the lining up of the output stages.

With the oscillator on 1850 kc. the 160-meter output stage is lined up for maximum output. The resistor in the plate circuit of this stage should make the tuning very broad. A wavemeter is very helpful for lining up this exciter, but is not absolutely necessary.

The second stage (80) is tuned to 3700 kc. with the oscillator still at 1850 kc. No trouble should be experienced in lining up these stages. The third output stage is tuned to 7100 kc.

with the oscillator set at 1775 kc. The next stage (20) is tuned to 14,200 kc. with the oscillator still at 1775 kc. Although this stage is not "flattened" out by a resistor, the output should be fairly constant from 14,000 kc. to 14,400 kc. The 10-meter stage is peaked up at 28,400 kc. with the oscillator still at 1775.

Some trouble may be had in aligning the 28-Mc. stage to the proper frequency. If there is oscillation in this stage with the key up, it is tuned to the same frequency as the preceding stage. If the output is very low, chances are it is tuned to 56 Mc. This same applies to the 5-meter stage. It is here that a wavemeter will be most useful. This stage (5) is set for maximum output in the 5-meter band with the oscillator set at 1775 kc. By maximum output we mean the output obtained at the link output terminals at the back of the unit.

The last thing to put on is the dial cord after all the wires have been grouped and laced. Ordinary linen cord was tried but found to have too much "give," so phosphor bronze dial cord was used.

This unit puts out about 1½ watts on all frequencies, (with 250 volts) and makes an excellent exciter for any transmitter.



Now at last—more comprehensive—more understandable—the very latest data on

F M

Theory . . . Receivers . . . Transmitters . . . will be found in the new 1942 "RADIO" HANDBOOK on sale in about a week at your dealer.

Engineers and amateurs alike will find this to be a virtual summary of today's information on frequency modulation. As such, it will be invaluable to you.

Complete — Up-to-Date — Understandable

THE EDITORS OF **RADIO** 1300 Kenwood Road, Santa Barbara CALIFORNIA

Postscripts and Announcements

[Continued from Page 86]

We have also added to our list lately our old and active friend, Dock Pickard, W1FUR, born Feb. 14, 1877. Old-timers, if you are 50 years old and over just write your date of birth and year on your card and send it to W1JIS, 46 Beal Court, Rockland, Mass.

Pacific Division Convention Fresno, Nov. 8-9

The Pacific Division Convention, sponsored by the San Joaquin Valley Radio Club, Inc., will be held in the Hotel Californian in Fresno, November 8-9. Registration fee will be \$3.30, including tax, which will admit ticket holders to all events.

Transportation will be furnished for a visit to Friant Dam and to the famous Roma Winery, special entertainment for the ladies, a dance and floor show, technical talks, code speed contest, hidden 2½-meter transmitter hunt, and other interesting features. The convention will be finished off with a banquet Sunday afternoon.

• • •

The first frequency standards were tuning forks.

The Marketplace

Classified Advertising

(a) Commercial rate 10c per word, cash with order; minimum, \$1.00. Capitals: 13c per word. For consecutive advertising, 15% discount for 3d, 4th, and 5th insertions; 25% thereafter. Break in continuity restores full rate. Copy may be changed as often as desired.

(b) Non-commercial rate: 5c per word, cash with order; minimum, 50c. Available only to licensed amateurs not trading for profit; our judgment as to character of advertisement must be accepted as final.

(c) Closing date (for classified forms only): 25th of month; e.g., forms for March issue, published in February, close January 25th.

(d) No display permitted except capitals.

(e) Used, reclaimed, defective, surplus, and like material must be so described.

(f) Ads not relating to radio or radiomen are acceptable but will be grouped separately.

(g) No commissions nor further discounts allowed. No proofs, free copies, nor reprints sent.

(h) Send all Marketplace ads direct to Santa Barbara accompanied by remittance in full.

QSL's. SWL's—Free samples. Theodore Porcher, 7708 Navahoe, Philadelphia, Penna.

BOB HENRY, W9ARA—has NC-200s, HQ-120Xs, SX-28s, SX-25s, SX-32s, S-29s and World's Largest Stock of all makes and models amateur receivers and parts for immediate delivery at lowest prices. He offers you more and better deal always. Best terms (financed by ourselves); largest trade-in; free trial; personal cooperation; 100% satisfaction. Write, telegraph, telephone. Henry Radio Shop, Butler, Missouri.

PANELS, CHASSIS, CABINETS—Portable cases, racks, specials. R. H. Lynch, 970 Camulos, Los Angeles, California.

RECONDITIONED GUARANTEED—Amateur receivers and transmitters. All makes and models cheap. Free trial. Terms. List free. Write. W9ARA, Butler, Missouri.

WANTED—Old spark equipment such as transformers, quenched gaps, mica condensers, etc.; also good receiver, DB-20, mercury arc, synchronous and dry disc type rectifiers. W5KD, 215 N. W. 19th Street, Oklahoma City, Oklahoma.

CRYSTALS FOR ALL BANDS—160 to 10 power pak; 1000-100 kc. bar or frequency standard two stages, in cabinet with A batts. Write W8KJ for details. 5050 Grayton, Detroit, Michigan.

HENRY RADIO SHOP—has a new branch store at 2335 Westwood Boulevard, West Los Angeles, Calif. Let's get acquainted. Your inquiries invited.

NEW AND USED—Katolight Plants, 300 watts through 10,000 watts, \$42.00 upwards. Write Katolight Corporation, Mankato, Minnesota.

"WANTED...."

back issues of RADIO"

Every day we receive orders for back issues. Don't take chances on *your* file. Keep your copies together in a "RADIO" Binder—handsome red imitation leather, gold-stamped. Each binder holds a full year's supply.

Each issue, too, can be removed if necessary for reference work. At your dealers—or direct from us.

\$1.50 in Continental U. S. A. Elsewhere \$1.75
Postpaid

EVERYTHING IN RADIO FOR ALL YOUR NEEDS



This one big book serves your entire requirements. It includes sets, parts and supplies, public address systems, amateur equipment, testers, kits and fluorescent lighting... the nationally known favorites at lowest possible prices. Our prompt, efficient service will please you. Write today and get your copy of this....

BIG FREE CATALOG

BURSTEIN-APPLEBEE COMPANY
1012-14 MCGEE STREET, KANSAS CITY, MO.

THE EDITORS OF
RADIO 1300 Kenwood Road, Santa Barbara
CALIFORNIA

The Amateur Newcomer

[Continued from Page 72]

the paper from the chassis, using a cloth rag to hold on to the chassis. Then clean the burrs from the newly drilled holes, using a larger drill, a knife, or a chisel. When this job has been completed it is time to get out the cleanest paint brush available and some clear lacquer. In case you have not used

clear lacquer it will pay you to buy some, as you will more than likely use it hereafter after the finished product is inspected. The lacquer keeps the units neat and clean and discourages rust and corrosion. Both chassis top and underside should be painted, as it is a poor policy to solder to the chassis anyway.

The next move is to bolt all the components onto the chassis and panel and start wiring. The mike plug is insulated from the chassis. There is, in fact, only one ground on the entire amplifier. This ground is at the socket of the 6SJ7 first stage. A bus wire is run from this ground point at the 6SJ7 to an insulated tie point at the other side of the chassis. All grounds return to this common bus, including the shields on the shielded leads that run up through a grommet on the chassis to the volume control. The use of a single ground point on the chassis goes a long way toward eliminating hum and r.f. pickup in an amplifier of this type. Another point to observe in constructing a high-gain speech amplifier is *not* to use a power transformer of the half-shell type which mounts through a large hole in the chassis. The eddy currents which flow through the chassis when a transformer of this type

[Continued on Page 98]

NEW W.A.Z. MAP

This DX map has been accepted by amateurs as the standard of measurement of DX work. Six great-circle maps enable you to determine the circle-direction and distance to any point on the globe, without calculations. Send 35 cents today for your copy.

THE EDITORS OF **RADIO** 1300 Kenwood Road, Santa Barbara
CALIFORNIA

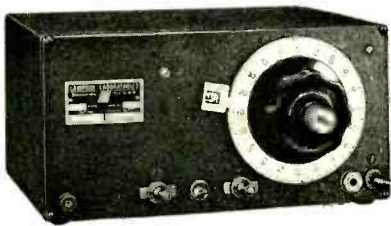

for
**POLICE,
AVIATION,
RELAY-BROADCAST**

stations, the Micrometer Frequency Meter will monitor one or a dozen transmitters, on any frequencies up to 56 mc., with accuracy 0.01%. Two models, priced \$90.00 and \$135.00, net. Write for details.

LAMPKIN LABORATORIES
— Bradenton, Fla. —

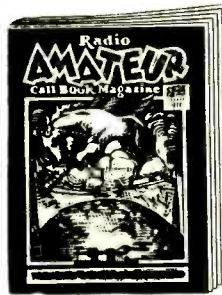

**Buy a Fresh
Copy Today
of the**

**RADIO
AMATEUR
CALL BOOK**

ISSUED QUARTERLY

March . June . September . and
December

Annual Subscriptions \$4.00

Single Copies \$1.25

**Bold Face Listing of your QRA \$1.00
for a year. Three years \$2.00**

RADIO AMATEUR CALL BOOK

608 South Dearborn St.
Chicago, Illinois, U. S. A.

Buyer's Guide

Where to Buy It

ROTHMAN V.F.O. AMPLIFIER

Page 8

C₁, C₂—Bud MC-905
C₃—Bud MC-912
C₄—Bud BC-1629
C₅, C₇, C₈—Solar MW-1235
C₆—Sprague TC-1
C₉—Solar XM-6-25
C₉—Cornell Dubilier KR504
C_N—Bud NC-892
807 grid return condenser—Solar MP-4129
R₁, R₂, R₃—Centralab 516
R₃, R₄—Ohmite Brown Devil
R₅—Ohmite 0580
RFC—Hammarlund CH-500
S₁—Centralab 2511
SO₁, SO₂—Amphenol S4
J₁, J₂, J₃—Amphenol PC1M
J₄—Mallory Yaxley A-2
L₁—Bud OLS
L₂—Bud VLS
T₁—Thordarson T-19F94
T₂—Thordarson T-19F97
T₃—Thordarson T-13R12
TU₁—Bud OCS-2
TU₂—Bud OCS-2
CH—Thordarson T-13C28
Tubes—RCA and Taylor
Dials—Bud

McLAREN PROBE RECTIFIER

Page 41

C₁—Aerovox 1450
C₂, C₃—Aerovox 1467
C₄—Solar S-0257
C₅—Solar S-0240
R₁, R₂—Centralab 710
R₃—Centralab 52-206
S—Part of R₃
Tubes—RCA
Battery—Burgess 5360
Plug—Amphenol
Jacks—Mallory Yaxley 418, 419
Metal box 4 1/2" x 5" x 5"
Wood box 4 1/2" x 5" x 3"
Brass tube 1 3/4" in diam., 7" long

TAYLOR PORTABLE TRANSMITTER

Page 32

C₁, C₂—Bud MC-396
C₃ to C₇—Solar type MW
C₁₀, C₁₁—Solar VIM-7
R₁, R₄—Ohmite Brown Devil
RFC_{2, 3}—Hammarlund CHX
T—Thordarson T-7543
VIB—Mallory 253-Y
Chassis & Cabinet—Bud CA-1750

DAWLEY SPEECH AMPLIFIER

Page 52

C₁, C₄—Cornell-Dubilier BR-252-A
C₂, C₆, C₈, C₇—Cornell-Dubilier DT
C₃, C₅, C₉—Cornell-Dubilier BR-845
1/2-watt resistors—Centralab 710
R₁—Centralab 72-105
R₁₃—Ohmite no. 1022
T—Thordarson T-13R13
CH—Thordarson T-57C53
Cabinet—Par-Metal SF-502
Chassis—Par-Metal C-4513
Tubes—RCA

LINK UNIT-TYPE AMPLIFIER

Page 64

C₁—Bud MC-1882
C₂—National TMC-100D
C₃—Bud FA-781
Solar XM-6-22
C₁, C₄—Cornell-Dubilier 9-12020
C₆, C₇—Bud NC-853
C₈—Solar XM-25-22
L₁—National AR-16
L₂—Bud VLS Series
Sockets—National Isolantife
RFC—Bud CH-569
Insulators—Bud: 4, I-304; 4, I-300; 5, I-738; 4, I-7507

MAILING LISTS



GET OUR FREE
REFERENCE
BOOK and
MAILING
LIST CATALOG

FREE

Gives counts and prices on accurate guaranteed mailing lists of all classes of business enterprises in the U. S. Wholesalers—Retailers—Manufacturers by classification and state. Also hundreds of selections of individuals such as professional men, auto owners, income lists, etc.

Write today for your copy

R. L. POLK & CO.

Polk Bldg.—Detroit, Mich.
Branches in Principal Cities

World's Largest City Directory Publishers
Mailing List Compilers. Business Statistics. Producers of Direct Mail Advertising.

The Amateur Newcomer

[Continued from Page 96]

is used can cause a considerable amount of grief in the form of difficult-to-trace hum.

Operation

No difficulty at all should be experienced in getting the amplifier into operation. The one illustrated is the fourth of this type that has been built for various speech-amplifier installations, and all four have

performed immediately as soon as the a.c. line was connected. The hum should be extremely low, there is ample gain for full output from the tubes when a crystal microphone is used, the 6A3's put out just slightly under 10 watts with negligible distortion, and the frequency response is substantially flat from 50 to 13,000 cycles—considerably more range than is needed for amateur and public address work, and ample for high-fidelity record and f.m.-a.m. radio reproduction.

• • •

T. Leaf is W3XPG. W1LBP is named *Obm*.

Kindly send me the items listed below for which I enclose \$..... in payment.

- "Radio" (five issues)
- "Radio" (one year)
- "Radio" (two years)
- "Radio" (three years)
- "Radio" Handbook
- "Radio" Amateur Newcomer's Handbook
- "Radio" Noise Reduction Handbook
- "Radio" Binder
- W.A.Z. Map (6 great circle maps)

Name

Call

Address

Note: All shipments are prepaid by us. Current editions are always supplied unless previous or future editions are requested in the original order. California and Illinois customers: please add sales tax.

Advertising Index

Aerovox Corp.....	91
Astatic Corp.....	79
Bliley Electric Co.....	85
Bud Radio, Inc.....	67
Burstein-Applebee Co.....	95
Centralab.....	81
Eitel-McCullough, Inc.....	83
General Electric.....	65
Hallicrafters, Inc., The.....	3
Henry Radio Shop.....	69
Hytronic Laboratories.....	II Cover
Johnson Co., E. F.....	73
Lampkin Laboratories.....	96
Malloy & Co., P.R., Inc.....	87
McGraw-Hill Book Co., Inc.....	88
Meissner Manufacturing Co.....	89
National Co., Inc.....	III Cover
Ohmite Manufacturing Co.....	75
Polk & Co., R. L.....	97
RADIO.....	77
RADIO— <i>Amateur Newcomer's Handbook</i>	84
RADIO— <i>Binders</i>	95
RADIO— <i>Handbook</i>	4, 5, 94
RADIO— <i>Noise Reduction Handbook</i>	90
RADIO— <i>Publications</i>	98
RADIO— <i>W.A.Z. Map</i>	96
Radio Amateur Call Book.....	96
R.C.A. Manufacturing Co., Inc.....	IV Cover
Solar Manufacturing Co., Inc.....	94
Taylor Tubes, Inc.....	71
United Catalogue Publishers.....	86
Ward Leonard Electric Co.....	92

THE EDITORS OF **RADIO** 1300 Kenwood Road, Santa Barbara CALIFORNIA

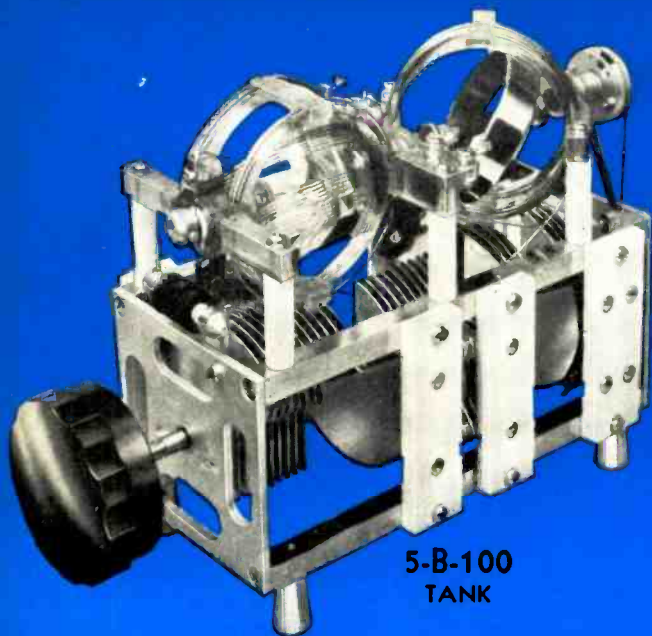

**5-B-100
TANK**



**AL
DIAL**



**AO
DIAL**

THE NEW 1942 CATALOGUE

Better get your copy of the new National 1942 Catalogue. It shows the 5-B-100 Tank which tunes through five amateur bands without plug-in coils. It uses variable inductances as well as a variable condenser, so that the L/C ratio remains at the correct value for all frequencies, in spite of the wide range. It is a convenient, compact and economical solution to your tank circuit problems.

You will find other new products you will like, such as the AO and AL Dials and the little MS Condenser. You will find old friends in new dress, like the revamped NSA Amplifier. And last but not least, you will find the NC-45 Receiver which is new to the Catalogue, if not new to Radio's readers.



**NSA
AMPLIFIER**



**NC-45
RECEIVER**

NATIONAL COMPANY, INC.

MALDEN, MASS., U. S. A.

They're Making TUBE HISTORY!

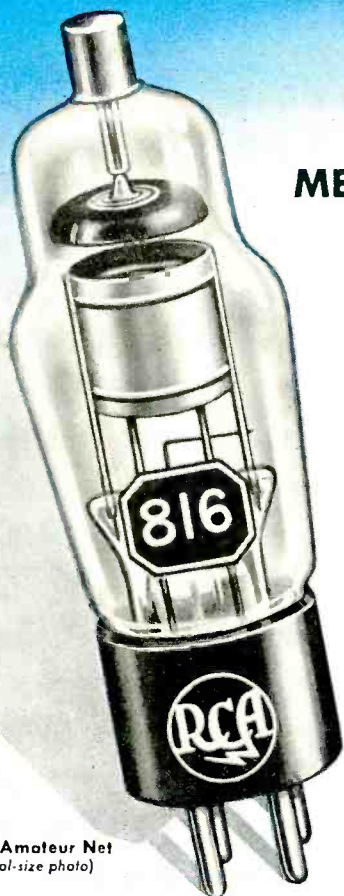

RCA-816 HALF-WAVE MERCURY-VAPOR RECTIFIER

"JUNIOR OF THE 866-A/866"

5000 VOLTS . 0.5 AMPERE

PEAK INVERSE VOLTAGE

PEAK PLATE CURRENT

The RCA-816 is the biggest little rectifier tube value RCA has ever offered—and that means a whale of a lot to those familiar with such outstanding developments of a few years ago as the 866-A and, still later, the famous 866-A/866. Designed for medium-power transmitters, the RCA-816 gives you plenty of rectified voltage at minimum cost. It's big enough by way of performance for any rig up to, say, 400 watts input—and it is physically small enough to fit in almost anywhere. Two RCA-816's in a full-wave circuit can deliver 1600 rectified volts at 250 ma.—at a total rectifier tube cost of only \$2!

\$1.00 Amateur Net
(Actual-size photo)

The NEW UHF MIDGETS

Real ECONOMY for UHF Applications

Similar to the well-known Acorn types, but considerably lower in price, these new UHF Midgets open a wide range of design and engineering possibilities to the amateur who likes to keep up with the times. You'll find them particularly applicable for use with high-efficiency, high-gain circuits at unusually high frequencies. They have glass-button stems which provide short leads and low lead inductance. Because of their small size and convenient button-type 7-pin base, they require an absolute minimum of space—and you can count on them for long life and real dependability.



(Actual-size photos)

RCA-9001 Detector, Amplifier (Pentode) Net \$2.50
RCA-9002 Detector, Amplifier (Triode) . Net \$2.00
RCA-9003 Super-Control R-F Amplifier (Pentode) . Net \$2.50



Transmitting Tubes

PROVED IN COMMUNICATION'S MOST EXACTING APPLICATIONS

RCA MANUFACTURING CO., Inc., Camden, N. J. • A Service of The Radio Corporation of America
For Canadian prices write to RCA Victor Company Limited, Montreal

