

OHM'S LAW

$$E = I \times R$$

$$R = \frac{E}{I}$$

$$I = \frac{E}{R}$$

CONDENSERS IN SERIES

$$C_{TOTAL} = \frac{C_1 \times C_2}{C_1 + C_2}$$

RESISTANCES IN PARALLEL

$$R_{TOTAL} = \frac{R_1 \times R_2}{R_1 + R_2}$$

BOTTOM VIEWS OF SOCKETS

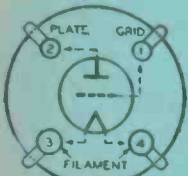

4-PRONG SOCKET
50-201-A, 45, 210, 30, 31, ETC.

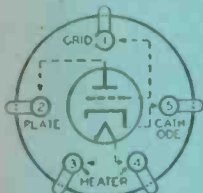

5-PRONG SOCKET
56-46-47-76-27-37

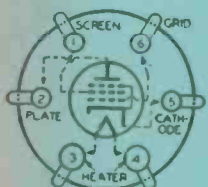

6-PRONG SOCKET
2A5-43-42-43

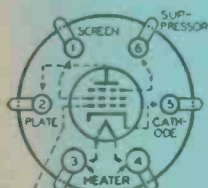

6-GRID-METAL TOP CAP
6-PRONG SOCKET
57-58-606-6D6-77-78

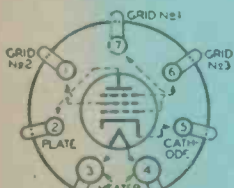

7-PRONG SOCKET 59

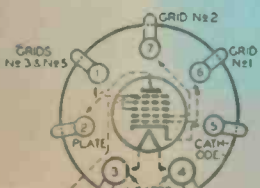

7-GRID-METAL TOP CAP
7-PRONG SOCKET
2A7-6A7

25c [^{30c} in Canada]

JULY, 1935

\$3.00 PER YEAR BY SUBSCRIPTION

RADIO

ESTABLISHED 1917

SHORT-WAVE AND EXPERIMENTAL

- IN THIS ISSUE -

W6CUH's 1936 Superheterodyne

High-Power C.W. and Grid Modulated Phone

The "20-40" Jones Receiver

125-Watt RCA Pentode Transmitter

A 10-Meter C.W. Transmitter

Parallel Rod Oscillators



"The 1936 Amateur Super," an advanced receiver using the new acorn tubes and many other interesting features. Designed and constructed by Chas. Perrine, Jr., W6CUH, this newest development will interest many DX hunters. Completely described in this issue.

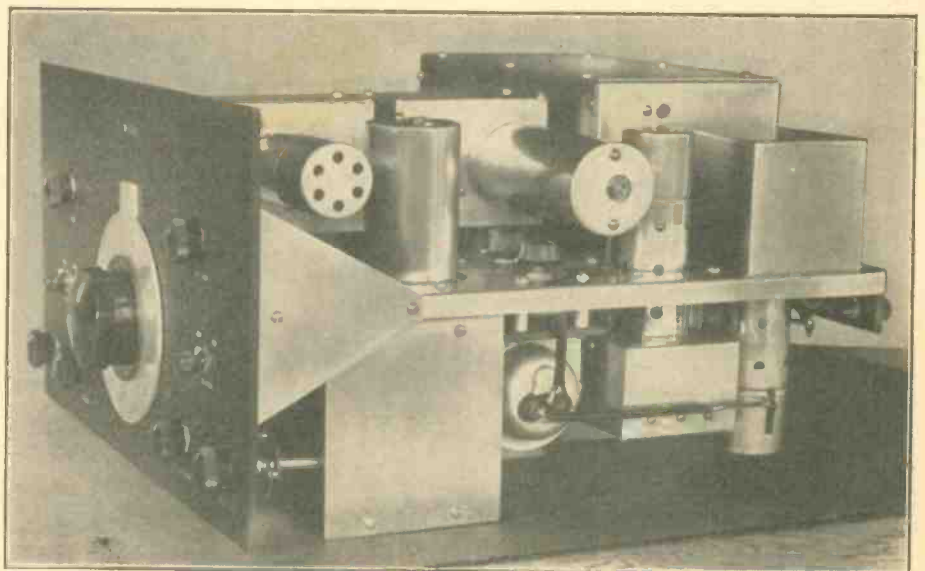

FEATURE ARTICLES BY ...

FRANK C. JONES - FRANK LESTER - COL. C. FOSTER
J. N. A. HAWKINS - FRANCIS CHURCHILL - CHAS. PERRINE, JR.

Continuously VARIABLE SELECTIVITY

Without Affecting Tuning

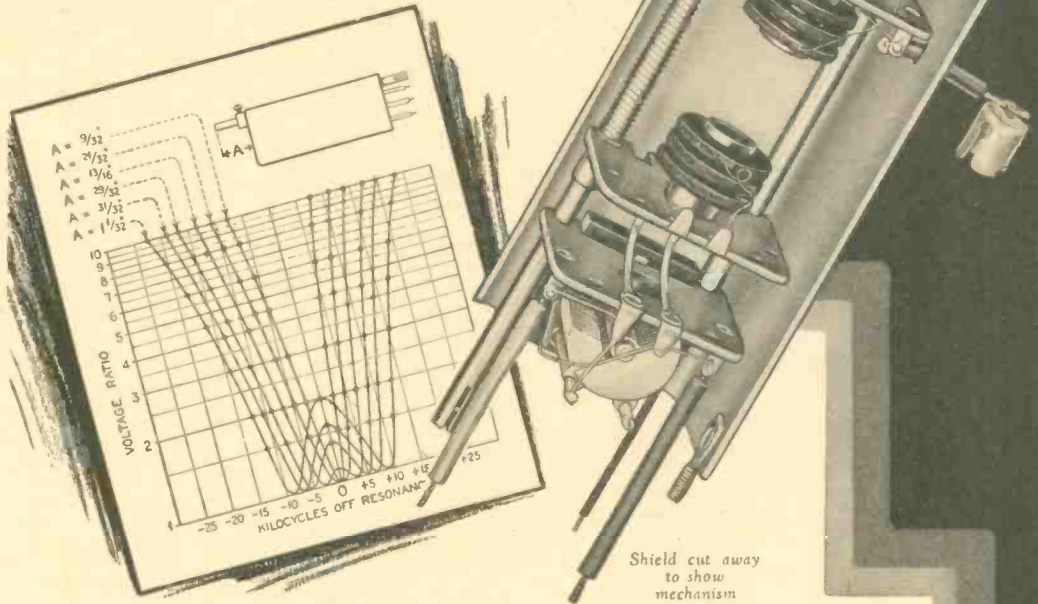

ANY range of coupling variation may be obtained in this new Hammarlund I.F. Transformer from approximately one-third critical coupling to three times critical coupling.

This means that your I.F. amplifier can be adjusted from needle-sharp selectivity to the flat-top curve required for high fidelity, or any degree of selectivity between—all with a mere twist of a panel knob—all without affecting tuning characteristics of the receiver.

The diagram illustrates the coupling range of a single transformer. Additional transformers having this feature will obviously increase the overall selectivity of the I.F. amplifier.

The variable coupling mechanism for panel control of up to four of these transformers is now available for the COMET "PRO" and other superheterodynes. Or, if preferred, the coupling in each transformer may be fixed at any desired point.

We believe this new transformer feature provides the greatest single improvement in receiver flexibility in recent years.

Transformers available for 465 kc. or 175 kc. List price, \$5.50 each. Variable-coupling mechanism for panel control of up to four transformers, \$2.50 list.

Mail Coupon for Complete Details and General Catalog



Canadian Office:
41 West Avenue North
Hamilton, Ontario



HAMMARLUND MANUFACTURING CO.
424-438 W. 33rd St., New York

- Check here for details of new Variable-Coupling I.F. Transformer.
- Check here for New General Catalog.

Name.....

Address.....

PR-7

BRANCH OFFICES:
New York City,
253 W. 128th St.
Tel. MOnument 2-2812
Boston,
J. H. Condon,
6 Marlboro St.
Chicago,
C. W. Nelson,
3618 North Bernard St.
Los Angeles, Calif.
1455 Glenville Drive.
Tel. CRestview 4017

RADIO

ESTABLISHED 1917

Reg. U. S. Pat. Off.

A NATIONAL MAGAZINE - PUBLISHED MONTHLY

Publication Offices—Pacific Building, San Francisco, California

H. W. Dickow, Publisher.

D. B. McGown, Technical Editor.
Clair Foster, Amateur Activity Editor.

Frank C. Jones, Engineering Editor
C. C. Anderson, Engineering Draftsman.

25c per copy, \$3.00 per year by subscription in the U.S. \$4.00 elsewhere. Send subscriptions to the San Francisco office. Entered as second class matter at the Post Office at San Francisco, California, under the Act of March 3rd, 1879.

Vol. 17

JULY, 1935

No. 7

Radiotorial Comment

"CORNERED"

MANY letters have come to us from thinking and experienced men in amateur radio inveighing against the impression sought to be conveyed by the author of the article headed, "Losses", on page 39 of QST for June, 1935. One of these men was a director during the years when the ARRL board was a self-appointed body. He makes no bones over calling the article by its right name.

Whether or not a statement is a lie depends upon the motive back of it. If the statement is made with no intent to deceive it cannot in all fairness be called a lie. It may be a deplorable untruth but if the relator has no intention to deceive and acknowledges his error then his transgression may be forgiven. On the other hand, a statement may accord with known facts and yet be the lyingest thing imaginable if it was made deliberately to create an impression contrary to the truth.

And a statement may be true so far as its actual wording goes but by deliberate avoidance of the whole truth still may be a lie. One of our immortals said, "Truth that is only half the truth is the biggest lie of all."

The intent of the author of "Losses" is to create in the mind of the reader the impression that the amateurs of America could not have suffered a series of losses in the waves below 150 meters because, he says, they never did have rights in that part of the spectrum until spokesmen for the ARRL secured them in the form of "substantial bands" at 80, 40 and 20 meters.

He states as a "fact" that only two international conventions, (Washington in 1927 and Madrid in 1932), have dealt with amateur radio. That is true only so far as the use of the word, "amateur", is concerned but it is not a "fact". Every radio convention that ever took place dealt with the case of amateur radio stations, but they were called "private" stations. So that saying amateur radio was not dealt with before these

two conventions is only half the truth—and a very small half, at that.

Parts of "Losses" are plausible if you accept the author's premise that the amateurs had no rights below 150 meters under the law of 1912, but the premise being untrue the conclusions must therefore be untrue. A writer can come to any conclusion that suits his purpose if you let him manufacture his own premise.

The premise of the author of "Losses" is that "since amateur licenses granted no right to transmit below 150" the amateurs had no rights in the territory below that wave. The falsity of this premise lies in the assumption that it was licenses issued by the Department of Commerce that granted rights. Well, licenses don't grant rights; only laws can do that. The law of 1912 specifically provided that "private" and non-commercial stations must be licensed by the Secretary of Commerce to use waves not exceeding 200 meters and an input not exceeding 1 KW. And the law gave the Secretary no authority to bar "private" (amateur), stations from using waves below 150 meters, and no authority to license commercial stations below 200 meters.

So when the amateurs gave up their right to use any and all waves below 200 they of their own free will gave up their rights under the only law that governed radio in the United States until the adoption of the Radio Act of February 23, 1927. And when they, "speaking through their authorized representatives", later agreed to accept of all this short-wave territory below 200 meters only some restricted bands at 150, 80, 40 and 20 meters they again gave up of their own accord their right under the law to be licensed anywhere below 200 meters.

After the adoption of the Radio Act of 1927 there was a case in the Court of Appeals that arose from the RCA and other radio corporations appealing from orders of the Federal Radio Commission. Section 16

of the Act required the Commission to file with the court a "Statement of Facts". The commission did so and their statement became a part of the printed record of the case. In one place in this Statement of Facts—referring to the amateurs—the commission tells the court:

"Prior to February 23, 1927, they were entitled to use the entire range of frequencies from 1,500 KC upwards. They were the first to make practical use of short waves and demonstrated their efficacy to the world by feats of the most dramatic character. Their contributions to the science of radio communication have only too often been the demonstration of the utility of frequency ranges only to arouse the desires of the commercial interests to deprive them of the use thereof. At the various National Radio Conferences, speaking through their authorized representatives, they offered to relinquish most of their territory for commercial development."

We have been told, (and it is altogether likely), that this particular section of the "Statement of Facts" was prepared by Mr. Paul Segal, a director of the American Radio Relay League, and at that time in the legal division of the Radio Commission. So we'll leave it up to Mr. Segal, now general counsel of the ARRL, to say which tells the truth—the QST article, "Losses", or the "Statement of Facts". If Segal should choose to back up his friend Warner by telling us that what the Federal Radio Commission told the court was not the truth that would be Mr. Segal's affair, not ours.

Next month we shall print quotations from Warner's own writings in contemporary issues of QST to show that he knew then just what the law of 1912 provided for the American amateurs and that he knows the amateurs have in fact suffered a series of losses. We shall show out of the very mouths of these "authorized representatives" the sophistry of the article, "Losses".

Colonel Foster's Comment

The ARRL Serves Notice on the World That the Amateurs Need No More Frequencies

In almost every issue of "QST" there are two or more pieces of propaganda aimed at creating in the minds of readers impressions more or less wide of the truth. Even the correspondence that is published is obviously selected to support the present administration of the American Radio Relay League. The cumulative effect on all members, including the commercial members, is enormous.

About every so often there appears an example of propaganda that is nothing short of diabolical in its possibilities for harm to the amateurs. The article called "Bucking" by the president of the ARRL that appears on page 16 of "QST" for August, 1929, is a glaring instance. Its theme is that "bucking" never did anyone—and specifically the radio amateurs—any good.

It cites the successive restrictions that have been placed on the users of motor cars and assumes that they parallel the restrictions that have been imposed upon the owners of non-commercial radio stations. The situations would be analogous only if most of the highways were taken away from the public and given over to the sole use of commercial vehicles.

Mr. Maxim says, "When congestion grew worse and hundreds of broadcasting stations and millions of the public added themselves to radio, amateurs had to be still further restricted. It was perfectly just and proper that they should be, since the public interest required it."

It is commercial interest he is talking of, not public interest. The public interest had nothing to do with the over-riding of the law of 1912 and getting the ARRL to accept on behalf of the American amateurs certain narrow strips of the territory the law had given them. Commercial interests alone were accountable for that. The interests of the public was of the least concern to the commercial interests and their adherents in the government employ.

Does anyone believe it was the public that demanded the amateurs give up their "200 meters and downwards!" What had the interest of the public in broadcasting to do with what happened in a part of the spectrum where there was no broadcasting! Does any amateur credit Maxim's conclusion, "Since the public interest required it!"

"When the ultra-efficient high frequencies came into use", continues Mr. Maxim, "the problems of traffic control became international. A congress of delegates from most of the nations of the earth was called in 1927 to agree upon still further restrictions. The amateurs, together with other interests, had to give ground again."

No, the convention of 1927 wasn't for the purpose of agreeing on further restrictions. It was largely to compose operating and business differences among the commercials themselves. But the outstanding motive of the commercial people who dominated that convention was to see—and each for himself—how nearly all of the short-wave spectrum they could annex and how little they might leave for Army, Navy and other really public interests. That this convention would be a dog-fight among commercial radio people was plain to every man of experience with the hard-boiled eggs of the business world. I went to Hartford myself to tell this to Warner six months or more

before the convention but he brushed it aside. Next month I'll tell you the story of this visit.

Mr. Maxim says that at this convention the amateurs "had to give ground again." No, they did not have to. This declaration is quite in character with the philosophy of fatalism that accounts for the futility and ineptitude of the present ARRL officers as "legislative representatives of the amateurs", as they grandiloquently call themselves.

Maxim pathetically inquires, "Of what avail is it to buck this sort of thing?" Mr. Maxim is evidently not a reader of history. Ever since man came upon the earth every advance in the civilization of the world has been started by a few thinking and courageous souls who bucked ignorance and prejudice and oppression. If it had not been for buckers the human race would still be living in the stone age. If the amateurs had done some real bucking when they had the law of 1912 on their side, instead of "relinquishing most of their territory for commercial development", they would not now be in the position they occupy through following leaders who have never for one minute got off the defensive.

Maxim said last year in his annual report to the directors, "QST passes across the desk of nearly every important figure in the radio world." Correct. And that means across the desks of the commercial men who have horn swoggled the amateurs again and again. And these "important figures"—because they have subscribed for QST—are members of the "amateur" organization and help pay the salaries.

And what do you think these important figures thought when they read this anti-bucking proclamation of the president of the organization that speaks for all amateurs! What would you think if you were in their place? "Oh, at Madrid these amateurs won't ask for any of the frequencies we took from them without the sanction of the law. Their president has put us all on written notice that if we impose further amateur restrictions his advice is not to buck."

The commercials did not have to respond to a request for more frequencies. The ARRL board, on the advice of K. B. Warner, voted to make no request. And the commercials did impose a severe amateur restriction at Madrid. Warner, always teaming up with Maxim, saw to it that the amateurs did not buck until it was too late for the bucking to do any good. He accomplished this by not telling this restriction even in his report to the directors. He told them and he told the amateurs in QST that there had been no change in amateur communications regulations; and he said, "The Madrid convention takes effect the first of 1934 but we'll never know the difference because it has no effect on us." Accepting Warner's report as the truth the amateurs did no bucking until eight months afterwards when an individual amateur learned the facts through the State Department.

And when the truth was disclosed Warner did his level-best to prevent bucking. In his efforts the pages of QST were used profusely, and he published and distributed—at the expense of the amateurs—a pamphlet that he called, "International Message Handling", designed to stop the bucking against the belatedly exposed restriction.

And when the Senate Committee on Foreign Affairs was considering the ratification of the Madrid Treaty this pamphlet was presented to the committee by the chief engineer of the Federal Radio Commission. The chief engineers in a letter directed the attention of the senators specifically to this statement in Warner's final paragraph:

"I have heard it said that it is the position of the ARRL headquarters that the treaty must be ratified. Our position is much simpler than that. It is simply that our executive committee, after thorough-going study, can find no reason from our standpoint why the treaty should not be ratified."

(Note that he does not say, "our board of directors". Warner never let this vital question come to the board for decision).

Members of the senate committee had received protests from individual amateurs and had really considered them seriously, as the verbatim minutes of their meetings show. But this pronouncement from the secretary of the ARRL finally disposed of the protests.

And thus the promise held out to "nearly every important figure in the radio world" by Maxim was made good to the best of his and Warner's ability.

And now along comes Warner with a piece of propaganda of his own equally as disastrous to amateur interests as Maxim's. Read again Warner's editorial in QST for June, 1935. Instead of starting with a positive sentence such as, "We know there is bad interference in the amateur bands", he makes the admission weak by using a string of negatives, "We would not like to be misunderstood as saying that there is not bad interference in the amateur bands." A statement purporting to be positive but made up of negatives is never positive.

Warner would not like to be misunderstood. Never fear, the intelligent reader will understand clearly that by means of this editorial he is telling "nearly every important figure in the radio world" the amateurs right now have all the space they really need if only they will provide themselves with complicated and expensive receivers such as no commercial company needs or would use. This same propaganda was preached after the 1927 convention by ARRL headquarters representatives. It was amazingly untrue then when there were only half the licensed amateurs there are now.

Note how Warner sums up at the end of his June editorial:

"Today with a SS receiver we can work more stations in an evening or work one station a longer period of time, keep more schedules or raise more desired stations—do more desired things rather than random things—than ever before in the history of amateur radio."

No weakening of this passage by the use of negatives. The conclusion was meant to convey to the world of radio with finality the thought that the amateurs need no more frequencies.

And just won't the important figures of the radio world make good use of this at Cairo! They could never have become important figures of the radio world if they were so dumb as not to capitalize a statement like this in the official publication of the ARRL by its general manager.

Just why should Warner serve this notice on the radio world? You're asking me!

—Clair Foster, W6HM.

A DX Superheterodyne—1936 Model

An Amateur Receiver Setting New Standards Unexcelled For DX Reception

By CHAS. D. PERRINE, JR., W6CUH

● About six months ago, W6CUH was moved to a new location and the change involved a complete rebuilding of the station. The first and most important item to be considered was the receiver. As there are many ways of getting a kilowatt into the antenna, it was decided that the receiver should have first attention—ever keeping in mind the old saying that we can't work what we don't hear. Most receivers have one or more compromises in their make-up to take care of several bands, phone or CW, and similar requirements. In this case, the receiver was to be a superheterodyne, for CW only, and designed for the greatest possible weak signal response and highest signal-to-noise ratio.

Only the two DX bands, 14 and 7 MC, are to be used and band changing must be as nearly instantaneous as possible. The bandspread should be comparatively small for good DX hunting—in this receiver, the 14 MC European stamping ground (14250-14400 KC) covers only ten degrees, so that an ear can be kept on the whole of this region almost continuously with but little dial cranking. The dial must be larger than usual and have its whole face visible; one can then tell at a glance in what part of the band he is tuning. RF, IF, and AF manual gain controls must be provided, because correct balance of the three is absolutely necessary to dig a weak signal out of the mud. Lastly, the power supply should be a separate unit in order to minimize hum and power line noise pick-up.

Starting with the above requirements, all available published data on supers was reviewed . . . then four months of rather steady spare time work saw completion of the receiver. It performs right up to expectations, showing that none of the added refinements were superfluous. However, this story will not attempt to present all the myriad small constructional and layout points—these being largely dependent on the make of apparatus used. Anyway, few ham receivers are ever exact copies of a model. So with this in mind, we will see how the DX requirements outlined above are fulfilled by application of rather general design improvements to a specific job.

Number one feature is the high-gain regenerative RF stage using two 954 acorn pentodes in parallel, a stage having enough gain on 14 MC to make a loud European block the first detector. Next is the automatic band change accomplished by three cam switches on the main tuning shaft; they shift trimmers to change from 14 to 7 MC, the coils being permanently wired in the circuit. On the dial, 7 MC occupies a region from 10 to 50 degrees and 14 MC 65 to 90 degrees, the actual switch in trimmers being set to occur at 60 on the dial. The shielding is unusually complete; each stage is enclosed in its own shield which in turn is insulated from the main chassis and grounded at only one point. Extra filtering and by-passing of all RF circuits also goes far to increase the signal-to-noise ratio. A very high-C tuned plate circuit has been added to the BFO to

reduce harmonics, and lastly only 15 volts on the audio stage does its part in holding down noise.

The layout of the parts was dictated entirely by short leads. Every effort was made to work-in each piece of equipment to obtain the shortest possible leads, regardless of convenience or trouble. As a result, there is hardly a grid lead over one inch in length in the whole set. Tubes are laid horizontally for the most part, although two are vertical (even one of these is upside down!) A special five-inch diameter dial with an improved ball bearing mounting is used. The

photos furnish a general idea of the unusual arrangement of parts.

Fig. 1 shows the complete circuit of the receiver. It is so drawn as to show the grouping of the parts in each shield compartment just as they are in the set itself. It will be seen that by-passes and resistors for each stage are shielded in a small compartment that is part of the main stage shield.

Two 954s are paralleled in the RF stage because then the output impedance of the combination is only half that of one tube; this makes possible a closer match between the tube output impedance and the load

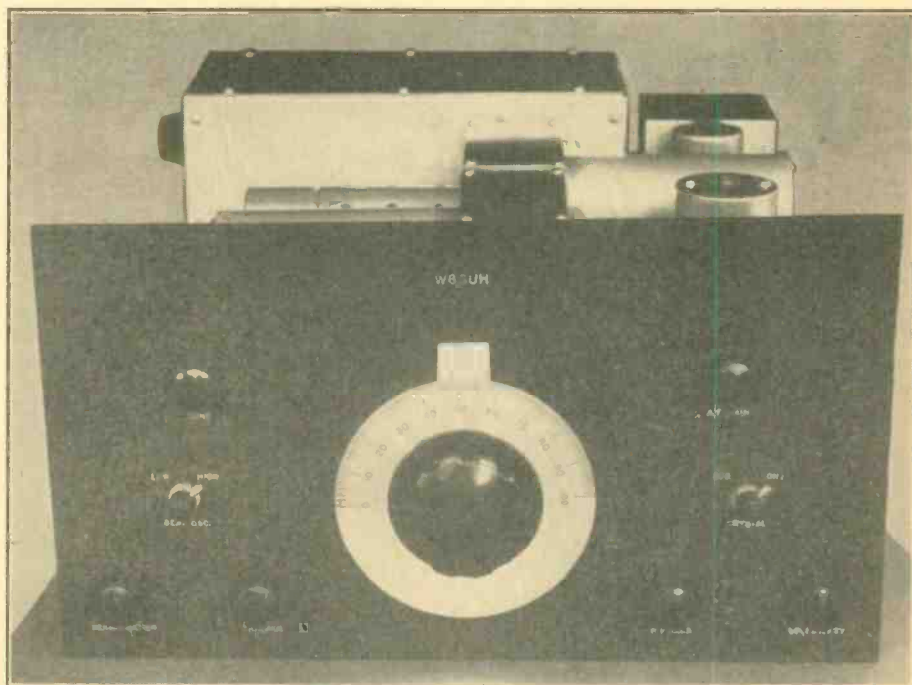

The front view of the receiver is impressive. The controls are arranged for optimum accessibility.

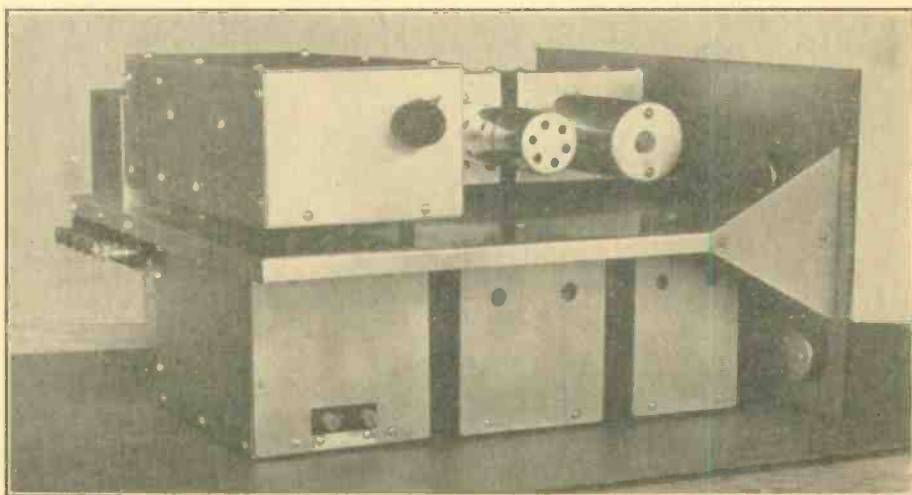

Left side of the receiver, showing the shield boxes for the front end and the HFO compartment.

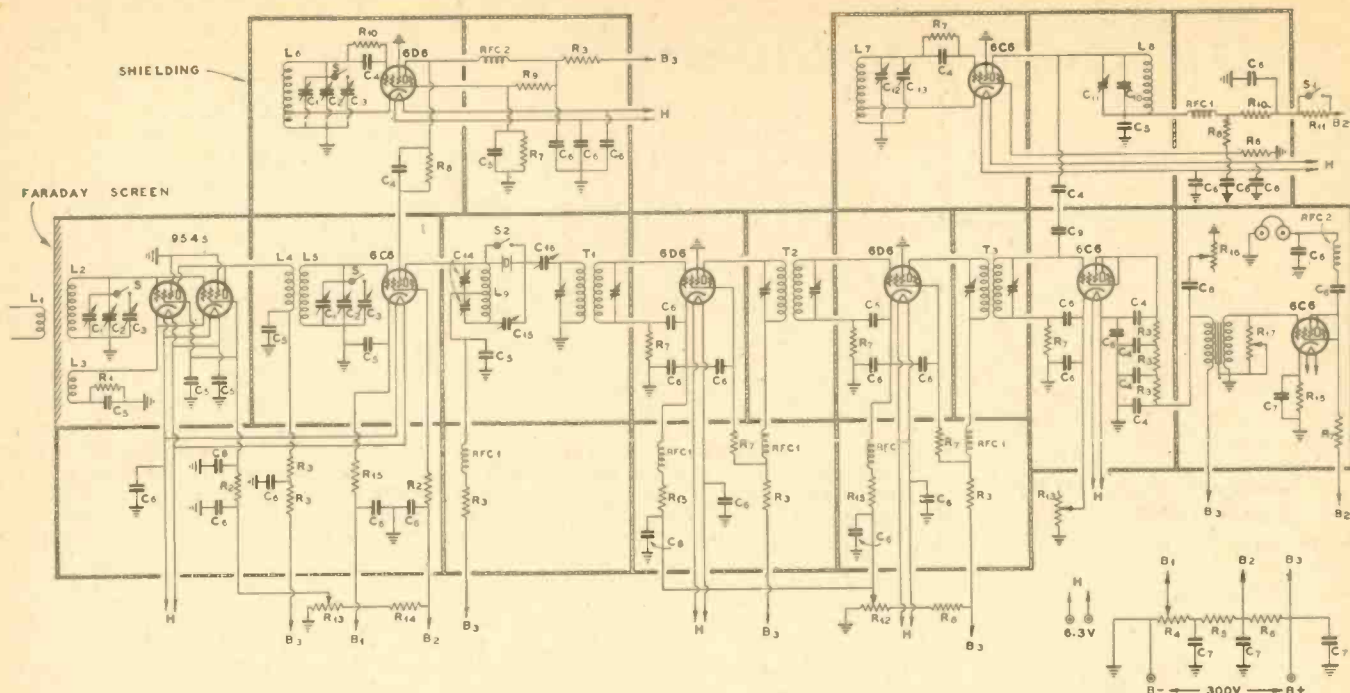

FIG. 1—Complete circuit diagram of the "1936" Amateur Superheterodyne. The legend is shown on the facing page.

represented by the detector tuned circuit, hence a higher effective gain. The 954 combination has the same plate impedance as a single 6D6, but with over twice the amplification factor. The first stage in any super must have the highest possible gain, because the signal to noise ratio depends almost directly on this gain.

Regeneration in the RF stage becomes unusually effective when using the 954s because the screen voltage regeneration control can be run right up to the point of oscillation with no sign of instability. A small cathode coil coupled to the ground end of the 954 grid coil serves to introduce the required feedback. The antenna coil is also coupled to the same end of the grid coil through a Faraday screen.

The circuit shows three condensers across L1. C1 is the main tuning condenser which is ganged with those in the oscillator and first detector. C2 is the 14 MC trimmer which is permanently in the circuit; a similar condenser is in the oscillator and first detector, the three being used to line-up the front end on 14 MC. The third condenser, C3, is the larger trimmer, that when cut into the circuit by the cam switch on the main condenser shaft, loads each circuit to 7 MC. The tuned circuits are thus quite low-C on 14 MC and medium-C on 7 MC; the higher C on 7 MC causes a slight loss in sensitivity, but this loss is more than compensated for by the increased gain in the 954s. The trimmer switching method was used because any type of coil switching or turn shorting introduces too much loss when coils and condensers must be crowded together in order to obtain short leads.

Note that the 954s have their heaters and screens by-passed twice. One set of by-passes is right at the tube terminals inside the special adapter shown in the photo. The other by-pass set is in the regular detector filter compartment.

The first detector is inductively coupled to the 954s and is conventional in all but the method of coupling the oscillator. The method shown couples the oscillator plate to the detector suppressor grid through the condenser C4 and the resistor R8 which places a positive voltage on the suppressor. The idea originated with Frank Jones and performs beautifully because the positive voltage on the suppressor seems to consider-

ably increase the conversion gain of the first detector. Adjustable fixed bias further increases the gain of the first detector, as has been repeatedly shown in the past.

There is nothing unusual in the HFO outside of the thorough filtering, both sides of the heater being by-passed. The screen voltage is obtained from a voltage divider located in the HFO's filter shield compartment. In addition to the three condensers across the coil, there is a small two plate, 2 mmf. trimmer controlled from the front panel. Its purpose is to allow convenient compensation of occasional shifts in frequency due to warming-up and changes in line voltage. Since this little trimmer only shifts signals about 2 KC on the dial, it affords an added vernier control that makes tuning easier on weak signals in the midst of QRM. While this trimmer controls only the oscillator, its effect is so small that the oscillator is not brought out of line with the rest of the front end by its use.

The crystal filter circuit is again a product

of Frank Jones, with but one modification. A split condenser with grounded rotor is used to tune L9 to 465 KC. This places twice as much capacity between the first detector plate and ground, thus by-passing more effectively the high frequency components in the first detector plate circuit.

The two stage IF amplifier uses the conventional circuit; however, about twice the usual amount of by-passing and filtering is used. Screen voltage is obtained separately for each tube by a dropping resistor. This prevents possibilities of screen coupling and means one less lead to be by-passed and filtered as it leaves the stage shield.

A 6C6, triode connected, is used for the second detector because of its low hum-level heater and general reputation for great quietness. Used in this manner, its amplification factor is about 25, which means just that much more gain. Its one disadvantage is its inability to handle large signals without blocking, but this receiver was designed primarily for best results on weak

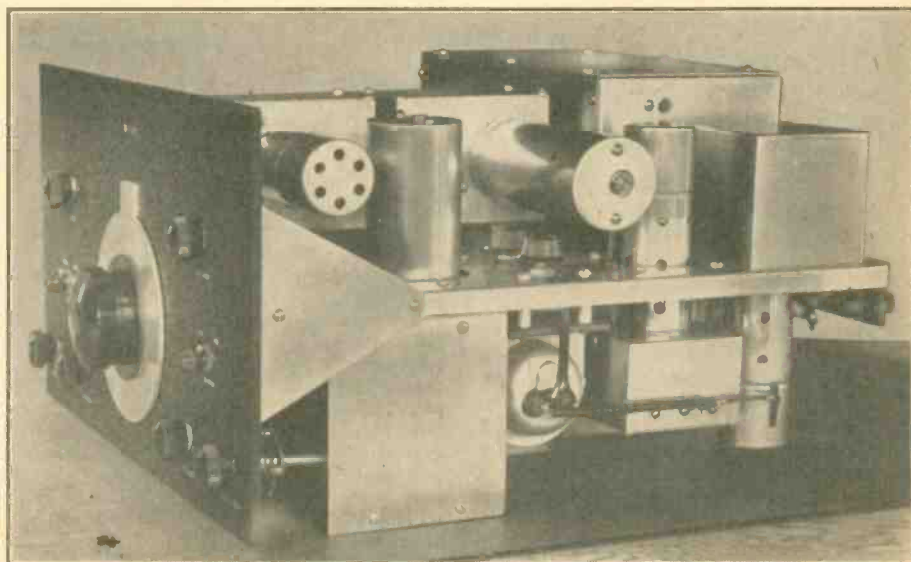

Right side of the receiver, showing crystal filter box under the chassis. The audio tube hangs upside down.

LEGEND FOR FIG. 1

- L1—5 turns, 1-in. diam., No. 28 enamel.
- L2—13 turns, 1-in. diam., No. 20 bare.
- L3—2 turns, 1-in. diam., No. 32 S.S.C.
- L4—9 turns, 1-in. diam., interwound with L5—No. 30 D.S.C.
- L5—13 turns, 1-in. diam., No. 20 bare.
- L6—12 turns, 1-in. diam., No. 20 bare, tapped 4 turns from ground.
- L7—95 turns, 1-in. diam., tapped at 30 turns, No. 32 D.S.C.
- L8—30 turns, 1-in. diam., No. 32 D.S.C.
- L9—Hammarlund choke with center pie removed.
- C1—Approx. 20 $\mu\text{mf.}$ —Hamm. 50 $\mu\text{mf.}$ with two stator plates removed.
- C2—20 $\mu\text{mf.}$ Cardwell Trimair.
- C3—100 $\mu\text{mf.}$ Cardwell Trimair.
- C4—.0001 mica.
- C5—.01 mica.
- C6—.1 non-inductive paper (500 V.)
- C7—.1 $\mu\text{f.}$ paper (500 V.)
- C8—.04 paper.
- C9—3 $\mu\text{mf.}$ —see text.
- C10—.004 mica fixed.
- C11—.001 mica variable (trimmer)
- C12—.001 air var.
- C13—50 $\mu\text{mf.}$ air midget (Hamm.)
- C14—140 $\mu\text{mf.}$ per section (Hamm.) midget.
- C15—Phasing control—10 $\mu\text{mf.}$
- C16—30 $\mu\text{mf.}$ midget.
- R1—400 ohm, 1 W.
- R2—10,000 ohm, 1 W.
- R3—1,000 ohm, 2 W.
- R4—1,000 ohm, var. pot.
- R5, R6—CT 30,000 ohm, 50 W. voltage divider.
- R7—100,000 ohm, 1 W.
- R8—50,000 ohm, 3 W.
- R9—40,000 ohm, 3 W.
- R10—50,000 ohm, 3 W.
- R11—500,000 ohm, 3 W.
- R12—15,000 ohm, var. tapered.
- R13—50,000 ohm, var. pot.
- R14—10,000 ohm, 3 W.
- R15—200 ohm, 3 W.
- R16—10,000 ohm, tone control.
- R17—500,000 ohm, AF Gain.
- R18—5,000 ohm, 3 W.
- T1, T2, T3—Hammarlund 465 KC IF trans.
- T4—UV712 RCA audio trans.—1,000 ohm peaked type.
- RFC1—85 mh.
- RFC2—2 mh.
- S—Band changers.
- S1—BFO strength control.
- S2—Xtal shorting SW.

signals; the strong signals can always be held down by manipulating the IF gain control. The self-bias resistor is adjustable because its value has a definite effect on the signal-to-noise ratio. The plate circuit is thoroughly filtered, resistors being used in place of RF chokes because they do not have any resonant tendencies which might cause oscillation in the second detector.

An old-time RCA audio transformer, somewhat peaked at 1000 cycles, was repainted and used to couple the audio stage to the detector. Eventually, a bandpass filter will be worked out to be used in its place. A conventional tone control across the transformer primary allows one to obtain best readability through different kinds of noise. The AF gain control across the transformer secondary is turned nearly all the way off for best signal-to-noise ratio.

The audio stage is used only to provide a measure of audio selectivity and to allow smooth AF gain control. A 6C6, triode connected, is again used here for the same reasons it was employed as second detector. Since little actual audio gain is required, the voltage is kept low with a consequent

improvement in signal-to-noise ratio. The measured voltage on the audio plate is only 15 volts, this voltage being fed through a resistor to keep plate current and voltage out of the phones. An additional RF choke and by-pass condenser keep RF from wandering in via the phone cord.

The BFO is different in two respects. First, it is entirely air tuned by a .001 mfd. variable condenser which assures absolute freedom from frequency drift. A small 50 mmf. midget condenser is mounted on the side of the BFO shield can and connected across the large tuning condenser for external vernier adjustment. The second feature is the high-C tuned plate circuit using .004 mfd. of tuning capacity. This definitely cuts down the otherwise strong harmonics in the BFO output and thus reduces slightly the characteristic oscillator hiss. Another refinement that helps on weak DX is the switch that cuts down the BFO plate voltage. The weaker BFO output thus obtained will still produce a good beat with a weak signal, but the oscillator hiss is less and the signal more readable. The BFO is coupled to the grid of the second detector by a small capacity formed by wrapping three turns of insulated wire around the detector grid cap. This is more capacity than nor-

edge are such that it fits flush with the main dial surface. It is held to the panel by two small machine screws, blind-tapped into the back of the dural square. This was done to keep the front of the dural marker clear of everything but the black line, so that sleepy eyes in the early AM can always remain centered on the marker line. Due to the large dial diameter, the bearing in the National vernier movement had to be trued-up by making the back of the dural disc ride on three ball bearings out near its edge; these are set in the ends of brass studs threaded through the panel from the back and furnished with lock-nuts. Then by adjusting the studs, the dial can be brought absolutely parallel to the panel and will run true indefinitely.

Looking at the left of the receiver, one can see the chassis mount about half way up the panel. Under the chassis are the three shield boxes comprising the front end. The HFO is next to the panel, then the first detector, followed by the RF stage at the back. The oscillator and first detector tubes are mounted horizontally in their respective shields, while the 954s mount in a special adapter that plugs into a 6-prong socket on the back of the detector shield so that they project through and into the RF shield box. Above the chassis is the BFO in the large

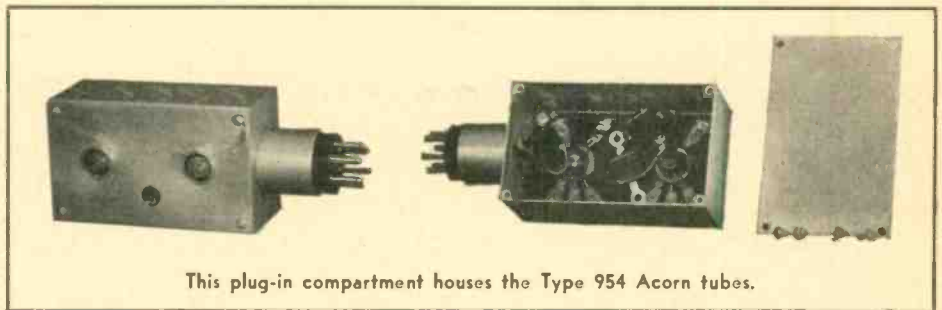

This plug-in compartment houses the Type 954 Acorn tubes.

mally used, but the effectiveness of the BFO shielding and filtering is such that absolutely no other coupling exists between the BFO and any other part of the receiver. When the BFO is de-coupled from the second detector grid, no trace of its output can be heard with all the gain controls running wide open.

The power supply is also an important item, although its circuit is not shown because it uses nothing out of the ordinary. It delivers an even 300 volts at the 40 MA load drawn by the receiver. The rectifier is a 5Z3, and 90 henries and 54 mikes in the filter take out every trace of ripple. Further noise reduction comes from the use of a grounded sheet copper electrostatic shield between the primary and secondary of the power transformer.

Now for some mechanical and constructional data. The front panel layout is shown in one photo and is self-explanatory. The panel is 1/8-in. dural, used chiefly because of the ease of machining. It has a black crackle enamel finish, and the addition of engraving puts on that final professional touch.

Chief item of interest on the panel is the home-made dial. The vernier movement was taken from a National Type A Velvet Vernier dial. The original National scale was replaced by a new one, made of 1/8-in. dural, 5-in. in diameter. The scale is machine engraved and filled with black enamel so as to contrast with the grained silver finish on the dural. One of the new large National knobs was added, so that now one can even get both hands on it and literally pull that weak DX right into the shack. The dial indicator is a black line engraved on a small piece of dural whose thickness and lower curved

shield at the rear left corner. The two IF stages occupy the space between the panel and the BFO. The right side view shows the crystal filter shield box under the chassis, right up next to the panel. The first IF transformer protrudes from the top of this box through the chassis just opposite the first IF tube's grid cap. The second detector is a little further back, also protruding half way through the chassis to bring its grid opposite the third IF transformer. The audio tube hangs upside down under the rear right corner of the chassis, the box just above it being a shield for the audio tube's associated equipment.

The chassis and all the shield cans are made of No. 18 gauge sheet steel. Most of the boxes are entirely bolted together, but the smaller ones are soldered together on five sides, the sixth screwing on as a top. 6/32 machine screws are used to bolt the shields together, the screws being tapped directly into the sheet metal, rather than using nuts. Every piece of metal is separately cadmium plated and rubbed down with steel wool. Then after assembly, each box is given a coat of clear lacquer to preserve the finish. The cadmium plating not only results in a beautiful silver finish, but is almost as efficient as copper in its shielding action. All the shield cans are mounted on 1/2-in. bakelite studs, 3/8-in. in diameter. These studs are drilled and tapped for 8/32 machine screws at each end. The studs supporting the second detector can are 1 1/2-in. long, so as to bring the tube to the proper level. Everything is strong and rigid because mechanical solidity is essential in a receiver of this type. Plenty of metal was used in this particular job to assure stability, some 20 lbs. of sheet steel being required. (Continued on page 8)

The Faraday screen is of simple but effective construction. A shield partition with a 3-in. hole in it is located in the RF can in such a manner as to separate the RF grid coil from the antenna coil, the coils being located opposite the hole. The screen covers the hole and consists of $\frac{3}{8}$ -in. bakelite with a copper strip screwed to its lower edge. Bare No. 30 copper wires are soldered to this strip and laid on the bakelite about $\frac{1}{8}$ -in. apart; their upper ends are left open. A few coats of clear lacquer is then applied to cement the wires effectively in place.

A 6D6 was originally used in the RF stage, hence the 954 adapter was made to fit a 6-prong socket. A glance at the illustrations will bring out most of the constructional details of this adapter. The 954 mounting clips are eyeleted on a piece of $\frac{3}{8}$ -in. bakelite which is slightly spaced from the side of the adapter. The opposite side comes off by removal of four screws. The grids of the acorn tubes protrude through the two holes in the isde. Small brass collars are soldered in each hole to improve the tube shielding. The two cathodes are tied together and brought out to the lug just below and between the tubes where convenient connection can be made to the RF cathode coil. Heater and screen leads are by-passed by the two condensers seen within the adapter, and then run to the corresponding prongs in the tube base. The entire unit can be used to replace the first RF tube in almost any receiver because voltages and capacities are almost identical with those required for a single 6D6.

The coils used in the detector and RF stages are of a very low-loss, high Q design. They are entirely supported on thin celluloid and are 1-in. in diameter and 1-in. long, best proportions for high Q at such high frequencies. A collapsible form is used in winding these coils. It is made by slitting a piece of 1-in. diameter tubing lengthwise down one side and then inserting a plug (such as an old tube base) into the tubing so as to expand it a trifle. Thus when the coil is finished and cemented, the plug is pushed out and the coil drops off as the tubing springs in. In winding the coils, thin sheet celluloid is wrapped around the form prepared as above, one layer being ample. The winding is then put on with twine of the correct diameter, interwound with the wire to space the turns. Once wound, the twine is removed and the coil given a coat of celluloid cement (made by dissolving scrap celluloid in acetone) to hold the turns in place. The detector primary is wound between the secondary turns after the twine has been removed, and before the cement is applied. The RF cathode coil is wound on the same celluloid as the RF grid coil, and is cemented in place simultaneously with it. The coils thus produced are very light and rigid, so that they are easily supported by the stiff secondary wire leads.

In the oscillator, losses are not so important, but rigidity is. Hence the oscillator coil is wound on threaded bakelite tubing which is solidly mounted on the shield wall. All other parts of the oscillator are likewise securely mounted and wired. All this is done to prevent frequency changes due to vibration and jarring.

The three band changing cam switches are mounted on the main tuning shaft, one behind each tuning condenser. The cams are made from 1-in. diameter pieces of $\frac{1}{4}$ -in. bakelite; part of the circumference is filed down to smaller diameter to form the cam. A 6/32 machine screw is threaded into the edge of the cam to serve as a set screw and to hold the cam rigidly on the shaft. A small square of bakelite carries the two contacts and is supported from the shield wall by two studs so as to come even with the cam. The

two contacts are made from $\frac{1}{8}$ -in. square pieces of coin silver. One of these is soldered on the end of a phosphor bronze strip, bent so as to bear against the edge of the cam; the other end of the strip is screwed to the bakelite piece mentioned above. The high part of the cam thus presses the contact against the other stationary contact supported in like manner from the bakelite square by a shorter phosphor bronze strip. As the cam bends the movable strip, a slight wiping action is obtained between the contacts as they make and break, and effectively keeps their surfaces clean. The action of these switches is positive and quiet.

First adjustment and lining-up of this receiver requires no more effort than for similar sets. The IFs should be lined up with some sort of calibrated signal generator, or by using the crystal in a temporary oscillator. The BFO is then set to the IF frequency and its plate tank tuned until maximum output is obtained at the second detector grid. This tuning is quite broad and no difficulty should be encountered in this part of the adjustment. Next in order is the adjustment of the crystal filter, the details of which have previously been covered in these pages.

The front end is first lined up on 14 MC by means of the trimmers permanently connected in the circuit. Once these trimmers are set, the dial is twisted over to the 7 MC portion and the 7 MC trimmers, thus cut into the circuit by the cams, are set to line up the RF, detector, and oscillator on 7 MC. The band switches should, of course, all be synchronized to close at 60 on the dial. Since the receiver covers only two narrow bands, front end tracking is accomplished rather easily. Slight modification of the oscillator tuning condenser may be required, and can best be done by slightly bending or twisting an end rotor plate on the oscillator tuning condenser until the tracking is as it should be. If care is exercised in winding the RF and detector coils, these circuits will track nicely without any juggling, and this in spite of the sharp tuning of the regenerative RF stage.

Due to the excellent shielding and isolation, the regeneration in the RF stage is very stable and effective. Even so, its performance should be checked to see that the cathode coil causes oscillation to begin when the screen voltage reaches 70, approximately. Otherwise some gain will be lost if oscillation is reached at too low a value of screen voltage.

Now for the proof of the pudding . . . results! Foremost is the receiver's flexibility. The quick band change made possible the hearing of all continents in less than four minutes during the March DX contest. On 14 MC the whole band can be covered with extreme effectiveness and there is small chance of missing desirable DX; on occasion over 30 Europeans have been logged in one evening, resulting in as many as 17 QSOs in four hours.

Sensitivity and quietness are quickly evident. The 954s were compared with the 6D6 in the RF by adjusting each to produce the same noise level in the output, and it was found that with the 954s even moderate signals would block the first detector, and signals unreadable on the 6D6 came right up above the noise. As further proof one night VK3PG was copied R1 on 14 MC when using .09 watts input! Best results on weak signals were always obtained by running the RF regeneration almost to the point of oscillation (point of highest RF gain), the IF gain also 'way up, and the AF gain 'way down. With such gain control settings, a 270-ft. antenna could be used without trouble on the weakest signal.

Thus ends the story of a receiver that was

intended to fit, within reason, all the requirements of successful DX work. Not one of the refinements added has been regretted. Greatest improvement came, of course, from the use of the 954s and the greatly improved shielding. As a whole, the receiver is an example of advances and refinements applicable to any receiver if one is after that super-elusive DX, fickle goal of every real DX man.

A New Electron-Ray Indicator Tube

Cunningham Radiotron RCA-6E5

● The 6E5 is a high-vacuum, heater-cathode type of tube designed to indicate visually the effect of change in the controlling voltage. The tube, therefore, is essentially a voltage indicator and as such is particularly useful to facilitate exact tuning of a radio receiver.

The visible effect is observed on a fluorescent target located in the dome of the bulb. For different controlling voltages, the pattern on the target varies through a shaded angle of from 90 degrees to approximately 0 degrees. Exact tuning is indicated by the narrowest shaded angle obtainable.

The RCA-6E5 provides a convenient and non-mechanical means to indicate accurate tuning of a receiver to the desired station.

Electron Ray Tube Considerations

In the basic design of an electron-ray tube, a hot cathode provides a source of electrons. These are attracted to a positively-charged target coated with a fluorescent material.

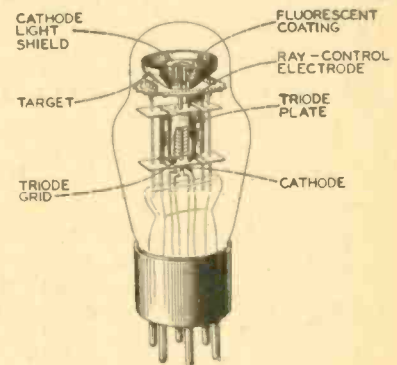

FIG. 1



FIG. 2

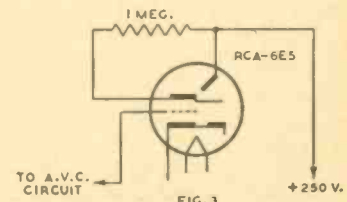

FIG. 3

Electrons impinging on the coated target cause it to glow. The extent of the fluorescent area can be controlled by means of a third electrode placed between cathode and target. The pattern developed on the fluorescent target depends on the contour of the target as well as on the position and shape of the third electrode.

Details of the physical arrangement of electrodes are illustrated in Fig. 1, which shows a cut-away view of the RCA-6E5.

(Continued on page 14)

Copyright, 1935, by RCA Manufacturing Co., Inc.

600-Watt C. W.—200-Watt Phone Transmitter

Wherein only 5% of the equipment is idle when C. W. is used

High-Quality Grid Modulation . . . Jones All-Band Exciter . . . Push-to-Talk for Phone Break-in . . . Crystal Keying for Full Break-in on C.W. . . Grid Neutralization . . . Completely Self-Contained Relay Rack Construction Which Eliminates the Use of Chassis. Power Gain of 20 Through the Final Amplifier. The Entire Transmitter Can Be Constructed For Less Than \$300.

● Such excellent results were obtained with the 50 watt phone recently described in "RADIO" that a higher power transmitter was built with a pair of 150Ts in the final

By FRANK C. JONES

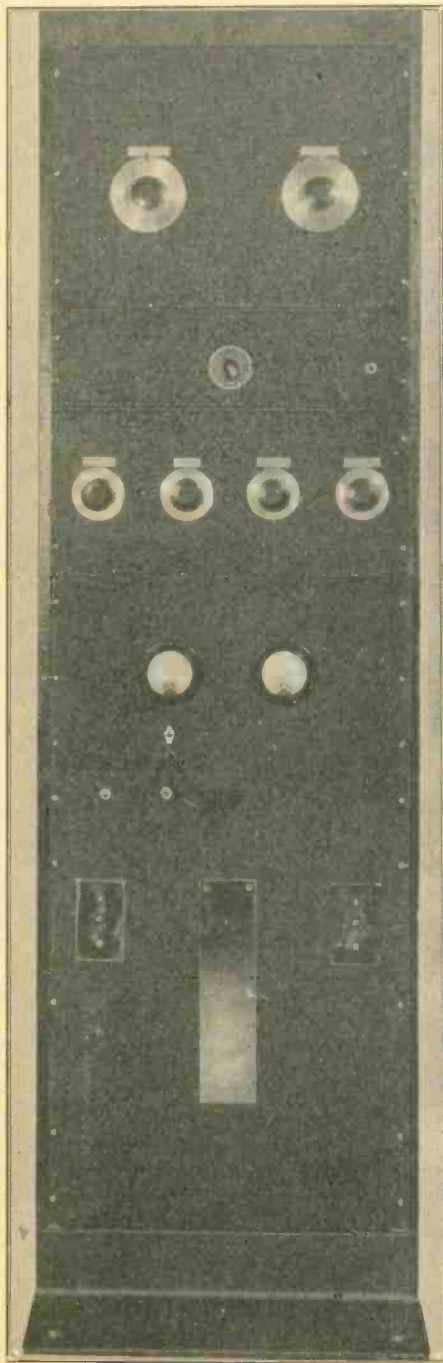

Front view of the transmitter. The long, narrow metal strip between the two switches on the lower panel section is used for showing the call letters of the station.

stage. The carrier power is about 200 watts on phone and a little more than 500 watts on CW in the 20 meter band. The quality of speech is excellent, due to the use of cathode resistor plus fixed bias equal to cut-off for use in grid modulation.

The entire transmitter is built into a standard relay rack, 36 units in height—that is, 36 1 $\frac{1}{4}$ -in. units or 63 inches of space for mounting panels. The RF amplifier panel at the top is 14-in. x 19-in. of No. 14 ga. iron. The next panel, 5 $\frac{1}{4}$ -in. x 19-in., contains the speech amplifier and modulator. The oscillator-doubler and buffer stages are mounted behind a 8 $\frac{3}{4}$ -in. x 19-in. panel with four dials for controls and 3 panel holes for regeneration and neutralizing adjustments to the subpanel. The low voltage power supply is mounted on a 10 $\frac{1}{2}$ -in. x 19-in. panel and the high voltage supply on a 24 $\frac{1}{2}$ -in. x 19-in. panel at the bottom of the rack. The entire unit makes a very pleasing appearance and takes up but little space. A rear ventilated cover should be used to prevent personal contact with the 3000 volt power supply.

The complete set can be built from parts costing not more than \$300, including a crystal mike and tubes. One of the advantages of grid modulation is the low cost of the modulator—most of the investment is for CW. To those interested in both CW and phone this system provides a very satisfactory solution.

The coils for this transmitter were wound for operation in the 20 meter band. If a set operates satisfactorily on 20, it invariably is more satisfactory on the lower frequency bands. The 150Ts are easily driven on 20 meters and a pair of 45s or 2A3s will drive them to over 500 watts output. As a test, the plate voltage on the 45s was increased to a little over 400 and the final plate voltage to about 3500, with an output of nearly 800 watts on 20 meter CW. Normally the plate voltage is run at 2900 to 3000 on the final. The plates of the 150Ts get somewhat red on phone but show no trace of color on CW. The output is about 500 watts on CW and approximately 200 on phone with modulation capability of 100%.

The oscillator uses a 53 tube as a crystal oscillator and frequency multiplier. This tube will provide sufficient excitation on 20 meters to drive the 150Ts to 200 watts for phone operation. Link coupling is used between the doubler plate coil and the buffer grid coil, as well as between the buffer and final stages. No. 18 hook-up wire is satisfactory for this purpose, with one turn link coils wound over the center of each coil. 2A3 tubes give about 15 to 20% more output than 45s at the same plate voltage, and because the plate current for these two tubes runs from 120 to 160 MA, it is desirable to use the 2A3s with their heavier filaments. The final stage uses grid neutralization; however, plate neutralization can also be used.

Grid neutralization eliminates the need of split-stator condensers and thus effects a saving in condenser cost. Antenna coupling can be through a Collins network or by means of 2 or 3 turns close-coupled to the tank coil for use with a twisted pair feeder.

The 53 oscillator gave a little trouble from a tendency to run wild, the plate current would creep or tend to motorboat with the doubler plate getting red-hot. This was finally cured by using a small adjustable grid coupling condenser between the crystal oscillator plate coil and the doubler grid. About 20 mmfd. is sufficient for use with either an 80 or 40 meter crystal. A slight amount of doubler regeneration helps in keeping the plate current low on this tube at higher plate voltages. About 7 to 10 mmfd. of capacity is generally used in this doubler regeneration control condenser. Too much regeneration allows the doubler to take off into oscillation

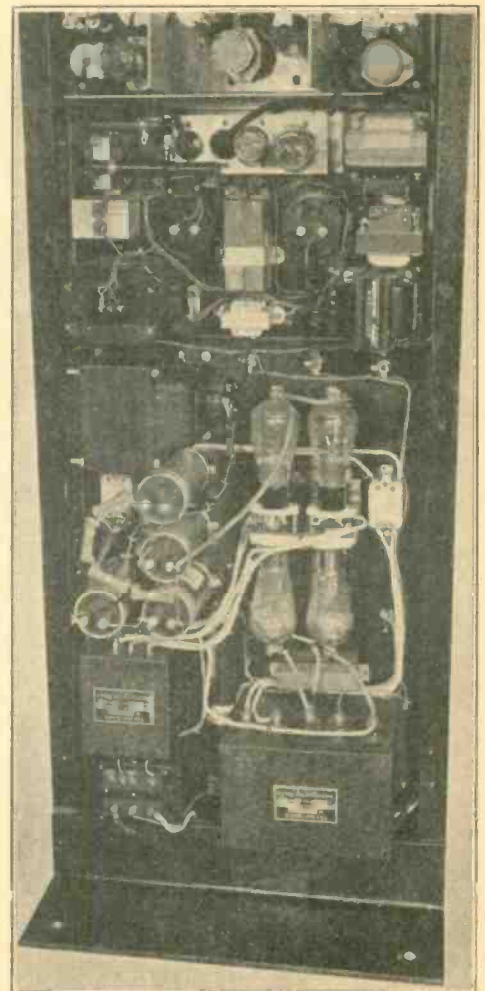

The power unit occupies the lower half of the relay rack. Note the mounting arrangement for the 866 Rectifier tubes. Four of the new Aero-vox Oil-Filled Transmitting Condensers are used.

which may not be controlled by the quartz crystal. The cathode current of the 53 tube should never run over 80 MA and better tube life and stability result when this current is not over 70 MA. Lowest cathode current and highest output occur at a setting of the oscillator condenser near the point at stopping of crystal oscillation. Setting the tuning condenser at slightly less capacity gives the best results, if over 350 volt plate supply is used.

The buffer stage uses two tubes in push-pull with two neutralizing condensers adjusted in the usual manner for no RF galvanometer deflection without plate voltage. Neutralizing can be done with a flash-light lamp and a turn of wire, RF galvanometer, or neon bulb. An open-circuit plug inserted into the cathode jack of the buffer stage cuts off the plate voltage. Push-pull operation is desirable for use on 20 meters. For use on 40 or 80 meters parallel operation has an advantage in that only one neutralizing condenser is required.

The final stage uses two 150Ts in parallel because these tubes have very low inter-electrode capacities. The neutralizing condenser for this stage is made with three aluminum plates, about 3 inches square, with 1/2-in. spacing. The total capacity for two tubes in parallel was given as 7 mmfd., according to the tube manufacturer's characteristics, but actual tests indicated only about 4 to 4 3/4 mmfd.; thus two plates would have provided sufficient neutralizing capacity. The grid tuning condenser is a 50 mmfd. double-spaced midget; the grid power input never runs over 30 or 35 watts. The 50 mmfd. plate tuning condenser is one rated for 6500 volts, but it will flash-over without an antenna load. The plate and grid blocking condensers are of the 5000 volt type. No trouble is had in neutralizing the high power stage when using the grid current meter as an indicator.

The high voltage plate supply uses a 2400-3000 volt 1 KW transformer with four 866s in a bridge rectifier circuit. The latter requires a three winding filament transformer having insulation of 10,000 volt break-down rating. The filter circuit shown uses a split choke with the input lead connected part way into the inductance so as to give choke input to the rectifiers. Apparently there is not much inductance, because 2900 volts is obtained at 200 MA load when using the lower tap on the power transformer. As a test, a regular swinging choke was cut into the rectifier circuit and the plate voltage dropped to about 2700 under load with the high tap. The swinging choke did not improve the filtering action and thus it was left out. An additional 2 mfd. across the output reduced the carrier hum somewhat. As shown, 2 mfd. 2000 volt condensers are used in series to give 1 mfd. across each end of the husky filter choke. The 400,000 bleeder consists of four 100,000 ohm twenty-watt resistors in series to provide a condenser discharge circuit after the power is turned off. It is far more than annoying to accidentally touch a high voltage condenser which has not been discharged. With grid modulation there is no variation of plate current and no heavy duty bleeder is needed on the power pack.

C bias is provided by means of a separate power pack with a 4000 ohm 40 watt adjustable resistor as a bleeder. The total resistance of this bleeder is adjusted to give 200 volts negative bias to the 150T tubes and another tap is taken at about 135 volts for the 2A3s. Using 30 henry choke input on this filter, a small power transformer having 300 volts RMS each side will deliver about 200 volts DC bias. A resistance filter causes

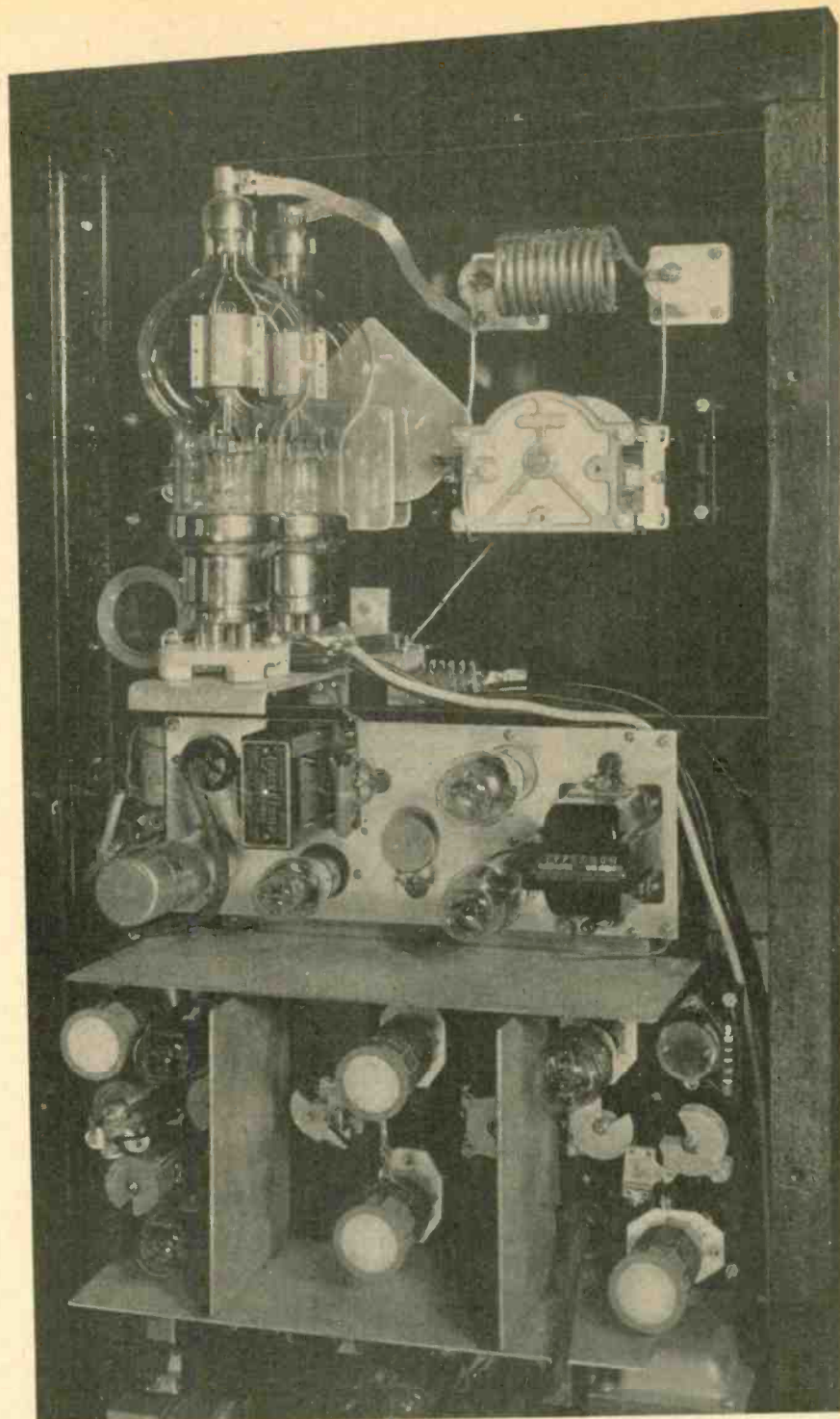

The final amplifier, speech channel and exciter, buffer units. The experimental copper-tubing 20 meter tank coil was replaced with a wire-wound coil. The grid coil for the final stage is mounted horizontally alongside the 150T tubes. Note the shielding between the exciter and buffer stages. The exciter doubler coil and the grid coil for the buffer stage are in the center compartment of the lower section. The coupling link between the two coils is clearly shown.

trouble when used in place of filter chokes, due to poor voltage regulation. The buffer and final stage grid current varies the voltage too much, unless a rather heavy duty bleeder is used. Even lower value of bleeder than that shown may be desirable.

The constants for grid modulation are calculated by assuming the possibility of obtaining 40% efficiency when using cathode resistor bias plus fixed bias equal to cut-off. This gives

$$W_0 = .66 W_{\text{PLATE LOSS}} = .66 \times 300 = 500 \text{ watts input. The plate current}$$

$$I_p = \frac{1.66 W_{\text{PLATE LOSS}} \times (1 + \mu)}{\mu E_p} =$$

$$\frac{1.66 \times 300 (1 + 13)}{13 \times 2800} = 92 \text{ MA}$$

$$E_{\text{DC BIAS}} = \frac{E_B}{1 + \mu} = 200 \text{ volts fixed grid bias.}$$

The cathode resistor could then be calculated from

$$R_k = \frac{E_B \mu}{1.66 W_{\text{PLATE LOSS}} \times (1 + \mu)^2} =$$

$$\frac{(2800)^2 \times 13}{1.66 \times 306 (1 + 13)^2} = 1060 \text{ ohms.}$$

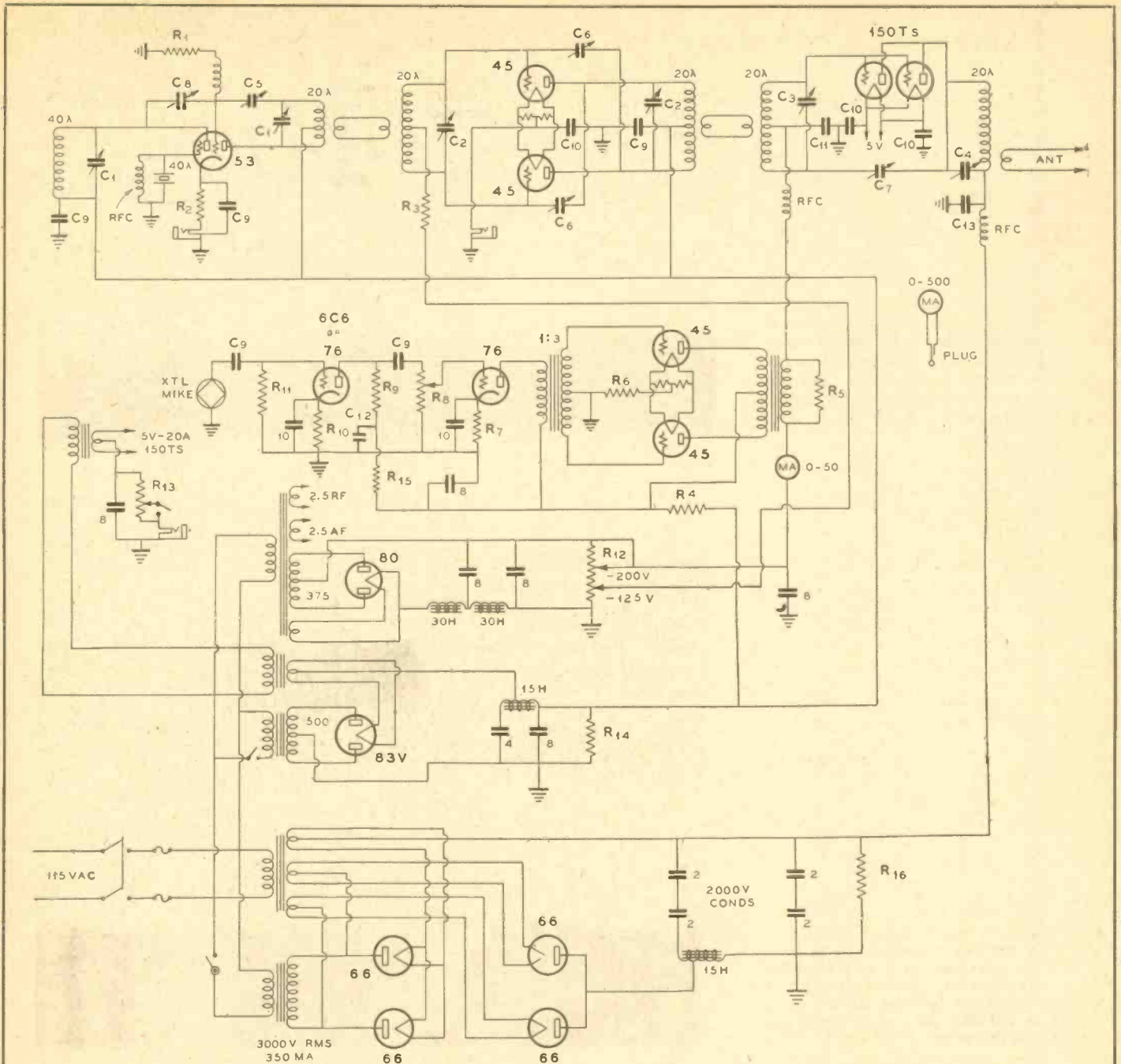

The Complete Circuit Diagram of the 600-Watt C.W., 200-Watt Grid Modulated Phone Transmitter

LEGEND: C1—100 mmf., 500 volts. C2—50 mmf., double spaced. C3—50 mmf., double spaced. C4—50 mmf., 6500 volts. C5—15 mmf., 500 volts. C6—25 mmf., double spaced. C7—6 mmf., 10,000 volts. C8—3 to 30 mmf. mica trimmer. C9—.01, 1000 volts. C10—.001, 1000 volts. C11—.0005, 5000 volts. C12— $\frac{1}{2}$ mfd., 600 volts. C13—.001, 5000 volts. R1—15,000 ohms, 10 watt. R2—500 ohms, 10 watt. R3—10,000 ohms, 10 watt. R4—3500 ohms, 20 watt. R5—5000 ohms, 10 watt. R6—750 ohms, 10 watt. R7—2500 ohms, 1 watt. R8— $\frac{1}{2}$ megohm, 1 watt. R9— $\frac{1}{4}$ megohm, 1 watt. R10—3500 ohms, 1 watt. R11—3 megohms, 1 watt. R12—4,000 ohms, 40 watt. R13—1000 ohms, 200 watt. R14—25,000 ohms, 40 watt. R15—50,000 ohms, 1 watt. R16—Four 100,000 ohms, 20 watt resistors in series.

These values were calculated before the transmitter was built and they are close to the actual values in practice. The actual cathode resistor used is a 1000 ohm 200 watt resistor. The plate current runs between 180 and 200 MA on phone, depending upon the antenna load. The plate voltage supply runs between 2900 and 3000 and the output checks at about 200 watts. The input runs a little over 500 watts and therefore the plate dissipation is a little over the 150-watts-per-tube rating. For this reason the 150Ts operate at a cherry red color when phone is used.

On CW, about half of the cathode resistor is normally cut out by means of a small snap switch on the power panel, and the plate current runs up to about 300 MA at 2900 volts with an output of between 500 and 600

watts, approximately. The plates show no color on CW and the efficiency with a twisted pair feeder 20 meter antenna calculates a little better than 70%. The actual total C bias is a little less than Class C due to lack of grid excitation, but 500 or 600 watts output on 20 meters should really go places! The input to the 45s or 2A3s usually runs between 40 and 50 watts with a power output of 25 to 35 watts; this means a power gain of about 20 in the final stage.

The speech amplifier uses a 57 triode connected, resistance-coupled to a 56. The latter is transformer coupled to a pair of 45s in push-pull. The 45s use a class B input transformer connected up as an output transformer to give about a 1 to 1 ratio. This output is loaded by a 5000 ohm 10 watt re-

sistor in shunt to the grid impedance of the two 150T tubes. Some difficulty may be experienced due to hum pick-up with the gain control on full, but this is not serious. An RF filter was found necessary on the input to the speech amplifier, as well as a small shield can around the microphone jack. A conventional crystal mike is used for fairly close taking which eliminates room acoustic difficulties. A 57 screen-grid connected, resistance coupled to a 2A5 pentode, will probably be satisfactory and give somewhat less trouble from hum pick-up. The 45s are claimed to give less distortion, but on voice tests the pentode tube gives entirely satisfactory results.

The grid return circuit is by-passed with
(Continued on page 36)

are of the small mica condenser type. Some paper by-pass condensers introduce circuit noise, resulting in a hiss in the headphones. Everything possible was done to make a superheterodyne of high sensitivity which would be as quiet as the ordinary autodyne 2 tube receiver. The resistors are of a type noted for quietness of operation when used in high-gain resistance-coupled amplifiers.

Aladdin iron core IF transformers are used because they give better selectivity and gain characteristics than the best air-tuned IF transformers available. Only one IF stage is needed for ample sensitivity, and the crystal circuit is of the type which gives very little attenuation of signal. The filter circuit is of a type which tends to match the crystal impedance to the extent of preventing its usual loading effect. At resonance it acts as a resistance of a few thousand ohms, but it is prevented from over-coupling the two IF transformers by means of a small 3-35 mmfd. semi-adjustable coupling condenser set to about 20 mmfd.

The second detector uses another type 79 tube in order to conserve on tubes and space. One triode acts as a bias detector and the other as an audio amplifier. The audio coupling unit uses series resonance in order to obtain a tuned 800 cycle audio amplifier. Since the detector is a triode with fairly low plate impedance, series resonance is practical when using a 5,000 or 10,000 ohm detector plate resistor. The audio signal builds up a high voltage at resonance across the .01 mfd. grid condenser and 4 henry grid impedance. Because the grid is only across the 4 henry coil, it makes use of this high 800

(Continued on page 14)

● The illustrations show the interior top and bottom views of the "20-40" Traffic Tuner. The upper illustration shows the correct placement of parts and the arrangement of the shielding "L" bracket around the crystal and its associated condensers. Long bakelite shafts are used to tune the small variable condensers. The lower illustration shows the arrangement of IF transformers, tubes, condensers, coils, etc. Note the "U"-shaped shield partition and the arrangement of the coils. The detailed drawing on the facing page is a better guide for the constructor in properly laying-out the parts

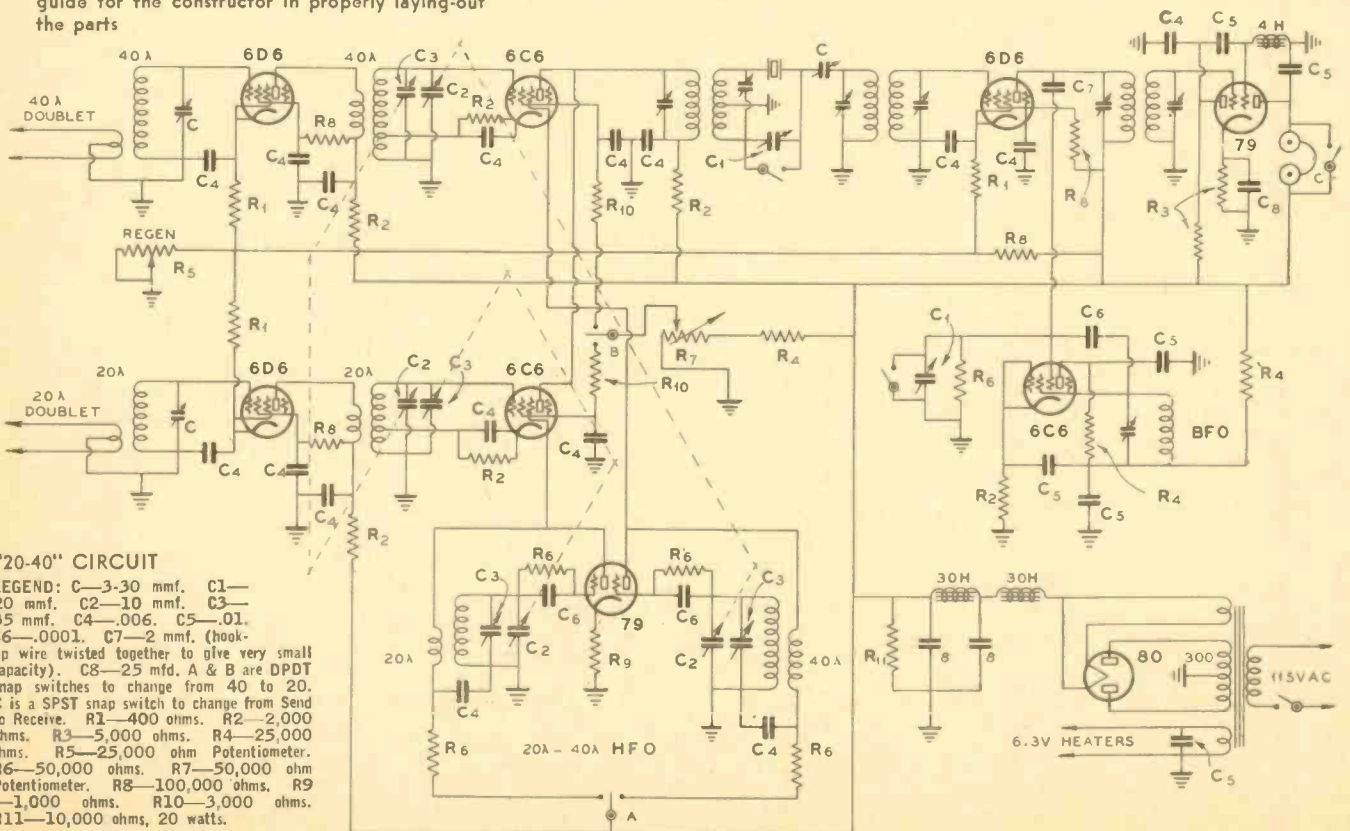
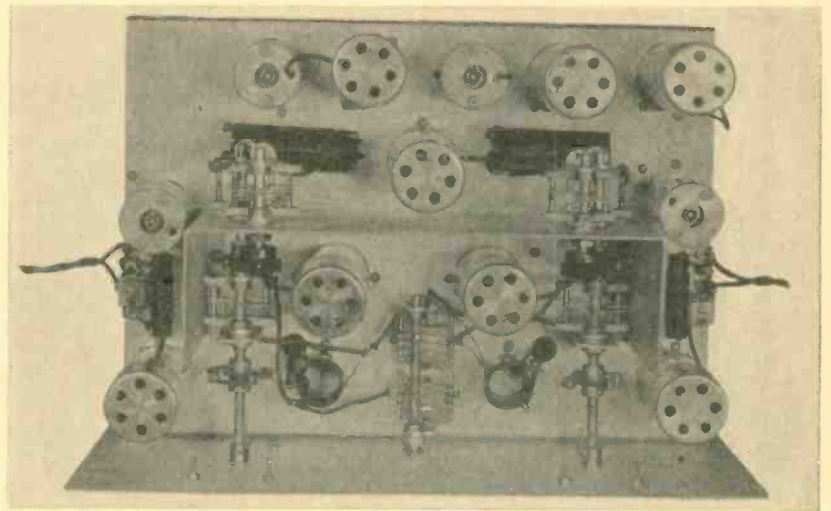
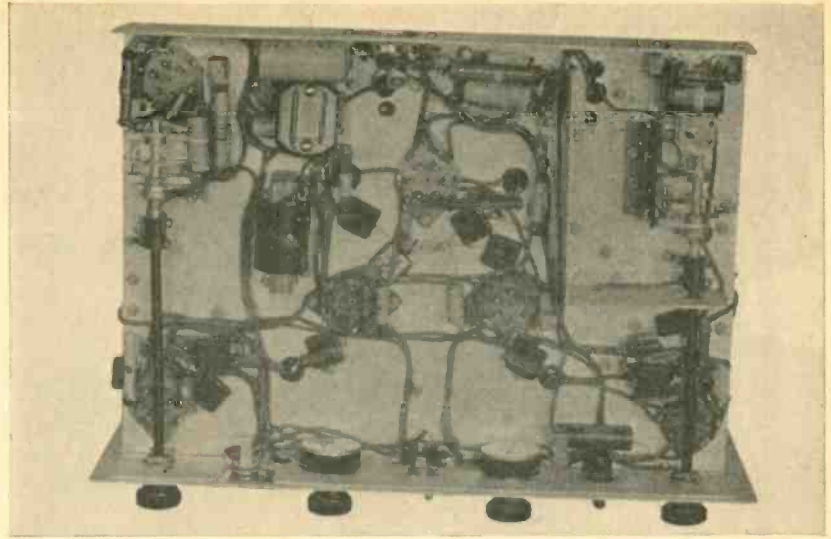

cycle peak voltage. The audio plate circuit uses a shorting switch for silencing the receiver during periods of transmission. Operation was designed for headphones only.

The beat frequency oscillator uses a relaxation type oscillator circuit with a 6C6 tube. This form of circuit has good stability, does not require a tapped coil, and has less harmonics than an electron-coupled oscillator. The oscillator coil can be any old IF transformer with one coil short-circuited. An IF coil should be used which has a mechanically well designed trimmer condenser, or an air-tuned condenser to maintain BFO stability. Front panel vernier frequency adjustment is made by means of a 20 mmfd. midget condenser across the suppressor grid to ground. The active grid in this circuit is the screen grid and oscillation is obtained by feed-back in phase to the suppressor grid when the screen voltage is about 100, the plate voltage 22 and the cathode and control grid a few volts positive. It is not a dynatron oscillator.

The audio amplifier could be resistance-coupled, using a 50,000 ohm plate resistor .006 grid condenser, or smaller, and a 1/2 or 1/4 megohm grid leak instead of the 4 henry choke. The RF by-pass of .006 would then have to be changed to about .002 mfd. and a 10 mh RF choke would be desirable in series with the detector plate lead. The 4 henry audio choke coil is made by using an old 250 mh RF choke with an "A metal" core from a small audio transformer. The audio amplifier is tuned to the desired audio frequency by adjusting the 48-in. variable air gap in the core. The coil of a small filter choke, with a few straight pieces of iron core inserted in the coil form, will provide a 4 henry choke suitable for this purpose.

The first detector 2-plate main tuning condensers are ganged with flexible couplings to their respective 2-plate oscillator tuning condensers. A 2-gang 35 mmfd. per section condenser provides a tank condenser capacity, plus front panel trimmer adjustment, which is needed when using regeneration. The 35 mmfd. oscillator tank or padding condensers are set for correct adjustment and clamped with a lock-nut so as to maintain good dial calibration on both bands. Each band covers between 2/3 and 3/4 of the full dial. A separate National type N vernier dial is used for each band. Thus one band can be set at some given station while awaiting a chance for a QSO, and in the meantime another transmitter can be operated on the other band. Sometimes the desired foreign station is on a long QSO of an hour or so, and with this receiver there is no chance of losing him since the dial on that band can be set to his frequency and an occasional check given on his frequency.

A 20 and separate 40 meter doublet with twisted pair lead-ins should be used with this receiver in order to minimize auto ignition and power line noise pick-up. There is practically no antenna capacity to the RF grid coil because a balanced primary is used. This prevents pick-up from the antenna feeders nearly as effectively as a very elaborate Faraday screen system. Tests made on vertical and horizontal 20 meter doublets with twisted pair lead-ins gave decidedly less noise from automobiles when using the horizontal antenna instead of the vertical. The signals, averaged, were about the same on either antenna.

The RF coils are wound on 1/2-in. tubing in order to minimize the external field. The 20 meter coil consists of 40 turns of No. 22 DSC wire, with a primary of No. 36 DSC of 8 turns center-tapped. These primaries are wound over the grounded end of the secondary in a small bunch winding with the center grounded. The 40 meter RF coil has 66 turns of No. 26 enameled wire with a center-

tapped 10 turn primary of No. 36 DSC wire.

The 20 meter detector coil consists of 10 turns of No. 22 DSC, 1-in. diam., 3/4-in. long, wound on celluloid strips. The wire is cemented to the strips with Duco cement. The primary consists of 7 turns of No. 36 DSC interwound with the secondary with the RF +B connection to the "ground" end of the coil. The cathode tap is made 1/4 turn from the ground end. This tap should be only high enough to allow the first detector to spill into oscillation with the regeneration control well advanced.

The 40 meter detector coil is made in the same manner as the 20 meter coil, but with 24 turns, one inch long, one inch in diameter. The cathode tap is made 1/3 of a turn up from ground, and the primary is interwound for 14 turns; No. 36 DSC wire is used. For mechanical rigidity, the ends of the celluloid strips are cemented to bakelite tubing which is fastened to the chassis with a machine screw.

The oscillator coils are wound on one-inch bakelite tubing in order to provide a rigid coil. The 20 meter coil has 10 turns, 3/4 inches long, of No. 22 wire with a three turn tickler interwound at the ground end of the secondary. The 40 meter oscillator coil has 22 turns of No. 22 DSC, one inch long, one inch in diameter, with a 6 turn tickler of No. 36 DSC interwound. All coils are coated in 3 or 4 places with Duco cement in order to give a rigid coil, mechanically. All coils for each band are mounted at right angles to each other and, of course, an aluminum shield of No. 12 ga. is used between them. The RF coils are tuned by means of small compression type 3-30 mmfd. condensers soldered across the ends of the RF coils.

The change from 20 to 40 meters is accomplished by switching the detector screen grids and oscillator plate returns through a small DPDT snap switch. There is no RF on these leads. The BFO vernier condenser and crystal filter "phasing" condenser have the corner edge of a stator plate turned in so as to act as a shorting switch with the condenser in full capacity position. The BFO is tuned to about 465 KC by means of the IF transformer trimmer condenser. Vernier control is obtained by means of the small variable condenser. The crystal filter phasing condenser is used to balance out the quartz crystal holder capacity in order to obtain single signal response.

As far as practical, each stage has all of its ground returns made to one point on the chassis in order to provide good circuit isolation.

The chassis is made of No. 12 Aluminum, 14-in. x 10-in. x 2-in., with a U-shaped vertical partition 6-in. high to shield the first detector sections. The cabinet is also made of No. 12 gauge aluminum with a "sand blast" finish. The cabinet measures 15-in. x 8 3/4-in. x 10 1/2-in. Another small shield can is placed around the crystal filter parts underneath the chassis.

Adjustment of this set or any other short wave superheterodyne receiver is fairly simple if one has a modulated all-wave test oscillator. If the crystal frequency is known, the IF amplifier can be aligned to that frequency by means of the test oscillator, beginning at the IF coil nearest the second detector. Once the IF amplifier is aligned to the crystal frequency, the coupling on the iron core IF transformers can be loosened for better selectivity on CW reception. These transformers have a 1 mh primary and a 1.5 mh. secondary, with a screw adjustment for coupling variation. The BFO should have enough coupling to the second detector to provide a good beat note on an R-7 signal, at which level the BFO voltage is not

(Continued on page 21)

A New Electron-Ray Indicator Tube

(Continued from page 8)

The third electrode is identified as "ray-control electrode," and is an extension of the triode plate. The visible effect produced by different voltages on this electrode is shown for two adjustments by the shaded areas of Fig. 2. The voltage on the ray-control electrode is determined by the voltage applied to the grid of the triode connected as a DC amplifier. A series resistor of one megohm is placed between the triode plate and the high-voltage supply to which the target is directly connected, as shown in Fig. 3.

The effect of the series resistor is to reduce the voltage applied to the triode plate, and consequently to the ray-control electrode, under conditions of decreased triode-grid bias (increased triode-plate current). For conditions of increasing triode-grid bias (decreasing triode-plate current), the triode-plate voltage increases and approaches the value of the supply voltage. In the practical use of the 6E5 as a tuning indicator, controlling voltage applied to the triode grid is obtained from a suitable point in the AVC circuit.

TENTATIVE DATA		
Heater voltage (AC or DC)	6.3	Volts
Heater current	0.3	Amp.
Plate-Supply voltage	250 max.	Volts
Target voltage	250 max.	Volts
Typical operation:		
Plate- and Target-Supply voltage	200	250 Volts
Series triode-plate resistor	1	1 Meg.
Target current (approx.)	4.0	4.5 MA
Triode-plate current for zero triode-grid voltage	0.2	0.25 MA
Triode-grid volt. for shadow angle of 0° (approx.)	-6.5	-8.0 Volts
Triode-grid volt. for shadow angle of 90° (approx.)	0	0 Volts
Maximum overall length		3 3/4-in.
Maximum diameter		1 1/8-in.
Bulb		ST-12
Base		Small 6-pin

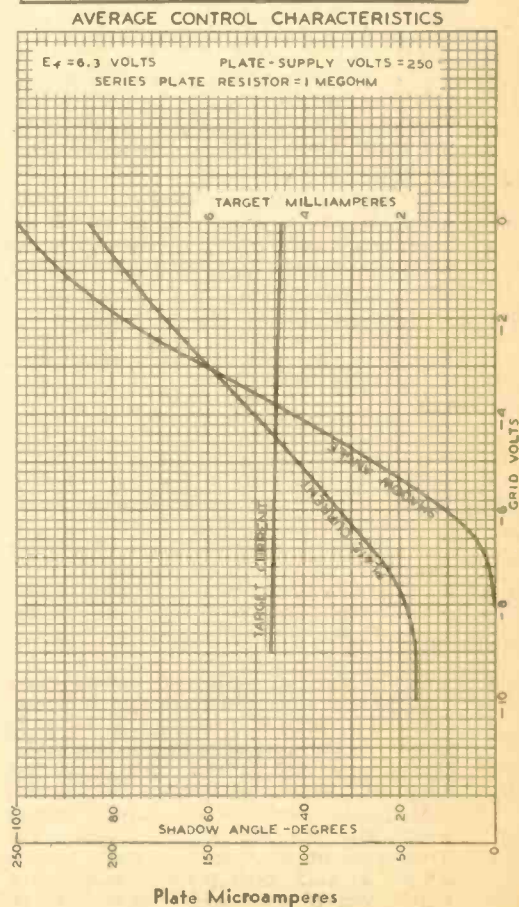

Closed Circuit Parallel Rod Oscillators

By FRANK C. JONES

● Parallel rod circuit oscillators of the form developed by Prof. F. E. Terman seem to be the answer to ultra-short wave transmitter problems. They are more efficient and they provide better frequency stability than any of the usual forms of oscillator circuits. Frequency doublers, controlled by piezo-electric crystal oscillators, are almost out of the question for wavelengths below five or six meters. For amateur work, parallel rod oscillators are extremely desirable for wavelengths between 1 and 10 meters.

The oscillator circuit shown in the accompanying illustrations may not be new in design, although the writer cannot recall any reference to this particular form of circuit. Numerous measurements were made of input and output, using a single 45 tube as an oscillator at five meters. It was found that the efficiency of this circuit is nearly twice as high as that of any of the usual coil and condenser tuned oscillator circuits.

The circuit consists of two parallel rods, 1/2-in. in diameter, and separated 1/2-in. on porcelain stand-off insulators mounted on a long strip of dry wood. The 45 tube is connected across a point between one end and the middle of the rods. The plate is tied to one rod and the grid, through a blocking condenser, is tied to the other rod. A high value of grid-leak is used for the 45 tube (100,000 ohms) and consequently no RF choke is needed at that point. The plate voltage is fed into one short-circuited end of the rods through a small RF choke, although this choke can sometimes be omitted. Filament chokes are used in order to thoroughly isolate the circuit, although these chokes are not as necessary at 5 meters as they are at 2 1/2 or 3 meters. All of the filament chokes have about 30 turns of No. 14 enameled wire, wound on a 1/2-in. dowel rod, then slipped off to form a self-supporting coil.

For operation at five meters a small additional capacity of about 5 to 10 mmfd. between plate and cathode or filament is desirable in order to maintain oscillation at one frequency of high amplitude. This capacity is not required for 2 1/2 meter operation. The 45 tube is not too effective at 2 1/2 meters, but by using very short leads and slotting the tube base between plate and grid prongs, fairly good output is obtained. The difficulty at 2 1/2 meters seems to be that the "local" circuit formed by the tube elements and the leads to the parallel rods resonates close to that wavelength. This condition is undesirable.

On long runs the plate current will creep and a 400 ohm cathode resistor is therefore included in the circuit in order to provide a certain amount of self-bias to the grid. This entirely eliminates the "running away" tendency.

The modulator consists of a high-quality single-button mike, 56 tube speech amplifier, and a pair of 2A5 pentode tubes in parallel in the final amplifier or modulator. Operating at 350 to 400 volts, these two tubes will deliver more than 10 watts of audio power which will modulate at least 20 watts input to the RF oscillator. The screen grids of these pentodes would become red-hot at such high plate voltage and a 10,000 ohm 10 watt series resistor is there-

fore used to drop the voltage to about 200 or 250 volts at the screens. The RF oscillator provides the correct load impedance for the two pentodes in parallel when used with choke coil output. The choke should be rated at from 20 to 30 henrys at 150 to 200 MA.

The five-meter oscillator has two aluminum rods about 7 feet long, while the 2 1/2 meter oscillator is about 30 inches long. One end is permanently short circuited and the plate voltage is fed into this point through a 50 turn RF choke. The other end had a sliding short-circuit for adjustment of frequency. The load consisting of a resistor and thermocouple, or two-wire matched impedance

result in less output, or an entire lack of oscillation.

In checking relative efficiencies, a 500 ohm 3 watt carbon resistor and a thermo-milliammeter can be used as a dummy antenna load. This form of thermocouple is inaccurate at such high frequencies, but for this purpose the accuracy is not of paramount importance because a comparative output reading for different adjustments or circuits is all that is required. Other forms of measurements have shown that efficiencies of from 20 to 35% can be obtained from 5-meter oscillator circuits using coils and condensers. The resistor and thermocouple indicated an efficiency of 28% for the 45 tube in a stand-



Breadboard layout of the Parallel Rod Oscillator, showing proper placement of tube, chokes, resistors and condensers.

RF feeders, is bridged across the rods near either end. This distance varies from 3 to 8 inches from the short-circuiting bridge.

The oscillator acts like a normal "long wave" oscillator in that the plate current is quite low with no load. Under conditions of load, the frequency is mainly determined by the distance between the two short-circuit connections on the rods. Moving the oscillator tube along the rods effect the frequency to some extent, but its main function is to match impedances. Apparently the 45 tube shortens the half-wave rods from 8 feet to about 6 1/2 to 7 feet, due to the capacity effect of the tube. Based upon this conclusion, the impedance would be a maximum at the center where the voltage would be greatest, and diminish at zero at the closed-circuit rod ends. By sliding the 45 tube along the rods, the best impedance match can be obtained for optimum plate load and grid

ard Colpitts or Ultra-audion 5-meter oscillator circuit.

Some of the measurements at 5 meters may be of interest and are given in the following paragraphs.

At 58 MC with the 45 tube 51-in. from one end, the load 4-in. from that end, the input was 21 watts at 370 volts and 57 MA. The output was 8.8 watts, giving an efficiency of 42%.

Sliding the 45 tube closer to one end raised the efficiency to 51% with optimum load conditions, but raised the frequency to about 61 MC.

Moving the short-circuit connections further out along the parallel rods brought the frequency back into the 5-meter band and gave an output of 9.1 watts at 19 watts input, or an efficiency of 48%. At this adjustment a change in plate voltage from 400 down to 200 volts caused a frequency change

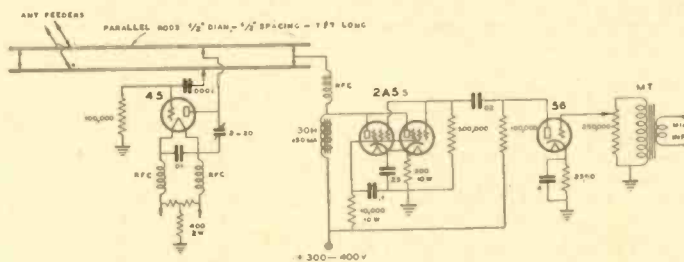

Circuit diagram of the Parallel Rod Oscillator and associated speech channel.

excitation. The latter can also be controlled by means of the external plate-to-filament capacity. Other types of tubes might require this added capacity from grid to filament, instead of plate to filament.

An easy method for adjusting the antenna feeder position is to use a 6-volt pilot lamp and a turn of wire, coupled to either closed-circuit rod end, as a modulation indicator. The antenna feeders can be moved out, increasing the load, until less upward modulation is obtained when whistling into the microphone. Too much load on any class C RF stage or oscillator makes it impossible to obtain high percentage amplitude modulation. Too much antenna load will also re-

of from 15 to 20 KC, which is about 1/2 to 1/3 that of the usual 5-meter oscillator. The change was more rapid below 200 volts, because at 75 volts plate supply the frequency has changed about twice as much.

Various adjustments gave efficiencies ranging from 37% to as high as 64%, with an average of about 50% for ordinary adjustments and plate supply of 300 to 400 volts.

At 3 1/2 meters with the same parallel rods, an output of 2.5 watts was obtained with an input of 8, with 40 MA at 200 volts . . . 31% efficiency. At 20 watts input at 320 volts, the output was 8 watts with an efficiency of 40%.

(Continued on page 29)

The New RCA-803 125-Watt Pentode in a 20 Meter Suppressor-Grid Modulated Phone

By the Technical Staff of "RADIO"

● The new 125 watt RF pentode developed by RCA offers numerous possibilities, such as the 50 watt suppressor grid modulated phone illustrated here. This new tube has a rated plate dissipation of 125 watts and is designed to operate from a 2000 volt plate supply. The output is rated at over 200 watts carrier as an RF amplifier and a little over 50 watts as a grid modulated phone Class C stage. It was possible to obtain about 40 watts carrier on 20 meters and more on the lower frequencies.

As a crystal oscillator this tube could be used as a fine driver for a 1 KW final amplifier, although the crystal would probably be somewhat overloaded. It should make a fine buffer stage for either phone or CW use since it is a screen-grid tube and would require no neutralization—only shielding between grid and plate circuits. As in common with other smaller RF pentode tubes, it requires very little RF excitation but the plate efficiency is lower than in a triode.

A small transmitter for test purposes could use a 6A6 or 53 tube used as a crystal oscillator-doubler to provide RF excitation for the RF pentode, as shown in the circuit diagram. Suppressor-grid modulation is used and a 42 or 2A5 pentode furnishes the AF excitation. Any type of microphone and speech amplifier can be used, but in order to simplify this transmitter as much as possible a single button, good quality mike gives enough sensitivity to work into the 42 tube through a mike transformer. The 42 plate transformer is a regular small class B input transformer with a 10,000 ohm load resistor across the secondary. The tube load is not constant since the suppressor is worked from a negative point over into the positive region on voice peaks. The suppressor-grid draws a few mills of current when it is positive.

Because only a limited amount of information was available on this new tube, a few heavy duty variable tapped voltage dividers were used across the high voltage supply and all grid returns made to these variable taps or sliders. A full 2000 or 2100 volts could be obtained from a power transformer having about 2350 volts RMS each side of center, or by means of bridge rectifier circuits and lower voltage transformers.

The crystal oscillator uses the Jones exciter circuit described in previous issues of "RADIO". It has proven to be a good oscillator and an excellent frequency multiplier and an 80 meter crystal can be used to produce practically enough RF excitation for the pentode on 20 meters. This oscillator is tuned-up by setting the oscillator triode plate condenser about mid-point in the range of crystal oscillation, then tuning the other plate condenser for maximum output at the desired harmonic of the crystal. The 15 mmfd. regeneration condenser in the grid circuit of the doubler should be increased to the point just below self-oscillation, without the crystal in its socket, but with all circuits in tune. The use of regeneration increases the harmonic output and reduces the plate current in the multiplier circuit.

The final amplifier should be tuned-up with the suppressor-grid negative until plate tuning resonance and proper antenna loading conditions have been found. An electric iron or small electric heater is a suitable primary resistor for use in reducing the high voltage supply by transformer primary volt-

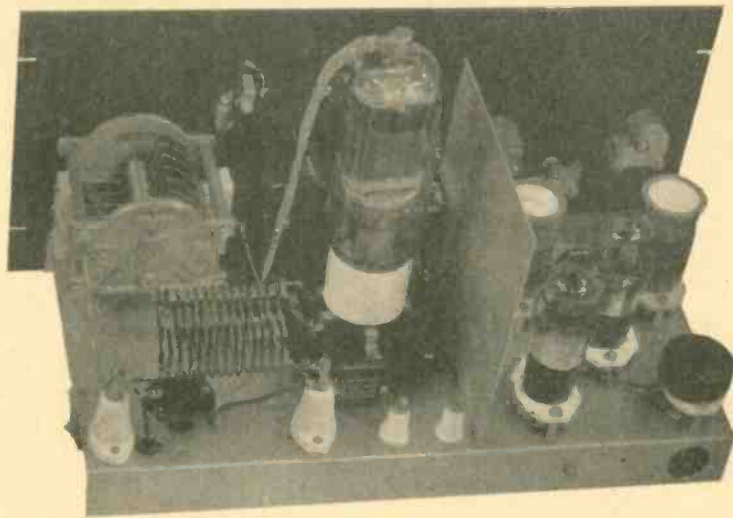

The complete R.F. portion is mounted on a single chassis.

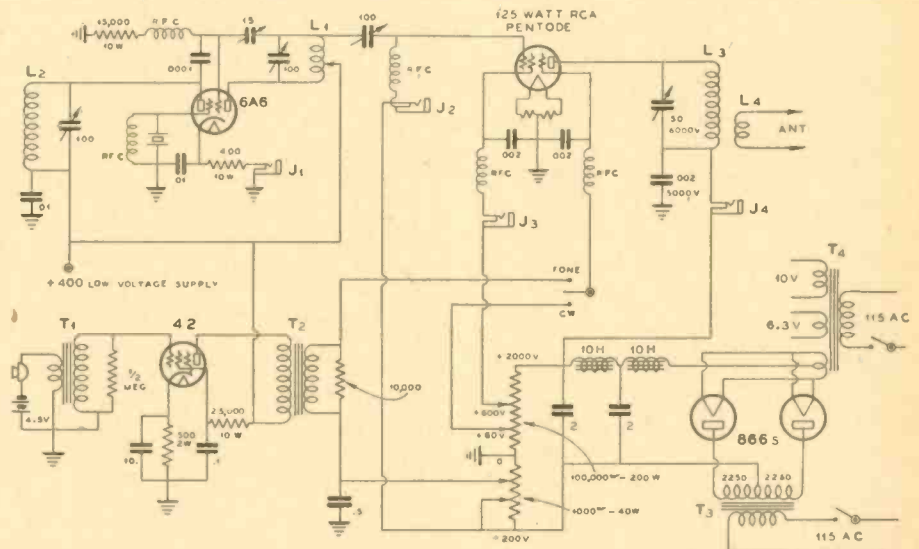

Suppressor-grid modulated phone using 125 watt pentode. A 53 or 6A6 is used as driver and the suppressor grid of the 125 watt pentode is modulated by a type 42 or 2A5 tube. The output is 200 watts for c.w. and 50 watts for phone operation. The 42 or 2A5 plate transformer T2 is a regular small class B input transformer with a 10,000 ohm load resistor across the secondary. T1 is the microphone transformer. The oscillator uses the Jones exciter circuit. Coil winding data for 20 meters: L1 (40 meters) 14½ turns of No. 18 DSC on 1½" dia. form, space wound to cover 1½" winding space. The doubler coil L2 is wound with 8 turns of No. 18DSC on a 1½" dia. form, space wound to cover 1" winding space. L3 (20 meters) 10 turns of 3/16" copper tubing, 1¾" diameter, 2½" long. The variable grid coupling condenser is changed to one of 35 mmf. capacity for 20 meter operation. For 40 meters, 100 mmf. is used, as shown in the circuit diagram.

125 watt pentode characteristics: Fil. 10 volts. Fil. current 3.25 amps. DC plate voltage 2000 max. Plate dissipation 125 watts. D.C. screen voltage 600 max. Suppressor voltage +60 max. Screen dissipation 20-30 watts, max.

age control. When resonance and loading has been obtained, the plate voltage can be raised to about 2000 volts, the screen to nearly 600, the suppressor to about 60 volts positive and the -B control grid voltage slider tap adjusted until 150 to 175 MA of plate current flows. The RF excitation on the control grid must be sufficient for Class C operation. The variable 1000 ohm resistor acts as part of the power supply bleeder and also as a cathode resistor for self-bias on the control grid. At -130 volts on the control grid, this grid current ran about 8 to MA on

20 meters when the crystal was a 40 meter oscillator. The screen-grid current ran about 20 MA and the carrier output was sufficient to fairly well light-up a 200 watt lamp coupled to the plate tank circuit.

For phone operation, the suppressor grid switch is thrown over to phone position which puts it through the modulation transformer to a negative point on the voltage divider. The method of adjustment is as follows: The suppressor-grid voltage is increased in a negative value until the antenna current is reduced one-half, which means ¼

as much carrier. This can be read on an RF meter in the antenna feeders, or a 50 watt lamp can be substituted for the 200 watt lamp. The latter method is a little more difficult, since more coupling is needed for the higher resistance, low wattage lamp. The plate current should drop to not over 75 MA, which is about half that used for CW operation.

Optimum setting of control grid voltage will vary for phone and CW because the plate current varies, but a compromise setting can be used of about -70 volts for phone. The suppressor-grid voltage in this case was about -70 volts.

When modulating, the antenna current should kick upwards, slightly. Steady tone should be capable of increasing it about 22% for 100% modulation. The modulator can be a pair of 45 tubes to good advantage; however, the 42 or 2A5 tube with 400 volts on the plate will give about 5 watts of audio output. This voltage is too high for the screen of this tube, which requires a series resistor to drop it to about 200 volts.

If metering jacks are used to measure grid and plate currents as shown in the circuit diagram, it should be remembered that 2000 volts plate supply is unhealthy to any individual. The primary switch on the high voltage supply should always be opened before plugging the milliammeter into that plate circuit.

The transmitter shown uses a front panel made of tempered Masonite or Celotex 19-in. x 8 3/4-in. x 7 1/8-in. A panel 10 1/2-in. or 12 1/4-in. wide would be necessary if it is to clear the pentode tube. This tube has a special 50 watt base with five prongs and a special socket had to be constructed, since these were not available on the market. The chassis was made of No. 12 gauge aluminum, 17-in. x 10-in. x 1 1/2-in. With 2000 volts DC supply, the wire used in this circuit should be of high tension type. The voltage dividers should be mounted in the power supply unit, but in this case these resistors were mounted underneath the chassis. For long periods of operation too much heat is radiated under the chassis.

Because 2000 volts DC is used in the plate circuit, the plate tuning condenser should be capable of withstanding about twice that value of RF voltage across it. This means that this condenser should be rated to stand 6000 volts or more on breakdown flash test. A 5000 volt plate by-pass condenser is sufficient for the tuned circuit return to ground or filament. If a plate RF choke is used, it should be capable of carrying 175 MA for CW, although for phone use a small receiving type choke is suitable, since the plate current does not run over 90 MA.

Suppressor-grid modulation is simple to adjust and gives good quality for amateur phone use. However, its cost is a little higher than control grid modulation since a much lower priced triode tube can be used with the latter system.

Most of the tests were run on 20 meters and it was found that the plate-to-ground capacity of this pentode is much higher than the usual triode tube of the same power rating. This means that fewer plate coil turns should be used than in most circuits. The plate coil used on 20 meters (not shown in photograph) was made of 10 turns of 1/8-in. copper tubing wound on a 1 3/4-in. diameter, 2 1/2-in. long. The 40 meter oscillator coil had 14 1/2 turns of No. 18 DSC wire on a plug-in coil form 1 1/2-in. in diam., with the winding 1 1/2-in. long. The doubler coil on 20 meters was similar with 8 turns 1-in. long on 1 1/2-in. diam.

The variable grid coupling condenser was changed from 100 to a 35 mmfd. double-spaced midget condenser. On 20 meters, 20 mmfd. seemed to be enough coupling capa-

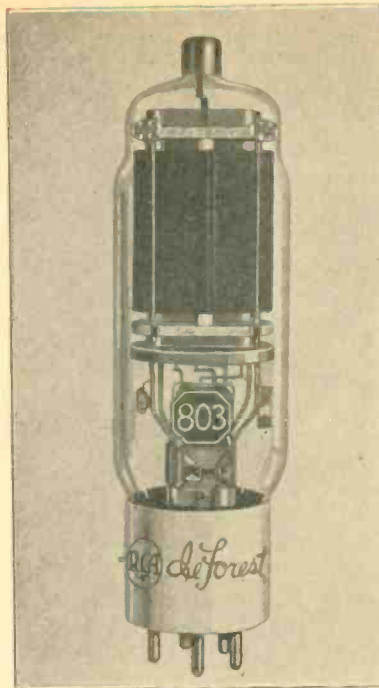

RCA 803 Pentode

city to the grid of the pentode tube. More capacity did not increase the output and caused self-oscillation probably due to insufficient shielding. More RF excitation did not increase the output, even with more control grid bias.

The following readings were obtained, using the transmitter shown. These may not be optimum values but they are a basis to work on until more data is available.

CW:
 $W_o = 150$ watts output
 $E_p = 2000$ volts $E_{SG} = +600$ volts
 $I_p = 130$ MA $I_{SG} = 20$ MA
 $E_G = 130$ volts $I_G = 7$ to 10 MA DC
 $E_{SR} = +60$ volts

Phone:
 $W_o = 40$ watts carrier
 $E_p = +2000$ volts $E_{SG} = +600$ volts
 $E_G = -70$ volts $I_{SG} = 20$ MA
 $E_{SR} = -70$ volts $I_G = 3$ to 7 MA DC

E_p = plate voltages
 I_p = plate current
 E_{SR} = suppressor voltage
 E_{SG} = screen voltage
 E_G = control grid voltage
 I_G = control grid current
 I_{SG} = screen grid current
 W_o = output

General Description and Characteristics of the 803

Tentative Characteristics	
Filament voltage (AC or DC)	10 Volts
Filament current	3.25 Amp.
Mutual Conductance, for 4,000 plate cur. of 55 MA	Micromhos
Direct Interelectrode Capacities:	
Grid-plate (with external shielding)	0.15 max. uuf
Input	15.5 uuf
Output	28.5 uuf
Base (see accompanying photo.) Giant 5-Pin Bayonet	
Maximum Ratings and Typical Operating Conditions	
As RF Power Amplifier—Class B Telephony Carrier Conditions per Tube; for use with a Modulation Factor up to 1.0:	
DC Plate Voltage	2,000 max. Volts
DC Screen Voltage (Grid No. 2)	600 max. Volts
DC Suppressor Voltage (Grid No. 3)	60 max. Volts
DC Plate Current	90 max. MA
DC Screen Current	60 max. MA
DC Suppressor Current	4 max. MA
DC Grid Current (Grid No. 1)	4 max. MA
Driving Power (Approx.)*	2 Watts
Carrier Power Output (Approx.)	33 40 53 Watts
DC Plate Current	80 80 80 MA
DC Screen Current	15 15 15 MA
DC Grid Current	4 4 4 MA
Driving Power (Approx.)*	2 2 2 Watts
Carrier Power Output (Approx.)	33 40 53 Watts

Typical Operation:

Filament Voltage (AC)	10	10	10
DC Plate Voltage	1250	1500	2000
DC Screen Voltage	600	600	600
DC Suppressor Voltage	40	40	40
DC Grid Volt. (Grid No. 1) Approx.	-40	-40	-40

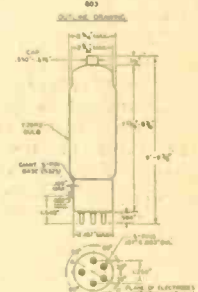
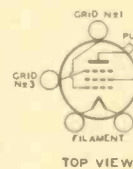
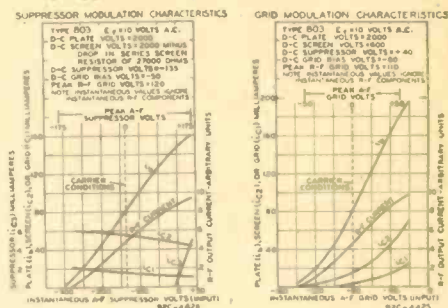

Peak RF Grid Voltage (Approx.)	55	55	55
DC Plate Current	80	80	80
DC Screen Current	15	15	15
DC Grid Current	3	3	3
Driv. Power (Approx.)*	1.5	1.5	1.5
Carrier Power Output (Approx.)	33	40	53

As Suppressor-Modulated RF Power Amplifier—Class C Telephony Carrier Conditions per Tube; for use with a Modulation Factor up to 1.0:

DC Plate Voltage	2000 max. Volts
DC Screen Volt. (Grid No. 2)	600 max. Volts
DC Plate Current	90 max. MA
DC Grid Current	50 max. MA
Plate Input	180 max. Watts
Plate Dissipation	125 max. Watts
Screen Dissipation	30 max. Watts

Typical Operation:

Filament Voltage (AC)	10	10	10
DC Plate Voltage	1,250	1,500	2,000
DC Screen Voltage	400	500	500
DC Suppressor Voltage, Approx. (Grid No. 3)	-85	-110	-135
DC Grid Volt., (Grid No. 1) Approx.	-35	-50	-50
Peak RF Grid Volt. (Approx.)	110	120	120
Peak AF Suppressor Volt. (Approx.)	125	150	175
DC Plate Current	80	80	80
DC Plate Current	55	55	55
DC Grid Current	15	15	15
Screen Resistor	15,000	18,000	27,000
Driving Power (Approx.)*	1.6	1.6	1.6
Carrier Power Output (Approx.)	33	40	53

As Grid-Modulated RF Power Amplifier—Class C Telephony Carrier Conditions per Tube; for use with a Modulation Factor up to 1.0:

DC Plate Voltage	2000 max. Volts
DC Screen Volt. (Grid No. 2)	600 max. Volts
DC Suppressor Volt. (Grid No. 3)	60 max. Volts
DC Plate Current	90 max. MA
Plate Input	180 max. Watts
Plate Dissipation	125 max. Watts
Screen Dissipation	20 max. Watts

Typical Operation:

Filament Voltage (AC)	10	10	10
DC Plate Voltage	1250	1500	2000
DC Screen Voltage	600	600	600
DC Suppressor Voltage	40	40	40
DC Grid Volt., (Grid No. 1) Approx.	-80	-80	-80
Peak AF Grid Voltage (Approx.)	50	50	50
Peak RF Grid Voltage (Approx.)	115	115	110
DC Plate Current	80	80	80
DC Screen Current	15	15	15
DC Grid Current	4	4	4
Driving Power (Approx.)*	2	2	2
Carrier Power Output (Approx.)	33	40	53

* At crest of AF cycle.

Application & Design of Voltage Dividers*

STRANGE as it seems, the voltage divider is one of the most misunderstood parts used in the radio field. Yet, it represents only ordinary DC engineering and should be readily understood by anyone who is acquainted with the fundamental laws of electricity. Questions are being received from radiomen who wish to find the specifications for voltage dividers of new sets which they have built; there are also many inquiries regarding a solution for the man who wishes to repair an old set when replacement parts are no longer available. It is hoped that this article will provide an answer for all such questions.

Purpose of Voltage Dividers

Since there are some receivers which do not have voltage dividers it is useful to explain their purpose and advantage here.

Curves of any rectifier will show that the output voltage varies with the load and that without a load the voltage may go up to the peak value of the transformer secondary voltage. For the sake of economy it is not customary to employ filter condensers which are able to withstand this high voltage with some margin left over for surges. Therefore, a voltage divider would be necessary as a safety measure to provide a minimum load should the tubes be removed and the set turned on or in case the load is removed due to a defect.

The name "voltage divider" already shows another one of its purposes—to "divide" the voltage or to supply to various parts of the circuit the different potentials required. This can be accomplished, however, by a simple series resistance which is cheaper from the standpoint of first cost as well as current consumption. Therefore, a voltage divider is used when in addition to this second purpose, it is also desired to provide a certain amount of regulation so that the voltages at different tube elements will not vary too much when the tube's plate current varies.

Summarizing the above remarks, a voltage divider has three purposes: (1) to protect the condensers from overload, (2) to "divide" the voltage, and (3) to provide a certain degree of regulation.

Application of Voltage Dividers

The average problem in providing a voltage divider runs about as follows: Given a power supply with a certain voltage and current rating and given the number and type of tubes to be employed with their operating currents and potentials, how can we supply these tubes satisfactorily, in the simplest and yet satisfactory way.

Let us take an example: A small superheterodyne having the following tubes: 58 as RF stage, a 2A7 oscillator-mixer, a 58 IF tube, a 2B7 detector and a pentode output stage, is to be supplied with the proper voltages. Assuming now that all tubes are self biased and that all plates are supplied directly from the power supply, the problem reduces to supplying the screens. This could be done in three ways.

The tube manual will show that all tubes require the same screen voltage (100 volts) and so it would be possible to supply these screens from a voltage divider with a single tap as shown in Fig. 1A. This divider can also consist of two separate resistors of the right value. Lately, many of the small sets have no longer a vitreous enamelled resistor but include a divider made up from two or more carbon resistors. As long as the current to be supplied is not too heavy this method can be used to advantage.

It is also possible to supply the screens through a series resistor from the high voltage supply (Fig. 1B), but in that case the regulation will be bad, for the screen voltage will drop when the volume control is

turned up full and when the variable tubes draw maximum current. Also, if this is done there should be a separate bleeder. The lack of regulation is sometimes an advantage for when the tubes are self biased and the bias resistor is variable, the actual screen voltage applied to the tube is equal to the potential difference between the cathode and the screen and not between the chassis and the screen. So, in order to arrive at the actual screen voltage one must subtract the cathode-to-ground potential. When the cathode-to-

ground potential is varied by means of the volume control the actual screen voltage increases with higher volume control settings. This effect is opposite to that of the bad regulation so they tend to neutralize each other. From this standpoint the second method is better than the first when volume control is obtained by means of varying the

several high gain stages so that it is very important to guard against any source of intercoupling between stages. Fig. 2 represents a voltage divider for use in an average receiver. Right here it is necessary to point out a common error. Supposing the power supply (after passing through the choke and perhaps the

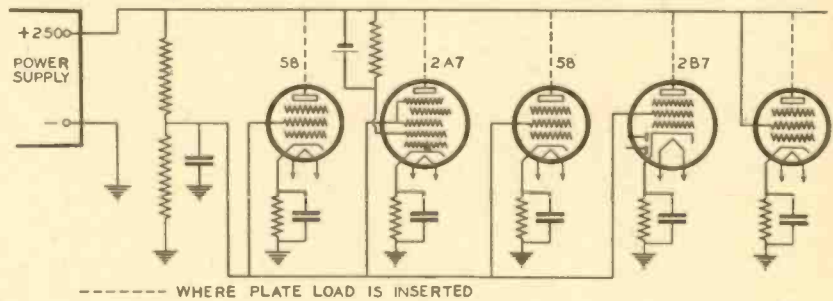

FIG. 1A

several high gain stages so that it is very important to guard against any source of intercoupling between stages. Fig. 2 represents a voltage divider for use in an average receiver. Right here it is necessary to point out a common error. Supposing the power supply (after passing through the choke and perhaps the



FIG. 1B

several high gain stages so that it is very important to guard against any source of intercoupling between stages. Fig. 2 represents a voltage divider for use in an average receiver. Right here it is necessary to point out a common error. Supposing the power supply (after passing through the choke and perhaps the

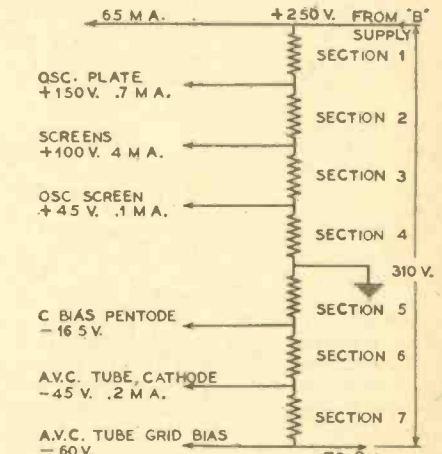

FIG. 2

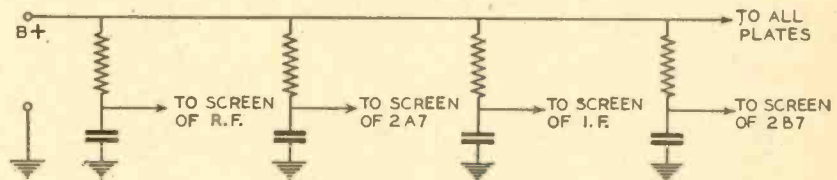

FIG. 1C

self bias. However, with AVC the first method is better.

A third possible method is to use individual series resistors for each screen as in

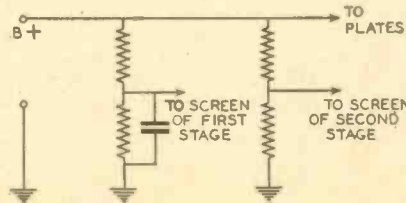

FIG. 1D

speaker-field) is 240 volts and a 20 MA bleeder current is desired. Many radiomen conclude that the total resistance of the divider should be 12,000 ohms because this will allow just 20 MA to flow when connected across 240 volts. However, when the resistor is tapped and some current is drawn from the tap, this current must pass through the upper section, making the voltage drop across the upper portion larger, across the lower portion smaller and thus reducing the bleeder current to less than 20 MA. Therefore, if exactly 20 MA bleeder current is desired, the total resistance will have to be smaller than 12,000 ohms in this case. If

* By the Engineering Dept., Aerovox Corporation.

the correct resistance value is not known and the experimenter is not mathematically inclined he could employ a 12,000 ohm divider and connect his B-plus lead to the upper variable tap, leaving the upper portion unused. All taps then have to be adjusted, the upper one too and the bleeder current ought to be measured.

Another method to follow is to employ several power rheostats, temporarily adjust them until the proper operating conditions are obtained, then measure the resistance of each section and replace them with the nearest commercial value of fixed resistor or have a special tapped one made up (in the case of quantity production).

Finally there is the method of calculation. The following procedure is to be followed:

1. Determine what voltage is required at each tap and what current is to be drawn from it. The tube manual will give this information. If this is not the case, the required data can be obtained by measurement.
2. Determine what bleeder current is desired. It depends on how much the total drain of all tubes is and how much more the power supply can deliver without overheating.
3. Determine the current which will flow in each section of the divider (by Kirchoff's Law).
4. Calculate the resistance of one section at a time by means of Ohm's Law.
5. Determine the power rating. When a single divider with several taps and uniform power rating is used, the power rating should be obtained by employing the equation:

$$\text{Watts} = \frac{I^2 R}{1,000,000}$$

when I is expressed in milliamperes.

The value of I here should be the highest current any section is required to carry. If the divider is to consist of several resistors the wattage for each section should be calculated separately and the actual current in that section should be used for the calculation. This sounds complicated but it isn't. As an example the voltage divider shown in Fig. 2 will be discussed.

Step 1 requires us to find the current at all taps and in order to visualize for the reader how currents leave the divider and return to it later, the same divider has been shown again in Fig. 4 with the external paths shown in dotted lines. The current in each section is also given.

The currents which pass through the tubes finally arrive at the chassis and then join the bleeder current again. At the same tap, the ground tap, where all these currents return, the plate current for the AVC tube leaves the divider.

Step 2 requires the determination of the bleeder current. The total of all currents drawn by tubes, as shown in Fig. 2, is 70 MA. Assuming that a transformer is used

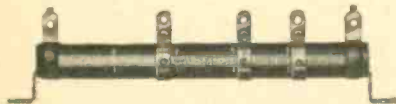

FIG. 3

which is rated at 100 MA, wishing not to overheat it, the maximum current could be restricted to 90 MA. This leaves 20 MA for the bleeder.

Now supposing that all currents and voltages at the taps are known the current in each section is found by simple addition. Beginning with section 4, the current here is equal to the bleeder current plus the .2 MA

for the AVC tube; a total of 20.2 MA. Section three must carry in addition the .1 MA which leaves at the 45 volt tap, a total of 20.3 MA.

Section two carries 4 MA more which makes 24.3 MA. Section one carries again .7 MA more or 25 MA.

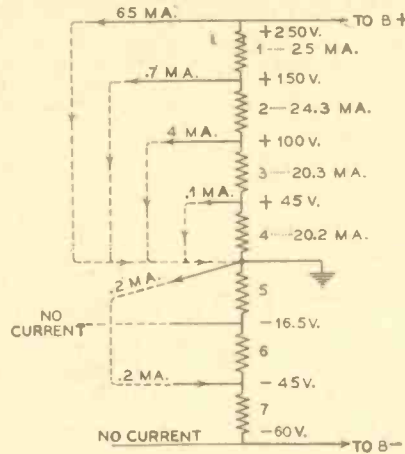

FIG. 4

At the ground tap all these currents return but .2 MA leaves. The current in section 5 is then

$$20.2 + .1 + 4 + .7 + 64 - .2 = 89.8 \text{ MA.}$$

The current in section 6 is the same and in section 7 the .2 MA has returned making a total of 90 MA.

Step 4 requires us to find the resistance of each section. This is simply an application of Ohm's Law. Section 1 has 100 volts across its terminals and a current of 25 MA flowing through it, the resistance is then

$$\text{Section 1} \frac{100}{25} \times 1000 = 4000 \text{ ohms}$$

Similarly, the resistance values of the other sections are

$$\text{Section 2} \frac{50}{24.3} \times 1000 = 2058 \text{ ohms}$$

$$\text{Section 3} \frac{55}{20.3} \times 1000 = 2710 \text{ ohms}$$

$$\text{Section 4} \frac{45}{20.2} \times 1000 = 2228 \text{ ohms}$$

$$\text{Section 5} \frac{16.5}{89.8} \times 1000 = 184 \text{ ohms}$$

$$\text{Section 6} \frac{28.5}{89.8} \times 1000 = 317 \text{ ohms}$$

$$\text{Section 7} \frac{15}{90} \times 1000 = 167 \text{ ohms}$$

$$\text{Total resistance} \quad 11664 \text{ ohms}$$

Assuming that the divider is to be of uniform power rating, the current to be considered is the largest one, 90 MA. The power rating is then

$$\frac{11664 \times 90^2}{1000000} = 27.9 \text{ watts approx.}$$

In the case that separate resistors are used, the power of each section is found by multiplying the voltage across each section by the current flowing in it. If this current is expressed in MA the result should be divided by 1000. Thus the power consumed in section 1 is

$$\frac{100 \times 25}{1000} = 2.5 \text{ watts}$$

The other sections are treated in the same way.

Power supplies of the type shown in Fig. 1B and 1C are simply series resistors. After finding what the current consumption is and what the voltage across this dropping resistor should be, the resistance is at once found by Ohm's Law.

It is at once obvious that the voltage divider offers a common impedance to several circuits and so may give rise to regeneration or degeneration. The obvious remedy for this is to employ by-pass condensers and if necessary extra filter stages in individual supply leads. It should be remembered that in order to constitute an efficient by-pass, the condenser reactance should be considerable lower, about .1 of the resistance being bypassed, at the lowest frequency to be amplified. This becomes difficult when the resistance value is small and low audio frequencies should be amplified.

By regulation we mean the ability of the resistance network to maintain constant voltage with varying load, due to volume control for instance. The only way to obtain satisfactory regulation is to employ a bleeder current which is large compared to the variations in load current. Even so, it is impossible to obtain perfect regulation for this would require an infinitely large bleeder current.

In a somewhat more complicated set which may have a pentode output tube, several RF pentodes, an oscillator of the 57 or 58 type which is being fed lower voltages and the set has a separate AVC tube of the 56 type which requires a negative voltage supply because its plate is connected to the chassis through a load. Furthermore, it is assumed that the bias of the pentode is to be taken from the voltage divider instead of using self bias. This figure is given as an illustration of what a voltage divider of a rather complicated set may look like and not as a design of a receiver nor as an opinion that these are necessarily the most desirable operating potentials. Presently it will be shown how the correct resistor values can be obtained.

Finally some receivers have even more complicated voltage dividers, consisting of several tapped resistors in parallel. These may be used in large sets when it is essential to prevent coupling between certain sections, or it may have been designed with a view to keeping the voltage between certain points constant.

Design of Voltage Dividers

The calculation of the correct resistance values and the power rating of voltage dividers involves nothing but the use of Ohm's Law and Kirchoff's Law ($\sum i = 0$). When a voltage divider as in Fig. 1A and Fig. 2 is to be used one can arrive at the proper values by experimentation or by calculation. For an experimenter or a designer of just one set or for the replacement of a divider which is no longer made, it is perhaps easiest to employ a so-called "adjustable voltage divider". In its most up-to-date form, this unit consists of a vitreous enamelled resistor having the enamel removed along a line running the entire length of the resistor and about a quarter inch wide so that sliding straps can make contact with the bare wire. This type is available in different lengths and with several adjustable sliders as shown in Fig. 3. The sliders can be adjusted until the voltages and currents are correct as determined by suitable measuring instruments. There remains to be determined the correct size to use.

The total resistance depends on the bleeder current that is to be allowed; in order to provide the best regulation the bleeder current should be as high as possible without overloading any part in the power supply.

An Improved 5-Meter Superheterodyne

Wherein the Original Jones Circuit Is Employed With Innovations by W2AMJ

By FRANK LESTER*

• A superheterodyne for five-meter operation can be made almost as simple as a straight super-regenerator, and will give definitely superior results insofar as sensitivity, selectivity and noise level are concerned. The absence of "rush", that noise characteristic of all super-regenerators, will appeal to amateurs accustomed to and annoyed by sets of the latter type.

A properly designed five-meter superhet has another important feature, and that is stability, both internal and external. By this the writer means it does not radiate strong signals via the receiving antenna. Some super-regenerators are better transmitters

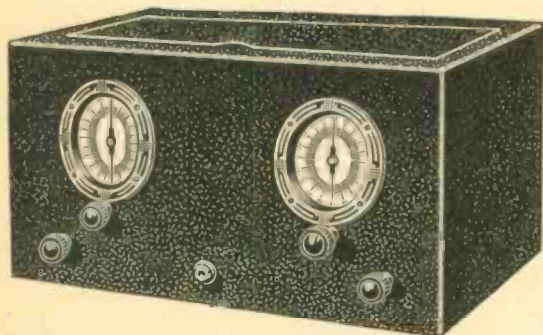

Front view of the Lafayette 5-Meter Superheterodyne, in its crackle finished steel cabinet. The lower left knob is RF gain control, the lower right knob audio volume.

The interior of the receiver reflects the best known 5-meter design practice. The coils are raised above the chassis by stand-off pillars. Interstage shielding is liberally provided. An external source of power supply must be used with this receiver.

than receivers; in crowded districts the QRM created by these sets is getting to be pretty serious.

A five-meter superhet that any ham can put together in a couple of evenings is the new Lafayette kit job, a completed sample of which is shown in the accompanying illustrations. This receiver was inspired by Frank C. Jones, whose ideas on ultra-high-frequency equipment are well known to readers of "RADIO". Certain changes have been made in Mr. Jones' original circuit to adapt it more readily for constructional purposes.

Six tubes are used exclusive of the power rectifier, which is not included. As the 6.3-volt series of tubes is employed, the same receiver unit can be operated without change with either a small AC power pack or a battery combination consisting of a six-volt storage battery and a block of "B" batteries. This arrangement makes the set adaptable to experimental use in an automobile and to fixed use in the shack.

The circuit comprises a stage of tuned RF amplification, tuned autodyne first detector, two stages of resistance-capacitance coupled IF, second detector and semi-A.V.C. tube, and a power pentode output stage capable of working a dynamic speaker to full volume.

*Engineer, Wholesale Radio Service Co., Inc.

To simplify the arrangement of the parts and to eliminate trimming and aligning troubles, separate controls are provided for the RF and detector tuning condensers, C1 and C2, respectively. The RF stage actually provides some appreciable gain (remember, it is not working into a super-regenerative detector), it improves the signal-noise ratio, and it eliminates dead spots in the detector tuning due to that old devil, antenna absorption.

The first detector works on the autodyne principle, the grid circuit being detuned a trifle from the signal frequency so that a comparatively low frequency beat develops. This simple method of obtaining heterodyne action is quite practicable on the ultrahigh-frequencies.

Feed-back between the grid and plate of the first detector is obtained by the use of a small RF choke in the cathode circuit—a form of electron coupling. The choke is common to both the grid and plate circuits and therefore oscillation is maintained at a steady rate. The grid condenser-leak combination and also the screen and plate voltages are adjusted to give smooth regeneration, but not super-regeneration.

The use of resistance-capacitance coupled IF greatly simplifies the construction of the receiver. There are no magnetic fields or interaction effects, and extensive shielding therefore is not required. A type 41 tube, with the screen and grid hooked together to form a high- μ triode, is used as the second detector. Part of the rectified grid current is taken off the grid leak and returned to the grids of the IF tubes, to give automatic volume control.

Two volume adjustments are provided: a cathode resistor R1, regulating the bias on the RF and IF amplifier tubes; and a grid potentiometer R2, regulating the audio output.

Various methods of coupling the antenna to the receiver can be tried. If a two-wire transmission line is used it can be connected directly to the antenna coupling coil, or one feeder can be grounded and the other run up a turn or two on the grid coil L2. Single wire lines should be connected to the grid of

the RF tube through a 10 to 30 mmf. trimmer condenser.

The hay-wire appearance and construction so common today among five-meter receivers have been carefully avoided in the Lafayette set. A heavy, copper-plated steel chassis, all formed and drilled, gives the finished set a truly professional appearance. A heavy T-shaped shield keeps the RF, detector, and IF-AF stages well isolated. The coils are of the plug-in type, with tiny banana plugs and mycalex bases. The antenna coil L1 is fixed, but L2 and L3 are removable. Coils for 2½ and 10 meters will be available shortly after this article appears. For five meters, L1 consists of six turns, L2 and L3 eight turns, of No. 12 tinned wire, wound around a ½-inch diameter form. The taps on L2 and L3, two turns from the grid ends, give enough band spread to make the tuning dials turn about three-quarters of the scale for the five-meter band.

The front panel is finished in black crackle. The chassis slides into a similarly finished cabinet, which has a hinged cover to permit changing of the coils. The whole set measures 12 inches long, 7¾ inches high and 8 inches deep.

When this new Lafayette receiver was shown to some local hams, the first question they asked was,

"Does the RF stage really tune?"

The answer is "Yes". A movement of three to five dial degrees off resonance will cause the signal to drop out. The detector dial is, of course, much sharper, one degree here being the average tuning "sharpness".

The set has been tested very thoroughly and has proved to be satisfactory in every respect. For instance, at the writer's station W2AMJ, located in Bergenfield, N. J., signals from a five-meter transmitter at Walden, N. Y., about 70 miles away, were R2-R3 with a super-regenerative receiver, and easily R7-R8 with the new Lafayette job, and with none of the QRM experienced with the first set. Several stations that were never heard before at all came in quite well with the superhet.

The set was also tried at W2DLG, located on top of the Hotel New Yorker, in New York City, one of the best known five-meter stations in the East. Here also it brought in new stations and in general outperformed several other receivers.

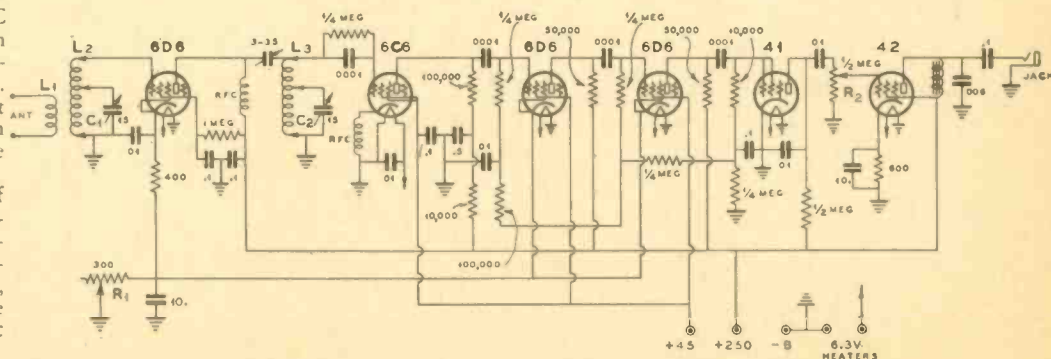

Circuit Diagram of the Lafayette 5-Meter Superheterodyne

2½ and 5 Meter "Linear" Transmitters

By W2AMJ*

● The mechanical dimensions of tuning coils of conventional shape become so small on five and two and a half meters that it has been found advantageous in many cases to dispense with "coils" altogether and to depend on the distributed capacity and inductance of rigid metal conductors. Oscillators of this type are of the Lecher type and are commonly called "long lines" or "linear". They are very stable and when properly adjusted and modulated, they can be received on a superheterodyne or autodyne receiver.

A pictorial diagram of this circuit is shown in figure 1. A transmitter of this type is especially well suited for use on 2.5 meters. The tube may be practically any triode; 45, 10, 801, etc. The rods connected to the grid and the plate are approximately a half wave length long (46 to 48 inches for 2.5 meters).

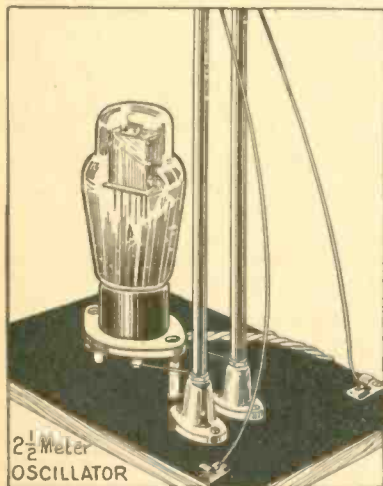
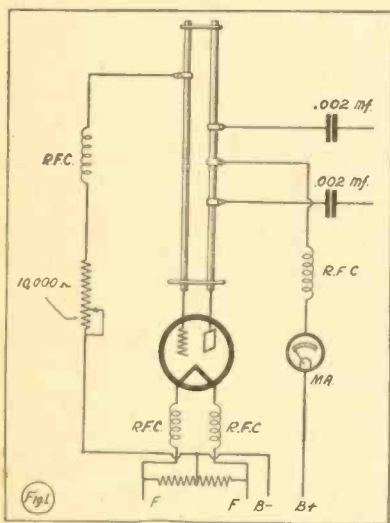

The actual wave length of oscillation depends of the length of the rods and the length of the tube elements and connecting wires, plus the capacity between the rods and the internal capacity of the tube. The grid and plate returns are connected through small R.F. chokes at the nodal points on the conductors which are each a half wave length long on 2.5 meters. The single tube circuit is not recommended on 5 meters because of the length of the rods which would have to be approximately 8 ft. at this frequency.

* Engineer, Wholesale Radio Service Co., Inc.

The antenna feeders are connected through a pair of fixed mica condensers to the plate rod, one each side of the nodal point. The clips are moved up and down until the desired degree of coupling is obtained. Untuned feeder lines may be connected in the same way by adjusting for the required impedance match.

It is necessary with a system of this kind to isolate the filament of the tube insofar as RF is concerned. This requires the use of series chokes in the filament circuit. Since the chokes must carry the full filament current they must be of heavy wire. Twenty-five turns of No. 14 wire space wound on a ½ inch diameter should be sufficient. These chokes should be preferably kept at right angles to the rods.

A Push Pull Version

A simple push-pull version of the "linear" oscillator is shown in figure 2. Here we have four rods and two tubes, with RF chokes in all filament leads. The tubes may again be triodes with the proper filament and plate voltages. Of course different values of grid leaks will be required; the values indicated are approximate and will serve as a starter.

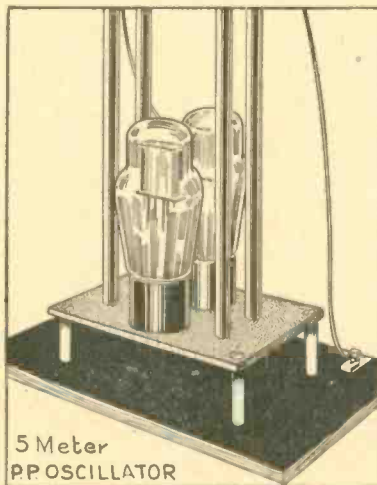
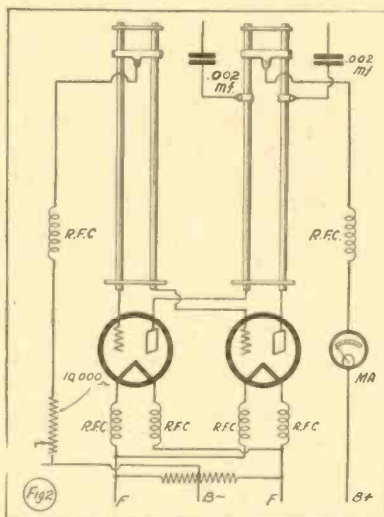

Tuning Is Easy

A plate milliammeter is absolutely necessary if correct tuning is to be accomplished. It will indicate minimum current (with antenna feeders disconnected) when the grid

and plate shorting bars are correctly adjusted for oscillation. It will also fluctuate a little when a screw driver or pencil is touched to the rods at points other than voltage nodes. With the circuit oscillating properly the feeders are then connected and gradually slid down the plate bars toward the plate ends of the rods until the correct current is being drawn by the tubes. Some slight re-adjustment of the grid shorting bar may then be necessary but great care must be exercised or the circuit will stop oscillating.

Although any stiff conductor will serve as the oscillator components, half inch diameter copper rods should be employed to assure stability of operation. They should be rigidly supported and spaced exactly a half inch apart and parallel.

Various methods of mounting the rods will suggest themselves to the constructor. Of course, the rods must be as close as possible to the socket terminals. A special two-in-one socket made of Mycalex (one of the finest high frequency dielectrics known) has been designed for use with the push-pull version. This socket provides mounting holes for the rods and can be mounted on stand-off insulators or ordinary metal rods as desired.

Easily Modulated

For phone or ICW operation an oscillator of this type is easily modulated. The exact power required depending upon the type of tube used and the input into the oscillator. For example a pair of 45's can easily be modulated by a pair of 47's or 2A5's in push-pull or parallel. A pair of 10's in the oscillator can similarly be modulated by a pair of 46's in Class B. Care must be taken so that the oscillator is not over-modulated or frequency modulation will occur.

"20-40" Traffic Tuner

(Continued from page 14)

high enough to give much hiss in the output. This coupling is varied by twisting one or more turns of hook-up wire together as a small coupling condenser.

After the IF amplifier and crystal filter circuit are functioning properly, the detector and oscillators can be tracked by means of 40 and 20 meter test oscillator signals. Slight bending of the 2 plate condenser rotors or stators will allow correct tracking throughout each amateur band. The oscillator inductance should be slightly less than the detector inductance.

Unless the IF is aligned to the crystal frequency, the signals will be attenuated when the crystal filter is cut into the circuit. In aligning the oscillator and detector circuits, care must be taken that no first detector oscillation is allowed.

The only hum present in this receiver was finally traced to filament wiring coupling into the tuned audio choke. Moving one filament wire about ½ inch cured this trouble.

Book Review

"Experimental Radio" (Third Edition, Revised). By R. R. Ramsey, Professor of Physics, Indiana University. Published by R. R. Ramsey, Bloomington, Indiana, 1929. (255 pp., 168 figures, 128 experiments.) Price \$2.75.

"Truly the finest book for the student of radio or the experimenter that has come to our desk for many a month. The book has gone through three editions, and the last, brought up to February, 1929, is as complete as a book of its kind can be.

The TOBE Amateur Communication Kit Set

By GLENN H. BROWNING

● Some time ago the writer and his associates designed an all-wave receiver from 22.6 MC to .54 MC which incorporated a novel tuning catacomb consisting of all the coils and condensers as well as a special switching arrangement for changing bands. The reception given this kit was rather remarkable and was probably in a large measure due to the fact that the signal-to-noise ratio was especially good as well as the sensitivity and selectivity characteristics.

So many requests were received from amateurs expressing a desire for a kit receiver which covered only the amateur bands that work was started on such a kit receiver early this year. Several model receivers were made up and placed in the hands of Frank C. Jones of "RADIO" and other amateurs for their suggestions and criticisms. Many of these suggestions have been adopted with the result that it is believed that this receiver will meet the exacting demands of the amateur for communication purposes.

The writer's purpose in designing this receiver was to place a fine strictly-amateur receiver within the range of the average Ham's pocketbook. It is believed that this has been accomplished, and the Hams who have tried out this receiver have commented especially about the high signal-to-noise ratio and the fine sensitivity of the set which is due mainly to the careful design of the tuned antenna system as well as the radio frequency transformer in the preselector stage.

In the kit receiver to be described, the 20, 40, 80, and 160 meter amateur bands cover approximately two-thirds of the dial, leaving the other one-sixth on either side of the amateur bands for foreign amateur reception. As will be noted by the circuit diagram, the receiver is a superheterodyne consisting essentially of a sharply-tuned input system and RF amplifier on all bands (sometimes called a preselector stage), one stage of band-pass triple-tuned IF amplification, a diode detector, and a pentode power tube. Automatic volume control has been incorporated, and a switching arrangement is provided which turns off the automatic volume control when the beat-frequency oscillator is turned on for CW reception. Two volume controls are used. One controls the gain of the IF amplifier while the other controls the input to the audio frequency system. By retarding the IF volume control when maximum gain is not needed a better signal-to-noise ratio is obtained.

The tuning catacomb, which is the heart of the receiver is absolutely single control. It consists essentially of twelve inductance coils for the four bands covered, the trimming and padding condensers, and the three 85-mmf. tank condensers. Coil switching is obtained by means of a switch which automatically shorts out all coils in the tuning catacomb which are not being used. Shields segregate the antenna coils from the IF transformers and oscillator coils so that there is no interaction between these circuits. The switches for the various coils are located in their respective compartments so that the leads to these switch contacts are extremely short. The switch employed has very low capacitance and low losses between its parts which is essential for efficient operation of a set such as this.

There are only seven connections and a ground which the set-builder must make to

(Continued on page 33)

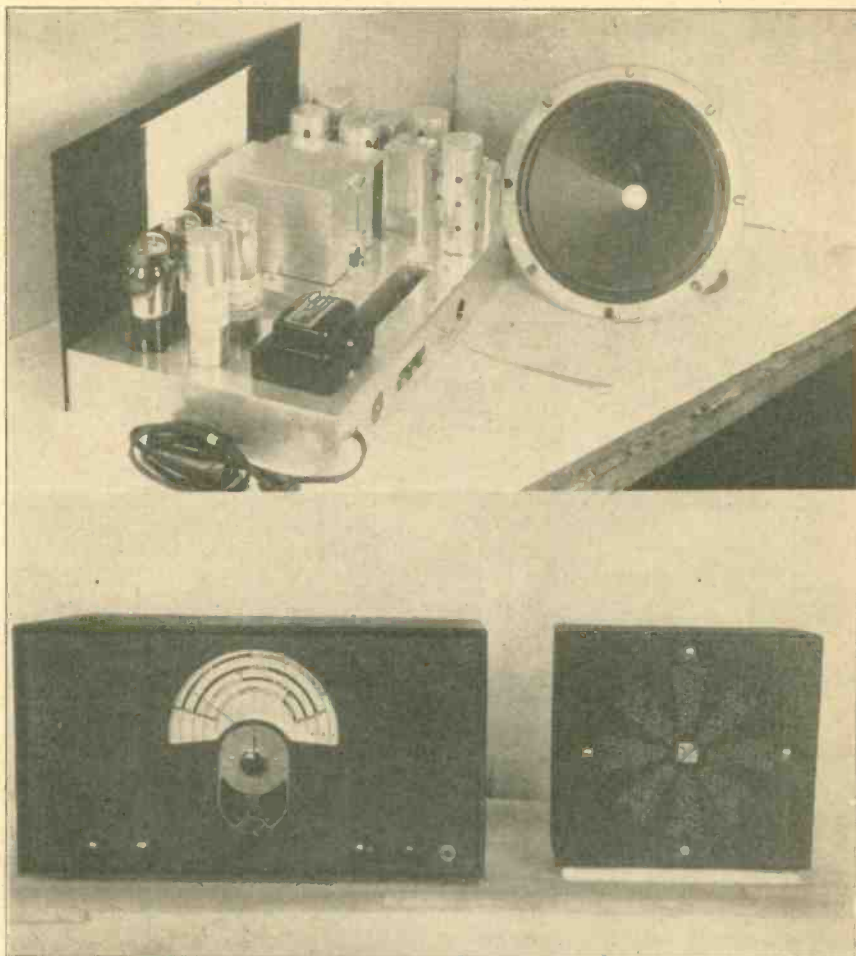

Front and side views of the new Tobe Amateur Communication Kit Set, a modern receiver designed by Glenn H. Browning, of Browning-Drake fame. The complete circuit diagram with all constants is shown below.

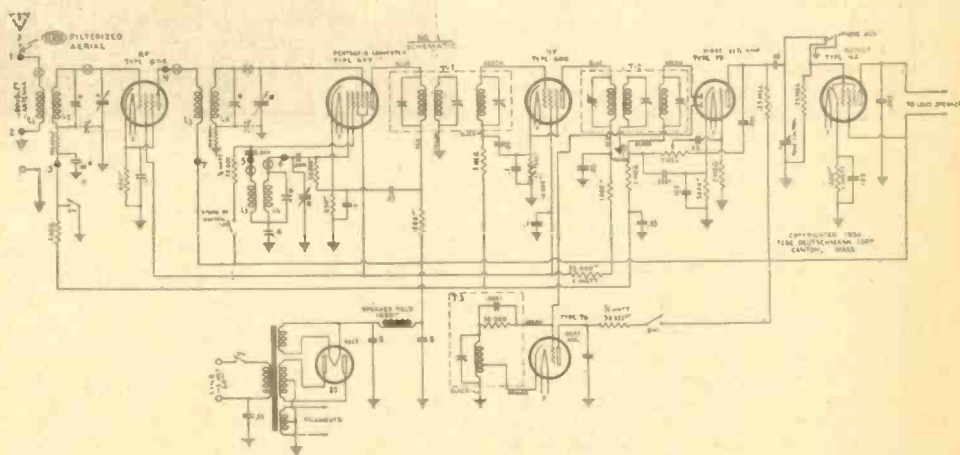

Circuit Diagram of TOBE Amateur Communication Receiver

Frequency in Megacycles	Microvolts for 50-milliwatt output including noise	Microvolts for 50-milliwatt output exclusive of noise
14.2	0.5	0.8
7.1	0.3	0.9
3.9	0.5	1.5
1.8	0.6	1.9

A Compact 10-Meter M.O.P.A. C.W. Transmitter Stabilized Output for Pure D. C. Note—Oscillator-Doubler System of Frequency Control—Effective Antenna Coupler

By FRANCIS CHURCHILL

● This is a simple CW transmitter for use in the 10 meter band. This band is rather unstable in that it is sometimes good for great distances, yet at other times it is "dead", except for practically visual ranges.

The circuit of the transmitter here described consists of a 6A6 and a type 10 (or 801) tube working as an oscillator-doubler and final amplifier. The oscillator circuit is the same as the one previously described in these pages, except for the fact that a resonant grid coil is used instead of a quartz crystal and RF choke. Oscillation is obtained on either 20 or 30 meters in one triode section of the 6A6, and the other section of the 6A6 is used as a frequency doubler or tripler. The output on 10 meters with a 350 to 400 volt plate supply is sufficient to burn out a flashlight lamp coupled to the tank circuit with a single turn of wire.

Link coupling is used between the 6A6 and the type 10 tube in order to obtain maximum grid drive. High efficiency cannot be obtained because the output of the 6A6 tube is not great enough for that purpose. However, the output is sufficient to drive the 10 or 801 to 25 watts output, using a 600 to 700 volt plate supply. A 25 watt lamp makes a good dummy antenna which can be used to get the set into proper adjustment.

The oscillator uses the TNT circuit with a resonant grid choke or coil and a fairly high C tank coil. A 20 meter tank coil is used and quite a bit of output can be obtained on 6 $\frac{3}{4}$ meters in the 6A6 output tank. The second harmonic on 10 meters gives more output. Capacity coupling is used between the oscillator tank circuit and the grid of the frequency multiplier. In order to secure optimum output, a variable 3-35 mmfd. grid condenser is used. The proper adjustment of this condenser gives about twice as much output as could be obtained with a fixed .001 grid condenser. The same idea can be used with crystal oscillators. Link coupling would undoubtedly give more efficiency and greater doubler output because the doubler grid would receive more excitation. However, this would add another tuned coil. No RF choke would be needed, so the cost would remain about the same. If link coupling is used at this point, the additional tuned coil should be on 20 meters with as low C as possible, as contrasted with the fairly-high C oscillator tuned circuit to which it would be coupled.

All circuits except the oscillator tank circuit are made low C. One turn link coupling gives sufficient coupling between the doubler plate coil and the 801 grid coil. Grid neutralization is used without difficulty. It was desirable to use the output circuit shown and consequently grid neutralization had to be used. Any standard form of neutralization and output coupling could be used.

The output circuit is easily adjusted for any antenna and is quite efficient for impedance matching. The 35 mmfd. double-spaced tuning condenser is the normal tank tuning condenser, and the BCL type 350 mmfd. condenser serves as an impedance matching system for antenna coupling. The RF voltage across the latter condenser is usually low and no flash-over occurs. This same arrangement, a 6A6 tube, was used to drive a 50T grid modulated phone on 10 meters with an output of 25 watts of car-

rier. The same antenna coupling method was used and allowed maximum output to be obtained with a dummy antenna, a 40 meter single wire fed Hertz or a short vertical 32 ft. end-fed antenna.

The method used here is one that makes use of a dummy antenna load to get maximum output and then note the plate current for that output, with resonance adjustment of the two tank condensers. Variation of one calls for a slight adjustment of the other in order to keep the plate current at a minimum for resonance. Then the antenna is connected in place of the lamp dummy antenna and the two tank condensers juggled until the same value of plate current is obtained at resonance. Sometimes the inductance must be changed a turn or two in

order to obtain resonance at the desired load plate current.

Neutralization can be obtained most easily by means of a thermogalvanometer coupled to the plate tank coil, without plate voltage being applied. This also gives a check on the size of the plate coil for resonance. The neutralizing condenser should be set for minimum galvanometer deflection and minimum grid current dip, maintaining resonant conditions in the final amplifier.

A combination of grid leak and C battery bias on the final stage is used in order to key the oscillator cathode circuit. A small 1 $\frac{1}{2}$ henry choke coil in series with the key, and a .1 or $\frac{1}{2}$ mfd. condenser, plus a 500 ohm resistor across the key contacts should be used

(Continued on page 30)

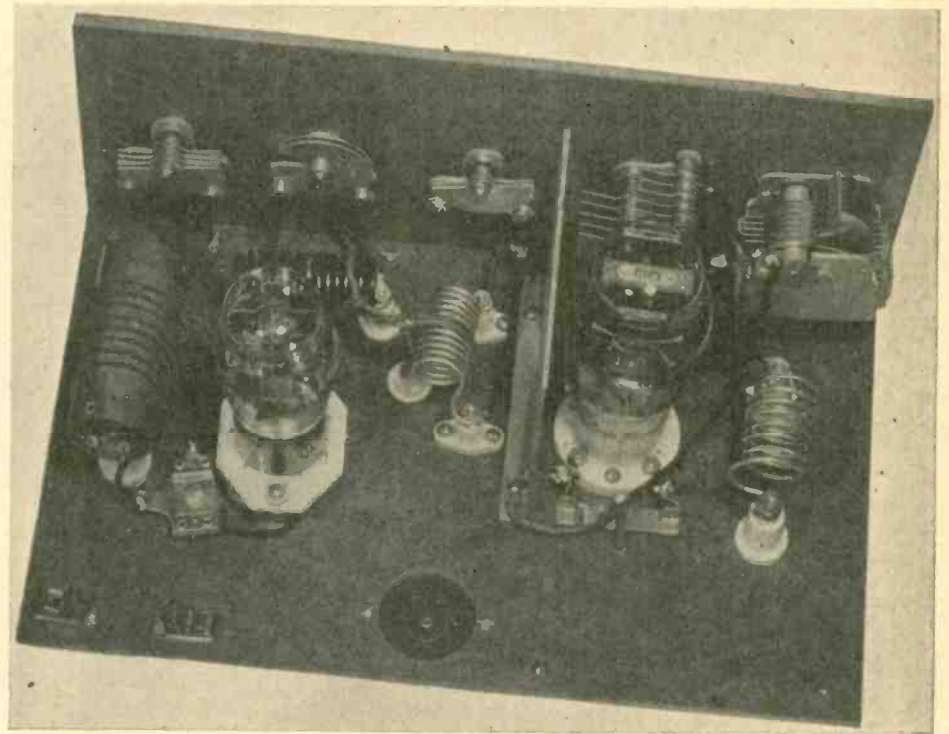

The 10-meter CW transmitter is mounted on a Masonite or Celotex baseboard with a front panel of similar material. The number of turns on the coils and the spacing are clearly shown in the illustration. An aluminum shield partition isolates the amplifier portion from the oscillator.

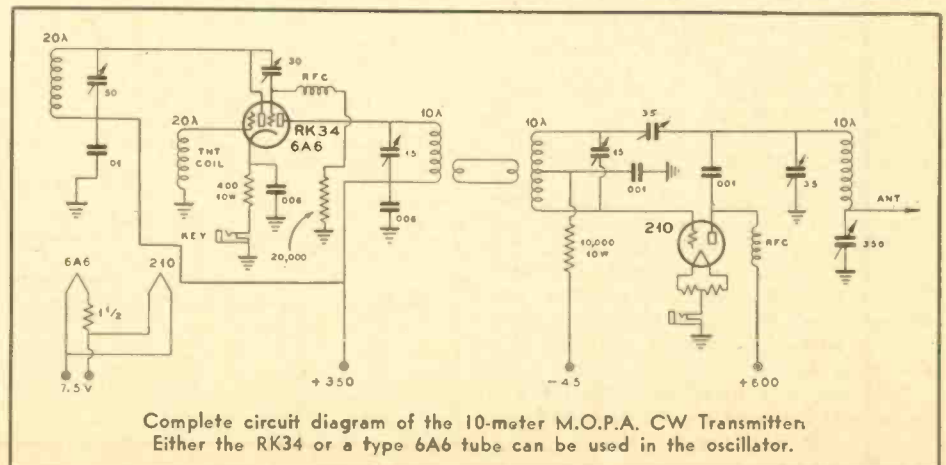

Complete circuit diagram of the 10-meter M.O.P.A. CW Transmitter. Either the RK34 or a type 6A6 tube can be used in the oscillator.

Practical Aids in Obtaining the Most From Headsets

● Radio headsets have become so commonplace that few realize their extreme absolute sensitivity—in fact, if one stops to consider their sensitivity it will be apparent that they will reproduce audible sounds from the feeble current found in a crystal set, while but few of the very high grade galvanometers will indicate the presence of current.

It probably has frequently been thought by the average radio amateur that there must be one method of coupling a pair of phones to a set that is better than any other, and it is the purpose of this discussion to point out the advantages and disadvantages of several circuits frequently used.

The best method of connecting a phone to a set, in a large number of cases, is to put it directly in the plate circuit, allowing the entire plate current to flow through it. This method used by a large number of amateurs possesses the following special advantages: first, the highest percentage conversion of electrical energy to acoustic energy can be obtained, presupposing a favorable impedance match between the tube and phone, because there is no other point at which part of the power can be dissipated; second, it is simpler and more direct, thus eliminating all excess parts and stray electrical fields, particularly objectionable in high powered receivers. The primary disadvantage lies in the fact that care must be exercised in having the direct current present pass through the phone in the correct direction or otherwise the phone will be demagnetized and thus permanently injuring the phone, although there is at least one phone manufactured, today, which has a magnet made of a 36% Cobalt-Steel alloy which cannot be injured in this way. The frequency response characteristic of a phone so coupled is similar to that obtained from the phone alone.

The second most common method is to couple the phone to the tube by means of a transformer. The particular advantages of this is that in certain cases better impedance matches may be obtained, and second, direct current is eliminated from external circuits. The particular disadvantage is that a certain amount of power is lost in passing through the transformer, which is objectionable on feeble signals.

A third type of circuit which should meet with favor among those amateurs who are troubled with considerable static is one in which frequency discrimination is used. The method is to couple the phone in parallel with either a resistance or capacitance. Since the impedance of the phone increases with frequency while the impedance of a pure resistance stays constant and that of a condenser becomes less, higher frequencies will become attenuated, due to a reduction of power of the high frequencies passing through the phone, thus a goodly portion of the noise may be by-passed and yet the signal will not be reduced much in volume.

In addition to this simple frequency discrimination circuit, a large number of more complex types can be produced, covering any range of frequencies, ranging from a raw 60 cycle AC to high frequency noises due to static. All of these depend for their value upon the fact that a reduction in noise level amounts to an equal increase in signal strength.

A fourth type consists of a choke coupling whereby the direct current is by-passed around the phone by means of placing a



HAM HINTS

By JAYENAY

blocking condenser in series with the phone and placing a choke in parallel with the phone. The advantages gained with this circuit are that the direct current is separated from the phone circuit; and second, this has a low frequency attenuation resulting in a reduction of output in this range.

In addition to the use of the correct output circuit for a headset, a number of other points will aid in bringing in those more elusive signals; first, the phone itself should be comfortable to wear, that is, light in weight and snug fitting—nothing distracts so much as a pair of phones that annoy the wearer; second, a good pair of sponge rubber earcushions will aid in reducing the effect of noise external to the headsets; third, a reduction in power will frequently make a signal clearer.

To summarize, for extremely high sensitivity to very weak signals, the phones should be connected directly to the plate with nothing else in the circuit; for the condition that a number of phones are to be used, or if the presence of direct current is objectionable transformer or choke coupling should be used; while if noise interference is particularly bad a frequency discriminating circuit should be used.



Parallel-Vs-Push-Pull Operation

● The recent development of low C tubes makes it easy to practically eliminate former difficulties encountered from parasitics and instability which accompany parallel operation of vacuum tubes. Parasitics are largely caused by the stray inductance and capacity in the tubes themselves, as well as in the connecting leads between the tubes and the associated grid and plate tank circuits. Parasitics are not confined to tubes in parallel, but are in fact nearly as common in push-pull circuits because the inductance of the leads when connected through the tank tuning condensers can form an ultra-high frequency tuned-grid-tuned-plate oscillator. This causes oscillation at a frequency other than that desired, with consequent low efficiency and reduced power output, as well as resulting in a poor note.

Parallel operation has many advantages over push-pull operation, even at the higher frequencies, provided low C tubes are used. The plate tuning condenser can be one of a cheaper variety for a given tuning capacity and one neutralizing condenser is eliminated for parallel operation. The tubes are usually easier to drive to a given output when used in parallel, due to the higher transconductance of two tubes in parallel. The amplification factor is the same for two tubes in parallel as it is for one tube, whereas the plate resistance is cut in half.

High C tubes, such as the 45, 2A3, 10, 211, 203A and 204A should generally be used in push-pull below 40 meters because the high capacity shunted across the plate tank when high C tubes are used in parallel makes the use of a low C, low loss tank circuit impossible.

Another advantage of parallel operation is that it permits the use of the Simplified PI Antenna Coupler System for effective reduction of illegal radiation of harmonics. This system also gives continuously variable antenna coupling.

When three tubes are used in parallel there is less tendency for parasitics than when two tubes are paralleled. This is because the addition of the third tube unbalances the TGTP ultra-high frequency oscillator effect which sometimes results from the inductance of the leads when two tubes are used in parallel.

Lafayette "PRO 9" AMATEUR RECEIVER



BUILD IT AND ENJOY REAL RESULTS ON ALL HAM BANDS

Here is the last word in modern amateur all-wave receiver kits! It incorporates a factory assembled coil-switching unit so that only a few simple connections are needed to wire this unit into the completed receiver. Features 1 R.F. stage on all bands; Beat Frequency OSCILLATOR for C.W.; AVC or manual control; Demountable power speaker unit, etc. No. PXY-22069—complete kit of parts including speaker and panel, complete instruction booklet, but less \$36.75 tubes and cabinet.

If wanted completely wired \$7.50 extra
Cabinet \$7.50 extra

5 METER Super Het

Here is a Super-het for 5 M. reception that is almost as simple as a straight super-regenerative receiver, but it will prove far superior as regards sensitivity, selectivity and noise level.

The absence of super-regenerative "Rush" is an outstanding characteristic. Any Ham can build it. No. PXR-22098—complete kit of parts including cabinet, panel and special copper plated chassis, complete instruction booklet, but less power supply, tubes and speaker \$16.75

If wanted wired \$3.25 extra



WHOLESALE RADIO SERVICE CO.
Main Office and Warehouse
100 SIXTH AVENUE • NEW YORK, N.Y.
BRONX, N.Y. ATLANTA, GA. NEWARK, N.J.
342 E. 84th St. 430 W. Peachtree St. N.W. 219 Central Ave.

WHOLESALE RADIO SERVICE CO.
100 Sixth Ave., Dept. P-75, New York, New York

- Send me more data on the "PRO-9"
- Send me more data on the "5 M. Super-het"
- Send me FREE Ham Catalog #58-A

Name
Address
City State

EIMAC Tubes—More Power, Less Grief

**HIGH EFFICIENCY
AT LOW COST**

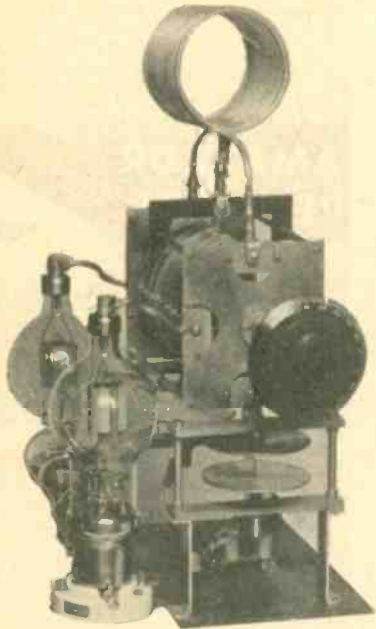

The final amplifier shown above uses home made tank and neutralizing condensers. It is notable mainly for the short, direct leads between the tubes and the tank and neutralizing condensers. At present it is being used as a class B linear amplifier following a 30-watt controlled carrier plate modulated class C stage operating on 14 MC.

Every tube application suggested by EIMAC results from a great deal of practical experimental work as well as the usual amount of theoretical research. We do our best to try out every new idea that comes along in order that, by constant refinement of detail, we can stay up toward the front of the procession of progress.

We maintain a tube application engineering service for the benefit of everyone interested in EIMAC tubes, so do not hesitate to write us about any of your transmitter problems.

No. 4
of a
Series
of 12

Your Problems—and Their Solution **GRID BIAS MODULATION**

ON THE basis of carrier watts per dollar there is very little difference between grid bias modulation and plate modulation, when the total transmitter cost is considered. The main advantage of grid bias modulation lies in the fact that about 90% or more of the total transmitter cost consists of CW equipment so that less than 10% of the total equipment lies idle when CW is used. If plate modulation were used, at least 50% of the total equipment would contribute nothing to the CW signal emitted by that station and would stand idle during CW contacts.

FUNDAMENTALS OF GRID BIAS MODULATION

The DC plate input to the modulated amplifier remains absolutely constant and the increase in power output during modulation is achieved by increasing the average plate efficiency, or power conversion efficiency, during modulation. The unmodulated plate efficiency can never exceed 50%, which is the theoretical limit. The practical limit is about 40% unmodulated plate efficiency. Thus the unmodulated carrier output, in watts, can never exceed about two-thirds of the available plate dissipation.

The amount of RF and AF grid drive required to obtain complete, linear and symmetrical modulation capability depends on the transconductance of the tube used and also on the shape of the grid voltage-grid current curve of the tube. Not only do EIMAC tubes have an exceptionally high grid-plate transconductance but the grid current curve is quite flat and free from negative resistance "Humps". This means that the grid of either the EIMAC 50T or 150T can be driven quite far positive without intercepting an excessive amount of grid current. Grid current serves no purpose in a vacuum tube and it should be noted that the modern design of all EIMAC tubes allows the control grid to be driven as far positive as the minimum plate voltage without non-linear distortion being produced. This means that EIMAC tubes allow more power output to be obtained at a lower plate voltage and with less grid driving power than most conventional tubes.



EIMAC 50T
Net - - - \$13.50

Compare and Reflect CONSERVATIVE RATINGS

50T

50 Watts of Available
Plate Dissipation . . .
30 Watts of Filament
Heating Power!

CHARACTERISTICS
Fil. Voltage 5V; Fil. Current
6A; Rated Plate Dissipation
50W; Amp. Factor 13; Max.
Plate Current 100MA. Plate
Voltage 1000 - Power Output
75W. Plate Voltage 2000 -
Power Output 150W. Plate
Voltage 3000 - Power Output
250W.

150T

150 Watts of Available
Plate Dissipation . . .
50 Watts of Filament
Heating Power!

CHARACTERISTICS
Fil. Voltage 5V; Fil. Current
10A; Rated Plate Dissipation
150W; Amp. Factor 13; Max.
Plate Current 200MA. Plate
Voltage 1000 - Power Output
150W. Plate Voltage 2000 -
Power Output 300W; Plate
Voltage 3000 - Power Output
450W.

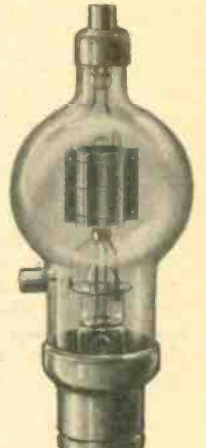

EIMAC 150T
Net - - - \$24.50

EITEL - McCULLOUGH, INC.

SAN BRUNO, CALIFORNIA, U. S. A.

Write us if you can't get EIMAC'S from your dealer

Albany, N. Y. Uncle Dave
Atlanta, Georgia. Wholesale Radio.
Baltimore, Maryland. Radio Electric Svc.
Boston, Mass. H. Jappe Co. The Radio Shack.
Buffalo, N. Y. Dymac Radio
Butler, Missouri. Henry Radio Shop.
Chicago, Illinois. Allied Radio Corp. Chirad Midwest Radio Mart. Newark Electric Co.
Cleveland, Ohio. Northern Ohio Labs.
Dayton, Ohio. Standard Radio Parts

Des Moines, Iowa. Iowa Radio Corp.
Detroit, Mich. Radio Specialties Co.
Denver, Colorado. Interstate Radio
Fayetteville, N. C. Hunter Brothers.
Fresno, California. Ports Mfg. Co.
Honolulu, T. H. Honolulu Furniture Co.
Kansas City, Mo. Radio Laboratories
LaCrosse, Wisconsin. SOS Radio Supply.
Little Rock, Ark. Vinson Radio Co.
Los Angeles, Cal. Radio Supply Co. Radio Television.

Milwaukee, Wis. Radio Parts Co.
Newark, New Jersey. Wholesale Radio Svc.
New Orleans, La. Shuler Supply Co.
New York City. Gross Radio, Inc. Wholesale Radio Svc.
Oakland, California. Electric Supply Co. E. C. Wenger Co.
Oklahoma City, Okla. Southern Sales Co.
Peoria, Illinois. Radio Mfg. Engrs.
Philadelphia, Pa. Radio Electric Svc. Herbach & Rademan
Pittsburgh, Penna. Cameradio Co.

Portland, Oregon. Wedel Company, Inc.
Providence, R. I. W. H. Edwards & Co.
St. Louis, Mo. Walt. Ashe Radio Co.
St. Paul, Minnesota. Lev Bonn Company.
San Francisco, Cal. Offenbach Electric.
Seattle, Washington. Seattle Radio Supply.
Spokane, Washington. Spokane Radio Co.
Texarkana, Ark. Mim's Radio
Toronto, Ont. Canadian Tire Corp.
Tulsa, Oklahoma. Radio, Inc.
Wheeling, W. Va. Cameradio Co.

Amateur News

The Amateur's Legion of Honor

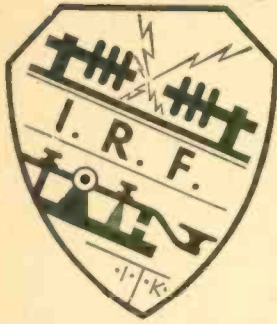

This department is edited by the Secretary of the International Radio Fraternity, Kenneth Isbell, radio W6BOQ, KFI, KECA. All communications concerning the International Radio Fraternity as well as inquiries from any amateur as to the requirements for membership, should be addressed to IRF Headquarters, International Radio Fraternity, 2705 1/2 St. Andrews Place, Los Angeles, California.

HOW many of you wrote your Congressman this month? Every member of IRF, when taken into the fraternity, promised to cooperate and do whatever he could toward helping regain what the amateurs have lost in the past years. This is your opportunity to show your cooperative spirit. If you have not already written your Congressman telling of facts of the amateur circumstances, write to him today... don't put it off. IRF headquarters will appreciate a note from each member as confirmation that he has written his letter. Those who are supposed to represent us in Congress will never know what we want if we do not all get together. Tell your Congressman, in your letter, the true conditions under which the American radio amateur is forced to operate. Tell him that the broad channels which the amateurs once occupied were literally handed to the commercial communications interests by a group of self-styled amateur radio leaders. Be sure to let your Congressman know that you are a member of the International Radio Fraternity, that IRF asks the support of every member of Congress to help in securing wider frequencies for the amateurs at the Calro Conference; that there are almost 46,000 licensed radio amateurs in the United States; that these men have no ulterior motives; that they number among their ranks many thousands of highly-trained technicians and operators; that their stations can be tied together to make up many chains of important communications channels across the nation in times of emergency.

In short, give your frank opinion of what you think of the amateur conditions of today, and how you think they can be bettered.

The Presidential Election is well under way and the next month's IRF News columns will introduce to you the new president of the IRF.

W2HTI, Alfred F. Palokat, 9135 - 81st street, Woodhaven, Long Island, New York, is one of the many members who has expressed desire to be active in the transcontinental phone chain. The photo shows his station, W2HTI. The transmitter is a 59 tri-tet, 841, 830, 210's, class B modulated for phone, 90 watts input, power supply 750 volts, choke input. The receiver is an 8-tube super. Zepp antenna is used. Mr. Palokat is a new member in the IRF and this means is taken to introduce him and his rig to the rest of our members.

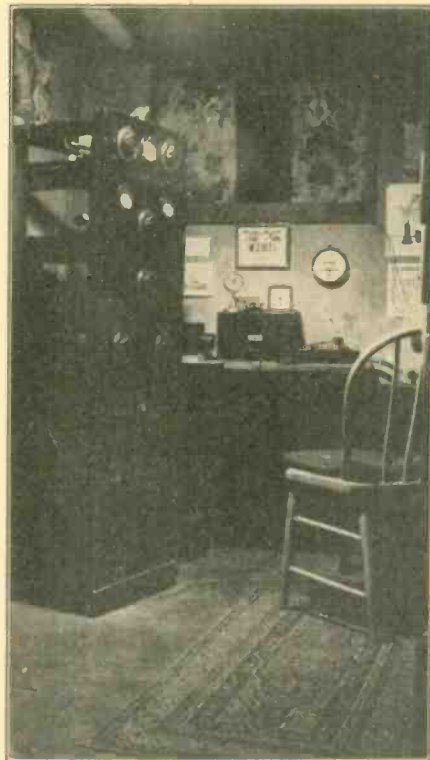

I.R.F. Station W2HTI

The IRF has several members who are confined in hospitals, and the editor would be very pleased to hear from them at any time, and know of their welfare and their activity on the air.

The San Diego Radio Amateurs' Assn., is completing plans for the gala ham "Fiesta" which is to be held on July 20 and 21 at the Exposition in San Diego. IRF men are especially invited to attend.

The yearly Pacific Division Ham Conventon of the ARRL is to be held in Los Angeles on September 1 and 2. The editor assures you that a large percentage of the attendance will be IRF.

The Kilocycle Club of Milwaukee, Wisconsin, broadcast a ninety-minute weekly program on the Milwaukee Journal shortwave station, W9XAZ, operating on 31.6 MC, with 500 watts of power in the final. The Kilocycle Club program begins at 6 PM and runs to 7:30 PM CST, each Saturday evening. The program is devoted entirely to topics of interest to the radio amateur and to the short-wave experimenter. This club has expressed a desire to affiliate with the IRF. Mr. Charles Kaetel, W9SNK, Chairman of the Radio Program Committee, has very kindly offered to give IRF time on the weekly broadcast, for IRF News items of interest to members and all listeners. Be sure to listen to this program whenever possible.

EAST COAST NEWS: In addition to W1DBG, Vincent Murphy, the President of the Bristol Radio Club, becoming an IRF member, several other men of this club are prospective IRF members. The Bristol Radio Club has just built a 100-foot mast, which was put in place on June 9. They are operating phone on all bands. The call of the club is W1DHT. IRF men are asked to listen for the station. On June 15 members of the Waterbury Radio Club were guests of the Bristol Radio Club and the IRF was widely discussed.

CANADIAN NEWS: VE5EO has been on the air regularly up to the last month. Made WAC in 12 hours on May 3, and received R7 report from Africa.

VE4MN is located many miles from "nowhere", up in Saskatoon, but he keeps in contact with the fellows and is on the air regularly. Always glad to QSO IRF men.

VE5DD is Division Chief for Vancouver, B. C.

CAPITOL DIVISION NEWS: The sixteenth anniversary hamfest of the Lansdowne Radio Club was held in Philadelphia on June 1. Was attended by W3FED, Bill Ellsworth, and several other IRF men.

RCA-803 Pentode

(Continued from page 17)

As RF Power Amplifier and Oscillator—Class C Telegraphy Key-down Conditions per Tube without Modulation**:

DC Plate Voltage	2000 max. Volts
DC Screen Voltage (Grid No. 2)	600 max. Volts
DC Suppressor Volt. (Grid No. 2)	60 max. Volts
DC Plate Current	175 max. MA
DC Grid Current	50 max. MA
Plate Input	350 max. Watts
Screen Dissipation	125 max. Watts
Screen Dissipation	30 max. Watts

Typical Operation:

DC Plate Voltage	1,250	1,500	2,000 Volts
DC Screen Voltage	500	500	500 Volts
DC Suppressor Volt.	40	40	40 Volts
DC Grid Volt. (Grid No. 1)	Approx. —30 —30 —30 Volts		
Peak RF Grid Voltage (Approx.)	150	150	150 Volts
DC Plate Current	160	160	160 MA
DC Screen Current	45	45	42 MA
DC Grid Current	18	18	16 MA
Screen Resistor	17,000	22,000	36,000 Ohms
Driv. Power (Approx.)	1.8	1.8	1.6 Watts
Power Output (Approx.)	130	160	210 Watts

** Modulation essentially negative may be used if the positive peak of the audio-frequency envelope does not exceed 115% of the carrier conditions.

Installation

The base pins of the RCA-803 require a new type of 5-pin socket which should be installed so that the tube will operate in a vertical position with the base down.

The plate dissipation of the 803 (the difference between plate in put and power output) should never exceed the maximum values given under MAXIMUM RATINGS AND TYPICAL OPERATING CONDITIONS. The maximum values are indicated by a barely perceptible red color on the plate. To determine this, all power switches should be opened with the tube operating in the dark. This procedure avoids reflections from the lighted filament which would otherwise interfere with the observation.

The screen voltage may be obtained either from a separate source, from a potentiometer, or from the plate supply through a series resistor.

Adequate shielding and isolation of the input circuit and the output circuit are necessary if optimum results are to be obtained. The impedance between the screen and filament must be kept as low as possible by the use of a by-pass condenser. When screen voltage is obtained from a series resistance, the screen by-pass condenser should have a voltage breakdown rating high enough to withstand the full plate voltage of the tube. The capacity value of the condenser should be about 0.01 uf. Values larger than this may cause excessive AF by-passing; smaller values may cause excessive RF feedback from plate to control grid, depending on circuit layout, frequency, and gain.

Application

As a Class B radio-frequency amplifier, RCA-803 may be used as shown under MAXIMUM RATINGS AND TYPICAL OPERATING CONDITIONS. Grid No. 1 is the control-grid; Grid No. 2 is the screen; and Grid No. 3 is the suppressor. In Class B RF service, the plate is supplied with unmodulated DC voltage and the grid is excited by RF voltage modulated at audio frequency in one of the preceding stages. In this service the plate dissipation is greatest when the carrier is unmodulated. It is important, therefore, that the plate dissipation for this class of operation should not exceed 125 watts. Grid bias for the 803 as a Class B RF amplifier should be obtained from a battery or other DC source of good regulation. It should not be obtained from a high-resistance supply such as a grid-leak, nor from a rectifier, unless the latter has exceptionally good voltage regulation.

As a suppressor-modulated Class C RF amplifier, RCA-803 may be used as shown under MAXIMUM RATINGS AND TYPICAL OPERATING CONDITIONS. Grid No. 1 is the control grid; Grid No. 2 is the screen; and Grid No. 3 is the suppressor. In this class of service the plate is supplied with unmodulated DC plate voltage and the DC suppressor voltage is modulated at audio frequency. Grid bias for this service may be obtained in the same manner as for Class C RF telegraph service. Suppressor voltage may be obtained from a battery, from a series screen resistor or from a bleeder tap on the high-voltage supply. (see INSTALLATION).

As a grid-modulated Class C RF amplifier, RCA-803 may be used as shown under MAXIMUM RATINGS AND TYPICAL OPERATING CONDITIONS. Grid No. 1 is the control grid; Grid No. 2 is the screen; and Grid No. 3 is the suppressor. In this class of service the plate is supplied with unmodulated DC plate voltage and the grid bias is modulated at audio-frequency. Grid bias for this service should be obtained from a battery or other DC source of good regulation. It should not be obtained from a high-resistance supply.

As a Class C RF amplifier or oscillator for telegraph service, RCA-802 may be operated as shown (Continued on page 29)

New

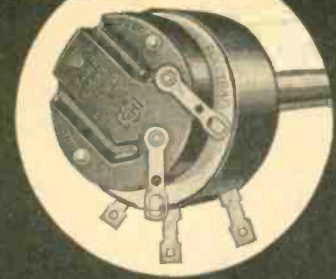

**ELECTRAD
VOLUME CONTROL**

**With CARBON
RESISTANCE ELEMENT**

A radically new type carbon control which challenges any test you can give it for quietness, smoothness and long life.



Carbon Resistance element fused to Bakelite ring.

Molded Bakelite case, when mounted, extends only 1/2 inch back-panel. New-type power switch (approved by underwriters) may be instantly attached or removed by a single screw. Long, easy-to-cut aluminum shaft.



Floating contact shoe glides over carbon resistance element.

All we ask is: "TRY IT!" All Standard and Special Values.

Mail Coupon for FREE Descriptive Folder, and General Catalog of Resistors for Every Purpose.

ELECTRAD 1935 CATALOG
175 Varick St., New York, N. Y.
Please send new Resistor Catalog
Check here for folder on new
QUIET Volume Control.

Name.....
Address.....
..... PR-7

**Closed Circuit Parallel
Rod Oscillators**

(Continued from page 15)

At 2 1/2 meters the efficiency decreased more rapidly and the maximum obtainable was 29%. A typical value was 21% with an input of 12.8 watts and an output of 2.7 watts. The rods were about 30 inches long with the two short-circuiting bars 24 inches apart. The 45 tube with slotted tube base was connected across these rods 5 inches from one end and the dummy antenna load 5 inches from the other end, considering the "ends" as the short-circuited points. Oscillation could be maintained with as little as 75 volts plate supply at 2 1/2 meters.

Reducing the plate voltage, at 2 1/2 meters, from 250 to 150 volts gave a frequency change of about 50 KC and the AC filament supply produced a slight modulation ripple on the carrier at this wavelength. The ripple was not present at 5 meters.

Since 50% efficiency can be obtained as against 25% or 30% for most other circuits, the modulator does not have to deliver nearly as much power output for a given value of carrier output. A carrier of from 5 to 10 watts can be easily modulated with one or two pentode tubes, instead of having to use a class B audio system. A carrier output of 5 to 10 watts will take care of most 5-meter station communication requirements.



RCA-803 Pentode

(Continued from page 28)

under MAXIMUM RATINGS and TYPICAL OPERATING CONDITIONS. Grid No. 1 is the control grid; Grid No. 2 is the screen; and Grid No. 3 is the suppressor. Grid bias for this service may be obtained from a grid leak of 2000 to 4000 ohms (25-watt size), depending upon the amount of available grid excitation; from a battery; from a rectifier; or from a cathode-bias resistor (preferably variable) suitably by-passed for audio and radio frequencies. The cathode-bias method is advantageous due to the fact that the grid bias is automatically regulated in direct proportion to the sum of the plate and grid current and that there is little chance of the plate current becoming dangerously high, even if the RF grid excitation is removed. The grid-leak bias method has the advantage of simplicity and of automatically biasing the grid in proportion to the excitation voltage available. Special care must be observed with the use of this system because the accidental removal of the excitation will cause the grid bias to fall to zero and the plate current to rise to an excessive value. Since the grid-bias voltage for Class C service is not particularly critical, correct circuit adjustment may be obtained with widely different values.

RCA-803 may be operated at maximum ratings at frequencies as high as 20 megacycles. If the tube is operated at frequencies above 20 MC the plate voltage and input power should be reduced and special attention should be given to shielding and RF by-passing. When shielding is used care should be taken to insure adequate tube ventilation and the maintenance of normal ambient temperature.

As a pentode oscillator (crystal or self-excited), the 803 should be connected the same as in amplifier service.



**Hermetically - Sealed
Metal-Can
ELECTROLYTICS**

For maximum fool-proof capacity at minimum first and last cost, nothing can excel Aerovox hermetically-sealed metal-can electrolytics. Available in many shapes and sizes; all standard capacities and working voltages.



As the pioneer in the field of dry electrolytics, Aerovox maintains its engineering and production leadership, offering:

- Hermetic sealing... no loss or absorption of moisture.
- Special composition spacers... safety against surge voltages... no deterioration.
- All internal parts of aluminum... no corrosion.
- Longest service life... adequate safety factor... freedom from breakdown.



Free DATA: Latest 1935 Catalog, featuring complete line of condensers and resistors, sent on request. Also sample copy of Research Worker. Meanwhile, see the line at your local supply house.



CORPORATION

84 Washington St.

Brooklyn, N. Y.

**REPLACEMENTS FOR
ALL REGULATORS OR
BALLAST TUBES**

Standardize on Amperite Regulators. There's an Amperite for every current or voltage problem in any set.



Write for CHART CV.

**AMPERITE
CURRENT AND VOLTAGE
REGULATORS**

AMPERITE Co.

561 BROADWAY NEW YORK

**new! KELLOGG
TRANSCIVER HANDSET**

A better all-around Transceiver Handset! Highly efficient single-button Kellogg microphone, super-sensitive Kellogg receiver. Easy to hold. Fits the face. Microphone has greater sensitivity and "flatter" response curve than the usual "mike" of this type. Precision built, as are all Kellogg products. Gold plated diaphragm. Especially processed carbon. Receiver is the product of 35 years experience building telephone apparatus. Bi-polar magnet of cobalt steel. Cadmium plated diaphragm. Small, compact, easy on the ear. Simply and ruggedly constructed and light weight. Cast aluminum triangular handle. Baked black enamel finish.

Has 6-foot, 4-conductor, 18-strand tinsel cord of telephone quality. You will be proud to own this unit. Better yet, it's not expensive. Code No. 38-A, 70 ohm receiver, list price \$10.00. Code No. 38-B, 2000 ohm receiver, list price \$11.

KELLOGG SWITCHBOARD & SUPPLY CO.
1070 W. Adams St. CHICAGO, ILLINOIS

**New Type
HEAVY DUTY TUBE**

Write for bulletin on new heavy duty tube; 750 watts input class "C" push-pull. 400 watts audio class "B", with 1500 volts D.C. Carbon plate. Liberal guarantee. Price only \$17.50.

Heavy-duty 866's, 1000 hour guarantee, \$1.39

TRANSMITTERS—Any commercial rig duplicated at 35% saving.

Aluminum panels and Electalloy chassis to order. Low prices.

HOWARD RADIO TRANSMITTER SERVICE
5648 RACE AVE., CHICAGO, ILL. Phone Austin 0177

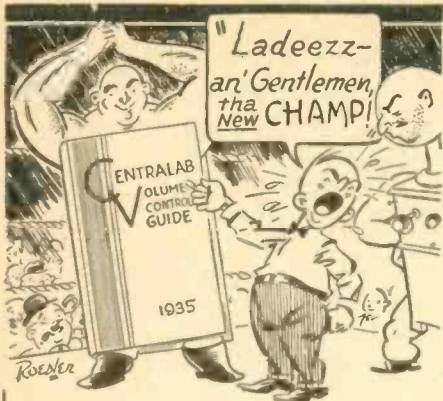

—he Takes all Comers!

The new CENTRALAB VOLUME CONTROL GUIDE is the serviceman's champion . . . he "takes on" the most difficult job and throws it for a victory.

This new 1935 revised edition represents the accumulated experience of engineers, consultants and servicemen—all of whom have contributed to make this the most accurate and complete Volume Control Guide yet published. In addition it contains a valuable cross index on controls—all standard Volume and Tone Control circuits and a load capacity chart.

Now you can get the exact, accurate dope on every service job, for there is a CENTRALAB RADIOHM specially made for every replacement.



and for emergency replacements—the new Guide shows you how a mere handful of controls will take care of any emergency service requirements.

Every Radio Service Man should be a member of the Institute of Radio Service Men

Centralab

Division of Globe Union Mfg. Co.
MILWAUKEE, WIS.



MOST SENSITIVE PHONES EVER BUILT

HERE IS NEWS! Like the now-famous Brush Crystal Microphone, the new Brush crystal headphones are writing a new chapter in radio history. Try a pair of these ultra-sensitive phones. Listen to the signals come up from no-where. The weakest signals are more audible . . . you will hear signals you never heard before. Using the piezo-electric principle, these phones give more faithful reproduction than any others. Prove the statement for yourself. For audio test purposes there is nothing finer. Non-magnetic; ideal for airplane use. \$12.00, list per pair. If your dealer cannot supply you, write us direct for literature.

Ask for Data Sheets PR7, describing these new headphones . . . will be supplied on request.

The Brush Development Co.
CLEVELAND, OHIO

FORMS CLOSE ON THE 10th OF MONTH

RATES 10¢ PER WORD PAYABLE IN ADVANCE

CLASSIFIED RADIOADS

Crystals, 80 and 160 meters, \$1.35. Get yours from The QSL Man, W9DGH, 1816 North 5th Avenue, Minneapolis, Minnesota.

Bakelite Engraving. Will the person who sent a check to "RADIO" for a classified advertisement on Bakelite Engraving please send new copy? His name and address has been misplaced.

TRANSFORMERS: Power and audio built to order. Guaranteed. No mass production. Right prices. California Radio Laboratories, 2523 South Hill Street, Los Angeles, California. W6CYQ.

Frank C. Jones' high-power grid-modulated phone-CW relay rack transmitter as described in this issue is for sale. Complete with all tubes, including EIMAC 150Ts, crystal microphone and coils for 20 and 75 meter bands. Also crystals to operate this set in 75, 40 and 20 meter bands. This transmitter was designed and built by the author, expressly for the purpose of securing the data for the editorial article in this issue. The net cost of the parts was \$300. Will sell the entire transmitter, ready to operate, for \$800, F.O.B. San Francisco or Berkeley, California. Shipping weight approximately 500 pounds. First check for \$300 takes it. Write to Frank C. Jones, 2037 Durant Avenue, Berkeley, California.

10 Meter Transmitter

(Continued from page 23)

to minimize key clicks. There is less frequency creep when keying the oscillator tube than when keying the final amplifier. Typical current readings were 70 MA at 400 volts on the 6A6 tube, 120 MA at 600 volts on the 801 or type 10, and about 5 MA of grid current.

By reducing the final amplifier plate voltage to between 400 and 500 volts, a class B audio system using a pair of 46s or 59s could be used for plate modulation for 10-meter phone operation. It would be desirable to use a 45 tube buffer stage for phone operation because the 10 should have more grid excitation for phone than for CW operation in order to insure linear modulation characteristics.

The oscillator grid coil consists of 40 turns of No. 16 DCC wire, wound on a piece of 3/8-in. dowel rod. The oscillator plate coil has 9 turns, on a 1 1/4-in. diam., 1 1/4-in. long. The doubler plate and final grid coils should be 12 turns of No. 14 or No. 12 wire, 1 1/4-in. long, on a 3/4-in. diam. The final amplifier plate coil has 8 turns, No. 12, 7/8-in. diam., 1 1/2-in. long. The RF chokes are ordinary 2.1 mh. section-wound midget RF chokes. The 6A6 heater is operated from the 7 1/2 volt supply by using a one ohm filament resistor in series. All resistors are of the 10 watt size, a 20,000 ohm for doubler grid leak, 400 ohm for 6A6 cathode, and a 10,000 ohm grid-leak for the final amplifier. All by-pass condensers are of the 1000 volt test type, mica. The only double-spaced condensers are those used for neutralizing and final amplifier tank condenser. The set is built on two pieces of tempered Masonite or Celotex, 7-in. x 12-in. x 1/8-in., using one as a sub-base and the other as a front panel. This material is cheap, looks well, and is easy to drill or saw to size.

RADIO CLUBS!

Write for Special Group Subscription Rates for "RADIO"

A NEW BOOK Second Edition of FUNDAMENTALS OF RADIO

(426 pages 6" x 9", 430 figures)

By Professor R. R. RAMSEY, Ind. Univ.



Revised, enlarged, repaged, reprinted. New cover. New subjects Multi-electrode Tubes; A, B and C amplifiers; and Cathode Ray Television. Radio theory and practice brought up to May, 1935. Problems and questions on each chapter. It still can be said that "Ramsey manages to provide that missing fact which seems to be hidden in other books." Every thing new and enlarged to the price. You cannot afford to miss this book.

Third Edition of EXPERIMENTAL RADIO

(255 pages, 168 figures, 128 experiments.)
A laboratory manual of radio experiments.

By the same author.

The book is actually a group of some 128 experiments covering most every imaginable phase of radio within the range of the average experimenter.

You have heard of the original radio manual of experiments. Get it. Prices: Fundamentals \$3.50; Experimental \$2.75 post paid.

Your check, postal order or C.O.D. brings 'em
RAMSEY PUBLISHING CO.,
Bloomington Indiana

AMPERITE LEADS AGAIN!

HIGH IMPEDANCE VELOCITY MICROPHONE

(Model RB-H)

Operates **WITHOUT** PRE-AMP

A HIGH IMPEDANCE VELOCITY MICROPHONE WHICH OPERATES DIRECTLY INTO GRID OF TUBE



REQUIRES NO PRE-AMPLIFIER WHEN USED WITH REGULAR HIGH GAIN AMPLIFIER (100 DB.)

Replaces condenser and crystal microphones—NO CHANGES or additions necessary! ELIMINATES INPUT TRANSFORMER and its losses. . . Therefore requires 12 db. less over-all amplification. . . Eliminates inductive hum. No feedback. Life-like, natural reproduction. Write for Bulletin H

LIST \$42.00 with coupling.

AMPERITE Corporation 561 BROADWAY NEW YORK

AMPERITE Velocity **1-POINT** MICROPHONE

AT LAST



Any Battery Radio Set, whether 2 volt, 6 volt or 32 volt can now be made All Electric, with a Carter Genemotor—the modern "B" Eliminator.

Greater Power—No Current Fluctuation—Minimum Operating Cost—Electrically and Mechanically Guaranteed.

There is a Carter Genemotor for Sound Systems, Two-Way Police Radios, Transmitters, etc.

Write for our latest catalog—it's free.
CARTER MOTOR CO.

365 W. Superior St.

Chicago

CROWE

RADIO COMPONENTS

DIALS, KNOBS and SWITCH PLATES for TRANSMITTERS, SOUND EQUIPMENT, OSCILLATORS, Etc.

CARRIED IN STOCK BY LEADING JOBBERS AND DEALERS.



Chrome and black Gain plates in several styles and readings.

Die-cut instrument dials. Professional appearance and extreme accuracy.



Black Bakelite knobs in matching sets. Bar Knobs - Switch Knobs - Skirt Knobs



Aluminum and black Switch Plates, Gain Plates, Volume and Selector Plates.

Write for Bulletin No. 60 for complete details.

Established 1899

CROWE NAME PLATE AND MANUFACTURING CO.

1755 GRACE STREET

Cable Address: Crowname, Chicago

CHICAGO, ILLINOIS

WE KNEW YOU'D BE SKEPTICAL!

We knew that a price of only \$4.90 for brand new, standard, genuine guaranteed Western Electric fifty watters would make you think, "TOO GOOD TO BE TRUE!" And to question, "What's the catch?" We expected the orders to be worded like a seagoing lawyer's brief. And they were!

BUT, HERE'S THE LAUGH!!

After getting their tubes and giving them a stiff test, almost all of the boys rushed back repeat orders for one, two, and even three more tubes! "They surely are FBI!" was the consensus of opinion.

MORAL:

When Harrison offers a value it's not too good to be true, but it is too good to last long! So get yours now at the low price!

Western Electric
211-D FIFTY WATTERS
GENUINE - BRAND NEW - FULLY GUARANTEED

Standard Fifty Watter base. Standard characteristics (Interchangeable with type 211 and 211-A). Has new long life filament! Rated RF output as an amplifier—100 WATTS!

Every tube is in its original Western Electric carton! The WESTERN ELECTRIC name is your guarantee of highest quality! We guarantee REAL VALUE and COMPLETE SATISFACTION!

Regular selling price—\$17.50. Harrison's SPECIAL PRICE—only \$4.90! Your money cheerfully refunded if you do not agree with us that this is the GREATEST VALUE ever offered to the Amateur! Every tube is UNCONDITIONALLY GUARANTEED FOR THIRTY DAYS! (Broken glass or burnt-out filament the ONLY exception!)



\$4.90

These are not 211-E1 No RF Chokes in the base! FB for RFI!

ALL STANDARD LINES AT LOWEST PRICES ORU?

HARRISON RADIO COMPANY
142 LIBERTY ST., Dept. P7 NEW YORK CITY

Mail Orders Filled Promptly. Deposit Required.

The Lafayette "Professional 9"

(Continued from page 24)

This unit makes the assembly, wiring and adjustment of the set as simple as that of a five-tube "bopper". All worries about tracking and proper tuning overlap are eliminated, and the construction of the receiver becomes a pleasure instead of a headache.

The receiver itself is a thoroughly up-to-date nine-tube superhet. A stage of radio-frequency amplification on all bands assures maximum sensitivity and selectivity and minimizes image frequency interference. This stage, using a 6D6, is followed by a 6C6 mixer, a 41 local oscillator, 6D6 first IF amplifier, 6B7 second IF amplifier, diode detector and automatic volume control tube, 6C6 AF amplifier, 42 power output tube, 7G beat frequency oscillator for CW reception and phone carrier "hunting", and 80 rectifier.

The use of a 41 as the local oscillator is a bit out of the ordinary. This tube results in a high conversion gain and produces strong oscillation at the highest frequencies within the range of the receiver.

The average sensitivity of the "Professional 9" is less than one microvolt, the selectivity seven kilocycles.

The mechanical construction of the set has been worked out very carefully, to make home assembly quick and painless. The dynamic speaker, the power supply and the audio output stage are mounted on a separate, demountable chassis unit, which normally is bolted to the left side of the tuner chassis. If desired, this unit may be placed a short distance from the latter, it only being necessary to lengthen a few leads. As these carry only direct or audio currents no complications develop.

With the band switching and audio units in place, the receiver chassis overall measures 22½ inches long, 10 inches high and 11½ inches deep. A heavy, black crackle finished steel panel is supplied with the kit; a heavy steel cabinet, shown in the accompanying illustration, is available at slight extra cost.

Eight knobs on the front of the receiver give the operator complete control of the sensitive circuit. These knobs are all plainly marked by legible etched plates, so the owner doesn't have to take a week off and memorize their functions! Under the speaker grille, on the left, are: AC line switch; tone control, which is a small variable condenser, not a resistor, across the grid of the audio output tube; and stand-by switch, which opens the B minus side of the power pack and kills the receiver during transmission periods.

The other knobs are grouped under the vernier tuning dial, and are backed by a handsome etched plate. Above the earphone jack is the audio volume control, a potentiometer working into the grid of the first AF tube. Then comes a three-position switch, with the following circuit controls: automatic volume control, manual volume control, and manual control plus beat frequency oscillator. The first position is most generally used for DX phone reception, the second for ordinary phone or broadcast work, and the third for CW.

To the right are the RF volume control and the band switch. The latter has four ranges, as follows: 9.7 to 30 meters, 30 to 75, 75 to 200 and 200 to 560. After a couple of evenings with this set, even the most obstinate plug-in-coil fiend is forced to admit that the band switch is a great convenience and permits rapid scanning of all bands.

Smooth band-spreading on all parts of all four bands is made possible by a unique double-drive dial, equipped with a double

(Continued on page 33)

Send for our new
HAM SHEET just
off the press . . .
FREE!

Long distance
Phone 4-5746.

GOSH—YES—AND
TWO-THIRDS OF IT—
COMES FROM
UNCLE DAVE'S RADIO
SHACK IN ALBANY.

YOU SURE
MIGHT HAVE
LOTS OF
MAIL FROM
THE BOYS!

UNCLE DAVE

356 BROADWAY, ALBANY, NEW YORK.
WE BUY—SELL AND TRADE "ALL HAM STUFF."
24 HOUR SERVICE—SHIP ANY PLACE.
IF WE HAVE NOT GOT IT—WE WILL BE ONLY TOO GLAD TO GET IT FOR YOU.
UNCONDITIONAL GUARANTEE IS UNCLE DAVE'S GOLDEN RULE!

75¢ FROM
UNCLE DAVE
W-2 APP
TO YOU

Cable Address
"uncle-dave"
Foreign trade
solicited

PEERLESS "40 DX" TRANSMITTER

A crystal controlled transmitter for Phone or C.W. operation. The tube complement is as follows: 2A5 oscillator, 2-46's power amplifier, 83 rectifier, 56 speech amplifier. The west coast is worked on 80 meters with this job on C.W. from Albany and often distances up to 1,000 miles are worked on the same band on phone. Here are a few of its features in concise form:

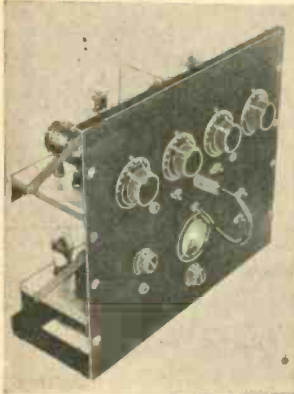

- ★★★Standard Rack mounted
- ★★★35 to 40 watts output on C.W.
- ★★★10 watts output on phone
- ★★★Crystal ground to your specified frequency
- ★★★Full output on 2 bands with 1 crystal
- ★★★2A5 Dow or Tritet oscillator
- ★★★Link coupling
- ★★★Standard relay rack bakelite panels
- ★★★Burnished aluminum chassis
- ★★★Weston milliammeter
- ★★★Higher power easily added
- ★★★Well filtered high voltage supply

This transmitter comes complete with "ALL" accessories, including crystal, coils for 2 bands, tubes, microphone, and in fact, everything but key and antenna. Transmitter for combination Phone CW \$63.50
Transmitter for CW only \$52.00

PEERLESS "4 PRM" RECEIVER

Truly a communications type receiver—designed especially for the ham or short wave listener who desires the utmost in flexibility and performance. Here are a few of its outstanding features:

- ★Tuned Radio Frequency
- ★Two Crowe airplane dials
- ★Bandspread 15 to 200 meters
- ★Careful engineering
- ★3-winding inductances used throughout
- ★Electron coupled detector
- ★Foreign reception on loud speaker
- ★Headphone jack
- ★Two double gang condensers
- ★Heavy crystalline finished chassis and panel

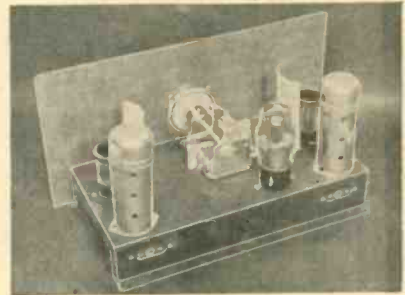

Complete kit, less tubes \$16.50
Kit of matched tubes, net 2.18
Wired and tested, additional 1.20
Handsome cabinet, net 2.00

WIRELESS EGERT TEST OSCILLATORS

Model 99, fundamental frequencies 21,000 to 100 KC . . . micro-vernier dial, 1000 cycle modulation and audio output. List price \$50, while they last. \$17.50

WESTON rebuilt model 301 meters, guaranteed like new
O-1 ma with regular Weston volt-ohm-mill analyzer scale, SPECIAL \$ 6.00
O-5 ma to 1 amp, any range 2.95
Above, bakelite cased 3.65
Dual range O-125 ma, 2.5 amps, bakelite cased, each 3.65
WESTON, used 30-0-30 galvanometers—FB for wheatstone bridge, each 6.95
Rawson and Sensitive Research microammeters O-15 microamperes, condition like new, special 17.50
We have in stock hundreds of new and used meters of all types . . . write us about your needs.

5 mfd. 1500 volt working Peerless oil impregnated condensers 4 1/2" x 5" x 2 1/2", special each \$ 3.75
R-81 rectobulbs \$1.25 each, 2 for 2.00
RCA 200-A, 240, 874, 3 for 2.00
VTE graphite anode 50 watters 8.75
CG-1162—5 watters, per doz. 1.00
W.E. 212-Ds, slightly used, complete with socket 16.50
Slightly used RCA 845's 8.00
Heavy duty 90 day guar. 866's 1.95
Extra Heavy duty 866's, 6-month guarantee 2.49
Peerless 50-watt sockets .35
Peerless 212-D sockets 1.95

3" K.K. vernier dials, special \$.29
Yaxley 5PDT 5-meter switches .69
5 hy. 500 ma chokes 1.25
Marco illuminated vernier dials, each 39c
3 for 1.00
4" black bakelite dials 25c, 5 for 1.00
Slightly used Cardwell 123-B .0005 condensers, each 1.00
B.M.S. speed bug, similar to the Vibroplex 6.95

NATIONAL ceramic coil forms—
XR-10-A \$.90 XR-12-A \$1.35
NATIONAL xmitting variable condensers:
TMS-100 1000 volt \$1.35
TMS-100-D 1000 volt dual 2.55
TMSA-35 2000 volt 1.65
TMC-100 3000 volt 2.55
TMC-150 3000 volt 2.85
TMC-100-D 3000 volt dual 4.50
All National Parts in Stock Always!

Resistance coupled SPRAGUE amplifiers, uses 24, 45, and 80 tubes \$4.95
5-watt amplifier, uses 57, 2B6, 5Z3, net 7.95
Soldering irons, all electric .79
2-gang variable condensers .00035 per section, special .69
Turner crystal mikes, prepaid in U.S.A. 13.25
Beehive standoffs, per dozen .59

RECEIVERS

New 7-tube SUPER SKYRIDER, short wave receiver, advanced superheterodyne complete with tubes, prepaid in the U.S.A. \$ 59.95
RCA ACR-136 communications type receiver, complete with tubes, power supply, speaker, etc., nothing else to buy, net 69.50
NATIONAL "HRO" 9-tube superhet amateur receiver, with coils, less tubes, speaker and power supply, net 139.80
WRITE FOR COMPLETE INFORMATION ON THE ABOVE RECEIVERS!
PHILCO automobile radios, all latest models in stock. Amateur discounts prevail.
5-Tube Superheterodyne all electric auto radio, latest type, remote control \$18.50
BROWNING 35 with TOBE tuner, all-wave set, complete kit of parts, less tubes, speaker and cabinet, prepaid in the U.S.A. 39.90
HAMMARLUND "SUPER PRO" complete with power supply tubes and special 12-in speaker, net prepaid in the U.S.A. 164.64

PEERLESS crystal ovens . . . absolutely safe and positive. Black crystalline finished box . . . accurate bent thermometer on front. Complete with crystal in 80 or 160 meter band, net \$8.25
PEERLESS 40-meter crystal, comp. with special holder, mounted 5.00
PEERLESS 80 and 160 meter crystals . . . complete with plugs for tube socket mounting 3.25
PEERLESS 80 and 160 meter A-cut crystals, comp., net prepaid 4.95
Ceramic crystal holder, plugs into tube socket 1.00

PEERLESS FILAMENT TRANSFORMERS Cased Uncased
7 1/2 v. 3 a; 5 v. 3 a; 2 1/2 v. 6 a \$2.75 \$1.75
5 v. 3 a; 2 1/2 v. 5 a; 2 1/2 v. 5 a 2.50 1.45
Three 5 v. windings, 3 a each, 5000 volt insul. 2.75 1.75
2 1/2 v. 10 a, 10,000 v. insulation 2.50 1.25
PEERLESS 5-meter transceiver kit . . . uses 2-19 and 1-30 tube, as per June, 1934, QST . . . complete kit less tubes, phones or mike, net \$10.33

PEERLESS LEARNOGRAPH . . . similar to the Teleplex, with 3 rolls of tape . . . \$14.95

WANTED—USED TELEPLEXES AND OMNIGRAPHS

The Lafayette "Professional 9"

(Continued from page 32)

knob. For quick tuning the low ratio drive of 25:1 is used; for accurate band-spreading, a 125:1 ratio drive is thrown in. This is a slick arrangement, and has elicited many favorable comments from hams who have already used the set.

As the chassis is supplied all formed and drilled, and detailed assembly, wiring and adjusting data are included, any amateur who can use a screwdriver and a soldering iron can put the "Professional 9" together and enjoy good results from it immediately. The finished set has a distinctly professional appearance, of which the builder will be very proud.

The Tobe Amateur Communication Kit Set

(Continued from page 22)

the tuner in constructing the amateur communication receiver. All chassis and ground currents are eliminated from this tuner by insulating it from the main chassis and grounding it at one point only. This type of construction not only reduces the tendency for oscillations but also increases the efficiency of the receiver. Insulation from the main chassis is obtained by means of soft rubber grommets which tend to materially reduce mechanical acoustical feed-backs due to the vibration of the tank condenser plate. This tuner is carefully aligned and tracked at the factory, but as the bands covered are extremely narrow, it may be necessary for the amateur to make slight adjustments on the trimming and padding condensers in order to have the ranges covered exactly the same as those marked on the model dial card.

On the 80 and 160-meter bands, band-spread is obtained by using small-range tuning condensers. On the 20 and 40-meter bands, however, series condensers must be employed in order to spread these bands over approximately the same area as the lower frequencies. This is automatically taken care of in the tuner by means of the coil-switching arrangement. The dial in this receiver is especially large and has a scale length of about eight inches so that stations may be readily logged. A large pointer moves over this scale and a small pointer attached to the vernier mechanism travels over a scale divided into 100 divisions.

Mr. Lamb is probably responsible for two coined names which give considerable information as to the tuning characteristics of a receiver. The first is "tuning rate" which is defined as the number of kilocycles covered by one complete revolution of the tuning knob. The fewer kilocycles covered per revolution the better the tuning rate. The second term is "calibration spread" which is defined as the number of kilocycles covered by the smallest division of the dial. This indicates how readily stations may be logged. The following table gives the tuning rate and calibration spread of the amateur bands covered by this receiver:

Band	160	80	40	20
Tuning Rate	26.5 Kc.	20 Kc.	18 Kc.	17 Kc.
Calibration Spread	2 Kc.	3.4 Kc.	2.0 Kc.	3.0 Kc.

The band-pass intermediate frequency stage with triple tuned circuits has several advantages, for not only does it give rise to a broad-nose tuning curve which gives better quality of received signals, but it actually gives better overall selectivity. The link circuits in these transformers are not connected to the grids or plates of tubes, but merely grounded, consequently, they act as a key circuit in the final alignment of the IF stage.

(Continued on page 34)

BUILD This New 5 Meter Super Het

LOW IN PRICE

\$16⁷⁵

INCREASED SENSITIVITY

IMPROVED SELECTIVITY

NO SUPER REGENERATIVE RUSH

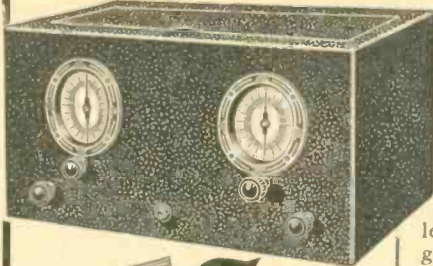

Free Catalog

If you have not yet received your FREE copy of this NEW 100% AMATEUR CATALOG, send for yours at once. Forty-eight pages crammed with information you need: general operating hints, questions and answers on Ham X'mitting and Receiving troubles; 16 pages of informative material.

Everything in S. W. Equipment is listed — at Lowest WHOLESALE Prices: Short and All-Wave Receivers & Kits; 2½ and 5 meter sets & kits; a complete line of C.W. and phone X'mitting equipment with outputs from 2-100 watts! Also tubes and accessories by all leading manufacturers.

A request, preferably on your call card, will bring your free copy. Address Dept. P-75.

Here is a Super-het for 2½ and 5 meter reception that the Ham can build himself without much difficulty. This receiver was originally designed by Frank C. Jones of "RADIO" but Lafayette engineers have made several changes in the circuit to simplify its construction. It's almost as simple as a straight super-regenerative receiver, but it will prove far superior as regards sensitivity, selectivity and noise level. The absence of super-regenerative "Rush" is an outstanding characteristic.

The use of resistance-capacity coupled I.F. greatly simplifies the construction of this receiver. There are no magnetic fields or interaction effects so that shielding is therefore minimized. Nor does the I.F. system amplify stray audio impulses for the grid coupling condensers are of such relatively low value. The I.F. circuit responds to frequencies from approximate 15 Kc. to 100 Kc.

PXR-22098—Complete Kit of Parts for 5 M. Super-het Kit including Cabinet, panel, and special copper plated chassis, but less Power Supply, tubes and speaker\$16.75

PXY-21942—Complete Power Supply Kit, less tubes\$ 8.25

Kit of Matched Tubes: 1-6C6, 3-6D6, 1-41, 1-42, \$3.20

If wanted completely wired, add the following:

For Receiver\$ 3.25

For Power Supply 1.25

WHOLESALE RADIO SERVICE CO.

100 Sixth Ave., Dept. P-75
New York, New York.

- Send me your new FREE exclusive HAM catalog of 48 pages.
- Send me the order described in attached letter.

Name _____

Address _____

City _____

State _____

WHOLESALE RADIO SERVICE CO.

Main Office and Warehouse

100 SIXTH AVENUE • NEW YORK, N.Y.

BRONX, N.Y. 542 E. Fordham Rd.

ATLANTA, GA. 430 W. Peachtree St. N.W.

NEWARK, N.J. 219 Central Ave.

A. T. CRYSTALS

With New Low Loss
Power Type Mounting

Priced as low as \$4.95



See Your Dealer
Bulletin on request

Monitor Crystals
2802 West Avenue 32
Los Angeles, Calif.

STEEL RACKS

Two 8x14" panels with 8x12½x1½" decks removable as units. Strong angle steel frame. Black crackle finish. Net price \$4.25, 13 lbs.

STEEL CABINETS

7x10x6¼". Panel and deck removable. Hinged lid. Crackle finish. Net price \$1.95, 5 lbs.

Bottom dust cover \$.25 extra, 1 lb.

R. H. LYNCH

970 Camulos St. Los Angeles, Calif.

Order direct or see your dealer.

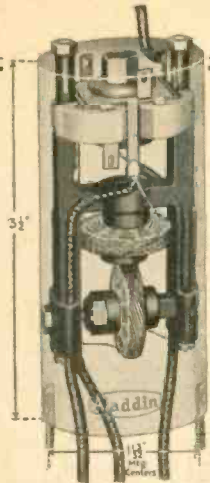

Aladdin Iron Core I.F. Transformer. Actual Size only
1 1/2" x 3 1/2"

FRANK C. JONES of "RADIO" Endorses Aladdin Units

Chosen by the technical staff of "RADIO", headed by Frank C. Jones, the new Aladdin Iron-Core I-f transformers give greater gain and greater selectivity in the "40-20" receiver than any other I-f units tested. In fact, only one stage of I-f amplification is required for optimum results when Aladdins are used.

In the new "40-20" receiver, described in this issue, Aladdin I-f units, were chosen because of the extreme sensitivity or gain required for the high frequency bands. Tube noise is greatly reduced when only one stage of I-f is used. See Frank C. Jones' article in this issue. Make sure you use Aladdin I-f units, as specified. Only when these units are used will this great receiver give you the results you rightfully expect. The specifications for the "40-20" are more exacting than other amateur receivers and no compromise in parts should be made. Play safe—use Aladdins throughout, and once you use them you will use no other. Aladdins save space, because one less stage of I-f amplification is required. The Aladdin Polyrion core is the secret of unusual performance. For amateur reception, selectivity is all important and you get MORE selectivity without sacrificing gain, better all-round results . . . you save space, you save on tubes, sockets, resistors, condensers. Aladdins pay for themselves even before you put them into your receiver. Buy a set today . . . you will never be satisfied with any other. Your dealer has these units in stock. If he is sold out, write direct to the factory. The price of each Aladdin I-f transformer is \$3.00 list . . . \$1.80 net to amateur.

Aladdin

"The Magic Word in Radio"

ALADDIN RADIO INDUSTRIES, 4049 West Diversey Ave., Chicago, Ill.

\$1 Brings You the Next 4 Issues of "RADIO"—Subscribe Now



1935 SPRING & SUMMER ALLIED CATALOG

You will find complete answers to all of your Short Wave Transmitting and Receiving needs in this new Catalog, devoted 100% to Radio. Prices are LOWER than ever before—it will pay you to consult this book before you do your radio buying. Every leading standard Short Wave line is listed—outstanding new gear is fully described. Use the ALLIED Catalog and take advantage of our personal service. Let us help you with quotations for building any type of circuit—let our competent engineers and Amateurs in on your problems. We can always serve you better at ALLIED.



ALLIED RADIO

ALLIED RADIO CORP.
833 W. Jackson Blvd.,
Chicago, Dept. J.
Send me your FREE 1935 Spring and Summer Catalog.

Name _____
Address _____

MILLIONS IN USE

- Two Year Guarantee
- Low Power Factor
- Long Life
- Self Healing
- Efficient and Compact
- Patented and Pending



The superior quality and performance of millions of Duco Condensers are recognized all over the world.

NOW GUARANTEED FOR 2 YEARS

Manufactured by

DUMONT ELECTRIC COMPANY, Inc.

514 Broadway New York, N. Y.

Write for free Catalogs, Sales and Jobber Territory



NEW EDITION Now Ready

The only Radio Call Book published that lists all of the radio amateurs throughout the entire world.

Also a complete list of high frequency commercial stations, International abbreviations and amateur prefixes, "Q, R, & T," systems for reporting signals, New US radio inspection districts, high frequency press, time and weather schedules, and high frequency commercial stations listed by frequencies.

Every ham should have one. Always up-to-date. Single copies \$1.25. Annual subscription \$4.00.

RADIO AMATEUR CALL BOOK, INC.,
600 SOUTH DEARBORN ST. CHICAGO, ILL

The Tobe Amateur Communication Kit

(Continued from page 33)

The frequency chosen for the intermediate amplifier is 456 kilocycles. The transformers used are carefully aligned at the factory, and though tube and lead capacitance may slightly change the alignment of four of these tuned circuits, the link circuits will be found accurately adjusted to the intermediate frequency.

The sensitivity of the receiver over all bands covered when taken in accordance with standard practice for a 50-milliwatt output including tube hiss, which is always present even in a well-shielded room, is less than one microvolt over all the bands. In some receivers such data have really very little significance as the tube hiss alone may be sufficient to give standard output when the volume controls are fully advanced. This is especially true where 2 IF stages are used. It was suggested to the writer that it would be interesting to obtain sensitivity characteristics for a 50-milliwatt output exclusive of tube hiss. This has been done in the case of the Tobe communication receiver with the results shown in the table on page 22. It is interesting to note that at a frequency of 1.8 MC the signal input to the receiver must be increased 3 times for 50-milliwatt output exclusive of tube hiss while at 14.2 MC the increase of input signal is less than 2 to 1. The signal generator on which the data given in the table were obtained was a very high-grade one, but it is believed that the attenuated network is probably somewhat inaccurate on the higher frequencies. The comparative results, however, should be correct.

The construction of the complete receiver is relatively simple, as the location of all parts has been carefully laid out and large-sized wiring diagrams are available so that any amateur will be able to construct the receiver with full assurance that when it is completed the set will perform to his entire satisfaction. Full constructional details are furnished; also there is available, the tuning catacomb, the panel, dial, and chassis assembly, as well as all the other component parts including all hardware which is necessary to build the complete receiver.

As said before, the receiver is absolutely single control and coil switching is employed. This will be appreciated by many amateurs and it is believed that this set will fill a long-felt demand for strictly amateur communication purposes and that the high signal-to-noise ratio will enable many Hams to increase their receiving range and receiving log materially.

U. S. S. Barracuda San Diego, California By W6CTV

June 6, 1935—

Col. Clair Foster:

The following list of calls was recorded while at Midway Islands, approximately 1200 miles west of the Hawaiian group. Listened for two hours on a standard type regenerative receiver:

7,000 KC
CB6A, J2KA, J2KN, J2KS, J2KU, J2T, J2LK, J2LO, J4CF, J4CJ, K6CJG, K7DVE, KAIHR, OM1TB, VE5EO, VE6CW, VK2CI, VK2LA, VK2ZX, VK3DW, VK6FO, VK6JE, VK7XL, VO5FEO, VSTRF, VS6AQ, VU2XQ, W6BTM, W6CUU, W6BLZ, W6CXK, W6DHS, W6DQZ, W6DTR, W6GDJ, W6GRU, W6LWX, W6JLO, W6JSZ, W6KJK, W6KUZ, W6LDJ, W6LON, W6LVQ, W6LYM, W6LLQ, W6MFX, W6TM, W7BRT, W7ECL, W7DVE, W7DVF, W7EAZ, X2BM, X1BC, XG5FO, XU6PZ, ZS6TL.

14,000 KC (Fone)
X1G, W4LC, W6BAY, W7BCI.



Osockme, Japan.
May 23, 1935.

Hon. Editor of "RADIO",
Dear Sirs:

Scratchi have just been released from serving seven daze in county jail again, and I have make appear before Hon. Pieces of Justice in local court house which are inscribed "Hall of Justice" but which Scratchi have re-named "Hall of Injustice" because I were lodged in such jail house for no reason other than the fact that I have connect one end of my tank coil to loose hanging antenna across neighboring street and I later find out that such antenna are receiving antenna used by Hon. Judge who have me arrested for attempted electrocution. Hon. Judge hear strange ringing sounds in ear drums which are quickly followed with terrific shocking feelings in head structure of Hon. Judge who make quick jump from chair and land in north-west corner of next door empty lot.

Hon. Judge hale me before him in court room and tell me that it are a pity that such people as I were not murdered while my bones were still soft.

It are later told to Scratchi that Hon. Judge are now preparing for ham license so that he can likewise play same trix of Scratchi as I play on him. So I make gift to Hon. Judge of copy of Morse land-line code and when he go to R. I. for code examination he will make quick flunk because he have make study of wrong kind of code. Such are way in which revenge are obtained here in Osockme. In meantime, Scratchi are packing other sock and extra shirt for quick skip to points north.

There have been no excitement here in Japan, Hon. Editor, since last I have write you. Only news are that local undertaker report brisk business among radio amateur clientele because of gentleman's agreement which amateurs have signed among themselves whereby it now become necessary for one old time amateur to commit suicide every time a new amateur come on air because there are not enough kilocycles in frequency spektrum to accommodate new amateurs. Only one case of cheating have been reported thus far. One old time amateur pretend he commit suicide and he are taken to coroner's office in large wooden box and then placed on marble slab where he are pronounced dead and deceased and extinct. When coroner close up shop for the night and return next morning, he find marble slab has disappear and so also have wooden box in which ham were shipped to coroner's ice plant. Detective bureau make investigation and later find that ham have taken marble slab and wooden box home with him and now have fine new transmitter rack in ham shack with marble front panel and dust proof box in back.

I must make haste and close now, Hon. Editor, as it are last day of month and Scratchi must take shunt off of electric house current meter because meter reader man are due here any moments. Scratchi hope that you, Hon. Editor, will also make sure to remove shunt from your meter because it are absolutely impossible to work good DX distances if electric light current are disconnected by power trust. Scratchi read watt-meter every month and this month I find that power company owe me two dollars and nine cents and I have great fear that suspicions of meter reading man will become arouse when he find that meter have been running in reverse rotations. It are now necessary for me to start up transmitter and lay few red bricks on key so that when meter reading man come around he can find that power trust no longer owe me money this month.

Then my conscience will be clear for another month, Hon. Editor, until next issue of your magazine make arrival here. In meantime I ask you please make apology for me to ham in your city to whom I sent 88. I were told it were a YL but I later find out that it were her brother and I are now blushing like pair of 210 tubes with 2000 volts on plates.

Hoping you keep your plate voltage down below the manufacturer's safe ratings, and boil your breakfast eggs on a cook stove instead of in your tank coils, I remain

Your overmodulated distorter,
Hashafisti Scratchi.

McMurdo Silver Announces

THE FINEST PROFESSIONAL RECEIVER OF ALL TIME . . .

SILVER MASTERPIECE IV_a

The Super-fine Phone Receiver!

- No Inherent Circuit Noise
- Controllable Selectivity
- Plenty of Band Spread
- One Half Microvolt Sensitivity
- Complete Flexibility

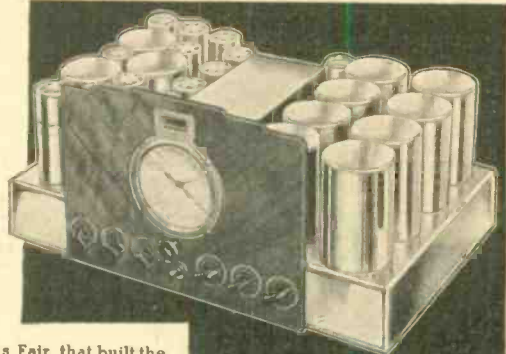

Out of the experience of over twenty-three years . . . that built all the receivers for W9USA at the World's Fair, that built the all wave receivers for Admiral Byrd, that has produced the famous 5B and 5C now doing their stuff in thousands of ham shacks, in government service, at engineering universities the world over . . . now comes the MASTERPIECE IV_a, the superlatively flexible professional receiver. It has so many totally new and unduplicated features that it takes the 32-page Blue Book to explain them all, but here are a few:

No Inherent Noise. Not over 20 milliwatts inherent receiver noise when "wide open" at 1/2 microvolt absolute sensitivity on all bands, means good readable signals where they are now lost in set noise or not even heard.

Controllable Selectivity. From sharp enough to give single signal C.W. to amply sharp to cut through crowded phone bands, to broad enough for standby, all controlled by the fidelity and two tone knobs.

Band Spread. One large 4" accurately calibrated air-planned, with accurately re-logging geared band spread pointer on inside 0-200 division, 360 degree, scale. Spread on 160 meter amateur band 540 degrees, 80 meter, 280 degrees, 40 meter 130 degrees, 20 meter 80 degrees, and ten meter 180 degrees.

Range. 140 to 410 kc. (2150 to 732 meters) and 530 to 32,000 kc. (568 to 9.4 meters) covers all five amateur bands, short wave and regular

broadcast and long wave commercial, all at maximum sensitivity and selectivity.

Two Tuned R.F. Stages On All Bands. Perfect image selectivity even at 20 meters and inherent noise so low you'll think the set is dead until Aussies and Zedders roar in R9. All r.f. oscillator and i.f. circuits use permanent air condensers—only one compression trimmer in 33!

High Fidelity. It's there—30 to 9000 cycles and 15 watts undistorted output thru matched Jensen speaker. Not only is it the perfect amateur receiver, but a wow of a high-fidelity all wave broadcast receiver as well.

Control Flexibility. All controls are calibrated so you know exactly what you're doing, and can duplicate adjustments from day to day. Tuning meter with calibrated sensitivity control is perfect R-meter, allowing exact measurement of received signal strength.

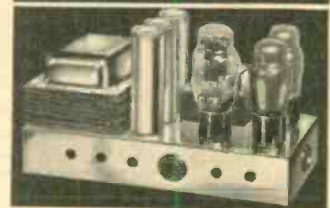

10 DAY FREE TRIAL
The Silver MASTERPIECE IV_a, like the 5C, is just so good that it's the only amateur receiver offered to you on a 10 day free trial basis. You can test it, make it do its tricks, and if you don't like it 100%. You can return it undamaged and get your money back instantly. With this wide-open guarantee, we get less than one-half of one percent back—so they must be good.

When you install a Silver MASTERPIECE IV_a on your operating desk, your receiver worries are over for years to come, for it's so far ahead of contemporary design that once you operate it, you'll only be able to say "man, what a receiver!"

These champion of champion receivers are being delivered right now—you can get one at once, without waiting until next year, and the pride complete with 15 watt power amplifier and matched high fidelity speaker, is less than you could buy the parts for.

MAIL COUPON FOR FREE BOOK

Send the coupon or a postcard for the complete story—even if you don't buy a Silver MASTERPIECE IV_a, the 32-page Blue Book will at least tell you what to look for in fine receivers.

McMURDO SILVER CORPORATION Division of G.P.H. Inc.

3362 N. Paulina St., Chicago, U. S. A.

McMURDO SILVER CORPORATION
3362 N. Paulina St., Chicago, U.S.A.

Send Free "Blue Book" with complete specifications of Silver MASTERPIECE IV_a, and details of FREE TRIAL OFFER.

Name _____

Address _____

City _____ State _____

7RM

Use Headphones for Short Wave!

Sensitive signals from "half way" round the world come in best on headphones. TRIMM Featherweights are the phones the experts use. Ask your dealer or write the factory. Direct current may be passed through all Trimm Featherweight Headphones without damage.



TRIMM
RADIO MFG. CO.

Dept. R-7
1528 Armitage Avenue
Chicago, U. S. A.

BIRNBACH 5-METER ANTENNA

For TRANSCEIVERS and
BEAM ARRAYS

\$2.00 and \$2.50

THREE aluminum tube sections, adjustable to desired frequency from 3 ft. (closed) to 9 ft. (open). Tightly locked by brass bushings. High-resistance standoff insulator base (4 1/2" high). Complete with standoff, \$2.50 list. Extensible antenna only, with threaded end, \$2.00 list.

Write Dept. PR-7 for Details

BIRNBACH RADIO CO., Inc.
145 HUDSON STREET NEW YORK CITY



600 Watt CW-200 Watt Phone

(Continued from page 11)

an 8 mfd. electrolytic condenser as an audio by-pass. The cathode resistor is also bypassed with an 8 mfd. condenser of a 450 volt rating because this resistor would offer an additional load common to both plate and grid circuits of the modulated stage. If low-frequency response such as for music is desired, the high voltage plate supply should be by-passed with a larger condenser, such as an additional 2 mfd. 3000 or 4000 volt condenser.

The low voltage supply should deliver about 250 MA at nearly 400 volts. This is a little difficult to obtain from one power transformer and rectifier, and a good method would be to put the buffer on a 400 or 450 volt supply for 150 MA and the oscillator and speech amplifier on another pack delivering about 100 or 120 MA at 350 volts. The total speech amplifier current drain is less than 50 MA because the actual plate voltage on the 45 tubes to ground is about 200 volts. Choke input on the low voltage supply or supplies is desirable because the oscillator tube is generally keyed for CW. A telegraph key in the cathode jack also provides a good push-to-talk switch for phone operation.

A key click filter is desirable. It consists of a 1 or 2 henry choke in series with the key, plus a .1 mfd. or larger condenser in series with a 500 ohm resistor across the key contacts. Fixed bias is used on all stages

following the oscillator-doubler and keying can therefore be accomplished in any of the current measuring jacks. Even the current measuring jack on the final stage is cold. Only a small spark occurs when this circuit is broken because the grid circuit is also opened, thus blocking the plate current and preventing an arc across this jack or the key contacts.

Preliminary adjustments are fairly simple. The oscillator is tuned for maximum output at lowest cathode current. The doubler section should provide a good excitation swing to the buffer stage grids. The cathode current of the 53 tube should run between 60 and 70 MA when properly adjusted, and the doubler output should drop to zero when the crystal is short-circuited. Too much regeneration will cause the doubler to oscillate by itself. A neon bulb, a RF galvanometer and loop of wire, or a lamp and turn of wire are good oscillation indicators. The buffer stage open plug should be left in that jack until after that stage is neutralized. In neutralizing, the two condensers should be adjusted in equal amounts until the plate tank circuit has no RF.

The plate current of the buffer stage should run between 110 and 160 MA when loaded by the grids of the 150Ts. For CW operation with half of the cathode resistor cut out and about 200 volts fixed bias, the final grid current should run between 25 and 45 MA when the buffer stage is operating properly. The higher value allows better

efficiency and a little more output. The plate current on the final should run between 250 and 350 MA on CW in this particular circuit.

On phone operation the grid circuit of the buffer stage can be detuned in order to drop the grid excitation on the final amplifier to about one to three MA under load. The plate current should run between 180 and 200 MA at a plate supply voltage of a little less than 3000 volts. The full 1000 ohm cathode resistor should be in use. Less plate current usually means insufficient antenna load.

To change from CW to phone, the mike is plugged into its jack on the speech amplifier panel, the buffer grid dial is detuned until only a trace of grid current flows and the cathode resistor switch thrown over to "Off", or phone position.

A steady tone should increase the antenna current about 20 to 22%. On normal speech the gain control should be backed off until only a bare flicker of RF current is noticeable. Too much RF grid excitation (too much grid current) will prevent modulation and zero grid current reduces the plate efficiency and drops the power output. About one or two MA of grid current seems to be about right.

The RF chokes, with the exception of the one in the final amplifier plate circuit, are all of the small 2.1 mh. type. The oscillator coils are made on 1½-in. plug-in forms. The 80 meter coil consists of 27 turns of No. 22 DSC, 1¾-in. long. The 40 meter oscillator coil consists of 16 turns, 1¼-in. long, of No. 18 DSC wire.

The 20 meter doubler and 20 meter buffer grid coils are each 10 turns of No. 18 DSC on a 1½-in. form, 1-in. of winding space, with a center-tap. The 20 meter buffer plate coil consists of 9 turns on a 1¼-in. form, wound to cover 1½-in., with a center-tap. The final grid coil for 20 meters consists of 9 turns on a 2¼-in. diam., 2-in. long. The latter could be a 10 turn coil on a 1½-in. diam., 1-in. or 1¼-in. long. These two coils should be wound with No. 16 wire because No. 18 shows some heating, even at low values of tuning capacities.

The final tank coil on 20 meters originally consisted of 18-in. tubing, but at high power this coil heated excessively. The proper coil uses a porcelain tube 2½-in. diam. with 7 turns per inch of No. 10 wire. This coil is wound with 16 turns, 10 of which are shorted-out for 20 meter operation. The whole coil would be used for 40 meter operation. By using a very low resistance shorting connection across the 10 turns, and very low C in the tank condenser, this coil does not heat excessively on 20 meters with about 800 watts input to the final stage. For connection to a Collins coupler, this coil should be tapped at about 3 turns for 20 meters and 8 turns for 40 meters. For use with a twisted pair feeder, two turns of No. 14 rubber covered wire wound over the +B end turn has been correct for proper load.

One curious case of trouble in the speech amplifier came to light on 20 meter tests. A high-pitched AC hum was introduced across the electrolytic by-pass condenser which is connected across the first speech amplifier tube. A .00025 mica condenser connected from cathode to ground cured this trouble. Probably ½ or 1 mfd. paper by-pass condensers on the cathodes would have been better from this standpoint than 10 mfd. electrolytic condensers. Higher speech gain could be obtained by using the usual pentode connection on the 57, or by the use of a 2A6 high mu tube, but the gain is sufficient for close talking and it eliminates room acoustic reverberation.

\$1.00 brings you the next four issues of "RADIO" —Subscribe NOW!

CANNON-BALL HEADSETS

Made by America's oldest manufacturer of headsets

Heavy bar magnets, double pole, aluminum cases, D. C. resistances of 2000, 3000 and 5000 ohms. Sturdy construction, sensitive and faithful in reproduction.

Sold everywhere in America

C. F. CANNON CO.
SPRINGWATER, N. Y.

NEON TATTLETE TESTER

"Tells the Tale"

Tests for blown fuses, condensers, or resistors, r.f. peaks and wave length, polarity, open circuits, live lines, defective spark plugs, etc. 100 uses—pocket size. With instructions—post-paid, a \$1.00 bill.

Send for catalog of other TattleTees. Instrument, Aircraft and High voltage Littelfuses, Radio Fuses, Mtgs., etc.

LITTELFUSE LABS.
4503 Ravenswood, Chicago, Ill.



Beat Frequency Audio Oscillators

20 to 12,000 Cycles
Direct Dial Calibration

THE AUDIO-TONE MODEL 12-A

\$48.00 Net, Less Tubes

\$66 Net, with A.C. power supply and output trans.

Licensed under A. T. & T. Co. Patents

THE AUDIO-TONE OSCILLATOR CO.
901 LONGBROOK AV., STRATFORD, CONN.

LITTELFUSES

Radio Dealers and Jobbers who desire to advertise in these columns are invited to write for rates.

RADIO BUYERS' GUIDE

A Monthly Listing of Reliable Radio Dealers and Jobbers who solicit the patronage of our readers. Buy from your nearest Dealer or Distributor. He is dependable and reliable.

CHICAGO, ILLINOIS

Chicago Radio Apparatus Company, Inc.
415 South Dearborn Street
Harrison 2276
Dependable Radio Equipment
Established 1921
Bulletins on request.
Everything for the amateur.
Get our very low prices.

CHICAGO, ILLINOIS

MID-WEST RADIO MART
520 South State Street
CHICAGO
Write for Special Catalog—Free

SCHENECTADY, NEW YORK

ATLANTIC RADIO SUPPLY CO.
712 Broadway
Complete Equipment Stocked for
Service men—Amateurs—Experimenters
Let us quote you

OAKLAND, CALIFORNIA RADIO SUPPLY CO.

2085 BROADWAY.
Hammarlund, Yaxley, Carter, National, Johnson, IRC, Cardwell, Miller, Morrill, Flechteim, Triplett, Haigis Transceivers
W6GFY

ST. PAUL, MINNESOTA

LEW BONN COMPANY
2484 University Avenue
Rex L. Munger, W9LIP, Sales Engineer

Radio Wholesaler

Complete Stock

BUFFALO, N. Y.

DYMAC RADIO
216 E. Genesee St. CL 2080
Complete Stock Amateur Parts
STANDARD DISCOUNTS
—W8AWK—

LOS ANGELES, CALIFORNIA

RADIO SUPPLY CO.
912 SO. BROADWAY
The Amateurs'
HEADQUARTERS of the WEST

All Nationally Advertised Parts for Receiving and Transmitting carried in stock at all times.

9 Licensed Amateurs on Our Staff



NEW PRODUCTS

Cathode-Ray Visual Receiver Servicer

A number of entirely new features are introduced in this new Cathode-Ray equipment for servicing radio receivers, which has just been announced by the Clough-Brengle Co. of 1134 W. Austin Ave.

Among these is an entirely new sweep system that produces on the Cathode-Ray tubes a receiver selectivity curve that is accurately calibrated and can be read directly in kilocycle width. This is secured by maintaining a uniform width of sweep (plus and minus 15 KC) at all test frequencies from 100 KC to 30 MC.

Another new feature in receiver servicing made possible with this equipment is the feeding of an RF wave modulated by a 400 cycle sine wave into the receiver at antenna and ground and then observing the shape of the wave at the speaker voice coil, as pictured by the Cathode-Ray tube. This test will show overall receiver audio distortion, including such distortion as may occur in first detector, second detector, AVC, and audio stages.

A complete Cathode-Ray Visual Radio Servicer is composed of the Model OM Signal Generator with built-in frequency modulator and the Model CRA or Model CRB Oscilloscope.

The Model OM Signal Generator has a built-in frequency modulator oscillator and motor-driven condenser unit. It is essentially similar to the usual RF oscillator except that it has a second modulated oscillator that wobbles the output of the first oscillator plus and minus 15 KC when it is desired to use with a Cathode-Ray Oscilloscope. With the wobble circuit switched off, the Model OM may be used as a standard 400 cycle modulated oscillator for output meter indications. Net price of the Model OM, complete with tubes, is \$47.85.

Two new Cathode-Ray instruments are offered in the Clough-Brengle line. The Model CRA is a complete Oscillograph with built-in linear sweep circuit, input amplifiers, and complete power supply for operating the standard 3-inch Cathode-Ray tube. Net price with Cathode-Ray tube, \$79.50.

The Model CRB Cathode-Ray Oscilloscope is identical with the above instrument, with the exception that the linear sweep circuit is not included. This circuit is not required for securing receiver selectivity curves when the Model OM Modulated Oscillator is used, as well as in many other applications. Net price, complete with 3-inch Cathode-Ray tube, \$69.50.

Kendall Clough, chief engineer of the Clough-Brengle Company, has just written a 24-page booklet on Cathode-Ray Test and Analysis, which is of unusual interest to every service man. Copies may be secured from your jobber or by sending 25 cents in stamps to the manufacturer.

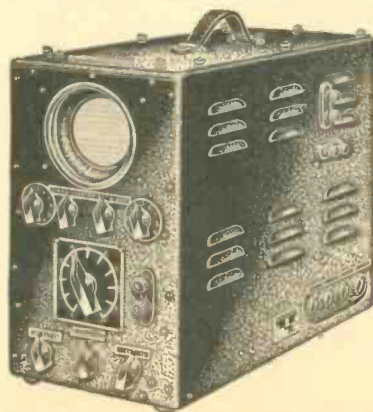

CHICAGO, ILLINOIS

Chicago Radio Apparatus Company, Inc.
415 South Dearborn Street
Harrison 2276
Dependable Radio Equipment
Established 1921
Bulletins on request.
Everything for the amateur.
Get our very low prices.

SAN FRANCISCO, CALIFORNIA



1452 Market Street.

"The House of a Million Radio Parts"

Hammarlund and National sets and parts.
Sylvania Amateur Transmitting Tubes
Collins Transmitters.
Arcturus Receiving Tubes.
Trimm Phones, all types.
Johnson Antenna Feeders, Insulators,
Transposition Blocks.

FRESNO, CALIFORNIA

PORTS MANUFACTURING CO.

3265 E. Belmont Ave. Radio W6AVV
National FB7-SW3 and Parts; Hammarlund,
Cardwell, Bliley Crystals; Johnson Insulators.
Distributors RCA-DeForest Transmitting Tubes
Established 1914 Send for Wholesale Catalog

BUTLER, MISSOURI

HENRY RADIO SHOP

Complete stock of Collins, Patterson, National, Hammarlund, Silver, RME9D, Super-Skyrider, Peake, Mac-Keys, Eimac, Sylvania, Taylor, Thordarson, Cornell-Dubillar, Cardwell, Dwyer, Triplett, Weston, Turner, Astatic, Trimm, Johnson, Bliley, and others at lowest wholesale prices. Your used apparatus accepted in trade, too. Write for any information.

Robt. Henry, W9ARA, Owner. 211-15 N. Main St.

OAKLAND, CALIFORNIA

ELECTRIC SUPPLY CO.

12th and Fallon Sts.—"Down by the Lake"

Our New Catalog contains valuable information for Dealers, Servicemen and Amateurs. FREE.

Amperex Transmitting and
Special Purpose Tubes

Raytheon 4-Pillar Tubes Factory Sealed Cartons

DISCOUNT 40% on most all lines

W6AZG	} Located in } our store }	W6IDB
W6DTM		W6KGE

CHICAGO, ILLINOIS

Newark Electric Company
226 W. Madison St.
Chicago
All Kinds of Equipment for
Service Men - Amateurs - Experimenters
Write for free catalog

“
**Our Sales
DOUBLED**

when we went 100%

SHELVADOR
”

Radio Electric Store

14 West High Street

Phone Main 473

SPRINGFIELD, OHIO

The Crosley Radio Corporation,
Cincinnati, Ohio.

Gentlemen:

We have sold electric refrigerators for the past seven years. We, like other dealers, have learned much from our refrigerator experience. This experience has fully convinced us of the wisdom of centering our efforts on one line; a line that appeals to the widest market. We have found such a line in the Crosley Shelvador, which we have handled for the past two years.

Through the splendid cooperation of the advertising department of the Crosley Corporation in conjunction with WLW, and through special promotion plans we have been able to work out locally, an acceptance for Shelvador has been created throughout this territory, that for the first time in our sales experience with refrigeration, has resulted in real profit.

There is no question that in Springfield, no one can think of an electric refrigerator without thinking of the Shelvador. While, until the past year, we sold other refrigerators along with Shelvador, we found that our sales volume doubled this past year when we went 100% "Shelvador". More than 300 units have been sold in Springfield during the past eight months.

We do not have a large sales organization, but we do have a large "organization" of completely satisfied Shelvador owners. We cooperate with these owners in a substantial way and they cooperate with us in getting new sales. The trouble-free operation of the Shelvador is a decided asset in maintaining this cooperation. Our service department shows that the number of service calls has been cut in half since we have handled only Shelvador. We have never found it necessary to canvass for Shelvador sales. Our owners send us more prospects than we can call on.

All of this is convincing evidence of the merits, the salability, and the satisfactory performance of this remarkable refrigerator. There is no question that, both from the dealer's standpoint and the owner's standpoint, Shelvador is the most desirable and satisfactory electric refrigerator on the market today.

Sincerely yours,

THE RADIO ELECTRIC STORE

per

V. J. Coughenour

VJC-S

It takes a RIFLE for big game. Specialty dealers of the widest experience agree that it is better to concentrate on one line than to scatter over several.

When you handle the Crosley Shelvador you need no other refrigerator line. Shelvador (in 3 types—Table Shelvador, Shelvador, and Tri-Shelvador) and 15 models ranging in price from \$79.50 to \$219.50 (delivered, installed...one year free service) meets every requirement from smallest home or summer cottage to largest mansions. Each group represents a distinct and unique value never before approached; each has features found nowhere else.

By buying from one source, by centering your efforts on one line, by pushing the exclusive Shelvador feature, by identifying yourself with the nation-wide Crosley Shelvador advertising campaign in dozens of national publications and over the radio... obviously you can go farther, make more money. The sooner you switch to 100% Shelvador, the bigger will be your year's volume.

THE CROSLEY RADIO CORPORATION - CINCINNATI

Home of "the Nation's Station"—WLW—500,000 watts—most powerful in the world—70 on your dial
POWEL CROSLEY, Jr., President



PRESENTS

New CHROMSHIELD TRANSFORMERS In Six New Amplifier Kits

All transformers are fully clamped, vacuum treated and then poured with humidity proof compound in the new chromium-plated, welded shields to assure long lasting satisfaction.

Many new circuits to choose from with a broad popular price range. Compare:

Chromshield "CS-1" Kit

Double pushpull power amplifier (56's into 45's) having a peak power output of 14 watts. Normal output 10 watts. Gain 45 db. List price of all UTC transformer components and chassis, fully mounted as shown \$27.00
Your net price..... 16.20

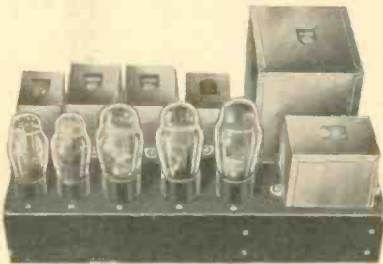

Overall dimensions, 14x7 1/2 x 2 1/2

Chromshield "CS-2" Kit

This three stage 6A6 power amplifier has sufficient gain for use with the newer types of crystal microphones. Gain 108 db. 10 watts output. List price of complete transformer kit with chassis..... \$19.50
Your net price..... 11.70

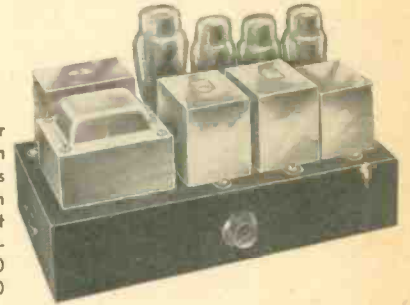

Overall dimensions, 12x6 1/2 x 2 1/2

Chromshield "CS-3" Kit

Three stage 46 class B power amplifier (57, -46, -46's). Output stage may be connected to voice coils or RF stage. Gain 84 db. 30 watts output. List price of complete transformer kit with chassis \$26.00
Your net price 15.60

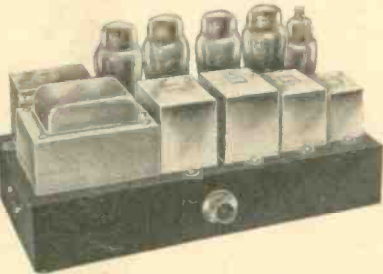

Overall dimensions, 14x7x2 1/2

Chromshield "CS-4" Kit

Three stage pushpull parallel fixed bias 2A3 or 45 A prime power amplifier, having a normal output of 30 watts (57, -56, -4-45's). Gain 85 db. List price of complete transformer kit with chassis. \$33.50
Your net price 20.10



Overall dimensions, 16 5/8 x 8 1/2 x 2 1/2

Chromshield "CS-5" Kit

A new, unique circuit, using the 6A6 tube cascaded into pushpull 6B5's to effect a gain of approximately 100 db. Peak power output 22 watts. Normal output 15 watts. List price of complete transformer kit with chassis \$20.25
Your net price 12.15

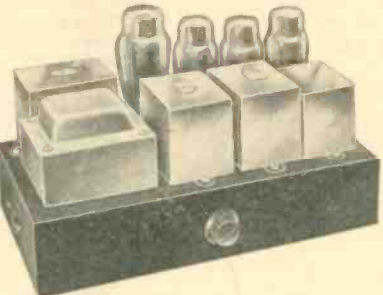

Overall dimensions, 12x6 1/2 x 2 1/2

Chromshield "CS-6" Kit

Output stage for small receivers, designed especially for the Browning 35 Receiver. 18 watts of audio in A prime fixed bias. Tubes used, 2-42's, 1-83-V, 1-45 bias rectifier. Complete power pack with all transformers and original Browning specifications as to Condensers, Resistors, Sockets and Terminal Strips, fully mounted and Ready to Wire. List Price \$25.00
Net to Hams..... 15.60



Write for Bulletin 11CC for information on Variactor Controlled Carrier Modulation

UNITED TRANSFORMER CORP.

72-78 SPRING STREET

Export Division, 15 Light St., New York, N. Y.

NEW YORK, N. Y.

Exclusive UTC distributors carrying a complete stock of UTC products.

Goldhamer's, Inc.	610 Huron Road, Cleveland, Ohio	Hall's.....	35 So. Cameron, Harrisburgh, Penna.
Wholesale Radio Service Co., Inc.	100 Sixth Ave., New York, N. Y.	Herbach & Rademan.....	438 Market St., Philadelphia, Penna.
Wholesale Radio Service Co., Inc.	219 Central Ave., Newark, N. J.	Cameradio Company.....	603 Grant Street, Pittsburgh, Pa.
Wholesale Radio Service, Inc.	430 W. Peachtree St. N. W., Atlanta, Ga.	W. H. Edwards & Co.....	32 Bway, Providence, R. I.
Sun Radio.....	227 Fulton Street, New York, N. Y.	Seattle Radio Supply, Inc.....	2319 Second Ave., Seattle, Wash.
Gross Radio, Inc.....	51 Vesey Street, New York City	Portland Radio Supply Co.....	1300 W. Burnside, Portland, Ore.
Leeds.....	45 Vesey Street, New York City	Spokane Radio Co., Inc.....	611 First Ave., Spokane, Wash.
William Gram.....	1444 Sheridan St., Lansing, Mich.	San Francisco Radio Exchange.....	1284 Market St., San Francisco, Calif.
Mohawk Electric Co.....	1335 State St., Schenectady, N. Y.		
Walter Ashe.....	1100 Pine St., St. Louis, Mo.		
Radio Shack.....	46 Brattle St., Boston, Mass.		
Harvey's Radio.....	105 W. 43rd St., New York, N. Y.		
United Radio Service.....	616 Main St., New Britain, Conn.		
Nutter & Cross.....	900 Milk St., Boston, Mass.		
Hatry & Young.....	203 Ann St., Hartford, Conn.		
Marine Radio Co.....	124-13 101st Avenue, Richmond Hill, N. Y.		

SOUTHERN CALIFORNIA

Pacific Radio Exchange Inc.....	729 S. Main St., Los Angeles
Radio Supply Co.....	912-14 S. Broadway, Los Angeles
Coast Electric Co.....	744 G. St., San Diego
Prest & Dean Radio Co.....	400 American Avenue, Long Beach
Radio Television Supply Co.....	1701 S. Grand Ave., Los Angeles, Calif.
Radio Specialties Co.....	1516 West 8th St., Los Angeles, Calif.