

# RADIO

REG.  
U. S. PAT.  
OFF.

THE NATIONAL TRADE MAGAZINE

APRIL, 1932

## Mission

# ALL-ELECTRIC MOTOR-CAR RADIO



6-tube all-electric complete **\$6450**      4-tube all-electric complete **\$4950**

A SIX-TUBE sensitive set, equipped with constant high gain radio frequency coils. Latest type 6.3 volt automobile tubes result in minimum drain on battery with maximum radio efficiency. Three of the newest type R.F. Pentode model 239 tubes, one 237 automatic volume control tube, one screen grid detector, and special 248 Pentode output.

The Mission 6-tube All-Electric set is so sensitive that a step plate antenna or single wire under the car frame will operate it very satisfactorily.

Your regular dealer discounts apply on these low-priced All-Electric motor car sets.

- 1—Simplified installation
- 2—No. "B" or "C" batteries
- 3—Automatic volume control
- 4—Full dynamic speaker
- 5—Complete inter-stage shielding
- 6—6.3 volt automobile tubes using latest type 239 R.F. pentode
- 7—"Aut-O-Bee" eliminator an integral part of the set
- 8—Cuts the average installation costs in half
- 9—Mission "All-Electric" 6 tube illustrated

## "AUT-O-BEE" Eliminator

Used as Standard  
Equipment in Both  
4 and 6 All-Electric Sets

This compact, efficient "Aut-O-Bee" eliminates "B" batteries and the trouble of installing them in your automobile radio. The "Aut-O-Bee" is hum-free and is simplicity itself, because there are no rotating parts to cause friction and wear. The "Aut-O-Bee" draws the approximate current used by one headlight from the storage battery, averaging 1½ amperes.

# Consolidated Radio Manufacturing Co.

1455 Venice Blvd.

Phone DRexel 6946

Los Angeles, Calif., U. S. A.



# Improved!

## • MERSHON • CAPACITORS

Greater Compactness Without Sacrifice of Quality • A Scientific Achievement

AND now—the improved Mershon! A new compact model in which space factor is emphasized—yet there has been no compromise with quality. Here is unquestionably the latest and finest component part of a radio set developed in recent years.

For all filtering requirements, choose Mershons. Choose them, not merely because of this exceptional saving of space, but to insure to your set a lifetime perfection of performance and noiseless operation as well. They are trouble-free—puncture-proof and self-healing—with a record of proven stability gained through more than ten years of dependable service. They are made in a complete range of capacities to fit

the requirements of every make of radio. The improved Mershons are equipped with a new type vent entirely free from any mechanical leakage.

They are made in both the standard stud type and a new clamp style which permits panel mounting in unusually small space. See illustration below.

A special type of seal, thoroughly enclosing and insulating the terminal, has just been developed, which is ideally adapted for combination speaker and capacitor mounting where added convenience is desired and where exceedingly small displacement is imperative. Write for Engineering Data.



### COMPACTNESS!

Compare the old and the new. The same capacity (8-MFD) Mershon Electrolytic Capacitor now requires just about half the space needed by the former model, as the above illustration reveals.

Magnavox engineers welcome consultation with radio manufacturers and offer service which insures the proper adaptation of Mershon Electrolytic Capacitors to all sets.

### Magnavox Company Ltd.

General Offices and Factory, Fort Wayne, Indiana

Subsidiaries:

The Magnavox Company, Electro Formation, Inc., Magnavox (Australia), Ltd., Magnavox (Great Britain), Ltd.





# Calling all cars!

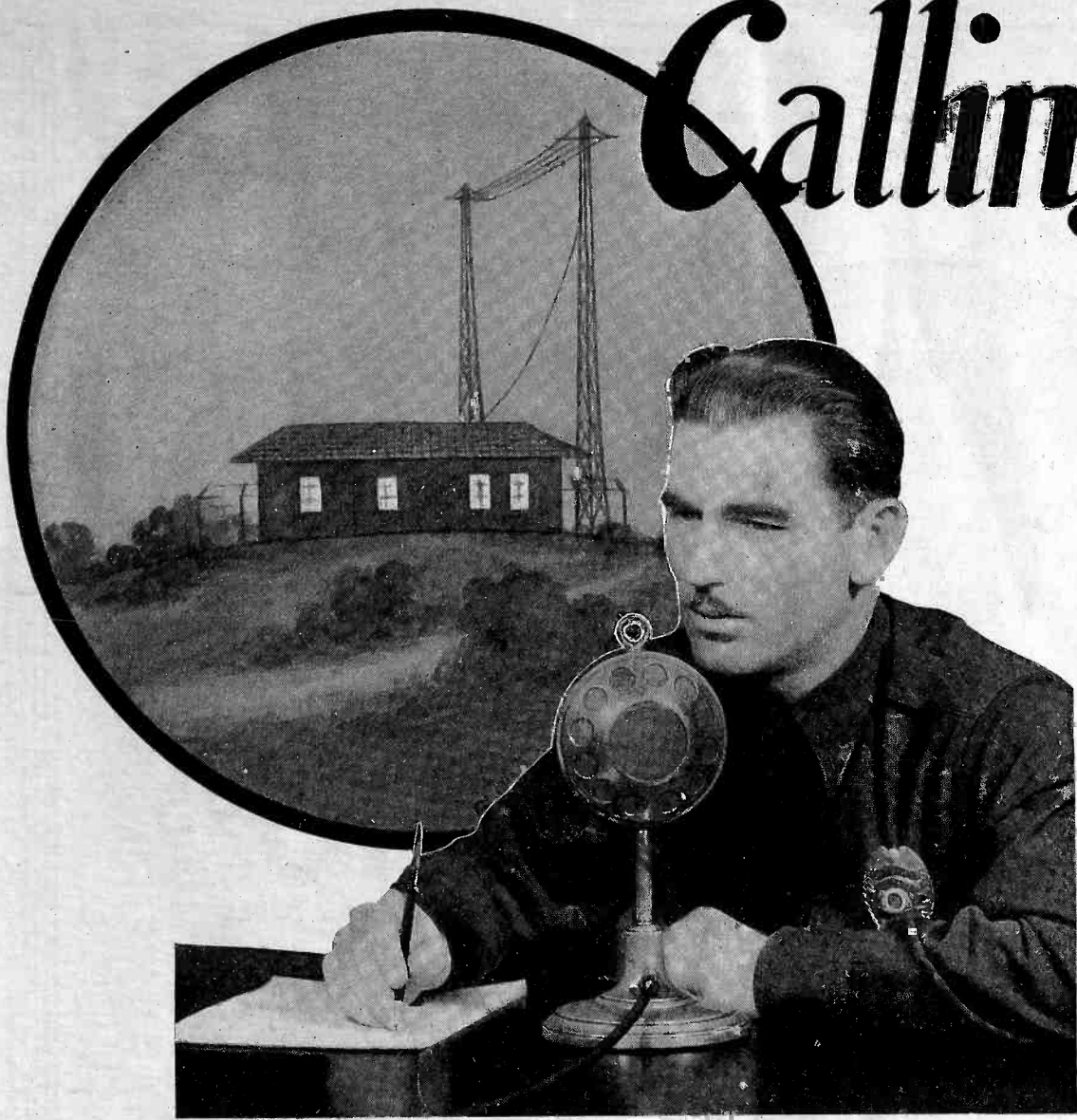

L. D. CONE, KGPL Announcer, Los Angeles Police Department Radio Station.

Arcturus Blue Tubes are commanding the attention of a radio-conscious world everywhere. Endorsing its merits are imposing lists of engineers, manufacturers, retailers, and most important of all, set owners...your customers. Arcturus' Quick Action, Clear Tone, and Long Life mean customer satisfaction...an asset that pays any dealer.

If you want the real facts about tube renewal business in 1932, ask your jobber or write us direct.

A word! A flash! A whole city stirs to action, and radio...society's greatest curb on lawlessness...is the first to answer the call. Speed...*action*...**DEPENDABILITY**...all are needed when desperate criminals are at large and precious moments count.

Riding in thousands of police radio cars throughout the country are Arcturus *Blue Tubes*...answering the call to duty with quick action and perfect performance.

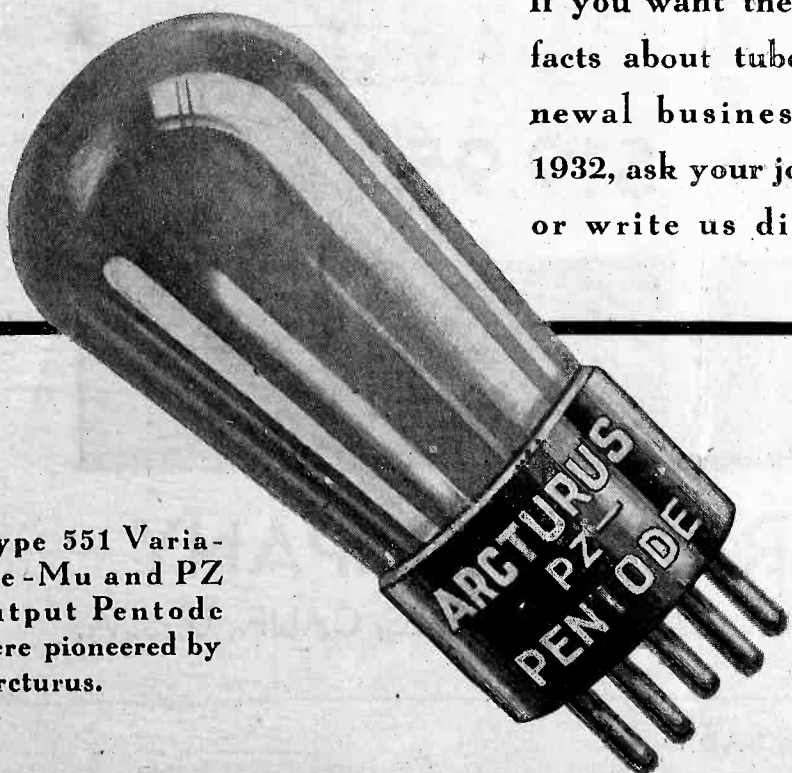
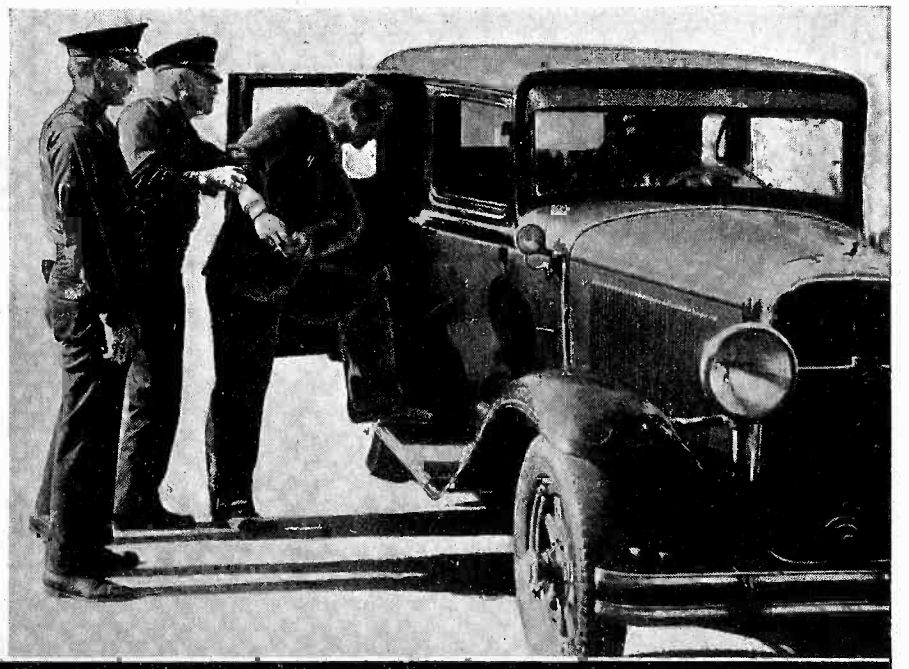

Type 551 Variable-Mu and PZ output Pentode were pioneered by Arcturus.

## ARCTURUS

"The BLUE TUBE with the LIFE-LIKE TONE"

ARCTURUS RADIO TUBE COMPANY • NEWARK, N.J.  
Western Division: 1855 Industrial Street, Los Angeles



# APRIL SPECIAL



ILLUSTRATED IS THE  
NEW 6 TUBE EL REY  
SUPER RECEIVER.

**\$16<sup>95</sup>** NET  
LESS TUBES

## EL REY—The King

**6 Tube  
SUPER  
\$16<sup>95</sup>**  
NET  
LESS TUBES

**4 Tube  
T. R. F.  
\$6<sup>95</sup>**  
NET  
LESS TUBES

**10 Tubes (in 2 Midget Radios) for \$23.90**

|       |                        |   |   |   |   |   |               |
|-------|------------------------|---|---|---|---|---|---------------|
| Viz.: | — 4 Tube Cub, \$6.95   | . | . | . | . | . | \$ 6.95       |
|       | 6 Tube Superheterodyne | . | . | . | . | . | \$16.95       |
|       |                        |   |   |   |   |   | <hr/> \$23.90 |

**5 Tube El Rey Auto Set, \$19.95 (Less Batteries)**

Shipped C. O. D. only, and as shown, two sets for \$23.90, less tubes.  
Guaranteed from factory for ninety days.

### EL REY MANUFACTURING COMPANY

8406 SO. BROADWAY

Phone PLeasant 9750

LOS ANGELES, CALIF., U. S. A.



# "Introducing - - - a REAL Service Man"



Dealers' Net Price  
f.o.b. Greenwood, Miss.

**\$147.50**

IS that what your instruments—and the results—say the very first time you call at a home? Do they quickly and positively spot the heart of the disorder? Or do they slow you up, force you to fumble, fuss and flounder around, finally requiring a shop trip, or worse still, cause "come-back" complaints? Simplify your service—guarantee its sure skill, labor-saving and money-making—with the instrument that has remade radio service history—

## SUPREME DIAGNOMETER AAA 1

**5** ultra modern testing instruments in 1 for the price of **1**

SUPER DIAGNOMETER, plus SHIELDED OSCILLATOR, plus ADVANCED TUBE TESTER, plus OHM-MEGOHMMETER, plus CAPACITOR TESTER - - - 5 essential instruments in one at the price of one.

### Ask Your Jobber for Demonstration

All good Jobbers can demonstrate the unmatched service-ability of SUPREME TESTING INSTRUMENTS. If yours can't, send coupon below for complete information on AAA 1, Model 70, and the other 3 of radio's "Big 5" in service equipment, namely:

### SUPREME SET ANALYZER MODEL 90

The famous one meter set tester that offers some of the unequalled features of the AAA 1 Diagnostics . . . and all of its own famous 1932 superiorities.

Dealers' Net Price  
F.O.B. Greenwood, Miss. **\$78.50**

### SUPREME OSCILLATOR MODEL 60

HANDY OSCILLATOR -- SUPREME VALUE

Dealers' Net Price  
F.O.B. Greenwood, Miss. **\$30.00** Portable type **\$3.00** extra

### SUPREME TUBE CHECKER MODEL 40

COUNTER TUBE CHECKER - - - "SUPREME BY COMPARISON"

Dealers' Net Price  
F.O.B. Greenwood, Miss. **\$30.00** Portable type **\$3.00** extra

# SUPREME

*Testing Instruments*

"SUPREME BY COMPARISON"

*Distributors in all Principal Cities*

Foreign Division, 130 West 42nd St., New York City  
Cable Address: LOPREH, New York

### SUPREME OSCILLATOR MODEL 70



A thoroughly shielded, completely attenuated Oscillator . . . output meter . . . high resistance ohmmeter.

Dealer's Net Price f.o.b. Greenwood, Miss., less tubes and batteries . . . **\$49.75**  
SUPREME OUTPUT OHMMETER **\$30.00**  
Handsome Carrying Case for both and Accessories . . . **\$5.00**

SUPREME INSTRUMENTS CORPORATION  
433 Supreme Bldg., Greenwood, Miss.

Please send me full particulars on  Supreme Diagnostics AAA1  
 Supreme Set Analyzer Model 90  
 Supreme Oscillator Model 70  
 Supreme Oscillator Model 60  
 Supreme Tube Checker Model 40

Name \_\_\_\_\_  
Address \_\_\_\_\_  
City \_\_\_\_\_ State \_\_\_\_\_  
Jobber's Name \_\_\_\_\_  
City \_\_\_\_\_ State \_\_\_\_\_

Tell them you saw it in RADIO



# A 20 Watt D.C. Power-Amplifier for **\$ 65<sup>00</sup>**

List with  
Cunningham  
Tubes

## Power Amplification Now Available for Automobile Public Address Systems of a New Principle in Design—Giving Enormous Undistorted Output

**Power**—tremendous audio power has ever been an expensive item. A good amplifier, giving 9.3 watts may cost from \$35 to \$75 to manufacture, and utilizes a power input of at least 100 watts. One of the best amplifiers on the existing market uses 150 watts input at 110 volts 60 cycles for 9.3 watts output at 280 watts for 18.6 watts output. This is 2.8 amperes at 110 volts. If a 100 per cent efficient converter to convert a 6 volt automobile storage battery to a supply sufficient for the latter amplifier could be built, the ampere drain would be 46.6 amperes. Most converters are about 60 per cent efficient and when using such a converter, a drain of 77 amperes would be thrown on the battery. What is the solution? A gasoline driven generator which costs upwards of \$100 solves the problem. This would make a complete portable installation which would list for \$350, complete with tubes and power supply.

Such an outfit would weigh about 250 pounds and would require special arrangements to be made in order to use it in an automobile. It could not be readily transported from one car to another and would be an expensive item when tube replacements were required.

Let us look at the advantages of a new type of amplifier. It weighs about 12 pounds, takes 2.9 amperes from a 6 volt storage battery, obtains sufficient plate supply from 6 heavy duty B batteries to operate for 6 months under normal usage. The filament may be supplied from any 6 volt source capable of furnishing 2.9 amperes. May be operated from A.C. line with an inexpensive rectifier and filter system. Such an amplifier lists for \$65.00 and gives an output of 18 watts with 270 volts of plate supply and 20 watts with 300 volts. The total list for the tubes in the old type of amplifier is \$48 while the new type amplifier is completely equipped with tubes for less than \$13. If one desires to use B batteries, less than \$14 will buy a complete set.

The difference between the amplifiers generally offered to the public and the new Victory is the way the output tubes are operated. Ordinarily one is accustomed to biasing the tubes in an amplifier in such a manner that the operating point falls in the center of the straight portion of the plate current.—C bias curve. In the new amplifier the linear portion of the curve is extended to meet the zero line of the plate current and thus values of C bias is applied to the output tubes. Special input and output transformers are required to meet the peculiar conditions existing in a circuit operated under these conditions. Also, considerable power must be furnished the output tubes in order to maintain the peaks of the A. C. wave, when the grids of the output tubes are driven positive. In order to preserve proper characteristics and eliminate distortion the correct value of resistor must be inserted in the grid circuit.

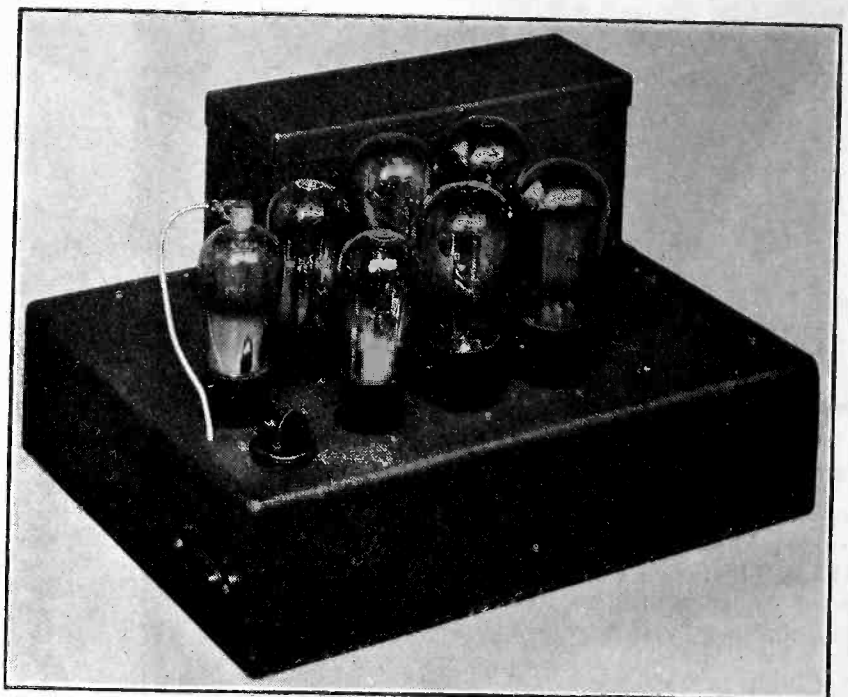

The amplifier is very small being but 9 1/4" wide, 7" high and 12" long. The input is 100,000 ohms and the output furnished to meet requirements, but is standardized at 8 ohms.

The frequency characteristics are excellent being within 4 D. B. between 60 and 8,000 cycles and 10 D. B. between 40 and 10,000 cycles. Input required is less than .2 volts for maximum output. Gain is 100 D. B.

Will operate from pickup, microphone or radio. The amplifier is excellent for public address work, in churches, schools, theatres and portable installations.

Will handle twenty speakers at satisfactory room volume.

This new principle will find uses in thousands of places where the old amplifier systems are not applicable and will undersell the old system three to one for a given power output.

*Wire for a Sample Today*

Manufactured by VICTORY AMPLIFIERS

A Subsidiary of

**VICTORY SPEAKERS, Inc.**  
7131 East Fourteenth Street  
OAKLAND, CALIFORNIA

*A Pioneer in the Manufacture of  
Quality Electro-Dynamic Speakers*

# The NEWEST Addition to the Wright-DeCoster Speaker Family..

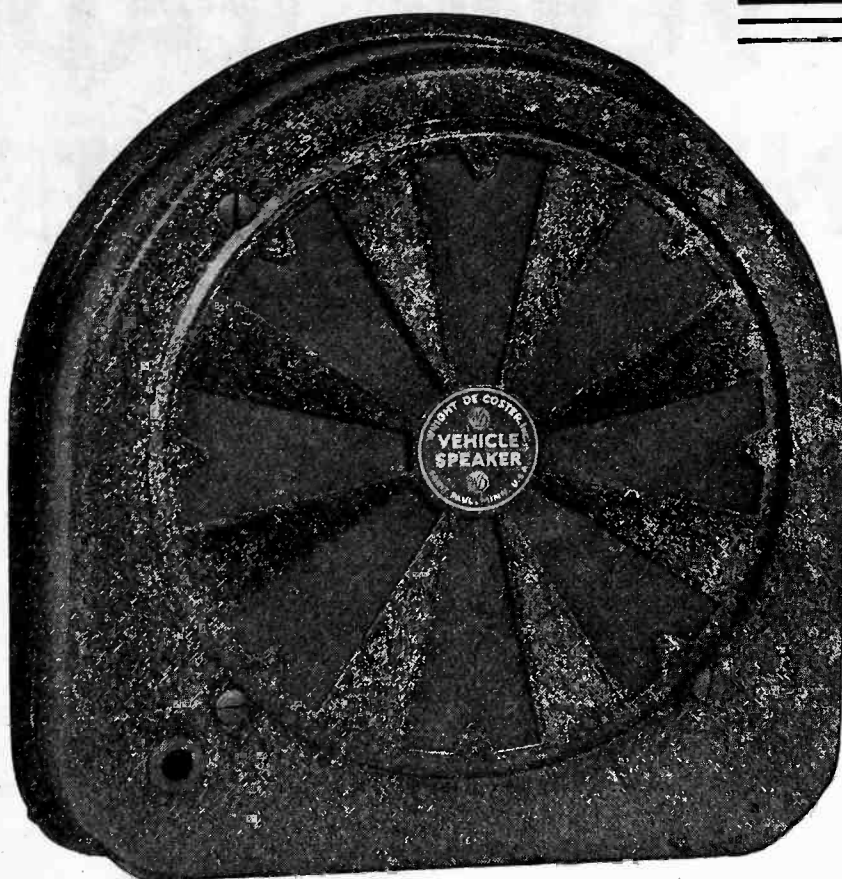

INFANT VEHICLE CABINET

## The Wright-DeCoster Vehicle Speaker

If you are critical of the reproduction of your auto radio... if you would like to get the same true, clear, rich tone quality that you get from a Wright-DeCoster Speaker in the home... then install the new Wright-DeCoster Vehicle Speaker.

Manufactured with the same high grade material and workmanship as our larger speakers. The Wright-DeCoster Infant Reproducer, installed in the Vehicle Cabinet, will not only give you beautiful reproduction on voice and music, but will also stand up for years under the abuse any receiver must expect to get in a car installation.

Easily installed in any type of car as you will see by the illustrations above. The design is modern and attractive; the black crinkly baked finish is not only good-looking, but serviceable, being difficult to scratch or mar.

Why not be sure your customer will be a booster for you by installing a speaker that will make him proud of his automobile radio?

Dimensions of cabinet,  $9\frac{1}{2}$  inches high,  $9\frac{3}{4}$  inches wide, 5 inches deep. Weight boxed for shipment 10 pounds.

Price, Vehicle Reproducer complete in cabinet - \$11.50  
 Infant Vehicle chassis only - - - - - 9.00

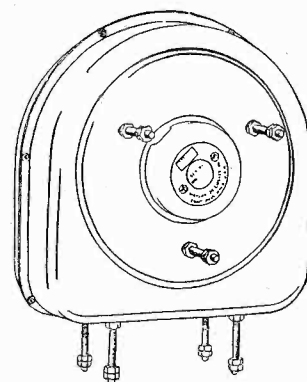

View showing how the Vehicle cabinet can be fastened either on the back or on the bottom.

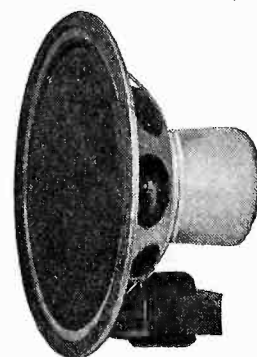

Infant Vehicle Chassis



The Speaker of the Year

**Wright-DeCoster, Inc.**

MAIN OFFICE AND FACTORIES

2217 University Ave. Saint Paul, Minn.

Export Department:

The M. SIMON & SON CO., 25 Warren St., New York

Cable Address: "Simonrice"

Tell them you saw it in RADIO

---

---

# IF YOUR RADIO BUSINESS ISN'T WHAT IT SHOULD BE!

1931 has been Silver-Marshall's best year, because . . .

Silver-Marshall Superheterodynes are sold **DIRECT** to DEALERS.

The jobber's profit is used in more profit for the dealers and lower list prices.

Silver-Marshall has a **COMPLETE LINE**. Full-size superheterodyne consoles to sell from \$49.95 to \$139.50.

In addition to 6, 8, 9, 10 and 12-tube supers, Silver-Marshall dealers have an 11-tube short-and-long wave super.

Silver-Marshall has a unique \$10.00 plan to cover trade-ins, time payments, etc. They do not come out of the dealer's pocket.

A half-million dollars has been spent in the last six months to advertise S-M receivers.

Silver-Marshall dealers have exclusive territory.

Those are **SOME** of the reasons. We will be glad to tell you the rest of them.

SILVER-  
MARSHALL Inc.  
6415 W. 65th St.  
Chicago, U. S. A.  
Please send me all  
details.

Name .....

Address .....

# SILVER-

Home Office: 6415 West 65th Street, Chicago





Model C-24. 12 tubes . . . superheterodyne . . . 3-unit construction . . . twin pentodes . . . double tone control . . . built-in tone chamber . . . meter tuning . . . automatic volume control . . . built-in aerial . . . 45-inch door console. A finer receiver is not possible. Complete with Eveready Raytheons . . . \$139.50 list.

**MARSHALL** Inc.

S-M Sales Co.: 224 East 16th Street, Los Angeles

Tell them you saw it in RADIO



# Meets the Needs of the Day

## The WILLARD

**\$798**  
 LESS TUBES  
 . . . . .  
 Dealer's Price.  
 Cash with Or-  
 der. F. O. B.  
 Los Angeles.



**\$798**  
 LESS TUBES  
 . . . . .  
 Dealer's Price.  
 Cash with Or-  
 der. F. O. B.  
 Los Angeles.

WEIGHT PACKED—12½ LBS.

HEIGHT — 11½ INCHES  
 WIDTH — 9¼ INCHES  
 DEPTH — 6¼ INCHES

SPECIFICATIONS:—Walnut veneer cabinet with high gloss finish; simplified dial with kilocycle markings; two screen grids, one pentode and a 280 tube; full dynamic speaker; cadmium plated chassis base; our own make speaker plug.

## THE WILLARD

THIS 4-TUBE TRF SET MEETS THE NEEDS OF THE DAY, AND THE WILLARD LINE WILL KEEP ABREAST OF THE EVER CHANGING TIMES. THE PUBLIC BUYS THIS TYPE OF MERCHANDISE. THE WISE DEALER WILL USE THIS MIDGET LINE AS A LEADER TO PULL CUSTOMERS INTO THE STORE AND SELL THEM HIGHER PRICED MERCHANDISE. THE WILLARD LINE SET IS 100% FULLY STANDARDIZED AND ONLY NATIONALLY KNOWN PARTS ARE USED. WE HONESTLY BELIEVE THAT NO FINER SET CAN BE PRODUCED IN ITS PRICE CLASS. STOCK UP ON WILLARDS, AND RIDE THROUGH THE SUMMER SEASON WITH RAPID TURN-OVERS AND A FAIR PROFIT.

**WILLARD RADIO CORPORATION, LTD.**  
 5137 AVALON BOULEVARD  
 LOS ANGELES, CALIF.



# Radiotorial Comment

---

By The Editor

## Underwriters Taboo Cheap Midgets -- Inspection Fee of \$200.00 Demanded

**T**HE ultra-cheap midget radio set enjoyed a short life and is now likely to drop out of public hearing. It has lost vogue, not because of its low price, but because of its incendiary propensities. The National Board of Fire Underwriters has instituted an energetic campaign to have all cities pass ordinances which make it a criminal offense to sell a radio set which has not been approved by the Underwriter's Laboratories. No ultra-cheap midget set has been or is likely to be approved.

Such an ordinance was scheduled to become effective in San Francisco, for instance, on March 1, but due to a protest from the radio dealers was delayed in execution until March 21. This gave the dealers a little time in which to clear their shelves of a part of this liability. A similar taboo has been put on all other sorts of unapproved electrical devices, like irons and heaters. The penalty for infraction of the law is a \$300 fine and 30 days in jail. Spotters are on the job. Similar ordinances have been or are about to be passed in other cities.

As the Underwriters are not so much concerned with the unused equipment on the dealers' shelves as with what is creating a fire hazard in the home, they have given little or no warning to dealers. The faint rumors that such summary action might be taken were not generally believed and many dealers are now caught with large stocks of unsalable merchandise.

Those who heeded the rumors and cleared their shelves are fortunate. The others are not; their loss may be heavy. Fifty years or more ago Herbert Spencer wrote: "Though the distorted or magnified image transmitted to us through the refracting medium of

rumor may be utterly unlike the reality, yet in the absence of the reality there would have been no distorted or magnified image." (Here is food for thought as regards the imminence of television.) Every radio man should have known of the long-standing Underwriter requirements as regards sets and should have realized that enforcement was only a matter of time. While we commiserate with the innocent dealer, we cannot question the justice of the requirements for safety against fire.

These requirements are that every radio set be equipped with a durable steel pan around the bottom of the chassis so as to act as a shield and prevent the woodwork from igniting in case of an electrical short; the power supply must be through heavy rubber-covered wire in the set and through heavy connecting cord to the supply socket; the set must be properly fused. This sort of an installation costs money. Furthermore a check for fifty dollars must accompany the manufacturer's sample which is submitted for Laboratory approval and an additional one hundred and fifty dollars must be paid if the set is approved and is to bear the label. The small manufacturer of the ultra-cheap midget cannot afford this expense. His product is consequently unsalable.

As the insurance companies are also notifying policy-holders that insurance will not be paid in case of a fire originating from a radio set which does not comply with the safety requirements, quite a brisk business is developing from the sale of approved sets to replace unapproved sets and from the revamping of sets so as to comply with the requirements. "'Tis an ill wind that blows no man good." And for the added protection against fire the public must pay more for its radio sets.



# NEWS OF THE MONTH

HOME MOVIE-TALKIE fans will be interested to learn that a film library is a recent innovation by The Sparks-Withington Company in connection with the sale of their home-talkie instrument, the Visionola. This library provides for the rental of movie reels and synchronized recordings of talking and sound effects at a very nominal rate. Sparton distributors and dealers report that the plan is proving extremely helpful in opening up new fields of distribution for this product.

Commenting upon the plan, V. A. Searles, advertising manager of The Sparks-Withington Company said, "We early recognized that one of the most serious obstacles to Visionola sales was the difficulty experienced by the average purchaser in obtaining suitable films and records for use in his instrument. The idea of a Sparton film library, by means of which films and records are made available to Visionola owners conveniently and at low cost, is proving highly beneficial to our dealers by enabling them to eliminate the principal point of sales resistance.

"When the customer purchases a Visionola he receives from the dealer a coupon book entitling him to three films and records each week for the first sixteen weeks of ownership. When the dealer delivers the Visionola, he leaves the first week's allotment of films and records with the customer, and tears the first coupon from the book. At the end of the week the customer is expected to return the borrowed equipment to the dealer. If the dealer has several Visionola owners in his territory, he keeps these films and records in circulation by exchanging them among the various owners. Otherwise he turns them back to his distributor. Visionola owners who have exhausted their coupon book are entitled to rent additional films and records from their Sparton dealer at the very low rental of 50 cents per night."

## Sell Foreign Language Records

VICTOR'S foreign language records are showing a remarkable disposition not only to maintain last year's volume of sales but, in some instances, such as in the Polish record field, are registering substantial gains, according to C. Lloyd Egner, manager of the record and recording division of the RCA Victor Company.

The influx of German, Italian and other foreign language talkies is credited with a large part of the renewed interest in foreign language records. These motion pictures have built up a loyal following of theatregoers who welcome the entertainment in their native or hereditary language. Since music plays an important part in the plot development of most of these motion pictures, the sale of theme song records is a natural outgrowth.

In many instances, foreign motion picture agencies are co-operating with Victor's foreign record department, in Camden, to the extent of furnishing a list of the exhibitors scheduled to show their picture output. Victor is then enabled to pass this valuable information on to its dealers in the various territories for an effective lobby tie-in with the local theatres. Too much cannot be said for the splendid work which these motion pictures are doing in winning the foreign language speaking classes over to records.

A substantial increase in the sale of Victor Polish records has been reported in many territories. Reports from the Victor foreign record representative in the Middle West, indicate that foreign record sales in that terri-

tory have been on a steady upgrade since the middle of December.

Mr. Egner attributed much of the increased foreign record business to Camden's policy of keeping a sharp lookout for current preferences in each language group and bringing out the records for which there is a definite demand. Numerous sample records from RCA Victor's many foreign subsidiary and associated companies all over the world arrive in Camden daily. These are carefully studied for their possibilities here. In this way, buyers of foreign records are assured the cream of the European and South American recording output.

## Special Radio Tax Appears Defeated

THE LATEST advices from Washington indicate success in opposition of the radio industry, marshalled by the RMA, against the treasury proposal for a special five per cent tax on radio, phonographs and accessories. In accordance with the alternative suggestion of the RMA, in lieu of the special, discriminatory tax against radio and automobiles, which would place a "luxury" stigma on radio, it now appears possible that a much smaller and general sales tax on manufactures will be adopted, at least by the House of Representatives. A general sales tax of two per cent is favored by the Democratic leadership of the House instead of the special "selective" and discriminatory tax on a few industries like radio.

In opposing the proposed five per cent special tax on radio, the RMA through its Washington legislative counsel, Frank D. Scott, and its witnesses expressed preference for a small and general sales tax. The plea of discrimination seems to have appealed to the Democratic leaders, according to statements by Representative Rainey of Illinois, Democratic floor leader, and others.

## Data Being Secured for School Handbook

MANY RMA members are supplying data and suggestions for incorporation in the booklet under preparation by the RMA in co-operation with the United States Office of Education, Department of the In-

terior, to promote equipment of schools with radio and sound apparatus. A. C. Kleckner of Racine, Wisconsin, Chairman of the RMA special committee in charge of the school handbook, is summarizing the data from manufacturers, while Orrin E. Dunlap, Jr., Radio Editor of the New York Times, is preparing other editorial features for the booklet. The RMA Board of Directors has approved the project which is in immediate charge of Dr. C. M. Koon, Chief of radio activities of the U. S. office of education.

## The Trade Has Endorsed the New Sparton Manual

"DON'T believe in sales manuals." How frequently this remark is heard—and indeed the experience of many radio salesmen more than justifies it. The representative of a Sparton distributor, however, has an answer to this objection that can hardly fail to win the sympathetic attention of anyone engaged in radio retailing today. He says, "Neither do I believe in sales manuals, if you are talking about the usual kind that just gives you a lot of stereotyped stuff about the manufacturer's product. But Sparton offers you a sales manual that really is different—as you can see in a moment by merely glancing through this copy." And then he shows the dealer or salesman a copy of the handbook that is one of the component parts of the new Sparton Radio Sales Plan.

This recently announced plan has just one purpose, according to Captain William Sparks, president of the Sparks-Withington Company—to help Sparton dealers make their business more profitable. The salesmen of Sparton distributors are now in the field presenting the plan to their dealers, and reports already on hand at the factory indicate that it is being enthusiastically received.

"Months of work and thousands of dollars have been invested in this project—the preparation of a complete, practical sales-building program for our dealers," said Captain Sparks. "The plan includes four distinct elements. First, it offers sales training for the dealer and his employees. I believe that the Sparton Manual of Radio Salesmanship is the most



The FADA factory is running full blast turning out the new "ROUND THE WORLD" All-Wave Receivers for which jobbers report a very healthy sale.



clear, concise, interesting and workable compilation of its kind ever made available to the men on the retail firing line.

"Secondly, the plan provides the sales equipment necessary to apply the ideas that the manual explains. The Sales Portfolio, for example, is a selling tool that dealers and their employees are finding equally helpful in the store and in the prospect's home. The third element of the plan involves fundamental training in sales management. The handbook 'Sales Managing the Retail Store,' if conscientiously studied and applied, will make any dealer or store manager more successful in retail radio merchandising. The fourth element of the Sparton Sales Plan has to do with its practical application in the dealer's store. It embodies well organized and thoroughly tested methods for drilling the sales personnel in the technique of the plan, enabling the dealer to make sure, too, that his men are actually applying what they have learned.

"We feel that this plan meets the conditions of the hour in radio retailing. Unquestionably the year 1932 puts a high premium on good management and intelligent, intensive selling. And it is our conviction that dealers and salesmen who use the Sparton Plan will surely benefit in terms of increased profits and increased commissions."

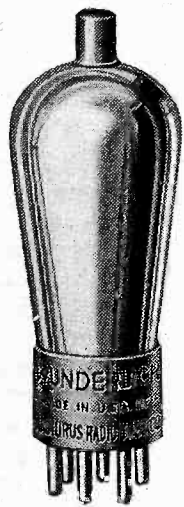

### Innovation in Detector Tubes Announced

**R**ADIO ENGINEERS who have had an opportunity to experiment with the Wunderlich Tube acclaim it as the first innovation in detection since the advent of the a.c. radio set. The tube is specifically designed to overcome the weaknesses apparent in tubes that have been used as detectors, though developed for other purposes.

The Wunderlich Tube, with one "auto-balanced" set of elements, gives full-wave grid detection with a minimization of overloading, full automatic volume control, and a stage of audio-frequency amplification without adding to the cost of the radio receiver, nor requiring major mechanical changes. Thus it provides an essential and efficient self-governor or floating-control of tone and quality. All signals, weak or strong, are detected and maintained with equal fidelity under the most favorable operating conditions. Tone is not sacrificed with volume, nor mellowness lost through suppression.

It is claimed that the Wunderlich Tube has four times the detector power

output of the triode. Because of its three-fold function, this new tube improves tone quality, provides automatic volume control which minimizes fading and practically eliminates detector distortion thereby preventing blasting and choking due to detector overload.

Reports from the field indicate that several of the large set manufacturers are incorporating the Wunderlich Tube and system in their 1932 receivers, in line with the tendency to banish overloading and include automatic volume control in new sets. The versatile Wunderlich Tube accomplishes this, and in tests it was proved that the superior performance of a 7-tube set employing the Wunderlich Tube could not be duplicated even in sets using many more tubes.

The Wunderlich Tube is described as the modern "auto-balanced" detector employing a construction developed by the Arcturus Radio Tube Company, known as the Unitary Structure Principle. This rugged construction locks all of the elements within the tube at the top and bottom so that proper inter-relation of the elements is constantly maintained through inter-dependence.

Mr. Wunderlich, the inventor of this tube, announces that arrangements have been completed with the Arcturus Company for the manufacture and production of this new tube which will be built in blue glass and have a red base to distinguish it from present day types.

### Mallory-Elkon Announces New Auto "B" Eliminator

P. R. Mallory & Co., Inc., Indianapolis, are in the field with a "B" Battery Eliminator for automobile radio.

This new unit is energized by the 6-volt "A" battery in the car which is constantly supplied with energy by the automobile generator. It ingeniously boosts

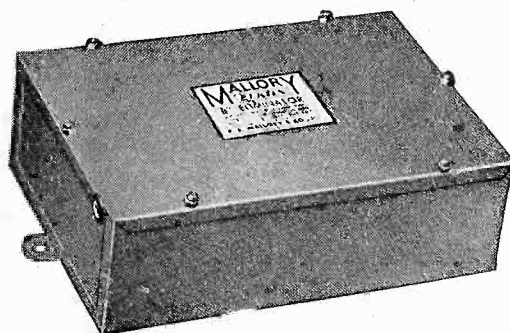

the 6 volts in the "A" battery up to 180 volts or the equivalent of four 45-volt "B" batteries.

The Mallory-Elkon "B" Eliminator is approved for all popular brands of automobile radio sets. It is compact (size 10"x7"x3 1/4") and is easily installed in any one of many places in the car.

Although the first shipments have just gone out to the trade this new "B" Eliminator is a tried and proven product. During the last two years on the company's own test cars, these units have given perfect reception in 10,000-mile

test runs. The company's own experience plus that of the police departments of several leading cities, where the units have for months been delivering unvarying power 24 hours a day, makes it possible to back the Mallory-Elkon "B" Eliminator with the standard R. M. A. guarantee.

The list price of this new unit is \$24.50 complete with nothing else to buy. The installation instructions in full detail are packed with each unit.

### P. S. Ellison Appointed Advertising Manager for Sylvania

**T**HE SYLVANIA DIVISION of Hygrade Sylvania Corporation, manufacturers of Sylvania Radio Tubes, announces the appointment of Paul S. Ellison as advertising manager.

Mr. Ellison, who recently resigned as general advertising manager of the Brunswick Radio Corporation, is one of



MR. PAUL S. ELLISON

the most widely and favorably known advertising executives in the industry. His connection with the Brunswick organization extended over a period of four years, as he joined the Brunswick Balke Colender Company in 1926 as general advertising manager.

Drawing on this vast fund of radio experience Mr. Ellison will be of invaluable assistance to Sylvania Jobbers and Dealers.

Previous to his Brunswick connection Mr. Ellison was a member of the advertising staff of the Vacuum Oil Company, joining that organization after a period of newspaper and publicity work.

In 1930 Mr. Ellison was appointed chairman of the first Advertising Committee of the R. M. A., continuing in that capacity until his recent resignation. He has also been prominent in the work of the Association of National Advertisers, having been a member of both the newspaper and the radio committees.

Tell them you saw it in RADIO





NO DEPRESSION HERE

*The new 3-story plant of the Universal Microphone Co. of Inglewood, California*

## Universal Microphone Company Moves To New, Larger Plant

INCREASING sales and an enlarged line of products have necessitated the removal of the plant and offices of the Universal Microphone Company, Ltd., from 1163 Hyde Park Boulevard, Inglewood, California, to their new three-story building at 424 Warren Lane, Inglewood, California.

The Universal Microphone Company was established five years ago by Jim Fouch, its president and general manager. During this time a complete line of microphones and microphone accessories were developed and are now being used and sold in every part of the civilized world.

"It has been evident for some time," said Mr. Fouch, "that our old quarters would soon be inadequate for our steadily growing volume of production. The new plant, with its 10,800 square feet of floor area, gives us approximately four times the space of the old plant. A further very decided advantage is the fact that our new plant is designed to meet the special exacting needs of microphone manufacture.

"As shown in the accompanying illustration, each of the three floors are provided with ample window area, insuring the light needed for precise manufacturing conditions and the constant ventilation and even temperature necessary in assembling our products. Acids are stored and electroplating is done in another building because of the need for preventing the presence of such gasses in the presence of microphones and microphone parts.

"The three floors provide ideal manufacturing and storage space, enabling us

to offer the trade microphones that are the best that modern manufacturing methods can produce. There are ample, completely equipped laboratories for testing the products before they leave the plant. Experiment rooms have been provided for the development of new products and for perfecting improvements in design and refinements of manufacture."

"In addition a complete duplicate of a broadcast station or record recording studio has been installed. Here microphones are tested out under conditions exactly simulating conditions of actual use."

### Two New Auto Radios by Consolidated

Two new model All-Electric Motor Car Radios have just been announced by the Consolidated Radio Mfg. Co., 1455 Venice Blvd., Los Angeles.

This reliable manufacturing company has held an enviable position for the past five years in the building of A. C. long and short wave sets.

They are featuring simplified installation, making it possible for any dealer to install his own sales. They have adopted the nationally accepted Aut-O-Bee eliminator as an integral part of the set.

Frigidaire has reduced its prices. The lowest-priced model now lists for \$130.00.

### Radio Retailing Estimates 1931 Radio Set Sales

In January "RADIO" was reproduced the Columbia Broadcasting Company's chart showing statistics relating to the

## Service Men Offer Valuable Suggestions for Resistor Replacement Practice

Prize of \$100.00 awarded for essay here reproduced.

IT HAS remained for an enterprising radio service man to solve the resistor replacement problem in everyday radio servicing. Louis Berkowitz, engaged in radio sales and service under the name of Louis Berkowitz Radio Company, in Dorchester, Mass., won the I. R. C. Service Man's Contest by suggesting that the resistance manufacturer could be of more service to the radio service man by introducing a handy resistor kit.

"For a service man to stock one each of the standard sizes of resistors means a large investment, and as a consequence the service man relies upon the jobber to carry his stock for him," states Mr. Berkowitz in his prize-winning letter. "When a resistor is required, time is lost getting the resistor or a serious delay encountered obtaining the resistor by mail.

"A survey of the Resistor Replacement Guide shows that the five most commonly used resistors are 500, 800, 1,000, 2,000 and 10,000 ohms. In a pinch, a 2,000 and a 1,000 ohm resistor could be used in series to obtain 3,000 ohms, which is another very common size; 2,000 and 500 could be used to obtain 2,500, etc.

"Bring out a standard package of either ten or twenty resistors together with a convenient table of the various resistances which could be obtained from this package by series and parallel arrangement of any two resistors. The sizes of the resistors should be such that a service man having this package in stock could, with a small investment, service most sets without loss of time to himself or objectionable delay for the customer."

As a result of the foregoing comments, Mr. Berkowitz won the first prize of \$100 in the service man's contest of International Resistance Company. The second prize went to Raymond Brieger of New York, the third to G. A. Adams of Wethersfield, Conn.; the fourth to Cecil L. Stephens of Lafayette, Ind.; the fifth to Edwin Griesbach of Detroit, Mich., and the sixth to George A. Turner of Pueblo, Colo. Additional prizes were awarded to six other service men throughout the country.

Based on the suggestion of Mr. Berkowitz, the International Resistance Company's engineers have worked up a certified resistor kit containing 20 of the most popular resistor values together with simple data on how to obtain resistance values by series and parallel arrangements. The handy package with sliding cover being sealed at the factory, the service man is assured of positively new and tested units. With this kit it becomes possible to replace defective resistors in any radio set without loss of time and at a minimum cost consistent with lasting satisfaction.

number of radio sets in use. "RADIO RETAILING" informs us that they were responsible for the figures showing estimated set sales for the final quarter of 1932. Please add this notation to your chart.



# McMurdo Silver

## Says:—

- ... The radio business will show a general improvement between October and December.
- ... Prices should not be increased until the spring of 1933.
- ... Audio Amplification Qualities are being sacrificed.

## What's Going to Be Offered At the Trade Show —And Sold Thereafter

By McMURDO SILVER

President, Silver-Marshall, Inc.

AS WE GO into the annual Trade Show the good old bugaboo of last minute new tubes is with us as in the past, plus a few new designs, or more correctly, sales trends.

Briefly, in order of importance, there are: Combination short-wave and broadcast receivers, multiple speaker sets, new tubes and class B audio amplification.

The distance possibilities of short waves are appealing increasingly to the public, forced to economize by staying at home in the evening and playing with the radio instead of night-clubbing. Hence, more all-wave sets will be offered and sold this year. The only new development in such sets comes from Silver-Marshall in a one dial, accurately logged set—this last point being the most important sales feature of such sets, for it alone insures customer satisfaction.

Sets with two speakers will be more popular, since they can give a little better tone, and certainly give additional sales appeal and higher unit selling prices.

New tubes this year are mostly a joke, for they really serve only one purpose—getting the tube manufacturers out of the “red” caused by less-than-cost

selling prices of tubes. This is some help to the dealer in terms of new sales appeal and higher unit selling prices—which later may prove a boomerang until October or November.

Class B audio amplification is a distinct step backward, for it gives poorer tone quality and costs more to build even acceptably decently than triode or pentode audio systems. Its sole benefits are new sales appeal and price increase—which its poorer tone quality definitely offsets. It is distinctly “bad” in the phrase of the economists.

What about prices and market possibilities? Prices will sag up to the Trade Show and then will be forced up—at the cost of sales. This is because it is always darkest just before the dawn, and the dawn of sustained general business improvement looks to be between *October and December of this year*. Until then the public is going to pay less, rather than more, for radio sets. The time for an effort to increase unit sale prices is in the Spring of 1933—not at the Trade Show when the probable attempt at this will cost many sales which every dealer needs badly during 1932, not in 1933—if he is to eat until then.

## Dubilier Loses R. C. A. Suit

THE United States Circuit Court of Appeals of the Third Circuit handed down a decision in the case of Dubilier v. Radio Corporation of America, which related to patents on radio sets employing A. C. current. The patents were Lowell and Dunmore 1455141, which related to the use of hum reducing means in A. C. sets, and Dunmore 1635117, which related to the use of rectified A. C. current for procuring negative grid bias.

The Dubilier Company contended that all sets operating on A. C. current and not licensed under these patents were infringements. Suits have been pending for several years against the Radio Corporation of America, alleging infringement of these patents. All patent claims in suit were held invalid by the United States Circuit Court of Appeals, which ordered the suits dismissed, reversing the decision of the lower court.



# A Mighty Fine Volume of Constructive Information Is Found in This Letter From a Country Dealer

## "TOWN" MERCHANDISING? "TOWN" MERCHADISING?

By ROGER H. HERTEL  
Hertel's Radio Store  
Clay Center, Neb.

Editor, "RADIO"  
San Francisco, Calif.

Dear Sir:

There is nothing more disgusting to me than the contents of two or three supposedly good magazines on radio merchandising — I find every article published in each issue, from year to year, has sales suggestions and timely merchandising methods for the large metropolitan area and the small town dealer living in a rural community is entirely ignored.

Because I have been so thoroughly disgusted with all the radio trade magazines publishing nothing but city merchandising suggestions, it was decided "something ought to be done about this." This letter is being written with one idea in mind, an inducement for other small town dealers, successfully merchandising radios, to write their experiences of rural selling.

This letter comes from almost the exact center of the United States. The town is Clay Center, and the state is Nebraska. Clay Center is a town of 937 population, the county seat of Clay. The town depends upon the farm trade. When the farmer is prosperous every one is happy and money is plentiful. But let the farmer have a set-back in the way of a short crop. The grain he has raised drops to bottom prices. That's what small town

folks call "hard times." Everyone goes around with a long face and says: "I wish the weather would clear up and maybe business would pick up," or, "if wheat would just go a little higher the farmer might feel better and business will be better." Expressions like these are all that can be heard by the people in the streets of a small town out here in the midwest.

Well, things didn't look so good. During September, 1931, the writer made it a point to visit all the radio dealers in every town in the county. All seemed half-dead. They all said: "We are not looking for any radio business this fall and winter; we don't think we will sell many radios; the people just can't afford to buy them," or, "if times don't get better soon I don't believe we will handle radios." Again, "Service is a lot of bunk; why the people can't even afford to get their old radio repaired." And even more disgusting was this statement made by a large percentage of the dealers: "We are not stocking such and such a standard make of radio, the price is a little out of line for these times. Of course, we like the such and such a standard make and have had the agency 4 or 5 years but can't sell any this year. The only thing that has a chance to move is a radio with a PRICE PROPOSITION." (Oh watta pain to hear this line of bunk.) The local newspapers thought I was crazy when I asked about an advertising schedule. One newspaper man even tried to talk me out of it.

Before I left the newspaper office in each of the surrounding towns, I not only had an advertising schedule arranged but also a news story column in the form of "WHAT'S WRONG WITH YOUR RADIO?" In my own home-town paper I carried a radio service ad each week, as well as a big ad on that standard radio for which I have held the agency for six years.

I made it a point to let the home-town folks know that I was selling radios. Of course, all the people gossip in a small town every time you turn around. But advertise all you want to, and do all you want to; make yourself known as a radio dealer, even though you were raised in this very same small-town, rest assured there are a number of folks who "DIDN'T KNOW YOU SOLD RADIOS."

Before the month of September was over I noticed a big increase in set sales. It was not a big year but enough of a gain to merit the work involved. While there were many questions coming in because I was conducting my "WHAT'S WRONG WITH YOUR RADIO" in question and answer form column in all of the county newspapers, there was but little service work. I made a trip to the local newspaper office, handed them my recommendation as a service man in a news story relating my radio training and experience from the time I was 10 years old until the present. Say, did this idea work? Two hours after the paper was out I walked into the local

Here is an outspoken and frank statement from a HE-MAN in the farm belt. We present his letter "as-is" for the benefit of those who wonder what the country dealer is doing to help keep the sheriff away



# In His Own Words He Tells You How To Get Business When the Going Is Hard

+ + +

restaurant and received four service calls. That evening the phone was busy at my home. The next week many more rural service calls came in until I had enough service work scheduled to keep me active for a month. It was necessary to employ the aid of an assistant in order to keep up with my service work.

Radio set sales continued to gain as did my service calls, until I was selling radios so far from my home town that it took all day to drive there and install the radio and return home. Again service calls came in from all over the county. It was very common to drive to the neighboring town and service a radio in Mrs. so-and-so's home and find her neighbor visiting with her that afternoon. When the job was completed, the neighbor would say: "My, that radio certainly does work fine now. Did it only cost \$4.50? Wonder if you would look at my radio which has not been in operation since lightning struck last summer? or, "Say, my neighbor wants you to look at his aerial and Mr. so-and-so, up the street does not have a lightning arrester. I see by your **WHAT'S WRONG WITH YOUR RADIO** column that there should be a lightning arrester on every aerial. Better drop up and see him. Tell him I sent you up and what for."

The last of November was drawing near. I sent word to cancel my advertising in all of the local newspapers, excepting the home-town paper. In order to avoid the "I TOLD

YOU SO GOSSIP" I sent a note saying: "THIS AD HAS BEEN TEMPORARILY DISCONTINUED BECAUSE WE HAVE BEEN RECEIVING TOO MUCH SERVICE WORK AND CANNOT POSSIBLY CARE FOR IT ALL." Which was the honest truth.

Set sales were not so hot during November so I tried a new method. Every fellow I met I tried to interest in a radio PROGRAM. The conversation finally turned toward radios and I made it a point to give him all the new features over his old radio and made sure to bring out what a new radio would do and what his old radio would not do.

The results were simply astonishing. I would tell a home owner about the advantages of radio, how it benefits his family, and what wonderful programs there are on the air, and yet the cost of radio was but 6½ cents per hour. December really did see a big radio set sale, January, fooled me. I expected to sell a few radios, but the results of one week were more than I expected in six months. The fellows I had talked to constituted 80% of the sales and I had not expected to see them trade in their old radio for a new one until the fall of 1932. Imagine my surprise! Well, you never can tell what might be done until you try.

Now here is one. I have been able to sell more used electric radio sets than I can trade for. I have a waiting list of used radio customers. It was very surprising, but true, that I

should have no trouble in turning over all the used AC radios. The reason: I don't allow too much and don't expect to sell for much. I always expect to get a radio in trade. I sell it for the price of its traded-in price. If this cannot be done, *DON'T TRADE*. Why try to trade for a radio worth 5 dollars and allow 25 dollars? Then sell it for \$10 or \$15? There is nothing to it. Allow \$5 and sell it for this amount, plus reconditioning charge.

Of course, there are a lot of farmers who want radios and can't afford to get them. They will buy as soon as they can and, whatever you do, don't tell them when to buy. Just keep them interested! When they get ready to buy, they will look you up. If they want a radio and can find the money they will buy, and buy from the fellow who seems anxious to do business, not from the fellow who says times are hard and don't expect any business this year.

It is up to you as a radio dealer to create an interest in radio in your rural community. Do not tell a fellow how hard-hit you and he are. Change his frame of mind by showing him how much there is to live for through the ownership of a good make of radio.

**Don't try to get business where there is none. Search for the fellow who is going to buy and then sell him. There is some business left. Get the business the other dealers are turning away by their "Hard Time Stories."**

"RADIO" invites correspondence from more of its country-dealer-readers. Our subscription files are filled with orders from the little fellows. Come on, boys, send in your stuff. Let's start a monthly pow-wow page in "RADIO."



# Statement of the RADIO CORPORATION OF AMERICA

**T**HE following statement, which was issued by the Radio Corporation of America, is quoted in full below:

"We are informed that the Government has filed an amended and supplemental petition in its suit which has been pending for some time in Delaware against the Radio Corporation of America and others because of alleged restraints on competition in the radio industry.

"In its original petition the Government attacked the fundamental cross-licensing agreements by which the Radio Corporation of America obtained its rights to patents and to license other manufacturing companies to use these patents. It is the position of this Corporation that those agreements are legal, because without cross-licensing of patents none of the companies, including Radio Corporation of America, could lawfully have manufactured or sold efficient radio apparatus. Many patents were required to make radio devices and these patents were in scattered hands. The patent cross-licensing contracts made legally possible the manufacture of radio apparatus. They did not restrain trade—they created it. The contracts were filed with the Department of Justice when they were executed and they have been considered by succeeding Attorneys General. They were investigated for four years by the Federal Trade Commission and the complaint was dismissed.

"The Radio Corporation of America was organized in 1919 to develop the radio art and to create a new business. The rapid development of radio shows that this was accomplished. Not only a great radio manufacturing industry resulted but broadcasting and international radio communications as well. Through broadcasting over 50,000,000 radio listeners now receive programs free and through international communications the business community of America has direct international telegraph service with more than forty countries at rates which radio has substantially lowered.

"The attack of the Government came twelve years after the arrangements it attacks were made. It takes little, if any account of the difficulties surrounding the men who made these arrangements when they were made and the problems which confronted them and which then had to be solved. It would not have been so difficult to have modified the fundamental arrangements if the Government, when first apprised of them, had then stated its objections to them. A different situation obviously arises twelve years thereafter. It would be impossible without destroying investments made in good faith by more than 100,000 shareholders to undo that which has been done throughout twelve years of a rapidly changing art and industry.

"Despite all this, the position of the Radio Corporation of America, when this suit was filed, was that if doubt remained as to the legality of these contracts the officers of the Corporation above all others desired to know their true status and they were quite willing to have them submitted to the court to the end that they might be tested. The Corporation has made available to the Department of Justice all its data, records and correspondence and has freely permitted its files to be inspected by representatives of the Department.

"The present suit was instituted after the Department had won a decision in the lower court against certain gasoline companies which had executed so-called patent pooling agreements. After this decision was reversed in 1931 by the

## Herein the Corporation States It Is Doing Less Than 20% of the Receiving Set Business and Less Than 40% of the Tube Business

Supreme Court of the United States, active negotiations were had between representatives of the defendants and of the Department of Justice, looking toward a settlement of the radio litigation. In the course of these negotiations the representatives of the Department of Justice pointed out in detail features of the existing situation to which they took exception. While not agreeing with the Department as to the validity of its criticisms this Corporation expressed its desire to cooperate by altering insofar as was practicable, the arrangements which the Department criticised, irrespective of how such arrangements might eventually be regarded by the courts should the litigation be carried to final judgment.

"In carrying out this program the Radio Corporation is in course of withdrawing from participation in the General Motors Radio Corporation, has changed its contractual relations with the United Fruit Company, has amended certain of its international traffic agreements and it gave favorable consideration to the creation of an 'open patent pool' which was suggested by the Department. All this was done to the end that prolonged and expensive litigation might be avoided, that the cost of such litigation might be saved to the Corporation's shareholders and the Government, that the energies of the officers and experts of the companies concerned might be devoted to constructive work in the interest not only of these companies and their stockholders but as well in the interest of the radio industry as a whole, all in the hope that stable conditions might early be brought about in the radio industry, which has suffered as few industries have from present economic conditions.

"The amended and supplemental petition just filed by the Department makes issue of and seeks an injunction against some of the very arrangements altered to meet the Government's views. As to two of the corporations, parties defendant to the original complaint, the arrangements to which the Government made objections, are being changed to meet the Government's views. Also other features have been changed to meet the Department's views, but despite this they are still the subject of attack in the new petition which the Department has just filed.

"In view of all these circumstances we are unable to understand the action of the Department in persisting in doing unnecessary things and making unnecessary charges particularly in times of great business depression and even when there is and long has been great competition—more than adequate from every point of view—in the radio industry. The Department's demand for additional competition came when there were so many competitors in the field that over production and cut-throat competition threatened the entire industry. This is even more true today, when surveys show that there now exist in the country radio plants with a capacity of approximately 25,000,000 radio sets per year while the market is estimated at approximately 3,000,000 sets per year, when prices for merchandise are lowest in the history of the industry and when few, if any, companies engaged in the manufacture and sale of radio devices are able to earn a profit on their business.

"The Radio Corporation of America and its associated companies, defendants in this case, together are doing less than 20% of the total business in radio receiving sets and less than 40% of the total business in radio tubes. It could hardly be contended that a monopoly is thereby threatened or that trade is thereby restrained."



## Boost Your Sales!

**D**ON WALLACE is a factory representative. He knows the short wave business from A to Z. Dealers who are on the look-out for more business should study this article with care. When you sell a combination set SELL a modern short-wave antenna installation at the same time. Rig up a system of this kind for your store. Use it in making demonstrations. Then show the customer how you do it . . . and how he, too, can do it. The weakest link in the short-wave chain is the antenna. This article by Don Wallace will help increase your summer sales.

By Don C. Wallace

Winner Hoover Radio Cup

**T**HE SHORT waves are full of wonderful programs, entertainment, and new things in radio to listen to. If great care is not taken in the installation, you will be thoroughly disappointed in a great many ways. Sometimes you will be in one of those "lucky" locations, where the stations just naturally roll in; sometimes you will not. If a lucky location is being used, then this article will enable even more stations to be heard, if in an unlucky location (more often the case on short waves) then this will permit a great improvement, sufficient to really enjoy some of the foreign broadcasts.

Figure 1 shows one of the most effective wave reception antennas. The horizontal part, A1 plus A2, is stretched as high and long as is possible. Insulators (I) are shown on the ends and in the middle. The ends are fastened with rope, rather than with wire, as rope is a non conductor and will further isolate the antenna. A1 and A2 should each be of the same length, and the longer the length, the greater the pickup. A1 and A2 do not necessarily have to be end to end as shown in the diagram, although this plan is the best. If they are at right angles to each other, or any other angle, it will be perfectly all right. The main thing is that A1 be as far from A2 as is possible, and that both be the same length. Both should be as high as is pos-

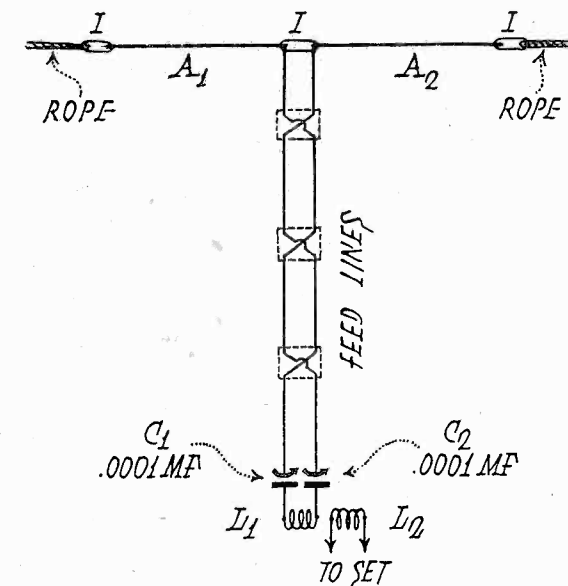

sible, rather than one over the other as in an antenna-counterpoise system sometimes described for noise reduction.

Those who live next door to a vacant lot, will have better results by stretching their antenna over this vacant lot. Those who can go across the street will be even better off, provided the street is free from electric and telephone wires. If either of these is not possible, cooperation with a neighbor can sometimes be secured for the benefit of both, each having a better antenna by swinging the antenna to each others property. The antenna should be as high as possible, and also as clear from all wires, houses, or metal construction as possible. If it is still impossible to secure a clear antenna, this type will still improve results over those received with an ordinary antenna in present use.

The types used by the writer in mak-

# Short-Long Wave Combination Sets Can Be Made to Perform 100% Better If You Follow the Advice of Don Wallace

● The Secret Lies In Antenna-Transposition

## Sell This Idea to Your All-Wave Customers

(Reprints for your Service Department supplied free of cost.)

ing comparisons included the following:

First, A1 and A2 were 33 feet long each, and 45 feet high, placed end to end in the diagram. This antenna went over the back yard (rather than over the house).

Second, the same antenna swung over the house, at a greater height. This had more noise in with the stations.

Third, the same antenna swung over the vacant lot, next door. This was better than either of the above, although it was not so high.

Fourth, the wires A1 and A2 were lengthened to 100 feet each, stretched over the vacant lot, and the results were surprising. Clear programs could be heard. These were totally messed in the noise when the first three antennas were used. The first three antennas were all better than a good antenna-ground arrangement. This fourth antenna, incidentally, required a pair of feed lines (to be described later) 140 feet long. With these long feed lines the antenna was really over the vacant lot, where the quietest pickup was secured.

The feed lines used with these antennas, are made with No. 14 copper enamel wire, stretched parallel with each other, and transposed every 15 inches. The transposition blocks were cut from clear bakelite, drilled with holes  $\frac{1}{8}$  inch in diameter, and saw slotted so the No 14 wire could be slipped into the slots easily. This type of transposition block crosses the wires on opposite sides of the clear polished bakelite block, making the leak-



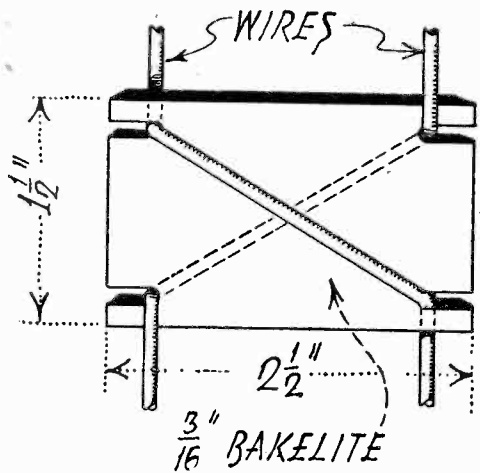

Fig. 2

age path very long. The holes are far apart. Figure 2 shows the construction as well as the method of transposition.

With transposed feed lines, no noise pickup exists in the lead-in itself; it simply carries the antenna pickup to the receiver

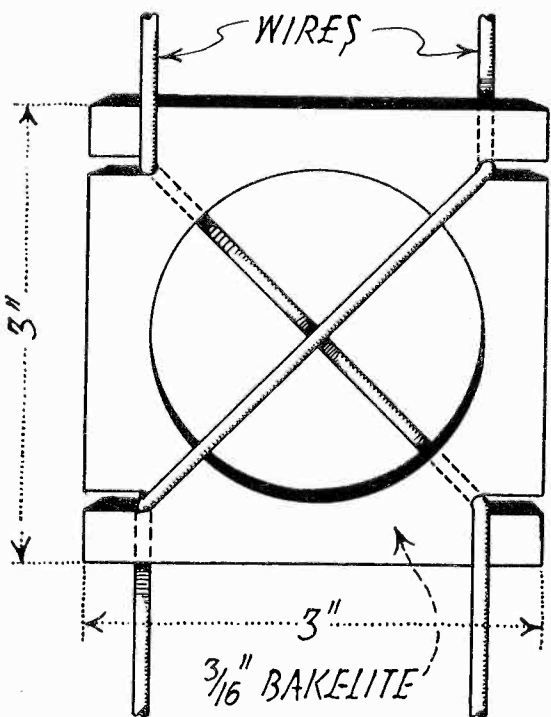

Fig. 2-A

Another well-used adaptation of Fig. 2

ceiver shown at L2. L1 is a coil with 12 or 15 turns of No. 22 DCC wire wound on a cardboard tube. The size should be about the same as the size of the plug-in coil on the short wave receiver or converter. The coil is placed on the end of the plug-in coil of the converter with the coupling so the noise to station ratio is satisfactory for reception.

The two variable condensers C1-C2 are midgets, coupled together and controlled from one knob. These permit the actual tuning for the feed lines on some stations, so that the response in the receiver is even greater.

The feeders should be spaced as far as logical from the house wall, or from wiring or metal construction. Here it is not nearly so important as it is in the case of the antenna, as the transposing of the feed lines is arranged so that any pickup in one wire is cancelled by the pickup in the other wire. The pickup from the wires is thus out of phase with itself, so

nothing comes down the feed lines, except that which is picked up by the antenna out in the clear.

Stucco walls, metal work, or wiring cause some absorption, and this is what we strive to avoid in keeping the feed lines at least two or three feet from surrounding objects. The lead-in may come in under or over the window. The best way is to come in right through the window. Window panes are cheap, com-

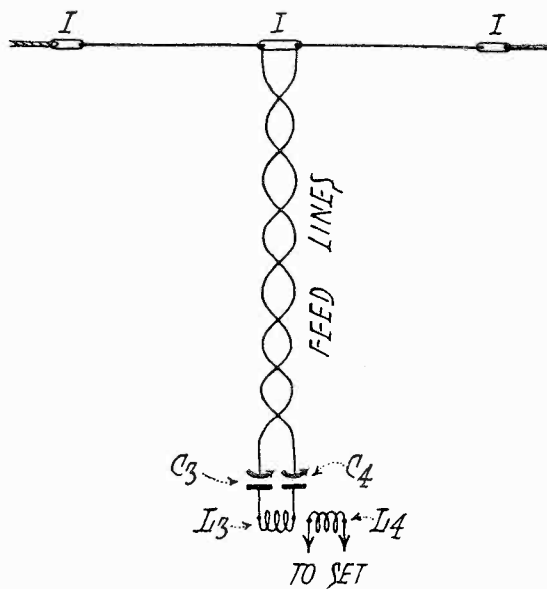

Fig. 3

pared to the cost of repairing walls. If there are small panes in the window a piece of plate glass may be secured from a window pane dealer in your city. He will be glad to drill it, with the necessary two holes, for a nominal charge.

No ground at all is used in this type of antenna. The ground has more noise in it than clear open antenna construction, and the design of this antenna is such as to do away with the ground and the added noise which this would cause in the receiver.

Figure 3 shows the same type of antenna, using twisted telephone wire for the feed line, instead of the carefully transposed feed line shown in Figure 1. The noise to signal ratio is about the same in this type of antenna, although the pickup is far less, not so many stations can be heard because of the absorption in the twisted pair. Lamp cord is even worse, because of the bundle of stranded wires in each cord. These have more capacity with each other than the twisted telephone pair. This antenna, however, is still superior to the usual antenna-ground combination and can be constructed quickly with but little cost. The connections, coils and arrangement shown correspond with that in Figure 1. The coils L2, L4 simply represent the plug-in coil on the receiver, or converter.

Sometimes the short wave receiver will have an antenna-ground coil of the same approximate dimensions as our suggested construction for L3. By making sure that this coil is not connected to other parts of the set, it may do very well for the coupling coil L3. It will not have vari-

able coupling, but the convenience may justify its use.

Figure 4 shows another arrangement, where the flat top of the antenna goes away from the feed lines. Feed line 1 does not connect to anything. Feed line 2 connects to the end of the antenna. The flat top portion A5 in this case represents the combined length of A1 and A2 together, and should be as high and as clear as possible. The feed lines are here shown as parallel wires, spaced 3 inches by wooden dowel sticks, soaked in paraffin to make them waterproof. The wires in this case are not transposed, but the simplicity of construction is convenient, and the noise pickup not much more than the twisted telephone pair. The signal pickup compares favorably with the feed line construction shown in Figure 1 and thus is quite useful for those who must make A5 short because of space limitations.

One question which may be brought up is this: "How long can A3-A4, or A1-A2, or A5 be made?" The answer:

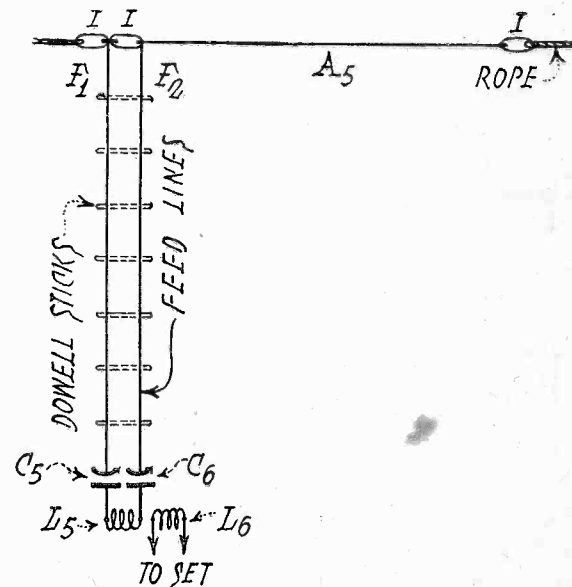

Fig. 4

"As long as your particular location will permit." One of the antennas here is 612 feet long connected with non-transposed feed lines as shown in Figure 4.

#### De Forest Purchases Jenkins Television Assets

AT A STOCKHOLDERS' meeting on March 11, the DeForest Radio Company was authorized to purchase the assets of the Jenkins Television Corporation. According to Leslie S. Gordon, president of both organizations, this move will affect marked savings in the operations under joint management, as well as facilitate the more rapid development and exploitation of the television art. The consolidation of interests completes the plans of the DeForest Company, begun with the acquiring of a controlling interest in the Jenkins Corporation through an exchange of stock, some two years ago.

# R. M. A. Trade Show Opens Next Month

## GO!

### "Business" Will Be Keynote of RMA Trade Show

**B**USINESS, without ballyhoo, again will be the keynote of the annual conclave of radio manufacturers, jobbers and dealers in Chicago next May for the Eighth Annual RMA Convention and Trade Show. The most business for dealers and jobbers as well as manufacturers with a minimum of time and expense is the basis of RMA plans made by its board of directors, show and convention committees. Scheduled earlier than usual, May 23-26, at the Stevens and Blackstone Hotels in Chicago, the great annual industry gathering has been shortened to four days. It is staged earlier to precede, with its display of new radio television and electrical products, the radio sales stimulation of the Republican and Democratic presidential nominating conventions which soon follow the trade show. For the first time it is expected that the political conventions will be televised as well as broadcast. Display of the progress of television also is a scheduled feature of the trade show, affording an opportunity to jobbers and dealers to view the latest television as well as radio and electrical products of RMA manufacturers. Admission to the trade show as usual, however, will be limited to the trade. The public will not be admitted.

The official convention and trade show hotels, the Stevens and Blackstone, already have received advance reservations. Regular hotel rates will be accorded convention and trade show visitors which numbered 22,000 last year. "Radio spe-

cial" trains on the New York Central and Pennsylvania railroads from New York already are being arranged and other special trains and cars are being planned from other parts of the country.

With "business" as the keynote of the annual radio gathering, there will be interesting meetings and discussions of important industry matters at several business sessions. Entertainment, however, will not be forgotten. Luncheons, dinners and other meetings for the trade are being arranged by manufacturers. Special trips for radio visitors to view the 1933 exposition buildings of the Chicago World's Fair and a radio golf tournament, followed by dancing and other

social dinners, are other entertainment features in preparation.

Virtually all prominent receiving set, tube, television, refrigerator and other electrical manufacturers of the RMA have reserved exhibit booths at the Stevens Hotel. A number have increased their space reservations over last year. Editors of the radio trade press will be invited to conduct the drawings for trade show space about March 15.

Invitations to the trade show will be sent to jobbers and dealers early in April, with credentials necessary for admission to the exhibit halls, the Stevens Ball Room as well as the Exhibition Hall and demonstration rooms in the Stevens, and also the Blackstone Hotel.



**The R. M. A. Show Committee**

Left to Right—Back Row: Chairman Leslie F. Muter, Messrs. Flanagan, Galvin, Beatty, Frankel and Simpson. Left to Right—Front Row: Messrs. Rauland, Geddes and Olson.



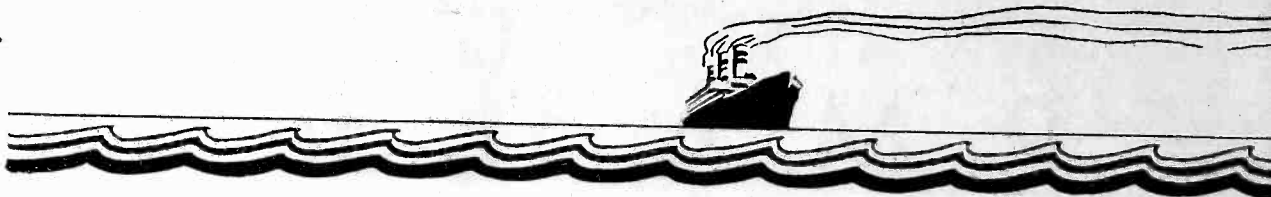

# There's something

## IT IS NOT A MIRAGE!

The farsighted man needs no telescope to see it. The foresighted man is getting ready for it now. It is television by means of the newly-perfected cathode ray receiver, producing brilliant black and white motion pictures by radio so that they can be seen in a lighted room on a screen a foot or more in width; pictures providing sufficient detail to satisfy the most critical lover of entertainment in the home. Here is something new and compellingly attractive for the radio man to sell or service.

**A**LTHOUGH the exact date of its announcement cannot yet be told, it will be soon, probably by fall. Then there will be a scramble to find out about it. But if you want, you can now at your leisure find out how and why it works. Whether you plan to sell or service it, the first essential is to know its underlying principles of operation. "Know your product."

**T**HIS necessary knowledge of cathode ray television receivers can be acquired by any man who already understands the simple principles of a radio receiver which is used to reproduce broadcast speech and music. And in acquiring knowledge of television, he gains a clearer conception of the underlying principles of radio.

**P**ERHAPS the easiest and quickest way for getting this knowledge is to study the clearly written text which is the basis of the lectures on television which are being given for the University of California Extension Division by Arthur H. Halloran. These lessons require no previous knowledge of mathematics. They have been prepared primarily for radio service men. They are concerned with the receiver rather than with the transmitter problems which require mathematical interpretation.

**T**HE lessons are ten in number, as listed on the facing page. One is mailed each week during a ten weeks' period. Each is accompanied by questions which emphasize the salient facts in the text. The student can mail his answers to these questions, if he desires, so that they can be corrected and graded, a certificate as to his passing being sent to him at the end of the course. The price for this service is one dollar per lesson.

**A**NY radio dealer, service man, jobber, or salesman can profit from the information in this course. By studying it slowly now, instead of hurriedly when television does "break," he can be ready for immediate, intelligent action. The first men to qualify should be the first to profit.

# on the radio horizon!

## Synopsis of the Course

**Lesson 1:** The Physical Problems of Television. The Optic Nerve. Peculiarity of the Eye. Disk Scanning. Cathode Ray Scanning. Amplification and Transmission.

**Lesson 2:** The Electron Theory of Matter. Nature of Substance. Liberation of Electrons. The Periodic Table. Periodic Classifications of the Elements. Thermionic Action. Photoelectric Action. Secondary Emission.

**Lesson 3:** Radiation. Conduction in Vacuum. Gaseous Conduction. Conduction in Solids. Electrostatic Effects. Electromagnetic Effects.

**Lesson 4:** Applied Electrical Theory. Electromagnetics. Capacitance. Electromagnetism. Inductance. Transformer Design.

**Lesson 5:** Physical Optics. Interference of Light. Law of Reflection. Dispersion of Light by Prism. Color Wavelengths. Diffraction. Refraction. Formation of Images. Mirrors and Lenses. Properties of Lenses. The Eye as an Optical Instrument.

**Lesson 6:** Photoelectric Cells and Neon Tubes. Photoconductive Effect. Photo-voltaic Effect.

**Lesson 7:** Mechanical Scanning. Light Sources and Modulators. The Kerr Cell. Scanning Methods. Disk Scanning. Baird, Jenkins, Sanabria, Gramophone Ltd., Ives and other Systems. Rotating Mirror Scanning. Vibrating Mirror Scanning. Nicholson System. Zworykin System.

**Lesson 8:** Synchronization of Mechanical Scanning. The A. T. & T. System. Baird System. Jenkins System.

**Lesson 9:** The Cathode Ray Tube. Fluorescent Screens. The Electron Gun. Focusing the Beam. Deflecting the Beam. Varying the Intensity of the Beam.

**Lesson 10:** Rosing's Cathode Ray Receiver. Electrical Scanning Methods at the Receiver. The Dauvillier Tube. Zworykin's Kinescope. Farnsworth's Oscil-light . . . and, finally, the system of electrical scanning which will be used in commercial television receiving sets for the home.

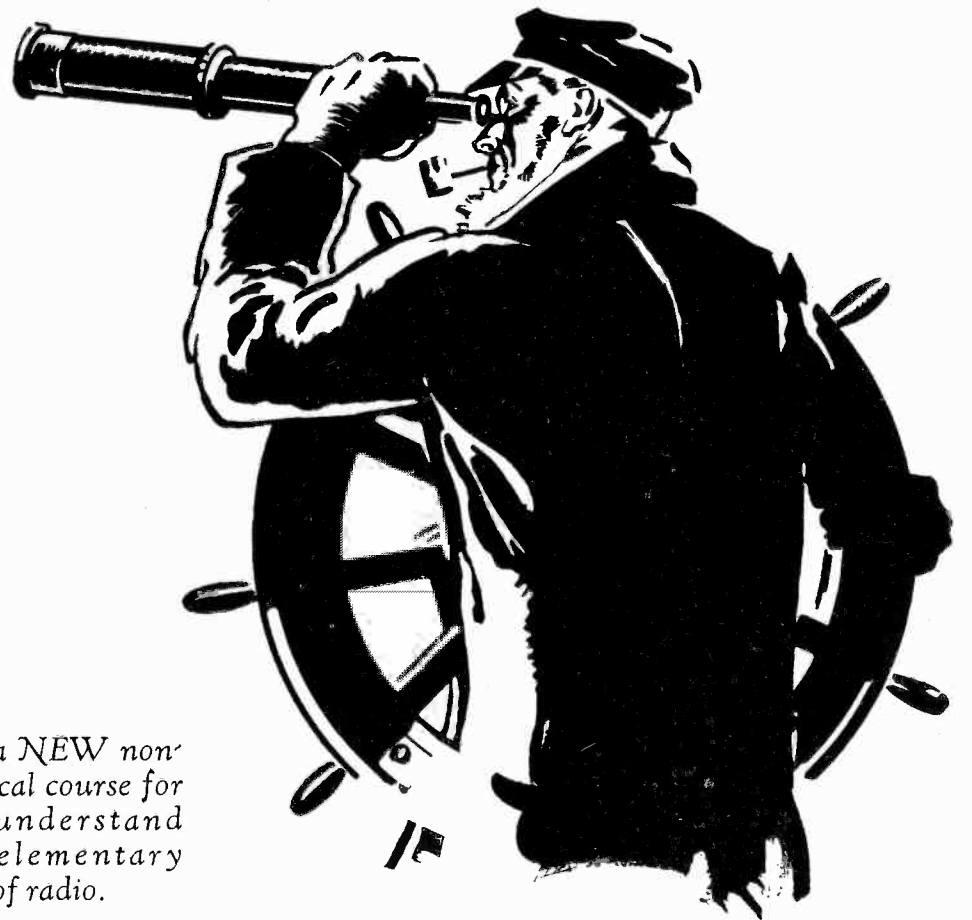

*This is a NEW non-mathematical course for men who understand only the elementary principles of radio.*

## Enrollment

Arthur H. Halloran, Television Consultant,  
430 Pacific Building, San Francisco, Calif.

ENCLOSED is \$ \_\_\_\_\_ for your non-mathematical course of instruction on Cathode Ray Television Receivers in 10 lessons. Send the first lesson immediately.

Name .....

Address .....

City .....

State .....

**T**HE Student is asked to remit \$5.00 with the enrollment coupon. This pays for the first 5 lessons. Then another \$5.00 is payable; this being the final payment. Or, if you prefer, you can remit the entire amount of \$10.00 with your enrollment. Because of the short time that may elapse before the cathode ray tube is commercialized it is advisable that you be prompt in sending the coupon.

Tell them you saw it in RADIO



# Don't Tub Your Tubes

By L. P. Naylor

Manager, Western Division,  
Arcturus Radio Tube Co.

THE ARTICLE which appeared in the March issue of RADIO entitled STOP THE "OLD SPANISH CUSTOM" OF GIVING THE CUSTOMER SOMETHING FOR NOTHING contained an accurate statement of conditions and purported to introduce a new system of protection to the manufacturer. In the latter sense the article was in error because our company, Arcturus Radio Tube Company, introduced the symbol system exactly eighteen months ago.

If distributing organizations would adhere to the spirit of this policy, there would not be but remote special instances in which the ultimate customer would receive protection without necessity of special policy arrangement. During these eighteen months in which our symbol policy has been in vogue, I have been privileged to study not only its results, but the occasions in which jobbers or dealers have criticised its operation. Almost without exception, criticism is because the distributing organization has been unwilling to co-operate—unwilling to accept the spirit of the plan.

Those of us who are experienced in radio realize that any defect in tubes, whether mechanical or electrical, will evidence itself within a comparatively short period of time, certainly within, let us say, two weeks of use. Time should not be a factor in the guarantee of a radio tube. It should not be guaranteed to give three months' service, six months' service, or a year's service. It should be guaranteed to be electrically and mechanically perfect when it leaves the factory.

In other businesses, if merchandise proves defective, it is replaced when a specific complaint is registered and an opportunity is presented for investigation of the complaint. Although a radio tube manufacturer is entitled to the same consideration,



MR. L. P. NAYLOR

unfortunately such a program does not receive co-operation on the part of its distributing organization. They claim that there is too much detail work.

## Turnover Period Is Six Months

WE FEEL that the greater majority of tubes pass through the jobbers' hands, the dealers' hands and into the consumers' hands within a period of six months from the date they are shipped. As it does not require over two weeks' use in a set to determine whether a tube is defective, most defects will be discovered within six months from the date of shipment. Consequently, to make the matter of replacement as easy as possible for the trade, we established the symbol system eighteen months ago, which provided that any tube returned to us within six months from the date it left our factory or warehouse, that tube might be immediately replaced if found to be not up to standard when presented for test to either our dealer or our jobber.

By referring to statement already made, it will be noted that we sincerely wish to protect the ultimate customer against any possible defect in material or workmanship. There are exceptions such as I shall endeavor to illustrate later in this article. Should such exceptions occur, it becomes "policy" to make replacement, even though the symbol may be out of the consideration period. We still guarantee such a tube, but we very reasonably wonder whether during the period of time the tube has been out of our hands it has not given expected service. To provide for protection to the customer, we state that the tube when returned for replacement after it has been out

of the factory six months should be labeled with the user's name and address and the history of such tube. In other words, the jobber or dealer claiming replacement should substantiate his claim.

From the above you will see that we, at no time, take the guarantee off of our tube. The tube is equally guaranteed irrespective of what shipping symbol it carries. We merely ask that if the tube has been out of our factory in excess of six months, we have specific information regarding the complaint.

Some have wrongly interpreted our guarantee to mean six months in the users' hands and others, equally wrong, have interpreted it to mean no guarantee after a tube has been out of the factory six months.

### Distributors Must Co-operate

MY EXPERIENCE proves that the danger for a radio tube manufacturer under this policy is not in natural wear and tear in the use of the policy, but it is the same danger which would occur in any policy—that of misuse or abuse on the part of unscrupulous dealers. The article of last month mentioned great difference in list and net prices on radio tubes of today as compared with but a few months ago. It has become necessary for tube manufacturers to become more stringent in the operation of their policies—it has become necessary for them to appeal to their distributing organization for co-operation. A distributing organization should be a part of the manufacturing organization. It should operate courageously in the spirit of policies which are formulated by the manufacturer. Manufacturers do not create policies as barriers to sales. Policies are created to assist in building a profit; in the distribution of the product in which all are interested.

This brings us to the title of this article, DO NOT TUB YOUR TUBES. Dealers have a habit of making replacements over the counter, some of which are within the policy and others are what I please to term "policy replacements." Under either of these, the dealer would be protected if he would then follow the policy that the manufacturer has laid down. He is careless in upholding his part of the transaction and immediately "tubs the tube"—throws it in a bin for attention at some future date. He has not marked the tube with history as aforementioned—he forgets the history, but does not forget that he made the replacement and then feels that the manufacturer should protect him. This bin accumulates tubes until it eventually is in the way, or the office calls for an inventory and now that it is time to clean house, we give the tubes to the manufacturer and, of course, a good percentage of them are outside of consideration. The manufacturer is then criticised because he has introduced a policy and because he wishes to abide by that policy which was laid down many months ago—a policy with which the distributing organization is thoroughly familiar.

### Examples of Abuse

FROM SAN FRANCISCO we received an assortment of tubes just about two weeks ago. Examination of the tubes proved without any question that the jobber had cleaned house. Some of the tubes were considerably more than two years old. In fact, a few of the tubes were more than three years old. Personal investigation proved that this jobber had purchased a receiver's stock of sets, tubes, and other accessories, among which he found these old tubes. He sent them along to us, merely hoping that because of the high regard which we had for his company and its business, we would forget the policy and help him to clean house.

Another case came from Seattle. A jobber requested us to accept certain types of tubes which he admitted had been in his stock for quite a period of time, but which he claimed were slow movers. He did not ask for credit, but in lieu of credit, requested that we send those types which would move more rapidly. Again, because of our respect for this good jobber we told him to send along the tubes. When they arrived, inspection proved that again there had been a cleaning of the house. The larger percentage of tubes were those which were at least three years old. They were dirty and shopworn to the extent that we could not believe that they had been on an active shelf. I am certain that these tubes came from the back room where they had been for years covered or hidden by other articles.

From Portland we received a letter explaining that certain types of tubes had been in stock until they had reached the expiration date of our symbol system. The jobber in this instance admitted that purchases during the period of time when this merchandise had been in stock had been placed in the front and the old tubes allowed to become older. He had discovered this by accident and asked us to make replacement with tubes of modern symbol. When the tubes arrived we found that they were not at all of the types which our customer had specified.

I could continue to mention similar instances which are confronting us daily and which cause us considerable worry. Every manufacturer of radio tubes would be glad to open his doors for a general house cleaning on the part of his distributing organization, if the distributing organization would then adhere to policies of replacement—if the distributing organization would enter into the spirit and intent of replacement policies.

Tubes have come to be the most active part of radio business. Some dealers are slow to realize that this is a profitable item—they consider radio tubes a necessary evil. Sets will not operate without tubes and for that reason alone they must carry some brand or perhaps a dozen brands. If they will study conditions and concentrate on a line of good radio tubes they will soon find, as have hundreds of others, that the merchandising of radio tubes is the cleanest and most profitable branch of their business.



# Radio World's Extra-Special Free Offers of Subscription Premiums!

RADIO WORLD, now in its eleventh year, is the first and only national radio weekly, and publishes the latest, up-to-the-second news of circuits, both of kit types and of 1932 commercial receivers, as well as news of happenings in the broadcasting field. Lists of broadcast and short-wave stations are published regularly. You get your information weekly—which means quickly—and you get it accurately, so be sure to become or remain a subscriber for RADIO WORLD. We are able to offer now specially attractive premiums and ask you to make your choice from the well-chosen variety offered here.

The regular subscription rates are: \$6 for one year, 52 issues, one each week; \$3 for 6 months, (26 weeks); \$1.50 for three months, (13 weeks); \$1.00 for 8 weeks; 15c per single copy. Newsdealers everywhere.

## BLUEPRINTS

- 627.** Five-tube tuned radio frequency, A-C operated; covers 200 to 550 meters (broadcast band), with optional additional coverage from 80 to 204 meters, for police calls, television, airplane, amateurs, etc. Variable mu and pentode tubes. Order BP-627 @ .....25c
- 628-B.** Six-tube short-wave set, A-C operated; 15 to 200 meters; no plug-in coils. Intermediate frequency, 1,600 kc. Variable mu and pentode tubes. Order BP-628-B @.....25c
- 629.** Six-tube auto set, using automotive tubes, with pentode push-pull output. Order BP-629 @ .....25c

## 115 DIAGRAMS FREE!

115 Circuit Diagrams of Commercial Receivers and Power Supplies supplementing the diagrams in John F. Rider's "Trouble Shooter's Manual." These schematic diagrams of factory-made receivers, giving the manufacturer's name and model number on each diagram, include the MOST IMPORTANT SCREEN GRID RECEIVERS.

The 115 diagrams, each in black and white, on sheets 3 1/8 x 11 inches, punched with three standard holes for loose-leaf binding, constitute a supplement that must be obtained by all possessors of "Trouble Shooter's Manual," to make the manual complete. We guarantee no duplication of the diagrams that appear in the "Manual." Circuits include Bosch 54 D. C. screen grid; Balkite Model F, Crosley 20, 21, 22 screen grid; Eveready series, 50 screen grid; Erls 224 A. C. screen grid; Peerless Electrostatic series; Philco 76 screen grid.

Subscribe for Radio World for 3 months at the regular subscription rate of \$1.50, and have these diagrams delivered to you FREE!

Present subscribers may take advantage of this offer. Please put a cross here  to expedite extending your expiration date.

## SOLDERING IRON FREE

Works on 110-120 volts, AC or DC; power, 50 watts. A serviceable iron, with copper tip, 5 ft. cable and male plug. Send \$1.50 for 13 weeks' subscription for Radio World and get these free. Please state if you are renewing existing subscription. Order P-R-SO. Radio World, 145 W. 45th St., N. Y.

# FREE!

## Your Choice of Nine Meters!

To do your radio work properly you need meters. Here is your opportunity to get them at no extra cost. See the list of nine meters below. Heretofore we have offered the choice of any one of these meters free with an 8-weeks subscription for RADIO WORLD, at \$1, the regular price for such subscription. Now we extend this offer. For the first time you are permitted to obtain any one or more or all of these meters free, by sending in \$1 for 8-weeks' subscription, entitling you to one meter; \$2 for 16 weeks, entitling you to two meters; \$3 for 26 weeks, entitling you to three meters; \$6 for 52 weeks, entitling you to six meters. Return coupon with remittance, and check off desired meters in squares below.

RADIO WORLD,  
145 West 45th Street, New York, N. Y.  
(Just East of Broadway)

Enclosed please find \$..... for .....weeks subscription for RADIO WORLD and please send as free premium the meters checked off below.

- I am a subscriber. Extend my subscription. (Check off if true.)
- 0-6 Voltmeter D.C. ....No. 326
- 0-50 Voltmeter D.C. ....No. 337
- 6-Volt Charge Tester D.C.....No. 23
- 0-10 Amperes D.C. ....No. 338
- 0-25 Milliamperes D.C. ....No. 325
- 0-50 Milliamperes D.C. ....No. 350
- 0-100 Milliamperes D.C. ....No. 390
- 0-300 Milliamperes D.C. ....No. 399
- 0-400 Milliamperes D.C. ....No. 394

NAME .....

ADDRESS .....

CITY..... STATE.....

**THE CLIFT**  
SAN FRANCISCO  
GEARY AND TAYLOR STREETS.  
540 Rooms With Bath  
Rates from \$3.00 single and \$4.00 double  
Garage Accommodations,  
Dining Rooms and Coffee Shop  
ARTHUR L. WATSON  
Executive Manager  
**EL MIRASOL**  
SANTA BARBARA  
For reservations write or wire  
**THE CLIFT**  
San Francisco  
LA QUINTA  
IN-THE-DESERT  
Five miles from Palm Springs  
RATES  
AMERICAN PLAN  
THREE CALIFORNIA HOTELS OF DISTINCTION

**HOTEL NORMANDIE**  
provides the maximum of comfort at reasonable cost. Located just outside the congested district of Los Angeles, yet close to the best shops, theaters and churches, the NORMANDIE offers every advantage you desire in your selection of a temporary or permanent home.  
Rates  
Room with Bath, single, \$2.50 per day  
Room with Bath, double, \$4.00 per day  
Monthly Rates on Application  
The cuisine, excellent service and reasonable rates in the COFFEE SHOP AND CAFE combine to make your stay a pleasant one.  
(Garage in Connection)  
CORNER SIXTH & NORMANDIE  
**LOS ANGELES**

**HEATHMAN HOTELS**  
530 ROOMS  
Finest location in Portland in the hub of the shopping and theater districts and facing park block. Convenient garage just across the street.  
RATES  
Single room with bath \$2.50 and up  
Double room with bath \$3.50 and up  
Concerts twice daily on \$25,000 organ  
HARRY E. HEATHMAN  
Manager  
**Portland, Oregon**

**MARVELOUS! WONDERFUL! SENSATIONAL MIDGET!**  
Something new . Real radio thrill . Long and short wave combined. Practically two sets for less than cost of one. Screen Grid, High Mu, and Pentode tubes. Dynamic speaker. Complete with Cunningham tubes, \$22.50.  
**ECONOMY SALES CO.**  
PA. AVE. STATION WASHINGTON, D. C.

NOTICE—To distributors of electric refrigeration and others who are considering entering this field

## Do You Want the "LOW-DOWN" on Electric Refrigeration?

220 of the country's leading distributors have furnished our Executive Offices with pertinent answers on 24 very important questions. They represent a true cross-section of the United States, having replied from 120 cities—42 states—representing 17 nationally known manufacturers. The summary of these replies in complete but compact form is the most valuable information you could possibly secure on the refrigeration field. The returns for each individual line represented in the survey have been summarized, thus giving a true picture of individual conditions. In order to respect the confidence of those replying, no names have been used.

## Can You Afford to be Wrong?

Copies of the complete recapitulation, distributors' comments together with photostatic prints of the individual summaries are available only to members of our association. In order to qualify for membership, you must be a recognized distributor in the Refrigeration, Electrical or Radio Fields.

Simply indicate your desire to affiliate — enclose a check for \$50.00 covering one full year's dues (effective April 1st, 1932) and mail it to our Executive Offices. If you do not feel that this survey alone is worth more than your membership dues, return it within five days and we will refund your money at your request.

### NATIONAL ASSOCIATION of RADIO, REFRIGERATION and ELECTRICAL DISTRIBUTORS INC.

32 West Randolph St.  
CHICAGO

H. G. ERSTROM, Executive Vice-President



# "The Keystone of Comfort"



**SEATTLE**  
 NEW WASHINGTON  
 BENJAMIN FRANKLIN  
 HOTEL ROOSEVELT  
 HOTEL WALDORF  
 CAMBRIDGE APT. HOTEL  
 HOTEL EDMUND MEANY  
*(Opening Fall 1931)*

**BELLINGHAM**  
 HOTEL BELLINGHAM  
 HOTEL LEOPOLD  
 HOTEL HENRY

**WENATCHEE**  
 HOTEL COLUMBIA  
 HOTEL CASCADIAN

**MOUNT VERNON**  
 HOTEL PRESIDENT

**WALLA WALLA**  
 MARCUS WHITMAN

**CENTRALIA**  
 HOTEL LEWIS-CLARK

**ABERDEEN**  
 HOTEL MORCK

**OLYMPIA**  
 HOTEL GOVERNOR  
 HOTEL OLYMPIAN

**EVERETT**  
 HOTEL MONTE CRISTO

**BOISE, IDAHO**  
 HOTEL BOISE



**VANCOUVER, B. C.**  
 HOTEL GEORGIA  
*(Affiliated)*

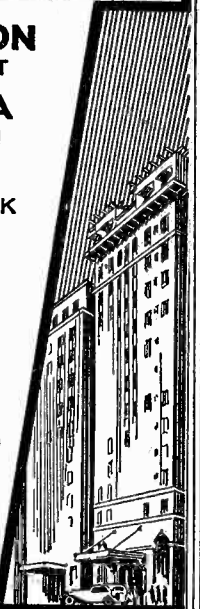

THE EMBLEM OF A SUPERIOR HOTEL SERVICE

## GOOD RADIO AND TECHNICAL BOOKS

"EXPERIMENTAL RADIO ENGINEERING," by Prof. John H. Morecroft, of the Department of Electrical Engineering, Columbia University. A companion book to the author's "Principles of Radio Communication," but in itself a text on practical radio measurements. Cloth bound, 345 pages, 6x9, 250 figures....\$3.50

"FOUNDATIONS OF RADIO," by Rudolph L. Duncan. A treatise for the beginner, setting forth clearly and carefully the electrical phenomena associated with radio. Just the book to give you a firm grip on the subject.....\$2.50

"THE RADIO HANDBOOK," by James A. Moyer and John F. Wostrel, both of the Massachusetts Department of Education. Meets the need for a complete digest of authoritative radio data, both theoretical and practical. Flexible binding, 886 pages, 650 illustrations. \$5.00

"PERPETUAL TROUBLE SHOOTER'S MANUAL," by John F. Rider. Service information of all popular broadcast receivers manufactured since 1920; latest diagrams, chassis layouts, etc., also course in Trouble Shooting. 1,000 pages (8 1/2 x 11), 2,000 diagrams .....\$4.50

"THE CHEVROLET SIX CAR AND TRUCK" (Construction—Operation—Repair) by Victor W. Pagé, author of "Modern Gasoline Automobile," "Ford Model A Car and AA Truck," etc., etc. 450 pages. Price.....\$2.00

"1932 OFFICIAL RADIO SERVICE MANUAL," by Gernsback. Complete Directory of all 1931-1932 Radio Receivers. Full Radio Service Guide. Leatheroid binding.....\$4.00

THE FORD MODEL—"A" Car and Model "AA" Truck—Construction, Operation and Repair—Revised New Edition. Ford Car authority, Victor W. Pagé. 703 pages, 318 illustrations. Price .....\$2.50

Remit with order. We pay carriage.

RADIO WORLD

145 WEST 45th ST.

NEW YORK CITY

## GUARANTEED Microphone Repairs

Any make or Model—24 hour service. Stretched diaphragm double button repairs \$7.50. Others \$3.00. Single button repairs \$1.50.

Write for 1932 Catalog with diagrams.

Universal Microphone Co., Ltd.  
 INGLEWOOD, CALIF.

## WANTED!!

Variable Condensers, .00035, single, double and triple; Rheostats, By-pass Condensers, Midget Condensers, Knobs, Dials, Pigtail Resistors, etc. CHEAP.

RANDON

524 Fairbanks, Oakland, California



## The ARCADY

Rising twelve stories above the exclusive Wilshire district, overlooking the beauties of Westlake and Lafayette Parks, the Arcady offers every comfort and convenience for the traveler

LOS ANGELES  
 WILSHIRE at RAMPART



## hotel DEL MAR

DEL MAR is a resort of the first class--no commercialism --no concessions--just one of the most beautiful spots in the world where fine people and world travelers congregate to enjoy nature's special gifts.

Write for reservations today to Manager Hotel Del Mar or Los Angeles office, 740 South Broadway. Rates from \$6-\$8 to \$10 per day single - \$11 to \$20 double room and three delicious meals.

20 miles north of San Diego--9 miles from La Jolla and 103 miles south of Los Angeles along the King's Highway  
 "The Garden Spot of the South Coast"

SOUTHERN CALIFORNIA

## The Gaylord AN APARTMENT HOTEL



OPPOSITE AMBASSADOR GARDENS



THE GAYLORD fulfills with lasting satisfaction the desires of a discriminating clientele; offering two, three and four rooms furnished, one and two baths. Rates from \$100.

In Los Angeles

Cafe - Room Service

WILSHIRE at KENMORE

**SERVICEMEN**  
*save*  
**TIME**  
**MONEY**



with  
**CLAROSTAT**  
*ad-a-switch*  
**VOLUME CONTROLS**

**C**ON'T lose service business. You need never be stuck in an emergency if your bag contains AD-A-SWITCH. You can convert from plain to switch control in a jiffy. Snaps on without tools. Ask your jobber or write us direct.

**FREE!** Write for your copy of the most complete handbook on every type of variable resistance — from tiny Center Taps and Volume Controls up to Heavy Motor Speed Controls.

*Every experimenter, service man and engineer should have a copy of the Clarostat Control Handbook.*

**CLAROSTAT MFG. Co.**  
285-287 N. 6TH ST. BKLYN. N.Y.

## May Radio and Television Corp. Outlines Extensive Sales Plan

D. W. May, dynamic head of May Radio & Television Corp., distributors of Philco radio in the Metropolitan district and northern New Jersey, has so many startling plans and new ideas to set before his dealer clientele that he has chartered the Ward Line Turbo Electric passenger liner *Oriente*, a vessel that has been in service less than a year, to carry the aforementioned dealer clientele to Bermuda.

Many astounding things have happened before in the Radio Industry but no one ever conceived or planned before such a tremendous expedition as this. In fact it seems that even the *Oriente* with its 17,000 tons displacement will not be large enough to accommodate the dealers who have signified their intention of going on this unique cruise.

The plan is to leave New York Thursday afternoon, May 26th, and arrive at Hamilton, Bermuda, early Saturday morning, May 28th, dock at the pier there, and make the ship their hotel while in port. The contingent will spend two solid days in Bermuda and the entertainment committee has worked overtime in arranging a program of entertainment that will keep them busy every waking hour.

While on the high seas en route to Hamilton, the dealers will not alone be treated to an exhibition and demonstration of what Philco

has to offer for the new season commencing June, but they will also hear sales talks and promotions from some of the keenest and best minds in the Radio Industry. In fact dealers who undertake this pilgrimage will receive a very liberal education in radio merchandising. It is planned to have aboard, leaders of the industry from different parts of the country who will tell their experiences in merchandising and promoting radio. The trade press will also be represented, and all in all, the radio retailer, when he arrives back in New York harbor Tuesday morning, May 31st, should be considerably encouraged and enthusiastic about the future of his chosen field.

Due to the fact that a Saturday, Sunday and a Holiday intervene, the actual time that any dealer will be absent from his store will be one and a half business days. The cruise will also be unique in another phase in that there will be absolutely no members of the weaker sex aboard, it having been found impossible to charter a steamer large enough to include the wives of the dealers for this particular time. So as to make it a 100 per cent stag affair, the Ward Line has displaced the stewardesses on board with stewards and the cruise could be rightfully named "Men Without Women".

*You'll feel at Home in  
the Spacious Manx Lobby*

**HOTEL  
MANX**

### OVERLOOKING UNION SQUARE

The Ultimate in comfort and genuine enjoyment... selected by seasoned visitors as San Francisco's ideal hotel... running ice water... Excellent Dining Room & Coffee Shop

### 350 ROOMS

WITH PRIVATE BATH

AS LOW AS \$2.50 SINGLE, \$3.50 DOUBLE

WITH DETACHED BATH

AS LOW AS \$1.50 SINGLE, \$2.50 DOUBLE

Home of **KROW** radio station  
Visit the studio

GARAGE IN CONNECTION

POWELL AT O'FARRELL

**SAN FRANCISCO**

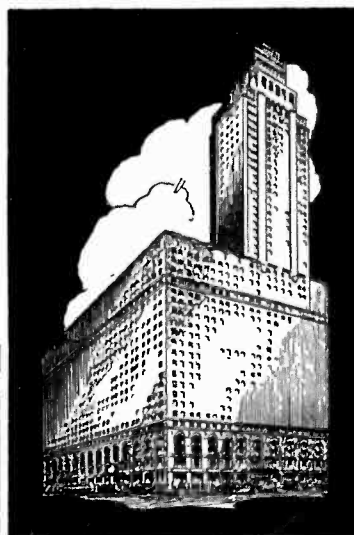

**A** GUEST at the Morrison enjoys all the luxuries that only a hotel of premier standing can offer. Yet rates are remarkably low — \$3.00 up — because sub-rentals pay all the ground rent. The saving is passed on to guests.

Every room in the Morrison Hotel is an outside room, with bath, circulating ice water, bed-head reading lamp and Servidor. A housekeeper is stationed on each floor.

The Morrison is the World's Tallest Hotel — 46 Stories High.

Nearest Hotel in the City to stores, Offices, Theatres and Railroad Stations.

CHICAGO'S  
**MORRISON HOTEL**

Corner Madison and Clark Streets

Leonard Hicks, Managing Director

**2500 ROOMS**  
**\$3.00 Up**



# RADIO AMATEUR CALL BOOK

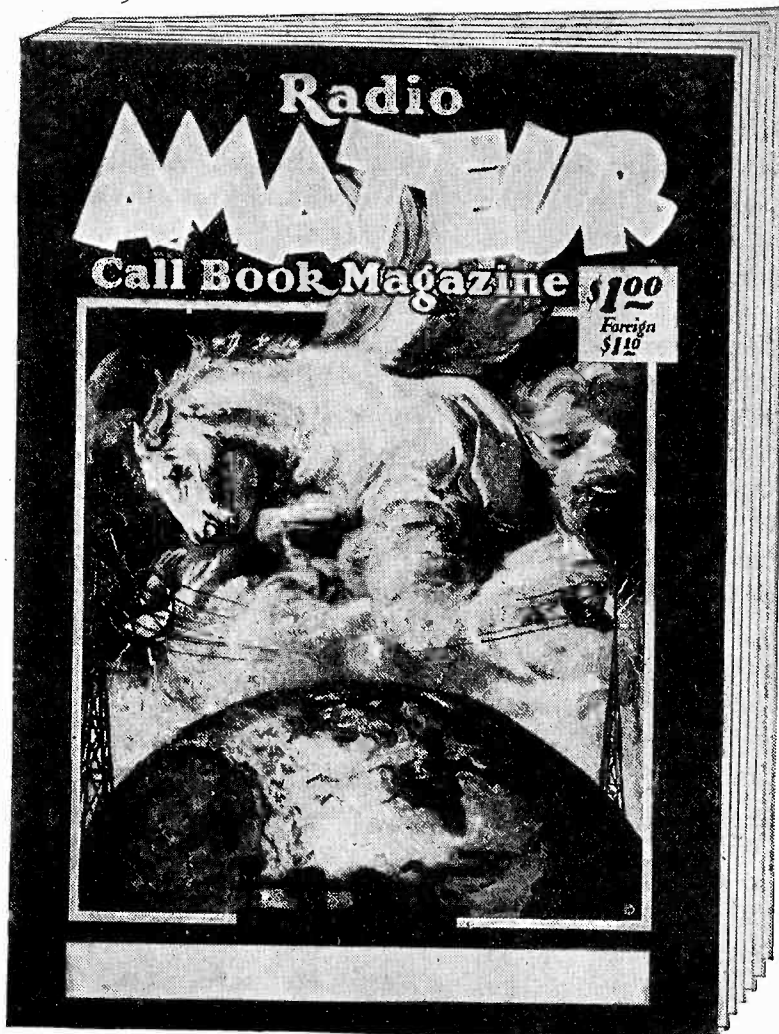

*The Most Complete  
"Call Book"  
Ever Published*

Issued Quarterly

MARCH, JUNE, SEPTEMBER,  
DECEMBER

Single Copy **\$1.00**

Annual Subscription **\$3.25**

**EVERY OPERATOR  
NEEDS THIS BOOK!**

*Buy your copy at the following stores:*

**ARIZONA**  
Phoenix—Nielsen Radio & Sporting Goods Co., 612 N. Central St.

**CALIFORNIA**  
Long Beach—Inter-City Radio Stores Co., 405 American Ave.  
Los Angeles—Natick Book Store, 104 W. First St.; P. O. Box 417.  
Radio Mrs. Sup. Co., 1000 S. Bdwy.  
Radio Supply Co., 912 S. Bdwy.  
Modesto—Nichol News Co.  
Oakland—Hammond Radio School, 3020 Champion St.  
Electric Supply Co., 329 13th St.  
Riverside—F. A. Gardner & Co., 899 Main St.  
San Francisco—I. S. Cohen's Sons, 1025 Market St.  
Offenbach Electric Co., 1452 Market St.  
Warner Brothers, 428 Market St.

**COLORADO**  
Denver—Vreeland Radio Corp., 1639 Tremont St.

**CONNECTICUT**  
West Hartford—American Radio Relay League, 38 LaSalle Road  
Hartford—Harty & Young, Inc., 119 Ann St.

**DELAWARE**  
Wilmington—Wilmington Electrical Specialty Co., 405 S. Delaware Ave.

**FLORIDA**  
Jacksonville—Winter's Radio Shop, 206 West Monroe St.  
Pensacola—Shepherd's.

**ILLINOIS**  
Chicago—Chicago Radio Apparatus Co., 415 S. Dearborn St.  
Newark Elec. Co., 226 W. Madison  
Western News Co., 17-29 E. Aust n  
Peoria—Peoria News Stand, 500 Main

**KENTUCKY**  
Louisville—P. I. Parks & Co., Inc., 911 W. Broadway

**LOUISIANA**  
New Orleans—Rose Radio & Electrical Supplies, 129 Camp St.

**MASSACHUSETTS**  
Boston—Sager Electrical Supply Co., 201 Congress St.  
Ben's Radio Shop, 70 Stuart St.  
Bon's Radio Shop, 228 Tremont St.  
Tremont Electrical Supply Co., Inc., 228 Tremont St.  
Washington Electrical Supply Co., 24 Stuart St.

Each issue contains UP-TO-THE MINUTE CHANGES in listing new calls, changes in address and cancellations for over 30,000 Licensed Amateurs in the United States and possessions, and over 10,000 Licensed Amateurs in more than one hundred different foreign countries.

It also contains HIGH FREQUENCY COMMERCIAL STATIONS, "WHO'S WHO" ON SHORT WAVES, COMMERCIAL STATIONS and EXPEDITIONS, INTERNATIONAL CALL LETTERS, NEW PREFIXES, HIGH FREQUENCY PRESS and WEATHER, and TIME SIGNAL SCHEDULES.

*Truly the Greatest Call Book Ever Published*

**GET YOUR COPY TODAY!**

**RADIO AMATEUR  
CALL BOOK, INC.**

608 S. Dearborn St. Chicago, Ill., U. S. A.

*Buy your copy at the following stores:*

**BUFFALO**—McCarthy Bros. Ford, 75-79 W. Mohawk St.

**NEW YORK CITY**—Blan, The Radio Man, Inc., 89 Cortlandt St.  
J. H. Bunnell & Co., 215 Fulton St.  
Leeds Radio Co., 45 Vesey St.  
Sun Radio Co., 64 Vesey St.  
Syracuse—Roy C. Stage, Montgomery and Burt Sts.

**NORTH CAROLINA**  
Charlotte—Buster Brown's News Stand, 5 East Trade St.  
Winston-Salem—Brown-Rogers-Dixson Co.

**OHIO**  
Cincinnati—United Radio, Inc., 1103 Vine St.  
Cleveland—Bergman Tool & Radio Co., 628 Prospect Ave.  
Northern Ohio Lab., 2073 W. 85th  
Columbus—S. S. Kresge Co., Store 1153, 97 N. High St.  
Dayton—Burns Radio Co., 140 E. 3rd  
Kent—Kladag Radio Lab., Kline Bldg.

**OKLAHOMA**  
Oklahoma City—Southern Sales Co., 130 W. Third St.

**OREGON**  
Portland—Rich's Cigar Store, 6th & Washington Sts.  
Stubbs Electric Co., 75 6th St.

**PENNSYLVANIA**  
Harrisburg—Hall's, 218 Chestnut St.  
Philadelphia—M. & H. Sporting Gds. Co., 512 Market St.  
Eugene G. Wile, 10 S. Tenth St.  
The Map Store, 60 N. 13th St.  
Pittsburgh—Cameradio Co., 603 Grant

**TENNESSEE**  
Nashville—Zibart Bros.

**TEXAS**  
Fort Worth—Fort Worth Radio Supply Co., 104 E. Tenth St.

**WASHINGTON**  
Seattle—Wedel Company, 520 2nd  
Spokane—Spokane Radio Co., 528 1st

**WISCONSIN**  
Milwaukee—Radio Parts Co., 332 W. State

Springfield—T. F. Cushing, 345 Worthington St.

**MICHIGAN**  
Detroit—S. S. Kresge Co., Store 1185, 1403 Woodward Ave.  
Radio Spec. Co., 175 E. Jefferson

**MINNESOTA**  
Minneapolis—Findley Electric, Inc., 818 Marquette St.  
Waseca—E. F. Johnson

**MISSOURI**  
Brunswick—O. R. Estes, 111 South Jackson

**KANSAS CITY**—Burstein-Applebee Co., 1408 McGee St.  
E. B. MacDowell, 3145 Karnes Blvd.  
Radio Laboratories, 1511 Walnut St.  
St. Louis—Foster Book Co., 410 Washington Ave.

**NEW JERSEY**  
Irvington—United Radiobuilders, 1234 Springfield Ave.

**NEW YORK**  
Albany—Uncle Dave's Radio Shack, 356 Broadway

# CROSLEY SUPERHETERODYNES are Fast-Moving Merchandise



## The Crosley TYNAMITE

The value that is packed into this radio receiver is amazing. This 4-tube superheterodyne incorporates pentode output and variable mu tubes, image suppression pre-selector, combined volume control and on-off switch, illuminated station selector and full floating moving coil dynamic speaker. Brings in distant stations when used with an antenna of reasonable length. Here are big set features at a remarkably low price. Dimensions: 13½" high, 9¾" wide and 7½" deep.

**\$ 29<sup>75</sup>**  
COMPLETE WITH 4 TUBES

CROSLEY radio receivers are built and priced to meet the needs and requirements of TODAY'S market. Crosley extremely low prices, sensational performance and exquisite cabinet design enable dealers everywhere to clinch sales and make more profits NOW! No other radio receivers offer more for your customers' dollars than do Crosley receivers. Every radio refinement has been incorporated into the fast-selling Crosley line. Crosley receivers are the profit-makers for 1932. See your Crosley Distributor for complete details about the Crosley line.

## The Crosley CAROLER

A superb 8-tube superheterodyne console model. It incorporates pentode output and variable mu tubes, continuous (stepless) tone and static control, illuminated hairline shadow dial with vernier drive, and latest type Crosley full floating moving coil dynamic speaker. Dimensions: 40" high, 22¾" wide and 12¾" deep.

**\$ 59<sup>75</sup>**  
COMPLETE WITH 8 TUBES AND TENNABOARD

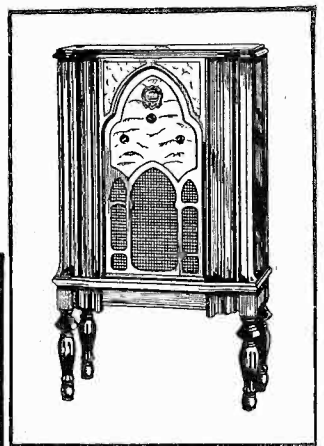

|   |   |                                  |                                    |                       |
|---|---|----------------------------------|------------------------------------|-----------------------|
| <b>CROSLEY MODELS</b>   | 4 TUBES   | PLAYTIME, Jr.....\$79.75         | CAROLER.....\$59.75                | PLAYTIME.....\$95.00  |
|   | TYNAMITE.....\$29.75                                    | 7 TUBES                          | MERRY MAKER..... 75.00             | (With Dual Speakers)  |
|   | BONNIBOY..... 39.75                                     | FORTY FIVE.....\$45.00           | (With Dual Speakers)               | 10 TUBES              |
|   | 5 TUBES   | 8 TUBES                          | ANNOUNCER..... 85.00               | TENSTRIKE.....\$69.50 |
|   | LITLFELLA.....\$36.36                                   | PLAYBOY.....\$49.75              | (With Dual Speakers)               | HAPPY HOUR..... 99.50 |
| BIGFELLA..... 48.48   | COMBINATION SHORT-WAVE AND STANDARD BROADCAST RECEIVERS |                                  | (With Dual Speakers) ....109.05    |                       |
|   |   | DISCOVERER (7 Tubes).....\$77.50 | ADVENTURER (12 Tubes).....\$119.50 |                       |
| All above models are SUPERHETERODYNES and are priced complete with tubes. |   |                                  |                                    |                       |

Montana, Wyoming, Colorado, New Mexico and west, prices slightly higher. Prices subject to change. Any Federal or State taxes which may be levied must be added to prices.

## THE CROSLEY RADIO CORPORATION

Powel Crosley, Jr., President

CINCINNATI

Home of "the Nation's Station"—WLW

YOU'RE THERE WITH A CROSLEY  
**CROSLEY RADIO**

Tell them you saw it in RADIO



**1932..**  
**a BIG**  
**BLUE TUBE YEAR**

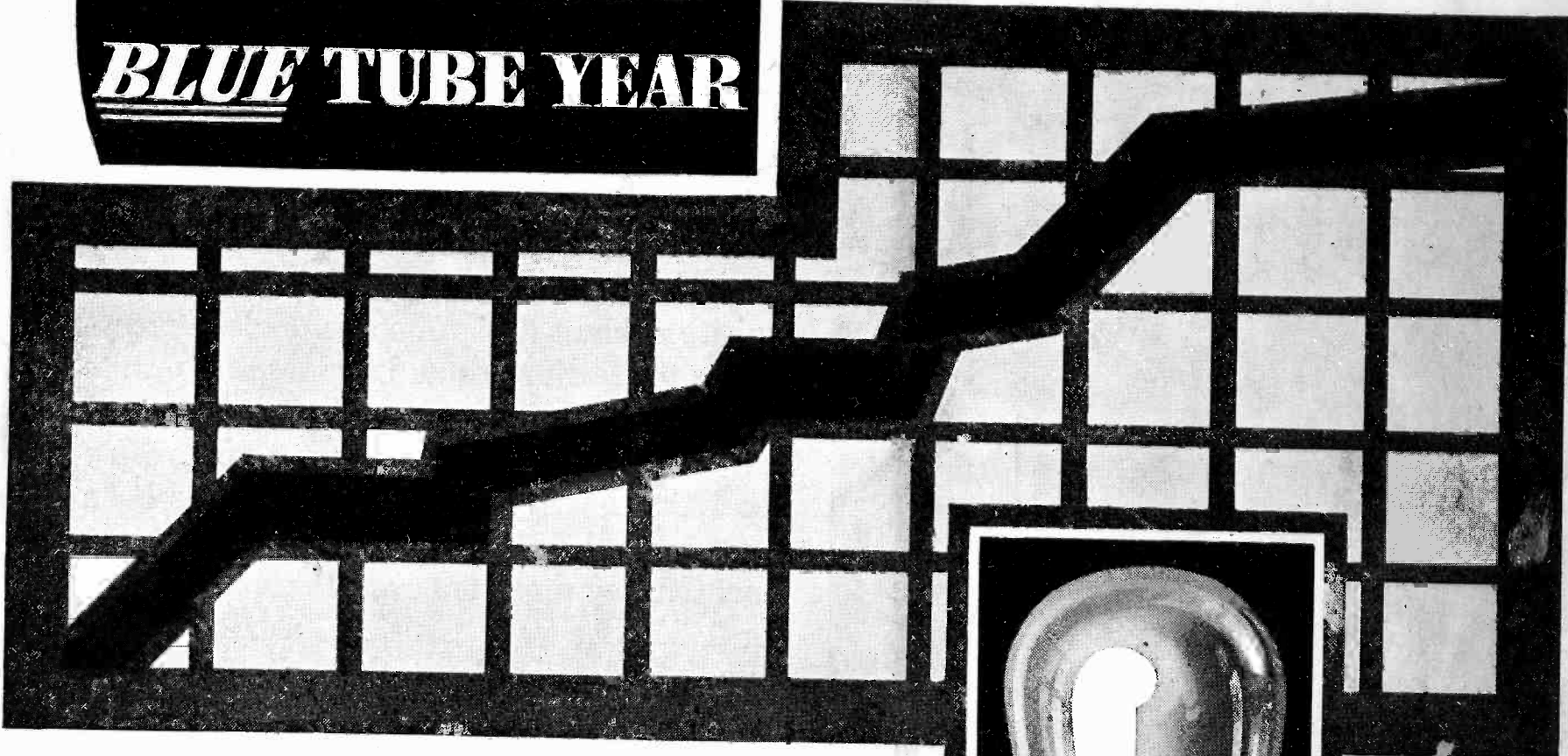

- Arcturus Blue Tubes were and are used by more set manufacturers than any other tube! We are building for Arcturus Dealers and Jobbers a bigger replacement market than any other tube!—establishing millions of satisfied *blue* tube users who in 1932 will become *blue* tube customers!
- The distinctive *blue* color of Arcturus Tubes gives you a tremendous advantage. It's the only distinctive tube on the market.
- Are you in line to get your share of this vast replacement market and the profits on this fastest-selling tube?
- Thousands of new set owners and millions of Arcturus users are going to demand *blue* tube renewals. Here's a big market you can't afford to overlook.

ARCTURUS RADIO TUBE COMPANY, NEWARK, N. J.

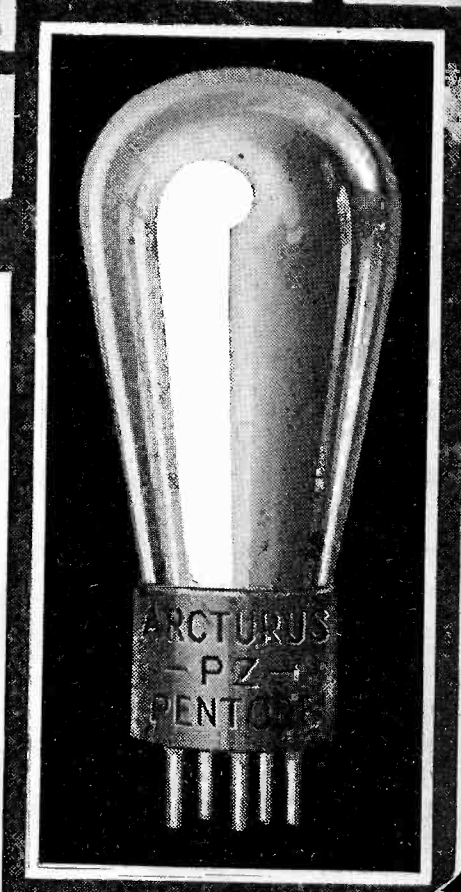

*The BLUE TUBE*

# ARCTURUS

*The* **TUBE** *with the* **LIFE-LIKE TONE***"*

WESTERN DIVISION: Arcturus Radio Tube Co., 1855 Industrial Street, Los Angeles, Calif.