

FEBRUARY, 1929

25 CENTS

RADIO

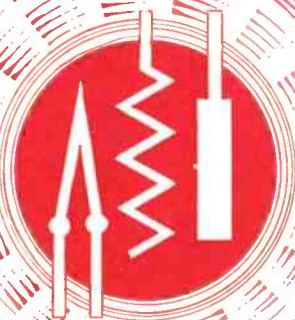

IN THIS ISSUE

RADIO MARKETING FOR THE FARMER
EXPERIMENTAL A.C. SCREEN-GRID RECEIVER
AMPLIFICATION OF PHOTOELECTRIC EFFECTS
EFFECTS OF ROOM FURNISHINGS IN SPEAKER QUALITY
SCREEN-GRID R.F. AMPLIFICATION



MAGNAVOX *Dynamic* SPEAKERS



Aristocrat Model

Beautiful butt burl walnut cabinet finished in two tones.
 For A-Battery Operation \$60
 For AC Operation \$70

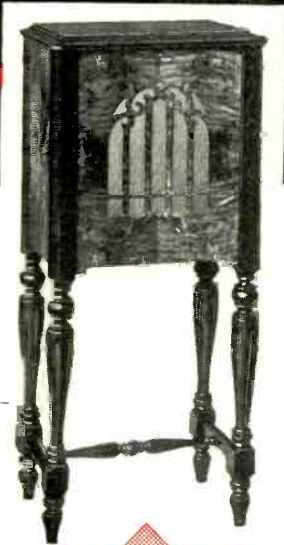

Beverly Model

Gracefully proportioned cabinet finished in light mahogany.
 For A-Battery Operation . . . \$50
 For AC Operation \$60
 Other floor and table models up to \$175.
 Units only; DC \$30; AC \$40.



Dynamic realism is radio's newly acknowledged refinement . . . originally sponsored by Magnavox. Every tone rich, full and vivid . . . over entire audible range. A cascade of volume . . . without distortion. America's finest radio sets are made with Magnavox Speakers as built-in equipment.

THE MAGNAVOX COMPANY

Oakland, California Chicago, Illinois

Faradon an Important Factor

FARADON quality and dependability have contributed in no small measure to the present high standard of radio reception and transmission.

Producers of quality equipment recognizing this are utilizing Faradon Capacitors in achieving the high performance standard required.

The extensive experience of Faradon engineers is available to assist in taking care of special electrostatic condenser requirements not covered by the more than 200 types of Faradon Capacitors in regular production.

Wireless Specialty Apparatus Co.

Established 1907

Jamaica Plain, Boston, Mass., U. S. A.



Faradon

Electrostatic Condensers for All Purposes

RADIO

Established 1917

Published Monthly by the Pacific Radio Publishing Co.

ARTHUR H. HALLORAN, Editor
 H. W. DICKOW, Business Manager
 P. S. LUCAS, Associate Editor
 A. I. RIVETT, Draughtsman

FRANK C. JONES, Technical Adviser

Entered as second-class matter at Post Office at San Francisco, Calif.

Subscription Price, \$2.50 per year in U. S. and Canada \$3.00 in Foreign Countries

Copyright 1929 by the Pacific Radio Publishing Co.

Address all communications to

PACIFIC RADIO PUBLISHING COMPANY
 Pacific Building, San Francisco, California

Vol. XI FEBRUARY, 1929 No. 2

CONTENTS

RADIOTORIAL COMMENT	9
RADIO MARKETING FOR THE FARMER	11
PICK-UP ADJUSTMENT	12
<i>By Thomas F. McDonough</i>	
FURNISHED ROOMS	13
<i>By Keith La Bar</i>	
FIVE-TUBE A.C. SCREEN-GRID RECEIVER	15
<i>By Frank C. Jones</i>	
AMPLIFICATION OF PHOTO-ELECTRIC CURRENTS	17
<i>By John P. Arnold</i>	
AUTOMATIC SYNCHRONIZATION	19
RAYFOTO SYSTEM	19
HOW TO MAKE 30 K.C. I. F. TRANSFORMERS	20
<i>By R. Wm. Tanner</i>	
SCREEN-GRID R.F. AMPLIFIER.....	21
<i>By J. R. Nelson</i>	
AN EFFECTIVE ANTENNA COUPLING UNIT	22
<i>By Thos. A. Marshall</i>	
TECHNICAL BRIEFS	23
THE COMMERCIAL BRASS-POUNDER	25
<i>By P. S. Lucas</i>	
THE TITANIC DISASTER.....	25
<i>By Wm. A. Brenimann</i>	
PARABOLIC REFLECTORS	26
<i>By A. Binneweg, Jr.</i>	
FREQUENCY CONTROL PRECAUTIONS WITH A QUARTZ CRYSTAL	26
<i>By H. A. Clark, Jr.</i>	
RADIOLAS 60, 62 and 64.....	27
RADIO KIT REVIEWS.....	29
COMMUNICATIONS IN THE NAVAL RESERVE	42

FORECAST FOR MARCH ISSUE

The principles of the electro-static loudspeaker are explained by "Yose." Frank C. Jones discusses resonance in the dynamic speaker cabinet. John P. Arnold traces developments in synchronization of visual communication and also presents many other interesting facts about radio pictures. R. Raven-Hart interprets foreign circuit diagrams and describes several novel foreign tubes. C. W. Guyatt tells how to make a condenser multiplier for an a.c. voltmeter. Harry R. Luheke analyzes the design of a practical vacuum tube voltmeter. Carl Joseph describes the construction of a direct-reading ohmmeter. A. Binneweg, Jr. illustrates the construction of a 1½-meter oscillator. Glenn Browning presents some interesting facts about the a.c. screen-grid tube.

"You Can Forget the Condensers—If They Are DUBILIER'S"

Specially designed for Thordarson Power Packs Type 574 for use with the Ratheon BH tubes or the Elkon Metallic EBH rectifier.

Type 575 for use with 210 type tubes and 281 rectifier tubes.

Type 1152 for use with 210 and 250 type tubes and 281 rectifier tubes.

Type 1120 for use with 280 type rectifier tubes or the Elkon E-80 metallic rectifier.



There is

No Substitute for Quality!

No amount of lurid claims by nimble-penned advertising writers will take the place of quality in the final analysis—the operation in your power supply.

Ever since the advent of Radio, Dubilier has been the manufacturers' standard—and the set builders' stand-by. Built in every Dubilier Condenser is a factor of safety which is your safeguard for years of service without failure.

DUBILIER LIGHT

SOCKET AERIAL

—*"A Moulded Bakelite Product"*

Bring in programs with a minimum of interference. Do away with the unsightly and trouble causing outside aerial and lightning arrestor. Simply attach to the set and plug into the nearest light socket. Uses no current. Sold by all good dealers. Price \$1.50.



Dubilier
CONDENSER CORPORATION

10 East 43rd Street, New York City

Address Dept. 22



for free catalog

Reg. U.S. Pat. Off.

Two Radio Magazines for the Price of One

CITIZENS RADIO CALL BOOK and RADIO, both magazines sent to your address for the cost of a subscription to RADIO alone. Send \$2.50, the full price, and your subscriptions will be entered immediately. CITIZENS RADIO CALL BOOK is published four times a year. You save \$2.00 by subscribing to this combination offer. Attach your check or money order for \$2.50 to the coupon and mail now. This great offer will be withdrawn shortly. **ACT NOW.**

RADIO, 428 Pacific Building, San Francisco, California.

Here is \$2.50. Send both CITIZENS RADIO CALL BOOK and RADIO for one year to

Name

Address

**164
PAGES
of RADIO
VALUES**

A NEW CATALOG JUST OFF THE PRESS

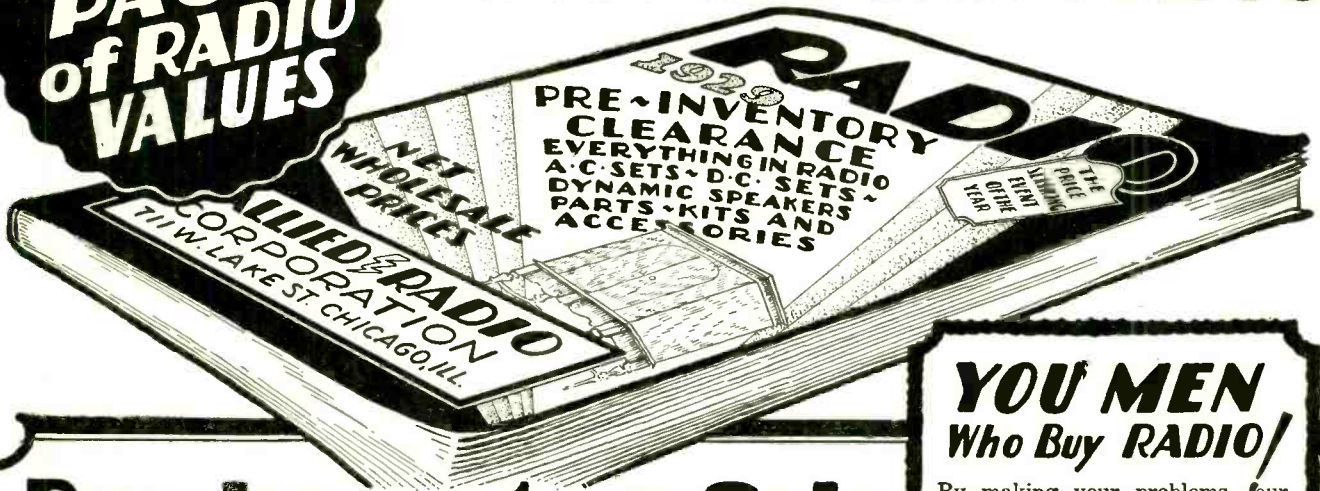

YOU MEN Who Buy RADIO!

By making your problems our problems, we know the service you require—and to render you such service the entire Allied organization is dedicated—to give you the service you have a right to expect. Tremendous stocks, remarkable values and a real desire to serve, all combine to make Allied your ideal source of supply.

Pre-Inventory Sale

A PRE-INVENTORY SALE featuring some of the most drastic price reductions of the season. Our tremendous stocks must be **reduced**. Prices have been cut to the bone. Everything in our large stocks of radio merchandise is included. You will marvel at the remarkable values. Now is the time to buy. A new large catalog, featuring these remarkable values is now ready. Every radio enthusiast—every dealer—every set builder should send for this new catalog—quoting **lowest wholesale prices** on **everything** in radio.

SET BUILDERS!

Set Builders, Amateurs and so called "Hams" will delight in the *unusual variety*—and **remarkable values** that are offered in standard kits and parts. Tremendous stocks—**real organization**—prompt shipping service all combine to make Allied your ideal source of supply.

RADIO DEALERS!

The live radio dealer—the man who keeps pace with the rapid advance of radio will find much of **real interest** in the Allied Catalog. New A-C Sets, D-C Sets, Dynamic and Magnetic Speakers, television equipment, in fact **everything** that an impatient radio public is demanding.

Lowest Wholesale Prices

Allied Service will prove a revelation to you in what radio service can really be. Allied Executives backed by years of training in radio are practical men. They know radio. Their vast experience has built up around them an organization trained to serve. Months of effort have built up here a tremendous reserve of stock that makes for prompt shipments; and this stock is new stock comprising the seasons pick of such prominent manufacturers as Silver-Marshall, Tyrman, Aero, Hammerlund-Roberts, etc.

You Profit When You Buy Right

Buying right is half the battle. From the small set builder to the large dealer, your success depends upon gauging the public pulse of radio and in **buying right**. Everything that is new in radio—the items the radio public is now demanding are here, ready for your call. Write now—the catalog is **free** for the asking.

Write for Catalog Now

Allied Radio CORPORATION

711 W. LAKE ST. Dept. E-5 CHICAGO, ILL.

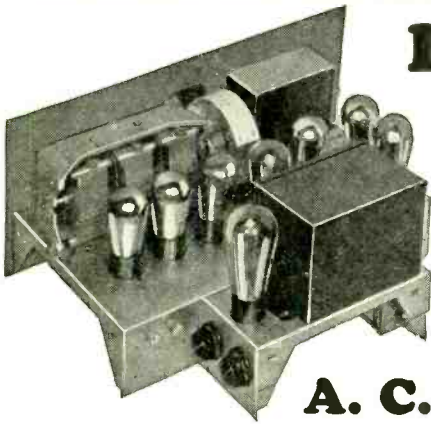

A. C.

ELECTRIC SETS

Allied offers you a new—complete line of A-C Receivers, available in either chassis form or in a wide variety of beautiful console models. Prices range from \$32.95 to \$199.00. Dollar for dollar they stand out as one of the season's leading receivers. Engineered to unusual perfection they offer you features found only in the highest priced sets.

And in 1929

The Jensen

AUDITORIUM SPEAKER

DYNAMIC, OF COURSE!

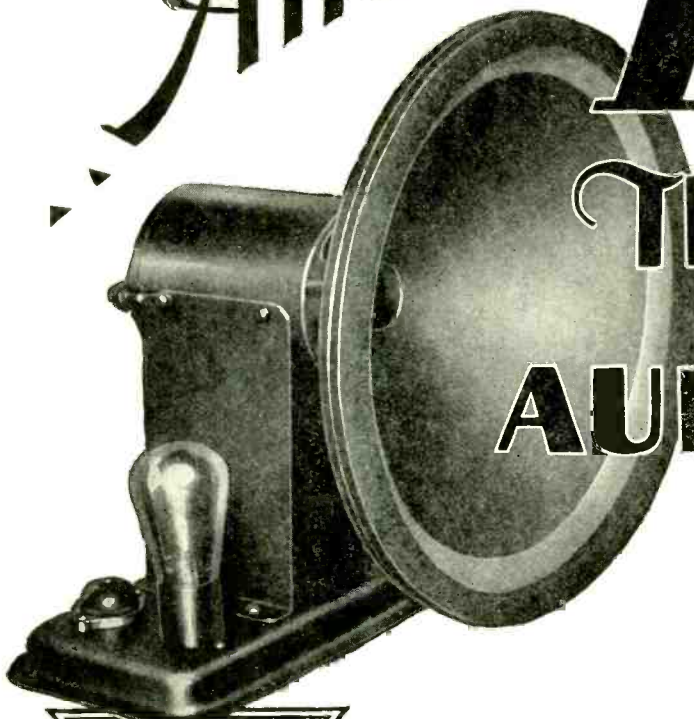

Salient Features

Size of cone, 11 inches.

Responds to frequencies of from 25 to 6,000 cycles.

One Jensen Auditorium Speaker operated at full volume is sufficient for the average theatre.

Makes any power-tube equipped radio set sound better.

Designed and developed personally by Peter L. Jensen.

Jensen
AUDITORIUM SPEAKER

In 1927 Peter L. Jensen perfected the first successful dynamic cone for use with conventional radio sets—and thus set the stage for the great radio year of 1928.

And now new standards are established for 1929 by the Jensen *Auditorium* Speaker. Designed without the slightest compromise or restriction, this new reproducer is indeed a master stroke of creative genius, a new perfected type of the famous original dynamic speaker, of which Peter L. Jensen is the co-inventor.

Briefly, the Jensen *Auditorium* Speaker assures extreme volume of reproduction, with greater sensitivity and a degree of fine tonal quality never possible before.

This new all-purpose speaker, ideal for theatres and auditoriums and for out-of-doors, will be especially appreciated in the home,

where its wide range of ability meets every individual requirement. It is also the most effective medium for demonstrating radio sets and phonographs.

And note particularly that when the Jensen *Auditorium* Speaker is added to a set equipped with one type 171 amplifier tube the performance approaches that of much more powerful sets and amplifiers when these are used with ordinary speakers.

Units for use in console cabinets or on open baffles are ready for delivery now. New Jensen cabinets of distinguished design will be announced shortly. Model illustrated is DA5—AC which requires one rectifier, type 280 or 380, for operation.

Model DA4 for 110 Volt DC Operation \$55.00
 Model DA5 for 220 Volt DC Operation \$55.00
 Model DA5 AC for 110 Volt AC Operation \$70.00

JENSEN RADIO MANUFACTURING COMPANY

212 Ninth Street, OAKLAND, CALIF.

339 N. Kedzie Avenue, CHICAGO, ILL.

Jensen Patents Allowed and Pending—Licensed under Lektophone and Magnavox Patents



PAM 16 or 17
List Price, without
tubes, \$125.00

Here's a Seat at the Cabaret

Enjoy your favorite orchestra as if it were present; recreate the renditions of famous artists so nothing is left for the ear to desire, and perfect the "atmosphere" of beautiful surroundings—by using the Samson PAM Amplifier.

A phonograph or a radio set may be used in conjunction with these amplifiers, to produce music in one or many rooms—or out-of-doors. And remember—wide awake cabaret owners are using PAM amplifiers to produce music and more business in their restaurants.

The PAM-17 is identical with the PAM-16 except that it furnishes in addition field current for a dynamic speaker designed to have its field energized by 90 to 165 volts direct current. For all other types of speakers, including dynamic, having their field energized from storage battery or AC 110 volt 60 cycle, use the PAM-16. Both amplifiers are designed to operate from 105 to 120 volts 50 or 60 cycles AC.

Send for handsome folder R4 describing the above and other Samson PAM Amplifiers which are also a "Sound Investment."

Main Office:
Canton, Mass.

Samson Electric Co.
MEMBER
R.M.A.

Factories at Canton
and Watertown, Mass.

NOW! AN ELKON DRY RECTIFIER for PHILCO POWER UNITS

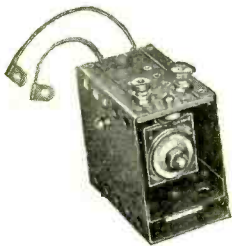

Type BNK for replacing the acid jars in Balkite Types N and K Trickle chargers.

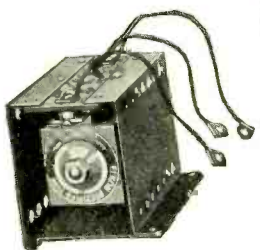

Type BJ for replacing the acid jars in Balkite Type J chargers

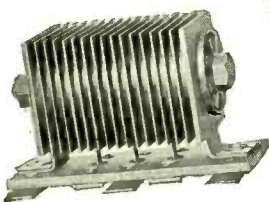

Type M-16 for replacing the rectifiers in 11 makes of "A" Eliminators and 3 Ampere chargers

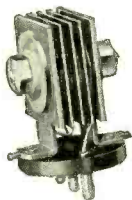

Type V-4 for replacing the rectifiers in 6 makes of Trickle chargers.

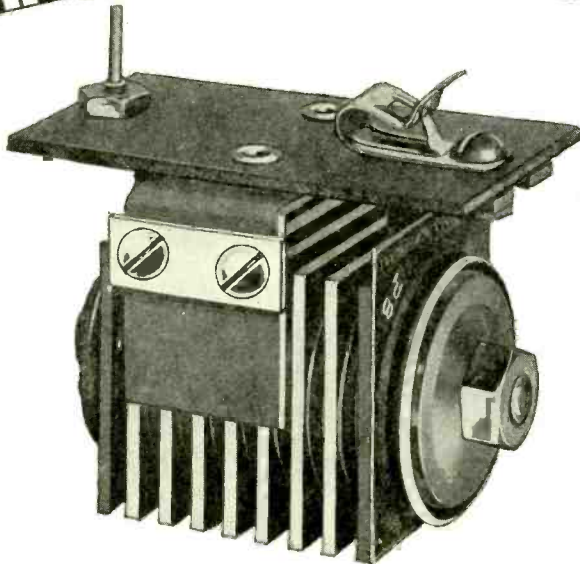

THIS new Elkon all-dry metallic rectifier Type U-P-8 is so designed that it replaces the wet jar rectifiers designated as Philcatron A and Philcatron AA used in Philco Trickle Chargers, Philco "A" Powers and Philco A and B combinations.

Very simple to attach, two wires to connect. May be done in a minute by anyone. No liquids to bother with—no attention—just satisfaction.

Do not be surprised at its small size—for in its sturdy couples are packed thousands of hours of perfect service. Its compactness is one of the reasons for its efficiency.

The U-P-8 is a fitting member of the Elkon family of dry-metallic rectifiers.

Visit your dealer today.

ELKON, Inc.
Division of P. R. Mallory & Co.
350 Madison Ave., N. Y. C.

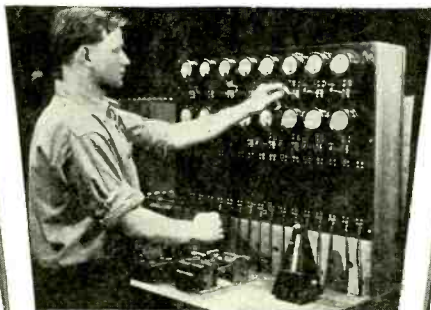

Not a music lesson but one of the many accurate processes of testing Elkon rectifiers.



5000 hour type EBH rectifier for replacing BH type tubes in "B" eliminators. Replaces fragile 1000 hour tubes.

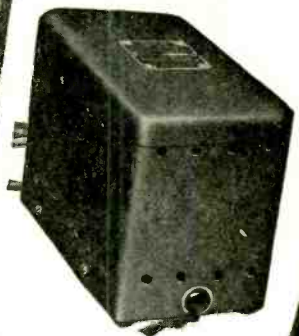

3 Ampere Charger. Dry, noiseless, no moving parts. Has tapering feature—long life. For radio or auto batteries.



Type E Tapering Charger. Maximum charging rate 1 amp. Dry. No moving parts. Long Life. Ideal for dynamic speakers.



Dry, high-capacity condensers. Capacities from 750 to 2000 microfarads. Used in many leading "A" eliminators.

ELKON, Inc., Dept. E-37
Please send me complete information on the Elkon Radio Products.
Name _____
Address _____
350 Madison Ave., N. Y. C.

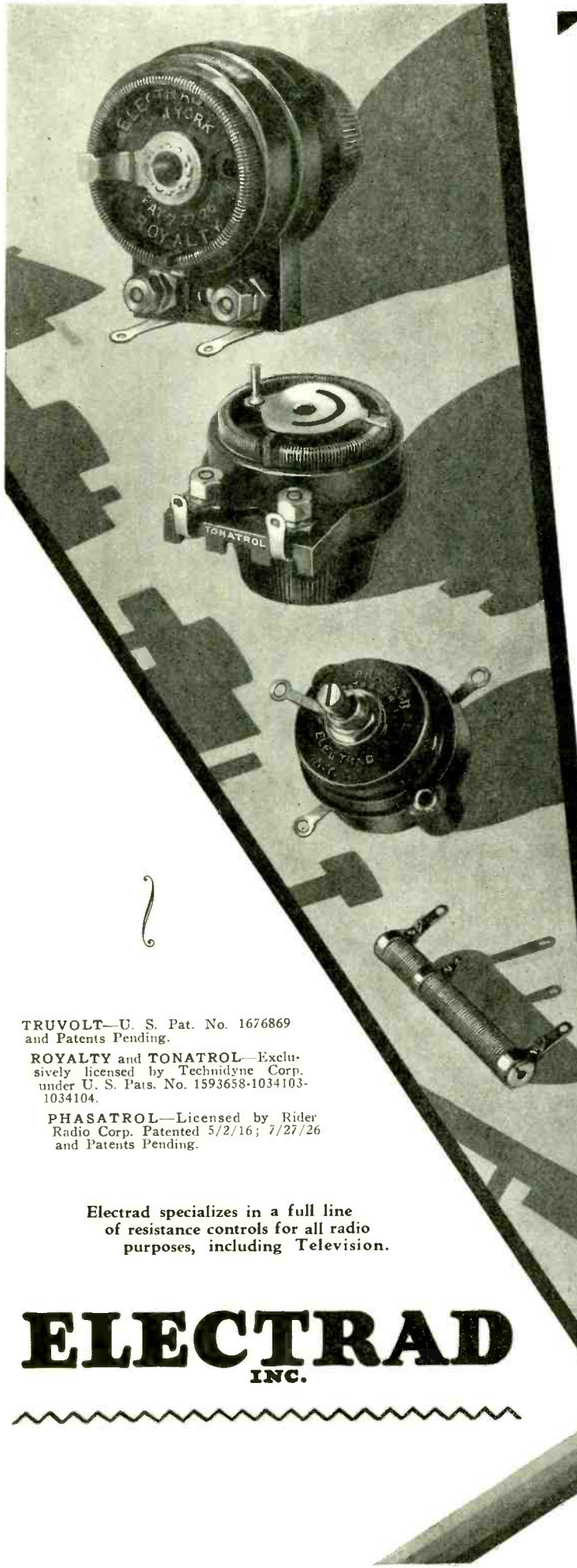

TRUVOLT

All-Wire Resistances

Control the "ups and downs" of your Radio Voltage

Eliminator and Power-Pack construction demands resistances that stand up under load—that deliver rated voltages *reliably* for long periods—that will not overheat, corrode, or wear out.

You can pin your faith to TRUVOLTS. TRUVOLT Resistances are wire-wound over asbestos, having a flexible enameled copper core—then wound in turn on a fire-clay base—a *distinctive Electrad principle*. Truvolt Variables eliminate difficult calculations. Truvolt Fixed Resistances are adjustable to different set values by use of sliding clip taps. Made in all desirable values and circuit ratings.

ROYALTY

Royalty Variable High Resistances are free from harmful inductance and capacity effects. They are permanently accurate—*dependable*. Made with the finest insulating materials. Potentiometer, \$2.00. All other types, \$1.50.

TONATROL

Tonatrol the volume you want, from a gentle murmur to the thunder of concert pitch. Made for all types of battery or A.C. receivers—with or without filament switch. \$1.50 to \$3.00.

PHASATROL

The PHASATROL counteracts grid-to-plate tube capacities and other stray currents that unbalance, distort and frequently ruin radio reception. Particularly valuable for the new A.C. circuits. \$2.75 each.

TRUVOLT—U. S. Pat. No. 1676869 and Patents Pending.

ROYALTY and TONATROL—Exclusively licensed by Technidyne Corp. under U. S. Pats. No. 1593658-1034103-1034104.

PHASATROL—Licensed by Rider Radio Corp. Patented 5/2/16; 7/27/26 and Patents Pending.

Electrad specializes in a full line of resistance controls for all radio purposes, including Television.

ELECTRAD

INC.

Mail the Convenient Coupon

ELECTRAD, INC.,
Dept. PR-2
175 Varick St., New York

I am interested in the following Electrad Literature:

- TRUVOLT ROYALTY
 TONATROL PHASATROL

Name _____
Street _____
City _____ State _____

RADIO

VOLUME XI

FEBRUARY, 1929

No. 2

Radiatorial Comment

THE popularity of the syndicated comic strip in the newspapers may be rivaled by that of the phonograph record which is supplied exclusively to radio broadcast stations. While these have been used mainly for voice and music, they are also available for rather a crude form of radio movies.

* * *

JEWELERS report a recent increase in trouble from magnetized watches. In many cases this can be traced to the strong magnetic field of an electro-dynamic speaker. This trouble may eventually require the use of a magnetic screen around the speaker. Of course a watch can readily be demagnetized by placing it inside a coil through which an alternating current is passing, but it is liable to be re-magnetized when again exposed.

* * *

THE FEDERAL RADIO COMMISSION has published a long list of signed comments from radio listeners who praise the new allocations. But a possibly equally long list of complaints is not published. Meanwhile the Radio Manufacturers' Association has queried its members regarding their opinions of the new set-up and how it may be improved. This information will be presented to the Commission in the form of a complete survey of national and local conditions.

* * *

IN TELEPHONY, the telephone transmitter is an electrical ear and the receiver an electrical mouth. In television, the transmitter is part of an electrical eye, or light-sensitive device, which converts variation of light into variation in electric current and whose optic nerve is a wire or radio channel which terminates in a device for converting variations in current into variations

in light. The usual converter of light to electricity is a photoelectric cell. The usual converter of electricity to light is a neon tube.

* * *

SHORT waves have resurrected the "good old days" for the broadcast listener. Once more can he strain his ears in order to hear the call letters of distant stations. Again it becomes possible for him to listen to the amateur QRM and to twirl his dials through great empty spaces.

Yet the short waves offer a fascination and interest, even to the BCL, which is lacking in the facile tuning of local broadcast stations. He will enjoy greater freedom from static and will often hear distant stations during the daylight hours. And if he possesses the patience necessary to tune his set and learn the code he will open up new pleasures in radioland.

* * *

DEVELOPMENT of the talking movie was dependent upon radio, because it was not until radio stimulated the demand were sensitive microphones and efficient sound amplifiers developed. With ordinary telephone and sound-recording equipment, the speaker must stand so close to the recorder that no acting can be done. On the other hand, a sensitive microphone and vacuum tube audio amplifier may be placed at such a distance that it does not appear in the picture and the voice and action can be recorded simultaneously.

* * *

SO SUCCESSFUL have been the results of the persistent and energetic campaign of the Pacific Radio Trade Association in reducing interference to radio reception in the San Francisco Bay region that other cities throughout the country are planning similar work. Nearly two

thousand complaints have been investigated and, in a majority of cases, have been remedied during the past year. The work has been financed by the public service corporations whose equipment is sometimes responsible for the interference. Thus neither the radio dealers nor the public has been put to any expense for eliminating these troubles.

The effect has been highly beneficial to the dealers, who are now selling sets where they could not be sold before, and to the listening public who can now enjoy radio without the unseemly noises due to interference. This will also redound to the benefit of the radio industry which is not selfishly allowing the public to suffer after buying radio sets.

* * *

RADIO and aviation typify man's success in piercing four of the seven veils. Nor is this statement purely allegorical. Scientists are gradually adopting the theory that evolution has been coincident with the development of space consciousness. Three of the seven veils that hide the "why" of things are the three dimensions of space: length, breadth and thickness. The fourth is time.

The lowest forms of plant life can be conscious only of the succession of events associated with the passing of time; rooted to one spot they have little or no consciousness of space. The lowest forms of animal life can be imagined as gaining an additional consciousness of space as they move from place to place. The higher forms of animal life are evidently able to think and function in two-space dimensions.

While man has long been able to think in three dimensions, aviation has been his first real opportunity to move in three dimensions. Aviators in the World War have told of watching armies function in two dimensions. While the aviator, from his superior position in the sky, could anticipate inevitable happenings before they occurred, the armies fought blindly because they were unable to see through intervening obstacles.

Radio, by communicating man's thought with the speed of light, has practically nullified both space and time. So now he is ready to conceive of the combination of space and time as the four-dimensional manifold in which world events occur.

AS RADIO develops from an art to a science standards of performance become essential. In the early days a receiver's selectivity was either "broad" or "sharp," its sensitivity was gauged upon its ability to give "coast to coast" reception, and its audio quality was either good or poor.

While these loose terms sufficed for the early state of the art, they are no longer acceptable. How broad is the tuning? What is the overall voltage amplification? What is the gain in deci-bells or transmission units for each of the audio frequencies?

These are questions which can now be definitely answered on the basis of precise measurements. This has recently been made possible by the development of new methods and more delicate apparatus than was required for the older electrical measurements. Many radio measurements in receiving sets are of currents and voltages which are less than one-millionth those used in electric light and power practice. A radio receiver is virtually a power converter whose output in milli-watts is proportional to its input in milli-volts.

The methods used for making these measurements have been described from time to time in the *Proceedings* of the Institute of Radio Engineers. So there is no reason why any radio manufacturer cannot specify that his receiver has a selectivity of such-and-such per cent ten kilocycles from resonance, and a sensitivity such that a stated minimum voltage input is converted into a standard power output, or a gain of so many D. B.'s at 60, 600, and 6000 cycles.

But as yet no authoritative organization has set up what may be accepted as standards of performance. Here is a task that may well be undertaken through the coöperative effort of I. R. E., R. M. A. and Nema committees. Thus it will be possible for the well-informed purchaser to know the relative performance of two receivers whose characteristics are technically defined.

Such standardization would tend to eliminate many careless statements in advertising and develop a public confidence which is now lacking in many of the exaggerated claims that are made by salesmen. Consequently the radio industry would acquire a greater stability. 'Tis a consumation devoutly to be wished!

Radio Marketing for the Farmer

A CENTRAL CALIFORNIA farmer was recently offered 60 cents a bag for his crop of onions by an agent who seemed very eager to buy. Suspecting that the buyer was armed with a superior knowledge of the marketing situation, the farmer got in touch with the Federal-State Marketing Service radio station, KRB, at Salinas, California, asking for a report on crops and current prices. KRB referred the question to the San Francisco station, KRG, where trained market analysts investigated the onion situation and reported at once that onion crops had been badly damaged in other sections and that the demand was on an upward trend. KRG sent the report back to Salinas and the farmer, no longer at a disadvantage, refused the offer of 60 cents, later selling at \$1.65.

This is a typical example of what the U. S. Department of Agriculture and the California Department of Agriculture are doing for the California farmer. Guided by Mr. B. H. Critchfield, Chief of the Division of Markets, the Federal-State Marketing News Service gathers, analyzes and disseminates information regarding the eastern and foreign markets; the supply and demand of farm produce. Effectually, they are equalizing the bargaining power of the farmer with that of the produce buyer.

Six thousand men are in the field to gather this information and send it to Washington for analysis. From here it is sent to San Francisco by leased wire, whence it is relayed to all points in the short-wave radio network.

KRG, the control station at San Francisco, is a 500-watt station, operated on a wavelength of 32.4 meters. The outstanding features of the equipment are its commercial appearance and workmanship combined with its adherence to the low loss principle.

The transmitter is mounted on a cast-iron frame, the separate circuits being isolated from each other with specially

moulded pyrex insulation. The condensers and coupling controls are operated by step-down gears, the scales on the rotor plates passing in back of a marker. The two meters on the antenna condenser panel are thermo-couple ammeters in the antenna and counterpoise circuits.

On the power control panel is mounted the filament and plate switches, filament

resulting oscillation, modulated at about 1000 cycles, is very steady and pleasing to copy.

The transmitters at the field stations are 100 watts in power, self-rectified, and are more or less portable so that they may be moved during the various seasons to more active agricultural centers. A great deal of experimental work was carried on by the engineer in charge, Mr.

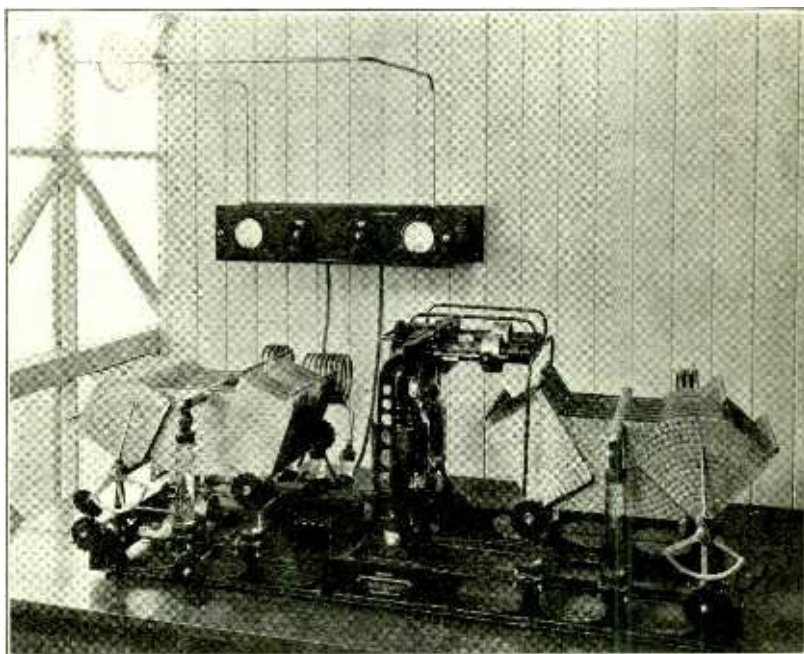

500-Watt, 32.4 Meter Transmitter at Control Station KRG

voltmeter, input ammeter and high-speed keying relay, which breaks the circuit in the primary of the plate transformer. This is a plunger type relay, designed by Ralph Heintz, builder of the apparatus, for continuous operation with a minimum of heating. A tuned-plate tuned-grid, self-rectified circuit is used, employing two UV 20+-A tubes which are supplied with 500 cycle a.c. from a 2 k.w. General Electric alternator. The

Herbert J. Breuer, prior to applying for a certain frequency, in order to determine which was best suited for daylight communication over specified distances. The final choice of 32.4 meters is found to carry much better to Los Angeles and El Centro than to shorter distances such as Sacramento. This is due to the skip distance phenomenon characteristic of short-wave transmission.

The receivers at all stations are tuned-



Power Panel and Receiver at KRG

grid tuned-plate detectors with two stages of a.f. amplification. With plug-in coils they will cover the range of from 10 to 100 meters.

The operators holding down the various stations are on the job from 7 a. m. until 4 p. m., ready to copy the bulletins

themselves, weather reports and requests for information.

And so, by the use of short-wave radio the California farmer is being supplied with hourly information regarding the supply and demand, current prices and trend of the markets for his produce in all parts of the world. He is now able to intelligently distribute his crops, and retain for himself and his community the largest part of the consumer's dollar.

PICK-UP ADJUSTMENT

By THOMAS F. McDONOUGH

IGNORANT use of phonograph pick-up units has caused much unnecessary damage to phonograph records. Too much needle pressure wears out the record. Improper lining-up undercuts the record grooves. Blunt needles impair the tone value and ultimately ruin the record. What is the correct usage?

The correct needle pressure is between 5 and 7 oz., depending somewhat upon the make of the record and the type of recording. This is best controlled by a counterweight, whereby the pressure remains nearly constant in spite of any wobble in the turntable. The proper weight may be checked with a small postal scale, the needle resting upon the surface of the record.

The counterweight can be conveniently arranged as a slider with a thumbscrew to hold it after it has been moved into the best place. This is the minimum pressure under which the needle maintains contact with the bottom of the groove in the record without jumping. This action can be observed by means of a small microscope and a suitable light.

Records where bass notes predominate usually require more pressure than others. Different makes of records require different pressure. The careful man will label each of his records to indicate the counterbalance setting that gives the best results.

To avoid under-cutting the pick-up ought to be so placed that a line drawn from the point of the needle to the center of the tone-arm pivot is tangent to the record groove at the needle's point of contact in the groove. As there are practical limits to the length of tone-arm which would make this possible, the tone-arm should be placed so that there will be a minimum angle (viewed from above) between the needle axis and any of the record grooves at the point of contact.

The axis of the needle should lie in the vertical plane passing through the line drawn from the needle point to the tone-arm pivot. Furthermore, the needle should not be vertical but should be inclined at an angle of about 65 degrees (viewed from the side) to the face of the record. This angle should be such that the needle will not dig in but will glide smoothly.

A new needle should be used each time a record is played. New needles have smoothly rounded points that fit the bottom of the groove properly. They rush along the groove, brushing and sliding past all the side-bumps and corners which represent music, at a pace of from 150 to 200 feet per minute. The pressure on the bottom of the groove often exceeds 30 pounds to the sq. in., and it requires as much energy to drag the needle past the side bumps as is consumed in normal friction on the bottom of the groove. By the time the needle reaches the end of the groove it has been worn blunt on the end. So blunt in fact that it can no longer follow the bottom of the groove closely and instead of sliding around the side bumps it starts "riding the high spots" so to speak. This means that the upper edges of the side bumps are taking most of the strain. In time they will be worn off until the tone value of the record has been impaired or, if the abuse continues, they will give away entirely and the needle will "take off across lots" when it comes to that point and another record will have "gone west."

Records should always be kept clean. Even finger marks contain a trace of oil to which dust will cling. Wipe the record carefully, both before and after use, with a soft brush. Brush along the grooves, not across them.

When the adjustments have been made as here outlined and the foregoing precautions observed, you may be surprised to find the needle scratch conspicuous by its absence. The quality and fidelity of tone should show a marked improvement also.

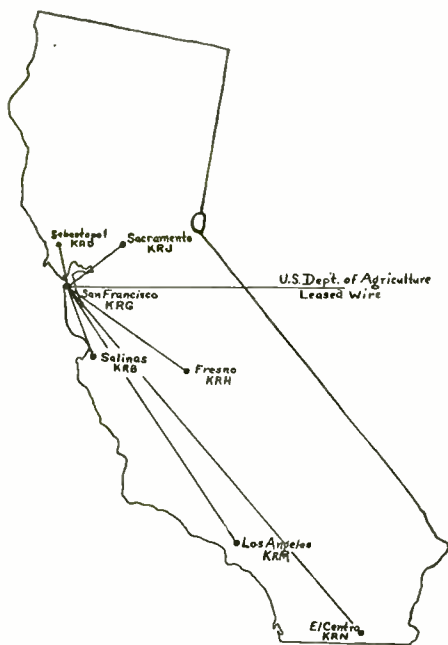

Map of Radio Network

that are constantly pouring into San Francisco from Washington to be transmitted to the network by KRG. The daily traffic over KRG has been averaging 3500 words, most of which is handled at from 30 to 38 words per minute, the operators being among the fastest in the profession. Between bulletins from the eastern and foreign markets the air is filled with reports from the farmers



100-Watt Field Station KRM

Furnished Rooms

By KEITH LABAR

Illustrated by LOUIS McMANUS

IN THE days when weary clerks assured customers that it was unnecessary to have a switch to shut off the B battery all that was demanded from a radio set was noise. A "powerful set" was a rival to the boy saxophonist next door.

Now we demand tone quality and are even progressing to the point where we do not consider that we have that quality if the announcer sounds as if he had taken up residence in a rain barrel. The improvement in quality has resulted from the improvement of equipment all along the line, from the microphone to the speaker. Music, after being carefully led into the microphone, emerges from the speaker without being much the worse for wear.

At this point everyone is satisfied; the engineers consider the job done and go home. And indeed, what more is there to it? The music is coming out of the speaker—good music. It has lots of umpa, umpa. All those low notes. And there is enough volume.

But we do not hear the music by putting our heads into the set. A pair of phones is rarely used for broadcast reception. We hear music in a room, and upon the design and construction of that room depends the quality of the music that reaches our ears.

Reverberation occurs in large auditoriums, especially, when there is a small audience. Many a theatre has gone on the rocks because of poor acoustics but theatres with heavily carpeted foyers, upholstered chairs, and special plaster decorations have acoustics that manage to get by.

But the same conditions apply to the



small living room of the home as are found in large auditoriums. An architect should submit his plans to an acoustical engineer in order to have the acoustics good for radio or piano. Your daughter's expensive voice will sound better in such a room. If a good engineer had been consulted about the "House of Usher," the regretted occurrence might not have happened there.

A sound wave travels with a definite speed in air and hits walls or objects which absorb all or part of the sound, depending on the material. Let us say that the sound is nearly all reflected, only a small portion being absorbed—a condition found in buildings with hard plaster walls. It will then go to the

opposite wall, be reflected again and the process will continue until all of the sound is absorbed.

A sound (one wave or more) builds up and dies out in the manner shown in the accompanying diagram. The second wave overlaps the first, due to the first lingering on and dying a slow death. When the series of sounds is music, the effect is not as displeasing as when there is speech. Overlapping sounds of speech are hard to follow. Remember the good old days when the train announcer would come out on a balcony and in a voice that boomed back from every wall announce the train? 'Member? His children are still announcing.

If we soak up much of the reflected sound by hanging curtains or using sound-absorbing plasters, the overlapping is diminished, as is also the intensity. Even though the actual volume of sound that reaches the ear is lessened, the speech is more understandable.

The reader has perhaps realized that there is some relation between the size of the room and the time the sound should be allowed to bounce around unmolested. The time of reverberation should be from 1.00 to 1.05 seconds for

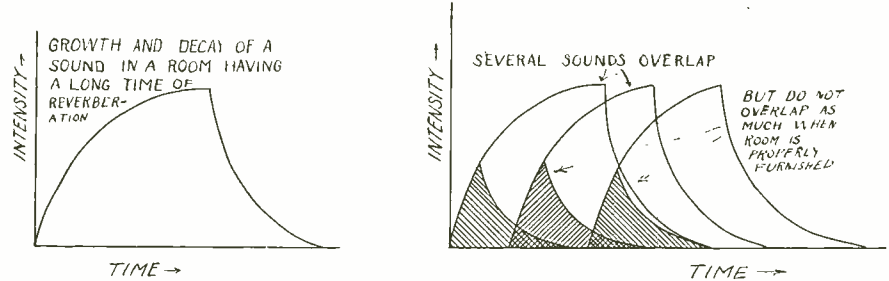

How a Sound Builds Up and Dies Away



Poor Acoustics Have Put Many a Theatre on the Rocks

the small rooms usually found in our homes. The time can usually be found by the formula: $time = .05V \div A$, where V is the cubic feet in the room, and A is a measure of the total absorbing power of the room. If A is small, not much sound being absorbed in walls or otherwise, then the formula shows that the time is large. And again, the larger the cubical size, the longer the time is, for it takes the sound a longer time to get from one wall to the other to be reflected. The factor .05 is merely put in to make the units come out right. It would be different if we measured in ells or meters or other cross-word puzzle units of length.

A is expressed in square feet of a perfectly absorbing medium, such as an open window. For a wall, for instance, it is equal to the area of the wall times the absorption coefficient of the material

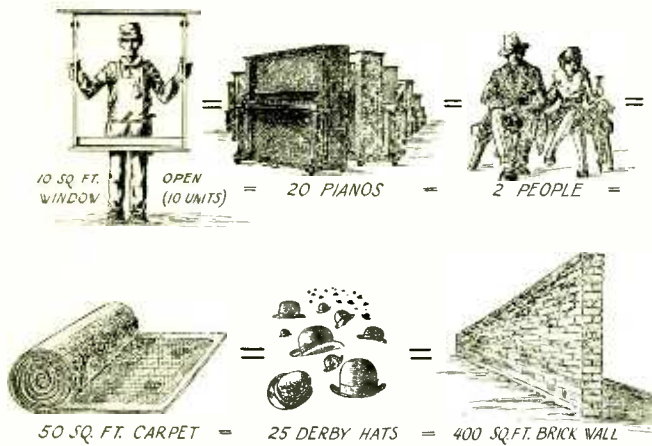

Typical Sound Coefficients



The Room Whose Sound Coefficients Are Figured in the Text

in the wall, or rather, how many square feet of open window is equal to our wall? Those who have calculated the number of rolls of wall paper required to paper a room can hunt for pencil and paper. The equivalent amount of open window for each surface or article in the room, all added up, gives the total number of units of *A* to be substituted in the formula.

Suppose you dwelt in marble halls. Marble absorbs 1 per cent of the sound that hits it, therefore coefficient .01, and reflects 99 per cent. Let us say the dimensions are 100 ft. x 50 ft. x 25 ft., a typical Hollywood bathroom. The calculations would then be:

2 walls 100 x 25 5000 sq. ft. x .01 = 50 units
 2 walls 50 x 25 2500 sq. ft. x .01 = 25 units
 1 ceiling 50 x 100 5000 sq. ft. x .01 = 50 units
 1 floor 50 x 100 5000 sq. ft. x .01 = 50 units

Total 175 units
 $t = .05 \times 100 \times 50 \times 25 \div 175 = 35$ seconds.

Try to put a radio set in such a room, when a sound would be just audible 35 seconds after the set was shut off.

But let us cover up the marble walls and ceiling with a trick plaster having a coefficient of sound absorption of .20 and the floor with a heavy rug with an

absorption of .30, and what do we get?

Total walls and ceiling—
 12,500 sq. ft. x .20 = 2500 units
 Floor 5000 sq. ft. x .30 = 1500 units

Total 4000 units
 $t = .05 \times 125,000 \div 4000 = 1.56$ seconds.

This is a good value for such a large room.

All of these calculations are on the basis of middle "C" on the piano. We assume that the materials take the same helping of low notes as high. Practically, this is not the case. The high notes are absorbed more easily than the low ones. Low notes are absorbed by thick materials, such as a thick rug, overstuffed chairs, curtains hanging in folds and so on. But do not let this worry you.

Now that we are getting into this new game in earnest we need a table of the materials and objects frequently found.

SOUND ABSORPTION COEFFICIENTS	
Carpets, unlined	.15 per sq. ft.
Carpets, lined	.20 " " "
Concrete	.015 " " "
Curtains, cloth	.15 " " "
Curtains, velour	.25 " " "
Books in shelves	.20 " " "
Glass	.027 " " "
Heavy rugs	.25 " " "
Linoleum	.03 " " "
Lime plaster	.04 " " "
Oil paintings	.28 " " "
Open window	1.00 " " "
Plaster on tile	.025 " " "
Soft wood	.06 " " "
Varnished wood	.03 " " "

OBJECTS, PER OBJECT

Audience, per person	4.2
Divan	14.0
Piano	.5
Overstuffed chair	8.

The calculations for the room shown in the illustration are as follows: Length 20 ft., width 14 ft., height 9 ft., volume 2520 cu. ft.

ABSORBING POWER	
Ceiling 25 x 14, 280 sq. ft. x .03	8.4 units
Rug, 9 x 15, 95 sq. ft. x .20	19.0 "
Bare floor 280-95, 185 sq. ft. x .03	5.5 "
Wall with windows 9 x 14 = 126 minus heavy curtains (20), 106 sq. ft. x .03	3.1 "

Note: Glass has same "a" as this plaster and so glass is not calculated separately.

The curtains (estimated) 20 sq. ft. x .25 = 5.0 "

Wall toward us, considered bare 9 x 14, 126 sq. ft. x .03	3.7 "
Wall with archway 20 x 9 = 180 minus archway, area 30, 150 sq. ft. x .03	4.5 "
Archway, 20 sq. ft. x 1.00	20.0 "
Wall where people are sitting 180 x .03	5.2 "
Oil painting 3 x 2, 6 sq. ft. x .28	1.5 "
Divan	15.0 "
Chair	8.0 "
Table	1.0 "
Radio	.5 "
Desk	.5 "

Total 100.9 units

This is equal to a square open window ten feet on a side. $Time = .05 \times 2520 \div 100.9 = 1.25$ seconds. This is a little too much. To cut it down to 1.05 requires that 19 additional units of absorption be added to the room. This can be obtained in the following manner: Three people and a baby, or 76 square feet of velour curtains, or open a window at the end out of the picture, 4 ft. x 5 ft. Or we could use a different plaster.

The small items need not be calculated as carefully as the larger items. The dimensions of the archway are very important, as the effect is large, but we could err in estimating quite a few of

(Continued on Page 32)



The Transmitter and



the Receiver

A Five-Tube A. C. Screen-Grid Receiver

A Discussion of the "Power" Detector as Used in an Experimental Receiver of Excellent Audio Quality

By FRANK C. JONES

SCREEN-GRID tubes may be used in a set as r.f. amplifiers and as a space-charge detector with only one stage of power audio amplification. A so-called power detector is used to work the power tube to its full limit.

This is accomplished by putting a high grid bias on the detector and by using one more stage of r.f. amplification than would be necessary if an ordinary detector and two-stage audio amplifier were used. All of the high frequency components of the detector output are

use of even five or six tuned circuits which are each rather broadly tuned will give a much better band-pass effect wide enough to pass side-band frequencies as high as 5000 or 6000 cycles per second above or below the carrier frequency.

The screen-grid tube as a space-charge type detector does not attenuate the higher audio frequencies in the process of detection as does a grid leak-condenser detector. For this reason the resulting quality from a good dynamic speaker is quite brilliant and has not the muffled

pass condensers are mounted inside of copper cans. In the picture the sides of one can were left off to show a little of the layout. The cans are made of thin sheet copper and are about $3 \times 5 \times 5\frac{3}{4}$ in. in size. Standard parts obtainable on the market may be used throughout.

The r.f. coils were of the double solenoid type to minimize the field in order to use the small size of shielding cans. These coils were wound with No. 28 enameled wire spaced in grooves about 45 turns per inch. There were a total

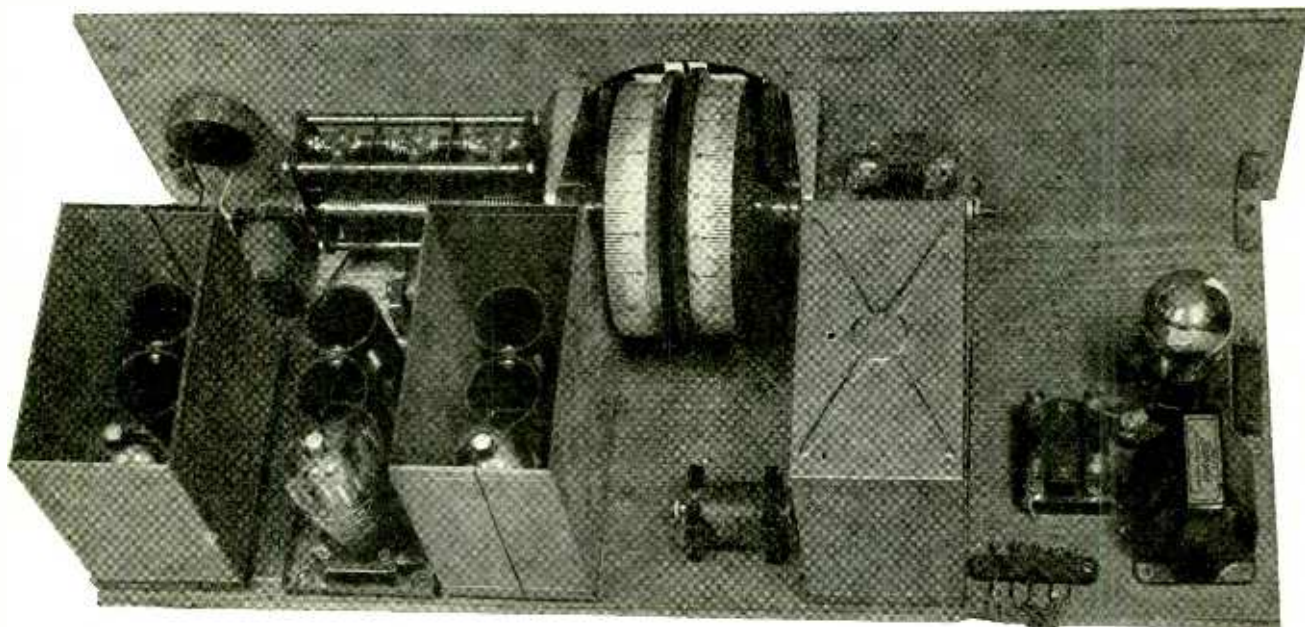

Rear View of Five-Tube A.C. Screen-Grid Receiver

bypassed to ground by a .0001 mfd. condenser in the plate circuit of the detector tube.

Eliminating one audio stage gives better quality with less hum. Even with a.c. filament supply for the '71 tube this receiver gives less hum with a 30-cycle cut-off than is heard from some a.c. receivers with a 200-cycle cut-off. Furthermore any distortion due to the first stage of audio as well as the phase distortion due to use of audio transformers is eliminated in this set.

By using three stages of screen-grid tubes as r.f. amplifiers the r.f. gain necessary for the usual distant reception is obtained. It is generally necessary to have at least four tuned circuits in order to obtain sufficient selectivity. The use of less than four tuned circuits generally means that the tuned circuit losses have to be so low that the upper edges of the side-bands are greatly attenuated. The

sound that many sets have. The low note reproduction is excellent with this detector.

The experimental set shown in the picture was first built for d.c. tubes and then modified for a.c. operation. The set is so satisfactory for a.c. operation that it should be built up that way using a.c. heater type screen-grid tubes. There is some possibility of a.c. modulation if the heavy filament type of a.c. screen-grid tube is used. Screen-grid tubes are recommended due to the gain of 15 to 25 per stage which is one and one-half to two times per stage that obtainable with a multistage amplifier using three-electrode tubes. Three stages of the screen-grid tubes give as much or more gain than a good four-stage r.f. amplifier using ordinary tubes.

The picture shows fairly well the layout of the parts. The four r.f. transformers and screen-grid tubes with by-

of 130 turns, 65 on each tube, which were clamped nearly together. The tubes were $1\frac{1}{2}$ in. in diameter and $2\frac{3}{4}$ in. long. The plate taps should be about 35 turns from the filament end. Tapping higher tends to give more gain, less selectivity, and is also liable to cause oscillation. If a standard solenoid coil is used, it should be tapped at about $\frac{3}{10}$ of the way up, from the filament end.

Using more turns does not increase the gain per stage very greatly unless a tuned impedance is used, since there is a quadrature current which is not exactly in phase with the induced current, especially at the lower end of the broadcast band.

Using an autoformer connection seems to give the greatest coupling of primary to secondary for the same degree of selectivity. Greater coupling means greater amplification. The problem of

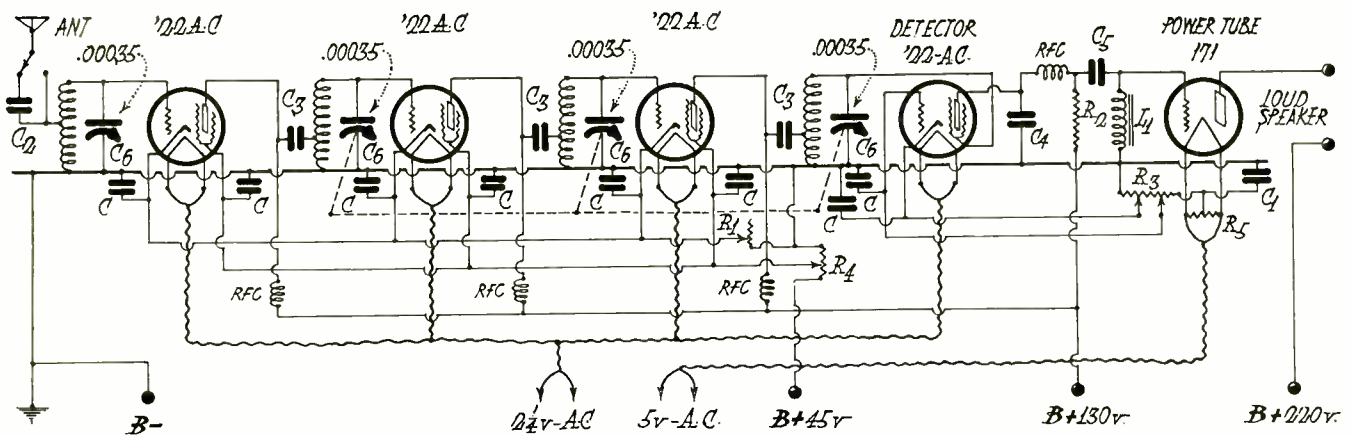

Fig. 1. Circuit Diagram of Five-Tube A.C. Screen-Grid Receiver

R_1 = 0-1000 ohm adjustable resistor.
 R_2 = $\frac{1}{4}$ megohm leak.
 R_3 = 2000-ohm strip with two adjustable taps.

R_4 = 10,000-ohm variable resistance (volume control).
 R_5 = 30-ohm center-tap resistor.

L_1 = 400 henries.
 C = .1 mfd. bypass condenser.
 C_1 = 1. mfd. bypass condenser.

C_2 = .0001 mfd. bypass condenser.
 C_3 = .006 mfd. bypass condenser.

C_4 = .0001 mfd. bypass condenser.
 C_5 = .04 mfd. or larger.
 C_6 = .00035 mfd. variable condenser.

whether a separate primary or an auto-former connection over the whole broadcast band is open for much discussion and experimental work. The number of tuned circuits, losses in each circuit, the amount of shielding, the desired selectivity and gain, and physical dimensions of the coils are all factors which should be considered in the design of any receiver.

Standard .00035 mfd. single and three-gang variable condensers were used. There are two drum tuning controls and a volume control. A 110-volt switch should be located on the panel for convenience. An old *B* eliminator was used for plate supply since it gave about 220-volts on the highest tap and, because of the small drain the adjustable 90-volt tap gave 130 volts for the screen grids. The filaments were heated by means of a small filament type transformer. Since the set was only an experimental set, the 110-volt switch was not mounted on the panel.

The panel was 7 x 24 x $\frac{1}{4}$ in. of three-ply walnut veneer. The baseboard was 23 $\frac{1}{2}$ x 9 x $\frac{1}{2}$ in. of dry spruce. Undoubtedly the set could have been mounted on an 18-in. panel without disturbing the electrical properties of the circuit.

The r.f. chokes should have an inductance of at least 80 millihenrys in order that their effect will be negligible when placed across the primary winding of the r.f. transformers. A similar choke should be used in the plate circuit of the detector, since there is a very strong r.f. voltage which would tend to overload the power tube.

The screen-grid detector requires from 10 to 15 volts bias on the input grid for bias detection at the other voltages used. By using the arrangement shown in the wiring diagram for obtaining bias voltages for the '71 tube and detector, the

proper adjustments for maximum sensitivity and quality are obtained. R_3 consists of a 2000 ohm resistor with two adjustable sliders for the cathode and space charge grid connections. The latter should be from 10 to 20 volts positive with respect to the cathode and the cathode about 12 volts positive with respect to *B*—. The drop across the whole resistor gives the proper bias for the '71 tube. Incidentally the '71 tube should not be used when its emission begins to drop. If the '71 tube does not draw somewhere near its rated current, the bias voltages on the detector tube will not be correct.

The audio coupling unit consists of a 250,000-ohm resistor R_2 for connecting the plate voltage to the detector, and a resonant circuit coupling to the grid of the power tube. This circuit resonates at about 40 or 50 cycles per second when using a blocking condenser of .04 mfd. and a grid audio choke of about 400 henries. A grid choke is somewhat preferable to a grid leak as the '71 tube does not block when overloaded occasionally. Using a choke means a slight drop at the lower audio frequencies because of its lower impedance for lower frequencies. By using the principle of resonance there is an increase of voltage across the condenser and choke due to the increased current. The sharpness of resonance depends upon the series resistance of which the R_p of the tube and R_2 are in parallel. This resistance is so great that the resonant action is not very noticeable though it does bring up the low notes a little. It is difficult to test by ear because few broadcast stations transmit notes low enough to check this action.

Bias for the r.f. amplifiers may be obtained by means of the 1000-ohm semi-variable resistance in the common plate return to the cathodes, or center tap of the filaments if the heavy filament type of tubes are used. Volume control is obtained by varying the positive bias on

the screen-grids from 0 to 45 volts by means of a 10,000-ohm potentiometer. This arrangement controls the gain of all three stages so the tube noises are minimized for local reception. It also gives very positive control of volume, which is generally a real problem in a.c. tube receivers.

A short aerial was used with the set since there are 35 turns for coupling to the antenna in the first r.f. transformer. If a long antenna is used, a fixed condenser C_1 of .0001 or .00025 mfd. should be cut in series with the aerial.

In lining up such a receiver, all voltages should be checked with the volume control set up towards maximum value. There is nothing complicated about the procedure. The bias resistor R_1 can be adjustable for obtaining the best setting. R_1 and R_3 can be mounted either in the set or in the power pack.

No output transformer is shown since most good dynamic loudspeakers have an output transformer incorporated in them. Generally better results can be obtained by using a 30 to 50 henry choke to supply the plate voltage to the '71 tube and connecting the loudspeaker output transformer from filament to plate through a .4 mfd. condenser. This prevents the d.c. plate current from lowering the primary inductance of the output transformer and so dropping some of the lower notes.

The main idea of this article is to encourage the use of the screen-grid tube as a power detector in a.c. receivers. The choice of r.f. amplifiers is immaterial as long as sufficient gain is obtained. For local reception only, one stage of screen-grid r.f. amplification is generally sufficient with this system. The type of power tube is immaterial also, either a '71 or '50 being satisfactory. The '50 tube will, of course, give much greater volume without distortion, but costs more and requires a more expensive power pack.

Radio Picture Transmission and Reception

Photoelectric Equipment and Methods for Visual Communication

By JOHN P. ARNOLD, *Departmental Editor*

AMPLIFICATION OF PHOTO-ELECTRIC CURRENTS

IT IS largely due to the introduction of vacuum tube amplifiers into telephony that the transmission of images has become something more than a rather uncertain and certainly an elementary form of communication. Without them, phototelegraphy and television would have very little significance in the modern sense, since the electrical output of the alkali metal photoelectric cell, which is the heart of practical systems, is extremely minute and, without amplification, such currents cannot be transmitted over ordinary communication channels.

The employment of the thermionic vacuum tube itself in amplifiers is quite familiar to those engaged in communication engineering. It is enough to say that the tube acts as a relay in that small voltages delivered to its grid produce large variations in the plate circuit cur-

rent. With a number of these tubes and their attendant apparatus connected in cascade, variations of potential impressed on the grid of the first tube are increased in magnitude through the amplifying system to the point where the power developed in the output of the last tube is sufficient to be transmitted to a distant receiving station.

When a photoelectric cell of the alkali metal type is connected to the input of a vacuum tube amplifier, "the cell may be considered for our purposes as an impedance, the value of which is determined by the quantity of light reaching it. With no illumination this impedance is almost entirely a capacitance of the order of 10 m.m.f. When the cell is illuminated this capacitance becomes effectively shunted by a very small conductance which is roughly proportional to the square of the voltage between the electrodes. For a fixed potential the magnitude of this conductance is nearly

a linear function of the illumination. With a suitable potential in series with the cell, then, there is obtained a current whose amplitude is proportional to the quantity of light reaching the cell." (See reference 1.)

For an example of how a cell is coupled to the input of a tube refer to Fig. 1, which shows a schematic diagram of a direct current amplifier used for the transmission of photographs over telephone lines. Below each individual circuit in this drawing are the characteristic curves of the tubes showing how the linear function between the illumination and the current is maintained during the progress of the signals through the amplifier. The current generated in the output of the photoelectric cell (at the extreme left) passes through the high resistance (I_0), and the potential tapped off this, of about 30 or 40 millivolts, is applied to the grid of the first vacuum tube. By appropriate grid biasing voltages (E_g), the range of current variations, is confined to the straight portion of the tube characteristic. The result of using the straight portions of the tube characteristic is that the received current, instead of varying between zero and a finite value, varies between two finite values. As will be shown elsewhere, this electrical bias can be matched by a mechanical bias of the light valve aperture at the receiving station.

When the same instruments can be used for both phototelegraphy and television, they are required to operate under much more rigorous conditions in the latter type of communication than in the former and are often taxed to the limit of their capacity. This is also true in the case of amplifiers. To transmit what we would consider a very crude series of images requires that not only a wide band of frequencies must be equally amplified over the entire range, but what is more difficult to encompass, the amplifier must operate from an input which is naturally small, since the light reaching the cell is that reflected from the subject to be transmitted.

In regard to the frequency range, to take a specific case, that of the Bell Laboratories system, it was found that a 50-line image transmitted at a rate of sixteen pictures per second required a frequency band from 10 to 20,000 cycles wide. By experiment, it was determined that the amplitude frequency must be constant to about plus or minus 2 T. U. and that the phase shift throughout the range must be "maintained so that the slope of its characteristic as a function

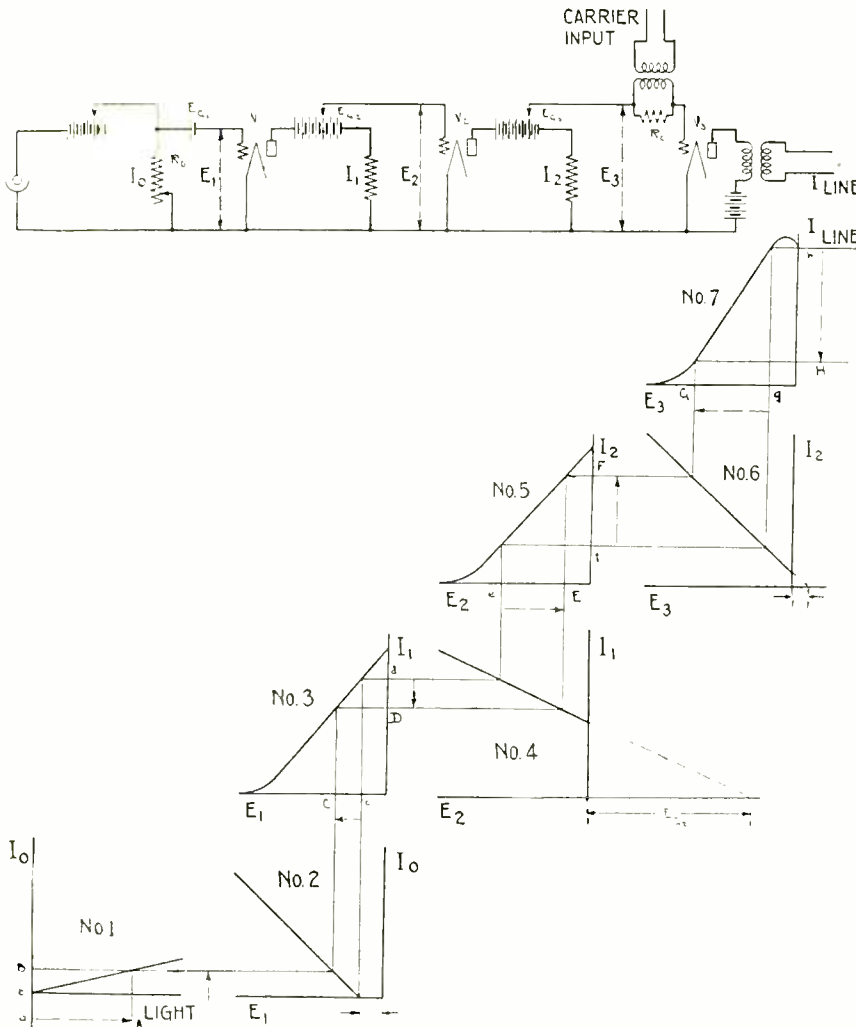

Fig. 1. Circuit Diagram and Characteristics of Amplifier-Modulator for Still-Picture Transmission

of frequency is constant to plus or minus 10 or 20 micro-seconds over all but the lowest part of the frequency range," where fifty times this limit was considered the maximum permissible. (See reference 2.)

The frequency band requirements as recounted in the foregoing paragraph were readily met, but the extreme weakness of the photoelectric currents demanded that especial precaution be taken to preserve the character of the signals. The usual sources of interference that arise in a case of this nature, where extreme amplification is necessary, are electrostatic and electromagnetic induction and mechanical and acoustic vibrations. The electrical disturbances can be reduced to a minimum by placing the amplifier close to the photoelectric cells, keeping the leads short and direct to avoid pick-up and closed loops of appreciable length. Vibrations, set up either directly through the supports of the apparatus or by sound waves acting upon the elements of the vacuum tubes, are avoided by lining the amplifier box with sound absorbing materials and by placing the tubes, wrapped in felt, in lead containers which are mounted on elastic supports. The so-called "peanut" tube has been found to be rather free from microphonic disturbances, and was used for the input stages of the amplifier to be described.

The amplifier circuit is shown in

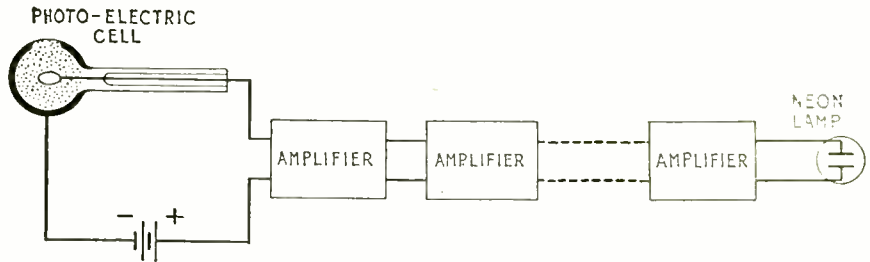

Fig. 3. Position of Amplifiers in Television Circuit

100,000-ohm resistance in series with the cell, the potential available at the first tube was roughly 10 microvolts, which, needless to say, is very small indeed.

The utilization of the output of amplifiers at both the sending and receiving stations is most conveniently described, as it shall be, in another place: our purpose here has been merely to discuss the

tensity which are distributed by a scanning system (not shown) so as to reconstruct images of the original subject.

It is not necessary to describe the repeating or receiving amplifiers at length. Once the signals are raised to a manageable level they are not allowed to fall below the point where especially designed apparatus is again required. A

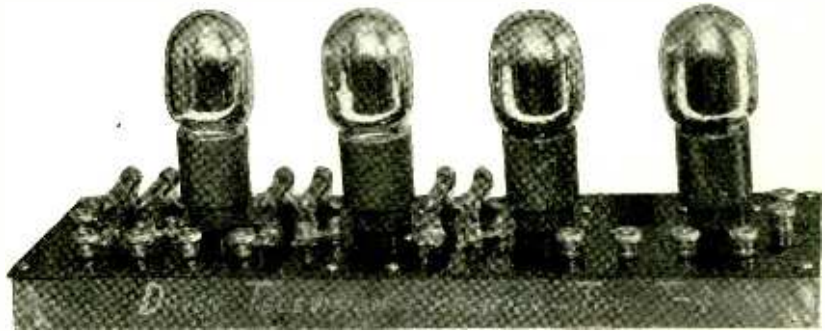

Fig. 4. Commercial Four-Stage Resistance-Coupled Amplifier of Received Television Signals

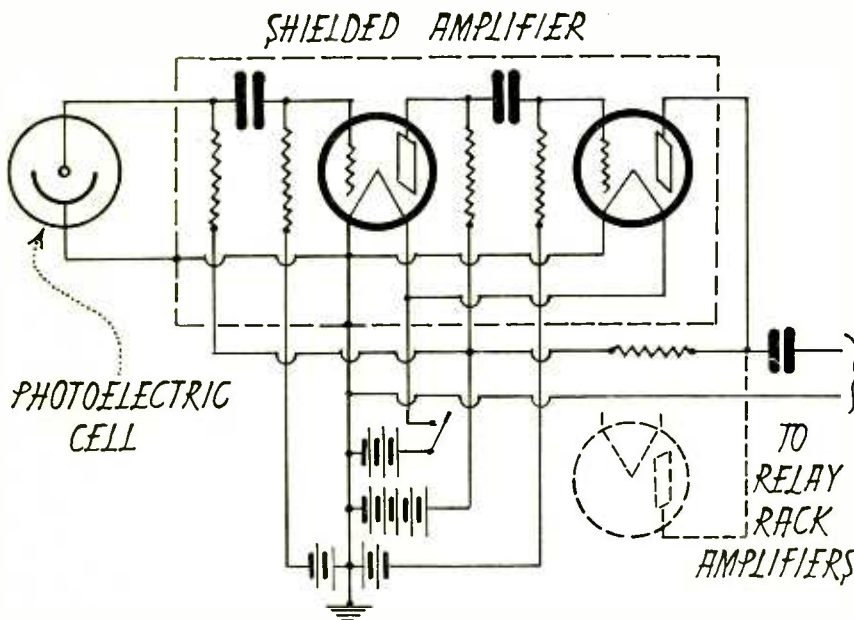

Fig. 2. Preliminary Stages of Television Amplifier Circuit

Fig. 2, or rather the preliminary stages of the amplifier, which is of the resistance-capacitance type and includes ten stages in all, the latter eight being similar to those shown in the diagram. The total amplification was about 130 T. U. It was from this known gain that the engineers were able to gauge the magnitude of the input to the amplifier from the photoelectric cell. This was found to be about 10^{-15} watts or, with a

functions of the amplifiers themselves. Where amplifiers are placed in a television system may be seen from Fig. 3. The initial amplifier increases the value of the minute image signals generated in the output of the photoelectric cell, repeating amplifiers are inserted along the line (the channel is a telephone circuit), and the receiving amplifier feeds the signals to a neon lamp, whereby the signals are converted to variations of light in-

commercial type of amplifier, which may be used in conjunction with the ordinary radio receiver, is shown in Fig. 4. It is of the resistance-capacitance type. Particular care should be taken in designing this apparatus to avoid electrical and mechanical interference as in the case of the initial transmitting amplifier. Other disturbances than those already mentioned are usually traced to defective resistances used in the grid and plate circuits of the tubes. In other respects these amplifiers do not differ materially from those used in speech reception.

SELECTED BIBLIOGRAPHY

1. Gray, Horton and Mathes: "The Production and Utilization of Television Signals." Bell Sys. Tech. Jour., Vol. 6, pp. 560-603; October, 1927.
2. Ives, Horton, Parker and Clark: "The Transmission of Pictures Over Telephone Lines." Bell Sys. Tech. Jour., Vol. 4, pp. 187-214; April, 1925.
3. Schriver: "Über Verstärkung in der Bildtelegraphie," (On Amplifiers for Photo-telegraphy). Telefunken Zeitung, Vol. 11, pp. 78-84; October, 1927.
4. Gherardi and Jewett: "Telephone Repeaters." Proc. A. I. E. E., Vol. 38, pp. 1287-1345; November, 1919.

ERRATUM NOTICE: In Fig. 2, page 22 of December, 1928, RADIO, the milliammeter connections are reversed. They should be changed so as to show a connection between the positive milliammeter terminal and the positive "milliamperes" input, and no connection between the positive milliammeter terminal and the negative milliamper input.

AUTOMATIC SYNCHRONIZATION

The greatest drawback to present television technique is in the manual synchronization of the scanning disk of the receiver with that of the transmitter. The usual practice is to use a suitable variable resistance in series with the motor, together with a push-button that short-circuits the resistance for quick starting and for momentary acceleration of speed in getting the scanning disk in phase with the image. While such a method has served the purposes of experimental television, an automatic means of synchronization must be employed if television is to be placed in the hands of the layman.

Research has led to an automatic television unit, comprising a driving motor,



Fig. 1. Automatic Television Unit

automatic speed control, and an adjustable neon-lamp mounting, as shown in Fig. 1. The scanning disk is optional with the experimenter, since different television signals call for different scanning disks.

The motor is of 1/25th h.p., high-speed type, with suitable reduction gearing and flexible coupling for driving the scanning disk. This arrangement provides the greatest degree of correction, and eliminates troublesome alignment of drive shaft and scanning disk arbor. On the motor shaft is mounted a special centrifugal governor actuating a pair of contact points in series with the motor current supply. The contact points are shunted by an adjustable resistance. Thus when the speed of the motor rises above a given point, the centrifugal governor opens the contact points, thereby reducing the current to the extent of the resistance then thrown into the circuit. As the speed of the motor falls below a given point, the contact points close, short-circuiting the resistance and restoring full current to the motor.

Two power rheostats are used as the controls for obtaining any desired speed and also for trimming the sparking at the contact points by varying the degree of short-circuited resistance. The knobs of the rheostats are at the front end of the motor base. In addition, there is a small knob for adjusting the contact points, which serves as a vernier in obtaining precise speed even to one revolution.

Provision is made for mounting any scanning disk on the drive shaft. The neon lamp is mounted on an adjustable platform which, by means of rack and pinion movements, may be micrometrically raised or lowered as well as shifted from side to side. In this manner the light source can be readily adjusted for any variation in the neon lamp, as well as to align the image with the opening through which the image is visible.

In operation, the speed control knob is adjusted for the necessary speed, which may be anything from a few revolutions to many hundred. Vernier adjustments to within a single revolution or less, are made with the small knob that regulates the contact points. Finally, sparking at the contact points is reduced by the knob controlling the short-circuited resistance until it is almost imperceptible. A constant speed is now maintained with speed correction at every fraction of a revolution. The sparking at the contact points in no way interferes with the delicate receiver employed for television signal reception.

With this device, synchronization is simple and positive, and we might say that it is practical, at least within the limitations of our present technique. The television image is brought on the screen by varying the motor speed until the correct speed is obtained. This speed is then held just so long as the controls are left alone.

THE RAYFOTO SYSTEM OF STILL-PICTURE RECEPTION

(Continued from January issue)

THE mechanical printer unit consists of a metal cylinder around which is wrapped a sheet of photographic paper, a metal stylus or needle which rests lightly upon this paper, and a friction clutch whereby the rotation of the cylinder may be arrested while the driving machinery is still free to turn. This unit is mounted on a triangular base which can be placed over the turntable of any phonograph so as to drive the cylinder and cause the stylus to trace a spiral course over the photographic paper.

Three connections are necessary to unite the amplifier-oscillator circuit to the printer unit. Flexible leads from the binding posts *L* and *M* on the former are connected to the windings of a trip magnet located under the cylinder of

the printer. The only other connection is a wire from the high frequency end of the corona coil, N_1 , to the stylus holder on the printer unit, Figs. 2 and 3.

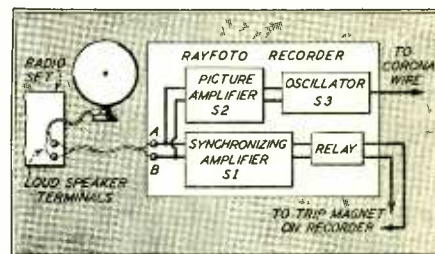

Fig. 2. Pictorial Diagram of Amplifier System

This lead should be of No. 22 or 24 wire and should not be longer than 3 ft., preferably about 1 ft. The wire should not be placed near any other conductor.

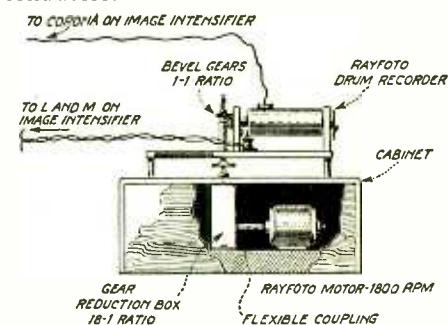

Fig. 3. Mechanical Printer Unit

Synchronism is effected by the "stop-start" system and is entirely controlled by the transmitting station. When the receiving cylinder makes one complete revolution, the check comes in contact with a lever on the trip magnet which is not released until a strong 1500-cycle signal from the transmitter, only passing through the synchronizing circuit due to its selective filter, actuates the relay and causes the trip magnet to release the cylinder. Thus synchronism

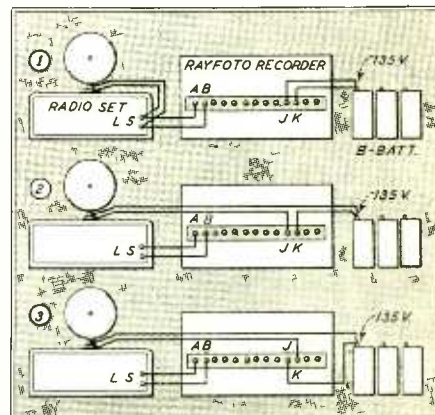

Fig. 4. Test Connections

is checked at every revolution or about 80 times for every linear inch of the picture.

After the various parts have been assembled and the batteries connected, the

constructor should first test the synchronizing circuit. To do this, the switch on the panel of the amplifier-oscillator unit is turned to the "On" position and the loudspeaker leads transferred to the points shown in diagram 2, Fig. 4. The receiver may be tuned to any station broadcasting speech or music. The input control R_1 , is turned to the mid-position and the relay adjusted until it clicks whenever a loud signal of 1500 cycles is heard in the speaker. Once this adjustment of the relay is accurately determined, no further attention should be necessary. Any movement of R_1 to the right will serve to increase the strength of the signals. Such results indicate that the synchronizing circuit is in working order and will operate on actual picture broadcasts.

To test the picture amplifier, the speaker leads are connected as in diagram 3, Fig. 4. Musical notes, probably badly distorted as before, will also be heard in the speaker, but this indicates that the signals are being carried through to the oscillator circuit. When this circuit is functioning properly, a flashing light will appear in the indicator at the top of the corona coil. A small piece of white paper is now placed on the cylinder with the stylus resting lightly upon it and the control R_1 turned to the left so that the relay does not release the cylinder. The variable condenser VC_1 is adjusted until the stylus begins to discharge upon the paper. This spark will just be visible in the dark when R_1 is turned fully to the left. The intensity of the discharge varies at different settings of the condenser and the ideal adjustment is just below the point which gives the most intense spark. Once made this adjustment need not be changed. With these tests completed the receiver is ready for operation on picture signals.

From what has gone before the reader has probably rightly suspected that a dip into photographic processes will be required for the reception of pictures. It is for this reason: The light and shade of the transmitted photograph is converted to variations in intensity of an 800-cycle note which, after reception and amplification, is fed into the oscillator circuit where the high-frequency output of the corona coil causes the spark discharge from the point of the stylus. The ultra-violet light of this spark affects the photographically-sensitive paper wrapped around the drum in accordance with the tone values of the original picture. The reproduction is of course a latent image, (See "Radio" for Sept., pp. 25-26), that is, it must be developed and "fixed" in order that the picture may be seen. This is a very simple process and will give the experimenter no difficulty. The method will be described in the next article on the actual reception of pictures.

(To be Continued)

"TELEVISUALIZATION" AS IT WAS

The New York *Herald* of April 8, 1910, contained the following remarkable interview with William Vincent Pruscino, a young Italian, of Rochester, New York, who invented a gadget which he called a "televisualizer."

"The invention which I have made and the apparatus which I have succeeded in putting together is sufficient for me to make the assertion that I can visualize an object at a distance of thousands of miles. The object can be seen with its properties of color effects, dimensions and movements and will be equal to the original with the exception that the object itself cannot be felt with the fingers.

"The actual demonstrations made by me not many weeks ago have completely satisfied me that seeing at the distance of ten or twenty thousand miles is no more an impossibility; but on the contrary, is absolutely possible."

The young inventor feared that someone would steal his idea and destroyed the apparatus he had constructed. Finally, it was reported, he found financial support and was about to apply for a patent. Whether he ever did so, I am not certain, but I do not recall ever seeing any patent papers in that name.

In the New York *World* of December 12, 1909, appeared the following: "A press dispatch from Mexico City less than three months ago reported that Alberto Sanchez, an electrical engineer, had invented a 'teleradiopticon' which would transmit vision as well as voice over an ordinary telephone wire. The apparatus resembled a short opera glass attached to a battery, and it was declared by persons who witnessed them that the tests were successful."

"Devices for 'seeing at a distance,' remarked a disillusioned paragrapher in the New York *World* for June 10, 1909, "are now almost as numerous as catarrh cures and just about as effective."

But there you are and here is the moral. Twenty years ago they had just as grand ideas about television as we have today. Villon was pleased to inquire: "*Où sont les neiges d'antan?*" Twenty years hence, we may resume the plaintive strain—where are the snows of yesteryear?

RADIO PICTURE STATIONS

Station	Location	Wave Length
WMCA	New York City	526.0
WTMJ	Milwaukee, Wis.	526.0
KMOX	St. Louis, Mo.	275.1
WJR	Detroit, Mich.	399.8
WFBL	Syracuse, N. Y.	333.1
KFEL	Denver, Colo.	267.8
KXA	Seattle, Wash.	526.1
CKNC	Toronto, Canada	516.9
KWCR	Cedar Rapids, Ia.	229.0
KFPY	Spokane, Wash.	247.9
KSTP	St. Paul, Minn.	205.4

HOW TO MAKE 30 K.C. I.F. TRANSFORMERS

By R. WM. TANNER

SATISFACTORY transformers for use in the intermediate frequency stages of a superheterodyne can readily be made by winding the proper number of turns on a wooden dowel drilled with a center hole for an iron core. These transformers will peak at about 30 kilocycles and may be adjusted by changing the capacity of the condenser shunted across the primary of the transformer in the last stage.

The winding forms are wooden dowels 1 in. in diameter and $1\frac{3}{4}$ in. long and drilled with a $\frac{1}{2}$ -in. hole through the center.

The type of tube determines the ratio of the number of turns between the primary for secondary. For type '99 tubes this ratio should be 2.2 to 1; for the '01-A type 2.9 to 1; for the '12-A type 4 to 1; and for the '22 type 1 to 1. The following description applies to the '01-A type.

To reduce the capacity coupling between the primary and secondary, and thus increase the gain per stage, an electro-static shield is placed over the primary winding with the ends about $\frac{1}{4}$ in. apart. This shield is grounded to the outside copper shield, which is, in turn, grounded to the negative filament.

The primary consists of 690 turns (for '01-A tubes) of No. 36 enamel wire either scrambled or wound in layers, directly on the wooden form, leaving about $\frac{3}{16}$ in. at both ends clear. Two layers of heavy paper and the electro-static shield are placed over this. The shield should be slightly longer than the windings as described below. It might be well at this time to solder a short length of wire to the shield and then wrap on a few layers of paper. The secondary consists of 2000 turns of No. 36 enamel and may, like the primary, be wound either in layers or scrambled. After the windings are completed, "boil" each transformer in paraffine to exclude all moisture and to hold the wire in place.

Two disks of $\frac{1}{8}$ -in. cardboard or fiber, a little larger in diameter than the windings and having a hole in the center are tightly fitted on the ends of each wooden form. As much No. 36 soft iron wire as possible is then crowded in the holes drilled in the forms. It is a good plan to tie the wires together with fine silk thread to insure solidity of the core.

The output transformer has a primary of 375 turns of No. 36 enamel and secondary of 2100 turns. An electro-static shield is used in the same manner as in the other transformers. When connected in circuit, the primary is shunted by a .007 mfd. condenser.

A short length of insulated flexible wire should be soldered to the four leads

(Continued on Page 34)

The Screen-Grid R. F. Amplifier

By J. R. NELSON

Engineering Department, E. T. Cunningham, Inc.

ALTHOUGH the screen-grid tube is very valuable as a radio frequency amplifier, there are two widely-accepted misconceptions as to its performance. One is that the use of this tube results in a much less selective r.f. circuit than may be obtained with a three-element tube. The other is that it entirely eliminates the feed-back capacity between the tube elements, and consequently that shielding is not necessary to prevent oscillation. Let us consider these two misconceptions.

The selectivity S of a coil is defined by $S = \frac{\omega L_2}{R_2} = \frac{f_r}{f_1 - f_2}$ (1), where

L_2 is the inductance of the coil in henries, ω is 2π times the frequency, R_2 is resistance of the tuned circuit, f_2, f_1 are the frequencies at which the current has 0.707 of its value at resonance, and f_r is the resonant frequency. This equation defines the selectivity of the coil L_2 alone.

When the L_2 is used in an amplifier as shown in either Fig. 1 or Fig. 2, the

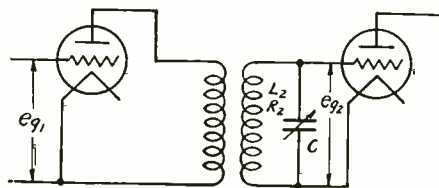

Fig. 1. Transformer-Coupled R.F. Amplifier Circuit

selectivity of the circuit is less than the selectivity of the coil alone. In Fig. 1 the plate resistance adds a resistance to the secondary resistance. The selectivity of the circuit is given by

$$S = \frac{\omega L}{R_2 + \omega^2 M^2} \dots\dots (2)$$

for Fig. 1 and by

$$S = \frac{\omega L}{R_2 + \omega^2 L^2} \dots\dots (3)$$

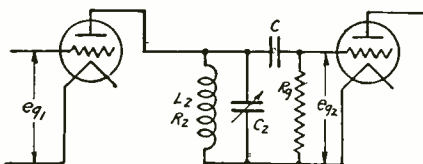

Fig. 2. Impedance-Coupled R.F. Amplifier Circuit

for Fig. 2, where M is the mutual inductance. In both circuits there is an additional loss caused by the presence of the condensers, shields, and any other metal that might be present. Equations 2

and 3 will be further discussed with the amplification equations.

In both Figs. 1 and 2 the voltage amplification, A_v , is defined as the ratio of e_{g2} to e_{g1} . The amplification is taken as the true repeater value, that is, the output does not affect the input so that regeneration is not considered.

The maximum possible amplification of a given tube and coil arranged in a circuit similar to Fig. 1 is given by

$$A_v = \frac{1}{2} \frac{\omega L_2}{\sqrt{R_2}} \frac{\mu}{\sqrt{r_p}} \dots\dots (4)$$

where μ is the amplification factor of the tube and r_p is the internal impedance of the tube. The coupling required to give this value of amplifications is

$$\omega^2 M^2 = R_2 r_p \dots\dots (5)$$

Under these conditions the selectivity of the coil and circuit is only one-half of the selectivity of the tube alone. It is possible to obtain greater than optimum coupling with three element tubes excepting possibly the high μ tubes such as the CX-340. It is, however, impossible to obtain optimum coupling with screen grid tubes such as the CX-322 with the conventional radio frequency type of tuned circuits. The selectivity of a circuit using a screen grid tube is always greater than one-half of the selectivity of the coil alone.

If the coupling does not have its optimum value the amplification is given by

$$A_v = \frac{\mu}{r_p} \frac{\omega M}{R_2 + \omega^2 M^2} \dots\dots (6)$$

In the usual three-element tube circuit ωM is considerably smaller than the optimum value (Eq. 5). The selectivity for this case has some value between the selectivity of the coil alone and one-half of its value. Equation 6 also applies to the screen grid tube. For the same selectivity considerably more amplification may be realized with the CX-322 tube than with a three-element tube, provided the coil is correctly designed.

In order to make ωM in (Eq. 6) large, a large primary inductance closely coupled to the secondary inductance L_2 is required. If the primary has about the same inductance as the secondary and is wound with rather large wire, about No. 24, the dielectric and eddy current losses will be excessive. The selectivity will be poor and the set will tune broadly. The correct method of obtaining a high primary inductance is to wind it with No. 36 wire or smaller. This may be coupled rather closely to the secondary without adding much loss. If the secondary coil is good, the value of the selectivity will be high.

As it is impossible to make M large enough with the conventional tuned radio frequency circuit to satisfy Eq. 5, the circuit of Fig. 2 is sometimes used. Its impedance at resonance is considerably higher than that of a circuit such as Fig. 1. The value of R should not be too low. It adds loss to the secondary resistance and the value of this added loss is

$$R = \frac{\omega^2 L^2}{R_g} \dots\dots (7)$$

The higher the value of R_g , the smaller is the added loss. The amplification is given by

$$A_v = \frac{\mu}{r_p} \frac{\omega L_2}{R_2' + \omega^2 L^2} \dots\dots (8)$$

where $R_2' = R_2 + \frac{\omega^2 L^2}{R_g}$

This amplification is higher than may be obtained with the usual transformer-coupled circuit. The selectivity is poorer, however, with impedance coupled circuits. Almost as much amplification may be obtained with a transformer-coupled circuit, so that, in general, an efficient transformer-coupled circuit may be satisfactorily used with a screen grid tube.

In any circuit using a tube with a control grid and plate the input and output circuits are coupled together through the control grid-to-plate capacity. This mutual coupling is enough to make most circuits oscillate in broadcast frequency amplifiers. There have been several methods of stopping the oscillations. The first one used was that of adding loss to stabilize the amplifier. This has not been very satisfactory except for the one using a resistance of several hundred ohms in series with the grid. The best method before the screen grid tube was available was to add another condenser in a bridge network to neutralize the effect of the control grid-to-plate capacity.

The plate and the control grid in a screen grid tube have a grounded conductor, the screen grid, to shield them. This prevents any lines from one reaching the other. If the screening or shielding action were perfect, the control grid-to-plate capacity would be zero. The screening is very good, however, in a tube such as the CX-322. The control grid-to-plate capacity is only .025 mmfd., less than one-hundredth of that of an ordinary three-element tube. The capacity is not increased by socket connections as the control grid is brought out at the top of the tube and the plate at the bottom.

An Effective Antenna Coupling Unit

By THOS. A. MARSHALL*

The limit of stable amplification of a single stage amplifier using the CX-322 plotted against frequency is shown by Fig. 3A. The value of control grid-to-plate capacity used in calculating this curve was .025 mmfd. This is the maximum permissible value and most tubes have a capacity under .02 mmfd. This is for an extreme condition so that the permissible amplification in practice would be higher than shown by the curve.

Fig. 3B shows how the critical value of amplification would be reduced when the total control grid-to-plate capacity is doubled. This condition might be found when no shielding is used between input and output circuits. From the reduction of the critical value of amplification to cause oscillations to occur it is easily seen that care is required in shielding and arrangement of the parts if a stable amplifier is desired.

To show what has been accomplished in the screen grid tubes, Fig. 3C shows the limit of stable amplification using a CX-301A tube in a single stage tuned radio frequency amplifier. The limit would be raised if the grid plate capacity were neutralized, or if a resistance were inserted in series with the grid. Curves A and C, however, are for the same conditions and show how much the screening raises the limit of stable amplification, which is the factor of most practical interest in the operation of the screen grid tube.

Although the critical value of amplification or slightly greater amplification may be realized in practice, the circuit might or might not oscillate, depending

(Continued on Page 34)

THE antenna coupling unit described in this article was designed primarily to prevent re-radiation of the oscillating energy developed by the autodyne detector circuit and to aid in reducing interference to nearby receivers. After a suitable circuit was developed to bring about the required results it was found that a resultant increase in sensitivity and selectivity was made possible. The signal was increased about three

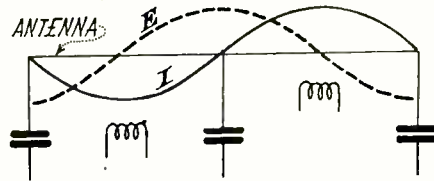

Fig. 1. Current and Voltage Distribution in Antenna System

times in the 18,000 k.c. band and was estimated to be as high as fifty times in the lower bands.

It is the writer's belief that most radio fans pay little attention to the problem of obtaining the most out of their receiving antenna since practically all receiving circuits are coupled to the antenna through a small condenser or by means of a few turns of inductance.

Fig. 1 shows the voltage and current distribution in an antenna system. For maximum signal strength the type of

* Formerly of the U. S. Naval Research Laboratory, Bellevue, D. C.

coupling along the antenna should be used as shown. Note that for greatest signal strength the antenna should be coupled capacitively at the voltage points and inductively at the current loop points. Thus, in an antenna operated at full wave or second harmonic, the antenna turns are at the current node point with maximum voltage in the coil system, resulting in the transfer of energy taking place capacitively rather than by inductive coupling. At other points the current and voltage distribution in the antenna system may be such that their respective fields neutralize one another, resulting in practically zero coupling.

Fig. 2 shows the distribution of voltage and current where an antenna is $\frac{3}{4}$ wavelength and adjusted for reception on the third harmonic. Fig. 3 shows the voltage and current distribution

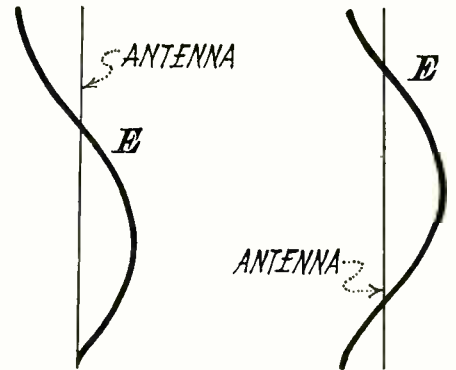

Fig. 2. Distribution in $\frac{3}{4}$ Wavelength Antenna

Fig. 3. Distribution in Full Wave Antenna

taking place in an antenna operated on full wave or second harmonic. Note that the antenna turns are at the current node point with maximum voltage in the coil system.

In all antenna systems, the current and voltage nodes and loops move along the antenna system as the frequency of the oscillating detector circuit is varied.

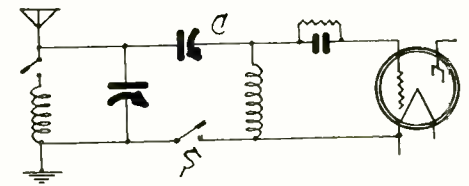

Fig. 4. Adjustable Antenna-Coupling Circuit

Thus, it is at once understood that a condenser-coil combination as illustrated in Fig. 4—will enable a variation of voltage and current distribution along the antenna system to be adjusted at will, resulting in a reduction in losses of signal strength taking place between current and voltage nodes as experienced in untuned antenna systems.

The greatest impedance of the con-

(Continued on Page 36)

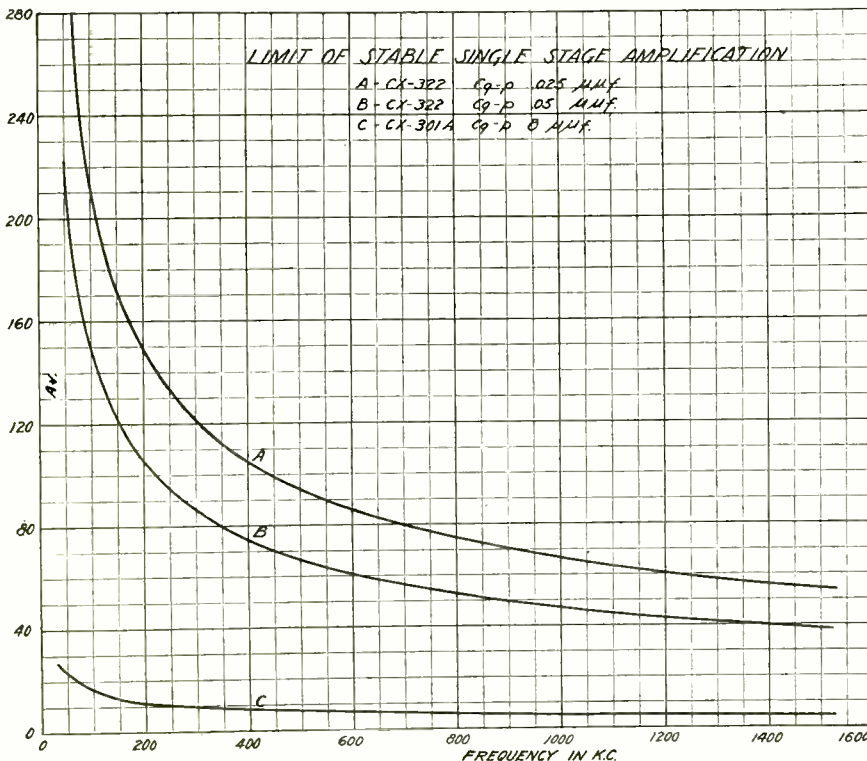
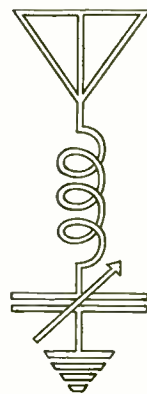

Fig. 3. Limits of Stable Amplification with Single Stage



TECHNICAL BRIEFS



OVERLOADING of a '71 power tube, even at low volume, is frequently due to too low an effective plate voltage and may be corrected by using a plate-supply unit, which will deliver 180 volts to the plate of the tube, 40 volts negative to the grid, and 15 volts, more or less for the voltage drop through the output choke or transformer. This requires an output of say 235 volts as compared with the 160 volts delivered by some power packs. If the desired voltage is not available, a dry-cell battery may be used to supply the grid voltage.

AUTOMATIC regulation of the 110-volt a.c. supply for a.c. receivers may be attained by several methods. One is to use a special resistance unit or lamp in series with the a.c. line plug and power transformer, the resistance of the unit or lamp increasing with the greater heating effect of a higher voltage, thus preventing any overvoltage. Another uses a similar unit and a power transformer designed to have a large magnetizing current which is increased with an increase in line voltage if operated near saturation; the series resistance thus becomes more effective since it need not vary so much with temperature.

A third method utilizes a complex connection of special transformers and condensers which allow large magnetizing currents and leakage reactance. This scheme gives quicker control since the voltage control is independent of the time necessary for a series resistance to heat or cool.

MANUFACTURERS advise that the type '80 rectifier tube may be used with 350 volts on the plate instead of 300 volts at the same maximum current drain of 125 milliamperes. This means that this full wave tube may be used to operate a type '50 power tube at about 250 to 300 volts. At this voltage the power pack design is fairly simple and economical and the power output available is from 2 to 3 watts. Increasing the a.c. voltage 50 volts per plate means approximately an increase of 50 volts at the output to the radio receiver. This should be of good use for a new tube which is a "cross" between a '71

and a '50 power tube. With 250 to 300 volts available, a push-pull '10 or '50-tube amplifier may be used to good advantage for receivers or phonograph amplifiers requiring large output. The cost of the power pack for the same factors of safety should be cut down from one-third to one-half.

HEATER type a.c. tubes are easily used in r.f., detector and a.f. circuits where grid bias is obtained by means of resistances in the $-B$ lead. Ordinarily this lead is grounded and all returns such as r.f. coils and audio transformer secondaries connected to this lead. This allows easy wiring in a set if a metal chassis is used. The cathodes of the tubes are then connected through suitable resistances to ground and the plate current provides the necessary grid bias.

This makes the cathodes positive with respect to the grids, which is correct. For example, a "plate voltage" of 140 on the r.f. tubes would usually mean about 131 volts effective plate-to-cathode and 9 volts grid-to-cathode. In this connection, separate resistances may be used in each cathode lead with proper bypass condensers, or several cathodes may be connected together and only one resistance and bypass condenser are necessary. Incidentally, a fairly large bypass condenser should generally be used in order that there will not be too high an impedance for a.c. ripple currents.

THE value of the fixed resistor, which is connected in series with the midpoint of the center tapped resistor across the transformer filament winding so as to give the grid bias of the tubes in the usual type of a.c. set, is obtained by dividing the voltage drop (the required grid bias) by the plate current drain, in amperes, of all the tubes which are supplied by that winding and which are operated at the same plate voltage and grid bias. In the case of a power tube, such as the '12A or '71A, supplied with 5-volt a.c. current, the correct grid voltage is $2\frac{1}{2}$ volts more than that recommended for d.c. operation, being -43 volts instead of $-40\frac{1}{2}$

volts for a '71 tube. This is because the connection to the transformer winding midtop lowers the bias by one-half the filament voltage.

WHEN a loudspeaker is placed out of doors the low tones are not so loud as when the speaker is within a room. Out of doors the listener hears mostly the direct radiation, while indoors he also hears the radiation reflected from the walls and objects in the room. The amount of direct radiation from the average speaker is considerably greater at high frequencies than at low. As the auditory response is dependent upon the amount of energy which impinges on the eardrum, the low-energy, low-radiated notes are not so loud as the higher-energy high notes. Within a room more of the high-note energy is ordinarily absorbed, so that proportionately more low-note energy is reflected and heard. The tone of a loudspeaker is largely dependent upon the sound-absorbing characteristics of the room wherein it is placed.

THE operating principle of the condenser type of loudspeaker may be illustrated by connecting the output terminals of a radio receiver to the terminals of an ordinary condenser. A condenser is constructed with metal plates separated by paper and air, which act as a dielectric. Alternate plates are connected to the same terminal. When the rapidly changing alternating voltage is applied between the plates there is a correspondingly rapid change in the electrostatic attraction between them. This tends to compress and expand the whole condenser, so that if the bottom plate is fixed the top plate moves up and down, or backwards and forwards. This movement sets the air in motion and thus causes a sound whose pitch corresponds to the audiofrequency of the amplifier output. Such a condenser to produce loud notes must be large in size compared to the condenser ordinarily used in radio. Recent experiments with this type of speaker have been so successful that it will probably be on the market at an early date.

A SIMPLE explanation of how grid detection is accomplished with a grid condenser S and a grid leak or high resistance R may be based upon the circuit diagram in Fig. 2. S readily passes an incoming small high-frequency a. c. voltage, which is blocked by R . Such a

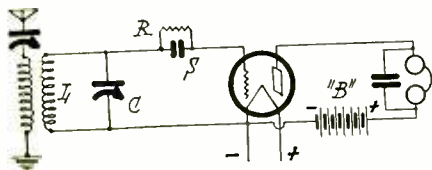

Fig. 2. Detection With Grid Leak and Condenser

voltage makes the grid alternately negative and positive.

When the grid is negative, its electrons are attracted in the external circuit through R to the relatively positive filament. This establishes a small grid current with a voltage drop across R , whose grid end is thus made more negative than its filament end.

When the grid is positive, no electrons are attracted through the external circuit to the filament and so there is no grid current. Current flows in the grid circuit only when negative half-cycles are impressed upon the grid by a carrier. Consequently, the carrier and its accompanying modulations are rectified or detected by the grid circuit. *Q.E.D.*

The rectified grid current consists of (1) the carrier high-frequency a.c. component, which is bypassed by S , (2) the modulating audio-frequency a.c. component which passes through R , and (3) a d.c. component which also passes through R . The resulting variations in grid potential control the internal flow of electrons from the filament to the positive plate, varying the intensity of the plate current, which thus reproduces and amplifies all the modulating variations in the rectified grid current.

PLATE detection in a vacuum tube circuit is accomplished with a C battery, which is used instead of a high-resistance R to keep the grid negative. If the grid be made sufficiently negative it will entirely cut off the plate current by preventing any electrons from reaching the plate. As the grid is made less and less negative, by decreasing the C voltage, more and more plate current flows.

Thus a series of measurements might show that .001 milliamperes flows at -5 volts C , .01 m.a. at -4 volts, 0.1 m.a. at -3 volts, 0.2 m.a. at $-2\frac{1}{2}$ volts, 0.3 m.a. at -2 volts, 0.5 m.a. at $-1\frac{1}{2}$ volts, 0.75 m.a. at -1 volt, 1.25 m.a. at $-\frac{1}{2}$ volt and 1.5 m.a. at zero volts. It will be noticed that between 0 and $-1\frac{1}{2}$ volts the current decreases from 1.5 to .5 m.a., a difference of 1 m.a., while between $-1\frac{1}{2}$ and -3 volts it decreases from 0.5 to 0.1 m.a., a differ-

ence of only .4 m.a. For the same difference in voltage less than one-half as much current flows when the voltage changes from $-1\frac{1}{2}$ to -3 volts as when it changes from 0 to $-1\frac{1}{2}$. This is due to the inherent characteristic of a detector tube.

When no signal is being received the grid bias is steady at say $-1\frac{1}{2}$ volts, likewise the plate current is steady at say 0.5 m.a. When the grid is being positively charged during a positive half cycle the plate current is very greatly increased. When the grid is being negatively charged during a negative half cycle the plate current is only slightly increased. For equal voltage changes on either side of the normal grid voltage, there are unequal changes in plate current, that for positive voltage changes being much greater than that for negative. Since the phones are actuated by the plate current, they easily respond to the large amount during a positive half cycle and do not respond to the small amount during a negative half cycle. Thus the plate current rectifies or detects the carrier and its accompanying modulating frequencies. The high frequency carrier oscillations cannot pass through the high inductance of the head phones but are bypassed by the condenser shunted across them.

AN ELECTROLYTIC rectifier consists of two dissimilar metallic electrodes suspended in a suitable electrolyte or solution. Its action depends upon the formation of a film on one electrode called the anode. This film conducts current much more freely in one direction than in the other and so rectifies an alternating current which is impressed across the two electrodes. When an a.c. voltage is applied, the free electrons readily pass from the anode through the film to the cathode, whereas the heavier positive ions with their greater mass cannot penetrate the film and consequently remain in the cathode.

The anode metals in ordinary use are aluminum, tantalum, or duralumin, the latter being an alloy consisting of 94.66 per cent aluminum, 3.93 per cent copper, 0.56 per cent manganese, 0.50 per cent magnesium, 0.33 per cent silicon, and 0.02 per cent carbon. Tungsten, bismuth and magnesium are among the other metals which may be used as anodes.

The cathode requires an inert metal which is not affected by the electrolyte. Lead, carbon and iron are frequently used.

The electrolyte depends upon the kind of electrodes. For aluminum and lead, either ammonium borate or ammonium phosphate are the best, the former handling heavier charging voltages but giving a sediment which does not occur with the latter. For the tantalum and lead, or lead peroxide electrodes, the electro-

lyte is dilute sulphuric acid. For duralumin and durion electrodes, the electrolyte is diammonium hydrogen phosphate, potassium dichromate and oxalic acid.

BETTER selectivity is secured by placing several tuned circuits ahead of the tubes in an r.f. amplifier than by using the same number of tuned circuits with one between each tube, provided there is no regeneration in either case. In the former case only the sharply tuned final wave form is amplified. In the latter case there is considerable amplification of the broader wave form passed by each successive circuit. Such a pre-selector is especially suitable for use with screen-grid tubes since they have little or no regeneration.

Difficulties in its use include that of obtaining an efficient untuned r.f. amplifier, its amplification of radio disturbances unless well isolated, and the difficulty of obtaining an efficient coupler. When regeneration is present, as with most three-electrode tube circuits, it not only increases the amplification, but also improves the selectivity. This regeneration usually more than offsets the damping due to the reflection of the tube plate impedance from the primary of the r.f. transformer into the tuned circuit.

MOST dry plate or so-called contact rectifiers use either copper sulphide or copper oxide disc or coating as a unit for unilateral conductivity. One of these discs offers a low resistance to the flow of current in one direction and a high resistance to current flow in the other direction. Each unit is capable of withstanding about 4 volts per element without breaking down, so that when higher voltages of alternating current are to be rectified or converted into pulsating direct current it is necessary to connect a number of units in series. The maximum safe current density per square inch of plate area is about .2 amperes. The copper oxide unit is claimed to have a rectifying ratio of 10,000 in one direction to one in the other, as compared to a 75 to one ratio which is ascribed to a copper sulphide unit. Rectifying efficiencies vary from 35 to 57 per cent and decrease with overheating or length of use, thus having to be eventually replaced to avoid hum. It is claimed that the copper sulphide elements deteriorate more rapidly than the copper oxide elements. For low voltage work these rectifiers are made in capacities up to 200 amperes.

A dynamic speaker, according to the R. M. A., "is one in which a portion of the conductor carrying the alternating signal current is a part of the moving system, the force producing the motion being due to the location of this conductor in a magnetic field."



The COMMERCIAL BRASSPOUNDER

A Department for the Operator at Sea and Ashore



Edited by P. S. LUCAS
R. O. COOK, Assistant



SOME time ago we discussed the comparative ability of the average foreign and American operators. A letter from Francis Bayley, brasspounder on the British ship *Adrastus*, gives an interesting slant on the radio situation in England. "The British schools are pretty bad," he says, "and the men can be divided into two classes; those who are keen on radio, and those who have been tried and found wanting in everything else." Well, there's a parallel case.

Mr. Bayley reminds us that it is more difficult to send fast on a "pump handle" than on a bug, which is very true. "Our instructions require full use of our call sign," Mr. Bayley goes on to say, "and there is often somebody ready to jump on us if we don't obey. In one company, at least, ops have to enter in the log the number of times the call sign is repeated each call."

To the American mind this super-adherence to regulations seems cumbersome and hidebound. Yet, where the Briton is perhaps over-cautious, the American may be too hasty. A happy medium might result in increased efficiency on all sides, but try and get it. Let's remember, at any rate, that the foreign operator may have to put up with all sorts of antique regulations which do not allow him to handle traffic in the U. S. A. style; and let's give him the benefit of the doubt before "putting him in his place."

There has been quite a rumpus between 2UO and the A. R. R. L. headquarters for a long time, and the consensus of opinion seems to have been that 2UO was in the right church but the wrong pew. Now, that a commercial license has been assigned this station everybody is happy, and the rare, snappy press that used to be sent on 40 meters is now to be found on 32. WHD is the new call.

SQUEEZING A RELAY OUT OF THE FLIVVER

By R. MADDEN, KDIY

Another of the many pieces of a Ford motor car that has found its way into the radio shack is the magnet coil of the horn. By mounting this on a board with an ordinary key as shown, it makes a fine keying relay. A piece of flat iron is mounted under

the knob of the key and 6 volts connected to the coil through the bug. The original will handle the bug at full speed with the weights removed.

THE TITANIC DISASTER

As Dug Out of the Old Congressional Records
By WM. A. BRENNAN, KOZC

The world has recently been stirred to the depth by a maritime disaster which almost parallels that related below. It is possible that the *Vestris* tragedy will result in a more liberal use of radio in time of peril. Perhaps the officers may be held accountable to the government at such a time rather than to a nickel-worshipping steamship company.

CQD CQD SOS SOS DE MGY TITANIC SINKING, PLEASE RUSH ALL POSSIBLE ASSISTANCE, RUSH, RUSH" were the few terse, electrifying words clicked out by the wireless operators of the gigantic White Star liner *Titanic* on the night of April 14, 1912. The startled world was thus given its first inkling of the terrible disaster that befell the doomed liner, and wireless, or radio, was skyrocketed to the attention of the world as a utility and safeguard of the utmost importance.

The *Titanic* was equipped with a 5-k.w. disk discharger, magnetic detector, valve receiver and emergency gear. It was the only vessel afloat that had one of the new disk discharger installations and it boasted a range of about 500 miles at daylight. At the key of the splendid liner were Jack Phillips, chief operator, and Harold S. Bride, 22, second operator. Both were in the employ of the British Marconi Company and were being paid a monthly salary of six and four pounds Sterling, respectively, (about \$28.00 and \$20.00 in American money), all for being entrusted with the safety of nearly 2500 souls in case of emergency.

On the morning of that fateful Sunday, trouble had been experienced with the insulation on the main panel of the transmitter and Mr. Phillips has arisen considerably earlier than usual to help repair the trouble. This finished, he started his 4 p. m. to 2 a. m. watch, with Mr. Bride's promise to relieve him at midnight, as the former was not feeling very well. At 5 p. m. the SS. *Californian* called the *Titanic*, MGY, and the *Baltic*,

MBC, with information regarding ice, stating that that ship had just passed three large bergs and a large number of growlers or smaller bergs. The *Baltic* acknowledged the call with the signal "RD," used at that time to QSL a message. The *Titanic* heard the report and copied it, but did not acknowledge immediately, as Mr. Phillips was working on his abstracts and had them all about him on his desk. After about twenty minutes, however, he gave the *Californian* the "RD" signal, whereupon the latter sent "TIS," or the finishing signal used at that time. Mr. Phillips took the information regarding the position of the icebergs to the bridge at about 5:30 p. m., ship's time, and the officer on watch figured they would be in the vicinity of the bergs about 11 p. m. that evening.

From 6 p. m. to 10 p. m. Phillips exchanged several regular messages with nearby ships and at 10 p. m. he listened in to press reports from the Cape Cod station, which called the *Titanic* at 11 p. m. with a large number of messages, which kept the two stations in communication up to the time of the collision. As closely as could be ascertained, this happened at 11:50 p. m., Sunday, New York time. There was just a slight grating and a little lurch of the vessel to port. The blow was so slight that it did not even serve to awaken passengers who had retired, although most of the ship's crew who were not on watch were awakened by the unusual lurch of the vessel and came on deck to investigate. No one thought, however, that anything serious had occurred.

Mr. Bride had planned to go on watch at midnight, so arose about 20 minutes before. The operators' sleeping quarters adjoined the operating room and before dressing, Bride stepped into this room, asked Phillips how he was making out and was told that there were still a number of messages for Cape Cod. Mr. Bride then dressed and put on the phones.

It was at this instant that the boat struck, but with such a slight shock that Phillips continued his preparations for retiring. Not long after that the captain came into the operating room and told Bride that he had better get assistance. Phillips, hearing him, came out into the operating room and asked the captain if he wanted him to use the distress call. The captain said he did, so Phillips took over the key and sent the "CQD" signal about half a dozen times, signing "MGY," the call letters of the *Titanic*.

The SS. *Frankfurt*, DFT, was the first vessel to answer the call. Phillips advised Bride that the *Frankfurt* had answered and asked him to take the information to the bridge. Captain Smith then asked for the *Frankfurt's* position. The *Carpathia* answered the call, giving her position, and said she was already coming to their assistance. Phillips then raised the *Olympic*, but while he was working him the captain came in and

(Continued on Page 38)

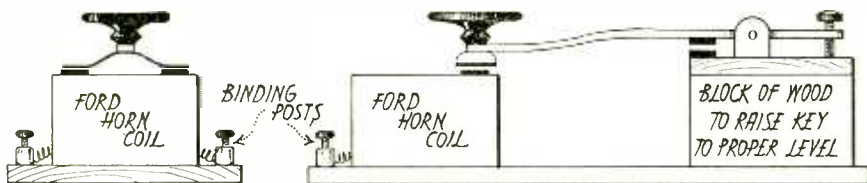

Fig. 1. Constructional Details of the Ford Horn Relay

With the Amateur Operators

PARABOLIC REFLECTORS

By A. BINNEWIG, JR.

THE gain in power radiated in a given direction with a simple parabolic reflector is of the order of 4 times that obtained with a single vertical wire favoring no particular direction. And because the expense entailed by the addition of the few wires and insulators necessary to this directional antenna and the installation of more powerful equipment to secure the same four-fold increase in result, the parabolic reflector is of great value to the transmitting amateur who must of necessity use low power. Parabolic reflectors, at the shorter wavelengths, are small enough to be conveniently used in most amateur stations. They are simple in construction and more effective than many of the more elaborate systems.

All the wires used in the reflector are approximately the same length as the main antenna and all are resonant at the frequency used. Untuned wires will not operate properly. For practical amateur use 3 or 5 wires arranged vertically along a horizontal parabola should be used.

The actual transmitting or receiving antenna is placed at the focus. The larger the aperture of the reflector around it; that is, the further its sides are extended, the sharper is the resulting beam. If it is possible to construct the reflector on the roof of the shack a vertical zeppelin feed may be used to the aerial at the focus. The reflector may be fixed for transmission in any particular direction, or some method of pivoting may be devised; the main aerial remaining fixed as the axis, with the wires in the reflector maintaining their relative positions.

With the design curves for the parabolas (see Fig. 1) no calculations are necessary.

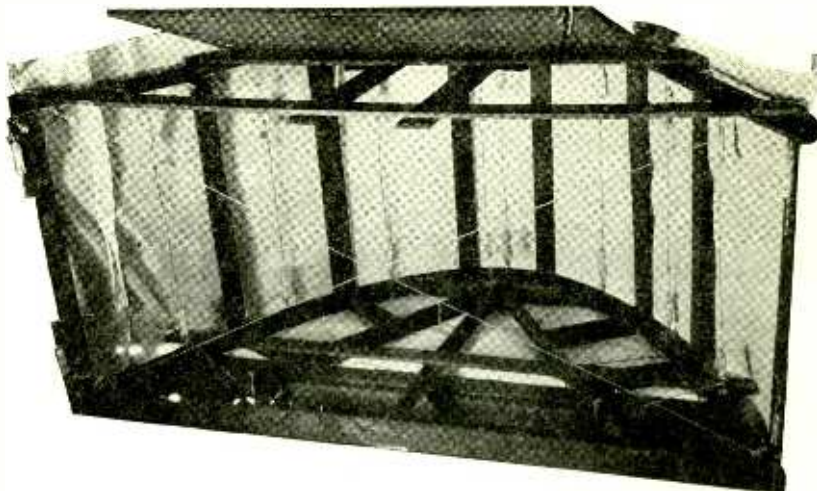

3/4 Meter Parabolic Reflector at 6BX

being coupled to the transmitter or receiver and the other three spaced along the parabola half a wavelength apart, with the center one at the vertex. The correct locations for other wires can be determined from the curves if it is desired to extend the ends of the parabola.

A 5-wire 5-meter reflector would consist of 5 wires spaced around the aerial according to the 5-meter curve. The shorter the wavelength used, the farther the sides of the parabola may be extended for a given amount of reflector space, and the sharper the beam. At 3/4 meters a very sharp beam may be obtained and the whole system is so small as to be practically portable.

At 3/4 and 5 meters, the wires used in the reflector should not be passed through the insulators and bent around as is cus-

into a parabola marked on the floor. These pieces were treated with hot water, bolted together and allowed to become dry before removal. It is only necessary to construct one frame for experimental purposes, for the wires can be accurately adjusted with a level or a plumb-bob anywhere around the frame. The bracing may be seen in the illustration. All parts are securely bolted together and the frame is quite sturdy. Two lengths of heavy cord should be tied diagonally across the front to securely brace the opening which is otherwise unbraced. Wire will not do.

Interference is reduced with directional transmission, and good efficiency for a given power is obtained. By the use of a reflector at both the transmitting and receiving stations, highly efficient and reliable communication is obtained.

FREQUENCY CONTROL PRECAUTIONS WITH A QUARTZ CRYSTAL

By H. A. CLARK, JR.

THE fallacy that a quartz crystal oscillator will operate only at the natural frequency of the crystal is apparently responsible for the fact that many crystal-controlled amateur stations are heard on other than the amateur bands. The chief factors, aside from the crystal's natural frequency, which affect the output frequency of a piezo-oscillator, are the working temperature, the load upon the unit, the plate potential of the oscillator tube, and the type of holder for the crystal.

The temperature at which the crystal oscillator will work may be controlled by suitable thermostatic units. But as the average amateur is not in a position to maintain units of this type, the next best bet is to calibrate the oscillator while working at normal room temperature.

The load imposed upon the oscillator as well as the potential upon the plate of the oscillator tube cannot be anticipated by the manufacturer of the crystal, so we can not expect his calibration of the crystal to fit our conditions.

The holder affects the frequency in three ways: First the supersonic waves imposed between the reflecting surfaces of the crystal and movable plate of the crystal holder; second, the capacity of the holder, and third, the mechanical load imposed upon the crystal by the movable plate of the holder.

(Continued on Page 42)

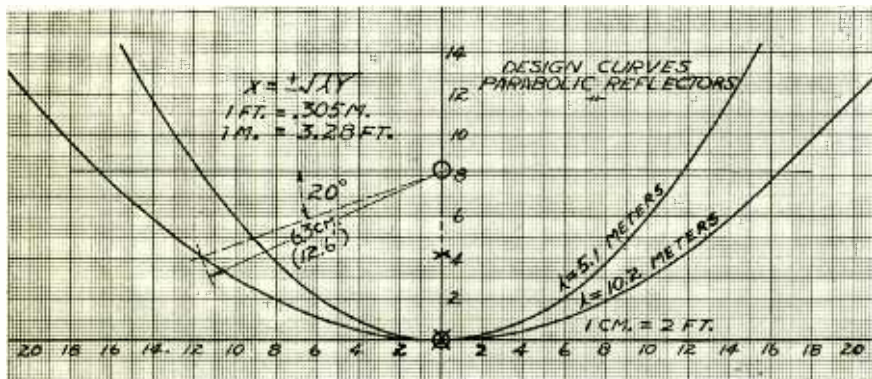

Fig. 1. Design Curves for Parabolic Reflectors

At the scale of 1 unit of the scale=2 ft. the parabolic curve may be plotted on the ground and the frame built to match. The spacing of the reflector wires should be one-half the length of one wave, and the radiating wire should be placed at the focus, which is one quarter of a wavelength from the vertex reflecting wire. In Fig. 1 the focus for the 10.2 meter parabola is shown by the circle 16 units or 8 ft. from the vertex, and the focus for the 5.1 meter wavelength is shown by the cross 4 ft. from the vertex. Best transmission will be in the direction along the axis from vertex to focus. This direction should be fixed by means of a compass.

A 3-wire 10-meter reflector would consist of 4 wires in all, each a half wavelength, or about 16 ft. long, the one at the focus

tomary. It is better to bend back a 1-in. length at the end of each wire so as to leave a small "eye" which is strengthened with solder. This gives a definite length of wire for measurement. The wires are secured to the insulators with waxed cord.

Parabolas for any desired wave may be constructed by using the formula given in Fig. 1. X and Y are coordinates of any point on the curve and λ is the wavelength to be used. The three factors must all be in the same units; if λ is in meters, X and Y must also be in meters. By using the conversion factors shown, it is simple to change from one to the other.

The parabolic frame for the 3/4-meter reflector at 6BX, shown in the illustration, was constructed by bending two 3/8 in. pieces of wood around finishing nails driven

the left end of the *C* voltage divider, just in front and below the level of the tuning condenser assembly. This potentiometer is connected in series with the *C* bias resistor and varies the grid bias on the two r.f. and two i.f. tubes. With the receiver in operation the voltage across terminals 1 and 7 should read 200. This includes the *C* bias voltage which is dropped through the 1290 ohms of resistance in the *C* voltage divider.

The voltage on the second detector terminals, 2 and 7 is 210, due to the fact that the output choke is not in the latter line, and the *C* bias is taken from this through 750 ohms of the divider. Terminal 3 is the positive lead for the r.f. and i.f. tubes, and should show 160 volts with respect to terminal 7, having been reduced to that figure by a 2250 ohm resistor in the power unit. The *C* bias in this case is obtained through the 190 ohm unit in the voltage divider plus the portion of the volume control between the cathodes and the ground. The plates of the oscillator and first detector tubes are connected to terminal 4, the voltage at this point having been reduced to 110 through the 14,300 ohm resistor in the power unit. The grid bias for the first detector is obtained from the 400 ohm tap and the oscillator operates with its grid at the same potential as the cathode.

Radiola 62 consists of the same receiving set as the 60, except that it is mounted on the upper shelf of a console cabinet with the power unit below. This set also includes a dynamic speaker mounted on a wide baffle-board, and incorporates a separate power unit for the speaker field.

The Radiola 64 has several added features, chief of which is the automatic volume control. An extra UY-227 tube is employed for this purpose and is located between the second i.f. tube and the second detector. With maximum sensitivity, the volume knob is turned back until local stations come in with the desired strength only. Distant stations may then be tuned in with all their volume up to the same point without danger of a local overloading the tubes or the ears when passed. The meter on the panel indicates resonance to the frequency of an in-

coming signal, making the final resonance adjustment visual rather than audible.

The frame is not grounded but is connected to the cathodes of the r.f. and i.f. tubes. The ground goes to the grid of these tubes, being separated from the frame by the grid bias resistance.

A UX-250 power tube is used in the one and only audio stage, and the power supply must therefore be rectified by two UX-281s instead of the UX-280 full wave tube. The voltage divider for all circuits is directly across the rectified high voltage output, and

(Continued on Page 43)

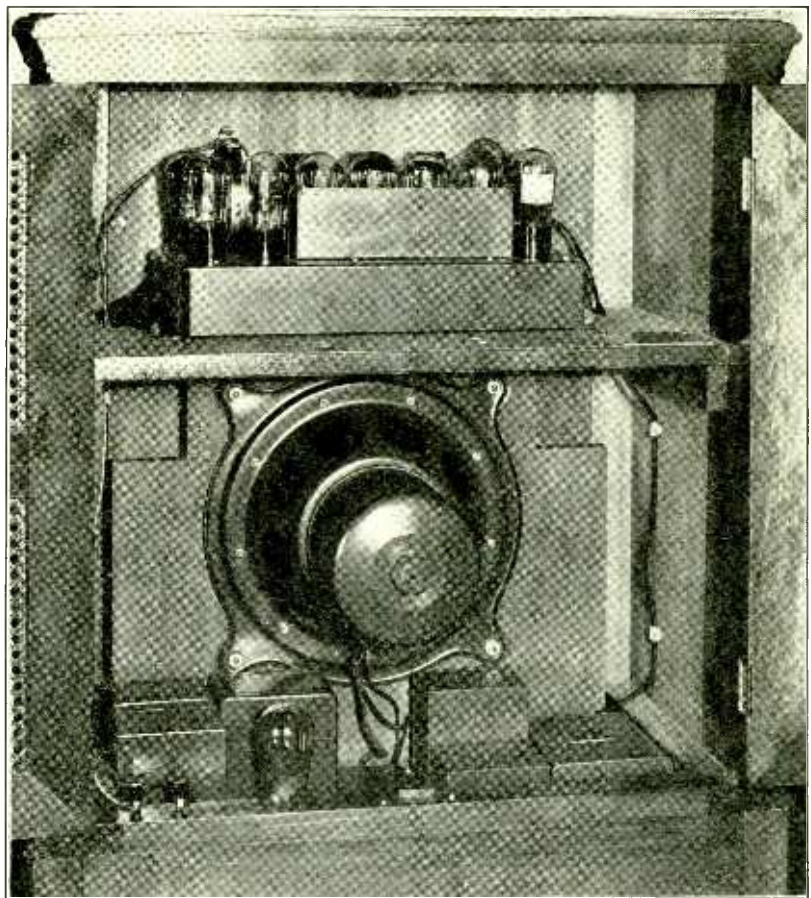

Rear View of Radiola 62

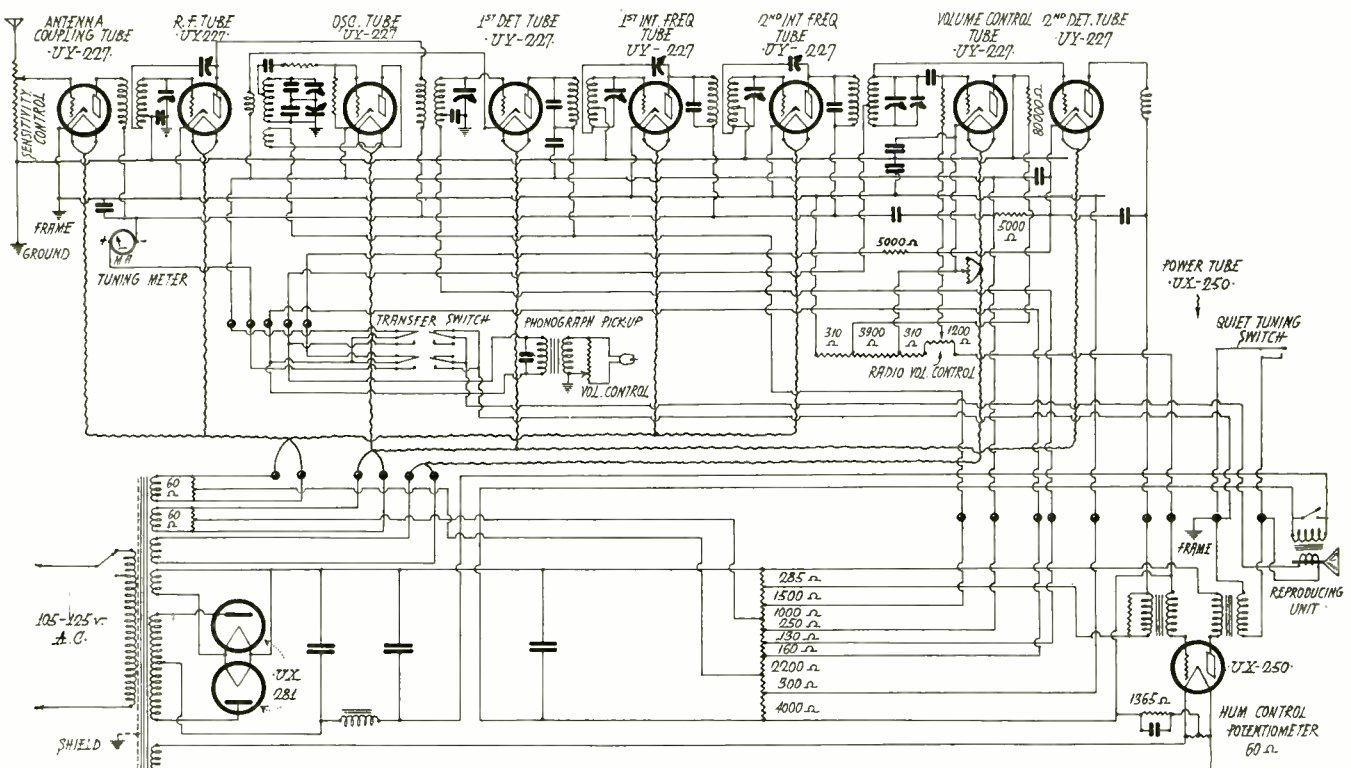
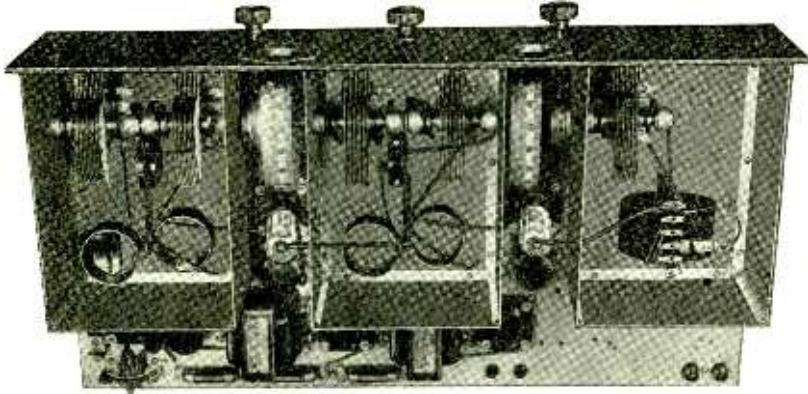

Fig. 2. Circuit Diagram of Radiola 64

Radio Kit Reviews

HAMMARLUND-ROBERTS MASTER "HI-Q 29"

THIS kit is designed to facilitate the assembly of a high-grade receiver which has maximum sensitivity, selectivity and fidelity of tone reproduction with five d.c. tubes. Extreme sensitivity is secured from the great amplification provided by two screen-grid tubes in the r.f. amplifier. Great selectivity without cutting of side-bands is



Top View of Hammarlund-Roberts "Hi-Q 29"

attained by special tuned-grid and tuned-plate r.f. circuits which afford a band-pass filter. Great volume without distortion results from the use of high-grade audio transformers and a power tube.

The necessary high degree of selectivity without corresponding reduction in the high amplification of screen-grid tubes results from the five tuned circuits which are necessary to tune both the grids and the plates. This double tuning can be accomplished without oscillation from these tubes whereas ordinary tubes would thus be thrown into violent oscillation.

In each interstage r.f. transformer, the primary coil is connected to the plate circuit of the preceding tube and the secondary coil is connected to the grid of the following tube, the two coils being exactly similar and placed so as to have a coupling co-efficient of about 1 per cent. Each coil is tuned to resonance by means of a .00035 mfd. variable condenser, all of which are gang controlled from a single dial. The other dial controls the antenna coupler and its associated transformer.

The general arrangement of these r.f. transformers and their associated condens-

ers is shown in the picture. The antenna coupling transformer, with its tapped primary, and its tuning condenser is in the left shielded compartment, the first r.f. transformer and its two tuning condensers in the center, and the second r.f. tuner in the right compartment, the two tubes and drum-dials appearing between the shield boxes.

These tuning circuits have been found by test to reduce an interfering signal which is 20 k.c. from resonance to 1/125 its original

intensity while the top of the response curve remains nearly flat with steep sides. This form of response curve gives a minimum of side-band cutting.

The volume control consists of a 100,000 ohm potentiometer connected across the 45-volt B supply to the screen-grids of the two r.f. tubes. This provides a smooth control within wide limits without affecting the tuning or the tone quality.

While the screen-grid tubes have an extremely low plate-to-grid capacity, thus minimizing feedback through the tubes, this advantage is nullified if feedback occurs in other parts of the receiver. So every effort has been made to isolate all circuits in which coupling might result in instability. The negative bias for the control grids of the r.f. tubes is secured by the drop across individual 10-ohm resistors in series with the negative leg of each screen-grid tube filament. Since the screen-grids of both these tubes are biased by the 100,000 ohm potentiometer, a 5,000 ohm isolating resistor is inserted in the lead to each of the screen-grids, which are in turn by-passed by means of separate 1/2 mfd. by-pass condensers. The plate circuits of these tubes are likewise

LIST OF PARTS FOR THE MASTER HI-Q 29 D. C. MODEL

- 5 Hammarlund ML-17 .00035 mfd. Midline Condensers.
- 1 Hammarlund Hi-Q 29 Coil Set.
- 2 Hammarlund SDW Knob-Control Drum Dials (Walnut).
- 3 Hammarlund RFC-85 Radio Frequency Chokes.
- 5 Benjamin Cle-Ra-Tone Sockets 9040.
- 1 Sangamo .0025 mfd. Fixed Mica Condenser.
- 1 Sangamo .001 mfd. Fixed Mica Condenser.
- 1 Electrad Type B Royalty Resistance 100,000 ohms. Potentiometer with filament switch.
- 2 Thordarson R-300 Audio Transformers.
- 4 Parvult .5 mfd. Series 200 Bypass Condensers.
- 1 Durham Metallized Resistor 1 1/2 megohms.
- 1 Yaxley 660 Cable Connector and Cable.
- 1 pr. Yaxley 422 Insulated Phone Tip jacks.
- 2 Amperites 1-A.
- 1 Amperite 112.
- 2 Eby Engraved Binding Posts.
- 1 "Hi-Q" 29 Foundation Unit Master (containing drilled and engraved Westinghouse Micarta panel, three complete aluminum shields, drilled steel chassis, shafts, binding post strips, Fahstock clips, fixed resistance units, resistor mounts, brackets, clips, wire, screws, nuts, washers, and all special hardware required to complete receiver).

isolated by individual filters consisting of separate r.f. choke coils and bypass condensers. In addition, the entire r.f. end of the receiver is thoroughly shielded. Each stage is entirely enclosed in a snug-fitting aluminum box which is securely fastened to the metal chassis. The screen-grid tubes are so located that the leads to the control grids are as short as possible and farthest away from the plate leads, which are also short. By placing these tubes between the cans, the sides are used also as electrostatic tube shields, effectively preventing coupling between the tube elements and other parts of the circuit. This arrangement provides minimum coupling between output and input circuits, which is extremely important.

The audio-frequency amplifier is of the conventional type consisting of two stages of transformer-coupled amplification. The a.f. transformers have a flat frequency characteristic over the usual a.f. range. A r.f. choke coil is placed between the plate of the detector tube and the first a.f. transformer to prevent any stray r.f. voltages from getting into the a.f. amplifier. A 171-type tube is recommended for use in the last stage, although other types may be used if suitable A, B and C voltages are available.

Complete detailed directions for mounting and connecting the various parts are furnished with the kit and have also been published elsewhere. These are accompanied by large-scale drawings in which all connections are clearly indicated. The completed chassis can be installed in any one of a number of different cabinets or consoles so as to fit any style of home decoration. This is the latest and most efficient of the famous sets which have borne the Hammarlund-Roberts name. It will be found that only one station can be tuned in at one time, snapping in without the usual gradual increase in volume.

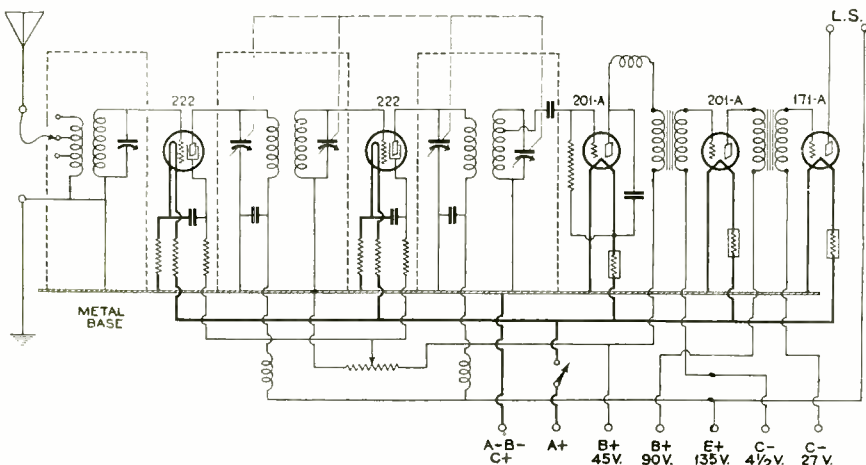

Circuit Diagram of Hammarlund-Roberts "Hi-Q 29"

Bosworth power amplifiers for radio and phonograph reproducers are made in a number of different sizes for various purposes. Model Amp. 1, which is illustrated herewith, uses a '26 tube in the first and two '71 tubes in push-pull for the last stage, with one '80 rectifier tube; 1A also has voltage taps for A, B, and C supply for a.c. sets. Model Amp. 2 and 2A, use a '26 tube in the first and a '50 tube in the last stage, with two '81 rectifier tubes. Models Amp. 3 and 4 are for use in auditoriums, with two or four speakers respectively, both being three-stage



amplifiers with a '27 tube in the first and two '27's push-pull in the second stage. The former uses two '50 tubes push-pull in the third stage with two '81 tubes and the latter four '50 tubes multiple push-pull and four '81 rectifier tubes. Model Mic, is a battery-operated two-stage outfit, for public address work.

The X-L link combines in one device a fused two-socket outlet, line voltage regulator, a control switch, and an antenna-ground connection for an a.c. receiver. The switch controls connection to the two sock-



ets which may be used as the current source for the receiver and the dynamic speaker. The light wires are used as the antenna. The voltage regulator protects tubes against burn-out.

The Amperite Lin-A-trol consists of an auto-transformer and Amperite which are intended to control the line voltage supply to an a.c. receiver. The auto-transformer is designed to place a 20-volt drop across the Amperite when the line supply is 95 volts. As the line voltage increases to a normal 110 or an abnormal 125 volts, the voltage drop correspondingly increases to as high as 40 volts. But the Amperite is designed to give a nearly constant current output between 20 and 40 volts potential difference, since its resistance rapidly increases as the current output slightly increases. Depending upon the current requirements of the radio set the Amperites are made to give .4, .5, .6, .7, or .8 amperes with a variation of 10 per cent or

less, which is within the recommended limits of filament and plate supply. The entire device is compact and draws about 20 volts for its operation.

The Na-Aid electric pick-up for adapting a phonograph for use with an audio amplifier and radio speaker is equipped with two magnets and an adjusting feature to



give maximum volume without rattling. Its adapter fits either a.c. or d.c. sets with 4 or 5-prong tubes.

The Dongan radio interference filter is especially designed to eliminate interference from oil burners. It is made in two models mounted in steel cases equipped with conduit fittings for direct attachment to an oil burner. Model D-207 contains an 8 mfd. condenser and D-215, a 4 mfd. condenser.

The Wright-De Coster dynamic reproducers are made in a number of styles for 6-volt d.c. and 110-volt a.c. operation, with and without output transformers. The field coil of the chassis produces 90,000 magnetic lines per sp. in. of a.c. gap, having 2700 ampere-turns. It is claimed to handle the output of a push-pull 250 amplifier without distortion or cracking. The chassis is sold separately or in cabinets, one model also including a power plant with two 281 rectifying tubes, one 874 regulator tube, and one 250 power tube.

The Valley "B" power unit, Model 828, is a new product designed for sets using up to 10 tubes. It employs a Raytheon B11 tube as a rectifier and is equipped with an over-size transformer, special chokes and high voltage condensers. It has four taps for positive plate voltages with a high resistance



control unit on the intermediate tap, and a 9 and 40 volt negative grid tap, all mounted under the cover. It is designed to give a maximum of 180 volts.

NEW RADIO CATALOGS

The Electric Supply Company of Oakland, California, has published a comprehensive catalog of radio sets, accessories and parts, which they supply at wholesale prices for resale. The parts and kits listed are of standard make and well advertised and comprise everything necessary for the construction and servicing of a.c. and d.c. receivers.

BOOK REVIEWS

Radio Library, 5 volumes, 5 x 7½ in., about 120 pp. in each volume; each subject covered by a specialist and all edited by J. F. Witkowski and F. H. Doane; published by International Correspondence Schools, Scranton, Pa. Price \$7.50.

THIS compact and convenient compilation of radio information is intended for home study by those who have the equivalent of a grammar school education. In general, the subjects are clearly and logically presented and the entire treatment is sufficient to give a good working knowledge to the practical man.

Vol. I is in two parts: "Elements of Radio Communication," by H. F. Dart and "Sources of Electromotive Force," by A. G. Zimmermann and C. H. Vose. These lay the foundation for the other volumes.

In Vol. II H. F. Dart discusses the simple principles of vacuum tubes in a conventional manner and H. H. Beverage describes the various types and properties of antennas, both transmitting and receiving. Vol. III consists of a discussion of spark, arc and tube transmitters by K. M. MacIlvain and an explanation of carrier current systems for code and sound transmissions by W. H. Freedman.

Vol. IV is devoted to a description of various standard radio receiver circuits by K. M. MacIlvain and to hints on radio servicing by the I. C. S. staff. Vol. V is in three sections: "Radio Measurements and Tables" by H. F. Dart, "Radio Developments by E. H. Hansen and "Fire Underwriter Regulations." The second section includes information on picture transmission and television.

Each volume is well-indexed. While there is nothing novel or noteworthy in the subject matter or manner of presentation, it constitutes a comprehensive review of the past and present stages of the radio art. The material has been carefully and judiciously compiled and might well form the basis for practical application of the principles developed.

"Encyclopédie de la Radio," compiled by Michel Adam, 355 pages, 8½ x 10¾ in. Published by Étienne Chiron, 40, rue de Seine, Paris. Price, 50 francs.

This is an illustrated encyclopedia of radio terms, with definitions and explanations in French, and with English and German translations of the terms themselves. 1310 subjects are discussed rather thoroughly, in a semi-technical language that the French speaking amateur set builder can easily understand; and the 1480 illustrations showing the mechanical features and circuit drawings of various pieces of equipment make it a very helpful volume. The terms are alphabetically arranged and the explanations delve into the underlying fundamental theory where ever necessary to give the reader a more comprehensive understanding of the subject.

PUBLICATIONS RECEIVED

Research Paper No. 35, United States Bureau of Standards, "Unidirectional Radio-beacon for Aircraft," by E. Z. Stowell, price 10 cents.

This pamphlet illustrates and describes a method for transmitting signals for the guidance of aircraft. Directive and non-directive fields are simultaneously transmitted with the proper phase and amplitude relations to secure unidirectional transmission. Consequently there is only one radiated course, thus reducing interference from other beacons and increasing the power efficiency of the beacon.

Stop "FOOLING" with RADIO!

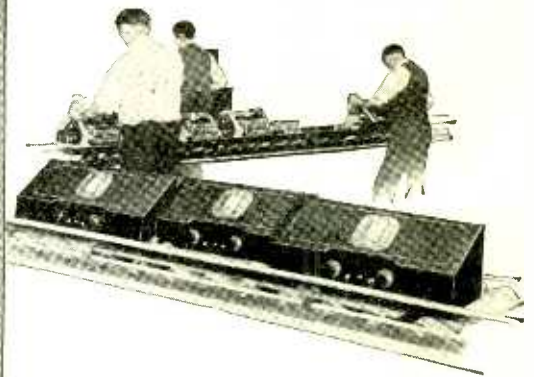

RADIO amateurs! Don't treat radio as a mere plaything! Make it pay you real money. Thousands of fellows are doing it. So can you. A little commercial training is all you need to give you money-earning confidence and ability. Get this training in spare time at home . . . through the marvelous home-laboratory course sponsored by RCA, General Electric and Westinghouse. The **FREE Radio Book** tells all about it.

If you've been playing around with radios and have a pretty fair knowledge of it, you can now easily and quickly lift yourself into the real money class. For a marvelous new home-laboratory course in Radio gives you just the added commercial training you need for big-time radio success. As a result of this course many men formerly in poorly paid positions are now earning as high as \$100 to \$250 a week in Radio work!

Home-Laboratory Training

With this advanced commercial training you get the "how" as well as the "why"

of every phase of radio work and technique. Only an hour or so a day—in spare time—is all you need to put the finishing touch to your radio experience. As part of your course, you receive absolutely free of extra charge—an outlay of fine apparatus.

Training backed by RCA . . .

General Electric . . . Westinghouse

Our graduates are in big demand everywhere. They enjoy greater success because they're posted right-up-to-the-minute in *everything* in radio. Radio's progress each year is measured by the accomplishments of the great engineers at work in the research laboratories of RCA, General Electric and Westinghouse. These three Radio organizations set the standards for the industry, and because they sponsor every lesson in the course you are assured of the most complete, authoritative and up-to-date radio training in the world!

Money Back If Not Satisfied

The lessons prepare you for success in all phases of radio—manufacturing, servicing, selling, ship and shore broadcasting, Television, Photodiagrams and radio equipment.

A signed and sealed agreement assures you of complete satisfaction upon completion of the training—or your money will be promptly refunded! So you cannot lose a single penny!

Read This Free Book

It tells you all you'd like to know about Radio. Its 50 pages and photos describe Radio's opportunities for adventure and success. It describes in detail the famous training that has enabled us to place thousands of our students in fine commercial positions, usually from 3 to 10 days after graduation! Read this great book . . . it may mean the turning point in your life! Mail the coupon now—the book is absolutely free! Radio Institute of America, Dept. RA-2, 326 Broadway, New York, N. Y.



RADIO INSTITUTE OF AMERICA
Dept. RA-2
326 Broadway, New York, N. Y.

Gentlemen:

Please send me your big FREE 50-page book which tells about the opportunities in Radio and about your laboratory-method of guaranteed radio instruction.

Name.....

Address.....

Prevents Current WABBLE

\$1.10 with mounting
(in U. S. A.) at all
dealers.

Install Amperite for every tube and smooth out "A" current wobble that ruins reception. Amperite adjusts itself to the exact need of each tube. A type for every tube—A. C. or D. C.



This symbol in a radio diagram means—

AMPERITE

The "SELF-ADJUSTING" Rheostat

Radiall Company
10 FRANKLIN ST., NEW YORK.

FREE "Amperite Blue Book" of modern circuits and valuable construction data. Write Dept PR2

REG. U. S. PAT. OFF.

REG. U. S. PAT. OFF.

SPINTITE WRENCHES FREE

With a one year subscription to "Radio" 3 Stevens Spintite wrenches for round nuts given free this month with a subscription to "RADIO." Send \$2.50, get "RADIO" for one year, and the wrenches also. We pay the postage. Only a few sets of these wrenches still on hand. **Hurry.**

Publishers of "RADIO"

Pacific Bldg. San Francisco



Will Put You In Your Own Business

One five dollar bill will take you from a slaving job and put you in business for yourself—YOUR OWN BOSS—CAPABLE OF MAKING \$5000 and up a year.

No Experience Necessary

That's the marvelous part of my plan. No matter what you are doing now—you can take my Service Station charger and make big profits THE MOMENT YOU START. Full directions explain everything. Anyone can do it!

Made \$175.00 First Week

Stuart Trego made \$175.00 the first week. He set his charger up in his basement and got neighborhood business. Max May made \$685.00 the first month. You can do the same.

Big Book FREE!

Act Now. Fill in Coupon and get my book of BIG PROFITS—absolutely free. Tells you how easily you can get out of the poor-paying slave class and go into business for yourself. This marvelous charger will handle 50% to 70% more batteries than similar chargers. By all means get my book. Now is the time to act.

Earn \$5000 to \$15000 a Year

Mail This Coupon - NOW

C. F. HOLMES, Chief Engineer
Independent Electric Works
5116 Ravenswood Ave., Chicago, Dept. "R"
Dear Mr. Holmes: Sure I want that book of Big Profits. Send it to me at once.

Name.....

Address.....

SET BUILDERS

write for

Discount Card

Enabling you to purchase the new and improved Knapp "A" Power Kit at big discount—Write for full particulars.

DAVID W. KNAPP, Pres.

Knapp Electric, Inc.

Division of P. R. Mallory & Co. Inc.
Room 416-B, 350 Madison Ave., N. Y. C.

FURNISHED ROOMS

(Continued from Page 14)

the other things without affecting the result much.

Formerly the average person was figured as equal to 4.7 sq. ft. of open window. But recent work has shown that the value is 4.2. An amount equal to 3 sq. ft. of cloth curtain has been lost from the costume of the modern woman. One sound engineer recently predicted that the value will reach a new low level of 2.5 in the near future.

Resonance in a room allows one certain note to persist long after others have died out. Often this is caused by small alcoves, a picture, window pane, or vase, which may have a vibration period within the audible range. A room would have to be as small as the average bathroom to have a period (frequency) high enough to be heard. If you sing at your bath, and have a very bad cold, you may hit the fundamental frequency, but otherwise not. The space between walls may also take a notion to vibrate, as this space is small enough to be in the audible range.

Echo is never found in small rooms and so will not be discussed here. Sound must travel through two paths to get an echo, and the difference in lengths of path must be 65 ft. or more in order to make one sound 1/17 second after the other. Less than this, the ear detects no echo.

It should be borne in mind that if a room is acoustically corrected, it is not soundproof. That is another story. If a room soaks up much sound in the walls, it may be that it is delivering this sound to an adjoining room. Or to take the opposite, if the common wall of two rooms reflected 100 per cent of the sound, the acoustics in each room would be terrible, but each room would be soundproof as far as the other was concerned, for no sound would get through the walls. It couldn't, being all reflected at the surface. Sound travels with a greater speed through metals and some solids than in air. One can see the difficulty of soundproofing a house without making the foundations and supports of rubber or soft material.

The biggest job of soundproofing that has been done lately is in the building of sound stages for the talkies. Using makeshift buildings in preliminary work, they have had some queer results. One photophone engineer tells the following incident, which is a bit puzzling.

Time: 12 noon. While the cameras grind the noon whistle blows.

The next day, time 12:20. The engineer is sitting in the projection room watching and hearing the rushes of the previous day. Suddenly, while a love scene is being whispered from the screen, the noon whistle is heard. Taking out his watch, the engineer notes that it is

(Continued on Page 34)

Tell them you saw it in RADIO

GET THIS BIG GREEN BOOK NOW!

New!

AERO KITS 1929

The Big Green Book gives the very latest details on Aero Coils and Kits, Short Wave Radio, newest broadcast radio receivers, short wave converters, telephone transmitters, coil kits, adapters and a host of new wrinkles for 1929.

24 Different New Kits Shown for 1929

The kits everyone is talking about are fully described in the new 1929 Aero Green Book—Aero 7-29, Aerodyne 6-29, Chronophase, Metropolitan, Trio, International, Standard, Radiophone—in Shield Grid, A.C. and D.C. models. Be sure to send for your copy of this 25c Big Green Book—worth \$25.00 to anyone who wants to keep up with the latest radio wrinkles.

Mail coupon for your copy today—NOW!

AERO PRODUCTS

INCORPORATED

4611 E. Ravenswood Ave., Dept. 529
CHICAGO, ILL.

----- MAIL THIS COUPON NOW -----

AERO PRODUCTS, INC. Dept. 529
4611 E. Ravenswood Ave., Chicago, Ill.

Send me your Big Aero Green Book, 25c, giving the latest information on What's New in radio, short wave, etc.

Name

St. and No.

City State

Newest Information TO SET BUILDERS

LATEST RADIO GUIDE

FREE

Basketball, football games, big National events will boost radio business this year. Set builders will reap a rich harvest. Barawik service will make you money. Everything in A-C sets, parts, supplies. World's largest radio stocks on hand. Orders shipped same day. Lowest rock-bottom wholesale prices.

Mail coupon for free Radio Catalog now

BARAWIK CO. 182 Canal St., CHICAGO, U. S. A.

Mail this coupon for Free Radio Guide

Name

Address

SACRIFICE!

6 XAO Selling Out. Complete short wave transmitter, built by Heintz & Kaufman. Consists of 100 watt tuned grid-plate transmitter oscillator, with interchangeable coils for frequencies of 2500 to 30,000 kilocycles; antenna panel with coils to match oscillator; power panel complete with auto-transformer power control, input wattage meters, etc.; 2 k.w. Westinghouse 2200; 110 volt, 50-60 cycles plate transformer in oil bath; motor generator consisting of 1/2-h.p. single phase 60 cycle motor belted to 250 watt 900 cycle generator. Power transformer operates on 900 as well as 60 cycles, so that either 1800 or 120 cycle note available. Ideal set for amateur or limited commercial station. Sacrifice price, \$250, f.o.b. Los Angeles. Complete with Western Electric 50 watt tubes, especially selected for this transmitter. Shipping weight approximately 400 lbs.

Also two stage portable auditorium type power amplifier, with 50 watt power stage, complete with self-contained 50 watt rectifier for plate supply. Suitable for store or multi-speaker installation, and can be connected directly to output of radio receiver. Complete with two Western Electric 50 watt tubes, \$125.00. Shipping weight, 125 lbs.

GERALD M. BEST

108 North Harper Ave., Los Angeles, Calif.



Thrilling Tone Purity
Radio's Richest Voice

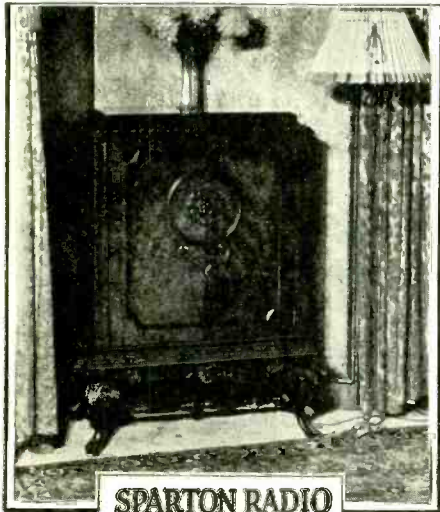

SPARTON RADIO
THE PATHFINDER OF THE AIR

We have now been using Thordarson transformers for some four years, which should be proof conclusive that we think them capable of maintaining the high quality of Sparton Radio Receivers, which we so jealously guard.

President-General Manager
The Sparks-Withington Company

THE manufacturers of the world's finest receivers realize the important relationship between the choice of transformers (power supply and audio) and the performance of their instruments. Almost universally they have turned to Thordarson as the source of their transformers.

In Thordarson Power Supply Transformers they have found an efficiency of design, an abundance of power and a constancy of performance that makes their power unit free from service calls; and in Thordarson Audio Transformers a fidelity of reproduction that renders their receivers musical instruments of the highest caliber.

The purchaser and builder of radio receivers who seeks the ultimate in performance will insist on Thordarson Radio Transformers.

THORDARSON ELECTRIC MFG. CO.
Transformer Specialists Since 1895
Huron, Kingsbury and Larrabee Streets
Chicago, Illinois

THORDARSON
RADIO
TRANSFORMERS

Supreme in Musical Performance

The LONG and SHORT OF IT



YET the twain meets in Arcturus A-C Long Life Tubes.

Long life and quick action — two salient features of Arcturus — not matched by any other tubes.

Once you've heard Arcturus A-C Tubes you'll never be content 'til you've put a complete set in your receiver. The vastly improved results

and tone quality will make you wonder why you've never used Arcturus Tubes before.

No wonder critical radio fans say "Give me the blue Arcturus Tubes for real radio reception every time."

Re-tube today — put a blue tube in every socket of your receiver — for real radio reception.

West Coast Distributors, UNIVERSAL AGENCIES,

905 MISSION ST., SAN FRANCISCO, CAL.

ARCTURUS RADIO CO. NEWARK, N.J.

ARCTURUS
A-C LONG LIFE TUBES

Send for New Radio Book—It's Free!

New hook-ups. This book shows how to make short-wave receivers and short-wave adapters. How to use the new screen grid tube in D. C. and A. C. circuits. How to build power amplifiers, ABC eliminators. Up-to-the-minute information on all new radio developments. It's free. Send for copy today.

KARAS ELECTRIC COMPANY
4031M North Rockwell Street, Chicago, Ill.
Portland, Oregon, 53 4th St.
San Francisco, 585 Mission St.
Los Angeles, 324 N. San Pedro

Name.....
St. and No.....
City and State.....

4031L2



O'NEIL
Dynamics

The
Speaker
Hit of
the Season

Two types—one for A.C. operation, the other for D.C. Equipped with our dynamic units. Beautiful two-tone walnut finish to match the popular sets. Write for literature.

O'NEIL MFG. CORP.
West New York New Jersey

Tell them you saw it in RADIO

FROST



FROST VOLUME CONTROL

Gives complete, stepless and wonderfully smooth control of volume and oscillation. Wearproof roller contact arm, Bakelite case and dust cover. \$2.00 and \$2.25.

FROST VOLUME CONTROL WITH A.C. SWITCH

We equip our famous Volume Control with approved A.C. Snap Switch tested to carry 250 volts at 3 amperes, so that both switch and volume control may be handled by single knob. \$2.75 and \$3.00.



FROST VOLUME CONTROL WITH D.C. SWITCH



Equipped with sturdy German silver switch mounted on Bakelite panel, and with switch points fitted with sterling silver contacts, this Volume Control gives quick operation, positive-locking off position and saves space. For battery operated sets. \$2.35.

FROST GEM VOLUME CONTROL

Identical with our standard size Volume Control units except in size. Gem units are only 1 1/2 in. in diameter, and only 1/2 in. thick. Great space savers. \$2.25 and \$2.50.



FROST GEM RHEOSTATS



Made to deliver a service that is not usually expected from little rheostats like these. Mighty good little rheostats, taking up little space and supplied either plain or with D.C. switch. Easy to solder to. Plain, 75c. With switch, \$1.00.

FROST BAKELITE RHEOSTATS

Long the standard air-cooled Bakelite Rheostat, as well as the original of this type. Resistance wire is wound on die cut Bakelite strip over moulded Bakelite frame. Wide choice of resistances. \$1.00 and \$2.50.



HERBERT H. FROST, INC.

Main Office and Factory

ELKHART, IND.

Chicago

San Francisco

RADIO

Herbert H. Frost, Inc.
160 No. La Salle St.,
Chicago, Ill.

Please send me your complete catalog of all Frost-Radio Apparatus by return mail.

Name _____

Address _____

City _____

State _____

(Continued from Page 32)

twenty minutes fast, and turns it back twenty minutes.

The next episode is sad. His train to New York leaves at four o'clock. He arrives at five minutes of four by his watch and finds that the train has been gone fifteen minutes.

We cannot see what is puzzling about this, but nine out of ten can't see what this is all about. Can you?

One curiosity in sound occurs where the room is of such a shape that it produces whispering galleries and spots where every word can be heard at another definite spot, even though there is a screen between. The capitol at Washington has the best known example. The effect is heightened because whispers are high pitched, and reflect from the walls more regularly than low pitched sounds.

If a source of high pitched sound is placed at the focus of a headlight, instead of a globe, the sound will follow the same path that the light follows (with the lens out). Whatever is whispered in front of one of two large sound reflectors at the University of California at Los Angeles can be heard only by the fair co-ed at the other reflector, an ideal arrangement. The barreled ceiling is the only curved surface commonly found in a home. If the floor is the center of the barrel the effect may be very bad.

Anyone should, then, before building a home, make sure that the architect knows a bit about what happens to sound in rooms.

SCREEN-GRID R.F. AMPLIFIER

(Continued from Page 22)

on whether the plate and grid phase angles were right for oscillations to occur. As is well known, the phase angles vary rapidly near resonance so that they might be right for oscillations. It is better in practice to keep the amplification slightly under the critical value and shield the input and output circuits from each other in order to keep the stray capacity as small as is possible.

30 K.C. TRANSFORMERS

(Continued from Page 20)

of each transformer and tied in place so that there is no strain on the No. 36 wire. Thin sheet copper may be used for making the electro-static shield. Cut two round pieces for each transformer, about 1/8 in. larger than the fiber disks. Then cut a piece 2 in. wide and long enough to go completely around the transformer with 1/4 in. overlap. Bend this piece in a circle and solder to one of the end pieces in the form of a can. Now punch four holes (for the lead wires) in the other end pieces. Place a transformer in each "can." Bring the leads through the punched holes, marking them P and S and 1 and 3 for the

(Continued on Page 36)

Tell them you saw it in RADIO

Short-Wave Radio Fans



Write for THIS BOOK!

10c

The Hammarlund Short-Wave Manual will save you many costly errors.

Chock-full of practical data every short-wave fan and experimenter will welcome.

Send 10c for mailing expense

Address Dept. SWR

HAMMARLUND MANUFACTURING CO.
424-438 W. 33rd St., New York, N. Y.

For Better Radio
Hammarlund
PRECISION
PRODUCTS

CUSTOM SET BUILDERS

Browning-Drake has an interesting and unusual proposition. Take advantage of the fact that more Browning-Drakes are built than any other. Write today.

BROWNING-DRAKE CORP.
CAMBRIDGE, MASS.

USE THE CLASSIFIED ADS IN "RADIO"

They Bring Results

Write for this Discount Card NOW!

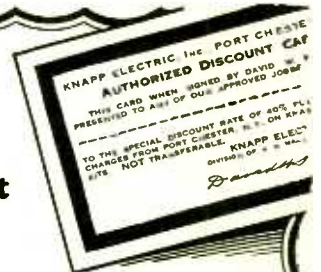

It will enable you to purchase the New and Improved

KNAPP "A" POWER KIT
at a liberal discount

The new Knapp "A" is the finest and most complete kit ever offered. It is the only "A" Power adaptable to Short Wave—Super Heterodyne and Television reception.

Take advantage of the wonderful offer today—write

David W. Knapp, Pres.

Knapp Electric, Inc.

Division of P. R. Mallory & Co., Inc.

Room 416-B, 350 Madison Ave., N. Y. C.

There Is a REMLER KIT for Every Purpose

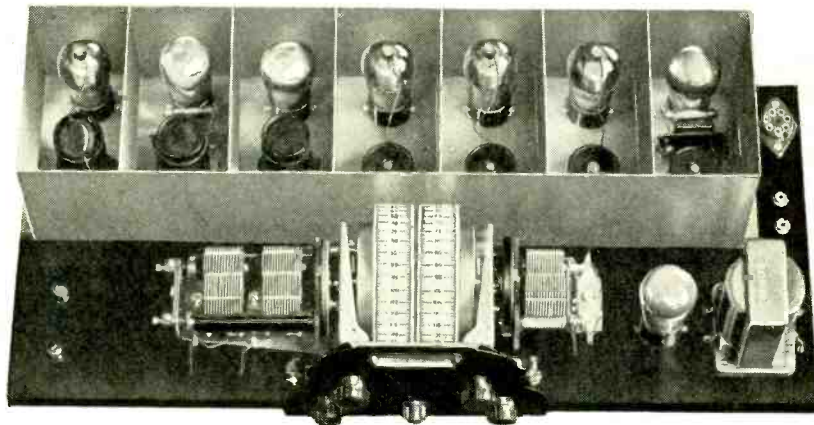

The REMLER 29

incorporates a stage of shield-grid radio frequency amplification, oscillator, first and second detectors in the first of which regeneration is used, three stages of transformer-coupled shield-grid intermediate amplification functioning at 115 Kc., and an audio amplifier. It is to be built up on a pressed steel chassis which is drilled for Remler Audio Transformers. Remler Audio Transformers provide reproduction far superior to that which can be had from any other units. Either one or two stages of audio amplification can be built into the receiver proper. It is particularly recommended for use in cities where the usual broadcast congestion exists.

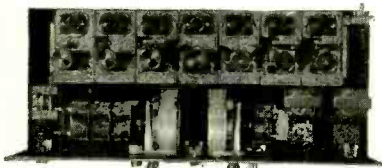

The BEST 115 SUPER

The Best 115 Kilocycle Super-heterodyne differs from the Remler 29 in that it incorporates two stages of shield-grid radio frequency amplification instead of one and two stages of impedance-coupled shield-grid intermediate amplification functioning at 115 Kc. as against three stages of transformer-coupled intermediate in the "29." The sensitivity of the "29" and the "115" are approximately the same although the selectivity of the "115" is slightly greater due to the use of two stages of radio frequency amplification. The Best 115 Kilocycle Super-heterodyne is not quite so compact and so easily constructed as the "29" but full-size blueprints with both schematic and pictorial diagrams and an instruction book make it simple for the man with average radio experience to build and operate. The "115" cannot be surpassed for selectivity and is highly recommended for use in cities where broadcast congestion is very bad. It will bring in distant stations under conditions which make the successful use of any other set impossible.



REMLER COMPENSATING TRANSFORMER

Any radio set can be improved from 25 to 100% in tone range. That is a flat, simple, direct statement from Remler—a firm famous for ten years of radio reliability.

The new Compensating Transformer, No. 905, replaces the first audio transformer in your receiver. This easy change is quickly made—and results are amazing. Especially when used with a dynamic speaker, the new Compensating Transformer proves its worth by delivering energy over the complete range of the speaker. Use it to get the most out of your Dynamic Cone. Not an experiment—proved and tested in every popular set and circuit.

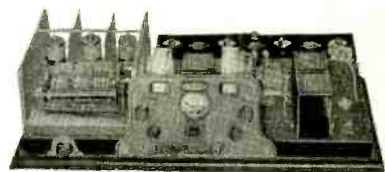

The 1928 INFRADYNE

incorporates one feature which commends it to everyone. While it is a ten-tube set, a switch is provided so that a five-tube, single-dial tuned radio frequency set is immediately available for local reception. This single-dial feature makes it the ideal set for all members of the family. The complete Infradyne is immediately available whenever the extra selectivity and sensitiveness necessary for distant reception are necessary. The Infradyne is intended for antenna operation and may be operated from a "B" eliminator if desired. A storage battery is recommended as a filament supply.

Complete information on any of these popular circuits or audio transformers will be mailed upon request

REMLER

Division of

GRAY & DANIELSON MFG. COMPANY

CHICAGO

260 FIRST STREET, SAN FRANCISCO

NEW YORK

THE TRUTH ABOUT Line Voltage Surges

RADIO Sets are designed to operate at approximately 110 volts A. C. and "hard" tone or reproduction. The prevention lies simply in the attachment of a Centralab Radio Control Box, which maintains an even, correct voltage on the receiver regardless of the line voltage. No complicated connections required. Plug the set in the Control Box and the Control Box in the wall. Your set and tubes are then permanently protected against injury from line voltage surges.

Power stations fluctuate in their output so that the voltage delivered from the light socket often is as high as 125 or 130 volts or more. This increases the output of the power supply in the set in proportion, causing a raise in the voltage supplied to the tubes in the set, which is injurious and results in a very distorted

Illustrate with Radio Control Box



List Price \$3.00

26 Keefe Avenue

Centralab

CENTRAL RADIO LABORATORIES

Milwaukee, Wisconsin

(Continued from Page 34)

start of the windings and 2 and 4 for the finish. Now solder the end pieces to the cans in the same manner that the first ones were soldered.

When connecting in circuit, the start of the primary, $P1$, goes to the B -positive, the finish, $P2$, goes to the plate. The grid is connected to finish of the secondary, $S4$, and the filament to $S3$.

ANTENNA COUPLER

(Continued from Page 22)

denser—coil combination system, Fig. 4—is obtained at resonance, therefore the voltage across the combination is maximum in value, and is capacitively fed to the receiver system through the condenser C .

There is another advantage in the use of this circuit in preventing resonance "drags" taking place due to harmonic relation of the antenna to the oscillating detector circuit. Another advantage takes place simultaneously when the antenna is in tune with the detector circuit which is a reduction of the antenna resistance due to the energy being fed into the antenna system.

If the antenna coupling scheme is used ahead of a radio frequency amplifier, increased selectivity will be obtained with a moderate gain in signal strength due to little or no change taking place in the effective resistance of the antenna system. However, a gain is made possible by operating on the proper distribution point of the current and voltage curves.

When the coupling unit is tuned to resonance the coupling condenser C or

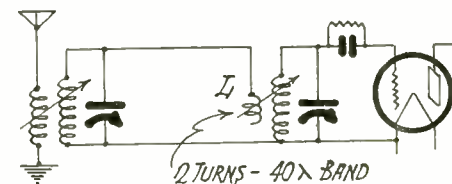

Fig. 5. More Selective Antenna-Coupling Circuit

the inductance L , Fig. 5, should be reduced until the detector circuit will oscillate with an increase of several divisions of the regenerative control dial. In other words, the coupling unit should not stop oscillations when both circuits are in resonance with one another. The switch S may be opened or closed as desired, enabling the radio fan to select a coupling combination for maximum results.

Either circuit as shown diagrammatically in Figs. 4 and 5 will bring about the desired condition as described in this article. The circuit as illustrated in Fig. 5 will enable better selectivity due to sharper tuning combinations existing in both antenna and detector circuits. It is therefore recommended for use where interference is severe. The circuit as described in Fig. 4 is easier to adjust and requires fewer coils.

POWER TRANSFORMERS for the UX 250 Power Tube



The General Radio Type 565 Power Transformers consist of two models for both half and full-wave rectification utilizing the 281 type of rectifier tube. The Type 565-A Half-Wave Transformer illustrated consists of one 600-volt secondary, two secondaries of 7.5 volts and one of 2.5 volts. It is designed for 105 to 125-volt, 50 to 60-cycle lines.

Bulletin No. 931 will be sent on request.



TYPE 565-A TRANSFORMER
(200 watts)

General Radio Co.

PRICE \$13.50

30 State Street, Cambridge, Mass.

274 Brannan Street

San Francisco, Calif.

— LAST MINUTE SPECIALS —

R. C. A. Uni-Rectron Power Amplifier, Mod. A. P. 935. List \$88.50.....	Our Price \$19.75 ea.
Genuine Black Bakelite Panels 38" x 43" 3/16" thick. Reg. Price \$29.....	" 8.75 "
E210 Bradleystats, list \$4.00, fine A. C. Line Voltage Control.....	" 1.60 "
G. E. Kenotron Rectifying Tubes (Type T.B.1).....	" 1.25 "
Gould Kathode Unipower, Automatic "A" Power (6 volts), list \$39.....	" 13.75 "
2 Henry—250 Mill Choke Coils, D.C. Resistance 20 ohms. List \$25.....	" 4.75 "

AMERICAN SALES CO., 19-21 WARREN ST., NEW YORK CITY

PROFESSOR HERMANN SCHNITZEL

Of the Ooniversity of Cincinnati, O-ho-ho

has written a booklet containing 21 short radio lectures which have been broadcast from many stations. 50 cents per copy, postpaid. You will enjoy this book.

For sale by "RADIO," Pacific Building, San Francisco

LYNCH METALLIZED FIXED RESISTORS METALLIZED

Lynch Metallized resistors are actually soldered in the end caps. The glass filament has metal baked right on its surface. By confining the metal to a small area, it is relatively thick, and thick metal can be soldered so it is absolutely noiseless. Nearly all resistors are quiet when first inserted. Lynch Metallized resistors stay quiet—even after the set has been running for hours. The grid leak actually has to pass a fraction of a milliampere—the ordinary type of resistor gets hot, disintegrates, contact becomes poor and noise develops. Not so with the Lynch Metallized resistor.



Sizes .25 to 10 Megohms
Standard Metallized 50c each
Lower sizes .2 to .0005 75c each

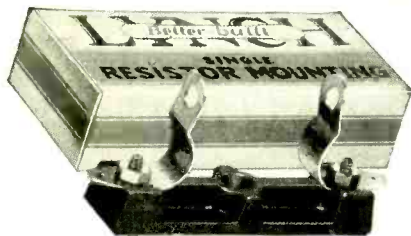

Leak-Proof Single Mountings

The Lynch single and double mountings are designed to give extremely low surface leakage. The springs are a single piece, rigidly held in grooves by a screw and nut. The spring and soldering lug are one piece, thus eliminating poor and noisy contacts. The mounting is for single hole mounting 35c
Double mounting 50c

Lynch Transmitting Resistors
Available in All Sizes

LYNCH Filament Equalizers with Mounting, \$1.00
(Less Mounting 75c)
LYNCH 2½-watt Resistors (DYNOHMIC TYPE)
for \$1.00 Each

Distributed by Leading Jobbers on the Coast

Manufactured by
ARTHUR H. LYNCH, INC.
General Motors Bldg. New York, N. Y.
Pacific Coast Representative
DON C. WALLACE
Bank of Italy Building
Broadway at Pine Long Beach, Calif.

SET BUILDERS Get this Book

Barawik, the first and oldest radio specialty house, offers you unusual service this year. Bigger stocks, quicker shipments, lower prices. Deal with an old established, reliable house. Get honest goods, honest service, honest prices. Barawik service makes you more money. Send now for big new Catalog showing lowest wholesale prices.

BARAWIK CO. 182 Canal Sta.,
CHICAGO, U. S. A.

Mail This Coupon Now for Free Radio Guide

Name _____
Address _____

RADIO PARTS QUICK

We carry the most complete stock of high grade radio parts in America. Complete immediate deliveries — No back orders — No substitutions.

Headquarters for

Magnaformer 9-8
Scott Screen-Grid Nine
Victoreen AC or DC
Kuprox Power Devices
Tyrman No. 80, No. 72 and No. 60
Remler No. 29—115 KC.
National Browning-Drake Kits
Silver-Marshall Kits

HAMMARLUND, NATIONAL
AND AERO SHORT
WAVE KITS

Write today for complete Catalog
and Dealer's Discount Sheet

NELSON ELECTRIC CO.

508 South Dearborn Street
CHICAGO, ILLINOIS
"WE SHIP FASTER"

Two Radio Magazines

for the price of

ONE!

Hundreds and hundreds of readers of "RADIO" have availed themselves of our special money saving offer whereby you subscribe to two radio magazines for the price of one. "CITIZENS RADIO CALL BOOK" and "RADIO"—both magazines sent to your address for a full year for the price of one year subscription to "RADIO"—\$2.50. The next issue of the "CALL BOOK" will be out on November first. Better subscribe now to avoid missing it. "RADIO" will be sent to you for 12 months, starting with our March issue, out on February 25th. Save \$2.50 by subscribing today.

"RADIO"

Pacific Building San Francisco

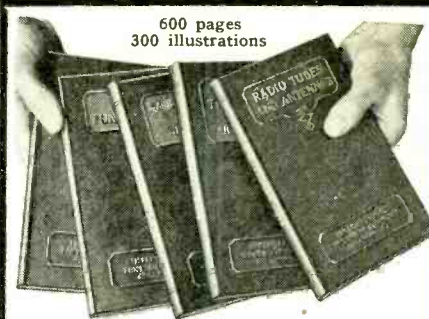

Everything you want to know about RADIO

Every branch of radio knowledge is covered in this complete 5-volume Radio Library. For everybody in the radio field—mechanics, operators, inspectors, service men, salesmen, owners of radio stores. Written by such experts as Harry F. Dart, E. E., Member, Institute of Radio Engineers; A. G. Zimmerman, B. S. in E. E.; H. H. Beverage, B. S., Radio Engineer, Member, Institute of Radio Engineers; K. M. MacIlvain, E. E., Radio Engineer, Member, Institute of Radio Engineers; E. H. Hansen, Consulting Radio Engineer; C. H. Vose, B. S. in E. E., of the Radio Engineering Dept. of the General Electric Co.; W. H. Freedman, E. E., Fellow, American Institute of Electrical Engineers, and other prominent Radio Engineers. Gives you the whole science of radio in clear, understandable English, illustrated with nearly 300 pictures and diagrams. Handsomely bound, pocket-size volumes, stamped in gold. Includes Picture Transmission and Reception. Worth many times its moderate cost. Send the coupon with \$7.50 in check or money-order.

Money back if not satisfied

International Correspondence Schools
Dept. 8264-D, Scranton, Pa.

I am enclosing \$7.50 for which please send me your five-volume RADIO LIBRARY. It is understood that I may return the books in five days and you will refund my money if I am not satisfied.

Name _____
Address _____

USE THE CLASSIFIED ADS IN "RADIO"

They Bring Results

The rate is 8c. per word
Mail Your "Ad" Now

More "A" Power For Less Money!

With the Set Builders discount card you can purchase a **KNAPP "A" POWER KIT** at a liberal discount.

Write me today for full details telling about this new money-saving plan for set builders.

DAVID W. KNAPP, Pres.
Knapp Electric, Inc.

Division of P. R. Mallory & Co., Inc.
Room 416-B, 350 Madison Ave., N. Y. C.

Tell them you saw it in RADIO

(Continued from Page 25)

FREE

A Booklet of Helpful Hints for Better Transmission and Reception



This booklet discusses facts that are important to every Radio Engineer and Amateur, explains why good insulation is essential, and gives data on correct insulators for all types of transmitting apparatus and receiving sets. A copy should be in your file for ready reference.

The PYREX* Insulators illustrated and described are the ones universally recommended for highest electrical resistance, strength in mechanical tension and the chemical stability for everlasting dependability under climatic and destructive exposure.

The PYREX line includes antenna, strain, entering, stand-off, pillar and bus bar types of every desirable size, such as are used by the big broadcasting stations, U. S. Lighthouse, Coast Patrol, Lighthouse and Air Mail Services, Commanders Byrd and MacMillan, and exacting Amateurs everywhere.

*Trade Mark Reg. U. S. Pat. Off.

Get the booklet

by mailing the coupon and get PYREX Radio Insulators from your nearest supply house or if necessary directly from us.

CORNING GLASS WORKS,
Industrial and Laboratory Division,
Corning, N. Y.

Please send the PYREX Radio Insulator booklet

Name Print name and address

Address

interrupted. Phillips advised the captain that the *Frankfurt* did not acknowledge his position, merely telling him he would see him in a few minutes.

After a lapse of about 20 minutes, during which time the *Titanic's* operator was working the *Carpathia* and *Olympic*, the *Frankfurt's* operator called again and asked what the matter was. Whether it was under the stress of strain or from being jammed, Phillips told him: "You are a fool, keep out!" and gave him the "DDD" signal, which means "QRT" in our present list of abbreviations.

The question has since been raised as to whether Phillips used good judgment in sending this, whereas, if he had sent his position and the *Frankfurt* had been close at hand it might have been possible to have saved all the lives of those on the ship. Phillips evidently thought that the *Frankfurt's* operator had received his first position report and was annoyed when he called him the second time and found that he had not. With the knowledge that the *Olympic* and *Carpathia* were steaming toward them at forced draft he perhaps felt that further talk with the *Frankfurt* would have been wasted effort, and it later turned out that he was right.

Mr. Bride then took the phones and raised the *Baltic*, while Phillips went out on deck to look around and ascertain just how badly the ship had been damaged. Bride told Phillips, when the latter returned, that the *Baltic's* signals were so weak that he did not think it worth trying further, so Phillips again took the phones while Bride went into the stateroom and proceeded to get their money together. When he came back to the operating room he saw a fireman or coalpasser trying to relieve Phillips of his lifebelt. The two of them forced him out of the cabin just as the captain came in and told them to look out for themselves, as the vessel was pretty badly damaged and would only stay afloat a few minutes longer.

They went on deck together and approached a collapsible boat which several members of the crew were trying to launch on the port side. Mr. Phillips left them, starting aft again, as he wanted to say that the engine room was being flooded, the dynamos were going out, and have a last word with the *Carpathia*. That was the last time Phillips was seen. The collapsible boat collapsed as soon as it hit the water, pinning Bride and several others under it in the icy waters, where they were held for about 40 minutes before another boat finally rescued them.

Mention might be made of the fact that only four ships carried two operators at that time, the *Titanic*, *Olympic*, *Mauretania* and *Lusitania*; all the others carrying one operator each, and requiring only that watch necessary for him to handle the traffic of his vessel. It was by the merest luck that Operator Cottam of the SS. *Carpathia*, the vessel that picked up the survivors, heard the *Titanic's* call for assistance.

At 10 p. m. Cottam was receiving press from Cape Cod. The latter station finished with press at 11 p. m. and started with the *Titanic* on a long string of messages. He then took the press items that he had just copied to the bridge and spent some time there. Returning to his operating room he decided to get confirmation on a message he had sent to the coast via the SS. *Parisian* earlier in the day, providing that operator was on watch. He called several times and received no reply, so took off his coat and started to retire. Three minutes later and he should have missed the *Titanic's* call and many more lives would have been lost.

When Cottam received the CQD call of

YAXLEY

RADIO CONVENIENCE OUTLETS
CABLE CONNECTOR PLUGS
RHEOSTATS POTENTIOMETERS
JACKS SWITCHES
RESISTANCE UNITS

For greater convenience in receiver operation and dependability in set construction make up your list of parts and accessories from the New Yaxley catalog. FREE. Send for it today.

Yaxley Mfg. Co.

Dept. A, 9 S. Clinton Street, Chicago



\$1.00 Brings you the next 6 issues of "RADIO"

Before Buying

Any "A" Eliminators

Write me about the discount card which enables you to purchase the new and improved Knapp "A" Power Kit at a liberal discount.

The most complete "A" Power Kit ever offered—Address for details of plan—

David W. Knapp, Pres.
Knapp Electric, Inc.

Room 416-B, 350 Madison Ave., N. Y. C.

Tell them you saw it in RADIO

the *Titanic* he rushed it to the bridge, returning with the *Carpathia's* position. Captain Rostron, of the *Carpathia*, figured that they were 58 miles from the *Titanic*, and at a speed of 19½ knots per hour under forced draft, would cover the distance by 4 a. m. Monday morning. During the last few minutes the *Titanic's* radio was in operation some nearby steam pipes burst, causing so much interference that it was almost impossible for the operators to work the other ships. This made it necessary for the *Carpathia* to do considerable relay work.

The *Carpathia* arrived at the scene of the disaster at 4 a. m. and took the first boatload of survivors aboard at 4:10, 20 boatloads, in all, being picked up, totaling about 720 lives. The *Carpathia* stood by during the balance of the 15th, cruising around the location in which the *Titanic* went down, but aside from a small amount of wreckage, nothing further was found. About 20 bergs, averaging from 150 to 200 feet in height, were sighted near the *Titanic's* last position, and extreme care had to be taken by the *Carpathia* in order to avoid them. The temperature at the time the *Titanic* struck was 31 degrees above zero, so it is little wonder that there was such an appalling loss from exposure. According to the final figures set by the officials of the White Star Line, 1503 people perished; many of them being of world renown. Although no positive proof has ever been submitted, it is believed that Phillips died from exposure aboard the collapsible boat. Bride was saved, but suffered severely from exposure and a sprained foot.

Cottam, operator of the *Carpathia*, remained on duty continuously from Sunday night to Tuesday night, until he was finally so completely worn out that he was unable to keep awake. Company messages were handled first, being followed by regular passenger traffic. Very little time was found for reports to the press, as the operators were kept busy with inquiry messages from ashore and reassurance messages from the passengers; so the world did not receive much information of the complete details of the disaster until the *Carpathia* tied up in New York the following Thursday.

The U. S. S. *Salem* and U. S. S. *Chester* were dispatched to the scene of the disaster by the Navy. Severe complaints and criticism were levied against the operators of the *Carpathia*, as the operators of the Naval boats claimed that the *Carpathia* discriminated and would not work them. It was shown later, however, that the third-class passenger list was sent to the operator on the U. S. S. *Chester*, but it was a long, drawn out process, as the operators on the Naval vessels used the Morse code and the *Carpathia* operators used the Continental code. This seems to be reason enough for the slight on Cottam's part.

The sinking of the *Titanic* is of special interest to the radio world because it was the primary cause of the standardization of radio procedure and other measures for safety at sea. From these measures might be mentioned the following:

1. Adoption of the Continental Morse code as a standard for all ship operators.
2. Adoption of the conventional "Q" signals.
3. Establishment of the Ice Patrol service in the North Atlantic.
4. The requirement for a continuous watch on all passenger vessels.
5. The requirement for auxiliary means of communication and a definite range for the main set.
6. The law regarding intercommunication regardless of the system employed. (It was a well known fact that in the early days a great deal of animosity existed between operators of competitive companies.)
7. The standardization of S. O. S. as the international distress signal.

Perform that
"adenoid
operation"
on your set



TAKE out the "adenoids", those inferior transformers which make your set sound as if it were afflicted with a bad case of adenoids... Then put in their place, the standard of excellence in Audio Transformers—AmerTran DeLuxe.

Ever hear a child talk before and after an adenoid operation? Well, if you have, you will appreciate the difference AmerTran transformers will make in any set.

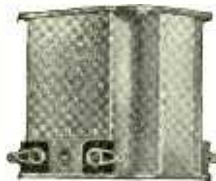

AmerTran DeLuxe—1st stage turn ratio, 3. 2nd stage turn ratio, 4. Price each \$10.00.

AmerTran products are built exclusively for the purpose of achieving realism in tone. It cannot be done cheaply, or haphazardly. AmerTran's 30 odd radio products all play their definite part in producing the finest tone known to radio.

Why not perform that "adenoid operation" today? See your dealer or write to us. Ask for Bulletin No. 1084.

AMERTRAN

AMERICAN TRANSFORMER COMPANY
Builders of Transformers for more than 29 years
61 Emmet St. Newark, N. J.

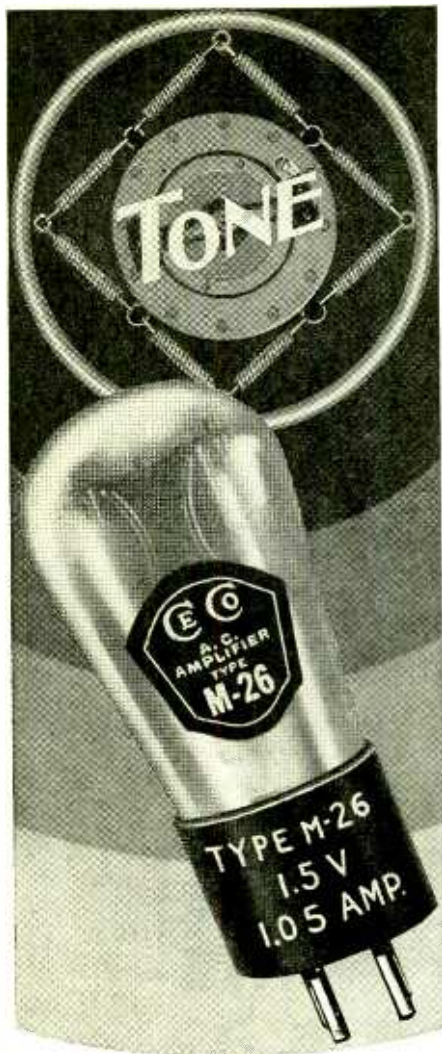

Clear Silver Tones ~ from the microphone to you

EXPERT workmanship, correct design and the careful selection and testing of all materials are responsible for the great popularity of CeCo tubes.

You'll find a CeCo tube will last longer, perform better and give you more genuine enjoyment from your set.

There is a CeCo tube for every need and they cost no more. They are the best engineered tube in the industry. Sold everywhere.

CeCo Mfg. Co., Inc. · Providence, R. I.

CeCo

Radio Tubes

Many other results could be traced to this terrible disaster. Never in the history of mankind has there been one single event that has caused so thorough a re-vamping of all laws governing safety at sea. Undoubtedly thousands of lives have since been safeguarded through this wise legislation.

One more item of interest that might be mentioned in closing is that at the time of the *Titanic* disaster there were only four radio equipped American ships, each carrying one operator at a salary of \$45.00 per month. These were the SS. *St. Paul*, SS. *St. Louis*, SS. *Philadelphia* and SS. *New York*.

Note from Harry Washburn:

Due to the fact that 2UO was considered out of place in the amateur band a commercial license was obtained and wavelengths of 47.13, 36.45, 27.17, and 18.226 meters were assigned. Five hundred cycle accw is still used and the transmitter is crystal controlled on all waves. Rates are 10 cents a word, with a minimum of one buck.

Another short wave commercial station is WSL, Commercial Wireless, Inc., Sayville, Long Island, N. Y. Waves: 17.805, 26.785, 35.6, 53.57 meters. Rates 10 cents, LL same as WSH.

Bill Pond, NIZJ, writes that he can't see why some of the gang insist upon jamming the weather. Sometimes we feel that there is malice aforethought, but when we cool off we realize that these operators just lack the vision to see beyond their own bulkheads. You would think that a radio operator, whose thoughts must necessarily extend to great distances, would keep in mind the doings of his neighbors. But such is not always the case.

From Charles C. Coffin, NPR:

NPR, Dutch Harbor, is situated on the Bering Sea side of the Aleutian Islands. Handles traffic from ships in the North Pacific and from the canneries in the vicinity during the fishing season. Sends local WX QST on 600 meters at 12:30 p. m. PST, and 9:30 p. m. PST. Also upon request.

Mr. Coffin wishes to pass along a word received from NPG that the GOVT weather reports from ships were reaching there too late. This can be remedied if these messages are given to either St. Paul, NPQ, or Dutch Harbor, NPR, at or as nearly after 4 a. m. and 4 p. m. PST, as possible.

FERRANTI

Radio Products

for

Real Reception

Highest quality heavy duty audio and output transformers for power and general purpose amplifiers.

High grade iron core chokes for "B" Eliminators. Three range portable meters. 1,000 ohms per volt. 10/50/250 scale. Three range portable meters. 200 ohms per volt. 150/7½ volt and 15 Mill. scale with switch. By-Pass condensers—2MF—400 volt and 200 volt.

Technical data and prices sent on request.

FERRANTI, INC.

130 West 42nd St. New York, N. Y.

Ferranti, Ltd.
Hollinwood,
England

Ferranti Electric
Limited
Toronto, Canada



Safeguard

Your A. C. Installation

Satisfactory and economical operation of A. C. receivers is contingent upon maintaining close regulation of operating voltages, by means of suitable A. C. measuring instruments. This is necessary because of the wide fluctuation in the potential or secondary lines furnishing current to house lighting circuits.

Set manufacturers, dealers and electric light and power companies everywhere are cooperating to the end that voltage regulation, both on supply lines and in connection with voltage control equipment of the receivers themselves, may be effected for the better operating service of all set owners. For this reason, as well as for other testing requirements outlined in the following, all purchasers of A. C. receivers are urged to provide themselves with an instrument such as is shown in the illustration—known as the Weston Model 528 A. C. Voltmeter, range 150/8/4 volts.

When you find that there is an excessive in-pu voltage, it follows that there is too high a voltage on the filament which shortens the operating life of the rectifying tubes. The Model 528 Voltmeter therefore checks the line supply voltage at all times and indicates when adjustment should be made to manually operated line voltage regulators between the power supply and the power transformer. This voltmeter also indicates when the line voltage is over-rated, thus enabling the operator to make an adjustment in the set for the higher line voltage so that normal life can be obtained from his tubes.

The Model 528 is also made as Am-meters which are especially useful in checking the total load of the A. C. Set—in conformity with set manufacturers' instructions. The determination of A. C. filament flow in A. C. tube filament circuits is easily obtained by means of this instrument.

Write for your copy of Circular J fully describing the Weston Radio Line.

WESTON ELECTRICAL
INSTRUMENT CORPORATION

600 Frelinghuysen Ave.
NEWARK, N. J.

Pacific Coast Representatives

Graybar Electric
Company, Inc.
84 Marion St.
Seattle, Wash.
J. H. Southard
San Francisco,
Calif.

A. A. Barbera
Los Angeles, Calif.
Repair Service
Laboratory
682 Mission St.
San Francisco,
Calif.

WESTON RADIO INSTRUMENTS

Present Radio Conditions

Sir: I have been reading with interest Mr. Gillis' article on "Why the Present Radio Conditions," and I most certainly agree with him. I am by no means an old-timer, having been going to sea for less than two years. Mr. Gillis says he doesn't know what is causing the present conditions, but perhaps he hasn't investigated. The following are a few incidents that tend to clear matters up.

Last year I was senior on a certain coast-wise two-man job in the east. One day the senior from another company ship asked if I'd trade jobs with him because he'd had an argument with the skipper. Please bear in mind that this man is about 40 years old, and has had 17 years sea experience. I went aboard his ship with him and found out quite a few surprising things. The ship had a three-day run but he refused to copy press. He'd been on the ship for three years. Many passengers asked for baseball scores and he told them he did not have to copy press. He showed me nine letters from the Navy and Department of Commerce officials in which they told him he did not have to copy press. He told me he had written them and asked if the law required copying said press.

The junior operator was forbidden to touch the transmitter. All he was supposed to do was keep watch on 600. If a message had to be sent during the junior's watch he had to wake the senior. I refused to trade ships for fear of consequences.

I left that ship and went on a tanker. The first two weeks aboard were everything but rosy. When the crew found out I could mind my own business things got much better. The other man was a drunkard; he got press when he felt like it and considered himself superior to the other officers. As the skipper put it he was "a pain in the neck." The radio apparatus showed worse. It was dirty, below normal efficiency and clearly bespoke the man's character and habits.

Experience No. 3 was still worse. The receiver didn't work; the transformers had been removed, and some of the dollar type put in, and the shack was filthy.

These three cases happened on the three ships I've been on so I guess there are plenty such. It seems to me the service companies should fire careless operators after the second or third offense.

Yours for the B. P. section and RADIO.....

ROGER SOUCASSE.

Without a doubt such cases as those cited in Mr. Soucassee's letter do their share in retarding the brasspounding profession all over the world. The pitiful part of it is that such instances as these make a greater impression on the average outsider than instances of operators who are loyal to their profession.

SIX RADIO STATIONS FOR PACIFIC COAST AIRLINES

Six radio airways stations, each costing \$30,000, are to be installed by the Department of Commerce along the Pacific airway at Portland, Medford, Redding, San Francisco, Fresno, Bakersfield and Los Angeles. The purpose of the stations will be to keep commercial planes equipped with telephone apparatus in constant touch with the ground for disseminating weather and field conditions, on a wavelength of 900 meters. Commercial plane owners are advised to equip their ships so they can receive this service. These stations will not duplicate the work of private stations now operated by the Pacific Air Transport Company in connection with its operation of air mail planes, nor will it alter the work of the weather bureau in furnishing weather reports to local airports along the route.

Now...4 or 6 Volts with the Improved Knapp "A" POWER

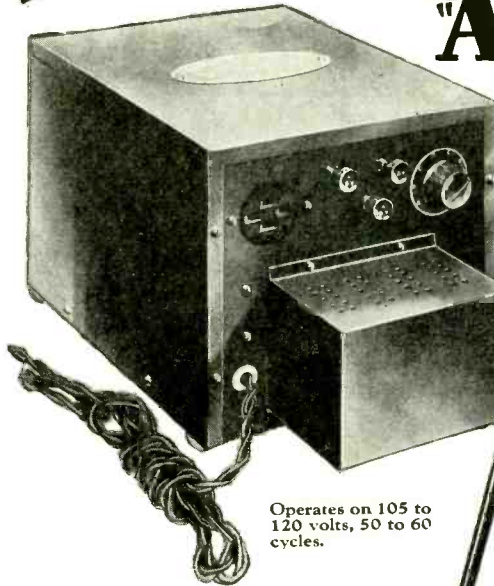

Operates on 105 to 120 volts, 50 to 60 cycles.



The only "A" Power Suitable for all Sets

— Irrespective of number of tubes — including SuperHets, Short Wave and Television receivers

THE new Knapp "A" Power is designed for the most exacting service — super-hets, short wave and television receivers included. I knew that if it would perform satisfactorily with these receivers that there could be no question as to its efficiency on ordinary broadcast signals. The three Elkon dry condensers, the improved choke coils and the special Elkon dry rectifier make the difference between ordinary and Knapp performance.

No Change in Price

Even with these wonderful and costly improvements, there has been no advance in price—due to the tremendous volume going thru my plant. Remember that the Knapp is the fastest selling "A" Power on the market.

KNAPP ELECTRIC, Inc.
—Division of P. R. Mallory & Co., Inc.—
350 Madison Ave., New York City

See your dealer today

Go to your dealer today. Most of the good ones carry the Knapp in stock. Do not accept a substitute—because only in the Knapp will you get full satisfaction as typified by the famous Knapp "A" Power. If your dealer cannot supply you send the coupon.



David W. Knapp, Pres.

Mr. David W. Knapp, Pres.,
Knapp Electric, Inc., Dept. K-13
350 Madison Ave., N. Y. C.
Send me complete information on the Knapp
"A" Power.

Cunningham RADIO TUBES



Each Cunningham
Radio Tube speaks
with a note of author-
ity on tone Quality

E. T. CUNNINGHAM, INC.
New York Chicago San Francisco



Ask for
them by
Name

\$1.00 Brings you the next 6
issues of "RADIO"

Potter Condensers



THE selection
of leading
manufacturers for
the finest radio
receivers. Insure
the operation of
your radio set or
power amplifier
with Potter con-
densers, which are

known for their **Quality—Uniformity—
Long Life—Economy.**

Potter T-2900 Condenser Block for sin-
gle 250 type tube amplifier—\$20.00.

Potter T-2950 Condenser Block for the
push-pull 250 type tube amplifier—
\$22.50.

Potter T-2098 Condenser Block for the
single 210 type tube amplifier—\$20.00.

Potter T-280-171 Condenser Block for a
power pack with 280 type tube rectifier
for a 171 type tube power tube—\$18.00.

Potter SM-673 Condenser Block as used
in Silver-Marshall Power Amplifier and
Power Supply Units—\$20.00.

The Potter Co.

North Chicago, Illinois

A National Organization at Your Service

FREQUENCY CONTROL

(Continued from Page 26)

The imposition of supersonic sound waves between the reflecting surfaces may be controlled by enclosing the crystal and holder in a vacuum. The capacity of the holder may be kept constant by using the metal-coated crystals. Since both of these devices are beyond the reach of the average amateur we may regard the effects of both mentioned causes as being constant under normal working conditions.

It is well known that the frequency of a piezo-oscillator increases as the mechanical load upon the crystal is increased or in other words, as we increase the weight of the movable plate of the holder or the tension of the spring retaining this plate in place we will also increase the frequency at which our crystal will work. We may control the frequency to some degree by adjusting the mechanical load on the crystal. But the oscillator must be adjusted after our crystal holder is adjusted.

COMMUNICATIONS IN THE NAVAL RESERVE

A BATTLE FLEET is no better than its communication system." This statement has been ruefully made after more than one naval disaster, and as recently as the late World War. In 1916 the United States Navy mustered ships more rapidly than it could train men to handle the radio equip-



Radio W 6 C T M

ment. The fleet was 7000 operators short, and insufficiently trained men were unable to cope with the difficult situations confronting them. Some operators never got on the air; some who were more successful with the equipment, had such a vague knowledge regarding naval procedure that they did more harm than good. So the United States Navy Department has made extensive plans in the effort to eliminate the same chaotic condition should history ever repeat itself.

The communications unit of the United States Naval Reserve has therefore been organized to train radio operators in the use of naval operating methods and tactical procedure; to train those who desire to become radio operators in the fundamentals of radio theory and code; and, to give the reservist some instruction in seamanship, military drill and the manual of arms.

With the United States Naval Reserve communications unit at work, the Navy Department is assured of a communication system, in case any future need should arise, that will be entirely adequate to guide the maneuvers of a stupendous war-strength navy. And the communication reservist, on the other hand, will be assured a berth in the line of work for which he is most fitted. He will be of greater service to his country in time of war, and will be advanced accordingly.

Various sections of the Naval Reserve

Tell them you saw it in RADIO

throughout the country hold classes for instruction in all branches of naval communication. Tactful code drills are held on the air. Coding and decoding; semaphore and other types of visual signalling, the cor-

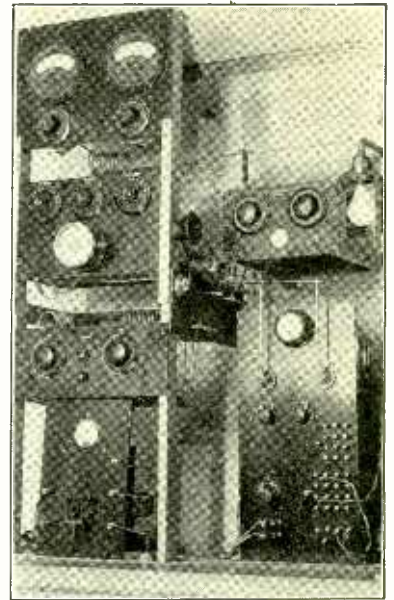

Radio W 6 N V

rect method of routing and the use of the naval abbreviations are studied. Some sections spend a part of their time on the drill field and on the water. All units are assigned a destroyer, upon which week-end cruises are made, and are open to all reservists who wish to take advantage of them. On these cruises practical instruction is given in the use of the ship's radio equipment and direction finders.

Any man between the ages of 18 and 35 who wishes to become a Communication Reservist, may apply to the Commandant of any naval district or to the Commanding Officer of any local section. Men enlisted in this branch of the United States Naval Reserve are not obligated to active duty, but may voluntarily apply for two weeks active training duty with full pay according to their ratings.

This service affords an excellent opportunity for thorough instruction in radio principles and practice, at no cost to the student. He has use of fine short-wave equipment which is provided by the Navy.

The ratings for which the men are enlisted are based on the following requirements:

- Commercial, Extra First Grade, Chief Radioman.
- Commercial, First Grade, Radioman, First Class.
- Commercial, Second Grade, Radioman, Second Class.
- Commercial, Cargo Grade, Seaman for Radioman.
- Experimental and Instruction Grade, Chief Radioman, Radioman First, Second and Third Class.
- Amateur, First Grade, Radioman, Second Class.
- Amateur, Second Grade, Radioman, Third Class.

Note 1.—The speed requirements for enlistments are as follows. Continental code only as required:

- Chief Radioman, send and receive at 20 words per minute.
- Radioman, First Class, send and receive at 20 words per minute.
- Radioman, Second Class, send and receive at 18 words per minute.
- Radioman, Third Class, send and receive at 15 words per minute.

All beginners not under the above classification are enlisted as Seamen for Radioman.



HOOK-UP WIRE
"THE BRAID SLIDES BACK"

FREE SAMPLE

Send us the name and address of your dealer and we will send you a sample package of Braidite FREE. Include 10c for postage. We do this because



we want you to get acquainted with Braidite and prove to yourself its many exclusive features. Send for your package now.

At All Dealers

25 Feet Stranded 35c
25 Feet Solid 30c
Red, Green, Yellow, Blue, Black

CORNISH WIRE CO.

26 Church Street New York City

RADIOLA 60, 62, 64

(Continued from Page 28)

the amplifier tube, audio and output transformers are located in the power unit. An a.f. choke is in the negative lead with the speaker field, acting as a second choke, also in that lead. A 60 ohm potentiometer across the filament of the UX-250 acts as an a.c. hum control. Fig. 2, being the circuit of the Radiola 64 as incorporated in the Victor phonograph, includes a phonograph pickup and transfer switch for changing from phonograph to radio, with a quiet tuning switch which shorts the resistance of its leads across the moving coil of the speaker, this resistance being designed to reduce the volume to a minimum.

WANTED

50-WATT TUBES

R. C. A. or W. E. Co.

NEW, USED OR BURNT OUT

J. T. SCOTT

908 Western Ave.

Seattle, Washington

Send For WESTERN RADIO New 1929 Catalog

Dealers and Set Builders

THE NEW 1929 Catalog is crammed full of the FINEST, NEWEST, Nationally known A.C. sets, consoles, cabinets, dynamic speakers, kits, eliminators and accessories at LOWEST PRICES. Largest stock of radio parts. Prompt delivery.

Write for our FREE catalog.
Western Radio Mfg. Co.
128 W. Lake St., Dept. R-11
CHICAGO

FREE



"The Big
Friendly
Radio House"

New Birnbach Cord



"IT'S MOISTURE-PROOF"

Birnbach Extension Cord enables you to move the Radio Speaker on one side of the room and the Set on the other, or to any room in the house. Attaches instantly to the cord of your Speaker.

It will pay you to replace your old cord with the New Birnbach Moisture-Proof Extension Cord and put an end to distortions often caused by poorly insulated cords. Your neighborhood dealer has these sizes in stock: 10-20-30-40-50 and 100 foot lengths. Get one today.

BIRNBACH RADIO CO.

254 WEST 31ST STREET, NEW YORK CITY

X-L LINK

Make YOUR Set WireLESS

X-L
LINK
List
Price
\$5.75



provides a positive LINE VOLTAGE REGULATOR-DOUBLE SOCKET OUTLET AND SWITCH FOR POWER UNITS OR DYNAMIC SPEAKER, COMPLETE FUSING TO PROTECT THE TUBES AND OTHER PARTS OF THE SET.

Unconditionally guaranteed by the manufacturer of the X-L Variodenser. If your dealer cannot supply you, send us his name and the purchase price direct.

X-L RADIO LABORATORIES

DEPT. J 1224 BELMONT AVENUE, CHICAGO

An antenna and ground wire is just as obsolete today as batteries. A conglomeration of wires inside and outside of the house is unsightly, undesirable, and by the use of an X-L LINK totally unnecessary.

Your set can be made really wireless, operating entirely from a single lightsocket or wall plug by simply connecting it through an X-L Link. This enables you to obtain an excellent antenna and ground from the shielded light wires. In addition the LINK provides

Here's
How You
CAN
SAVE
\$2.00

Send \$2.50 now—get "CITIZENS RADIO CALL BOOK" and "RADIO" both for a full year for the price of "RADIO" alone. A tremendous number of our readers are taking advantage of this most liberal subscription offer. Get in on it now. Save money by subscribing to both magazines. \$2.50 is the full price. Insure yourself against missing a copy of either magazine. CITIZENS RADIO CALL BOOK is published four times a year. Send check or money order for \$2.50 TODAY!

RADIO

Pacific Bldg.
SAN FRANCISCO

RADIO FREE CATALOG

AT WHOLESALE PRICES

A fascinating pastime that puts real money in your pocket. Everything in radio at actual wholesale prices. Send for catalog and particulars now.

ALLEN RADIO CORPORATION
711 W. Lake St. Dept. E 4 Chicago

GET MY
DISCOUNT CARD!

Before buying a
KNAPP "A" POWER KIT

Absolutely dry—Magically
silent—the finest "A" Power
adaptable to Short Wave,
Super-Heterodyne and Tele-
vision reception.

WITH THE
10 NEW IMPROVEMENTS
Write me today for details of this
money saving plan and get your dis-
count card. Address

DAVID W. KNAPP, Pres.
Knapp Electric, Inc.
Division of P. R. Mallory & Co., Inc.

Room 416-B, 350 Madison Ave., N. Y. C.

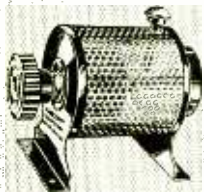

BALANCE!

Good radio, like a good watch, is a question of proper balance. And precise resistance provides that balance. Whether it is line voltage, plate voltage, regeneration or grid bias, you can always obtain the proper balance by means of a Clarostat, because—

There's a Clarostat for Every Purpose

From grid leak to power applications, from a few ohms to ten megohms, from the compact requirements of a volume control to the sturdy requirements of a television motor control, your requirements are instantly met by the proper type of Clarostat.

Ask your dealer or write us for information. Better still, send a quarter in stamps or coin for this book—20,000 words and 88 pictures of real radio dope!



CLAROSTAT MFG. CO., Inc.

Specialists in Radio Aids

287 N. 6th Street Brooklyn, N. Y.

SAN FRANCISCO LOS ANGELES
PORTLAND

CLAROSTAT

AEROVOX BUILT BETTER CONDENSERS AND RESISTORS

Without a Doubt The Most Complete Line of Condensers & Resistors

No matter what your requirements may be in the fixed condenser or resistor field, you are sure to find an AEROVOX unit exactly suited to your needs.

- | | |
|--|---------------------------|
| Filter Blocks | Pyrohm Heavy Duty Units |
| Buffer Blocks | Edison Base Pyrohms |
| Socket Power | Tapped Pyrohm Resistors |
| High Voltage & Transmitting Condensers | Universal Tapped Resistor |
| Bypass Units | "Adjustable" Units |
| "A Power" Units | Wire Wound Units |
| Bakelite Case | Center Tapped A.C. Units |
| Moulded Mica | Grid Suppressors |
| Interference Filters | Non-Inductive Lavites |
| | Grid Leaks & Resistors |
| | Resistorformer Kits |
| | Resistor Mountings |

A COMPLETE CATALOG with illustrations and detailed descriptions may be obtained free of charge on request.



The Aerovox Research Worker is a monthly publication that will keep you abreast of the latest radio developments. Your name will be put on the mailing list free of charge on request.

AEROVOX WIRELESS CORP.

80 1/2 Washington St., Bklyn., N. Y.
PRODUCTS THAT ENDURE

Before Buying any "A" Eliminator

Get my authorized Discount Card and complete description of the finest "A" Power Kit ever offered.

DAVID W. KNAPP, Pres.
Knapp Electric, Inc.
Division of P. R. Mallory & Co., Inc.
Room 416-B, 350 Madison Ave., N. Y. C.

\$1.00 Brings You the Next Six Issues of "RADIO"

SILVER THE KING

24 Kt Gold
Pure Silver
Soft
Copper

Gosilco Super Aerial Wire Gold over Silver on Copper

Greatly Increased DX Range. 50% More Volume—Clearer Tone—35% Sharper Tuning—Non-Corrosive. Endorsed by Naval Research Laboratory. Gerald M. Best, Major Mott, Ormiston, Van Buren, World's DX Champion. A permanent investment. No. 14, 100 ft., \$4.00; 75, \$3.25; 50, \$2.50. Pat. applied for. If dealer cannot supply you, write or phone us. Over 50,000 GOSILCO Aerials in use—There's a Reason.

GOSILCO RADIO PRODUCTS CO.

6420 Marbrisa Ave. DE. 3940 Huntington Park, Calif.

Northern California Customers Order Your GOSILCO SUPER AERIAL WIRE from
Radio Dealers Supply Service

Wholesale Division of



1452 Market Street
San Francisco, California

**Modern Tube Control
A.C. or D.C.**

AMPERITE self-adjusting Control of tube temperature insures best results from modern radio receivers. Tone, sensitivity, volume—all are improved by AMPERITE. \$1.10 with mounting (in U.S.A.) at all dealers.

Radiall Company
50 FRANKLIN ST., NEW YORK

This symbol in a radio diagram means—

FREE "Amperite Blue Book" of modern circuits and valuable construction data. Write Dept. R2.

AMPERITE
The "SELF-ADJUSTING" Rheostat

Fada Announces New Models

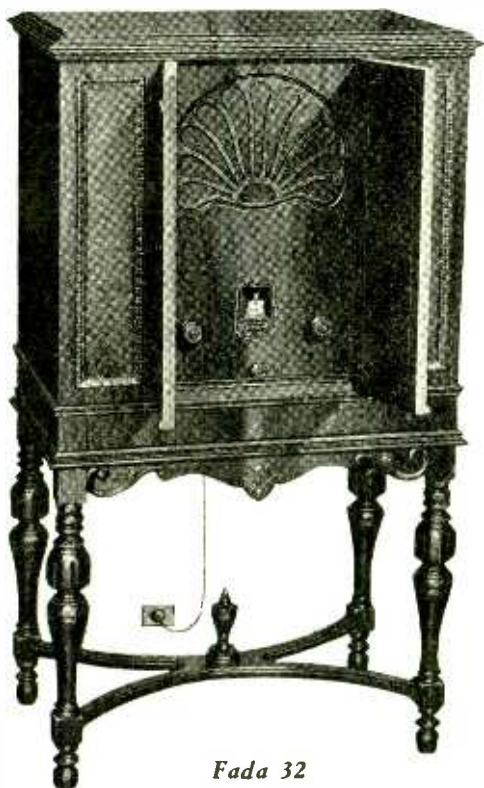

Fada 32

FADA 32

Dynamic speaker built-in—push-pull power amplification in the last audio stage—illuminated single dial—single tuning control—equipped for phonograph attachment—uses five 227 type indirect heater tubes, 2-171A type power tubes in push-pull and 1-280 type rectifier. Long and short antenna connections and also special adjustment for different antenna installations. Completely self contained as illustrated in a beautiful console cabinet of walnut. Yes, it's a neutrodyne.

*Retail price less tubes \$225
West of the Rockies \$235*

There is nothing in the world of radio today that gives you the value you'll find in these new models by Fada. Fada 17 is the same as the 16 except that it is encased in a walnut cabinet. Other Fada models include the 50 and 70 and the 72 radio phonograph combination. Also magnetic and dynamic speakers.

FADA 16

Fada 16 table model, in velvetex finish cabinet for use with Fada dynamic or magnet speaker has same radio receiver chassis features as the Fada 32 described above.

Retail price \$110

West of the Rockies \$115



Fada 16

FADA

Radio

San Francisco Office
5 THIRD STREET

F. A. D. ANDREA, INC.
Long Island City, New York

Chicago Office
2619 SO. MICHIGAN

KROBLAK

WIRE
WOUND RESISTANCES

For all Eliminators, Power Amplifiers, Electric Sets and Television. For Service Stations we carry a complete line of Resistances for all standard make Receivers. Use Mountford Plunger Type Variable Grid Leaks. Write for circular.

C. E. Mountford, 30 Sullivan St., N. Y.



OMNIGRAPH

Today—as for 20 years
The Surest, Easiest, Quickest
Code Training Marvel

Right in your own HOME the Omnigraph AUTOMATIC TRANSMITTER will teach you the code in preparing to become a Broadcaster, Operator, Railroad Official, Manager, etc. The U. S. Govt. tests you for a license with it. Radio and Telegraph Schools, Universities and Scientific Institutions throughout the world use the Omnigraph.

Ask your dealer about it. Catalog FREE.

Omnigraph Mfg. Co., 15 R. Hudson St., N. Y. C.



New York's Newest Hotel The Piccadilly

227 West 45th Street at Broadway
NEW YORK

Adjacent to Every Activity. 600 Bright, Sunlit Rooms. Each with Bath, Electric Fan, Ice Water. Single Room & Bath, \$3.00 Double Room & Bath, \$4.50 Exceptional Restaurant and Luncheonette.

Wire at our Expense for Reservations.

F. D. SOFIELD, Mgr. Dir.

RADIOADS

A CLASSIFIED ADVERTISING SECTION READ BY BETTER BUYERS

The rate per word is eight cents net. Remittance must accompany all advertisements. Include name and address when counting words.

Ads for the March Issue Must Reach Us by February Fifth

IMAGINE AN ORGANIZATION with over 4,000 clients scattered throughout the world, all radiowise dealers, builders, experimenters, hams. Over \$50,000.00 stock of high grade receiving and transmitting parts only, no sets. Spend \$5,000.00 yearly on our own experimenting. Carry nothing until it passes our tests. 50c brings prepaid over four pounds catalog, circuits, data, etc. Weekly data (more than all radio magazines together)—20 weeks, \$1.00; 52 weeks, \$2.50. Sample "Over The Soldering Iron," 32-page experimenter's magazine, 25c. Full trade discounts to licensed hams and radiowise builders. We carry approved items advertised in RADIO. Kladag Radio Laboratories, Established 1920, Kent, Ohio.

SALESMEN WANTED—Screw-holding screw driver! Amazing brand new patented invention! Retail \$1.50. Factories, garages, electricians, auto, radio owners buy on sight! Exclusive state territory. Genuine opportunity earn big money. Free trial offer. Jiffy 1027, Winthrop Bldg., Boston.

ALFALFA SEEDS, hardy common varieties, \$8.40, \$10.20, \$12.60 bushel; Grimm variety Alfalfa seed \$18. Scarified sweet clover \$3.90, \$5.20; Alsike or red clover \$15. Bags Free. Send for samples and catalogue. Kansas Seed Co., Salina, Kan.

"B" ELIMINATORS REPAIRED. New Condensers installed; Chokes, Transformers, etc., repaired; \$2.00 to \$4.00. Fast Service. Clark Brothers Radio Co., Albia, Iowa.

WANTED—Men to work with National Radio Service organization. No selling scheme. Radio Doctors, Inc., Dept. R, Essex St., Salem, Mass.

MAKE MONEY WITH PATENTS! We offer patents with money-making possibilities; circular free. Floyd Clymer, Denver, Colo.

RADIO STATION stamps bought, sold and exchanged. Chas. A. Phildius, 510 East 120th St., New York, N. Y.

BIG PAY.—South American work. American firms pay fare, expenses. South American Service Bureau, 14,600 Alma, Detroit, Mich.

SPEAKERS REPAIRED, Rewound, Magnetized, Guaranteed, \$1.50 to \$2.50. Fast Service. Clark Brothers Radio Co., Albia, Iowa.

POWERFUL, Shieldless, Loop, Antenna Circuit, \$1.00. Archer. 617 Decatur St., Brooklyn, N. Y. (3T)

SHERMAN SQUARE HOTEL
70TH ST. & B'WAY NY

CONVENIENT QUIET COMFORTABLE EXCELLENT FOOD AT MODERATE PRICES COURTEOUS SERVICE

SINGLE ROOM \$2.50 AND BATH \$4.00 FOR TWO

REASONABLE RATES WIRE AT OUR EXPENSE

Philadelphia
Your Choice Should Be
The

HOTEL MAJESTIC
BROAD ST. AND GIRARD AVE.

400 LARGE ROOMS

Only Hotel in Philadelphia with a subway entrance from main lobby. MOST MODERATE RATES!

Single room, running water.....\$2.00
For two.....\$3.50
Single room, private bath.....\$3.00
For two.....\$5.00-\$6.00

Garage Connected with Hotel

Wire at our expense for Reservations
JNO. C. GOSSLER, Mgr. Dir.



A HOMEY HOTEL IN THE HEART
OF NEW YORK

THE *New Flanders*

47th to 48th STREET EAST OF BROADWAY

One of the finest Hotels in TIMES SQUARE

Single Rooms with Running Water, \$2.00
Double Rooms with Running Water, \$3.00
Single Rooms with Bath.....\$2.50
Double Rooms with Bath.....\$3.50

Special Weekly Rates

F. W. BIZEL, Resident Manager



Free

A Continental Control Switch will be given free with a one year subscription to RADIO (\$2.50) if you act immediately. Only a few on hand.

"RADIO"

Pacific Building

San Francisco

Free Radio Apparatus

"RADIO" will present you with one of the following premiums, free of all cost, if you subscribe now to the magazine for only one year. The full price is \$2.50. Take your choice of one of the following premiums, which we will send to you postpaid, in return for your subscription.

Set of Spintite Wrenches
 or Continental Control Switch
 or Latest November 11th Log Book
 or General Radio SLW condenser, Type 334
 or Na-Ald Midget Cone Speaker
 or Three G. R. Rheostats, 6, 12 and 25 ohms.

OR—

1 year subscription to MOTION PICTURE MAGAZINE

or

1 year subscription to SUNSET MAGAZINE

or

1 year subscription to PICTORIAL REVIEW.

Subscribe for 2 years (\$5.00) and get either the new heater type Arcturus detector or amplifier tube, type 126H or 127.

Or—Subscribe for 5 years (\$12.50) and get an AIR KING SHORT WAVE KIT FREE. This great offer will be withdrawn shortly. ACT NOW. Get your subscription in the mails. We ship your premium on the same day that we receive your subscription.

"RADIO"

428 Pacific Building
 SAN FRANCISCO, CALIFORNIA

USE THE CLASSIFIED ADS
 IN "RADIO"

They Bring Results

Mail Your "Ad" Now

MASTER the CODE

Phonograph Motor

Good pay. Travel. Excitement. Adventure. This wonderful instrument will teach you to read the code like an expert. Reproduces actual sending of expert operators. Sends messages, radiograms, etc.,—regular code traffic anywhere, anytime and at any speed. Easy and fascinating. Waxed tape-records carry complete instructions. Just what you need for home practice. Why delay?

Write for booklet.
 TELEPLEX CO.,
 74-76 Cortlandt St.,
 N. Y. C., N. Y.

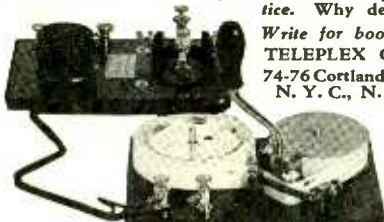

Sterling Accessories for Better Tone—

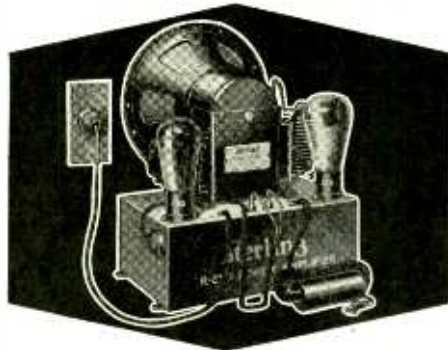

POWERFUL DYNAMICS

Never before such fidelity of tone, such power and accuracy of reproduction. Unusually efficient on sets employing ordinary power tubes, such as the types 171 or 112. Speaker Chassis is shown with the new R-250 Sterling Power Amplifier, \$39.50, which uses the 210 or 250 super-power tube.

R-13	100-125 volt, 50-60 cycle A.C.	\$40.00
R-16	100-125 volt, 25-40 cycle A.C.	45.00
R-14	6 volt, D.C.	30.00
R-15	100-150 volt, D.C.	35.00

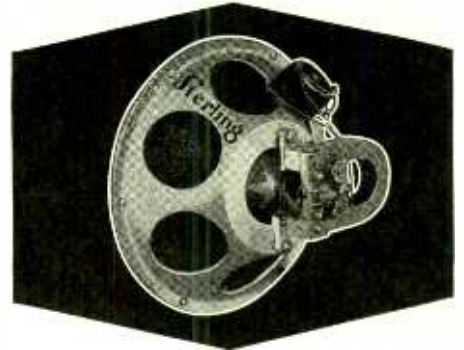

SUPER-MAGNETICS

The peer of low-priced speakers—Sterling's highly improved magnetic speakers deliver better tone and more volume than many dynamic speakers on ordinary amplification. This speaker offers excellent tone quality at low cost. It is easy to install the chassis types into your radio cabinet.

R-1	Stripped Chassis	\$15.00
R-3	Boxed Chassis	19.00
R-2	Table Model	26.50

Sterling offers America's greatest line of radio accessories. Send for catalog folder.

THE STERLING MANUFACTURING CO., CLEVELAND, OHIO

Pacific Coast Sales Representatives—DETSCH & CO.
 341 10TH STREET, SAN FRANCISCO, CALIF.

Northern California Jobbers

RADIO DEALERS' SUPPLIES SERVICE
 Wholesale Division of



"The House of a Million Radio Parts"

1452 MARKET STREET, SAN FRANCISCO, CALIFORNIA

Never before at this Sacrifice Price!



Radiotron Model UV-204.



250 Watt Transmitting Tubes

Normal Plate Voltage 2000 V. Filament Voltage 11 V.

The operating characteristics of this 250 watt tube are similar to that of the UV-204-A Radiotron, with the exception that the filament current is higher. Aside from this modification the tube is interchangeable.

At our price you should carry a few of these tubes if only as spares.

These genuine R. C. A. UV-204 Transmitting Tubes are first grade, brand new, and packed in original factory crates.

Terms:—20% with order, balance C. O. D.

Extra special \$52.00 ea.



Net Price
 \$127.50 ea.

AMERICAN SALES CO., 19-21 Warren Street, New York

Tell them you saw it in RADIO



On Land, Sea, or in the Air DURHAMS are Supreme!

—wherever the perfect operation of radio apparatus is of paramount commercial and governmental importance—in radio transmitting or receiving apparatus—in power amplification units—in the sensitive resistance-coupled amplifiers of the photo-electric cell circuit in Television apparatus—there you will find that experienced radio engineers use and endorse DURHAM Resistors, Powerohms and Grid Suppressors! Why? Because years of experiment have proved the indisputable value of the DURHAM Metallized principle. Because these resistances are calibrated accurately according to their stated ratings. Because they are available for every practical resistance purpose from 250 ohms to 100 Megohms and in power ratings. We will be glad to send you descriptive literature explaining the entire Durham line.

DURHAM

RESISTORS & POWEROHMS

INTERNATIONAL RESISTANCE CO., 2006 Chestnut Street, Philadelphia, Pa.

Weston
Meter
Equipped



Model 400A

It Is Amazing

Radio Men Everywhere

No Other Instrument Will Make ALL These Tests

THE SUPREME is sweeping the country by storm. Radiotricians and engineers everywhere are amazed at its performance, and its already long list of users are enthusiastically proclaiming its superiority. Truly an amazing instrument; it makes every test that can be made by all other testing devices combined, and many that heretofore have not been available in any service instrument.

A Real Money Maker

You have waited long and patiently for an instrument such as the SUPREME. It is now here—at your command for greater accuracy and thoroughness, bigger profits and satisfied customers.

Tubes, power units, loads, breakdowns, voltages, all instantly analyzed, peaking condensers, also modulated radiator. Everything you have ever hoped for is there—all contained in one compact instrument.

The only self-rectifying oscillation tester in existence.

The exact working conditions of any tube from 1½ to 15 volts, including screen grid, heater type, and rectifier tubes, are shown by meter readings; the only service instrument that shows output of rectifier tubes on meter.

The oscillation tests from alternating current are made possible by the exclusive self-rectifying SUPREME Power Plant. Every radio engineer and service man will appreciate this feature.

The SUPREME radiator sends out a modulated wave. Simply plug into A.C. line. No more wasting valuable time on broadcast stations; always at your service and finer adjustment assured.

Condensers can be balanced or synchronized—not by the former tedious methods—but with both meter reading and audible click. Easy and much more accurate.

All continuity tests can be made from socket on either A.C. or D.C. sets, with independent cathode readings.

The SUPREME heavy duty rejuvenator provides scientific method of rejuvenation of any thortiated filament tube. Will reactivate up to 12 tubes at one time without removal from set. Push a plug—the SUPREME does the rest.

The SUPREME will give direct reading of amplifying power of tubes, and will show actual working condition of all tubes.

The SUPREME will play radios with open transformers and will give condenser, choke coil output, and capacity output on radios not wired for that purpose.

Access is provided to all apparatus through pin-jacks. Will test condensers for breakdown. Contains various fixed condensers from .001 to 2 mfd., a 30 ohm rheostat, a 500,000 ohm variable resistance, and an audio transformer, for instant use and various combinations.

It will give plate and filament voltage readings with or without load; will test voltage and current of all radios, including those using tubes such as 210 and 250. It will give grid circuit readings up to 100 volts; plate voltage readings up to 600 volts; will test output of trickle chargers, or any output up to 2½ amps.

Why wait longer? Share in the satisfaction and added profits that come with SUPREME ownership.

THREE WESTON METERS

Mounted in Bakelite cases.

1 Voltmeter, three scales of 0/10/100/600, 1000 ohms per volt.

1 Milammeter, of 125 mils and 2½ amps.

1 A.C. Voltmeter, three large scales of 0/3/15/150.

PRICES AND TERMS

Under our time payment plan, the Model 400A SUPREME can be bought for \$38.50 cash and 10 trade acceptances (installment notes) for \$10 each, due monthly. Cash price, if preferred, \$124.65. All prices are net and do not carry dealers' discounts.

Complete Handy Carrying Cases

The case containing the instrument was designed after careful study by practical radiotricians of many years' experience in radio service. Its arrangement is most complete and convenient—a proper place for every tool, accessory, part, and material that a service man might need; even a swinging tube shelf that affords absolute protection to tubes. A complete set of tools, from electric soldering iron to screw driver, is furnished, and of course, all necessary adapters and accessories. Everything the service man requires—all in one case. And still, due to ingenious design, this case is only 18" x 10½" x 7", and weighs complete only 25 pounds.

Send No Money

The SUPREME must sell itself to you on sheer merit and performance. We are willing to place it in your hands for actual use in your service work, and allow you to be the sole judge of its value. Fill out and sign the following request for six-day trial.

6-Day Trial

Date

Supreme Instruments Corporation,
313 Supreme Building,
Greenwood, Miss.

Please ship me one Model 400A SUPREME.

Upon delivery of the instrument I will deposit with the express agent either the cash price of \$124.65 or \$38.50 cash and 10 trade acceptances (installment notes) for \$10 each, due monthly, at my option, subject to the following conditions:

It is agreed that the deposit made with the express agent shall be retained by him for six days. If, within that time, after testing the instrument I am not entirely satisfied, I have the privilege of returning the instrument to the express agent in good condition, with the seal unbroken (see note below) and all tools and parts intact. Upon such return and upon the prepayment of return express charges, the deposit I have made with the express agent will be promptly returned to me.

Signed

Firm Name

Address

City State

Please send three or more trade references, including at least one bank, with this coupon.

Note: The seal on the panel of the instrument covers the master screw in the assembly. It is never necessary to disturb this, and it does not in any way prevent or restrict the use of the instrument. Factory guarantee ceases with disturbance of seal.

SUPREME

Radio Diagnetometer

conceivable
**Makes every test on
any Radio Set-**

Look for This Sign of Efficient Radio Service. Radio Owners: Look for this emblem in your radio shop or on the button worn or card carried by your service man. It is your guarantee of dependable service.



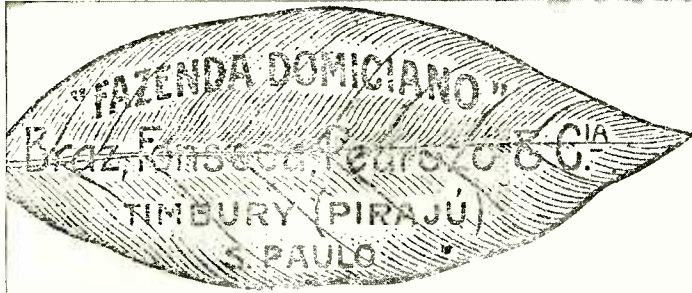

END. TELEGRAPHICO:

BRAZ, PIRAJÚ

CODIGOS USADOS:

A. E. C. 5 TH EDITION

BRAS L

PRIVADO

Fazenda Domiciano,

October 28, 1928

DICADA POR: 5000

ESCRITA POR:

RESPONDENDO A SUA DE:

ASSUMPTO: *Congratulations.*

*Browning-Drake Corporation
Cambridge, Mass., U.S.A.,*

Gentlemen

I live here in this my coffee farm, 500 miles from São Paulo, 950 from Rio de Janeiro and 1,300 from Buenos Ayres.,

I have money enough to buy all the Sets I want, and, by Jove, I have done it., I have had all the Victus, Radiolas, Selects, Zeniths, Vegetics, Radis, Strombergs, SuperHartleys made by myself and "magna caterva",,, but I have found no other than your little Model 6-A. in connection with a 560 A. V. Western Electric Loud Speaker.,

For that reason I want to shake hands with you.,

I tell always to my friends:-Who that do not want, but noise, may buy any other radio set, but who that want, real music cannot buy a better set than theBrowning-Drake.,

Yours truly

E. de Moura Ferreira.

Please excuse my bad english., In 1911, when I was 18, I used to be a brazilian student in that dear old Chicago town, but since that time I have no more written in english