

JULY, 1925

25 CENTS

RADIO

(Reg. U. S. Patent Off.)

In this issue:

SILVER'S NEW SUPERHETERODYNE

HAYNES' IMPROVED
DE LUXE SUPER.

DUAL RECEPTION

IMPEDANCE COUPLING

SHORT WAVE RECEPTION

QUARTZ CRYSTAL
OSCILLATOR

SELECTIVITY AND
DISTORTION

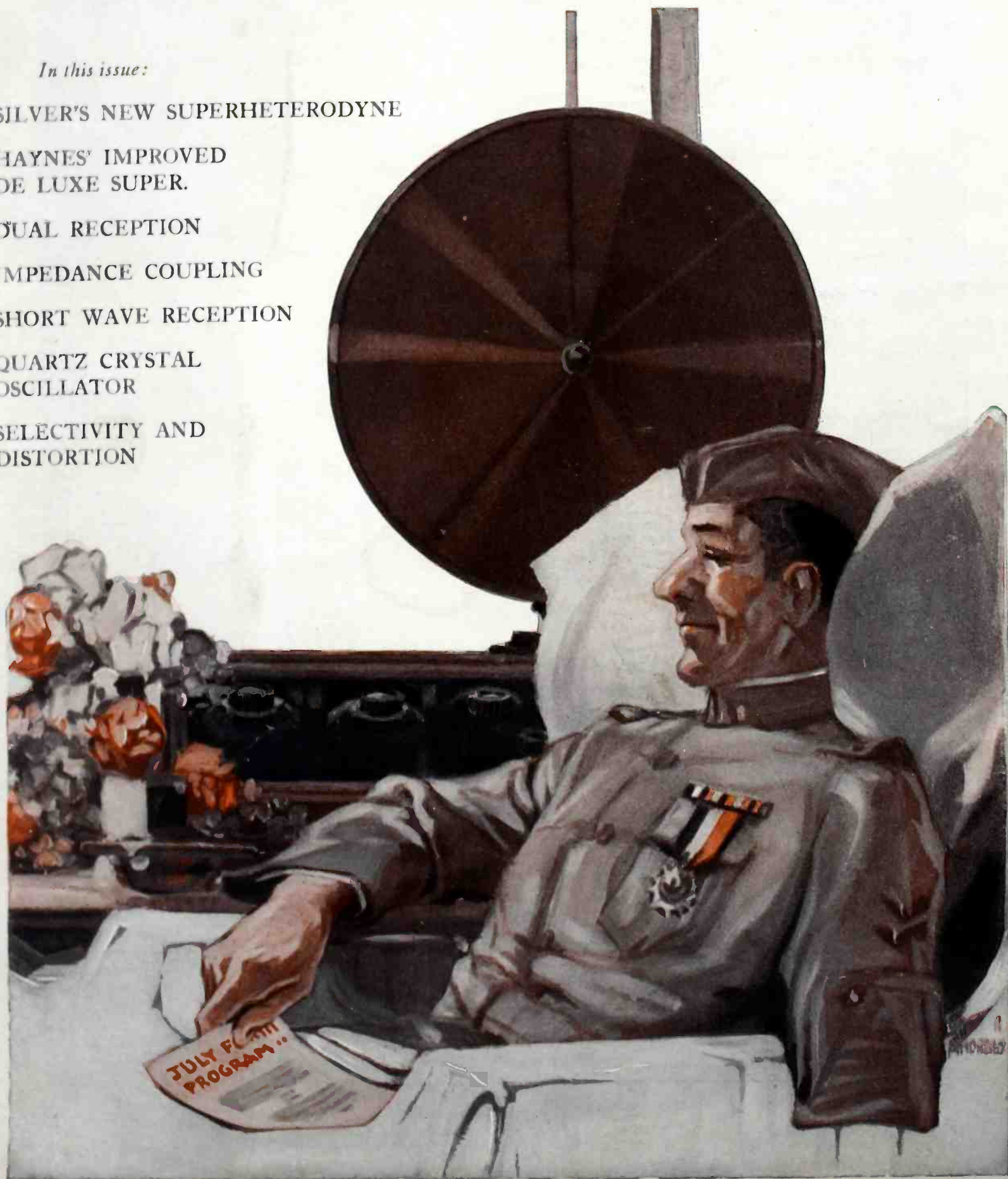

Cunningham RADIO TUBES

Since 1915—
Standard for all Sets

Types C-301A : C-299 : C-300 : C-11 : C-12

In the orange
and blue carton
Price \$3.00 Each

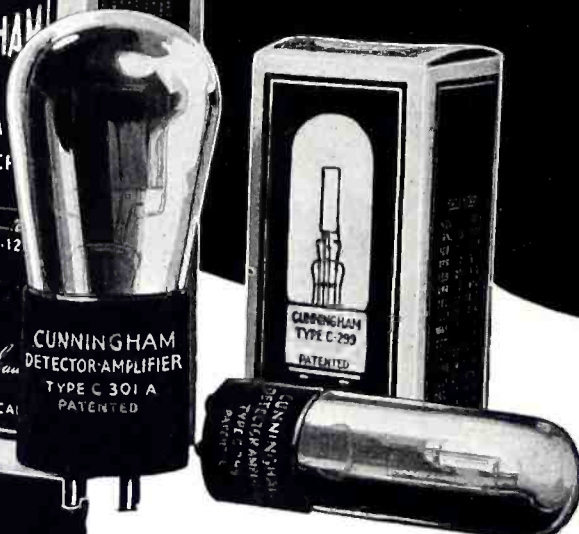

**Sensitive as a Bare Nerve
Delicate as a Spider's Web
Enduring as the Brute**

A single inferior tube in any socket of your receiver and you might just as well try to get a resonant, clear-ringing tone from a cracked bell.

When you neglect the tube, you endanger the entire performance of your set. In millions of American homes—where radio rules supreme—perfect reception is made a certainty by Cunningham Radio Tubes.

Home Office:
182 Second Street
San Francisco

E.J. Cunningham Inc.

Chicago
New York

Patent Notice: Cunningham Tubes are covered by patents dated 2-18-12, 12-30-13, 10-23-17, 10-23-17, and others issued and pending.

Tower

Little
Spitfire
Loud
Speaker

\$4.95

All Tower Loudspeakers
equipped with
adjustable units

Covers EVERY Chromatic in the Entire Scale

The high quality of Tower Radio Products needs no introduction to the MILLIONS now using Tower Scientific Headsets in every corner of the World

Each Tower Loudspeaker---from the "Little Spitfire" to the beautiful "Tower Meistersinger," with its special duralumin horn and deep, full tone---is equipped with an adjustable unit that reproduces accurately every tone from the lowest note on the double bass to the highest tone on the piccolo.

On sale from Coast to Coast wherever good radio is sold.

There's a Tower Loudspeaker to
fit YOUR particular pocketbook.

TOWER MFG. CORPORATION
98 BROOKLINE AVE. BOSTON, MASS.



WORLD'S GREATEST LOUDSPEAKER VALUES

Tell them that you saw it in RADIO

RADIO

Established 1917

Published Monthly by the Pacific Radio Publishing Co.

ARTHUR H. HALLORAN,
Editor

LAURENCE MOTT,
Associate Editor

GERALD M. BEST,
Technical Editor

H. W. DICKOW,
Advertising Manager

Branch Offices:

New York City—17 W. 42nd St.
Chicago—157 E. Ontario St.
Boston—52 Irving St.
Kansas City, Mo.—1102 Republic Bldg.

Correct Addresses:

Instructions for change of address should be sent to the publisher two weeks before the date they are to go into effect. Both old and new addresses must always be given.

Rates:

Issued Monthly, 25c a copy.
Subscription price \$2.50 per year
in the U. S., \$3.00 per year
elsewhere.

Advertising:

Advertising Forms Close on the
First of the Month Preceding
Date of Issue.

Member—Radio Magazine Publishers Association
Entered as second-class matter at Post Office at San Francisco, Cal.
Copyright 1925, by the Pacific Radio Publishing Co.

Address all communications to

Pacific Radio Publishing Company

Pacific Building, San Francisco, California

VOLUME VII

JULY, 1925

NUMBER 7

Forecast of Contributions for August Issue

The feature article is "The Modified 45,000 Cycle Superheterodyne" by G. M. Best. This incorporates the very latest practical developments, so that it may be used as the basis for building a new set or for improving an old one constructed in accordance with previous directions. Provision is made for either loop or antenna reception from 50 to 600 meters. Storage battery tubes are used in all except the three intermediate amplifier stages. The entire article with its many illustrations is written so as to help the home constructor to make the most efficient receiver yet known.

A receiver built especially for the amateur desiring to get the very short waves from 5 to 100 meters is well described by D. B. McGown as the result of wide and successful experience in designing and constructing this type of instrument.

Every superheterodyne owner, present or prospective, will be interested in and helped by J. E. Anderson's explanation of the cause and elimination of interference and distortion in this popular type of receiver. This concludes the story on selectivity and distortion in the July issue. Mr. Anderson also has an unusually fine and timely article regarding the comparative efficiencies of various types of tuning coils.

Glenn H. Browning, of Browning-Drake fame, presents the results of a long series of tests of low-loss apparatus, especially coils.

Some lighter material is presented for the novice by E. T. Jones in "Some Interesting Data On Reception."

M. T. Rogers gives some helpful data on "Electrical Instruments for Radio Sets."

Articles held over from the July issue include those by Volney T. Mathison, E. E. Griffin and L. R. Felder.

The transmitting amateur will be interested in Frank R. Bowman's practical ideas on the most efficient operating wave for the amateur antenna.

The concluding chapter of G. M. Best's valuable series on audio-frequency amplification will discuss the test methods employed and the probable trend of future development in audio-frequency amplification.

John Minton introduces a series of articles on the performance of loud speakers by means of a discussion of the methods employed in testing them.

G. F. Lampkin has a good story on wave-meters.

Clinton Osborne describes the construction of a cone type loud speaker using a phonograph type unit as a base.

Earl Ennis thinks that "The Praying Jonah" is the best radio story he has yet written. In view of his excellent past contributions, this is most promising.

CONTENTS

	PAGE
JULY FOURTH COVER DESIGN <i>By W. H. Andrews</i>	9
RADIOTORIAL COMMENT	10
MALABAR, RADIO PKX	11
IMPROVEMENTS TO THE DE LUXE SUPERHETERODYNE..... <i>By A. J. Haynes</i>	14
AN ALL-WAVE SUPERHETERODYNE..... <i>By McMurdo Silver</i>	17
ELECTRICAL CODE REQUIREMENTS FOR RADIO..... <i>By C. W. Mitchell</i>	19
THE TOROIDAL COIL..... <i>By E. C. Nichols</i>	20
IMPEDANCE COUPLED AUDIO AMPLIFICATION..... <i>By G. M. Best</i>	22
WHAT ABOUT STATIC ELIMINATION?..... <i>By Edward T. Jones</i>	23
THE REMOVAL OF JASPER HOLMES..... <i>By H. A. Highstone</i>	24
SELECTIVITY VERSUS DISTORTION..... <i>By J. E. Anderson</i>	28
CANNED AUDIO	29
THE QUARTZ CRYSTAL OSCILLATOR..... <i>By D. B. McGown</i>	30
IMPROVING THE RADIO SET..... <i>By C. William Rados</i>	33
A LOWER-LOSS RECEIVER..... <i>By G. F. Lampkin</i>	34
ROUND'S CIRCUIT FOR SHORT WAVE RECEPTION..... <i>By A. H. Vance</i>	36
DUAL RECEPTION	38
QUERIES AND REPLIES..... <i>By G. M. Best</i>	40
LETTERS TO THE EDITOR.....	41
WITH THE AMATEUR OPERATORS.....	41
6,000 MILES WITH 5 WATTS.....	42
FROM THE RADIO MANUFACTURERS.....	

EVEREADY HOUR
EVERY TUESDAY AT 8 P. M.
(Eastern Standard Time)

For real radio enjoyment tune in the "Eveready Group." Broadcast through stations—

WEAF New York	WEAR Cleveland
WJAR Providence	WSAI Cincinnati
WEEI Boston	WWJ Detroit
WFI Philadelphia	WCCO Minneapolis
WGR Buffalo	WOC St. Paul
WCAE Pittsburgh	WOC Davenport

Get a good set— and Evereadys

To ENJOY radio for the rest of your life, get the best set you can afford. There are receivers at all prices, made by reputable manufacturers; it isn't necessary for anyone to get 'round-the-corner, unproved, unreliable merchandise at any price. That applies to batteries too. Eveready Radio Batteries are made in so many sizes and prices that there is a correct, long-lasting Eveready for every receiver and for every radio home, ship or commercial station. Specify Evereadys for your new radio set. It is false economy to buy nondescript batteries at any time. In the long run you'll find it most economical to buy either the large or extra large Evereadys. Always buy Evereadys and enjoy the knowledge that no one can get any more in batteries for the money than you. There is an Eveready dealer nearby.

Manufactured and guaranteed by

NATIONAL CARBON CO., INC.
 New York San Francisco
 Canadian National Carbon Co., Limited, Toronto, Ontario

EVEREADY Radio Batteries

- they last longer

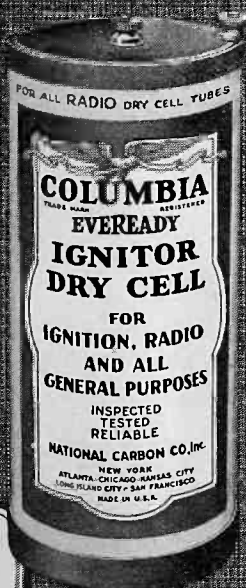

Columbia Eveready Ignitor the proven Dry Cell for all Radio Dry Cell Tubes 1½ volts

No. 766
22½-volt
Large
Horizontal
Price \$2.00



No. 772
45-volt
Large
Vertical
Price \$3.75



No. 771
4½-volt
"C"
Battery improves quality, saves "B" Batteries
Price 60c



Tell them that you saw it in RADIO

YOU'RE INVITED TO THE

PACIFIC RADIO EXPOSITION

CIVIC AUDITORIUM
SAN FRANCISCO

Aug-22-28
1925

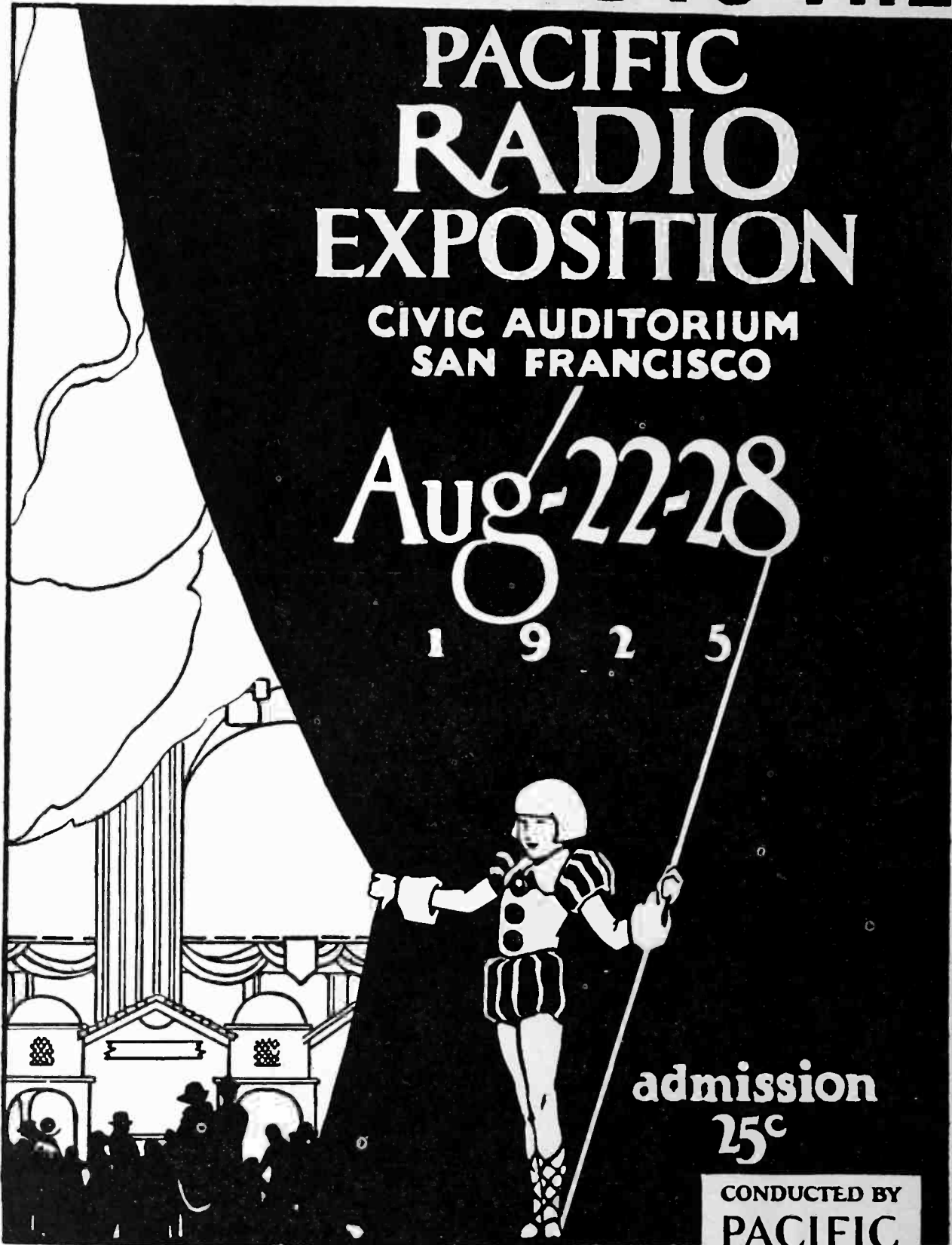

admission
25^c

CONDUCTED BY
**PACIFIC
RADIO**
TRADE
ASSOCIATION
TRADE MARK REG. '15

**MEET YOUR FAVORITE RADIO
ENTERTAINER AND BROADCAST
ANNOUNCER IN PERSON—**

Write for Program and Details

PACIFIC RADIO TRADE ASSOCIATION

HECKERT L. PARKER, Association Manager

905 Mission St. : SAN FRANCISCO : Tel. Garfield 6214

Let Us Answer Your Radio Questions. Let us Give You Expert Advice On Your Radio Problems

GERALD M. BEST, Technical Editor of "RADIO", will give you this new service!

"The Queries and Replies" Department of "RADIO" is pre-eminent for its accuracy and reliability. It is conducted by experts whose statements are based upon wide knowledge and experience. You can depend upon the correctness of "RADIO'S" answers. Questions have been answered by mail in the past for twenty-five cents each. Our technical department will answer TEN of your questions FREE OF CHARGE if you send us your subscription to "RADIO" for one year, \$2.50.

Upon receipt of \$2.50 from you we will send "RADIO" to your address for one year and you will receive ten coupons from us, entitling you to ten answers to radio questions. At 25 cents each, these coupons are worth \$2.50 to you. Under the terms of this offer, you get \$5.00 value for only \$2.50.

You need this dependable service. It is worth many times more to you than the small price asked for a one-year subscription to "RADIO." Tell your friends about this offer. Over 20,000 radio questions have been answered by the technical department of "RADIO." And you get prompt service from us. There is no delay.

Definite guarantee cannot be given that circuit diagrams of factory-built sets will be furnished

The coupon and \$2.50 brings you this wonderful service for one full year.
Now is the time to act!

COUPON

"RADIO," Pacific Building, San Francisco, Calif.:

Here is \$2.50. Send me "RADIO" for one full year and 10 Coupons, which entitle me to have ten radio questions answered free of charge by Gerald M. Best.

Name.....

Address.....

City and State.....

ZENITH

TRADE MARK REG.

RADIO

→ LONG DISTANCE ←
TRADE MARK REG.

While MacMillan Charts the Arctic Zenith Broadcasts to the World!

Between Alaska and the North Pole stretches an unexplored area one million square miles in extent—the last remaining “blind spot” on the face of the globe.

Over this vast area will fly, this summer, two great planes of the amphibian type, piloted by U.S. Navy air pilots and equipped with the most highly perfected scientific apparatus obtainable by the United States Government. This entire expedition, which has rightly been described as the greatest expedition of modern times, is under the direction of Commander Donald B. MacMillan.

The purpose of the expedition is the study and photographic charting of this unknown area—and—new tests in radio transmission and reception of unparalleled importance. The section to be explored has never been heard from by radio. Communication will of necessity be *day-light* communication, for in this area the days are six months long.

On an expedition representing so

great a risk, both in capital and human life, only the *best* in radio equipment can possibly command a place. Once more, therefore, MacMillan chooses ZENITH exclusively, both for his ships and for the two great planes flying across uncharted seas of ice.

Thus, while the world awaits reports from this greatest expedition of modern times, it is worth remembering that the only way these reports can possibly be transmitted is by Zenith radio.

Never in all your life, it is safe to say, will you require of a radio set such *outstanding* performance as MacMillan requires of ZENITH in the Arctic. But can you imagine greater satisfaction than to know that your receiving set can *deliver* such performance, any time it's called upon to do so?

Call this evening at your nearest ZENITH dealer, and ask him for a demonstration.

Zenith Radio Corporation
310 S. Michigan Ave., Chicago, Ill.



Super-Zenith IX

Costs More—But Does More

THE complete Zenith line ranges in price from \$100 to \$475.

With either Zenith 3R or Zenith 4R, satisfactory reception over distances of 2,000 to 3,000 miles is readily accomplished, using any ordinary loud speaker. Models 3R and 4R licensed under Armstrong U. S. Patent No. 1,113,149. They are NON-RADIATING.

Zenith 4R - \$100
Zenith 3R - \$175

The new Super-Zenith is a six-tube set with a new, unique, and really different patented circuit, controlled exclusively by the Zenith Radio Corporation. It is NOT regenerative.

SUPER-ZENITH VII—Six tubes 2 stages tuned frequency amplification—detector and 3 stages audio frequency amplification. Installed in a beautifully finished cabinet of solid mahogany—44½ inches long, 16½ inches wide, 10½ inches high. Compartments at either end for dry batteries. Price (exclusive of tubes and batteries).....**\$240**

SUPER-ZENITH VIII—Same as VII except—console type. Price (exclusive of tubes and batteries).....**\$260**

SUPER-ZENITH IX—Console model with additional compartments containing built-in Zenith loud speaker and generous storage battery space. Price (exclusive of tubes and batteries).....**\$355**

SUPER-ZENITH X—Contains built-in, patented, Super-Zenith Duo-Loud Speakers (harmonically synchronized twin speakers and horns), designed to

reproduce both high and low pitch tones otherwise impossible with single-unit speakers. Price (exclusive of tubes and batteries) **\$475**

All Prices F. O. B. Factory

Zenith Radio Corporation

Dept. H-7
310 S. Michigan Avenue, Chicago, Illinois
Gentlemen:

Please send me illustrated literature about Zenith Radio.

Name.....

Address.....

Tell them that you saw it in RADIO

RADIO

Established 1917

Volume VII

JULY, 1925

No. 7

Radiatorial Comment

A STORM of controversy has centered around the Reinartz short-wave transmitting circuit. This circuit gives really remarkable results, considering its low power and light weight. It is to be used for 37 meter transmission on the three planes which MacMillan is taking on his Arctic flight. Preliminary tests with an outfit weighing less than one hundred pounds and employing dry cells for both plate and filament supply indicated that it is thoroughly practical for long distance communication from a flying plane. Undoubtedly it will be the means for following MacMillan's progress far better than was possible when his expedition used a longer wave transmitter last year.

But the controversy rages not about its use by MacMillan in the inhabitantless regions of the far North where its radiations will disturb no one, but concerning its use by thousands of amateurs in densely populated areas. The question is whether the circuit is loosely coupled to the antenna. If so, it complies with the Department of Commerce regulations for amateur transmission. If direct coupled, it does not.

Before presenting our viewpoint it is of interest and profit to consider the purpose of these regulations, which were adopted in accordance with the recommendations of Hoover's Third Radio Conference. Experience has shown that an inductively or direct coupled circuit emits a relatively broad wave and sends out harmonics or wavelengths other than that upon which the actual communication is taking place. This may cause interference to radiocast reception, especially when aggravated by key thumps or clicks. Experience has also shown that such interference is minimized if the circuit is loosely coupled. Hence the Department has banned the conductively coupled circuit as one means of protection to the radiocast listener.

These facts are well understood by most amateurs and are here introduced merely to illustrate to the lay reader what efforts are being made by the Department and what sacrifices are being made by the amateur in order to lessen interference to the listener. For the distance-reaching ability of a circuit may be cut down materially if the oscillations of the vacuum tube are not directly conducted to the aerial.

We did not publish the Reinartz circuit in May because, in our judgment, it did not comply with the Department's regulations. Other magazines, and

of course, hundreds of newspapers were not so particular, so that the circuit has been given unusual publicity. Many prominent engineers concurred in our judgment as did likewise the Radio Supervisor for the Sixth District, who recommended against its approval.

Subsequently, however, the Supervisor for the Ninth District stated that it was loosely coupled and recommended its unqualified approval. So the Chief Supervisor at Washington now has the matter under consideration. Contrary to press reports, official decision has not been reached up to the time of writing this.

Our analysis of the circuit shows it to be a standard Hartley oscillator modified by the addition of three unnecessary condensers. We find that its harmonic oscillations are directly impressed across the antenna so as to be easily radiated. Generally accepted theory and practice demonstrate that these harmonics are produced whenever the tube oscillates, especially as there is no grid bias and no stabilizing resistance in the plate.

Our tests also show that an 8,000 to 10,000 cycle side band is transmitted on each side of the carrier frequency so that the keying is heard by other listeners as a series of sharp clicks, even though their receivers are tuned to widely different wavelengths.

Our criticism of this circuit applies to many others which, together with this one, have been published in *QST* with a warning against their use. Our position is not that of a judge or jury but merely as a friend of the court presenting *ex parte* evidence. In all fairness to Mr. Reinartz similar opportunity should be accorded him. In fact, these columns are open to his side of the story should he desire to avail himself of the opportunity.

We are also of the opinion that it is too much to expect the Chief Radio Supervisor to act as judge, jury and chief of police. It does not seem to be within the present province of the Department to differentiate between the merits of a circuit proposed by Mr. X. or Mr. Y, but merely to determine whether a given installation is a nuisance and, if so, to abate it. This eliminates the necessity for expert judgment as to whether or not a circuit is loose coupled and reduces the duty to that of shutting down stations that do cause interference.

Malabar Radio PKX

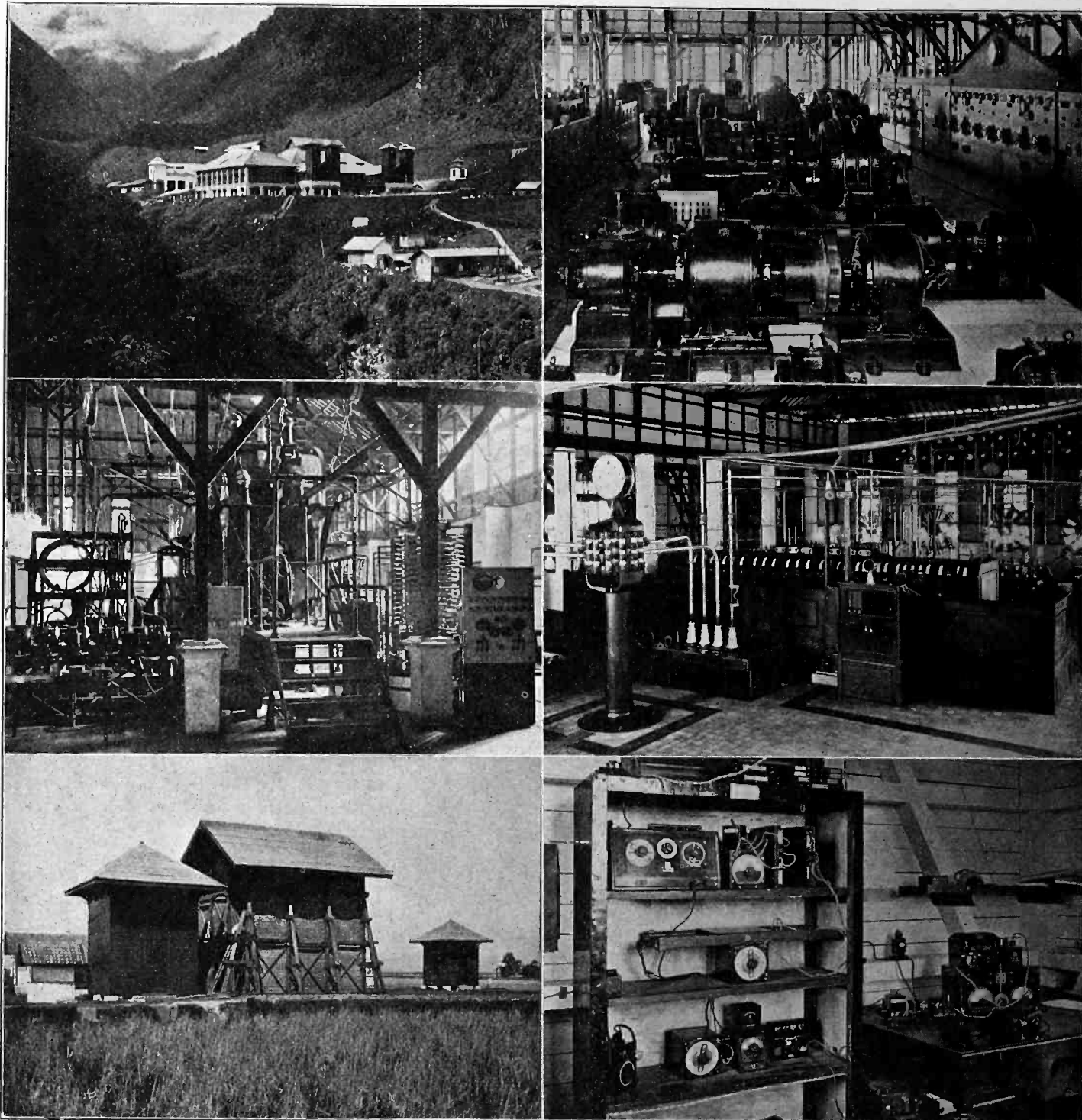

Views in and Around the Malabar Radio Station.

AMATEUR and radiocast listeners on the short waves below 100 meters may have heard a distant telegraph station signing the call PKX, and wondered as to its location and nature. Located practically at the equator, on the island of Java, at Malabar, about 300 miles from Batavia, the Dutch East Indian Capital, PKX represents an interesting commercial installation maintained for communication between the Far East and Holland, as well as the United States.

A 5 kilowatt vacuum tube transmitter operating on a wavelength of 85 meters, while only an auxiliary transmitter at the station, has been heard over remarkable distances and while not as reliable as the long wave transmitters, for 24 hour service, demonstrates that the Dutch engineers are not overlooking the short waves for future commercial use.

The main installation consists of a 2,400 kilowatt arc transmitter, which is shown in the illustration. To operate this

arc, a power house sufficient for a fair sized city is required, several generators of 1200 kilowatts capacity each being maintained for the large transmitter exclusively. As an adjunct, an alternator of 800 kilowatts output is installed, and enables transmission simultaneously to two distant stations. The arc transmitter operates on a wavelength of 15,600 meters, while the alternator is used on both 15,600 and 7,500 meters.

Contrast the size of the huge arc and
(Continued on Page 50)

Improvements to the De-Luxe Superheterodyne

A Receiver Using One Stage of Tuned R. F. Ahead of Super and Employing Storage Battery Tubes

By A. J. Haynes

SINCE the article on the De-Luxe superheterodyne appeared in February RADIO, many inquiries have been received about the receiver, especially as to shooting trouble in the radio frequency stage, and particularly about the possibility of re-designing this remarkably sensitive set for use with five volt tubes throughout. This is a very natural desire on the part of the builder, as there is no question but that the larger tubes are more satisfactory, since they are less critical, give greater amplification per stage and as a rule last longer. There are two drawbacks, however, one being that the larger tubes take up more

employs all storage battery tubes, the current consumption for the filament circuit will be $2\frac{1}{4}$ amperes, while the B battery drain will be between 25 and 35 milliamperes. This is not much more than the average superheterodyne requires, when using the potentiometer type of volume control, but is nevertheless large enough to make the cost of dry cells a consideration. Consequently the improved set is essentially a storage battery receiver.

Fig. 1 shows a front panel view of the receiver, the set consisting, as did the original one, of one stage of specially designed tuned radio frequency amplifica-

tion. Impedance coupled amplification is used as the final audio amplifier rather than resistance coupling. This was done because this set is capable of delivering a large amount of energy from an outdoor aerial, and the impedance coupled amplifier handles the output better than the ordinary form of resistance amplifier, making it unnecessary to use extreme values of B battery. A three scale voltmeter has been included in the panel as a matter of convenience to allow a careful check to be kept on the condition of both A and B batteries.

Fig. 3 gives a rear view of the entire

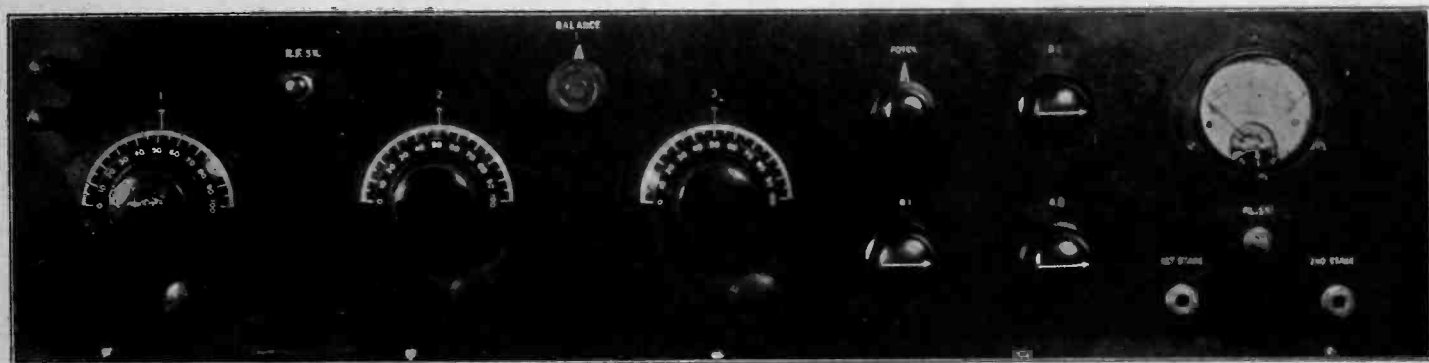

Fig. 1. Improved De Luxe Super.

room and require a larger panel, and the other which is more important, is that the set will require larger A and B batteries.

One of the features of the former set was the fact that with a combination of large and small tubes the entire A battery consumption was only one ampere and but 20 milliamperes were drawn from the B battery. If the set

tion ahead of the 1st detector. Due to the greater available space on the panel, the switch for throwing in and out of this special stage of tuned r. f. is mounted on the panel itself.

It will be noted in the schematic diagram, which is shown in Fig. 2, that a few slight changes have been made in the circuit wiring in adapting this set to the large tubes. Also a stage of impe-

layout, which shows the placing of the various instruments. In Fig. 4 a detailed diagrammatic view of the entire layout and wiring is shown, which not only gives the exact placing of the instruments on the panel and sub-base, but the actual wiring of the set as well, for those who prefer this type of diagram.

In this set it will be noticed that three rheostats are used, one controlling the

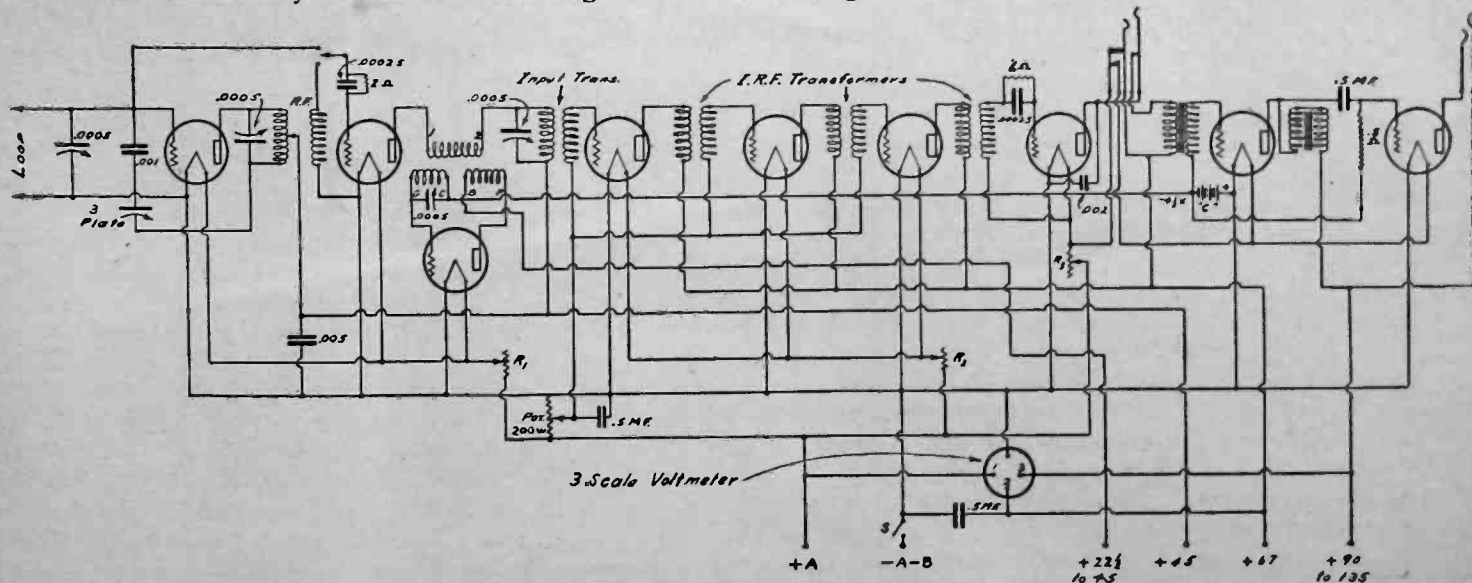

Fig. 2. Schematic Wiring Diagram.

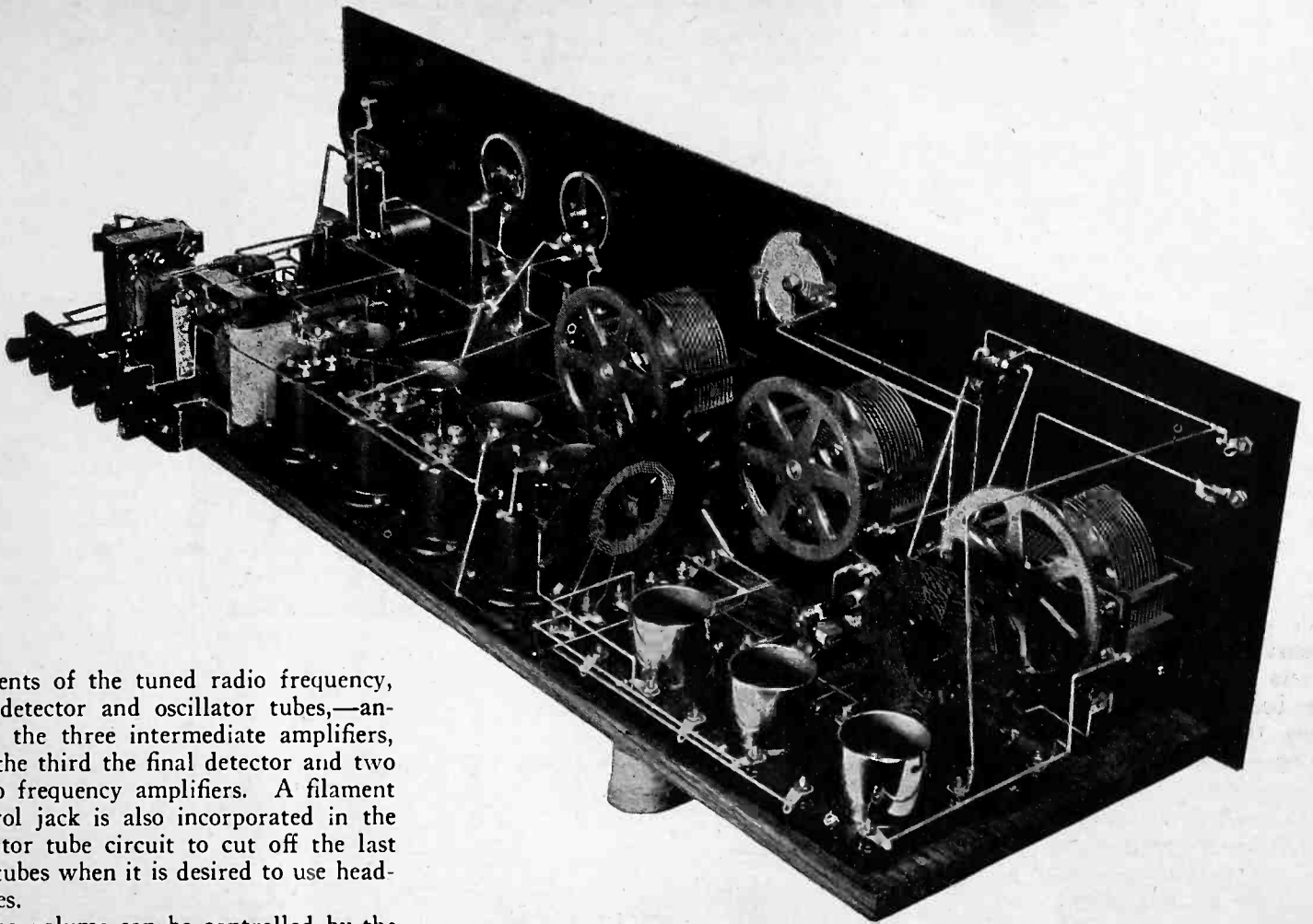

Fig. 3. Back Panel View of Receiver.

filaments of the tuned radio frequency, first detector and oscillator tubes,—another the three intermediate amplifiers, and the third the final detector and two audio frequency amplifiers. A filament control jack is also incorporated in the detector tube circuit to cut off the last two tubes when it is desired to use headphones.

The volume can be controlled by the potentiometer alone, or in some cases where there are powerful local stations, it may be advisable to put a good variable resistance, such as the Bradley-ohm (10,000 to 100,000 ohms resist), across the secondary of the first transformer, which can be used for controlling the loud speaker output if preferred. A separate lead is brought out for the plate supply of the oscillator, as with the large tubes this oscillator needs comparatively little *B* battery voltage and its current consumption is accordingly low.

Some trouble was experienced by the builders of the original De-Luxe model in stabilizing the first radio frequency tube. This is due to the fact that the condenser used to neutralize this tube is very small, so that the circuit is affected by small variations in the capacity of the wiring in this first tube. A very simple general rule, however, can be given for overcoming this difficulty. The stabilization of this stage of tuned radio frequency is dependent upon the tap which is brought out from the primary coil of the radio frequency transformer. With the particular layout of parts used in the first set, this tap was brought out from the 20th turn from the center. On the other hand, if the placing of the apparatus or the wiring was varied, it would almost certainly change this point slightly. If the first tube oscillates continually and cannot be neutralized by the small neutralizing condenser, this tap should be moved toward the plate end of the coil, i. e.; the

LIST OF PARTS

- 3 .0005 mfd. vernier condensers.
- 3 Intermediate freq. transformers—3000 meters.
- 1 Tuned transformer—Haynes-Griffin.
- 1 Input Condenser—Haynes-Griffin No H-G-2.
- 1 Oscillator coupler.
- 1 Tuned r. f. transformer—See text.
- 1 400 ohm potentiometer.
- 3 10 ohm rheostats.
- 9 Vacuum tube sockets for A tubes.
- 1 .5 megohm grid leak.
- 1 1.0 " " "
- 1 2.0 " " "
- 1 Double circuit filament control jack.
- 1 Single circuit jack.
- 2 Audio transformers—Rauland Lyric, Stromberg Carlson, Haynes-Griffin.
- † 3-plate condenser.
- 1 Grid leak mounting.
- 1 .00025 mfd. fixed condenser—mica insulated.
- 1 .001 mfd. fixed condenser—mica insulated.
- 1 .002 mfd. fixed condenser—mica insulated.
- 1 .005 mfd. fixed condenser—mica insulated.
- 1 .006 mfd. fixed condenser—mica insulated.
- 3 .5 mfd. fixed condenser—paper insulated.
- 2 .00025 mfd. fixed condensers with grid leak mounting.
- 8 Bakelite insulated binding posts.
- 1 3 scale Voltmeter.
- 1 S. P. D. T. low capacity switch—Federal Harco Battery Switch.
- 1 Bakelite strip 1 in. x 6 1/2 in. drilled for six binding posts.
- 1 Bakelite panel 7 x 28 in.
- 2 Brass mounting brackets for binding post strip.
- 1 Wood baseboard 8 x 27 in.

end which connects to the plate of the first or r. f. tube. If on the other hand, the circuit appears too stable,—that is; if it cannot be made to oscillate when the small condenser is revolved and if the

signal strength is weaker rather than stronger when the stage of radio frequency is thrown in ahead of the set, it is an indication that the tap is too far toward the plate end of the coil and it should be shifted toward the end which connects to the small neutralizing condenser. Whether the plate of this tube connects to the inside or outside of the smaller or primary coil does not matter materially, as long as the proper neutralization point for the tap is found.

It is a very simple matter to tap this type of coil, as each of the wires is well separated between the points where they cross. In counting the turns on such a coil, each of the wires between the intersections represent four turns, or counting them up along one of the supporting pins where they intersect, each wire represents two turns. Hence a tap taken from the 20th turn from the inside would be placed on the 5th wire counting out from the inside between supporting pins.

When using the large tubes throughout, as in the revised set, described here, this tap must be taken from a point nearer the plate end of the coil than when the small tubes are used. Outside of this one point, there are no changes necessary in the radio frequency transformer or the oscillation coupler as shown in the original arrangement.

In testing out the set, it is well to take the first radio frequency tube entirely

(Continued on Page 56)

An All-Wave Superheterodyne

Using Two Stages of Intermediate Frequency Amplification and Interchangeable Oscillator Coils

By *McMurdo Silver, Assoc. I. R. E.*

NO doubt the unfortunately crowded state of the present radiocast wavelength band is in a large measure responsible for the persistent rumors of an extension of this band to cover some of the less congested lower wavelengths, particularly when the immense interest created by the rebroadcasting experiments of KDKA and WGY is considered. Naturally, many radio enthusiasts have wished to hear these shorter wave stations, and the wide publicity that has been given to constructional data for short wave receivers in the past few months has not only been responsible for the building of many receivers, but it has created a strong desire in the minds of many fans to convert their existing receivers so that, with a single set, all waves from say, 50 to 600 meters could be received.

It is hardly necessary to go into reasons for the utter impracticability of so converting a neutrodyne or other tuned radio frequency type of receiver, because, were it mechanically feasible, such a change would not be warranted when it is remembered how inefficient is direct radio frequency amplification at short wavelengths—practically worthless below 200 meters—in any easily converted or assembled receiver.

It is possible to regard the tuned r. f. receiver as an intermediate amplifier, and with an oscillator and first detector before it convert it into a fair superheterodyne capable of operating on waves not only below, but above, the regular radiocasting range quite effectively. A standard super-heterodyne receiver, however, aside from being the most satisfac-

- LIST OF PARTS
- 2 .0005 mfd. variable condensers.
 - 2 4 in. dials.
 - 1 6 ohm rheostat.
 - 1 200-400 ohm potentiometer.
 - 1 2-contact jack.
 - 1 3-contact jack.
 - 2 intermediate freq. transformers—Silver 60 K. C.
 - 1 tuned transformer—Silver 60 K. C.
 - 2 honeycomb coil plugs.
 - 7 "A" type sockets.
 - 2 low ratio audio freq. transformers.
 - 1 filament switch.
 - 3 5 mfd. fixed condensers.
 - 2 .00025 mfd. condensers with clips.
 - 2 .002 mfd. condensers.
 - 2 .000045 mfd. variable condensers.
 - 7 insulated top binding posts.
 - 1 5 megohm grid leak.
 - 1 2 megohm grid leak.
 - 1 bakelite panel, 7x24x3/16 in.
 - 1 7x23x1/2 in. baseboard varnished.
 - Misc. screws, nuts, lugs, wire and spaghetti.

fathers. Further, the efficiency of the superheterodyne amplifier remains constant regardless of the wavelength of the received signal, so that it is possible to realize at 50 or 100 meters more amplification than can possibly be obtained by any other system—so much more that it is not worth while considering any other type of receiver.

No doubt amateurs reading this last statement will regard it as, while the truth, not the whole truth, since it has been demonstrated by repeated experiments that a one or two tube regenerative receiver will give all that can possibly be desired in the way of short-wave reception. This is true for continuous wave telegraph reception, but it does not hold entirely true for dependable reception of radiocasting, since radiocasting signals are of the nature of modulated

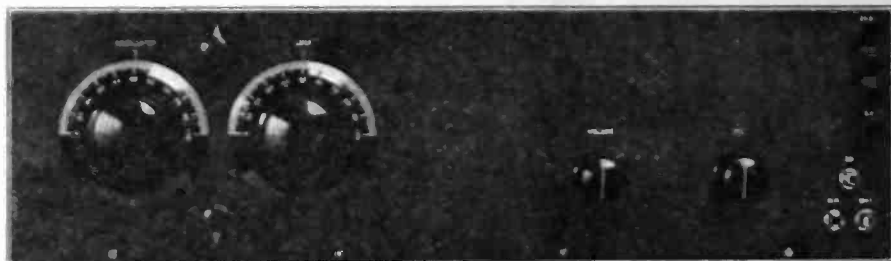

Fig. 2. Panel View of Silver Superheterodyne.

tory type of receiving system ever devised from the standpoints of selectivity, sensitivity, ease of control and quality of reproduction, is so easily built or converted into an all-wave receiver that the latter operation is like "rolling off a log", to revert to the idiom of our grand-

continuous waves and the typical amateur receiver loses a very large portion of its sensitivity when the detector circuit is operated in a non-oscillating condition, as it must be for modulated reception.

The conversion of a standard radio-

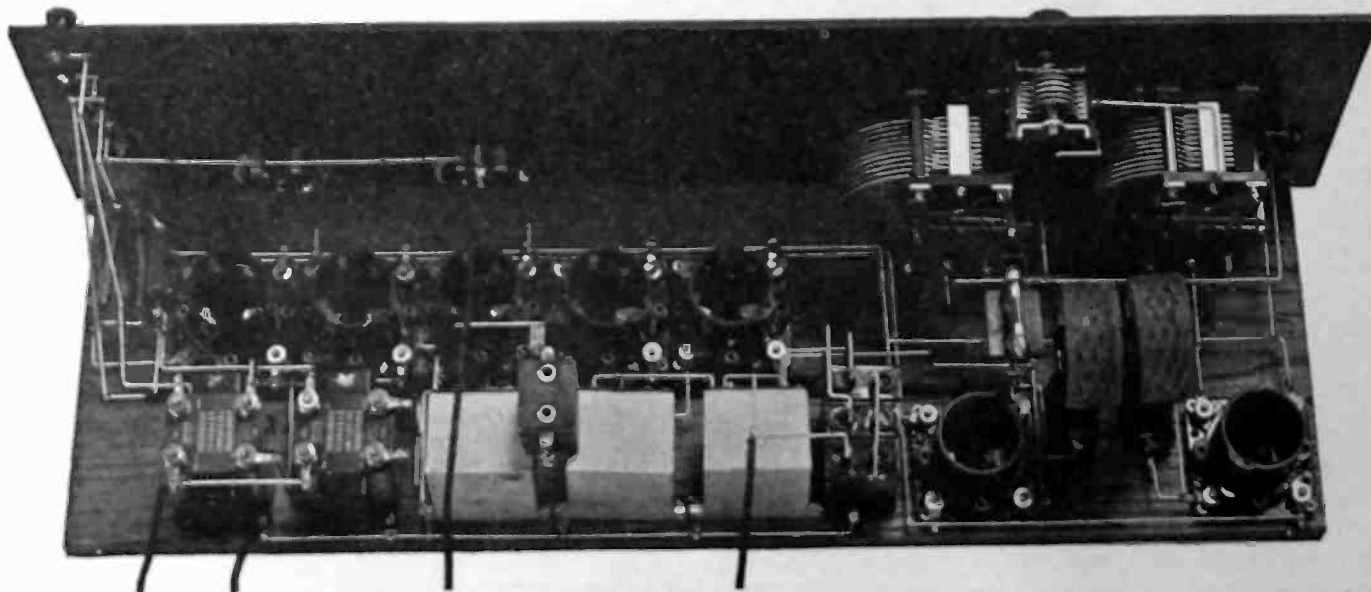

Fig. 1. Rear View of Silver Superheterodyne.

parts recommended. Each part should be carefully examined before assembly to make sure it is O. K. both mechanically and electrically.

For the oscillator coils, a number of honeycomb or other compact wound coils will be necessary, as listed below, to tune from 50 to 600 meters. In order to obtain a 15-turn coil, it will be necessary to remove 10 turns from a 25-turn coil.

Grid coils, 15, 25, 50.

Plate coils, 25, 35.

Actually but four coils are used, the first combination being a 15 turn grid with a 25 turn plate coil, the second 25 turn grid with a 35 turn plate and the third, a 50 turn grid with a 35 turn plate. The grid coil and oscillator condenser determine the wavelength range of the oscillator, the plate coil merely being a tickler, and its size being not critical.

The loops required, assuming a 2 ft. form, wound spirally with turns spaced $\frac{1}{4}$ in., will consist of 4, 8 and 14 turns. It may be well on the shorter waves, for stability, to ignore the center tap of the loop, and shortcircuit the two lower loop binding posts on the panel.

In assembling the set, it is first necessary to drill the panel, then grain it if desired by rubbing with fine sandpaper and oil in one direction only, after which it may be engraved if desired. It is hardly necessary to explain how the parts should be fastened to the panel and baseboard, as the pictures show this clearly. The exact baseboard layout suggested need not necessarily be adhered to, but the parts should be screwed down in approximately the manner illustrated.

The wiring should be done upon the panel and baseboard separately as far as possible.

The fixed condensers may be hung upon the wiring as it progresses, but the .5 mfd. bypass condensers should have their cases soldered together, and be screwed to the baseboard. Their cases, as well as the metal cases of all the transformers, are connected together and to the negative filament line. The r. f. and a. f. C batteries are connected to the flexible leads visible in Fig. 1. After the panel and baseboard have been wired, screwed together and the balance of the joining wires put in place, the entire assembly should be carefully checked over, and the outfit is ready for test.

Either dry-cell or storage battery tubes may be used, though standard sockets are shown in the illustrations. If desired, 199 type sockets may be installed, which would necessitate a slight rearrangement of the wiring, but will not otherwise affect the operation of the set as a whole—the volume, distance and selectivity obtainable being about the same with either wet or dry battery tubes. Ninety volts of B battery will be needed, two $4\frac{1}{2}$ volt tapped C batteries, and either a storage battery for "A" tubes, or six

dry cells connected in series-parallel for "99" tubes.

The A battery should be connected, the filament switch pulled out, the rheostat turned barely on, and one tube inserted successively in the different sockets. The A plus lead should then be reconnected: first to the B+5 post and then to the B90 post. If the tube lights, the wiring must be corrected. Assuming it lights only when the A battery is connected to the A posts, the B and C batteries should be properly connected to their respective posts, the coils plugged in, the loop hooked up, tubes inserted, and a pair of phones plugged into one of the jacks.

If the rheostat is turned on $\frac{7}{8}$ for "A's" or $\frac{2}{3}$ for "99's", the potentiometer set just to the positive side of the adjustment where a "plunk" indicating amplifier oscillation is heard, the regeneration condenser left all out, the coupling condenser all in, and the two tuning condensers rotated, signals will be heard. From then on the operation is similar to any super, except for the coupling condenser, which will act as the variable inductive oscillator coupler control does on another receiver.

It is best to first test the receiver on regular radiocasting, using a standard loop, with the 35 and 50 turn oscillator coils. If it works satisfactorily, the coils may be changed to the next smaller combination and extra taps taken from the loop so that 7 or 8 turns will be used, with a center tap at the approximate center. If the loop circuit is unstable, moving the center tap of the loop one or two turns closer to the inside or plate end will help matters. It may be advisable, as suggested, to leave the center tap entirely unconnected and short the two lower loop posts on the set, which then connect to the inside end of the loop.

If an antenna is to be used, interchangeable coils may be employed connected in place of the loop, a 15 turn coil, together with 35 and 75 turn ones being required in place of the loop, either tapped in the center, or connected as suggested for the loop when using but the two end connections. The antenna coil, connected to antenna and ground, will vary between 2 and 10 turns, depending upon the length and height of the individual antenna. It may be wound with any magnet wire on a 2 or 3 in. tube, or the turns may merely be bunched together, and placed close to the coil substituted for the loop.

For wavelengths above 600 meters, and up to 5000 meters, the oscillator grid coil will have to be respectively, 100, 200 and 300 turns. The plate coils may be respectively, 75, 100 and 200 turns. The use of an antenna is recommended for these longer waves, with 100, 200, 300 and 500 turn coupling coils.

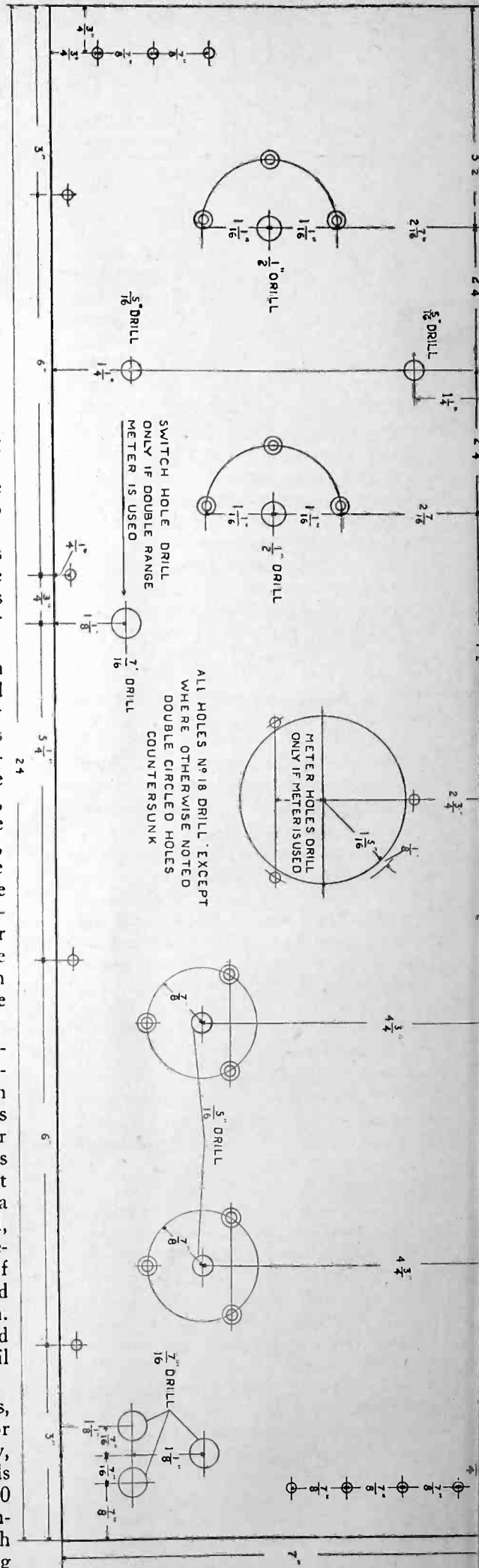

Fig. 3. Panel Layout.

Electrical Code Requirements for Radio

An Authoritative Interpretation of the 1925 Rulings
on Receiving and Transmitting Installations

By C. W. Mitchell

THE National Electrical Code, or so-called "Underwriters' Rules," constitutes the regulations of the National Board of Fire Underwriters for the safe installation of electric wiring and apparatus. These rules constitute the recommendations of nineteen organizations, three of which are connected with the Underwriter's interests, the others consisting of representatives of the U. S. Bureau of Standards, American Institute of Electrical Engineers, Institute of Radio Engineers, National Electric Light Association, etc. The code is approved as an "American standard" by the American Engineering Standards Committee.

This code is issued biennially, the 1925 edition being ready for distribution in a few weeks. The rules to be considered in this article are those pertaining to radio as they will appear in the 1925 edition which contains a few amendments to the 1923 edition.

The code specifies construction details for antenna and counterpoise with relation to other wires, so as to avoid possibility of accidental contact. It is recognized that practically the only hazard of a receiving antenna lies in the possibility of its conducting current to or into a building by reason of contact with light or power wires or in serving as a conductor to ground for lightning. These rules do

not apply to light and power circuits used as receiving antenna, but the devices (socket condenser antennas) used to connect the light and power wires to radio receiving sets shall be of approved type.

The term "approved" signifies a device which has been submitted to and, after examination and test, listed by the Underwriters' Laboratories as "Standard." Such listing indicates that the device has been found to be constructed in accordance with certain specified minimum requirements. Not all listed devices bear labels, for this service has not been extended as yet to include all classes. Labeled devices, or at least a certain percentage of them, are inspected and tested at the factory before being labeled. Other listed devices have what is termed re-examination service which means that at stated intervals, samples, either from the factory or from the stock of some retailer, are examined and tested to see if the manufacturer is complying with requirements.

The only condition to be observed when installing or using an indoor an-

tenna of any type is that its wire or wires shall not come nearer than 2 inches to any electric light or power wire.

In order that they will have sufficient mechanical strength at all times lead-in conductors shall be of copper, approved copper-clad steel or other metal which will not corrode excessively, and in no case shall they be smaller than No. 14, except that bronze or copper-clad steel not less than No. 17 may be used.

To insure against accidental contact with other wires, lead-in conductors on the outside of buildings shall not come nearer than 4 inches to electric light or power wires unless separated therefrom by a continuous and firmly fixed nonconductor which will maintain permanent separation. The non-conductor shall be in addition to any insulating covering on the wire. Each lead-in conductor shall enter the building through a non-combustible, non-absorptive, insulating bushing slanting upward toward the inside or by means of an approved device designed to give equivalent protection.

The purpose of the insulating bushing is not so much to prevent contact between lead-in wire and building as it is to prevent contact between lead-in and other wires which may be within the wall. When a hole is bored through a wall for the purpose of bringing in the lead-in it is in nearly all cases an uncertainty as to whether or not light, power or signal (telephone, bell, etc.) wires are in the vicinity. "Approved" lead-ins are now on the market which fit over the window sill and ledge and do away with the necessity for boring holes through walls or window sashes.

It is not believed that an outdoor antenna attracts lightning but if a bolt strikes in the immediate vicinity of one the antenna and ground connection will undoubtedly serve as a lightning rod. Should lightning strike an antenna not equipped with a protective device the junk dealer probably would offer very little for the remains of any radio set which happened to be in the circuit. And damage probably would not be confined to the set. As a protection against lightning the rules state that each lead-in conductor shall be provided with an approved protective device (lightning arrester) which will operate at a voltage of 500 volts or less, properly connected and located either inside the building at some point between the entrance and the set which is convenient to the ground, or outside the building as near as practicable to the point of entrance. The protector shall not be placed in the immediate vicinity of easily ignitable stuff, or where exposed to inflammable gases or dust or flyings of combustible materials.

It is quite true that certain parts of the Pacific Coast territory seem to be almost free from lightning and therefore there are a large number of radio installations in which no thought seems to have been given to the protective device. However experience of the last few years shows that lightning has struck in several places where least expected and with disastrous and expensive results. It is the belief of some that the frequency with which these events are happening is increasing. Be that as it may, if one believes in the slogan "Better be safe than sorry," it is well to pay the small additional cost of a lightning arrester and install it in the antenna circuit.

On an antenna used only for receiving it is not required that a grounding switch be installed. But if one is employed, it shall in its closed position form a shunt around the protective device. Such a switch shall not be used as a substitute for the protective device. It is recommended that an antenna grounding switch be installed, and that in addition a switch rated at not less than 30 amperes, 250 volts, be located between the lead-in conductor and the receiving set.

Fuses are not required in the antenna circuit but if they are used they shall not be placed in the circuit from the antenna through the protective device to ground. This rule is to prevent opening of the protective grounding circuit. The blowing or opening of fuses installed in this circuit would eliminate the protective ground connection and might not be noticed for some time after its occurrence.

Grounding conductors are classified in two ways, namely, protective and operating. The protective grounding conductor is that which connects the protective device or lightning arrester with the ground and the operating grounding conductor is that which serves as a grounding connection for the radio set or equipment.

The protective grounding conductor may be bare and shall be of copper, bronze or approved copper-clad steel. The protective grounding conductor shall be not smaller nor have less conductance per unit of length, than the lead-in conductor and in no case shall be smaller than No. 14 if copper nor smaller than No. 17 if of bronze or copper-clad steel. The protective grounding conductor shall be run in as straight a line as possible from the protective device to a good permanent ground. Preference shall be given to water piping. Other permissible grounds are grounded steel frames of buildings or other grounded metal work in the

building, and artificial grounds such as driven pipes, rods, plates, cones, etc. Gas piping shall not be used for the ground.

The use of gas piping for the ground is prohibited because of the serious fire hazard involved. Should lightning strike the antenna or should the antenna circuit come in contact with other wires there is a possibility that the gas pipe might be punctured permitting gas to escape which might be ignited by the electric current. Especially is this possible at the gas meter which is constructed of comparatively thin sheet metal and usually connected to the gas piping by means of lead pipes which would, of course, puncture or melt very easily.

The protective grounding conductor shall be guarded where exposed to mechanical injury. An approved ground clamp shall be used where the protective grounding conductor is connected to pipes or piping. The ground clamp usually forms the weakest link in the grounding circuit and therefore none but approved ones should be used. If located where subject to mechanical injury a ground clamp should be protected in some way to prevent it from being loosened or disconnected from either the wire or pipe.

The protective grounding conductor may be run either inside or outside the building. The protective grounding conductor and ground, when installed as prescribed in the preceding paragraphs may be used as the operating ground. It is recommended that in this case the operating ground conductor be connected to the ground terminal of the protective device. If desired, a separate operating grounding connection and ground may be used, this operating grounding conductor being either bare or provided with an insulated covering.

For antenna circuits, lead-in wires or grounding conductors, all wires inside buildings shall be securely fastened in a workmanlike manner and shall not come nearer than 2 inches to any electric light or power wire not in conduit unless separated therefrom by some continuous and firmly fixed non-conductor such as porcelain tubes or approved flexible tubing, making a permanent separation. This non-conductor shall be in addition to any regular insulating covering on the wire.

Whether the wires be inside or outside the building, provided they are installed in all respects as outlined in the preceding paragraphs, it is immaterial, in-so-far as the Code requirements are concerned, whether they be mounted upon insulators or fastened directly against the building surface.

Battery leads may be fastened to the battery terminals by either lugs or suitable clamps, and may be run upon insulators or not, as desired but all storage battery leads shall consist of conductors having approved rubber insulation. The circuits from storage batteries shall be properly protected by fuses or circuits breakers rated as not more than 5 amperes and located preferably at or near the battery.

The requirement of fuses is a new addition to the rules found necessary because of the large ampere capacity available under short-circuit conditions. The requirement applies to all storage batteries

regardless of voltage or ampere-hour rating. There are no special requirements in the Code as to location of batteries or enclosures for them. Storage batteries should not, of course, be located near an open flame particularly when the battery is being charged.

At the present time Underwriters' Laboratories do not list any battery eliminators. When these devices are submitted to the Laboratories their tests and examinations will determine the proper method of connecting and handling such devices.

If located in a garage a battery charger shall be placed at least four feet above the floor level. This should be done also if the charger is located outside the garage but in a room on the same floor level, as it might be in a building where the garage occupies part of the basement.

Chemical, or electrolytic rectifiers are undesirable as under certain conditions full potential of the lighting circuit may be upon one side of the secondary circuit. For this type of rectifier all wiring between the source of power and the battery connections shall be done in the same manner as is required for the circuit supplying the current. A switch shall be provided so that the battery may be disconnected from the charging circuit.

Wherever attachment plugs and plug receptacles are used in connection with radio equipment the plugs and receptacles should be of a type different from that used for lighting or heating circuits so that it will be impossible to "plug in" radio equipment on lighting or heating circuits.

The requirements for transmitting stations are somewhat more stringent than for receiving stations. The precautions necessary to be taken to prevent accidental contact between antenna or counterpoise and other wires are the same for both receiving and transmitting stations but the smallest wire permissible for a transmitting antenna lead-in is No. 14.

For transmitting stations greater insulation is required than for receiving stations as

antenna and counterpoise conductors and wires leading therefrom to ground switch, where attached to buildings, shall be firmly mounted 5 inches clear of the surface of the building, on non-absorptive insulating supports such as treated pins or brackets, equipped with insulators having not less than 5 inches creepage and air-gap distance to inflammable or conducting material, except that the creepage and air-gap distance for continuous wave sets of 1000 watts and less input to the transmitter, shall be not less than 3 inches.

In passing the antenna or counterpoise lead-in into the building a tube or bushing of non-absorptive, insulating material, slanting upward toward the inside, shall be used and shall be so insulated as to have a creepage and air-gap distance of at least 5 inches to any extraneous body, except that the creepage and air-gap distance for continuous

wave sets of 1000 watts and less input to the transmitter, shall be not less than 3 inches. If porcelain or other fragile material is used it shall be protected where exposed to mechanical injury. A drilled window panel may be used in place of a bushing provided creepage and air-gap distance as specified above is maintained.

A double-throw knife switch having a break distance of at least 4 inches and a blade not less than $\frac{1}{8}$ inch by $\frac{1}{2}$ shall be used to join the antenna and counterpoise lead-in to the grounding conductor. The switch may be located inside or outside the building. The base of the switch shall be of non-absorptive insulating material. This switch shall be so mounted that its current-carrying parts will be at least 5 inches clear of the building wall or other conductors, except that for continuous wave sets of 1000 watts and less input to the transmitter, the clearance shall be not less than 3 inches. The conductor from grounding switch to ground shall be securely supported.

It is recommended that the switch be located in the most direct line between the lead-in conductors and the point where grounding connection is made.

Antenna and counterpoise conductors shall be effectively and permanently grounded at all times when station is not in actual operation and unattended, by a conductor at least as large as the lead-in and in no case smaller than No. 14 copper, bronze, or approved copper-clad steel. This protective grounding conductor need not have an insulated covering or be mounted on insulating supports. The protective grounding conductor shall be run in as straight a line as possible to a good permanent ground. Preference shall be given to water piping. Other permissible protective grounds are the grounded steel frames of buildings and other grounded metal work in buildings and artificial grounding devices such as driven pipes, rods, plates, cones, etc. The protective grounding conductor shall be protected where exposed to mechanical injury. A suitable approved ground clamp shall be used where the protective grounding conductor is connected to pipes or piping. Gas piping shall not be used for the ground.

It is recommended that the protective grounding conductor be run outside the building.

Transmitting station operating grounding conductor shall be of copper strip not less than $\frac{3}{8}$ inch wide by $\frac{1}{32}$ inch thick, or of copper, bronze, or approved copper-clad steel having a periphery, or girth, of at least $\frac{3}{4}$ inch, such as a No. 2 wire, and shall be firmly secured in place throughout its length.

Transmitting station operating grounding conductor shall be connected to a good permanent ground. Preference shall be given to water piping. Other permissible grounds are grounded steel frames of buildings or other grounded metal work in the building, and artificial grounding devices such as driven pipes, rods, plates, cones, etc. Gas piping shall not be used for the ground.

When the current supply is obtained directly from lighting or power circuits, the conductors whether or not lead covered shall be installed in approved metal conduit, armored cable or metal raceways.

In the early days of amateur "wireless telegraph stations" considerable difficulty and annoyance was experienced by the power companies and consumers in the immediate vicinity of these stations because of the "kick-backs." This difficulty has been overcome by proper installation methods. The Code provides that

when necessary to protect the supply sys-

(Continued on Page 52)

The Toroidal Coil

An Interesting Account of Its Advantages, Construction and Application
By E. C. Nichols

OF the many things contributing to the efficiency of radiocast receivers in the past year not the least important has been the widespread use of more efficient types of inductances. There have been developed numerous types for the selection of the radio builder, making possible better reception, this being a natural and decidedly necessary step in the evolution of the tuning unit of the receiver. This trend has followed in the path of improved condenser design and considerable strides have yet to be made in the design of inductances equal in point of perfection to the better grades of variable condensers. Many ingenious methods of winding have been developed and advantage taken of inherent factors.

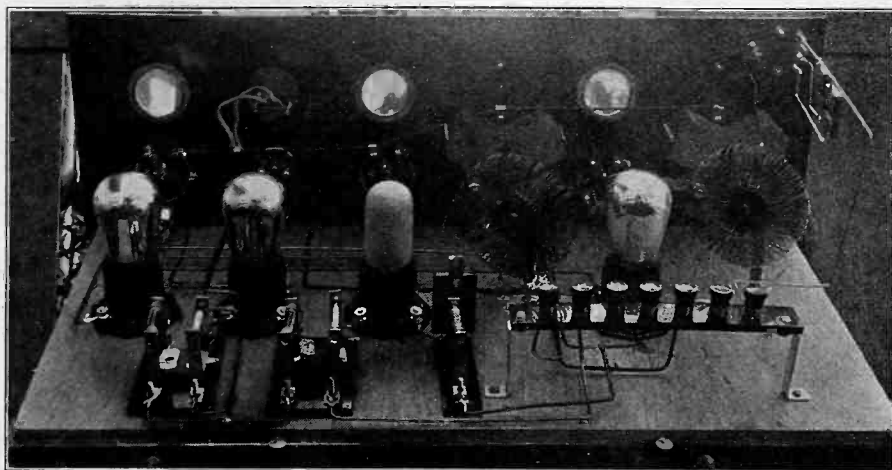

Set Employing Toroidal Coils.

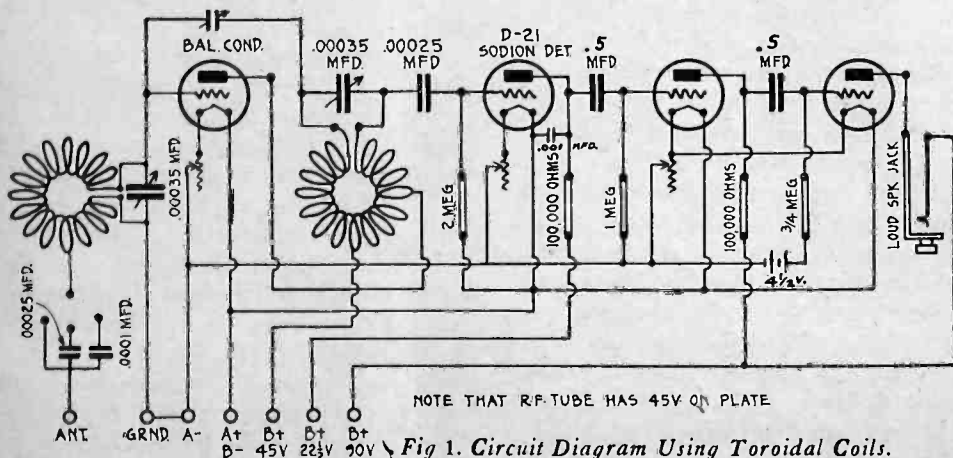

Fig 1. Circuit Diagram Using Toroidal Coils.

One type in particular, the toroidal coil, when properly proportioned and constructed, will be found by practical demonstration to have the virtues of low inherent capacity, almost ideal supporting dielectric, the resistance but slightly higher than the coils of the solenoid type and with very little, if any, dissipated

inductive field. This type of coil may be applied to any of the tuned r. f. circuits and can be designed as the usual tuned r. f. transformer, with primary and secondary windings, or as an auto transformer. The various methods of overcoming r. f. tube oscillation by neutralizing or balancing are applicable.

The fabrication of a toroidal coil involves some skill and patience. The form for the coil winding may be a piece of $1\frac{1}{4}$ in. diameter fibre tubing 5 in. long with a saw kerf running lengthwise into which a piece of bus bar wire $1/16$ in. square is forced to expand the tube to a slightly larger diameter, the removal of which, after the coil is wound, will facilitate the slipping of the coil off the tubular form. The binding strip is a piece of celluloid or pyralin $3/16$ in. wide and approximately 5 in. long. This strip should be tested by bending, for if it is old and crystallized it will break when mounting the coil on the button. The mounting strip is defined on the winding form by bending over each end and fastening with rubber bands as shown in the illustration. Before the winding is started a part of the strip is coated with a celluloid cement which is made of equal parts of acetone and amel-acetate into which is dissolved scraps of celluloid until the desired consistency is reached. This cement should run freely so as to thoroughly bind the wire to the mounting strip. A small portion at a time is coated and the wire wound in place, using as little cement as possible. Cement which is tacky will not bind the wire to the mounting strip. Collodion may be used as a cement but some trouble may ensue due to the fact that it sets so rapidly. No. 28 enameled wire is used and the winding is $3\frac{1}{4}$ in. long, making a total of approximately 220 turns; about 72 ft. of wire. The button on which the coil is mounted is made of $1/8$ in. Bakelite or rubber, its diameter being approximately 1 in. and

(Continued on Page 58)

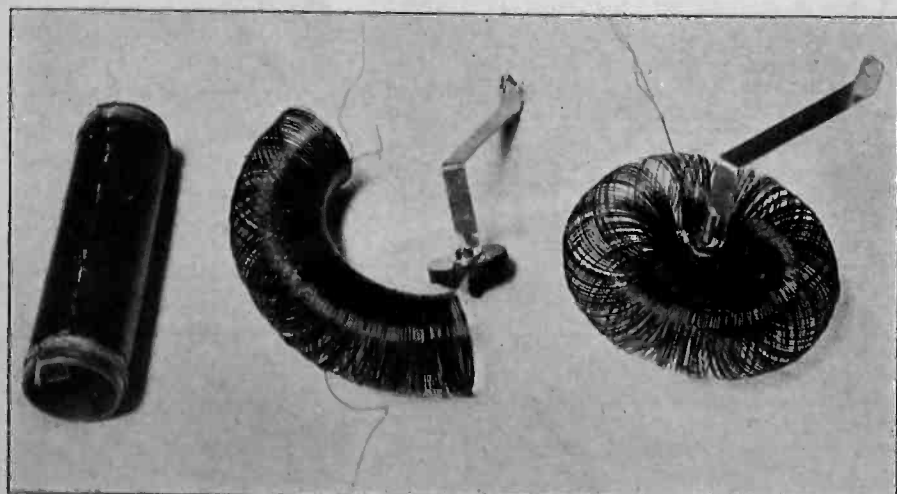

Constructional Details of Toroidal Coil.

Impedance Coupled Audio Amplification

A Discussion of the Theory of Impedance Coupling and Its Superiority Over Other Forms of Amplification

By G. M. Best

A TYPE of coupling employed in audio frequency amplification, about which little is generally known, is impedance coupling. Like its counterpart, resistance coupling, this means of conveying the output voltage of one tube to the input of the next tube is seriously limited by the fact that the amount of amplification cannot exceed the voltage amplification constant of the tube. Since nearly all vacuum tubes at present on the market have amplification constants of about 6 to 8, the possible amplification per stage is far below that obtainable with good transformers.

The advantages of impedance coupling lie in the fact that, on one hand, it is easy to obtain much flatter frequency characteristics than with transformer coupling and on the other hand, it makes possible slightly greater amplification per stage than with resistance coupling, for the same tubes and battery voltages. Due to the relatively low direct current resistance of the impedances used, practically the full effective *B* battery voltage can be applied to the plate of the vacuum tube and the defect most prominent in resistance coupled amplifiers, namely, power loss in the plate resistance, is eliminated.

The circuit arrangement of the usual impedance coupled amplifier is shown in Fig. 1, the essential elements of the

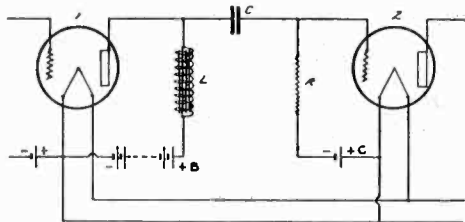

Fig. 1. Theoretical Diagram of Impedance Coupled Amplifier.

coupling being the choke coil or impedance, *L*, the condenser *C* and the grid leak *R*. The impedance prevents the flow of alternating current through the

B battery and must therefore have a high enough inductance to choke back the low as well as the high frequencies. The condenser provides a means of passing on the variations in plate potential of Tube 1 to the grid of Tube 2, and the grid leak resistance *R* supplies *C* potential to the grid without short circuiting the input circuit. The resistance *R* should therefore be large enough so that it causes only a small loss and yet small enough so that an occasional positive swing of the grid due to some extra loud note will not block the tube. About 500,000 ohms is a good value for *R*.

The *C* battery should be as carefully selected as in a resistance coupled or transformer coupled amplifier, especially in the last stage, which should have enough *C* potential applied to the grid of the tube so that the grid will at no time become positive with respect to the filament. With vacuum tubes capable of handling a plate voltage of 120, a 9 volt *C* battery will be correct for the last stage, and in that case a 4½ volt tap may be taken out, on the *C* battery, to provide *C* potential for preceding stages having only 90 volts plate.

The effects of varying the magnitude of *L*, the choke coil inductance, are shown in the curve of Fig. 2. These measurements were made with *R* equal to .5 megohm, *C* 1 microfarad, and the following values of *L*: Curve I—14 henries, Curve II—40 henries, Curve III—350 henries. The amplification constant of the tube used was about 8. Note how the low frequency characteristic improves with increase in *L*. The slight falling off of amplification at the higher frequencies is due to the large distributed capacity of the choke coils used. Curve IV resulted when the primary of a bell-ringing transformer was used as a choke, showing that the inductance of this transformer primary is not high enough for a good impedance coupled

amplifier, since the amplification is very poor at the low frequencies.

The capacity *C* is not critical, but for best results should be fairly large. Too small a capacity results in a poor low frequency characteristic, particularly if the grid leak resistance *R* is too small. Curve V shows the effect of a small capacity, when the inductance is so large as to cause no low frequency losses. This curve was obtained with a capacity of .0025 mfd. instead of the usual 1mfd., *L* being 350 henries and *R* equal to 500,000 ohms. Note the poor low frequency characteristic with the small condenser and large inductance and then figure out for yourself what the characteristic of the amplifier would be with too small an inductance as well as coupling condenser.

For those who already have a two stage transformer coupled amplifier, using poor transformers, one of the best and least expensive ways to improve its quality is to use the transformers, properly connected, as choke coils, thus making the amplifier impedance coupled. To obtain sufficient volume one more stage must then be added, which may be another impedance coupled stage using a cheap audio transformer as a choke. For this purpose the secondary windings of most transformers will be found to have plenty of inductance. If still more amplification is desired, a stage of high grade transformer coupling may be used.

The sort of improvement which may be obtained is amply demonstrated by Fig. 3, in which Curve I is the normal characteristic of a poor transformer which has a bad resonant hump near 1000 cycles, and Curve II is the result obtained by using the secondary of the same transformer as a choke coil for impedance coupling. While the total volume is greatly reduced, there is an enormous improvement in quality.

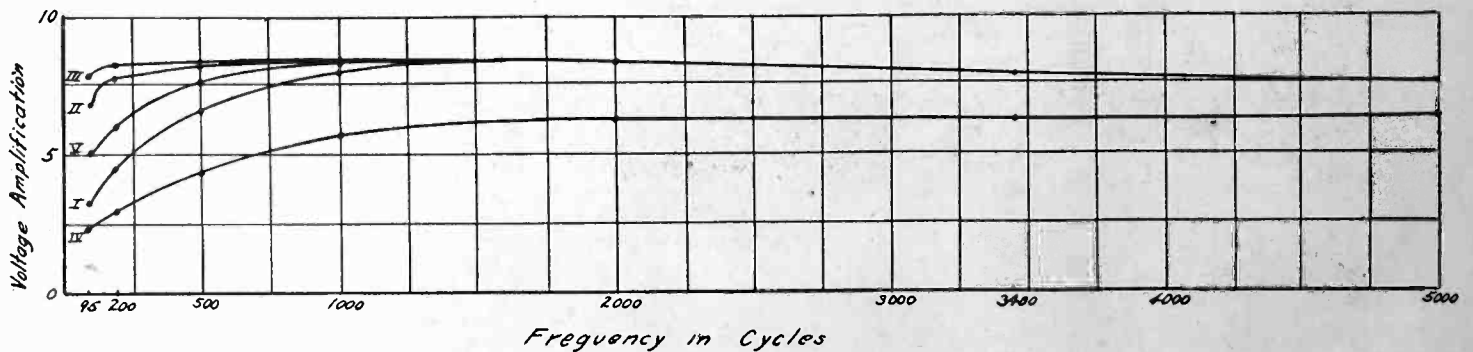

Fig. 2. Effect of Varying Choke Coil Inductance.

- I. Amplifier characteristic with 14-Henry choke.
- II. Effect of increasing inductance to 40 Henries.

- III. Same as II with 350 Henries.
- IV. Poor characteristic with bell-ringing transformer as choke.

- V. Effect of too small a blocking condenser.

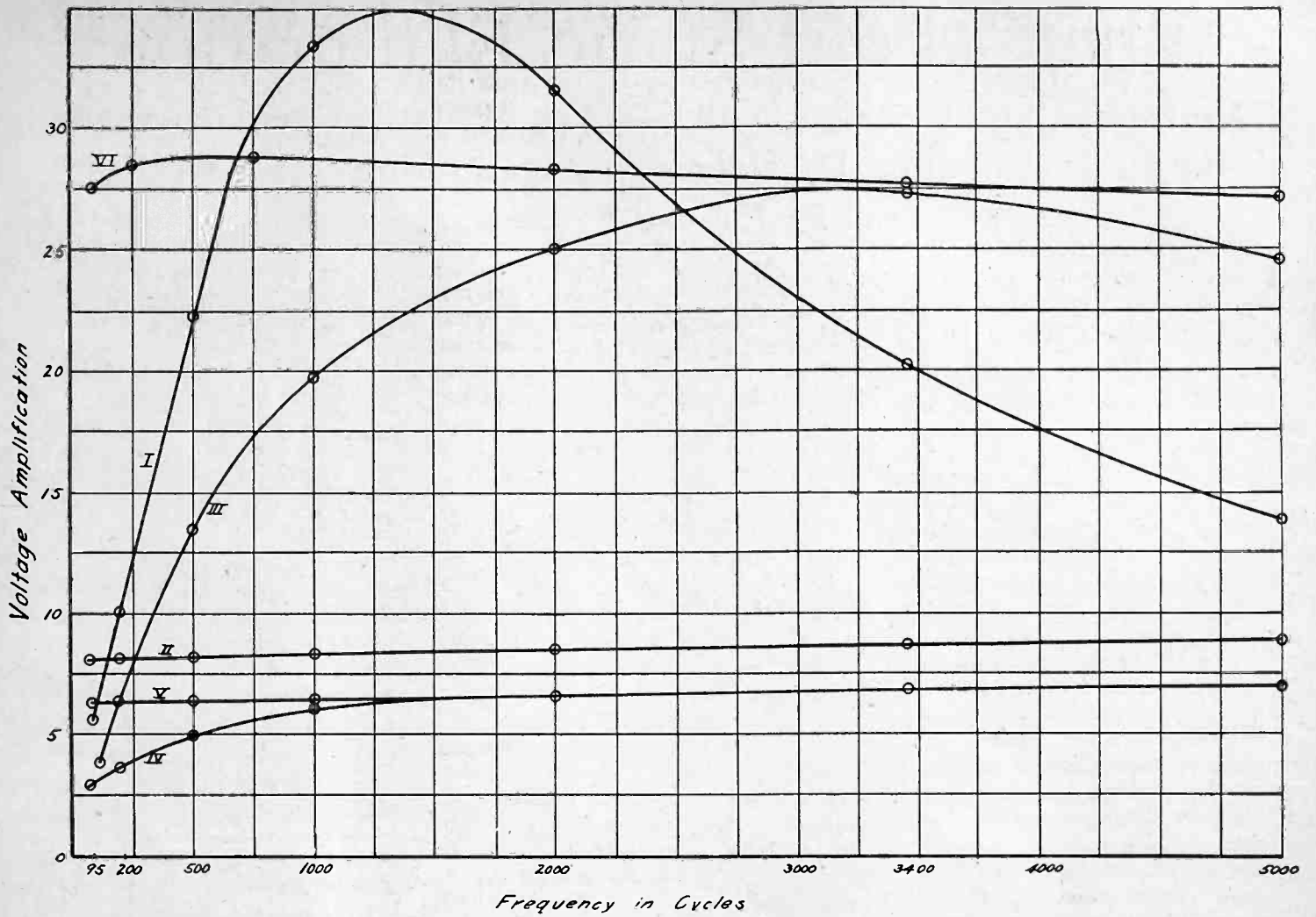

Fig. 3. Improvements Due to Choke Coils.

- I. Normal characteristic of poor audio transformer.
- II. Same transformer used as choke coil.
- III. Normal characteristic of fair audio transformer.

- IV. Secondary of same transformer used as choke coil.
- V. Advantage of connecting primary and secondary windings in series aiding.

- VI. Effect of tube with high amplification constant.

Another interesting case is shown in other curves of Fig. 3, which were taken with a transformer of very low primary impedance. Curve III is the normal characteristic when used as a transformer in the usual way, and Curve IV is the impedance coupled characteristic using the secondary for a choke. Note that at 95 cycles the impedance coupled arrangement gives almost twice as much amplification as the regular transformer coupling, even though the latter greatly exceeds the former at high frequencies. In this case, however, even the impedance coupling is not as good as could be de-

sired, due to insufficient inductance. However, there was still the inductance of the primary and the mutual inductance of the two windings which could be added, and by connecting the two windings together, series aiding, Curve V of Fig. 3 was obtained, which shows about 15 per cent improvement at 95 cycles over Curve IV.

When connecting the two windings in this manner, care should be taken not to get them series opposed. Probably the simplest way for the average radio fan to determine the proper arrangement is to listen with a pair of headphones

to an orchestra selection, or better yet, an organ number, and observe particularly the low notes, while trying the two series connections of the transformer choke coil alternately. The connection which brings the low notes in best is the correct one.

Impedance coupling today is seriously limited by the low amplification obtainable, per stage. Until tubes having much larger amplification constants than at present are placed on the market, impedance and resistance coupling cannot become very economical.

(Continued on Page 53)

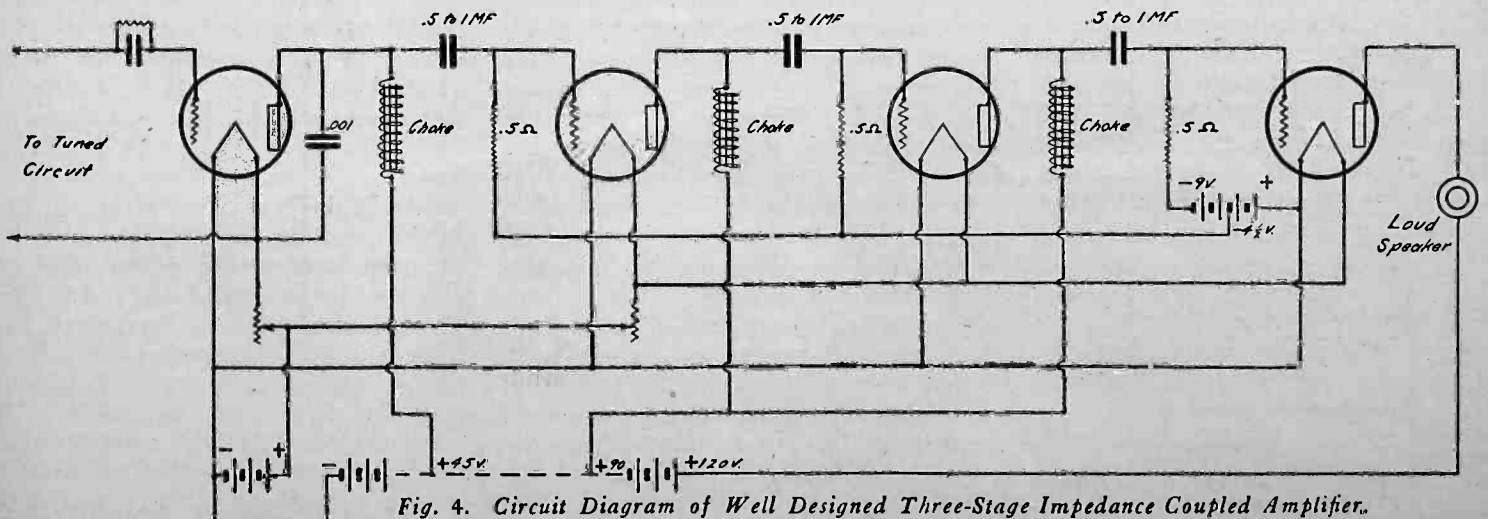

Fig. 4. Circuit Diagram of Well Designed Three-Stage Impedance Coupled Amplifier.

What About Static Elimination?

An Interesting Discussion of the Theory of Static Interference and the Probable Future Development of Static Eliminating Devices

By Edward T. Jones

EVER since the first few dots and dashes were received on radio equipment this question has been foremost in the minds of those interested in radio. Numerous devices have been described purporting to *totally eliminate static*—however, until this very day static is a much known “quantity,” particularly in the Southern states. There is no reason for anyone who is in position to know the facts concerning this problem to promise the total elimination of static. It is much the same as the “perpetual motion” problem. Some inside facts on the “static” problems may prove of interest as well as value to radiocast listeners and experimenters. The following is taken from general notes made by the author in all of his work on this problem and it is hoped that everyone interested will obtain something of value.

To begin with, *static* is undoubtedly a misnomer; whoever started the ball rolling was wrong from the very beginning. Static, according to Webster means “at rest.” Surely it is not necessary for anyone to listen-in very long in order to ascertain for themselves that this so-called static is not at rest—by any means. Static electricity is present in greater quantities in the air during the colder months of the year and during that time it really is “static” electricity, because it cannot be heard by the most sensitive recording instruments. The electricity in the air is actually “at rest” and the term “static” is very appropriate. However, as we approach the warmer months we begin to hear *what was at one time “static”* and is most probably now the result of a discharge of static electricity between clouds or from some other source. Let us get to the very bottom of this problem: If we take an ordinary condenser in the laboratory and charge it from a high voltage transformer as shown in Fig. 1, the condenser becomes very highly charged from the 20,000 volt supply delivered to the metal plates. Now the charge is stored up in the condenser and no matter how sensitive our

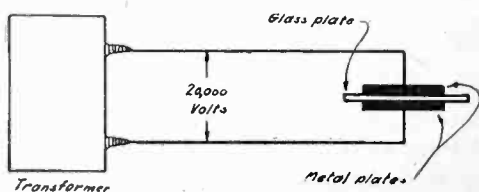

Fig. 1. Method of Charging High Voltage Condenser.

radio receiver is, we can bring it very close to this highly charged condenser and cannot obtain any response in the receiver. This is identically the same condition existing in the air during the winter months. The air is literally charged with electricity—however it is not in motion and really is “static” electricity.

Now, as has been proven in the laboratory, before any response will be had in the receiver from the transmitter it is necessary to discharge the charge in the condenser through a gap of some kind. In discharging through the gap, as shown in Fig. 2, oscillations are produced and

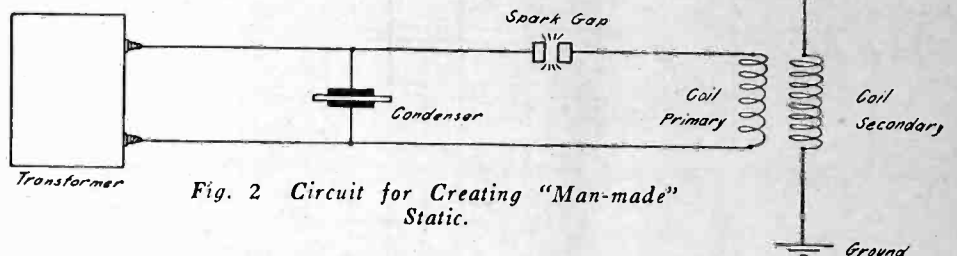

Fig. 2. Circuit for Creating “Man-made” Static.

it is these oscillations which propagate as waves through the ether to the receiving station. Now we have the transmitter imitating the summer static. This static in the laboratory is no longer at rest but it is discharging radio waves. There is no doubt in my mind but that radio waves produced in the laboratory are reproductions of the natural electrical waves—known today as static (during the summer only).

The discharge of static during the summer time seems to be a complex problem for the owners of wavemeters (a wavemeter is an instrument which permits the wavelength of any transmitter to be read directly from a scale provided for that purpose). There seem to be several thousand “static” transmitters, each operating on a different wavelength and all pressing the key at one time—for no matter where you tune in—the static is there. On some occasions the static waves are stronger on long wavelengths and at other times more audible on short wavelengths. There seems to be no fixed wavelength for these natural transmitting stations.

In the laboratory, radio waves have been moulded by engineers to the point where they will produce a maximum beneficial effect on receiving equipment at one critical adjustment. This results in delivering a maximum of the available energy to the receiver, while

the static is dissipated all over the scale on the dial. Receiving equipment has also been designed so that there is very little chance of these very sharply tuned transmitters being picked up on several degrees of the dial. The so-called static is thereby shut-out, so to speak—when the transmitter and receiver are tuned exactly together on the very same wavelength.

A radio wave is supposed to comprise two components: the electro-static and the electromagnetic. Without getting too technical let us consider these components as we would galena, which is composed of lead and sulphur. One piece of galena may contain 60 per cent lead and 40 per cent sulphur while another specimen will contain less lead and more sulphur. So it is with the radio and static waves. We know positively, that the radio wave as generated in the laboratory by man has a larger electromagnetic component and a smaller electro-static component than static. Therefore, if we can design our receiving equipment to respond more to the electromagnetic component of both waves the result will be (in all cases) better reception from the radio than from the static waves. This is unquestionably proven by the loop antenna—which is an excellent electromagnetic pick-up antenna system. During the late war the Rogers underground system of reception was installed by the Navy Department at many of its naval stations. The writer had the good fortune to be placed in charge of one of these installations and to bring about improvements which were later made public in U. S. patents. The main idea was to get away, as far as possible, from the electrostatic component of the wave and thereby receive a greater signal from the radio wave than from the so-

(Continued on Page 50)



"He got into the good graces of Henrietta and old Oom Pok Van Oopjik."

The Removal of Jasper Holmes

By H. A. Highstone

THE Chief Operator of the radio service company opened the door marked "Private", poked his head out, and with a mildly curious stare surveyed the assemblage of radio operators awaiting berths. For the most part they were composed of "lids", as green operators are so crudely designated, with two old-timers draped morosely over a table, checking off the ship position reports for the night before from a crumpled section of newspaper.

"No ships today." The door closed and the Chief Operator and all prospects of immediate jobs disappeared into the cubbyhole which served as an office. Three of the "lids" immediately departed noisily down the two flights of stairs to the street; another, one of the watchful, waiting variety, picked out the most comfortable chair available and settled himself for his all-day vigil of waiting for some chance job. After a few minutes more of lingering the remaining "lids" gave up and meandered out, followed by the two old-timers. A snatch of conversation drifted up the stairway as they descended.

"—and I'm agonna get me a blackjack and make some of those operators on that Stetson run turn up missing if I don't

get a ship pretty quick," a plaintive voice announced. "I been waiting here six weeks now—" The first old-timer chuckled.

"That reminds me of Henry and the West Cajappa," he told his companion. They crossed the sidewalk and crawled into a touring car of uncertain make and vintage.

"I forget how it was Henry spelled his last name, but the way he pronounced it was 'Tomahawk'. He'd get mad as a hatter if you tried to pronounce it like it was spelled—something like a man sneezing with a mouthful of popcorn—so I always humored him; his way was easier.

"Well, this Henry Tomahawk, or plain 'Tomahawk' as everybody called him, was the radio operator on the West Carolina running out of 'Frisco for the old Hardman & Pelton outfit, carrying general merchandise down to Surabaya and thereabouts in the East Indies. And although they had never laid eyes on one another, he and Jasper Holmes, the operator on the West Cajappa were as bitter a pair of enemies as ever sailed the Pacific, being in the habit of staging a row over the air regular once a month when they passed one an-

other about a thousand miles west of Honolulu. The Cajappa ran opposite to the Carolina on the same run, these two ships being the only ones which Hardman & Pelton owned at the time. Both of these battling brass-pounders used to sit up nights trying to concoct new insults. When the two ships passed neither one of them shut off their motor-generators except to eat, deluging one another with a continuous flood of conversation which was anything but amiable and in defiance of all laws and regulations, both International and American.

"As for the cause of the trouble—her name was Henrietta Van Oopjik, the only daughter and sole heir of Oom Pok Van Oopjik, a Dutch planter with a big plantation near Surabaya. He was both excessively rich and aged. Jasper had made tremendous headway with the Dutch maiden, who was a winner despite her name, ever since he had met her on his first stop at Surabaya.

"He had stumbled onto old man Oopjik at an inn and in the course of the ensuing hour or so had put him and a number of his friends under the table, thereby earning their most profound respect. Thereafter he had parked himself

(Continued on Page 44)

Selectivity versus Distortion

A Searching Analysis of How Selectivity Reduces Interference but Increases Distortion in a Radio Receiver

By J. E. Anderson

PERFECT selectivity and complete freedom from distortion are incompatible in a radio receiver. They are opposites which cannot exist together. To attain one, the other must be sacrificed.

If a receiver is perfectly selective it will pass one frequency and exclude all others. Not only will it exclude the signals from all other stations, the squeals from neighboring oscillating sets, and most static disturbances, but it will also exclude the desired program if the tuner is adjusted exactly to the carrier frequency. The perfectly selective circuit will eliminate every note in the desired program just 32 cycles before it can be heard, if 32 cycles is the lowest audible note.

On the other hand, if the circuit is distortionless it will pass all frequencies alike, and there can be no selectivity at all. This reciprocal relation between selectivity and distortionless amplification in a radio receiver is understood by radio engineers, but is not widely known by the general public.

It is interesting to see just to what extent the quality of the received program is affected by the selectivity of the tuners in typical radio receivers. Is the quality adversely affected to a degree which would justify limiting the selectivity, or is the effect so small that it may be neglected for all selectivities practically attainable?

With a view to answering these and similar questions the writer engaged in a series of slide-rule observations covering certain phases of the subject. The results were plotted as characteristic curves to give a visual conception of the effect. Although these curves have been calculated, and are therefore more or less ideal, they are better for a discussion of principles than actual laboratory observations. Theory follows so closely on fact that, point for point, they are probably more accurate than curves obtained from ammeter readings. The object is to show the order of the effect rather than to show the effect to an accuracy of a small fraction of a per cent.

Since these curves have been calculated, it is well to introduce the equations used in the calculation, and to define the conditions assumed. At the top of the next column is a typical radio circuit having one tuned circuit, composed of the inductance coil L and the condenser C . In series with this circuit is an effective resistance R , here assumed

Equations

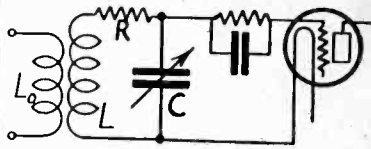

$$I = \frac{E}{\sqrt{R^2 + (L\omega - \frac{1}{C\omega})^2}} \dots\dots (1)$$

$$\text{When } L\omega = \frac{1}{C\omega} \dots\dots (2)$$

$$I_h = \frac{E}{R} \dots\dots (3)$$

$$\frac{I}{I_h} = \frac{R}{\sqrt{R^2 + (L\omega - \frac{1}{C\omega})^2}}, \text{ or } \dots\dots (4)$$

$$\frac{I}{I_h} = \frac{1}{\sqrt{1 + Q^2(1 - \rho^2)^2}} \dots\dots (5)$$

in which $Q = \frac{L\omega}{R}$, and $\dots\dots (6)$

$$\rho = \frac{\omega_k}{\omega} = \frac{f_k}{f}, \text{ or } \rho = \frac{\omega}{\omega_k} = \frac{f}{f_k} \dots\dots (7)$$

$$\left(\frac{I}{I_h}\right)^2 = \frac{1}{1 + Q^2(1 - \rho^2)^2} \dots\dots (8)$$

$$Q = \sqrt{q_1^2 + q_2^2 + q_1^2 q_2^2 (1 - \rho^2)^2} \dots\dots (9)$$

$$Q_2 = Q_1 \sqrt{2 + Q_1^2 (1 - \rho^2)^2} \dots\dots (10)$$

$$Q_3 = Q_1 \sqrt{3 + 3Q_1^2 (1 - \rho^2)^2 + Q_1^4 (1 - \rho^2)^4} \dots\dots (11)$$

$$D = \frac{Q^2(1 - \rho^2)^2}{1 + Q^2(1 - \rho^2)^2} \dots\dots (12)$$

to be confined to the inductance coil. A voltage E is introduced into the circuit by means of the primary coil L_0 .

If an ammeter of negligible resistance is introduced into this circuit, the current reading will have a value given by equation (1), in which I is the effective current and ω is 6.28 times the frequency of the current in cycles per second. At resonance, or at the frequency for which the circuit is in tune, the inductive reactance is equal to the condensive reactance, a condition stated by equation (2). When this condition holds, the current in the circuit will be a maximum and its value will be as expressed by equation (3).

It will now be convenient to introduce the ratio of the current at any given frequency to the current at resonance for the same voltage in the circuit. This ratio is given by equation (4), and also in a simplified form by equation (5). In

the latter equation occur two quantities, the letter Q and the Greek letter ρ , which are of especial importance in this study.

The first is defined by equation (6). It is the ratio of the inductive reactance at resonance to the effective resistance in the coil, also at resonance. This quantity is variously called the sharpness of resonance, the selectivity, and, erroneously, the time constant, of the circuit. It is a measure of the selectivity of the circuit, and for that reason it will be referred to as the selectivity, or simply as the Q of the circuit. It will be regarded as a constant in the calculations. This assumption is not strictly true, but practically so over the small frequency changes which will be considered.

The second quantity is the frequency ratio and is defined by equation (7). It is the ratio of the frequency of resonance to some other frequency, or the reciprocal of that ratio, depending on which is less than unity. For frequencies above resonance it is defined in the first way; for frequencies below resonance, in the second manner. The introduction of the frequency ratio makes the resonance curve symmetrical about the unit ratio axis, and renders unnecessary the study of the curves on both sides of resonance.

The current ratio given in equation (5) is the ratio of the currents in the tuned circuit. This is equal to the ratio of the voltages either across the inductance coil or the condenser, and hence the ratio also gives the relative strength of the voltages impressed on the grid. It also gives the relative strength of the radio frequency currents in the plate circuit of the tube. But we are not particularly interested in the radio frequency currents, but primarily in the audio frequency currents, whether these are due to interference or to the modulated carrier desired. The detected currents are proportional to the square of the input voltages, and hence the ratio of the audio currents will be as the square of the ratio given by equation (5). This is expressed by equation (8), to which we now transfer our chief interest.

The first application of this equation was to the calculation of a set of transmission curves for 6 different values of selectivity and for frequency ratios from .85 to unity. These curves cover most of the "interference range" as well as the "distortion range". The results have been plotted in Fig. 1, the ordinates

being the audio frequency transmission ratio and the abscissas the frequency ratio. The curve for $Q=5$ may be taken as a crystal receiver of the broader types, the $Q=10$ as a better crystal receiver or as a broader type of tube set. $Q=25$ represents a fairly selective circuit, and the rest very selective circuits. A circuit that has any claim to be low loss should be considerably above $Q=25$, and the good circuits may cluster around the $Q=50$ curve. It is very difficult to increase the selectivity above that value without using many tuned circuits in series, and even then the increase is not rapid. A low loss coil by itself may have a selectivity as high as 250, but that is another story.

Selectivity and Interference

LET us first consider these curves in connection with interference. The current ratios in this case and the following will be on the basis of equal strength of the two carriers at the antenna and also equal modulation of the two carriers. If the two carriers are

of different strengths at the antenna the current ratio given by the curves must be multiplied by the square of the ratio of the strength of the two carriers, and then the results will be true for equal modulation. The frequency ratio taken will be that of the two carriers. This is permissible because both side bands are present in the interfering carrier, and the mean of any two side frequencies corresponding to a given audio frequency will be that of the carrier.

Suppose we wish to know to what extent WEAF (610 kc) and WJZ (660 kc) will interfere with each other. Their frequency ratio is .925. Referring to the curves we see that for that value of the frequency ratio the interference for $Q=5$ is 67%. It would be difficult to tell which of these was the stronger on the loud speaker. For $Q=10$ the interference is 32.5% and for $Q=25$ it is only 7.5%. For $Q=50$ it has been reduced to 2%. The separation of any other two frequencies having the same frequency ratio would be the same, for instance the separation of the harmonics

of the above two stations, or 1220 from 1320 kc.

The separation of WNYC and WJZ is much easier because their frequency ratio is only .864. The top curve shows an interference of 38%, the next 14%, the third 2.5%, and the $Q=50$ curve less than 1%. The separation of WNYC and WEAF is slightly more difficult than the separation of WEAF and WJZ, because their ratio is about .934. If we attempt to separate stations differing only by 10 kilocycles we get into trouble because we have to climb up the steep slopes of the curves at the right. Suppose we wish to separate the 1,000 kc channel from the 990 channel. The frequency ratio is .99 and it requires a selectivity of about 75 to reduce the interference to 10%, while a selectivity of 50 only reduces the interference to 50% of the desired signal strength. The curve for $Q=5$ shows a reduction of only 1%, or the interference is 99% as strong as the desired signal. That difference is, of course, entirely inappreciable to the ear. At the higher frequencies it is still more difficult to separate two adjacent channels of the same frequency difference.

Another way of plotting the interference is given in Fig. 2, this showing more clearly how it depends on the selectivity. The three curves *A*, *B* and *C* show the interference ratio as a function of the selectivity for three values of frequency ratio. (Interference ratio is just another name for transmission ratio, but looked at from a different point of view.) *A* represents the interference between 1500 and 1510, the ratio of which is .9934. This is located at the upper limit of the radio range, and these two channels are the most difficult to separate in this range. It is slightly easier to separate 1490 from 1500 since their ratio is a little lower, being .9933.

The two adjacent channels in the radiocast range easiest to separate are the 550 and 560 kc frequencies, which have a ratio of .982. This differs considerably from unity. It is only slightly more difficult to separate WEAF (610 kc) from its nearest rival (600 kc), which have a ratio of .9836. *B* represents the separation between these two for different selectivities. *C* represents the separation, or interference, between WEAF and WJZ, which have a frequency ratio of .9242. These two stations are 50 kc apart, and are the closest approach of two class B stations in the same locality, with few exceptions.

On curve *A* the interference at $Q=20$ is 93.5%; on curve *B*, 70%, and on curve *C*, only 10%. At $Q=50$ these values are, respectively, 69.5%, 28% and 2%; and at $Q=100$ they have been reduced to 36.5%, 8.7% and .5%. It requires a selectivity of more than 150 to reduce the interference in the *A* curve to 20 per cent.

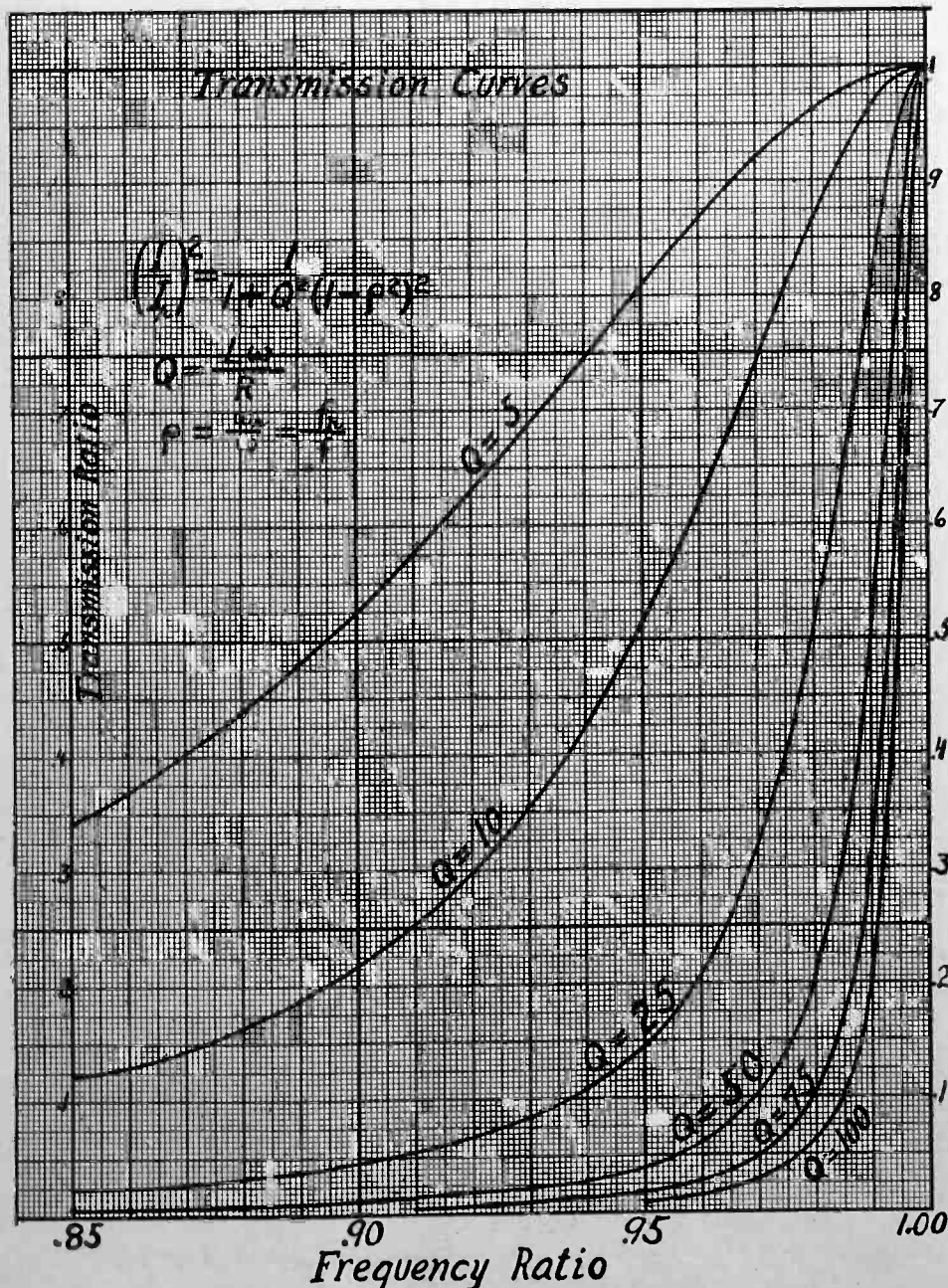

Fig. 1. Transmission Curves.

At this point it may be well to state what values of selectivity may be attained in practice. A non-inductive resistance unit has a Q equal to zero, a single circuit tuner with crystal detector from 5 to 10, a loosely coupled tuned circuit with crystal detector from 10 to 20, a single circuit tuner with vacuum tube detector from 10 to 25, a loosely coupled circuit with vacuum tubes from 25 to 75. These values of course are only rough approximations. Higher selectivities may be attained by combining several tuned circuits as in various radio frequency amplifiers like the superdyne and the neutrodyne. This, however, complicates the problem, as the individual selectivities do not add up linearly. How they combine will be shown below.

For lower frequencies, where it is possible to use iron and silicon cores in the tuning coils without introducing excessive losses, much higher values of Q may be attained. Thus an iron core transformer intended for an audio frequency oscillator may have a $Q=150$, and if the best silicon core and heavy wire are used in the construction of the coil the selectivity may be 200 and over.

Now suppose we have an amplifier circuit with two or more tuned circuits in tandem. The tube amplifies all frequencies to the same extent, within very wide limits, and hence it neither adds to nor detracts from the selectivity. But when the current encounters the second tuner the ratio is reduced accordingly to the selectivity of the second tuner. It arrives to the second circuit in the ratio given by equation (5), and the second tuner reduces it by another such expression. Then if it is impressed on the detector the whole thing is squared and two such factors as given by equation (8) will express the audio frequency current ratio. If there had been another amplifier before the detector the final result would have been expressed by three factors of the form given by equation (8), and so on for additional tuned circuits.

If the two or more tuned circuits are not in resonance with the same frequency the resulting effective selectivity of the amplifier and tuner may be less than the selectivity of any one. If they are only slightly separated as to the resonance frequency, the resonance curve will be flattened out a little at the top and the selectivity of the whole will be less than that of either part. If the separation is too great there will be two or more humps. If, however, they are fairly closely tuned to the same frequency, the selectivity of the amplifier will be greater than that of either tuned circuit. For simplicity we will assume that they are all tuned to exactly the same frequency.

On this assumption it may be shown that the effective selectivity of an amplifier having two tuned circuits of separate selectivities of Q_{-1} and Q_{-2} will be

as given by equation (9). This shows that the effective Q is no longer independent of the frequency ratio. It also shows that for frequency ratios nearly equal to unity, or for low values of selectivity, the squares of the separate selectivities add up to form the square of the effective selectivity. By applying equation (9), equations (10) and (11) may be derived. The first gives the effective selectivity Q_{-2} of two identical circuits of selectivity Q_{-1} , and the second gives the effective selectivity Q_{-3} of three identical circuits of selectivity Q_{-1} . The latter is the case of a neutrodyne in which all the three coils are the same and all tuned to the same frequency.

Equations (9), (10), and (11) show that if the object of the tuned circuits is selectivity regardless of quality it is better to use many tuned circuits of moderately high separate selectivities than to use a single tuned circuit of the same effective selectivity at resonance. But if the object is quality rather than selectivity, as will become evident later, it is better to reverse the condition.

Aside from showing how the selectiv-

ities of several tuned circuits combine to form the effective selectivity of a receiver, there is no practical application for equations (9), (10), and (11). Transmission ratios and other desirable information about a receiver may be calculated much more easily by applying equation (8) directly, from which the other three equations were derived. Equation (8) holds for all values of Q , and for all values of the frequency ratio; that is, it may be applied whether the circuits are all tuned to the same frequency or not.

Selectivity and Distortion

THE distortion introduced by increasing selectivity is due to the partial suppression of the radio frequency side bands on either side of the carrier frequency. The nature of these side bands has been explained so often in these columns as to require no further amplification other than the statement that in these calculations the side bands will be considered as extending from the carrier to 5000 cycles on

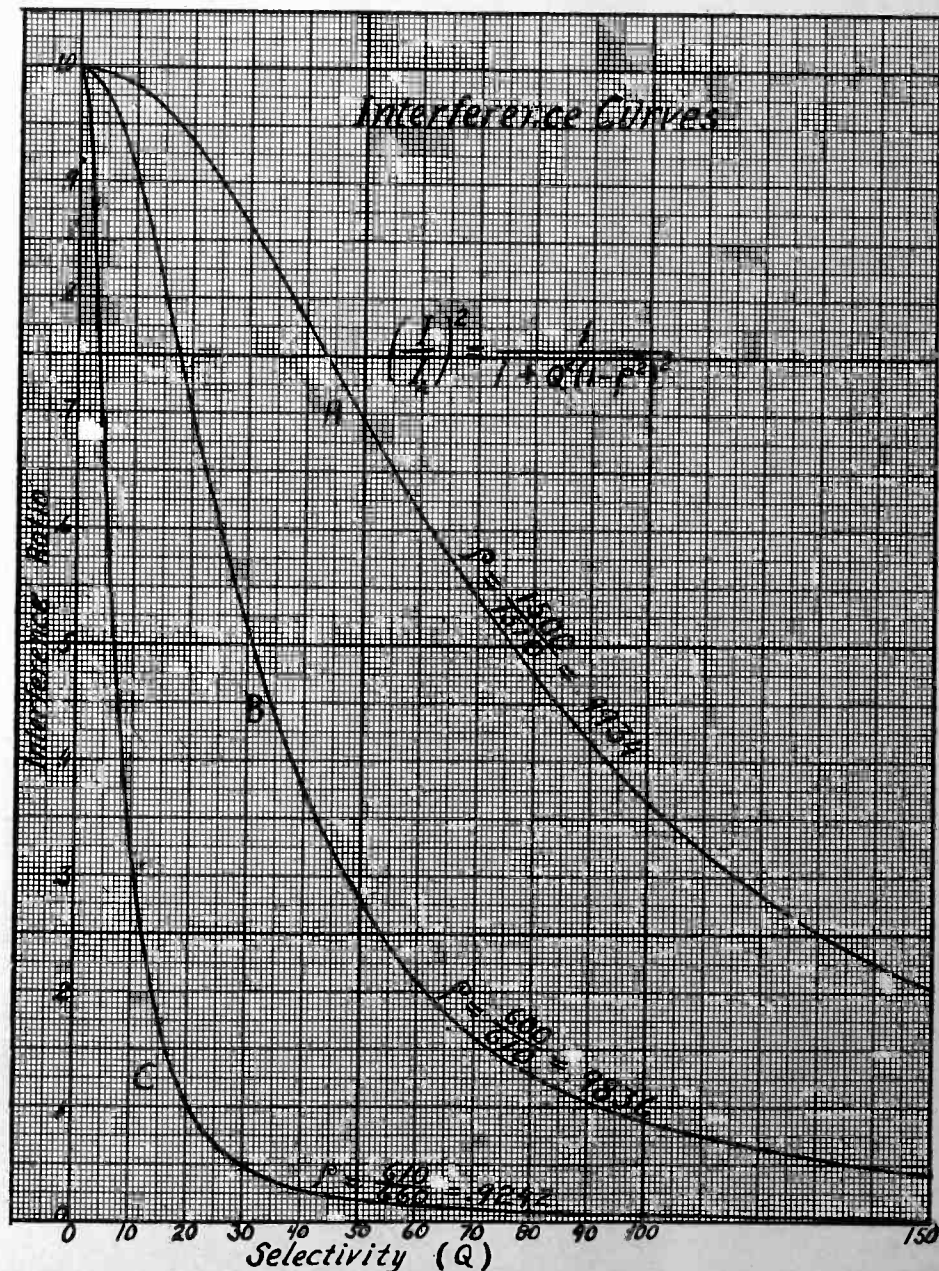

Fig. 2. Interference Curves.

either side of it. By maximum distortion will be meant the distortion at this upper limit of the side band, or the distortion of the 5000 cycle audio frequency as compared with the audio frequencies very close to the carrier.

Since the side band frequencies are radio frequencies of the same nature as the carrier it is evident that if the circuit is tuned to the carrier, the frequencies in the side bands will be suppressed in the same manner as an interfering carrier. The tuned circuit does not know how the waves were produced. The farther away from the carrier the side band frequencies are the greater will be the suppression. The amount they are suppressed will depend on the frequency ratio between the carrier and the side frequencies. For this reason we may apply the same formulas as were used in the calculation of interference to the calculation of distortion at various side frequencies. Formula (8) previously given is still of greatest importance.

The distortion may be found directly from the transmission curves already given. It is the difference between unity and the value of the transmission ratio. It may be read off the transmis-

sion or interference curves by reading from the unity line to the curve. But these curves have not been plotted on a convenient frequency scale for reading the distortion, and hence it is better to plot new curves. The formula used in calculating the distortion is obtained by subtracting (8) from unity, and it is given in equation (12).

It was shown in connection with interference that it was easier to separate carriers near the lower end of the radiocast band than at the upper, because the frequency ratios were lower for a given absolute separation in the frequency scale. For the same reason the distortion due to selectivity will be greatest at the lower end of the radiocast band. Hence the distortion has been calculated for the lowest carrier frequency, or for the longest carrier wave, used in radiocasting. The results have been plotted in Fig. 3. The ordinates give the distortion while the abscissas give the frequencies. Although these are labelled Side Band Frequencies they are actually the audio frequencies corresponding to these frequencies, so that the curves give directly the amount of distortion for any given audio frequency as

it is heard in the loud speaker or headset, provided no other distortion is introduced between the detector and the ear.

The same selectivities have been used for the distortion curves as were used for the transmission curves. It was found that the distortion for a selectivity of $Q=5$ was so small that it was necessary to plot the percentage distortion rather than the distortion itself. It will be observed that the maximum distortion is just .8 of 1%. For $Q=10$ the maximum distortion is 3%, for $Q=25$ about 16%, for $Q=50$ it is 44.5%, for $Q=75$, 64.5%, and for $Q=100$ the distortion is about 76 per cent.

As has already been pointed out the first two represent the selectivities of crystal receivers. This explains the main reason why the quality of crystal detectors is so excellent. There is no magic attribute of a crystal which makes the quality of its signals perfect.

The $Q=25$ represents a moderately sharp tuner, and the distortion may still be regarded as negligible. This is in line with experience which shows that there is very little difference in the quality of signals as rendered by a rather broad tube detector and a crystal outfit. But when the selectivity has been increased to 50 the distortion begins to be noticeable. It is still possible that the quality will pass as perfect simply because there is no perfect signal with which to compare it, and the distortion is not enough to cause unpleasant sensations. It must be remembered that this is the maximum distortion, both in the radiocast range and in the audio frequency scale. For audio frequencies within the range of a soprano, for instance, the distortion is considerably less, and still less within the range of the speaking voice. The only musical notes that would approach the upper range are the higher notes on the piccolo. However, the harmonics of all musical sounds play a large part in determining the quality of a particular note, and the harmonics must not be suppressed too much. For the two higher selectivities, $Q=75$ and $Q=100$ the distortion is quite serious; and these are attainable in the more selective circuits.

Now the distortion for the higher frequencies in the radiocast range will be somewhat less, but not a great deal for any of the class B stations. The maximum distortion at 1,000 kc (300 meters) is for the selectivities shown in the curves: for $Q=5$, .25%; for $Q=10$, 1%; for $Q=25$, 6%; for $Q=50$, 20%; for $Q=75$, 36%; and for $Q=100$, 50 percent. That is, for the highest selectivity considered in the curve the intensity of the 5,000 cycle notes in the signal will be only half as great as the intensity of the lowest audible notes, say 100 cycles or below. The distortion for the most important frequencies in

(Continued on Page 59)

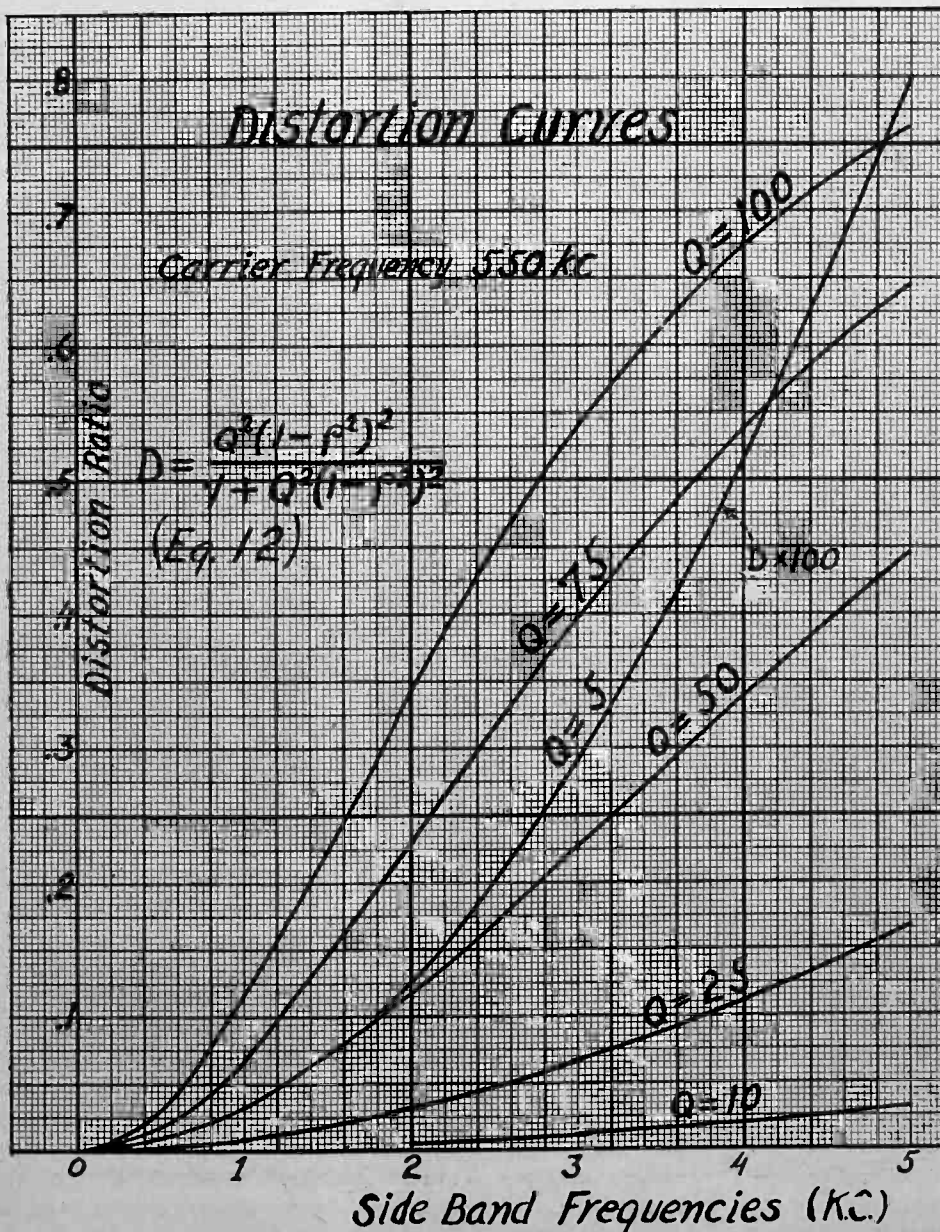

Fig. 3. Distortion Curves.

Canned Audio

A Simple and Effective Means for Reproducing Phonograph Music Through A Loud Speaker

By *W. H. Wenstrom*

STATIC comes with the summer and bloopers, like the poor, are always with us, and between the two many a radio dance leads but to the victrola. For such occasions, it is often of advantage to be able to retain the radio atmosphere by connecting the phonograph to the radio receiver in such a manner that the phonograph music will emanate from the loud speaker instead of the phonograph horn. This can be accomplished with a small amount of additional apparatus, and a little patience on the part of the constructor, at a cost of only five dollars, provided that a radio set and phonograph are already at hand.

The desired result can be accomplished after a fashion by placing a microphone connected in series with a battery and input to an amplifier, in or near the phonograph sound chamber, or a single headphone or loudspeaker unit may be used in place of the microphone. Another scheme occasionally used commercially is to have the pick-up device mounted in the tone arm, but this method baffles the average home builder of such apparatus. The above methods usually invite extraneous noise and energy loss, and if the loud speaker is placed near the phonograph and microphone, a howler action of several hundred cat-power ensues which should daunt the most zealous home scientist.

So by elimination, we come to a telephone receiver mounted in a phonograph reproducer. No originality is claimed, for the device exists in more perfect and expensive form in the Western Electric Laboratory. As theirs is not on the market, the simplest way of getting one is to build it. In the bush league model, the telephone receiver is mounted in the phonograph reproducer so that the receiver diaphragm, vibrating with the phonograph needle, induces varying currents in the receiver windings, as shown in Fig. 1.

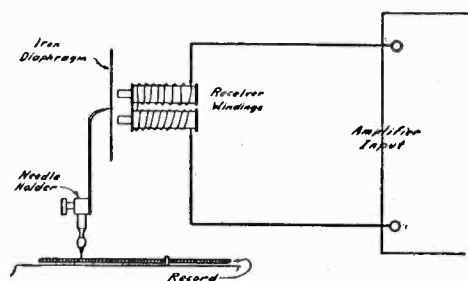

Fig. 1. Method of Attaching 'Phone Receiver to Phonograph.

As any orthodox radio article must contain a list of parts, this is:

- 1 Phonograph reproducer (can be had from a national mail-order institution for about two dollars).
- 1 Small headphone unit of good make.
- 4 Machine screws, with bushings, length about 1 inch and size same as those originally in reproducer.

The usual reproducer or sound box consists of a metal ring supporting a mica diaphragm, to the center of which the needle holder is extended, and a metal back which connects through a bayonet joint to the tone arm. The back is removed by taking out four small machine screws. Drill out the holes in both back and ring for larger and more easily obtained screws. The cap and iron diaphragm are taken off the receiver, and the back of the latter is centered against the reproducer back plate, where it is cemented in place by a very poor soldering job with plenty of resin. A ring of thin rubber should be placed over the edge of the receiver case, to fit between it and the diaphragm.

ner, except for the rubber gasket between them. The machine screw bushings are of such length that the whole assembly is tight without undue pressure on the diaphragm. Length of these bushings, thickness of the rubber gasket, and properties of the diaphragm itself are the factors governing quality and volume, making the ensemble just another one of those things or a joy forever.

The model shown has been used with the best transformer coupled amplification available of one, two, three and four stages. Of course power tubes must be used beyond the second stage to handle the volume. One stage gives loud headphone volume, while two operate the loudspeaker with what might be called fibre needle loudness. Three stages step the volume well above that of a phonograph, while good quality is retained if the loudspeaker is large and acoustically perfect. With four stages the volume is increased to that of a full orchestra and the music can be heard for

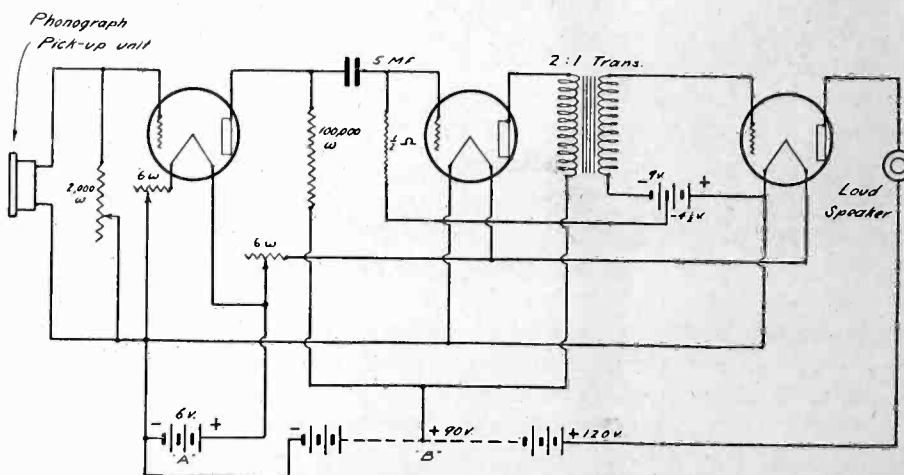

Fig. 2. Circuit Diagram of 3-Stage Amplifier.

We now come to a fine point—the screw which holds the mica diaphragm to the needle holder extension. The mica is removed, but the rubber ring underneath it remains in place. A very small hole is drilled in the exact center of the iron receiver diaphragm, and it is mounted in place of the discarded mica disk. In the model illustrated the receiver is from a Western Electric headset, but any well made phone with an aperiodic diaphragm will do. The reproducer is assembled, using the long machine screws, so that the receiver case fits against its diaphragm in the usual man-

several blocks, if anyone is unwise enough to leave the windows open.

Fig. 2 shows the schematic circuit diagram of a well designed 3-stage amplifier for use with the phonograph unit. The transformer used between the 2nd and 3rd stages should be of the low ratio type, and the resistance coupled stage should have the proper C battery as shown, or the output will be distorted. A good volume control can be obtained by shunting a Federal No. 25 potentiometer or other good 2,000 ohm variable resistance across the phonograph pickup device.

The Quartz Crystal Oscillator

An Understandable Explanation of the Theory and Application of This Most Dependable Frequency Control

By D. B. McGown

CERTAIN natural crystals, such as quartz, Rochelle salts, and tourmaline, change in size under certain conditions of pressure when placed in an electric field. This "piezo-electric" effect has long been the subject of scientific interest but only recently has been applied practically to radio in controlling the frequency of a vacuum tube oscillator.

Of these crystals, quartz is the most useful because of its cheapness, hardness and practically zero coefficient of expansion. Rochelle salts are so hygroscopic that their shape and condition change as they absorb water from the air. Tourmaline is rather rare and expensive.

Natural quartz crystals, several of

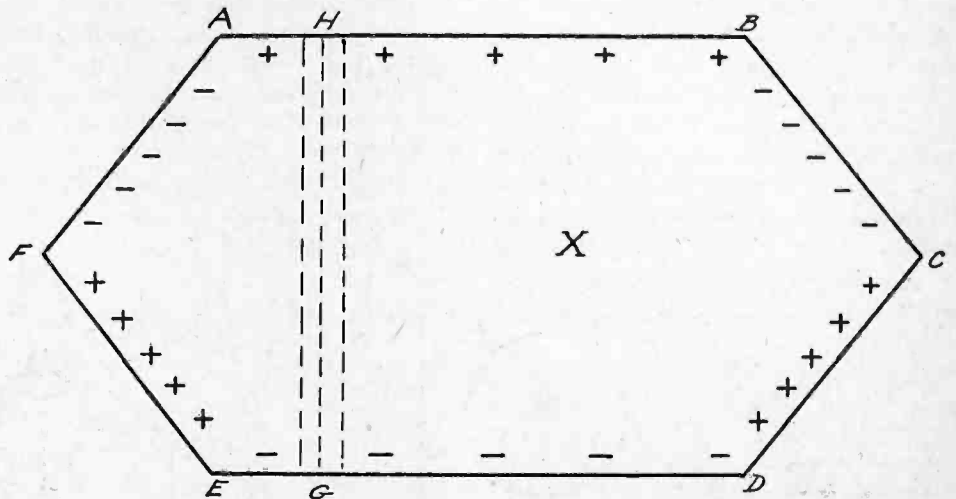

Fig. 2. Electrical Polarities of Quartz.



Fig. 1. Natural Quartz Crystals.

which are shown in Fig. 1, may be cut so as to show different electrical and optical effects in different portions. Opposite faces of a natural crystal have opposite electrical polarities, as shown in Fig. 2. Consequently a section, such as HG may be cut from a crystal so that one edge is positive and the other negative. This may give a slab with the polarities shown in Fig. 3.

If such a section is placed in the influence of an electric field it will elongate or shorten slightly, depending upon the polarity of the field. If the field is produced by an alternating current the crystal will change its shape as often as the current alternates. While this change is too small for mechanical measurement it may be easily detected electrically or optically.

In practice, one of these sections is mounted between two brass plates from which it is insulated by rubber or Bake-

lite as in Fig. 4. Leads from the brass plates are connected to an oscillator circuit as in Fig. 5, where Q is the quartz crystal which is connected to either the plate or filament circuit of the tube through the switch SW . The tuned circuit consists of the condenser C and the inductance L , plate voltage being sup-

plied by the battery B through the telephones and milliammeter.

If the constants of the circuit LC are correct, we may vary C until at a certain point the plate current, as indicated by the milliammeter, will drop and a click will be heard in the telephones.

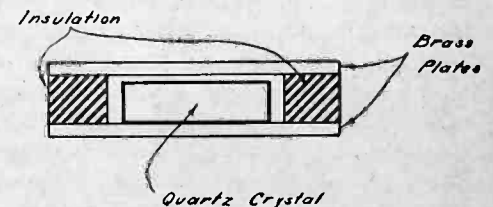

Fig. 4. Mounted Quartz Section.

This drop in plate current indicates that the tube is oscillating. This oscillation is controlled by the quartz crystal in the grid circuit. This effect can be easily explained in view of what has already been said.

A certain potential is impressed on the two sides of the quartz crystal, due to the charge on the grid of the tube, the charge being furnished by the electrons given off from the filament of the

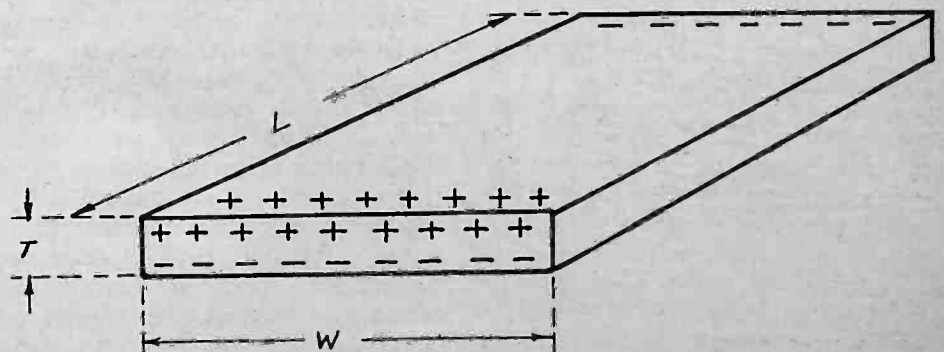

Fig. 3. Polarities of Quartz Section.

tube. Thus there are two unequally charged plates on either side of the crystal which put it under a state of electric strain, one side being charged more positively than the other. When the grid accumulates all the charge possible, it comes to a state of equilibrium and nothing more happens.

Suppose that condenser C is gradually increased from zero, thereby decreasing the resonant frequency of the circuit LC and at a point where the frequency of LC is equal to the frequency of the mechanical oscillation of the crystal the plate current falls off suddenly and oscillations are set up in the tube. These oscillations are a true feedback effect, but they are made absolutely constant by the fixed mechanical conditions of the crystal Q . As soon as the resonant frequencies of the LC circuit and of the crystal ap-

to continue. This device then makes one of the finest possible sources of a primary standard of frequency.

Formerly standard wave meters or frequency meters were cumbersome, bulky affairs and were very delicate. Generally they depended for their action on the natural frequency of a very accurately and permanently built inductance coil, shunted by a condenser of equally high grade, both being built with extreme care so that they would remain as near constant as was possible with a mechanical assembly. These wavemeters required careful transportation and it was often found necessary to recalibrate them after moving.

Compare this system with the quartz

possible. Fortunately the oscillation of a quartz crystal controlled vacuum tube is not sinusoidal and possesses a very large number of harmonics. These harmonics are of considerable amplitude and can be readily used up to the 15th harmonic with little trouble.

Therefore, instead of having only one frequency available, we have at least 15 frequencies to use for calibration purposes, all with an accuracy equal to that of the fundamental frequency. Of course, all these harmonics will be higher in frequency than the fundamental, but this can be easily taken care of by making the fundamental low enough. Make one fundamental frequency of the crystal at say 2000 meters and it will have points at 1000, 666, 500, 400, 333, 285, 240, 222 and 200 meters as well as other frequencies at the lower wavelengths. If the above fundamental is made the proper one for the width of the crystal, the fundamental produced by the length of the crystal will give us at least 10 more points, starting at 3000, then 1500, 1000, etc., down to 300 meters, which will give a very good check on the two fundamental frequencies against each other. The third natural fundamental of the crystal will be due to the thickness and will be higher in frequency than the other two, or say about 300 meters, thus giving reference points down to as low as 30 meters without trouble.

We have thus covered all waves from 30 to 3000 meters, which is much broader than is covered by any ordinary wavemeters. The crystal can now be used to go above the 3000 meter limit by setting the crystal controlled oscillator at its maximum wave of 3,000 meters. If we then take another vacuum tube self oscillator tuned to 6000 meters, there will be a second harmonic present in the latter and this will beat with the 3000 meter oscillator, enabling the 6000 meter point to be checked. Likewise the 9000, 12,000 and 15,000 meter points may be checked by using the higher harmonics of tubes adjusted to these frequencies. Other harmonics can be obtained by reference to the 2000 meter fundamental of the crystal oscillator, obtaining points at 4000, 6000, 8000, etc., meters, as high as the harmonic beats are audible in the receiving equipment.

Thus one crystal with three fundamental frequencies enables us to cover all common wavelengths, since with the numerous reference points obtainable, a calibration curve can be plotted which will give the intermediate points accurately. Should it be desired to go below the 30 meter limit ordinarily assumed, the amplification of the listening device can be increased so that harmonics up to the 20th are audible and wavelengths down to 15 meters are available. As a check measurement, a common vacuum tube self oscillator may be used

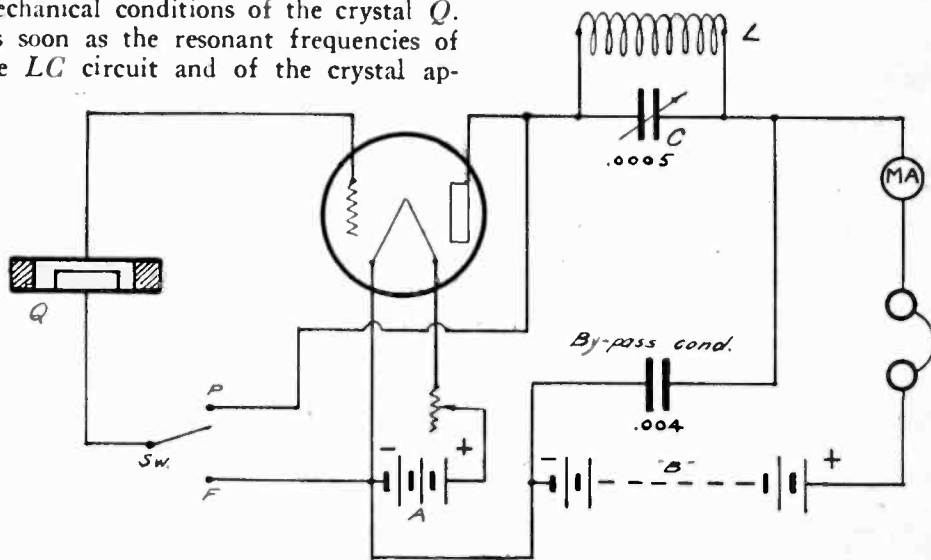

Fig. 5. Oscillator Circuit with Quartz Crystal Control.

proach each other very closely there will be current fed back from the plate to the grid which latter is interposed between the plate and filament. This voltage varies the charge on the grid of the tube and the process is repeated until a state of continuous oscillation is maintained.

Under certain conditions more reliable or persistent oscillations will be set up and maintained in the system if the grid is connected through the crystal to the filament at F and again under other conditions when connected to P . These conditions correspond respectively to the common tuned plate system, and the "ultraudion" circuit. The only difference is that a slightly different feedback effect is obtained in the two cases, which may work better or worse under a given set of conditions.

The frequency of these oscillations will be absolutely constant as long as the crystal is not changed. Thus, once calibrated, the crystal may be used indefinitely to control the frequency of the tube. The change of frequency of the tube due to change of impedance, plate potential, etc., has no effect whatever, as the frequency is absolutely independent of any of the functions of the tube as long as the frequency of the plate circuit is near enough to that of the crystal so that oscillations are permitted

crystal controlled oscillator and the advantages of the latter become more readily apparent. A simple holder of vest pocket size can be made for the crystal, and, barring accidents, the crystal could be shipped through the mails over long distances. Common apparatus such as may be obtained from any radio dealer, even if it be of indifferent or poor quality, may then be used to set up the oscillator and the result will be a frequency standard with a degree of accuracy as fine as that obtainable in the laboratory.

The wavelength or frequency of the system thus set up is extremely constant, but covers only one particular frequency, so the question arises as to the usefulness of the system unless a number of crystals of different oscillation periods are available. But each crystal has not one but three fundamental oscillating frequencies, which are determined by the three dimensions of the crystal, if it be rectangular in shape. A circular crystal would have only one fundamental frequency, due to its diameter and a square crystal would possess but two fundamental frequencies.

Even then, with three fundamental frequencies, there are not sufficient points to cover all the normal wavelength bands and the problem of checking a number of frequencies is still not

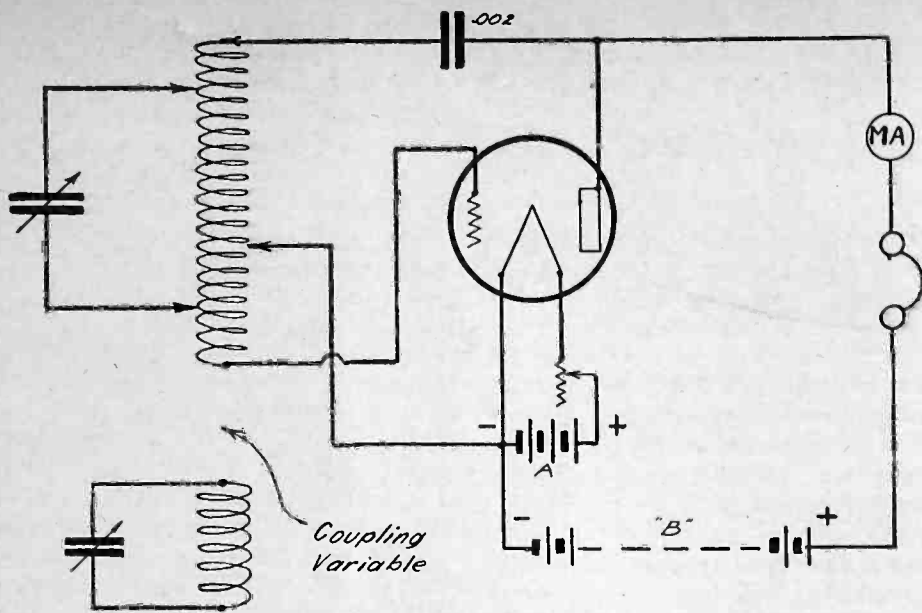

Fig. 6. Hartley Oscillator.

to verify points below 15 meters by using the second and third harmonics of 15 meters.

A good vacuum tube oscillator can be made by using the Hartley circuit as shown in Fig. 6, with proper values of inductance and capacity to cover the wavelength ranges desired. This oscillator should be coupled to the crystal oscillator closely enough so that the two high frequencies can be heard heterodyning each other, and then the variable condenser *VC* in the self-oscillator circuit may be adjusted to the position of zero beat, when the two systems will be in exact resonance. If the wavemeter to be calibrated is coupled loosely to the Hartley oscillator, this coupling being variable, we can tune wavemeter *WM* to resonance and thus accurately locate one point. Exact resonance can be easily noted by watching the deflection of the low-reading milliammeter, which will indicate a slight fluctuation when the two circuits are in resonance. The coupling should be varied until exact resonance is obtained and this process repeated for all points in the range desired to cover.

The pre-determination of the size of the quartz crystals so that they will cover the wave-bands desired can easily be done. If the dimensions of the crystal are given in millimeters, this figure multiplied by the constant 104.6 will give the natural wavelength of the crystal in meters, or conversely a crystal 1.046 millimeters thick will give a wavelength of 100 meters, a crystal 2.092 mm. thick a wavelength of 200 meters, etc. A crystal 25.0 millimeters thick would thus give a fundamental of 2511.5 meters. Practically, the fact that 1mm. thickness is equal to 100 meters will serve for most work, as it is very hard to grind quartz crystals to such accurate limits as those given. The best method is to cut the crystals to the approximate size wanted and determine their exact wavelength by measurement of their emitted oscillations.

Besides being an ideal frequency standard for wavelength measurement, quartz crystals have another very important field, for by using proper amplifiers, it is possible to obtain any amount of radio frequency power desired at an absolutely constant frequency, this frequency being determined by the constants of the crystal. Suppose we employ the crystal to control the vacuum tube shown in Fig. 7, and couple the output of the tube to another vacuum tube acting as an amplifier. This latter tube will deliver a greatly augmented frequency exactly like the original and if the output of the tube is coupled to an antenna, the high frequency oscillations can be transmitted into the ether. Due to the constant properties of the crystal, the emitted wave will not vary in the slightest, and such changes as swinging of the antenna, fluctuations in battery voltages, etc., will not affect the frequency of the output. With this system the frequency of a vacuum tube transmitter

may be determined at the factory with great exactness, and if more than one wavelength adjustment is required, extra crystals can be provided for each individual wave desired.

In the case of radiocasting stations it would no longer be necessary to assign a certain wave to a station and for the operators to constantly endeavor to keep the station on that wave. Instead of tuning the antenna circuit to the wave desired and then adjusting the closed circuit to suit the antenna, the process will be reversed and the antenna tuned to accommodate the frequency of the crystal oscillator. Should the antenna sag or swing in the wind, or the voltage supplied to the filament and plate circuits of the transmitting tubes be reduced, the changes would be noted only as a reduction in the antenna current and the wavelength would not vary at all. Since the frequency of each radiocasting station equipped with crystal standards would be constant, radio receivers could be calibrated with absolute accuracy and radiocast listeners could enjoy better reception than ever before.

Here, then, is a solution for the amateur using the very short waves, and for the radiocaster where radio repeating stations are employed as in the case of KDKA and KFKX. The amateur could have a few crystals ground for him by his local optician and would then be in possession of a means for making his transmitter absolutely constant at the wave he desired to use. The pioneer development work on the crystal oscillator was done by Dr. August Hund of the Bureau of Standards, to whom the writer is indebted for advice and information incorporated in this story. A concluding article will describe methods whereby the amateur may make his own crystal oscillator, although they are now obtainable in the open market.

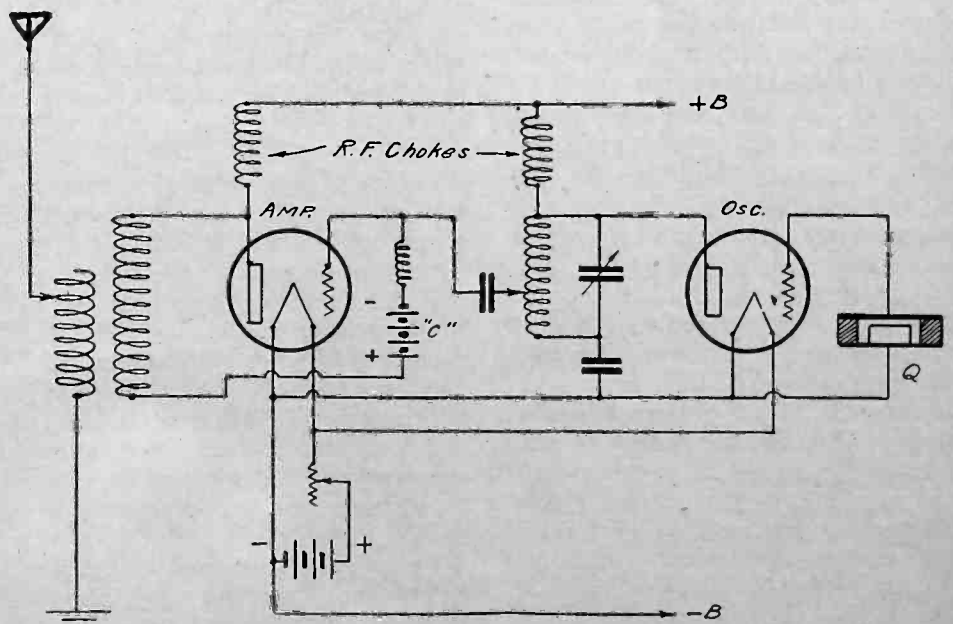

Fig. 7. Circuit with Constant Frequency Output.

Improving the Radio Set

By C. William Rados

THERE comes a time in every man's life when he decides that his radio set is becoming an antique, and should either be rebuilt or replaced with a new one made up entirely of new parts. When this turning point is reached, it is time to consider the advisability of rebuilding the parts rather than the set as a whole, and rearranging them in an improved manner, rather than buying a lot of new apparatus and charging the old set off the books as a total loss.

For example, in these days of "low-loss" condensers, it is surprising what a good condenser can be made from an old one of the semi-circular plate type, by making a few changes. Fig. 1 shows

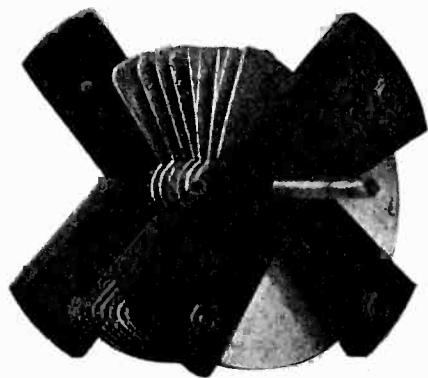

FIG. 1. Rebuilt Condenser.

how an old condenser was rebuilt by cutting away as much bakelite from the end plates as was practicable, and trimming the rotary plates so that a gradual increase in capacity somewhat like that obtained with a straight line wavelength condenser was had. As a result of these changes the condenser will naturally permit better tuning at the lower end of the dial and at the same time will present less loss to the circuit to which it is connected.

If you have a set of coils wound with insulated wire, on a cylindrical form, the wire being shellacked to the form, it will be easy to make a big improvement by removing the old wire and all traces of compound, and rewinding with cotton covered wire, the turns being spaced apart by means of thread or other spacing so that the distributed capacity will be cut to a minimum. Avoid the use of any shellac, glue or other compound and the result will be a better coil at little additional expense.

If your set has too many adjustments, it may be that your condensers can be geared together with a little re-arrangement of apparatus on the panel. If your

condensers are of the geared vernier type, it is a relatively simple matter to mount them so that the gears will mesh with each other, or a pair of extra gears can be provided so that the condensers are coupled mechanically to each other. This would be particularly useful in the case of the neutrodyne, where the adjustments are many, and all at approximately the same dial settings.

Some receivers have many filament rheostats, more than are necessary and in rearranging the set it is well to think about eliminating as many of them as is possible. If the set is a five tube neutrodyne, there is no reason why the filaments cannot be controlled by two rheostats, one for the four amplifier tubes, and one for the detector tube. If the detector is not of the soft type, the rheostat controlling the amplifier tubes can be used to control the detector also. A rheostat for five A type tubes must be capable of carrying at least $1\frac{1}{2}$ amperes and should be 4 ohms resistance. If the tubes are of the 299 type, then the rheostat should be at least 10 ohms, but only has to carry .5 amperes safely.

Mount each audio frequency tube socket, as well as the detector, on sponge rubber, thus eliminating many noises due to mechanical coupling. Connect the metal cases or shields of the audio frequency transformers to the negative A battery, and see that the latter connection is well grounded. If the transformers have no shields, connect the iron core of each transformer to ground. While on the subject of shielding, it would be a good idea to shield the back of the panel with sheet copper or brass, drilling holes in the shielding large enough so that the shielding will not touch any of the apparatus. The inside of the cabinet should also be lined with the same shielding material, and the entire set of shields connected to the negative A battery and to ground. This will eliminate a great deal of outside interference and will improve the selectivity of any set, without introducing losses of a material nature.

A good volume control can be added to the rebuilt receiver by the use of a variable resistance such as the Bradleyohm or Centralab variable rheostats, which come in 10,000 to 100,000 ohm size. Shunt this resistance across the secondary of the first audio frequency transformer, and the volume can be controlled without affecting the quality of the output. Never control the volume by means of the filament current, as this is the surest method of producing distortion. If the filament current is reduced while receiving strong signals, the

plate current in the audio amplifier tubes may be reduced to a point where the tubes will not amplify any power without badly distorting the output, with resultant poor quality in the loud speaker.

A handy device to save filament current when not using the loud speaker for reception is shown in Fig. 2, a fila-

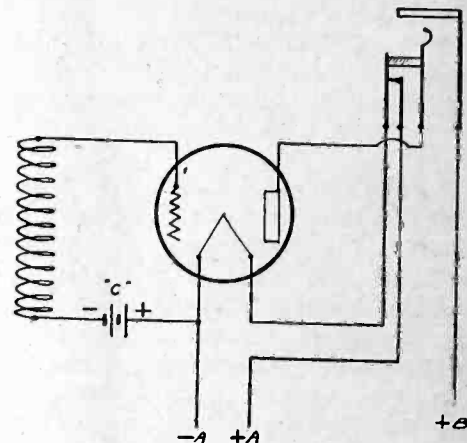

FIG. 2. Circuit for Saving Filament Current.

ment control jack being the only necessary addition to the set. By means of the extra set of contacts, the filament of the last audio frequency tube is lighted only when the loud speaker is plugged into the jack.

Even if it is not intended to entirely rebuild the receiver, it is a good idea to think over some of the suggestions given above and eliminate a few of the controls where possible while at the same time improving the general efficiency of the apparatus by shortening the wiring, shielding and keeping all neutral points well grounded.

Analine dye can be purchased from almost any druggist, in various colors, and can be thinned to proper shades to suit. By coloring the wire before you assemble the set, with this dye, you can work out a color scheme for the set wiring, all filament wiring in green, all B battery in red, etc., which will aid in testing or tracing circuits, should a fault develop.

In drilling bakelite, even at ordinary speeds, it is much better policy to use "high speed" steel drills, as these will not be damaged by the overheating which is usually experienced. They cost a little more, but their increased life will more than make up for their first cost.

A Lower-Loss Receiver

Structural Details for Correct Placement of Parts
So As To Minimize Inter-Coupling

By G. F. Lampkin, 8ALK

THE types of coils and condensers which have the lowest losses are pretty generally known; so that the design of a low-loss receiving set becomes a problem of so placing the parts that the losses are made no greater. The set shown herewith, is intended primarily for use on the amateur bands, or from 15 to 200 meters. This range is obtained by means of interchangeable coils; and of course, may be run on up to include the radiocast band, by winding suitable coils. No details are given on the set, for the layout is applicable to any of the standard parts.

The design of condensers has advanced several laps ahead of that of coils; and there are several makes now on the market that are really good. The designs are such that any reasonable placement of the condenser in the set does not increase the losses. However, when the wavelength range of the set is moved downward, body capacity begins to be troublesome, even on the grounded rotor and end-plate instruments. So that it becomes an advantage to move the whole condenser away from the body field.

As to coils, it should be well known that any solid material in the coil field raises the resistance—and yet most coils are placed on the baseboard, or mounted on the condenser, or in some equally damaging position. The clearance a coil should have in all directions depends on its size—a large coil naturally having

a more widely distributed field. An average value of clearance for the size of coils more common is 1½ inches. There should be nothing more than is absolutely necessary within this distance of the coil. The “absolutely necessary” includes only the coil supports. Two leads must be taken from each coil; and by using large enough wire, these leads may be made to support the coil. No.

condenser plates allows a vernier control to be incorporated; and a coil mounting is provided where the coil leads form the support, and at the same time are as short as possible. The center of gravity of the coil is below the suspension, and so the rigidity is increased. The coil is entirely clear on all sides by the 1½ in. limit.

The tickler mounting strip, of hard rubber, is separated from the center of the secondary by 3 in. The binding posts on the strip are neces-

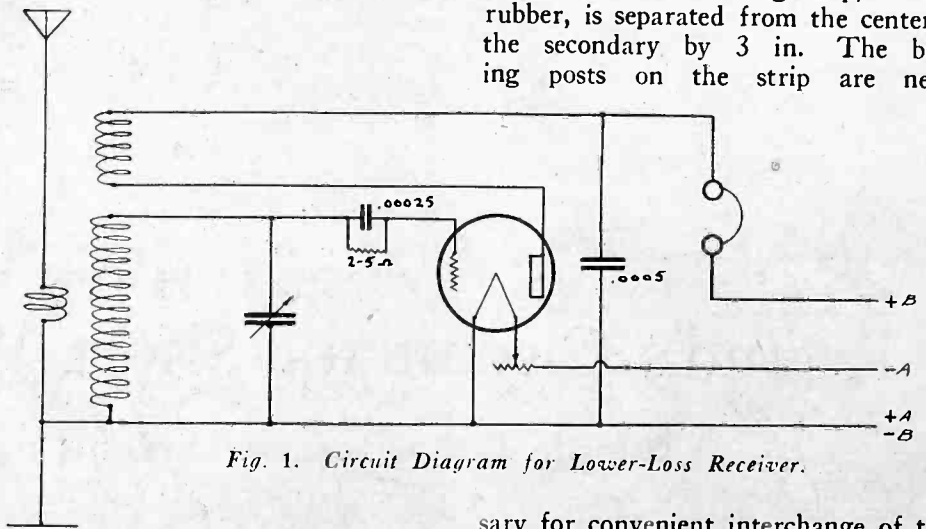

Fig. 1. Circuit Diagram for Lower-Loss Receiver.

16 enamelled wire is large enough to be self-supporting, but is still below the size of wire where eddy current losses become large. The enamel coating does away with any corrosion of the wire.

By putting the condenser high in the set, as shown, it is removed from capacity effects of the body; the necessary extension for the rotation of the con-

sary for convenient interchange of tickler coils. The tickler requires roughly ¾ of the number of turns used on the secondary. It may also be wound of No. 16, and be extended on its terminal wires from the binding posts, to within ½ or ¾ in. of the secondary. This distance should be adjusted till the set just oscillates on the top range.

Having obtained the maximum vol-

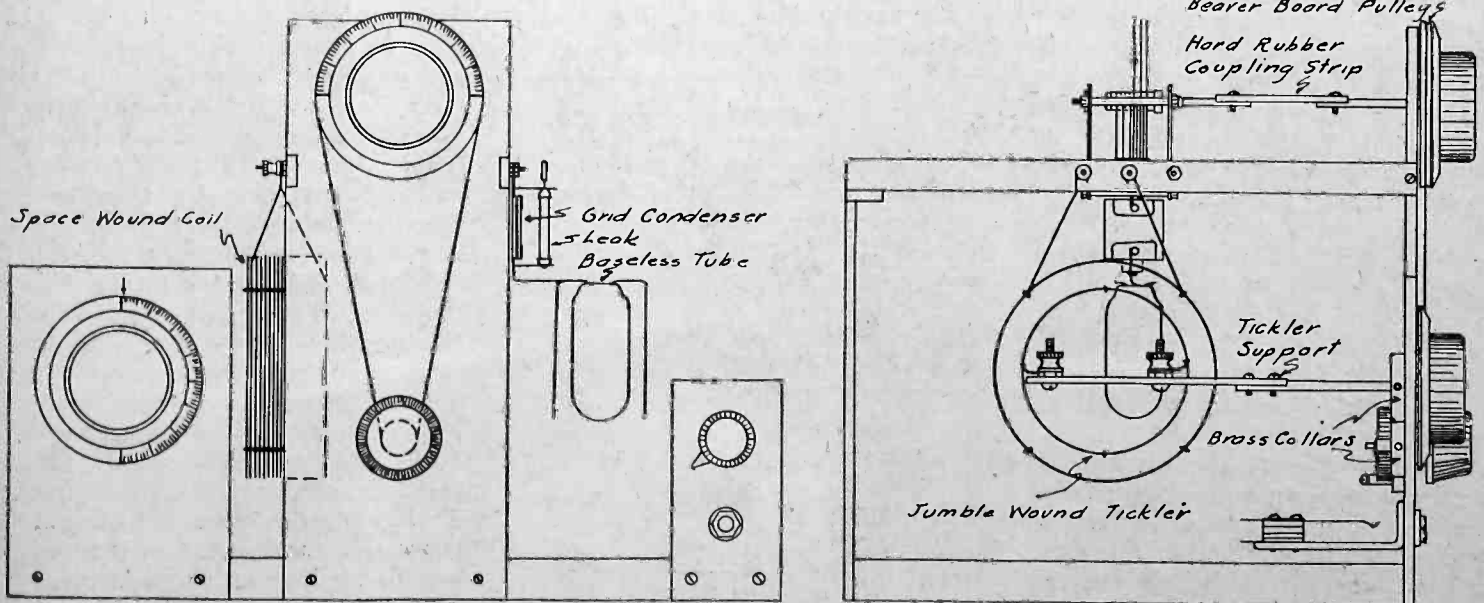

Front Elevation

Side Elevation

Fig. 2. Pictorial Representation of Parts Placement.

tage from a signal, on the coil and condenser, it remains to place this voltage, undiminished, across the grid and filament of the tube. The mounting shown gives very short and direct leads to these two terminals of the tube. A dry cell tube used as a detector will be free from any fading due to possible irregularities in storage batteries. The removal of the tube base eliminates one more possibility of losses. A good mica postage-stamp grid condenser, and a variable plunger leak are as compact as any.

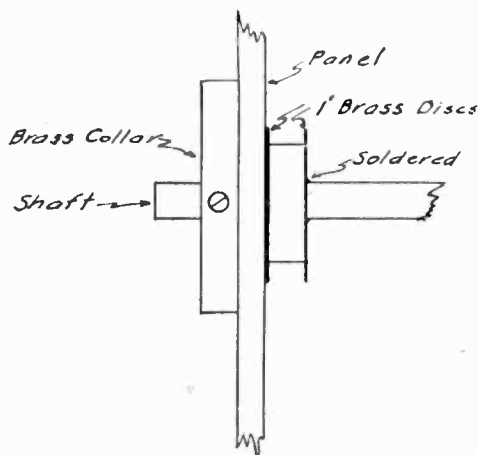

Fig. 3. Pulley Detail.

The tube is supported by bus leads from the condenser, and to the base. A mica by-pass condenser completes the radio frequency circuits; the remaining audio circuit is conventional, and of course may be extended into an amplifier.

In constructing the vernier pulley arrangement, a dial, backed with beaver board, may be used for the upper pulley. The board can be glued to the dial, and grooved with a three-cornered file. The lower pulley is made of a $\frac{1}{4}$ in. piece of brass cut from the end of a $\frac{3}{4}$ in. rod. A $\frac{1}{4}$ in. hole is drilled through the center; two 1 in. circles of sheet brass are also drilled with $\frac{1}{4}$ in. holes, and the three pieces soldered in place on a $\frac{1}{4}$ in. shaft. Fig. 3 gives a detail of the small pulley. A brass collar, set screwed on the shaft behind the panel, prevents play or loosening. A similar collar is used on the tickler shaft. The belt is a piece of rosined twine; two turns are taken around the lower pulley, to guard against slipping.

If all but three of the rotary condenser plates are removed, the wavelength scale will be opened out so that tuning on the lower bands is not criti-

cal. A sufficient ratio of maximum to minimum capacity will be retained, and any given band may be covered easily with one coil. The hexagon nuts on the two condenser coil-mounting screws are replaced by knurled nuts, so that the coils may be easily changed.

Space wound coils are made by winding the No. 16 wire rather loosely on a circle of pegs. Starting at any one point on the bottom, a paraffined string is threaded between the lower and the next turn, and an overhand knot made over the lower turn. The ends are threaded back over the next wire above, and an overhand knot tied over it. This is continued up vertically to the top turn of the coil, where a couple of knots are taken to secure the whole. Four such supports spaced equally around the coil circumference will make a rigid job.

The filament may or may not be grounded; it is best to try both ways on a received signal. The antenna coupling is not important on the short waves. An 8 or 10 turn coil may be jumble wound and supported upright on a small base. It may be moved to and from the secondary to give the desired coupling.

Round's Circuit for Short Wave Reception

A Simple Loop Receiver for the 75-80 Meter Band

By A. H. Vance

WHILE assisting John Sandy of 9ABH to change his station over to the 75-80 meter band, the writer conceived the idea of building a lowest loss receiver. Nearly all receiving sets made at the present time use low loss coils and low loss condensers, so why not combine all the best ideas and make something different? Round's Number 16 circuit was used together with the vertical non-shielded type of the Pettet loop. In former tests on short waves with this circuit the writer had considerable difficulty in controlling the strength of the oscillations in the radio frequency tube. The natural result of this lack of control was to make the set unstable, it either emitting loud howls of protest or nothing at all. The cause of the disturbance was finally traced down to the masses of material in various parts of the circuit, the tube socket and condenser probably being the principal offenders.

After reading everything available on the subject and doing a lot of hard thinking most of the parts ordinarily found in a receiving set were scrapped. The panel was first discarded as entirely unnecessary, as were also the tube socket and the condenser. In fact, no condenser of any kind is used in the set, detection

being accomplished by means of a crystal. It was thought best to use knobs for the tuning but the smallest ones available were selected. The base was left on the tube principally because the writer did not wish to take a chance of ruining a \$3.00 tube. The baseboard was discarded, and its place taken by two narrow strips of bakelite, as will be shown later.

The parts needed for the construction of this set are as follows:

7 Binding posts.....	\$1.05
2 Strips of $\frac{1}{8}$ in. bakelite 10 in. long and $\frac{1}{2}$ in. wide.....	.15
20 ft. spring brass wire No. 14 bare	.10
1 Small spool No. 18 DCC copper wire10
1 Rheostat	1.00
1 Hard tube.....	3.00
3 Knobs30
1 Crystal detector	1.00

Total

\$6.70

The circuit is shown in Fig. 1. The

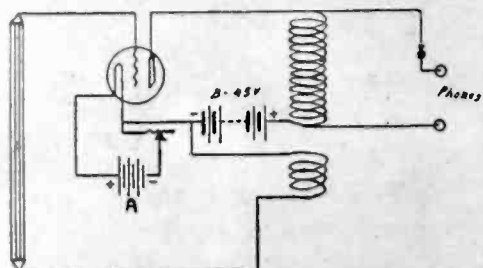

Fig. 1. Diagram of Round's No. 16 Circuit.

set will operate on a 22½ volt B battery but 45 volts is preferable. A general idea of the construction of the set may be had from Fig. 2. The two strips of bakelite were supported edgewise, $\frac{1}{2}$ in. apart, and 5 in. clear of the table by means of triangular shaped blocks of wood. Notches are sawed in the wood blocks, into which the ends of the bakelite strips are pressed. They are held in place in one of the blocks by means of a small scrap of bakelite and a brass wood screw, which clamps them down firmly. The other ends are held in place in a different manner due to the fact that the arm for stretching the coils must be supported between the strips at this end. A wood screw must pass through the ends of the bakelite and form a pivot for this arm. The details of this construction are shown in Fig. 3. The correct location of holes is also given.

The tuning is done by means of a spring tuned inductance wound with the No. 14 spring brass wire. This inductance coil is formed by placing a 2-in. coil inside of a 2¼-in. coil and connecting the top ends of the two coils together. It was found necessary to wind these coils on a lathe, as when wound by hand it was impossible to wind them tightly enough to keep them

from expanding excessively when they were removed from the form. The smaller coil was wound on a $1\frac{3}{8}$ -in. mandrel and the larger coil was wound on a $1\frac{5}{8}$ -in. mandrel. These coils must be wound in opposite directions so they will not oppose each other when assembled. They should consist of twelve turns each and should not be longer than $1\frac{1}{4}$ -in. when contracted, and must not touch each other. When expanded they will be about $2\frac{1}{2}$ -in. long. It is presumed that the constructor has made the inner coil by running the lathe forward, its normal running direction. If this coil is wound in this manner and the outer coil made by running the lathe backwards no trouble will be had when assembling the coils in position in the set.

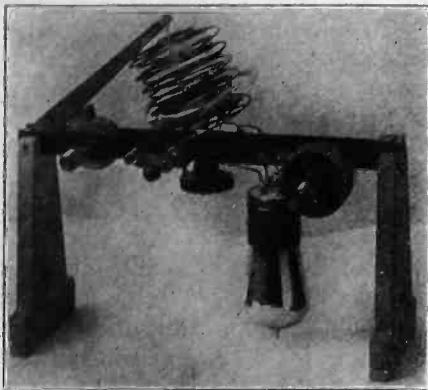

Fig. 2. Completed Short-Wave Receiver.

The smaller coil is placed in position first, the lower end being passed through the holes drilled through both the bakelite strips, bending the end around the crystal cup. The lower end of the outer coil is now passed through the holes provided and the end bent directly up over the edge of one of the bakelite strips. If desired it may be bent under the binding post directly beneath it and fastened there. The writer used the former method of fastening because it left the end accessible and an additional coil could be easily added to this inductance without disturbing the wiring too much. This extra coil is shown in place in the picture.

The top ends of the coils may now be soldered together and tied with a piece of string to the wooden arm which is used to stretch the spring. Any small piece of wood may be used for this purpose. This lifting arm is moved by means of a wooden cam pressed on a $3/16$ -in. brass shaft and supported between the bakelite strips. The constructor may wish to operate this lifting arm in some other way.

It will be noticed that the inductances lean toward the left end of the set at an angle of about 45° , the tickler coil being located inside of the inductance, giving the tickler operation similar to a 180° coupler. This tickler coil consists of 12 turns of No. 18 DCC wire, self supporting and mounted on a vertical brass shaft operated by means of a knob underneath the bakelite strips. This shaft is supported in a small wood block clamped between the bakelite strips. The rheostat is placed at the extreme right side of the set and mounted with the contact arm towards the operator. The shaft is extended through to carry the knob.

The tube is supported underneath the bakelite strips and is held in place by being soldered to the leads. The leads are made of soft brass wire, the temper being drawn from a short piece of the spring brass wire, so that it may be easily bent. The leads from the tickler coil are made of short pieces of flexible wire. There are no right angle bends in any of the wires and the longest wire in the set is $2\frac{1}{4}$ -in.; 8 in. of No. 14 wire is sufficient to wire the set completely.

Six binding posts are mounted on the rear, and one on the front. The phones are connected to the two binding posts at the left and the others used as shown. The antenna consisted of 12 strands of braided wire spaced at $1/4$ -in. centers and soldered to a 4-in. length of copper tubing at the ends. It was $8\frac{1}{2}$ ft. long and was suspended from a screw hook in the ceiling. A weight was hung on the lower end to stretch the wires. The vertical flat top antenna was then

inclined toward the south at an angle of 7° , the top of the antenna being connected to the antenna binding post on the set and the bottom of the antenna to the ground binding post. The antenna circuit was untuned, no ground connection being used.

The sensitive point on the crystal is found by placing the tube in oscillation and finding the point which produces the loudest whistle. If this whistle is not heard look for trouble as no results will be had until the whistle has been obtained. After setting the crystal, stations can be tuned in and the whistle entirely eliminated. The range of the tuning is between 75 and 80 meters, giving a tuning range of only 5 meters. If the coils could be stretched out more this range might be increased slightly.

The A. C. tube, a vacuum tube using the 110 volt alternating current instead of a 6 volt battery as the primary source of current for heating the filament, is at last on the market. As previously described in these columns, it is operated by means of a heater coil which heats the electron-emitting element by radiation instead of by current conduction. The heater is supplied with 4 volts alternating current by means of a step-down transformer. This current is supplied through two terminals at the top of the tube. The grid and plate terminals are base prongs fitting the standard socket terminals for these connections. A third base prong, corresponding to the usual negative filament terminal, is connected to the negative B battery, with provision for negative grid bias of amplifiers. The fourth prong is a blank. With a slight modification of wiring this tube may be used in most standard sets.

Commercial radio messages to and from the Philippine Islands are now handled by KZFR, the new station of the Far Eastern Radio Inc., at Manila. The Naval radio station NPO will handle no further ship to shore traffic except in case of emergency. Shipping Board and government business will be accepted by NPO as heretofore.

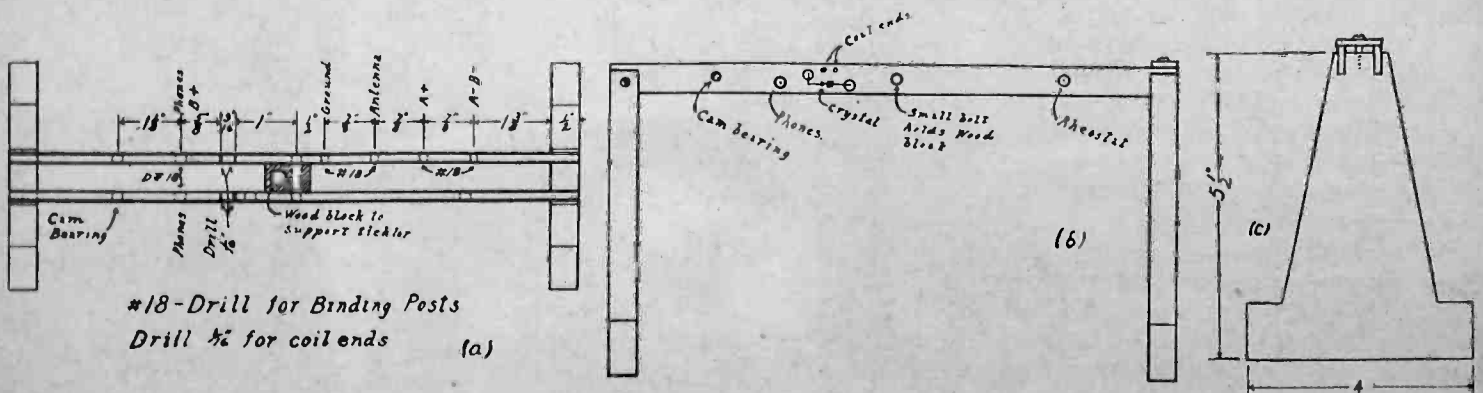

Fig. 3. Constructional Details.

Dual Reception

A Novel Suggestion for the Simultaneous Use of One Aerial by Two Operators

By *H. Diamond*

THE operator of a non-selective radio receiver frequently tunes in two stations simultaneously, each station interfering seriously with the other. If he is of an inquiring turn of mind, he wonders if it would be possible by an arrangement of the tuning circuit not only to separate the two signals so that they do not interfere with each other, but also to direct each signal to a proper output circuit, where it may be heard.

The object of this article is to describe a circuit due to L. S. Palmer and H. W. Forshaw, British engineers, whereby this very thing is accomplished. Using a modification of their method, the writer has succeeded in constructing a receiving set so that two operators, employing the same aerial and the same simple tuning arrangement, may listen in to two stations of different wavelengths at the same time without in any way interfering with each other. In addition either one of the operators may tune in to any other wavelength he desires, provided it differs by ten meters or more from the wavelength of the signal to which the other operator is listening.

For a proper understanding of the theory underlying this arrangement, let us consider two circuits L_1C_1 and L_2C_2 , each tuned to, say, 300 meters when acting alone, and coupled to each other by the coupling inductances L_3 and L_4 as shown in Figs. 1 (a) and 1 (b). Let us assume also that $L_1=L_2$ and $C_1=C_2$. It may be shown that this system will have two natural frequencies, or wavelengths; one when the currents in the two tuned circuits are circulating in the same direction and the other when they are circulating in opposite directions.

When the currents through the two circuits are circulating in the same direction, as shown in Fig. 1 (a), the coupling inductance L_4 has two equal and opposite currents flowing through it, the resulting current being zero. Consequently the voltage drop between points C and D is equal to zero. The voltage drop across the coupling inductance L_3 is equal, however, to the sum of the voltage drops across L_1 and L_2 , and a current will flow through L_3 in the direction of the dotted arrow.

For this condition of currents, then, the circuit behaves as though it consists of an inductance equal to L_1 and L_2 in series connected in parallel with L_3 , and a capacitance equal to C_1 and C_2 in series. The natural wavelength of this equivalent circuit is called a natural wavelength of the circuit under consideration, and is obviously the signal wavelength which will set up in this cir-

cuit currents circulating through L_1C_1 and L_2C_2 in the same direction. It is seen that the value of this wavelength is independent of L_4 but varies with any variation in L_3 , decreasing below 300 meters as L_3 is increased from zero to its maximum range.

A coupling condenser may, of course, be used in place of the coupling inductance L_3 . Let us call this condenser C_3 . By increasing C_3 from zero to its maximum range, the signal wavelength necessary to set the currents oscillating as shown is increased above 300 meters.

We have shown, therefore, that there is a range of wavelengths below 300 meters (as controlled by L_3) and a range of wavelengths above 300 meters (as controlled by C_3) for which there is a potential drop between points A and B, but no difference of potential between points C and D. A detector connected across points A and B will, therefore,

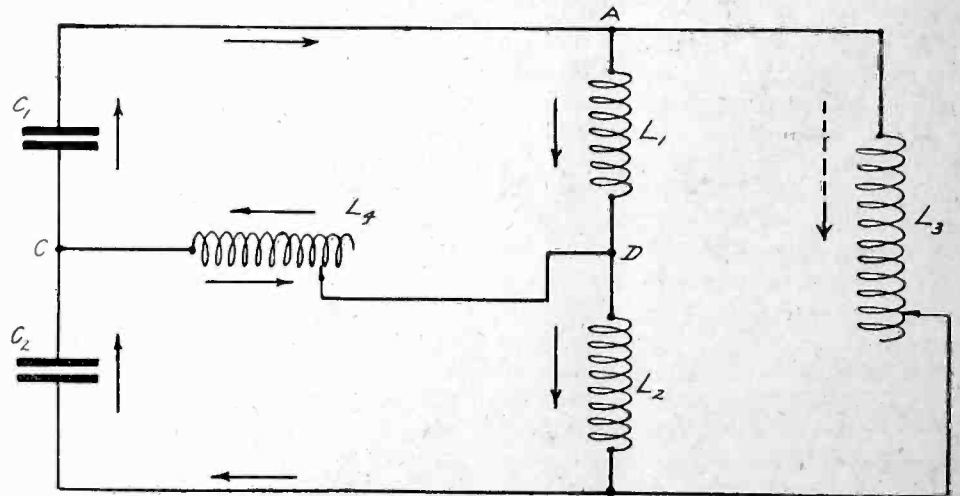

Fig. 1A. Currents Circulating in the Same Direction.

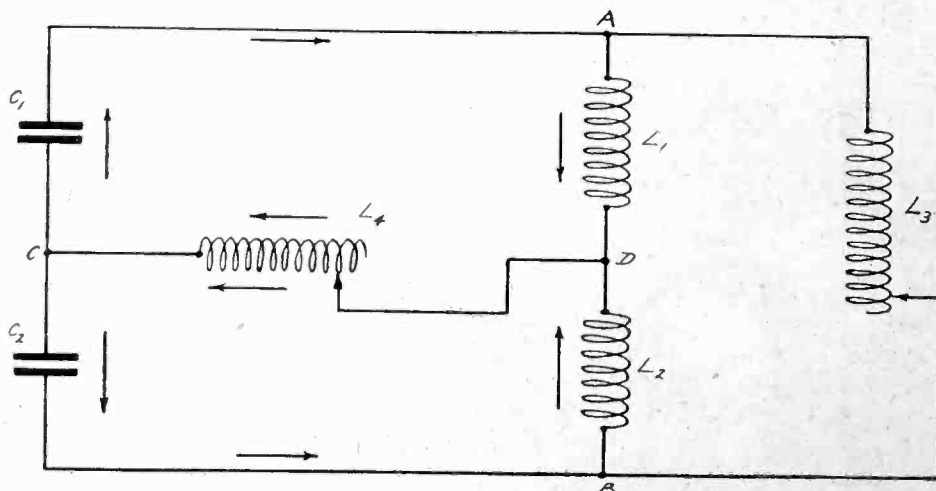

Fig. 1B. Currents Circulating in Opposite Directions.

receive this range of signals while a detector across C and D will be unaffected.

Now consider the condition where the currents in the two tuned circuits L_1C_1 and L_2C_2 are circulating in opposite directions as shown in Fig. 1 (b). The coupling inductance L_4 has two equal currents through it flowing in the same direction. Consequently, there is a considerable voltage drop between points C and D. The potential difference between points A and B, however, will be equal to zero, since the currents through L_1 and L_2 are equal and in opposite directions. There is, therefore, no current through the coupling inductance L_3 .

The circuit now behaves as though it consists of an inductance equal to L_1 and L_2 in parallel connected in series with L_4 and a capacitance equal to C_1 and C_2 in parallel. The natural wavelength of this equivalent circuit is another natural wavelength of the circuit under consideration, and is obviously the wavelength of the applied signal which will set up in L_1C_1 and L_2C_2 currents circulating in opposite directions. In this case it is evident that the value of this wavelength is independent of L_3 (or

trolled by C_4) for which there is a potential drop between points C and D, but none between points A and B. A detector across points C and D will, therefore, receive this range of signals while the detector across points A and B will be unaffected.

Summarizing, then, we see that two detectors, one across points A and B and the other across points C and D, will each receive the same range of signal wavelengths without interfering with each other. The only restriction is that the wavelengths of the two stations received simultaneously by two different operators differ from each other.

Fig. 2 shows the circuit used by

above 1600 meters and C_4 alone for wavelengths below 1600 meters.

The writer decided to apply this theory of dual reception to wavelengths corresponding to the American, radio-casting stations, and also to somewhat simplify the number of controls. Towards this end the values $L_1, L_2, C_1,$ and C_2 were so chosen that the natural wavelength of L_1C_1 or L_2C_2 acting alone was less than the lowest wavelength to be received. L_4 was then used for tuning in detector No. 2 to stations of wavelengths higher than this value and C_3 to tune in detector No. 1 to these stations. Since no wavelengths were desired lower than the natural wavelength of L_1C_1 or L_2C_2 acting alone, C_4 and L_3 became unnecessary and were therefore omitted.

Fig. 3 gives the circuit diagram as actually used. L_1 and L_2 are coils of ten turns each wound on a tube of $3\frac{1}{2}$ in. diameter. C_2 and C_1 are condensers of 150 micro-micro-farads each. In actual practice C_2 may be fixed, but C_1 should be variable and should be adjusted to tune the aerial circuit to the same wavelength as L_2C_2 . C_1 may therefore well be an 11-plate condenser of 250 micro-micro-farads capacity.

For these values, the wavelength of either L_1C_1 or L_2C_2 acting alone is 115 meters. To tune in stations as high as 600 meters, C_3 should have a maximum

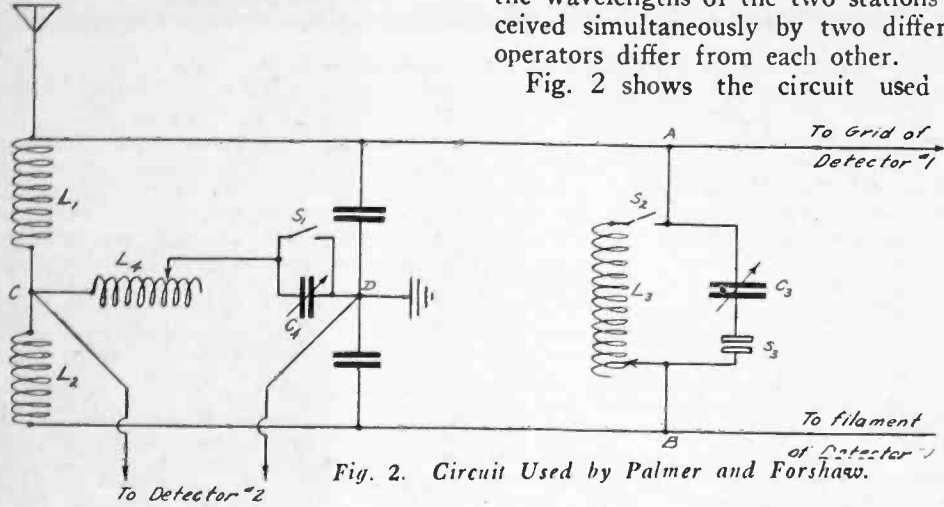

Fig. 2. Circuit Used by Palmer and Forshaw.

C_3) but will be varied by varying L_4 , increasing above 300 meters as L_4 is increased from zero to its maximum range.

Similarly, if L_4 is replaced by a coupling condenser C_4 the same relations remain true except that the signal wavelength necessary to set up currents in L_1C_1 and L_2C_2 which will circulate in opposite directions decreases below 300 meters as C_4 is increased from zero to its maximum range.

We have here shown that there is a

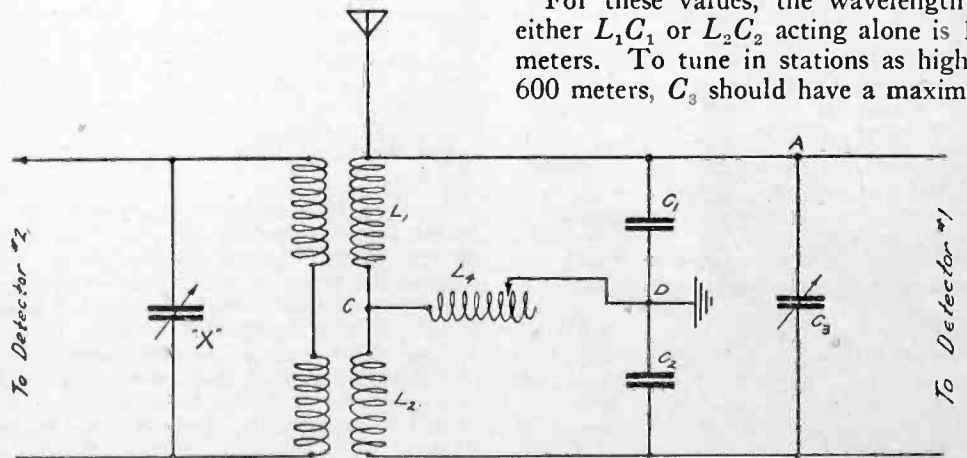

Fig. 4. Alternative Circuit Used for Dual Reception of Short Waves.

capacity of 2,500 micro-micro-farads and L_4 a variable inductance of about 400 micro-henries. This variable inductance may be obtained either by the use of a variometer or by winding a coil of 50 turns on a $3\frac{1}{2}$ in. diameter tube with a tap at each turn. The former method is of course the more efficient.

To obtain the value of the minimum wavelength difference in meters for which the two signals will not interfere with each other, the circuit as shown was excited by a buzzer-driven wave meter set at 300 meters and detector No. 1 tuned in to this wavelength by adjusting C_3 . By adjusting C_4 , detector No. 2 was also tuned in to this wavelength and then detuned until the signal was inaudible. The wave meter setting was then changed for maximum signal in the phones of detector No. 2 and the wavelength found to be 310 meters.

For this setting of the wave meter
(Continued on page 54.)

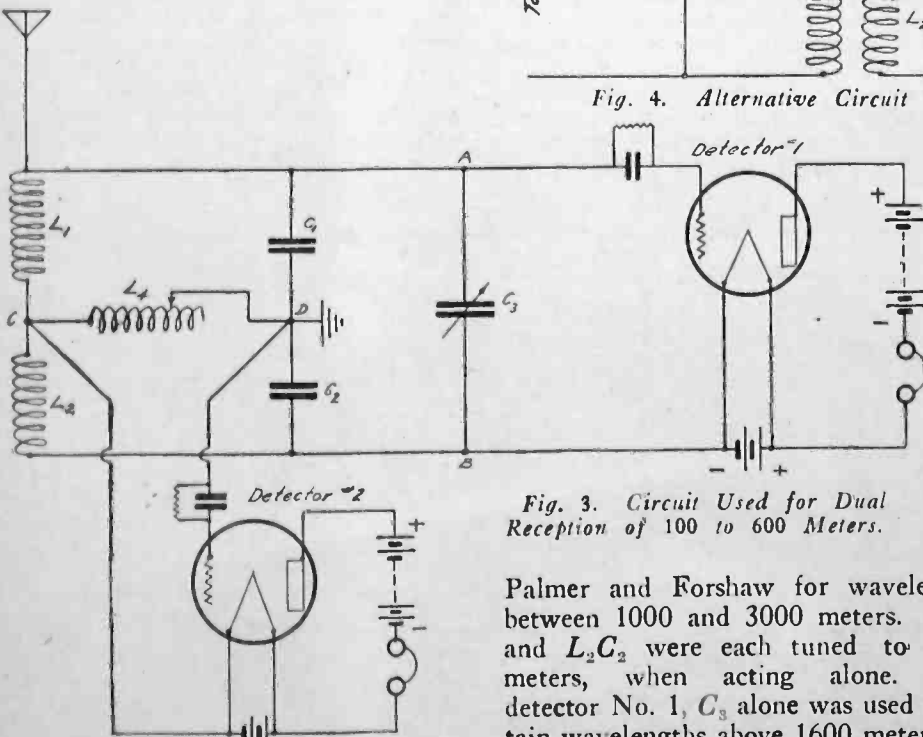

Fig. 3. Circuit Used for Dual Reception of 100 to 600 Meters.

Palmer and Forshaw for wavelengths between 1000 and 3000 meters. L_1C_1 and L_2C_2 were each tuned to 1600 meters, when acting alone. For detector No. 1, C_3 alone was used to obtain wavelengths above 1600 meters and L_3 alone for wavelengths below 1600 meters. Similarly, for detector No. 2, L_4 alone was used to obtain wavelengths

range of wavelengths above 300 meters (as controlled by L_4) and a range of wavelengths below 300 meters (as con-



QUERIES *and* REPLIES



Questions submitted for answer in this department should be typewritten or in ink, written on one side of the paper. All answers of general interest will be published. Readers are invited to use this service without charge, except that 25c per question should be forwarded when personal answer by mail is wanted.

In connection with "A Receiver Designed for Quality," as described in August 1924 RADIO, would the quality be further improved by adding a three-stage resistance coupled amplifier instead of using two stages of transformer coupling.—T. C. L., New York City.

Provided that the proper coupling resistances and condensers were used, extra fine quality would result from the use of such an amplifier. A good circuit diagram for a resistance coupled amplifier suitable for addition to the receiver you mention is shown in Fig. 3, Page 40, of April, 1925 RADIO.

Please publish a circuit of a superheterodyne using only 4 tubes, the 3 intermediate frequency amplifiers being reflexed for use as audio frequency amplifiers. What is the best frequency for intermediate amplification and what is a good make of transformer for such work?—D. P., Vallejo, Calif.

We would not advise the reflex combination that you suggest. Reflexing more than one intermediate frequency stage would introduce complications, and with vacuum tubes selling at very reasonable prices, the urgent need of reflexing so many stages is not present. It would be better to use one of the standard circuits such as we have published during the past few months. Frequencies from 40,000 to 50,000 cycles are the most satisfactory for intermediate frequency amplifiers, but in your location, your best frequency would be 48,000 cycles, in order to avoid interference from the powerful arc transmitters at Mare Island. We cannot recommend specific makes of radio apparatus in these columns.

Will you please furnish me with a circuit diagram of a two stage radio frequency amplifier, using Browning-Drake coils, with regeneration, and push-pull audio frequency amplification.—A. M. N., Sacramento, Calif.

In Fig. 1 we have shown a circuit for two stages of radio frequency amplification, detector and two stages of audio frequency, the last stage of audio being of the push-pull type. You can employ regeneration in only one stage, as shown in the circuit, and the tickler winding must be removed from the first "regenerator," using the primary and secondary windings as an ordinary tuned radio frequency transformer. The antenna coil is the same as used in the regular Browning-Drake circuit, and a full description of how to make it appeared in April RADIO. Careful balancing with the two neutralizing condensers will be necessary in order to obtain the maximum amplification of the set without radiation into the antenna due to oscillation of the first amplifier tube.

I would like to build a receiver that would cover a wavelength range of from 20 to 25000 meters. Have built the "Abele Receptor" a described in RADIO, but this will not cover the short waves.—J. R. F., North Braddock, Pa.

The only receiver suitable for such a wavelength range is the common three circuit regenerative, using honeycomb or other compact wound coils. It is possible to use various types of bank wound and lattice work coils to accomplish the same result, but in order to efficiently operate the receiver on waves above 600 meters, the honeycomb coils are the best to use. In Fig. 2, Page 39

of April RADIO is shown the circuit diagram of an all-wave receiver, with suggestions as to the proper size of coils to cover the entire wavelength range. For waves below 200 meters, however, we recommend special coils such as have been described in various articles in both RADIO and QST, as honeycomb coils are rather inefficient below 200 meters, and practically worthless below 100 meters.

Which is the best way to connect the oscillator tube, in the Best 45000 cycle Superheterodyne; the grid to the rotor, or to the stator plates of the oscillator condenser?

If you use condensers of the conventional type, it would be well to connect the oscillator plate to the rotor plates of the condenser, in order that the body capacity introduced by the hand on the dial will not change the frequency of the oscillator. If the grid were connected to the rotor, slight body capacity would have a considerable effect on the oscillator frequency. The condensers shown in the January, 1925 Super have shafts insulated from the plates, so that this effect will not occur.

Would like to use an extra radio frequency stage in the Browning-Drake circuit together with push-pull audio amplification. Can automatic filament control resistances be used in this circuit without difficulty?—H. V. K., Long Beach, Calif.

A circuit showing how to accomplish this is shown in Fig. 1 on this page. Amperites or other automatic filament control resistances may be used in place of the filament rheostats if desired.

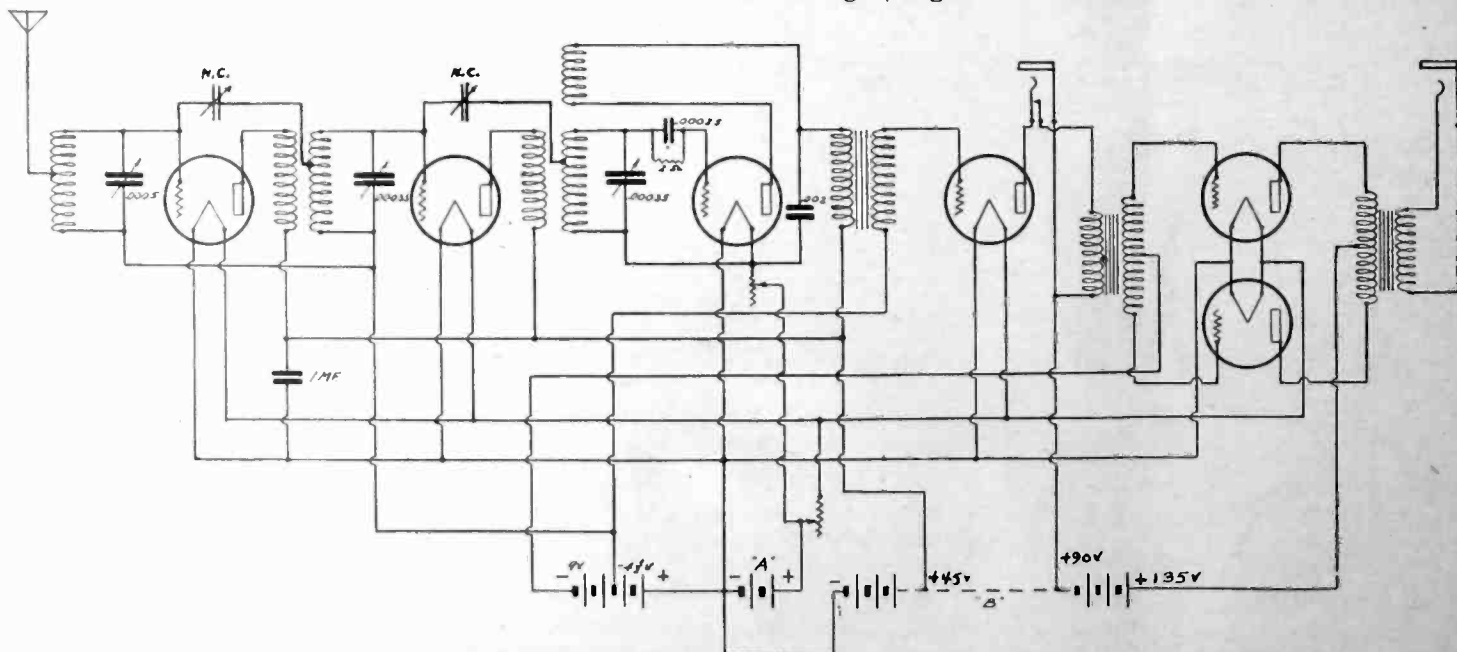

Fig. 1. Circuit Diagram for Adding an Extra Radio Frequency Stage to the Browning-Drake Receiver.

I have a 5 watt transmitter using the Hartley oscillator, with direct coupled antenna and counterpoise. As this is not according to the present rules, how could I couple the antenna to the transmitter by means of capacity, without a great deal of extra apparatus or complications?—H. S. L., Seattle, Wash.

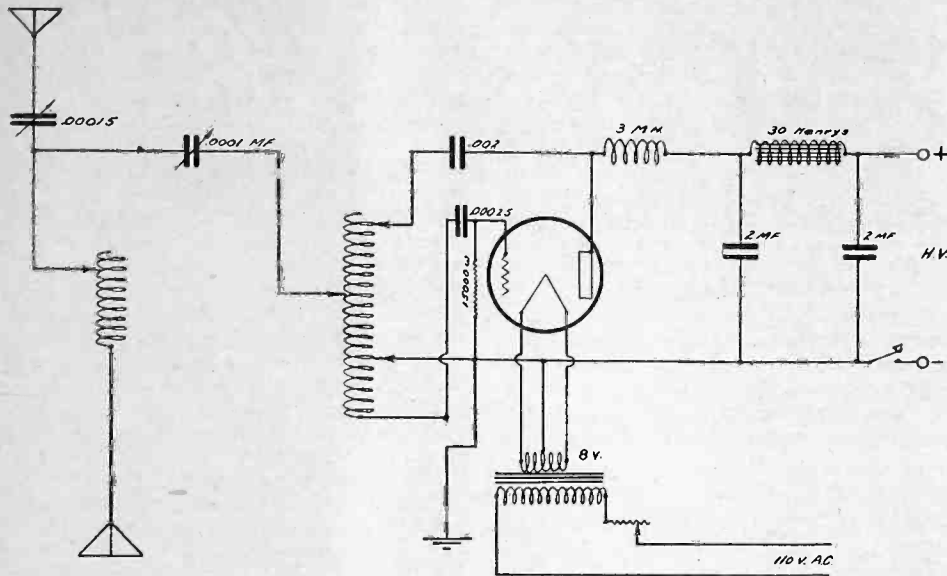

Fig. 2. Capacitively Coupled Hartley Oscillator.

In Fig. 2 is shown a circuit for a Hartley oscillator coupled to the antenna by means of a condenser. This is a more or less standard arrangement and will give good results. The antenna load coil, which consists of 5 turns of heavy copper wire wound to 5 in. diameter, may or may not be needed, depending upon the constants of the antenna.

I have a one tube Autoplex set which my neighbors say interferes with their reception due to its oscillations and I would like to cure the trouble if possible by the addition of a radio frequency stage. How may this be done?—S. F. L., Omaha, Neb.

Your set is a bad squealer if not carefully operated, and should be modified. Fig. 3

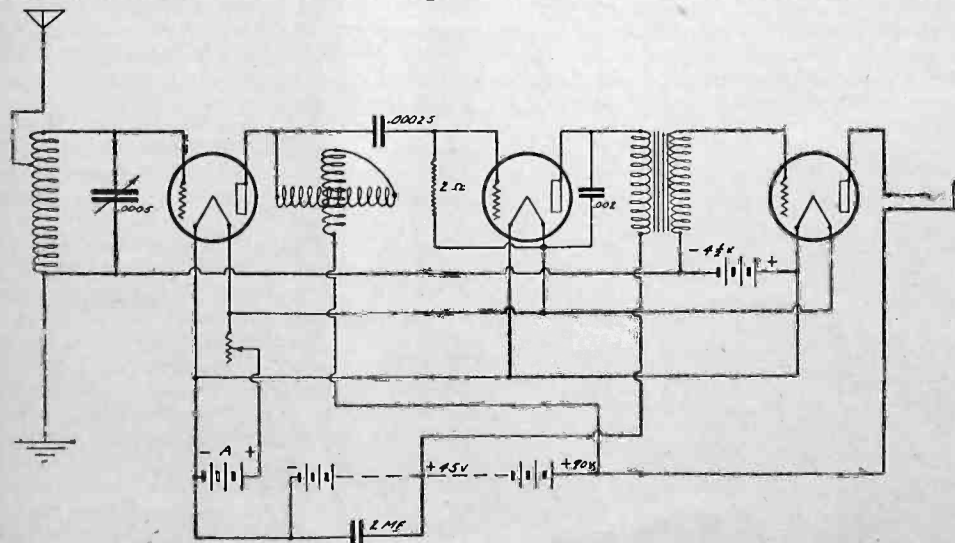

Fig. 3. Circuit for Modifying the Autoplex Receiver to Prevent Radiation.

shows how some of the apparatus can be utilized in constructing a set consisting of one stage of radio frequency amplification, detector and one stage of audio, which will give as good volume and better quality than your present arrangement. The adjustment of the plate variometer in the radio frequency stage will be somewhat critical and care must be exercised to see that the set does not oscillate. The antenna inductance may be made by winding 70 turns of No. 22 D. C. C. wire on a 3½ in. tube, with tap at

the 20th turn in order to take care of different sized antenna systems. In case the set oscillates with the C battery as shown, it will be necessary for you to install a 200 ohm potentiometer across the A battery and connect the grid return of the audio frequency amplifier tube to the slider of the potentiometer. If the selectivity of the

arrangement is not satisfactory, it may be necessary to install a two circuit tuner for the antenna circuit, but this will introduce additional adjustments which may not be desirable and it would be best to try the single inductance method first.

Will the Kane Antenna cut out all power noises such as motor hums, leakage from faulty insulators, etc., as it is advertised to do?—D. H., Suisun, Calif.

The Kane Antenna is in the same class with the "noise filter" and other such devices and we take the liberty of quoting from our esteemed contemporary, *QST*, with regard to their comment on a noise filter which had been submitted to them for test. "Nobody claims that such a device will get rid of

the rackets caused by leaking line insulators or arcing grounds—such things are radio and will go through the set. However, it may help in getting rid of 60 cycle hum, provided that the noise is really coming in from the antenna and not being dumped into the set itself by the wiring in the house wall right behind it." Telephone engineers tell us that an antenna built with a transposition scheme, in which the two wires are short-circuited together at the lead-in, is no better than a single wire.

Would the construction of a counterpoise to replace my ground connection improve my reception, and what are the proper dimensions of the counterpoise if recommended?—R. J. L., Anaheim, Calif.

If you can conveniently erect a counterpoise in your backyard, six feet or more above the ground and underneath the antenna, you will be enabled to tune to wavelengths which you cannot now reach with your ground connected, and at the same time you may become rid of annoying interference due to the use of a common ground connection with power apparatus in your neighborhood. A counterpoise should have four or more wires, spaced at least 18 in. apart, and may be in the form of the convenient flat top antenna. It should be thoroughly insulated from the ground and treated as an extra antenna, in so far as touching various objects are concerned.

I am much interested in the tube rejuvenator which has received mention in your columns, and would like to know if the outfit can be used to bring an old Audiotron detector tube to life again. I have several of them which have become insensitive and thought perhaps the filament could be given new life with the rejuvenator.—C. R. V., Berkeley, Calif.

Unfortunately, your old tubes have a plain tungsten filament, not thoriated in the manner of the present day tubes, and if the tube filaments have lost their activity, there is no way to re-activate them with the rejuvenator. The C-299 and C-301-A tubes have a tungsten wire filament coated with thorium, and a quantity of thorium lodges in the minute cracks in the wire. When the surface of the wire has lost its coating of thorium, the sudden heat of the flashing process produced by the "tube rejuvenator" drives the thorium out of the cracks and forces it to evenly cover the surface of the filament which makes the filament capable of emitting electrons again over a long period. If you wish to obtain more use from your old Audiotrons, you might try one of the tube repair companies.

I have a superheterodyne receiver and am continually troubled with harmonics from amateur tube transmitters, from one end of the oscillator dial to the other. Can you tell me what can be done to cure the difficulty?—D. W., Aberdeen, Wash.

Your trouble is due to the fact that your oscillator tube generates harmonics in large quantities. If, for example, your oscillator is tuned to a frequency of 1,000,000 cycles, it will have a rather prominent harmonic at 3,000,000 cycles, and if an amateur station is operating at a frequency a few thousand cycles one way or the other from 3,000,000, an audio frequency beat note will be set up, which will create interference with the radiocast station being received. This can be partly avoided by shielding the inside of the cabinet and back of the panel with sheet brass or copper, and by grounding this shield to the negative battery and to a good waterpipe connection. Harmonics from amateur stations would hardly cause you interference unless they were from an amateur station located within a city block of your receiver.

Would a loop antenna wound on the principle of the low-loss coil be better than one wound as per instructions for building the Best 45,000 cycle superheterodyne recently published in *RADIO*? If stranded wire is used kindly tell me how to make it rigid enough to stand up well. E. R. San Francisco, Calif.

The word low-loss has been over pressed, and we gather that you refer to basket weave coils. The loop as recommended in the superheterodyne article is as

(Continued on page 53)

Letters to the Editor

Matching Tubes in the Set

Sir:

Outside of a city, it is difficult or impossible to obtain matched tubes for the intermediate amplifier of a superheterodyne. If sent to you as such, they arrive far from such. The method of matching described below has proven very satisfactory to me, for 201-A tubes in a potentiometer controlled amplifier. It not only matches tubes, but matches them for the particular set in which they are to be used; and requires no apparatus other than the set itself. It takes into account the fact that the same tube in the same set, will oscillate more readily in one stage of the amplifier than another. I have not seen it previously described.

The point we strive for in matching intermediate amplifier tubes is to obtain those which, when placed in the set, will oscillate at the same point; that is, at the same grid voltage, which is in turn controlled by the potentiometer. The tube is in its most sensitive state just below oscillation point. When one of the tubes oscillates at some point, say 70, on the potentiometer, and another at 75, we must keep the potentiometer below 70 to prevent oscillation in tube 1. But then tube 2 is working at a point far below its most efficient one. If we had matched tubes, oscil-

lating at the same point, and running them just below this, both would be operating at maximum efficiency.

Now place an easy oscillating tube, for example, No. 8, which oscillates at 71, in socket III, and two poorly oscillating tubes, 3 and 4, which oscillate at 76, 77, in sockets I and II. Any other tube in IV. Repeat the above test. If tubes are operating with same filament current as previously, oscillation should occur at 71, which is the same point as the easy oscillating tube broke into oscillation in previous test. And by test (touching grid with finger) it will be found that this is the only tube oscillating. If all three amplifiers are controlled by one rheostat, it will require adjustment to cause oscillation at 71, as the load of the two added tubes brings down filament current to III. Now exchange tubes in sockets II, III, the easy oscillating tube being in socket II. Repeat test. Oscillation occurs at some point, say 68, on potentiometer, and test shows that tube in socket II is the only one oscillating. Exchange tubes in sockets I, II, the easy oscillating tube being in socket I. Repeat test. System oscillates at some point, say 69, and test shows that tube in socket I is the only one oscillating. And thus we get Table II. We now see that, if we were to use three tubes of exactly similar characteristics, tube in first

same tube should oscillate at same point in any of the three stages. Theoretically yes, practically no. The above tables are neither arbitrary or standard. They were compiled, in one of many tests, using nine 201-A tubes, not previously tested. The set was what I consider a well designed one, a 9 tube Haynes De Luxe, described in February RADIO, but using 9 201-A tubes. It is a wonderful set, surpassing the Best in sensitivity, and that is saying a great deal. The prongs of Flewelling sockets are mounted directly on the transformer binding posts, making contact direct from binding post to tube prong, with no intervening wiring, a distance of 1½ in. Transformers are spaced 3 in. Yet oscillation occurs as in Table II. And if you don't believe this compensating system is a remedy, try it. I've matched tubes for several of the superheterodynes of this district. And the owners think it's been an improvement.

Incidentally, if you want to avoid a lot of grief, and loss of time, in neutralizing your first short wave amplifier in the 9 tube Haynes De Luxe, reverse connections to primary of a short wave radio frequency transformer, as given in February RADIO. Inside lead goes to plate of radio frequency tube, and outside to rotors of first tuning condenser, and compensating condenser. (This when using 9 201-A tubes.) Tap coil at same point as given in February RADIO. And your 201-A tube neutralized beautifully, with compensating condenser about half way in.

Very truly yours,
DR. WALTER H. FROLICH.
East Ely, Nevada.

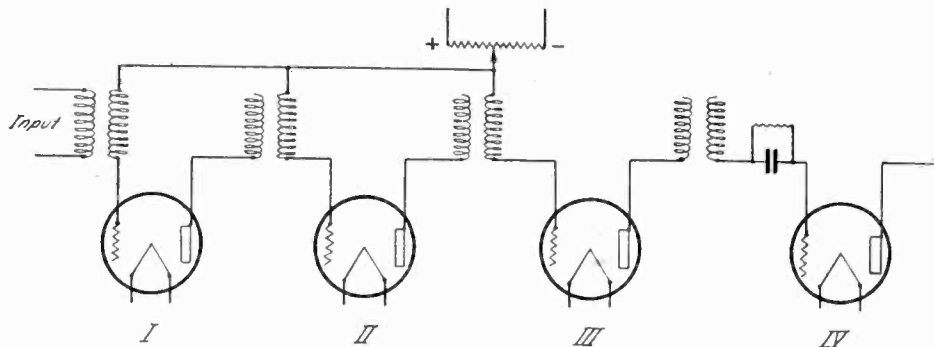

Fig. 1. Intermediate Amplifier and Second Detector of Potentiometer Controlled Superheterodyne.

lating at the same point, and running them just below this, both would be operating at maximum efficiency.

Fig. 1 represents a standard intermediate amplifier and second detector of a superheterodyne, I, II, III, being amplifiers, and IV second detector. Place a tube in IV, and one of the tubes to be tested in III. No tubes in other sockets. All batteries connected. Rotate potentiometer arm from positive to negative side. At some point, say 72½, tube goes into oscillation, indicated by click in phones. Remove amplifier tube and replace with another of those to be tested. Repeat test. Tube oscillates at some point, say 74. Repeat process in turn with each tube to be tested, when you will have a chart resembling Table I.

Table I

Tube	Oscillates at	Tube	Oscillates at
1	72½	6	74
2	74	7	75
3	76	8	71
4	77	9	72
5	74		

stage (in this example) would be running three points below its best value, under optimum conditions.

Table II.

Socket	Oscillating Point
I	71
II	68
III	69

But now, to compensate. Place any tube, say 9, in socket I. According to the table, this is a 72 oscillator. Table II shows that tube in socket II will oscillate 3 degrees easier than in socket I. To compensate, put in a tube that will oscillate 3 degrees poorer. Tube 7 oscillates at 75, and will do the trick. Following the same reasoning, we wish a tube for stage 3 that will oscillate 1 degree better than II. Tube 6 oscillates at 74, and is acceptable. Now try out your system. All three tubes go into oscillation at same potentiometer point. If we run potentiometer just below this point, all three tubes are in most sensitive condition.

You may say that in a well designed set,

Likes the Homemade Browning-Drake

Sirs: It may prove interesting to you to know that by means of the article in your publication for April, written by Volney D. Hurd, I constructed a "Browning-Drake" receiver that gave me a very pleasant surprise. I did not go at the task to see how well I could do the job from a mechanical standpoint but to see how cheaply I could make the set.

The antenna inductance and the "Regen-former," I constructed from the details in your article: the rest of the material was purchased for the most part from the Kresge Stores, even to the audio transformers for which I paid one dollar each. Tubes also were Kresge tubes at one dollar each.

The results equalled any five tube outfit I ever heard and surpassed most of them.

The first program that I picked up was from the Sanger Amusement Co., and the Maison Blanc Department store, located in New Orleans. This program came through beautifully over the loud speaker and considering that the air line distance is about 1800 miles, I certainly shall have to compliment Mr. Browning and Mr. Drake on their achievement, also Mr. Hurd on the clarity of his article.

Jackson, Mich. HERMAN D. BROWN.

BOOK REVIEWS

World's Time Chart, published by Radio Chart Bureau, Patterson Bldg., Fresno, Calif. Price 50 cents.

While not a book, this simple and practical little device gives information for which many books would have to be consulted. Its purpose is to quickly locate any desired city or country and to find its actual time at any instant.

With The Amateur Operators

6,000 Miles With 5 Watts Power

Radio Z3AL, Dawson, Ashburton, New Zealand, the station that has just communicated with U6AWT, B Molinari, 653 Union St., San Francisco, Calif., using one five watt valve with slightly under its normal input, is one of the most efficient stations south of the line.

The keynote of Mr. Dawson's success has been efficiency rather than power, judging by the distance records he has attained, such as communication with the Steamer Port Curtis at a distance of 4,600 miles, and reliable communication with New Zealand amateurs at a distance of 400 miles with an input of .01 watts. The following description is of interest to American amateurs in particular, since it tells of an efficient transmitter operating on a wavelength of 40 meters, wherein the antenna is operated at a wavelength of 120 meters, and the oscillator is worked on the third harmonic of the antenna fundamental (40 meters).

As is shown in the circuit diagram, the reversed feedback circuit is employed, using a UV-202 five watt valve. All the power is derived from the 230 volt 50 cycle mains, a distribution board supplying the current for both the filament and plate transformers. For the plate supply the high voltage from the transformer is rectified by a 24 jar electrolytic rectifier. The filament lighting transformer is fitted with a vibrator so that it may be used to charge storage batteries as well as to operate the filament of the transmitting tube.

For 60 cycle service, the number of turns in the primary winding can be obtained by multiplying the supply voltage by 7.5 and dividing the product by the number of square inches in the cross section of the core. For 25 cycle supply the constant is 12 instead of 7.5 and for 50 cycles it is 9.

Apparatus such as meters, rheostats, etc., are mounted on a panel, the remainder of the equipment being mounted on the baseboard to the rear of the panel. By means of a multiplier, the milliammeter in the plate circuit is made to read

the plate voltage, the milliammeter scale being calibrated to read volts as well as milliamperes. Since the current through the resistance is exactly the same as that drawn by the tube, the voltage reading is practically the same as under normal operating conditions.

The filament circuit is provided with a resistance with center tap, and two small mica condensers shunt the resistance in order to provide a low resistance path for the high frequencies. The antenna inductance is a pancake coil of 6 turns of No. 10 bare copper wire, the inside diameter of the coil being 2½ in. and the outside diameter 5 in. The plate coil consists of 10 turns of No. 10 copper wire, solenoid wound about a 3½ in. diameter and supported by three ebonite posts, the spacing between turns being about ¼ in. No condenser is used across the plate coil, the self capacity of the turns and the capacity of the tube together with the inductance of the coil being resonant at 40 meters. The grid coil consists of five turns of No. 20 D. C. wire wound on a three inch tube, the spacing between turns being ¼ in. from center to center. The antenna used with this set is a four wire cage 4 in. in diameter, and 40 ft. long. The hoops are of No. 10 copper wire, brazed and butt jointed, the wires being sweated and bound to each hoop. The counterpoise is 12 ft. above the ground and consists of a four wire fan, covering approximately 500 square feet of area.

The receiving set consists of a detector and one stage of audio frequency amplification, but nearly all the work is done on the detector tube alone. The tuning range goes down to include 5 meters, as well as the longer waves. The primary is a single turn of No. 10 square wire and the secondary is made variable according to the wavelength used. A UV-199 serves as the detector and a DV-3 as the amplifier.

Mr. Dawson has been granted special permission by the New Zealand Government to carry out tests between 38 and 42 meters and is particularly anxious to work with American amateurs on the

above waves. He will be on the air from 10:30 P. M. to 2 A. M. Pacific Standard Time, calling on a wavelength of 88 meters in order to advise of the tests on the shorter waves.

NEWS OF THE AMATEUR OPERATOR

8ZE-8GX is maintaining a relay transmitter which is at present on 41.5 meters. Tests are being conducted on the lower wave bands, particularly on 5 meters. Communications from stations interested in taking part in these tests and reports on the signals will be greatly appreciated by E. W. Thatcher, Oberlin College, Ohio.

O. T. Cooper, an old-timer, is now stationed on the U. S. S. Pillsbury (227), (Asiatic Station, care Postmaster, Seattle, Wash.) He is on 78 meters with a 10-watt transmitter using the ship's call NUQG with which he hopes to work west coast stations from China.

8ATX is now at 924 Arlington Avenue, S. W., Canton, Ohio, with 15 watts on 78.5 meters also on 41.5 meters.

Activities at 6XAD-6ZW

Major Mott's station at Avalon, Catalina Island, Calif., has been doing good work during the past two months, stations in every state in the U. S., all Canadian provinces, Australia and New Zealand, Macao, China, and various European countries having been worked, on a wavelength of 75 meters, using a 250-watt Western Electric tube. Considerable experimental work is being done with telephony on a wavelength of 198.5 meters, the station having been heard with voice in various eastern states and at Raratonga, Cook island, 5000 miles distant. For the purpose of working with WNP, the MacMillan Expedition, a special transmitter for work on waves between 20 and 80 meters is being built by Ralph Heintz of Heintz & Kohlmoos, San Francisco. This set will use two W. E. 250-watters in a self-rectifying A. C. circuit, and should enable 6XAD to repeat the performances of last year, when the MacMillan Expedition was on its first trip.

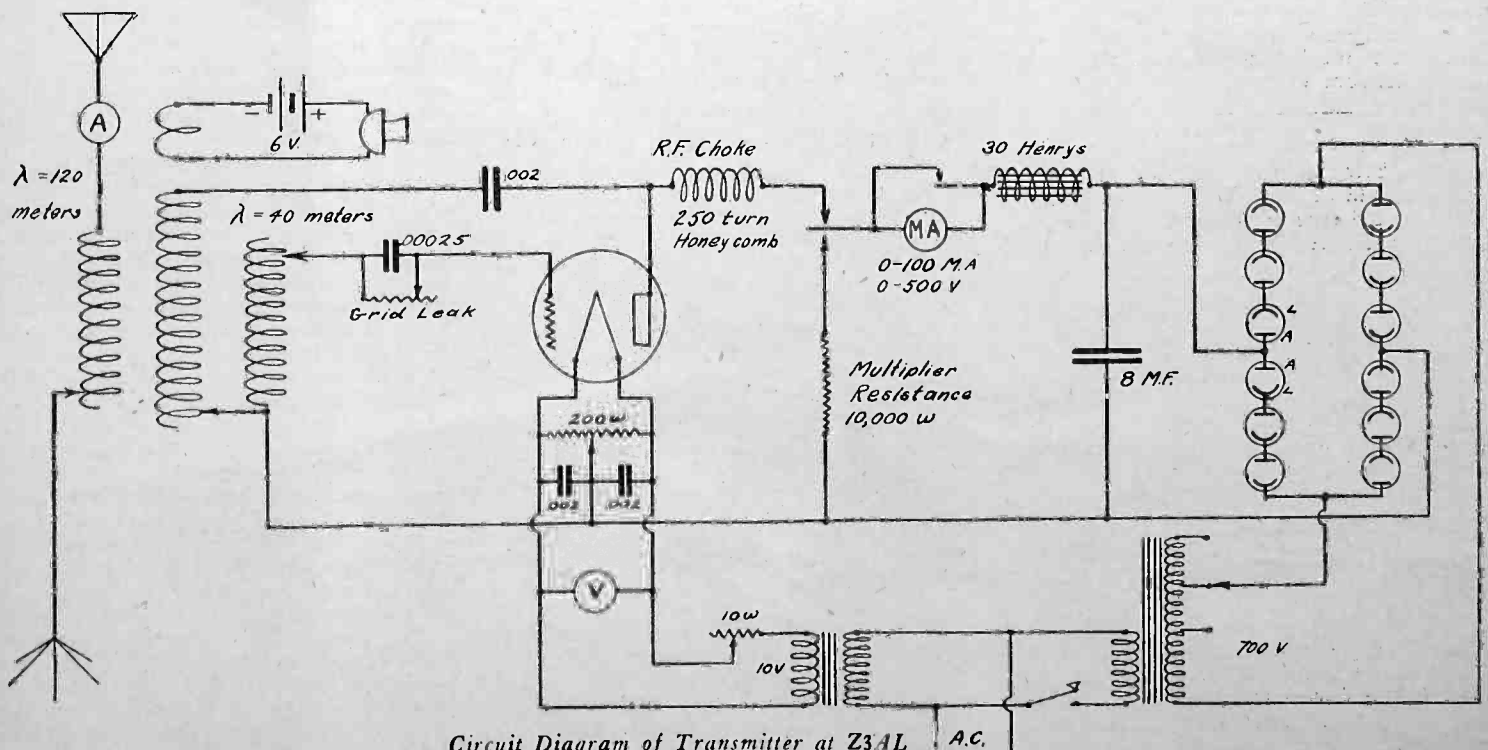

Circuit Diagram of Transmitter at Z3AL A.C.

FROM THE RADIO MANUFACTURERS

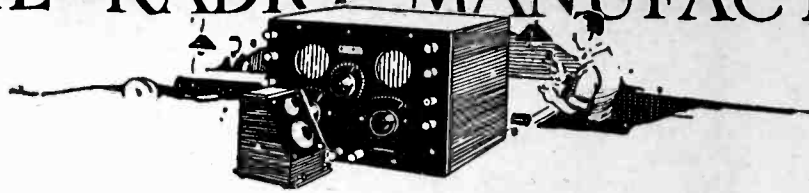

The Thordarson sub-panel mounting audio transformer is identical with the standard type except that its binding posts are underneath so as to facilitate concealed wiring.

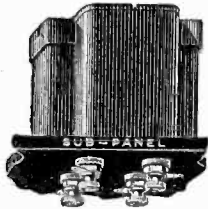

ing underneath a sub-panel. This not only gives neater assembly but also allows shorter leads. It is made in three ratios: 2:1, 3½:1, and 6:1.

The Jewell receiving set voltmeter, No. 135, has been designed for easy panel mounting. The instrument is placed in a 2-in. hole which has been drilled in the panel and is then held neatly and securely in place by a mounting cup fitted with a knurled nut which can be tightened with the

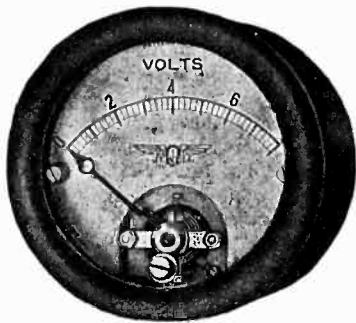

fingers. It has a range of 0-8 volts plainly etched in black on a silver ground. Connections are easily made to the insulated terminals. The movement is of the moving coil type, fully jewelled and supplied with the best tungsten steel magnets. Such an instrument is the best protection against too great a filament voltage.

The Remo radio tube receiver is intended to bring to full efficiency in a few minutes an old or weak UV-201A or 199, or C-301A or 299 type of tube. This is accomplished by electrically heating the filament

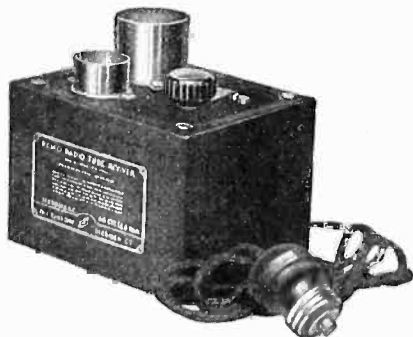

so as to bring the contained thorium to the surface and thus revive its electron emitting power. The device is designed for attachment to a 110-volt alternating current lighting circuit.

The Mozart-Radioceiver, Type B, is a direct acting, electromagnetic loud speaker unit which is semi-adjustable. It has been specially designed and constructed so as to hold any given adjustment under extreme

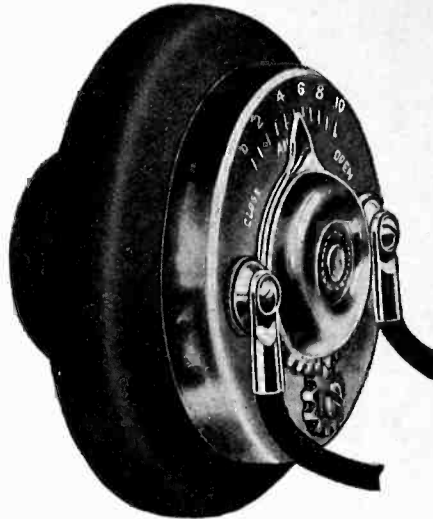

temperature variations. It is intended for use on the tone arm of a phonograph or with an upright horn, appropriate fittings being supplied for either of these purposes.

The Electrad Resisto-Coupler is a convenient new device, especially for use in resistance coupled amplifier circuits. It con-

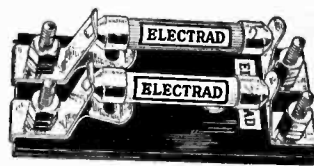

sists of two grid-leak mountings on one moulded bakelite base which is equipped with special clips for holding "postage stamp" mica condensers without soldering.

The Fleron Radio Outfit comprises in convenient form all of the materials usually purchased separately for an outside aerial. It contains 100 ft. seven strand enameled copper wire, 70-ft. No. 14 rubber covered lead-in wire, 2 porcelain insulators, one refillable lightning arrester, 1 lead-in window



strip, 2 stand-off insulators, 1 three-inch porcelain tube, 12 insulated staples, 1 ground clamp, 1 six-inch porcelain tube, 3 nail knobs, 2 galvanized screw eyes, and instructions for putting up the aerial. The whole equipment is contained in a convenient box.

The Thorola doughnut coil, so named because of its shape, is designed as a low-loss inductance with a self-contained magnetic field. This minimizes inter-coupling

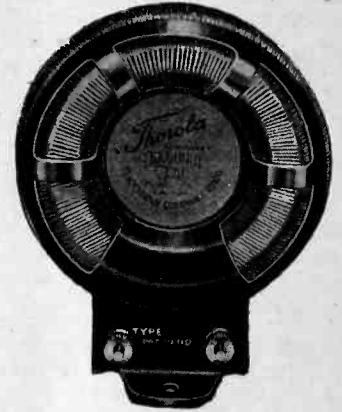

with other parts when it is used as a coupler or as a radio-frequency transformer. The claim is furthermore made that it will not pick up or absorb signals other than that brought in through the antenna system.

A compensated multiple variable condenser is announced by the United Scientific Laboratories as a practical single dial control unit for tuned radio frequency cir-

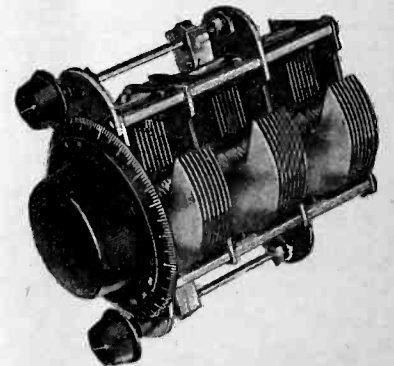

uits. It has a capacity of .00035 mfd. per unit, giving a straight line tuning curve. Its compactness reduces panel space requirements.

New Radio Catalogs

Bulletin No. 400 from the Roller-Smith Co. illustrates and describes two new lines of small direct current ammeters, milli-ammeters, voltmeters, milli-voltmeters and volt-ammeters. These are 3½ in. and 4 in. in diameter respectively, and are intended for radio sets, battery eliminators and battery chargers.

"B Battery Service Hours" by W. B. Schulte is the subject of a valuable engineering circular from the Burgess Battery Co. In it is discussed shelf life, discharge and capacity characteristics. Tube plate currents with various grid bias voltages are shown by curves. The effects of the number of B batteries, the number of tubes, the grid bias voltage, the size of B batteries, and the type of tubes are clearly shown as a help for the user to figure his own requirements.

The Barnett-Lloyd Co. of Chicago have issued an attractive catalog of "Hi-Power" receiving sets in both factory-built and "knock-down" form. Interesting information is included on the Sickles diamond-weave coils and other accessories.

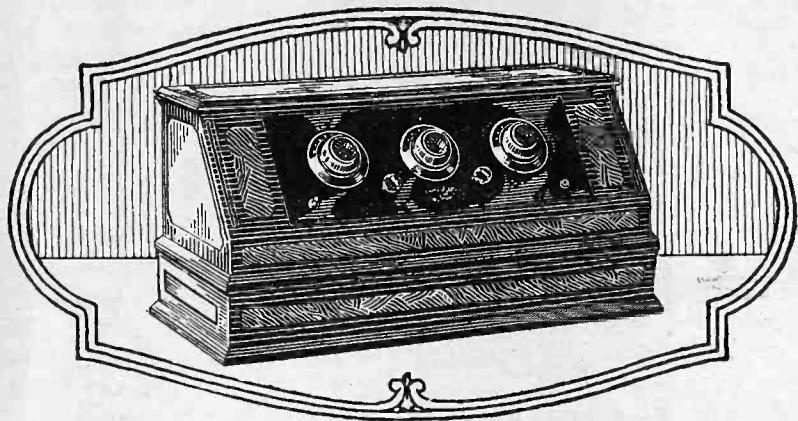

Distinguished for its Musical Excellence!

Refinements had to come before radio could make its true appeal on the basis of musical excellence.

This was the view of the Thompson engineers, who, with fifteen years' experience in manufacturing wireless equipment to their credit, set their ample resources to the task of producing a radio receiver which should be not "just a radio," but a musical instrument.

On every hand the Thompson Neutrodyne is acknowledged as the maestro of radio, a truly fine musical instrument by every standard. The recognition accorded the Thompson is due to Thompson Tone. Tone that is versatile in its handling of every sensitive shade of music. Tone that falls pleasantly upon the ear of the most orthodox music-lover. Tone that does not and cannot offend the sensibilities of the most critical listener. Thompson Tone!

SIX TUBES GIVE DISTANCE WITH VOLUME

An unique transformer (an exclusive Thompson engineering feat) permits the use of six tubes in the Thompson Neutrodyne — an achievement heretofore confined to the experimental laboratory. Distant programs that come in faintly (if at all!) on ordinary receiving sets are delivered with the volume and brilliance of nearby broadcasts on the 6-tube Thompson.

THREE SETS FROM WHICH TO CHOOSE

The 6-tube Thompson Concert Grand, illustrated above, retails at \$185. This is unquestionably the finest thing in radio today at any price. There is also the 5-tube Thompson Parlor Grand which retails at \$150. Thompson quality throughout, but with one tube less than the Concert Grand. Then there is the 5-tube Thompson Grandette which retails at \$130. This differs from the Parlor Grand chiefly in size and cabinet work.

R. E. Thompson Mfg. Co., 30 Church St., N.Y.

THOMPSON RADIO



The Thompson Speaker

The Thompson Speaker contains over-size magnet and coils, amplifying armature, diaphragm in scientific cone shape. The volume regulator enables adjustment for varying strength of near and far stations. Uses no battery current. For supremely natural home radio — The Thompson Speaker — Retail at \$30.

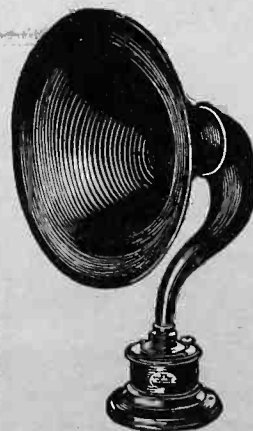

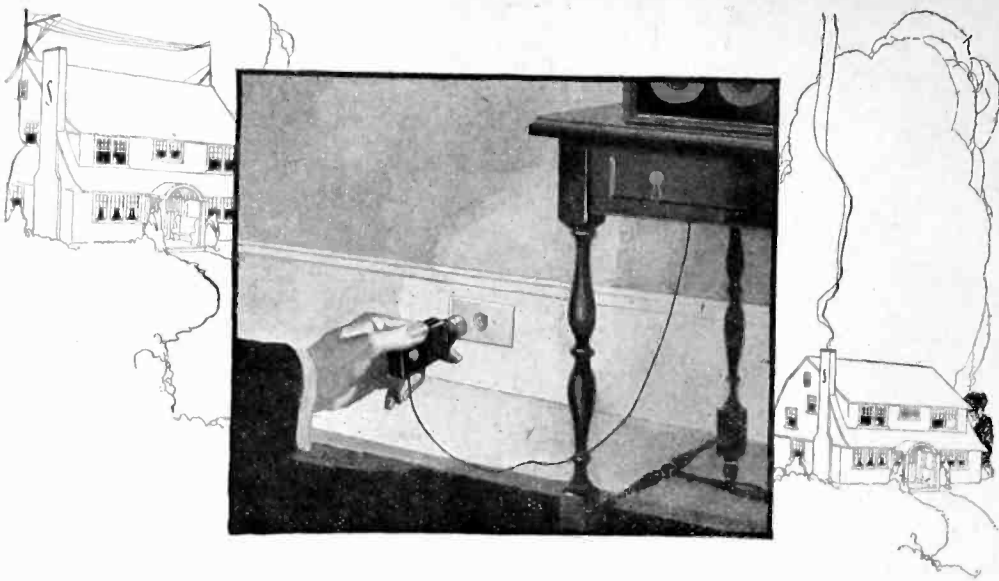

The \$1.50 Ducon → and *no* antenna!

A small Ducon screwed into a light socket—or a cumbersome, unsightly aerial? Surely the Ducon! It's so inexpensive—so easy to use—so sure in its results.

Take home a Ducon today—and hear tonight's best programs!

The Ducon is sold by all reliable dealers. Try one for five days. If it is not THOROUGHLY satisfactory, your money will be refunded.

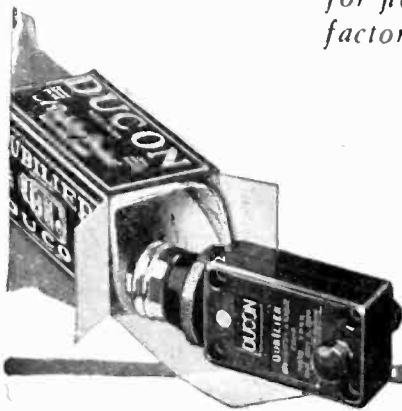

Dubilier

CONDENSER AND RADIO CORPORATION

Send \$1.00 for a trial subscription to "RADIO" for 6 months.....

CARTER PORTABLE JACK



75c

A sturdy, well made jack that takes any standard plug. For use in extending Loud Speaker or head set to porch, garden or other rooms. Any dealer can supply.

Coast Distributors:

Atlantic-Pacific Agencies Corp.
204 Rialto Bldg., San Francisco, Calif.
In Canada, Carter Radio Co., Ltd., Toronto

Carter Radio Co.
300 S. MICHIGAN AVENUE
CHICAGO, ILL., U.S.A.

3 TUBE LOUD SPEAKING

only \$29.50

GUARANTEED LONG DISTANCE RADIO

Users everywhere report Miraco Tuned Radio Frequency sets get programs coast to coast; outperform sets 3 times as costly. Send for proof they are radio's most amazing values. One tube guaranteed, completely assembled long distance outfit, only \$14.35. Three tube (above), \$29.50. Five tube \$75

SEND POSTAL TODAY for latest bulletin and special offer. It will interest you.

MIDWEST RADIO CORP'N
Pioneer Builders of Sets
414-P E. 8th St., Cincinnati, Ohio

MIRACO RADIO GETS 'EM COAST TO COAST

AGENTS DEALERS
Our proposition's a winner. Write.

JASPER HOLMES

(Continued from page 23.)

at the old man's plantation all the time his ship was in port; the eatables being considerably better than aboard ship and free from cockroaches and suchlike, while Henrietta was not at all bad to look at, especially when one included the plantation in his view. In a way Jasper took an unfair advantage of his Dutch friends in the matter of his introduction because he had almost cut his teeth on Bristol Bay potato home-brew and was reputed to be able to down a quart of shellac without batting an eyelash. Anyway, Jasper nearly had Henrietta and the plantation cinched when Tomahawk appeared on the scene via the West Carolina. Tomahawk had made a living for a number of years selling life insurance before he took to the sea, and having stated this fact it is needless to go into detail as to how he got into the good graces of Henrietta and old Oom Pok Van Oopjik.

"Of course Jasper got plenty hot when he found out about this serpent which had snuk into his Eden. But he began tearing his hair and plucking at the covers in earnest when, after he got back to 'Frisco and tried to get Tomahawk fired, he discovered that this gentleman had almost succeeded in pulling the same trick on him. Then the war began in earnest.

"Shortly after this the first skirmish in mid-Pacific took place, and Tomahawk, having a more fertile mind at repartee, maddened Jasper to such an extent that when he reached Surabaya he told old man Oopjik and Henrietta a cock-and-bull story about Tomahawk being a renegade half-breed red Indian who had in his earlier years massacred whole villages to the last man, woman and child, Dutch settlements having been his especial meat.

"Oopjik, being filled up on American movies, and having an idea that the western part of the United States was nothing more than a stamping ground for cowboys, Indians and road-agents, swallowed the yarn whole and decided that maybe it was better to keep such a desperate character at a safe distance thereafter. So when Tomahawk appeared again, it took him two whole days before he could get near the old man to show him the phoney newspaper clipping he had had printed in San Francisco, relating how Jasper had been arrested for driving an automobile while intoxicated, running over a woman and three small children, and callously leaving them lying in the street in his hurry to get to the apartment where his second wife was living so that he could kill her before she had a chance to break up the latest wedding he had engineered for himself.

"After Oopjik had an interpreter read the item to him a couple of times and after he had listened to the line of talk

Tomahawk gave him he sat down and spent a whole afternoon figuring things out. Tomahawk, he decided, didn't look anything like the Indians he had seen in the moving pictures, being entirely white and considerable better-looking. Next, he remembered Jasper's capacity for schnapps and such-like and decided that he didn't have the room in him to hold enough furniture-polish to get even half-way lit up. Then he slept on the matter and after some more deep thought the next morning he came to the conclusion that maybe the boys were trying to take a mean advantage of one another.

"So he told Tomahawk that he was willing to let bygones be bygones and as long as they didn't try to murder anyone around Surabaya they could drop around to dinner as often as they pleased. And when Jasper came snorting up to the ranch again after another exchange of greetings out by the Marshall Islands, Oopjik told him the same thing.

"When the old man put the blue pencil to the knocking business Tomahawk and Jasper had to confine themselves to shouting their own virtues and as they had over two months in which to think up new lies they had Henrietta fair bewildered as to which paragon she should pick. No sooner would she get all worked up over the big estates which Tomahawk would inherit some day, when back would come Jasper with some tale or other of how he pretty near won the battle of Chateau Thierry single-handed or maybe about the time he killed three Indians with one shot during the siege of Milpitas in 1918. Jasper was strong on the Indian stuff, having been severely injured at the age of six months by a cigar store Indian falling on him.

"Between times they continued to violate the law regarding superfluous signals regularly every month when the two ships passed one another and this continued until one fine morning when Tomahawk arrived in San Francisco and found himself out of a job—the West Carolina had been withdrawn from service due to a slump in exports, while the Cajappa was to take care of all the company's East Indian business. The Carolina was towed up to the mud flats and Tomahawk spent the next two weeks in discovering that there were positively no other ships running out of 'Frisco for Surabaya.

"After another week of wandering around biting his nails, with the prospects of Henrietta and the plantation steadily disappearing into the distance, Tomahawk set himself to work to figure some scheme to get Jasper's job on the West Cajappa, a tough order, to be sure. But Tomahawk was an exceedingly capable gentleman when it came to figuring out any kind of deviltry. He had his trap all laid and baited a week before Jasper, having had advance information

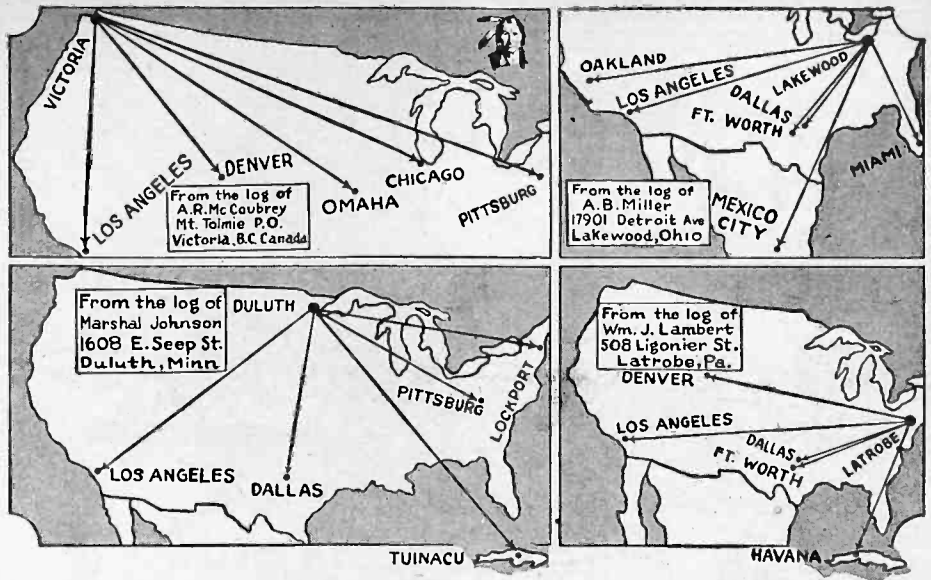

Through the Locals — ALL-AMAX Reaches Out

Every ALL-AMAX Set, wherever it may be, brings to its owner his choice of all the beauties in the air. Every day come more and more letters to our office, telling of the long distance reception, almost unbelievable on a three-tube set, which has rewarded the owners of ALL-AMAX.

Remember, too, that ALL-AMAX is completely mounted on panel and baseboard. You can wire it in one delightful evening, following simple photographic instructions.

ALL-AMAX SENIOR, three tubes and detector . . . Price, \$42.00
ALL-AMAX JUNIOR, one tube and detector Price, \$22.00

ALL-AMERICAN RADIO CORPORATION

E. N. RAULAND, President

2654 Coyne Street

Chicago

ALL-AMERICAN



FROST-RADIO

FROST-RADIO PAN-TAB JACKS ARE BEST for YOUR RADIO SET

The finest radio jacks made, for either panelhung assembly or usual installation.
At your dealer's, 70c to \$1.00 list.

HERBERT H. FROST, Inc.
314-324 West Superior Street Chicago

New LeFAX RADIO HANDBOOK—\$2.00
(Seventh Edition)
in bound form. For sale by
"RADIO," San Francisco



JEWELL

No. 95
Jewell
Radio
Test-Set

ASK YOUR DEALER—
or write to us asking for our
14-C Circular, describing
our Radio Test Set.

Jewell Electrical Instrument Co.
1650 Walnut St. Chicago

SEE PAGE 63

SM SUPER-AUTODYNE

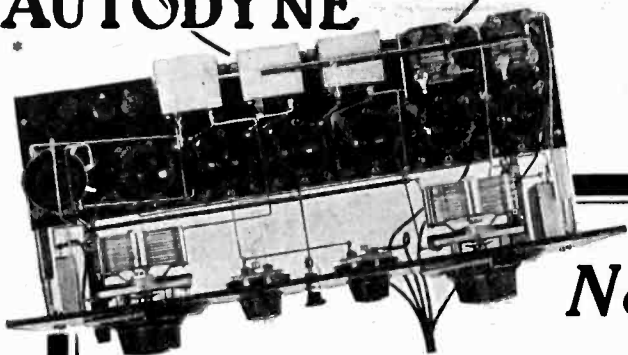

New!

A Perfected Super-Heterodyne

Again Silver-Marshall engineering leads the field, just as it has since the first Silver Design was offered less than a year ago. Not content with a seven-tube super-heterodyne, which has become the acknowledged standard of comparison with radio engineers and editors, McMurdo Silver, Assoc., I. R. E., has developed "The Super-Autodyne," a six-tube receiver that will out-perform average seven and eight-tube sets. Read the description of this remarkable radio achievement in the July issue of "Radio Broadcast." Plans and instructions for the "Super-Autodyne" may be had for 50c.

Complete Parts

	Each		Each
2 S-M 305A S-L-W Condensers.....	\$5.00	1 .0075 Condensers75
2 4" Moulded Dials, KK	1.00	2 .00025 Balancing Condensers.....	1.50
1 U.S.L. 6 ohm Rheostat.....	1.00	1 S-M .25 meg. leak50
1 U.S.L. 240 ohm Potentiometer.....	1.50	1 S-M 2 meg. leak50
3 Insulated Top Binding Posts.....	.05	1 Carter No. 3 Jack Switch.....	1.15
1 Carter 101 Jack70	1 Benjamin 8630 Switch30
1 Carter 102A Jack80	1 S-M No. 701 Color Cable.....	1.00
1 S-M 211 Filter with Matched Tuning Capacity	8.00	1 pair Benjamin 8629 Shelf Brackets70
2 S-M 210 Charted Intermediate Transformers	8.00	1 Bakelite Panel, 7"x18"x3/16", drilled, grained and engraved.....	6.00
1 S-M 101B Coupling Unit	2.50	Spaghetti, bus-bar, lugs, screws, nuts, etc.	1.00
1 S-M 6-Gang Socket Shelf (536- 201A), (537-UV199)	10.80	All Parts for "ALL WAVE SUPER- HETERODYNE" described by Mc- MURDO SILVER in this issue for	\$72.55.
2 Thordarson 3 1/2-1 Transformers	4.00		
2 S-M 5 Condensers90		
2 .00025 Condensers with Clips.....	.45		
2 .002 Condensers40		

*Trade
Mark.

Silver-Marshall, 110 B-S. Wabash Ave.,
Chicago, Illinois.

about the layup of the Carolina, came chortling back to 'Frisco.

"UP in the 'Inquirer' building the 'Dutch-American Petroleum Co.' had opened an office, with the name in big black letters on the door and a desk, filing cabinet, safe and some pictures of oil derricks, which he had rented, located artistically around the room. An actor whom Tomahawk had picked up somewhere had been crammed full of information about the East Indies and was ready to sit in back of a desk and look wise for two days—at fifteen dollars a day—and a stenographer and office-boy were on tap also.

"A week before the Cajappa was due in 'Frisco a one inch display advertisement appeared on the radio page of the morning 'Inquirer' and ran every day thereafter up to and including the morning when Jasper stepped ashore and headed up to Hardman & Pelton's office. It ran like this:

'COMMERCIAL RADIO OPERATOR
Wanted for radiotelegraph station in Dutch East Indies. Contract, liberal salary and bonus for experienced man.
BOX 282, 447 INQUIRER.'

"This cost him three dollars and some odd cents per insertion, so you can see that Tomahawk was no piker when it came to getting the right atmosphere. He got 247 replies to that advertisement and when Jasper saw it and found out that it had been running for a week he burned up the mails with a special delivery letter to make the two hundred and forty-eighth.

"Well, in due time Jasper came, looked and fell. After the manager of the 'Dutch American Petroleum Company' had probed into his habits most unmercifully and compiled considerable data concerning his habits, morals, religion and experience in radio and after he had found out whether or not he had any leanings toward Socialism and quizzed him on nearly everything except the Fourth Dimension he gave him the job and signed him up on a two year contract. He did a pretty thorough job of it and Jasper left the office shaking hands with himself over his luck. He didn't know Tomahawk well enough; if he had—but he didn't.

"After giving Jasper plenty of time to get well on his way, Tomahawk stepped out of the next room, shook hands with everybody in a wild fashion and hiked down eleven stories to Market Street, being in too much of a hurry to wait for an elevator.

"About an hour afterward he dropped into the office of Hardman & Pelton and found out from their office boy, whom he had subsidized for giving him reports as to Jasper's movements, that the latter had quit his job alright—and brought his younger brother along with him. The brother was already installed as radio operator on the West Cajappa!

"When Tomahawk heard this distress-

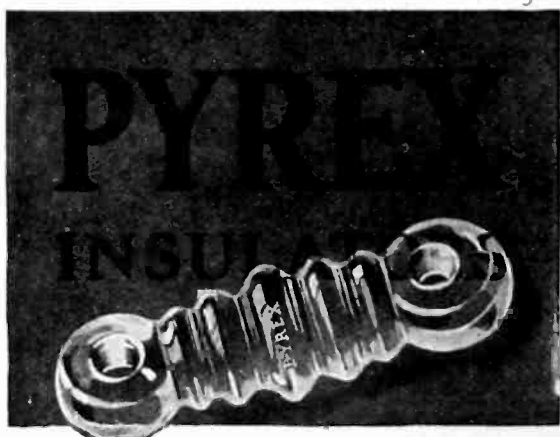

PYREX Insulators

mean

*Clearer, Louder
Reception*

Look for the Name PYREX

PYREX Insulators stop energy leaks because PYREX is the effective insulating material. The surface of PYREX is so hard and smooth that it will not pick up dust or hold water. PYREX Insulators give efficient insulation in any weather. The result is clearer, louder signals. The quality of the original broadcasting is preserved. Use PYREX Insulators and notice how your set improves.

PYREX Insulators are used by the U. S. Government because they stand up under the most exacting conditions.

Be sure to get genuine PYREX.

Industrial and Equipment Division CORNING GLASS WORKS, Corning, N. Y

sing news he blinked a couple of times and went downstairs and bought a fist-full of five cent cigars. Then he got on a street car and went up to his room in the Alpine and sat down to think things over. Tomahawk wasn't one to be phased by one of his plans falling through; he was used to having plans fall through. So he lit one of his lengths of cabbage and started in to devise some scheme to get rid of Jasper's younger brother.

"The disposal of Jasper himself was easy; that had been thought out coming up on the street car. Jasper would receive ticket for Los Angeles on the next day's 'Lark' with instructions and 'credentials' to secure his ticket for Honolulu from the purser of the 'City of Los Angeles,' then due in four days. At Honolulu a passage on the 'Dretchdkye' to Surabaya would be waiting for him. Of course, Jasper would never get any farther than Los Angeles, but by the time the 'Los Angeles' got in Tomahawk and the Cajappa would be well out to sea on the way to Surabaya and Henrietta. The ticket to Los Angeles cost Tomahawk fifteen dollars even at scalpers' prices, but he had to get Jasper out of town lest his brother's resignation from the Cajappa cause any suspicions as to foul play to arise in his mind.

"Seven cigars later Tomahawk suddenly jumped up and by moving fast, he caught the 3:20 ferryboat for Oakland Pier where he took the Melrose train to Seminary and dropped in on an acquaintance of his who was holding a candy-butcher's job on the 'Overland Limited.' He visited his friend half an hour or so and left the house grinning, even though he had twenty dollars less than he had left San Francisco with. This was quite the equivalent of his stating in so many words that Jasper's brother would never sail on the West Cajappa; that trip, at least.

"The candy-butcher departed from Oakland on his regular run that night on the 8:23 for Salt Lake City and the next day Jasper's brother received a telegram from Carson City, Nevada, his home town, telling of the death of his grandfather, who had left him a matter of three thousand dollars, the bequest being subject to his attending the funeral.

"But the candy-butcher was about as dumb as they make 'em and sent the message 'Rush' instead of 'Night Letter' as Tomahawk had instructed him and when this *hombre* packed up his clothes and swaggered into Hardman & Pelton's office the next morning he found out that the latest operator on the Cajappa had quit his job alright—the afternoon before; leaving it open to some 'lid' who had wandered into the office about 4:30 and grabbed it.

"This about finished Tomahawk, because he not only hadn't the slightest idea who the 'lid' was, or where he was

Build this phenomenal new radio in 45 minutes

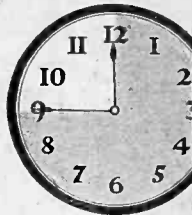

The revolutionary Erla Circloid-Five Factory-Built Kit—as you receive it.

Price \$49.50

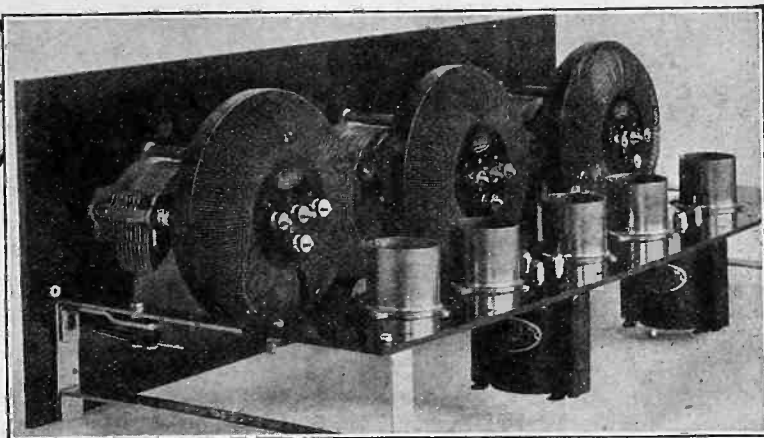

This new type kit is factory assembled. Ready cut, flexible, solderless leads make it ridiculously easy to wire. Amazing new inductance principle brings results hardly thought possible. Send for book, *Better Radio Reception*.

NOW anyone can build the finest of receivers in only a few minutes. No more wire bending or soldering. Merely attach a few ready cut, flexible eyeletted leads and the job is done. The finished set is unsurpassed even by the costliest factory-built receiver.

But most amazing is the new inductance principle incorporated in this last word in kits—called the Erla Circloid principle of amplification.

Four vital improvements result from this great discovery, which are not found in ordinary sets.

1. **Greater Distance:** Erla *Balloon *Circloids have no external field, consequently do not affect adjacent coils or wiring circuits. This enables concentration of proportionately higher amplification in each stage, with materially increased sensitivity and range.

2. **More Volume:** Increased radio frequency amplification made possible by Erla Balloon Circloids gives concert volume to distant signals inaudible with receivers of conventional type.

3. **Increased Selectivity:** Erla Balloon Circloids have no pick-up quality of their own. Hence only signals flowing in the antenna circuit are amplified. Static is greatly reduced for this reason.

4. **Improved Tone Quality:** The self-enclosed field of Erla Balloon Circloids eliminates stray feed-backs between coils and consequently does away with mashing of signals and distortion. Tone is crystal clear and perfectly lifelike.

Write for free information on kit—also book

See how 45 minutes of fun will give you the newest and most nearly perfected set known to radio science. Easy as A-B-C to finish. Examine it at any Erla dealer's, or send the coupon for full information, illustrations and diagrams free. Also ask for remarkable new book, "Better Radio Reception," describing the sensational new Circloid principle. Enclose 10c for mailing and postage on book.

ELECTRICAL RESEARCH LABORATORIES
2529 Cottage Grove Ave., Chicago

*Trade Mark Registered.

ELECTRICAL RESEARCH LABORATORIES,

2529 Cottage Grove Ave.,

Chicago, U. S. A.

Send me free information on kit. Enclose 10c for postage for book "Better Radio Reception."

Name.....

Address.....

City....., State.....



This sign identifies authorized Erla distributors. All are equipped to give complete radio service.

Dealers

Exclusive franchises are available to high-class dealers in localities still open. Write or wire immediately.

Don't miss the next issue of "RADIO," containing Best's New Super. Send 25c today for a copy

The Andrews Deresnadyne RADIO RECEIVING SET

Combines Tone Quality and Selectivity With Distance.
Price \$165 Without Accessories.

ANDREWS RADIO CO., Tribune Tower, Chicago.
F. L. TOMLINSON CO., Los Angeles and San Francisco
ROBINSON SALES CO., Seattle

Tell them that you saw it in RADIO

"results are truly amazing!"

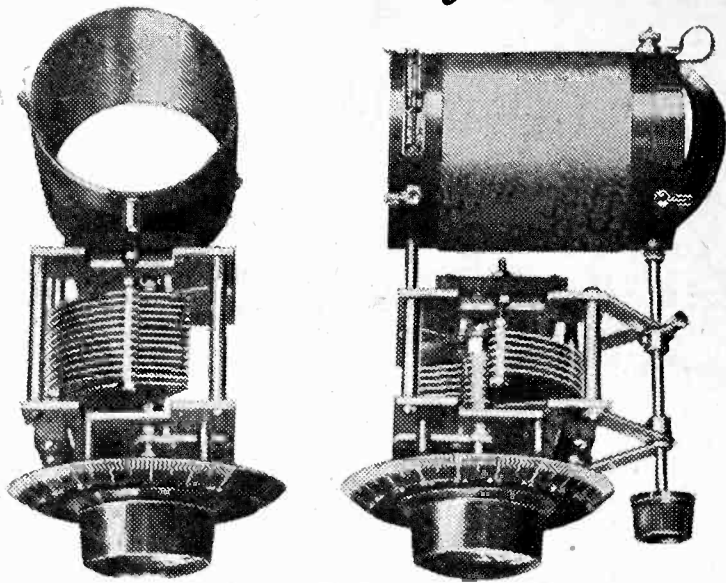

A National Velvet Vernier Dial driving a National Condenser upon which is mounted the new NATIONAL radio products—

The NATIONAL Antenna Coil and the NATIONAL Regenerator

*[Prime requisites of
an efficient radio set]*

The National Regenerator is a tuned radio frequency transformer of highest efficiency. When used with a Browning-Drake receiver the results are amazing. Sets using these parts have given transcontinental radio reception with ease.

Dealers Supplied by the following distributors:

- SAN FRANCISCO—Alexander & Lavenson, 926 Howard Street; Coast Radio Supply Co., 648 Howard.
- LOS ANGELES—The Electric Corporation, 1050 Santee St.; Cook-Nichols Company, 411 South San Pedro St.; Yale Radio & Electric Co., 1111 Wall St.; Radio Supply Co., 920 South Broadway; Western Radio, Inc., 1224 Wall St.
- SAN DIEGO—Coast Electric Co., 744 G Street.
- SEATTLE—Electric Corporation, 321 Occidental Ave.; L. C. Warner Co., 301 Occidental Ave.
- PORTLAND—Electric Corporation, 285-287 Couch St.; Stubbs Electric Co., Sixth and Oak Sts.; L. C. Warner Co., 307½ Pine St.
- VANCOUVER, B. C.—Radio Specialties, Ltd., 179 Pender St., W.

NATIONAL COMPANY, Inc.

110 Brookline St.

Cambridge, Mass.

Sole licensees for the manufacture of the genuine and justly famous Browning-Drake Transformer. Patents pending.

CARDWELL TORO-TRAN

The ideal inductance

Allen D. Cardwell Mfg. Corp.

81 Prospect Street

Brooklyn, N. Y.

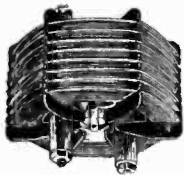

THE ANDREWS PADDLEWHEEL COIL

A low-loss inductance. Improves tone quality and increases signal strength and selectivity.

Price with bracket, \$3.00

RADIO UNITS, INC.
1303 First Ave., Maywood, Ill.

Make Your Own Set at Half Cost!

THE GENUINE SHAMROCK-
HARKNESS TWO-TUBE
REFLEX

\$35

SHAMROCK

FOR SELECTIVE TUNING

Dept. 33-A, 196 Waverly Ave.

Newark, N. J.

TELOS RADIO

Write for a free copy of our new, handsomely illustrated booklet, "The KIT of a Thousand Possibilities."

DANZIGER-JONES, Inc.,

Department F. 25 Waverly Place
New York, N. Y.

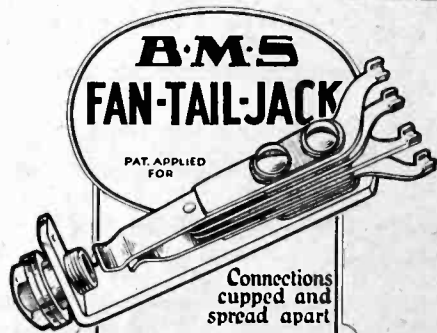

B.M.S. FAN-TAIL-JACK

PAT. APPLIED FOR

Connections cupped and spread apart

For Easy Soldering

Mfg. by BROOKLYN METAL STAMPING CORP.
718 Atlantic Ave., Brooklyn, N.Y.

At all good dealers!

WESTERN REPRESENTATIVE
F. L. TOMLINSON & CO.

443 S. San Pedro Street, Los Angeles, Calif.
152 Security Building, Portland, Oregon

staying, but also because the crew was to sign on at nine o'clock the next morning, seven hours before the ship sailed. He spent the rest of the day locked in his room, trying to smoke up a box of 5c perfectos at one sitting and cussing horribly every time he thought of the hundred and forty-two dollars he had spent in getting rid of Jasper and his brother.

"But by and by he got a grip on himself again and about eight o'clock he rushed downstairs and hired a taxi. A little while later an automobile, which was the spit image of the one Tomahawk had hired drew up before the entrance to pier 47, where the Cajappa was docked, and somebody jumped out, slipped the watchman a piece of filthy lucre when he tried to stop him, and disappeared into the darkness of the pier. After he had crossed the quartermaster's palm with some more paper this somebody scuttled up the gangplank and presently sneaked along the boat deck of the West Cajappa and for a time busied himself in prying open one of the windows of the radio shack. As this second-story worker walked off the dock, about five minutes afterward, he handed the watchman a fistfull of cigars, wished him a merry Fourth of July and disappeared in the taxi. The watchman carefully smelled the cigars and then against his own opinion, lit one of them and took a healthy suck at it. When he had gotten over his strangling fit he stamped it out and laid the rest of them on a shelf to give to his friends, meanwhile loudly informing his pet tomcat of his personal opinion of the pole-cat who had given them to him.

"Came dawn, and an assistant Radio Inspector prowling around the West Cajappa. This gentleman peered into the storage batteries and assured himself that the motor-generator would still turn over and then, as he was preparing to leave, told the 'lid' to break out his license and put it up on the wall. The 'lid' stared fixedly at the spot on the wall for a minute or so, this being the place he had tacked up his 'ticket' the day before, gulped a couple of times and began throwing the contents of the various lockers and drawers of his room out onto the floor in a vain attempt to locate the missing document.

"It was only a short time after that when the port steward called up the Hardman & Pelton office and informed them that if they expected the Cajappa to leave when she was scheduled to, they had better send down a radio operator as fast as the good Lord would let them. He put on an emphatic P. S. that the operator must positively be possessed of a license which he could produce in a reasonably short length of time.

"Tomahawk had been lolling around the office since eight-thirty flirting with the stenographers and he was on his way down to the ship in a taxi about

two minutes later. His two suitcases and banjo had been reposing in the third engineer's room on the Cajappa ever since six o'clock that morning. He paid off the driver with the last of his roll of one hundred and sixty dollars and when he had flashed his license on the Radio Inspector and signed his name in three places for the Shipping Commissioner he went up to the radio room and went to sleep, for the strain of the previous few days had told on him. He was still asleep when the Cajappa backed out of the dock and began churning her way out through the Golden Gate in ballast for Surabaya.

"Jasper came galloping back to San Francisco three days later and when he found the office of the 'Dutch American Petroleum Co.' deserted he put two and two together and even then he could hardly believe the answer; which was Tomahawk. But when his brother came hastening back, mad enough to bite nails over his grandfather being very much alive, having borrowed ten dollars from him, Jasper at length had to admit the bitter truth—that Tomahawk had scalped him proper, and his brother into the bargain. Which of the two of them was nearest to apoplexy as they ate their supper in a dairy lunch that evening is a question.

"But their train of thought was a Salvation Army hymn to the torrent of pyrotechnics with which Tomahawk was at that moment blistering the walls of the radio shack of the West Cajappa. In front of him, trailing off to the last in an unintelligible mess of hen-tracks, was a pencilled copy of a message which he had but a minute before received from the Federal Beach station in San Francisco. In effect it read something like this:

'MASTER SS WEST CAJAPPA SAN FRANCISCO

CANCEL PREVIOUS ORDERS AND PROCEED TO VALPARAISO LOADING NITRATES FOR NEW ORLEANS. WEST CAJAPPA RE-ASSIGNED TO THIS COMPANY TODAY BY SHIPPING BOARD.

KANE-HOLT.' "

HEATH

RADIANT CONDENSERS

For Real Radio Reception

HEATH RADIO AND ELECTRIC MFG. CO.,
208 First Street, Newark, N. J.

"THE RADIOBUSTER"

Written by the author
of "On the Trail of
the Tube Sharks"

This wonderful book sells
for only \$1.00

PACIFIC RADIO PUB. CO.
San Francisco

Stations Don't "Bunch" On the Dials

Showing stations "bunched" as they are found on a 100 degree dial using any ordinary condenser.

The location of the same stations on the same dial using Ultra-LowLoss Co. condensers—"spread," simplifying tuning.

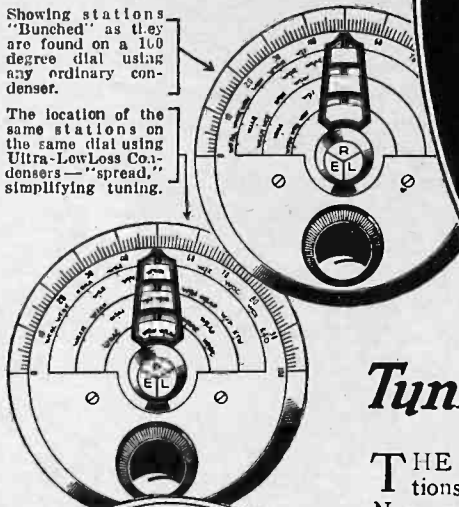

ULTRA-VERNIER TUNING CONTROL

Simplifies radio tuning. Pencil record a station on the dial—thereafter, simply turn to the slider to your pencil mark and you get that station instantly. Easy—quick to mount. Eliminates fumbling, guessing. A single vernier control, gear ratio 20 to 1. Furnished clockwise or anti-clockwise in gold or silver finish.

Silver, \$2.50
Gold, \$3.50

This seal on a radio product is your assurance of satisfaction and a guarantee of Lacault design.

At your dealers, otherwise send purchase price and you will be supplied postpaid.

ULTRA-LOWLOSS CONDENSERS



.0005 mfd

\$5.00

PATENT PENDING

Tuning Simplified Now!

THE day of tedious fumbling about for your stations is past—science has been brought into play. Now, with the Ultra LowLoss Condensers you can instantly tune in on any station as easy as turning the hands of a clock to the hour.

With one station of known wave length located on the dial, all others can be found instantly. Each degree on a 100 degree dial represents approximately $3\frac{1}{2}$ meters difference in wave length. This applies to both high and low wave lengths. Other than 100 degree dials vary accordingly.

This simplification of tuning is made possible by the new Cutless Stator Plates to be found only in the Ultra LowLoss Condensers. Every feature of the Ultra-LowLoss Condenser was developed with one predominating purpose—to overcome losses common in other condensers. Designed by R. E. Lacault, originator of the famous Ultradyne Receivers and Ultra-Vernier Tuning Controls.

Design of lowloss coils furnished with each condenser for amateur and broadcast wave lengths showing which will function most efficiently with the condenser.

TO MANUFACTURERS WHO WISH TO IMPROVE THEIR SETS.

Mr. Lacault will gladly consult with any manufacturer regarding the application of this condenser to his circuit for obtaining best possible efficiency.

ULTRA-LOWLOSS

CONDENSER

PHENIX RADIO CORP.

114-B East 25th Street
New York City

Pacific Coast Representatives: CARL A. STONE CO., 644 New Call Bldg., San Francisco;
1116 Minor Ave., Seattle; 429 Insurance Exchange Bldg., Los Angeles

\$3.50

Each.
Set of 3
With
Brackets
and
Screws,

\$10.50



AERO-COILS The Lowest Loss Inductance System

Replace your tuning inductances with Aero Coils. You will be amazed at the immediate, tremendous improvement in performance!

So low is the circuit resistance of the Aero Coil that it tunes sharply into resonance, thereby giving you knife-like selectivity; so minute is the distributed capacity of its air spaced windings and so infinitesimal is its dielectric absorption loss that energy delivery to the vacuum tube reaches a new high maximum, even at the higher waves—giving you absolute clarity and much greater volume!

Use Aero Coils in your tuned R. F. receiver with .00035 condensers. They will take you below 200 and above 600 meters. Use them in any set where an inductive grid coupling is required. Get them at your dealers.

Manufactured by
HENNINGER RADIO MFG. CO., Dept. 35, 1772 Wilson Ave., Chicago

Pacific Coast Rep.: S. A. WNSOR, 1221 W. 16th St., Los Angeles, Calif.

Advertising a Fact



THE service of this Burgess Radio "A" Battery is and has been its greatest advertisement; its present recognition and world-wide use is one of the most outstanding tributes paid to a quality product in the radio field.

To date we are widely sustained in our opinion that no other dry cell Radio "A" battery approaches the combined electrical efficiency and economical service of the especially designed Burgess Radio "A."

Use the Burgess Radio "A." Test it. Compare the service in any manner you wish.

"ASK ANY RADIO ENGINEER"

BURGESS RADIO BATTERIES

BURGESS BATTERY COMPANY
Engineers - DRY BATTERIES - Manufacturers
FLASHLIGHT - RADIO - IGNITION - TELEPHONE
General Sales Office: Harris Trust Bldg., Chicago
Laboratories and Works: Madison, Wisconsin

In Canada: Niagara Falls and Winnipeg



MALABAR

(Continued from page 10.)

alternator installations with the ordinary 500 watt radiocasting station, and some idea will be gained of the enormous amount of apparatus and power that is required to transmit over distances of 5,000 miles or more on the long wavelengths.

Several elaborate receiving systems are installed in the weird looking "receiving pavilions," as they are called, most of the apparatus being manufactured by the Telefunken Company of Germany. Many of the distant stations are received on underground aerial systems, with the aid of multi-stage tuned radio frequency amplifiers. Five underground systems are maintained in constant operation, as many as 10 vacuum tubes being used in each set of amplifiers. In the lower right hand illustration may be seen the frequency meters, which are used as standards for adjusting the transmitters, as well as the receiving equipments.

Located in a setting of magnificent scenery, this station presents a striking contrast to most of our American stations, which are usually found in flat country, with no mountains adjacent. While it is expected that the arc transmitter will shortly increase power to 3,600 kilowatts, in order to have reliable daylight communication with Holland during the summer months, undoubtedly this station will ultimately be equipped with a set of high powered vacuum tubes using only a small fraction of the power required for the arc transmitter, and perhaps on a wavelength close to that of the experimental 5 kilowatt transmitter now operating on 85 meters.

STATIC ELIMINATION

(Continued from page 22.)

called static waves. It worked very nicely, and although there was no total elimination of so-called static, it was possible to operate with this system when it was necessary to abandon the overhead system of reception. This system will work equally well on short wavelengths for radiocast reception and this summer numerous tests will be conducted in various parts of the country in order to prove conclusively that it can be done. It is not promised that there will be a total elimination of so-called static but it will be possible to receive with this antenna system when it will be impossible to receive over long distances with an overhead antenna system.

Now, we have reached the point where everyone who has absorbed all that preceded has a general working knowledge of this problem which confronts all of us today. We have arrived at the conclusion that while we can "separate cream from milk, it is an impossible task

Clarity and Tone Range With Kellogg Transformers

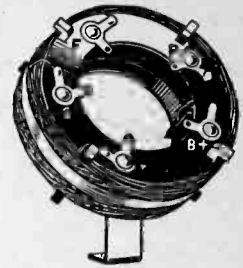

The reproductions of the highest tones as well as those of the lower extreme of the scale, with faithful, pure quality, is essentially the spirit of Kellogg Transformer design.

The Kellogg radio frequency transformer is of the low loss type, having many important features. It will operate at all wave lengths with .00035 to .0005 variable condensers. For best results, use the Kellogg .0005 low loss variable condenser. Kellogg R. F. Transformers at all dealers.....\$2.35 Kellogg audio frequency transformers give greater volume with clearer reproduction, due to the high quality materials and expert workmanship, used in the Kellogg process of manufacture. Kellogg audio frequency transformers are made in both shielded and unshielded types ranging in price from \$3.50 to \$4.50.

Kellogg transformers can be obtained at all radio dealers.

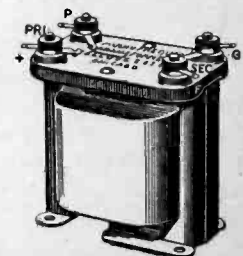

Kellogg Switchboard & Supply Co.
1066 W. Adams St., Chicago, Ill.

SEND FOR TRIAL SUBSCRIPTION
\$1.00 FOR SIX MONTHS

RADIO BOOK only

514 PAGES—Greatest book on Radio ever written. New—authoritative—complete. Packed with sound, practical information useful to every radio fan. Send \$1 to-day. Money back if not satisfied.
International Correspondence Schools
Box 8264-C, Scranton, Penna.

\$1

The New CHELSEA SUPER-FIVE

West of Rocky Mountains.....\$55.00
East of Rocky Mountains.....\$50.00
Chelsea Radio Co., Chelsea, Mass.

WITH better and more powerful broadcasting—

and with a sensitive, responsive Telemonic III receiver—the fascination of radio continues this year, regardless of the calendar.

Write to Danziger-Jones, Inc. Dept. R, 25 Waverly Place, New York, for Booklet, "The KIT of a Thousand Possibilities."

TELOS RADIO

de forest

The Greatest Name in Radio



\$2.00

All Types Guaranteed

Send money order plus 10 cents Postage and we will send you a New Tube. No old Tubes required.

C. A. W. Laboratories

608 Chestnut St. Philadelphia, Pa.
Suite 405

You Can Get

Greater Reflex or Crystal Set Reception if you use the

BROWNLIE

Vernier Detector

\$2.00 at Your Dealer or Direct
ROLAND BROWNLIE & CO.
22 Saunders St. Medford, Mass.



NO STATIC NO DANGER OF LIGHTNING

THE Antennaphone

REPLACES THE AERIAL

IMPROVES RECEPTION

Gives wonderful results with any radio set. Not attached to, but merely placed under the telephone. Price One Dollar. Complete with insulated wire and simple instructions. At Your Dealer or Mailed C.O.D. on 3 days approval.

Antennaphone Co., 90 West St., N. Y. C.

to separate milk from milk." So it is with these so-called static waves and radio waves. They are very much alike, different enough, however to permit us to eliminate some portion of the static wave, but not without the sacrifice of some little portion of the radio wave.

Sometime ago while conversing on this subject with Lieut.-Com. Moses, U. S. N., retired, he suggested that the problem be attacked in the same manner as the pioneer steel hull shipbuilders went after the compass deviation trouble. It is common knowledge that the magnetism (residual magnetism) of the ship's hull offsets the compass. In order to overcome this magnetized iron strips were placed near the compass to offset the magnetism which is residual in the hull of the ship. This suggests the idea of fighting "fire with fire" or, in other words, injecting static into the receiver from another antenna system and offsetting the static effect which is brought in on the aerial which also brings in the signals.

This is much the same as taking an over-dose of poison to commit suicide, for it has the opposite effect. There seems to be lots of room for thought in this suggestion and it is possible that someone will solve the problem in some such way. For the present, we seem to be as far away from the solution as we were in 1909, insofar as the total elimination of static is concerned, but hope for the best.

The most effective fighter of static is a powerful transmitter. The greater the signal strength ratio to static strength the better reception is. When you are receiving a strong signal you know that the static is still present, but it is in the background. As the signal fades out the static continually rushes to the foreground and stands out wretchedly, since it is necessary to increase the amplification in the receiver.

Those who live a considerable distance from powerful radiocasting stations are forced to set their receiving equipment to the very last notch in order to pick up the programs and a receiver in this condition naturally responds very readily to local and nearby (so-called) static waves, as well as many parasitic waves produced by trolley cars, electric signs, arc lamps, street light and power lines, etc. It would therefore appear that the present situation depends on the power of the radiocasting stations, as only in that way, for the present, will year-round reception be possible to those living at a considerable distance from powerful stations.

In making a loop antenna, a couple of second-hand bearings can often be picked up for a few cents at an automobile wrecker's place.

Balkite Battery Charger. Charges 6 volt "A" storage batteries.

Price \$20
East of Rockies \$19.50
In Canada \$27.50

Balkite "B"—replaces "B" batteries and dry cells. Operates from light socket.

Price \$55
In Canada \$75

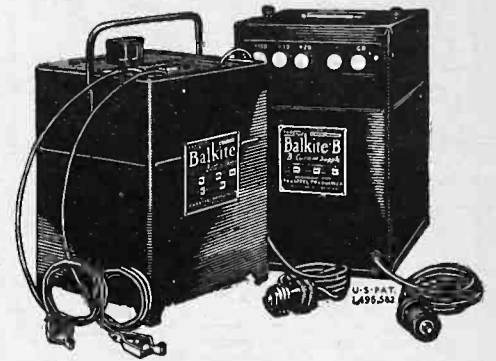

An unfailing power supply for both circuits

Here at last is an unfailing power supply for your radio set. Balkite Radio Power Units furnish constant uniform voltage to both "A" and "B" circuits and give your set greater clarity, power and distance. The Balkite Battery Charger keeps your "A" storage battery charged. Balkite "B" replaces "B" batteries entirely and furnishes plate current from the light socket. Both are based on the same principle, are entirely noiseless and are guaranteed to give satisfaction. Sold by leading radio dealers everywhere.

FANSTEEL PRODUCTS CO., Inc.
North Chicago, Ill.

PACIFIC COAST DISTRIBUTORS:
Seattle, George H. Maire, 95 Connecticut St. San Francisco, A. S. Lindstrom, 274 Brannan St. Los Angeles, Lombard J. Smith, 324 N. San Pedro St. Portland H. A. Killam, 146½ N. 10th St.

JENNINGS & McCOLLOM CO.
407 Dooly Bldg., Salt Lake City, Utah
JACK L. HURSCHE CO.
1641 Stout St., Denver, Colorado

FANSTEEL *Radio*
Balkite Power Units

BALKITE BATTERY CHARGER
BALKITE "B" PLATE CURRENT SUPPLY

MELCO
SUPREME RECEIVER

BY
AMSCO PRODUCTS, INC.
BROOME & LAFAYETTE STREETS, NEW YORK
443 PACIFIC BLDG., SAN FRANCISCO, CALIF.

SHARPEST TUNING

When You Use a
LOPEZ

Low Loss Tuner

Price \$10.00

At your dealer's or sent postpaid
A. C. LOPEZ & CO.
234 Fifth Avenue, Dept. R-4
New York City

Tell them that you saw it in RADIO



KIMLEY
STORAGE BATTERY
"B" ELIMINATOR
SIMPLICITY
PERMANENT
ALKALINE STORAGE
BATTERY RECEPTION

KIC-O MULTI-POWER UNITS operate from your lighting line and eliminate the replacing of dry cell "B" batteries... usually saving their cost in the first six to twelve months of service on Neutrodyne and Super Heterodyne sets.

Its RECHARGER is attached to back.

Guaranteed Two Years PRICES MULTI-POWER UNITS (Complete)
130 volt P.U. \$43.50
100 volt P.U. \$35.00
100 volt C.U. \$32.50

Power — Economy — Performance
Unexcelled for better Radio. Backed by years of research. Write NOW for SPECIAL FREE TRIAL OFFER! DEALERS! EVERYBODY!

KIMLEY ELECTRIC COMPANY, Inc.
2661 Main Street, Buffalo, N. Y.

ARE YOU A SUBSCRIBER?
SEND FOR TRIAL SUBSCRIPTION
\$1.00 FOR SIX MONTHS



VOLUME

3 1/2 TO 5

IF YOU want volume without distortion, use Supertran Audio Transformers. They are shielded, assuring absolute protection against damage to the coil while mounting.

\$6 AT ALL DEALERS

Distributed by

Philip Chandler & Co., Boston, Mass.; L. W. Cleveland & Co., Portland, Me.; Gray Sales Co., Philadelphia, Pa.; The Beckley-Ralston Co., Chicago; Waite Auto Supply Co., Providence, R. I.; Coast Radio Supply Co., San Francisco; Radio, Ltd., Montreal, Canada.

Ford Radio and Mica Corp.
111 Bleeker Street New York



REGISTERED U.S. PATENT OFFICE

AUDIO TRANSFORMER

ELECTRICAL CODE

(Continued from page 18.)

tem from high-potential surges and kick-backs there shall be installed in the supply line as near as possible to each radio-transformer, rotary spark gap, motor and generator in motor generators set and other auxiliary apparatus one of the following:

1. Two condensers (each of not less than 1/10 microfarad capacity and capable of withstanding 600 volt test) in series across the line with mid-point between condensers grounded; across (in parallel with) each of these condensers shall be connected a shunting fixed spark-gap capable of not more than 1/32 inch separation.

2. Two vacuum tube type protectors in series across the line with the mid-point grounded.

3. Resistors having practically zero inductance connected across the line with mid-point grounded.

NOTE: It is recommended that this third method be not employed where there is a circulation of power current between the mid-point of the resistors and the protective ground of the power circuit.

4. Lightning arresters such as the aluminum cell type.

These provisions need no explanation.

Some power companies will not permit any transmitting set to be attached to lighting circuits and in general this is a good rule to follow. However, if it is necessary to obtain power from the lighting circuit some certain conditions will determine the wattage capacity of the equipment which may be permitted.

Fuses in a branch lighting circuit (ordinary 110-volt system) shall not exceed 15 amperes in capacity. Therefore the size of the transmitting set will be limited by the other lamps or devices in the circuit as the combined load shall not exceed 15 amperes. If the transformer or motor of a motor-generator set is to be attached to a socket or receptacle by means of a cord and attachment plug, the capacity will be limited as above or by the rated capacity of the socket or receptacle. Some of these are rated at 250 watts and others at 660 watts, and, of course, approved devices are to be used.

As pointed out in the beginning of this article radio interests have had a part in the formation of these rules and on the part of no one has there been any desire or inclination to put forth regulations which were not deemed necessary. As they stand the rules have been adopted as a standard by many interests, among them, underwriters and insurance companies.

To insurance engineers radio is a hazard. That does not mean necessarily that it is more dangerous than some of the other electrical devices or appliances in common use in the house. All things possess inherent or potential hazards but not all to the same degree. Radio installations have caused fires, and undoubtedly defective radio installations will cause more fires. Therefore, to a greater or less degree, a radio installation is a hazard. But this fact will not prevent your obtaining insurance on your

EBY
PATENTED
BINDING POSTS

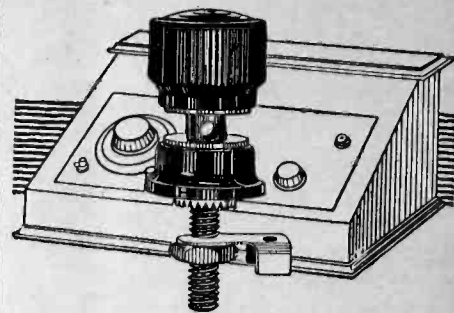

Standard Equipment
On 150 Manufacturers' Sets

Unvarying, built-in superiority made them select EBY posts. They are your logical choice, too. Furnished either plain or engraved in twenty-five different markings and the base of every post is clearly marked EBY.

The Tops Don't Come Off

15c --- At All Dealers --- 15c

The H. H. EBY MFG. CO., Phila., Pa.

THE SILENT
FRANCE
MULTI-DUTY
SUPER-CHARGER

PROVEN SUPERIOR!



France Silent Super Charger charges 2, 4, 6 or 8 volt storage battery at 5 to 7 ampere rate; charges 20 to 120 volts of "B" Radio storage batteries IN SERIES at varying rates as desired.

Price \$22.00; West of Rockies \$23.00. Canadian prices upon request.

The France Mfg. Co. 10323 Berea Road
Cleveland, Ohio

Authorized Cockaday Coil - \$5.50

Precision Autodyne Coupler - \$3.50

PRECISION COIL CO., Inc.
209 CENTRE ST., NEW YORK CITY

Specialists in the manufacture of all types of radio coils

"RADIOCAST WEEKLY"

A 48-Page Magazine of Programs, Photos, etc., of Pacific Coast Radiocasting Stations
5c per Copy--Radiocast Weekly
433 Pacific Bldg., San Francisco

with the \$100 Guarantee



Absolutely warranted to protect your set from lightning, with a guarantee to pay you \$100 or repair your set, should it be damaged through any fault of the

FIL-KO-ARRESTER.

Listed as standard under the re-examination service of National Board of Fire Underwriters.

If your dealer has none, send his name with remittance to Dept. R-625

DX Instrument Co.
Harrisburg, Pa.

\$2.19 IN CANADA



ARE YOU A SUBSCRIBER?
SEND FOR TRIAL SUBSCRIPTION
\$1.00 FOR SIX MONTHS



The 100%
Self Shielded
Transformer

has made a big hit with both set makers and set manufacturers because of its small size, its amazing volume, and most of all, because of its pure, undistorted tone. It is half the size of other transformers, but its results are unsurpassed. Absolutely new and scientific design and construction. Ratios 1 to 3, 1 to 4, 1 to 5, \$3.50; Ratio 1 to 10, \$4.50. SEND FOR BULLETIN No. 94. Read all the exclusive features of this and other Premier parts. Tells how to get free hook-up diagrams beautifully printed in two colors.

Premier Electric Co., 3813 Ravenswood Ave., Chicago

PREMIER Quality Radio Parts

The Five Tube Set which startled the World!

FRESHMAN MASTERPIECE

The Greatest Value Ever Offered in A Radio Receiving Set

For sale by authorized Freshman dealers only.

home if you have a radio installation. If insurance companies carried insurance only on buildings in which no hazard existed there would be very few insurance companies in existence for not many policies would be written. As a rule the rate at which the policy is written is somewhat of a measure of the hazard. If your installation were defective that fact might be reflected in the rate.

Carelessness is one of the greatest factors contributing to the great fire loss in the United States and disregard for proper methods of safeguarding hazards may be classed as carelessness. Correct installations will minimize the possibilities of loss and assure you a greater feeling of security from fire.

IMPEDANCE COUPLED AMPLIFICATION

(Continued from page 21.)

To show what results can be obtained if such tubes become available, a tube whose amplification constant is 30, and which is used in practically every radio-casting station of importance in this country, was compared with the tube used in the other impedance coupling measurements described in this article. The coupling constants were $L=350$ henries, $C=1$ mfd., $R=500,000$ ohms. The results are shown in Curve VI of Fig. 3, which shows that the amplification obtained with the high "mu" tube is as great as that from the average transformer coupled stage and the frequency characteristic is better than the best of the transformer coupled amplifiers.

In Fig. 4 is shown a correctly designed 3 stage impedance coupled amplifier, for the vacuum tubes now available, and capable of supplying a good loud speaker with ample volume for all ordinary purposes, at the same time giving the best possible quality of reproduction.

(To be concluded.)

QUERIES AND REPLIES

(Continued from page 39)

low a loss loop as you will require, as the turns are well spaced, from each other, and the supporting dielectric is of the best. A loop wound basket weave fashion will not be as satisfactory as the loop described in RADIO, and would be infinitely more difficult to construct. No 18 single fixture wire is a good grade of stranded wire to use, and can be stretched tightly enough to stay in place, without much effort.

What is the largest antenna that I can build for use between 200 and 500 meters with particular reference to the length?

K. L. B., San Francisco.

For a height of 50 feet, the antenna may be 150 feet long without seriously affecting the tuning around 200 meters provided that a series condenser is used in the antenna.

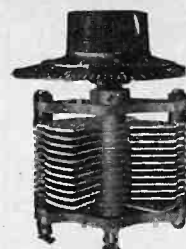

Easy to Install
Easy to Tune
PROUDFOOT
LOW LOSS!
CONDENSER

Just a half-inch hole drilled in your panel is all that is necessary to install the Proudfoot. And after it is mounted it can be tilted to the most efficient working angle merely by loosening the locknut.

The Proudfoot tunes just as easily as it mounts. Rough adjustment is made by turning the whole knob. Vernier adjustment is made by turning the pointer section only. Second scale gives definite vernier reading. Made in the following sizes and favorably priced.

Number of Plates	M. F. C.	With Vernier Dial and Knob	Without Vernier Dial and Knob
13	.00025	\$3.75	\$3.25
17	.00035	4.40	3.90
25	.0005	4.50	4.00
43	.001	5.75	5.25

Get one at your dealer's today. If he cannot supply you write us. Circulars on request.

CRUVER MANUFACTURING CO.

2456 W. Jackson Blvd.

Chicago, Ill.

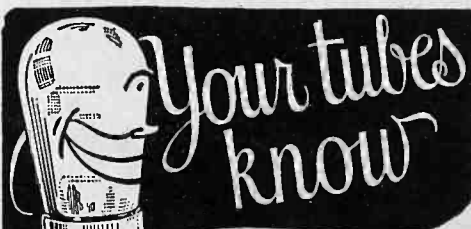

Your tubes know

The Difference—

When Using AMPERITE

AMPERITE the "self-adjusting rheostat", automatically controls the flow of current, and makes hand controlled rheostats obsolete.

Permits the use of any type of tubes or any combination of tubes. Specified in every popular construction set.

For perfect results you must use AMPERITE for filament control. Price \$1.10 everywhere.

RADIALL COMPANY

Dept. R-12 50 Franklin Street, New York City



Write for FREE Hook-ups

AMPERITE
REG. U.S. PAT. OFF.
"means right amperes"



Bracket mounting type,

For battery, antenna and ground leads

Jones
MULTI-PLUG
THE STANDARD SET CONNECTOR

Lombard J. Smith
24 N. San Pedro St., Los Angeles, Calif.
A. S. Lindstrom
274 Brannan St., San Francisco, Calif.
Mr. H. A. Killam
146 1/2 N. Tenth St., Portland, Oregon
Mr. G. H. Maire
95 Connecticut St., Seattle, Washington
JENNINGS & McCOLLOM CO.
407 Dooly Bldg., Salt Lake City, Utah
JACK L. HURSCH CO.
1041 Stout St., Denver, Colorado
HOWARD B. JONES
614 S. Canal St., Chicago

DONGAN

35 Types Audio Transformers

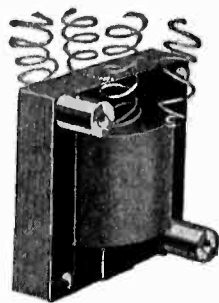

Dongan builds an Audio Transformer for any possible requirement — it is for this reason Dongan Transformers are the choice of so many of the forward-looking set manufacturers. No matter what the requirements, Dongan builds the transformer best suited — unmounted (coils and laminations); semi-mounted furnished with bushings and clamps; mounted types — both shields and otherwise.

Unmounted—CBS—5157.
34 Other Types for Every Set.
Ratios—2-1, 4-1, 6-1.

All Dongan Transformers are constructed for the highest degree of performance. Perfectly balanced transformers, guaranteeing uniformly fine reception. Dongan Transformers already are used as standard equipment by 38 of the leading Set Manufacturers.

Panel Voltmeters
5 Types
0-7 Volts to 0-100 Volts
List Prices:
\$1.75 to \$2.00

Manufacturers Quoted on Request.

Jobbers: Get Dongan electro for your catalog.

DONGAN ELECTRIC MFG. CO.

2981 Franklin St., Detroit, Michigan

Distributors for Western Coast:

SIERRA ELECTRIC CO.

515 Market St., San Francisco

443 S. San Pedro St., Los Angeles

222 Hinckley Bldg., Seattle

ROBINSON SALES CO.

53 Fourth St., Portland, Oregon

Transformers of Merit for Fifteen Years

DUAL RECEPTION

(Continued from page 37)

there was no signal in the phones of detector No. 1. The difference between 310 and 300 meters, or 10 meters, was thus found to be sufficient to satisfy the condition that the two signals be free of interference from each other. The actual volume in practice is no doubt even less than 10 meters, since the latter value was obtained by using a broad incoming wave characteristic of buzzer excited oscillations.

Returning to Fig. 3, detector No. 2 is seen to be connected across L_4 which as described above has not only the desired amount of inductance but also a considerable distributed capacity. Depending on the winding of the variometer or coil, then, it is possible that for one particular value of L_4 , it will be in resonance with the natural frequency of the circuit. The impedance between points C and D will consequently be zero and no signal will be heard in the phones of detector No. 2.

To overcome this possible difficulty, a circuit X may be used, (see Fig. 4) loosely coupled to L_1 and L_2 in such a manner that when the currents through L_1 and L_2 are in opposite directions, the induced voltages due to these currents add up in the loose-coupled circuit. With such an arrangement, when the currents are circulating in the same direction, the currents through L_1 and L_2 are in the same direction and will induce opposing e. m. f.'s in the coupled circuit. The detector No. 2 is therefore just as independent of the value of C_3 as if it were connected across points C and D . The two inductances of the circuit X may be of ten turns each, and the condenser of 2,500 micro-microfarads.

In general, however, rather than using this auxiliary circuit with its additional apparatus and also its extra control, it is preferable to miss the wavelength which makes L_4 in resonance with the natural frequency of the circuit, provided of course there is such a wavelength.

ARE YOU A SUBSCRIBER?
SEND FOR TRIAL SUBSCRIPTION
\$1.00 FOR SIX MONTHS

"B" BATTERIES

AN
EVEREADY
PRODUCT

At Standard Prices

43V. Batteries, tapped
22½ V. Batteries, Navy Type
22½ V. Batteries, Commercial Type

Latter two types especially adapted to
Cunningham and Radiotron Tubes.

Postage Prepaid Anywhere in U. S.

ETS-HOKIN & GALVIN
Wireless Engineers

10 Mission Street San Francisco

Solicitor of Patents and Trade Marks Counsellor in Patent Causes Specializing in Radio & Electrical Inventions

JOHN FLAM

formerly of the Examining Corps, U. S. Patent
Office, also of the Patent Department,
General Electric Company

MEMBER OF THE FEDERAL BAR
821 Merchants National Bank Bldg.
Phone TUCKER 7471
LOS ANGELES, CALIF.

MUSICAL QUALITY

DX RECEPTION, SELECTIVITY and NOISE
ELIMINATION is improved to an unusual degree by the use of NEW YORK COIL COMPANY'S PRECISION MICA FIXED CONDENSERS.

Used by the leading set manufacturers

Our "Selector" Variable Condensers, Mounted and Unmounted Audio Transformers and Battery Eliminator Condensers, are leaders.



New York Coil Co.

338 Pearl St. New York City
Pacific Coast: Marshank Sales Co.,
926 Ins. Exch. Bldg., Los Angeles, Calif.

FREE RADIO BOOK

Write for 64 page Handy Book
on Principles of Radio by eminent radio authority. Contains book ups
and other valuable data. Send 4c in stamps to cover mailing and postage.
Dietzen, Inc., Dept. A 71 Cortlandt St., N.Y. C.

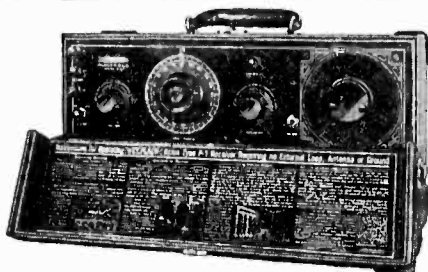

The Famous Truly Portable TELMACO P-1 Receiver Four Tubes Do the Work of Seven

The peer of portables in size, weight, ease of tuning, selectivity, distance, volume, workmanship and price. Aerial, loud speaker and batteries self contained. Complete with tubes and batteries. \$125.00
\$148.50. Receiver only

P-1 Kit Saves You Money!

Our offer of the Telmaco P 1 Receiver in kit form has met with enthusiastic reception. This contains all parts, as built by us, including case, drilled and engraved panel, and illustrated instructions. \$80.00 Complete kit
Ask your dealer or write us. Descriptive folder free.

Radio Division:

Telephone Maintenance Co.
20 So. Wells St. Dept. A Chicago, Ill.



Quality Radio Exclusively Established 1918

Exide

RADIO BATTERIES

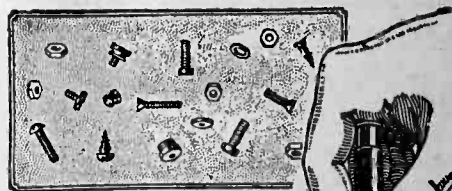

ONE C & C REACHIT

WRENCH
TAKES THEM ALL

No necessity to pick over a half dozen wrenches to fit one nut when you use a REACHIT wrench.

It not only fits all sizes but automatically HOLDS THEM ALL firmly (with adjustable jaws) while getting into the intricate positions.

NO OTHER WRENCH CAN DO THIS
It assures a tight connection in the hard-to-get-at places.

A REAL TOOL FOR MECHANIC, ELECTRICIAN & RADIO BUILDER

Nickel finish—Hardened jaws and Fully Guaranteed.

PRICE \$1.00

If your dealer cannot supply, will be sent post paid on receipt of above amount and your dealer's name

CAUFMAN & CLOUGH CO.
Wilmington Delaware

The Quiet NILES



Battery Charger

TAKES LESS TIME

The only charger that uses both sides of alternating wave in charging. Converts 72% of current into battery charge—at 8 to 10 ampere rate. Quick action. Low upkeep. Model A for 6-volt batteries, \$19.00; Model AB for 6-volt and 24-volt batteries, \$21.00. West of Rockies, \$1.00 extra. Ask Any Radio Dealer.

NILES MANUFACTURING COMPANY
Dept. 75, Ypsilanti, Mich.
Coast Representative: CLARK & CLOSE,
1609 Pine St., San Francisco, Calif.

ARE YOU A SUBSCRIBER?
SEND FOR TRIAL SUBSCRIPTION
\$1.00 FOR SIX MONTHS

CALLS HEARD



By C-308, A. D. Macpherson, Boyd Road, Nundah, Queensland, Australia.

U. S. A.: 2acp, 2bgl, 5lr, 5ok, 5ox, 5ux, 6apt, 6weaf, 6cso, 6jy, 6agw, 6css, 6ut, 6vt, 6chs, 7czy, 7gq, 7lw, 7gq, 8cbp, 9bcw, 9rw, kel.kgo. Canada: 5ba. Would like to correspond with American Yanks.

By J. deR. Sarinva, Macao, China

2ap, 2by, 2rk, 2cjb, 3ju, 3xi, 3ee, 4iz, 5go, 5dw, 5qy, 5sd, 5afu, 5cv, 5bz, 6cmu, 6awt, 6sf, 6fb, 6apw, 6cto, 6akw, 6ew, 6bcl, 6vc, 6amo, 6aea, 6agk, 6cqe, 6zh, 6cgw, 6bkl, 6afg, 6cni, 6ew, 6at, 6ctc, 6bpf, 6ccy, 6ase, 6xad, 6bve, 6ac, 6chl, 6bge, 6bb, 6fy, 6cix, 6qi, 6bez, 6wp, 6cgo, 6bur, 6agn, 6uc, 60l, 6eb, 6no, 6hm, 6alv, 6dao, 6app, 6aww, 6kb, 6ct, 6bmw, 7fd, 7lr, 7qd, 7uj, 8ba, 9zt, 9cvo, 9bhi. All heard on 75-85 meters band. The amateurs 6awt and 6cgo have been heard sometimes without aerial or earth. Miscellaneous: wgh, ket, nkf, lpx, ane, hva, jaa. On 20 meters band: ulhk, Aus 2cm, jjaa, 6xad, 6ts. On 30 meters: pox, lpx.

By H. C. C. McCabe, 71 Holloway Road, Wellington, N. Z.

U. S.: 1cmp, 1cc, 1cr1, 1alw, 1aao, 2ag, 2buy, 2gk, 2acs, 2er, 2xbb, 3ac, 5zai, 5rg, 5ce, 5ail, 6no, 6vo, 6ajq, 6bjv, 6cto, 6cdg, 6alf, 6cub, 6crs, 6aji, 6agw, 6chi, 6crw, 6bbq, 6dax, 6bjx, 6yb, 6bh, 7abb, 7lh, 7df, 8bcv, 8byn, 8bjc, 8dka, 8bch, 8bve, 8ba 9co, 9dwx 9avy, 9ejy, 9cyd, 9ebf, 9ig, 9zt, 9amx, 9del, 9bpn, 9dix, 9cfs. Chile: 9tc. Mex.: bx.

At 2-BUY, Bradley Park, N. J.

(4ea), 4fm, (4mi), (4oi), (4ry), 4ux, 5aab, 5aeg, 5aek, 5ac, 5ca, 5fj, (5fq), 5ms, (5uk), 5xa, 5xau, 5zai, 6alf, 6bes, 6bik, (6buj), 6dg, 6yb, 7df, (7ls), (7mx), (pseqs!!!), (9abs), (9adk), 9ado, (9afe), (9alo), (9axb), (9axq), 9axx, 9bdp, 9bek, (9bfi), 9bjz, 9bhm, (9bpn), (9brk), 9bt, 9djr, (9dka), 9dqr, 9et, (9ev), 9qr, (9rw). Canadian: 1ar, (1eb), 2am, (2ax), (2au), (3dh), 3kq, 3tv, 9bj. Porto Rico: (4oi). British: 2nm. Cuban: 2mk, (2lc), pse, qsl!!!. Miscellaneous: dil, qra?, hva. All cards appreciated and answered despite the raise in postal rates. Hl.

By SATX, Canton, Ohio.

4aa, 4ai, 4ao, 4ak, (4bq), 4bo, 4bw, (4bz), 5bk, (bx), 4cp, 4cv, 4da, 4db, 4dv, 4do, 4dy, 4eb, 4eq, 4er, (4ez), 4ey, (4fd), 4fz, 4fi, 4gw, 4gz, 4hr, 4ho, (4ja), 4jb, 4jr, (4lo), 4ln, (4un), (4uc), (4va), 4oo, 4lb-??, (4vn?), 4wa?, (4wc)?, 4ws?, (4xe), 4xb, 5aa, 5aal, 5aab, 5aaq, 5abc, 5acj, (5acf), 5add, 5adq, (5ade), 5ads, (5aex), 5aey, 5afa, (5afu), 5agl, 5aol-?, 5aef, 5ais, (5arr), 5aiy, 5amk, 5ams, 5amt, (asj), 5asy, 5ass, 5ath, (5att), (5atx), 5aur, 5auz??, 5ar, 5ab, 5aa, 5bq, 5bg, 5er, (5hr), 5mq, (5fh), gra, 5ik, 5ym, 5qx, 5rq, 5pi, 5vo, 5vi, 5wo, 5xat, 5xx, 5zav, 5zas, 6aa, (6ab), 6ae, 6ao, 6ap, 6aam, 6apw, (6apz), 6afh, 6afj, 6agk, 6apw, 6ano, 6ahp, 6aan, 6aao, 6ar, najp, 6bnw, (6awt), 6bnw, 6ano, 6anb, 6bur, 6bub, 6baa, 6bjj, (6atw), 6bjo, 6bjx, (6bbv), 6bng, 6bdx, 6bol, 6bko, 6bku, 6bux, 6bul, 6bvo, (6bwo), 6bwi, 6bwz, 6bss, 6caa, 6cae, 6cva, 6cvb, 6cmp, 6cmq, 6ctq, (6cuw), 6cto, 6ctq, (6cqw), 6ctw, 6cix, 6cve, 6cc, 6eo, 6ceo, 6cd, 6al, 6ua, 6bk, 6ro, 6eo, 6rn, 6rb, 6rj, 6wt, 6qb, 6qa, 6fs, 6fo, 6rf, (6xad), 6xaa, 6xam, 6yl, 6zt, 7ao, 7ab, 7ald, 7abb, (7ajf), 7bs, 7abb, 7qb, 7gb, (7gy), 7gy, 7gs, 7la, 7ls, 7ey, 7vs, 7qd, (7st), 7sl, 7zf, 7zz-gra?. Mex.: (jb) gra??, 1b, bx, laa, 1k, 1af, 1m. Porto Rico: (4sa), 4je, 4oi. Can.: 1dq, 1bq, 2av, (3fs) gra?, (3afz) gra?, 3acf, 3nl, 3oa, 4ch, 4cr, (4hh) gra?, 5hc, 5bn, 5bz, 5ct, 5ba, (9aot) gra?. English: 2ja, 2jf, 2kf, 2ky, 2od, 2wj, 2cc, 2sh, 2vb, 3ay, 3vz, 5lf, 5lj, 5na, 5nn, 5qv, 6lo, (5bk?), 5pu, 6lu. French: 8ab, 8ba, 8go, 8ssc, 8ae, 8sm. N. Z.: 4aa, 4ag, 2ac. Aust.: 3qb or 3ba. South America: wjs, ch9tc. Argentina: rc8. Cuban: 2lc.

HVA? heard here about February 25, 1925. PKH? heard here about March 2, 1925. Will QSL to anyone who cares for a card. Please report SATX if you hear me. Transmitter 15 watt. A card awaits every QSL. 73's.

(Continued on page 62.)

A Pleasant Surprise Awaits the User of The A. C. H. Sharp Turner Dials

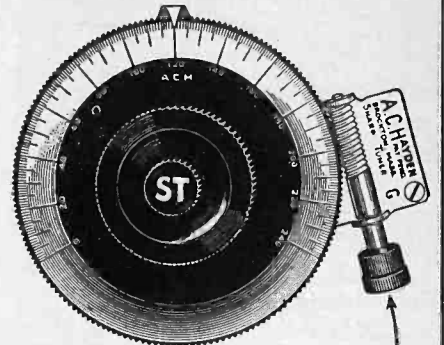

Why the A.C.H. is different

3 in. DIAL → ACH → 156-T0-1
4 in. DIAL → ACH → 215-T0-1

Will improve any receiving set, making difficult tuning easy

MONEY BACK GUARANTEE

Price 3-inch size...\$2.50 Price 4-inch size...\$5.00
Regular fitting 5/16 shaft 1/4 and 3/16...5c ea. extra

Extra Advantage of the A. C. H.

1. Can be attached or removed from any instrument.
2. Rough tuning same as any dial.
3. Movement so fine that the eye cannot detect but the ear can.
4. Automatically locks instrument so no jar can disturb it.
5. Dial grounded reducing the body capacity to a minimum.
6. Special dial 2 graduations where ordinarily one.

Mail Orders sent Prepaid in U. S. A.

A. C. HAYDEN RADIO & RESEARCH CO.
Brocton, Mass., U. S. A.

Just what you need



Valley Battery Charger

Here is just what you need to increase the pleasure and entertainment of your radio. With the Valley Battery Charger as part of your equipment, you need never miss a program because of a dead battery.

The Valley Battery Charger will completely recharge 2-volt peanut tube cells, 6-volt A batteries and from 1 to 4 B 24-volt batteries. It is the only charger necessary for all radio batteries.

Quiet in operation
Full 6-ampere charging rate
No liquids. No bulbs

Plugs into the ordinary light socket like a fan or other household necessity. Just as easy to operate. Takes only about a dime's worth of current to bring your battery up to full charge.

It has grained and engraved Bakelite panel which harmonizes with any radio set. Clear glass top shows the simple, patented working parts at all times.

At radio dealers everywhere

Valley Electric Co.

101 Rialto Bldg., San Francisco, Calif.

Special Summer Service for Readers of Radio World

First national illustrated radio weekly.

Every issue during the summer months will contain helpful articles by experts. Many hook-ups, and other valuable technical illustrations. Programs, Stations, etc.

\$6.00 per year (52 nos.), \$3.00 six months, \$1.50 three months, 15c all new dealers.

Special to Radio Readers:

Send \$1.00 for eight issues, or \$6.00 for Radio World for one year (52 nos.), and we will include Radio for one year free.

RADIO WORLD

1493 Broadway, New York City

Yours-free!



WHOLESALE RADIO SERVICE CO.
6-R CHURCH ST. NEW YORK CITY

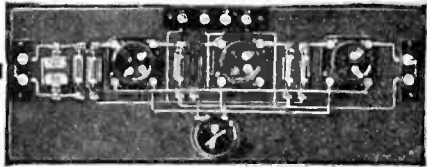

NEW!

Resistance-Coupled Amplifier Kit for only **\$5.00**

"Electrad" 3 Stage Resistance Coupled Amplifier Kit No. 1—

PRICE, \$5.00

Write for free diagram and instructions

ELECTRAD, Inc.

428 Broadway, New York City

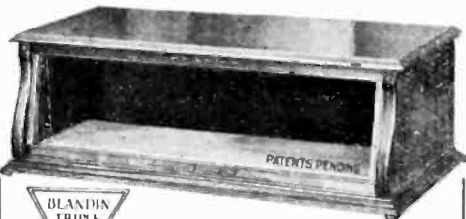

You'll Like This Duplex

One cabinet—

Any panel size, 7x26, 7x24, 7x21 or 7x18", Depth, 11".

Either straight or sloping panel—grooves, no screws.

Built of solid Honduras mahogany. Lacquer hand-rubbed piano finish. Entire lid raises. Full length piano hinge. Folding lid supports. Felt covered feet. Extra mounting board.

Write for Duplex price list. Dealers, write your jobber.

PACIFIC COAST DISTRIBUTORS:

L. D. Read & Staff, 518 Grant Bldg., Los Angeles, and 222 Chronicle Bldg., San Francisco.

Blandin
Radio Cabinets

Built by Blandin 1900 16th St. Racine, Wis.

JUST PUBLISHED!

Most fascinating radio book ever written! "Radio for Everybody" has created a sensation among fans. Everything—crystal to super-dyne, superheterodyne and all the rest of the "dyne" family. A complete Radio encyclopaedia. Written so everyone understands. 360 pages, 5x8. Profusely illustrated. Guaranteed biggest radio value today. \$1.65 postpaid. Satisfaction or refund. (Mail only). Order yours now and make your set 100 per cent efficient!

INVENTORS' LIBRARY BUREAU
RADIO DEPT.

417 West 21st Street, New York

DE LUXE SUPER

(Continued from page 13.)

out of the socket, also cutting it out with the small switch. Thus the set can be operated as straight superheterodyne, to make sure that this end of the receiver is working properly. This method should be followed because the first tube is liable to go into oscillation, even though it is cut out of the circuit with the small switch, if it is not properly neutralized. If this tube is oscillating, it will prevent the oscillator from functioning properly, causing distortion as well as innumerable heterodyne squeals and whistles.

If the straight superheterodyne is found to be functioning properly, the radio frequency tube should be replaced and thrown into the circuit with the small switch which is shown toward the top of the panel between the first two variable condensers. This should be done after some station is tuned in on the superheterodyne alone. After the radio frequency amplifier is placed in operation and the rheostat for the first three tubes readjusted slightly to compensate for the extra tube, the radio frequency tuning condenser should be brought into tune, at the same time increasing the loop tuning condenser two or three divisions.

This slight change in the loop tuning condenser is always necessary when shifting from straight superheterodyne to the radio frequency. The oscillator condenser need not be touched, as it will always tune at the same point for a given station, regardless of whether the stage of r. f. is used or not.

If a series of whistles and squeals are heard when this third tuning condenser is brought into resonance, it means that the first tube is oscillating. The small neutralizing condenser should then be revolved slowly until this condition ceases. Or, if it cannot be neutralized, the tap on the primary of the radio frequency transformer should be moved toward the plate end of the coil, as described above. When the proper tap is found, the first tube should neutralize at a point approximately one-half way on the neutralizing condenser scale; that is, with the plates half in mesh. Then when this condenser is moved either way, the tuned r. f. should go into oscillation. It will be found that when this is properly adjusted, the set is very stable and not difficult to operate or tune, although the tuning will be very sharp.

A slight change in the setting of the neutralizing condenser is usually necessary when shifting from very low to very high wavelengths—not more than three or four degrees on the dial as a rule. When using the straight super with the tuned r. f. cut out, the r. f. tuning condenser should be left with the dial at 0 setting, i. e., with the plates entirely out of mesh. In building this set, let me strongly recommend that no

change be made in the layout or the placing of the instruments. Do not turn the coils around facing in some other direction, or change the relative position of the tuning condensers, etc. The layout and wiring should be strictly ad-

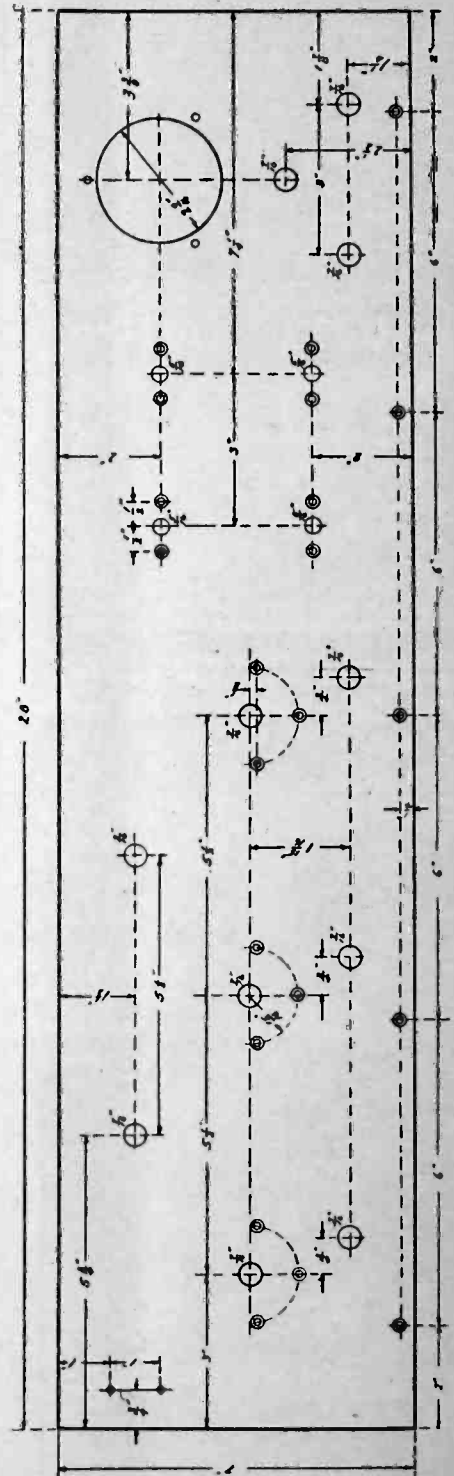

Fig. 5. Specifications for Drilling Panel.

hered to and if this is done, very little trouble will be experienced in properly adjusting the circuit.

I would not recommend the use of too large a loop with the set, as it is extremely sensitive and capable of a tremendous degree of amplification. In

MARWOL

Five-Tube Radio Receiver Offers the Greatest Dollar for Dollar Value in Radio.

MARWOL RADIO CORPORATION

Represented by

MARSHANK & COMPANY

962 Insurance Exchange Bldg. Los Angeles, Calif.

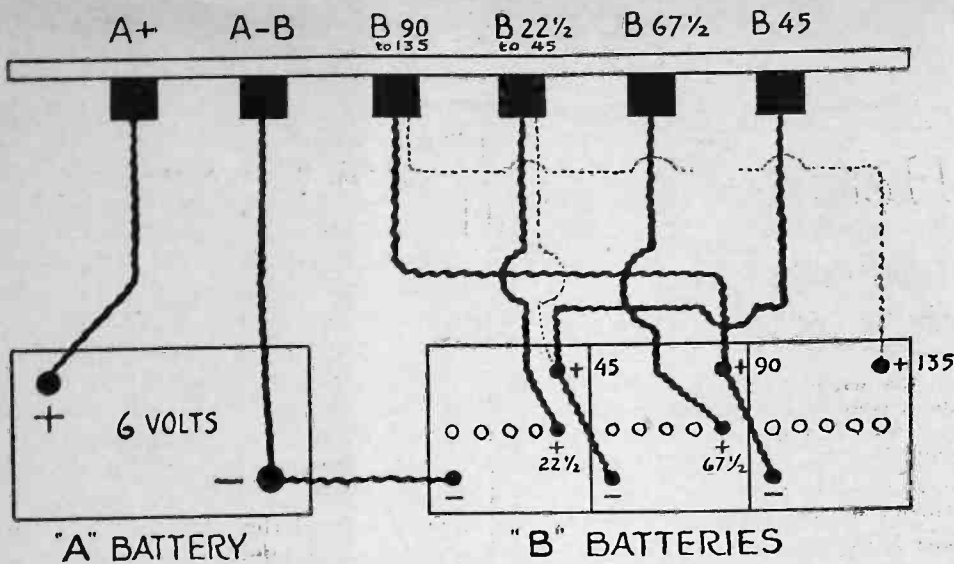

Fig. 6. Battery Terminal Arrangement.

fact very good work can be done using a coil as small as a honey-comb for a loop. In general, however, an average loop of approximately 2 ft. on a side will give very good satisfaction. If the radio frequency stage is working properly, it should give as much amplification as a good stage of audio. This can be tested for in the following manner: Tune in a signal with the r. f. tube thrown out by means of the small switch. Reduce the volume by means of the potentiometer until the signal is barely audible in the speaker, then throw in the r. f. and after tuning in on the r. f. condenser with a slight readjustment of the loop condenser, the signal should come out of the loud speaker with good volume, the difference being about what you would expect on an ordinary three tube set between one and two stages of amplification. This gives an indication of the tremendous gain derived from this single stage of tuned r. f. Furthermore, it must be remembered that this gain is entirely in the radio frequency or business end of the set and is not added audio amplification.

Several people have asked why it is necessary to use any special type of neutralized r. f. to accomplish this. Indeed it does sound rather simple to say add a stage of r. f. ahead of your super. But unfortunately to do this and obtain stable tuning and a real gain in amplification is not so simple a matter. If the use of a potentiometer or some ordinary type of neutralization is attempted in order to stabilize this tube, the result will almost invariably be a failure, or else very critical tuning will be required to accomplish any gain at all. It must be remembered that this circuit is tuned very closely to the same wavelength as the oscillator, which has a tendency to drive the r. f. tube into oscillation and this usually occurs before any perceptible degree of amplification is obtained.

The person who builds this set carefully and conscientiously, will be greatly surprised by the degree of amplification

that is obtained by the addition of this single tube. Of course the answer is that this gain is ahead of the entire super and that it increases geometrically as it passes through the set, being actually squared in both of the detector tubes. Thus it does not require a very great difference in the amplitude of the initial impulse to make a large difference in the output.

In closing it is well to say a word about the audio amplifier. Generally speaking, the quality of reproduction which is obtained from any radio set is mainly dependent upon the last tube or two, that is, the audio amplification.

In order to be as nearly perfect as possible the amplifier should be designed to give sufficient output to handle the particular loud speaker that is to be used with it. The amplifier used in the De Luxe Super is particularly good and you will find that the reproduction will be surprisingly accurate and far above the average even with a cheap speaker. Hence, if extreme volume is desired, it is recommended that the plate voltage for the last tube be raised to 135 volts, and the C battery to -9 volts, in order to have the best quality of output.

It will be noted that provision is made for plugging in the speaker on but one stage of audio amplification. The reason for this is that use is made of the two different types of characteristic curves existing in these two stages to give a resulting even amplification. If the single stage of transformer coupled amplification is used without the stage of impedance, the resulting quality will not be nearly as good as when both stages of audio are used. Hence the volume should be controlled with the potentiometer, or if desired, with a leak across the first transformer secondary as explained above, although this is not really necessary and hence has not been incorporated in the set.

Always remember to retard the third rheostat when the phones are plugged in on the detector jack as the two audio tubes are then cut out and the only load left on this rheostat is the final detector

tube. If the rheostat is retarded as far as possible in this case without turning it off, the detector tube will receive its proper filament voltage.

The DAVEN SUPER AMPLIFIER

will give to your receiver ample volume of wonderful quality. Completely assembled, easy to attach, low "B" Battery consumption.

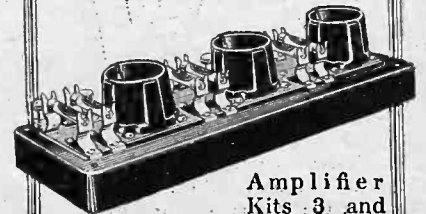

Amplifier Kits 3 and 4-stages.

The Resistor Manual at your Dealer 25 cents. Post-paid 35 cents.

The Sine of Merit
DAVEN RADIO CORPORATION
Resistor Specialists
NEWARK, N. J.

OLD MAN STATIC "KILLED" AT LAST

Statchoke Has Started the Radio World. Sent Direct to Radio Fans on 10 Days Free Trial

What is claimed to be one of the greatest modern improvements in Radio, through reduction of static and clearer, long distance and better quality of reception is announced for a new imported unit which is easily connected to any set.

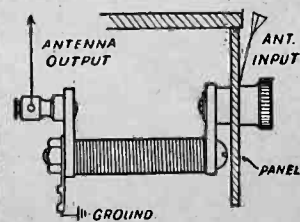

The Statchoke, as this unit is known, is of the transformer type. It collects the static and other variable currents outside the set, drawing them off through an independent ground connection. Other features claimed for the Statchoke are sharper tuning, better quality of both local and long distance reception, greater selectivity, especially on low wave lengths and a perfect safety lightning arrester. This unit was recently awarded a Certificate of Merit by the Radio News of Canada.

Owing to the limited number of Statchoke units available for American use this season, the distributors have set aside 25,000 units for distribution direct to radio fans for only \$2.50 each on 10 days free trial.

Send no money—just your name and address to Radio Dept., Imperial Laboratories, 9559 Coca Cola Bldg., Kansas City, Mo., and the Statchoke will be sent you by insured mail. Use it for 10 days with the distinct understanding that if it does not do everything claimed for it, return it in good condition and even this special price will be refunded. Write today and enjoy "Summer Radio," as this offer is fully guaranteed and you do not risk a cent.

THE MOZART GRAND CO.
Manufacturing Fine
Radio Reproducing Apparatus
at 235-40 Elizabeth Avenue
Newark, N. J., U. S. A.

NEW MODEL A—Haynes De Luxe Super-Heterodyne

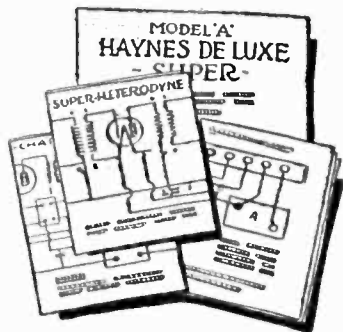

**Complete working
blueprints ready now!**

Prepared under the personal supervision of A. J. Haynes for those who want the most complete constructional data on this splendid new set described in "Radio."

Every wire, every connection, every detail of construction is shown in these actual size blueprints.

The new Model A De Luxe "Super" uses nine storage battery tubes and gives a marked increase in selectivity, sensitivity and distance range.

*Write for complete price list.
It will be sent without charge.*

Haynes-Griffin De Luxe Oscillation Coupler \$3.50

Haynes-Griffin De Luxe Radio Frequency Transformer \$4.25

Included in each set of blueprints is: panel and instrument layout, picture wiring diagram, schematic wiring diagram and battery connections.

Price, complete set
Postage prepaid **\$1.25**

HAYNES-GRIFFIN RADIO SERVICE, Inc.

41 West 43rd Street, New York, N. Y. 111 S. Clark Street Chicago, Ill.

Radio Pleasure

KNOW the condition of your batteries. Operate under the right plate and filament voltage. Prolong the life of your tubes. Give your set a chance by getting the best out of it.

There is just one way to do this—by using Weston Model 301 Filament Voltmeter for mounting on the panel or the Model 489 Radio Table Voltmeter.

And for the fastest change from headset to loudspeaker—the Weston Radio Plug.

Write today for the little book showing how these advantages can be secured—entitled "Weston Radio Instruments."

PACIFIC COAST REPRESENTATIVES:
Western Electric Company
Seattle, Wash.
J. H. Southard
San Francisco, Calif.
A. A. Barbera
Los Angeles, Calif.
Repair Service Laboratory
682 Mission St.,
San Francisco, Cal.



WESTON ELECTRICAL INSTRUMENT CORP. - 156 Weston Avenue, Newark, N. J.

STANDARD THE WORLD OVER

WESTON

Pioneers since 1888

A DOZEN THRILLING YARNS

Read the Story of the Life of a Sea-going Radio Operator—
"THE RADIOBUSTER"

\$1.00
Per
Copy

SENT POSTPAID ANYWHERE
PACIFIC RADIO PUB. CO.
Pacific Bldg., San Francisco, Cal.

\$1.00
Per
Copy

TOROIDAL COIL

(Continued from page 19.)

should be filed to fit the coil. A slot is sawed to take the two ends of the celluloid mounting strip and the whole is cemented in place. It is important that just as little cement be used as is necessary to make a good mechanical job.

An ideal circuit for the application of this type of inductance has been described in an article on "The Neutralization of Tuned R. F. Amplifiers," by Thomas W. Benson, in RADIO for July, 1924, and also in an article on "Balanced Tuned Circuit R. F. Amplifiers," by C. M. Jansky, Jr., in RADIO for March, 1925. This circuit is commendable because of the efficiency of the auto transformer method of transfer of energy and the inherent stability of the grid filament circuit. Fig. 1 shows a schematic diagram of the circuit and the illustrations show the general arrangement of parts. The receiver described here was designed primarily for the reception of local radiocasting but due to the efficiency of the tuning and the R. F. units it is a remarkably good D. X. getter. The selectivity is all that is required for distance reception.

A general resume of the circuit will reveal that the entire radiocast range may be received with equal efficiency by the use of the point switch and the two fixed condensers, one of .00025 mfd. and one of .0001 mfd. The higher wavelength stations should be tuned with the antenna directly connected to the set. For distant reception the selectivity is enhanced by using one or the other of the fixed condensers. The coils are designed on the auto transformer principle. The r.f. amplifier tube is balanced to prevent oscillation by a variation of the Rice method of tube counterbalance. In the antenna coupling inductance the antenna connection is tapped at $\frac{1}{4}$ the total number of turns on the coil from the ground connection, giving a transformer ratio of 4 to 1. In the r.f. amplifier inductance, one end of the coil connects to the tuning condenser and to the coupling condenser. The coil is tapped for the plate connection of the r.f. amplifier tube at a point $\frac{1}{4}$ the distance from the tuning condenser end and then at the middle the coil is tapped again for the B. battery connection. Finally the other end of the coil is connected to the r.f. tube balancing condenser and to the tuning condenser.

The ratio of this transformer is also 4 to 1. Greater selectivity may be obtained by using a smaller proportion of the total windings in the antenna and plate circuits. This will increase the transformer ratio. For tuning .00035 mfd. variable condensers are used. A D-21 Sodian tube is used as the detector with a positive grid return and 22½ volts on the plate. Two stages of resistance coupled amplification are used with 90 volts on the plate.

SELECTIVITY VERSUS DISTORTION

(Continued from page 27)

the musical scale will be proportionally less, since the curves approximate straight lines.

As soon as the distortion becomes less by virtue of an increased frequency ratio, the demand for selectivity increases, and the two exactly off-set each other. At the upper radiocast limit, 200 meters, and for higher frequencies, even a selectivity as high as 100 will behave much like a broad crystal receiver. The quality will be excellent, but there is no separation between adjacent channels.

The distortion in these curves is based on the assumption that the signal comes to the antenna in an undistorted condition; that is, that distortion due to the selectivity of the transmitter has been equalized. That is seldom the case. There are only a few transmitting stations which make any attempt at "equalizing" their transmission for any kind of distortion; but these particular stations hold the quality of their signals within very narrow limits over the entire audio frequency scale from zero up to 5,000 cycles per second. It is not difficult to pick them out because their quality is markedly superior. The object of many stations seems to be to kick up a tremendous disturbance in the atmosphere, and they are succeeding far above our desires.

The distortion produced by a too selective circuit may be observed by connecting a large by-pass condenser across the primary or secondary windings of an audio frequency transformer, or across the input terminals of the sound reproducer. There is a general lowering, or softening, of the tone of the signal, which effect is greater the larger the condenser. The sibilant and fricative consonants are suppressed markedly, particularly the s's and the z's. The b's and the v's are often confused and misinterpreted, as are several other pairs of consonants. This is not the same, of course, as selectivity distortion but the effect is similar.

The effect of this kind of distortion may also be observed in a regenerative circuit in which the regeneration is driven a little too far. The sound reproducer has a hollow sound, like a cave or a large room in which only the low pitched sounds reverberate. It is due to a similar cause. The tuned circuit may be regarded as a hollow chamber in which only the low notes, those lying next to the carrier, reverberate and are intensified. The effective selectivity of the circuit is very great when that condition occurs. Almost everybody has observed this phenomenon when tuning a regenerative circuit.

Before concluding this section of the article it will be interesting to consider the demands for selectivity which are

NEW!

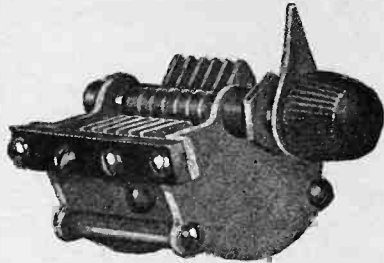

Actual Size
Actual Price \$1.50

CONTINENTAL LO LOSS

A radical departure from the inefficient geared, friction, or single-plate type of micrometric control. It is a miniature condenser with exactly the same low losses, rigid construction and precision workmanship of its big brother. Coupled with the standard Continental Lo Loss Condenser it produces a tuning element with results which amaze even the most expert operators.

Two Condensers for the Price of One!

The Standard Continental Lo Loss is now sold with the new Junior condenser for exactly the same price you pay for any high-grade Low Loss Condenser. Two condensers for the price of one—and an added efficiency to your set that cannot be reckoned in dollars and cents.

The new Continental unit is now at your dealers. Don't delay getting it into your receiver, and learn how really efficient your set can be. You will be delighted with the increased clarity and volume.

All Capacities Are Exact

18 plate cap. 00025 with Junior.....	\$4.50
18 plate cap. 00035 with Junior.....	4.75
25 plate cap. 0005 with Junior.....	5.00
45 plate cap. 001 with Junior.....	6.00

Buy your condensers by capacity—not plates. Connecting links furnished free with the above units—no soldering—no losses.

If your dealer is not yet stocked, place your order now and he will supply you as prompt as possible.

GARDINER & HEPBURN, INC.,

Sales Office: 611 Widener Building, Philadelphia

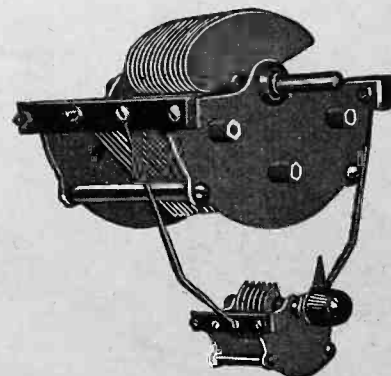

NA-ALD

Na-ald DeLuxe Sockets are the only ones with these 3 exclusive features—lowest loss, lowest capacity and positive side-scraping contact. Send for booklet and laboratory test. Alden Mfg. Co., Dept. G5, Springfield, Mass.

Wholesale Distributors of
Nationally Known

RADIO SUPPLIES

DEALERS—Send for price list and discount sheet.

**COSMOPOLITAN RADIO
APPLIANCE CO., INC.**
321 Broadway, New York, N. Y.

A Laboratory
Product



CRESCENT LAVITE RESISTANCES

for Distortionless Amplification

12,000, 48,000, 50,000, 100,000 Ohms. List \$1.50 each. Special Sizes to Order \$2.50 each. Dealers write for discounts. When Better Resistances are made they will be Crescents.

CRESCENT RADIO SUPPLY CO.
3 Liberty Street Jamaica, N. Y.

MARVELOUS NEW AUDIO TRANSFORMER

adds a musical quality to any set far beyond anything you ever heard before.

KARAS HARMONIK

Amplifies low, middle and high tones—all to the same big volume, thus eliminating distortion. Brings out the vital harmonics and overtones of music. Price \$7.00. Write



KARAS ELECTRIC CO.,
Dept. 59-39, 4040 N. Rockwell St., Chicago.

Tell them that you saw it in RADIO

Unconditionally Guaranteed

THORDARSON

Super TRANSFORMERS

Standard on majority of quality sets

"HIGHLY SATISFACTORY"

Reports Deresnadyne

"THE results obtained with Thordarson Transformers in the Deresnadyne Receivers manufactured by us have been highly satisfactory," advises Mr. E. F. Andrews of the Andrews Radio Company, Chicago.

"The Deresnadyne has a country-wide reputation for the beautiful quality of its reproduction and its freedom from undesired noises. The signal from the detector is faithfully reproduced by your transformers with excellent amplification.

"We have been very favorably impressed by the uniformity of your product and the fact that we have had surprisingly small amount of transformer trouble." Follow the lead of the leaders. Build or replace with Thordarsons. Audio Frequency: 2-1, \$5; 3½-1, \$4; 6-1, \$4.50. Power Amplifying, per pair, \$13. Interstage Power Amplifying, each \$8. Write for latest hook-up bulletins—free. Dealers everywhere.

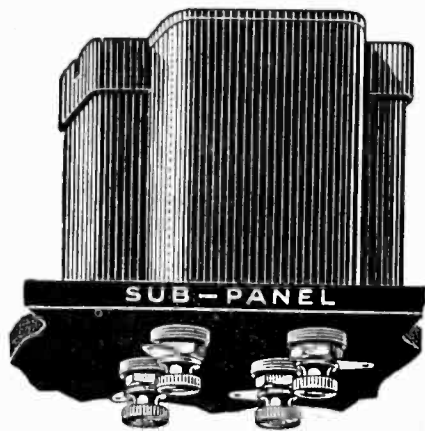

ZENITH
KENNEDY
RADIODYNE
THERMIODYNE
ULTRADYNE
MURDOCK
AZARKA
Pfanstiehl
MICHIGAN
Deresnadyne
MALONE LEMON
MASTER RADIO
ADLER-ROYAL
Howard
Pathé
HARTMAN
AUDIOLA
EAGLE
GLOBE AND
MANY OTHERS

SUB-PANEL MOUNTING TYPE THORDARSONS NOW ON SALE

They permit a neater assembly, the shortening of leads and the concealing of wiring—as in factory built sets. Same ratios—same prices—as standard type Thordarsons. If dealer cannot supply, order from us.

THORDARSON ELECTRIC MANUFACTURING CO.
Transformer specialists since 1895
WORLD'S OLDEST AND LARGEST EXCLUSIVE TRANSFORMER MAKERS
Chicago, U.S.A.

For Your Motor Boat

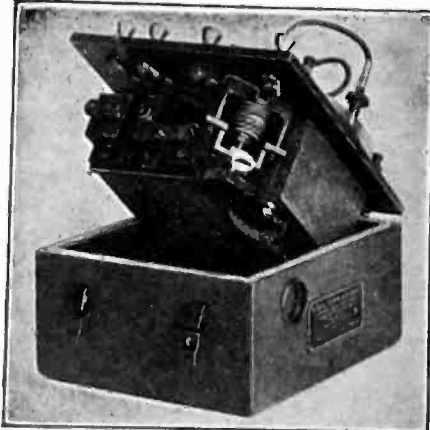

For Your Camp

Radio Spark Transmitters

(75 Watt, Portable)

Made for U. S. Army Aeroplanes

This is a tuned spark coil transmitter, with a wavelength of 100-300 meters. The set is made of the finest of materials and the essential parts are the spiral tuning inductance, the induction coil, sending condenser and spark gap. Can easily be converted into spark coil CW set. Brand new, in original cartons.

ORIGINAL GOVERNMENT COST, \$47 each

Our Price \$5.75 Each

AMERICAN SALES COMPANY
21 Warren Street New York City

constantly being made of receivers, and what the effect on quality would be if these demands could be met. It frequently happens that a fan wants to tune in a station located on the Pacific coast 3,000 miles away while a local station only 10 miles from the receiver is operating on the same power as the distant station and on a frequency only differing by 10 kilocycles. The demand is further that the set be so selective that the local signals be reduced to a point where not even a murmur from the local can be heard over the distant station. Suppose that it be desired to reduce the relative strength of the two signals so that the signals originating at the distant station are one hundred times stronger than those coming from the local. Suppose further that the distant station is operating on a frequency of 1,000 kilocycles and the local on a frequency of 990. Their frequency ratio is then .99, which is rather close to unity.

Now the strength of the signals under ideal conditions is inversely proportional to the distance, so that the relative strength at the antenna is 3,000 to 10, or the local signals will be 300 times stronger. After detection they will be 90,000 times stronger. And it is desired to reduce these to a point where they are only one hundredth as strong as the distant signals, that is, they must be reduced 9 million times. Hence the denominator in equations (8) and (12) must be equal to 9 million. Since unity is negligible in comparison, we may say that the square root of this number, or 3,000 is equal to the product of the selectivity and the frequency ratio factor, which in this case is .0199. The required selectivity then is very nearly equal to 150,000. The actual case is worse than this because the signals decrease faster than the inverse law would indicate.

With a selectivity of this order, the maximum distortion would be practically unity, and even at a frequency as low as 100 the distortion would only differ from unity by one part in 900. In other words, there would be no quality and no signal, it would all be tuned out. Perhaps there is no harm in making the demands as long as they cannot be met. The trouble comes from the fact that many fans are led to believe that the demands can be met by the so-called "razor-like" circuits which are being advertised, many of which are not sharp enough to cut through anything but a bank roll, which they do.

In the next section will be taken up the selectivity and the distortion in a superheterodyne. The effect of audio frequency transformers will also be shown.

REG. U.S. PAT. OFF. THE TUBE SUPERTRON WITH A SENSIBLE GUARANTEE. A GOOD TUBE.

Protection

SERIAL NUMBER GUARANTEE



TWO DOLLARS EACH

An "unlimited", "unconditional", etc., guarantee, with all kinds of promises is not sound---that's nonsense.

Specific limitations with means of identification is the only kind of guarantee that can be sound---that's sensible.

Each SUPERTRON tube is serial numbered and wrapped in a guarantee certificate bearing a corresponding number for your protection.

Buy SUPERTRON Fearless! The dealers guarantee them fearlessly!

Pacific Coast Representative

GLOBE COMMERCIAL CO.

905 MISSION STREET, SAN FRANCISCO

SUPERTRON MFG. CO., Inc.

32 Union Square, New York

Export Div., M. SIMONS, 220 Broadway, New York

This Condenser Given Free of Cost with a 2 year subscription to "Radio"

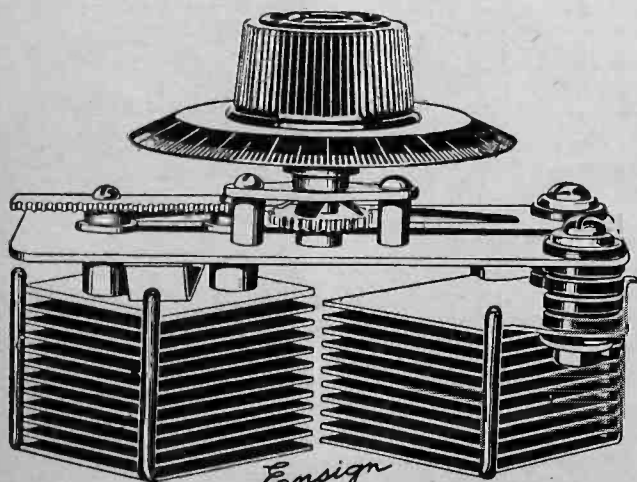

PATENT PENDING VARIABLE CONDENSER ALL RIGHTS RESERVED

The new Ensign square plate condenser, as illustrated, given free this month in return for your subscription to "RADIO" for 2 years. Full price, \$5.00. You get double value for your money.

COUPON

"RADIO," Pacific Building, San Francisco, California.

Send me "RADIO" for 2 years and one Ensign Condenser as a premium. I enclose \$5.00 in full payment.

Name.....

Address.....

A E R O V O X



are you after perfection

How can your set deliver maximum results unless the small parts are scientifically right? AEROVOX is your insurance of quality. If it is fixed or by-pass condensers or grid-leaks--use AEROVOX and you make sure of perfection.

AEROVOX

(AEROVOX)

AEROVOX Tested Fixed Mica or By-Pass Condensers are made in all capacities. Also Fixed Mica Condensers with grid mountings. The testing laboratories of Radio News, Popular Radio and Professor Wheeler of Yale have enthusiastically endorsed them. Prominent set manufacturers throughout the country depend on them. Why shouldn't you have the best?

Write for particulars of our complete line, including Resistofomers and Rheostats.

Western Representatives: RICE-HITT CO.

San Francisco and Los Angeles

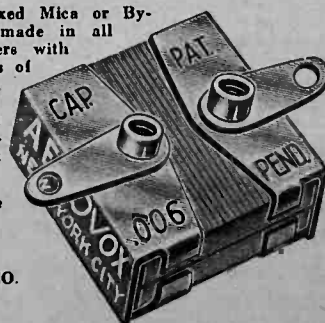

AEROVOX WIRELESS CORP.
489 Broome St., New York City

TESTED FIXED CONDENSERS

Tell them that you saw it in RADIO

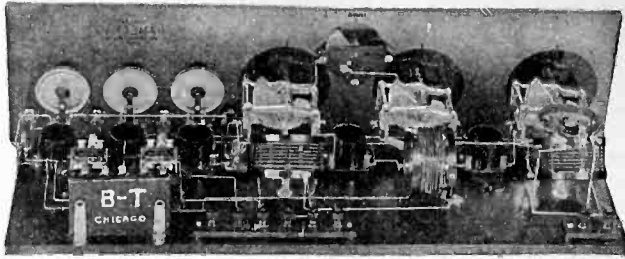

A Set You Can Rely Upon

Have you ever had the experience of logging almost every station in North America? And then—the very next night after you have bragged about your radio all day and a bunch of friends are in to listen, the same set refuses to drag in anything over 500 miles away, and that with difficulty?

We all demand from our radio whatever the make, distance, selectivity, tone quality; but there is another characteristic that applies peculiarly to the B-T "NAMELESS" and that is *Consistency*. Once you have it logged—go back and get it.

Because of the circuit itself and the efficiency of B-T apparatus used in its construction, the "NAMELESS" has that extra sensitivity, a reserve power to go out and bring them in even when atmospheric conditions are not the best.

The "NAMELESS" is a combination of a circuit designed for the parts and the parts designed for the circuit with a method of construction that insures success to even the most inexperienced builder.

Kits containing the essential parts for the "NAMELESS" can be purchased at all reliable radio stores. Descriptive bulletins describing the "NAMELESS" may be had from your dealer or by mail at your request.

BREMER-TULLY MFG. CO.

532 S. CANAL STREET

CHICAGO, ILLINOIS

YANKEE TUBES—

Proven Beyond All Doubt—

"THE ACE OF INDEPENDENTS"

TYPES 199-201A

\$ 3.00



TRADE MARK REGISTERED

Sold only thru well-established retail dealers

Distributed by
W. E. & W. H. JACKSON
San Francisco
MARSHALL-WELLS
Portland
THE BANTA COMPANY
Los Angeles
RADIO SUPPLY CO.
Los Angeles

DEALERS—Write to the distributor in your territory as shown below for attractive proposition.

BALDWIN PACIFIC & CO., San Francisco

(PACIFIC COAST REPRESENTATIVES)

"COMO DUPLEX"

The World's Standard Push-Pull Transformer, \$12.50 per pair. Send for descriptive literature. COMO Apparatus Corp., 446 Tremont St., Boston, Mass. Washington and Oregon Representative

C. E. GAY

166 Lownsdale St., Portland, Oregon

NEXT MONTH!

Best's New Super will be featured in the next issue of "RADIO"—Don't miss it!

Wire-Nuts for joining

radio antenna and lead-in wires in one minute without solder, tape or tools.

Many other uses. A million perfect joints have already been made with these new Wire-Nuts.

Listed by Underwriters' Laboratories. Booklet free. Ask your dealer for Wire-Nuts.

We will send 3 Wire-Nuts post paid on receipt of 25c R. TORK COMPANY, 8 W. 40 St., New York

10c RADIO LOG Books for keeping Records. "RADIO", San Francisco.

CALLS HEARD

(Continued from page 55.)

By Albert E. Scarlett, Jr., 23 Cooley Place, Mount Vernon, New York.

6aak, 6agn, 6aib, 6ajh, 6ajq, 6alw, 6ame, 6bac, 6baw, 6bbq, 6bcp, 6bik, 6bmo, 6bno, 6btl, 6bwd, 6cal, 6cey, 6cdg, 6cgc, 6cgw, 6chl, 6chx, 6clv, 6cmd, 6cmg, 6csr, 6ctc, 6cto, 6cvi, 6dbh, 6ea, 6fh, 6fy, 6hp, 6km, 6oi, 6rn, 6vc, 6wp, 6xl, 6zbo, 6ng, 6ek, 6et, 6acy, 6ajy, 6df, 6ec, 6fg, 6gr, 6ls, 6md, 6nh, 6ru, 6cmq. England: 2fu, 2kz, 2lz, 2od, 2rb, 2sg. France: 8ab, 8sm. Cuba: 2lc. Mexico: 1aa, 1af, 1b, 1j, 1k, 1n, 9a. Denmark: 7ec. Porto Rico: 4sa, wkk. New Zealand: 4aa, 4ag. Canada: 5ba, 5bz, 5go, 5hc. Brazil: wjs, lr. Hawaii: 6xo. Morocco, Africa: ain. Argentina: lor. Off Ireland: in. All heard on an 80 ft. indoor antenna and 1 audio.

By GCLP, L. Fry, Empire, Calif.

taao, 1abe, 7abf, 1air, 1aj, 1ajo, 1ajx, 1all, 1ary, 1ban, 1bbe, (1bcr), 1bes, 1bca, 1bfl, 1bgq, 1bhn, 1bv, 1cak, 1cmz, 1cmp, 1cmx, 1er, 1ga, 1gs, 1my, 1py, 1rd, 1wl, 1yb, 1za, 2aan, (2aay), 2abt, 2ag, 2akb, 2ale, 2apu, 2aqh, 2ash, 2axf, 2bg, 2bgl, 2blm, (2byi), 2chk, 2cjb, 2cpa, 2cqz, 2cvj, 2cwi, 2cxw, 2cyx, (2czz), 2dd, 2eq, 2hs, 2kf, 2ko, 2le, 2qt, 2wr, 2xq, 2zb, 3aha, 3ajo, 3bdo, 3bfe, (3bg), 3bjp, 3bmn, 3bnu, 3bpm, 3brc, 3buq, 3bwj, 3ccx, 3chg, 3ck, 3hj, (3ig), 3mf, 3mi, 3wb, 3zo, 4bq, 4d, 4eg, 4eh, 4eq, 4fs, 4gw, 4lo, 4ku, 4mb, 4ne, 4oa, 4pk, 4qf, (4rm), 4sb, 4sl, 4tj, 4tw, 4ua, 4uc, 4xe, Australian: 2ay, 2bk, 2ds, 2me, 2yg, 2yl, 3bd, 3bm, 3bq, 3xo. New Zealand: (1aa), 1ao, (2ac), 2ao, 2ap, 4ag, 4ak. Japan: (1aa). Philippine Islands: nirx. French Indo China: hva. Java: ane. Porto Rico: 4sa. Hawaii: (6cat). Canadian: 1bq, 2cg, 2fo, 3aa, 3acu, (3nf), (4eo), (4dq), 4fm, 4fv. Cards for all. Appreciate reports on mi 5 watts.

By SDGV, 1169 East 145th St., Cleveland, Ohio

1aao, (1afo), (1af), 1agl, 1alw, 1apk, 1asf, (1atq), (1bql), 1cab, (1cpc), 1doq, 1qe, (2agp), 2alf, (2alc), (2ams), (2hkl), 2by, 2cel, 2cig, (2cnp), 2ctf, 2cqz, 2cul, (2kf), 2sz, (3aal), 3ajd, 3as, (3ash), (3bau), 3bnu, 3bq, (3cey), 3ckh, 3qi, 3qt, 3rs, (4bk), (4bi), 4gx, (4tw), (4ua), (4uc), (4uc), 5afb, (5afd), (5afu), 5ajj, 5and, 5aom, (5aon), (5avn), (5aw), (5bb), (5ek), 5lr, 5ls, (5jv), 5oq, (5ny), (5ms), (5rg), 5se, 5uv, 5xa, 5wy, (6af?), (6awb), (6baw), (6bcp), 6bhx, 6bik, (6bip), 6bir, 6bur, 6buw, 6cbb, 6cgw, (6chl), (6cra), 6cto, 6ea, 6eb, 6km, 6of, (6wp), 6wt, (7adm), 7af, 7afo, 7af, (7ec), (7gr), (7lr), 7ly, 7mp, (7nh), (7us), 7zf, (9abw), 9ach, (9ad), 9aha, 9aib, (9ajj), 9aim, (9auc), (9axb), (9baw), (9bb), (9bht), 9bml, 9bnk, (9bpy), (9buk), (9bwb), 9bwu, (9cfs), 9ckh, (9cjo), (9co), 9col, (9cuo), (9cv), (9cxc), (9deo), 9dly, (9doa), 9dkc, 9dil, 9dvi, 9dwx, (9dwz), 9dxn, 9dyt, 9ees, 9eib, (9elb), (9la), 9mm, 9np, (9pn), (9nv), 9th, 9um, 9zd, 9zw. Can.: 1ei, 2au, (2be), 3ck, (3ms), (3tf), 3xi, (3zd), 4cr, (5bz), (5ef), (5go), 5hc. Mex.: (1aa), 1af, 1k, 1n, 1x. English: (2kx), 2kx, 2nm, 5ka. Cuban: 2mk. S. A.: wjs. Belgian: 3ad. Unidentified: wycj, hp. Would appreciate reports from anyone hearing my signals.

By C. A. Nichols, Route 2, Box 181, Los Angeles, Calif.

1kc, 1pm, 1ow, 1af, 1xav, 2cyw, 2bro, 2adm, 2wb, 3ws, 3bva, 3ab, 4ny, 4fs, 5lg, 5ox, 5ew, 5cgc, 5amw, 5lr, 5ba, 6im, 6bhs, 6ccl, 6awt, 6and, 6axp, 6bfl, 6akt, 6aol, 7rl, 7nx, 7gb, 7qu, 7wo, 7eo, 8bkq, 8jj, 8chk, 8bjp, 9dez, 9bkr, 9eak, 9dit, 9caw, 9avg, 9cuv, 9lc, 9caa, 9ell, 9cv, 9cgm, 9cxx, 9sr, 9ded, 9bjk, 9mm, 9dfh, 9cpm, 9jt, 9bkr, 9bht. I would appreciate any QSLs and will return a card.

By GCTP, Daiton J. Atherton, P. O. Box 87, Fullerton, Calif.

1aac, 1aao, 1abp, 1aci, 1ad, 1af, 1afa, 1afo, 1agb, 1agq, 1aja, 1ajc, 1ajm, 1ajd, 1ajy, 1akz, 1all, 1alw, 1amf, 1ana, 1anx, 1apc, 1aqm, 1ary, 1asr, 1asy, 1atj, 1aur, 1avf, 1aw, 1awe, 1awy, 1axn, 1axz, 1ayn, 1apy, 1bbe, 1bcc, 1bdx, 1bes 1bhm, 1bie, 1bkl 1bkr, 1bpb, 1bsd, 1bv, 1bvb, 1bz, 1bzp, 1cab, 1cav, 1cc, 1cl, 1cme, 1cmp, 1cmx, 1cpc, 1cpv, 1cri, 1cru, 1da, 1er, 1ez, 1gs, 1kc, 1ml, 1px, 1py, 1qm, 1rd, 1sf, 1ve, 1vq, 1wl, 1xao, 1xm, 1xz, 1yb, 1yd, 1zt. New Zealand: 2ac, 4ag. Australia: 2yi, 3bd. Porto Rico: 4sa. Mexico: bx, 1aa, 1af, 1b, 1g, 1j, 1k, 9a. Canada: 1am, 1ar, 1bq, 1dj, 1dq, 1el, 2am, 2au, 2az, 2bg, 2cg, 2fo, 3abg, 3acu, 3kq, 3ly, 3mo, 3ms, 3mv, 3nf, 3nl, 3tf, 3ws, 3wx, 3xi, 3xx, 4ab, 4cr, 4dq, 4eo, 4fv, 4gt, 4io, 5ba, 5bz, 5ct, 5ef, 5go, 5hp, 9al. Cuba: 2lr, (qra?). Hawaii: 6asr, 6cu, 6oa, 6ct. Costa Rica: sj. Brazil: wjs, ub, ur, 3ad, (qra?). Also: nerki, nrri, nkt, kdka, kfkx, wgh, 6xi, 86a. I have sent cards to almost all of the above, and would appreciate it if they would acknowledge them.

BEST'S : NEW : SUPER

will be featured in the next issue of "RADIO," out on July 25th, in San Francisco . . .

A REMARKABLE DEVELOPMENT BY OUR TECHNICAL EDITOR, GERALD M. BEST.

Two New Superheterodyne Receivers will be featured in the August issue of "RADIO." Gerald M. Best has made a number of important improvements to his 45,000 cycle wonder. He will describe a new shielded model—covering a wavelength range of from 50 to 600 meters. This range in wavelengths has not heretofore been possible with the old-style supers. The shielded set will be complete in every detail. Numerous illustrations, wiring diagrams and lay-outs will be shown. The publishers of "RADIO" believe that Best's new receiver is the last word in radio.

In addition to this new shielded model, Best will also describe an unshielded type of super. It is constructed along the same lines as the set described by him in "RADIO" for May. Improvements to the unshielded receiver can be easily made by those who have already constructed the set described in May "RADIO." The baseboard layout is unchanged. Only a few slight changes and several additional parts are necessary to improve your present super.

A Fair Warning to Our Readers

Thousands of requests for copies of the August issue of "RADIO" will flood our office. News stand copies will sell fast. Don't take a chance at getting a copy from a newsdealer. Write direct to the publishers of "RADIO" for your August issue. Send us 25 cents today and we will mail a copy to your address on July 25th.

"RADIO"

PACIFIC BUILDING,
SAN FRANCISCO, CALIFORNIA

Here is 25 cents. Send me the August issue of "RADIO," containing Best's new Superheterodyne feature.

Name.....

Address.....

City and State.....

N.B.

Why not subscribe for 6 months at the extra special rate of only \$1.00? You save 50 cents. We will start your subscription with the August issue, out on July 25th.

RADIOADS

A Classified Advertising Section Read by Better Buyers

The rate per word is eight cents net. Remittance must accompany all advertisements. Include name and address when counting words.

ADS FOR THE AUGUST ISSUE MUST REACH US BY JULY FIFTH

ARC & SPARK SYSTEMS
Send for Descriptive Circular QRD.
Interesting and Instructive
Pacific Radio School 433 Call Bldg., San Francisco

VACUUM TUBE HOSPITAL
We repair and guarantee them.
Agents, Dealers, and Customers Wanted.
Radiotube Co., 903 Broad St., Newark, N. J. (TC)

BIG MONEY AND FAST SALES—every owner buys gold initials for his auto. You charge \$1.50, make \$1.44. 10 orders daily easy. Sample and information free. World Monogram Co., Dept. 68, Newark, N. J. (SAS)

AGENTS WANTED TO ADVERTISE OUR GOODS and distribute free samples to consumers; 90c an hour; write for full particulars. American Products Co., 2132 American Bldg., Cincinnati, O.

STORAGE "B" BATTERIES are easily made in one evening. Use my genuine Edison elements.
A. J. Hanks, 107 Highland Ave., Jersey City, N. J.

15 to 25 per cent discount on nationally advertised sets and parts. Every item guaranteed. Tell us your needs. IMPERIAL RADIO COMPANY, Delaware, Ohio.

FOR SALE—Why bother with dry cell? Build an everlasting "HAWLEY" storage "B" battery of the nickeliron type. No frying or hissing, clearer reception, and greater volume. Put up in both knock-down units and assembled types. Requires no soldering or former experience to put together. Knock-down units contain all the parts to build the following sizes: 90 volt, \$8.95; 100 volts, \$9.95; 120 volts, \$11.60; 135 volts, \$12.75; 150 volts, \$13.90; 200 volts, \$17.50. Sold on a 2 year guarantee with 30 day trial offer with return of your money without any ifs or ands. Sample cell 35c prepaid. 8 page illustrated folder of instructions containing simple means of putting together, making charger, and charging. Complete manufactured charger, \$2.75. Order direct or write for my literature, guarantee and testimonials. Same day shipments. Address B. E. Smith, 31 Washington Ave., Danbury, Conn. (TC)

2650 MILES DISTANCE with one tube. Any novice understands our Simplified Instructions including Panel Layout, picture diagrams, etc. Write for BIG FREE BOOKLET. VESCO RADIO CO., BOX 117-RC, OAKLAND, CAL. (TC)

AGENTS—Signs for stores and offices. Entirely new. \$50 week easily made. World Signs, 116 W. Washington, Chicago. (TC)

LEARN CODE in one hour. Method now \$1.50 postpaid. H. Anderson, Box 593, Great Falls, Mont. (2T)

SPECIAL TRANSFORMERS
Power Audio, B-Supply, any kind. Send for circulars. S. M. Gardner, Emeryville, Calif.

BACK COPIES of "RADIO" for sale. Volume V to Volume VII. M. J. Lewis, 61 Hamilton St., Rahway, N. J.

NEW IDEAS WANTED—Well known radio manufacturer whose products are nationally advertised and sold everywhere wants new radio device to sell. Will pay outright or royalty for idea or invention which is really new and saleable. Address Mr. R. F. Devine, Room 1101, 116 West 32nd St., New York, N. Y.

FIFTY WATT TRANSMITTER for sale cheap, parts or complete. Write for prices. R. HORN, 1023 Morro St., San Luis Obispo, Calif.

FREE—16 valuable radio hints. Postage, 2 cents. G. LISMAN, Hooker, Oklahoma.

SWAMP THE STATIC. Circuit and specifications for powerful four-tube broadcast receiver covering 40 to 600 meters mailed for \$3.00. Easy when you know how. W. G. CONGER, Independence, Missouri. (2T)

FOR SALE OR EXCHANGE—Kennedy Receiver and Amplifier, 175-3000 meters, covering broadcast, ship and Navy waves, \$45 cash or will exchange for motor generator, 500 volt. ELYVN BEALL, Newman, Calif.

GENUINE EDISON ELEMENTS for that rechargeable "B" battery. ELECTRICALLY WELDED connections made with pure nickel wire, .07½ cents per pair postpaid. Sample and "dope" sheet, 10 cents. Separators, ½ cent; wire, 1¼ cents per foot. CHAS. SNIVELY, 7UV, Woodburn, Oregon.

A RECHARGEABLE "B"

With a Strong Guarantee

The See-Jay Battery has met all tests and is endorsed and recommended by the Washington Information Service Bureau and thousands of satisfied users. Genuine Alkaline connected elements. Strictest Government tests passed. No drilling or wiring. Connectors crimped under 1000 pounds pressure. Save Time, Temper and Money. 100-Volt Unit, \$7.00; 140-Volt, \$10.00. Why pay more? Complete assembled batteries, solution separate, shipped dry, 100-Volt, \$12.00; 140-Volt, \$16.00. See-Jay Units sold on money-back guarantee. Write for literature and send 20c for improved sample cell. See-Jay Battery Co., Dept. R, 915 Brook Ave., New York. Prompt Mail Order Service. Wholesale and Retail.

FREE DIAGRAM of the Browning-Drake circuit using CONE-COILS—the "Perfect Low Loss Coil." Or send \$6.50 for necessary coils for this marvelous circuit when built REAL LOW LOSS! Packed in attractive box and includes diagram and instructions. Set builders and dealers allowed discount. MUNZIG RADIO MFG. CO., Redlands, Calif.

AMRAD "S" TUBES, Type 4000-1; \$8.00 each. Immediate shipment. DEALERS SUPPLIED. George Voigt Radio Supply Co., 56 Maiden Lane, Maspeth, N. Y.

1500 VOLT GENERATORS FOR \$45.00!!!!
BRAND NEW General Electric Navy Type, 6,000 RPM, ball bearing dynamoters, 24 volts DC to 1500 volts, DC, drawing 31 amps., and delivering 233 M. A. (rated) for \$45.00. With shafts extended for belt drive, \$3.00, extra. Make fine power supply for 50 watters, or will handle a 250 watt, even! F. O. B., San Francisco, Calif. D. B. McGown, 1247 Forty-seventh Avenue, San Francisco, Calif.

GREAT BARGAINS IN 500 CYCLE GENERATORS. All sizes from ¼ KW to 2 KW. Make fine plate supply for tube sets, or for supplying current for tube bombarding equipment. Write for details. D. B. McGown, 1247 Forty-seventh Avenue, San Francisco, Calif.

THE NEW square plate Ensign Variable Condensers. JUST OUT! Brass plates. Efficient on low waves. Get one of these condensers without cost in return for your subscription to "RADIO" for only two years. Five dollars brings you the condenser and the magazine. Send your check now. There are only a few of these condensers in our stock. "RADIO," Pacific Building, San Francisco.

THE LEFAX RADIO HANDBOOK, 7th Edition. In bound form. Contains a wealth of useful radio data. Very convenient size for carrying in your pocket. This \$2.50 book is given to you free of cost if you subscribe to "RADIO" for one year. \$2.50 covers the entire cost of this big offer. "RADIO," Pacific Building, San Francisco.

PHONOGRAPH UNITS FREE. The new Union Fabric Unit with soft rubber attachment. One subscription to "RADIO" for one year at \$2.50 brings you the unit as a premium. Get one now. Only a few on hand. "RADIO," Pacific Building, San Francisco.

KEEP station records in THE RADIO LOG BOOK, a handy pamphlet for recording stations heard, dial settings and other data. The price is only 10 cents per copy. For sale by Pacific Radio Pub. Co., Pacific Bldg., San Francisco.

FUNNY RADIO STORIES. 12 of 'em in the "RADIOBUSTER," Volney G. Mathison's humorous thriller. 112 pages in bound form. Mathison knows how to write. You will enjoy his stories. Send \$1.00 today for a copy of the "RADIOBUSTER," or get it free with your subscription to "RADIO" for one year (\$2.50). Pacific Radio Publishing Co., Pacific Bldg., San Francisco.

YOUR RADIO QUESTIONS ANSWERED FREE.—Gerald M. Best, technical editor of "RADIO," will answer ten radio questions for you if you subscribe to "RADIO" for only one year at \$2.50. Get this wonderful technical service, together with a good, practical radio magazine. "RADIO," Pacific Bldg., San Francisco.

FOR SALE—Kennedy Type 110 Universal and Type 525, 2 stage amp. \$80.00 Paragon R. A. 10 Tuner and DA2, 2 Stage Amp. \$40.00. Magnavox A. C.-2, 2 stage power amp. \$20.00 Magnavox R-3 \$15.00. William Gray, Jr., Milford, Del.

RADIO HOSPITAL—Specialists in Neutrodyne and Superheterodyne, Dept. 3, Abilene, Kansas. (T.C.)

Tell them that you saw it in RADIO

• SELECTIVITY • VOLUME • RANGE • QUALITY •

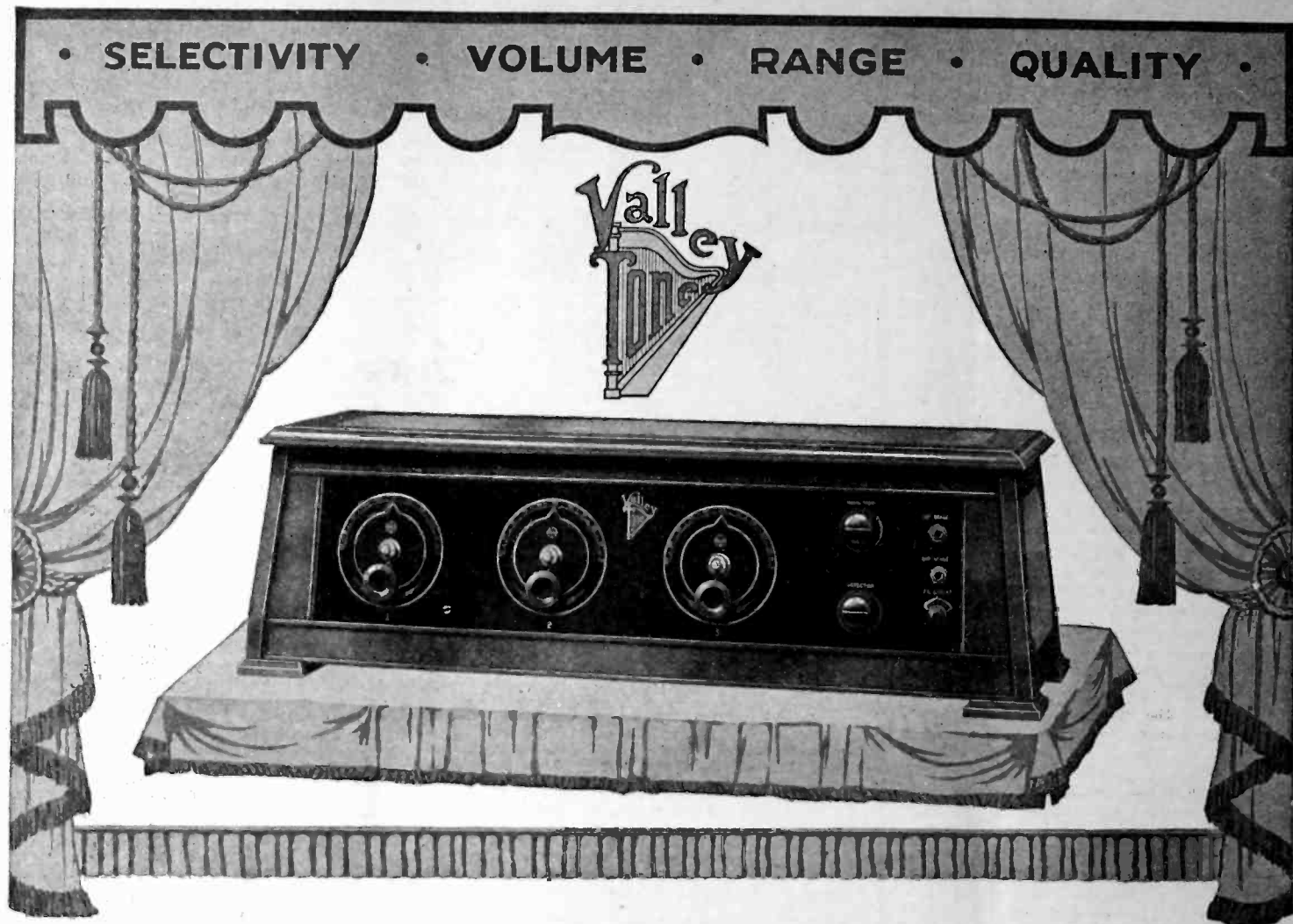

New— The Valleytone Radio Receiver



VALLEY B-ELIMINATOR

Takes the place of B batteries in providing plate voltage. Has rheostat controls for exact adjustment.



VALLEY BATTERY CHARGER

Charges A Battery at correct 6 ampere rate with minimum current consumption. Also suitable for B storage batteries. No bulbs or liquids.

Here is the Valleytone Receiving Instrument with a new principle in radio reception.

By the new "potential balance" method (Pat. Pend.), which is used for the first time and exclusively in the Valleytone Receiver, increased efficiency is obtained with the use of low loss parts throughout.

In planning the Valleytone, we realized that to make just another receiving set would not be sufficient. Accordingly we selected to head our radio engineering staff a man who for years has spent practically his entire time in radio research.

With our engineers, this expert went to work to develop a superior instrument. The result was the "potential balance" method of controlling radio frequency. The "potential balance" control suppresses all tendency of the receiver to go into oscillation and makes possible reception efficiency

never before achieved in a five-tube radio frequency receiver.

In addition to the use of "potential balance" for the first time, the Valleytone is also employing for the first time the toroidal or doughnut coil radio frequency transformer. This coil is a special bank-wound toroidal giving the peak of efficiency. It will give greater distance, volume, selectivity and quality of tone.

The Valleytone Receiving Instrument has three tuning vernier dials and two rheostat dials, one governing the detector and one governing the radio frequency. It also has two jacks on the panel. Underneath the jacks is an A battery switch. All wire connections are made from the rear.

The cabinet is solid walnut in two tones, with inlaid gold stripes. The panel is Bakelite, engraved and lettered in gold. The whole instrument makes a beautiful appearance— an ornament to any environment.

VALLEY ELECTRIC COMPANY

San Francisco Office:

144 Second Street

Valley Electric

See the Valleytone Receiver, Valley B-Eliminator, and the Valley Battery Charger at the Pacific Radio Exposition, San Francisco, August 22-28.

Tell them that you saw it in RADIO

GENERAL RADIO

Condensers

are BALANCED

Electrically and Mechanically for Perfect Performance in Radio Reception



GENERAL RADIO Condensers Have Good Interplate Con- ductivity and Low Losses.

Total condenser losses at radio frequencies are the sum of conductivity losses, eddy current losses, and dielectric losses.

Conductivity losses most seriously affect the efficiency of a condenser under working conditions. They arise from poor contacts between plates and from poor bearing contacts. Soldered plates and positive spring bearings reduce these losses to a minimum.

Eddy Current losses occur in metal end plates and condenser plates themselves. The use of hard rubber end plates eliminates entirely eddy current losses introduced by metal end plates.

Dielectric losses are due to absorption of energy by the insulating material. When a good dielectric such as hard rubber is used in the end plates they have less effect upon the efficiency of a condenser at radio frequencies than any other set of losses.

For use at broadcast wavelengths General Radio Type 247 condensers represent the best balance between low conductivity, eddy current, and dielectric losses that is consistent with efficient design and popular price.

The plates of the rotor and stator groups are individually straightened before assembly and firmly soldered in a jig while they are in perfect alignment. The use of high-grade hard rubber in the end plates eliminates entirely eddy current losses from the end plates.

Specially shaped plates assure a uniform wavelength variation.

Positive contact spring bearings provide a good connection with the rotor group and eliminate the disadvantages of a pig tail connection. Mechanically as well as electrically General Radio condensers are the standards of excellence.

Rotor plates are counterbalanced to permit smooth operation and accurate dial settings.

Lower losses and lower prices make General Radio condensers the outstanding values for popular use.

Type 247-H 500 MMF Vernier.....	\$5.00
“ 247-F 500 MMF Plain.....	4.00
“ 247-M 250 MMF Vernier.....	4.50
“ 247-K 250 MMF Plain.....	3.50

Write for descriptive folder, "Quality Condensers" and our latest Catalog 921-C.



GENERAL RADIO CO.
Cambridge, Mass.

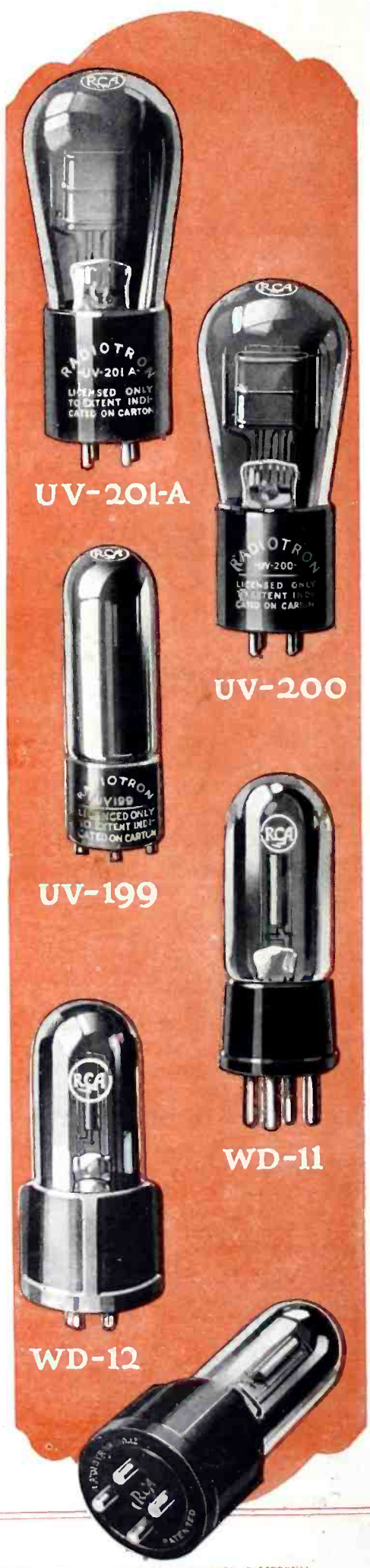

UV-201-A



UV-200



UV-199



WD-11



WD-12



Vital to every radio fan

In a radio set, it is the tube that detects the sound—that amplifies the sound—that determines in large part the quality and volume of the sound. Therefore the tube—intricate of mechanism and delicate to make—is the vital spot in every set. And it always pays to be sure you use genuine Radiotrons—made with experienced precision by RCA.

Build any circuit—simple or complex. Buy any set, plain or fancy, simply boxed or elaborately cabinetted. But give it every chance to achieve its best—with genuine Radiotrons. Be just as careful when you replace tubes, too. Always see for yourself that each one bears the identifying marks of a Radiotron: The word Radiotron and the RCA mark.

Radio Corporation of America

Chicago

New York

San Francisco

Sales Offices: Suite 56

Radiotron

REG. U.S. PAT. OFF.

PRODUCED ONLY BY RCA



PRINTED BY THE LEIGHTON PRESS, SAN FRANCISCO, CALIFORNIA