

April, 1923

25 Cents

# RADIO

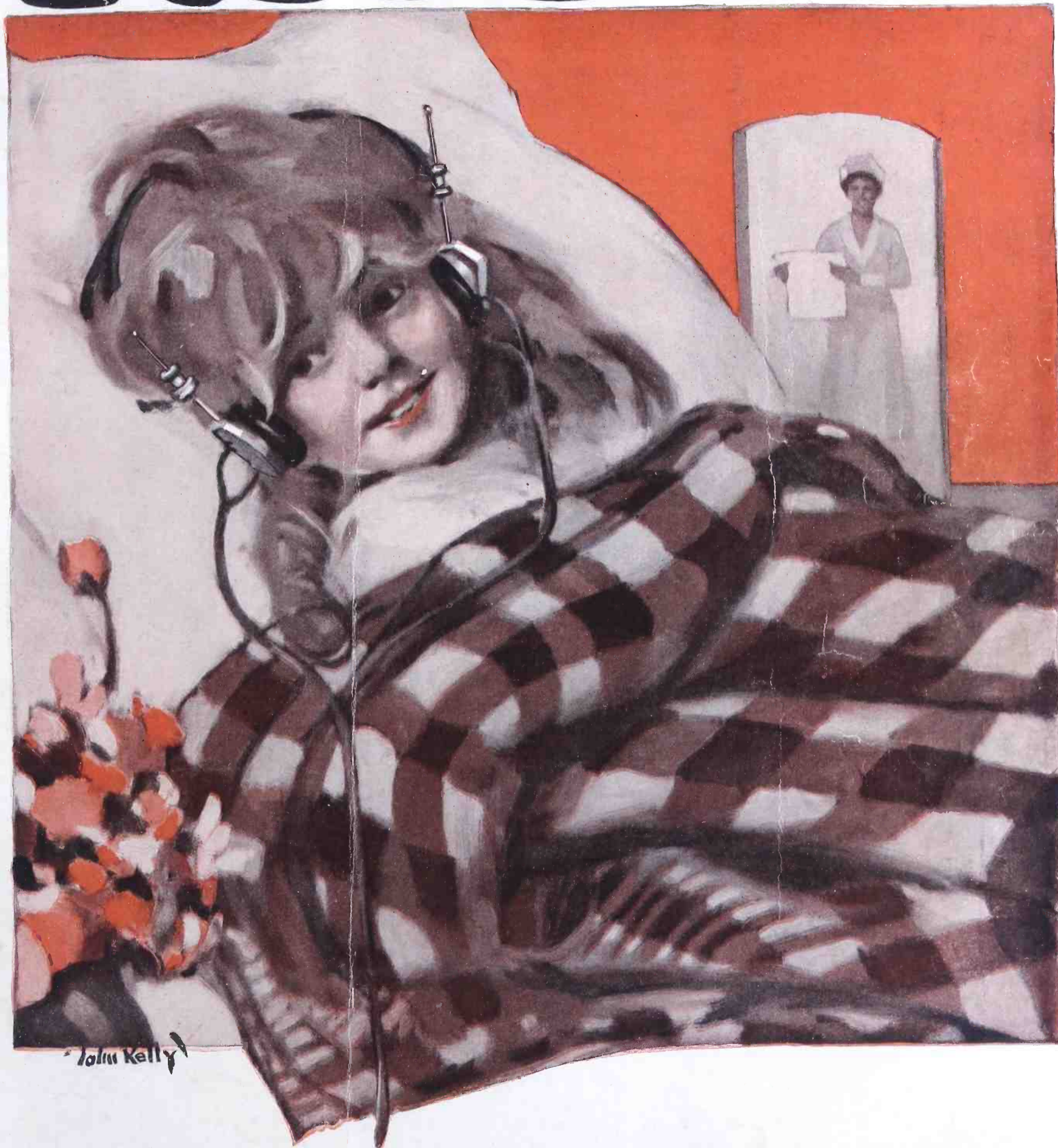

An Independent Magazine Serving the Needs of  
the Radio Amateur and Commercial Operator



# Cunningham

## Tubes for Every Requirement

Vacuum tubes are used for two distinct individual purposes in a receiving set—as DETECTORS and as AMPLIFIERS. The qualifications of a tube for these two uses are so different that for maximum efficiency tubes of entirely different design must be used.

This point was one of the chief considerations of the research engineers who designed Cunningham tubes in the great laboratories of the General Electric Company. After years of research and experimental work, the Cunningham C-300, a SUPER-SENSITIVE DETECTOR, the Cunningham C-301, a DISTORTIONLESS AMPLIFIER, and the Cunningham C-301A, a LOW FILAMENT CURRENT AMPLIFIER, were developed. These three tubes, now nationally recognized as standards for all types of receiving sets, are responsible for the highly perfected results obtainable in radio phone reception.



The trade mark GE is the guarantee of these quality tubes. Each tube is built to most rigid specifications.

**TYPE C-300**  
Super-Sensitive  
**DETECTOR**  
**\$500**

**TYPE C-301A**  
 $\frac{1}{4}$  Amp. Fil-Current  
Amplifier and Detector  
**\$650**

**Patent Notice**—Cunningham tubes are covered by patents dated 11-7-05, 1-15-07, 2-18-08 and others issued and pending. Licensed for amateur, experimental and entertainment use in radio communication. Any other use will be an infringement.

**Home Office:**  
248 First Street  
San Francisco, Calif.

**Eastern Representative:**  
154 West Lake St.  
Chicago, Illinois

# Paul F. Godley's Amazing Experience With

## BURGESS RADIO BATTERIES

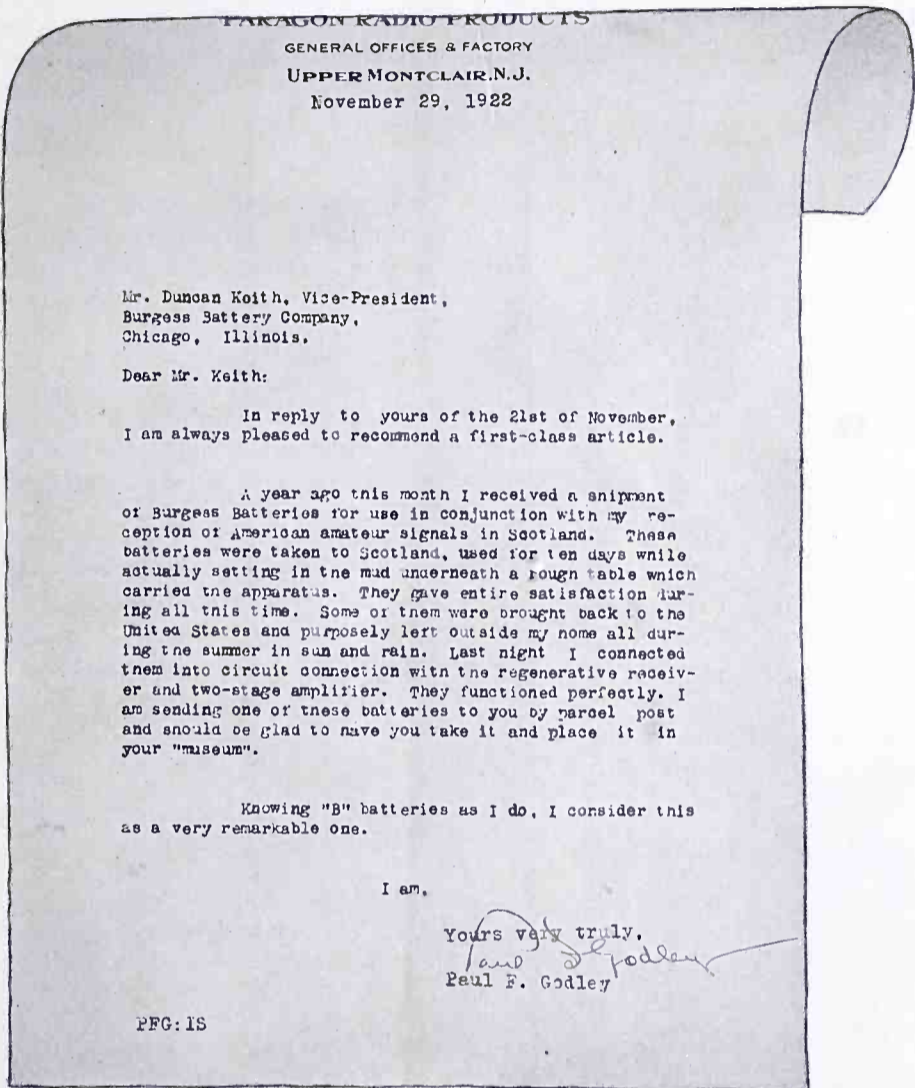

**T**WICE across the stormy Atlan-  
tic, engulfed in oozing mud, and  
exposed for months to the destruc-  
tive action of the elements, Paul God-  
ley's set of BURGESS Radio Batteries,  
wind-swept, rain drenched and sun-  
scorched though they were, responded  
instantly and powerfully, with the vital  
energy necessary to the perfect opera-  
tion of his delicate receiving set.

While it is seldom that a radio battery  
is required to function under the stress  
of conditions a fraction as difficult as  
these, Paul Godley's experience stands  
out as a remarkable and heretofore un-  
heard-of example of the long life, high  
capacity, tenacity of power and inde-  
structible construction of Burgess Bat-  
teries—*enduring qualities that are built in.*

### BURGESS BATTERY COMPANY

Engineers—DRY BATTERIES—Manufacturers  
FLASHLIGHT—RADIO—IGNITION—TELEPHONE

General Sales Office: Harris Trust Bldg., Chicago  
Laboratories and Works: Madison, Wisconsin

BRANCHES:  
NEW YORK                      BOSTON                      WASHINGTON  
KANSAS CITY                ST. PAUL                    NEW ORLEANS  
In Canada: BURGESS BATTERIES, Ltd.  
Winnipeg                      Toronto                      Montreal

"ASK ANY RADIO ENGINEER"

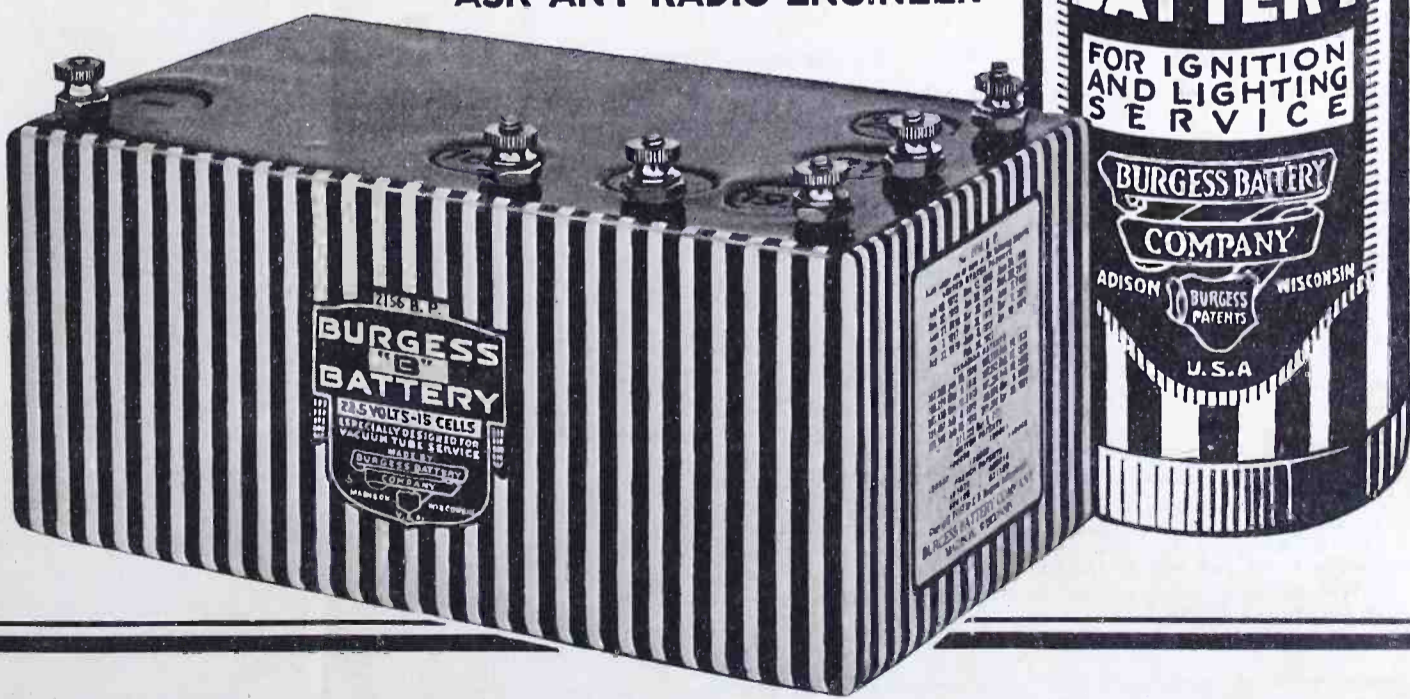

Tell them that you saw it in RADIO

# RADIO

Established 1917 as Pacific Radio News

Volume V for April, 1923 Number 4

## CONTENTS for APRIL, 1923

Radiatorial Comment .....	9
How De Forest Makes The Movies Speak .....	10
By ALFRED M. CADDELL	
Receiving Circuit Experimentation .....	12
By SAMUEL G. MCMEEN	
Making The Set Pay Dividends .....	14
By C. A. REBERGER	
A Short Range Radio Telephone Set .....	15
By MAURICE BUCHBINDER	
Modulation Circuits and Broadcasting .....	17
By ELLERY W. STONE	
Improved 1½ Volt Wet Cell for Filament Lighting .....	19
By ARTHUR S. GORDON	
Scratchi Publishes Some Third Class Matter .....	20
By DAVID P. GIBBONS	
The Unknown Broadcaster .....	21
By RAYMOND W. SHIREY	
Tuning A Double Circuit Regenerative Receiver .....	22
Sparks McAllister Solves A Problem .....	23
By S. P. WRIGHT	
Distributed Capacity: Its Effects and Measurement .....	24
By JESSE MARSTEN	
How To Plan Your Set .....	27
By PAUL MCGINNIS	
A Closed Core Magnetic Rectifier .....	29
By FLORIAN J. FOX	
Methods of Measuring Voltage Amplification of Amplifiers .....	32
A Chemical Rectifier for Small C. W. Sets .....	34
By CARLOS S. MUNDT	
With The Amateur Operators .....	35
Letters To The Editor .....	36
News of the Broadcasters .....	37
Digest of Recent Radio Patents .....	38
Queries and Replies on C. W. Practice .....	39
By Gerald M. Best	
Calls Heard .....	40
New Apparatus and Supplies .....	42

RADIO is Published Monthly by the Pacific Radio Publishing Co., Inc., Pacific Building, San Francisco, Calif.

ARTHUR H. HALLORAN	Editor
LAWRENCE MOTT	Associate Editor
LOUIS TREVISO	Art Editor
GERALD M. BEST	Technical Adviser
O. SCHUWENDT	Engineering Draughtsman
H. W. DICKOW	Advertising Manager

Branch Offices: 17 West 42nd St., New York City, Telephone Longacre 8248; 157E. Ontario St., Chicago; 761 Spitzer Bldg., Toledo, Ohio; 52 Irving Street, Boston, Telephone Copley 5107-R; 1102 Republic Bldg., Kansas City, Mo.; Suite 511, 456 So. Spring St., Los Angeles, Cal., Telephone 12050; 2218 Third W., Seattle, Wash., Telephone Elliot 1903.

European Representatives: Compagnie Universelle De Representation wt de Commerce. Rue des Fortifications, 69, Anvers, Belgium.

Advertising Forms Close on the First of the Month Preceding Date of Issue.

Issued Monthly, 25c a copy. Subscription price \$2.50 per year in the U. S., \$3.00 per year elsewhere. Instructions for change of address should be sent to the publisher two weeks before the date they are to go into effect. Both old and new addresses must always be given.

Entered as second-class matter at the Post Office at San Francisco, Calif., under the Act of March 3, 1879.

Copyright 1923, by the Pacific Radio Publishing Co., Inc.

## Forecast of Contributions for May Issue

The prospective transmitter will find some helpful ideas in Samuel G. McMeen's article on "Radio Transmission Circuits." This gives diagrammatic explanation of all the useful circuits.

R. C. Denny, operating engineer for the San Joaquin Light & Power Corporation, gives an account of his practical experience in operating KMJ as an emergency means for communication between office and power plant.

Paul Oard, well known as a radio engineer, contributes as the fiction feature "The Radio Mystery of Mt. Diablo." Mr. Oard has also promised to write a number of practical radio articles for future issues.

J. W. Kidd gives the results of his successful experience in constructing and operating a mechanical rectifier for a C. W. transmitter.

Florian J. Fox follows up his general article in this issue by a more detailed account of how to design a receiving set. In this he applies developed principles to the construction of a regenerative single-circuit tuner with three stages of amplification.

A timely article by Arthur Gordon tells how to get the most out of a dry cell tube.

Among the kinks C. A. Reberger offers a suggestion for making a neat message blank holder.

A. Machson discusses in a practical manner the theory of the use of choke coils in radio.

Stuart A. Hendrick, 2BJG, presents complete directions for building his justly famous DX Bringer In.

Raymond F. Yates has an inspiring article on some needed radio inventions. Here is a chance for some of our readers to get busy.

L. R. Felder discusses the subject of modulation systems in radio telephony.

Six Zee Jay describes the construction of a small portable receiver that works without an aerial.

The concluding assignment in the University of California correspondence course in Elementary Radio by Ellery W. Stone offers some excellent practical hints for radiophone reception.



A. H. GREBE & CO., Inc.  
 Richmond Hill, N. Y.  
 Western Branch  
 451 East 3rd St., Los Angeles, Cal.



Write for  
 "Musings of  
 Dr. Mu."

“What is whispered — in the ear is heard miles away.”

said Mencius.  
 The wise radioist hears voices  
 a thousand miles  
 away with a **Grebe Receiver.**

*Doctor Mu.*

Licensed under Armstrong  
 U. S. Pat. No. 1113149



## This New Frost Jac-Box Lets All the Family Listen In



No. 139 Frost-Radio Cord Tip Plug 60c



No. 131 Frost-Radio Double Circuit Jack 90c



No. 138 Frost-Radio Multi-Phone Plug \$2.50

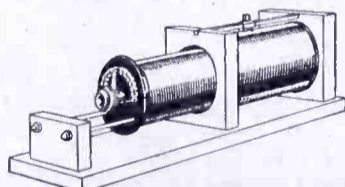

No. 400 Frost-Radio Receiving Transformer \$8.50

YOU folks who have receiving sets will welcome this new Frost Radio Jac-Box. It enables the family to listen in on broadcasted programs by providing four jacks into which four pairs of Frost-Fones may be plugged simultaneously, or three pairs of Fones and a loud speaker.

### FROST-JAC-BOX

will prove the handiest little accessory you ever used on your receiving set. With it the tuning of your loud speaker may be accomplished without disconnecting your Frost-Fones. The Jac-Box is beautifully made of quarter-sawed oak, with Formica front and back panels, green felt base and metal parts nickel plated and polished. If your dealer cannot supply you with descriptive literature, write us direct.

No. 501 Jac-Box, with 10 inch cord and Cord Tip Plug, complete	\$3.00
No. 502 Jac-Box, with 10 inch cord for use with sets having binding posts	\$2.50
No. 503 Jac-Box, only	\$2.25

Go to your dealer today and order one of these Jac-Boxes for your receiving set



HERBERT H. FROST, Inc.  
154 WEST LAKE STREET, CHICAGO, ILLINOIS.

Tell them that you saw it in RADIO



## When every hour counts

**B**ILL wanted to make his radio set as quickly as possible. The ABC station was broadcasting some "great" concerts every day.

But at the very beginning there was a delay in getting his panels. It wasn't a long delay, but he was impatient and wanted to make every hour count.

You, Bill, and every radio set-builder can avoid such a delay by getting Celoron Standard Radio Panels. These panels are made in seven sizes, selected to meet every requirement of the set-maker. You don't have to wait for your panel to be cut. There's no extra expense for cutting to your order. You go to your dealer and give him the size. He has a Celoron panel which you

can carry home with you at once.

Thus, for the first time, as far as we know, panels are on the market ready for the consumer. Each panel comes trimmed and wrapped separately in glassine paper to protect the surface. On each one are full instructions for working and finishing.

Celoron makes an ideal panel. It is easily worked, machine drilled and tapped and will engrave evenly without feathering. After thorough tests it has proved to have all the essential characteristics for radio work. It has high surface and volume resistivity, high dielectric strength and low dielectric losses. That's the reason thinking radio enthusiasts who want the highest type panel insist upon Celoron.

Select from these sizes the one you need:

- |                               |                              |
|-------------------------------|------------------------------|
| 1. — 6 x 7 x $\frac{1}{8}$    | 4. — 7 x 18 x $\frac{3}{16}$ |
| 2. — 7 x 9 x $\frac{1}{8}$    | 5. — 9 x 14 x $\frac{3}{16}$ |
| 3. — 7 x 12 x $\frac{1}{8}$   | 6. — 7 x 21 x $\frac{3}{16}$ |
| 7. — 12 x 14 x $\frac{3}{16}$ |                              |

*Make every hour count in making your radio set. If your radio dealer has not yet stocked these panels, ask him to order for you. Or write direct to us. Be sure to designate by number the size you want.*

### Diamond State Fibre Company

BRIDGEPORT (near Philadelphia) PENNSYLVANIA

BRANCH FACTORIES AND WAREHOUSES  
 BOSTON CHICAGO SAN FRANCISCO  
 Offices in Principal Cities

In Canada: Diamond State Fibre Company of Canada, Limited  
 245 Carlaw Avenue, Toronto

To radio dealers:

Condensite Celoron Radio Panels in standard sizes offer an exceptional opportunity in quick sales and substantial profit. Write for special dealer price list showing standard assortments.

# CONDENSITE CELORON STANDARD RADIO PANEL

# *Are You Interested In* **RADIO?**

Radio is one year old now! What are its possibilities in another year? Over 1,500,000 Radio Receiving Sets are in daily use. Estimated daily radio audience is 10,000,000. What will the radio audience be, 5, 10, 20 years from to-day?

**FREE** ADVERTISING PRIZE CONTEST **FREE**  
FOR RADIO FANS

## FIRST PRIZE

**\$250.00 Radio Set Free**  
**Six Tube Radio-Audio Frequency Set**

## SECOND PRIZE

**\$150.00 Radio Set Free**  
**Four Tube Set, Detector and 3 stages Amplification**

## THIRD PRIZE

**\$100.00 Radio Set Free**  
**Three Tube Set, Detector and 2 stages Amplification**

To advertise our business we will give the above prizes to the three persons sending us a list of five or more names of Radio fans and who compose the best slogan or phrase of words we can use for our advertising matter. We are interested in sending our catalogue and price lists to Radio fans.

If you are interested in Radio and in its future possibilities don't overlook this opportunity to get acquainted with us, secure low prices on your purchases and an opportunity to win one of the above prizes free of charge.

In the event of two or more persons submitting the slogan judged the best, second best, or third best, each will receive the full amount of the prize tied for.

**All entries must be received by us  
not later than March 31, 1923.**

**National Radio Products Corporation**  
**509 FIFTH AVENUE** **NEW YORK**



# KENNEDY

USES

KENNEDY  
EQUIPMENT

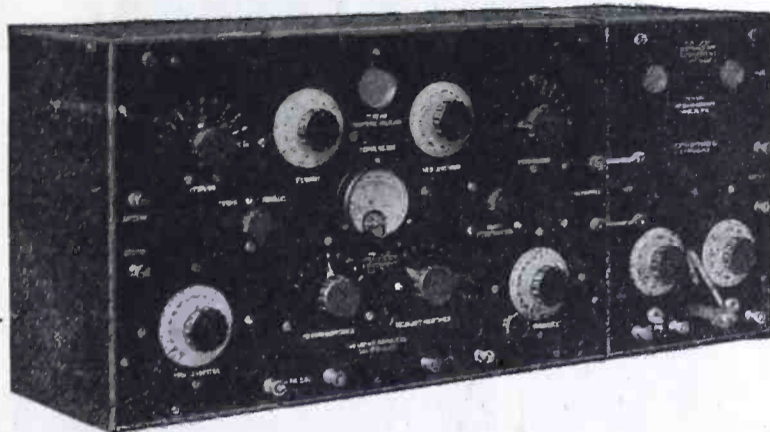

KENNEDY  
EQUIPMENT

## Formica Panels and Insulation

**T**HE Colin B. Kennedy Company uses Formica exclusively for its panels, tubes and other insulating parts in its entire line of Receiving Sets.

The handsome appearance of Formica, its high dielectric strength and wonderful uniformity meet the exacting Kennedy standards and have contributed to the creation of the splendid Kennedy reputation.

A list of the companies who use Formica Insulation reads almost like a directory of the leading independent radio manufacturers.

This patronage of men who know radio insulation establishes Formica's claim to leadership in its line.

**DEALERS:** Formica advertising and sales support is the most aggressive and effective in the industry. The Formica Insulation Company treats you right.

### The Formica Insulation Company

4616 Spring Grove Ave.  
Cincinnati, O.

Sales Offices:

50 Church St., New York, N. Y.  
422 First Ave., Pittsburgh, Pa.  
1042 Granite Bldg., Rochester, N.Y.  
415 Ohio Bldg., Toledo, Ohio

1210 Arch St., Philadelphia, Pa.  
1819 Lyndale Ave., S. Minneapolis,  
Minn.  
Sheldon Bldg., San Francisco, Calif.  
Whitney Central Bldg., New Orleans

414 Finance Bldg., Cleveland, O.  
9 S. Clinton St., Chicago, Ill.  
313 Title Bldg., Baltimore, Md.  
47 King St., Toronto, Ontario.

# FORMICA

Made from Anhydrous Redmanol Resins  
**SHEETS TUBES RODS**

Tell them that you saw it in RADIO



# Radiotrons



*This symbol of quality  
is your protection*

- Radiotron UV—200**  
The long distance detector . \$5.00
- Radiotron WD—11**  
The ideal dry battery detector 6.50
- Radiotron UV—201**  
The amplifier tube . . . . 6.50
- Radiotron UV—201A**  
The super-amplifier tube . . 3.00

*At the Nearest  
RCA Dealer*

Radio in a million homes already—and the vast majority of vacuum tube receivers choose Radiotrons for reception and amplification! It was perfection of the Radiotron that made the swift success of broadcasting possible—and the Radiotron still stands alone, as it did from the first.

The only name by which anyone demands a vacuum tube is *Radiotron* — the key to clear, true reception of speech and music, with the simplest set or the most imposing.

**Radio**  **Corporation**  
*of America*

Sales Dept., Suite 2069

233 Broadway  
New York, N.Y.

District Sales Offices:

10 South LaSalle Street, Chicago, Ill.  
433 California Street, San Francisco, Cal.

Tell them that you saw it in RADIO

April 1923

# RADIO

Vol. 5, No. 4

## Radiatorial Comment

**T**HAT the Senate failed to pass the White-Kellogg radio bill is the cause of bitter disappointment to all who are interested in the cause of better radio. Great hopes had been placed on this measure for bringing order out of the present chaos of the air. These hopes were raised when the House passed the bill, only to be dashed to the ground by the Senate.

The first impulse is to roundly berate the Senate for its failure to understand the need for the relief that the bill would afford. This is a non-political issue, one that effects the interests of millions of people. No valid reason has been advanced for its non-passage. The bill was prepared as a result of the Washington Radio Conference last year. While admittedly not a cure-all, for that is not to be expected thus early in the development of this new art, it was at least a long step forward in the right direction.

But on second thought we must realize that the Senate's inaction was in a large measure due to a corresponding apathy on the part of the public. 'Tis a sad commentary on our chief legislative body that it responds only to the most vigorous pressure. It is only when a strongly organized effort, like the agricultural bloc, is brought to bear, that action can be expected. This country is run by organized minorities.

So the remedy is for the radio interests to organize. Now is none too soon to get ready for the next session of Congress. A new bill should be framed to embody the best in the old bill and to include whatever recent experience has shown to be necessary. It should be given the greatest possible advance publicity together with strong arguments for its immediate necessity. Endorsements should be secured from influential organizations and individuals. A concerted campaign of letters and telegrams from all over the country should be directed to all Congressmen until they are made to realize that the public wants regulation of the air ways as well as of the highways. Readers are invited to send their ideas to the editor of RADIO.

'Tis fruitless to inquire who killed Cock Robin and why. The fact that the bill is dead calls not for a coroner's inquest nor a fulsome obituary but a vigorous effort to provide a worthy successor.

Meanwhile we see no reason why the Department of Commerce cannot substitute for the present allocations of wavelengths to amateur and broadcast stations those proposed in the dead bill. This will give some measure of relief until a better is available. Secretary Hoover has called for another conference on the situation, at which time it is hoped that some of these matters can be corrected. It is

reported that the Navy may give up the wavelengths from 500 to 800 meters for radio broadcasting and thus help to clear the air.

**R**ADIO shows are as numerous and popular as auto shows. They interest not alone those who already have receiving and transmitting equipment but also the thousands who want to learn something about this marvelous new development. It is no secret to state that little more can be seen at a show than by visiting all of the radio stores, but a show offers the more convenient and time-saving method.

Comparative construction and operation of various makes can be more readily judged at a show. The apparatus is generally more open for inspection and the exhibitors more anxious to explain and answer questions. Greater display is possible and devices that might be overlooked in a store are more forcibly brought to the attention.

So we urge upon all readers the advantage of visiting the next show in your vicinity. Several big shows have been held in the large cities. One is to be held at San Francisco early in April. Even the smaller cities are holding worthwhile exhibits. No person can be considered up-to-date who has not gained the familiarity with radio that can be gained at a show.

**T**HE woods are full of self-styled radio engineers. Most of them are about as competent to design and install radio apparatus as a donkey engine operator would be to lay out the equipment for a modern steam turbine power plant.

Those who are really entitled to the title are graduates in electrical engineering who have had wide experience in research laboratories or in practical work. Much of this same experience could be given in specialized college courses leading up to the degree of radio engineer.

So far as we are aware, no university has yet seen fit to provide such courses and confer such a degree. This is a lack that should be filled. The importance of the industry requires it and the opportunities for graduate radio engineers justifies it.

Radio engineering offers as interesting and remunerative a career as any other branch of professional work. For the young man who is already interested in the subject we advise a thorough college course in the theory and practice of high frequency electricity as holding in store a brilliant future for his life work.

# How De Forest Makes the Movies Speak

By Alfred M. Caddell

*This is an interesting account of the application of radio principles to the recording and reproducing of sound for use with moving pictures. It represents the results of Dr. Lee de Forest's work for the past three years.*

THE simultaneous record of sound and motion on a film is a problem that has engaged the attention of inventors for many years. Of the several methods that have been devised, that of Dr. Lee de Forest is of especial interest to radio amateurs, not only because of his pioneer work with the vacuum tube, but also because of his application of some radio principles to the solution.

The chief difficulty to be surmounted was to reconcile picture or light photography at a speed of 186,000 miles a second and sound photography at 1090 feet a second. This was finally done by superimposing the slow vibrations of sound first on electrical waves and then on light waves, thus giving synchronization so that the sound from the actor's lips is photographed simultaneously with their movement.

In ordinary conversation, the vibration frequency of a man's voice is be-

lowed to stream through a narrow slit (only 1/40th of a millimeter wide and 1 millimeter long) makes its impression the same as a photograph on a section of the moving roll of film at the back of the camera. And the film, after being

a telephone transmitter, only very much more sensitive. The sound waves strike against a parchment disk which vibrates at the faintest sound. At each fluctuation of sound this disk varies the flow of an electric current exactly as the microphone does in a telephone circuit. This telephonic current is then applied to the grid of an audion tube which impresses the plate current of the tube circuit, so that the output is a greatly strengthened voice-impressed current.

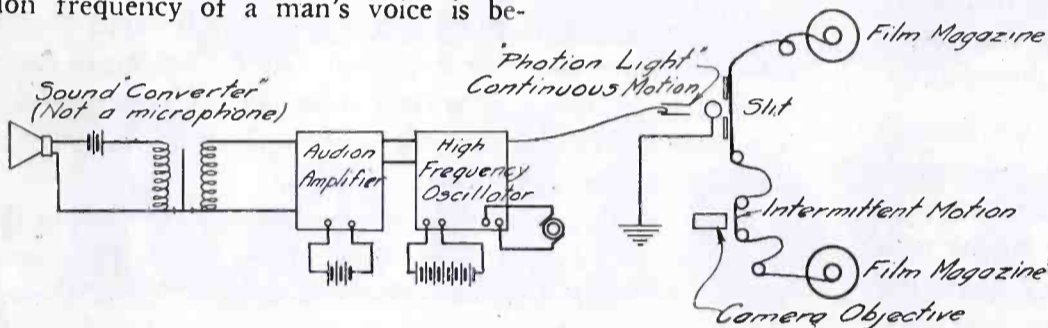

Fig. 1. Sound Recording System



Enlarged "Positive" of Phonofilm, Showing Sound Record Between Picture and Perforation at Left.

tween 700 and 800 times per second; that of a woman's between 1000 and 1200, and that of many musical instruments higher still—the piano ranging from 27.2 for the lowest note to 4138.4 for the highest. And those comparatively slow vibration frequencies have to be superimposed on a train of electrical (radio) vibrations.

Almost every radio fan knows the method by which the voice vibrations may be made to modulate an electric current. You speak into a microphone or telephone transmitter, the vibrations produced by your vocal cords setting up a variable output of sound waves. These variations cause changes in the microphone resistance, which in turn causes an electric current to vary in intensity. In radio this current is stepped-up and applied to the grid circuit of a modulating or vacuum tube, which amplifies and transforms it into electrical waves to be radiated from the antenna.

Up to a certain point the same procedure is followed in photographing sound. As the players of the movies are being photographed in their parts—acting, speaking, singing—the resulting sound waves fall upon a "converter," which is similar to the microphone of

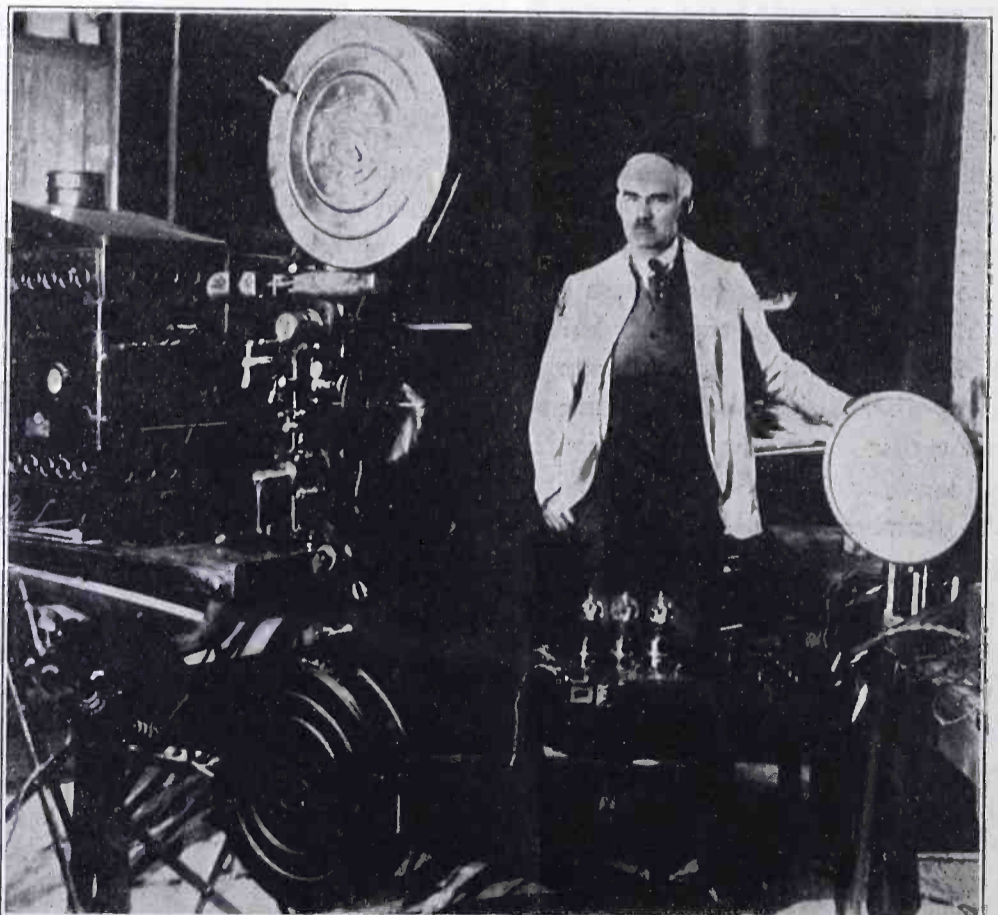

Dr. de Forest's Laboratory, Showing Projection Machine Used to Reproduce the Sound on the Phonofilm. The Weak Voice Currents Registered from the Film Are Magnified by the Vacuum Tubes in the Foreground

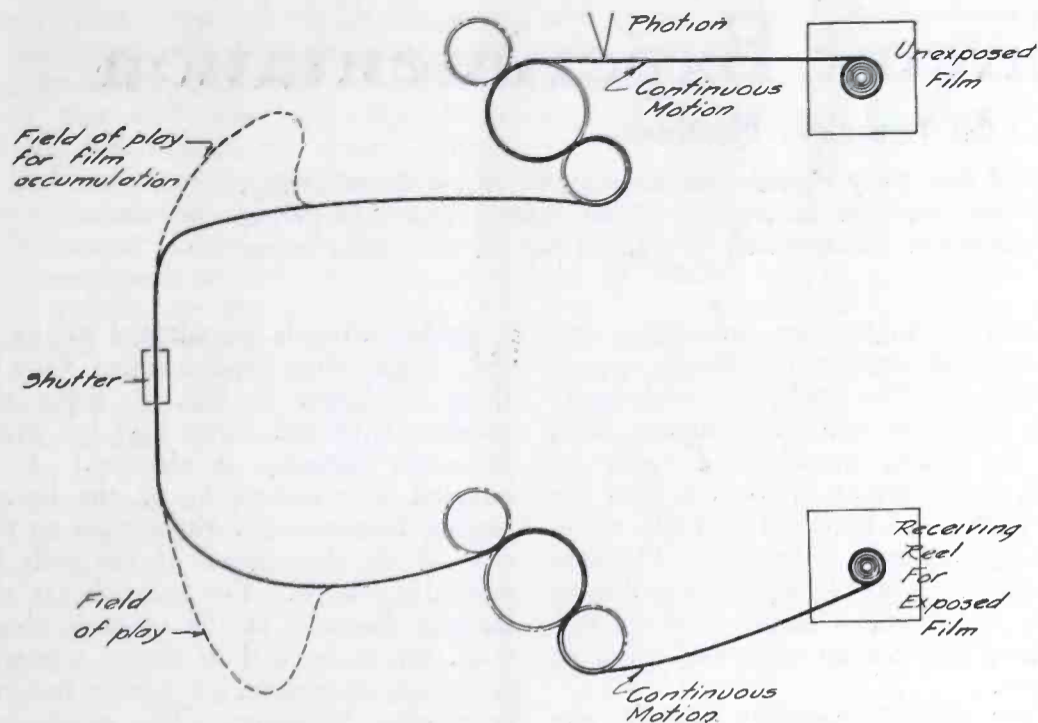

Fig. 2. Sound Projection System.

developed by the usual photographic process, shows not only the picture but what looks like a narrow path of uneven hair-line marks, or rills, which are the varying intensities of the photon light as they streamed through the microscopic-size slit and registered on the rapidly moving film.

About the Photon.

An ordinary electric light filament has too much of a "lag," being incapable of delicate control by varying electric currents. The ordinary 60-cycle current goes on and off 120 times a second, which gives a sense of continuity to eye. But it could not be made to vary 800 times or more a second, to accommodate the different vibrational sounds of a man's voice (and higher for musical instruments, etc.). So a gaseous "filament" became necessary, something that would act quickly and correspond exactly to the vibrations of speech and music. The photon registers high-pitched musical notes on the film at the rate of about 3000 per second; which means that each of the vibrations of the parchment disk of the "converter" is transferred to the electric current and that the light brightens and wanes 3000 times in one second, which light variations are instantly recorded alongside the picture on the film.

Thus the photon is a glow lamp containing a mixture of gases which are made luminous by the passage of a high-frequency electric current. The flickers or changes in intensity of the violet glow correspond to speech modulations which have been superimposed on the high-frequency current by means of the sound converter and amplifier tubes. The flickering is photographed through a slit onto the film so as to make dark lines when the photon is bright and gray lines when dim.

To reproduce this series of lines as

sound a strong light is shown through the film so as to fall on a sensitive photo-electric cell whose metal plate gives off electrons when illuminated, the number of electrons given off depending upon the intensity of the light. The more light the more electrons, the variation

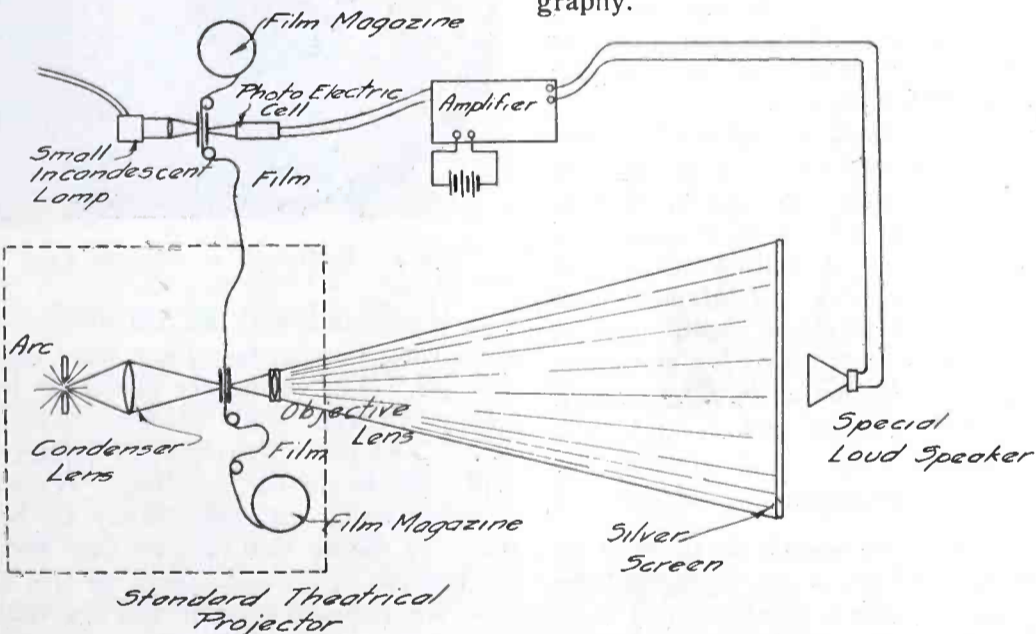

Fig. 3. Method of Synchronizing Sound and Motion Photography

in electron flow corresponding to the variations in light intensity and thus to the original voice modulation. This flow of electrons constitute a feeble electric current which is amplified by four or five vacuum tubes until it has sufficient strength to operate a telephone loud speaker and thus reproduce the sound.

The photo-electric cell, like the photon, has been the subject of considerable research by Dr. de Forest, who has finally developed an exceedingly sensitive device. It consists of a metallic coating in an evacuated glass bulb. This coating may be any one of a number of substances, including selenium, potassium, rubidium, molybdenite or silver nitrate.

The entire process is shown in the accompanying diagrams. Fig. 1 shows the recording system, Fig. 2 the projection



Dr. de Forest and Recording Camera. He Holds "Photon" in Right Hand and Microphone in Left. The "Photon" is Placed in the Small Opening, Above the Lens. The Microphone Converters are Placed in Receptacles All Around the Field of Action to "Pick Up" the Sound.

equipment and Fig. 3 the means for synchronizing sound and motion photography.

Summarizing, we record pictures and sound: (1) by superimposing sound waves on electrical waves; (2) by superimposing electrical waves on light waves, and (3) by photographing the light waves on the edge of the film, alongside the picture of the actor who spoke or rendered the music.

To reproduce pictures and sound the process is reversed: (1) As the film likeness of the actor is being run off, the photographed light impressions on the edge of the film are transformed into electrical waves, which are in turn (2) amplified by vacuum tubes and (3) transformed into sound waves by the well-known electromagnetic action of telephone receivers, or as in this case, loud speakers placed near the screen so that everyone in the audience may hear.

# Receiving Circuit Experimentation

By Samuel G. McMeen

*All radio fans may be divided into three classes—the novice who enjoys broadcasting, the amateur who sends and receives code messages, and the experimenter who gets a real kick from making all his parts. This article is written for the last, who learns much from his fun.*

THERE is entertainment to be had from the experimental rearrangement of the standard elements of receiving sets, and the combination of the parts of one arrangement of standard units with those of another. There is also much more than entertainment to be had, in the new knowledge that accrues to the worker. For, after all, knowledge of the basis of science comes best by trying things, and while there is a great deal to be learned from the scanning of printers' ink, the true road to mastery is trial, though not necessarily tribulation.

One of the happy features of interest in radio research is the great number of combinations and permutations that can be given to the parts of sets and still attain results. Out of these arrangements have come the many receiving sets, and out of them can come more. Doubtless the larger number of the sets we have, originated because of exploration in just the way we are describing, of changing known into untried forms.

One of the excellent ways of preparing for such adventure is to provide units of inductance and capacity, capable of being connected up in a variety of ways, like a set of building blocks or the cards of a deck. The number of arrangements depends on the number of elements, and fortunately for our game of shuffling and dealing, there are several units in most types of sets.

## Spiderweb coils.

For short wave sets all the turns of an inductance will go in one layer, and the usefulness of such a one-layer coil is as great as that of a duolateral or honeycomb coil. It is in the longer wavelengths that the latter type of coil shows its superiority, which is due to the lower distributed capacity between turns. As there are few turns in the short wave coils, and as there are no superimposed layers, not even bank winding has to be resorted to.

Convenience and orderliness of use make it desirable that all of the lot of inductances used in experimental hookups shall be mounted on bases. In this way the required units can be set out on a table and combined and rearranged to one's heart content. The same is true of the capacitances, but these ordinarily must be of the variable condenser type, and not much variety is possible. The latter, however, may well be attached to small baseboards somewhat as in the case of the coils next described.

Coils on tubing are convenient, but for ease and certainty of winding require a lathe. "Pancake" or "spiderweb" coils, being flat coils on insulating disks, can be wound quickly and easily by hand, and a supply of them is ideal for much work of trial. The tools necessary are one pair of scissors. The materials are a piece of pasteboard and some wire. The process savors of doing embroidery but has no other objectionable feature.

The picture herewith shows the scheme of the spiderweb winding. The

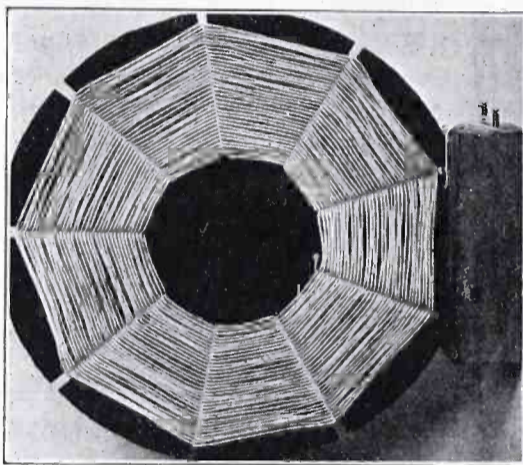

Fig. 1. Spiderweb or Pancake Coil

disk is provided with an odd number of slots, their number being any from three upward. The fewer the slots, the less nearly circular will be the resulting coil. The more the slots the longer it will take to do the winding. A good compromise is nine slots. They are best made by taking two parallel cuts about a sixteenth of an inch apart, as this allows the turns to cross in the slot without warping the pasteboard.

The bases for the coils are easily made in the form of small blocks with a saw-cut across them, into which cut the edge of the disk is slipped. The thickness of the pasteboard may be chosen such that the cut one's saw will make will be a fit. It is convenient to use lengths of flexible cord to connect up the coils into the various circuits, and so terminals may be provided on the ends of the coil-bases. Good terminals are formed of brass escutcheon pins to which the wires are soldered.

The flexible cords should have spring clips on their ends, thus adding greatly to convenience as well as to order. Such cords will be continuously useful, for all sorts of hookups, and for all but storage battery leads they may have tinsel conductors, thus assuring maximum flexibility.

Spiderweb coils are adapted to any of the circuits that require coils. One of them is shown in Fig. 2, being the familiar three-coil tuner that has given so many listeners satisfaction. It is adapted to wavelengths of the broadcasting frequencies without taps on the coils if the dimensions of the coils be carefully chosen. For example, if the average diameter of the turns is about 4 in. the turns will be these: primary, 25 turns; secondary, 75 turns; tertiary or tickler, 50 turns. The condensers give some leeway in the wavelengths to which the circuit will respond, so that

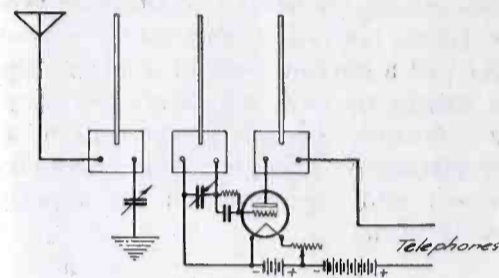

Fig. 2. Three Spiderwebs with Detector Tube

broadcasting at both 360 and 400 meters can be tuned in, without change in the coils. If the diameters of the windings are less than 4 in. average, then the number of turns must be more.

In operation, the distance between the coils as they stand on the table may be varied to hit upon the most desirable spacing and relation. The distance between primary and secondary coils will control the selectivity of the circuit; that is, the power to exclude neighboring wavelengths while concentrating on one wavelength. The position of the tickler with relation to the secondary controls regeneration; that is, enables one to put the circuit in its most sensitive and responsive condition by enabling the plate current to re-excite the grid circuit. This tickler placing is merely that of turning the base of the tickler in the plane of the table.

The foregoing is based on the use of spiderweb coils having but two terminals and no taps. The advantage of this form is that unused end turns absorb energy and do not turn it into useful work, and with coils that have no taps one always uses the entire winding and there are no end turns. But in coils of this type the end turn losses are at a fair minimum, so that the results will be good even if there are taps and end turns.

To provide taps is very simple. The wire is merely looped outwardly and

then twisted and bared. By placing three or four intermediate taps on the primary and secondary coils one may have a tuner that will cover the range from 200 to 600 meters, the coarse adjustment being made on the taps and the fine adjustment on the condensers.

Permanent mounting can be given to an arrangement of the coils that gives good results in the table trials, by mounting the primary and secondary windings with the determined separation between them, and the tickler so that it can be rotated on one of its diameters, not on its center like a wheel but on a line-axis like a damper in a stovepipe.

There are numberless ways in which these flat-wound inductances can be utilized in radio receiving sets, and their use in more robust forms may as well be extended to transmitting sets. A radiophone that can be placed in a silk hat may easily be built on the British airplane circuit by their use. Perhaps that may well be saved for another time, but we shall try to remember to get back to it.

Mr. Laurence Emmons of California has developed an interesting form of receiving circuit in which he uses three spiderweb coils, two of them forming a

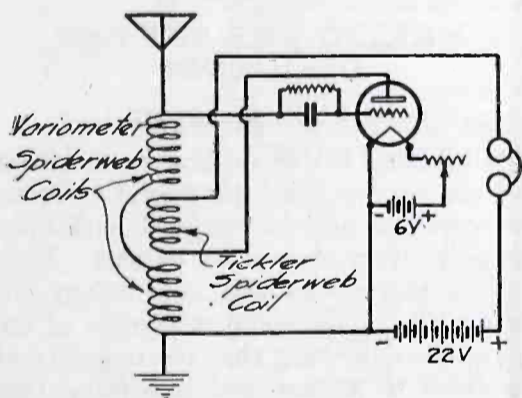

Fig. 3. Regenerative Circuit with Variometer Made of Two Spiderwebs

variometer and the third a regenerative tickler. The circuit is shown in Fig. 3, and will be seen at a glance to have the merit of simplicity, though its performance is excellent.

In this arrangement, the two spiderwebs that make up the variometer are connected in series with each other, and form the path from aerial to ground. No condenser is used in any part of the circuit, the plan being the same in that regard as that using two variometers, and shown in Fig. 4. From the aerial

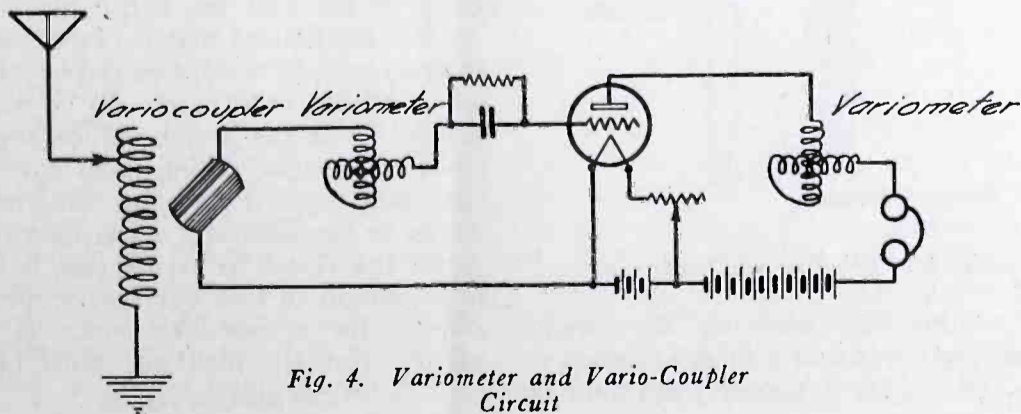

Fig. 4. Variometer and Vario-Coupler Circuit

and ground ends of the variometer so formed are taken the leads to grid and filament respectively. The plate circuit contains the telephones, the third spiderweb coil and the B battery. An A battery and a grid condenser and leak complete the roster of elements. The tickler coil is placed between the two halves of the variometer, and the circuit operates. The distances between the variometer halves can be varied, and the tickler can be slid edgewise to change its influence upon the other two coils, thus accomplishing regenerative adjustment as positively as if a rotor were used.

For the moment at least we are inclined to give Mr. Emmons' arrangement of parts first place among receiving circuits for simplicity, compactness and ease of making. It of course has no claim to great selectivity.

### A Loop Receiver.

It is not essential that there be coils in the receiving set, nor that there be more than one condenser. The arrangement shown in Fig. 5 is both selective and directional. Probably it is selective just because it is directional. It consists of a loop of sixteen turns wound on a three-foot square, associated with one condenser and a tube. The condenser is of twenty-three plates.

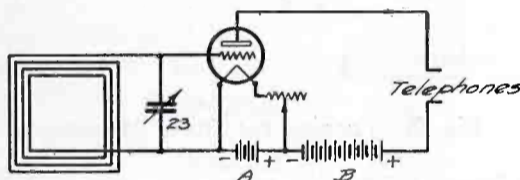

Fig. 5. The Simplest Tube Circuit, Which Receives Without Coils or Aerial

The rough adjustment is accomplished by attaching one of the loop leads to the loop at an intermediate or end point, while the fine adjustment is done by the condenser. The directional adjustment is simply to turn the loop till it lies in the vertical plane passing through both the sending and receiving stations.

The quality of receiving best from stations that are presented to the loop edgewise on can be utilized for non-directional reception by laying the turns of the loop in a horizontal plane. The larger the loop the greater its inductance, and the fewer turns are required to give the same result. So one may

place the turns around the room, in the groove of the picture-hanging molding if desired, and receive from all directions.

The circuit can be made regenerative by carrying the plate circuit through a second coil inductively presented to the loop, as shown in Fig. 6. The regenerative or tickler coil is of somewhat the dimensions of the principal or primary

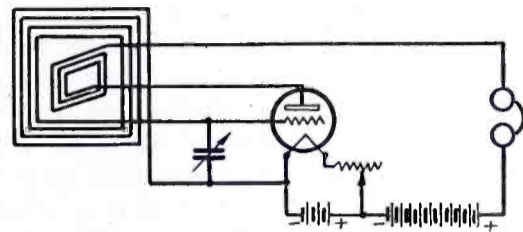

Fig. 6. Regenerative Loop Circuit

loop, and may be placed inside of it, may embrace it, or, less effectively, may be merely rotated beside it. If the dimensions of the tickler coil are say three feet on a side, it may well have twenty turns, and the optimum number may be determined by trial.

### A Push-pull Circuit.

The use of two tubes co-operating in such a way that their grids receive opposite charges simultaneously and their plates as a result develop alternating potential with relation to each other gives what has been aptly named the "push-pull" circuit. In its usual form this circuit contains a transformer before and one after the pair of tubes, these being related to the grids and plates of the two tubes so as to give the action mentioned. But it is possible to make the loop serve the purpose of the first transformer, while still doing all that it should as a reception loop; likewise it is possible to cause the pair of head receivers to do the work of the second transformer, in the sense of providing the point of connection for the positive

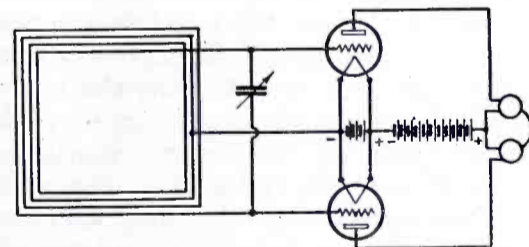

Fig. 7. Push-pull Circuits without Transformers

end of the B battery. Fig. 7 shows the circuit. The loop has its ends connected to the grids of the tubes, and the middle point of its turns connected to the negative side of the filament, which latter are connected together, like to like. The plates each connect to a telephone receiver. The junction between the two receivers takes the positive side of the B battery.

The degree in which this use of two tubes is better than that of one tube is measured by the amount in which one

receiver gives a louder response than either of two in series with the same plate potential. The gain in most cases will not be great, but this is an art in which small economies often prove of value. It certainly offers a simple and ready means of testing out the principles of the push-pull idea.

A second use of the push-pull notion is that in which the plates of the two tubes are connected to a choke coil, around which the telephones are shunted in series with a condenser as shown in Fig. 8. In this way there is no direct current in the telephones, and they are actuated solely by the alternating potential developed on the two plates. For this use the choke coil acts as an auto-transformer. It may be wound of many turns of fine wire, and should have an iron core, as it is in an audio-frequency relation to the rest of the circuit elements. This iron core should be either

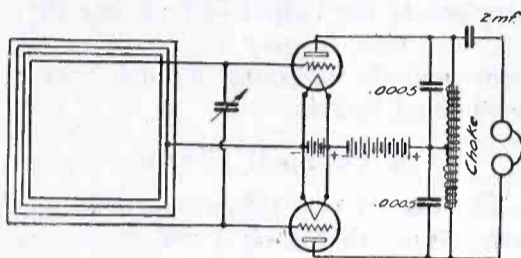

Fig. 8. Push-pull Circuit without Transformers

of sheets of iron or steel, or of iron or steel wires. The ignition coils of Ford automobiles contain sections of secondary winding that are useful in many radio circuits, and two of these sections will serve as a choke coil for the circuit under description. The junction between the sections gives the place for the attachment of the B battery.

The condenser in the telephone circuit is a large fixed one, of two microfarads capacity, such as is used in telephone apparatus. It is necessary to use a large capacity at this point because the frequency of what the telephones get is relatively low, say an average of about 1000 cycles per second. On the other hand, the two condensers in shunt with the two halves of the choke coil may be small ones, of the order of size of grid condensers, because they have only to pass high frequencies, say an average of 1,000,000 cycles per second.

#### Variometers.

One of the deservedly popular receiving circuits is that using inductances as the only variable elements, without any variable condensers. This is the type using vario-couplers and variometers. These units can of course be had in the market at reasonable prices, and of a satisfactory excellence. But occasionally there comes upon the amateur craftsman the desire to make something, and in such a case the making of variometers and variocouplers fills the need very well.

The variocoupler problem is an easy one. The stator may well be a 4-in. tube, and the rotor a section of tubing enough smaller to allow it to rotate within the main tube. The variometers are not so simple, but are readily made if a lathe is available.

The most workmanlike way of making variometers is of laminated stock. Three pieces of mahogany or other good hardwood should be glued together with the grain of the middle piece at right angles to that of the other two. Use the best hide glue or waterproof glue of the casein variety. Turn the cup-shaped depression for the winding by the method shown in Fig. 9, by pivoting the tool on the top of the hand-rest, setting the latter at the correct height opposite the center. Begin with the hand-rest further from the work than shown in the picture, bringing it nearer as the depression grows. Finally place it at the point

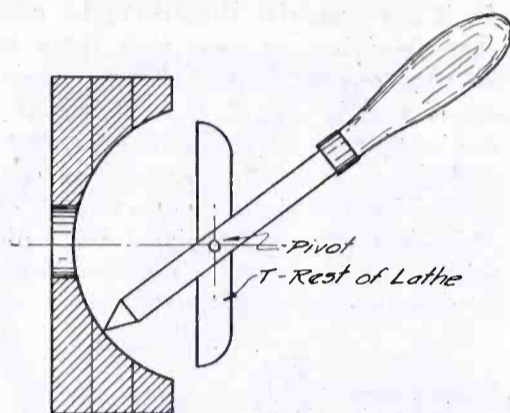

Fig. 9. Turning the Stator Mounting

where the pivot of the turning tool is in the plane which lies just halfway between the two sections of the variometer as planned.

The block from which the stator halves are turned is best supported in the lathe in a four-jaw universal chuck. It can, however, be attached to a face plate, even if the latter has a central screw to engage the wood. In the latter case the screw can be avoided in turning the cup-shaped depression.

The coils for the stator sections are cups of wire, fitting accurately into the cups of the wood. They are to be made

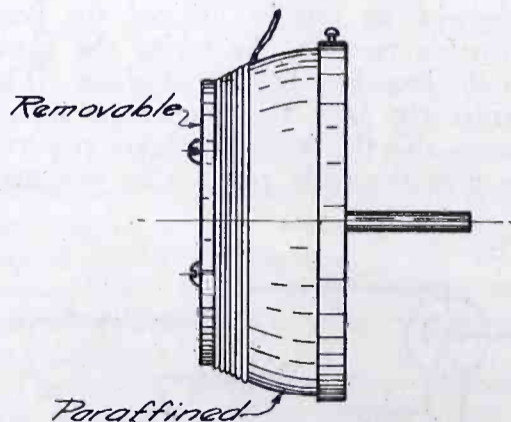

Fig. 10. Winding the Stator Coil

by winding the wire on the convex paraffined surface of a form as shown in Fig. 10. This is turned from hard or

soft wood with a radius slightly less than that of the cups of the stators. It is further provided with an end cap that is removable. The end of the wire is placed through this end cap at the beginning of the winding, and thus the wire builds up toward the larger diameter of the form. The final end is belayed to a pin, and the surface of the wire is painted with glue and allowed to dry. Then the last end is freed from the pin, the end cap removed and the firm cup of wire is slid off the form. The inside of the stator cup is now painted with glue and the form pressed into it.

The making of the rotor is simple. The winding of its two halves is similar to the winding of the stator halves, except that the wire remains in place as wound on the wood ball.

Fig. 4 shows the circuit of the devices. It deserves the popularity it has gained, as it is free from all faults but one, that of being sensitive to changes of resonance due to the nearness of the person of the operator. These body-capacity variations can be limited by the use of metal screens between the variometers and their knobs, the screens being grounded.

## MAKING THE SET PAY DIVIDENDS

By C. A. REBERGER

**S**UGGESTIONS on how to make the set pay for itself are bound to interest everyone and be received with open arms by every class of set owners. Each month that comes and goes brings out before the public some new piece of apparatus—something that the majority of us crave to possess, and something that will tend to decrease the cost of operating our outfits. But many of us, owing to financial circumstances, are compelled to refrain from purchasing these new devices and those who have the cash available generally think twice before making the purchase. The money is going out and none coming in, therefore it is not surprising that the average radio "fan" should devote much time to trying to devise some sort of scheme to make his set earn money.

Several excellent plans have already been carried out by radio enthusiasts and the results were astonishing. A very bright fellow whom I know was among those to see that his outfit pays dividends. He figured that if canoes, roller skates, rowboats and horses can be rented out, why not radio sets? So he corresponded with the secretaries of several clubs and lodges, telling them how fine the radio concerts are, how the crowds would be automatically drawn to a radio dance and closed by saying that he was in a position to rent out a very efficient receiver for a reasonable sum. It was evident that the plan met with favor,

Continued on page 95



# A Short Range Radio-telephone Set

By Maurice Buchbinder

*This is a descriptive rather than a constructional article. It tells somewhat of the how and why of the radio telephone in general as well as of the set described in particular.*

THE radio telephone set herein described is intended for short range work and was used extensively by the United States navy. It was manufactured and designed by the Western Electric Company soon after commencement of hostilities.

Radiophone set Type No. CW936 consists of a transmitter-receiver unit in one panel box, an amplifier unit, a power system including storage and B batteries and dynamotors, and an extension system for connecting the output of the amplifier with a loud speaking horn located in some other room than the radio room, thus permitting the operation of the set from distant points on the ship. Developing a relatively minute amount of power, the set permits communication over surprisingly high distances and over ten to fifteen miles quite reliably.

the fluctuations of the voice. The same dynamotor supplies plate voltage for both tubes and the same 16-volt battery the filament current.

The high frequency or oscillatory system is seen to be a simple capacity coupled feed-back system. The high frequency current flows between antenna and ground, thence directly in series through the grid or input condenser and thence through a tuning transmitter inductance which would be different in value for each wavelength employed. Thus the frequency of the radiated wave would be simply that of the antenna to ground loaded up with inductance and in series with the input condenser.

The energy is supplied to the antenna through the plate of the oscillator tube by a tap on the transmitting inductance

The modulation circuit is entirely independent of the oscillator and constitutes what is known as the Heising system of radio telephone modulation. The principle of it can be understood somewhat as follows: If some means could be found whereby we could alter the plate voltage in accordance with the variations of the voice or of music we should expect that the radiated current would be similarly altered and a "voice wave" instead of a continuous wave in the ether would result. This is really the function of the modulator tube. The circuit of this tube parallels the oscillator circuit in that they both draw energy from the dynamotor, in series with a low frequency iron core choke coil 66A (1 1/3 henry). If now the current in the dynamotor varies for any reason, the current in the choke core being directly in series, would also vary. Now, by the simple laws of alternating currents a varying current through a choke coil brings about a varying voltage across its terminals. Accordingly we see that even though the voltage of the dynamotor may be constantly maintained at 350, the voltage across the oscillator plate will vary. And this of course means the radiation output into the antenna will vary accordingly. Now the current in the dynamotor is being changed by the variation of the grid voltage of the modulator, following the simple rule of a vacuum tube, that variation in grid voltage brings about simultaneous and parallel change in plate current.

To summarize, we see that speech into the transmitter causes a fluctuation of current in the primary of the voice transformer 201C. The secondary of this transformer, connected across the grid of the modulator, brings about a synchronous change in the grid voltage. This in turn creates a fluctuating dynamotor current, then a fluctuating oscillator plate voltage, and finally a varying supply of energy to the antenna system and the typical "voice waves" in the ether.

The high frequency choke 67A (1.3 millihenry) is interposed between plate of oscillator and plate of modulator to prevent passage of radio frequency currents through the latter. All of the filaments are lighted in series off the 30-volt storage battery line. The set is adapted for use of two different types of vacuum tubes, C. W. 1162 and C. W. 93 respectively, and special 18 ohm resistances are arranged to be cut in as needed so as to keep the filament current proper for each type used.

Auxiliary pieces of apparatus such as condensers, resistances and inductances

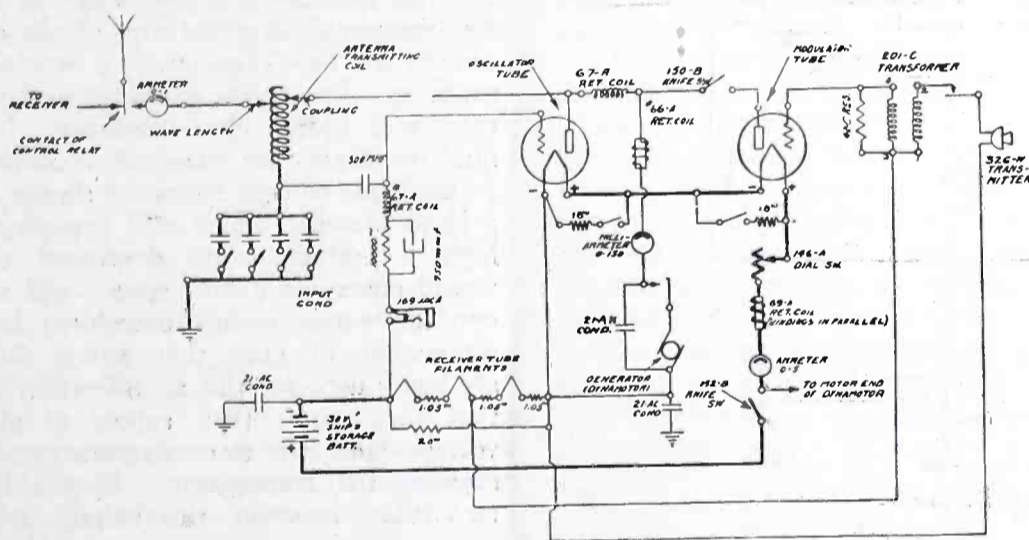

Fig. 1. Oscillator and Modulator Circuits

Coil 66A 1 1/3 henry, 67A 3 millihenry, 69A 1 henry. Input condensers 49A and 49B variable up to 2000 micro-microfarads. Condensers 21AC and 21AF 1 microfarad.

One of the features of the transmitter is a wave changer which permits shifting to any one of five different wavelengths in less than one second, or the time it takes to rotate a switch. When we consider the extent of interference possible both from spark stations and from other C. W. stations the value of this arrangement is obvious. The circuit which is employed for the generation of the high frequency current and for its modulation by the human voice during speech is accurately shown in Fig. 1. An analysis of the diagram reveals the fact that there are two distinct phenomena involved in the production of "voice waves" in the ether. Two vacuum tubes are being used to get the final product, the radiated "voice wave," but one of them takes care of only the high frequency wave production, while the other simply releases these waves so that they follow in intensity and pitch,

coil running to the plate. The position of this tap on the coil is varied during tuning of the set for best radiation and is accordingly different for each separate wavelength used.

To prevent the building up of excessively high negative voltages on the grid, which would take place because of the well known rectifying action in a vacuum tube, a form of grid leak is employed represented by retardation coil 67A (3 millihenry) in series with a 10,000 ohm resistance. This coil prevents radio frequency from passing through the leak path, but does not prevent accumulated voltages on the grid from leaking back to the filament. The 500 mmf. condenser is interposed to keep the plate voltage off the grid, while the 10,000 ohm resistance serves to fix the grid potential at a definite normal working voltage which is most efficient for the tube employed.

shown in Fig 1 can be explained in each case as a by-pass for radio frequency current, a voltage-limiting device or a choke for radio frequency currents, which increase the efficiency of the set but are not of vital importance. The physical values of each item used in the transmitter is given in the drawing.

We now pass to a consideration of the receiver system, which is shown schematically in Fig. 2, from which it is seen that it is possible to connect the vacuum tube directly to the antenna. Tuning under these circumstances would be expected to be rather broad, and indeed this is the "listening-in" position. For finer adjustment, coupled circuits are used and by means of a wave-changer switch a tuning condenser may be thrown in parallel with the secondary for longer waves.

The detector circuit is of the simplest non-regenerative type which, while not so sensitive to faint signals as the stan-

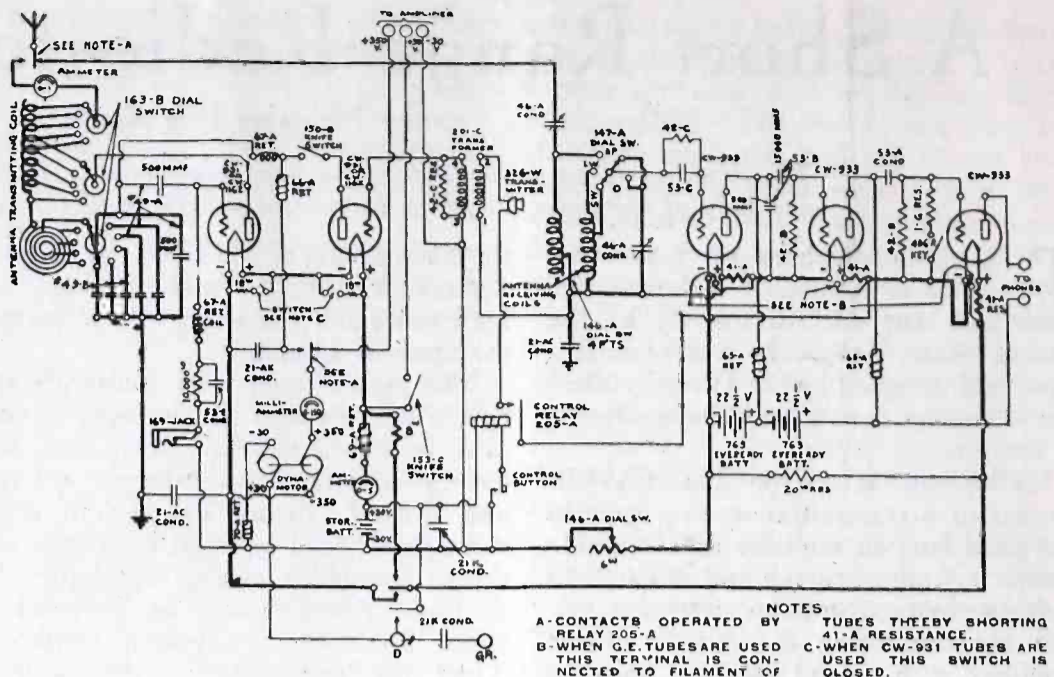

Fig. 2. Receiver Circuit.

Condenser 21K 1 mf., 536 .001 mf., 53A .0015 mf., 53E .00075 mf. Variable condenser 46A .00085 mf. max. Coil 65A 15 henry. Resistance 42C 2 megohm, 42B 1 megohm, 1G 3000 ohm.

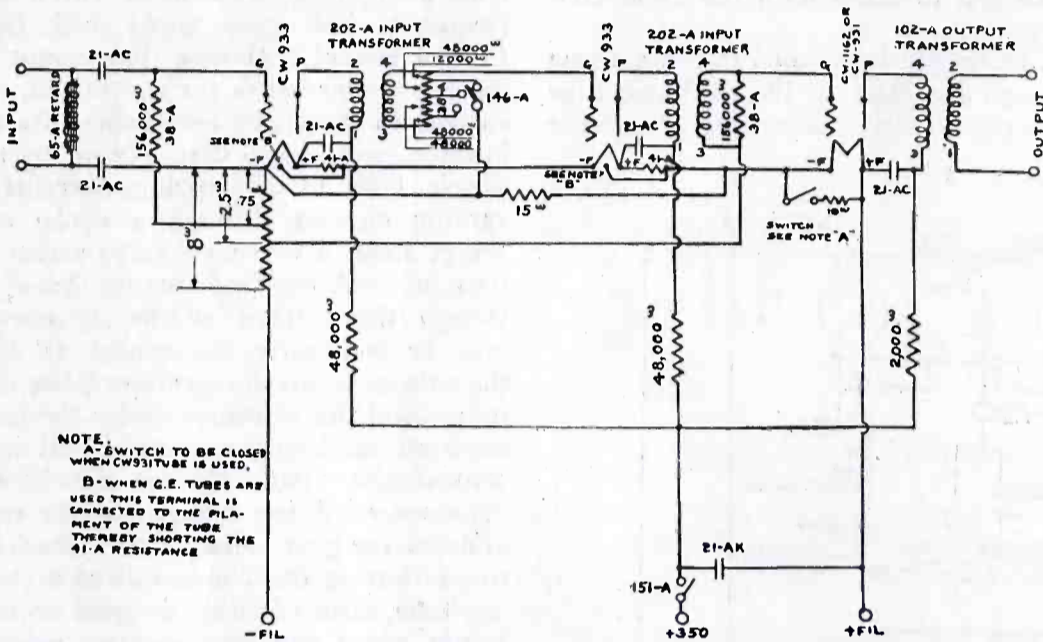

Fig. 3. Amplifier Circuit Diagram

The amplifier unit (see Fig. 3) which operates the loud speaker is an example of two different types of coupling, reactance and transformer coupling respectively. Between the last stage of the receiver circuit and the first of the amplifier, we have interposed a reactance coupling. Preventing excessive grid voltages is a 15,600 ohm resistance. The final two stages are transformer coupled. In each case enough resistance shunts the grid to filament which will prevent too high a voltage being developed that would otherwise distort speech and render the whole circuit unstable. It is interesting to note that power tubes are being used for this amplification and that they derive their supply of plate voltage from the same dynamotor that supplies the transmitter. In the first two tubes, however, this voltage is re-

Continued on page 48

dard regenerative receiver in common use, is far more stable in operation and does not emit the weird whistling noises inevitable in the tuning of an oscillating or regenerative circuit. A 2 megohm leak is thrown across the grid condenser to prevent accumulation of excessive negative voltages. Making up for lack of sensitiveness of the detector circuit is a two-stage resistance coupled amplifier. Here again by the use of resistance instead of transformer coupling, efficiency of amplification is sacrificed to stability and fine, clear reproduction without distortion.

The filaments are, as in the case of the transmitter tubes, connected in series. Thus all the filaments in the entire set are connected in series (except the amplifier, which has its separate supply) and varied by a single dial switch rheostat. During transmitting, when the filament circuit of the receiver tubes is opened by the automatic relay controlled by the operator, exactly enough resistance is substituted (8 ohm) to make up for the three receiver tubes.

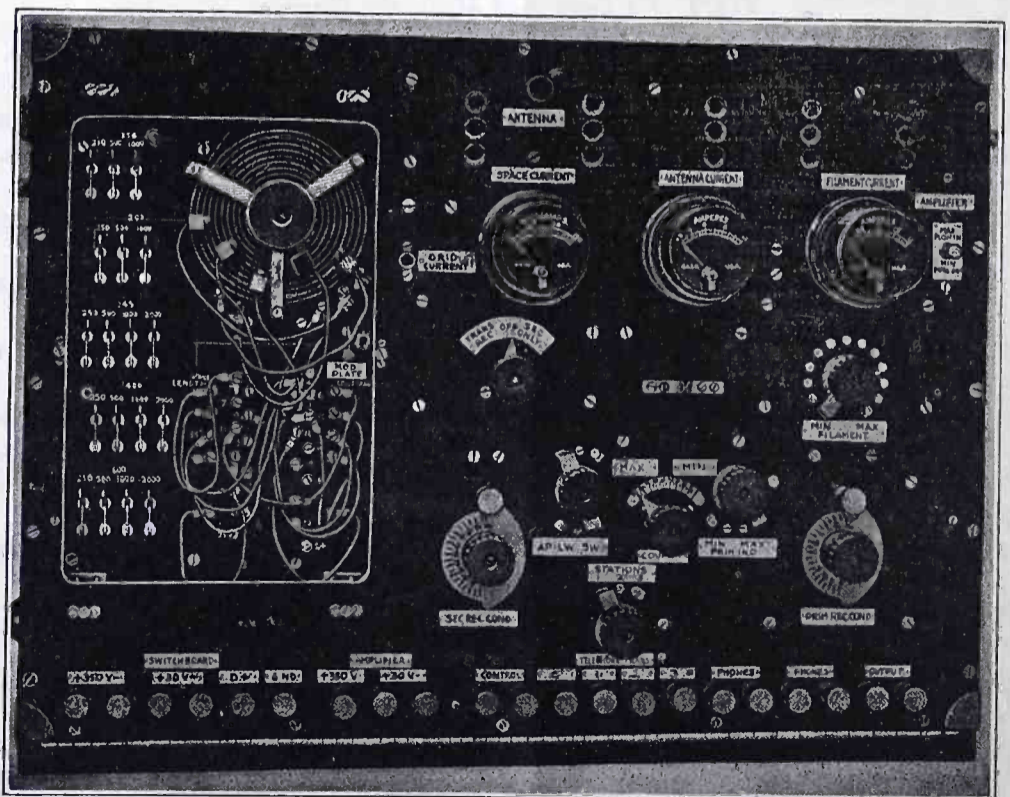

Fig. 4. Transmitter-Receiver Unit

# Modulation Circuits and Broadcasting

By Ellery W. Stone

*This constitutes the thirteenth and fourteenth assignments in the correspondence course on Elementary Radio conducted by the Extension Division of the University of California. One deals with tube modulating circuits for radiotelephony. The other tells about the general conduct of a broadcasting station.*

IN assignment No. 12, we considered briefly some simple circuits used for radiophone transmission. It was explained that these circuits generated undamped oscillations or continuous waves. No means were shown for controlling such oscillations, when once generated. In this assignment we shall consider some of the methods by which the oscillations are *modulated* by the human voice or other sounds which we may desire to transmit, such as music, so as to be faithfully reproduced at your receiving set. The circuits which are applied for this purpose to the simple generating circuits shown in the last assignment are called modulation circuits.

Let us consider the simple wire telephone by means of which sounds picked up by the transmitter are reproduced in the receiver. In Fig. 80 we have a tele-

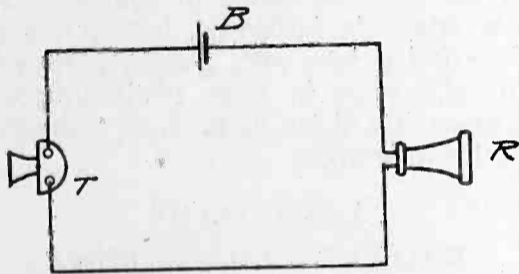

Fig. 80. Microphone Transmitter, Battery and Receiver

phone transmitter or *microphone*, T, in series with a dry battery, B, and a telephone receiver, R.

The action of the receiver is that described in the eighth assignment. The receiver may be of the simple hand type indicated in the diagram or it may be of the single or double watch case type ordinarily employed for radio purposes. The dry battery supplies a small, direct current which flows through the transmitter and receiver.

The transmitter or microphone consists, generally, of a metallic disk or diaphragm, on the back of which is mounted a carbon button. Another circular piece of carbon is mounted in a position parallel to the button at the back of the transmitter. The two carbon disks are separated by a short distance and between them and, making contact with both, is a loose pile of carbon grains or granules.

Since these carbon granules do not make a firm or close contact with each other, their normal resistance is quite high. If the metallic diaphragm is pressed in, however, the granules are compressed and, due to the better contact between them, the resistance of the transmitter is greatly lowered. If the

pressure is now removed from the diaphragm, it moves outward, due to its inherent elasticity, the carbon granules are no longer compressed, and the transmitter regains its normal high resistance.

The effect on the direct current flowing through the transmitter is to increase it when pressure is applied to the diaphragm since the resistance offered to the current is lowered. The current is decreased when the pressure is removed, since the resistance rises.

When one speaks into the mouthpiece of a telephone transmitter, therefore, the vibrations of the diaphragm produced by the vibrating sound waves of air set up fluctuations in the current flowing through the microphone. These fluctuations in the current flowing through the telephone receiver reproduce the same sounds.

The same principle is applied in radio telephony. In the latter case, however, instead of direct current we employ undamped oscillations to produce the continuous waves necessary for radio transmission. These oscillations are modulated by a telephone microphone suitably coupled to the generating circuits. The radiated waves are therefore of a nature suitable for generating currents in the receiving set which will reproduce in the telephone receivers the original sounds transmitted.

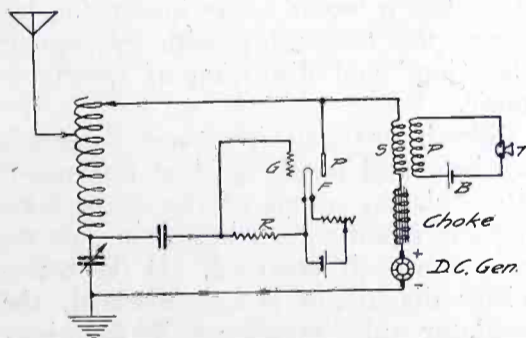

Fig. 81. Simple Form of Modulation Circuit

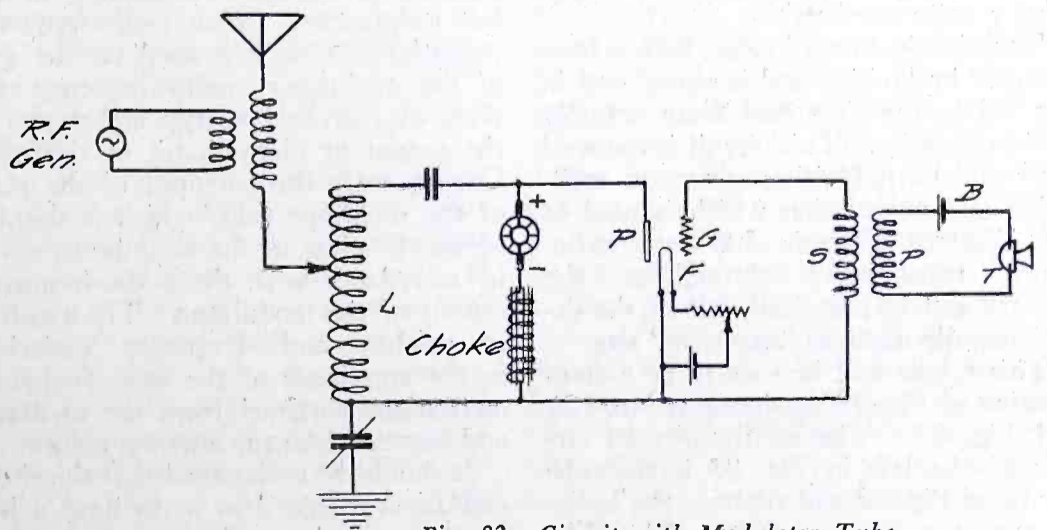

Fig. 82. Circuit with Modulator Tube

The simplest form of modulation circuit is that shown in Fig. 81. This is identical with the Heising circuit shown in Fig. 79 in assignment No. 12, with the exception that a *modulation transformer* is connected in series with the plate circuit of the transmitting tube. The modulation transformer is a small, iron-core transformer for coupling the microphone circuit, TBP (See Fig. 80), to the radio circuit. Modulation transformers have a transformer ratio of approximately 25. That is to say, the ratio of turns on the primary to that on the secondary is generally about 1 to 25.

Current fluctuations in the microphone circuit, set up by the voice, induce fluctuating potentials of the same frequency in the plate circuit of the oscillating tube through the medium of the modulation transformer. These fluctuating potentials add to or subtract from the potential of the d.c. generator supplying the high voltage in the plate circuit, according to their polarity. The output of the tube, and hence the antenna current, is increased and decreased depending upon whether these induced audio frequency potentials add to or subtract from the generator potential. The transmitted waves thus consist of really two sets of frequencies—the radio frequency “carrier” wave, on which is superimposed the audio frequency voice currents set up in the microphone or modulation circuit.

This form of simple modulation circuit is only suited to very low power tube transmitters and is not in use at any broadcasting stations.

Another form of modulation circuit is that shown in Fig. 82. In this diagram, the oscillating tube circuit is not shown in detail but is represented by the radio frequency generator coupled to the antenna circuit in the upper left part of the figure. The rest of the dia-

gram consists of the modulation circuit.

In this circuit, a *modulator tube* is employed, to the grid circuit of which is coupled the usual microphone circuit, *PBT*, through the medium of the modulation transformer.

The principle of this system of modulation is as follows: The inductance,  $L$ , in the antenna circuit is shunted by the resistance of the plate circuit of the modulator tube. The output of the radio-frequency generator or the antenna current depends, therefore, upon the value of this plate circuit resistance. Due to the amplifying properties of the modulator tube, any fluctuations of audio-frequency potential on the grid of the tube will affect the plate resistance and the antenna current is varied accordingly. The function of the modulation transformer, of course, is to induce audio-frequency potentials in the grid circuit due to audio-frequency current fluctuations in the microphone circuit.

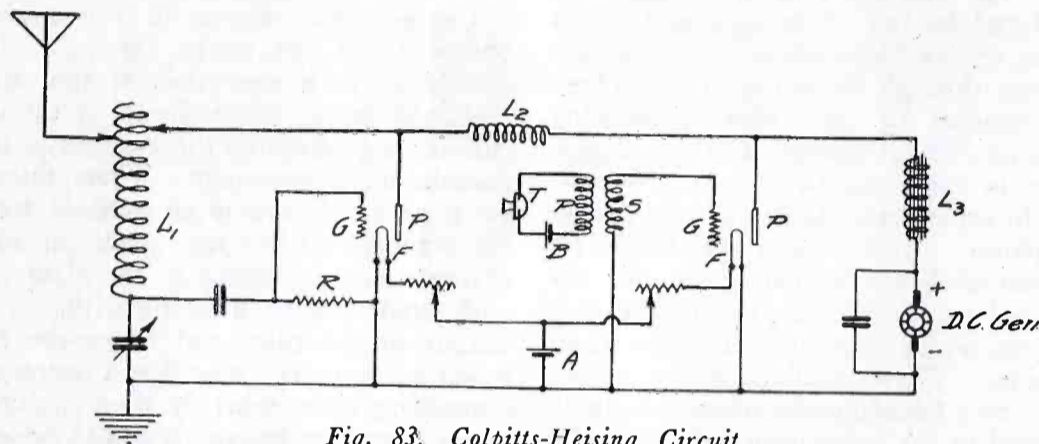

Fig. 83. Colpitts-Heising Circuit

Or we may say that audio-frequency potential fluctuations on the grid of the modulator tube produce very large current fluctuations in the plate circuit. Since the plate circuit is connected into the antenna circuit of the radio-frequency generator through the inductance  $L$ , the antenna current is increased or decreased depending upon whether the audio-frequency modulator tube plate currents add to or subtract from the radio-frequency antenna current.

This system of modulation shows perhaps even more clearly than the last how the resultant antenna current consists of a radio-frequency "carrier" current on which is superimposed the audio-frequency voice currents.

The circuit shown in Fig. 82 has been modified by Heising and is reproduced in Fig. 83 in the simplified form actually used in practice. This circuit is the well known Colpitts-Heising system of oscillation and modulation which is used in the Western Electric 500-watt radiophone transmitters throughout the country and in practically all of the experimentally made or "hay wire" sets.

This figure will be seen to be a combination of Fig. 79 (assignment No. 12) and Fig. 82. The oscillator tube circuit on the left in Fig. 83 is the tube circuit of Fig. 79 and replaces the radio-frequency generator of Fig. 82. The

modulator tube circuit on the right of Fig. 83 is the tube circuit shown in Fig. 82. The principle of operation of this system is as follows:

The plates of both oscillator and modulator are supplied by the same high voltage direct current generator, through the inductance  $L_3$ . The function of this large iron cored inductance is to supply a constant direct current to both tubes, since it offers a high reactance to any current fluctuations. The condenser shunted across the generator serves the same purpose. Their effect is to eliminate the motor generator hum which is sometimes heard in the immediate vicinity of improperly assembled, experimentally made radiophones.

Between the oscillator and modulator tubes is interposed another choke coil  $L_2$ . Its purpose is to prevent any radio-frequency currents from the oscillator tube making their way back into the radio-frequency generator and into

the modulator tube. Its omission would probably not endanger the motor generator windings on account of the high impedance of  $L_3$  to radio-frequency currents, but it would cause interaction between the two tubes with consequent "howling" and distortion of speech or music.

Speech or audio-frequency potentials are impressed on the grid of the modulator tube by means of the microphone and the modulation transformer, as we have previously observed. If the transmitter diaphragm is not actuated, the oscillator tube supplies radio-frequency currents of constant amplitude to the antenna circuit as we learned in the last assignment. If an audio-frequency potential is now impressed on the grid of the modulator, audio-frequency currents of increased energy are set up in the output or plate circuit of this tube. Consequently the potential of the plate of the oscillator tube, which is shunted across the plate of the modulator, varies in accordance with the audio-frequency output of the modulator. The result is to produce audio-frequency variations in the amplitude of the radio-frequency oscillations obtained from the oscillator and impressed on the antenna circuit.

It should be understood that the choke coil  $L_2$  is designed so as to have a low reactance to the audio-frequency output

of the modulator and at the same time to maintain a high reactance to the radio-frequency output of the oscillator. This is easily effected with a series inductance such as is used in this instance since the reactance of an inductance increases directly as the frequency.

If the sounds to be picked up by the microphone transmitter are very weak or if they are to be sent over a long length of telephone wire—as happens in picking up music from a concert hall or theatre located at some distance from the broadcasting station—it is sometimes necessary to interpose a *speech amplifier* between the microphone circuit and the grid circuit of the modulator. This amplifier circuit is similar in principle to a one-stage audio-frequency amplifier as used in receiving sets except that the tube, amplifying transformer, and other parts of the circuit must be designed to carry the relatively heavy currents involved.

In the pioneer days of radiophone broadcasting, another type of modulation known as *grid leak modulation* was occasionally used. It provided means for applying audio-frequency potentials to the grid of the oscillator tube instead of to the plate as shown in Fig. 81. It was relatively inefficient, however, and since it has been very generally discontinued, except in some small amateur stations, it will not be further considered in this assignment.

#### ASSIGNMENT 14

#### RADIO BROADCASTING

SO far as can be ascertained, the first radiophone broadcasting station in the country was installed by Dr. Lee de Forest, inventor of the three element vacuum tube, at the California Theatre in San Francisco in March, 1920. In this work, Dr. de Forest was assisted by the author of this course. The antenna was rigged on the roof of the building which housed the theatre and the transmitting equipment itself was installed in a small room in the fly galleries of the theatre. The equipment comprised a 250-watt de Forest transmitting set employing grid leak modulation.

A Kellogg microphone transmitter was connected to a Magnovox horn, the latter being suspended above the stage so as to be invisible to the audience. From this collecting device, leads were run to the transmitting equipment some twenty feet away. Since no data were available as to the proper methods to employ in collecting the music from the theatre's symphony orchestra, the details of operation had to be worked out empirically or by "cut and try" methods.

At first, it was considered possible to employ microphones, connected in series or in parallel, scattered throughout the orchestra at points of vantage. The fallacy of this plan, however, soon became apparent, for it was discovered that each

Continued on page 52

# Improved 1½ Volt Wet Cell for Filament Lighting

By Arthur S. Gordon

A WET cell may date back to the Middle Ages, but at the same time it is a mighty convenient affair for the amateur who has a W D 11 filament to keep cheery red. Dry cells don't cost very much a single throw—but then the amateur finds it annoying to pay out even a small sum many times during the course of one calendar month. Therefore, why not a home-made cell, designed so as to discharge about 1½ volts?

Such a unit must necessarily be an improvement over the usual type of single-circuit, quickly-polarized wet cell

carbon electrode. A cell of this kind is unsuited for filament lighting.

In the cell described in the following paragraphs, that disqualification does not appear. If a continuous tendency to polarize is present, then there is a continuous counter-tendency at work which is strong enough to keep the zinc clear of hydrogen. The theory of battery is sound, and the practice is perfect, but before business of that nature must come the pleasure of building.

Tear apart four old dry cells and dig out the carbon rods. They will be in good condition, for carbon is not chemi-

solution from eating away the joint and the connecting wire before the zinc is in need of replacement.

The zinc rods, should they be used, may be assembled as in Fig. 2. They should be 3 in. long and drilled and tapped at one end so they can be fastened to the connecting bar, which is also of zinc. A piece of the same zinc rod 2½ in. long, filed flat along two sides, will serve as a rod. The bolts used should be brass or copper—not steel or iron. The copper wire connection should be made as before, and coated well with the protective shellac.

A glass jar 6 in. high by 4 in. diameter is about the right size for the container. This size takes in cigar humidors as if they were made for the purpose. The beauty about them is that they have no neck and a wide-open top, which makes them ideal for wet cells. Failing cigar humidors, the amateur can always dig something up in the way of a glass or earthenware jar which will do. The size, of course, is not necessarily as given. Any size will do, provided that it is deep enough to get most of the carbon electrode inside the jar.

The zinc electrode goes on the bottom but separated from it by wooden strips ¼ in. thick. There is a space of another ¼ in. between the zinc and the carbon. The cover, or top, is made of wood. It should be rather thick, fit snugly, and drilled so as to receive the carbon rods in separate holes. A binding post should be mounted for the zinc connection. All this is shown in Fig. 3.

The electrolyte is a solution of chloride of ammonium (sal-ammoniac) and water. The dose is 8½ ounces of the salt to 3½ pints of water. If the jar doesn't hold that much water, then cut down the amount of sal-ammoniac in proportion to the cut in water. Fill the jar to within ½ in. of the top.

The action of this cell is really ingenious. Oxygen from the air is absorbed by the carbon rods and released at the bottom, near the zinc electrode. The oxygen combines with the otherwise fatal hydrogen, which in turn combines with the disintegrated zinc to form zinc chloride and ammonia. Due to its greater weight, the ammonia stays at the bottom, while the zinc chloride rises to the top. When enough of both has formed so that they mingle at a half-way point, they do a fabled-Phoenix act by reacting to form sal-ammoniac again.

Thus the action of this battery is limited only by the gradual eating away of the zinc electrode. It is good for about 200 ampere hours without renewal of zinc, and what is best of all from the viewpoint of the radio amateur, it gives a steady terminal voltage of from 1 to

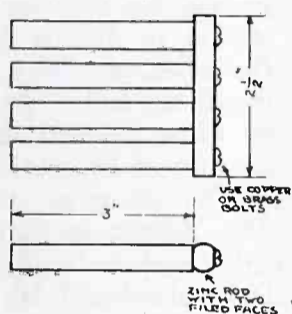
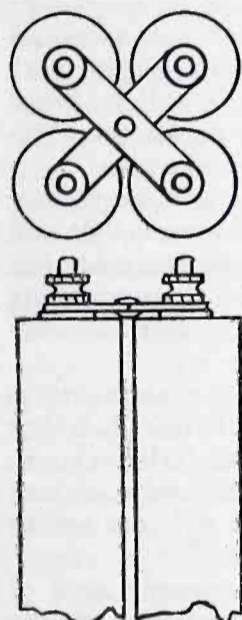

Fig. 1. Positive Electrode Made from Four Carbons from Old Dry Cell.

Fig. 2. Negative Electrode

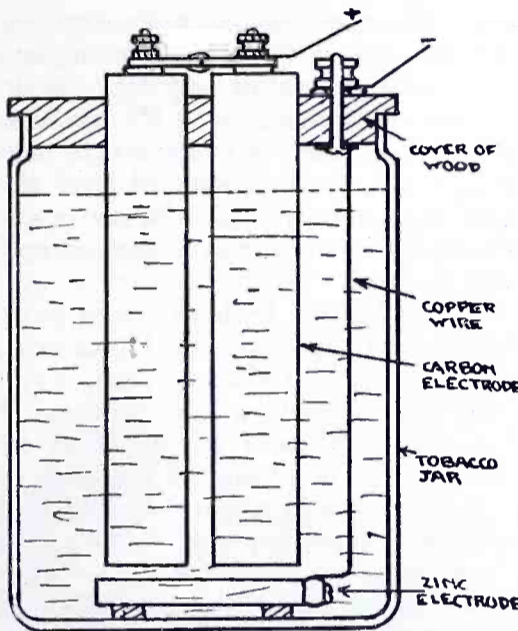

Fig. 3. Battery Assembly

familiar to us all. The filament of the W D 11 or of the de Forest "dry-cell" tube demands super-critical control. In fact, so critical that the rheostat is made to function almost like a tuner. What chance has an unimproved wet cell, with its unsteady voltage, its appreciable lag and its intermittent service to fill such a demand? What is needed is a battery which will give steady voltage and maintain that voltage right up to the last minute.

Such a battery is described here. It is specially designed so as to make use of the odd parts of old dry batteries—that is, to a certain extent. It can be made by the most unassuming amateur at a very small cost.

The trouble with the bell-ringing variety of wet cell is that it polarizes too quickly. While operating, hydrogen bubbles collect on the zinc electrode. Hydrogen is not a conductor of electricity, therefore it offers resistance to the none too strong current generated by the cell. When the zinc electrode is so covered by hydrogen that all the manufactured energy is dissipated before it reaches the outside circuit, that cell is said to be polarized. That, briefly, is the fault with the wet cell where the zinc electrode is in the center of the

cally affected by either the action of a dry or a wet cell. It is a mere "collector" of energy. Keep the brass cap and binding post intact. If you haven't any old dry cells, go down to the nearest Ford garage or repair station and sign up for the next dozen or so. At those places, they are thrown away in barrels.

Fasten four of these carbons together at the top as shown in Fig. 1. To do this, cut out two pieces of brass plate 2 in. long by ¾ in. wide. Drill them so that when they are fastened down by means of the binding posts, the centers of the rods will not be more than 1½ in. apart. Also fasten the brass strips where they cross each other.

This, when complete, is the carbon electrode.

The zinc electrode is made of either a thick piece of plate zinc or of four short lengths of zinc rods, the same that are used in the unimproved wet cell. If plate zinc is used, solder a piece of copper wire to it and bring it out to the negative binding post of the battery. Shellac both this wire and the soldered connection thoroughly. Shellac is proof against the action of sal-ammoniac (which is used in this battery as the electrolytic) and will prevent the saline

Continued on page 50

# Scratchi Publishes Some Third Class Matter

By David P. Gibbons

To Editor of RADIO (which hold up the radiobug at any cost.),

Expensive Sir:—

I am stamping to you in same mailbox with this a fresh made copy of very latest weakly periodic which my Cousin Scratchi are putting before the indulging public and I hope it gets you without loss. As you can see by looking, Mr. Editor, he have named this new literary output the "Radio Universe" and he claim that inside of quite short time-space he will rub out all similiar competitors from off the radio map.

The price, which are clearly engraved on upmost right-handed corner, are 35c, for my Cousin say, with financier accent, the higher you climb up the harder they fall for it. He are making tense study of the principals of success which Hon. Prof. Barnum laid out some years back ago, and claim to me that the rapidness the radio fishes grabbed up first number of his magazine are fine proof of true-ness of this grand old gent's filosofy. He make special refer to section which deal about one coming to life every time clock tick, and he say he have carried around this mental idea in his head at all times when getting together the materials for the printing presser.

After you have given even slight examining to this copy, Mr. Editor, you will also carry same mental idea in you head, I believe so.

Take for an instant the eye-tickling cover page. It are highly enlarged negative picture taken in backyard of school-house and show numerous group of little scholars of all ages up to six. They are all kneeling carefully down and are watching with not natural quiteness at other little fellow who are standing beside blackboard and pointing at something on it which resemble closely diagram of patent egg-smasher or pattern for lap-wound motor. The secret of this puzzle-picture are given in very darkface type at bottom of page where it say "This are snapshoot of little Tony Freeko, aged 5, who hold down the radio chair in Publick School 23, and can copy messages at 94 words per minute. He are giving daily lecturing to his class which thinks very much of little Tony."

When I see this I inform my cousin that Hon. Uncle Sam think 20 words per minute are sufficient for test by the Inspec. Gent, and he reply back to me "If too many sharp readers make squawk nois, mightbe next week I shall reduce the speed by means of low-gear phonograph."

"But must you not make apologizing explanation of such blunderful ignorants?" I rush along.

"By no means at all," he dignify his speech, "Great editor people like my-

self and Hon. Hearst never give out regret for any mistakes on earth. Because why?" he pop, with comic sector expression, "No use crying over an ice-cream split."

On next inside page he devote loud topline to astonished discovery which, he say in big types, mark new erie in radio histories. This one are full, complete description of weird wireless invention by lofty general in the glorious army, who have solved problem by connecting common clothesline to common doorbell. All other details are consealed up for the present time on account of patent situations which are somewhat upsettled, but it show real photograph of inventing general in very act of pushing common doorbutton. Picture also show quite clearly all the stripes and stars which have showered on the Klassy-Kut uniform that this stern soldier gent put on wherever camera person come near.

Scratchi tell me he have eleven more such startled discoveries on hands now, including a loud-talking crystal, a receiverless aerial and a portable ground which can fold itself flat to avoid all static, and he are going to give one to his more or less intelligent readers each week from hence onwards.

Next page are what my cousin sinuates are editorial part and not collection of funny radio humors like I think, but you can form your own courthouse about this, Mr. Editor.

Two pages which turn over next are thickly covered with very positive printings which my cousin secure most freely from the Mick Senator Fillum Company and such, and display high-price movie queens of the dumb stage who cannot hear radio concerts unless undressed in classy beach recreations.

Next one are the Womens Page, conducted by Miss Dottie Dasher, who tell the fair readers, if any, how to make most cunning salad for radio luncheon party. She also explain some simple decoratings she have made with cute bow-ribbons for dainty receiver which friendly husband have bought for her. Scratchi tell me this page are all wrote up by long-boiled old egg from Oakland who dont know anything else but he can write womens pages for all styles of periodics. My cousin say that the women are crazy to read this page, and I utter to myself "How adorably truthful!"

Last two or four pages my cousin give over to novelty hitchups, question-mark dept. with answers, calls heard without answers and 8 or 11 relibel ads. He have large stock of such smart up-hooks which he have clipped from formal copies of RADIO. He make slite moving around of fones and B bat-

tery in printed diagrams and them write down under it "This uneek arrange for splendid receiver was submitted to us by Mr. Killer, a student in the Southern African Seminary," or words to that affect.

The questioning sector he pick fourth from same supply, only he put differences of names to each and change the answerings about so as to make the eager reader, if any, excise his own judgements.

Calls heard he snip out of old call book starting at front page, and in few weeks will reach sixth district. Each weekly list of these will be headed by station in district which are away off the most, so, the way my cousin work it, all six and seven boys will be heard by some misfortunit ham in the ever-swamps of Florida, and *vici vidi*.

The ad sector is nearly negligable, Mr. Editor, as Scratchi say he do not enjoy such in highly rank magazine like his, and when I ask him who are going to pay printer-man and other bill-seekers, he orate to me,

"Mightbe I should pay these others quite small percentum of their dues, but as even you know, my swivelide cousin, all printer people have own private devil, so I think I let this one go to Hongkong for his money."

I hope you like this sample issue of my cousins maidenly entrants in the publicly spotted lights and will send you all succeeding nrs. if any more come out.

With splendid regards, Mr. Editor, and many happy turns of same,

I remain yet,

Your regulated reader,  
—Hololi Nogo.

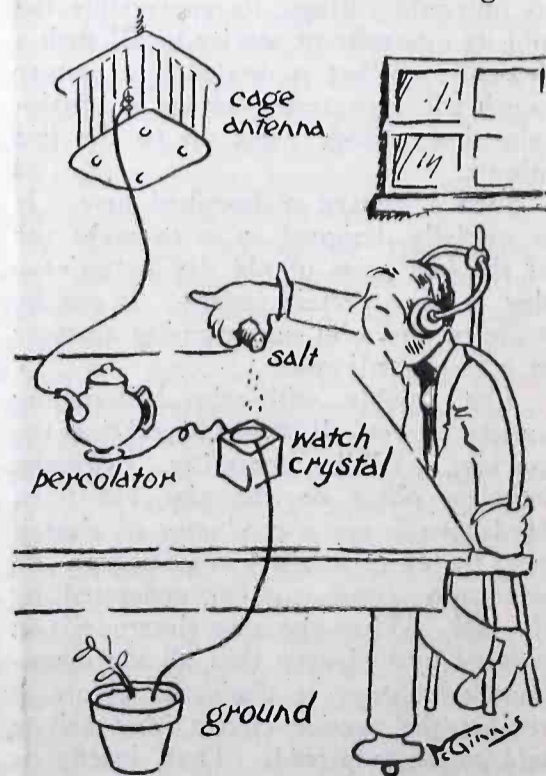

This is my present hook-up. Would the messages come faster if I added a mailing tube?

# "The Unknown Broadcaster"

By Raymond W. Shirey

*This is a thrilling tale of life behind the scenes in a newspaper office. Radio broadcasting plays the important role of bringing the quick-witted hero his just reward.*

A HUNGER for something startling lurked in the mind of Owen Brainard as he thumped the keys of his "Old Remy." So it was with an air of satisfaction that he finished his article on the impending steel strike, for the afternoon edition of the *Mail*. He had always been assigned to write such articles, not because he could write them better than the others, but because he was absolutely impartial, giving the facts as he found them, regardless of the effect it had on public opinion.

After placing the article in the editor's box he hurried to the reporters' room, where a meeting was called to select the man to fill the position of the former editor, who had just resigned. There had been no promotions on the *Mail* for some time, a condition due partly to the fact there had been few changes in the positions higher up, and partly because competition among the reporters had been so keen that it was hard to select one man from the staff without doing an injustice to the others.

Soon after Owen entered the room Mr. Hunter, the managing editor, appeared in the door. Cigarette stubs were shot in the cuspidor with an astonishing accuracy. The boys came to attention as though military life prevailed. Experience had taught them that Mr. Hunter was a man of few words and demanded the closest attention.

"Boys,"—he always stated his talks with this word—"the *Mail* has decided upon some new policies which need the co-operation of every man on the staff. Our nearest competitor has gained on us the past six months. So we are starting some innovations, which we feel will be appreciated by the public. A campaign to increase the circulation will be started next week. The new broadcasting station is now in operation with a program every evening. The people have taken an astounding interest, and already many have come to the station and sent out messages to those who "listen-in." But for the first time in a decade the *Main* was scooped by the *Tribune* on the Crabtree murder case. We must in some manner make an atonement, as a matter of business.

"Each of you know that the position

of editor is now open on the *Mail*. It carries with it remuneration, power, and prestige. We know every man in our employ has given us his best efforts. To select one among you would perhaps be doing an injustice to the others. The position must be filled at once.

"At the meeting of the directors this afternoon it was decided that the man bringing in the first big story, which will allow us to scoop out competitors, will be given the position. We have placed the editorship open to each of you by adopting this method. In selecting this plan we are giving each individual an equal opportunity."

Owen did not linger in the room to take

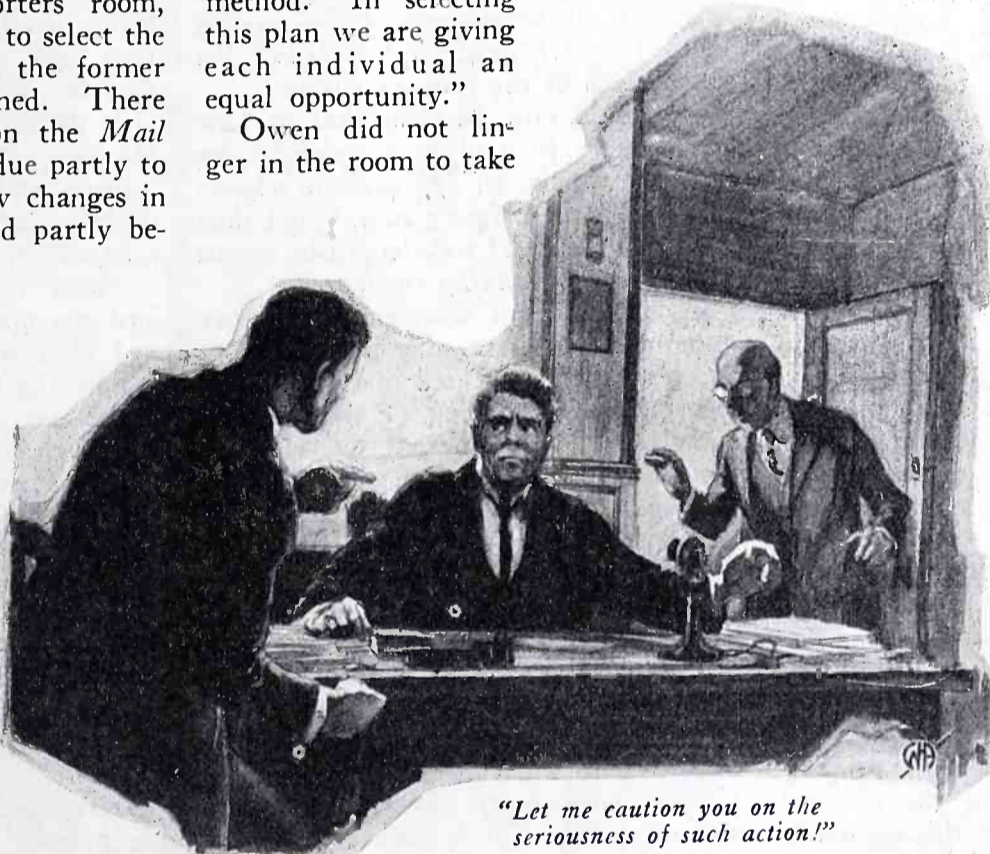

"Let me caution you on the seriousness of such action!"

part in the remarks which followed. Until now there were but two things which held his interest. One was the stock market, where he had just cleaned up five thousand in a good buy in rails; the other was radio. He was trying out his new set tonight.

Having eaten his dinner, he started to tune in with his new set. There was some little difficulty in getting the right adjustment, static being worse than usual. He finally tuned in at 369 meters just as the evening concert started. A splendid musical program was given, followed by market reports, a few local items about the political campaign, and the strike situation. Several individuals had sent out personal messages to their friends. Owen had listened to them with unusual interest. As he started to take the receiver from his ears the following message held his attention: "W.E.W. dress in black,

come to the Dutch Mill Cafe Thursday night at eight o'clock. Bring money, have letters and document. Will watch the personal column each day for answer. G. C. L."

His first impression of the message was that some women had sent out a mysterious communication for the thrill it would give the fans. But the more he thought of it the more he was convinced there was something clandestine in its meaning. The words "bring money, have papers and documents" gave

material for thought. The tone of the speaker would indicate the "bring money" was a command, the "have papers and documents" a statement. One might assume from the words used the speaker did not know W.E.W. for she had told him what to wear. Of course it might be for some other reason than a mark of recognition. Then, too, it might be just a joke to arouse the curiosity of those who were listening-in.

"Documents and money" sounded interesting to him. If they were worth money to some one, they might be worth money to him. Regardless of the motive of the unknown broadcaster he would

look in the personal column of the morning edition of the *Mail*.

O WEN was waiting for the paper boy the next morning. He turned hurriedly to the Want Ads and found immediately the personal column. Glancing over the lines, his eyes fell on the following: "G.C.L. Will be out of town until last of the week. Will meet you Saturday night, same time, same place. W.E.W."

His assumption that there was something tangible to the message had been proven out a fact. The growing curiosity to know what the documents were had not been dispelled. He now held to his former conclusion there was something of more importance than one would at first think.

The thought flashed through his mind again and again, "I must see those

*Continued on page 62*

# Tuning a Double Circuit Regenerative Receiver

*These directions are taken from the instruction book of the Colin B. Kennedy Co. and apply directly to their Type 110 Universal receiver. Being so well presented, they are applicable to any two-circuit variometer regenerative set.*

**TUNING** is accomplished in the receiver by making the proper setting of the various knobs and dials in accordance with the procedure explained in the following paragraphs. There are two separate circuits that must be adjusted or tuned to the exact wavelength of the transmitting station: the *primary* and the *secondary* circuits.

The *primary* circuit is the part of the receiver that is directly connected to the *antenna and ground*. The antenna and ground form an external part of this complete circuit or portion of the receiver. Every antenna has a certain definite wavelength to which, unaided by any additional apparatus, it is inherently tuned and this wavelength is determined chiefly by the length of wire used.

For purposes of explanation, let us assume that the natural or inherent wavelength of your particular antenna is 160 meters and that you desire to tune the primary of your receiver to 360 meters in order to receive from a station adjusted to transmit at that wavelength. To tune the *primary* to 360 meters it is necessary to add enough wire (*inductance*) to your antenna to increase its wavelength from 160 to 360 meters. In other words, 200 meters of wavelength must be added within the receiver before the primary circuit is turned to 360 meters. Wire (*inductance*) is added to the antenna circuit as the *primary switch* is turned to the *right*, thereby tuning or adjusting the primary circuit to a *higher* wavelength. When this knob is turned to the extreme *left*, the smallest amount of wire is added and the primary is consequently tuned to the *shortest wavelength*. Every time this switch is moved a step to the *right* a certain amount of wire is added to the primary, thereby tuning it to a *greater wavelength*. Inversely, as this knob is turned back to the *left*, the *primary wavelength* is decreased, since wire is then taken out of the circuit.

A glance inside the set by raising the top of the cabinet will reveal the coils of wire (*inductance*) which are connected in and out of the circuit by means of the primary switch.

As a large amount of wire (*inductance*) is added or subtracted from the *primary circuit* by turning the switch to the *right* or *left*, respectively, the resultant change in tuning for each step on the switch is large. Therefore, the primary may be adjusted only approximately to the wavelength of the transmitting station by this method. Since the primary must be adjusted to the *exact* wavelength used by the sending station, a *finer* adjustment is accom-

plished by the use of the *primary tuning condenser*.

As this condenser is turned from left to right by means of a knob, the effect on the tuning of the primary is the same as if extremely small amounts of wire were added to the primary circuit, thereby permitting a very *gradual increase* in the wavelength to which the primary is tuned. Although the effect is the same as would be obtained by adding very small amounts of wire (*inductance*), the primary tuning condenser actually adds what is known as *capacitance* (more commonly called "*capacity*"). Starting with this dial in a given position, turning it to the *right* gradually *increases* the wavelength while turning it to the *left* gradually *decreases* the wavelength of the *primary circuit*.

It should now be clear that to tune the primary to a given wavelength we must *first* make an *approximate* adjustment with the *primary switch* and then adjust to the *exact* wavelength by means of the *primary tuning condenser*.

As the inherent wavelength of every antenna is different, due principally to the length of wire used in its construction, the *exact* setting of the primary switch for the different wavelengths cannot be given in advance. The *approximate* setting of this switch for different wavelengths is given, however, in Tables I and II.

The next circuit or part of the receiver to be tuned or adjusted to the exact wavelength of the transmitting station from which reception is desired is the *secondary*. This is the circuit which is connected to the vacuum tube detector. Unlike the primary, the secondary circuit in the receiver is entirely independent of, and therefore unaffected by, changes in the antenna; consequently, exact settings for the secondary switch and the secondary condenser are given in Tables I and II.

In tuning the secondary circuit, the procedure is exactly the same as in the case of the primary. Turning the secondary inductance switch to the *right* adds wire (*inductance*) to the *secondary* circuit and thereby *increases* the wavelength. Turning the secondary tuning condenser to the *right* *increases* the wavelength very gradually, while turning this knob to the *left* similarly gradually *decreases* the wavelength.

The coupler is the connecting link between the *primary* circuit, which is connected to the antenna or ground, and the *secondary* circuit, which is connected to the detector tube in the receiver.

Interference from nearby sending stations, or from more distant stations tuned to nearly the same wavelength as

the station to which you are listening, can be greatly reduced by the proper adjustment of the coupling. When considerable interference is experienced, the coupling should be set at a very low point, say between 1 and 2—sometimes even lower. Somewhat greater coupling should be used, however, when no interference is experienced, for with greater coupling the strength of the received signal is often greater.

When tuning to the wavelengths of transmitting stations which operate at adjustments *below* 1,000 meters, the *maximum* coupling which should be used is approximately 5. When the wavelength on which the receiver is being tuned is *above* 1,000 meters, however, any value of coupling up to 10 may be used safely.

It should be noted that every time the coupling is changed, the tuning of the primary and secondary circuits is thereby slightly disturbed, necessitating a small readjustment of these circuits.

Many receivers on the market combine the primary and secondary circuits and eliminate the coupler in order to reduce the number of parts in the receiver and the number of operations in tuning the set. It will be found, however, that in receivers, where these two circuits are used and the coupling or interaction between them can be controlled, it is possible to eliminate stations which it is not desired to hear, which could not be eliminated with "single circuit receivers." These receivers use the principle of "inductively coupled circuits," which provides what is in effect an electrical filter and which is recognized as the best radio engineering practice for obtaining this desirable feature of selectivity. This principle is utilized in all high-grade commercial and government receiving equipment.

The regenerator is a feature used only in receivers employing the patented Armstrong regenerative circuit, is used for the purpose of greatly amplifying or increasing the strength of the received signal by placing the receiver in a more sensitive state.

For every setting of the secondary tuning condenser, there is a certain definite point at which the regeneration must be set for *maximum* signal strength. For purposes of explanation, we shall assume that the receiver primary and secondary circuits have been tuned to a semi-distant broadcasting station and the music and speech are being heard in the head telephones. As the *regeneration* is now *increased* from 0 by turning the knob to the *right*, the *intensity* of the music and speech *increases* up to a point

*Continued on page 82*



# Sparks McAllister Solves a Problem

By Sewell Peaslee Wright---9 SP

*For the amateur who wants to try out new hook-ups here is a practical suggestion for making a test board. This is one of a series of narrative kinks that have been running for several issues. The question comes up—do you like them? If so, or if not so, let the editor know.*

"I WONDER, Wildcat" said Sparks McAllister in a meditative tone of voice, "why don't you have things in a bit more ship-shape around your shack? This is a horrible dump, the way you keep it; all cluttered up with wires, condensers, switches and a thousand and one other things all over the place. Why don't you have a little system about things?"

Wildcat, not in the least insulted by this unprovoked, but not unwarranted tirade, continued hooking up a new set he was trying out.

"I imagine YOUR shack is a perfect imitation of Martha Washington's sewing room, or some other neat place, eh?" he queried with heavy sarcasm. "I've never seen it when your working table wasn't cluttered up just about like this one," he added with a malicious grin.

Sparks drew out his reprehensible old pipe and started filling it with elaborate care.

"You are referring, old timer, to a past age. My operating table is now as free from junk of this sort as the dining room table. My well-known inventive genius has solved the problem of how to test an average of thirty-seven new hook-ups a month without having the operating table look like a barbed wire entanglement in miniature."

Wildcat groaned in derision, and swore softly as he tried to operate an unmounted variable condenser which persisted in lopping over on one side, a rheostat that wouldn't stay put, and at the same time vary the inductance on a coil by twisting connections to various taps as the tickler coil was rotated by means of an ingenious contrivance involving the use of a lead pencil, two thumb-tacks and a bit of wire.

"Dashitall!" he finally exclaimed, removing his headset. "It's no doggone wonder some of these hook-ups don't work, the way we guys have to monkey around, trying 'em out!"

"The way YOU guys do it!" corrected Sparks, exhaling a suffocating cloud of smoke toward the rafters, "Don't put me in your class; I've reformed!"

Wildcat disconnected the *A* and *B* batteries, for safety's sake, and then came back at Sparks with his usual sarcasm:

"I presume that when you wish to test out a new hook-up you mount the apparatus on a quarter-inch bakelite panel, connect her up with silver wire to silver-plated binding posts and switches, and mount the whole beautiful

thing in a hand-polished mahogany cabinet, eh?" he inquired. "I can picture you doing that!"

"Calm yourself, sonny, and I tell you all about it. I've been trying every new hook-up that has come out in the last twelve years, and I'll admit that I've been guilty of some pretty mean setups in my day.

"Probably this stunt of mine is nothing new, but then as the guy says, there's nothing new under the sun, so why strain yourself trying to be original? I took an old panel about eight by fourteen or sixteen or thereabouts, and mounted it to a base of three-fourth inch pine. Then I stuck two binding-posts on the left end for the aerial and ground, (I'm still old-fashioned enough to want my output on the right end of the set) and then I mounted two old switches and ten taps to each one, one above the other—so!" and he illustrated on a sheet of paper that he found on the table.

"Then I stuck on a couple of these book-type mica-insulated variable condensers—used 'em because they are cheap, durable and plenty efficient—and a rheostat—so fashion."

He puffed vigorously at his pipe for a second or two, until it responded nobly, and then continued:

"On the base-board I mounted an old socket, replacing the tiny screws and soldering-lugs with spring binding posts. The entire back of the panel is devoted to binding posts; a double connector spring binding post to each connection: The aerial, the ground, the two switch arms, both sides of the condensers, the *A* battery, variable *B* battery, and so forth.

"The old panel I used is all drilled full of holes from past sets that have been mounted on her, so if I need to run a rod through to operate a tickler or secondary, I can generally find a hole already drilled where I want it—if I can't, I drill one. To each of the switch points are soldered wires with small single spring binding posts soldered on their outer ends, so that the inductance used can be varied without soldering or bothering.

"The base block should be left plenty large—the full length of the panel, and at least ten inches deep—so that you have plenty of room for whatever incidentals are called for; which reminds me that there should also be a variable grid-leak and a grid condenser mounted somewhere. I've got mine on the base-board, in back, but probably it would

be handier to have them on the panel itself.

"I've had more real sport in trying new ideas since I rigged up this testing board than usually falls to my lot in a month of Sundays; and——" he stopped suddenly in consternation as he found his pipe had gone out.

Wildcat studied the scrawled plan that Sparks had made.

"Looks as though you really had stumbled onto something good," he conceded patronizingly. "Wonder I didn't think of that myself!"

Sparks relit his pipe with tender care, and grinned derisively.

"Brains, my boy, brains!" he said, "That's what you need! Not to change the subject, though, how's the old junk percolating?"

"Oh, so-so," said Wildcat, casually starting the rotary motor and manipulating the rheostat so that the hum of the motor rose to a shriek and undulated weirdly—a trick which, exercised on the final part of his "sig" had given his spark a sound that was responsible for his nickname.

"Only thing is that Bozo claims I'm causing a lot of Q R M, even though I'm as sharp on 200 as a guy could get, and with a decrement that even the Assistant R. I. admits is O.K."

"I've always admitted that C. W. had it all over spark" remarked Sparks, the proud owner and sole operator of a twenty-watt C. W. set for almost two years. "Why, only last night (or rather, this morning) I gave old 5 C——"

"Pipe down! Pipe down!" begged Wildcat. "I know all about how you just called once, and he came back with a 'vy QSA OM,' and you cleared eight to him in one string without a single repeat. What I want to know is how am I going to stop causing Q R M around here; I don't want to be a nuisance—but I do love to hear the old spark roar," he added rather wistfully, with boyish affection.

"Just for speaking so disrespectfully of your elders in age and experience," said Sparks coldly, "I shall refuse to divulge the secret you desire. In fact, I shall depart immediately," looking at his watch, and discovering, as usual, that it was about an hour later than he had thought.

"Aw, gee, Sparks, if you've got the dope, spread it!" begged Wildcat.

"Can't be did, my son," said Sparks firmly, buttoning up his overcoat, "Got to teach you a lesson not to be so dis-

*Continued on page 50*

# Distributed Capacity: Its Effects, Its Measurements

By Jesse Marsten

## Effects of Distributed Capacity.

THE ordinary condenser consisting of two or more conducting plates with a dielectric between has a capacity which is concentrated or localized within the condenser. Such capacity is called "lumped" capacity and is intentionally produced by design. Such a condenser has a capacity by virtue of the fact that it stores electrical energy in the space between its plates. However, not only condensers, as such, have capacity, but any two electrical conductors which are at different electrical potentials will have some capacity between them.

Thus consider an inductance coil AB, Fig. 1. If an oscillating current is

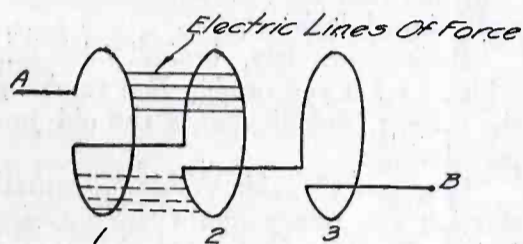

Fig. 1. Distributed Capacity in Induction Coils

passed through the coil there will be a potential difference between the terminals A and B independent of the ohmic drop and inductive drop. Turn 1 will be at a different electrical potential from each of the other turns and therefore electrostatic lines of force will pass from each turn to all of the other turns, as shown in Fig. 1. This is an indication that electric energy is stored in the dielectric between the turns of the coil, which turns may therefore be considered as the plates of very small condensers. We thus have a series of small capacities distributed along the length of the coil which capacities add up to make up the total "distributed" capacity of the coil. Any coil, therefore, is not a simple inductance but must be considered as a pure inductance with a capacity across its terminals equal to the total "distributed" capacity of the coil, Fig. 2.

It will be found upon analysis that this distributed capacity of a coil influences to a marked extent the other constants of the coil, such as the inductance and effective resistance. Furthermore it will be found that the magnitude of this influence depends upon the wavelength at which the coil is operated. Since this is the case it will be evident that it is very important to take this factor of distributed capacity into account in all measurements and design work. Unless measurements are taken at certain wavelengths or in certain ways values thus obtained may fall wide of the true values.

1. It alters the period of the oscillatory circuit in which it is placed. If a coil whose true inductance  $L$  is known is placed in an oscillatory circuit with a known capacity  $C$  across it, the period of the oscillatory circuit, instead of being given by the equation  $T = 2\pi\sqrt{LC}$ , is given by the equation

$$T = 2\pi\sqrt{L(C + C_d)}$$

where  $C_d$  is the distributed capacity of

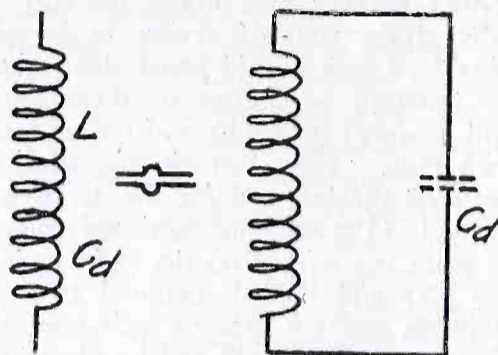

Fig. 2. "Lumped" Representative of Distributed Capacity

the coil. It will be observed that if the external capacity  $C$  is very small the effect of the distributed capacity will therefore be very great. The smaller

this external capacity is the greater the effect of the distributed capacity, while if the external capacity is large the distributed capacity may be negligible. Consequently at low wavelengths the effect of distributed capacity would be very objectionable.

2. It alters the value of the coil inductance as obtained by measurement. Since the inductance of a coil is generally measured by obtaining the wavelength of a circuit with known capacity across it, and then calculating from the equation

$$\lambda = 1885\sqrt{LC}$$

it is evident that the value of inductance  $L$  thus obtained does not take into account the distributed capacity. Since the effect of the distributed capacity is to increase the wavelength of the circuit, if the capacity  $C$  externally added is obtained from the calibration of the condenser this increase comes out in an increased value of the inductance. That is the inductance obtained by the calculation above is not the true inductance, but the apparent inductance, which is greater than the true inductance due to the distributed capacity of the coil. The effect of the distributed capacity is to increase the apparent inductance, the

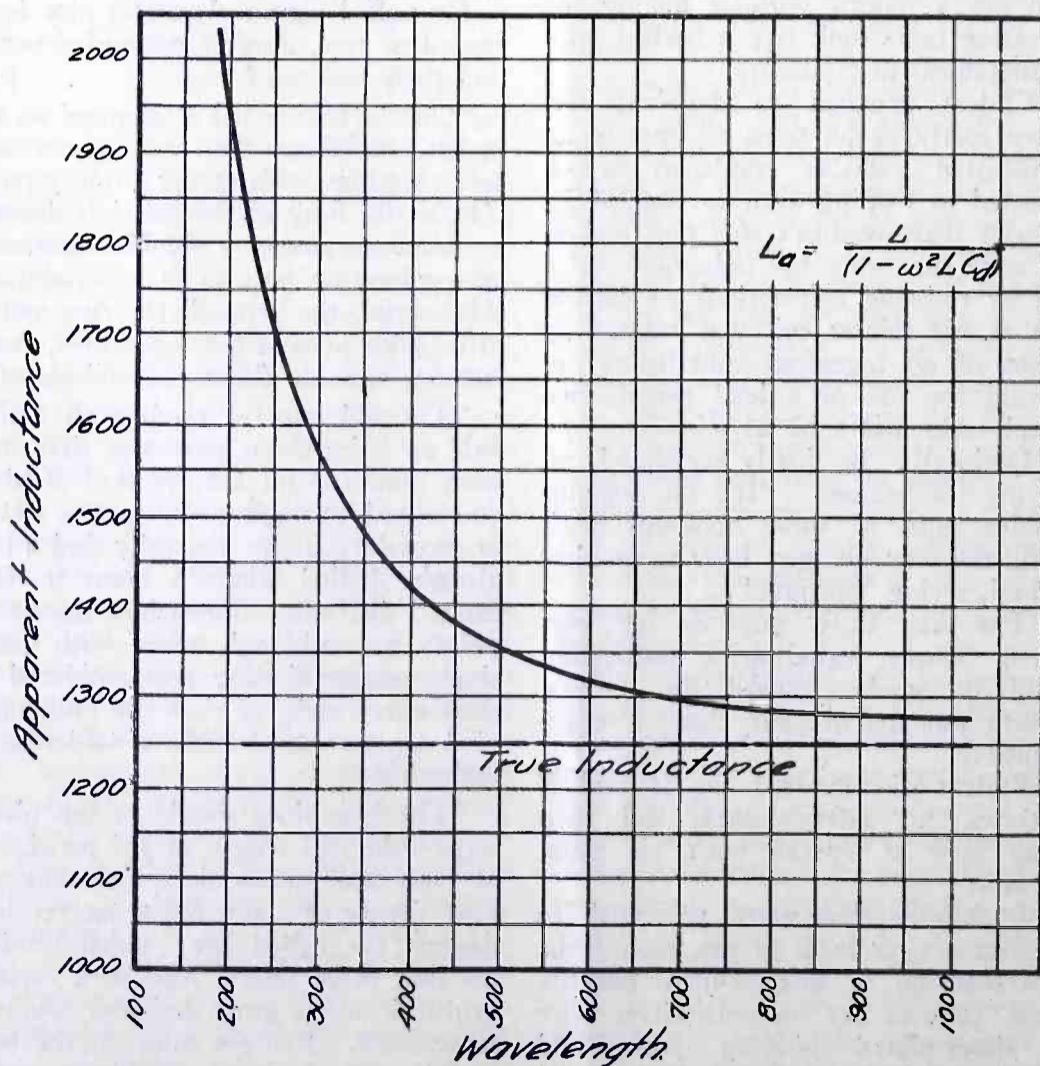

Fig. 3. Variation of Apparent Inductance with Frequency Because of Distributed Capacity

amount of this increase depending upon the wavelength, and is given by the equation

$$L_a = \frac{L}{1 - \omega^2 L C_d}$$

in which the apparent inductance is  $L_a$ , the true inductance is  $L$ , the frequency is  $\omega$  and the distributed capacity is  $C_d$ .

From this equation it will be seen that for very small values of the frequency  $\omega$ , the numerator becomes equal to one, and hence the apparent inductance equals the true inductance. On the other hand, for large values of frequency the numerator becomes less than one, and hence the apparent inductance is greater than one. If a curve is drawn from this formula of apparent inductance against true inductance for any given distributed capacity it will therefore have the shape shown in Fig. 3. This is the result of an actual experiment made on a coil whose true inductance was 1252 microhenries and distributed capacity 0.0000039 micro-farads. Calculations

made of its apparent inductance gave the curve shown in Fig. 3. This curve is very instructive. It will be observed that at the higher wavelengths, namely where the external capacity is very high compared to the distributed capacity, the apparent inductance approaches the true inductance in value, as shown by the curve approaching the horizontal line which represents the true inductance. On the other hand at the low wavelengths, namely where the external capacity is small and the distributed capacity preponderates, the apparent inductance becomes very great and approaches infinity. It is obvious that the inductance cannot be infinite in value, but this result is due to the presence of distributed capacity, which if not taken into consideration, apparently increases the inductance to these high values. It is therefore obvious that a measurement of inductance of a coil made at very low wavelengths or with extremely small capacity in circuit would be very unreliable in its results.

3. An inductance with distributed capacity will vibrate electrically even if no condenser is shunted across the coil. It behaves like an open oscillator. Experiment shows that the manner of vibration of such a coil differs from an ordinary alternating current circuit in that the distribution of current and voltage along the coil is not the same at all points, but is the same as in an antenna. The voltage is a maximum at the ends of the coil and a minimum in the center, while the current is a maximum in the center and a minimum at the ends. The free period of such a coil is given by the equation

$$T = 2 \pi \sqrt{L C_d}$$

This effect is very often the direct cause of poor reception. Consider a receiver designed to cover a band of wavelengths between 300 and say 3000 meters, in which a coil and condenser combination is used. Obviously on the lower wavelengths as 300 to 600 only a small portion of the coil is used. The entire inductance, however, may have a free period of vibration due to its distributed capacity of nearly the wavelength at which reception is taking place. Although the entire coil is not directly in circuit, it is in inductive relation to the portion of the coil which is in circuit and hence will absorb considerable of the received energy, thus reducing the efficiency of reception. Not only does it cause inefficient reception, but this is very often the chief cause for the failure of regenerative sets to oscillate. For no matter how closely the feedback coupling is adjusted, the extraction of energy from the set by the tuned hanging-on coil is so great that it prevents the set from regenerating. Good design of receivers therefore demands that no coils in the receiver should have a natural wavelength falling within the band of wavelengths to be received.

4. Distributed capacity in a coil increases the effective resistance of the coil. The above illustration of the effect of a hanging-on coil on regeneration illustrates this point well. The extraction of energy from the receiver by the tuned coil reduces the receiver current, and this is equivalent to increasing the effective resistance of the receiver. This effect is entirely due to the distributed capacity of the coil. It can be shown mathematically that the effective resistance of a coil whose true inductance is  $L$ , true resistance  $R$ , and distributed capacity is  $C_d$  is given by the equation

$$R_a = \frac{R}{(1 - \omega^2 L C_d)^2 + \omega^2 C_d^2 R^2}$$

and a plot of this equation showing apparent resistance against true resistance will have the appearance shown in Fig. 4, which is made from a series of measurements taken on the same coil from which Fig. 3 was made. It will be observed that the apparent resistance of the

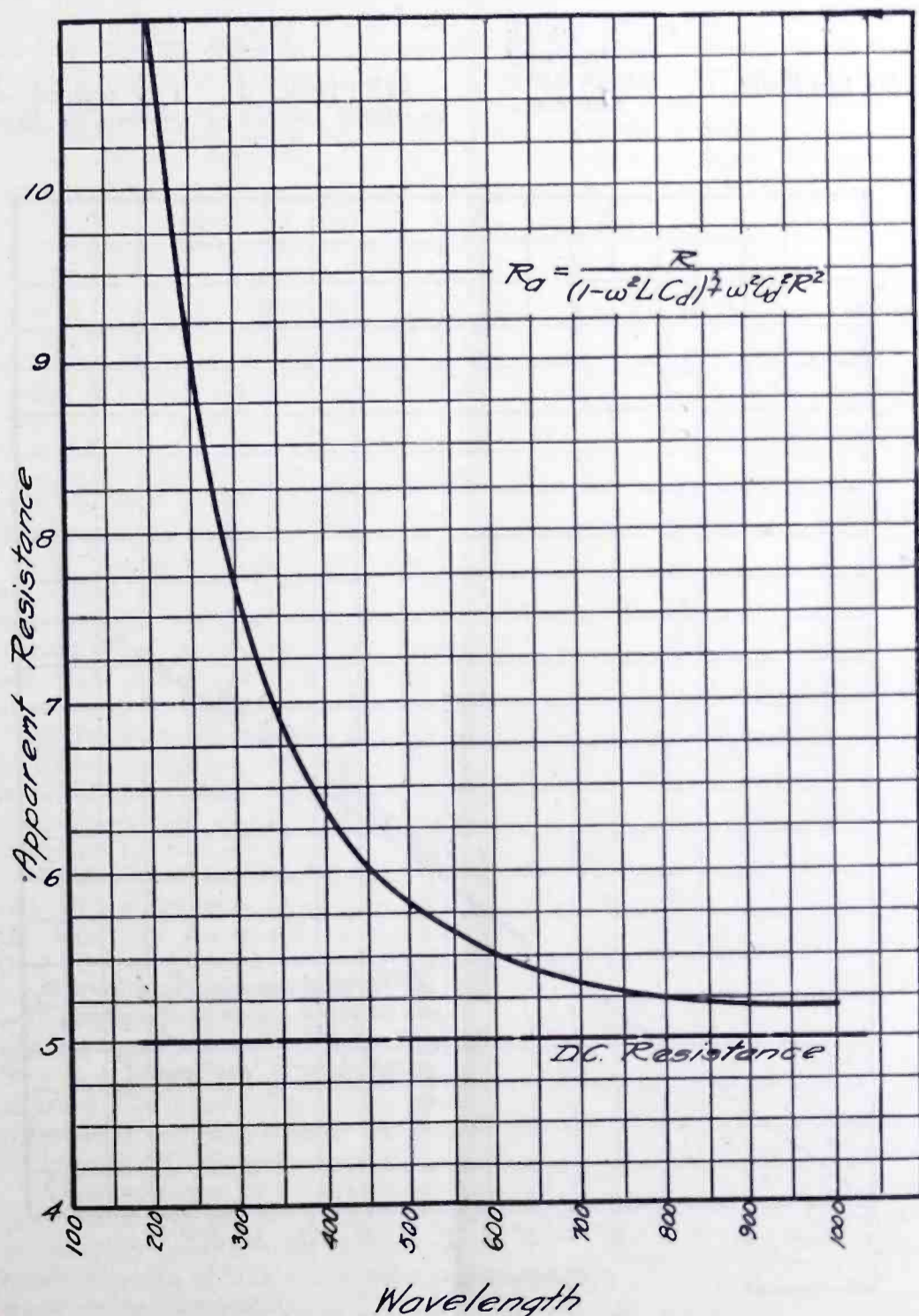

Fig. 4. Variation of Apparent Resistance with Frequency Because of Distributed Capacity

coil is a minimum at the highest wavelengths and at these wavelengths approaches the d.c. resistance as its limit. As the wavelength decreases the apparent resistance increases, and becomes a maximum at the natural wavelength of the coil. At this wavelength there is no external capacity, the distributed capacity of the coil being the only capacity in circuit.

5. At the very low wavelengths distributed capacity exerts another deleterious influence. As the wavelength decreases the reactance of a condenser decreases. As a result high-frequency currents will tend more and more to flow through condensers at the low wavelengths. Distributed coil capacity often

has no free period of vibration. In order to have a circuit of coil vibrate in its own period we must then have an aperiodic exciting circuit. The circuit for measuring distributed capacity is shown in Fig. 6.  $L, C_d$  is the coil whose distributed capacity is to be measured. Coupled to this coil is a buzzer circuit consisting of a single turn loop, a fixed condenser  $C$ , a high resistance  $R$  and a buzzer  $B$ . The single turn is coupled to the coil under test. Now in order that the exciting buzzer circuit be aperiodic the resistance of its circuit must have a certain minimum value, and theory shows this to be

$$R = \text{or} > 2 \sqrt{\frac{L}{C}}$$

If the resistance is less than this the circuit will have a period corresponding to its capacity and inductance, if greater than this resistance it has no vibration period. By inserting a large resistance  $R$  of several hundred ohms this condition is then fulfilled. Operating the buzzer circuit then has the effect of merely impulsing the coil under test and making it vibrate in its own free period. A wavemeter  $L, C$ , is coupled very loosely to the coil so that its natural wavelength when vibrating may be measured. This is given by

$$\lambda = 1885 \sqrt{L C_d}$$

Knowing  $\lambda$  from the wavemeter measurement, and knowing the inductance of the coil, the distributed capacity may then be calculated from the above equation. If instead of a wavemeter we have a known coil and condenser tuned to the coil under test, and the values of coil and condenser are  $L, C$ , then the distributed capacity will be given by the following equations:

$$L_1 C_1 = L C_d$$

$$\therefore C_d = \frac{L_1 C_1}{L}$$

**METHOD II.** This method is a graphical method of determining distrib-

*Continued on page 46*

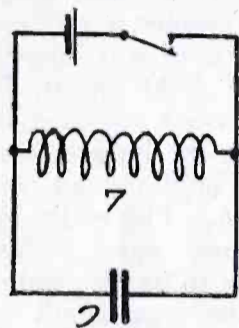

Fig. 5. Representation of Impulse Excitation

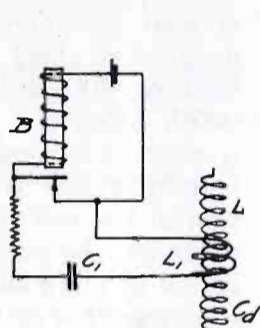

Fig. 6. Circuit for Measuring Distributed Capacity

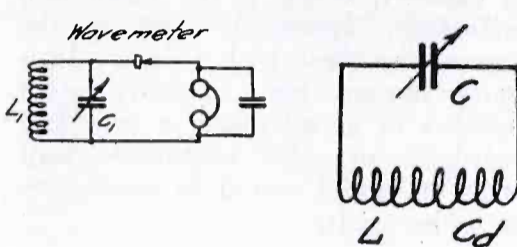

Fig. 7. Circuit for Graphical Measurement of Distributed Capacity

affords such a capacity path and the high-frequency currents take them. The dielectric of the coil capacity is a very poor one and as a result the effective resistance of a circuit is thereby increased over and above the increase mentioned in the previous paragraph.

From this discussion it will be clear that most of the harmful effects of distributed capacity take place at the low wavelengths, namely when the distributed capacity is not negligible. It is therefore evident that measurements of coil constants, to have any validity, should not be taken at such low wavelengths or near the fundamental period of the coil. Furthermore a knowledge of the distributed capacity of the coil, and hence its fundamental wavelength, will enable a more careful design of sets. The following are some of the best ways whereby this important coil constant may be measured.

**Methods of Measurement.**

**METHOD I.** This method is called the "impulse excitation of free period" method. Impulse excitation is a simple means of exciting a circuit to vibrate at its own period and damping regardless of the primary or exciting circuit. Pure impulse excitation is well represented by Fig. 5. Here we have a r.f. circuit consisting of  $L$  and  $C$  shunted by a battery and switch. If the battery circuit is closed and then abruptly opened the e.m.f. induced in  $L$  will charge  $C$ , which then discharges through  $L$  at the natural frequency of the circuit regardless of the presence of the battery circuit, which is aperiodic in its action, that is,

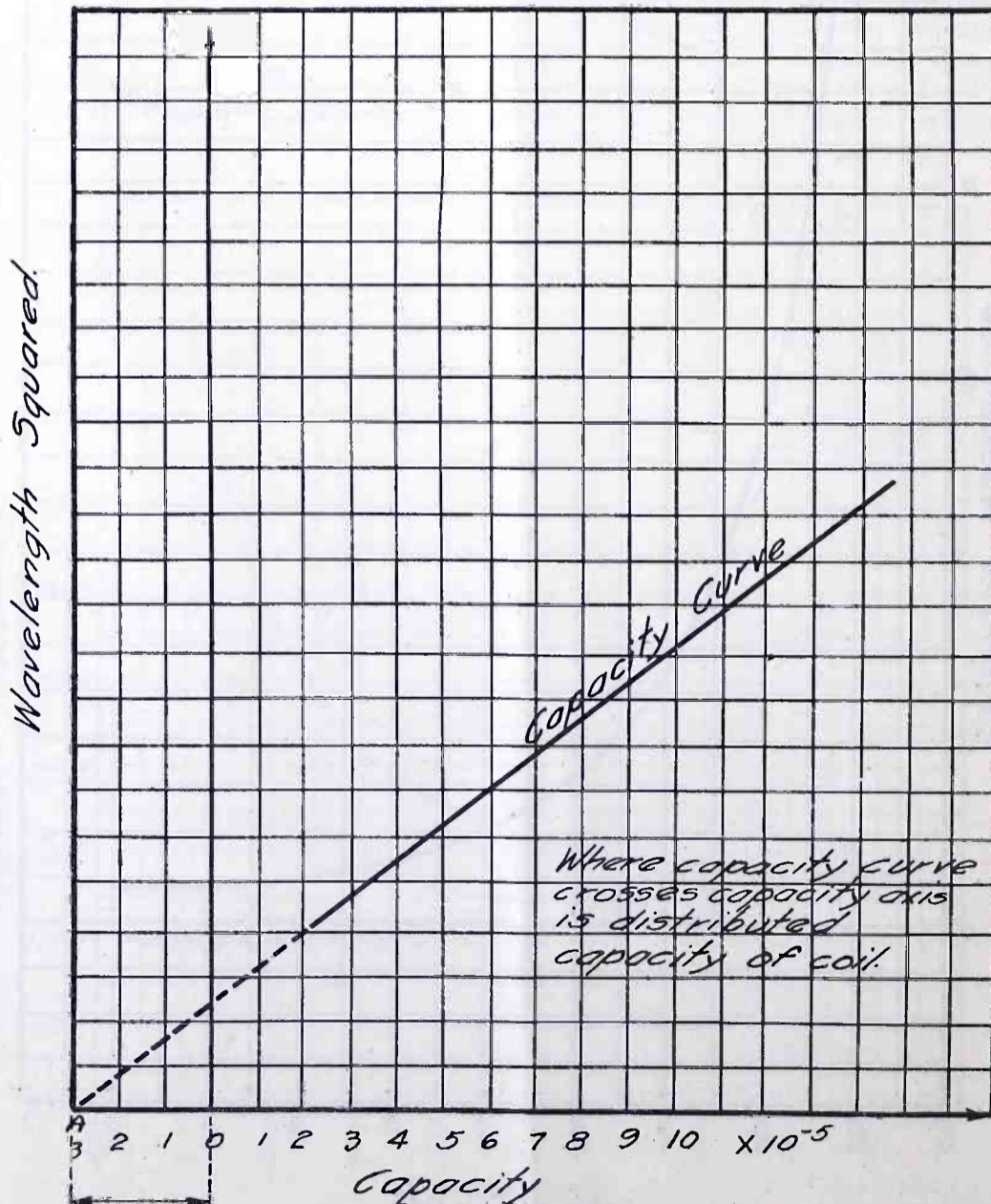

Fig. 8. Plot for Determining Distributed Capacity

# How to Plan Your Set

By Paul McGinnis

*This is good advice for the novice who wants to start with a crystal detector and gradually add to his set. Several simple hook-ups are given and directions for making a loose coupler.*

THE ordinary man falls into the ways of radio not only to hear programs but to operate the various contraptions, and the more honest among us will admit that radio offers the greatest toy we have had since childhood. Such a man wants to build his own set or at least put it together so that he can change it now and then and make it grow.

The first instrument to consider, no matter what type of set you plan to build, is the inductance, the coils of wire which have most to do with reception. If you want the best, buy a variocoupler. You can use it with a crystal detector, a pair of head phones and a small phone condenser. With it you will hear ten to twenty-five miles and sometimes when you sit up late and turn the knob slowly you will hear stations several hundred miles away.

If you want to start in making the instruments, saving money and having the real enjoyment that comes to all diligent makers of things, build a loose coupler. The cardboard salt box, the large mailing tube you almost destroyed or any other tube of good insulating material will serve as a form for winding one of the coils. It should be about 3½ or 4 in. in diameter and only thick enough to support the wire to be wound about it. A secondary form must be of a size so that with its single layer winding it will fit inside this primary form, leaving barely enough room to slide in and out easily.

You now have a good start for an instrument you can always use. You will need six ounces of No. 24 cotton-covered wire. As you wind the primary coil, twist a 6-in. loop of the wire at every turn during the first ten turns. These loops are used as taps and should be slightly staggered so as not to interfere with each other. Make one tap at every tenth turn during the next 100 turns and the coil is wound.

Wind only 80 turns on the secondary coil, with a tap every tenth turn. Pull the taps into the inside of the tube through small holes. Mount this smaller tube on an L-shaped standard so that it will slide into the larger tube, and connect the taps to an eight-pointed switch. The taps of the primary coil are connected to switches of ten and eleven points, and the job is done. You are ready to slide and switch for action.

When you are tired scratching on your crystal, you can put a vacuum tube in its place and increase your range, possibly double or treble it without any more tuning instruments.

After you have learned how your tube

works and think you should be picking up a few foreign countries, add a variometer to the plate circuit and learn the language of radio howls and squeals, what they mean and how they help you to tune.

A variometer can be made of two coils, each having about 40 turns. One coil must rotate within the other, but since it is necessary to have the two coils come close to each other, the instrument is hard to make.

You may now be ready for a variable condenser, to help in tuning out interfering stations and strengthening signals you wish to hear. You can make one of two plates of non-magnetic metal which will fold like a book or you can use two tubes, one sliding in the other and insulated from it, but in many instances a condenser serves as a delicate instrument and the machine-made variety is much more desirable.

Placing a condenser in series in the

antenna circuit shortens your wavelength and placing it in shunt or in parallel with an inductance coil increases your wavelength.

The antenna must be considered when you think of condensers, as they will help to overcome its natural deficiencies of length. A practical antenna for broadcast programs is one wire, bare or insulated, 150-ft. long, strung as high as possible. Adding strands to it, two or three feet apart, will help some, but length and height are most to be desired.

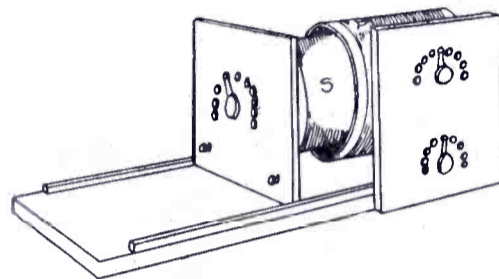

Completed Loose Coupler

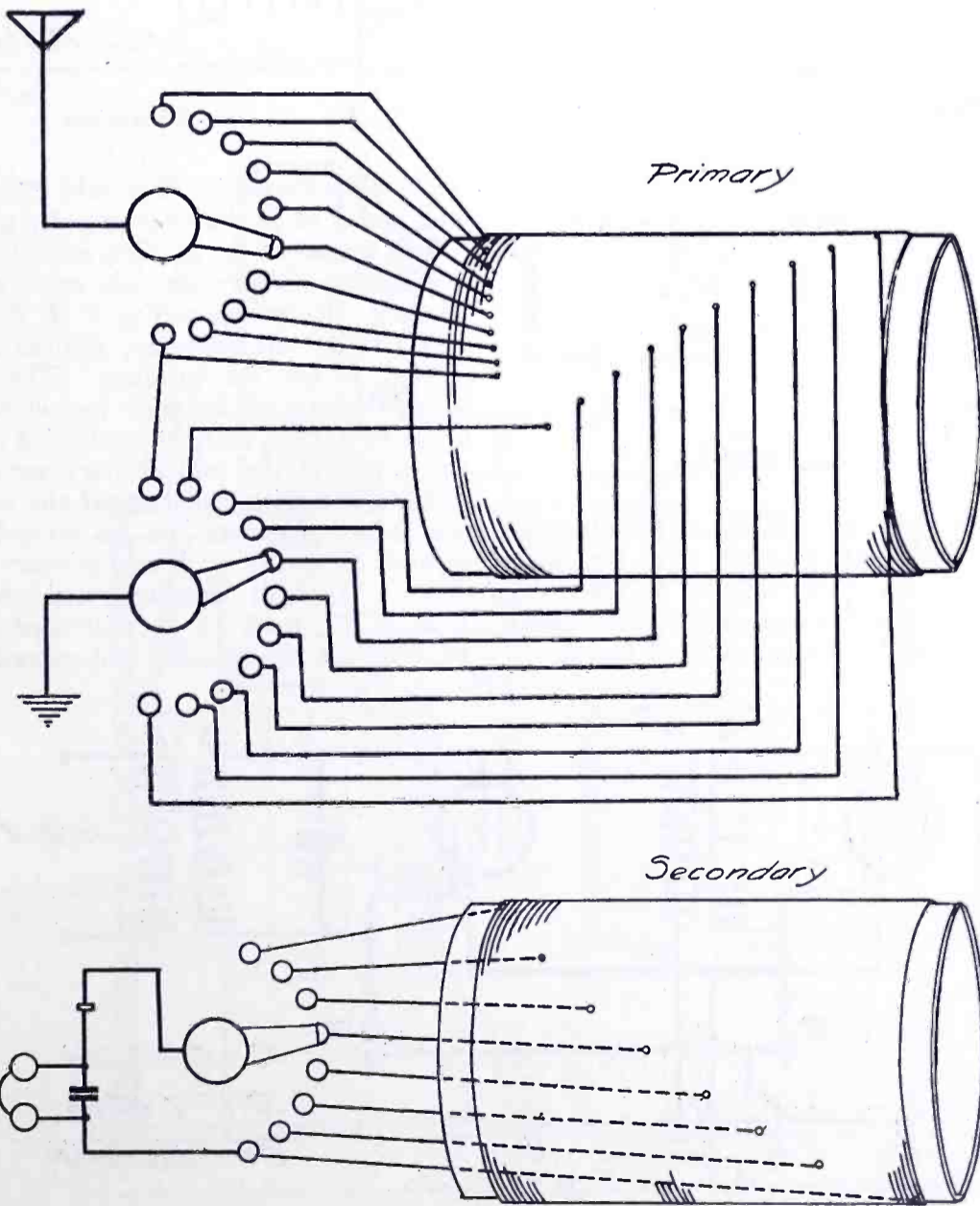

Loose Coupler Construction

When you have added two more tubes and hooked them up with audio-frequency transformers, you will be ready to treat your friends to a loud speaker concert and they will be ready to ask you why you don't add two more tubes with radio-frequency transformers and cover half the globe for them.

### AN AIR-CORE AUDIO-FREQUENCY AMPLIFYING TRANSFORMER

By SIX ZEE JAY

AN air-core audio-frequency amplifying transformer has many features in common with the iron-core, the most noteworthy being its ability to respond to a wide range of voice frequencies. Moreover it lacks the tendency to "howl" and distort signals. However, the good points of a well designed iron-core amplifying transformer cannot be denied.

Those who were with the Radio Service of the U. S. Navy will remember how well the two-step amplifier, designed by the Radio Laboratories of the Bureau of Standards and built at the Washington Navy Yards, worked. Many, no doubt, tried to get its constructional data. Those who weren't fortunate enough to obtain this information will welcome a description of the construction of the air-core transformers used in it.

binding posts, and, if both the transformer and panel are mounted on a small wood base, a very neat appearing amplifying transformer will be the result. Or the whole works can be enclosed in a small wooden box, not taking up more room than the outside dimensions of the transformer windings.

An important factor often overlooked in an amplifier is the insertion of the small resistances at R (Fig 2). This resistance is usually about 1 ohm, having a tendency to produce a more negative charge on the grid—a condition that results in a more efficient operation of the amplifying tubes due to their characteristics.

A small fixed condenser of approximately 500 micro-farads is shunted across the secondary of the first transformer. Its function is to provide a by-pass across the high impedance of the secondary windings, resulting in a more uniform operation of the amplifier.

### SUCCESS OF U. S. MARKET BROADCASTS

Nation-wide, practical use of the radio market reports broadcast by the United States Department of Agriculture is indicated in a survey just completed. Nearly 50 per cent of the hundreds of returns to an inquiry sent out by radio were from farmers who had radio receiving equipment. The remainder of the returns were from grain dealers, mills, elevators, banks, telephone companies, cooperative organizations, farm bureaus and other agencies which disseminate the reports among large groups of farmers.

Greatest interest was shown in the grain market reports, which inform farmers of wheat, corn and oats prices at the leading grain markets. Next in importance came the livestock reports of prices and movements at the principal livestock markets of the country. The weather reports came next, followed by reports on poultry products, fruits and vegetables, dairy products, hay, cotton and other farm crops.

This is the first survey made by the department to determine how widely its radio market reports are being received and used by farmers, and affords much valuable information for developing the service to the maximum of efficiency. It has been known in a general way that the service has been of value to producers and other agricultural interests in the marketing of crops, and to consumers through the regulating of market supplies, but definite data were not available until developed by the present survey.

The survey shows that there are now few places in rural districts where people congregate even in small groups that are without the benefits of radio. Agricultural leaders see in this the development of a true community spirit, which forms a large part of the base of agricultural prosperity.

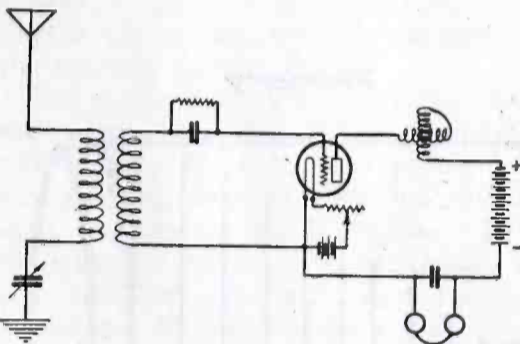
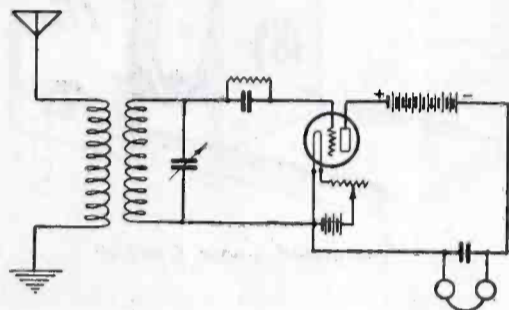
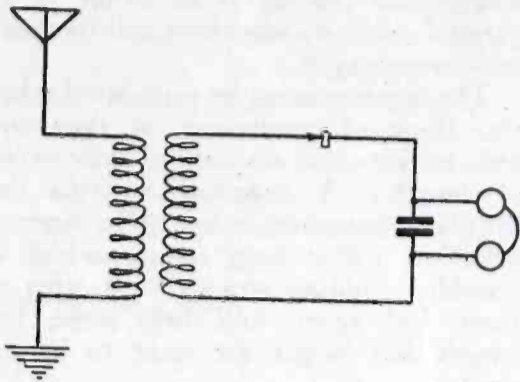

Simple Hook-ups

All this you will do mostly because you can't stop yourself after you have started, and then you will be ready for the fancy super-regenerative and reflex circuits and the other frills of fashion.

On a cardboard or fiber tube 2½ in. long and 2 in. in diameter, equally space 9 fiber washers 1/16 in. thick and 2¾ in. in diameter. There are eight sections of winding. Referring to Fig. 1, A, B, D, E, G, H are the secondary sections and C and F are the primary. The six secondary sections are each wound with 6,000 ft. of No. 40 B.&S. enameled copper wire and the two primary sections each wound with 3,000 ft. of the same size wire. Connect the six secondary sections in series and the primary in series. A small bakelite panel about 1 in. x 2½ in. x 1/8 in. will appropriately mount the primary and secondary

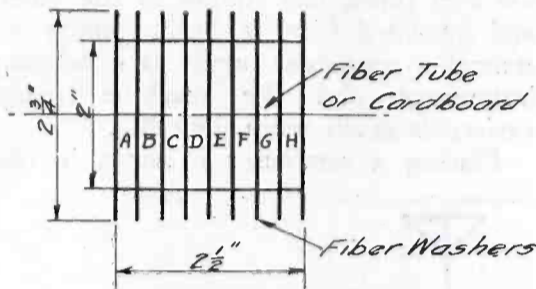
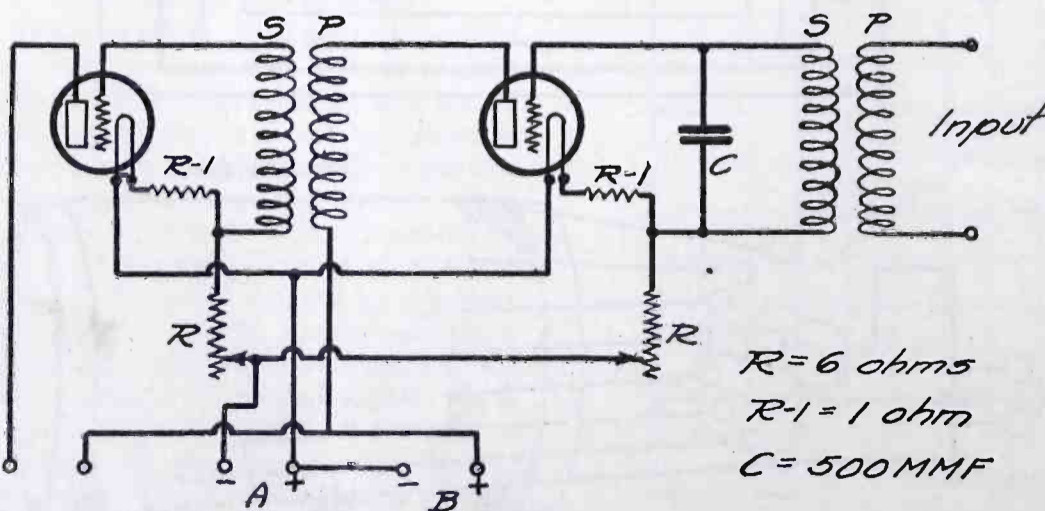

Fig. 1. Core Dimensions



R = 6 ohms  
R-1 = 1 ohm  
C = 500 MMF

Fig. 2. Two-Step Amplifier Hook-up

# A Closed Core Magnetic Rectifier

By Florian J. Fox

*Of the several common methods for charging storage batteries, when only alternating current is available, the magnetic rectifier is the least wasteful of current. Consequently the time spent in building the one herein described means an ultimate saving in the electric bill.*

HERE is a really satisfactory and practical battery booster which is fairly easy to build. The materials necessary can usually be found in the aver-

finished. If the job has been done right, when one looks at the end of any one leg, the laminations should alternately be short and long. Before assembling

it should first be determined how many laminations there will be for each leg. Now plan to have from seven to nine of those in the center of the leg project about  $1\frac{1}{4}$  in. beyond the outside of the core. To do this these projecting strips will have to be  $5\frac{3}{4}$  in. long. If desired, the spaces between these may be filled with strips  $1\frac{1}{4}$  in. x  $1\frac{1}{2}$  in.; however this is not necessary. The one in the very center of this group should now be cut down about  $\frac{3}{4}$  in. shorter than the rest in order to make a seat for the armature or commutator. If an old transformer core is used, a few strips which project the required amount can easily be fitted in. See Figs. 1, 2 and 7.

After the core has thus been assembled, tape may be wound around three of the legs (primary, secondary and one side leg) and the remaining side leg removed. After the coils have been wound and taped they may be placed on their respective legs and the side leg assembled and taped. Holes can then be drilled as shown in Figs. 2 and 3 for brackets and for commutator.

Coils are wound on a form as shown in Fig. 6. This is a tapered block with

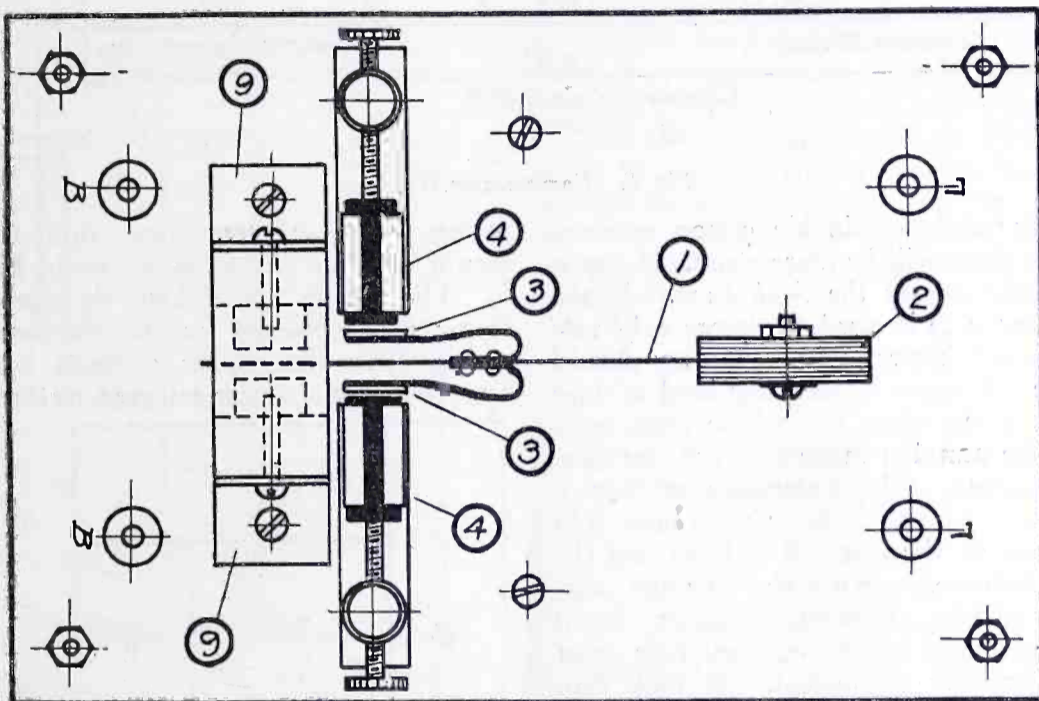

Fig. 1. Top View

age experimenter's "junk pile," and such things that he may not have at hand can be bought cheaply. It is hard to give specific dimensions for drilling, etc., because they will depend on the size and shape of the parts the experimenter has at hand. I shall therefore present a general description, leaving out most dimensions that are subject to change, so that each experimenter can adopt the idea to meet his special conditions.

The core should be made of transformer iron if possible, an old current transformer is good if one can be obtained. Stove pipe iron will also do if nothing better can be obtained. If stove-pipe iron is used it is advisable to varnish the laminations in order to keep eddy current losses down as much as possible. Plan to have a core which, when assembled, will measure about 6 in. x 6 in. x  $1\frac{1}{2}$  in (each leg having cross sectional dimensions of  $1\frac{1}{2}$  in. x  $1\frac{1}{2}$  in). Try to get laminations that are as thin as possible. If the builder has an old transformer the assembly is simple. However, for the benefit of those who intend to cut the laminations themselves I suggest that the strips be cut to say  $4\frac{1}{2}$  in. x  $1\frac{1}{2}$  in. The core is then assembled by laying the strips out in such a way as to form a 6-in. square, taking care that for each layer a new corner is chosen as a starting point so that the core will be rigid when

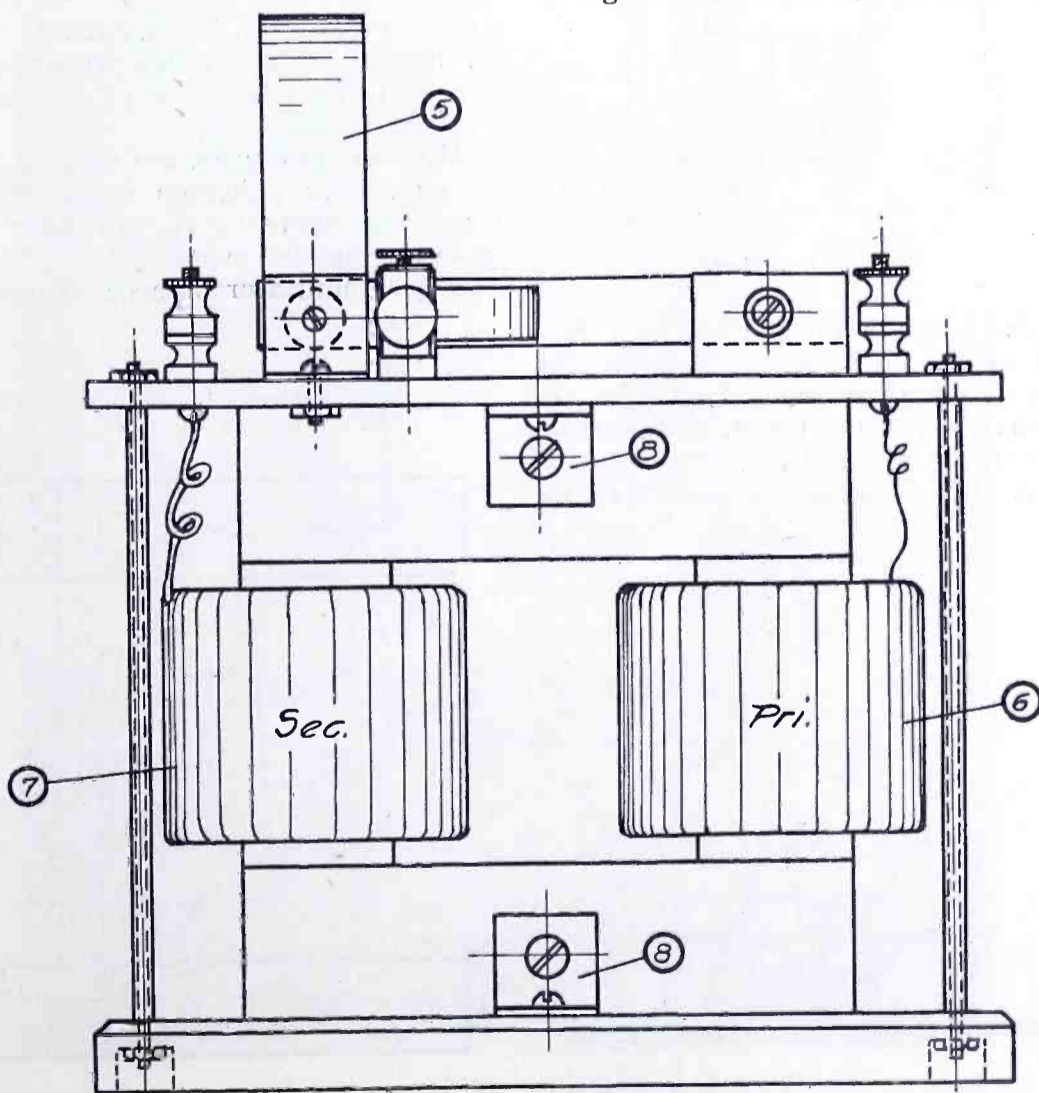

Fig. 2. Side View

two end pieces. The piece at the smallest end is removable, two wood screws holding it in place. A hole is drilled through the center of the whole form. A spike may now be placed through this hole and the spike clamped horizontally in a vice. The wire can be wound on by simply turning the spool by means of a brad driven into one corner of the removable end piece. A couple of pieces of wire may be placed across the form before beginning to wind and when a coil is wound the ends may be twisted together. This will hold the coil in shape when it is being removed and taped. To remove a coil simply take off the end piece and tap the wooden center and it will drop out. The coil is held in shape by the wires mentioned above. The finished coil is then neatly taped.

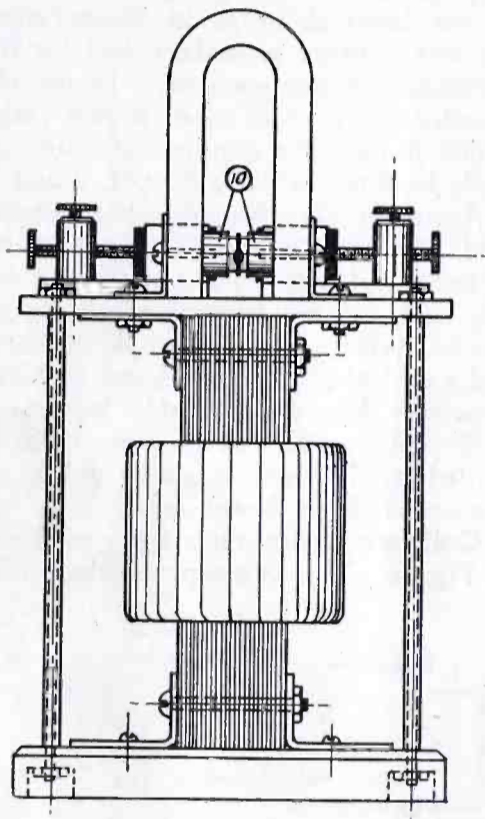

Fig. 3. End View

The primary (for 110 volt a.c.) consists of 500 turns of No. 18 or No. 20 single cotton covered wire. The secondary, for a 6-volt battery consists of 100 turns of No. 12 or No. 14 wire (No. 12 preferred). This may be

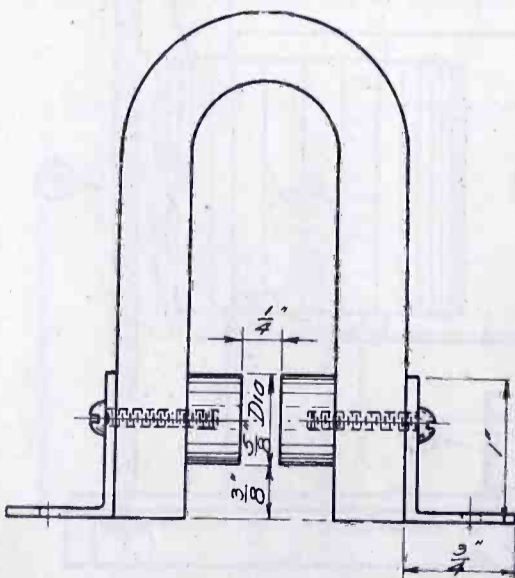

Fig. 4. Magnet Detail

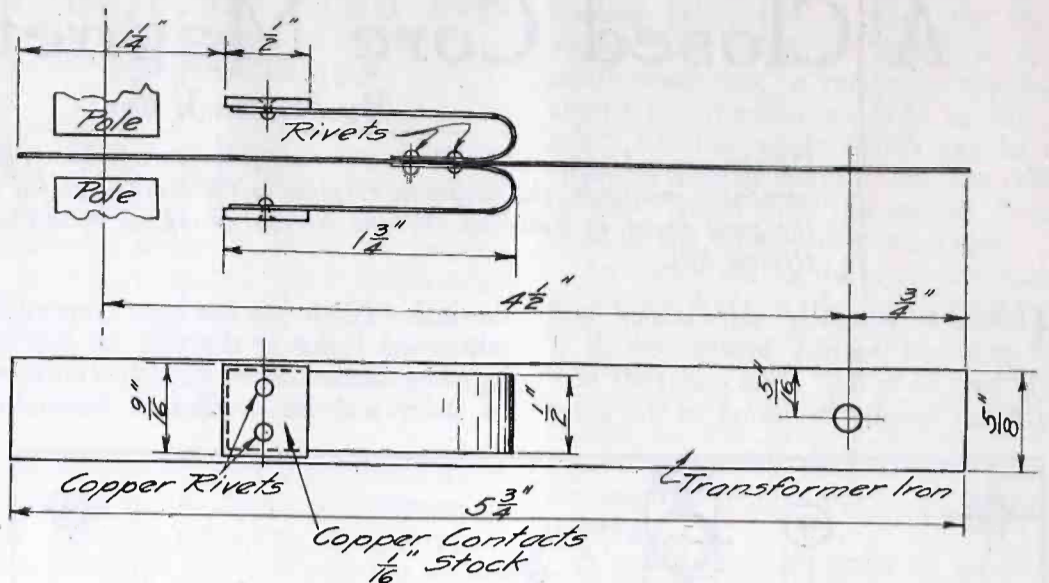

Fig. 5. Commutator Detail

either single or double cotton covered, since there will be more room. A tap is brought out at the 50th turn. If the booster is to be used to charge a 12-volt or 8-volt battery, the secondary should have 150 turns of the same kind of wire with a tap taken out at the 75th turn.

The panel is made of fibre, formica, or bakelite. The dimensions are 9 in. x 6 in. x 1/4 in. The arrangement will depend on the material at hand and the experimenter's own taste, but the position of the permanent magnet, brush holders, and projecting core lugs must be carefully duplicated. It took considerable experimenting on my part to find the right positions, and it will pay to profit by my experience because I wasted a good deal of material in experimenting. Fig. 1 shows the arrangement and Fig. 5 will give all the necessary dimensions.

The base is of wood, size 9 in. x 6 in. x 3/4 in, black asphaltum finish. Four brass rods with sleeves will serve to make the machine more rigid.

The commutator is made of trans-

former iron or stove pipe iron and should be made exactly as shown in Fig. 5. The springs which hold the copper contacts are riveted on to the main spring after the copper contacts have been riveted and sweat soldered to them.

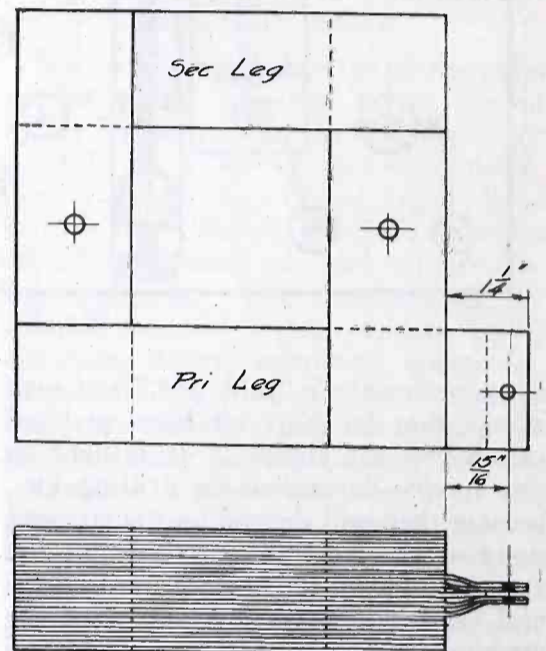

Fig. 7a. Core Dimensions

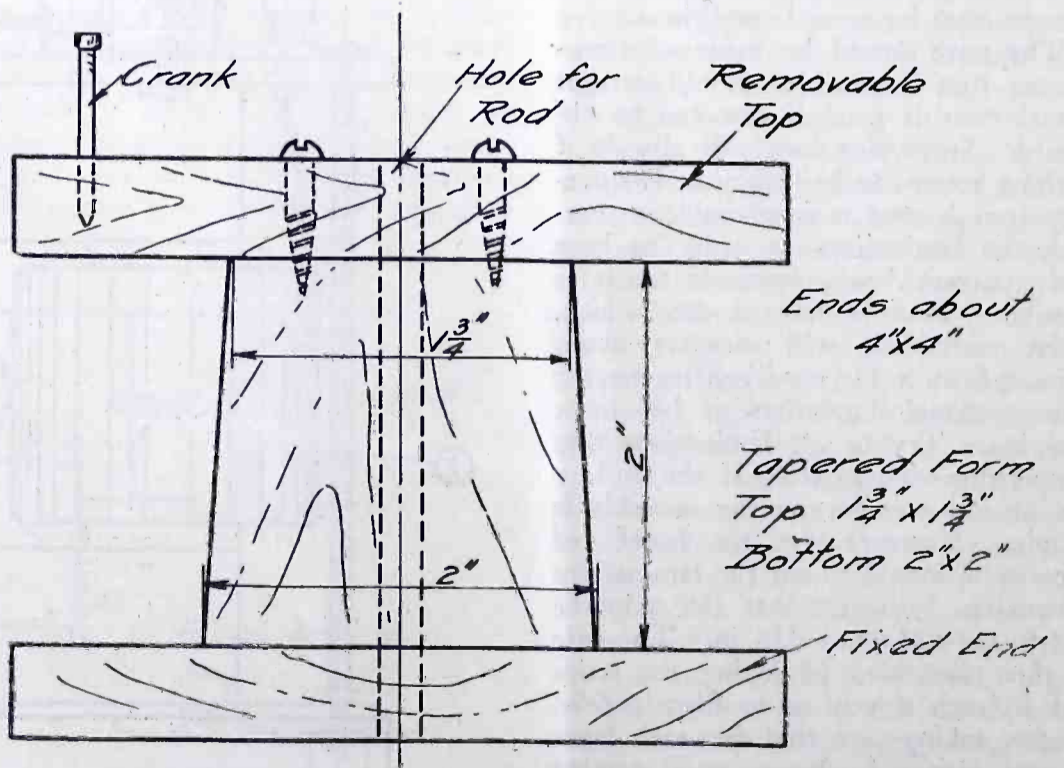

Fig. 6. Form for Winding Coils



Iron rivets may be used for the springs, but flat-head countersunk copper rivets must be used for the contacts. Solder alone will not do. Do not use hardened steel for the main spring: it will not vibrate, as the magnetic reluctance is too great.

The brushes or stationary contacts are cut from motor or generator brush carbon. The size is 1 in. x 1/2 in. x 1/2 in. The holders may be made by bending up two pieces of brass or copper 1 in. x 1 3/4 in. as shown in Figs. 1, 3 and 7 (b).

terminated only by experiment. Figs. 1, 2 and 3 show how the magnet is attached to the instrument. Care must be taken to have the main spring of the commutator lie exactly between the pole pieces attached to the magnet.

It could be predicted which side will be positive, but there is always a chance of making a mistake. The easiest and simplest way is to run the wires from the battery posts of the instrument into a solution of salt water when the rectifier is running smoothly. Bubbles will appear at the negative wire.

It is best to mark the posts and also the magnet, for if later the magnet were accidentally turned around while experimenting, the polarity at the posts would be reversed and a good storage battery might be ruined. It is also advisable to fuse the battery side to prevent the battery from discharging if by some chance the machine stopped. This has never happened to me but it is well to guard

against possibilities. To secure the best results the machine should be adjusted every few hours, as there always is a little brush wear.

This type of rectifier is electrically almost twice as efficient as a Tungar because it rectifies both halves of the cycle. Fig. 8 shows the "hook-up."

### JENKINS SENDS PICTURES BY RADIO

The latest of several means devised for transmitting pictures by radio is the invention of C. Francis Jenkins, who is shown here with his equipment. But not satisfied with this accomplishment, he is now working on an invention to transmit moving pictures by radio.

The accompanying pictures of President Harding and Secretary Denby were received over a fifteen-mile transmission and by the time this account is printed it is hoped that similar successful results will be attained over a distance of one hundred miles.

The method consists in cutting a photograph into hundreds of small pieces and in moving the projected image of each piece across a photo-electric cell, thus impressing the picture point by point on the cell. The cell converts light variations into electrical variations which are amplified and transmitted from an antenna. The process is reversed at the receiving end.

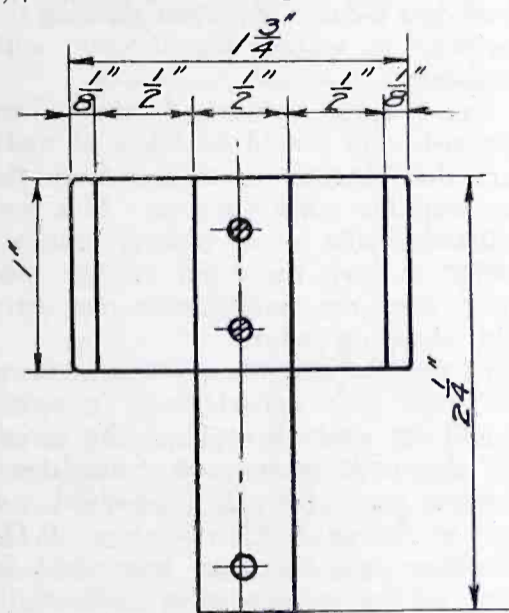

Before Bending

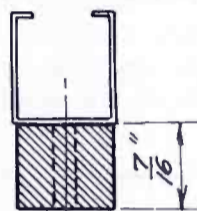

End View Of Finished Holder.

Fig. 7b. End View of Finished Holder

These are then fastened by means of flat-head countersunk screws to either a metal or fibre block. Adjustment screws are mounted as shown in Figs. 1, 2 and 3. The charging rate is regulated by the adjustment of the brushes. They require careful adjustment for best results, should be well seated to prevent arcing and overheating, and the contacts should be cleaned occasionally.

The permanent magnet should preferably be one which has holes already in it near the ends, as it will be found almost impossible to drill holes if they are not already there. Otherwise it is best to make iron clamps which will serve to hold both the magnet and the iron pole pieces. Fig. 4 shows how the magnet should be assembled. In this case the iron pole pieces have tapped holes, the screw holding both the pole piece and bracket. All the dimensions shown in Fig. 4 must be duplicated except those referring to the two brackets.

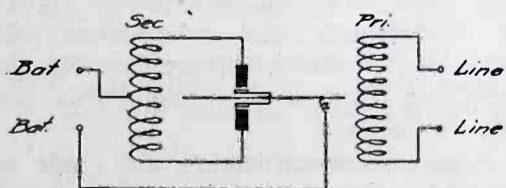
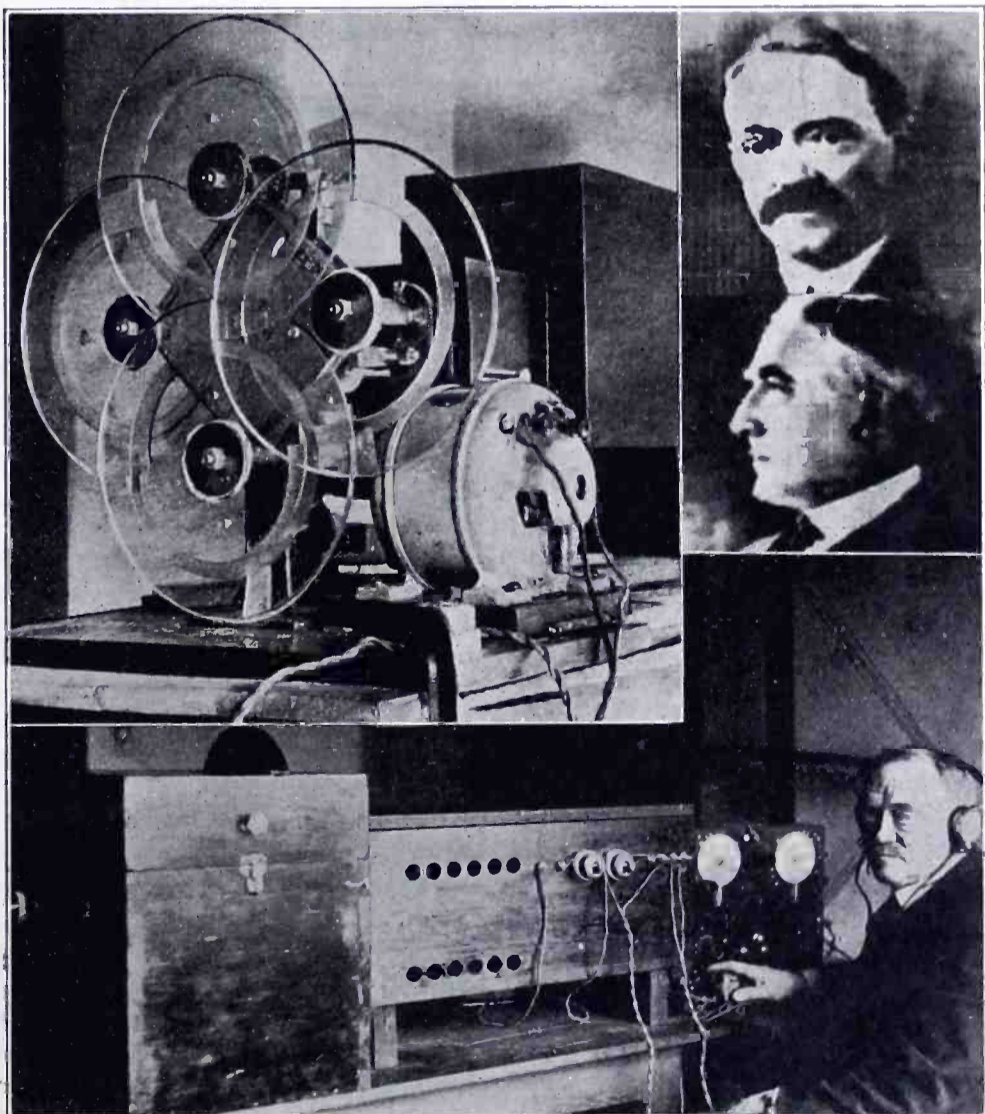

Fig. 8. Diagram of Connections

If the magnet is too strong and causes the spring to hit the pole-pieces or to stick to them, the air gap between them must be widened. This can be de-



C. Francis Jenkins and His Radio Picture Transmitter, Showing Pictures as Received. International Newsreel Photo

# Methods of Measuring Voltage Amplification of Amplifiers

So many questions have been received as to the characteristics of various amplifying transformers that the method of testing used at the Bureau of Standards as reported in Letter Circular 86 is here printed for the benefit of the amateur who wants to make the tests for himself.

AMPLIFIER circuits used in radio work fall into two distinct classes depending on whether they are used to amplify the radio-frequency currents before detection or to amplify the audio-frequency currents produced by the detector. These two types of amplifiers are called respectively "Radio-Frequency Amplifiers" and "Audio-Frequency Amplifiers." This paper describes methods commonly used at the Bureau of Standards for measuring the amplification of the two different types. As the amplifiers are most commonly used the voltage amplification is the most important and is the only one considered in this paper.

With the arrangement here described

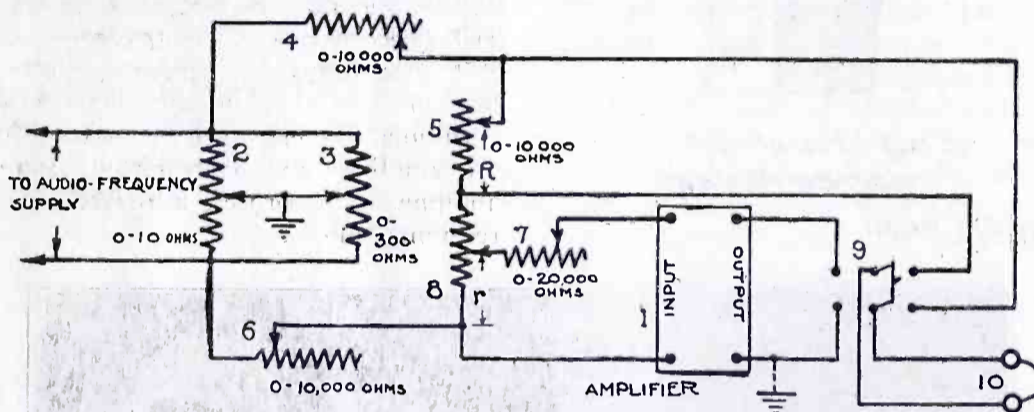

Fig. 1. Circuits for Measuring Audio-Frequency Voltage Amplification

the voltage amplification of audio-frequency amplifiers having amplification up 20,000 can be measured at any audible frequency for which a supply voltage is available. Most two stage audio-frequency amplifiers have a voltage amplification of less than 5000 so that they fall well within the range of this method of measurement.

A diagram of the circuit is shown in Fig. 1, the parts being designated as follows:

1. Amplifier under test.
- 2, 3. Voltage dividers for rough and fine adjustment of ground potential.
- 4, 5, 6, 7. Variable resistors as indicated.
8. Slide wire.
9. DPDT quick acting switch.
10. Telephone receivers.

The audio-frequency generating set which should be capable of giving about 5 volts at the desired frequency is located at some distance from the test circuit in order to prevent induction in the amplifier or leads. The leads from the batteries to the amplifier are made as short as possible.

If it is desired to measure the input voltage supplied to the amplifier a voltmeter of the thermal type may be connected to the input terminals of the cir-

cuit and the value of the input to the amplifier calculated from the value of the resistances.

If the amplifier under test is transformer-coupled where there is no electrical connection between the input and output terminals, one of the output terminals at 9 must be grounded to prevent howling. If it is any other type having the input connected to the output, the output terminals must be ungrounded.

To make a measurement the audio-frequency generating set is adjusted to the desired frequency by comparison with a tuning fork of that frequency. The voltage across it is applied to the input circuit of the amplifier as shown

in the diagram. The voltage across the telephone receivers 10 is then adjusted to equal that across  $R$ . This is accomplished by varying  $R$  and  $r$  until the intensity of sound in the telephone receivers is the same for both positions of the switch 10.  $R$  is so adjusted that the required setting of  $r$  lies well within the limits of the slide wire scale, under the limitation that  $R$  must be kept small in comparison with the impedance of the telephone receivers. Resistors 4 and 6 are adjusted to give the least intensity of sound in the telephone receivers with which satisfactory observations can be made. Voltage dividers 2 and 3 are adjusted so that there is no sound in the phones when  $r=0$ .

In making comparisons of the intensities of sound in the telephone receivers for both positions of 9 the ear is concentrated on the fundamental frequency of the generator, disregarding as far as possible the harmonic frequencies present.

When the intensity of the sound is the same with the switch 9 in either position the voltage amplification

$$\mu_v = \frac{R}{r}$$

The frequency of the generating set is changed and the amplification measured over the audible range. From these data a curve is plotted showing the variation in voltage amplification with frequency.

Every time resistors 4 and 6 are changed, care should be taken to make sure that there is no output from the test amplifier when  $r$  is zero. It is generally desirable, when making measurements, to keep the input voltage constant, since the amplification may vary with changing input.

In making a series of measurements the same pair of telephone receivers should be used throughout the series, and also in the comparison of amplifiers, unless a particular type is specified. A pair of Western Electric, type P-11, telephone receivers have been used in most of the measurements made with this apparatus.

The measurement described here is open to the criticism that it disregards the power consumed by the input of the amplifier, and likewise takes the voltage across a given pair of telephone receivers as a criterion of the output of the amplifier. The power consumption is not negligible in actual use and it is likely to affect the operation of the detecting device with which it is used in radio reception. The output voltage may vary greatly with different types of telephone receivers.

## Amplification of Radio-Frequency Amplifiers.

The voltage amplification of radio-frequency amplifiers consisting of one or more stages of radio-frequency amplification and a detector can be measured with the apparatus herein described at frequencies of 500,000 to 75,000 (wavelengths of 600-4000 meters).

The amplifier and measuring apparatus are completely enclosed in a screen wire cage which shields the apparatus from the radio-frequency generating set and from stray radio-frequency signals or disturbances, and is supplied with modulated radio-frequency and audio-frequency current from apparatus outside of the cage.

Separate measurements are made on the radio, detector, and audio stages, if the amplifier under test combines all three, which may involve separating the connections of the various parts of the instrument.

The method used for this measurement can be understood by reference to

Fig. 2. It consists of applying a measured radio-frequency voltage (completely modulated) to the amplifier input and measuring the audio-frequency detector output by comparison with a known audio-frequency voltage of the same frequency; then making a similar measurement on the detector tube alone, applying the radio-frequency to the input of the detector tube and measuring

plate voltage is about 120 v. alternating current supplied by a small 500-cycle motor generator, which also furnishes through a stepdown transformer 30 volts to the leads 2.

The radio-frequency voltage having the frequency at which measurements are to be made, is introduced into the cage by means of the coils  $L_1$  and  $L_2$ , the coupling of which can be varied. The

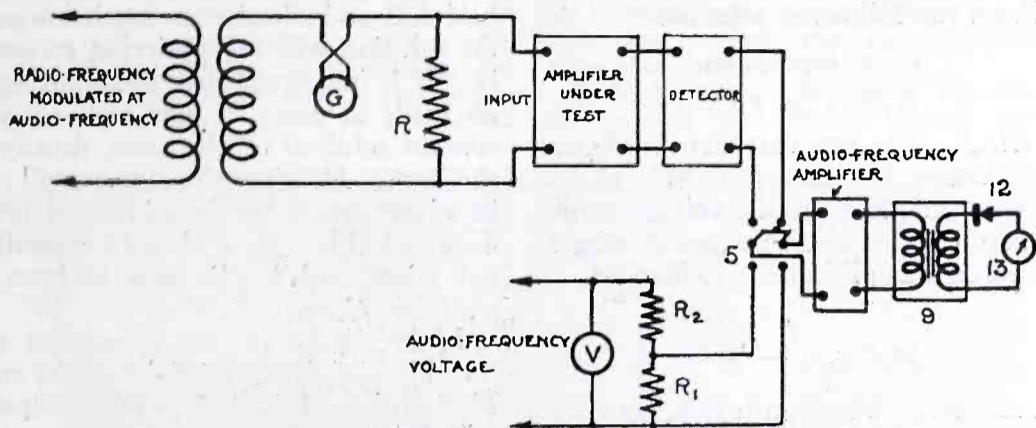

Fig. 2. Simplified Diagram of Circuits for Measurement of Voltage Amplification of Radio Frequency Amplifier

its audio-frequency output. By a combination of the two measurements the term involving the detection coefficient is eliminated and the absolute voltage amplification of the radio-frequency stages alone is thus known. The audio-frequency stages are measured separately as described in the measurement of voltage amplification of audio-frequency amplifiers.

In Fig. 3 is shown the circuit and apparatus for making these measurements, the cage being represented by the dotted line.

coil  $L_2$  outside the cage has an inductance of about 140 microhenries and since it is in an untuned circuit is used over the entire range of wavelengths. Two coils are used at  $L_1$  in the tuned circuit,  $L_1$ -C-15-7-R, inside the cage to

of Standards Circular 74 page 176) varying from 0 to 30 ohms. They must be measured occasionally on a direct current bridge to check their resistance as they do not remain constant.

If the amplifier to be measured has only radio-frequency stages and a detector tube, its input and output terminals are connected to the terminals 3 and 4 respectively; but if the amplifier has one or more audio stages, the terminals 4 are connected inside the amplifier to the output of the detector tube, which will be across the primary of the first audio-frequency transformer, if transformer-coupled stages are used, or across the impedance in the detector tube plate circuit if impedance-coupled stages are used. Telephones are connected to the amplifier in their normal position, using the audio-frequency stages as in actual operation. The filament terminals of the amplifier are connected to terminals 14, and the leads from these terminals connected to a filament battery. The grounded input terminal at 3 marked G should be connected to the filament side of the amplifier input, and short leads used in all connections to the amplifier.

The audio-frequency comparison voltage is supplied to the switch 5 through

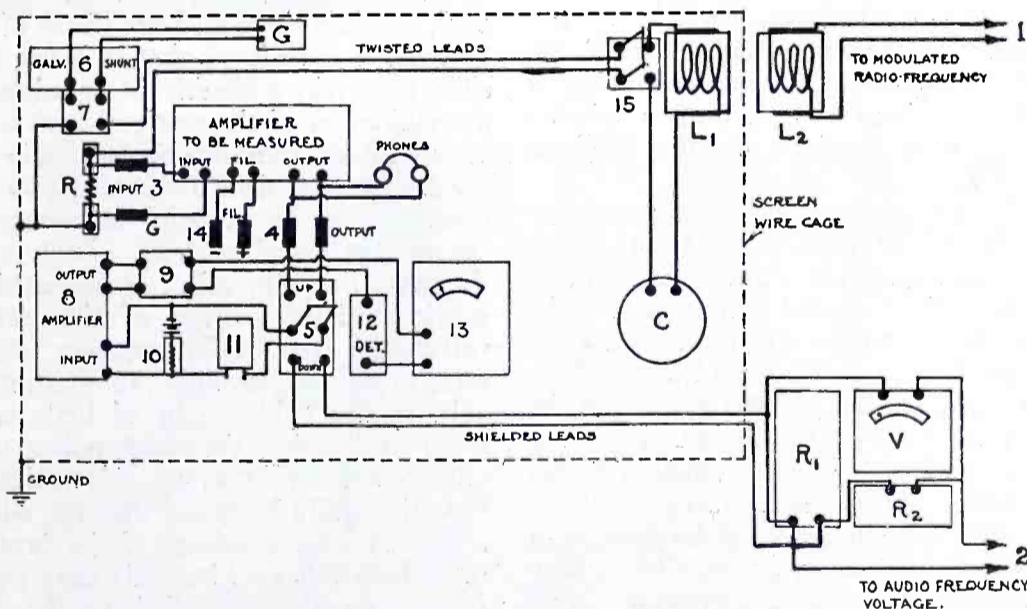

Fig. 3. Circuit for Measurement of Radio-Frequency Voltage Amplification

1. Leads to radio-frequency supply.
2. Leads to audio-frequency supply.
3. Terminals connected to input of amplifier under test.
4. Terminals connected to output of amplifier under test.
5. DPDT switch.
6. Galvanometer shunt resistance.
7. Sensitive low-resistance vacuum thermoelement.
8. 3-stage audio-frequency amplifier.
9. Audio-frequency transformer.
10. Grid leak, 2 megohms, and 2.5 volt battery.
11. Mica condenser, 0.02 microfarads capacity.
12. Crystal detector (carborundum) (These may be replaced by a thermoelement and galvanometer).
13. Milliammeter.
14. Filament battery terminals.
15. DPST switch.
- C. Variable condenser, maximum capacity 0.005 microfarad.
- G. Sensitive galvanometer.
- $L_1$  and  $L_2$  radio-frequency coupling coils.
- R. Radio-frequency link resistance.
- $R_1$  Decade resistance box, 0-1000 ohms.
- $R_2$  Decade resistance box, 0-10,000 ohms.
- V. Hot-wire voltmeter, 0-30, 0-150 volts.

The modulated radio-frequency is supplied by an electron tube radio-frequency generating set enclosed in a metal lined box and placed about 3 meters from the cage. The wavelength of the generated radio-frequency can be varied from 600-4000 meters using the two coils with which it is equipped. The

cover the range of wavelengths required, one the same size as  $L_2$  used from 600-1500 meters, and a larger coil having an inductance of about 860 microhenries used from 1500-4000 meters. This input circuit is tuned to the frequency of the current in  $L_2$  by varying the condenser C.

The amplifier input is the  $iR$  drop across the resistance R due to the radio-frequency current flowing through R, and is varied by using different values of R and varying the current through R by changing C. This current is measured by the thermoelement 7, and galvanometer G which are calibrated with the shunt 6 at the value used. The resistances used at R are standard high-frequency link resistances (see Bureau

twisted leads by the voltage divider at  $R_1$  and  $R_2$ , consisting of a resistance  $R_1$  variable by one ohm steps from 0-1000 ohms to which are connected the leads the DPDT switch, in series with resistance  $R_2$  variable from 0-10000 ohms in 10-ohm steps. The voltmeter V and supply voltage from the audio-frequency source are connected across  $R_1$   $R_2$  as indicated.

Either the audio-frequency output voltage of the test amplifier or the comparison voltage obtained from the voltage divider is connected to the input of the voltage-indicating circuit by switch 5, and is amplified by the three-stage resistance-coupled audio-frequency amplifier 8 and transformer 9 causing an alternating current to flow in the cir-

cuit 9, 12, 13. This current is rectified by the crystal detector 12, and deflects the d.c. milliammeter 13. The detector and milliammeter may be replaced by a thermoelement and galvanometer.

With the frequency of the radio-frequency generating set adjusted to the desired value, the zero resistance link is inserted at  $R$ , the switch 15 closed and the input circuit tuned by varying  $C$  until a large deflection is obtained on galvanometer  $G$ , being very careful to prevent excessive current flowing through the thermoelement. With switch 5 up, connecting the voltage-indicating circuit to the amplifier output, there should be no deflection on the milliammeter as the test amplifier input is short circuited. If there is a deflection, and it continues even with switch 15 open, it may be due to "howling" of the permanent amplifier 8 and may be eliminated by adjusting the filament current of 8. If a deflection is observed on 13 with 15 closed and none with 15 open, it is due to induction in the test amplifier, or resistance in the contacts at  $R$ . The contacts at  $R$  should be cleaned and the input leads of the amplifier shortened, eliminating as far as possible any induction from the coil  $L_1$  to the amplifier.

When no deflection of 13 is observed with the radio-frequency current flowing (15 closed), resistance links are put in place of the zero resistance at  $R$ , always opening 15 before removing a link at  $R$ , increasing  $R$  until a suitable deflection is obtained on the milliammeter 13.

The comparison voltage is now connected to the voltage-indicating circuit by throwing switch 5 down, and  $R_1$  and  $R_2$  are adjusted until approximately the same deflection on the milliammeter is obtained as previously. Switch 5 is thrown to the up position again and the amplifier input varied by varying  $C$ , it being equipped with a small variable condenser for fine adjustment, until exactly the same deflection is obtained with switch 5 either up or down. The audio-frequency output voltage  $e_t$  is now equal to the comparison voltage across  $R_1$ , and since the voltage  $E$  across  $R_1$  and  $R_2$  measured by voltmeter  $V$ , is known, the amplifier output voltage—

$$e_t = E \frac{R_1}{R_1 + R_2}$$

The thermoelement and galvanometer being calibrated, the current,  $i$ , flowing through  $R$  is obtained from the galvanometer deflection, and the radio input voltage

$$e_i = i R$$

These measurements are repeated at the different frequencies at which the amplification is to be determined.

Then the input terminals, 3, are disconnected from the amplifier input and connected directly to the detector tube input, removing the connections from the preceding radio-frequency stages to

the detector tube if necessary. This can usually be done by leaving the grounded terminal at 3 connected to the filament, and connecting the other terminal temporarily to the grid condenser of the detector tube. Input and output voltages are measured at the same wavelengths at which the previous measurements were made, calling these new voltages of the detector tube alone:  $e_i^1$  and  $e_t^1$ .

From the following relations:

$$e_t^1 = \delta (e_i^1)^2 \text{ and} \\ e_t = \delta (\mu_v e_i)^2,$$

in which  $\delta$  is the detection coefficient (See Letter Circular No. 87) of the detector tube and  $\mu_v$  the voltage amplification of the radio-frequency stages; the voltage amplification, combining,

$$\mu_v = \sqrt{\frac{e_t}{e_t^1}}$$

for any given wavelength if  $e_i = e_i^1$ .

Some trouble may be experienced by changes in the radio-frequency input while making measurements due to changes in the line voltage from which the audio-frequency generator is run, which may be partially eliminated by running the generator on storage batteries.

In view of the fact that a radio-frequency amplifier, as it is usually assembled, involves three separate pieces of apparatus, it is believed that it is not possible to obtain a significant or adequate determination of the merit of such a device without considering the radio-frequency stages, detector and audio-frequency stages separately, according to the process described here. Data upon the overall amplification, as indicated by a direct determination of the output voltage of the audio-frequency stages relative to the applied radio-frequency voltage, are likely to be of little assistance in locating the weak points of a given combination as an aid to design. It will usually be found that the audio-frequency output voltage of the detector tube alone is less numerically than radio-frequency voltage applied to the first stage, even when there are several stages of radio-frequency amplification, on account of the inherently inefficient operation of the detector.

## A CHEMICAL RECTIFIER FOR SMALL C. W. SETS

By CARLOS S. MUNDT

**T**HIS rectifier is intended for a 5-watt tube operating at normal voltage (350 v.). The following materials are needed:

- 10 glass jars, dimensions about 3 in. x 6 in. (jelly glasses will work, but are susceptible to overheating).
- 10 aluminum strips,  $\frac{3}{4}$  in. x 5 in. (those furnished by University Apparatus Company are very good).
- 10 lead strips,  $\frac{3}{4}$  in. x 5 in. (as above).
- 20 8/32 brass machine screws, with nuts.
- 1 pkg. borax.
- 20 brass washers.
- 2 qts. distilled water.

Through each strip drill a hole about  $\frac{1}{4}$  in. from one end to pass an 8/32 screw. Then bend up the drilled end about  $\frac{1}{2}$  in. so as to form an  $L$ . Join each aluminum to each lead by means of the 8/32 bolt and washer so as to form a  $U$ , but retain two aluminums and two leads for end jars.

Now measure out enough distilled water to fill each of the ten jars about half full and dissolve as much borax as the solution will take, stirring constantly. It is important that this solution be all made at once, so that each jar will contain solution of the same density as the rest. Heating the water will not be advantageous, as the additional borax dissolved this way will only crystallize out when cooled. Be sure to have all materials clean.

Make sure that the aluminum and lead  $U$ 's are clean, especially at the ends. If slightly oxidized No. 00 sandpaper will brighten them up.

Now assemble the rectifier for forming as shown in the drawing, the source of voltage being a step up C. W. transformer of 350 or 550 volts, but leave the lead  $A$  unconnected to other apparatus as yet.

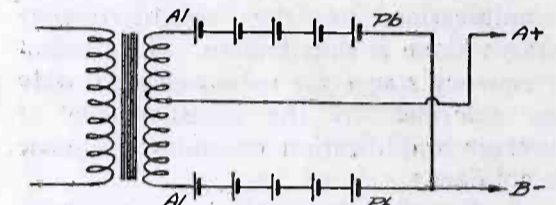

Rectifier Assembly

Throw your 110 volt switch on for about two periods of ten minutes each if 550 v. is used. In case the 350 v. is available alone then a series of longer formation periods will be necessary. When forming is completed the aluminums will present a white-coated appearance where they are immersed in the solution. Any which do not show this as a uniform deposit should be either cleaned for a new trial or discarded and others substituted.

The borax solution needs no attention other than renewal of water lost through evaporation. A few crystals placed in the bottom of each jar before filling will insure the solution remaining saturated.

This rectifier will operate successfully on 350 volts without noticeable heating, unless the jars used are too small. Operation on 550 volts will result in considerable sparking over the aluminum surfaces, indicating incomplete rectification. For 550 v. 18 to 24 jars will be needed, depending on their size.

Do not hook up your rectifier to your C. W. set and assume that your output will resemble C. W. What you get out of your rectifier is pulsating d.c., heavily modulated by 60 cycle flavoring. To eliminate this a suitable filter system must be provided, usually consisting of a  $1\frac{1}{2}$  henry choke in the positive lead, with one 1 mfd. condenser shunting the d.c. leads before the choke and a similar one following the choke.

# WITH THE AMATEUR OPERATORS

## DX AT 6XAD—FEBRUARY

By MAJOR LAWRENCE MOTT  
(Sig-ORC-USA)

I find, from much correspondence, that I must *again* call attention to the fact that ALL stations with whom I have worked—are so designated! The *others* have been so courteous as to advise of hearing *me!* I would beg that DX operators make a note of this, as it will save them a lot of writing, and obviate the impending fact of my being driven into an early grave, by the MASS

Call 6CBD has been assigned to Claiborn Schonhoff, Oakdale, Calif.

Call 5AIF has been assigned to Charles Reilly, 1713 Homan Ave., Fort Worth, Texas.

6ZJ—A. L. Munzig, 1017 Tribune St., Redlands, Calif.; 6ZH—J. Lawrence Martin, 605 E. 4th St., Amarillo, Texas; and 6XAS—all ex-service men—are laid up. They would appreciate a card from radio amateurs to cheer them on their way.

6EA, Howard C. Seefred of Los Angeles, has received word from L. H. Steel, operator

Los Angeles, was heard by New Zealand amateurs several times during November. He was also heard in France, England and China.

8KS, C. E. Dengler, 285 Brown St., Rochester, N. Y., advises that his C. W. signals are reported from 6ZY at Honolulu and 7ABB at Everett, Wash. 8KS has a radiation of 2 to 2.5 amperes from 3 tubes with total power of 15 watts.

### 3BLF

Down in Richmond, Virginia, C. Russ Hofmann is getting some wonderful results. With his 100-watt set he was heard by French and English amateurs during both the preliminary and final transatlantic tests, worked 6XAD and was reported from Colon, Panama, and from Hawaii (6ZAC). With 15 watts he has worked 6CC, 6ZH, 7LR and all districts.

His transmitting equipment is arranged for interchangeable use of either 15 or 100 watts according as 5-watt or 50-watt tubes are used. High voltage direct current is secured from a G. E. motor-generator with field rheostat control of tube voltages. The circuit employs tickler feed-back. The filter consists of ten 1 mf. condensers and 4 mh. chokes.

The antenna is a 7-wire inverted "L," 65 ft. long and 15 ft. spread, supported at one end by an 82-ft. steel windmill tower and at the other by a 30-ft. mast on roof of house. A cage lead-in is employed. A 9-wire counterpoise, 65 ft. long, 30 ft. high and 15 ft. spread is directly under the antenna. In addition a crow-foot ground is used, consisting of about 200 sq. ft. of galvanized sheet iron.

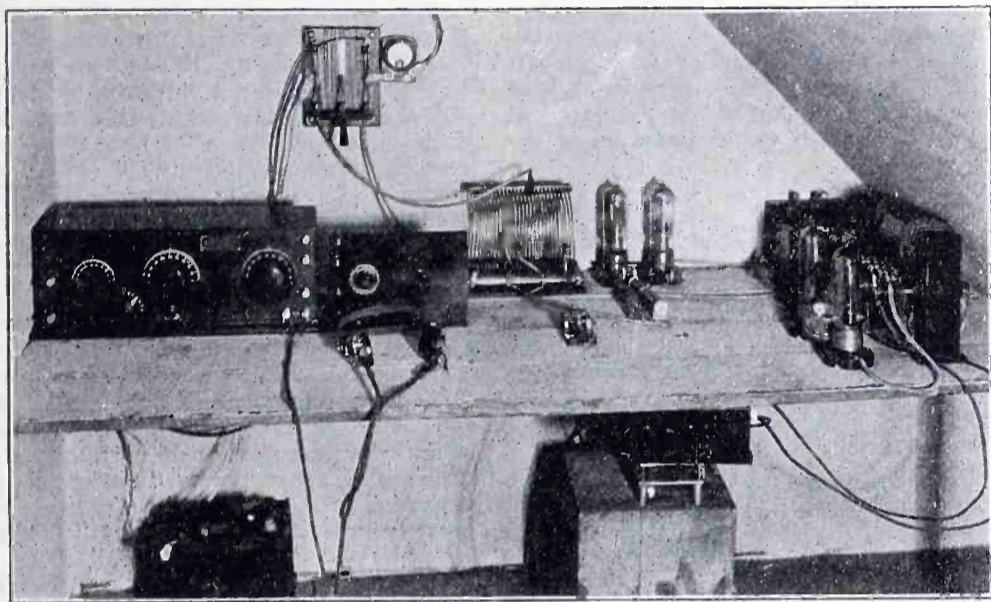

8ADG, Operated by Chas. H. Schrader, Utica, N. Y., Whose 100-watt C. W. Works 6XAD

of cards, etc., that come, under erroneous impressions!

The list:

(1cmk), 1hx, 1gv, 1nw, 1aab, 1bnl, A. J. Blue—Northampton, Mass., 1bes, 1cbj, C. F. McCaffrey—Somerville, Mass., 1boq, 1ctx, 1aac, 1bsz, 1bnt, 1cmp, 1ro, 1rd, 1mo, 1sn, 1coh, 1adb.

(2ayv), (2el), (2fp), (2hj), (2hu), 2ahb, 2ask, 2bzb, 2fc, 2bb, 2xz, 2mu, 2bwp, 2bsc, 2gk, 2awh, 2bjo, 2cme, 2ccd, 2cwr, 2axk, 2bg, 2cbg, 2cuk, 2bgi.

(3aqr), (3ajj), (3yo), (3aro), (3pz), (3bva), (3can), 3adv, 3amx, 3apr, (3aln), 3alx, 3apv, 3dh (Can), 3hs, 3bvc, 3in, 3em, 3sx (Can).

4ag, (4co Can.), 4bx, 4ea, (4eb), 4hw, 4kl, 4lu, 4oi. John Ross—Knoxville, Tenn.

(5hn), (5iq), (5kp), (5kc), (5zak), 5zas, 5abb, 5xac, 5pv, 5tj, 5gd.

Sixes and sevens too numerous.

(8bvr), (8adg), (8ajx), (8afd), (8bfq), (8beo), (8bch), (8boz), (8bxx), (8cei), (8vy), (8hn), (8cf), (8ck), (8vq), (8adz), (8brl), (8coo), 8jy, (8bo), (8cf), (8cuu), (8cpx), (8xap), (8amm), (8caa), (8kg), (8bnz), 8ate, (8ahe), (8ckv), (8cqu), (8qc), (8jj), (8cmy), (8cwp), 8aik, 8abx, 8abo, 8abx, 8aeb, 8anb, 8aix, 8alf, 8atn, 8avd, (heard 6XAD without aerial, loop, ground, and on detector only! He is in Waverly, N. Y.), 8avj, (8bda), 8boa, 8bwa, 8cmx, 8byo, 8cck, 8cjb, 8cjb, 8cmx, 8cwp, 8fq, 8cy, 8ft, 8cok, 8cxi, 8bjs, 8cdw, 8brr, 8adh, 8aip, 8awn, 8bbe, 8bky, 8boe, 8bvp, 8cyu, R. McGregor, Dayton, Ohio.

## NEWS OF THE RADIO OPERATORS

Call 6BJF has been re-issued to T. A. Stout, 421 W. Palmer Ave., Glendale, Calif.

Call 6CFM has been assigned to Claude Perkins, 347 So. Fremont Ave., Los Angeles, Calif.

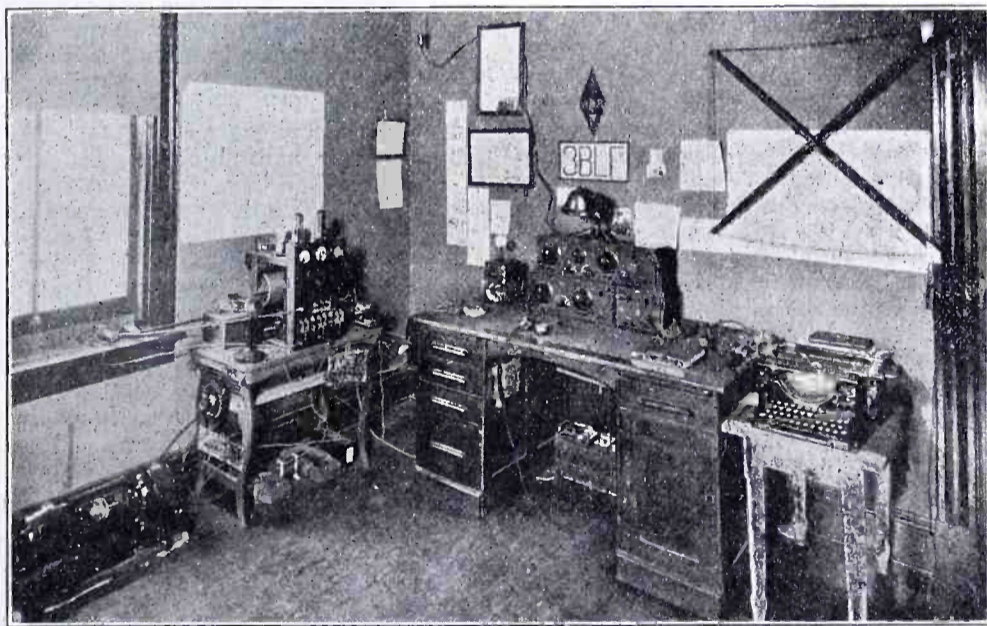

3BLF, Richmond, Va.

at Awarua radio station, Invercargill, New Zealand, that his C. W. signals were heard there in January 10 and 12.

IHE, W. A. Battison, Stoneham, Mass., was heard by 6BOV on January 27 and 28. IHE has a 1/4 kw. tube set and 6BOV a Reinartz tuner.

6ZH, Lester Picker, of San Afsidro, San Diego, Co., Calif., who has been confined to his bed for many months, was present, through radio, at the graduation exercises of his high school class. His diploma was sent him by the principal and his fellow radio operators installed a receiver and loud speaker in the school auditorium. By this means he spoke to the class and extended his thanks for the honor.

6KA, T. E. Nikirk, 1050 West 89th St.,

The receiving equipment consists of a Grebe CR5, CR8 and RORK two-step with Western Electric phones.

## NEW RADIO CATALOGS

Bulletin R-4 from the Radio Apparatus Division of the King Sewing Machine Co. of Buffalo, N. Y., is devoted to their line of "King Quality" bakelite products, including vacuum tube sockets, binding posts, dials and other parts.

American Radio & Research Corp., Medford Hillside, Mass., have issued an attractive booklet, "The Voice of The Air," which tells of the advantages and pleasures of receiving radio broadcasts on Amrad equipment.

# LETTERS TO THE EDITOR

## Radio-Frequency Amplification with Honeycombs or Spiderwebs.

Sir: In the March issue of RADIO the writer described a simple and useful form of radio-frequency amplification, applicable to certain forms of regenerative sets. Its use by amateurs has suggested that there is an applicability which was not mentioned in the article, and the purpose of this letter is to describe that use.

What we refer to is the use of the radio-frequency amplification stage with honeycomb and spiderweb coils. These both lend themselves admirably to the circuit. The arrangement is shown in Fig. 1 herewith, and the only essential point of the connections so far as the linking to the first stage is concerned is that the primary condenser of the honeycomb or spiderweb tuning portion be in parallel and not in series with the prim-

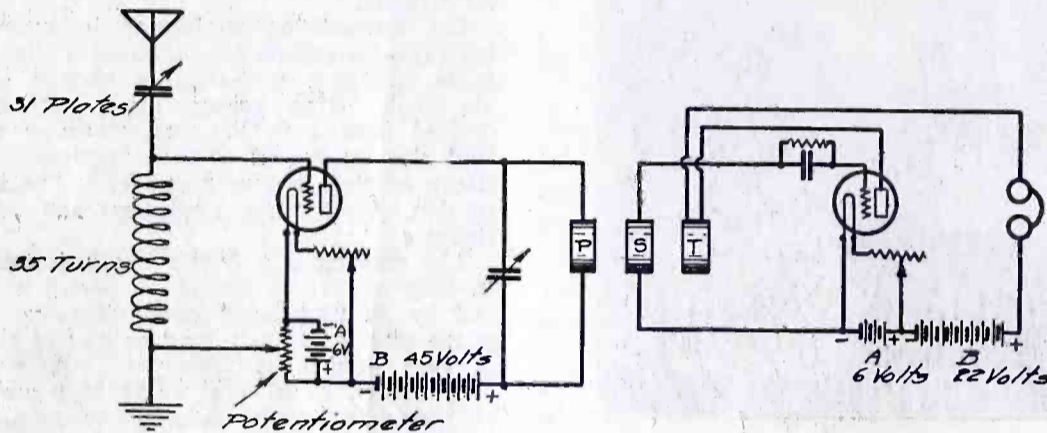

Radio Frequency Amplifier with Honeycomb or Spiderweb Tuner.

ary coil. If the latter be the case there will be no path for the direct current of the amplifier plate battery.

For the sake of openness in the diagram we have shown the amplifier and detector batteries separately, but this is not necessary in the actual hookup. The same storage battery is of course used for both the tubes, and the B battery connection for the detector tube is taken at a tap on the 45 volt source.

The advantage of the use of spiderweb coils is the convenience of making them. They have practically all the virtues of honeycomb coils so far as operation is concerned, and cost nothing but the wire and a little industry.  
Pasadena, Calif. S. G. McMEEN.

## Danger from Exposed Tubes.

Sir: In a recent issue of RADIO appeared a fanciful article concerning a zealous experimenter and his radium bulb. I presume many readers have marked that article for future reference, but I have clipped it because to me it has a peculiar significance.

Last week, feeling a slight soreness in the eyes, and believing that a visit to a good oculist might be of benefit, I visited a specialist for a careful examination. He prescribed some glasses which benefited my vision and relieved the soreness.

In the course of the examination, he inquired if I worked as a photo-engraver by intense light, or had anything to do with electric arc welding, stating that my eye showed the effect of exposure to powerful light and was slightly strained.

I now realize that the doctor's diagnosis was correct. For over a year I have succumbed to all the hypnotism of radio. Night after night I have worked over radio lamps mounted on a base-board, endeavoring to gather in half the continent by radio-frequency. These lights dazzling not over 24 inches from eyes already tired by a day's

work in an office, have temporarily affected my vision.

I write these few lines not as a scare, but to suggest to brother fans, experimenting as I have, to coat their bulbs with colored lacquer, smoke them, or wear colored glasses.

A RADIO FAN.

## Deserved Sarcasm

Sir: I have just finished reading a letter in the current issue of RADIO in which the writer puts forth some of the troubles he encountered while trying to receive phone on a crystal. I had the same troubles which he seems to have had, until I obtained a very thin crystal. Immediately I obtained remarkable results. While listening to a concert from EL TORO the signals came in so loud that they caused my crystal to "vibrate" so badly that at times it would jump out of the cup.

I also experienced the same trouble that my friend from Oregon did in regard to wireless and radio signals. Wireless signals came loud and clear but I was unable to grasp the elusive radio signals. I presumed that this was due to my grid leak starting to oscillate on its natural voltage.

Please, Mr. Editor, won't you tell the dear little "phonephinds" again for nth time that radiotelegraph and wireless telegraph mean one and the same thing? Also that crystals neither oscillate, osculate, nor vibrate in their function as detectors of radio frequencies. And that when they do vibrate, the thoughts that rise in the op's mind are not publishable.

Yours for C. W.,  
WILBUR BROWN.

Whittier, Calif.

## Single Circuit vs. Double Circuit Tuner.

Sir: Misinformation has been broadcasted to the radio trade with regard to the relative capabilities of the double-circuit and single-circuit receiver. By skillful distortion of certain fundamental technical facts, the public, as well as the jobber and dealer, has been informed and in some cases led to believe that the two-circuit tuner enables one to obtain unusual results which cannot possibly be secured with the single-circuit tuner.

There are, however, certain outstanding facts in the situation which no amount of propaganda can contravert:

First—The interference sometimes encountered in radio broadcasting reception is primarily a problem of broadcasting transmission. It will be eliminated by the enactment of suitable Government legislation that will enable wavelengths other than 360 and 400 meters to be assigned to broadcasting stations.

Second—No receiving tuner, whether it be of the single or double-circuit type, will prevent two broadcasting transmitting stations

operating identically on the same wavelength from setting up interference in the receiving set, unless the signals of one station are of sufficient intensity to drown out those of the other station.

Third—Two broadcasting stations operating on nearly the same wavelengths will produce an audible note or "whistle" in a receiving apparatus, which no tuner of either the single or double-circuit type will eliminate. The cure for this problem is the assignment of wavelengths to the transmitting stations of sufficient separation so as not to produce an audible note.

The single-circuit tuner will enable the listener to differentiate between two local broadcasting stations by one of two ways, (a) by connecting a variable condenser in series with the antenna circuit, such as the Radio Corporation UC-1820, or (b) by erecting a short antenna 15 to 40 ft. in length and not of too great height. It has been conclusively demonstrated that a low antenna is more selective than a high antenna.

Selectivity in regenerative receiving sets is primarily a function of the amount of regeneration. Two local broadcasting stations on different wavelengths will often interfere with one another on either the single or double-circuit receiver, but this is due to the overwhelming power of the transmitter which causes the apparatus to function by shock excitation and respond even when not accurately tuned to the transmitter. It has been demonstrated beyond all cavil that interference set up by two local stations can be eliminated on the single-circuit receiver by an antenna not exceeding 40 ft. in length.

The ordinary regenerative set with the double-circuit tuner gives from 20 to 50 per cent reduction in signal audibility over the single-circuit with the same number of tubes and the same general circuit. In other words, stronger signals will be obtained, in long distance reception, from a single-circuit set than from a double-circuit set.

For those who have interest in long distance reception, as well as local reception, it is sometimes advisable to erect two single wire aeriels, one for long distance reception—which may be of any length up to 150 ft., and the other for local reception—which may be of any length up to 40 ft., depending upon the sensitiveness of the receiving instrument. The small antenna enables one to differentiate between local signals, while the larger antenna can be used for long distance work after the local stations have discontinued.

Many users of broadcasting sets are now installing two antennae—a long one for long distance reception after the local stations have closed down, and a small one, or an indoor aerial, for local reception. The indoor aerial may consist of 25 to 50 ft. of lamp cord concealed behind the picture moulding, or a piece of No. 28 wire stretched across the corners of the room. Listeners located up to 15 or 20 miles from a broadcasting station can often obtain all the signal audibility necessary for local work by concealing the antenna under the carpet of the living room or the library of the home.

The foregoing are technical points which will stand the closest analysis. Speaking purely from the commercial phases of the matter, the single-circuit tuner is, without qualification, the most suitable for the novice, that is, for the user unskilled in the art; for generally, the multiplicity of knobs involved in the operation of the double-circuit tuner places them beyond the stage of practicability for the non-technical public. Single-circuit tuners were designed primarily with the idea of providing simplified operation, and as such, they enable the novice to

Continued on page 91

# NEWS OF THE BROADCASTERS

## THE NEW KFI

During the past summer Radio KFI, owned and operated by Earle C. Anthony Inc., was heard in practically every state in the union. But Mr. Anthony, the head of the firm and himself an enthusiastic radio fan, soon realized the increasing importance of radio broadcasting and, as a result of his foresight and large public spirit, the new KFI which went on the air on January 27th was installed.

New KFI is now known as the Radio Central Station of Los Angeles. It is located on the roof of the Packard Building at Tenth and Hope Sts., Los Angeles. It is owned and operated by Earle C. Anthony Inc., Packard distributors, and, in addition to broadcasting its own programs, it also operates at present two remote control stations from which are broadcasted the programs of the Los Angeles *Examiner* and the Los Angeles *Evening Herald*. The remote control programs come to KFI over the telephone lines of the Southern California Telephone Co. These lines terminate in a speech input amplifier from

consists of a plate glass panel which allows visitors to the station to see the full operation of the set.

In addition to the radio room the entire plant consists of a studio done in the Spanish style, a reception room for the convenience of visitors and performers and an office where the details of operation are handled.

In the first week that it was on the air this new station was heard in every one of the forty-eight states, four provinces in Canada, Cuba, Porto Rico and Hawaii.

## TRADE BACKS KPO

Members of the Pacific Radio Trade Association are contributing to a fund to be used to defray the expenses of an organization to provide good programs for KPO, Hale Bros. broadcast station at San Francisco. The association hopes in this way to assist the cause of better broadcasting.

## KDN TO CLOSE

KDN, operated by the Leo J. Meyberg Co. at the Fairmont Hotel, San Francisco,

will be off the air after a new speech amplifier has been installed to connect the Fairmont with KPO. By this means it will be possible to broadcast music from the Fairmont Hotel orchestra to even better advantage than through KDN.

## KZDK AT RENO

KZDK, the broadcast station of the *Nevada State Journal* at Reno, Nevada, is operated by the Nevada Machinery & Electric Co. in the Majestic Theatre. Concerts are given from 4:00 to 4:30 p.m. daily, 6:30 to 7:30 p.m. on Wednesday, and 8:00 to 9:00 p.m. Friday. No phonograph is used for the evening concerts.



Studio at KFI

which the program is carried into the radio transmitter and goes onto the air in exactly the same manner as the programs from KFI's own studio. It is truly a Radio Central exchange, the first of its kind to be operated on the Pacific Coast, and by means of it an entire city can be served from various studios through one aerial and one transmitter. In addition there is a portable remote control set which can be installed for various special events in any portion of Los Angeles served by the telephone lines. There are arrangements pending for the installation of permanent remote controls at other places in the city and within a short time a still more varied program will come from KFI.

The entire installation is Western Electric equipment and was installed by Western Electric and telephone company engineers. The antenna consists of four wires swung between two steel towers 175 ft. above the ground. It has a working length of 100 ft.

The set itself is a standard Western Electric 500 watt transmitter with two 250 watt modulator tubes and two 250 watt oscillator tubes. It is housed in what is called the Radio room off of which opens the generator and battery room. One end of this room

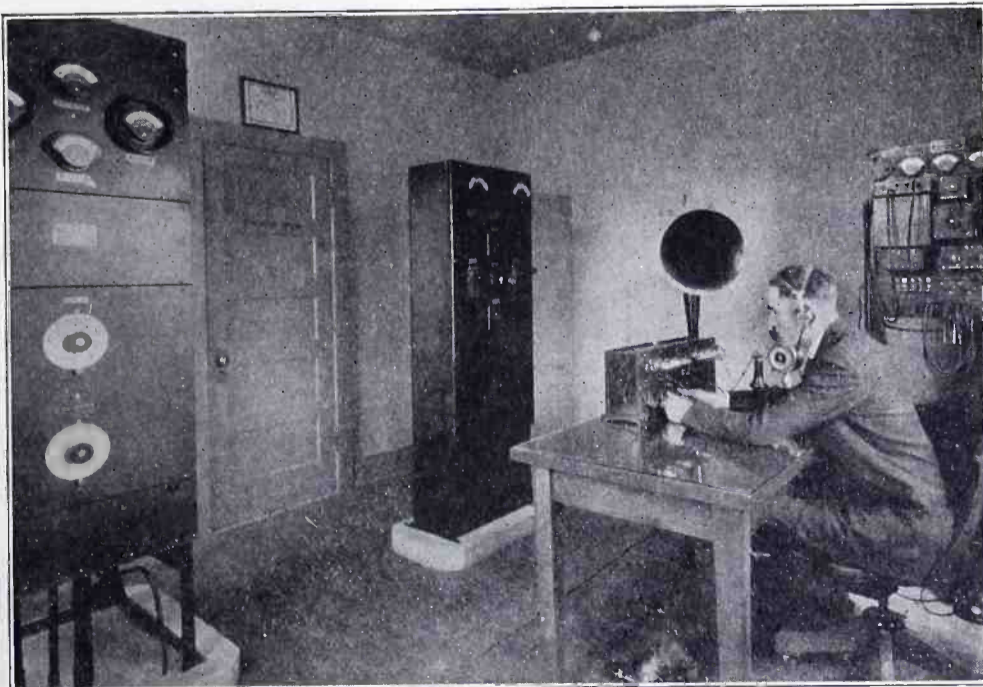

Radio Room at KFI



Aerial at KFI Supported by Roof. 96 ft. Steel Towers and 25 ft. Masts so as to be 175 ft. Above Ground.

## NEW G. E. STATION FOR SAN FRANCISCO

Martin P. Rice, manager of publicity for the General Electric Co., has been investigating the possibility of installing a 1000-watt broadcast station at San Francisco or vicinity. This station will be similar to the General Electric station at Schenectady and will constitute one of the nine stations to be operated by the Radio Corporation, the Westinghouse Company and the General Electric Company.

# DIGEST OF RECENT RADIO PATENTS



Prepared by White, Prost & Evans, Patent Attorneys, San Francisco, who have been particularly active in the radio field for many years, and from whom may be obtained further information regarding any of the patents listed below.

L. Espenschied, Pat. No. 1,438,988: December 19, 1922. High Frequency Translating Circuits.

A scheme to prevent interference between a source of high frequency current, such as *G*, and a source of modulating current, such as produced by the telephone *T*, is described. The two currents are caused to affect a common magnetic core *M*, so that their effects may be added and transmitted by the aid of winding *4* to the antenna. A low frequency filter *F*<sub>1</sub> in the modulating circuit and a high frequency filter *F*<sub>2</sub> in the high frequency circuit prevent cross currents, and in this way there is no waste of energy. A direct current winding *3* is also utilized on the core *M* to bring it up to the proper saturation point, the filter *F*<sub>3</sub> being arranged to prevent flow of current induced by either the high or the low frequency circuit.

L. Espenschied, Pat. No. 1,438,989: December 19, 1922. High Frequency Translating Circuits.

A scheme for modulating the output current of a pair of arcs *A*<sub>1</sub>, *A*<sub>2</sub>, is described. The two arc circuits are in parallel, and each path includes one of the coils of transformer *T*<sub>1</sub>; these coils *1* and *2* are so arranged as to neutralize each other while no signals are transmitted by the telephone transmitter *T*. There-

fore the antenna circuit is also inactive. However, signals from the transmitter *T* destroy the balance between coils *1* and *2*, due to the connection of this transmitter circuit to both arc branches, and antenna coil *3* is accordingly energized. The frequency filter *F*<sub>1</sub> is arranged to transmit only low frequency alternating current, and thus the radio-frequency oscillations of the arcs do not interfere with the transmitter *T*. Likewise the filter *F*<sub>2</sub> can transmit only below and above the range of *F*<sub>1</sub>, and thus there can be no interference between the direct current source *B* and the transmitter *T*, nor is the transmitter circuit short-circuited through the right-hand connection between the arc circuit branches.

H. J. Hammond, Jr., Pat. No. 1,439,363: December 19, 1922. Receiving System for Radiant Energy.

This invention relates to the radio control of a vessel capable of submerging either partially or entirely, but in which an antenna *13* is arranged to extend out of the water. Upon the occurrence of a wave large enough to submerge an antenna support *12* for an appreciable interval, the signal received by the circuit *17* and transmitted to the control circuit *21* may be improperly broken in two, and the wrong kind of steering impulse may result.

The object of the invention is to prevent this by causing a holding circuit *51-32-50* to be closed, for the control relay *23* every time a wave washes over the insulated parts *33* and *36*.

H. M. Williamson, Pat. No. 1,439,495: December 19, 1922. Radio Receiving Apparatus.

In order to eliminate static as well as to prevent undesirable oscillations in detector and amplifier tube circuits, condensers such as *17*, *22* and *24* are placed in shunt across the transformer coils *13*, *18*, which serve to couple the detector circuit and amplifier circuits together. In addition resistances *23*, *25* may be employed. It is stated that high frequency currents such as caused by static or by an oscillatory tube, by this means do not pass into any of the grid-filament circuits, and that as many as 6 or 7 tubes have been employed which were stabilized in the manner described.

P. D. Lowell, Pat. No. 1,439,562: December 19, 1922. Amplifying System.

A scheme for quickly connecting and disconnecting amplifier transformers for use between thermionic tubes is described. To support the transformer, which is in a rectangular container *31*, as well to connect them

Continued on page 91

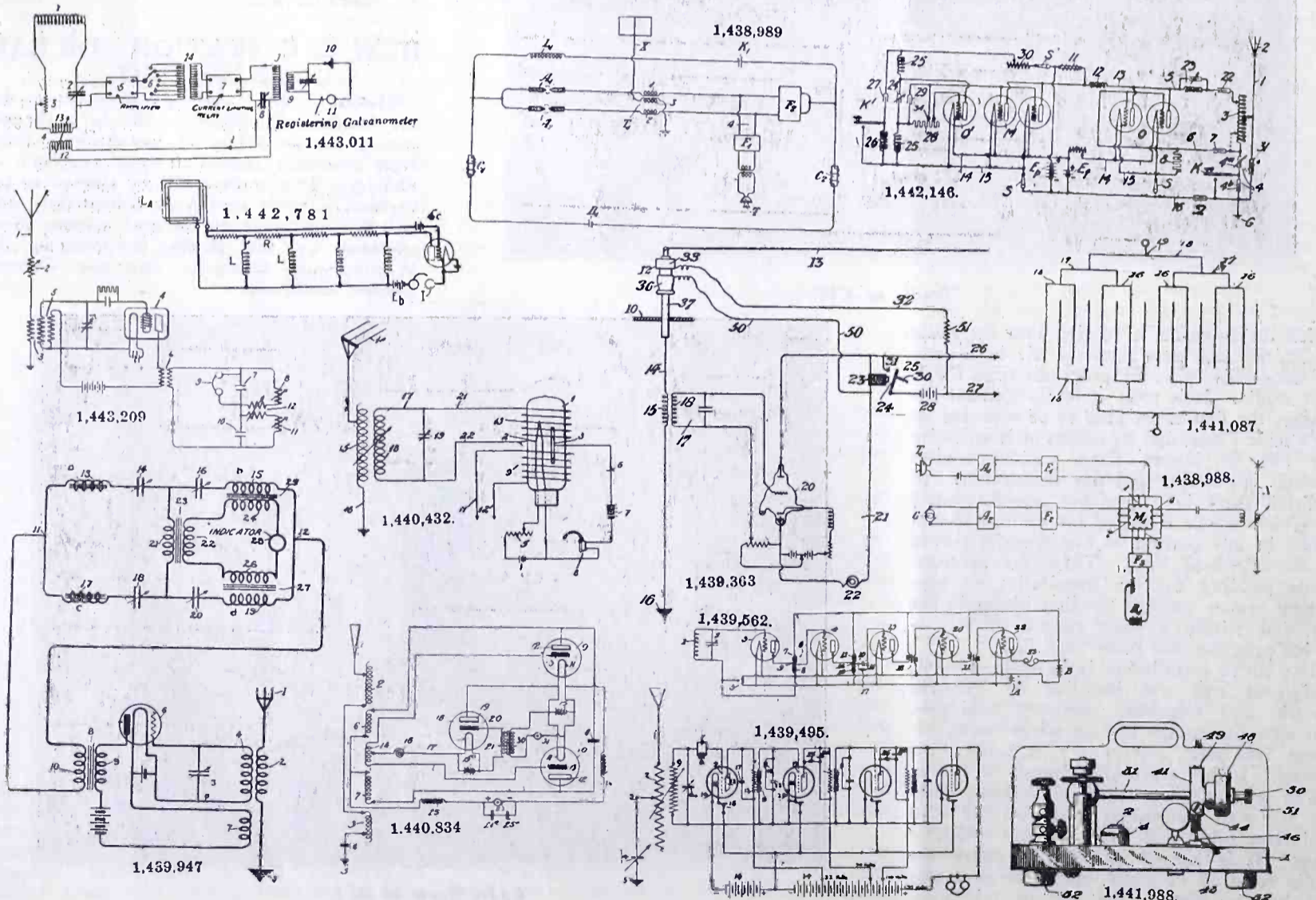



# QUERIES & REPLIES

## ON C.W. PRACTICE

BY  
**Gerald M. Best**  
TECHNICAL ADVISOR



Questions submitted for answer in this department should be typewritten or in ink, written on one side of the paper. All answers of general interest will be published. Readers are invited to use this service without charge, except that 25 cents per question should be forwarded when personal answer by mail is wanted.

Please publish a circuit for three stages of radio-frequency amplification, using tuned amplifiers instead of transformers.  
G. A. M., Barre, Vt.

This circuit is shown in Fig. 1. The plate inductances may be either tapped choke coils, or variometers. The advantage of the tapped coils is that they can usually be mounted on one shaft, necessitating only one dial for a three-stage amplifier, whereas the use of variometers will require three dials.

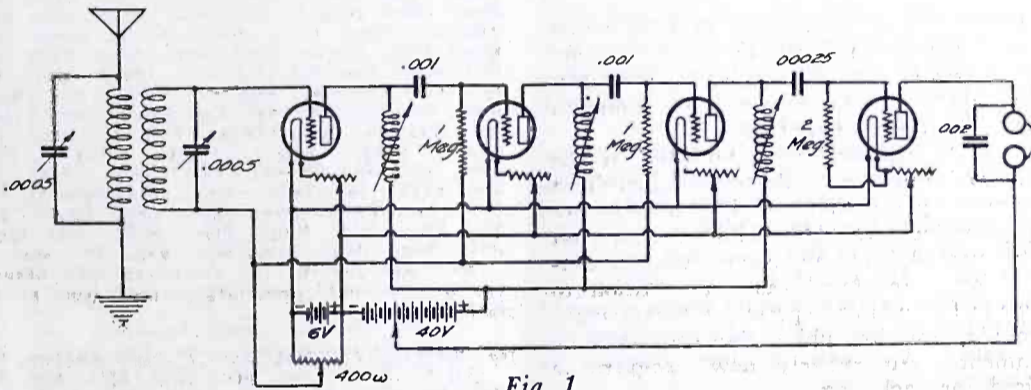

Fig. 1

Please show a circuit for three stages of radio-frequency, detector, and three stages of audio-frequency amplification, using Acme transformers.  
G. D. K., Seattle, Wash.

This circuit, in which transformers are employed in the radio-frequency stages, is shown in Fig. 2. The choke coil indicated in the plate circuit of the third audio-frequency stage should be of at least 25 henrys inductance, and a Wayne bell ringing transformer primary should answer the purpose very well. You will have to shield all your amplifiers very carefully in order to get any kind of results, especially the radio-frequency stages. Be sure to ground this shielding, as well as the negative of your "B" battery. It would be a good idea to place each tube in a separate metal compartment, which would, of course, form a part of the shield on the back of the panel.

Please show a three-circuit receiver using

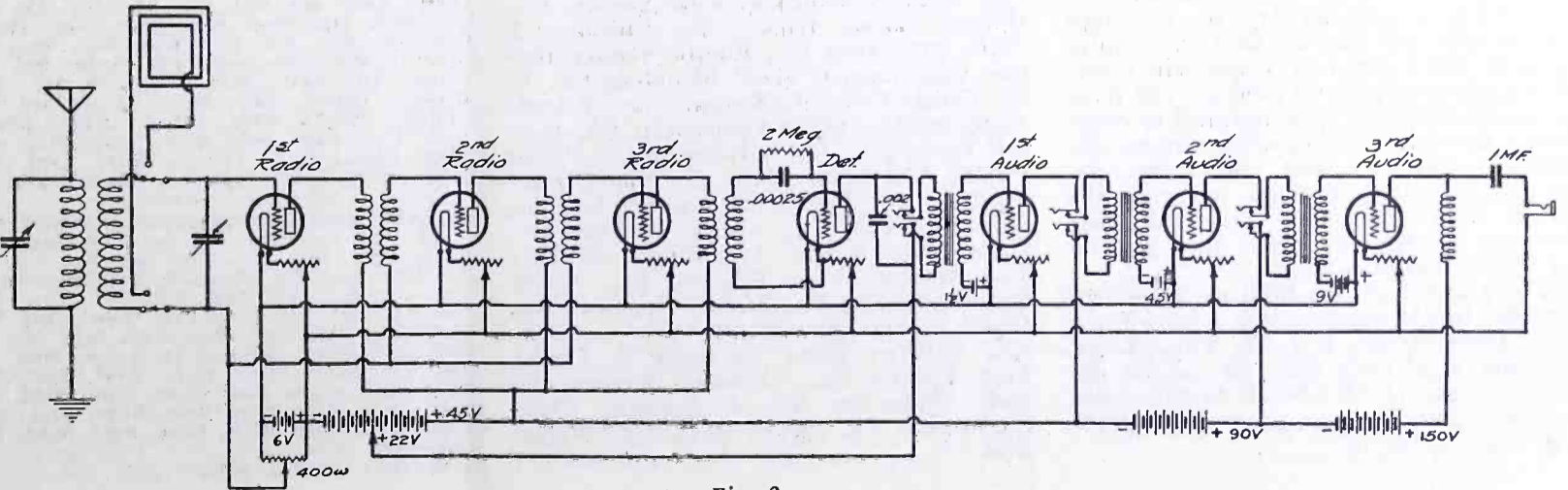

Fig. 2

three stages of radio- and audio-frequency amplification, to be used with a loop antenna.  
C. F. K., San Fernando, Calif.

A circuit of this type is shown in Fig. 2. The connections when using the loop are also shown.

I have a Fisher All-Wave variometer which I wish to use in a three-stage radio-frequency amplifier. Please publish a circuit using the variometer, so that I may use either loop or antenna.  
J. B., Newark, N. J.

variometer as the tuned circuit. The connections for the antenna or loop are shown as requested.

Does the WD-11 and the Welsh WT-501 tube use the same socket? Is a two-stage audio-frequency amplifier using either tube successful? Can you supply a diagram using honeycomb coils, detector and two-stage amplifier, with WD-11 tubes, with an anti-capacity switch to change over to a variometer set for short waves, the honeycomb coils being used for long wave work? Please show in the diagram an additional power amplifier, for loud speaker work.  
J. C., Washington, D. C.

The WD-11 and WT-501 tubes require different sockets. A two-stage audio-frequency amplifier using either tube would be very limited in output, and while such an amplifier would operate a pair of head telephones satisfactorily, enough power could not be generated to give much volume for loud speaker work. The circuit you request is shown in Fig. 4.

Please correct the circuit of my C. W. transmitter so that it will operate efficiently. When I connect two 5-watt tubes in parallel I do not get more than one-tenth additional radiation. Should I not get more than this? Are cage antennae more efficient than other types? If so, what length should the wires be?  
V. J. M., San Francisco, Calif.

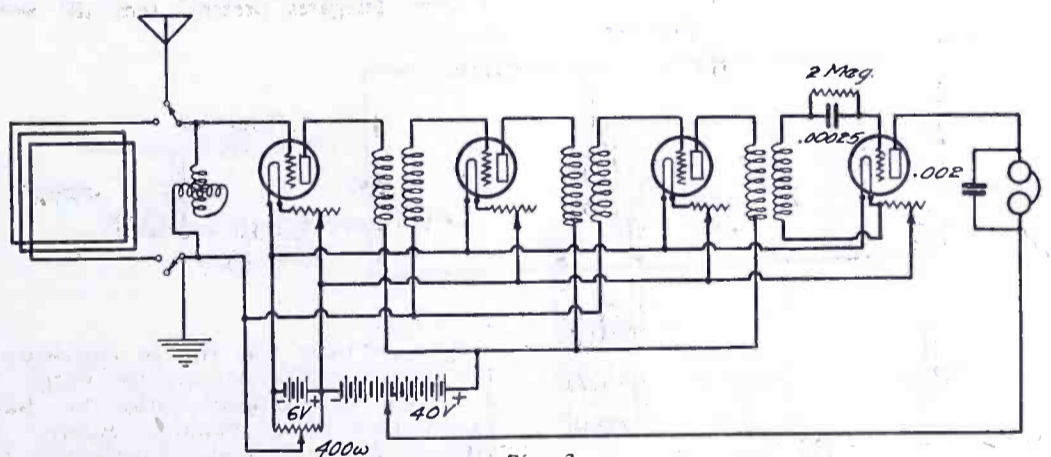

Fig. 3

A correct diagram of your circuit is shown in Fig. 5. You could not tune the grid circuit, the way you originally had it connected. Either the tube you add to your present set is defective or you do not re-tune, for with two five-watt tubes, as you should get at least 25 per cent additional radiation. It is usually necessary to re-tune when you change the number of tubes in the circuit. The merits of cage antennae over the other types is a long-winded argument, and I can say that both flat top and cage types have their

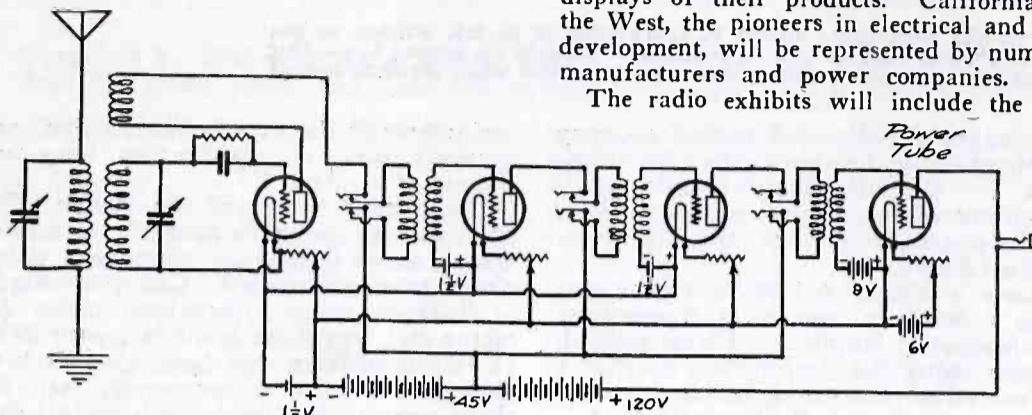

Fig. 4

### RADIO SHOW AT SAN FRANCISCO IN APRIL

A complete Radio and Electrical show will open to the public Tuesday morning, April 3rd, and will continue daily up to and including Sunday, April 8th. The entire Civic Auditorium, San Francisco, has been leased and arrangements for special display booth construction and decorations are well under way.

Radio and electrical manufacturers from all parts of the country are arranging for displays of their products. California and the West, the pioneers in electrical and radio development, will be represented by numerous manufacturers and power companies. The radio exhibits will include the latest

merits. It depends on how much room you have, the height of your masts, and the wavelength you wish to transmit. Ordinarily, for 200 meters, the total overall length of your antenna, lead-in and ground wire should not exceed 125 ft. or you will require a series condenser, with correspondingly decreased radiation.

My 80-ampere hour 6-volt storage battery says on the nameplate that the gravity when fully charged should be 1280. When I charge it over night, the gravity rises to 1300. Is this harmful to the battery?

N. K. J., Grand Junction, Colo.

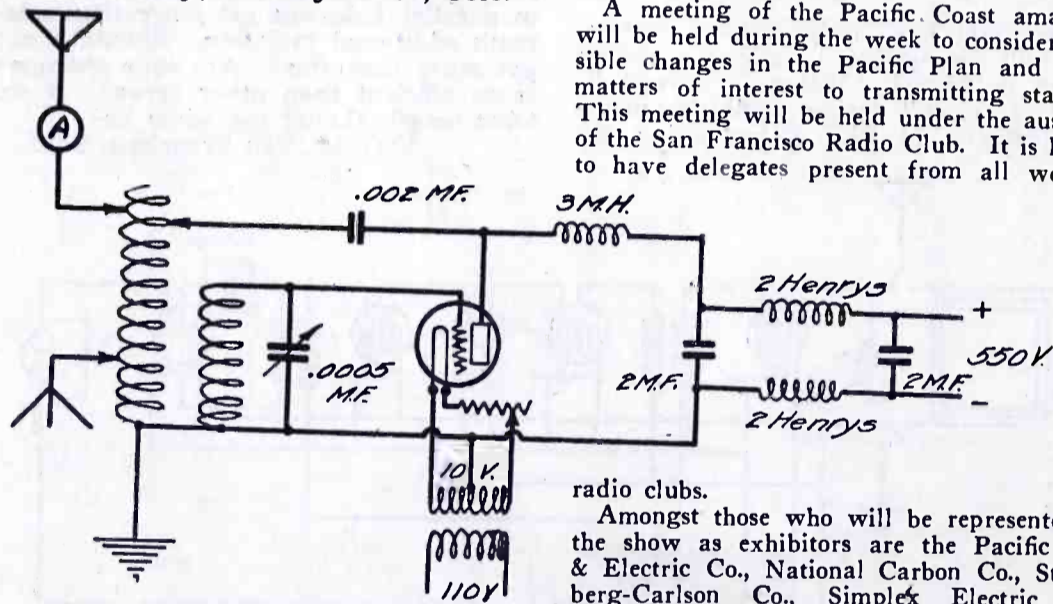

Fig. 5

Without doubt you have a new battery. As a rule, a new battery of the high gravity type will rise to 1300 when fully charged, but a few weeks' use will lower this maximum figure to 1280, so you have no cause to worry. It is harmful to overcharge the battery, however, for an extended period, so you had better determine how long it takes to bring the gravity from the point when you start charging, to 1280, in order that you do not overcharge too long.

Where can I obtain high grade silicon steel for use in constructing a core for a C. W. transformer. L. L. R., Tulsa, Okla. Silicon steel core material can be obtained from U. S. Steel Corporation, Carnegie Steel Co., or other high grade steel manufacturers.

inventions and developments in both receiving and transmitting equipment and everything electrical will be displayed, from electrically heated curling irons to mammoth motors and power apparatus.

Mr. J. C. Johnson, local manager for the American Radio and Electrical Exposition Company, reports that display booths are being provided for 144 exhibitors and that to date over 80% of this space has been contracted for. He stated that in addition to the wonderful exhibits, special features would be provided for the public education and entertainment. An entirely new program is promised for each day.

A meeting of the Pacific Coast amateurs will be held during the week to consider possible changes in the Pacific Plan and other matters of interest to transmitting stations. This meeting will be held under the auspices of the San Francisco Radio Club. It is hoped to have delegates present from all western

radio clubs.

Amongst those who will be represented at the show as exhibitors are the Pacific Gas & Electric Co., National Carbon Co., Stromberg-Carlson Co., Simplex Electric Co., Atlantic & Pacific Radio Supply Co., Eismann Magneto Corporation, Mortimer Radio Co., Kellogg Switchboard & Supply Co., Willard Storage Battery Co., Kilbourne & Clark, Magnavox Co., Electric Storage Battery Co., National Metal Moulding Co., C. D. Tuska, Colin B. Kennedy Co., Electric Appliance Co., Globe Commercial Co., Garnett Young Co., Hart & Hegeman Co., Pacent Electric Co., Remler Mfg. Co., Signal Electric Mfg. Co., Bristol Co., Formica Ins. Co., Gillespie-Eden Co., Clapp-Eastham Co., United Mfg. & Dist. Co., Wilson McGuire Co., Aerovox Corp., Brandes, Inc., Pacific Radio Publishing Co., Electric Appliance Co., Gould Storage Battery Co., Geo. A. Gray Co., Gilfillan Bros., Kilbourne & Clarke, Levy Electric Co., Trumball Electric Co., Radio Industries, E. M. Sargent, Union Construction Co., Victory Radio Co., Warner Bros.

# CALLS HEARD



Readers are invited to send in lists of calls heard from stations distant 250 miles or more from their own station

By 6BNT, 225 Willard St., San Francisco  
 5xt, 5za, 5acf, 6ak, 6cc, 6ea, 6eb, 6ef, 6fh, 6gr, 6ka, (6ku), 6lu, 6oh, 6om, 6ol, 6kq, 6qm, 6nx, 6rm, 6rr, 6su, 6zb, 6zh, 6zo, 6zn, 6zt, 6zz, 6ak, 6aat, 6abx, 6ael, 6aib, 6akl, 6aol, 6apw, 6avr, 6avv, 6atj, (6anb), 6xad, 6xas, 6bej, 6bip, 6biq, 6bjy, 6bjq, (6bmn), 6bnv, 6boe, 6bqr, 6bqv, 6bqw, 6brs, 6brv, 6bua, (6bun), 6buw, 6bux, 6bvg, 6bwp, 7bj, 7bk, 7dp, 7hj, 7hm, 7ke, 7ln, 7lr, 7lu, 7na, 7nf, 7mc, 7pf, 7sc, 7tq, 7tn, 7vf, 7wx, 7wm, 7zn, 7zl, 7zu, 7af, 7agi, 7aic, 7oo, 9bx Can., 9pn, 9zt, 9bji, 9bri, 9bxm, 9bzi, 9ccv, 9cfy, 9cvc, 9dsm.

By 6KU, Manton, Calif.  
 C. W.: 5ax, 5ej, 5ct, 5ci, 5la, 5px, 5za, (6ak), 6aak, 6ajg fone, 6awd, 6ajn, 6abx, 6akd, 6arb, 6aah, (6aat), 6ajd, 6amu, 6arv, 6ajf, 6awx fone, (6bm fone C. W.), 6ble, 6bix, 6bjq, 6bce, (6bnt), 6bnu, 6brv, 6bcd, 6bur, 6beg, 6bar, 6bqk, 6bjq, 6bqw, (6brf fone), 6bab, 6bon fone, 6eu, 6cay, 6ea, 6eb, 6ek, 6ev, (6fy), (6if), 6jn, 6jx, 6lh, 6ro, 6su, 6th, 6ti, 6uw, 6vm, (6wh), 6wn, 6zb, 6zg, 6zh, 6zt, 6zz, 7aca, 7acm, (7aic), 7aii, (7aek), 7afo, (7ahc), 7dh, 7dp, 7hi, 7jw, (7ke), (7ks), (7mc), (7mf), (7ny), (7oh), 7om, 7pf, 7rm, (7ro), (7sc), 7so, (7tc), 7tq, 7up, (7ut), 7ve, 7wm, (7wx), (7zu fone C. W.), 8dp, 8fu, 9bxm, 9bcv, 9bx, (9bp Can.), 9bu, 9bx Can., 9bk, 9bpd, 9clw, 9cfk, 9cfy, 9exp, 9ldg, 9dgd, 9dsx, 9dvg, 9mp, 9xac, 9zt, 9zta.  
 6KU has just put in a new set and antenna system. I would appreciate a card from all DX stations East.

By 6BWE, 3081 West Pico St., Los Angeles, Cal.  
 All C. W.: 1bcg, 2ccd, 2fp, 3blf, 4bq, 4nt, 5di, 5ir, 5px, 5uj, 5un, 5aec, 5aar, 5adb, 5za, 5zak, 5zh, (6ak), (6gx), (6rm), (6tc), (6lv), (6cc), (6vm), (6abx), (6aol), (6ark), (6bcj), (6bju), (6avv), (6bqf), (6brv), (6zz), (6bds), (6zb), 6zac, 7ac, 7bi, 7hj, 7bk, 7ex, 7fd, 7fr, 7gh, 7kr, (7lr), 7mf, 7na, 7nf, 7ny, 7lu, 7om, 7ot, 7sc, 7sy, 7tq, 7ud, 7aae, 7adp, 7aea, 7aem, (7ln), 7to, 7afh, 7afw, 7zb, 7zl, 7zn, 7zo, 7zu, 8ib, 8sp, 8ue, 8cf, 8azd, 8bsg, 8yd, 8zy, (9bm), 9bp, 9fv, 9gk, 9kp, 9pi, 9ps, 9anq, 9aon, 9asf, 9awm, 9ayu, 9avz, (9bji), 9bjv, 9bxa, 9bxm, 9bxq, 9bzi, 9cfy, 9cjj, 9cns, 9dky, 9dsm, 9dtm, 9dun, 9dwk, 9ccv, 9dhi, 9dlm, 9xac, 9xaj, 9zn, 9zaf.  
 Canadian: 4bv, 5cn, 9ac, 9bx.

By 6EA, 343 South Fremont Ave., Los Angeles  
 C. W. only: (2fp), 4eb, Can. 4bv, (Can. 5cn), 5di, 5ds, 5ek, 5fv, (5kc), (5kp), 5ns, 5px, 5qi, 5ss, 5xb, 5za—voice, 5zb, 5abb, 5ado, 5aec, 5aib, 5xad, 5xaj, 5zak, (5zav), 6ak, (6bf), (6bu), (6cc), (6fh), (6ii), (6jn), 6km, 6lu, (6lv), 6nx—buzzer, 6re, 6rm, 6su, 6tc, (6ti), (6vm), 6xb—buzzer, voice and music, 6zb, 6ze, (6zh), 6zx, 6zz, (6aak), 6abx, 6ajf, (6ajr), 6akl, (6alv), 6alx, 6anh, 6aol, (6aor), 6aqq, 6arb, 6arf, 6ark, (6asj), 6avv, (6awt), 6bay, (6bbh), 6bel, (6bgd), 6hic, 6bju, 6bmd, 6bnv, (6boe), 6bow, 6bqb, (6bql), (6bsa—voice and buzzer), 6bua, (6buy), (6bzl), 6can, 6cao, 6cek, 6zac, 6zaf, (7ba), 7bj, 7ey, 7fd, (7gq), 7gs, (7jw), 7ln, 7lr, 7lw, 7mf, (7na), 7nf, 7om, (7ot), 7pf, 7qn, (7sc—buzzer), 7sy, (7th), 7wm, (7wx), 7zn, 7zo, 7zu, 7zv, (7abb), 7aem, (7aff), 7ake, 8er, 8ml, 8ue, 8vq, 8yd, 8zq, 8zw, 8aic, 8aio, 8ais, 8apw, 8axc, 8bch, 8cmi, (8cxw), Can. 9al, 9bp, 9ei, 9gk, 9hk, 9kp, 9mo, 9ps, 9qf, 9rc, 9uh, 9xv—voice and buzzer, 9yf, 9yw, (9zn), 9zt, 9aaf, 9ajh, 9alg, (9amb), 9aog, (9apw), (9atn), 9atu, 9avz, 9axu, 9bed, 9bji, (9bjk), (9bkk), 9bsg, (9bxa), 9bxc, (9bxm), 9bxt, 9byc, 9caa, 9cfy, 9cns, 9cpu, 9dge, 9dkq, 9dky, 9dlm, 9dqw, (9dsd), 9dtm, 9cea, 9ekh, 9daq, nof, ad7, dd5, kgg, klz, kzn and kfaf.

By 6ASN, 2043 Berryman Street, Berkeley, Calif.  
 4oi, 5go, 5kp, 5pa, 5qi, 5za, 5zk, 5aib, 5zae, 5zada, 7au, 7ak, 7bj, 7dl, 7gc, 7iy, 7lm, 7ln, 7lr, 7mc, 7mf, 7na, 7nf, 7qt, 7ri, 7rn, 7ro, 7sc, 7qs, 7tg, 7tq, 7tt, 7ve, 7vf, 7wi, 7wn, 7wm, 7ws, 7xf, 7zl, 7zm, 7zu, 7aat, 7abn, 7adf, 7adr, 7ael, 7afe, 7afs, 7agi, 7aic, 7aii, 7ajv, 8ib, 8qu, 8wr, 8xz, 8bkk, 8bkl, 8bjz, 8hpw, 8dto, 9gr, 9ik, 9ve, 9aey, 9ami, 9ams, 9akf, 9asn, 9avl, 9avz, 9ayu, 9aap, 9atn, 9han, 9hfz, 9bhd, 9bji, 9bri, 9buy, 9bzi, 9ccv, 9cds, 9cwr, 9cui, 9dkk, 9dkm, 9dgs, 9dsn, 9dsm, 9ehw, 9ekh, 9yak, 10ak.  
 Can.—5ct, 5ej.  
 Spark: 7kj, 7xj, 9bkj.

By 6EB, Lyndon F. Seefred, 343 So. Fremont Ave., Los Angeles, Calif.

C. W.: 1fd, 2fp, 5di, 5gr, 5ir, 5ke, 5kp, 5nk, 5ns, 5px, 5qi, 5nn, 5sk, 5ss, 5uo, 5xa, 5xb, 5xt, (5za), 5aar, 5abb, 5ado, 5aec, 5anx, 5xaj, 5xay, (5zak), (5zav), (6aa), (6bf), (6cc), (6cp), (6fh), 6fy, 6gf, 6gy, 6gx, (6iv), (6jn), 6lu, (6lv), 6nh, 6nx, 6oh, 6ok, 6qm, 6rd, 6re, 6rk, (6rm), 6tc, 6ti, 6vm, 6xh, 6zb, (6zh), 6zt, (6zx), (6zz), 6aa, 6aa, 6aa, 6abx, 6ajf, (6ajr), 6akl, 6alv, 6alx, 6anb, 6anh, 6aol, (6aor), 6arb, 6arf, (6asj), 6atu, 6auu, 6aul, (6aay), 6avv, 6avw, (6awt), 6bbh, 6bed, (6bcj), 6beh, 6bgd, 6bgh, 6bip, 6bjy, 6bki, 6bmd, 6bmh, 6bmy, 6bnu, 6bnz, 6bob, (6boe), 6bpi, (6bpl), 6bqb, 6bqf, 6bql, 6bru, 6bsa, 6bum, (6cae), 6cai, (6caj), 6can, 6cay, 6cbd, 6cbx, 6cej, (6cek), (6cfq), 6xax, 7ak, 7ba, 7bj, (7ey), 7ge, 7hj, 7ks, 7ln, 7lo, (7lr), 7lu, 7lw, 7mf, (7na), 7nf, 7nr, 7om, 7qr, 7qt, 7rn, 7sc, 7to, 7td, 7ud, (7vf), 7wm, (7wx), 7xc, 7yg—buzzer, 7zb, 7zo, 7zu, 7zv, (7abb), 7aem, 7afs, 7aic, 7ajq, 8cf, 8fu, 8hn, 8iv, 8nb, 8qv, 8wx, 8yu, 8yv, 8zw, (8zy), 8adz, 8alf, 8apw, 8asv, 8atc, 8azb, 8azq, 8bbt, 8bch, 8bda, 8bfq, 8bkb, 8bke, 8bsy, 8brl, 8bwa, 8bxx, 8cfh, 8cjh, 8erb, 8cyu, 8xak, 9bm, 9bp, 9bx, 9gk, 9gl, 9gs, 9kp, 9ps, 9px, 9sh, 9uu, 9wd, 9yf, 9yw, 9zn, 9abu, 9ahv, 9aiy, 9ajh, 9amb, 9anq, 9ans, 9aog, (9apw), 9aps, 9ath, 9aul, (9awm), 9aya, (9ayu), 9bji, 9bkk, 9bky, 9bsg, 9bt, 9bxa, 9bxm, 9bzz, 9car, 9ccv, (9cns), 9cpu, 9dge, 9dhi, 9dlm, 9dpc, 9dsd, 9dky, 9dsq, 9dta, (9eea), 9ekh, 9xaq, 9zaa, Can. 5cn, 9ac. Also agl, ad7, bq3. Would appreciate card from those 1000 miles or more away hearing 6EB.

By 9CIP, 480 Grand Ave., St. Paul, Minn. All C. W.: 1fd, 1pr, 1tj, 1ajp, 1aol, 1ary, 1awb, 1awp, 1bsz, 1cja, 1ckp, 1cnf, 2gk, 2hk, 2xz, 2zs, 2afp, 2aj, 2aqi, 2aqj, 2bea, 2bjo, 2blp, 2bpc, 2bas, 2bto, 2cdd, 2cfe, 2cjr, 2col, 2cpd, 2cqz, 2xao, 3ab, 3as, 3bj, 3bz, 3cc, 3cu, 3dh, 3fk, 3fo, 3fq, 3gk, 3hj, 3jl, 3rf, 3tj, 3vw, 3acy, 3adt, 3aex, 3anq, 3apr, 3aq, 3bdt, 3bec, 3bfu, 3bgi, 3hhl, 3bhm, 3bho, 3bit, 3biw, 3biy, (3blf), 3bof, 3bq, 3bt, 3buc, 3buw, 3bva, 3bvc, 3cdg, 3cdy, 3ckn, 4bx, 4cg, 4cl, 4do, 4ea, 4eu, 4ft, 4hw, 4kl, 4ya, 4zc, 5be, 5bj, 5bw, 5cy, 5da, 5dn, (5ek), 5en, 5gj, 5gr, 5ho, 5ik, 5ix, 5jl, 5js, 5my, 5nd, 5nv, 5nz, 5pv, 5qi, 5qm, (5rh), 5rn, 5sk, 5tp, 5uo, 5va, 5xk, 5xv, (5za), 5zx, 5aat, 5ado, (5aec), 5afz, 5agn, 5agy, 5az, 6ak, 6cc, 6ea, 6eb, 6fh, 6mk, 6rm, (6ti), 6tf, 6zo, 6zz, 6abx, 6ada, 6ahf, 6alv, 6apw, 6avn, 6avr, 6awt, 6bhq, 6bic, 6bqc, 6brf, 6bum, 6bv, 6cbi, 7hj, 7hm, 7ix, 7ln, 7lu, 7ud, 7zu, 7am, (7afw), 8wg, 8cp, 8nb, 8qk, 8sm, 8ue, 8uf, 8vl, 8wa, 8wo, (8yn), 8zw, 8aaf, 8adu, 8ago, 8agx, 8aim, 8az, 8ajn, 8aol, 8ape, 8atn, (8avt), 8axn, 8ben, 8bet, 8bgl, 8bgq, 8bjv, 8bmk, 8bsf, 8but, 8bxx, (8caa), 8ccb, 8cdd, 8cej, 8cih, 8cmi, 8cpb, 8zae, (9bp), (9ce), (9ar), (9av), (9bal), (9bri), (9bxy), (9ckw), (9dfb), (9dlm), 9dqu), (9dta).

By 6AKC, 1385 Clay St., San Francisco, Calif. Canadian 3sg, 3ko, 4dk, 4bv, 4cb, 5cn, 5ct, 5bq, 9ac, 9bd, 9bx, (qra?). U. S.: 5za, 5tj, 5zav, 5ul, 5ek, 5zak, 6's and 7's too numerous, 8zy, 8zx, 8yy, 8asv, 8azd, 8ib, 9amb, 9bz, 9dtm, 9awm, 9ax, 9apw, 9ami, 9bxa, 9bqx, 9wc, 9gk, 9vv, 9bii, 9bed, 9zaf, 9yaf, 9arz, 9cns, 9ccv, 9dky, 9bik, 9kp, 9bp, 9afn, 9asf, 9dp, 9dli, 9dcg, 9bjv, 9bey, 9bbf, 9ayu, 9baj, 9anq, 9um, 9aa, 9xaq, 9aou, 9bqw, 9aza, 9bch, 9ani, 9hk, 9zt, 9cfy, 9dio, 9aix, 9bvy. Will all stations please qsl, if they have not already done so!

By 7VE, H. J. Carey, 289 Ivy St., Portland, Ore. C. W.: 6ak, 6bm, 6cc, 6ea, 6fh, 6gr, 6gz, 6ik, 6ka, 6lv, 6nh, 6oh, (6rm), 6su, 6tc, 6vf, 6xk, 6zn, 6zq, 6zx, 6zo, 6zx, 6zz, 6abw, 6abx, 6alv, 6alx, 6anb, 6aor, 6arb, 6awt, 6bcj, 6bed, 6bic, 6bip, 6biq, 6bmn, 6bnu, 6bqc, 6brf, 6bum, 6bvw, 6cbi, 7ba, (7cd), 7lu, 7hj, (7hm), 7hj, 7mc, (7mf), 7ng, 7nf, 7om, 7ot, 7sc, (7tq), (7abb), 7adp, 7afm, 7afw, 7aif, 8bdv, 9bji, 9bm, 9bx, 9bxt. Spark: (6tu), (6akt), 6gf, 6aqu, 6aje, 6ark, 6ala, 6amk, 6awg. C. W.: Can.—(5go), 5cn, (5ct), 4bv.

By 6CBG, 719 1/2 N. Alameda St., Los Angeles. All C. W.: 2fp, 5di, 5fo, 5gr, 5kp, 5la, 5px, 5sk, 5tj, 5za, 5aar, 5adb, 5ado, 5and, 5anx, 5xaj, 5zak, 5zav, 6ak, 6bo, 6cc, 6gx, (6fh), 6jn, 6re, 6rm, 6ti, 6zi, 6zt, 6zz, 6abx, (6ajf), 6bu, 6alv, 6arb, 6arf, 6awt, 6bgm, 6bhq, 6biq, 6bip, 6boe, (6bpi), 6caj, 6zo, 7gs, 7kr, 7ln, (7lr), 7mf, 7na, 7nf, 7sc, 7zn, 7zu, 7zv, 8er, 8bk, 8ib, 8yx, 8zw, 8bwa, 8cmi, 9bm, 9bp, 9bx, 9cp, 9gf, 9kp, 9pi, 9ps, 9uh, 9wd, 9yw, 9zt, 9aey, 9alg, 9amb, 9anq, 9ans, 9asf, 9avc, 9bch, 9bhd, 9bik, 9bji, 9bkk, 9bkm, 9bxa, 9bxq, 9bxm, 9bzi, 9dhi, 9dky, 9dsd, 9dte, 9dtm, 9cdr, 9cfy, 9cns, 9cvg, 9xaq. Will appreciate a cord from all those hearing my C. W.

By Richard R. Martindale, 1219 W. 24th St., Los Angeles, Calif. C. W.: 1bka, 1gv, 3auw, 3ot, 3pz, 4bk, 4eh, 4kc, 4ki, 4oi, 5aah, 5ado, 5be, 5bw, 5cy, 5di, 5ek, 5hh, 5kc, 5ke, 5ov, 5pb, 5po, 5rh, 5xa, 5xad, 5xaj, 5xb, 5xd, 5xk, 5za, 5zad, 5zak, 5zas, 5zav, 5zak, 5zb, 6's too numerous, 7ak, 7gc, 7ge, 7hm, 7ln, 7mf, 7ny, 7zn, 7zu, 8adz, 8alt, 8anb, 8asv, 8azd, 8bda, 8bdo, 8bog, 8boz, 8brd, 8bsu, 8bxf, 8bxx, 8cae, 8cdd, 8cej, 8cia, 8ij, 8kj, 8pv, 8qk, 8vy, 8xan, 8yn, 9aap, 9aey,

9ahh, 9ami, 9anq, 9aod, 9arz, 9avc, 9ayu, 9bak, 9bed, 9bik, 9bji, 9bjn, 9bjv, 9bkj, 9bly, 9brk, 9brs, 9btt, 9bvy, 9bxh, 9bxm, 9bxt, 9bzz, 9caa, 9cba, 9ccm, 9cdr, 9ceh, 9chk, 9cjj, 9cng, 9cte, 9ctv, 9cvg, 9dca, 9ddy, 9dgg, 9dlb, 9dio, 9dkb, 9dkq, 9dky, 9dte, 9dti, 9dvw, 9dts, 9dxc, 9ei, 9ep, 9iy, 9ox, 9pi, 9ps, 9ql, 9rc, 9uh, 9uk, 9ve, 9vk, 9wa, 9xaq, 9xm, 9yf, 9yw, 9zl, 9zt, 9zy. Spark: 7abh. Phone: 5ado, 5xad, 5xaj, 5zak, 9xm, 9yf. Can.: 3xn, 4co, 4dk, 4hh, 5cn, 9bx.

By 5SF, 1616 Worth St., Ft. Worth, Texas. C. W.: 1cbj, 1gv, (2ajf), 2ccd, 2mx, 3bg, 3blf, 3bvl, 3hg, (3su), (4bg), 4bi, 4by, 4eb, 4eh, 4el, 4hw, 4iz, 4km, (4lj), 4sc, 4oi, 5's too numerous, 6ajd, 6ajf, 6anh, (6arb), (6bh), 6bu, 6bbc, 6bnh, (6bun), 6jd, 6ka, 6rm, 6zb, (6zh), 6zn, 6zo, 6zz, 6xb, 7zu, 8's and 9's too numerous. All stations over 1000 miles.

By 6ASL, Lyle Anderson, 1816 Broderick St., Apt. 11, San Francisco, Calif. C. W.: 3xn, 4yd, qra?, 5ga, 5ado, 5aib, qra?, 6bu, 6ka, 6ajd, 6akl, 6anb, 6aol, 6apw, 6aqp, 6aqq, 6asx, 6avv, 6awq, 6awx, 6bcl, 6bip, 6bjh, 6bji, 6bjq, 6bjv, 6bfl, 6bnv, 6boe, 6bpb, 6bua, 6bur, 6buy—voice, 6bv, 6bqd, 6bqg, 6bqq, 6bsj, 6bwg, 6cec, 6cee, 6cej, 6cet—voice, 6ege, 6xas, 6zt, 6zz, 7na, 7nf, 7pf, 7wm, 7ya, 7zi, 7zu, 8zo, 8cyu, 9fm, 9ajh, 9awm, 9bpm, 9bxm, 9cap, 9cwn, 9zn. Spark: 6apl, 6bos.

By 9ZT, D. C. Wallace, 54 Penn. Ave. N., Minneapolis, Minn. (All districts worked.) C. W.: 1fd, (1qp), 1xm, 1xu, 1asf, 1bas, 1bes, (1bka), (1bkq), 1boq, (1ckp), (2fp), 2kf, (2xq), 2afz, 2agv, 2ajf, 2bmr, 3bv, 3fo, (3oe), 3ot, 3su, (3xm), 3vo, 3zo, (3ava), 3bij, 3bof, 4bi, 4cg, 4co, 4el, (4gg), 4gz, (4hw), 4kl, 4km, 4ya, (5be), 5cy, 5di, (5ee), (5ek), 5fv, 5gj, 5gr, 5jb, 5ml, 5nn, (5ns), 5nz, (5pd), (5px), 5qi, 5qm, 5rz, (5sf), 5sm, 5ta, 5tc, 5tj, (5uk), (5us), (5we), 5xa, (5xb), (5xt), 5xv, 5za, 5zb, (5aah), (5aam), 5ade, (5aec), 5aib, 5ant, (5xad), (5xaj), 5xav, (5zak), 5zat, 5zaw, (5zax), (5zaz), 6fh, 6jt, 6qn, (6zz), (6abx), 6anh, (6apw), 6boe, (6xad), (7lu), 7qm, (7sc), 7afw, (8aa), (8cf), (8cp), (8cy), (8ek), (8ij), (8jj), (8oi), (8rj), (8wx), (8yd), (8yu), (8adg), (8adt), (8aim), (8alc), (8apw), (8awp), (8azg), (8bdo), (8brd), (8bwa), (8cb), (8ced), (8cgb), (8crb), (8ctn), (8cwp), (8dal). Can.: (3ad), (3co), 3de, 3ji, (3ta), (4hh), (9al), 9bx. Army: (brl), (one), (kfdf).

By A. E. Meditz, 623 Sandusky Ave., Kansas City, Kansas (1 tube). 1gv, 2fp, 2bve, 3ab, 3gk, (3hj), 3ko, 3pz, 3sv, 3tj, 3aao, 3aln, 3aqr, 3aro, 3xt, 3yv, 3zh, 4bq, 4bv, 4cg, 4dn, 4eh, 4ya, 5at, 5ci, 5di, 5ek, 5gr, 5ix, 5ke, 5kv, 5lj, (5nk), 5ns, 5ok, 5pv, 5px, 5qi, 5rh, (5sf), 5tj, 5vj, 5us, (5aby), 5ace, 5ado, (5aec), 5ams, (5xb), (5xv), 5xy, 5xaj, 5za, 5zb, 5zav, 5zas, 6bip, 6caj, qra?, 6xad, 6zz, 7zo, 7zu, 8ef, 8cp, 8dv, 8fu, 8hn, 8ii, 8iq, (8jj), 8kg, 8kp, 8ls, (8lt), 8ml, 8qk, 8sm, 8qv, 8vy, 8aaf, 8aco, (8adg), 8adk, 8adz, 8aea, 8aer, 8afg, 8aih, 8aim, 8alf, 8aql, (8asc), 8azg, 8azq, 8bda, 8ben, 8bgl, 8bke, 8bog, 8brd, 8bye, (8byo), (8cab), 8cae, 8cdd, (8cgl), 8cho, 8ciz, 8cqh, 8dak, 8dat, 8yd, 8yn, 8zd, 8zo, 8zw, 8zy, 9cr, 9ei, 9hk, 9mc, 9pf, (9qf), 9qr, 9uc, 9uh, 9vm, (9ace), (9adf), 9aep, 9aky, 9ami, 9apm, 9atw, (9ava), 9aus, 9avp, (9aws), (9axa), 9azn, 9azq, (9zac), (9beg), 9bhd, 9bhi, 9bhz, (9bjv), 9bqw, 9bri, (9brk), 9bz, 9hta, (9btt), (9bxj), (9bxl), (9bxm), (9byz), 9cha, 9cvt, (9ccm), (9cfk), (9cfy), (9clq), 9cx, 9dga, (9dio), (9dma), (9dqu), 9dri, (9dtj), 9dtm, 9dvl, 9dvw, (9dxc), (9eeb), 9eey, 9yb, (9yu), (9zy). Can.: 3bp, 3dh, 3jl, 4bv, (4cn).

By 4EB, Palmetto, Ga. (All districts worked.) 1fd, 1gv, 1ii, (1mc), 1mv, (1qp), 1adl, 1ank, 1anm, 1anr, (1ary), 1aws, (1bas), (1bes), 1bet, 1bkq, (1bqd), (1bsd), (1bsz), 1byn, 1cja, 1cmk, 1cnf, 2da, 2fp, (2kl), 2mx, 2ry, (2zs), 2fc, 2af, 2afp, 2anm, 2ayv, (2bay), 2bgi, (2bii), 2bms, 2brc, 2bse, 2bue, 2buy, 2bzq, (2ccd), 2cgt, 2ckk, 2cor, (2cqi), 2caz, 2cui, 2civ, 3bz, (3fk), 3jg, 3jt, 3mo, 3rf, 3sm, 3su, 3adt, 3agj, 3akr, (3atg), (3bfu), 3biy, 3blf, (3bre), (3bt), (3buc), 3blz, (3can), (3cel), 4oi, 5bw, 5cm, 5dq, 5es, 5fv, (5gp), (5hl), (5ho), (5ix), 5ml, 5mo, (5ns), 5nv, (5pb), (5qi), (5rn), 5us, 5vy, 5xa, 5xk, 5xv, (5aag), 5aby, 5aec, (5agj), (5ahc), 5xak, 5zas, 6abx, 6bic, 6ea, (6xad), 6fh, 6xk, 6zh, 6zi, 6zz, (7na), 7nf, (7sc), 7zu, 8fm, (8kc), (8on), 8ak, (8rj), 8rw, (8aaf), 8abe, (8agc), 8ago, 8aim, 8alf, 8asv, 8atc, (8aue), 8avd, (8ben), 8beo, 8bnh, 8bog, (8bqc), (8brm), 8bsf, 8bzd, (8ccu), 8cie, (8ciz), 8clw, 8cnw, 8coa, (8cok), 8cpd, 8cqh, (8cvm), (8cwp), (8dae), (8dat), (8zae), 9be, (9bx), (9ep), 9fm, 9pf, (9qf), 9uc, 9uk, 9zn, (9zy), 9afd, (9ahm), 9aod, (9aog), 9aps, 9apw, 9aqp, (9asf), 9aza, 9bhi, 9bij, 9bin, 9bji, (9bjv), (9bkk), (9blg), (9bop), 9boz, 9bns, 9bpw, 9bre, 9brs, 9bta, (9bwr), (9bxc), 9bxt, 9bzi, (9cbs), 9ccs, 9ccv, 9ccy, (9ceh), 9cfk, (9cfz), 9cek, (9cyy), 9cvd, 9cxh, 9dgv, 9dio, 9dim, 9dlf, (9dmj), 9dpl, 9dqw, 9dri, (9dsq), 9dsl, (9dtj), 9dtu, 9dvw, (9dws), 9dxe. Can.—2af, 2at, 2fu, 3gk, (3ji), (4bv), 4co, 5cn.

By 6BQL, 575 21st Ave., San Francisco, Calif. Can.—4bv, 4hh, 5ac, 5cn, 5go, 9bp, 9bx. U. S.—4ya, 5ct, 5di, 5ej, 5ek, 5kp, 5px, 5qi, 5ad, 5aqi, 5za, 5zak, 5zas, 6bh, 6cu, 6ea, 6eb, 6ef, 6ek, 6en, 6ft, 6ka, 6ku, 6lu, 6om, 6ol, 6pi, 6re, 6rm, 6rr, 6za, 6zb, 6zh, 6zm, 6zn, (6zo), 6zr, 6zt, 6zz, 6xk, (6aag), 6aak, 6aks, 6amn, (6anb), 6anh, 6aol, (6apw), 6aqq, 6avr, 6avv, 6beh, 6bet, 6bgh, 6bgy, 6bih, 6bji, 6bjt, 6bvv, 6bvy, 6bki, (6bmd), 6bmn, 6bnh, (6bob), 6bod, 6boe, 6bow, 6bqc, 6bqd, 6bqe, 6bqg, 6bqw, 6brg, 6brs, 6bru, 6bum, 6bun, 6buw, 6bvf, 6bvg, 6bv, 6zaa, 6xad, 6xah, 6xas, 6xax, 6caj, 6cbi, 6cbg, 6cek, 7ba, (7bj), 7bk, 7dp, 7ey, 7fd, 7ke, 7ks, 7ln, 7lr, 7lu, 7lv, (7mc), 7mf, (7na), 7nf, 7nn, 7nv, 7om, 7ot, 7pb, 7pf, 7qt, (7sc), 7tg, 7th, 7tq, 7tt, 7vf, 7wk, 7wm, 7xq, 7xu, 7zb, 7zl, 7zn, 7zv, 7abb, 7adf, (7adg), 7adm, 7afs, 7afw, 7aif, 7ajq, (7aex), 8bk, 8cd, 8cf, 8er, 8vq, 8yd, 8yn, 8yv, 8zo, 8zw, 8zy, 8apw, 8azd, 8bch, 8boz, 8bkk, 8brc, 8bwa, 8bxx, 8byo, 8cfk, 8crb, 9kp, 9dx, 9ps, 9uh, 9yu, 9yw, 9zn, 9zt, 9aah, 9abv, 9aey, 9afk, 9apw, 9avz, 9aws, 9bbf, 9bcf, 9bed, 9bik, 9bji, 9bzs, 9bvr, 9bvx, 9bxm, 9bzi, 9ccv, 9cfy, 9cij, 9cns, 9cpv, 9ctu, 9cvo, 9cwr, 9dfl, 9dkq, 9dlm, 9dsl, 9dsm, 9dtm, 9dvw, 9ekh, 9xac, 9xaq.

By F. M. Rives, La Puelle Place, Austin, Texas. 1bes, 1cnf, 1cwm, 2fp, 2zs, 3bgj, 3blf, 3km, 3yo, 3zo, 4bb, 4bi, 4bk, 4db, 4cg, 4do, 4eb, 4eh, 4fg, 4gl, 4hh, 4hw, 4kc, 4oi, 4ya, 4zc, 5aah, 5aam, 5aar, 5aat, 5aba, 5aby, 5adb, 5ado, 5ado, 5aem, 5aec, 5aef, 5ag, 5ahq, 5be, 5bw, 5ci, 5di, 5ek, 5fa, 5fc, 5fv, 5gr, 5ho, 5hz, 5im, 5iq, 5ix, 5jc, 5jl, 5js, 5ke, 5kn, 5mb, 5mo, 5nn, 5nv, 5ov, 5pb, 5po, 5qi, 5qm, 5ra, 5rh, 5sf, 5sg, 5tc, 5tj, 5tp, 5uk, 5vy, 5xad, 5xaj, 5one, 5sd, 5xv, 5xt, 5zas, 5za, 5zat, 5zac, 5zad, 5zb, 5zd, 5zm, 5zt, 6av, 6apv, 6avt, 6hgs, 6bh, 6bic, 6boe, 6bqg, 6brf, 6brs, 6bvg, 6bvw, 6cc, 6cbl, 6ceb, 6om, 6rm, 6xad, 6zav, 6zbn, 6zr, 6zt, 6zz, 7bj, 7lr, 7zu, 7uf, 7zv, 8adt, 8aim, 8alt, 8ann, 8apw, 8atx, 8avt, 8azd, 8azg, 8azq, 8bda, 8bdb, 8bdo, 8ben, 8bgi, 8bku, 8bjc, 8bma, 8bog, 8brc, 8bxh, 8bxx, 8byo, 8byt, 8cf, 8bmv, 8bog, 8brc, 8bxh, 8cax, 8cxw, 8cyu, 8civ, 8ckv, 8cld, 8clk, 8cqc, 8cvm, 8cxw, 8cyu, 8dag, 8er, 8fq, 8hn, 8jj, 8kq, 8uc, 8vq, 8vy, 8xan, 8yd, 8yv, 8zd, 8zo, 8zq, 9abv, 9adf, 9afk, 9afn, 9aif, 9ajh, 9ami, 9anq, 9aod, 9aog, 9apw, 9arz, 9asf, 9atn, 9aus, 9avc, 9avz, 9aza, 9azh, 9bce, 9bce, 9bdr, 9bed, 9beg, 9bhd, 9bhi, 9bie, 9bj, 9bjm, 9bki, 9bkk, 9bm, 9boz, 9bqw, 9brk, 9brs, 9bsq, 9bsz, 9bta, 9bt, 9btt, 9buh, 9bvw, 9bwn, 9bx, 9bxc, 9bxl, 9bxm, 9bxt, 9bzz, 9bzi, 9caa, 9cac, 9cao, 9eba, 9eby, 9eck, 9ecs, 9ccv, 9cdu, 9ceh, 9cfk, 9cgd, 9cie, 9ckm, 9cng, 9cns, 9cpb, 9cr, 9ctg, 9ctv, 9cvc, 9cwg, 9cwr, 9exp, 9der, 9ddw, 9ddy, 9dge, 9dgg, 9dhh, 9dhi, 9dio, 9dis, 9djb, 9dkq, 9dlm, 9dpc, 9dqu, 9dri, 9dsd, 9dsl, 9dsm, 9dts, 9dvw, 9dxc, 9dxe, 9dxn, 9dxy, 9ebt, 9eey, 9ehh, 9ei, 9ekf, 9fm, 9gh, 9ig, 9kp, 9mc, 9ox, 9pe, 9qr, 9rc, 9rr, 9uk, 9uu, 9ur, 9vm, 9ve, 9xac, 9yw, 9yg, 9zl, 9zn, 9zt, 9zy. Canadian stations—3bv, 3dh, 9bx.

By 6AVR, Fullerton, Calif. C. W.: 3qo, 3aqr, 3hlf, 3yo, 4by, 4eb, 4el, 4fv, 4km, 4ya, 5ac, 5de, 5ek, 5jl, 5ml, 5ns, 5adb, 5aec, 5xb, 5xd, 5xaj, 5za, 5zb, 5zak, 5zas, 7bj, 7dp, 7du, 7ey, 7ln, 7mc, 7mf, (7na), 7ne, 7nf, 7nn, (7om), 7sc, (7sy), 7tq, 7jj, 7vf, 7wk, 7ab, 7aif, 7aem, 7ahi, (7ajq), 7ya, (7zn), 7zs, 7zt, 7zu, 8bk, 8bo, 8ib, 8kg, 8sp, 8adz, 8asc, 8apw, 8asv, 8awz, 8boz, 8bp, 8bsf, 8bsy, 8cdd, 8cex, 8cpd, 8xae, 9hp, 9iy, 9kp, 9ox, 9pn, 9uu, 9vk, 9aap, 9aey, 9aix, 9aiz, 9amb, 9ami, 9aps, 9arz, 9asf, 9awm, 9aza, 9bhf, 9bed, 9bfy, 9bji, 9bly, 9brd, 9bri, 9btt, (9bxa), 9bxm, 9bzi, (9caa), 9cba, 9cvg, 9cwr, 9dca, 9dio, 9dhh, 9dhi, 9dky, 9dlm, 9dpc, 9dts, 9xaq, 9yf, 9yaf, 9zt, 9zav. Can. C. W.: 4hh, 5cn, 9bd, 9bx, qra?. Spark: 5zh, 7ws, 7abh. Anyone hearing my C. W. pse qsl to 6AVR, Fullerton, R. F. D. No. 3, Bx. 104A.

By 5AIF, 1713 Homan Ave., Ft. Worth, Texas. Spark: 5jd, 5ji, 5jm, 5sm, 5to, 5tu, 5ud, 5uk, 5xa, 5yu, 5aej, 9jn, 9jx, 9aaw, 9ahq, 9aol, 9ayw. C. W.: 4cg, 4eb, 4el, 4hw, 4kc, 4km, 5's too numerous, 6eb, 6ka, 6zz, 8fu, 8jj, 8sl, 8sm, 8zy, 8ag, 8aah, 8aav, 8aea, 8aih, 8ajx, 8apv, 8asc, 8brd, 8bxx, 8byo, 8cab, 8cei, 8cgl, 8cwp, 9ei, 9ep, 9fm, 9ig, 9iz, 9mc, 9of, 9ox, 9ps, 9rc, 9uc, 9yf, 9yu, 9zm, 9zt, 9zy, 9aan, 9abv, 9aep, 9afk, 9ahh, 9ahq, 9ajh, 9ami, 9ano, 9aol, 9ase, 9ate, 9aws, 9ayl, 9bcf, 9bji, 9bji, 9bkk, 9bxx, 9bop, 9boz, 9bri, 9bst, 9btt, 9buh, 9buo, 9bxc, 9bxd, 9bzi, 9cac, 9cde, 9ceb, 9cfk, 9cho, 9cin, 9cit, 9cic, 9ckk, 9clw, 9cvo, 9cxp, 9daa, 9dga, 9dio, 9dky, 9dmj, 9dpc, 9dqu, 9dta, 9dze, 9eey, 9efc. Fone: 5ci, 5kc, 5lf, 5lj, 5xt, 5aby, 5aej, 5xaj, 9dhh, 9yf.

By 6UW, L. Farwell, Los Gatos, Calif. 1xm, 2cbw, 3bwa, 4cg, 4oi, 5px, 5xa, 5za, 6xad, 7aw, 7er, 7jm, (7mc), 7mf, 7na, 7nf, 7pf, (7sy), (7th), (7tq), (7aea), 7adm, 7aif, 8ab, 8fu, 8jj, 8lh, 8kq, 8vy, 8wk, 8yd, 8afd, 8ajx, 8alt, 8asc, 8asv, 8bda, 8bnj, 8bsy, 8bwk, 8bxa, 8bxb, 8chu, 9cr, 9of, 9apw, 9aey, 9bcf, 9bji, 9bkk, 9bri, 9bvt, 9bvx, 9bxt, 9ctg, 9dah, 9dfb, 9dky, 9dlm. Can.—3bp, (5cn), (5ct), 5go. Continued on page 44

# NEW APPARATUS & SUPPLIES FROM THE RADIO MANUFACTURERS

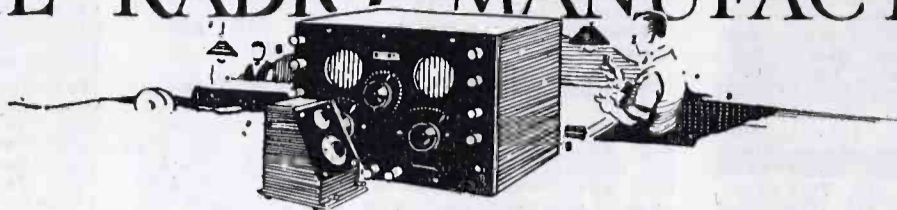

## A NEW TYPE OF RADIO VARIOCOUPLER

The Pioneer Radiophone Corporation of Galesburg, Ill., are producing a radio variocoupler which is inside-wound, on the same principle as a variometer. As will be seen by the illustration, the rotor is enclosed by a spherical stator, the shell of which is made of molded bakelite. Internal resistance is reduced to the minimum by the use of a large size of wire and by the close coupling which this type of construction permits.

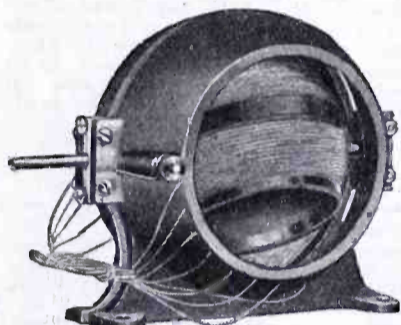

*Pioneer Variocoupler*

The relative position of rotor and stator is maintained positively by a unique type of cone-bearing on the shaft, in connection with what is known as the "riding-spring" contact.

The same company also builds a variometer to match its variocoupler. Both instruments are exceedingly attractive—their circassian walnut-finish bakelite shells contrasting with the bright green of the silk-covered wire of the stator and harmonizing with the nicked brass hardware. Both are perfectly balanced on wavelengths from 150 to 750 meters, and are stated to be producing remarkably fine, clear, long-range results.

## TUNGAR ACCESSORY FOR CHARGING "B" BATTERIES

A device for charging *B* batteries, to be used as an attachment to the Tungar battery charger, has been developed by the General Electric Company and recently placed on the market. The Tungar was devised for charging *A* batteries, and so many requests were received for something that could be used for charging *B* batteries that this attachment has been developed.

It consists of a small porcelain spool wound with resistance wire and enclosed in a small sheet metal box, which can be hung on the side of the Tungar. Two connection leads come from the resistance, one going to the Tungar and the other (the longer) to the positive pole of the *B* battery. It can be attached in a few seconds, and without the slightest difficulty. It will charge a 20-24-cell storage *B* battery at approximately .1 ampere, or 10-12 cells at approximately .2 ampere. It can be removed easily and quickly for charging the *A* battery.

To meet the rapidly growing demand for the Tungar, brought about by its popularity for charging batteries used for radio, the factory facilities for manufacturing the smaller sizes have been greatly increased.

## RADIO CORPORATION OFFICIALS VISIT PACIFIC COAST

General J. G. Harbord, president of the Radio Corporation of America, and David Sarnoff, vice-president and general manager, are having their voices recorded on the pallophotophone as shown in the accompanying picture. In the background is C. H. Hoxie, inventor of this wonderful new sound recording and reproducing device.

General Harbord and Mr. Sarnoff are now visiting the Pacific Coast, where the Radio Corporation not only maintains a merchandizing organization and warehouse at San Francisco but also operates a trans-Pacific radio telegraph service. This service includes ship to shore communication, a circuit from California to the Hawaiian Islands, and from the Islands to Japan.

General Harbord assumed his duties as president of the Radio Corporation on January 1, 1923, upon his retirement from active service after a period of thirty-four years' distinguished record in the army. Mr. Sar-

noff is rounding out sixteen years of service with the Radio Corporation and its predecessor, The Marconi Wireless Telegraph Co. of America, in the course of which experience he has covered practically every branch of the radio communication art.

## BOOK REVIEWS

"Citizen's Radio Call Book," 128 pages, 9x12, published by Citizen's Radio Service Bureau, Chicago, Ill. Price 50 cents.

This is the second edition of amateur radio calls corrected to January 20, 1922. It contains all re-assigned, cancelled and re-issued calls and changes of address up to the date of issue. Call letter addresses, including special radio stations, are given for each of the nine districts of the United States and the five districts of Canada. There is also a complete list of U. S. and Canadian broadcast stations, giving schedules in many cases. Other features include a list of naval radio stations, federal market broadcast schedules, world's time and press schedules, and high power transoceanic stations.

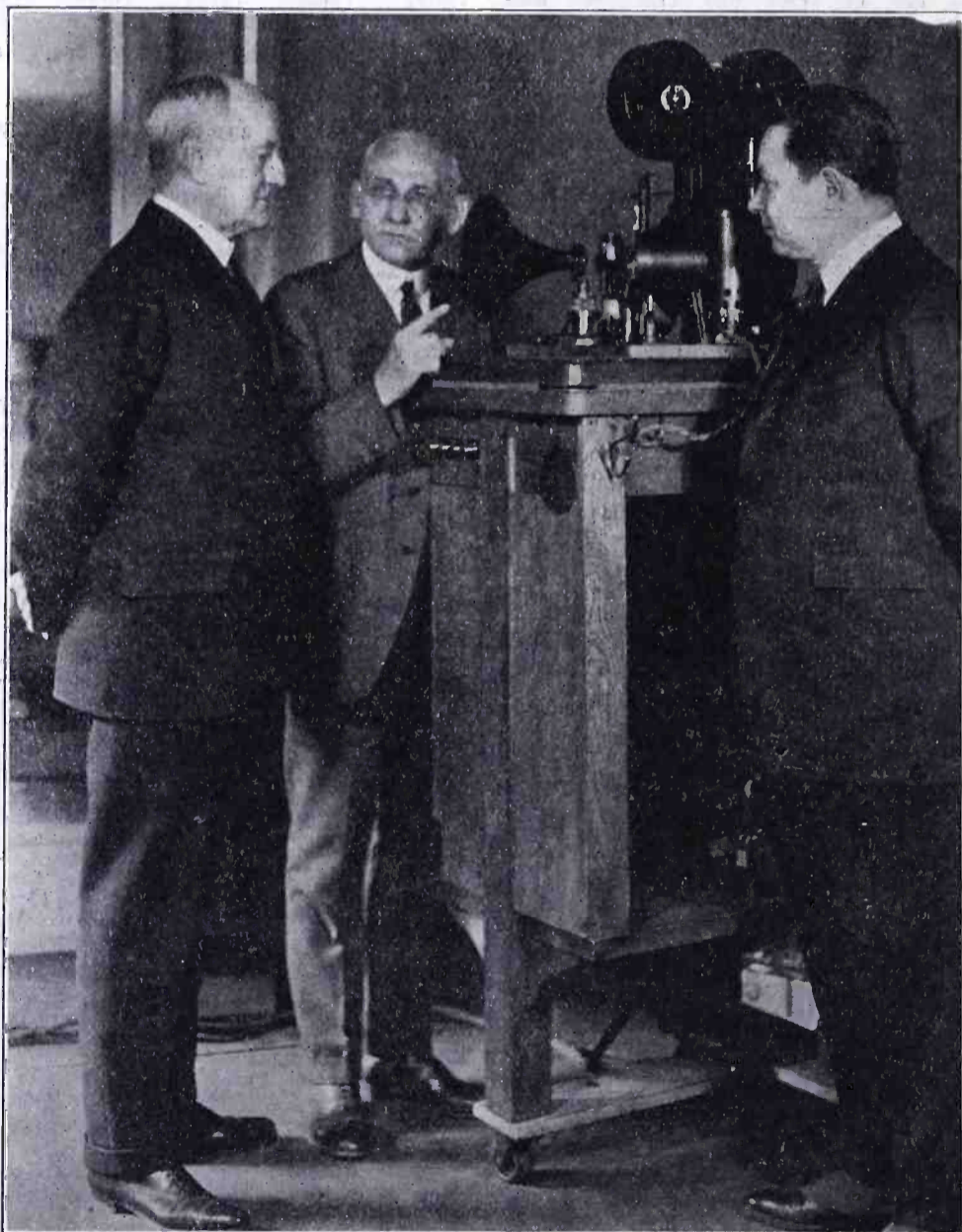

*General J. G. Harbord and David Sarnoff, respectively President and Vice President and General Manager of Radio Corporation of America, Having Their Voices Recorded on Pallophotophone*

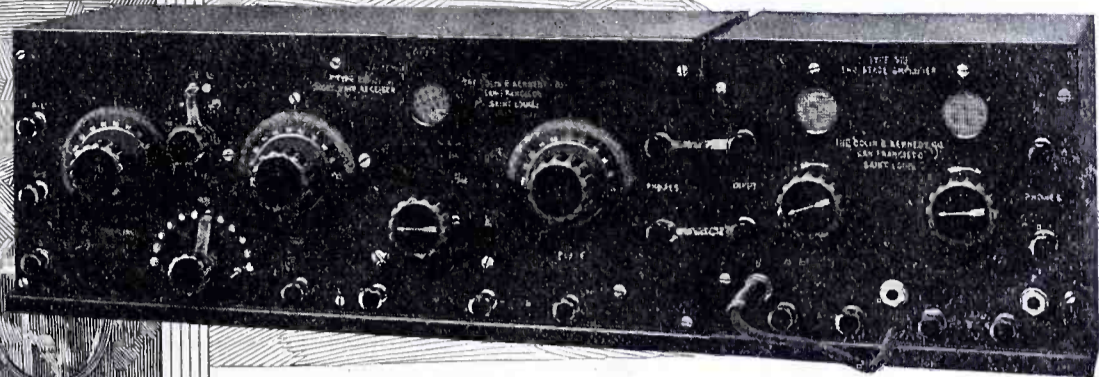

# Elegance and Scientific Precision Combined!

YOU will welcome a Kennedy Receiving Set in your home. Its distinguished appearance lends itself to the most refined surroundings and outwardly reflects the accuracy and precision exercised in its manufacture.

In a cabinet of beautifully finished hardwood and mounted behind a richly polished panel you will find a series of precision instruments—each correctly designed in itself and each exactly co-ordinated with the balance of the set.

Ease of control, long distance reception, elimination of interference and the utmost pleasure and satisfaction in its use are assured with a Kennedy receiver.

*Arrange with your Kennedy Dealer for a demonstration. Or write us direct for further information.*

THE COLIN B. KENNEDY COMPANY  
SAN FRANCISCO                      SAINT LOUIS



### *The Kennedy Variometer*

This, as well as all other parts, is scientifically constructed by Kennedy artisans. The minute clearance between rotor and stator, the firm windings and positive contact eliminate dielectric losses and increase sharpness of tuning.

# K E N N E D Y

The Royalty of Radio



Tell them that you saw it in RADIO

# HOMCHARGE



Your  
**RADIO  
BATTERY**  
for  
**A NICKEL**

ENJOYABLE concerts and maximum receiving range are obtained only when your battery is fully charged.

## THE HOMCHARGER

charges your "A" or "B" battery over night for a nickel without removing it from your living room. No muss—no trouble—no dirt—requires no watching.

After the concert connect to any lamp socket, snap the clips on your battery and "turn in." While you sleep the HOMCHARGER is silently charging your battery, the charging rate being governed automatically. In the morning it is fully charged. No OTHER battery charger can boast of such QUICK and ECONOMICAL performance.

The HOMCHARGER is the only battery charger combining all of these NECESSARY HOMCHARGING features: SELF-POLARIZING—FIVE TO EIGHT AMPERE charging rate—UNDERWRITERS' APPROVAL—beautifully finished in mahogany and old gold—UNQUALIFIEDLY GUARANTEED. OVER 90,000 NOW IN USE.

Sold complete with ammeter, etc., by all good radio and electrical dealers for \$18.50 (\$25.00 IN CANADA).

See the RADIO HOMCHARGER DE LUXE at your dealer's or write direct for our FREE circular showing why the HOMCHARGER is the BEST battery charger at any price.

MOTORISTS—The HOMCHARGER will also charge your AUTO battery.

Western Distributor

**BERTRAM SMITH**

516 San Fernando Bldg., Los Angeles, Cal.

Shipments to all points west of Rockies from Los Angeles stock.

## THE AUTOMATIC ELECTRICAL DEVICES CO.

117 WEST THIRD STREET CINCINNATI, OHIO

Largest Manufacturers of Vibrating Rectifiers in the World

# "ILLINOIS" THE RELIABLE

CONDENSER THAT IS MADE RIGHT  
AND STAYS RIGHT

	Panel	Cased	23 Plates	Panel	Cased
67 Plates	\$7.00	\$8.50	23 Plates	\$2.75	\$4.00
43 "	\$3.50	\$4.75	13 "	\$2.25	\$3.50

Vernier with single movable plate applied to 13, 23 or 43 sizes, \$2.00 extra.

Above list is for our Regular Style with Knob, Pointer and Scale. We also furnish the Condenser with smooth 3/16 inch staff suitable for Dial at 15c off list.

A 3-inch Fine Black Beveled-Edged Dial with Condenser, add 50c to list.

Fully Assembled and Tested. IMMEDIATE SHIPMENT.

Money back if not satisfied. Just return within 10 days by insured Parcel Post.

Sent Prepaid on Receipt of Price, Except: Pacific States, Alaska,

Hawaii, Philippines and Canal Zone, add 10c. Canada add 25c.

No Discounts except 5 per cent on orders of 6 or more. Send for Bulletin.

## G. F. JOHNSON

625 Black Avenue  
Springfield, Illinois

Tell them that you saw it in RADIO

## CALLS HEARD

Continued from page 41

By 3RB, 1510 N. Gratz St., Philadelphia, Penn.  
1aw, 1ee, 1fd, 1fx, 1gs, 1gv, 1il, 1my, 1or,  
1qp, 1un, 1xz, 1adl, 1agh, 1ajp, 1akl, 1anr,  
1aok, 1aol, 1ary, 1asj, 1ban, 1bas, 1bdi, 1bes,  
1bet, 1bfe, 1bka, 1bkq, 1bnt, 1bsd, 1bsz, 1bwj,  
1cak, 1civ, 1cjh, 1ckp, 1cmk, 1cot, 1cpo, 1crw,  
2da, 2dd, 2ex, 2fp, 2gk, 2hj, 2nz, 2rm, 2tb, 2zs,  
2anm, 2ats, 2avf, 2awl, 2ayv, 2bgi, 2blp, 2bmr,  
2bmrv, 2bqd, 2brb, 2bxp, 2bzq, 2cgt, 2cim,  
(2ekl), 2ckr, 2cnk, 2cpo, 2cqz, 2csl, 2cvu, 3ab,  
3ca, 3gz, 3hg, 3km, 3mk, 3ro, 3sp, 3tu, 3yo),  
(3zo), 3ajd, 3ajj, 3apr, 3aro, 3asp, 3auu, 3bfe,  
3bhl, 3bho, 3bij, 3blf, 3buc, (3cdy), 4cg, 4dc,  
4ea, 4en, 4ft, 4gh, 4hw, 4jk, 4km, 4ya, 5bw,  
5ek, 5fv, 5kc, 5px, 5qm, 5aam, 5ade, 5ams,  
5zas, 6zz, 8ab, 8an, 8bk, 8ef, 8ck, 8dv, 8eo,  
8er, 8fu, 8hj, 8hn, 8ii, 8ij, 8jj, 8jy, 8kg, 8kj,  
8ks, 8ls, 8lt, 8mz, 8nb, 8nn, 8pj, 8qk, 8rb, 8rj,  
8rv, 8sb, 8sm, 8sp, 8tt, 8uc, 8ue, 8uf, 8uj, 8uk,  
8vl, 8va, 8wa, 8vr, 8wv, 8wx, 8xe, 8yn, 8zd,  
8zo, 8zw, 8zy, 8zz, 8aaf, 8abo, 8abx, 8adk,  
8adz, 8aea, 8afd, 8afl, 8agr, 8agx, 8ahr, 8aim,  
8aip, 8aiw, 8aiz, 8aje, 8ajt, 8ajx, 8alc, 8alf,  
8alt—fone, 8amp, 8amx, 8anb, 8ape, 8apn, 8apy,  
8apw, 8apy, 8asc, 8atu, 8atx, 8aux, 8avd, 8avj,  
8awp, 8awz, 8axm, 8axt, 8ayz, 8azq, 8bae, 8bbf,  
8bch, 8bda, 8bdo, 8bef, 8beo, 8bfq, 8bfv, 8bfz,  
8bin, 8bjs, 8bkh, 8blc, 8bnh, 8bnj, 8bny, 8boa,  
8bog, 8boq, 8bpv, 8bqa, 8bqb, 8brc, 8brm, 8brq,  
8brt, 8bry, 8but, 8bwa, 8bwz, 8bxx, 8byo, 8byt,  
8cah, 8cay, 8ccb, 8cci, 8cfb, 8cfo, 8cgb, 8schu,  
8cij, 8ciz, 8ckv, 8cl, 8cl, 8cl, 8con, 8coo, 8cpc,  
8cqh, 8crb, 8crc, 8crn, 8crv, 8cur, 8cuu, 8cuv,  
8cve, 8cvz, 8cwp, 8cxw, 8czc, 8czn, 8daa, 8dak,  
8dal, 8dat, 8xan, 8bp, 8ig, 8ii, 8kp, 8lz, 8ox,  
8pf, 8rr, 8uc, 8uu, 8vm, 8yb, 8yy, 8zn, 8aap,  
8aas, 8aen, 8aep, 8afk, 8ahj, 8ajh, 8amq, 8amt,  
8anq, 8aou, 8apm, 8aps, 8aqm, 8arz, 8aus, 8avz,  
8awf, 8awm, 8aws, 8axa, 8axu, 8ayl, 8aza, 8bak,  
8beh, 8bds, 8bed, 8bgb, 8bhd, 8bhq, 8bij, 8bik,  
8bkk, 8bly, 8bqw, 8brk, 8bsq, 8bvy, 8bzi, 8bz,  
8cba, 8cgd, 8cpc, 8cte, 8cui, 8cxh, 8cxp, 8dah,  
8ddy, 8dfb, 8dgv, 8dhl, 8dio, 8djb, 8dky,  
8dqu, 8dri, 8dsd, 8dsm, 8dtj, 8dvl, 8dvw, 8dww,  
8dxn, 8dyn, 8ece.  
Can.—2hg, 2hg, 2kf, 3bp, 3bv, 3de, 3dh, 3j,  
3xn, 9al, 9bj, 9bv.

By 5ZAV, 312½ N. Broadway,  
Oklahoma City, Okla.

C. W.: 1ajp, 1ary, 1agc, 1bas, 1bed, 1cnf,  
1uj, 1yd, 1xm, (1xz), 2axf, 2bzv, 2cnk, 2bzq,  
2bq, 2el, 2gk, 2qk, 2nz, 2fp, 2xz, 2zs, 3adx,  
3ajd, 3atb, 3acy, 3ark, 3ari, 3aro, 3asi, 3ajj,  
3blf, 3bwi, 3bva, 3bvc, 3bhl, 3bss, 3bgl, 3bgj,  
3lif, 3cep, 3dva, 3ab, 3at, 3cc, 3cx, 3cm, 3fg,  
3fo, 3fg, 3gk, 3hk, 3hg, 3ii, 3jj, 3lp, 3ls, 3rf,  
3sx, 3ta, 3xm, 3zo, 4bb, 4bo, 4bx, 4bi, 4by,  
4bk, 4cg, 4cl, 4cd, 4co, 4db, 4do, 4dk, 4eb,  
4eh, 4ep, 4el, 4ft, 4fu, 4fd, 4hs, 4ix, 4il, 4jk,  
4jz, 4jm, 4kl, 4ku, 4nv, 4kc, 4oi, 4pf, 4ya, 4zc,  
(5sf), (5nv), 6aoy, 6ael, 6arb, 6abx, 6onh,  
6aau, 6awt, 6boe, (6hvg), 6bsg, 6bhb, 6bwb,  
6btv, 6bwz, 6bbe, 6bun, 6bqe, 6bpi, 6bic, 6cc,  
(6ea), (6eb), 6ef, 6lu, 6ka, 6lv, 6nr, 6rm, 6rr,  
6jd, 6uc, 6xad, 6xk, 6zh, 6zi, 6zt, (6zz),  
7lu, 7aiv, 7awf, 7na, 7qn, 7sc, 7lr, 7zo, 7zu,  
7zv, 8aaf, (8adt), 8aip, 8ajw, 8alf, 8aot, 8aod,  
8awo, 8azo, 8hed, 8hek, 8het, 8hjc, 8bin, 8bkz,  
8brg, 8brf, 8blu, 8boz, 8bxx, 8bys, 8bwt, 8bxa,  
8bzd, (8beo), 8cab, 8cae, 8cei, 8cl, 8clz, 8col,  
8ctu, (8cqv), 8cpd, 8con, (8cpx), 8cvt, 8cwl,  
8czc, 8czn, 8day, 8dvr, 8ab, 8aa, 8bo, 8cf, 8cv,  
8ch, 8er, 8fq, 8hw, 8hz, 8hg, 8hh, 8ij, 8jj,  
8kj, 8lf, 8ki, 8nb, 8nz, 8nn, 8pj, 8qk, 8qn, 8rr,  
8rv, 8ab, 8sn, 8tt, (8uk), 8up, 8uc, 8uu, 8vp,  
8vf, 8vy, 8ws, 8wa, 8xb, 8xy, 8zaf, 8zw, 8zy,  
8zz, (9blg), 9zn.  
Can.—(3bv), 3bq, 3ko, (3ad), 3dh, 3pg,  
(4bv), 9aj.  
Fone—5ja, 5za, 5zx, 9bay, 9bhc, 9lj, 9kp,  
9yf, 9xm.  
Use a 200-watt d.c. C. W. at 5ZAV! Always  
glad to work stations and qsl.

By 7VF, 793 Michigan Ave., Portland, Ore.  
4bv Can., (4hh Can.), (5ac Can.), (5cn  
Can.), (5ct Can.), (5ej Can.), 5ek, (5go Can.),  
5ir, 5po, 5rn, 5tc, 5tj, 5xad, 5za, 5zag, 5zak,  
5zas, 5zh, (6abx), (6anb), (6aoa), (6aol),  
(6avr), (6avv), (6bip), (6bod), (6bun),  
(6can), (6cc), (6cu), (6eb), (6fy), (6ku),  
(6lu), (6lv), (6su), (6tu), (6vf), (6zh), (7hj),  
(7hm), (7zn), 8afd, 8amy, 8apw, 8asv, 8atu,  
8axc, 8azd, 8azf, 8bch, 8bk, 8brm, 8bxh, 8cdd,  
8cf, 8mz, 8qd, 8wr, 8yd, 8abu, 8aec, 8aix, 8ajh,  
8amb, 8ami, 8aog, 8arz, 8aul, 8avz, 8awm,  
8ayu, 8bhf, 8bcf, 8bed, 8bji, 8bjv, 8bp, 8bri,  
8bsg, 8bxm, 8bzi, 8cev, 8cgy, 8cns, 8cr, 8cxp,  
8dfb, 8dge, 8dky, 8dtm, 8dug, 8gk, 8kp, 8pi,  
8ps, 8uh, 8yaj, 8zt.  
4br Can., 4bv Can., 4dv Can., (5cn Can.),  
(5ct Can.), (5ej Can.), (5go Can.), (6bu),  
(6fh), (6zh), (6aaz), (6arf), (6awt), 6bel,  
6bnu, 6bob, (6bql), 6brf, (6bsa), 6bun, 6bvf,  
6bvg, 8la, 8ts, 8zy, 8adg, 8alt, 8aul, 8axb, 8axc,  
8ayu, 8ax Can., 8bd Can., 8bm Can., 8bp Can.,  
8dk Can., 8df Can., 8fh, 8ya, 8zn, 8abq, 8anq,  
8apw, 8asf, 8avz, 8awm, 8ayu, 8bbf, 8bcu,  
8bey, 8bed, 8bic, 8bik, 8biz.  
All stations hearing my C. W. pse qsl.

By 7LR, Royal V. Howard, 540 West 13th St., Eugene, Oregon

C. W.: 1mc, 1bdi, 1bgi, 1cpn, 2fp, 3ot, 3aro, 3bhm, 3bhw, (3blf), 3zo, 4bf, 4eb, 4eh, 4bi, 4jz, 4km, 4uu, 4ya, 5ar, (5abb), 5aby, 5ct, 5cf, (5di), 5er, 5ex, 5fj, 5gh, 5jt, 5kc, (5kp), 5lo, 5nk, 5nc, (5ns), 5qi, 5sf, 5sk, 5sm, 5tc, 5uj, 5vo, 5xk, 5xaj, 5xak, 5za, 5zav, 5zat, 5zh, 5xc, 5acf, 6aa, (6bf), 6bu, (6bm), (6cu), (6cc), 6cp, (6eb), 6ea, 6en, (6ex), (6fh), (6gx), (6gr), (6jd), (6jn), 6ka, (6ku), 6lf, (6lu), (6nx), (6om), 6pi, (6rm), (6rd), (6rr), 6su, (6sz), (6tc), (6ti), (6xk), (6xad), 6xaf, 6xas, 6ze, 6zf, (6zh), 6zi, 6zn, 6zs, 6zx, 6zz, (6aag), (6aak), (6aaj), (6aat), 6asc, 6awp, (6awt), 6asj, 6acr, (6abx), 6apw, 6atv, (6ate), 6atg, 6awu, (6ajf), 6aiy, 6aqw, (6aor), 6aty, 6atg, 6agp, 6arv, 6asx, 6akg, (6akt), 6aen, (6ajd), (6apv), (6apl), (6ajr), (6amz), (6bae), 6boe, 6bjd, 6bjy, 6bes, (6bmd), 6buo, (6bic), (6bun), 6beg, 6bod, 6bpz, (6bv), 6brk, 6bz, (6bip), (6biq), (6bin), (6bum), 6bnt, 6bvd, (6bcl), (6bcr), (6brg), (6bv), (6bcj), (6bqc), (6bqd), (6bqe), (6bqg), (6bqp), (6bqz), 6bqr, 6bow, 6bmy, (6bru), 6btz, 6bci, (6bju), (6bnu), (6bkg), 6bfy, (6bgd), (6beq), (6bqw), (6bjc), (6bwe), (6bqr), (6bpz), (6bv), 7hm, 7iy, 7ig, 7ce, 7sh, 7hi, 7bk, 7nr, 7dh, 7ey, 7lv, (7ng), (7om), (7qn), (7nn), (7ln), (7vf), (7ge), (7ak), (7wk), (7ba), (7sa), (7to), (7wq), (7zn), (7gp), (7tt), (7za), (7cz), (7bj), (7bh), (7sg), (7tq), (7lu), (7qt), (7th), (7nj), (7dp), 7zo, 7cn, 7pf, 7oe, 7ny, 7nv, 7aw, 7ne, 7nf, 7ve, 7zv, (7ac), (7oh), (7rn), (7ri), (7tq), (7abb), (7aff), (7aft), (7adf), (7adm), (7adp), (7adg), (7aea), (7aif), (7agi), 7aiy, 7aew, 7aby, 7ahi, 7afh, 7afw, 7abs, (7ajq), (7aic), 8aa, 8ab, 8cd, 8bo, 8bk, 8hn, 8jj, 8ow, 8qk, 8sp, 8uc, 8ue, 8vl, 8aim, 8anb, 8afd, 8amq, 8aov, 8asv, 8axc, 8azd, 8bch, 8bfh, 8bfz, 8bif, 8bnj, (8bsf), 8bsy, 8bva, 8bvt, 8bxa, 8bxz, 8bow, (8cxw), qra?, 8cyu, (8cm), qra?, 8dwa, 8dtm, 8rh, 8awm, 8zaf, 8dpl, 8nx, 8ani, 8baf, 8ps, 8bct, (8zt), 8aiy, 8bwa, 8bbf, 8arz, 8anz, 8uu, 8bvi, 8bjd, 8dte, (8bji), 8bed, (8cns), 8zn, 8gk, 8cmm, 8dlt, 8bxq, 8cni, 8ccu, 8adf, 8bds, 8cfy, 8pi, 8ei, 8bey, 8ox, 8ct, 8avz, 8aul, (8bhd), 8ami, 8bam, 8yal, 8ii, 8dyn, 8ej, 8dmf, (8yw), 8ep, 8bik, 8qk, 8afn, 8bzi, 8ccv, 8afo, 8apw, 8xm, 8arg, 8bsg, 8gr, 8dso, 8dcu, 8pw, 8yu, 8gk, 8dkq, 8bxq, 8pn, 8amu, 8bly, 8bta, 8dwx, 8bvi, 8anf, 8aau, 8bjv, 8dsd, 8aza, 8cfy, 8dwx, 8bri, 8brk, 8ddy, 8amb, 8vm, 8buh, (8uh), 8cdu, 8bjb, 8asf, 8aey, (8bxm), 8dny, 8bgh, (8ctv), 8btz, 8dhi, (8blt), 8bzi, 8dvl, (8abu), 8amq, 8cnr, (8dgn), qra?, (8apv), qra?, (8dge), qra?

Spark: 1cni, (6aoa), (6awh), (6amk), (7fh), (7kj), (7af), (7abh), (7aft), (8bda), 9aoj.  
Can. C. W.: (4dq), 4dy, 4bv, 4hh, (5ac), 5ak, (5ct), (5cn), (5ej), (5go), (9bx), 9ac, 9bd, Spark—(5go), (5gt), 9bd, 3co.  
All hearing my 50-watt ACW pse qsl. All cards answered.

By 5AAH, Ardmore, Oklahoma.

All C. W.: 3adt, 3awr, 3bm, 3bgt, 3blf, 3jt, (3yo), 3zz, 3xm, 3zo, 4bx, (4cg), 4cy, 4eh, 4el, 4fm, 4gz, 4jk, 4kl, 4km, 4zi, (5di), (5dy), (5nv), (5ta), (5tj), (5u), (5un), (5vy), 6cc, 6ff, 6gk, 6jd, 6om, 6sm, 6su, 6um, 6xk, 6zb, 6zh, 6air, 6alu, 6arb, 6bic, 6biq, 6bjy, 6boc, 6bod, 6boe, 6bpi, 6bum, 6bun, 6bvq, 6bvw, (6caj), 6xad, 6zn, 7afw, 7aiu, 7bh, 7bj, 7gs, 7lr, 7lu, 7zai, 7zu, 7zv, 8ab, 8be, 8ef, (8fc), (8fu), 8if, 8ii, 8kg, 8ko, 8mz, 8sb, 8sr, 8tt, 8vq, 8xe, 8zy, 8zz, 8alt, 8akb, 8atc, 8avz, 8awz, 8boz, 8ccm, (8cgu), (8cgr), 8cko, 8cve, 8cxw, 8xau, 8zap, (8abu), (8aao), (8ami), 9bda, 9bds, 9bfg, (9bgh), (9bhn), (9bri), 9buh, 9bvl, (9bxh), (9bxt), (9bzi), (9bzz), 9cp, (9caa), 9cao, (9ccs), (9ccv), 9cfk, 9cls, (9cte), (9cvo), 9dkf, (9dpl), (9dqm), 9dq, (9dfm), (9dta), (9dug), 9dun, 9dvn, 9ei, 9ebt, 9ecz, (9edb), 9efa, (9fm), (9pw), 9rr, (9yf), (9zt), (9zy), 9zla.  
Can.—3at, 3bv, 3ko, 4cn.

At 5ADB, 2117 Grant, El Paso, Tex., E. R. McCracken & E. H. Funk, Official A.E.R.L.

All C. W.: 1ary, 1amp, 1ban, 1ckp, 1xm, 2awl, 2ayv, 2bmr, 2bvz, 2ccd, 2cxl, 2dd, 2fp, 2ho, 2rn, 2rp, 2xz, 2zs, 3aro, 3bjg, 3bvc, 3gk, 3hg, 3oe, 3tj, 3zo, 3zs, 4bg, 4ea, 4ft, 4hh (Can.), 4hw, 4ik, 4ku, 4ya, 4zc, (5ahd), 5ado, 5aar, (5aec), 5adz, 5afq, 5aam, (5aah), 5aeq, 5abh, 5aat, 5aht, 5acq, 5aib, 5aby, 5bm, 5bp, 5bv, 5ci, 5cs, 5cy, 5dn, 5di, 5ek, 5en, 5ft, 5fu, 5gi, 5ga, 5gf, 5gn, 5hh, 5ho, 5hz, 5im, 5ix, 5jb, 5jl, 5jm, 5ke, (5kc), 5kn, 5kp, (5ml), 5mo, 5mx, 5mz, 5ns, 5nn, 5nv, (5nk), 5nz, 5ok, 5ov, 5pb, 5pd, 5pf, 5po, (5px), 5pv, (5qi), 5qm, (5rn), 5sj, (5rh), 5rr, 5sp, 5sf, (5sr), 5sm, (5ss), 5ta, 5tc, 5tm, 5tj, 5ui, 5uo, 5uk, 5uj, (5va), 5vo, 5vy, 5wz, 5xa, (5xaj—fone), 5xb, 5xd, 5xk, 5xac, 5xt, 5za, 5zav, 5zak, 5zas, 5zaf, 5zag, 5zad, 5zaz, 5zax, 5zh, 5zu, 6awz, (6awt), 6afh, 6aak, 6avv, 6atq, 6ahx, (6aib), 6awx, 6anh, 6ak, 6aag, 6aa, 6bjy, 6bqd, 6bwp, 6boe, 6bur, (6bun), 6bic, 6bfp, (6bnv), (6bsq), 6bv, 6bh, 6bvp, 6bpi, 6bq, 6brs, (6bh), 6bv, 6bod, 6boc, 6bko, 6bix, 6bgh, (6bjj), (6caj), 6cu, 6cdu, 6edo, 6ef, 6ek, 6eb, 6ka, 6pn, 6rr, 6rm, 6su, 6xk, 6xad, 6xxa, 6xav, (6zz), 6zt, 6zh, 7afw, 7ad, 7brm, 7lu, 7lr, 7nv, 7sc, 7zn, 7zu, 8afw, 8abb, 8alv, 8avz, 8aog, 8ab, 8ah, 8blx, 8byo, 8bjs, 8bsy, 8bog, 8caa, 8cf, 8clv, 8cdd, 8cyu, 8cci, 8dat, 8ib, 8kg, 8uv.

8ve, 8vq, 8wa, 8yq, 8yv, 9atn, 9atz, 9azh, 9aig, 9ayu, 9amu, 9aey, 9aws, 9apw, (9aqz), (9aog), 9aus, 9amb, 9abv, 9ave, 9aod, 9anb, 9aau, 9axu, 9arj, (9aeq), 9aky, 9aec, 9bxm, 9bsg, 9bji, 9btg, 9bcf, 9bed, 9bhi, 9bkk, (9bxt), 9bvy, 9bxc, 9bbf, 9bri, 9bwe, 9bxy, (9bjk), 9bzi, (9brk), 9bsz, 9bbs, 9bhd, (9bun), 9bfe, 9bvl, 9byc, 9bik, 9ct, 9cf, 9cpb, 9clg, 9cin, 9cng, 9cuc, 9cuv, 9ccm, 9cvt, 9cfk, 9cny, (9cfy), 9ccv, 9cvo, 9ckm, 9clw, 9cde, 9cxp, 9cpv, 9cvt, 9cjt, 9cwc, 9ccy, 9cdr, 9cdu, 9coc, 9cki, 9cti, 9dwf, 9dah, 9dti, 9dky, 9dsm, 9dxn, 9dof, 9djb, 9dpl, 9djm, 9dsd, 9dzy, 9dpi, 9dxe, 9dmj, 9dgv, 9dkq, 9dvw, 9dqm, (9dte), 9dkx, 9dkg, 9dgn, 9dyn, 9dio, 9dge, 9ebi, 9ekh, 9ew, 9eea, 9eht, 9ekf, 9efa, 9fm, 9fv, 9en, 9mo, 9of, 9ps, 9uu, 9uh, 9uk, 9um, 9ve, 9yb, 9zt, 9zn. Pse qsl our C. W. if hrd.

By 6BEQ, Route 1, Box 76A, Puente, Calif.  
C. W.: 1qp, 2xq, 3bj, 3km, 3pz, 3ard, 3blf, 4bi, 4bv, 4cg, 4eb, 4eh, 4fs, 4gh, 4km, 4me, 4oi (Cuba), 4sb, 4ya, 5cy, 5di, 5ek, 5el, 5fu, 5fv, 5gj, 5ir, 5is, 5ix, 5jz, 5kp, 5my, 5kc, 5ns, 5ok, 5nz, 5ov, 5px, 5pv, 5qi, 5qy, 5rh, 5sf, 5sm, 5ss, 5tc, 5ts, 5uo, 5un, 5uj, 5uk, 5xa, 5xb, 5xd, 5xk, 5xm, 5xv, 5xad, 5xaj, 5za, 5zb, 5zg, 5zh, 5zas, 5zav, 5zax, 5aah, 5aar, 5ado, 5aec, 5ahd, 5aid, 5anb, (6qy), (6atq), (6bhh), (6biq), (6bql), (6bkx), (6bnu), (6cee), (6za), (6zt), 7ad, 7aw, (7bj), 7cd, 7dp, 7eq, 7ex, 7hj, 7iw, 7ln, 7lr, (7lu), 7ly, 7mf, (7na), 7om, 7ot, 7pf, 7qt, 7ri, 7sc, (7tq), 7wm, 7aby, (7aem), 7afw, 7adp, 7aic, 7aim, 7aiu, 7zn, 7zo, 7zu, 7zv, 7ya, 8bk, 8cf, 8cp, 8er, 8ft, 8ib, 8jj, 8ju, 8kg, 8ld, 8lh, 8ml, 8mz, 8pd, 8qk, 8rn, 8xe, 8yd, 8yn, 8zd, 8zo, 8zy, 8zz, 8aaf, 8acf, 8ago, 8aio, 8aim, 8aio, 8alv, 8amu, 8anb, 8aqv, 8asv, 8azd, 8azf, 8axc, 8bdo, 8bdu, 8bei, 8bef, 8bfm, 8bfq, 8bsg, 8bur, 8bwa, 8bxh, 8bzy, 8caa, 8chb, 8cei, 8cih, 8cmi, 8crb, 8cuh, 8cqh, 8cur, 8cyu, 8xad, 8xae, 8xan, 8zaf, 9bk, 9bm, 9er, 9gk, 9fu, 9hk, 9ei, 9ew, 9ep, 9ig, 9lz, 9ox, 9mc, 9pi, 9pw, 9uh, 9um, 9ym, 9zn, 9zt, 9zy, 9aap, 9abu, 9abv, 9aey, 9afk, 9ain, 9aiu, 9aix, 9aiy, 9asp, 9ami, 9anq, 9aou, 9ape, 9arg, 9arz, 9aon, 9aou, 9apw, 9aqm, 9asf, 9asu, 9aue, 9auw, 9aul, 9avu, 9auz, 9awf, 9awm, 9ays, 9aza, 9bbf, 9bds, 9bgh, 9bhd, 9bed, 9bei, 9bek, 9bie, 9bik, 9bji, 9bjv, 9bkk, 9bly, 9bri, 9bsq, 9btz, 9bug, 9bun, 9buy, 9bxa, 9btt, 9bx, 9bxm, 9bxq, 9bxt, 9bzi, 9caa, 9cao, 9cba, 9ccv, 9ccm, 9cdr, 9ccs, 9cfy, 9cjt, 9cmk, 9cns, 9cte, 9cow, 9cwr, 9cui, 9cxn, 9dah, 9dae, 9def, 9dfb, 9dgt, 9dkq, 9dky, 9dpl, 9dlm, 9dpw, 9dte, 9drf, 9dtm, 9dsm, 9dvw, 9xac, 9zaa, 9yaj, 9egy, 9ekh.  
Can.—3dh, 3ko, 4bv, 4cb, 4co, 4xn, 5cn, 9al, 9bt, 9bx. Anyone hearing my 10-watt C. W. pse qsl.

By 7TT, 7126 54th Ave., S.E., Portland, Ore.

5akt, 5za, 5zas, 6ak, 6bh, 6bu, 6bp, 6cb, (6cc), 6cu, 6ek, 6en, 6fh, (6jn), 6ku, 6lu, 6lv, 6na, 6nh, 6oh, 6om, 6qz, 6re, 6rm, 6rr, 6su, 6tc, 6ti, 6uw, (6vm), 6aak, 6abx, 6ajd, 6alv, 6amz, 6anb, 6ang, 6anh, 6aoi, 6apw, 6arb, 6asi, 6ato, 6atq, 6atu, (6auy), (6awt), (6bcj), 6bdf, 6bic, 6biq, 6bip, 6bjc, 6bjr, 6bmd, (6bmn), 6bnv, 6bod, 6boe, 6boi, 6bqc, (6bql), 6brf, 6bru, 6bum, 6bun, 6bv, 6can, 6cbi, (6zh), 6zt, 6zw, 6zz, 6xad, 6xas, 7ba, 7du, 7hj, 7kf, 7kg, (7ke), 7mf, 7nf, 7an, 7rn, (7wx), (7ae), (7aem), (7afh), 7agi, 7ac, 8ib, 8alt, 8bch, 8bef, 8cbi, 8zy, 9ck, 9kp, 9pn, 9ps, 9aix, 9bbf, 9bcb, 9bjc, 9bkd, 9bri, 9bji, 9bxa, 9bxm, 9bzi, 9cwn, 9dlm, 9dnd, 9dok, 9zt, 9zaf. Canadian: 4bv, 4dq, (5cn), (5ct), 5ej, 9bd, 9bx, 9cc. Any station hearing 7tt, pse qsl.

By 7ZU, Polytechnic P. O., Mont.

C. W.: 3bvl, (3yo), (4bv), (4cn), (4hh), 4ya, 5abb, 5di, 5ek, 5gj, 5ix, 5jh, 5ma, 5mu, 5nn, 5px, 5qs, 5sf, 5sk, 5tj, 5uo, 5xv, 5xaj, 5xl, 5xd, 5zk, 5zav, 5zak, 5zs, 5zm, 5za, 5zh, 6alu, 6ajh, 6arf, 6anh, (6ak), 6awt, 6apj, 6atq, 6asx, 6aix, 6aqq, (6apw), 6arb, 6aau, 6ba, (6bu), 6bum, (6bun), 6bdf, 6bip, 6biq, 6bu, 6bec, 6bcj, 6bh, 6boe, (6bv), 6bih, 6bnh, 6bic, (6bvw), 6ckm, 6cc, (6cbi), 6ea, 6ff, 6gx, 6if, 6lu, 6ka, 6ns, 6rm, 6rr, 6re, (6ti), 6vf, 6vm, 6xad, 6xk, (6zo), 6zs, 6zh, 6zt, (6zx), 6zz, 7ar, 7aby, 7abb, 7afs, 7abh, 7bk, 7ba, 7da, (7dp), (7dx), (7ey), 7fr, 7ke, 7kr, 7kb, 7mc, (7mo), 7na, (7nf), 7om, 7oe, 7pf, (7qe), 7sa, 7sc, (7sj), 7tq, 7vf, 7xc, (7zv, (8azd), 8amu, 8apt, (8bo), 8bk, 8bdo, 8boz, 8bk, (8bxx), 8cia, 8cjh, 8dv, (8fe), (8vy), (8yd), (8zy), 8zz, 8zw, 9aqu, 9aog, 9arf, 9amb, 9afd, (9awm), (9asf), 9aot, 9afn, 9an, 9aau, 9aqv, 9abu, (9ahk), 9apw, 9aya, 9arz, 9aap, 9aau, (9arz), (9asu), 9amt, 9aul, 9ayu, 9amj, (9aig), 9aza, 9aws, 9ajs, 9apw, 9awh, 9aou, 9abv, (9ajh), 9ayi, 9aod, 9aad, 9afs, 9adf, 9ayu, 9aau, 9avj, 9aaj, 9afo, 9axj, (9atn), 9aig, 9asf, 9aey, (9aij), 9aor, 9hkk, 9bki, 9bre, 9bxt, 9bjg, 9bsq, 9bed, 9bvy, 9bcf, 9bly, 9blo, 9bko, 9bzi, 9bji, (9bsg), 9bjv, 9bik, 9bx, 9bdr, 9baa, (9bp), 9bch, 9bzg, 9bxf, 9bxm, 9bxi, 9bkh, 9bsz, 9bmn, 9bjk, 9bpt, 9baf, 9bkw, 9bzz, (9bhq), 9bey, 9bbf, 9bxq, 9bri, 9cns, 9cfk, (9cm), (9ceh), 9clg, 9cxn, (9cfy), 9cfv, 9cpu, (9cac), 9cny, 9cde, 9cdv, 9cl, (9ccv), 9cj, 9caa, 9ce, 9cy, 9cwr, 9cc, 9chn, (9ctg), (9dsg), 9dkb, 9did, 9dsd, 9dnh, 9dio, 9dnd, 9dyg, 9dpl, 9dge, 9dpl, 9dta, 9dgc, (9dkq), 9dok, 9dsm, 9dey, 9dcy, 9dte, 9ddy, 9ddn, 9dgn, 9dxc, 9eak, 9fm, 9gk, 9clq, 9ig, (9kp), (9mf), 9mo, (9ps), (9qf), (9rc), 9qr, (9rk), 9uf, 9uh, 9ve, 9vm, 9vk, 9xaq, 9xac, 9xm, (9yu), (9yaj), 9yw, 9zaa, 9zaf, (9zn), 9zt, 9zy.  
Fone: (9asf), 9cls, (9asf), (9yy), 9gk, 5za, 9af, (9ccv).  
Can.—(5cn).

Continued on page 46

# A Big Stride forward

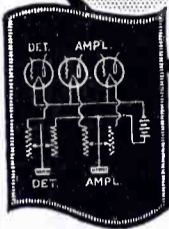
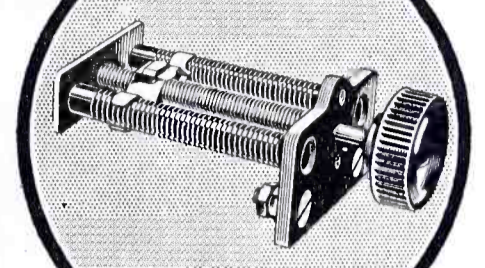

## The Autostat A Super Rheostat

Can be used with 6-Volt or WD11 Detector Tubes, two Amplifying bulbs, or one 5-Watt Power Tube.

**THE AUTOSTAT** presents an entirely new principle in filament rheostat construction and radio takes another **BIG** step forward.

No longer is it necessary to turn a "hair's breadth" to tune in that elusive station, for with the AUTOSTAT you can give the knob a substantial turn and get a superfine adjustment. No other rheostat to date possesses the necessary "fineness" of adjustment to eliminate interference and "tube howls" under all conditions. But the AUTOSTAT, with its micrometer adjustment, will positively give these much-sought-for results.

### How It Works

Two parallel mounted resistance tubes are connected in series by a "micrometer-operated" slider—the length of wire in circuit depending upon the location of this movable slider. Forty turns of the AUTOSTAT knob are required to complete the variation from minimum to maximum resistance—against one-half to three turns on others.

This exclusive patented construction means:

1. One full turn of AUTOSTAT knob produces finer tuning than a "hair's-breadth" turn on any other.
2. Economical—only two AUTOSTATS required for a three-bulb set.
3. Greatly increased receiving range and clearness of signals.
4. A uniform change in resistance with each turn of the AUTOSTAT knob.
5. Indestructible wire-wound fireproof lava resistance element.
6. Unqualifiedly guaranteed.

Popularly priced, \$1.35

### Dealers

See your jobber or write direct for Radio's most attractive Rheostat proposition.

### Western Distributor BERTRAM SMITH

516 San Fernando Bldg., Los Angeles, Cal.

Shipments to all points west of Rockies from Los Angeles stock.

### The Automatic Electrical Devices Co.

117 W. Third St., Cincinnati, Ohio

Builders of Precision Rheostats Since 1914

Tell them that you saw it in RADIO

For  
**BETTER  
RESULTS**

use

**EVEREADY**

"A" and "B"

**BATTERIES**

with your  
radio set

Westinghouse  
WD-11 Vacuum  
Tubes operate  
best when used  
in connection  
with

**Columbia**

**Dry  
Batteries**

—they last longer

Manufactured on the  
Pacific Coast—  
fresh and full of pep

**NATIONAL CARBON  
COMPANY, Inc.**

599 Eighth St.

San Francisco, Calif.

**DISTRIBUTED CAPACITY**

*Continued from page 26*

uted capacity. The method is based on the following analysis. The natural uted capacity is then as follows: Set denser  $C$  is given by

$$\lambda = 1885 \sqrt{L(C + C_d)} \dots (1)$$

Squaring both sides, we have

$$\lambda^2 = (1885)^2 L(C + C_d) \dots (2)$$

Since  $L$ , the inductance, is a constant, the curve giving the relationship between  $C$  and  $\lambda^2$  is a straight line. From equation (2) when  $\lambda^2$  is equal to zero it follows that  $C$ , the external capacity, must equal the distributed capacity of the coil, for if

$$\lambda^2 = 0 = (1885)^2 L(C + C_d)$$

$$\therefore C + C_d = 0, \text{ or } C = -C_d$$

The method for determining the distributed capacity of the circuit as shown in Fig. 7, in which  $L$  is the coil whose distributed capacity  $C_d$  is to be measured.  $C$  is a variable condenser whose calibration is known. Measure the wavelength of this circuit for various values of  $C$ . Calculate the square of the wavelength for each value of  $C$  and make a plot as in Fig. 8, showing  $\lambda^2$  against  $C$ . Extend the curve until it crosses the  $C$ -axis, as shown by the dotted extension. Where it crosses the  $C$ -axis, the wavelength is zero. As shown above the capacity corresponding to this wavelength must be the distributed capacity, or its negative, hence the value  $CA$  is the distributed capacity of the coil. This is a very easy and convenient method of obtaining this constant and is quite reliable.

**CALLS HEARD**

*Continued from page 45*

By 6RR, 415 N. Gower St., Los Angeles, Calif.  
1gv, 3gk, 3abd, 3aro, 4eb, 4by, 4gr, 4hh, 4kk, 4xc, 4hw, 4ya, 5aj, 5di, 5ek, 5fo, 5fw, 5gr, 5hz, 5nk, 5ns, 5px, 5qy, 5sz, 5xb, 5xd, 5xt, 5xv, 5zh, 5acf, 5ado, 5ahw, 5xaj, 5zak, 5zas, 5zau, 5zaw, 6's too numerous, 7bj, 7bk, 7dp, 7jf, 7ke, 7na, 7ny, 7oz, 7rn, 7sc, 7tq, 7ur, 7wm, 7zo, 7zw, 7zv, 7zn, 7adp, 7aea, 7aem, 7afs, 7afw, 8bk, 8hn, 8mz, 8ue, 8vy, 8xd, 8xy, 8yk, 8zw, 8zz, 8zy, 8amj, 8aqf, 8ate, 8axe, 8bch, 8bda, 8cow, 8dae, 8cur, 8zaf, 9al, 9bx, 9cm, 9ej, 9fs, 9fm, 9mk, 9dx, 9qr, 9rc, 9uh, 9yw, 9zt, 9aap, 9afm, 9afo, 9aix, 9anf, 9aps, 9apw, 9aqv, 9arz, 9aul, 9avc, 9avz, 9ayu, 9ays, 9aza, 9bbf, 9bds, 9bhd, 9bik, 9biz, 9bji, 9bkk, 9bkm, 9bly, 9bnm, 9bun, 9bvm, 9bxm, 9bxq, 9bxt, 9bzn, 9caa, 9ede, 9efy, 9ejm, 9eiy, 9cmk, 9cow, 9cpa, 9cuc, 9czz, 9dae, 9dca, 9dep, 9dhi, 9dio, 9djm, 9dky, 9dlm, 9aqu, 9dyn, 9ekh, 9yaj.

By 7ACX, H. P. MEYERS, 755 Borthwick St., Portland, Oregon  
Can.—1gv, 4dq, 4hh, (5ct), 5cn, (5go), (5ej), (5ac), (9bp), 9bx, 9ac.  
U. S.—4ya, 4hh, 5px, 5za, 5zak, 5hb, 5kc, 5rh, 5ix, 6eb, 6aes, 6bes, 6om, 6zo, 6boe, (6cbd), (6awt), (6ku), (6alv), (6fh), (6jn), (6bql), many others, 7's too numerous to mention, 8bo, 8sb, 8cf, 8bxx, 8abx, 9zy, 9asf, 9aps, 9bk, 9bp. Anyone hearing 7ACX's C. W. signals pse qsl.

By Robert Nagle, 6CAH, Van Nuys, Calif.  
4eh, 4el, 4bv, 5ado, 5cn, 5ek, 5fv, 5kc, 5nk, 5pz, 5xai, 5xb, 5xd, 5xv, 5za, 5zak, 7ad, 7adp, 7afw, 7aic, 7bj, 7bk, 7ey, 7ln, 7lr, 7lu, 7mc, 7mf, 7na, 7nf, 7ng, 7ny, 7om, 7sc, 7th, 7tq, 7wm, 7zn, 7zu, 7zv, 8ajx, 8ate, 8ble, 8bog, 8byo, 8cf, 8cmi, 8zy, 8zz, 9afo, 9afs, 9aiy, 9anq, 9apw, 9asf, 9avz, 9bbf, 9bji, 9bkk, 9bly, 9bm, 9bqw, 9bri, 9bry, 9btt, 9bvy, 9bx, 9bxa, 9bxm, 9bxq, 9bzi, 9caa, 9ede, 9efy, 9ejm, 9etg, 9cwr, 9dhi, 9dky, 9dpf, 9dsd, 9dte, 9dtm, 9dww, 9fm, 9kp, 9lz, 9ox, 9ps, 9uh, 9xac, 9yf, 9yw, 9zn, i. C. W., 9zt.

Tell them that you saw it in RADIO

**Standard  
Radio  
Supplies**

We offer no cut prices or "junk" merchandise — but we do guarantee you full value for your money, prompt and courteous service, and experienced advice — the result of 15 years in the radio field.

**Send Us  
Your  
Mail  
Orders**

Everything in stock that's standard in radio—

Grebe Apparatus—every model always in stock.  
Cunningham Tubes—all Types.  
WD-11 Tubes, Detector and Amplifier.  
Westinghouse Radio Receiving Apparatus.  
Frost Fones and other accessories.  
Magnavox.  
All Radio Corporation of America Receivers.  
Remler Radio Mfg. Co.—full line of parts.  
Baldwin Phones—all models.  
Tungar and Homcharger Rectifiers.  
Atwater-Kent Radio Parts.  
Bradleystat.  
Fada Parts.  
Western Electric Loud Speakers and Amplifiers.  
Eveready Batteries.

*And Others too Numerous to Mention!*

**Coast Radio Company  
Incorporated**

**EL MONTE, CALIF.**



# Audiola adopts the Bradleystat

*Another Radio Manufacturer discards the wire rheostat!*

*Why? Read this letter—*

January 2, 1923.

Allen-Bradley Co., Milwaukee, Wis.

Gentlemen:

Regarding the Bradleystat in the Audiola Receiving Set, we wish to advise that while your rheostat is more expensive than the wire-wound type, we would not go back to the wire rheostat and have standardized on the Bradleystat.

The Bradleystat is noiseless, permits more accurate tuning and increases the loudness of signals and the range of our set. Since incorporating the Bradleystat, we have received many letters from dealers and users stating that they are receiving stations 700 to 1,100 miles distant with our single tube detector set.

Yours very truly,

AUDIOLA RADIO COMPANY.

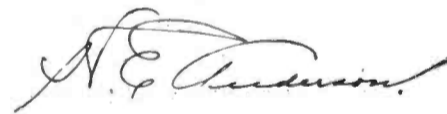

Sales Manager

For bulletins, write to  
**Allen-Bradley Co.**  
Electric Controlling Apparatus  
288 Greenfield Avenue  
Milwaukee, Wis.

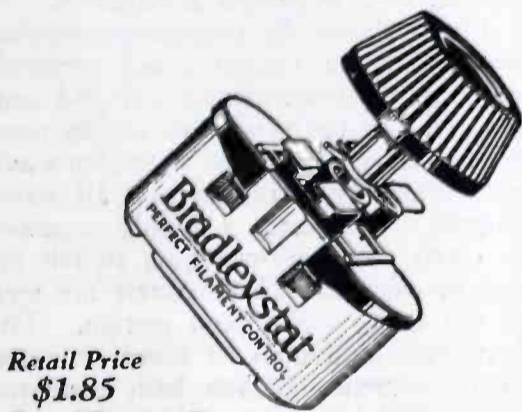
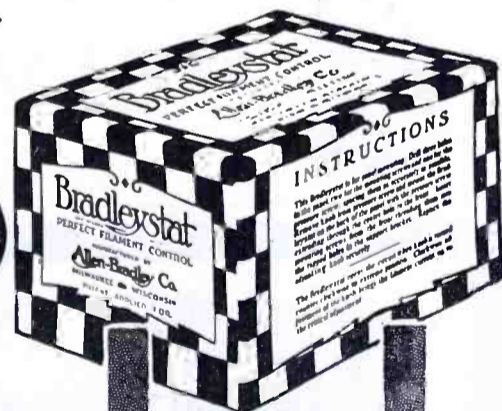

Retail Price  
**\$1.85**

Parcel Post 10c Extra

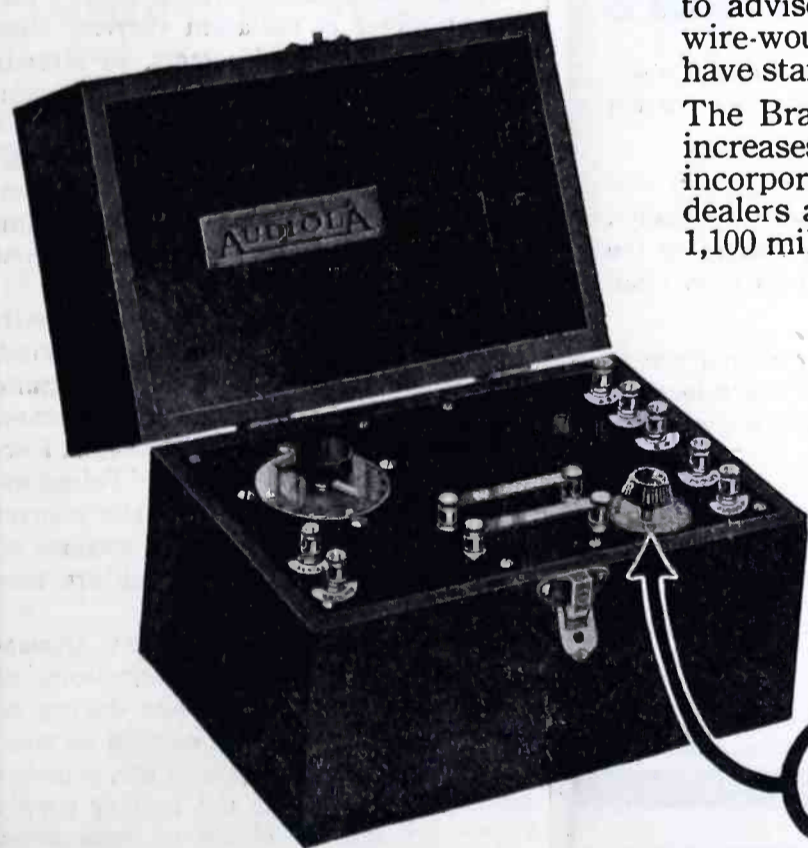

# Bradleystat

REGISTERED

U. S. PAT. OFF.

## PERFECT FILAMENT CONTROL

Tell them that you saw it in RADIO

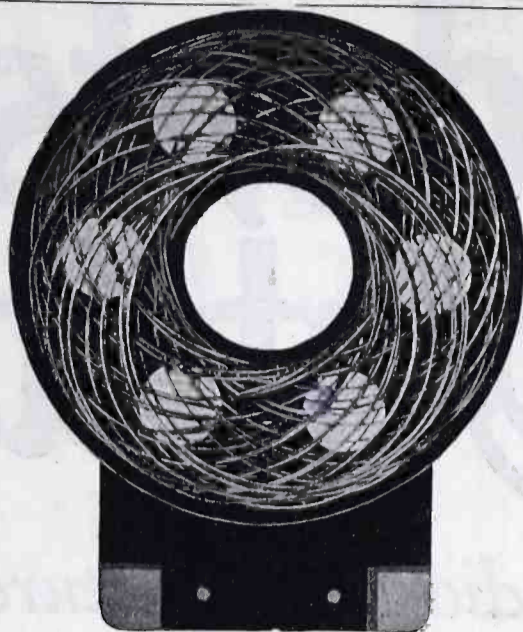

# CURKOIDS

CURKOIDS are inductances wound in the form of Curtate Epitrochoids. This form of winding does result in minimum distributed capacity and maximum concentration of the valuable inductance.

Resulting in maximum signal strength and clearness of tone in both broadcast and code reception.

## CURKOIDS

No. 20K...\$1.20	No. 250K..\$2.10
No. 25K... 1.25	No. 300K.. 2.20
No. 35K... 1.35	No. 400K.. 2.30
No. 50K... 1.50	No. 500K.. 2.50
No. 75K... 1.60	No. 600K.. 2.70
No. 100K.. 1.70	No. 750K.. 3.00
No. 150K.. 1.80	No. 1000K. 3.30
No. 200K.. 1.90	No. 1250K. 3.75
Curkoid Triple Coupler.....	No. 1500K. 4.25
Curkoid Dual Coupler.....	Curkoid Triple Coupler.....
Curkoid Adapter .....	Curkoid Dual Coupler.....
	Curkoid Adapter .....

Patents Pending

**RIEGER RESEARCH CORPORATION**

122 W. 14th St., New York City

## RADIO TELEPHONE SET

*Continued from page 16*

duced by the presence of 48,000 ohm resistances in series, whereas in the final stage only a 2000 ohm reduction is necessary. The unavoidable hum of the dynamotor, which would ordinarily be so loud as to render use in an amplifier or receiver quite impossible, is reduced by means of a combination of choke coils and condensers to such an extent as to be practically inaudible. This is an achievement that promises well for the development commercially of a device to accomplish the same thing on a 110-volt d.c. line and eliminate the care and expense of storage and B batteries.

Fig. 4 shows the transmitter receiver unit with the tuning panel removed, showing the transmitting coil and condensers. In the process of tuning these are mutually adjusted so as to give maximum efficiency of radiation at all wavelengths. Thereafter it is only necessary to rotate the wave-changing switch for instant change. Three meters are seen in the upper right hand section. The first reads milliamps of space or dynamotor current. When both oscillator and modulator are in place the space current is approximately 50 mils. The second meter is radiation current, close to one amp. at 300 meters, as already mentioned. The last meter reads filament current (1.2 to 1.5 amps.). To the right of this meter is seen a small switch labelled "amplifier." This controls amplification by varying the number of turns in the secondary of the first amplifying transformer (see Fig. 3). The other controls are almost self-explanatory. The wave-changing switch is labelled AP, LW, SW, meaning aperiodic (or broad tuning) long wave, and short wave. The small switch, lowest down of all, labelled "Telephone Transmitter" merely shifts the control of the set to any one of three stations on the ship where voice transmitters may be located.

A brief mention of auxiliary apparatus would include the dynamotors, of which there are two, so that during an extended conversation one could be cooling off while the other is in use, a power panel which controls the battery supply to the set and the choice of dynamotor, head sets, transmitter and push control in one unit, so that by merely pressing this push control the set is automatically shifted to the send position, and finally loud speaking telephone.

As to the use of the C. W. 936 radio-telephone set in peace times quite a good deal can be said. It is at present being marketed by a large department store. In country districts it should prove exceedingly useful and in places such as the West and in Canada, where telephone lines are not well developed, it could be an excellent bridge between towns or posts miles apart.

# The New R T-8 Radio Frequency Transformers

on the market March 1st, 1923, are specially designed by the *Radio Service Laboratories* for maximum efficiency when used with any low filament current consumption and low voltage tubes on the market.

For Audio Frequency the new RT-A2 will give you 100% Tone Quality and High Amplification without distortion. For best results on both tone and distance, use *Radio Service Laboratories* Radio Frequency R T-8 (for all stages) in the black case, retail price \$6.00, and Audio Frequency R T-A2, in brown case, retail price \$6.50.

For sale at all reliable electrical or Radio Stores. If your dealer cannot supply you, order direct. Order by type number, accept no substitute, and remember that all *Radio Service Laboratories* Transformers are individually triple tested and unconditionally guaranteed.



Send ten cents for new booklet on Radio Frequency with schematic diagrams—a most valuable and helpful publication for radio amateurs and expert.

## RASLA SALES CORPORATION

National Distributor

Dept. C

10 East 43rd Street

New York City

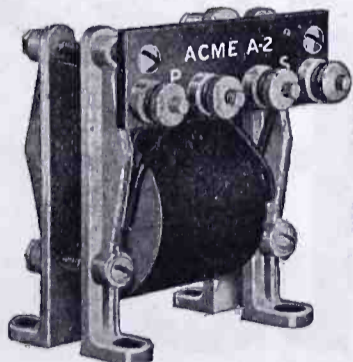

Acme A. F. Transformer..\$5.00

## ONE HOUR RADIO SERVICE

*All Orders Shipped One Hour  
From Receipt*

**Get Our New Price  
Bulletin Today!**

## COMPLETE LINE

**PORTS RADIO MANUFACTURING CO.**

3305 Belmont Ave.

QST RADIO SHOP

FRESNO, CALIF.

Tell them that you saw it in RADIO

## Magnavox prices are the result of Magnavox quality

IN the long run, the price of the really successful and satisfactory product is set by the purchaser—not by the maker or the dealer.

Because when the manufacturer and dealer charge too much for a product, they destroy its market; and when they charge too little they destroy its quality—which results in the something—loss of market.

Magnavox Radio products are of the highest quality—and their prices bring them within reach of every serious radio user.

### R2-18 Magnavox Radio (With 18-inch horn)

This instrument is intended for those who wish the utmost in amplifying power; for clubs, hotels, dance halls, large audiences, etc. It requires only .6 of an ampere for the field.

Price \$60.00

### R3-14 Magnavox Radio (With 14-inch horn)

As illustrated

The ideal instrument for use in homes, offices, amateur stations, etc. Same in principle and construction as Type R-2.

Price \$35.00

### AC Magnavox Power Amplifier

As illustrated

For use with the Magnavox Radio and insures getting the largest possible power input.

2-stage, \$55.00

3-stage, \$75.00

Magnavox Radio, can be used with any receiving set of good quality. Ask your dealer to demonstrate it with the Magnavox Power Amplifier, as illustrated. This combination produces the most satisfactory results.



*What matters bad weather  
when Radio entertains?*

RADIO'S "every-hour-every-where" broadcast schedule is the most stupendous organization of the means of entertainment the world has ever witnessed.

So responsive have people been to the opportunity of enjoying these programs at their best that Magnavox equipment has become synonymous with the full enjoyment of radio music and speech for an ever-greater circle of satisfied users.

*Magnavox Products can be had from good dealers everywhere. Our interesting new booklet will be sent on request.*

The Magnavox Co., Oakland, California  
New York: 370 Seventh Avenue

# MAGNAVOX

## Radio

### The Reproducer Supreme

Tell them that you saw it in RADIO

SOLD  
THROUGH  
JOBBER  
DEALER

# K & C RADIO

**K**UALITY  
**C**ERVICE

**KILBOURNE & CLARK MFG. CO., SEATTLE, WASH.**

**SAN FRANCISCO BRANCH: 591 MISSION ST.  
PHONE SUTTER 40**

## No More Storage Batteries

The new WD-11 vacuum tubes requiring but a single dry cell to heat the filament have opened up a whole new field in radio. Sets are now brought within the reach of vast numbers who could not even consider them before. These new tubes differ in construction from the older types of tubes and require different associated instruments. For this service we announce the following:

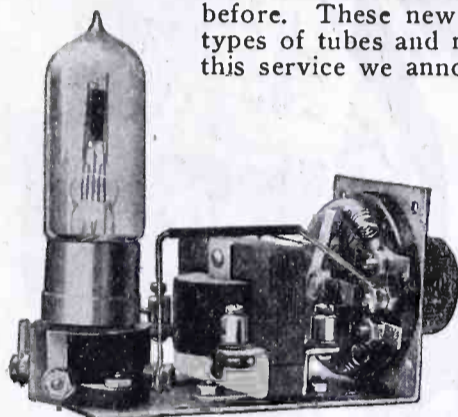

### Type 300-A AMPLIFIER UNIT

A compact unit consisting of our Type 231-A Amplifying Transformer, Type 225 Filament Rheostat and Type 282 WD-11 Tube Socket mounted on a nickel finish brass mounting. These parts are all wired ready for the external connections. The mounting is so designed that the unit may be used on a table or mounted behind a panel with only the rheostat knob projecting.

Price . . . . . **\$7.50**

### TYPE 282 WD-11 TUBE SOCKET

A socket of molded bakelite arranged with positive contact springs to take the WD-11 tubes. This is a socket in itself, not an adapter.

Price . . . . . **80 cents**

### TYPE 255 RHEOSTAT

A rheostat of molded bakelite, not a substitute, for panel or table mounting, smooth in operation and attractive in appearance. Resistance 6 ohms, with current carrying capacity of 1.25 amperes.

Price . . . . . **\$1.00**

### TYPE 247 CONDENSERS

These already popular condensers may now be equipped with gear and pinion providing a vernier adjustment with but a single setting. A low loss condenser with a micrometer adjustment at a fair price. Used in large quantities by such representative organizations as the Western Electric Company. Made in eight types.

Prices . . . . . **\$3.25 to \$7.75**

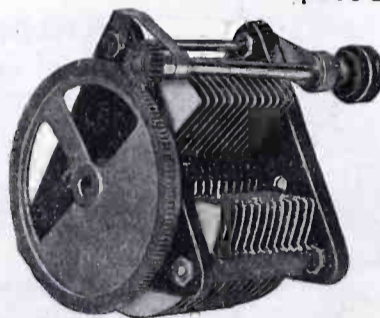

### TYPE 231-A AMPLIFYING TRANSFORMER

Remember that this transformer is particularly suited to the WD-11 tubes.

Price . . . . . **\$5.00**

Send for NEW FREE RADIO BULLETIN 913-C and learn about these instruments

## GENERAL RADIO COMPANY

MASSACHUSETTS AVENUE AND WINDSOR STREET

CAMBRIDGE 39

MASSACHUSETTS

Do not confuse the products of the GENERAL RADIO CO. with those of other concerns using the words "General Radio." The General Radio Co. has been manufacturing radio and scientific instruments for many years. It has no affiliation with any other company.

**Standardize on General Radio Equipment Throughout**

### 1½ VOLT WET COIL

*Continued from page 19*

1½ volts, which is just the amount needed for the filament of the so-called dry-cell tube.

**CAUTION:** Before using this cell on a dry-cell tube, give it a short circuit test for maximum voltage! It is easy to construct the cell (especially with the latitude allowed in the size of jars, and the possible over-dose of sal-ammoniac) so that it will have a terminal voltage greater than the filament of a W D 11 will stand. This is important! If desired to cut down the voltage of this cell, take away one of the zinc rods, or make the zinc plate smaller, as the case may be.

### SPARK McALLISTER

*Continued from page 23*

respectful to your uncle. Next time I want to tell you about calling old 5—"

"You win! You win!!" broke in Wildcat. "Don't tell me a thing!"

"Just one little hint," said Sparks. "It's the receiving station that will have to improve, not you, for you've got a mighty good wave—for a spark set! And—did you ever hear of a wave-trap?"

"Yeah," said the younger man with an intriguing disregard for the rules of pronunciation, "but they aren't practical for ham use."

"Ever try one?" asked Sparks.

Wildcat shook his head.

"Heard they were the bunk!" he commented.

"Wait 'til I show you the one I just made—and listen to it work!" said McAllister, as he stepped out into the night.

"Be over tomorrow night!" sang out Wildcat, and . . . . .

"Suits me!" called back Sparks, accent on the first word, as became a good poker player.

And that's how Wildcat happened to hear of McAllister's practical wave-trap, which—But if we told about that now, what would we write about next month?

Tell them that you saw it in RADIO

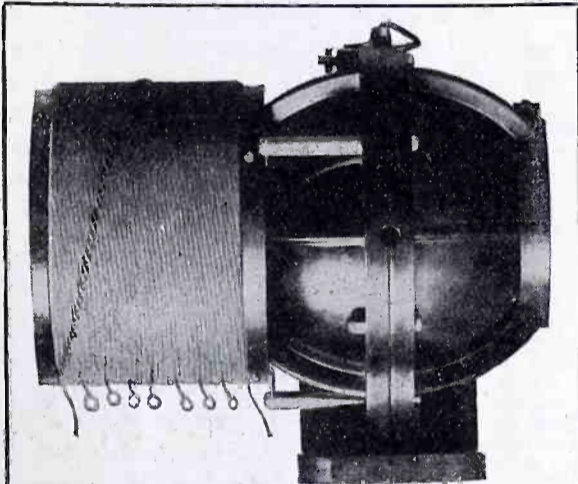

Catalogue No. 165.....\$13.00  
SE-AR-DE RADIOMETER WITH  
B. W. INDUCTANCE

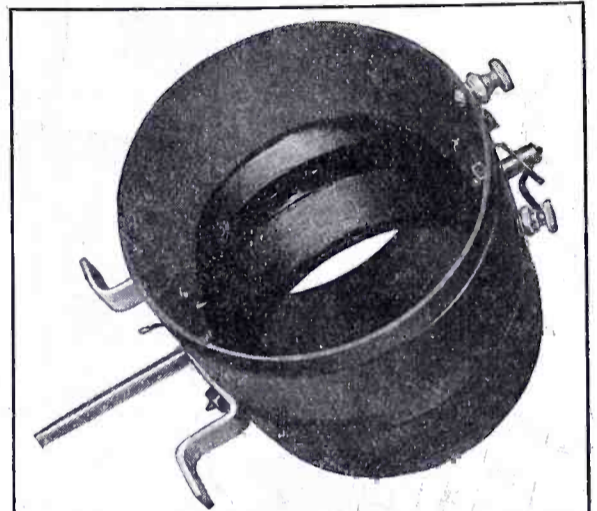

Catalogue No. 166.....\$5.50  
SE-AR-DE VARIO COUPLER  
(Center Rotor Type)

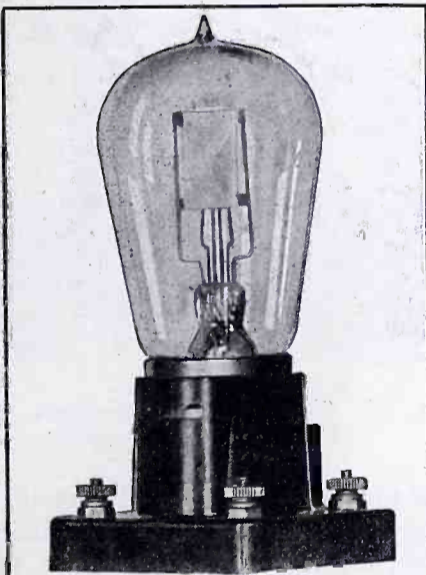

Catalogue No. 163...\$1.00  
SE - AR - DE VACUUM  
TUBE SOCKET for stand-  
ard and W.E. VT2 without  
change.

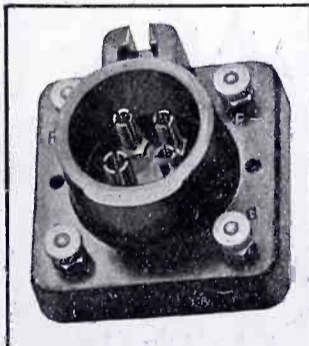

Catalogue No. 199,  
\$1.00  
SE-AR-DE Socket  
for WD11 Tube,  
positive contacts.

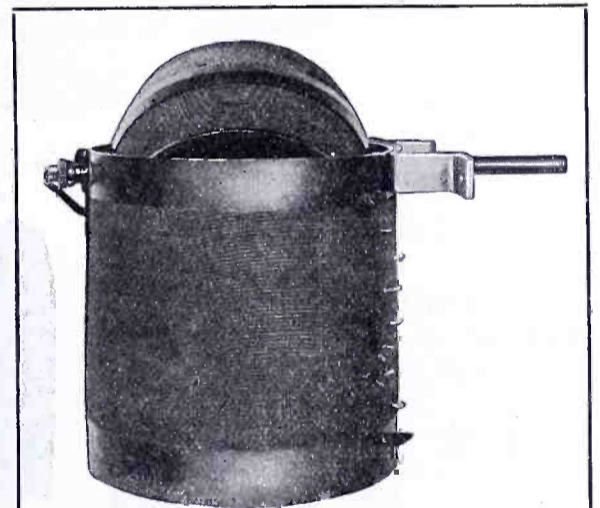

Catalogue No. 167.....\$5.50  
SE-AR-DE VARIO COUPLER  
(Bracket Type)

# R. MITCHELL & CO.

255 Atlantic Ave.

Boston, Mass.

*For 47 years Manufacturers of Scientific and other equipment  
Look for trade mark on every piece*

**Jobbers and Dealers write for discounts**

Tell them that you saw it in RADIO



# Radio Catalogue FREE

One copy of this complete Catalogue of Radio Outfits, parts, Dictionary of Radio Terms, Instruction Book, and Guide to Successful Radio Work—one copy is yours Free.

Simply write us a post card and we will mail the complete book to you Free, by return mail.

It quotes the lowest prices, amazingly low prices on everything for the expert and the amateur. Every improved part, the most up-to-date outfits, everything that is needed of the most modern type—at the lowest possible prices.

It gives a list of broadcasting stations, and gives much information about radio construction and operation. Every one interested in Radio needs this complete catalogue and book of instruction.

## Why Pay Higher Prices?

Montgomery Ward & Co. has for fifty years dealt on a Money-Back basis, absolutely guaranteeing everything they sell. With quality absolutely assured, why pay higher prices elsewhere? Write today for this Free Radio Book and see for yourself the Saving it will bring you.

One copy is yours Free. You need only write us a post card.

Write to the house nearest you. Address Dept. 39-R.

Chicago Kansas City St. Paul Fort Worth Portland, Ore.



# Montgomery Ward & Co.

—The Oldest Mail Order House is Today the Most Progressive—

## RADIO BROADCASTING

Continued from page 18

microphone not only picked up sounds originating in its immediate vicinity but also sounds from instruments at some distance away. Since sound waves travel at a comparatively slow rate of speed, it followed that music from any one instrument would be picked up by one microphone before the wave would arrive at another located some distance away. Since all the microphones were connected together in the same pick-up circuit, hopeless distortion resulted. The single collecting device was accordingly resorted to. In passing, it may be of interest to note that in all of the Western Electric broadcasting stations, for these have set a standard by which all others are compared, and in most of the independent stations, only a single pick-up device is used at one time.

In November, 1920, the first transmitting station on the Atlantic Coast

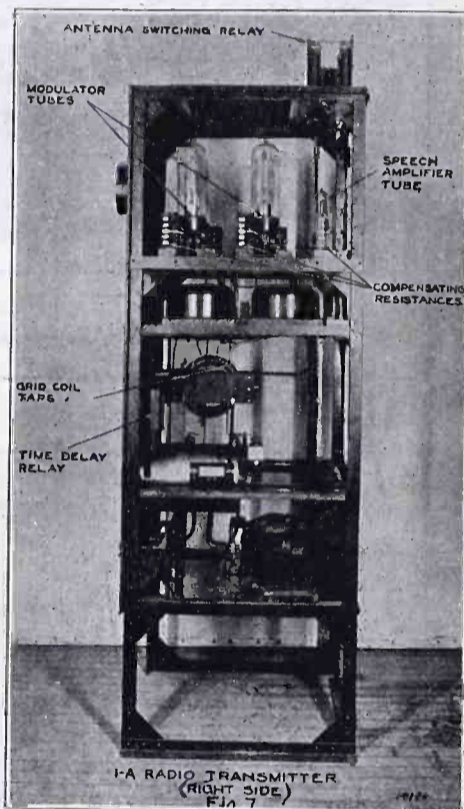

Fig. 84. Side View of 500-Watt Western Electric Broadcasting Set

was put into operation, that of the Westinghouse Electric and Manufacturing Company at East Pittsburgh. This set employed the Colpitts-Heising system of modulation, a system which is in use at practically all broadcasting stations today.

Following the installation of the East Pittsburgh station, high powered stations were installed at many points throughout the eastern states. In 1922 the Western Electric Company put on the market a 500-watt broadcasting set which was developed as a result of that company's experience in furnishing radiophone communication for the Pacific Telephone and Telegraph Company between Long Beach, California, and

Continued on page 54

Constant, steady voltage.  
No battery noise in your V. T.  
Easily recharged at home.  
A life of from 3 to 5 years.  
Jelly electrolyte, no spillage.  
Clip on for any required voltage.

—A FEW OF THE REASONS WHY

### SNELL CELLS STORAGE "B" BATTERY

should be on YOUR set.  
At your Radio Dealer, or

22 v., 11 cells.....	\$ 6.50
44 v., 22 cells.....	12.00
Chemical Rectifier.....	1.25

F.O.B. San Francisco

Order yours now for immediate shipment.

MANN & SNELL 6BQL 4733 Geary St., San Francisco, Cal.

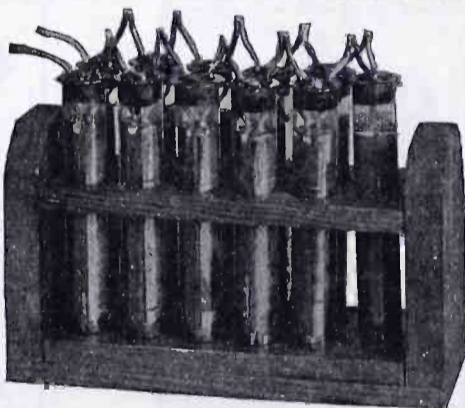

Send 10c for new and complete catalog  
Dealers and Jobbers write for our discounts  
EMPIRE RADIO CORPORATION  
271 W. 125th Street, New York City

*Investigate!*  
**WESTERN-RADIO DEALERS SERVICE**  
Wholesale RADIO Only  
637 So. Hope Street, LOS ANGELES  
565 Howard Street, SAN FRANCISCO

You should be a subscriber

Tell them that you saw it in RADIO

# Victory-Grantone

In developing these Victory-Grantone units our aim was concentrated to produce complete self-contained units of highest efficiency and of such design that would permit its production on a large commercial scale. We knew, in this way, we could market them at rock-bottom prices. Simplicity was our watchword, but not to the point of sacrificing efficiency and beauty, but to eliminate useless expensive parts which do not add to the performance of the set. We have finally accomplished our aim and offer to radio buyers the fruits of our efforts at prices of astounding value.

## Victory Grantone

### Radio Receiver No. 520

A most complete receiving amplifying and loud speaking radio set of compact and attractive design. Detector and Amplifying Loud Speaker units, which are described below, are mounted on a beautiful mulberry colored velour base. Completely wired ready for use.

Efficient receiving radius is conservatively rated at one hundred miles, although reception of over five hundred miles is being regularly accomplished with it with remarkable ease and volume. For long distance receiving, however, we recommend the additional use of our No. 575 DX Unit, which brings in louder signals and increases range of set to over a thousand miles. This unit may be added on at any time. Requires no storage battery, but operates only on two or three dry cells.

Price without tubes . . . . \$55.00  
Price complete, with tubes and batteries . . . . . \$85.00

## Victory Grantone

### Radio Receiver No. 550

Truly, this is the most compact, neatest and totally self-contained complete radio receiver yet developed. Embodies everything necessary for its operation. No unsightly loose batteries, wires, parts, etc., but can readily be carried from place to place and ready for instant operation. The Detector and Amplifying Loud Speaker units, which are described below, are mounted on a beautiful leather-covered cabinet containing both 'A' and 'B' batteries, with space provided for tubes when not in use.

This set has an efficient receiving radius of one hundred miles, although users are reporting continuous reception of over five hundred miles with remarkable clarity. For long distance receiving, however, we recommend the additional use of our No. 575 DX Unit, which increases receiving range to upwards a thousand miles. Operates on two dry cells without storage battery.

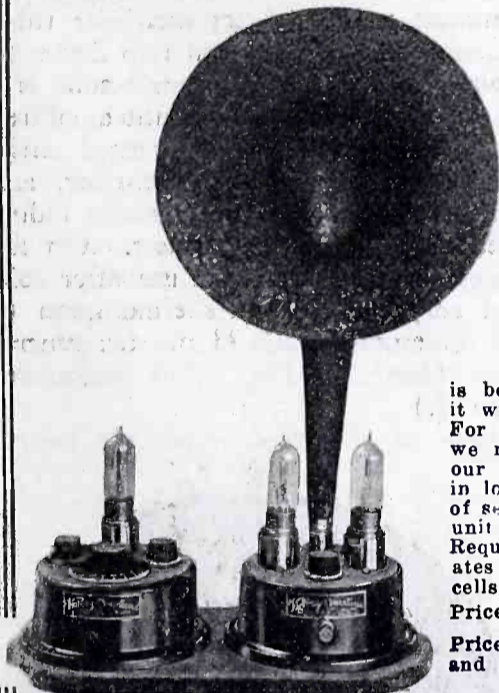

Price without tubes and batteries, \$65

## Victory Grantone

### Amplifying Loud Speaker No. 525

This unit has no equal in the entire radio industry. Enables everybody now to fully enjoy radio entertainment without nuisance of taking turns with head receivers. Operates with equal remarkable efficiency from the simplest kind of crystal set to the most elaborate vacuum tube detector.

Contains besides two stages of audio frequency amplification a super sensitive loud speaking element with heavy mica diaphragm adjusted to give a true natural mellow tone, which can be controlled from a soft audible sound to a mighty volume.

Horn is of durable wood fibre composition designed on best acoustic principles.

A Victory Selector Jack with automatic filament control gives one or two stages of amplification. No storage battery, works on two dry cells.

Price without tubes . . \$37.50  
Price with tubes and batteries complete . . . \$54.00

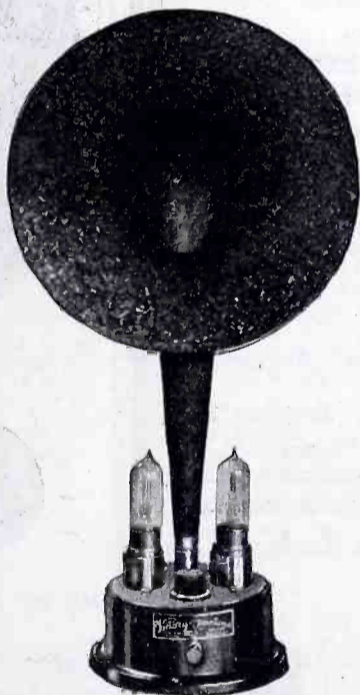

## Victory Grantone

### Loud Speaker No. 530

They are the best value on the radio market.

Has same sensitive heavy mica diaphragm loud speaking element as our Amplifying Loud Speaker. Faithfully reproduces in a natural mellow tone, without distortion or rattling, the finest notes from near and distant stations. Free from all metallic sounds. Designed for use on one or two stages of audio frequency amplification.

The horn is wood fiber composition, designed on best acoustic principles for perfect clarity and maximum volume. Neatly finished with crystallized black enamel. Furnished complete with cord.

Better one cannot be bought for three times the price. Fully guaranteed.

Price complete . . . . . \$16.50

Horn with base and phone adaptor . . . . . \$8.00

## Victory Grantone

### Detector Unit No. 500

Tuning is simple, sharp and very selective. Encased in a housing which shields it from all body capacity effects and other external influences, thereby giving maximum receiving efficiency.

Range 175 to 700 meters. Receiving radius conservatively rated at one hundred miles, but used with No. 575 DX Unit increases range to upwards one thousand miles.

Operates with one dry cell. With tube and batteries . . . . . \$27.50

Detector and amplifying loud speaker can also be furnished for use with standard 6v. tubes.

## Victory Grantone

### DX Unit No. 575

By simply connecting this unit to the output binding post of the detector unit creates an efficient regenerative circuit which increases strength of signals and receiving range. Also makes tuning sharper and more selective. Being completely shielded, eliminates all body capacity effects.

Can also be used with any other type of non-regenerative detector.



Price \$10.00

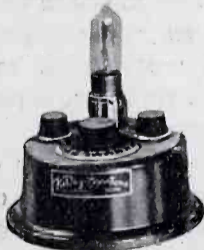

Price without tube \$17.50

DEALERS! Wire or write at once for real merchandising proposition. Send for free descriptive catalog.

VICTORY RADIO-ELECTRO CO., 559-561 Howard Street, San Francisco

Tell them that you saw it in RADIO

# MARLE

**Audio Frequency**

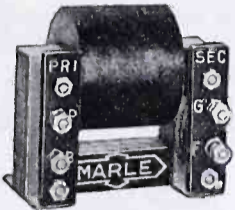

**TYPE A4**  
Black Terminal Boards  
Ratio 3 3/4 to 1  
List Price \$3.75

**Radio Frequency**

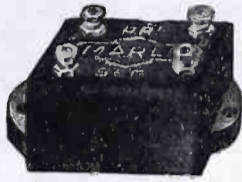

**TYPE R1**  
List Price \$4

**Audio Frequency**

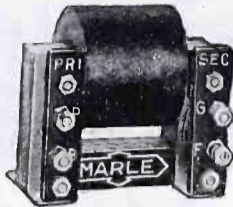

**TYPE A6**  
Red Terminal Boards  
Ratio 5 to 1  
List Price \$4.25

Type A6, List Price \$4.25

## TRANSFORMERS

Superior Quality Transformers Used and Recommended by Leading Reputable Manufacturers of Radio Apparatus.

MANUFACTURED BY

**MARLE ENGINEERING CO.**  
ORANGE, N. J.

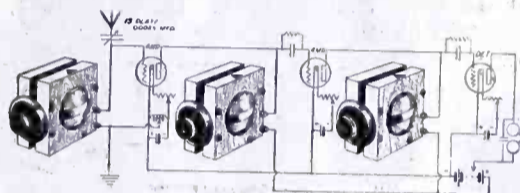

Two Steps of Radio Frequency Are Better Than One, and Best When Using

**CYMO**  
TRADE MARK REG.  
**VARIOMETERS**

**BECAUSE**—Cymo puts a smaller effective resistance into your circuit on account of its smaller distributed capacity, one-third that of any molded variometer.  
**BECAUSE**—Cymo requires a smaller condenser when used in series with it to tune your aerial circuit; never use more than a thirteen plate—it isn't necessary. You save the difference in cost between 13 and 23.  
**BECAUSE**—Cymo will give you better regeneration, longer distance reception on wavelengths as low as 150 meters, and best results on radio frequency.  
**If You Drop It—It Won't BREAK. Can You Say as Much for Molded? Made of Kiln Dried Spanish Cedar—It Won't WARP. Double Silk Insulated Wire. Nickel Plated Shafts, Bearings, etc.**

**CYMO IS BUILT, NOT ASSEMBLED**

If your dealer does not carry, order direct C. O. D. and send us his name. The price is **FIVE DOLLARS—Worth Every Cent of It.**

We Build the Cymo Units and Special Sets.

**RADIO DEVICE CO.**  
693 Mission Street, San Francisco, California

Hook-ups Furnished with Every Order.

## ATTENTION! RADIO DEALERS

The Tremendous Demand

For

# EBY

**BINDING POSTS**

Is Greater Today Than Last Spring



Commander



Ensign



Corporal



Sergeant

We anticipate a great volume of business during the coming Spring, and we request that you anticipate your orders through your nearest jobber at once. There is an EBY jobber in or near your City, but if you are unable to procure our products, send us your order with your jobber's name and we will ship direct and bill you through him. When placing orders with your jobber, don't fail to ask for a quantity of attractive EBY literature.

**The H. H. EBY Mfg. Co., Philadelphia, Penn.**

Tell them that you saw it in RADIO

Continued from page 52

Catalina Island, a small island in the Pacific about thirty miles from the Coast. More than a score of these sets are now in operation.

The Western Electric equipment, as has been stated above, represents the latest and highest development of tube circuits for radiophone broadcasting purposes.

Fig. 84, showing side view of 500-watt Western Electric Set. You will see that four large tubes and one smaller tube are employed. The large tubes comprise two 250-watt oscillator tubes connected in parallel and two 250-watt modulator tubes. The small tube is a 50-watt tube used as a speech amplifier.

Below the tubes are mounted choke coils and modulation transformer, and below the latter are the antenna inductance and variable condenser. On the lowest shelf are mounted the filter coils and condensers for the elimination of the commutator hum of the d.c. generator. (Refer to Fig. 83 of assignment No. 13.)

One of the most important instru-

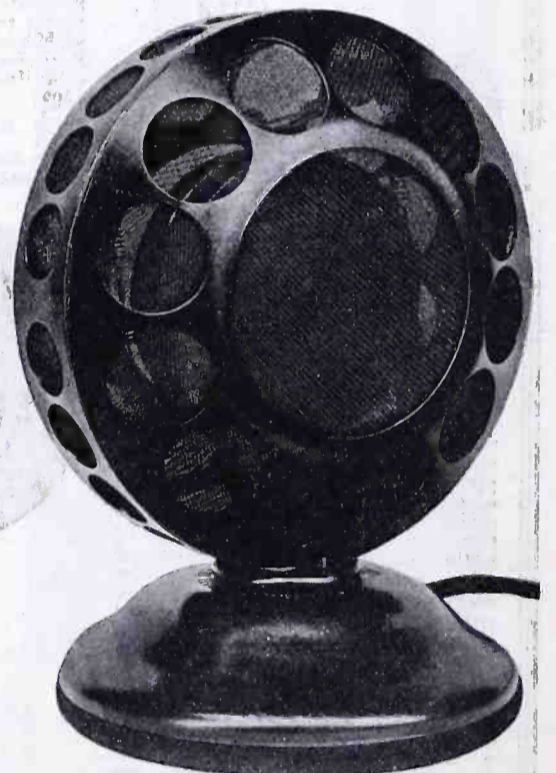

Fig 85. Capacitative Transmitter Microphone

ments in a radiophone transmitter is the microphone. Two types are common. For ordinary speech and music, a carbon microphone of refined construction is used, but for special work, such as the broadcasting of organ music, a capacitative transmitter is generally used. The latter type consists of two metallic disks or diaphragms, insulated from each other so as to form a condenser. As the outer diaphragm vibrates, the distance between the two disks is varied and the capacity is therefore increased and decreased. By connecting such a transmitter in a suitable modulation circuit, excellent reproduction is obtained, but considerably

Continued on page 56



# PROGRESS

**N**ATURALLY, at this early stage, the Art of Radio Communication is not standing still. It is undergoing a normal evolution.

The low-hung, straight line automobile of today is unlike its cart-like predecessor of twenty years ago, although the principle of locomotion remains the same.

So, too, the design of Radio apparatus advances. Insulated panels and live shafts are supplanted by metal panels and completely insulated instruments—the obvious thing to do, making unnecessary the use of a shield. Unsightly, protruding knobs are replaced by recessed dials and straight tuning bars, permitting fine adjusting without cramping the hand. The tap switch is removed entirely from the panel and becomes an integral part of the variocoupler, being placed *inside* the rotor, thus eliminating all soldering of primary leads.

It is significant that all these improvements have been developed in the Eisemann laboratories.

*Descriptive literature  
will be sent upon request*

**EISEMANN MAGNETO CORPORATION**

William N. Shaw, President

BROOKLYN, N. Y.

DETROIT

CHICAGO



Tell them that you saw it in RADIO

Continued from page 54

more speech amplification is required with this transmitter than with the microphone type.

Fig. 85 shows the latter type. It consists of a special form of microphone transmitter, so designed that both outward and inward movements of the diaphragm are utilized. The transmitter itself is suspended on springs within the housing shown so as to be unaffected by external vibration. This microphone is so extraordinarily sensitive that it picks up with almost equal intensity sounds at distances of a few inches to more than ten feet. For example, a canary singing in the studio of the Los Angeles "TIMES" station has been clearly heard on the "air," although its cage was fifteen feet from the microphone.

It is customary at broadcasting stations to install the actual transmitting equipment in a room separated from the studio proper. This prevents any extraneous noises attendant upon the manipulation of the apparatus from being picked up by the studio microphone. In addition, since the actual music or speech in the studio cannot be heard in the transmitting room, a better check can be maintained on the quality of the modulation through the use of a dummy receiving set installed in the transmitting room.

The studio itself is so designed as to eliminate the reflection or reverberation of sounds from the walls, floor and ceiling. In some studios, this is effected by covering the walls with heavy draperies, or by placing an inner lining of heavy felt between the walls. The latter method is used in all studios operated in connection with the Western Electric sets.

Adjoining the studio is generally some form of ante-room for the reception of performing artists. A hostess or attendant is usually in charge. Here artists are received and await their turn on the program.

In the studio itself, a director announces the various numbers on the program and reads the press dispatches. The director is also charged with the preparation of the program, and, in the case of amateur talent, conducts the "try-outs" outside of concert hours.

Frequently, in order to simulate actual stage performances, artists appear in the costumes which they are accustomed to wear in rendering their professional numbers.

In assignment No. 13 was mentioned the use of speech amplifiers for amplifying sounds picked up at concerts, church services, etc., several miles from the transmitting station. By arrangement with the American Telephone and Telegraph Company, it is possible to pick up musical entertainment or other programs at any point and to relay them over

Continued on page 58

# MU-RAD RECEIVERS SUPREME



*EVERYDAY RECEPTION* over distances that far outstrip the commonly accepted records — this (not baseless claims) is the evidence of MU-RAD superiority. The only set that can achieve such astonishing sensitivity, using a small loop aerial. Delightfully fine selectivity. With all this efficiency and completeness, utterly simple to operate. Each set guaranteed for 1000 miles reception.

**4300 MILES**  
on an indoor loop aerial

Four thousand, two hundred and seventy-eight miles away in Honolulu, the Royal Hawaiian Orchestra plays for delighted listeners in St. Louis, U. S. A., through their MU-RAD Receiving Set. An example of MU-RAD supremacy.

Write For Literature.

The New  
Star in  
the Radio  
World



## MU-RAD LABORATORIES, INC.

806 FIFTH AVE. ASBURY PARK, NEW JERSEY

Try **REYNOLDS RADIO Service**

**9ZAF**

from **DENVER**

**KLZ**

The exclusive distributors of

## KENNEDY EQUIPMENT

IN THIS TERRITORY

If you have a **KENNEDY Receiver** you have the best in Radio

**REYNOLDS RADIO CO., Inc., 1534 Glenarm St., Denver, Colo.**

Largest distributors of Radio Apparatus in the West

? Did YOU receive our 68-page Catalogue ?

Tell them that you saw it in RADIO

# Popular!

## -for good reasons

**R**ADIO enthusiasts wanted an expertly designed, moderate-priced set that any intelligent man or woman could operate. So we built the Popular, to sell at a popular price.

Just two dials to turn to find the stations broadcasting within a range of 500 miles. As you become more experienced you can reach out twice as far. You don't have to become an expert to operate this set to your complete satisfaction. But the more you know about radio, the better you will appreciate it.

The fine piano finish, mahogany case, moulded and shielded panel, Bakelite dials and splendid beauty of the Popular promises you a set you will be proud to own. And that promise comes true! It is the ideal set for busy folks who want the thrills of radio.

THE C. D. TUSKA CO., Hartford, Conn.

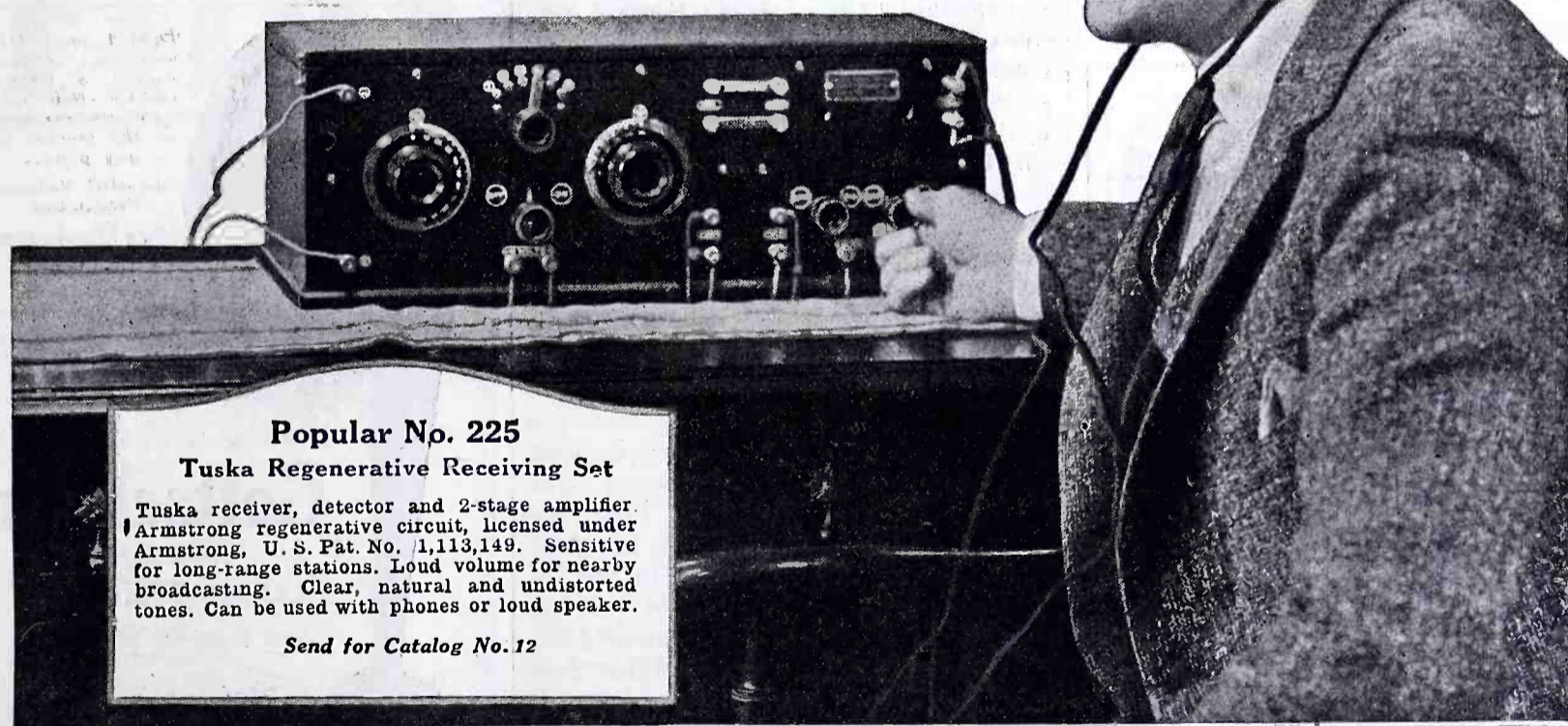

### Popular No. 225

#### Tuska Regenerative Receiving Set

Tuska receiver, detector and 2-stage amplifier. Armstrong regenerative circuit, licensed under Armstrong, U. S. Pat. No. 1,113,149. Sensitive for long-range stations. Loud volume for nearby broadcasting. Clear, natural and undistorted tones. Can be used with phones or loud speaker.

Send for Catalog No. 12

# TUSKA RADIO



Tell them that you saw it in RADIO

Continued from page 56

standard telephone lines to any Western Electric broadcasting station.

One notable example of church service broadcasting by this method was recently given in New York when the entire service was sent from a church by radio over a distance of one thousand miles. Not only the organ music, but the singing of the congregation, the sermon and the altar service were clearly audible. Microphones were placed at different points within the church and were switched into operation at different parts of the service according to their locations.

In orchestral broadcasting a single microphone is employed, irrespective of the number of instruments; the reason for which has already been explained. The stringed and wood-wind instruments are placed near the microphone and the brass and other heavy instruments are placed at a greater distance so as to produce the proper ensemble effect.

Radiophone broadcasting stations are licensed by the Department of Commerce, as are all radio transmitting stations. Two classes of licenses are in effect—A and B. Class A stations are those with less than 500 watts output, and these transmit on a wavelength of 360 meters. The majority of stations are in this class but are rapidly being supplanted by the Class B stations. Stations of the latter class are licensed to transmit on a wavelength of 400 meters so that they will not be interfered with by Class A stations. It is required by the Government that Class B stations have an output of 500 watts, that the modulation be distortionless and complete, and that no phonographic music be broadcasted. The stations of the Radio Corporation, the General Electric and Westinghouse Companies, and the stations employing Western Electric equipment are in this class.

At the present time, radiophone broadcasting stations are owned and operated by various interests. First, we have the large manufacturers of radio equipment who are interested in the development of the art and the sale of radio apparatus. Next in importance, on account of the publicity which they control, are the large newspapers. A third class comprises the rest of the owners who derive sufficient advertising from the operation of broadcasting stations to warrant the expense of installation, maintenance and programs. In some localities, the radio interests band together to defray the program expense of a Class B station which may be owned by a concern foreign to the radio field. In other vicinities, the public, which derives the benefit of radio entertainment, contributes directly or indirectly to the maintenance of broadcasting stations.

Tell them that you saw it in RADIO

# SOMETHING



# \$ 1<sup>00</sup>

# NEW

### SELECTIVITY AT LAST!

The **UNIVERNIER** obtains selective tuning through vernier action. It is an attractive bakelite knob substituted for the ordinary knob on the shafts of Variometers, Vario-couplers, Variable Condensers, Potentiometers, and Rheostats and may be installed in a few minutes.

**THE UNIVERNIER** obtains a ratio of 12 to 1 by means of a self contained mechanism which is so constructed that rotation of the knob is 12 times that of the instrument shaft. Pressure towards the panel permits coarse adjustment.

**THE UNIVERNIER** . . . . . \$1.00  
 Finely graduated, 360° silver plated dial . . . . . 25  
 (Made for use with the **UNIVERNIER**)—  
**COMPLETE** . . . . . \$1.25

**SEND NO MONEY**—Mail us your order today for one or any number you need to equip your set—and pay the postman for each when delivered:

Made in two sizes  
 No. 251 for 1/4 inch shafts  
 No. 188 for 1/8 inch shafts

*Dealers and Jobbers Write for Discounts*

**WALBERT MANUFACTURING COMPANY**  
 927 Wrightwood Ave. Chicago, Ill.

# UNIVERNIER

### It's the contact that counts



Na-ald W.D. 11  
No. 411

The special phosphor bronze clips of the Na-ald W. D. 11 Socket maintain perfect contact regardless of any variation in tube prongs and bases. Moulded from genuine Condensite, these sockets are made for use with the famous W. D. 11 tubes, operated by a single cell battery.

The Na-ald De Luxe V. T. Socket is of highest quality throughout. Its laminated phosphor bronze strips press firmly with a side wipe action on the contact pins, keeping surface clean and insuring perfect contact.

These sockets retail at 75c each

Send stamp for dial, small-space socket, condenser and R. F. transformer circulars.

**Alden Manufacturing Co.**  
 Formerly Alden - Napier Co.  
 Dept. H 52 Willow Street  
 Springfield, Mass.



Na-ald De Luxe  
No. 400



## Investigate!

# WESTERN-RADIO DEALERS SERVICE

Wholesale Radio Only

637 So. Hope Street, 565 Howard Street  
 LOS ANGELES SAN FRANCISCO



PAT. PEND.

## DUPLEX VICTROLA ATTACHMENT

### NEW PRICE \$3.00

An Attachment of highest quality for making a Radio loud speaker of your talking machine and a pair of head phones. At your dealer or post paid on receipt of price. State make of talking machine when ordering.

**W. B. McMASTERS**  
 Wheeling, W. Va.

# A SUPER LOUD SPEAKER

Not merely a head-phone instrument



The Latest Development to produce a loud speaker that surpasses anything on the market at any price.

**Powerful Volume Producing**

**Mica Diaphragm Element**

Employed in an Entirely New Manner Assures Maximum Clarity With Total Elimination of Distortion

Patent Pending

## Gottschalk

Trade Mark

### LOUD SPEAKER

Will Positively Not Rattle

The Price:

## \$22.00

No Metallic Ring—Beautifully Finished Moderately Priced.

Greater Volume with less energy. Supersensitive for Long Distance Reception.

*Dealers—Write at once for trade proposition.*

## GOTTSCHALK ELECTRIC & MANUFACTURING CO.

992 Howard St., San Francisco

# Proof!

Graphic proof of FIL-KO-STAT superiority as shown here can be had in any laboratory equipped with Bureau of Standards Instruments.

Practical proof of FIL-KO-STAT superiority is evident the moment you put FIL-KO-STATS in place of the devices you now use to regulate filament action.

Here's the Comparison of Fine Adjustment Control Range of FIL-KO-STAT with Rheostats and Other Filament Controls Clearly Indicating How FIL-KO-STAT Excels and Showing Wherein it Permits Perfect and Gradual Current Increase With Infinite Adjustments

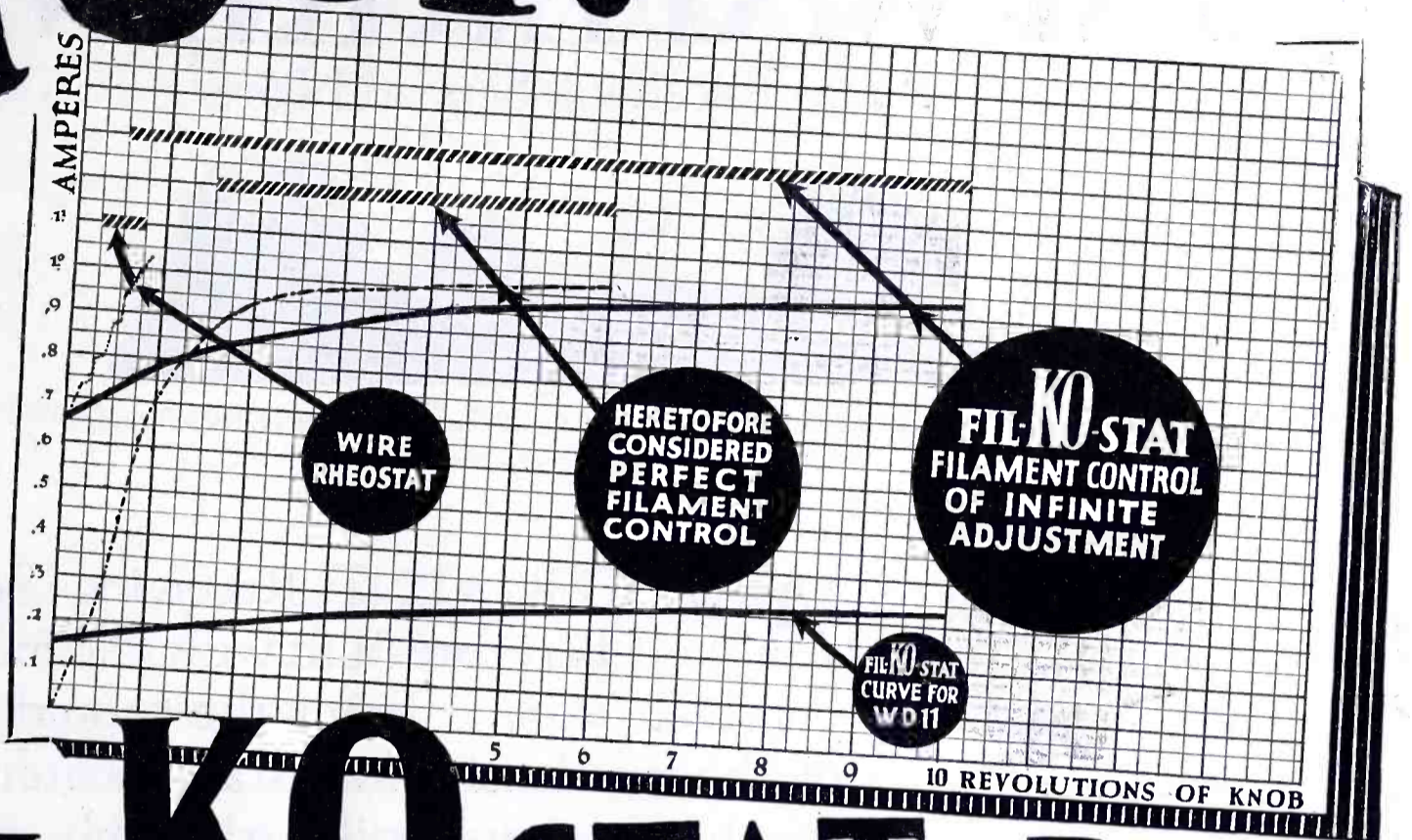

# FIL-KO-STAT Best Filament Control



- Infinitesimal Control** of Electronic Flow
- Definite Off** indicating complete "A" Battery disconnection.
- Fine Adjustment** starts where tube begins to function.
- At Full On** Resistance practically zero.
- Absolutely Silent** Non-microphonic, free of all noises.
- No Current Variations** Resistance constant at any setting.
- No Disks to Break or Chip** Resistance element so finely divided further division impossible.

**GUARANTEED**

The FIL-KO-STAT is to all purposes "fool proof". Each instrument is packed with the maker's guarantee that it will be replaced if broken within one year.

Manufactured by



You have been eagerly waiting for just this instrument Mr. Set Builder, amateur or manufacturer. It marks a step forward in Radio. It is not an adaptation of some old method of current control. It is not a rheostat. IT IS A FILAMENT CONTROL, distinctly designed to utilize the great tuning possibilities of the vacuum tube itself.

Its superiority is proven by every test. It regulates the FILAMENT HEAT. It gives absolute control of the ELECTRONIC FLOW and consequently permits THE FINEST TUNING POSSIBLE.

Perfect and gradual increase of filament heat assures longer life to the tube. Fine adjustment of fractional currents makes it ideal for use with Dry Cell tubes.

And infinitesimal control of electronic flow gives a corresponding control of fine detection so absolutely essential in DX tuning.

The time to replace all other filament control devices with FIL-KO-STATS is now. Say "FIL-KO-STAT" to your dealer today. If he has none in stock send his name and your remittance direct to

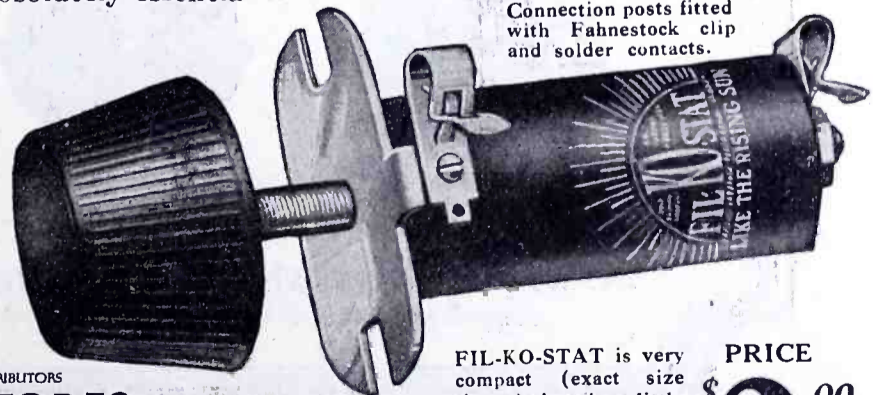

Connection posts fitted with Fahnestock clip and solder contacts.

SOLE INTERNATIONAL DISTRIBUTORS  
**RADIO STORES CORPORATION**  
 218-222 West 34th St.  
 NEW YORK  
 Dept. R

WIRE ORDERS FILLED TO JOBBERS AND DEALERS

FIL-KO-STAT is very compact (exact size shown) it takes little space on the panel. So mountable it can replace any other control without redrilling.

PRICE \$ **2.00**

# ATWATER KENT

Radio Receiving Sets and Parts

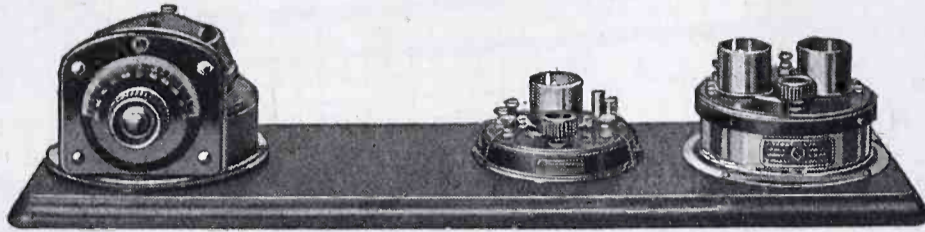

Complete Set consisting of Coupled Circuit Tuner, Detector Unit and 2-stage Amplifier. Other sets shown in circular.

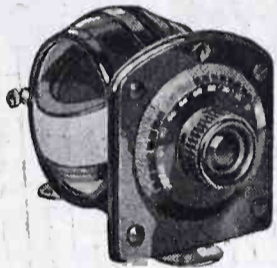

Mounted Variometer

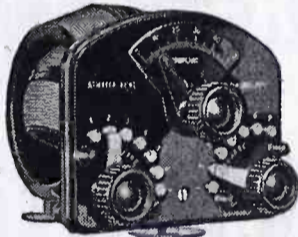

Mounted Variocoupler



Type 11 Tuner

ATWATER KENT Receiving Sets and Parts are built with the most particular care. From the moulding of the condensite forms and winding of the various coils, through the assembling and finishing of the units to the final mounting and wiring, every step is subjected to the most rigid inspection. It must be "just so." This is the reason why ATWATER KENT radio equipment has that "different" look that makes it instantly noticeable in any surrounding.

*Atwater Kent products sell on appearance.*



Standard Tube Detector Unit



1 1/2-Volt Tube Detector Unit



1-stage Amplifier

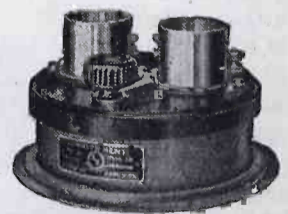

Detector 1-stage Amplifier  
A similar unit is furnished  
in a 2-stage Amplifier

ATWATER KENT MANUFACTURING COMPANY, PHILADELPHIA, U. S. A.

Radio Department

4947 STENTON AVE.

Correspondence Solicited

Tell them that you saw it in RADIO

# ATWATER KENT

Radio Receiving Sets and Parts

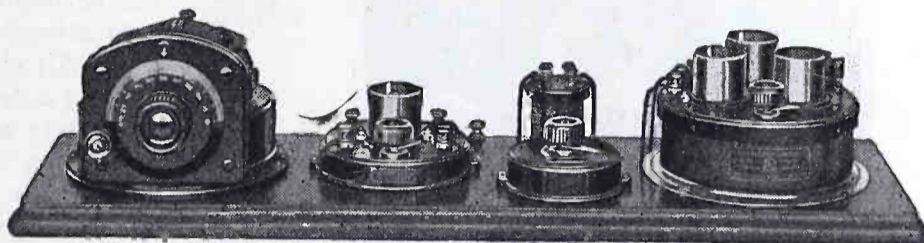

Complete Set consisting of Type 11 Tuner, one stage of Radio Frequency Amplification, and Detector 2-stage Audio Frequency Amplifier.

**B**UT appearance is not the only feature that is watched. Even though the factory is pushed to its utmost capacity by the extraordinary demand for ATWATER KENT sets and parts, every unit is carefully tested to make certain that its performance is right. By this means, the radio fan is sure of getting a part or set that is not only strikingly handsome in appearance, but works perfectly, and gives the utmost satisfaction.

*They stay sold on quality of performance.*



R. F. Transformer



2 to 1 A. F. Transformer Type L



Standard Vac. Tube Unit

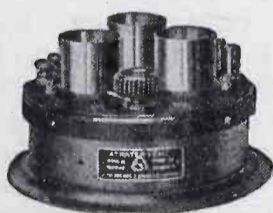

Detector 2-stage Amplifier



Table Potentiometer

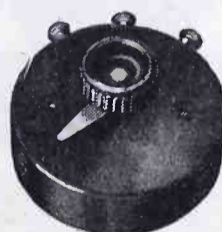

Panel Potentiometer



1 1/2-Volt Tube Socket

ATWATER KENT MANUFACTURING COMPANY, PHILADELPHIA, U. S. A.  
 Radio Department                      4947 STENTON AVE.                      Correspondence Solicited

Tell them that you saw it in RADIO

# "ESCO" BATTERY CHARGERS

To meet an insistent demand for

**Rugged, Reliable  
Neverfailing  
Motor-Generators**

For charging Batteries used in wireless operation, we have developed a complete line of many sizes. With or without panel boards. "ESCO" quality thruout. You KNOW what THAT means.

Ask for Bulletin 242

**ELECTRIC  
SPECIALTY  
COMPANY**

**215 South Street  
STAMFORD  
Conn., U. S. A.**

Pioneers in developing  
Quality Wireless Apparatus

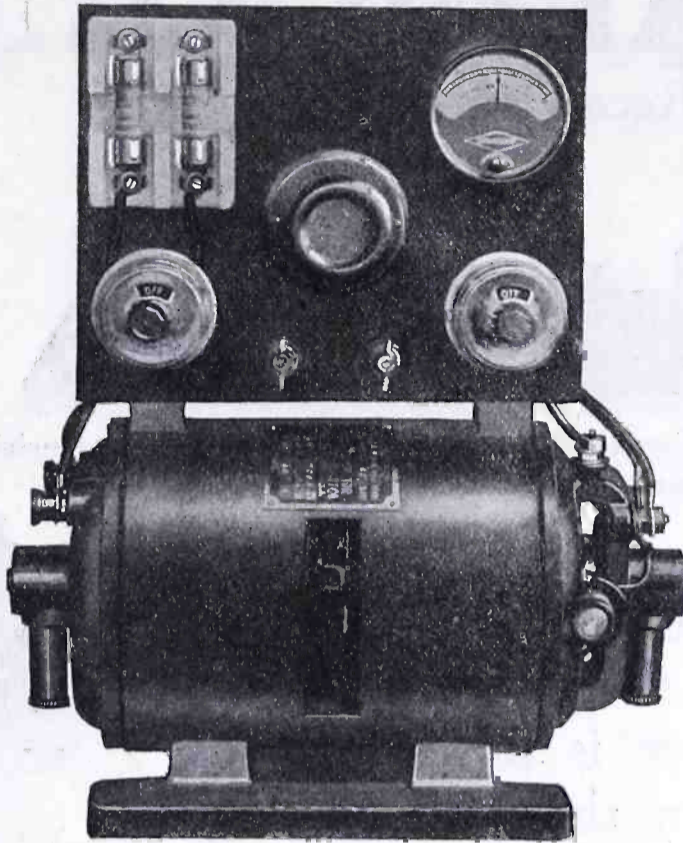

## TRADE "ESCO" MARK

**THE AMATEUR TRANSATLANTIC TESTS SHOW**  
(At the Time This Advertisement Was Written)

**That more operators succeeded in getting across with  
"ESCO" MOTOR-GENERATORS  
THAN WITH ALL OTHER MAKES COMBINED**

*Paul Godley is using an Esco Motor-Generator in England, 8BSS, Cazenovia, first to be heard in Switzerland—Same Station 8AQO heard in England, France and Switzerland first 8 nights. 1BGF, Hartford, first to be reported back. Very many others made remarkable records with our apparatus.*

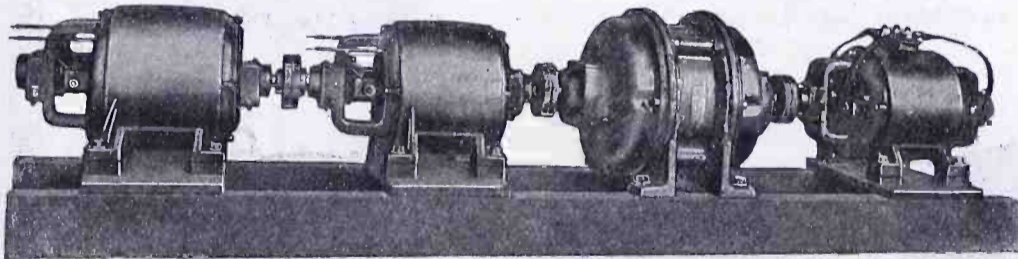

This is a Special Four-Unit Set for the Largest Broadcasting Station in Existence—a 10 h. p. 220 v., 60 Cycle, 3 Phase Motor, Two 1000 v. 2000 w. Generators Designed to Operate in Series, thus producing 2000 v. 4000 w. and One 12 v. 2000 w. Filament Current Generator. **BESIDES MAKING STANDARD OUTFITS IN OVER 200 COMBINATIONS, WE ARE CONSTANTLY DEVELOPING SPECIAL APPARATUS FOR SPECIAL PURPOSES.**

**Battery Charging Motor-Generators in Many Sizes  
Motors — Dynamotors — Generators — Motor-Generators**

**Electric Specialty Co.**

**215 South Street Stamford, Conn., U. S. A.**

*Sold by Principal Dealers Everywhere*

## THE UNKNOWN BROADCASTER

*Continued from page 21*

papers; I'll pay if necessary. Why not go as W.E.W. whoever he is. The unknown broadcaster would never know the difference." He debated in his mind the ethical part of such actions. Was it absolutely square as he had always tried to be? The shadow of doubt crept over his thoughts, yet who knew but what he might be rendering a big service to others by doing the questionable thing. All elements of doubt soon gave way, and a definite plan was formulated immediately in his mind. He would at least take a chance, and should failure lie across his path he would not be out anything for the adventure.

Before leaving the building that evening he stopped long enough to place the following ad to be run in the personal column: "G.C.L. Have been detained, will meet you Thursday instead of Saturday, same time, same place. W.E.W."

His only fear now was that G.C.L. would not see the ad, since one answer had already appeared. She had said she would read the column each day—perhaps there were more messages to follow. He consoled himself with this thought. Nothing remained now but wait until Thursday for final developments.

A new spirit seemed to prevail all through the big organization of the *Mail*. It was more prevalent among the reporters than any place else. Each individual seemed to be just a little more alert. The great press doled out the thousands of copies for the morning and afternoon editions. Four days had gone by since the announcement by Mr. Hunter, but nothing unusual had happened in the news lines. Yet the tension under which the men were working was plainly visible.

**T**HURSDAY evening found Owen dressed in his black suit. He placed the money he had drawn from the bank that afternoon securely in his pocket. It was all he had made in his deal on rails, and part of last month's salary. The meeting time had been placed at eight o'clock, but Owen thought it to his advantage to be on the scene before the appointed hour. When he arrived at the Dutch Mill Cafe, he gave orders to the waiter for dinner, and asked that champagne be served with the meal. A private place had been given him for his stranger guest, or guests, which ever it happened to be. He hardly expected the lady to be alone, yet one could never tell.

The preparations had hardly been completed, when a lady in a dark suit, followed by a dignified looking gentleman, appeared in the entrance. She

*Continued on page 64*

Tell them that you saw it in RADIO



**Thordarson Amplifying Transformers**

Regular Price \$4.50

**Special \$3.50**

**MYER'S HI MU TUBES**

**With Receptacles \$5.00**

6OE

KGO

6XR

**I Ship All Over  
the United States**

*"Everything Worth While In Radio"*

AT

**THE RADIO STORE**

OF

**PAUL FRANKLIN JOHNSON**



560-562 East Colorado Street

PASADENA, CALIFORNIA

If you have not already received one of my RADIO MANUALS, write for one, enclosing 10c in stamps to cover mailing.

**Type E-2 3000 ohm Everett Fones**

Regular Price \$8.50

**Special \$7.00**

**Type 2-A 2000 ohm Stromberg**

**Carlson Fones**

Regular Price \$8.50

**Special \$7.00**

Tell them that you saw it in RADIO

Continued from page 62

gave a sweeping glance over the room, hesitated a moment and then started directly towards Owen.

A waiter showed them to the table which had been prepared for their coming.

"I have been uneasy for fear you would not see my last notice, and keep the original date, Miss——"

"Mrs. Ley," she added, finishing Owen's remark, "and yours may I ask?"

"Names are of little importance, you may call me Blair for this evening."

"Mr. Blair, this is my friend Mr. Shaw." The two men acknowledged the introduction. The lady removed the fur from around her neck, while her companion helped her to be seated.

"I was agreeably surprised when I read your last notice. Tonight is much better than the last of the week. Don't you think so, Ned?"

"Yes, the sooner this matter is settled the better it will be for all concerned."

The stranger spoke with an air of professionalism, and Owen judged he was the lady's attorney. The conversation drifted on general subjects with no reference being made to the purport of the meeting. They had eaten and drunk freely of the wine which had been prepared for them. Owen thought it was best for her to approach the subject, besides he was utterly in the dark when it came to speaking intelligently on the main cause of the meeting. He must proceed cautiously, using all the discretion he could command. One mistatement might cause him to make a fiasco out of the whole affair. He was growing somewhat uneasy in regard to the matter, when the lady cautiously said, "I have the letters here in my bag if you are prepared to pay for them."

"Of course you realize, Mrs. Ley, I cannot pay any money for the papers until they have been examined. If they are worth the money to us we shall be willing to pay you well for them."

"Mr. Blair," said her companion, "we are not here to quibble over this matter. We know of course whom you represent. Our price has been placed very low for the evidence we have, unless you pay us the five thousand we asked we shall proceed to publish the letters at once. You know it will wreck the political chances of your candidate. It will mean disgrace and ruin for some of the men who are back of the political machine you represent. Our terms are small in comparison to what others would ask in our position. Tersely speaking, it is the money, or the publication of the whole diabolical plot."

The tirade was over, and Owen came to the conclusion quickly the speaker meant just what he said. There would be no dickering with this man. He seemed to hold the winning hand and

Continued on page 66

## The Trinity Loud Speaker



TYPE "A1"  
\$25.00  
21-in. Fiber Horn

The only device of its kind in the Radio field

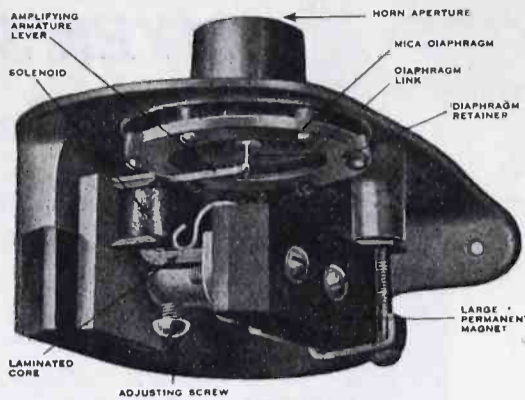

Type "B" \$12.50

Study the illustration carefully and you will understand why it produces full, clear, natural tones with perfect reproduction of all vocal and instrumental music. May be used with phonograph. No storage battery required.

The Trinity Loud Speaker is an instrument that combines the best qualities of a phonograph reproducer in combination with electro magnetic principles best fitted for radio amplification. Absolutely perfect reproduction of all music and speech without distortion. The volume may be regulated from that required for a room in your home to a tremendous output that can be heard hundreds of feet out of doors by simply increasing "B" battery voltage. No storage batteries required. The instrument is of a heavy duty type and is guaranteed fully by the manufacturers.

Ask your dealer for demonstration—if he cannot we can

TRINITY RADIO CO., 168A Dartmouth St., Boston, Mass.

## Delicate Soldering

Both the manufacturers' and amateurs' problems on all fine work is readily solved by the instrument constructed for this particular purpose.

THE POST SOLDERING IRON

Platinum Heating Unit—Interchangeable Tips—Universal Current  
(Large & Small)

\$6



ONE-HALF ACTUAL SIZE

Awarded Certificate of Excellency, N. Y. Evening Mail Radio Institute

From your Dealer, or write

POST ELECTRIC COMPANY (Fifth Division), 30 E. 42nd St., New York

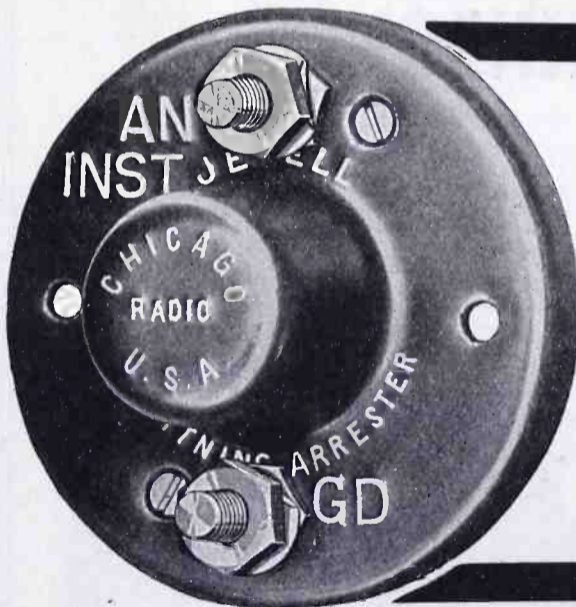

## JEWELL LIGHTNING ARRESTER

Approved by Underwriters' Laboratories, latest Code. Carbon block types (not vacuum type) using a brown glazed porcelain case which can be installed inside or outdoors. Carbon block arresters have been standard in Railway signal and telephone protection for over 20 years. Ask your dealer or write us for special circular.

PRICE \$1.10

JEWELL ELECTRICAL INSTRUMENT CO.  
1650 WALNUT ST. CHICAGO

VARIOMETER OR VARIOCOUPLER  
FREE with 2 subscriptions to "RADIO."  
Work-Rite Type (\$3.50)

PLEASE SEND 12c FOR MAILING CHARGES

"RADIO", Pacific Bldg., San Francisco, Cal.

Tell them that you saw it in RADIO

# ANNOUNCEMENT



WARNER BROS., largest radio supply house in the West, announce the opening of their third radio store, 428 Market Street, San Francisco

To celebrate this big event we further announce a great radio sale, commencing Monday, March 12, and continuing until further notice

*Only the highest grade standard radio equipment and parts sold by us. Our sale prices will astonish you. Visit any of our stores today, or write at once for our radio price lists.*

## WARNER BROS.

THREE STORES

350 Market Street San Francisco 428 Market Street  
Oakland—Twenty-second and Telegraph Avenue

If you are unable to call for a copy of our big radio bulletin, be sure to mail this coupon now. Send it to any of our three stores. 

SEND ME YOUR BIG RADIO PRICE LIST AT ONCE.  
Name.....  
.....  
Address.....  
.....

Tell them that you saw it in RADIO

Continued from page 64

knew just how to play it. From the substance of the speech there was a great deal more to the game Owen was playing than he had anticipated.

"I shall not consider the payment of any money until the letters and documents have been produced, so I may have the opportunity to examine their validity. If after such examination we feel warranted in meeting your demands, we shall pay the money at once."

The man motioned Mrs. Ley to give Owen the papers. She took them rather reluctantly from her bag and handed them to him.

So far he had played the game well. Nothing had been said or done which might lead them to question his being there. The papers being in his possession, there remained but one thing to do—examine them—then either pay or else decline their demands.

He fumbled the purloined letters awkwardly as he proceeded to study them in detail. Their contents were startling. No wonder Shaw had been so explicit in his demands. He had evidence to back up what he said.

The bundle contained the direct correspondence of Judge Davis to Henry Ley, who was the leader of the Steel Workers' Union. Judge Davis was president of the steel corporation, a director in several of the largest banks in the city, and at the present time candidate for governor of the state. One of the letters was the speech Ley was supposed to have delivered to the directors when he met with them to discuss the demands of the union. The last was a letter in the judge's own handwriting offering Ley a fabulous sum of money if he would call off the coming steel strike without getting an increase in wages for the miners.

In the closing paragraph of the letter the judge had said: "Let me caution you on the seriousness of such actions. Come to my office for final settlement."

There was only one thing more not clear to Owen as he read the close of the last letter. Just how to bring out this information was rather puzzling. There had evidently been something wrong between the Mrs. Ley and her husband. Trusting that his talisman would still carry him through, he looked at his new acquaintance, and spoke earnestly:

"Do you think you have sufficient reason, Mrs. Ley, for such actions against your husband?"

He was observing her closely now. There was a faint network of lines which radiated from the corner of her eyes, but with her hat pulled well forward she looked almost youthful. She sad moodily introspecting as if stunned by memories of the past. The muscles of her face tightened, the camouflage calm-

Continued on page 68

## Why do you do it ?



## Do you lug your battery to have it charged?

Do you put off lugging it until it fails to give good results?

How many concerts do you miss or only half hear?

With Tungar—the go-between—from the house lighting circuit to storage battery—you are prepared for best results always.

Just turn it on and leave it. It charges your battery while you sleep. Its cost of operation is low. It makes convenient the necessary charging that prolongs battery life.

Tungar has no moving parts to cause trouble. It is *certain, clean, quiet.*

Good for the auto battery too—the same Tungar.

See it at any good electrical shop, or write for literature. Address Section Ro.-4

Merchandise Department  
General Electric Company  
Bridgeport, Connecticut

Tungar Battery Charger operates on Alternating Current.

2 ampere outfit—\$18.00.

5 ampere outfit—\$28.00

(east of the Rockies)

Special attachment for

charging 12 or 24 cell

"B" Storage Battery—\$3.00

—fits either size Tungar.



Charge 'em at Home, with

# Tungar

## BATTERY CHARGER

A GENERAL ELECTRIC PRODUCT

35A-94D

The most satisfactory book for beginners that has yet appeared.—Public Ledger.

## RADIO SIMPLIFIED

By KENDALL & KOEHLER  
Radio Instructors

WHAT TO BUY  
HOW TO BUILD  
HOW TO OPERATE

A clear explanation of Radio in simple language with complete directions for assembling and installing home radio equipment. Will aid you in getting the best results from your set.

96 Illustrations including picture diagrams showing hook-ups, etc. Cloth, 250 pages, \$1.00.  
On sale at Booksellers or mailed on receipt of price

THE JOHN C. WINSTON CO., 35 Winston Building, Philadelphia, Pa

## LEARN RADIO

Here's your opportunity. Radio needs you. Win success in this fascinating field. Trained men in demand at highest salaries. Learn at home, in your spare time.

## Be a Radio Expert

I will train you, quickly and easily, to design, construct, install, operate, repair, maintain, and sell all forms of Radio apparatus. My new methods are the most successful in existence. Learn to earn

**\$1,800 to \$10,000 a Year**

**FREE** Wonderful, home-construction, tube receiving set, of latest design. Write for "Radio Facts" free. Engineer Mohaupt.

American Electrical Association  
Dept. 294 4513 Ravenswood Ave., Chicago

Tell them that you saw it in RADIO

# Your Radio-Knowledge Worth Big Money

**M**ANY amateurs are so absorbed in the fascinating fun of radio that they do not realize the big opportunities awaiting them in the commercial field. Thousands of men operating amateur stations have never considered that they can earn amazingly big salaries doing the same easy, interesting work.

Radio Amateur, don't waste your knowledge of Radio. Don't use it only as a fad or a hobby. Radio is more than that. It is a gigantic, six-billion-dollar industry—and growing bigger every day! Hundreds of commercial stations are in operation today; thousands more are being erected. Nearly every vessel on the seas is a floating radio station. Hundreds of manufacturers, thousands of stores, millions of people are interested in this great, new, marvelous industry!

## Trained Men Needed Now

Do you realize what this worldwide expansion means to you? Many land radio interests employ a force of a thousand or more Radio men. Every vessel needs from one to three operators. Schools, stores, factories, newspapers and cities need operators, demonstrators, salesmen, instructors, technicians, designers, inventors, engineers. Everywhere you turn you see the tremendous demand for more trained certified Radio-tricians.

Here is your greatest opportunity for fortune and success. Take advantage of it. Radio needs YOU NOW! Get into this fascinating profession. The field is uncrowded. Jobs are literally going begging for competent trained men. The pay is big, and the work fascinatingly easy.

## "Cash In" On Your Knowledge

Don't be a stay-behind. Don't let the other fellow beat you to the wonderful positions now awaiting for you in Radio. Make Radio a profession—not a plaything. Don't let your Radio-knowledge go to waste. "Cash in" on it—*Big!*

Thousands of men with no knowledge or experience now, are preparing for wonderful careers in this great profession. Will you allow these beginners to get ahead of you? Will you let them get all the big jobs while you sit idly by? Will you always be satisfied with being just an extra-good amateur when it is so easy to earn big money as a professional Radio-trician?

## "Radio Headquarters" Will Help You

The knowledge you have now of Radio operation and maintenance makes it easy for you to train yourself and obtain a wonderful position. You can work up to positions paying as

high as \$10,000 a year. If you are attracted by the adventure and excitement of travel, Radio offers you a glorious opportunity to see the four corners of the earth, with all expenses paid and a fine salary besides, or you can stay at home and take one of the fine positions all around you.

Use your present Radio experience to help you achieve a wonderful success in this great field. America's "Radio Headquarters," the National Radio Institute, has devised an amazing new plan that will complete your Radio education in spare time at home, and enable you to qualify for a Government Commercial operator's license so you can take your place in the Radio profession in the shortest possible time.

One of the features of this remarkable course which is approved by the Government, is that you are furnished free with four wonderful instruments for practical work at home. Among them is the wonderful Natrometer which quickly helps you acquire expert speed and accuracy in sending and receiving code.

In addition to this splendid, simplified short-cut course and the four patented instruments, nationally known Radio experts are your instructors. They correct your papers, give you the advice you seek, help you in every way with their wide experience to become a successful Certified Radio-trician.

## Special Opportunity Now Open

The urgent need for radio experts and the calls which come to us for our students prompt us to make a special offer open to new students for a limited time. Through this special offer your enrollment will be accepted at a special rate, and you will receive, without extra cost, our new course in Wireless Telephony.

## Get This New, Free Book

The National Radio Institute is ready to give you the same practical help that has put hundred of its graduates on the highway of Radio success. Read the letters in the panel from just a few of our 8000 students and graduates. You have the basic knowledge now. Just a part of your spare-time spent in learning the professional side of Radio, will qualify you for your career in this field of unparalleled opportunities.

Radio is paying enormous earnings to men all over the country today—it is making hundreds of men wealthy. Find out at once about your opportunity in Radio. Send for the interesting big Book which tells all about the future waiting for you in this great field, and gives complete details of the plan by which the National Radio Institute prepares you quickly in your spare time to become an expert Radio-trician and helps you through its Free Employment Service to a good Radio position. Mail the coupon, or write a letter NOW! NATIONAL RADIO INSTITUTE, Radio Headquarters, Dept. 10-D, 1345 Pennsylvania Ave., N. W., Wash., D. C.

## WARNING!

Ours is the one complete Course that prepares you for a first class government license. It is complete in every detail. Necessary practice instruments are supplied free. Don't be confused by cheaper or free courses. They cannot secure for you a government license which is necessary to obtain a good position in Radio.

## NATIONAL RADIO INSTITUTE,

Radio Headquarters  
Dept. 10-D

1345 Pennsylvania Ave., N. W.  
Washington, D. C.

Please send me your free book "How to Learn Radio at Home," with full particulars about the opportunities in Radio, and how you will quickly train me in my spare time at home to become a certified Radio-trician. Also, tell me how your free employment service will help me to a position and particulars of your special short-time offer

Name.....Age.....

Address.....

City.....State.....

### The National Radio Institute Can Help You As It Helped These Men

#### N. R. I. Graduate a Radio Engineer

I believe your course in Radio Telegraphy and Telephony operation to be the best and most complete on the market today. I feel more than confident that any student taking your course and applying himself should have no trouble in passing the government examination. I, myself, am a graduate of your school.

R. J. DAUGHERTY, Radio Engineer, Hamilton, Ohio

#### No Course More Complete

No course could be more complete, more clear to the beginner. Besides giving a comprehensive study in Radio, the N. R. I. course practically covers every branch of electrical phenomena. An N. R. I. graduate has a wide and useful knowledge that cannot but be of use to him in any line of electrical work.

NEILSON V. LLOYD, Ralston, Washington.

#### Easy to Get Good Job

Only a short letter to let you know that I am still on board and waiting for the ship to sail. Tell your students for me that a man with a license has no trouble obtaining a good position. Believe me a job like this is worth a good deal of studying.

L. M. WARING, JR., S. S. "Lake Farney," Norfolk, Va.

#### Course Superior to Others

I will say that the training I received from you and the careful instructions have enabled me to thoroughly understand Radio. The Natrometer is a great help to one who wishes to receive the code fast. The course is superior by far, to any other I know of.

PHILIP PAUDIER, Lawrence, Mass.

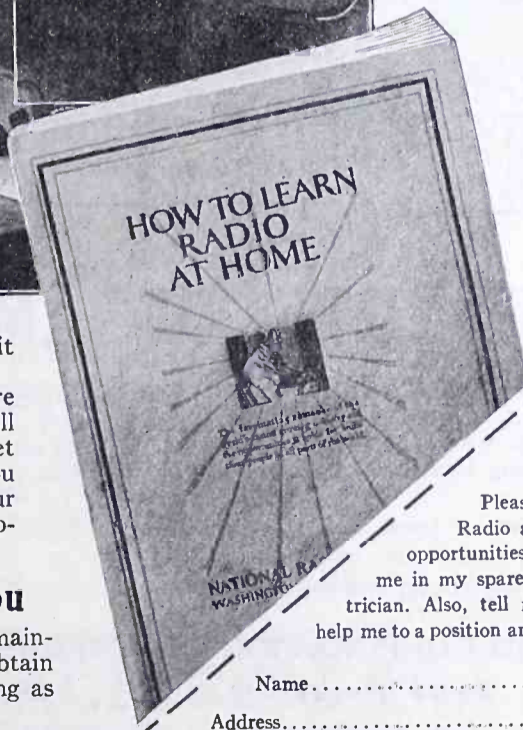

Tell them that you saw it in RADIO

**RADIO "A & B" STORAGE Batteries CHARGED at Home For Few Cents With "PATENTED FULL WAVE" Automatic Magnetic 100-130 Volt 60 Cycle A. C.**

# F-F RADIO RECTIFIER

Eventually You Will Buy an F-F RECTIFIER, Why Not Now? The Sooner You Buy It; The More You Save

It CHARGES All 6 Volt RADIO "A" & AUTO Batteries; & All RADIO "B" & LOUDSPEAKER Storage Batteries Up To 120 Volts In Series Inductively At Home Overnight. Disconnecting & Multiple Connections Unnecessary. Charging Circuits Separate. Nothing Like It Made. No Chance For Grounds Or Short Circuits. No Skill Required. AMMETER eliminates Guess Work. It Costs You Less To Buy An F-F RECTIFIER than To Be Without One. You PAY for ONE whether You Buy One Or Not, for It Costs An Average Of \$2. for Charging & Rentals Every Time An Auto Battery Is Charged By Others, but Only A Few Cents When You Charge Your Own From A Lamp Socket With An F-F Battery Boosting RECTIFIER. If You Have Never Known The Delightful Feeling Of Having Your Storage Batteries Always Fully Charged for RADIO & AUTO You Will Experience A New Thrill When You Have An F-F RECTIFIER Which Gives You A Fully Charged Battery Overnight At A Cost of A Few Cents & A Pleasant Feeling of Things Well Done. Those Who Own Them Feel Their F-F RECTIFIER is Their Faithful Friend. It Charges Automatically & Being Clean Can Be Placed Anywhere. Nothing To Stop Over Be Filled Burn Out Need Attention Or Cause Trouble Both Waves Are Rectified Thru Infusible Carbon Rectifying Brushes, Maintaining Constant Efficiency Uninterruptedly. While Its FULL WAVE Delivers RAPID TAPER CHARGE recommended By All Storage Battery Manufacturers. The F-F RECTIFIER is A Complete Compact Portably Handy Charging Unit. Delivers Service Day & Night Automatically & Will Charge A Dead Battery Do Not Think Battery Is Dead & Worn Out Simply Because It Will Not Start Your Car. Buy an F-F RADIO RECTIFIER & Fill It With LIFE. It SAVES MORE than Its Cost & Lasts Lifelong. Leave Your Battery In Car, Or Wherever It Is, Without Even Disconnecting It Screw RECTIFIER Plug In Lamp Socket, Snap RECTIFIER Clips on Battery Terminals: Turn Switch & Battery Will Be Charged In Morning At Cost Of Few Cents. Is It Not Gratifying To Be Ready For All RADIOPHONE BROADCAST Music Sermons & News When Friends Call? Never Having To Be Careful Of, or Tell Friends Your Batteries Are Dead & to Feel Your Car Respond Like A Greyhound, Splanning Engine With Power When You Throw in STARTER? Fully Charged Battery Starts Car Quick & Requires Fewer Expensive Replacements. INSIST on The F-F RECTIFIER. Built By A Master Of The Art In 7 TYPES. So Many Thousands Are Being Sold It Has Made Possible These POPULAR PRICES.

They Also Charge AUTO Batteries Overnight Right In Your Car

**\$20**

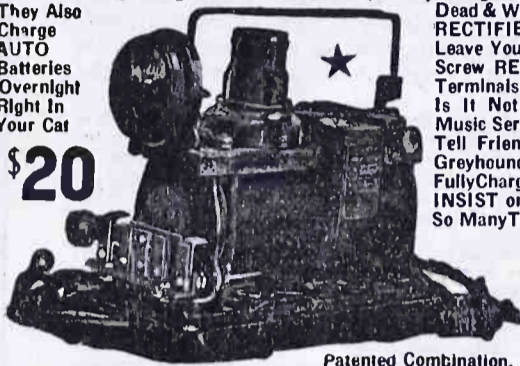

Patented Combination.

CHARGES "A" & "B" RADIO & AUTO BATTERIES.

- TYPE 6 Charges 6 Volt Radio "A" & Auto Batteries At 6 Amperes \$15
- TYPE 12 Charges All 12 Volt Batteries At 5 Amperes \$15
- TYPE B Charges All Radio "B" Storage Batteries Up To 120 Volts \$15
- Type A-B Is a Combination of TYPES 6 & B \$20
- TYPE 166 Charges All 6 Volt Batteries At 12 Amperes \$20
- TYPE 1612 Charges All 12 Volt Batteries At 7 Amperes \$20
- TYPE 1626 Is a Combination of TYPES 163 & 1612 \$28
- ALL TYPES But "B" Also CHARGE AUTO BATTERIES.

The Lower 3 Are Large TYPES Built for Heavy Batteries, or Where Charging Time Is Limited. SHIPPING WEIGHTS Complete With AMMETER & BATTERY CLIPS 11 to 15 lbs. Purchase From Your DEALER Or Mail Check for Prompt Express Shipment. If Via PARCEL POST have Remittance Include Postage & Insurance Charges, or WRITE us To Ship TYPE desired C. O. D. Other F-F Battery Boosters Charge Batteries From Farm Lighting Plants & D. C. Circuits & for GROUP CHARGING Economy Use Our 8 Ampere 12 Battery Capacity Automatic Full Wave F-F ROTARY RECTIFIER described in ROTARY BULLETIN 33A. ORDER Now, or WRITE Immediately for FREE Descriptive RADIO & AUTO BOOSTER & ROTARY BULLETINS 33A & 33

**FRANCE MFG. CO.** General OFFICES & WORKS: CLEVELAND, OHIO, U. S. A. Canadian Distributor: The Jack V. Elliot Co., Hamilton, Ontario, Canada.

## 24 Hour Service

No order too small—no Dealer too far away. We ship everywhere.

COMPLETE Radio Standard Sets and STOCK Parts.  
LARGEST of Standard Supplies in Middle COMPLETE West. Write for 64-Page STOCK Catalog No. D 10.  
DEALERS: Greater Discounts, Better Profits

**American Radio Mfg. Co.**

Dept. N

107 E. 13th St. Kansas City, Mo.

*Investigate!*  
**WESTERN-RADIO DEALERS SERVICE**  
Wholesale RADIO Only  
637 So. Hope Street, LOS ANGELES  
565 Howard Street, SAN FRANCISCO

# Free Catalogue

Make D X Records With D X Supplies

This Catalogue should be called "Recipes for Long Distance." It was written to help amateurs pull in the most distant stations.

To Get Your Copy Write Department S

**D-X Radio Company**

123 Liberty St. New York City

# RADIO INSTITUTE OF AMERICA

TRAINING IN ALL COMMERCIAL BRANCHES OF RADIO

If you cannot attend the Radio Institute of America in person the same instruction can come to you through our recently inaugurated "HOME STUDY COURSE"—Investigate.



Detailed information free on request.

Conducted by

**THE RADIO CORPORATION OF AMERICA**

331 Call Bldg.

Phone Douglas 3030

San Francisco, Calif.

98 Worth St.

Phone Franklin 1144

New York City

Tell them that you saw it in RADIO

Continued from page 66

ness which she had maintained gave way to the powers which had kept them dormant.

"Reason! Reason!" she uttered in a voice almost hysterical, "could any woman have more?" I hate him with all the hate a deceived woman can possess. His lies to me were worse than his being traitor to the men who placed their confidence in him. I shall have the things he promised me with the money I get from these letters, or I'll see him in prison."

"Calm yourself Clara," and her friend attempted to caress the hand which she had brought down upon the table with an emphatic thump. Wine and hatred form a combination that even the admonition of a friend cannot withstand. She seemed not to notice he had cautioned her as to what she was saying. No attempt was made to control the frenzy she was allowing herself to display. A leering smile played upon her lips.

"He promised me jewels, clothes, travel, and all the things any woman craves. I have stayed with him through misfortune, and as soon as he gets his dishonest money, he leaves me for another woman."

The whole situation cleared to Owen instantly. It was the old story of a woman's misplaced love, giving way to thoughts of revenge. He could hardly blame her. But was it not to be expected from a man who sells his honor?

There was little more for Owen to do. He was firmly convinced that the price they demanded was reasonable, considering the information the letters contained. He took from his pocket the money he had drawn from the bank, laid the five thousand on the table, and placed the papers in his pocket. He then bade them good night and left.

ONCE secure in his room, he again opened the letters and arranged them on the table before him. He studied their contents. It was a case of out and out bribery on the part of the man who was running for the highest office the people of the state had to give. What an antithesis between the real man, and the way he had been portrayed by the *Tribune*. He had asked the voters of the state to support him on the ground that he was a successful business man whose integrity was beyond question. He was one of the wealthiest and most influential men in the city. His activity in church work, as well as politics, had placed him before the public until his name was known in every household.

His word was sufficient to cause the market to fluctuate several points. He created and directed the orbit around which a score of satellites looked for guidance. He was the unseen power

Continued on page 70

# “WorkRite”

## Super 180° Variocoupler

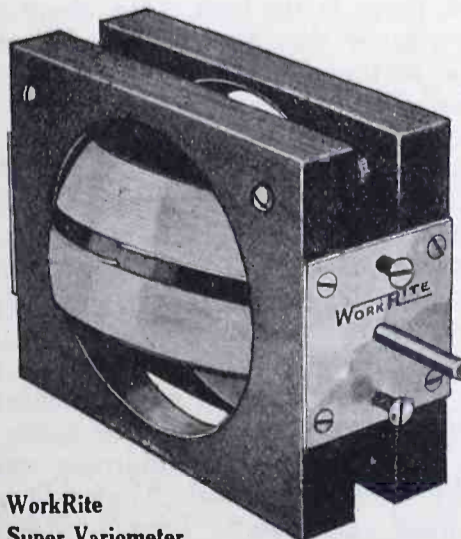
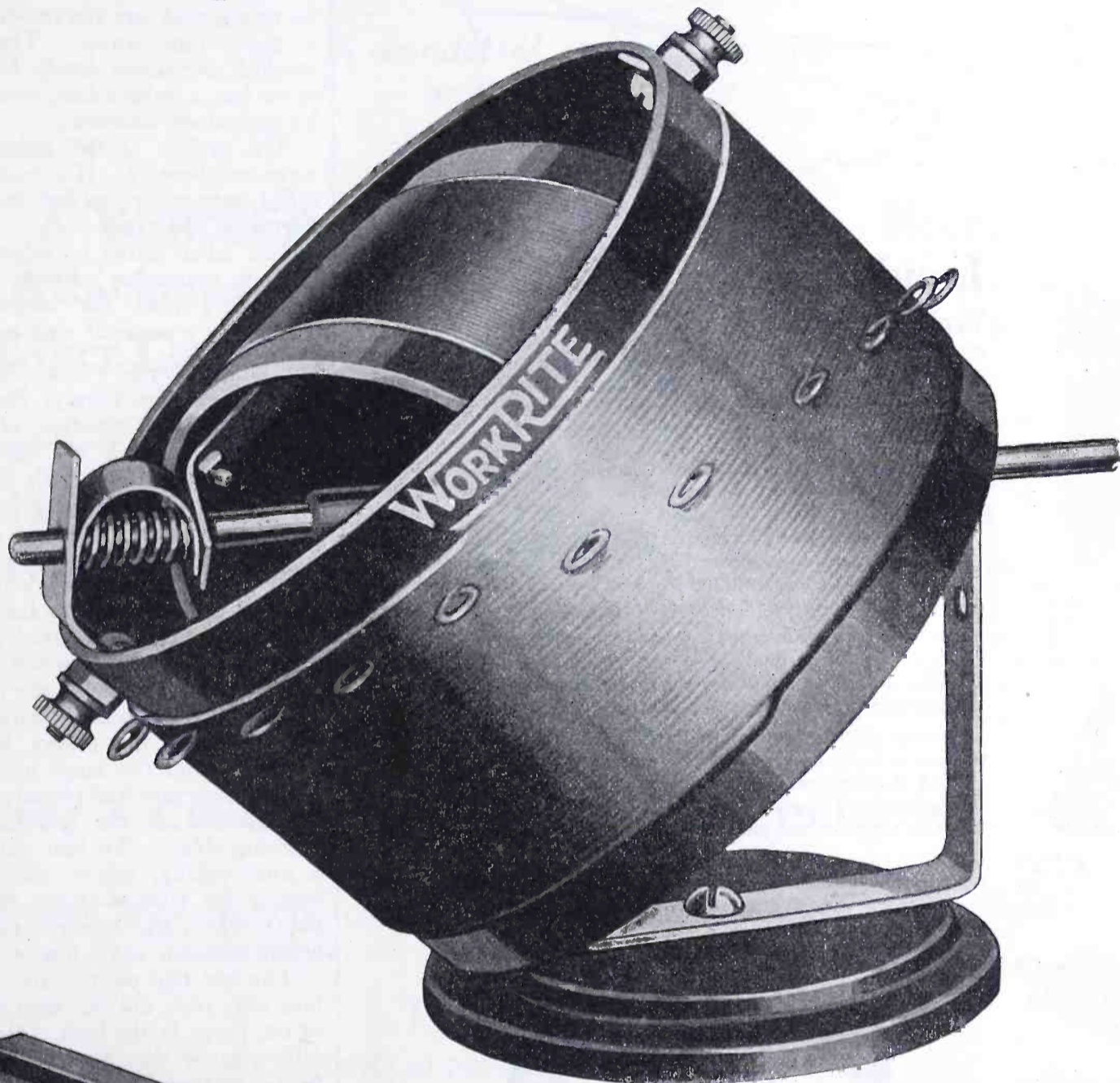

WorkRite  
Super Variometer

This instrument represents perfection in getting all dimensions and number of wire turns JUST RIGHT. Both primary and secondary are made from molded Bakelite and are wound with green silk wire. Range from 180 to 800 meters. Has 12 taps. Tunes twice as sharp as the ordinary 90° coupler. One WorkRite Super 180° Variocoupler and two WorkRite Super Variometers make up the WORKRITE TUNER TEAM—the most selective circuit obtainable. Will also give good results on single circuit. The prices on these instruments have been reduced from \$6.00 each last spring to \$3.50 each now. The enormous demand for these reliable WorkRite instruments has made possible large quantity production and this big reduction in prices. Can you equal them any place?

WorkRite Super 180° Variocoupler..... Each **\$3.50**  
 WorkRite Super Variometer..... Each

*Other WorkRite Products are WorkRite Concertolas, WorkRite E-Z-Tune Dial, WorkRite Super Vernier Rheostat, WorkRite Head Sets, and WorkRite Hydrometers.*

**WORKRITE RADIO PARTS WORKRITE**

**THE WORKRITE MANUFACTURING CO.**

Branch Office, 2204 Michigan Avenue, Chicago

5507 EUCLID AVENUE  
 CLEVELAND, OHIO

Tell them that you saw it in RADIO

# What One Tube Did In a Single Evening

New York City  
Newark, N. J.  
Detroit, Mich.  
Kansas City  
Minneapolis  
Denver  
St. Louis  
Los Angeles  
San Francisco  
Portland, Ore.

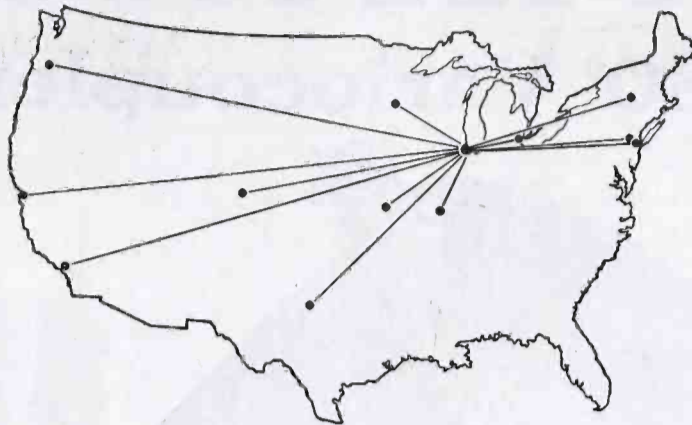

## Loud Speaker Was Used!

Typical of the amazing results that are being secured daily with the new Erla Duo-Reflex circuit, using but a single vacuum tube, is the experience of Dr. G. Edwin Farley, of Beverly Hills, Ill., who writes:—

"Between 9 p. m. and 2 a. m., Dr. Duff, a friend of mine, and I, listened to voice and music at New York City, Newark, Troy, Detroit, Stanford, Tex., Kansas City, Minneapolis, Denver, St. Louis, and, last but not least, Los Angeles, San Francisco, and Portland — all, with the exception of the last, very clear and loud. *Most were heard on the loud speaker.*"

Never before has such range and power been obtained with a single tube. Tone quality, likewise, is delightfully pure, while tuning is so sharp as to require hardly a movement of the controls to cut out undesired stations.

The basis of this new circuit, and the mainspring of its efficiency, is the Erla radio frequency transformer. Overcoming the high capacitance effects of domestic vacuum tubes in unique degree, and with lowest inherent capacitance, it provides unequalled amplification without distortion.

Diagrams of the new Duo-Reflex circuit, with notes regarding its proper construction, are now available, gratis. Ask your dealer or write us.

Manufactured by **Electrical Research Laboratories**, Dept. H, 2515 Michigan Ave., Chicago  
Coast Representative **Globe Commercial Co.**, 709 Mission Street, San Francisco



Erla radio frequency transformers greatly improve the range and power of any receiving set, incorporating utmost efficiency and value. Results guaranteed. List, \$4



Erla bezels are now made in 1" as well as 1 1/2" diameter, finished in nickel or dull black enamel. Telescope to fit any 1/8" to 1/4" panel. Price, 20c



Erla condensers are distinguished by superior accuracy and fine workmanship. 11 sizes. Price, 30c to 75c each

*Continued from page 68*

which had placed many men in office, and then controlled their actions after they were elected.

The part Ley had played in the transaction was of little importance as far as Owen was concerned. He had secured his position in the union through politics. There had been a shadow of doubt over all his actions. He had never had the united confidence of the men whom he represented and his removal was but a short time away. That he was crooked, the union firmly believed, but never had a cause which would warrant his immediate dismissal.

The actions of the judge, however, were unbelievable. His crime was magnified because he had betrayed the confidence of the people.

Just what action to follow was difficult to determine. Briefly Owen formulated a plan for tomorrow. He would pay a personal visit to the judge.

JUDGE Davis' luck had always brought him victory. Never had he experienced the sensation of playing a losing game. It is bad for a man to come in contact only with the pleasant. It narrows his heart until he cannot be sympathetic with others. As to the judge's election there was little doubt. He would receive an overwhelming majority if the primary was taken as a criterion, for he had received more votes than all the others combined.

The judge came into the office somewhat later than usual. Seating himself, he picked up the papers before him, going through the large bundle of letters the secretary had placed on his desk. He glanced at the headlines in the morning *Mail*. To him the *Mail* was a muck-raking, yellow sheet. It had fought his election from the start, a policy which had brought forth considerable criticism and a loss of circulation.

The fact that most of the items about him were true, did not alter the feelings of the judge in the least. He, above all others, knew they were true. But the public at large looked upon the attack as mud-slinging campaign material. He noticed the big black headlines for a moment and then slammed it in the wastepaper basket. He picked up the *Tribune*, which had been his staunch supporter through all the years he had been in public work. It was a pleasure to read the "Reliable Trib," for it brought forth the things he loved to hear. Most men can be won by flattery in case others wish to play so mean a part. The headlines this morning were more pleasing than usual: "Judge Davis on Final Campaign Tour." "Steel Workers Lose Strike." He read the articles completely and then turned to the market. M-K steel had dropped off another five points, the third in as many days.

*Continued on page 72*



## QUALITY PRODUCTS

Instruments 'Phones Loud Speakers

Send for Bulletins AI-10 and AI-20

ROLLER-SMITH COMPANY, 20 Park Place, NEW YORK

WORKS: BETHLEHEM, PA.

Offices in Principal Cities in U. S. and Canada

Tell them that you saw it in RADIO



*Immediate Demand*  
for the New  
**CHELTEN MIDGET CONDENSER**

*A wonderful improvement to  
any Receiving Set*

**A-VERNIER  
Attachment for  
Every Condenser**

---

**List Price \$1.50**

---

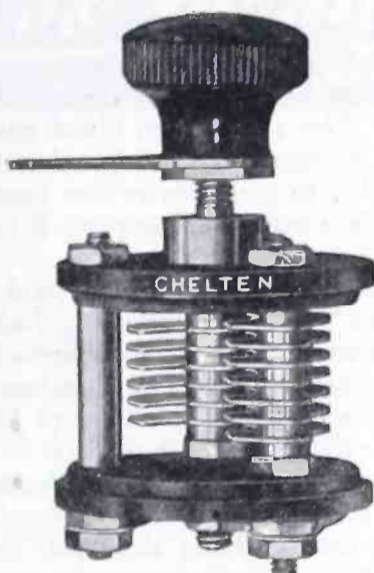

**Necessary  
for  
Sharp Tuning**

---

*Distributed through the  
Jobbing Trade*

---

Actual Size  
CHELTEN VERNIER  
Cat. No. 850  
Drill only one 5/16" hole for  
panel mounting

**Try a CHELTEN MIDGET in the following circuits**  
*For Secondary Circuits*

To avoid body capacity, connect center shafts of both condensers to filament side of secondary.

*For Primary Circuits*

Connect in parallel with primary condenser.

*For Tickler Circuits*

Connect in parallel with tickler. Connect condenser shaft on "B" Battery side of tickler, NOT on plate side.

*For Radio Frequency*

Vernier Grid Leak Condenser. Connect between grid leak and ground.

Be informed—Write for Bulletin No. 15

Established manufacturers of electrical apparatus since 1910

Pacific Coast Rep. C. A. STONE CO., 538 San Fernando Bldg., Los Angeles

**CHELTEN ELECTRIC COMPANY**  
PHILADELPHIA, PA.

# ANNOUNCING TWO NEW TUBES 1 1/2 VOLTS

Voltage ..... 1 1/10-1 1/2  
Fil. Amp. .... .25  
Plate Volt. .... 20-75  
Base.... Large Standard Size

**Guaranteed  
Unsurpassable Quality**

On **SAMPLE ORDERS** we **OFFER**  
**CONSUMERS AND DEALERS**

## Introductory Price

**WRC 22** Amplifier 5.50 List 6.50  
Detector

**WRC 20** Detector 5.00 List 6.00

**Cash with order. Shipment  
made same day order received.**

**Conway Electrical Laboratories**

Sales Div., Box 22

125 E. 34th St. New York City

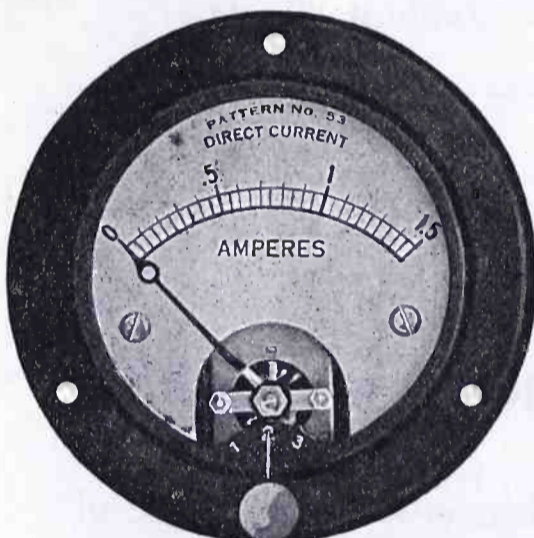

## Triplex Filament Meter

Filament control by the use of proper instruments in receiving sets is the trend of the times. The Jewell triplex filament instrument, made as an ammeter or voltmeter, places on your panel the proper means for controlling the filaments of three tubes. It has a self-contained mechanism for switching to either tube and being of small size, can be accommodated on the most compact tube set.

**Price \$10.00**

We were the first to supply a complete line of miniature radio instruments of uniform size. Ask your dealer or write to us for complete radio circular.

**JEWELL ELECTRICAL  
INSTRUMENT CO.**  
1650 WALNUT ST., CHICAGO

Continued from page 70

News of the coming strike had caused the bullish movement of the market, which had been taking place since early spring, to end abruptly. Every day saw the shrinkage of the gain accumulated in the past few months. To the judge this was good news, for he lacked only a few shares of having enough to control the company. He had planned to buy enough to give him controlling interest. In order to get them at the cheapest price he had done all in his power to stop the bull market. Longer working hours and a refusal to grant any wage increase had caused the men to threaten a strike. Once this news became known and the market had taken one set-back after another.

Things were indeed bright for the judge. Not the faintest cloud appeared on the horizon. Before him lay a path which led to more power and fame. It was only a matter of hours until his ambitions would be realized.

A loud knock on the door woke him from his thoughts. Before he had time to answer "Come" the door opened and his secretary placed a card before him. At any other time the actions of Phillip, the secretary, would have drawn a reprimand, but this morning in the judge's world there was nothing but sunshine.

The name "Owen Brainard" on the card was of little importance to him, but when he saw that he was a reporter from the *Mail* it did make some difference. Not that the judge felt it was necessary to have the support of the *Mail* in the present election, but if there was some way for him to stop their imperiousness it would be a shrewd move on his part. The *Mail* had a knack of disseminating facts from multifarious rumors which was anything but pleasant. With this motive in his mind he gave word for Owen to be admitted.

Owen did not take the chair the secretary had offered him until he had left the room. The judge placed aside the letter he was reading and turned slowly in his chair until he met the direct look of the man before him.

"Rather surprised the *Mail* has sent you to see me," he said glancing again at the card he had picked up from his desk. "Are you after political information, or news in regard to the strike situation?"

"Neither, and yet it is in regard to both I called to see you."

"The *Mail* has never given me any support, but of course if they have decided to change their policy—the fact of the matter is, you are the first reporter from there to come for an interview during the campaign."

"Mr. Davis, I am not here as a representative of the *Mail*. I am here in my own behalf."

"Well, may I ask you to be brief and state the nature of your business, I leave

Continued on page 74

Tell them that you saw it in RADIO

## ABOLISH STORAGE BATTERIES



The BRU No. 5 receptacle in your circuit will accomplish this.

**NO TROUBLE  
CHARGING**

**NO TROUBLE  
HANDLING**

Replace dirty storage battery with neat 1 1/2 volt dry cell. Use BRU No. 5.

Fit your circuit with BRU No. 5

Moulded Bakelite Socket.... 75c each

BRU No. 5  
Pat. Pend.

**Bruno Radio Corp., New York**  
152 West 14th St.

*Investigate!*  
**WESTERN-RADIO  
DEALERS SERVICE**  
Wholesale Radio Only  
637 So. Hope Street, 565 Howard Street  
LOS ANGELES SAN FRANCISCO

## BALDWIN PHONES

Type "C" Baldwin Complete	..... \$12.00
Type "E" Baldwin Complete	..... 12.00
Type "F" Baldwin Complete	..... 13.00
Type "G" Baldwin Complete	..... 13.00
Type "C" Single Unit With Cord	..... 6.00
Type "C" Single Unit Without Cord	..... 5.50

**SPECIAL** Federal Universal Plug  
FREE with any pair of  
phones purchased from us.

Mail Orders Promptly Filled

POSTAGE PREPAID ANYWHERE IN U. S.

**DAVID RADIO SUPPLY CO.**

P. O. Box 596, Reedley, Calif.

**"COPPERWELD"**  
THE IDEAL RADIO ANTENNA

COPPERWELD IS 50% STRONGER than Copper. can be strung taut, stays up when other wires stretch and break, and gives 100% electrical efficiency.

COPPER CLAD STEEL COMPANY  
BRAODOCK P. O., RANKIN, PA.  
Directions for Antenna construction on reverse side of carton

**BUY IT IN CARTONS**



**SIGNAL**  
Radio  
Talks, No. 3

*Facts from the Factory*

**D**ID you ever stop to think why SIGNAL Radio outfits are different—why they meet the requirements of the keen radio student who recognizes and demands the best, and yet are so simple in operation the amateur readily obtains perfect results—why they—

But, before you read one word further, just look at the SIGNAL Vernier Rheostat at the right. It's the first successful vernier using a single knob for control! Like all SIGNAL apparatus it is built like a watch — with jeweler's precision. Not a screw is slighted! Not a wire left loose!

Our corps of expert research engineers present the latest developments in radio *first*. The products of the Signal plant are not measured by commercial standards alone. Utmost precision marks even the smallest detail of manufacture.

So for the newest and best in radio, ask for SIGNAL. It's *your* protection.

**SIGNAL Vernier Rheostat**

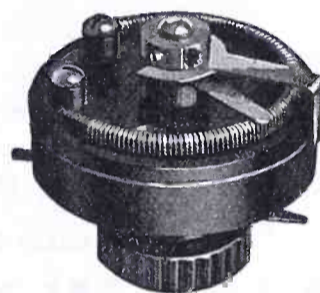

A simple coupling between the main contact and the vernier contact, carries the main contact by vernier to point nearest proper tuning. From here a fine adjustment is obtained by revolving the knob in the opposite direction. Furnished both with or without knob and pointer, so dial to match others of set may be used.

**SIGNAL Electric Mfg. Co.**

Factory and General Offices:  
1913 Broadway, Menominee, Mich.

Atlanta  
Boston  
Chicago  
Cleveland

Minneapolis  
Montreal  
New York  
Pittsburg

San Francisco  
St. Louis  
Toronto

*You'll find our local address in your Telephone Directory*

(2204D)

**Information Coupon**

Signal Electric Mfg. Co.,  
1913 Broadway,  
Menominee, Mich.

Please send catalog and bulletins giving complete information about SIGNAL Radio equipment to name and address written below.

\_\_\_\_\_  
\_\_\_\_\_  
\_\_\_\_\_

Tell them that you saw it in RADIO

# The Laboratory Technician Says:



Audibility — Plus  
 Matching — Perfect  
 Volume — Plus

## Why Strain Your Ears?

A whisper may be understood at a distance if clearly enunciated.

"T-B-H" Head Sets reproduce clearly and naturally. No "Fuzz" or "Tinny" tone. Extremely sensitive.

Aluminum cases—6 Foot cord—Weight 12 oz.  
 Type 6-A 17500 Turns (2200 ohms) Hard Rubber caps.....\$7.00  
 Junior 16000 Turns (2000 ohms) Composition caps.....\$5.00

If your dealer does not carry them he will order them for you.

Dealers and Jobbers Write For Discounts

**THE TELEPHONE BOOK HOLDER CORPORATION**  
 Dansville, New York, U. S. A.

District Agents:  
 CENTRAL STATES ENGINEERING CO., CHICAGO, ILL.

**DO NOT BE CONFINED TO LISTENING IN ON THE NEARBY STATIONS, WHEN BY INSTALLING THE**

**Genuine and Guaranteed Capitol**

## "ALL WAVE" COUPLER

(Trade Mark)

Patents Granted

in your set

you can receive remarkably clear and selective broadcast entertainment

From Stations

**THOUSANDS OF MILES AWAY**

and on any

**Wavelength from 150 to 3000 Meters**

without the use of variometers, vario-couplers, and loading coils.



Eventually—Why Not Now?  
 If your dealer cannot supply you, send us your order and remittance together with his name.

**Price \$9.00**

Beware of Imitations. Look for the Trade Mark "ALL WAVE" on the rotor, and the six efficient hook-ups packed in every box.

Six efficient and simple hook-ups sent free upon receipt of ten cents to cover cost of mailing.

**Capitol Phonolier Corporation** 58 Lafayette St., New York.

**SIXTH DISTRICT AMATEUR CALLS** appear in "Broadcast Program"—\$1.00 for 6 months.

*Investigate!*  
**WESTERN-RADIO DEALERS SERVICE**  
 Wholesale RADIO Only  
 637 So. Hope Street, LOS ANGELES 565 Howard Street, SAN FRANCISCO

Tell them that you saw it in RADIO

Continued from page 72

on the noon train for the final tour of the state before election."

Owen met the full gaze of the judge, and in a clear, calm voice said slowly: "Judge, you are not going on the trip, your last journey has been made, your last speech has been given, your days of political autocracy have passed. The nature of my business is to ask you for your withdrawal as a candidate for governor of the state."

The expressions on the judge's face changed rapidly. He did not know whether to be angry or amused at the arrogance of the stranger. The judge was a person who had never been crossed. No one had ever dared to tell him what to do. It had been his good fortune to be the one who always gave commands, but never had to receive them. To be asked for an interview and then have the person demand his withdrawal on the eve of election was something indeed more than the judge was accustomed. He turned and rang for his secretary.

"Young man, I shall have to ask you to leave at once." Turning to Phillip, who had just entered the room, he said, "Show this man out."

Owen refused to go. Rising from his chair he faced the judge, "I came here with but one purpose—to get your withdrawal. I shall not leave until I have it."

The judge motioned for the secretary to proceed with force in putting the upstart out of the room.

Owen turned quickly, looking at the judge he said, tauntingly using the words the judge had used in his letter to Ley, "Let me caution you on the seriousness of such actions."

The words fell with deadly effect on the judge's ears. He tried not to show an unusual emotion. The words he recognized with burning regret. He did not know whether Owen had just accidentally spoken the words he had written to Ley or not. A pallor swept over his face. Nervously he motioned for the secretary to leave the room. His deep voice trembled as he attempted to add words which would be in keeping with his gesture. His secretary withdrew.

Quoting the judge's words had given Owen new power. He settled himself in his chair. The words had sunk deep in the mind of the one who had used them in the letter. Still there was a question of doubt in regard to their significance. Knowingly spoken, they were a weapon to bring forth any demand. Accidentally used, they were of little consequence. This the judge must find out. Inwardly he harbored the thought they were not uttered by accident. The newcomer had given evidence of knowing his ground before the words were spoken.

Continued on page 76

**WDAP  
CHICAGO**



**3,700 MILES**

**CHERBOURG**



# "ALL AMERICAN"

## Sets World Record for Long Distance Radiophone Receiving

**When WDAP Chicago Talked to S. S. Berengaria**  
The Signals were Amplified Aboard-Ship Thru  
**"ALL-AMERICAN" AMPLIFYING TRANSFORMERS**

WDAP, The Drake Hotel, Chicago, made history in radio, by talking, day-by-day, with the S.S. Berengaria, enroute, New York to France. Miss Florence McDonald, a passenger, installed standard Zenith Receiving Set in the steamship cabin and, every evening during the voyage, WDAP talked to her and other passengers from Chicago, their voices coming clear and strong with the personality easily recognizable. The Set used by Miss McDonald is one of the regular Zenith Sets, manufactured by the Chicago Radio Laboratory, Chicago, Illinois. It contains, as standard equipment.

**"ALL-AMERICAN" AMPLIFYING TRANSFORMERS**

R-10—Radio Frequency (150-500 meters) \$4.50	R-13—Audio Frequency (Ratio 10 to 1) \$4.75
R-12—Audio Frequency (Ratio 3 to 1) 4.50	R-21—Audio Frequency (Ratio 5 to 1) 4.75

Send for our circular—"Cascading of Amplification." Also Free Book of Radio Hookups





## RAULAND MFG. CO.

200 N. Jefferson St., Chicago, Ill.



# DICTOGRAPH

## Radio HEADSET

*The Best Headset in the World at ANY Price*

Made by the makers of the world standard Dictograph Products—the marvelous "Acousticon" for the Deaf, the famous Detector Dictograph, the Dictograph System of Interior Telephones and Dictograph Radio Loud Speaker for the Home.

**The First Choice of Experts**

La Porte, Ind.

"I have been experimenting with Radio for the past year; in my experience have tried out 14 different headsets, including the—which I purchased for \$16.50. I at last have found the ideal phone where tone quality excels, and harshness is eliminated, and I cannot express myself in words as to the wonderful results I have obtained."

J. T. BACHMAN



\$8

Type R-1, 3,000 ohms. For all types of crystal and vacuum tube receiving sets.

Go to your dealer's today and listen-in with this supreme instrument. Note the difference. Buy two or three Dictograph Headsets and let the rest of the family enjoy your set.

Always insist on Dictograph Products. They are Fully Guaranteed.

DEALERS: Sell goods you know your customers will be proud of. Order through your jobber or write direct for names of authorized distributors.

**DICTOGRAPH PRODUCTS CORPORATION**  
 220 W. 42 St., New York City  
*Branches in All Principal Cities*



"B"

BATTERY

LASTS **5** YEARS



Exceptionally powerful. Makes weak signals strong. A single charge will last six months, recharged (for less than 1/2c) from any lamp socket or farm lighting generator. Patented high ampere plates charged and formed before leaving the factory. Positively eliminates battery noises often blamed on static. Container will not leak and is made of genuine hard rubber. Size 2 1/2 in. x 3 in. x 4 1/2 in. You assemble the battery easily and pleasurably in less than ten minutes. Complete illustrated directions with each battery.

Large illustrated circular on request.

Price 22 1/2 volt, unassembled.....	\$4.25
Price 22 1/2 volt, assembled.....	4.65
Rectifier for A.C.....	.35

**Sidbenel Radio Equipment Mfg. Co., Inc.**  
 1663 Jerome Avenue, New York City

Tell them that you saw it in RADIO



# It IS the Most Sensitive Receiving Set on the Market

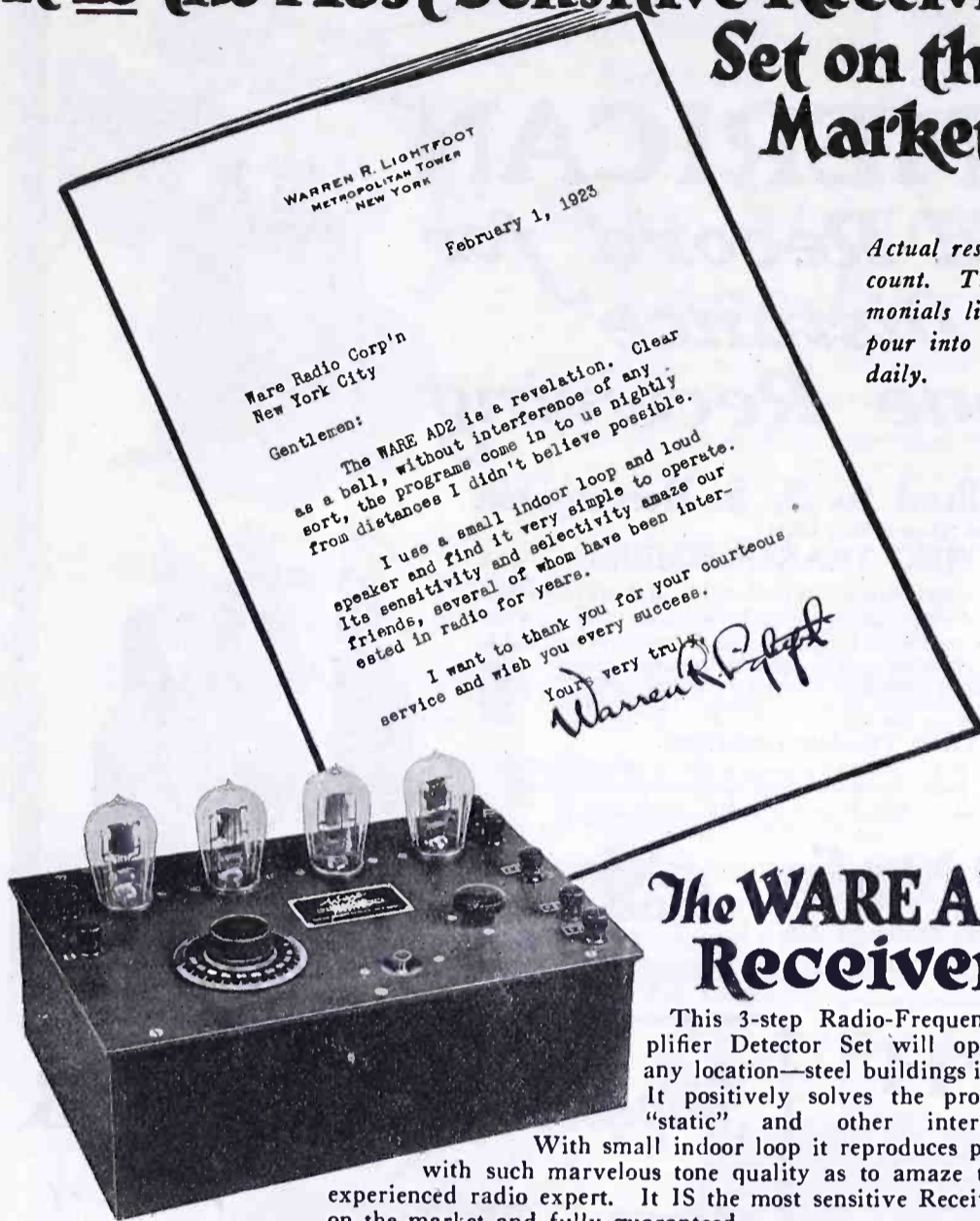

WARREN R. LIGHTFOOT  
METROPOLITAN TOWER  
NEW YORK  
February 1, 1923

Ware Radio Corp'n  
New York City  
Gentlemen:

The WARE AD2 is a revelation. Clear as a bell, without interference of any sort, the programs come in to us nightly from distances I didn't believe possible.

I use a small indoor loop and loud speaker and find it very simple to operate. Its sensitivity and selectivity amaze our friends, several of whom have been interested in radio for years.

I want to thank you for your courteous service and wish you every success.

Yours very truly,  
Warren R. Lightfoot

Actual results count. Testimonials like this pour into us daily.

## The WARE AD 2 Receiver

This 3-step Radio-Frequency Amplifier Detector Set will operate in any location—steel buildings included. It positively solves the problem of "static" and other interferences.

With small indoor loop it reproduces programs with such marvelous tone quality as to amaze the most experienced radio expert. It IS the most sensitive Receiving Set on the market and fully guaranteed.

Price---without accessories, \$110

Order direct, or send for descriptive pamphlet.  
DISTRIBUTORS and DEALERS write for proposition.

# WARE RADIO CORP'N

160-162 DUANE ST.

NEW YORK, N.Y.



**Investigate!**  
**WESTERN-RADIO DEALERS SERVICE**  
Wholesale RADIO Only  
637 So. Hope Street, LOS ANGELES | 565 Howard Street, SAN FRANCISCO

**VARIABLE CONDENSERS**  
43 Plate...\$1.65 | 23 Plate...\$1.45  
3-in. Dial, to fit...25c  
Fully Guaranteed Money Order or Check  
**MORGANSON ENG. CO.**  
800 Union St., Brooklyn, N. Y.

**WIS WIN**

No. 764 SERIES PARALLEL  
Concealed type, mounted on formica base .....\$1.50  
No. 754 visible type, switch alone, 65c  
Our sheet of diagrams showing the many uses of this popular switch, sent free upon request.  
**WILLIS SWITCH & INSTRUMENT CO.**  
8 Kingsbury St., Jamestown, N. Y.

Continued from page 74

"Why do you demand my withdrawal and on what grounds?"

"Briefly speaking, Mr. Davis, I have your letter to Ley,—an offer of bribery in your own handwriting,—using your money for the purpose of inducing a weakling to sell the trust others had placed in him. He received your money and then deceived you in selling the information you gave in regard to the true conditions of the M-K steel corporation. Knowing these things I cannot and will not allow such a man to deceive the people any longer."

Owen had finished his talk with a clear ring in his voice. He had started out in a low tone and gradually led up to the climax in his brief exposition of the matter. The judge knew that the situation now required all the thought he could command. The matter was very plain. There was only one way left to handle the dilemma. It was the power which men had used since the dawn of time—money—never had it failed him. The judge whirled in his chair, took his pen and check book, then turning to Owen he said in a cold voice: "How much do you want for those letters?"

"You are right in taking it for granted I have them, but you make a terrible mistake when you think your money will be a sufficient guerdon to bring their return. They are not for sale."

The situation was getting desperate for the judge. He fumbled and chewed his cigar, not knowing whether to become angry or to hold his temper. His long fingers bit the palms of his hand. The muscles in his face twitched until they moved his pale thick lips. Again he could hardly believe his ears. For the first time in his life his money was of no value. He had heard of men whom money had failed to influence, but never had he come in contact with them. There had been times when he was even dubious about their existence. Such men had been like the mirage of the desert. They had appeared in the distance but had faded away. Perhaps a definite sum would have more effect.

"I'll give ten thousand dollars for those letters."

Owen shook his head with an emphatic "No!"

"Twenty thousand."

"Did you understand my statement a moment ago, I reiterate: they are not for sale."

Far below came the muffled roar of the street. The clanging of bells, honking of horns and grinding of wheels gave evidence of the ever-present traffic between the hours of eight and six. The turmoil of the outer world was but a reflection of the judge's inner self. The instinct of self preservation now pre-

Continued on page 78

Tell them that you saw it in RADIO

# Kellogg Radio Equipment for Better Results

A better product of unusually fine workmanship

No sliding contacts

Nothing to wear

Will not produce tube noises

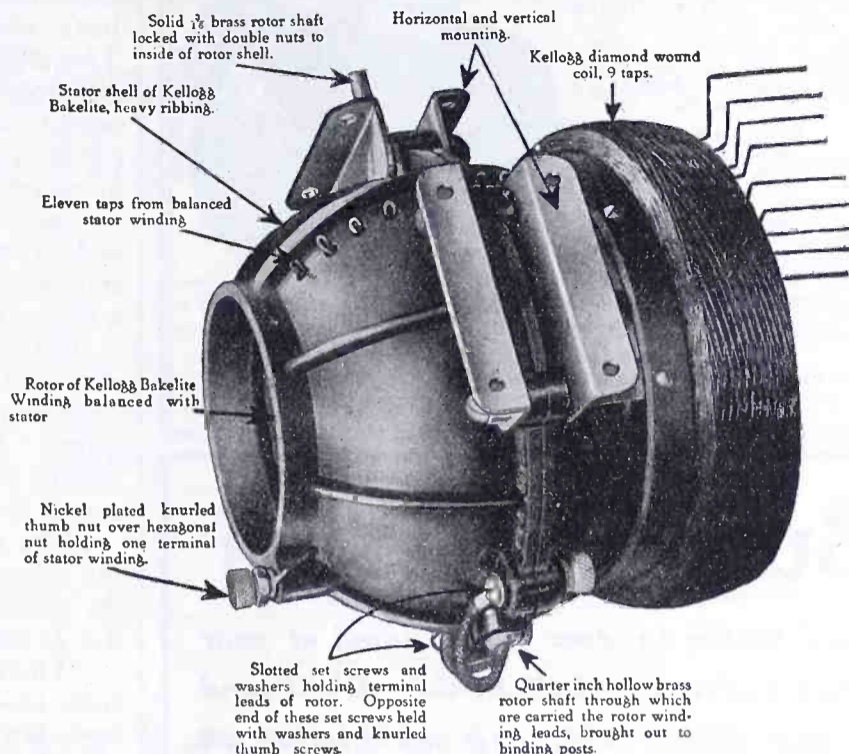

High induction and low distributed capacity

The No. 502 Diamond wound coil increases the wave length from 500 to 2500 meters

No. 501—Varicoupler \$8.00 - With No. 502 Coil as shown above \$12.00

**KELLOGG SWITCHBOARD & SUPPLY CO., CHICAGO**

## You can get **MURDOCK** Receivers

AND OTHER MURDOCK RADIO APPARATUS

--- Why bother with any other kind?

**\$5.00**

2000 Ohms  
No. 56  
Double

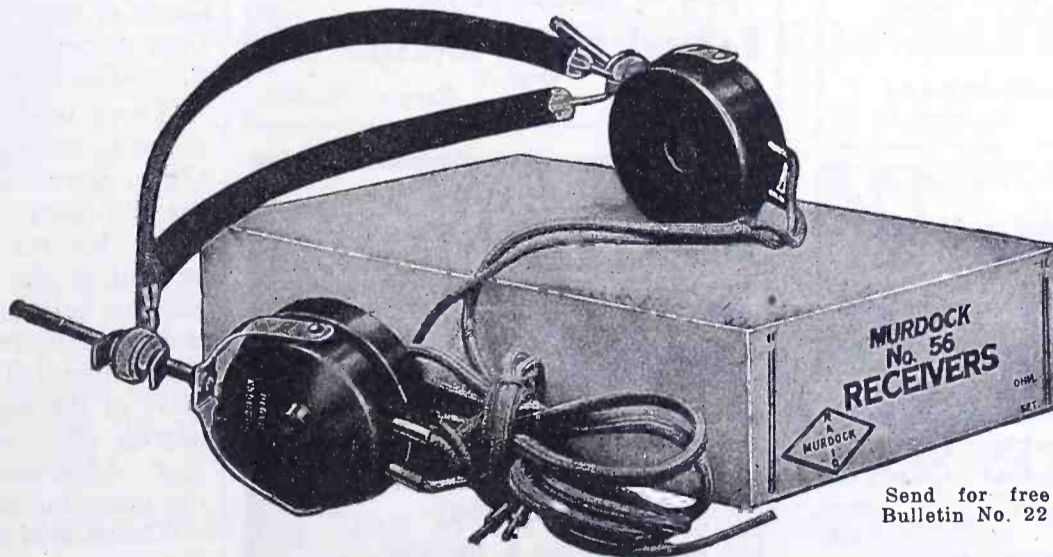

**\$5.50**

3000 Ohms  
No. 56  
Double

Send for free Bulletin No. 22

If your dealer is not supplied send remittance direct to us and your order will be promptly filled.

MURDOCK MADE 800,000 TELEPHONE RECEIVERS BEFORE GOING INTO THE RADIO BUSINESS AND HAS MADE THE BEST RADIO RECEIVERS FOR 14 YEARS

We carry a complete stock in our Pacific Coast warehouses. Write for dealer discounts.

### KEELER WHITE COMPANY

Pacific Coast Agents—WM. J. MURDOCK CO.—Since 1905

509 Mission Street, SAN FRANCISCO

211 So. San Pedro Street, LOS ANGELES

Polson Bldg., 71 Columbia St., SEATTLE, WASH.

Tell them that you saw it in RADIO

**"REGAL" INDUCTANCE SWITCH**

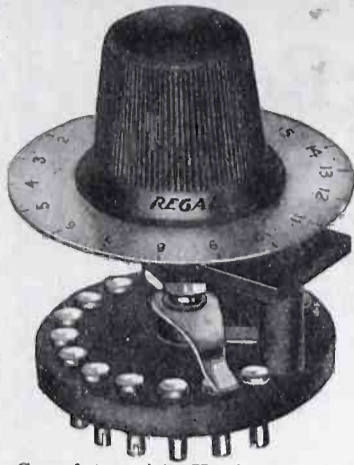

**TWO BIGGEST HITS IN RADIO**

**Regal Inductance Switch**  
Does away with all drilling of holes in panel. Does away with all switch points. Requires but one hole to attach to panel. Complete 15 point switch in one unit.

**Regal Rheostat**  
A scientific precision instrument. Full exposed resistance wire. More sensitive than a vernier. 6 Ohms resistance—2.2 Amperes. Condensers, Power Rheostats, Potentiometers, Variocouplers, Jacks, Knobs, Dials, etc. Send for our new catalog No. 27.

**"REGAL" RHEOSTAT**

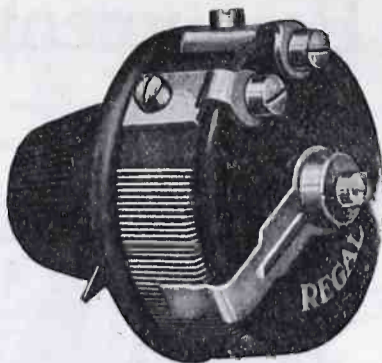

Complete with new Regal Knob \$1.00

Complete with Knob and Dial \$2.00

(If your dealer does not carry Regal Radio Products write us direct)

**THE AMERICAN SPECIALTY COMPANY**

**BRIDGEPORT, CONN.**

# Radio Bug Emblems

An artistic bronze-finished button to wear on the lapel of your coat. "Tell the world that you're a RADIO BUG." We'll send you this emblem, free of charge, with one subscription to "RADIO" for one year.

**RADIO — PACIFIC BLDG. — SAN FRANCISCO**

**"EURACO PRODUCTS"**

(Guaranteed)

Compact — Interchangeable — Accurate Most Efficient



Price 60 cents per Unit Mfrs. of

MICA CONDENSERS, GRID LEAKS, MOUNTINGS

Interesting Proposition for Dealers

**European Radio Company**

1342 East 22nd Street Brooklyn, N. Y.

## Cut Rate Radio

STANDARD APPARATUS ONLY  
Write for 54 Page Catalog of Bargains!

- Baldwin Type "C" Phones..... \$10.25
- Brandes Superior Phones..... \$6.45
- Radiotron UV200 Detector Tubes.... \$4.25
- Acme Audio Transformers..... \$4.45
- 43 Plate Condensers..... \$1.95
- 23-Plate Condensers..... \$1.60
- Federal Phones..... \$6.35

Everything for Radio at less. Immediate Delivery.

**Federal Radio Electric Co.**

Dept. N  
1233 Grand Ave., Kansas City, Mo.

**CARTER "HOLD-TITE" JACKS**



1 to 5 springs; price 70c to \$1.10

New design; heavy phosphor-bronze springs; no spacer washers required. Write for Bulletin on these Jacks, the well-known "TIL-WAY" Plugs and other Carter products. All-Pac. Radio Sup. Co., San Francisco, Coast Dist. CARTER RADIO CO., 209 S. State St., Chicago

*Investigate!*  
**WESTERN-RADIO DEALERS SERVICE**  
Wholesale RADIO Only  
637 So. Hope Street, 565 Howard Street  
LOS ANGELES SAN FRANCISCO

## PARTS PRICES SLAUGHTERED

CASH WITH ORDER  
PARCEL POST PREPAID

- |  |        |                                      |        |
|--|--------|--------------------------------------|--------|
| \$5.00 Detector Tubes, guar.....                                     | \$2.75 | \$1.00 3 in. Hard Rubber dial.....   | \$ .30 |
| 6.00 Amplifier Tubes.....  | 3.50   | .90 V. T. Sockets.....               | .60    |
| 6.50 Guar. 1½ Volt Tubes (detector and amplifier) for dry cells..... | 4.95   | 1.50 22½ V. Cyclone B. Batteries.... | .79    |
| W. D. 11 Transformer and for all dry cell tubes.....                 | 4.50   | 1.75 22½ V. Cyclone B. Batteries.... | 1.15   |
| Phones, 2200 ohms.....   | 3.75   | 12.00 King Amplitone Loud Speaker    |        |
| 4.75 43 Plate Variable Condenser....                                 | 2.75   | Horns.....                           | 7.75   |
| 1.00 Rheostat.....   | .39    | Dictograph Loud Speaker.....         | 13.50  |
| 1.50 Klosner Vernier Rheostat.....                                   | 1.19   | 3.75 Vario Couplers.....             | 1.75   |
|  |        | 7.00 All Wave Coupler, 3000 Meters.. | 6.95   |
|  |        | 5.00 Variometers.....                | 2.75   |
|  |        | 1.75 3 Plate Variable Condenser....  | 1.25   |
|  |        | 3.75 23 Plate Variable Condenser.... | 1.49   |

To avoid delays check items and total amount.

**B. B. RADIO COMPANY**

2202 Mermaid Avenue

Brooklyn, N. Y.

Continued from page 76

dominated in his mind. There appeared an unsurmountable obstacle to keep him from realizing his dream of a lifetime. The valley of shattered hopes is filled with men Fate has led to the shadow of life's ambitions only to be cast aside. The collapse of his political career was fast approaching. The sacrifice of political fame was better than exposure.

"Is my withdrawal all you want?" he asked in a broken voice.

"No, one thing more. At twelve o'clock today I want you to make a statement to the stock exchange, giving a true account of the steel strike."

The judge picked up a pen from the desk and wrote out the message which was the death warrant of his public career. Written so that it was scarcely legible, yet it carried with it the wreckage of the city's most prominent man.

"You may give this to the papers for the afternoon edition," he said, handing the resignation to Owen. "I shall notify the *Tribune* myself."

"There is to be no announcement from you to any of the papers. I shall look after those details myself. Your resignation will appear in the *Mail* only. If the other papers wish to use the news we have given to the public after it has appeared in the *Mail*, they may do so."

"I'll not stand for any such thing. The *Tribune* has been my staunch supporter through all the years. They shall not be scooped by any of their competitors. I shall give them the news myself. To give such information to the one paper who has been my enemy would be the height of ingratitude. I refuse to allow the *Mail* any such advantage."

Owen faced the judge squarely. "Which do you prefer, your resignation appearing in the *Mail* only, or a facsimile of your letters to Ley, with headlines announcing your diabolical acts? The *Mail* prints one of the two."

There was nothing for the judge to do but consent to Owen's demands. Owen placed the resignation in his pocket and quickly left the office.

On his way back to the *Mail* he stopped at the stock exchange. It was an hour before the judge would give his statement in regard to the strike situation. The daily crowd was there. The news of the coming strike had caused a bearish effect on the market for weeks past. M-K steel had fallen daily, carrying many industrials with it.

Owen secured an order blank from the desk, and wrote: "Buy 50 shares M-K steel." He placed the order at the market price. A minute later, after being notified the order had been filled, he departed for the managing editor's office.

Speed now was the essence of the exigency. There was little chance of any paper getting the coveted news he pos-

Continued on page 80



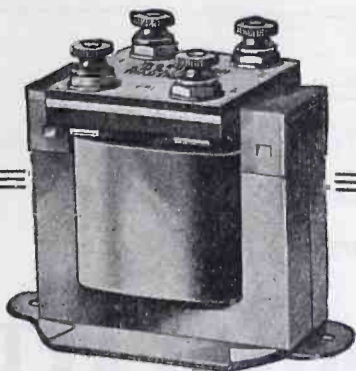

**On the First Step**

*Thordarson  
6 to 1 Ratio  
A. F. Transformer*

The ideal two step amplifier has a Thordarson 6 to 1 ratio transformer on the first step.

This is a new product — recently perfected and is distinguished from our 3½ to 1 ratio transformer by the red lettering on the top plate. It gives unusually high amplification without distortion, the core having twice the cross-section of the ordinary transformer.

Remarkably low priced to retail at \$5.00. Good discounts.

**Couple up these two for Highest Amplification**

We should be able to make better radio transformers for less. And we do!

We have specialized in transformers for the last twenty-five years. That means we know how to make them right! We have the men and the manufacturing facilities to produce them in quantity. That means we can make them economically!

Together they mean the best audio frequency amplifying transformer that can be made, at the lowest possible cost.

Hook up to Thordarson Transformers and see what perfect amplification really means. If you are a dealer, demonstrate to your customers what a perfect combination two Thordarson Transformers make for a two step amplifier—

These transformers can be used with excellent results on low voltage tubes.

And such a demonstration will certainly make sales if results are what your customers are after.

*Get a supply of Thordarson Transformers from your jobber now*

**THORDARSON**  
**ELECTRIC MANUFACTURING CO.**  
500 W. Huron St., Chicago, Ill.

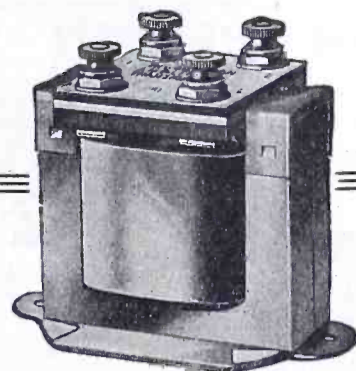

**On the Second Step**

*Thordarson  
3½ to 1 Ratio  
A. F. Transformer*

For best results and perfect reproduction of signals, the 3½ to 1 ratio transformer should be used on the second step. Used together in this way, these two transformers give exceptionally loud signals, yet in perfect modulation.

The Thordarson 3½ to 1 ratio transformer is distinguished by the black lettered top plate.

All silk insulated wire used throughout. Unequaled value at \$4.50 list—also with good discounts.

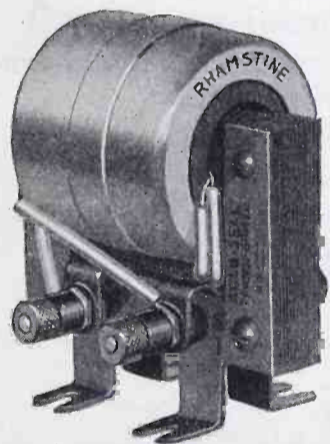

**RHAMSTINE\***

**“GOLD SEAL”**

**Amplifying Transformer**

*(Model C)*

**price \$4.50**

To be assured of the utmost value in selecting a Transformer—choose a Rhamstine\*. You will be especially well satisfied with the new “Gold Seal,” Model C.

It carries the pledge of highest quality from an organization that holds the unquestioned confidence of the radio public.

It stands for the accurate knowledge of Transformer design and construction—it assures you the best both in material and workmanship and its handsome gold-finished frame and coil shield will immediately appeal to you.

The Rhamstine\* Model A Transformer lists at \$3.50; the Model B with shielded coil, \$4.00; and the “Gold Seal” or Model C is \$4.50.

**For Amplification Without Distortion Choose RHAMSTINE\***

Catalog upon request

Dealers: Write for attractive discounts

**J. THOS. RHAMSTINE\***

2152 E. Larned St.

\*Maker of Radio Products

Detroit, Mich.

Tell them that you saw it in RADIO

Continued from page 78

**WELSH PEANUT TUBE**

W. T. 501

*"The Tube That Cannot Squeal"*

Sold for experimental use as a detector only.

Filament Current less than 1/2 amp. 4-6 volts. Plate voltage 16-22 1/2.

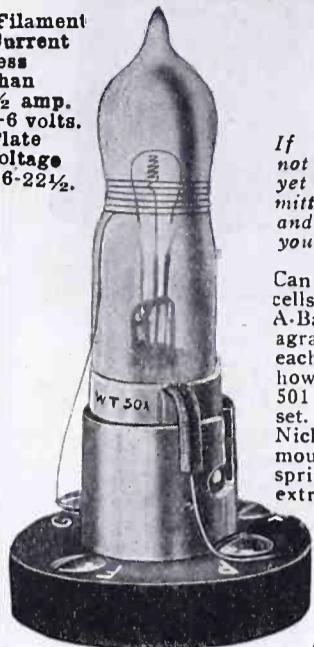

List Price  
**\$2.00**

*If your dealer has not got his stock in yet send us your remittance and his name and we will see that you are supplied.*

Can be used on 3 dry cells or regular 6-volt A-Battery. Wiring diagram packed with each tube showing how to use the W. T. 501 with any crystal set. Nickel-plated socket, moulded base, double spring contacts, 40c extra.

Adaptor for V. T. sockets, 75c extra. actual size 2 1/4 inches without base. Jobbers and dealers wire for merchandising plan.

Packed 10 in a carton, 10 cartons per case. Orders filled in rotation. Please do not ask us to open an account to ship sample tubes. Samples shipped only at list price which will be credited towards your first stock order.

**RADIO RESEARCH GUILD**  
40 Clinton St. Newark, N. J.

sessed, but there would be such a relief when it was all over.

Entering the building, he went immediately to Mr. Hunter's room. Between breaths he told the news he had secured. Not until the resignation was presented, read and re-read did the boss send word to the press room to make way for an extra with all possible speed. Seating himself before "Old Remy" he wrote up a detailed account of the story. As fast as the sheets were finished they were sent to the composing room. Twenty minutes after he had written the last page a copy of the extra lay before him.

It was now past one o'clock, the newsboys had gathered in the alley to wait for the afternoon edition. The daily crap game was brought to a sudden close when they were told an extra would be ready for them in five minutes. A few minutes later above the noise of the street the cry of the newsie could be heard: "Extra! Extra! Judge Davis Resigns!"

Seated in his room that night Owen relaxed from the suspense of the day. After completing his story he had gone directly home without saying a word to anyone. He was fatigued in mind more than body. He knew there was nothing which brought such enjoyment and pleasant relaxation as the evening radio concert, so he tuned in just as the opening number began.

After the music came the market reports. He listened with special interest when M-K steel was quoted six points above the price he had paid. Then came the local news. Judge Davis' withdrawal from politics on the eve of election was the paramount news item of the day.

The voice making the announcements was unfamiliar to Owen. He knew most of the people connected with the Radio Department, but tonight a stranger's voice came over the air. Just as he was about to take the receiver from his head he heard "The Mail wishes to announce that beginning tomorrow morning Owen Brainard will take up the active duties as editor."

A feeling of personal content settled over him. The unconquerable charm which lay hidden in his eyes dispelled the look of tiredness which had been there for the past few days. His mind turned back quickly to a few nights ago when a stranger spoke to some individual among the great number of radio fans. Again it was the voice of an unknown Broadcaster who brought to him the news that his dream since boyhood had been realized.

*Thousands of radio fans are reading*

# BROADCAST PROGRAM

*Every Week*

**5c**  
Per Copy

*You, too, Should read it---*

*32 Pages*

*Programs—  
Stories—  
Schedules—  
Questions & Answers—  
Definitions—  
Photographs—  
Humor—  
and other big features weekly.*

**\$1.00**

**Brings it to you every week for Six Months. Subscribe Now!**

*RADIO, Pacific Building,  
San Francisco, Calif.*

*Send me Broadcast Program for 26 weeks. I enclose \$1.*

Name .....

Address .....

**KEEP A DAY AHEAD**  
of the headlines of tomorrow's newspapers!  
Don't be satisfied with the regular broadcasted programs! Get the most out of radiol! Hundreds of radio enthusiasts are doing it!

*Equip your vacuum tube set with a*  
**FINCH RADIO RELAY**  
and you will automatically receive and at the same time have a permanent record of all the important and interesting news events of the world, whether or not you know the code.  
*Send Today for Booklet p. 2*

**FINCH RADIO MFG. CO.**  
303 FIFTH AVE. N.Y. CITY.

**NOVO "B" BATTERIES FOR RADIO**  
22 1/2, 45 & 105 VOLTS

**NOISELESS DEPENDABLE GUARANTEED**  
**ASK YOUR DEALER**  
**NOVO MANUFACTURING CO.**  
424-438 W. 33rd ST. NEW YORK  
531 SO. DEARBORN ST., CHICAGO.

Tell them that you saw it in RADIO

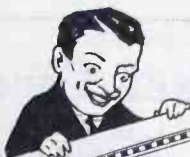

# This little book

## Shows why the KING QUALITY line is in demand!

ALL THE NAME IMPLIES

Write for a copy today.

QUALITY sells King Quality Radio Apparatus on sight: service keeps it selling. That's why the King Quality line is a desirable one to handle: why leading jobbers and dealers throughout the country are finding it the most profitable quality line on the market.

It keeps moving in stock—it satisfies users and produces profits and turnover for the dealer.

Our catalog will show you why there is no finer line of radio goods made anywhere in the world. Write for your copy.

RADIO APPARATUS DIVISION  
King Sewing Machine Co., Buffalo, N. Y.

### KING QUALITY

ALL THE NAME IMPLIES

## RADIO APPARATUS

Lower in Price—  
Highest in Quality

We maintain our own Bakelite Plant

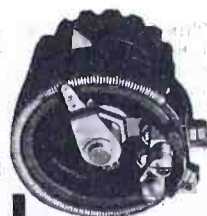

KING QUALITY Rheostat. R-630 Resistance valve 6.5 ohms. Special Brass Panel Bushing insures smooth operation. Genuine Bakelite Base.

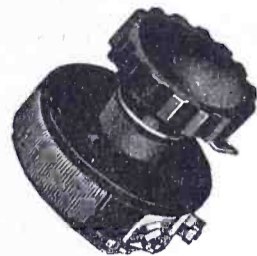

KING QUALITY "Universal" Adapter. R-10 designed to fit all tubes and valves.

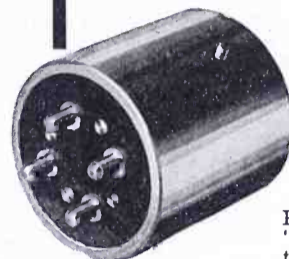

KING QUALITY VACUUM TUBE SOCKET  
Base of black or mahogany finished genuine moulded Bakelite with mirror finish; tube and terminal binding posts of brass, nickel plated and highly polished.

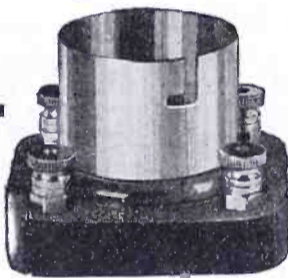

## Amplification Perfection

with all standard tubes

An audio transformer will give the same results with all tubes which are alike in A. C. Impedance and Amplification Factor.

- WD-11
- UV-199
- UV-201-A
- UV-201
- C-301

These tubes all have nearly the same A. C. Impedance.

## The AMERTRAN

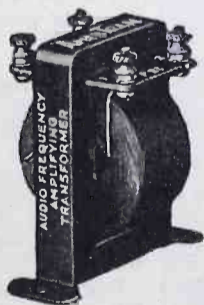

—universally acknowledged the greatest of all amplifiers, gives the same wonderful amplification curve with WD-11 dry cell tubes as with UV-201 Radiotrons.

Price \$7

### American Transformer Company

Designers and builders of radio transformers for over 20 years.

174 Emmet St.

Newark, N. J.

W. I. Otis, California Distributor, Rialto Bldg., San Francisco

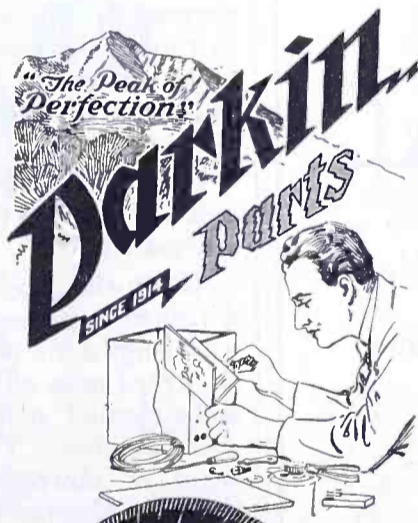

## Dial-Type Rheostat

"The Peak of Perfection"

GUARANTEED to improve both the appearance and operation of any set. Improves appearance because it matches and harmonizes with the other dials on the panel. Improves operation because it assures constant signal strength and prevents resistance overheating. Resistance element recessed in the back of the dial outside the cabinet, also giving more cabinet space. Sold through dealers, or direct if cash accompanies order. Money back if not satisfied. Price—

\$1.50

Mail this coupon  
FREE catalog

Parkin Mfg. Co.,  
San Rafael, Cal.

Gentlemen: Please mail me copy of PARKIN Catalog. Name and address of myself and of the dealer I favor, are:

MY NAME.....  
STREET.....  
ADDRESS.....  
DEALER.....  
STREET.....  
ADDRESS.....

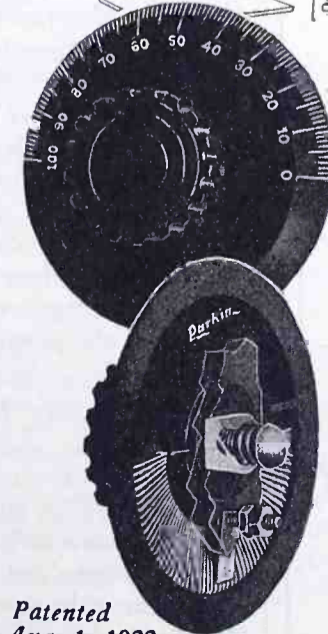

Patented  
Aug. 1, 1922

Tell them that you saw it in RADIO



This official 14 K. gold plated lapel button is now being given FREE to all new Members of the RADIO EXPERIMENTERS' LEAGUE. See special notice in RADIOAD section (page 90) this magazine. Old Members who have not yet received their lapel buttons write at once for one FREE. Get your friends to join RADIO EXPERIMENTERS' LEAGUE (run by Amateurs for Amateurs) 68 Glenridge Ave., Glenridge, New Jersey.

### RADIO TUBES REPAIRED EQUAL TO NEW

6 Volt Detectors ..... \$2.50  
6 Volt Amplifiers ..... \$2.75  
5 Watt Power Tubes ..... \$4.25  
We do not repair the V.T. 1 or V.T. 2 Tubes.

### REFILLED TUBES ON HAND

Original Electron Relays ..... \$2.75  
Original A. & P. Amplifiers ..... \$3.00  
Cunningham Detectors ..... \$2.75  
Cunningham Amplifiers ..... \$3.00  
Radiotron Detectors ..... \$2.75  
Radiotron Amplifiers ..... \$3.00  
Moorehead Det. or Amp. .... \$3.00

Our Repaired Tubes Speak for Themselves  
Repair work accomplished in  
Forty-eight Hours.

ALL WORK GUARANTEED

RADIO TUBE LABORATORIES, INC.  
776 Broad Street, Newark, N. J., U. S. A.

**Investigate!**  
**WESTERN-RADIO**  
**DEALERS SERVICE**  
Wholesale RADIO Only  
637 So. Hope Street, 565 Howard Street  
LOS ANGELES SAN FRANCISCO

# C. W. MANUAL

By Jennings B. Dow,  
Lieutenant, U. S. N.

Tells You how to build  
radio telephones

112 PAGES

**\$1.00** Per Copy  
Post Paid

**One of Radio's  
best books**

Published by

Pacific Radio Pub. Co., Inc.

Pacific Building

San Francisco, Calif.

## TUNING

Continued from page 22

quality and distorted, but much louder than at first. The regenerator has, therefore, been turned slightly too far to the right and the receiver begins to *oscillate*. When receiving speech and music, therefore, the regeneration should be turned very slightly back to the *left* until the signals are free from distortion. In other words, the regeneration should be set *just below* the point, mentioned above, where the receiver oscillates.

When no signals are being heard, the oscillation point is distinguished by a dull click in the head telephones as the regenerator reaches the oscillating point. The location of this point varies with the different settings of the secondary condenser.

When tuning for distant stations, the regenerator should always be kept at this oscillating point, or *slightly above* it, until the primary and secondary circuits are in tune, because the receiver is then in its most sensitive state and is in the best condition for receiving weak or distant stations. The signals are then accompanied by a high whistling note and the music or speech is rough and distorted. The whistle and distortion are removed after the primary and secondary circuits are tuned by turning the regeneration dial slightly back to the left, as explained above.

The series-parallel switch is for the purpose of providing greater flexibility in tuning the primary circuit of the receiver under the varying conditions encountered in different antenna installations.

Under ordinary conditions this switch will be turned to the *right* to the *parallel* connection.

When the receiver is used with some antennae, however, there may be certain wavelengths to which the primary can be turned most effectively by turning the series-parallel switch to the *left* to the *series* position. This produces the same effect as *shortening* the antenna and therefore *decreasing* its wavelength. It is necessary, therefore, to compensate for this shortening effect by adding more wire (*inductance*) by means of the primary inductance switch. Consequently, when the series-parallel switch is in the *series* position, the primary switch is turned about two points *farther to the right* than it would be for the same wavelength with the series-parallel switch in the *parallel* position.

Every vacuum-tube detector has a definite filament brilliancy at which it operates best. As there is considerable variation between detector tubes, means are provided in the receiver for adjusting the current which lights the filament to the proper value best suited to the particular tube in use. This is accomplished by means of a filament rheostat.

Tell them that you saw it in RADIO

## Chelsea Condensers

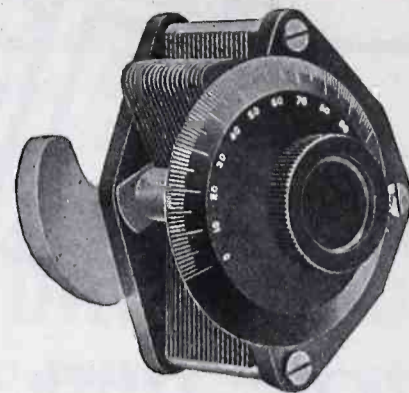

No. 1

### PRICES :

No. 1 Table.....	.001	\$5.00
No. 2 Table.....	.0005	4.50
No. 3 Panel.....	.001	4.75
No. 3a Panel without dial..		4.35
No. 4 Panel.....	.0005	4.25
No. 4a Panel without dial..		3.85
No. 5 Panel.....	.00025	3.75
No. 5a Panel without dial..		3.35
No. 6 Panel vernier.....		2.90
No. 6a Panel without dial..		2.50
No. 7 Table with vernier....		6.75
No. 8 Panel with vernier....		6.50

**Genuine Bakelite  
Construction**

The best and most complete  
line of condensers in  
existence.

Write for our catalog No. 7

**Chelsea Radio Co.**

152 Fifth Street  
CHELSEA, MASS.

## Crystal Receiving Set

**\$2.50**

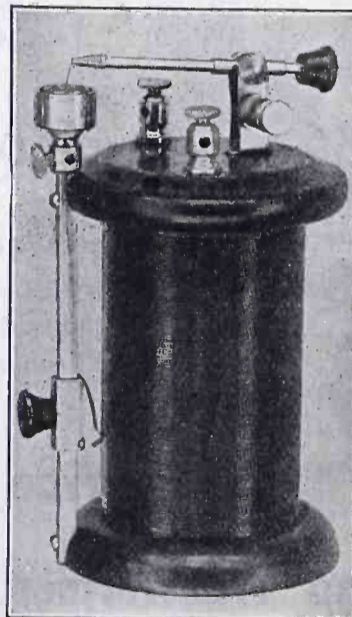

The Ritter Grand Crystal Set is everything that the beginner could wish for. It will tune up to 600 meters and will receive broadcasting stations from 25 to 50 miles. It is made of the best material with mahogany finish, stands six inches high and has the guarantee of high-class receiving qualities with a 100% rating by the Technical Department of RADIO.

Free circular of set with instructions on how to direct your aerial, sent upon request.

Ritter Grand Sets are sold at all J. G. McCrory Co. stores, F. & W. Grand Stores, and at reliable radio dealers.

We invite Jobbers' and Dealers' inquiries

**RITTER RADIO CORPORATION**  
232 CANAL STREET NEW YORK CITY

This control serves two purposes—(1) that of switching the filament current on and off, and (2) that of definitely adjusting the filament brilliancy to the proper value. *When the receiver is not in use, the current should always be turned off by turning the filament rheostat knob to the extreme left against the stop.*

When the receiver is to be used the current should be turned on and the proper adjustment determined by first setting the *regeneration* at 0 and then turning the filament rheostat knob to the *right* until a hissing sound, similar to that of escaping steam, is heard in the telephone receivers or loud speaker. The knob should then be turned very slightly to the *left* until the hissing just ceases. This is the proper filament adjustment for the particular detector tube in use and it will need very slight, if any, further adjustment when the receiver is tuned.

A voltmeter is provided for indicating the terminal voltage on the filament as controlled by the Filament Rheostat. This should never exceed 6 volts for the ordinary standard tubes and if good results can be obtained without going above 5 volts, the length of life of the filament will be increased. This voltmeter enables the user at all times to see what voltage he is employing on his vacuum tube filament.

The grid condenser is a refinement added for the purpose of adjusting the receiver so that it operates most effectively with whatever standard detector tube is being employed. Ordinarily, on the shorter waves, this condenser is best set at a comparatively low value, say approximately 20 to 30, whereas, for the very long waves, such as used by the high-power radio telegraph stations, the adjustment will be better at a high setting, around 80 or 90.

It is to be recommended that the receiver be always tuned by the use of head telephones rather than a loud-speaker, and without the use of the amplifier, even though an amplifier be connected to the receiver. If an amplifier is connected, the plug should be placed in the first jack on the amplifier and a pair of head telephones connected in place of the loud speaker (if one of the latter is employed). This is of particular importance when tuning for distant stations, as it is difficult to accomplish tuning of this sort when using the loud-speaker, on account of the very small amount of energy reaching the receiver from a distant station.

After the desired station is satisfactorily tuned in, the amplifier and loud-speaker may be connected in and used as described below.

*As in driving an automobile, the best operation of the radio receiver is obtained after the user has had some little*

*Continued on page 86*

# Cotogrip

"Put It First to Last"

This little beauty was approved by our engineers only when convinced that they had produced the one socket that combines all the essential features of a good socket.

1. Positive Cotogrip Contacts.
2. Hard Rubber Insulation.
3. Rugged Construction.
4. Compact Design.
5. Concealed Mounting.

It is impossible to show the unique mechanical action of Cotogrip contacts in a photograph. It is different from any other socket you have ever seen. This socket will interest you in every way.

You ought to have one.  
Ask Your Dealer



## COTO-COIL CO. PROVIDENCE



### HIGH EFFICIENCY HEAD SETS

- Army and Navy Type:
- 2500 ohm, per pair.....\$10.00
  - 3200 ohm, per pair.....\$12.00
- Swedish-American Type:
- 2200 ohm, per pair..... \$8.00
- Victor Type:
- Double pole, single coil, per pair ..... \$6.00

**American Electric**  
COMPANY

CHICAGO, U. S. A.  
Per 30 Years Makers of Good Telephones

## RADIO SUPPLIES

Mail Orders Promptly Filled  
WE PAY THE CHARGES  
If It Is

### RADIO

We Can Supply It.

U. C. BATTERY  
and ELECTRIC CO.

2158 Univ. Ave. Berkeley, Calif.



Those Broken and Burned-Out  
**VACUUM TUBES**  
Can Be  
**Repaired**

and Guaranteed Tool  
If your dealer does not know send direct to us.  
**Harvard Radio Laboratories**  
P.O. Box 1781  
BOSTON, MASS.  
Tubes returned P.P., C.O.D.

## \$5.25

Guaranteed 1½ Volt Tube  
Operates on Dry Cell

Detectors and Amplifiers, Best Made

- \$5.00 Guaranteed Detector Tubes (6 Volt).....\$2.95
  - \$6.50 Guaranteed Amplifier Tubes (6 Volt)..... 3.45
- Sent post paid anywhere, upon receipt of price  
Price list free (containing 100 bargains)

**Broadway Electrical Novelty House**  
Mail Order Department R. O.  
134 Third Ave., New York, N. Y.

PROLONGS LIFE OF TUBES  
**AMPERITE**  
AUTOMATIC FILAMENT CURRENT ADJUSTER  
ELIMINATES RHEOSTATS  
EXPELS ALL TUBE TROUBLES  
FROM YOUR DEALER OR  
**RADIALL COMPANY** \$1.10 WITH MOUNTING  
89 WARREN STREET NEW YORK

Tell them that you saw it in RADIO

# CROSLEY *Model X*

# \$55

## *A 4 tube Radio Frequency Set*

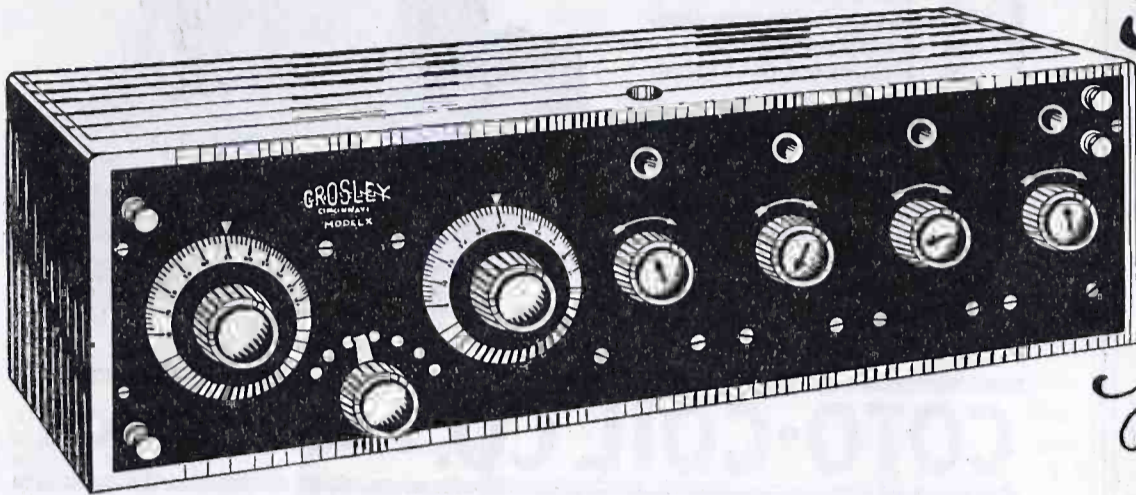

**TWO VERY  
EFFICIENT RECEIVERS**

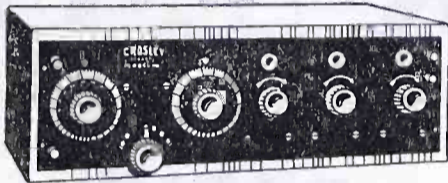

**CROSLEY MODEL VIII**  
A recent Crosley achievement. A three tube set that stands in a class by itself. Price, without tubes, batteries or phones \$48.00

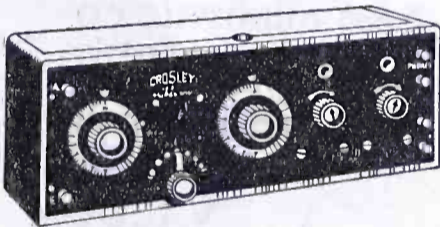

**CROSLEY MODEL VI**  
An instrument that has taken the country by storm. Its efficiency, in comparison to its cost, cannot be equalled. Price, without tubes, batteries or phones \$28.00

#### CROSLEY PARTS

We also manufacture a complete line of parts each one of which is guaranteed to perform perfectly. Among these are: Crosley Variable Condensers, Radio Frequency Amplifying Tuner, Sheltran Transformer, Cabinets, Vacuum Tube Socket, Rheostat, Vacuum Tube Adapter, Knob and Dial, Vario Coupler, Crystal Detector Stand, etc. Write for Complete Catalog.

The hit of the radio world. Not until you have listened in on a Crosley Model X can you appreciate the wonders of radio. Every day letters are received from satisfied customers telling of far distant stations clearly and distinctly heard.

The Crosley Model X offers you by far the greatest value on the radio market today. It is a four tube set, consisting of one stage of tuned radio frequency, detector and two stages of audio frequency amplification. It is very easy to tune and eliminates static and local interference to a remarkable degree. Because of its simplicity any one may quickly tune in the desired broadcasting station to maximum volume.

Listen In On a Crosley Model X And You Will Have No Other. We invite correspondence from high-grade dealers concerning their handling these self-selling instruments.

For Sale By Good Dealers Everywhere.

## CROSLEY MANUFACTURING COMPANY

*Better—Cost Less RADIO*

419 ALFRED STREET

CINCINNATI, OHIO

Tell them that you saw it in RADIO

# CROSLEY Model Vc

## \$20 Regenerative Receiver Set

*Licensed  
under Armstrong  
U.S. Patent No. 1,113,149*

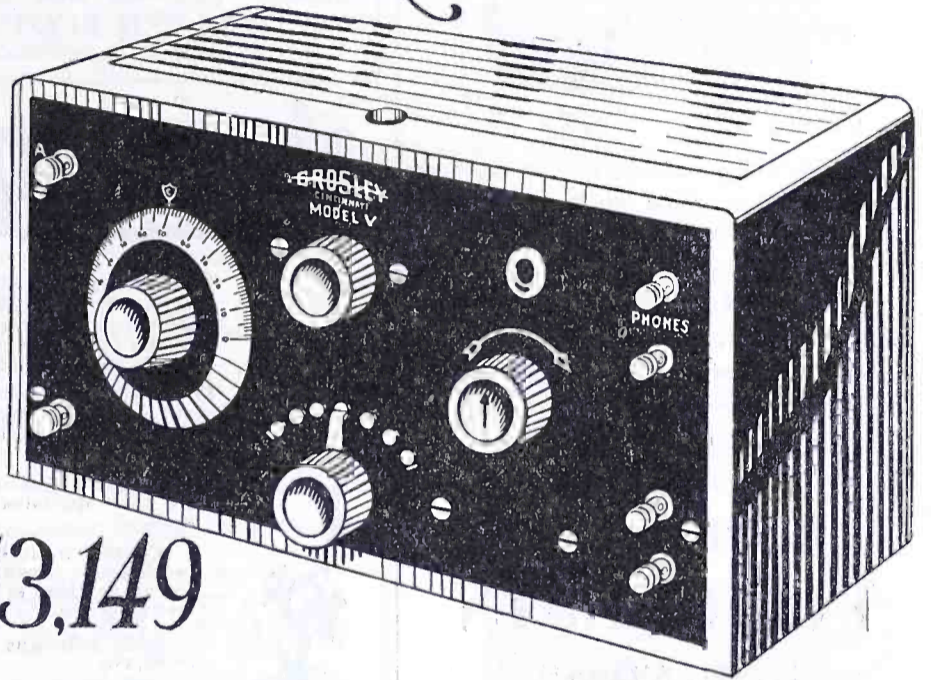

There is no other one-tube set being manufactured today that will give better results than produced by the Crosley Model Vc Regenerative Radio Receiver. The proud owner of one of these instruments can bring in any powerful station in the United States. Stations more than 1000 miles away are being copied regularly on this set. Equal in every respect to the guaranteed performance of this instrument are its finish and appearance.

It is made in two models as follows:

	Tuner Detector	2 Stage Amplifier
Model Vd with overhanging lid, panel engraved, without tubes, batteries or phones. Price.....	\$19	\$17
Model Vc with regular new style Adam Brown Mahogany cabinet, panel engraved. Price.....	\$20	\$18

Compare these prices with any set on the market.

The cabinets of both models are arranged so that the now popular 1 1/2 volt tubes may be used if desired. The trade name "Crosley" is used by permission of the Crosley Manufacturing Company.

For Sale By Good Dealers Everywhere

The Model Vc, pictured above, is only one of many regenerative receivers made by The Precision Equipment Co. which have proven so tremendously popular. We also offer a complete line of parts.

Wide-awake dealers will find it to their advantage to get in touch with us in regard to handling this popular line.

## THE PRECISION EQUIPMENT CO.

*Powel Crosley Jr. President*

419 GILBERT AVENUE

CINCINNATI, OHIO

Tell them that you saw it in RADIO

# FLERON VERNIER ADJUSTER

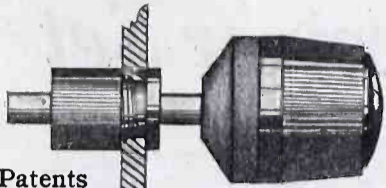

Patents  
Pending

65c

An absolute necessity for close sharp tuning. One should be with every tuning dial on your set.

Easily mounted by drilling only one 5/16" hole. Normal position of Vernier is away from the dial. A slight pressure causes beveled soft rubber of Vernier to make contact with bevel of dial. Vernier is then turned for accurate tuning.

# FLERON PORCELAIN INSULATORS



No deterioration in the weather with Fleron Porcelain Insulators. These insulators are made with a heavy Black Glaze without kiln marks or white spots. Each one packed in a separate Carton. FIVE SIZES.

No. 0—1 1/8x3 long	.....\$0.20
No. 1—1 5/8x4 long	..... .30
No. 2—2 1/8x3 3/4 (Ball)	..... .35
No. 3—1 5/8x5 long	..... .40
No. 4—1 5/8x8 long	..... .60

**M. M. FLERON & SON**  
INCORPORATED  
Manufacturers  
TRENTON, N. J. U. S. A.

## LOUD SPEAKER for any CRYSTAL SET

By using the STEINMETZ amplifier you can fill the whole room with music and can increase your range up to 1000 miles. \$8.50, remit by check or money order.

Specials for limited time only  
Radiotron UV200 Detector tube.....\$3.75  
Amplifier tubes ..... 4.75  
1 1/2 volt dry cell tubes..... 4.75  
Sockets for standard tubes, 50c; sockets for 1 1/2 volt dry cell tubes, 50c; standard 2000 ohm phones, \$3.90; 3000 ohm, \$4.90; SUPERIOR crystal sets, \$3.90; Eveready 22 1/2 volt "B" Batteries, \$1.50; Rheostats, 50c; Vac. tube detector sets, \$5.50; Amplifier sets, \$8.50.

This add must accompany order.  
Complete instructive catalog, 5c.  
At your dealer's or

STEINMETZ WIRELESS MFG. CO.  
5704 Penn. Ave., Pittsburgh, Pa.

## Original Nathaniel Baldwin HEADSETS

Type C Complete  
Special Price **\$11.75**

FREE

with each pair of phones  
—a \$5.00 Shelton Loud  
Speaker.

Phones can be used  
as head set or on  
speaker. Both for  
less than the regular  
price of the



Baldwins. Cash with order or C. O. D.

**WALTER SCOTT**

10 St. Lukes Place, Montclair, N. J.

## Chi-Rad handbook for this Ad and 10c

Because of the astonishing number of requests for Chi-Rad's latest Handbook-Catalog, we are forced from this date on to make a small wrapping and mailing charge.

In this Chi-Rad Handbook are 48 pages of valuable information for every radio fan. It includes the following:

1. Technical discussions of standard radio apparatus and equipment.
2. Complete instructions, including diagrams, circuits, and illustrations on "How to Build a Reintartz Receiver."
3. Radic definitions, codes, wire tables, etc.

Just wrap a dime up in this ad and mail it to us today. Requests for books will be filled in the order in which we receive them.



**Chicago Radio Apparatus Co.**  
415 S. Dearborn St.,  
Chicago

*Investigate!*  
**WESTERN-RADIO  
DEALERS SERVICE**  
Wholesale RADIO Only  
637 So. Hope Street, 565 Howard Street  
LOS ANGELES SAN FRANCISCO

### All Under One Cover!

A complete list of all Amateurs, Special Amateurs, and Telephone Broadcasting Stations of United States and Canada; also a large two-color map to record your DX work on, size two ft. by three ft. MAILED ON RECEIPT OF \$1.00 (No Stamps)

RADIO DIRECTORY & PUB. CO.  
45-D Vesey St. New York City

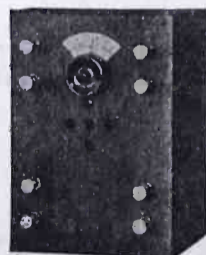

## Loud Speaker for Any Crystal Set

The Steinmetz Amplifying unit selling for \$8.50 will enable you to hear any crystal set all over the room. No storage battery required.

All Steinmetz equipment is thoroughly guaranteed.  
STEINMETZ 3000 Ohm Phones.....\$6.50  
STEINMETZ 2000 Ohm Phones.....\$5.00  
STEINMETZ 1000 Ohm Phones.....\$1.75  
Equal to any \$10.00 or \$12.00 Phones made.  
"Superior" Crystal Set, \$4.75  
Complete catalogue, 5 cents, at your dealer or  
**STEINMETZ WIRELESS MFG. CO.**  
5706 Penn. Ave. Pittsburgh, Pa.

Tell them that you saw it in RADIO

Continued from page 83

experience with it. It is obviously impossible in instructions of this kind to cover every possible point that will improve the results obtained. After the user operates his receiver for a short time in accordance with these directions he will find that he instinctively tunes his receiver just as he instinctively goes through the various actions necessary in driving his automobile.

Tuning for a 360-Meter Broadcasting Station.

### Initial Settings:

1. Set the regeneration at 0.
2. Adjust the filament rheostat to the proper point by turning knob to the right until the hissing sound is heard, then turning back to the left until this just ceases.
3. Set the coupling between 2 and 3.
4. Turn the series-parallel switch to the right to the parallel position.
5. Set the primary inductance switch at point 3 (approximate setting in accordance with Table II).
6. Set the primary condenser at 50.
7. Adjust the secondary inductance switch at point 1, at the left. (See Table II.)
8. Set the secondary tuning condenser at 32 (in accordance with Table II).

### Final Adjustments for nearby stations:

1. Adjust the secondary tuning condenser by turning slightly to the right and left of the position at which it was placed above, until the greatest strength of received signals is obtained. Leave it in this best position.
2. Readjust the primary circuit as follows (the former setting being only approximate):

Slowly turn the primary tuning condenser knob to the right and left until maximum signal strength is obtained. If a constant increase is found up to 100 as the knob is turned to the right, this indicates that still more wire (inductance) is required in the primary circuit. The primary inductance switch should therefore be turned one step farther to the right and the primary tuning condenser then turned toward 0 until the best signal strength is heard. The primary is then tuned to the exact wavelength.

If, however, the signal strength increases as the primary tuning condenser is turned to the left toward the point 0, this indicates that there is too much wire (inductance) in the primary circuit. Therefore, the primary switch must be turned back one point to the left. The primary tuning condenser is then turned to the right until maximum signal strength is obtained. The primary at this point is in exact tune with the transmitting station. When the primary tuning condenser is turned to the point that brings it into exact tune or resonance a dull click known as the "primary resonance click" is heard. This sounds



somewhat like the oscillation click mentioned above.

3. If greater signal strength is desired from the receiver, the *regeneration* knob should be turned slowly to the *right*. As it is progressively moved to the right the signal strength will increase up to the point where distortion or roughness in the signal quality is encountered. The dial should then be turned slightly *back to the left* until the distortion is eliminated.

4. If there is another nearby station operating on a wavelength near that at which you are receiving and causing some interference, the *coupling* may be turned to the left to a very low value, thereby greatly reducing the interference. When the coupling is thus "loosened" or reduced, the resultant signals may be somewhat weaker than before. They may be brought back to practically their original intensity, however, by slightly retuning the primary and secondary circuits and possibly slightly readjusting the regeneration. *Final adjustments for distant stations:*

*Tuning the receiver for distant stations is exactly the same as tuning to nearby stations except that the receiver should be in its most sensitive state in order to respond to the extremely small amounts of energy coming in from the great distance. The adjustments below should follow those given above under "Initial Settings."*

1. In order to put the receiver in its most sensitive state, turn the *regeneration* dial to the *right* until the receiver is oscillating freely (well beyond the point where the dull click indicating oscillation is heard).

2. Readjust the *secondary tuning condenser* by slowly turning the knob slightly to the *right* and *left* of its original position until the whistling note or the distorted music or voice from the broadcasting station is brought to its greatest intensity.

3. The whistling and distortion may now be eliminated by tuning the *regeneration* dial slowly back to the *left* until these effects disappear and the resulting signals are clear and distinct. As explained above, the purpose of permitting the set to oscillate while tuning the secondary is to accomplish this tuning while the receiver is in its most sensitive state and therefore most responsive to the weak signals from distant stations.

4. Adjust the grid condenser by trial to the value which gives the best signals.

5. If the station to which you are listening is at a great distance and the signals are very faint after this resetting of the regeneration dial, a slight improvement may now be obtained by a *very small readjustment* of the *secondary tuning condenser*.

Continued on page 88

## Use a Leich Non-Tune Rectifier For Charging Your Radio Storage Battery



The Leich NON-TUNE Rectifier has a charging rate of 2 amperes when connected to a six volt storage battery.

This rate is sufficient for home use where three to four 5 watt tubes are operated.

Before many months one to one and one-half watt tubes (1 1/4 amp.) will be common practice.

Here the Leich NON-TUNE Rectifier is in a class by itself, highly efficient; at full load it consumes less current than a 40-watt lamp; reliable, and with a charging rate to assure long life to the battery.

NON-TUNE FEATURE, gives this charger flexibility in its operation, allowing for considerable voltage and frequency variation of the power circuit.

A PATENTED RELAY LOCK keeps the battery circuit open when the power current fails.

LEADING RAILROAD COMPANIES have used Non-Tune Rectifiers for years for charging batteries in their signal service because Non-Tune can be depended upon to function properly at all times.

Try a NON-TUNE. Ask your dealer or write for Bulletin No. 101B.

# LEICH ELECTRIC CO.

Manufacturers

Genoa, Illinois

NON-TUNE RECTIFIERS—LEICH COMFORTABLE HEADPHONES

## CRYSTAL FANS

Are you satisfied with your crystal, or do you want better results?

### MOLYBDIC GALENA

A new detector just discovered is sensitive even when ground to dust.

Send 50c for one of these wonder crystals. We will refund your money if you are not entirely satisfied.

Phoenix Radio Laboratory  
Box 842, Phoenix, Arizona

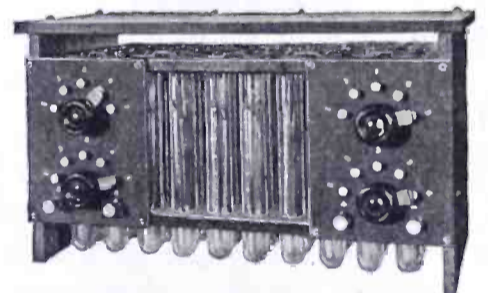

## KICO Radio Storage "B" Batteries for EFFICIENT Receiving

1. KICO "B" batteries allow single cell variations by means of switches mounted on panels. (The first in the market with this feature.)
2. Alkaline type.
3. Rechargeable from your 110-volt A. C. line in connection with the rectifier supplied.
4. One charge lasts from three to six months in the detector plate circuit.
5. Neat, efficient and compact.
6. Unlimited life.
7. Your money back if unsatisfied within a 90-day trial.

	(Plain)	(With Panels)
16 cell 22 volt.....	\$8.50	.....
24 cell 32 volt.....	8.00	\$12.00
36 cell 48 volt.....	10.00	14.00
50 cell 68 volt.....	12.00	17.00
78 cell 100 volt.....	16.00	21.00
108 cell 145 volt.....	21.00	26.00

"A" and "B" Battery Literature gladly furnished

## KIMLEY ELECTRIC COMPANY

1359 FILLMORE AVENUE BUFFALO, N. Y.

## "B" BATTERIES AN EVEREADY

PRODUCT

43V. Batteries, tapped.....	\$5.00
22 1/2 V. Batteries, Navy Type.....	3.00
22 1/2 V. Batteries, Commercial Type.....	2.00

Latter two types especially adapted to Cunningham and Radotron Tubes.

Postage Prepaid Anywhere in U. S.

### ETS-HOKIN & GALVIN

Wireless Engineers

10 Mission Street San Francisco

### HYGRADE SPECIALS

200 ft. 7 Strand No. 22 Copper Aerial Wire.....	\$1.25
Morse Eureka Test Clips, per dozen.....	.50
Skinderviken Transmitter Buttons.....	.95
No. 763 Eveready 22 1/2 Volt Variable B. Battery.....	1.25
No. 766 Eveready 22 1/2 Volt Variable B. Battery.....	2.25
No. 767 Eveready 45 Volt Variable B. Battery.....	4.25
2000 Ohm Murdock No. 56 Head Sets.....	4.49
3000 Ohm Murdock No. 58 Head Sets.....	4.98
Federal or Brandes 2200 Ohm Head Sets.....	6.50
Dictograph 3000 Ohm Head Sets.....	6.98
Fada or Framingham Rheostats.....	.65
Acme Amplifying Transformers (new type).....	4.25
Acme R. F. Transformers, Types R.2-R.3-R.4.....	4.25
6 Volt Marko Storage Batteries.....	8.95

All orders must include Parcel Post charges

HYGRADE ELECTRICAL NOVELTY CO.  
41 West 125th Street New York, N. Y.

*Investigate!*

## WESTERN-RADIO DEALERS SERVICE

Wholesale RADIO Only

637 So. Hope Street, 565 Howard Street  
LOS ANGELES SAN FRANCISCO

Tell them that you saw it in RADIO

# New "United" Vernier

A Miracle-Worker in Fine, Selective Tuning. Operates on a New Principle.

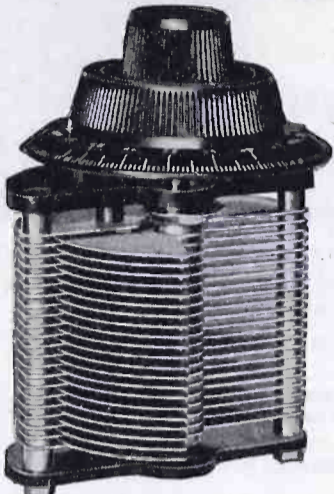

Will bring in the elusive stations that have thus far defied you, by giving at least twice as fine a tuning as has ever been possible with the best condensers thus far developed.

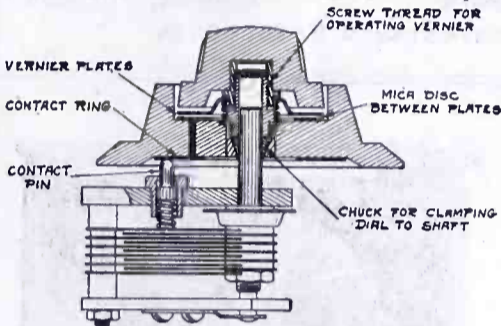

Can be attached to any plate condenser, by drilling one hole in top plate.

Price, each, postpaid, \$2.50

### "UNITED" VARIABLE CONDENSERS WITH NEW VERNIER

- 43-plate — each, \$6.50
- 23-plate — each, 6.00
- 11-plate — each, 5.50

### "UNITED" TRANSFORMER

Audio Frequency. Amplifies detected signals so they come in clear and strong, for either headphone or loud speaker reception.

Each, \$4.50

Send for catalog of United Products

## United Mfg. and Distributing Co.

536 Lake Shore Drive, Chicago, Ill.

NEW YORK OFFICE

50 Church St., New York, N. Y.

SAN FRANCISCO OFFICE

709 Mission St., San Francisco, Cal.

6. The next step is to slightly readjust the *primary* circuit as indicated above for nearby stations.

7. A final *very slight adjustment* of the *coupling dial* may be found helpful. After considerable experience with the receiver you may find it also helpful to make a *slight adjustment* of the *filament rheostat* after all other adjustments are completed.

TABLE I. SECONDARY CALIBRATION

Position of Secondary Inductance Switch	Setting of Secondary Tuning Condenser	Wavelength in Meters	Approximate Position of Primary Inductance Switch	
1	0	175	1	
	10	240	1	
	20	310	1	
	30	350	2	
	40	385	2	
	50	410	2	
	60	435	2	
	70	460	2	
	80	485	3	
	90	510	3	
2	0	370	2	
	20	530	3	
	40	660	3	
	60	760	3	
	80	850	4	
	100	940	4	
	3	0	780	3
		25	1045	4
		50	1275	4
		75	1450	5
100		1600	5	
4	0	1310	4	
	25	2060	5	
	50	2540	5	
	75	2930	6	
	100	3300	6	
5	0	2550	5	
	25	4300	6	
	50	5650	6	
	75	6600	7	
	100	7450	7	
6	0	4550	6	
	25	7500	7	
	50	9650	7	
	75	11300	8	
	100	12950	8	
7	0	9300	7	
	25	15300	8	
	50	19800	8	
	75	23400	9	
	100	26900	9	

NOTE: The settings given for the Primary Inductance Switch are of necessity only approximate. They may vary a point to the right or left of those given, depending on the antenna used. The settings given are for the Parallel position of the Series-Parallel Switch. The Primary Tuning Condenser should be set at 50 in the beginning, so that it may be turned to either the right or left in tuning.

It should be remembered that the calibration given above may vary a little, depending upon the settings of the other controls, as each of these has a slight effect upon the secondary tuning.

### Tuning for a 400-Meter Broadcasting Station.

The tuning procedure for a 400-meter broadcasting station is exactly the same as that outlined above for a 360-meter transmitter except that the *secondary tuning condenser knob* is set at 45 in accordance with Table II, in order to tune it for the slightly longer wavelength. The procedure above outlined should then be followed explicitly. It will be found, of course, that the final setting of the *primary tuning condenser* will also be at a higher point on account of the greater wavelength.

Tell them that you saw it in RADIO

## STANDARD EQUIPMENT

# PRICES?

## Can U Beat 'Em?

Every item is guaranteed highest grade and perfect or money refunded.

	Regular	Our Price
Magnavox, R-3	\$45.00	\$34.50
WD-11 Peanut Tube—Socket Free		6.50
Cunningham Detector Tubes		5.00
Cunningham Amplifier Tubes		6.50
With each Cunningham tube purchased we will give free 1 bakelite base, metal neck socket and 1 high grade rheostat.		
Baldwin Phones	\$12.00	\$ 9.25
Western Electric Aviation Type Army Phones with Headbands Guaranteed New Stock. A Remarkable Value at the price of.....		8.00
11 Plate Variable Condensers	3.00	1.45
23 Plate Variable Condensers	3.50	1.50
48 Plate Variable Condensers	4.50	1.75
Large Size Tapped "B" Battery 22½ Volt.....	3.00	1.75
Large Size Tapped "B" Battery 45 Volts.....	5.00	3.00
All-American A. F. Transformers Shielded 10 to 1.....	4.75	3.35
All-American A. F. Transformers Shielded 5 to 1.....	4.75	3.35
All-American A. F. Transformers Shielded 3 to 1.....	4.50	3.25
Erla Radio Frequency Transformers	4.00	2.95
Carter Radio Jacks—Open Circuit Jack.....	.70	.50
Closed Circuit Jack.....	.80	.60
Double Circuit Jack.....	.90	.70
Filament Control 4 Spring	1.00	.80
Filament Control 6 Spring	1.10	.90
High Grade Filament Rheostats	.75	.45
Moulded Variometers	5.50	3.75
Moulded Variocouplers 180 Degree	4.50	3.25
Freshman, Micon, etc.....	30% off list	
Switch Lever—Tapered Knob	.40	.17
Switch Points.....Special at Per Dz.		.10
Switch Stops.....Special at Per Dz.		.24
Guaranteed Radiocite Mtd...	.30	.20
Guaranteed Million Point Mtd.	.30	.20
3" Bakelite Dial	.75	.45
Tone Tested Mtd. Galena....	.30	.20
Grewol Crystal Detector	2.00	1.65
Federal No. 226W. Transformers	7.00	5.25
Triple Honey Comb Coil Mounting	5.00	3.50

SPECIAL SPECIAL SPECIAL SPECIAL  
TUSKA STANDARD LICENSED REGENERATIVE RECEIVER AND TWO STAGE AMPLIFIER COMPLETE WITH—3 Cunningham Tubes—6 Volt 100 Ampere "A" Battery—2 Large Size "B" Batteries—3000 Ohm Headset—Aerial Equipment—and Arkay Loud Speaker—In Short, Nothing Else To Buy—At The Very Special Price of..\$100.00

Send Your Order In Today!  
Shipments made within 24 hours. Please remit by Express or Postal Money Order. Include postage at your zone rate or shipment will be made by Express.

## INDEPENDENT Radio Supply Co.

3239 Ogden Ave.  
Chicago, Ill.

# Radio Questions Answered

Let the Radio Quiz Book answer all your questions about radio. This book contains 260 questions and answers—detailed descriptions of radio equipment and how to take care of it, and explanations of radio terms, symbols, diagrams, formulae tables, laws, regulations etc. It is a book of ready reference everyone interested in Radio should have.

Send for the Radio Quiz Book today. For a short time we are selling it for \$1.00. Mail letter with \$1.00 now!

NATIONAL RADIO INSTITUTE, Dept. R  
1345 Pennsylvania Ave., N.W., Washington, D.C.



# ★ ★ RADIOADS ★ ★

A CLASSIFIED ADVERTISING SECTION READ BY BETTER BUYERS

The rate per word is five cents, net. Remittance must accompany all advertisements.  
Include name and address when counting words.

ADS FOR THE MAY ISSUE MUST REACH US BY APRIL FIRST

**RADIO EXPERIMENTERS' LEAGUE** members wear a RADIO EXPERIMENTERS' lapel button (see cut on page 82, this magazine). Be identified as an alert and progressive radio enthusiast. Join RADIO EXPERIMENTERS' LEAGUE, conducted by Amateurs, for Amateurs. Every owner of a radio set is eligible for membership. Every member receives one of the official 14K gold plated lapel buttons, also a membership card and private identification code number. All members of the LEAGUE are entitled to a ten per cent discount on any approved standard receiving or transmitting radio apparatus. You may also have your choice of any one of the following "DOPE SHEETS": (1) Ten Super-regenerative Circuit Diagrams, every one designed by the famous Major Armstrong himself, together with a complete discussion of their operation by Major Armstrong reprinted by special permission from the Proceedings of the Institute of Radio Engineers. (2) Diagram of Armstrong Super receiver with accurate panel layout, list of parts and where to get them, also three photos. This set actually works. (3) Diagram how to make a simple and inexpensive "WAVE-TRAP" to separate 360 and 400 meter waves and minimize interference. (4) Wiring diagram of the best transmitting set we have seen for O. W., voice or buzzer, with accurate panel layout. (5) Detailed diagram of new "REFLEX" circuit showing how to get two stages of Radio and two stages of Audio frequency amplification using only two bulbs. This also shows the electrical values of the various parts used.

We always have the facts on the latest developments. If you have any hard nut to crack or question to ask, shoot it in, we will send a "DOPE SHEET." We old-timers are sincerely glad to lend a hand wherever possible. This is one of the most valuable features of membership. Send your name today. Enrollment and registration fee 50c includes button, membership card, 10 per cent discount privilege, and choice of any one of the above "DOPE SHEETS." Additional "DOPE SHEETS" in the above list or special "DOPE SHEETS" answering a question, 50c each. We have been able to get a number of the new W.T.501 PEANUT detector tubes while the supply lasts, \$2.00 each; special sockets, 40c extra; adaptors, 75c extra. Radio Exchange (see cut on page 82, this magazine). Be members of League, 68 Glenridge Ave., Glenridge, N. J. More Radio Clubs invited to affiliate.

**RADIO WORLD, THE GREAT NATIONAL WEEKLY**—published every seven days with all the latest news, developments and pictures of the radio field. 15c a copy. \$6.00 a year (52 numbers), \$3.00 six months, \$1.50 three months. Special to radio readers. Send \$1.00 and we will send you the next eight issues of RADIO WORLD. Pub. Office, 1493 Broadway, New York. (tc)

Vacuum Tube Hospital  
We repair and guarantee them.  
Agents, Dealers, and Customers Wanted.  
George H. Porell Co., Inc.  
West Somerville, Mass.

**FOR SALE**—1 K. W., 45,000 volts, Transformer. Two .004 mfd. Dubilier Condensers— for high voltage. Benwood "Sink." O. T. 50 Watt Tube with socket. Phonotron. Write for particulars. T. A. Work, Jr., Pacific Grove, Calif.

**RADIO GENERATORS**—500 Volt, 100 Watt, \$23.50. High Speed Motors, Federal Phones, \$5.50. Battery Chargers, \$12.50. Motor Specialties Co., Crafton, Pittsburgh, Pa. (T.C.)

1000 to 1500 miles on 1 tube, 1 control. 150 to 25,000 meters. No rheostat, storage battery, variocoupler, variometer, 3 coil mounting, variable inductance, taps or radio frequency. Nothing to guess about. Complete particulars and hookup, \$1.00. No checks. Save 50% and get better results. Radio Experimental Laboratory, Box 194D, Berkeley, Calif.

**FOR SALE**—Regenerative Tuner, using Groves coils with Detector and Two-Step. Must sell, \$65.00. Wilson Borland, 231 Hay St., Wilkesburg, Pa.

**C. W. and RADIO PHONISTS**—Our new converters will satisfy your need for a more efficient and durable direct current plate supply. No armatures to burn out. Output from seven hundred to two thousand volts at .4 amperes.

Synchronus Motors, Transformers and other parts sold separate. Write immediately. Kimley Equipment Mfg. Co., 290 Winslow Ave., Buffalo, N. Y. (T.C.)

**Fifty General Electric V.T.11 five watt power tubes**, made for the Signal Corps. Sealed with the Signal Corps labels as having passed final test. \$8.00 each, postpaid. BERT C. PROF-FITT, Honolulu, Hawaii.  
**NAVY STANDARD IP500 TUNER**, range 250 to 6,800 meters. Condition A1. Also Detector and Two-Step Amplifier built in one unit especially to match same. Will sell at a bargain or consider trade for IP501 or Kennedy Universal Receiver. F. D. Bowman, Edinburg, Indiana.

Get the very latest hookup on Radio Frequency. Sent for 50 cents. Cost of parts very low. Max Electric Co., 1516 Macdonald Ave., Richmond, Calif.

Spiderweb forms made of hard fiber. Price postage prepaid 20 cents each. We have everything in the line of Radio. Richmond Radio Shop, 421 Macdonald Ave., Richmond, Calif.

Our big special pre-inventory sale of slightly shop-worn radio supplies. Must be sold to make room for new stock. These supplies are positively in finest condition but are slightly shop worn. Guaranteed same as new apparatus. Here is a list of what we have for immediate sale: Mahogany variometers, \$2.00 each. Mahogany variocouplers, \$2.00 each. Moulded variometers, \$4.50 each. Remler type variocouplers, \$4.00. Amplifying transformers, regular \$5.00 type, \$3.00 each. Three for \$8.00. Electrose 3-inch dials only 40c each. Electrose 2-inch dials only 30c each. Heavy bakelite moulded tube sockets only 30c each. Will ship these parts C.O.D. so that you can inspect them. Four-hour mail order service. If you have not already received our big free radio bulletins write for them at once. They are issued every month. ROSS RADIO SERVICE, 693 Mission Street, San Francisco, Calif.

**WANTED**—Radio Engineer to travel extensively. Must be capable of highest type of sales service work in demonstrating and introducing line of patented radio equipment for well known manufacturer of thirty years standing. Write, stating experience, education, age and salary desired. Box 333, "RADIO", San Francisco.

**BUILD YOUR OWN "B" STORAGE BATTERY** from twenty to one hundred volts. Elements, container and instructions fifteen cents per cell complete. Each cell is 1.2 volts. CO-OPERATIVE MERCHANDISE CO., 63 Chestnut St., Chelsea, Mass.

**BUY IT —  
SELL IT—OR  
EXCHANGE IT**

**through a  
RADIOAD**

**5c Per Word.**

**These little ads  
bring BIG results.**

**Mail your RADIOAD  
today for the  
next issue.**

receiver, tuning on the receiver should be done as explained above with the head telephones and without the use of the amplifier. This means that the plug on the amplifier should be connected in the first jack. After the receiver is entirely tuned and the desired signal is heard with the plug in the first jack, the signal strength may be increased by moving the plug over to the jack, controlling the first stage of amplification. The left-hand knob controls the filament brilliancy of the amplifier tube in the first stage exactly as the filament rheostat knob on the receiver controls the brilliancy of the filament in the receiver. When the knob is turned all the way to the left the current is turned off. As the knob is turned to the right a greater amount of current is allowed to flow through the filament, thereby increasing its brilliancy. There is, however, no critical point in the brilliancy of the amplifier filament as there is in the case of the detector tube. The controlling knob should be turned to the right until the maximum signal strength is obtained. It is better not to go beyond this point, as the life of the tube is thereby decreased; it is consequently desirable to use as small current as possible to get the best results.

If still further strength of signal is desired, the second stage of the amplifier may be connected in and adjusted in exactly the same manner by moving the plug over to the third jack similarly adjusting the second amplifier tube.

### Turning Off the Set

To shut off the set completely and to cut off all current supplied by the batteries, it is only necessary to turn the three filament rheostat knobs to the extreme left. The set may be allowed to stand in this position for any length of time without drawing any current from the batteries.

In turning off the set this way without adjusting any of the other settings, the circuits of the receiver are left tuned to the station which was last heard. If this station is operating when the set is next used, all that is necessary to bring in its signals is to place the rheostats in turn at their proper positions.

**RUSONITE**  
CRYSTAL RECTIFIER  
MULTIPOINT (Patent Pending)

A Synthetic CRYSTAL DETECTOR,

sensitive over its entire surface.

Eliminates all detector troubles. Extraordinary clearness and volume. Endorsed by Radio experts and press. Sold in Sealed Packages only. Join the ever-increasing Rusonite fans.

Price Postpaid, Mounted 50c  
Sensitivity Guaranteed

**RUSONITE CATWHISKER**  
14 Karat Gold Multipoint contact. Super-sensitive ..... 25c  
Order from your dealer or direct from us.

RUSONITE PRODUCTS CORP.

15 Park Row, N. Y.

Dept. "R."

Tell them that you saw it in RADIO



A high-grade Headset of standard aluminum construction, at a price that appeals to the average purchaser of radio apparatus.

# CLARION

## RADIO HEADSET

# \$5.00

The Clarion Headset is guaranteed to give perfect satisfaction or purchase price will be refunded.

Circular 21-A, mailed free on request, is of interest to Jobbers, Dealers and those desiring a high grade headset at moderate cost.

**Radio Supply Company**  
Hornell, N. Y.

### LETTERS TO THE EDITOR

*Continued from page 36*

obtain results which can only be secured from the double-circuit tuner when the user possesses an intimate knowledge of the technicalities of the art.

Comparing collectively the advantages of the two types of tuners, it is clear that the single-circuit tuner is by far the more useful to the average member of the family, as it enables him with a minimum number of adjustments to pick up far distant or local broadcasting stations. Usually the distant station can be found on the single-circuit tuner several minutes before it can be located on a double-circuit tuner, to say nothing of the increased audibility which the single-circuit set provides.

For long distance reception, it is preferable in every case to install an outdoor antenna in a free open space, keeping the lead-in away from the building and bringing it as directly to the receiving apparatus as possible. The antenna is preferably kept at the maximum distance from the trolley car lines, power lines, trees, buildings, etc., whereupon a marked increase in selectivity and in signal strength will be obtained. Lead-in wires should not be tacked to wooden mouldings or laid parallel to metal mouldings or framework.

Yours very truly,

E. E. BUCHER,  
Manager Sales Dept.  
Radio Cor. of America.

New York City.

### RECENT RADIO PATENTS

*Continued from page 38*

properly to the input and output circuits of adjacent tubes, four stationary spring clips 45, 46, 47 and 48 are provided. These are mounted on the back of panel 41, and contact with the terminals of the primary and secondary windings. The thermionic tubes such as 40 may be mounted opposite the transformers on the front of panel 41.

L. Cohen, Pat. No. 1,439,947: December 26, 1922. Electrical Signaling.

A scheme for securing very sharp tuning is described, in which the detector tube 6 is made to oscillate at a frequency differing only slightly from that received by antenna 1. The resulting beat note current is transmitted to a Wheatstone Bridge arrangement having impedance arms *a*, *b*, *c* and *d*, and an equipotential connection 21. When the beat note frequency is of the proper value corresponding to the reception from the desired station, no current flows in this connection 21. However, current does flow in coils 15 and 19, which are caused to affect the indicator 28 cumulatively. However, in case the beat note frequency varies from that corresponding to the desired signals, current also flows in coil 21 which is arranged to affect indicator 28 differentially with respect to the coils 15 and 19. For any particular interfering station, these coils or their associated parts may be so adjusted that the response of the indicator is nil for that station.

C. T. Allcutt, Pat. No. 1,440,432: January 2, 1923. Wireless Receiving System.

In order to detect undamped waves received by antenna 14, these waves are caused to generate, by the aid of coil 13, a magnetic field transverse to the flow of electrons in a two-electrode thermionic device 1. A heterodyning effect is obtained by combining with this field a field generated by a coil 9 connected to a local source of slightly different frequency from that received. Due to the beats of magnetic force influencing the flow of electrons, the signals can be recognized by the phone 8. In addition a rectifier 6 may be included in the tube circuit, although not essential unless a direct current flux is also impressed on the tube to render it still more sensitive.

## A "Radio Wonder" \$1.25

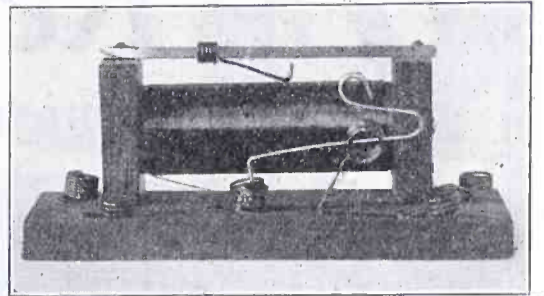

This splendid little set will receive radio concerts from any station within thirty miles, and will give just as satisfactory results as the larger and more expensive machines. Each outfit is equipped with an extra-sensitive piece of Standard mineral and is complete—ready for use—when you receive it. Full directions sent with each set.

Results are simply a revelation, so why be without one. Order yours at once and include ten cents with your money order to cover postage.

Dealer Inquiries Invited

**GERING SPECIALTIES CO.**  
274 Halsey Street  
Newark, N. J.

## CRYSTALS

Unconditionally  
GUARANTEED



Crystals are unconditionally guaranteed to give satisfaction—we tie no strings to our offer, they must be right.

**Standard Mineral Company**  
216 Market St. Newark, N. J.

This is the Switch  
that does the trick.  
Turn it till you hear it click



**Four Way  
Switch Plug**

ASK TO SEE IT

MANUFACTURED BY  
**THE FOUR WAY COMPANY**  
Springfield, Mass. U.S.A.

PRICE \$1.50  PRICE \$1.50

*Investigate!*

**WESTERN-RADIO  
DEALERS SERVICE**

Wholesale RADIO Only

637 So. Hope Street, LOS ANGELES      565 Howard Street, SAN FRANCISCO

### VARIABLE CONDENSERS

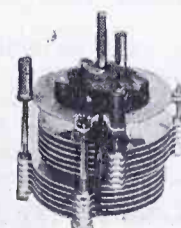

8-Plate Vernier . . . . \$0.75  
23-Plate .0005 Mfd. . . 1.75  
43-Plate .001 Mfd. . . . 2.25  
24-Plate Bal. Cond. . . . 3.75  
44-Plate Bal. Cond. . . . 4.75  
Add 10c for postage.

Aluminum Plates, accurate spacing. Shaft runs in bearings. Money back if you are not satisfied.

**MONTROSE MFG. CO.**  
1200 Bedford Ave.,  
Brooklyn, N. Y.

Tell them that you saw it in RADIO

# The Receiver

which has met with  
Universal Favor

## Telmaco

### Type B-R Receiver

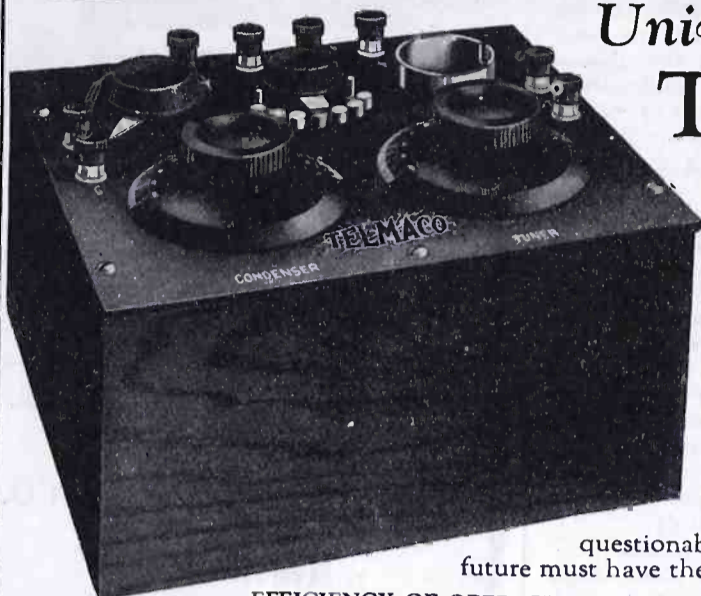

Manufactured exclusively for us by the Tri-City Radio Electric Supply Co., licensed under Armstrong U. S. Patent No. 1113149, Oct. 6th, 1914, for use in amateur stations and for radio experimental work.

A careful analysis of the past two revolutionary years in Radio shows unquestionably that the receiver of the future must have the following qualifications:

**EFFICIENCY OF OPERATION:** Securing distance, volume, selectivity, EASE OF OPERATION enabling the novice to secure satisfactory results. **HIGHEST QUALITY OF WORKMANSHIP AND MATERIALS.** The time when inferior radio products can be successfully merchandised is past. **PRICE** within the reach of everybody. All these qualifications are combined in the TELMACO Type B-R Receiver.

## Specifications:

Panel—Formica, grained and machine engraved. Varico-Coupler—TELMACO special silk wound with loading inductance in series with primary. Condenser—Special 13-plate with Bakelite ends. Rheostat—Single knob control. Sockets—Highly nicked shell, Bakelite base. Dials—are polished, presenting pleasing contrast with dull panel. Workmanship—manufactured according to TELMACO'S rigid specifications. This guarantees your satisfaction. Either 6 volt or 1½ volt tube may be used.

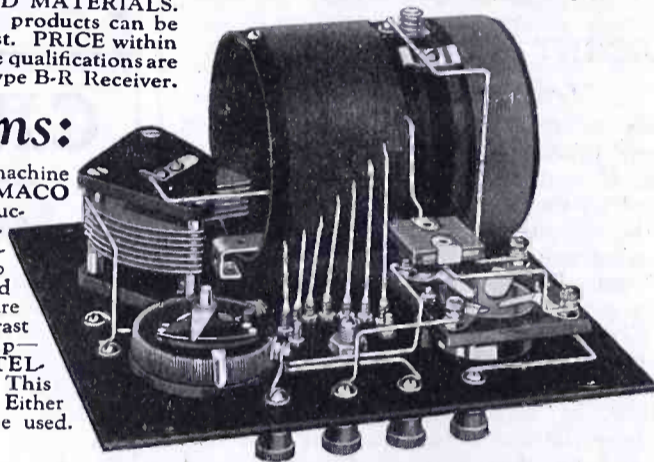

## Price \$25

The ultimate in value.

### Telmaco Type B-A Two Stage A. F. Amplifier

Matches the above in size and construction. The greatest Amplifier value on the market. Price \$20.00.

**Quality Radio Exclusively**  
Bona Fide Jobbers—If our salesmen have not reached you with our proposition, write or wire for it today.

RADIO DIVISION  
TELEPHONE MAINTENANCE CO.

20 S. Wells Street

Dept. A

Chicago, Illinois

## BRECO RADIO APPARATUS

*Bring Best Results—They are Dependable*

Listed below are a few BRECO specialties. Owing to our increased facilities, we are able to reduce the prices on some of our manufactured products.

Variometers .....	\$7.00	Crystal Detectors .....	\$1.75
Variocouplers .....	5.00	Inductance Switches complete	
Variable Condensers, 43 plate.....	4.50	with 7 points and 2 stops.....	.50
Dials, 3 in. Moulded.....	.50	Switch Points .....	.03
Rheostats .....	.75	A. F. Transformers.....	5.00
Binding Posts, N. P. or Insulated Knob.....	.08		
Mahogany cabinets, various sizes.....	\$5.00 up		
Bakelite sheets .....	per lb., \$2.00		
Straight Circuit Tuner with Detector.....	\$35.00		
Detector and Two Stage Amplifier.....	\$50.00		
Straight Circuit Tuner with Detector and Three Stage Amplifier.....	\$115.00		

Write for Catalogue

If your dealer cannot fill your requirements on BRECO apparatus, your order mailed to us will receive prompt attention.

**BRONX RADIO EQUIPMENT COMPANY**  
Bronx, N. Y. C. "Manufacturers of Quality" 687 Courtlandt Ave.

C. V. Logwood, Pat. No. 1,440,834: January 2, 1923. Radiocommunication.

A transmission system is described in which a pair of vacuum tubes 9 and 10 are so connected together and with a source of plate current 23 that oscillations are set up in the coils 6 and 7, which are located in the plate circuits. These coils are coupled to the antenna 1, as well as to the grid coil 14, located in the circuit connecting the two grids 13. In order to complete the grid-filament circuit of each tube, a mid-point of this coil is connected to one of the electrodes of a tube 18, while the other plate, 19, is connected to filaments 11. In order to transmit signals the resistance of this tube path is varied by controlling the potential of grid 20 by the aid of a microphone 31 inductively coupled to the tube 18. Variation in the resistance of this path causes corresponding variations in the intensity of the oscillation produced.

J. W. Hill, Pat. No. 1,441,087: January 2, 1923. Wiring System.

The inventor states that one cause for a broad band of waves of transmitting or receiving, which causes interference, is lack of symmetry in certain parts of the circuit. To remedy this for example in a radio condenser, he pairs the plates as shown, and pairs the result, until he obtains a single connection 19 to each set of plates. It is evident that each of the plates is symmetrically disposed to this common lead-in point.

E. P. Lindner, Pat. No. 1,441,988: January 9, 1923. Wireless Wave Detector.

A crystal detector of improved form is described, in which the crystal 20 is held in a cup 8 by a flat spring member 22. This cup may be rocked by handle 9 and is frictionally held in adjusted position by aid of a spring 18 acting on one of the bearings of the cup. The exploring point consists of a coiled spring 43 with a pointed end, which spring is fastened in a support 41. This support is slidably mounted on rod 31, which has a ball and socket connection with a stationary part of the apparatus.

R. A. Heising, Pat. No. 1,442,146: January 16, 1923. Modulating and Transmitting System.

A system for transmitting modulated or heterodyned waves is described, in which there are provisions for preventing the low frequency modulating current from directly entering the antenna, and also for preventing possible short circuits of the plate battery of the oscillation generator in case the antenna becomes grounded, as is liable in boats or the like. The oscillating tubes 0 generate the carrier waves, and their output circuits include wire 13, low frequency choke coil 12, inductor 11, plate battery  $E_D$ , and the filaments of tubes 0. The input circuit includes the grids of tubes 0, capacities 7 and 4, and the filaments. A coupling between the input and output is secured by aid of the antenna reactance 3. One method of signaling consists in varying condenser 4 as by key K, and thus changing the transmitted frequency slightly. By means of a heterodyning effect at the receiving station, this small change of frequency can be recognized. Another method of signaling involves the use of one or more modulator tubes M, the output circuits of which also include battery  $E_D$  and reactance 11. Due to the tendency of this reactance to maintain its current constant, variations in the output of these modulating tubes M cause corresponding variations in the tube 0. Control of tubes M is effected by an oscillating tube 0' of audio-frequency, which may be changed by manipulating key K'. A tone trap 23 prevents this low frequency from entering the antenna directly.

R. A. Heising, Pat. No. 1,442,147: January 16, 1923. Production of Modulated High Frequency Oscillations.

Tell them that you saw it in RADIO

# MELCO

S U P R E M E

Favored by Thousands of Radio Fans



**T**HE "Melco Supreme" Radio Frequency Amplifying Receiver can be used with indoor or outdoor aerial, loop or lighting plug—its operation is simplicity itself. Operates over a wavelength of 175 to 500 meters—covering all broadcasting ranges. It is a new departure in radio, non-reflex, non-regenerative, tuned radio frequency.

Amplification of the "Melco Supreme" is extremely high per stage—without the slightest loss of tone quality. It neither distorts the wave nor interferes with other members of the radio audience. Single tuning adjustments, assuring a great degree of program selectivity and long distance reception are permitted by this new system.

Entertain your family and friends with "Melco Supreme" concerts, lectures, current news, musical comedies, sporting news—in fact everything broadcast—every day in the year. Everlasting entertainment assured. Can be operated by a child.

Price \$125.00

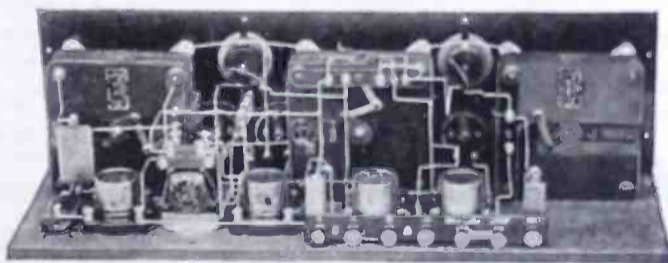

A complete line of high grade parts are also available.

Write for Catalogs No. 1001 and 1002

See our exhibit at the San Francisco Radio Show—week of April 3rd

## MORTIMER RADIO CORPORATION

114-116 Fulton Street

New York City

Huntington, W. Va.  
1028 Fourth Ave.

Los Angeles, Cal., 337 South Western Ave.

Pittsburgh, Pa.,  
704 Granite Bldg.

St. Louis, Mo.  
13 South Fourth

Philadelphia, Pa.,  
636 Victory Bldg.

Atlanta, Ga.,  
Flatiron Bldg.

San Francisco, Calif.,  
709 Mission St set

Exclusive Canadian Representative, Scott Bros., Ltd., 332 St. Catherine St. West, Montreal, Que.

## MELCO SUPREME

Tell them that you saw it in RADIO

**FRESHMAN PRODUCTS—ACCURATE AND DEPENDABLE**

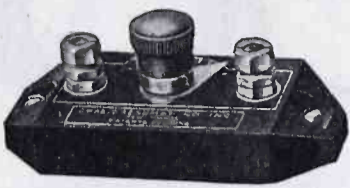

**“MICON”  
Tested Mica  
CONDENSERS**

Assure absolute noiselessness  
—clarity of tone—accuracy—  
constant fixed capacity.



**Antenella**

No antenna or aerial needed.  
Eliminates all the inconveni-  
ences in radio; operates from  
any light socket. Price only

**\$2.00**

**Variable Resistance Leak**

With .00025 mfd. Micon Condenser Combined **\$1.00** Without Condenser **75c**

Unbroken range—Zero to 5 Megohms.  
Clarifies signals, lowers filament current,  
increases battery life, eliminates hissing.



Size	Price	Size	Price
.00025	\$.035	.0025	\$.050
.0005	.35	.005	.75
.001	.40	.006	1.00
.002	.40	.01	1.50

**.006 MICONS and Variable Re-  
sistance Leaks especially adapted  
for New Flewelling Super Circuit.**

At your dealers—otherwise send purchase price  
and you will be supplied without further charge.

**Chas. Freshman Co., Inc.**  
106 Seventh Ave., New York

**Hit it anywhere! MAGNETITE  
RADIO-CRYSTAL**

The most sensitive Crystal Detector on the world market. Unaffected  
by handling or moisture and will render efficient service indefinitely. Price  
50 cents at ALL DEALERS—or mailed direct. GUARANTEED by

GIBBONS-DUSTIN RADIO MFG. CO.

OWNERS AND NATIONAL DISTRIBUTORS

518 WEST 9TH STREET

LOS ANGELES, CALIF., U. S. A.

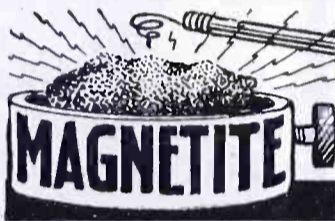

*Don't Take Chances With Your Radio*  
Safety and Pleasure Is Assured When You Install the  
**BRACH**  
VACUUM  
**RADIO PROTECTOR**

It Lasts For Years

Engineers whose experience qualifies them as competent judges  
acknowledge the Brach Vacuum Arrester to be unsurpassed as  
an instrument for insuring clear signals and protecting home  
and radio from lightning.

Approved by the National Board of Underwriters

Mend Your Wires and Joints With



At All Dealers  
or By Mail at  
25c a Tube



A Metal  
In Paste Form  
Insures perfect  
reception. All  
you need is a tube of this paste solder  
and a match to heat it. Results guar-  
anteed equal to bar or wire solder.



\$3.00

**L. S. BRACH MFG. CO., Newark, N. J.**

Coast Representatives: Pacific States Electric Co., San Francisco, Los Angeles, Oakland,  
Seattle, Portland, Spokane.

Tell them that you saw it in RADIO

Continued from page 92

A scheme for modulating the current from an oscillating tube is described. The filament-plate circuit of this tube includes a reactor 9 and battery 8, as well as coil 12 which is coupled both to the antenna circuit and to the filament-grid circuit. Across the reactor 9 and battery 8 is also connected the output circuit of the modulator tube 15, the impedance of which circuit is varied by the microphone 22. Since the reactor 9 tends to hold the current constant through the battery 8, any variation in the current flow in the modulating output circuit manifests itself as a variation in the current flow through the tube 1 and the coupling coil 12.

H. W. Nichols, Pat. No. 1,442,781: January 16, 1923. Reamplifying System.

A reamplifying or oscillating arrangement is described, in which a tube has a feed-back connection. This connection is so arranged that the current fed from the output circuit into the input circuit is in phase with that already existing in the input circuit. For this purpose the output circuit includes a network consisting of series and parallel arranged resistances *R* and reactances *C*, said reactances being all either capacitive or inductive. In this instance, the receiving antenna 14 forms one of the reactances. The input circuit is connected to one end of the network, while the output circuit is connected to the other. By proper choice of values of *R* and *C*, the desired phase relations are obtained, and the tube may be made either to oscillate or to reamplify, and serve either for ordinary reception or for heterodyning. The frequency, when oscillating, depends upon the tube constants, as well as upon the number of network elements *R*, *C*.

H. J. J. M. Der. de Bellescize, Pat. No. 1,443,011: January 23, 1923. Atmospheric disturbance reducing means.

This invention aims to minimize the effect of atmospheric disturbances on receiving systems. The receiving circuit consists of the resonant arrangement 1, 2, 3, 4 and connected thereto in succession are an amplifier 5, transformer 14, and a current limiting relay such as a vacuum tube. This relay limits the maximum intensity of the disturbance. The output circuit for this relay and the receiving circuit are coupled together as by the variocoupler 12-13. It may be proved mathematically that the signal intensity may be made a maximum by tuning the circuit 1, 2, 3, 4 by varying the coupling between 12 and 13, and by properly fixing the phase relation of the current *i* in the coil 12, as by the variable condenser 8. For this maximum response it is found that the natural period of vibration of the receiving circuit 1, 2, 3, 4 differs slightly from that of the signal. With this adjustment, strong atmospheric disturbances are found to be greatly damped, so that they quickly subside to an amplitude no larger than that of the signals, in the detector circuit 10.

B. Bradbury, Pat. No. 1,443,209: January 23, 1923. Radio Receiving System.

A constant wave heterodyne receiving system is described, in which interfering signals are minimized. This is accomplished by coupling a circuit to the output circuit of heterodyning detector 4, a pair of frequency traps in series. One trap comprising capacity 7 and parallel inductance 8 is tuned to the frequency of the audio beats, and a phone 9 shunts this trap and carries all the signaling current. The other frequency trap 10-11 is tuned to the frequency of the interfering signals, and prevents their passage. To reduce the interfering current still further, the two traps may be coupled together as at 12, and the coupling may be so adjusted that the interfering current in trap 7-8 is substantially entirely neutralized.



**DIVIDENDS FOR THE SET**

*Continued from page 14*

for within a period of a week he had been instructed to arrange to give such a concert. Two organizations asked him to prepare to arrange for a radio dance. He received \$10 each night he rented his set to a club and as a result made a profit of over \$60 by the idea. Through this plan he was also able to sell six receiving sets, at another attractive profit.

Another radio fan rents his set to a motor-boatman on Saturday afternoons and Sundays. The boatman's profits took a sudden leap. It can readily be seen that the people were not slow to take advantage of getting additional enjoyment by patronizing this man. Soon after several other boatmen rented radio sets and installed them on their motor-boats.

Pleasure craft of this type generally operate during May, June, July and August, Saturdays and Sundays. Some run every day, depending upon where they may be located. In these four months then, the average pleasure boat will be in operation thirty-four days, considering there are seventeen Saturdays and a similar number of Sundays in that period. Now let us again assume that we are paid \$3 per day for the use of our set. It will then mean that for the thirty-four days we are paid \$104. Such a sum would not be too much to pay for renting a set, for the average operator of a pleasure boat makes at least \$50 per day. It was said that the owners who put receivers on their boats were able to realize a 33 1/3 per cent increase in their business.

A Staten Island Radio Club was in need of funds and a special meeting was called to discuss how the money could be raised. Finally one member suggested that, as a well-known opera was to be broadcast, a receiving set be installed in a nearby hall. Attracted by the music just previous to the broadcasting of the opera, many persons gathered outside the door. Before they were given admittance they were made to pay ten cents, the members of the club informing them of the club's need of funds. The people generously assisted the organization and \$30 was realized that night.

OTHER STERLING RADIO DEVICES
Portable Rectifiers
Pocket Voltmeters
Filament Meters
Filament Rheostats

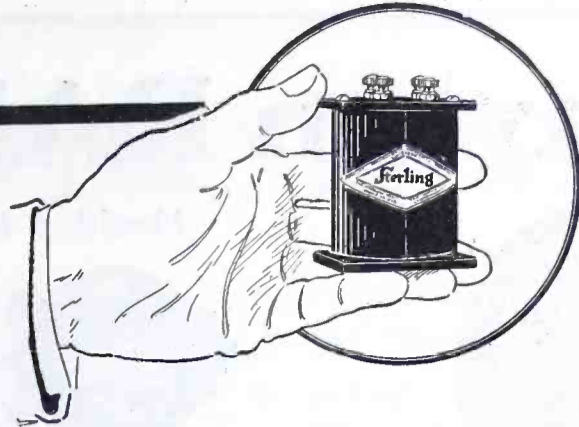

**A Regular Tom Thumb in Size — A Giant for Work**

These little transformers—size 1½ inches by 2 inches and 2⅞ inches high—make all the difference in the world in bringing out clear, forceful messages on your radio set.

They spell the difference between success and failure on countless receiving sets because they incorporate the best principles of radio and electrical engineering.

Made by a company whose experience began prior to the birth of radio.

STERLING FREQUENCY AMPLIFYING TRANSFORMERS

*Sterling*

2831 Prospect Ave. Cleveland, Ohio

**AUDIO FREQUENCY AMPLIFYING TRANSFORMER** reduces stray fields to a minimum. The coil is mechanically protected.

Type R301.  
Price \$4.00.

**RADIO FREQUENCY AMPLIFYING TRANSFORMER** will operate on any wave length and assures pure amplification.

Over 3,000,000 Sterling devices in use today

TRADE DISCOUNTS

**TOO LATE!**

With the "Cut" of Our New

**"S. R. 25" RECEIVER**

— BUT —

We Can Tell You This:

**We Challenge the World!**

To Outperform It

**2 Radio — Detector — 2 Audio**

\$150.00—less tubes

*And a beauty of finish that we believe unequalled.*

WRITE

**Hallock and Watson Radio Service**

192 Park Street

"KGG"

Portland, Ore.

**RADIO GOODS**

*at Bargain Prices*

- \$6.50—1½ V. Dry Cell Detector or Amplifier Tubes, fits standard socket, guaranteed ..... \$5.25
- \$5.00—6 V. Detector Tubes, guaranteed 3.00
- \$6.50—6 V. Amplifier Tubes, guaranteed 3.50
- \$5.00—Acme Audio or Radio F. Transformers ..... 4.25
- \$1.75—22½ V. Cyclone Variable B. Batteries ..... 1.00
- 2000 Ohm Gilbert Headsets (very sensitive) ..... 3.95

Numerous other bargains in our FREE PRICE LIST sent upon request. Goods shipped POST-PAID promptly upon receipt of remittance.

**Bergen Radio Supply Co.**

606 Bergen Ave.,

New York City

<b>RADIO MAILING LISTS</b>	Per M.
12,422 Radio Dealers, U.S. by States	\$7.50
	Per list
1,614 Radio Mfrs., U.S. by States	\$15.00
1,760 Radio Supply Jobbers, U.S. by States	15.00
260 Radio Stations	4.00
257 Mfrs. complete Radio Sets	4.00
67 Radio Battery Manufacturers	1.50
<i>Ready to send on receipt of remittance</i>	
Trade Circular Addressing Co.	
166 W. Adams St., Chicago	

**FREE!**

We have a very interesting leaflet on the **ARMSTRONG REGENERATIVE AND SUPER-REGENERATIVE CIRCUITS**. A copy is waiting for you. Just send us your name and address and enclose a two cent stamp to cover postage and your copy will go out by first class mail. Send for yours NOW!

**QUEENS RADIO COMPANY**

12 Forest St.

Winfield, L. I.

*Investigate!*

**WESTERN-RADIO DEALERS SERVICE**

Wholesale RADIO Only

637 So. Hope Street, 565 Howard Street  
LOS ANGELES SAN FRANCISCO

Tell them that you saw it in RADIO

# Dayton RADIO Products

## Moulded Bakelite Products

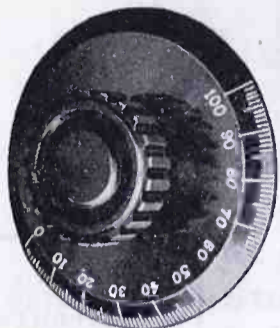

**BAKELITE KNOB & DIAL**  
2", 3" and 4" Diameter  
3/16 and 1/4 Shaft hole

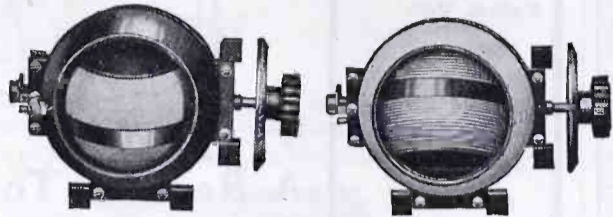

TYPE A VARIOMETER    TYPE A VARIO-COUPLER



INSULATING TUBING  
5 and 10 ft. Packages

## FIL-FONE SWITCH

One Installation  
One Movement



INDUCTANCE COIL

No Jacks  
No Plugs  
No Switches

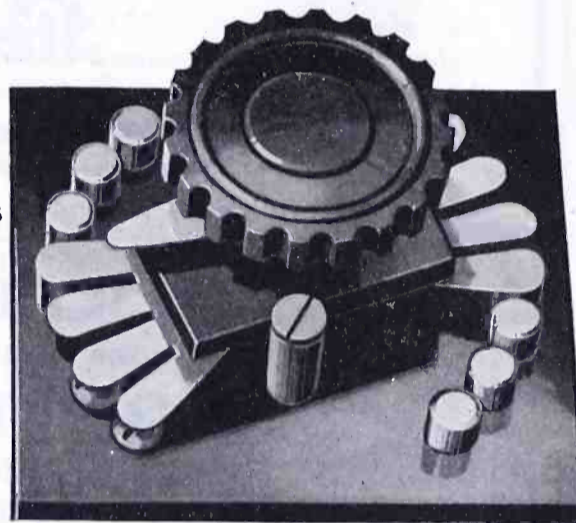

DESIGN AND CIRCUIT CONNECTIONS PROTECTED  
BY PATENTS PENDING

Price  
**\$3.50**

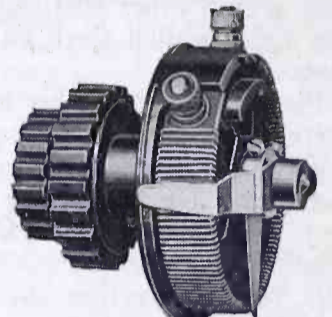

VERNIER RHEOSTAT



TYPE C VARIO-COUPLER  
90°

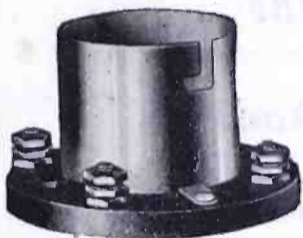

TUBE SOCKET

Dayton Fil-Fone Switch will be universally adopted in all Tube Sets.

Designed for convenience and elimination of surplus parts.

Dispenses with three jacks, plug and separate switch in every three tube set.

Simplifies wiring. Eliminates soldering, dispenses with 12 connections, and 10 feet of wiring in the average set.

Gives operator perfect control without noise or inconvenience of plugging phones from one stage to another.

Filaments, "B" Battery and Phones are automatically connected to either detector, first or second stage as desired, with a positive and progressive operation. It has an "off" position which disconnects all batteries and phones from the set.

Sold ready for mounting, with a complete wiring diagram.

Prompt shipments.

Complete catalog of radio parts with useful radio information sent on receipt of six cents in stamps for mailing.

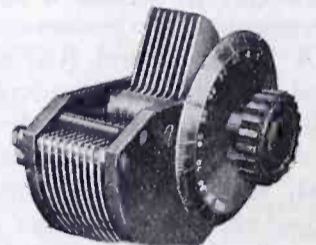

TYPE 17 P. C. ROUND  
CONDENSER  
Capacity, .0005 Mfd.



TYPE 31 P. C. ROUND  
CONDENSER  
Capacity, .001 Mfd.

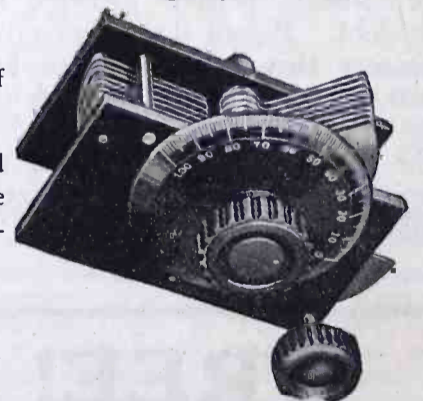

TYPE 17 and 31 P. C. S.  
CONDENSERS WITH VERNIERS  
ATTACHED

**THE A-C ELECTRICAL MFG. CO. - DAYTON, OHIO**

MAKERS OF ELECTRICAL DEVICES FOR OVER 20 YEARS

Tell them that you saw it in RADIO

# 373 In One Day!

## Read this

If you send us two subscriptions to "Radio" for one year each, we will send you one of the following premiums—free of charge.

- Work-Rite Variometer
- Work-Rite Variocoupler
- Amplifying Transformer
- Radio Frequency Transformer

For one subscription you may have one of these premiums:—

- C. W. Manual Bakelite Socket 3 inch Dial

*Please include 12c for mailing charges when you send us your order.*

February was a big circulation month for "Radio." On a single day we received 373 "Paid in Advance" subscriptions. March is going to be another banner month.

We make it worth while for our readers to subscribe. We give you premiums that cost you almost as much as the subscription price. And you get these premiums free of charge.

Several thousand additional subscriptions are needed to further increase our paid mailing list. Our special subscription offer will expire on May tenth. Get one of your radio friends to subscribe and send us your own subscription. Read the premium list to your left—select the apparatus that you want and mail us your subscriptions right now—before you forget it.

You get a \$5.00 Amplifying Transformer; \$4.50 Radio Frequency Transformer; \$3.50 Variometer or a \$3.50 Variocoupler free with only two subscriptions for one year each. It's worth-while to subscribe to "Radio."

**Every news stand purchaser of "RADIO" should be a subscriber. "RADIO" is getting better every month. It is the best practical radio magazine published. Subscribe today!**

*Mail this coupon with your remittance and the premium will be sent to you without delay!*

Get one of these valuable premiums before this big offer expires on May tenth

RADIO, Pacific Bldg., San Francisco

Send "Radio" for 1 year to:—

Name .....

Address .....

Name .....

Address .....

Premium desired .....

Send premium to .....

Why take a chance at not getting a copy from the news stands when you can subscribe and get a premium?

*Built on the  
best Engineering  
Principles*

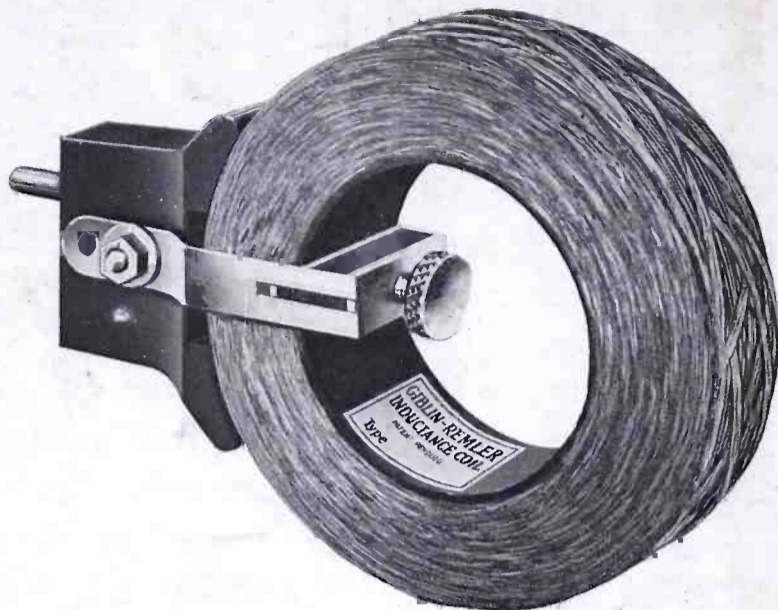

**Maximum Inductance.  
Minimum Distributed  
Capacity for a given  
number of turns.**

## **What Influenced You Most to Buy Your First GIBLIN-REMLER COIL?**

**YOU WANTED A COIL** that would give you the greatest possible selectivity of tuning—maximum signal strength under any given conditions—and, of even greater importance, a coil that would reduce interference to a minimum.

**WE KNOW** that the Giblin-Remler Inductance Coil is undoubtedly the greatest step forward in the radio art since the advent of the vacuum tube. Designed on the best engineering principles by Mr. Thomas P. Giblin, the originator of the compact inductance coil, it embodies every feature necessary to obtain **maximum inductance, minimum distributed capacity and minimum high frequency resistance** with a given length of wire and in a minimum of space. These are the essentials of an inductance coil for obtaining **maximum selectivity of tuning, maximum signal strength and a minimum of interference.**

*Write for table of constants and complete information regarding these coils.*

Send 10c for new 40-page Remler Catalogue containing circuit diagrams for Remler Apparatus and other useful information, including a table of inductance, capacity and wave length.

*The Remler Technical Bureau is at your service. Address your problems to Dept. R.*

## **REMLER RADIO MANUFACTURING COMPANY**

Factory and Home Office  
248 First Street, San Francisco, Cal.

Eastern Sales Office  
154 W. Lake Street, Chicago, Ill.