

# RADIO

no ground  
no aerial

*The Oard Phantom* Receptor



*Carry one in your car*

*Joys of radio opened  
to new thousands by  
this marvelous new*

## A-P set

Many people live in locations where an aerial is impossible or undesirable. The Oard PHANTOM Receptor opens the delights of radio to these additional thousands of people. It requires neither aerial nor ground connection. It operates anywhere. With a single antenna wire not exceeding 50 feet in length, laid or placed wherever most convenient, it will give better results over both short and long distances than other types of receivers requiring ground connections and elaborate aerials or loop systems. Ask your dealer to demonstrate, or write us for Bulletin R-3, mentioning his name.



DEALERS and  
JOBBERs WRITE—

### Atlantic-Pacific Radio Supplies Co.

Radio Supplies

646 Mission St. San Francisco

Receiving Sets

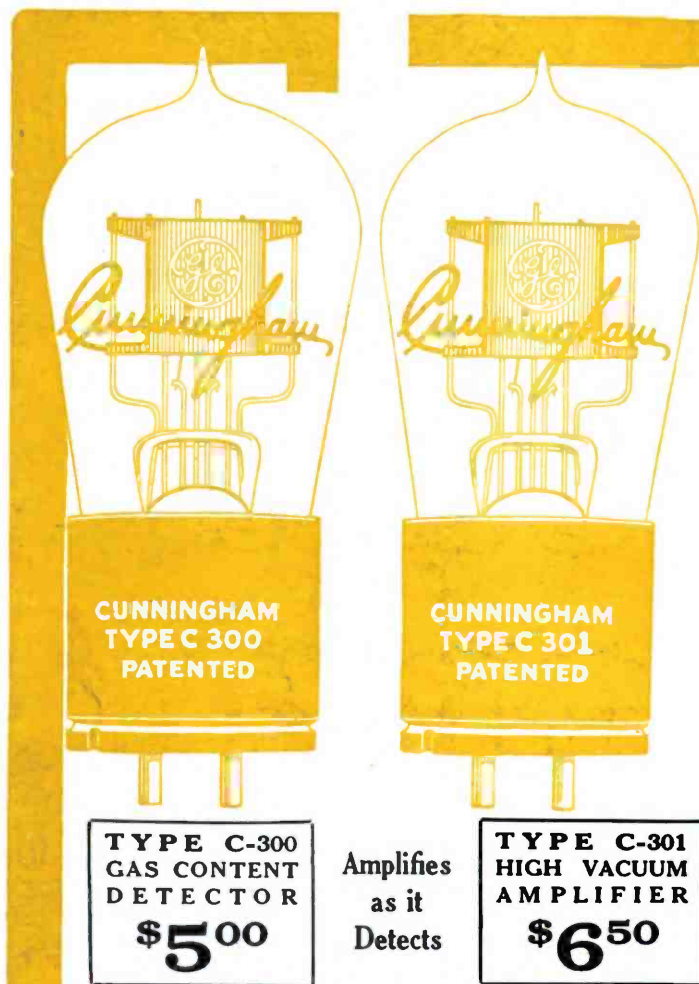

CUNNINGHAM  
TYPE C 300  
PATENTED

TYPE C-300  
GAS CONTENT  
DETECTOR  
**\$5.00**

Amplifies  
as it  
Detects

CUNNINGHAM  
TYPE C 301  
PATENTED

TYPE C-301  
HIGH VACUUM  
AMPLIFIER  
**\$6.50**

## SUPER-SENSITIVE DETECTOR

## DISTORTIONLESS AMPLIFIER

*Nationally recognized standards  
for all types of*

## RADIO RECEIVING SETS

# CUNNINGHAM

# VACUUM TUBES



The trade mark GE is the guarantee of these quality tubes. Each tube is built to most rigid specifications.

#### PATENT NOTICE

Cunningham tubes are covered by patents dated 11-7-05, 1-15-07, 2-18-08 and others issued and pending. Licensed only for amateur or experimental uses in radio communication. Any other use will be an infringement.

Written indelibly in the annals of radio progress is the record of Cunningham service in placing before the public, vacuum tubes of the highest conceivable standard.

The rapid expansion of radio telephony, now one of the world's foremost utilities, was made possible by the wonderful development of the vacuum tube.

The CUNNINGHAM SUPER-SENSITIVE DETECTOR and DISTORTIONLESS AMPLIFIER TUBES, designed and built in the great laboratories of the General Electric Company, are now nationally recognized as standards for all types of receiving sets.

**Home Office:**  
248 First Street  
San Francisco, Calif.

**Eastern Representative:**  
154 West Lake St.  
Chicago, Illinois

# Burgess, the *Radio* Battery Not a Group of Flashlight Cells

Burgess "B," the *Radio* Battery, has been manufactured for wireless use since the infancy of radio. Burgess "B" Batteries never have been, nor are they now, merely assemblies of flashlight cells.

Burgess "B" Batteries were designed by radio experts for exclusive radio use, and these radio

features are fully patented. You will find this special *radio* construction in Burgess "B" Batteries *only*.

Burgess "B" Batteries are handled by all progressive radio jobbers and dealers. "Look for the Black and White Stripes." And if you can't get the Burgess "B" from your dealer, just address:

## BURGESS BATTERY COMPANY

Manufacturers of

Flashlight, Ignition and Telephone Batteries

Offices and Warehouses at:

CHICAGO, ILL., 111 W. Monroe St. NEW YORK, N. Y., 50 Church St. BOSTON, MASS., 136 Federal St.  
ST. PAUL, MINN., 2362 University Ave. KANSAS CITY, MO., 2109 Grand Ave. MADISON, WIS., Main and Brearley Sts.

In Canada: BURGESS BATTERIES, Ltd.  
Winnipeg, Toronto, Montreal

# BURGESS "B" BATTERIES

"ASK ANY RADIO ENGINEER"

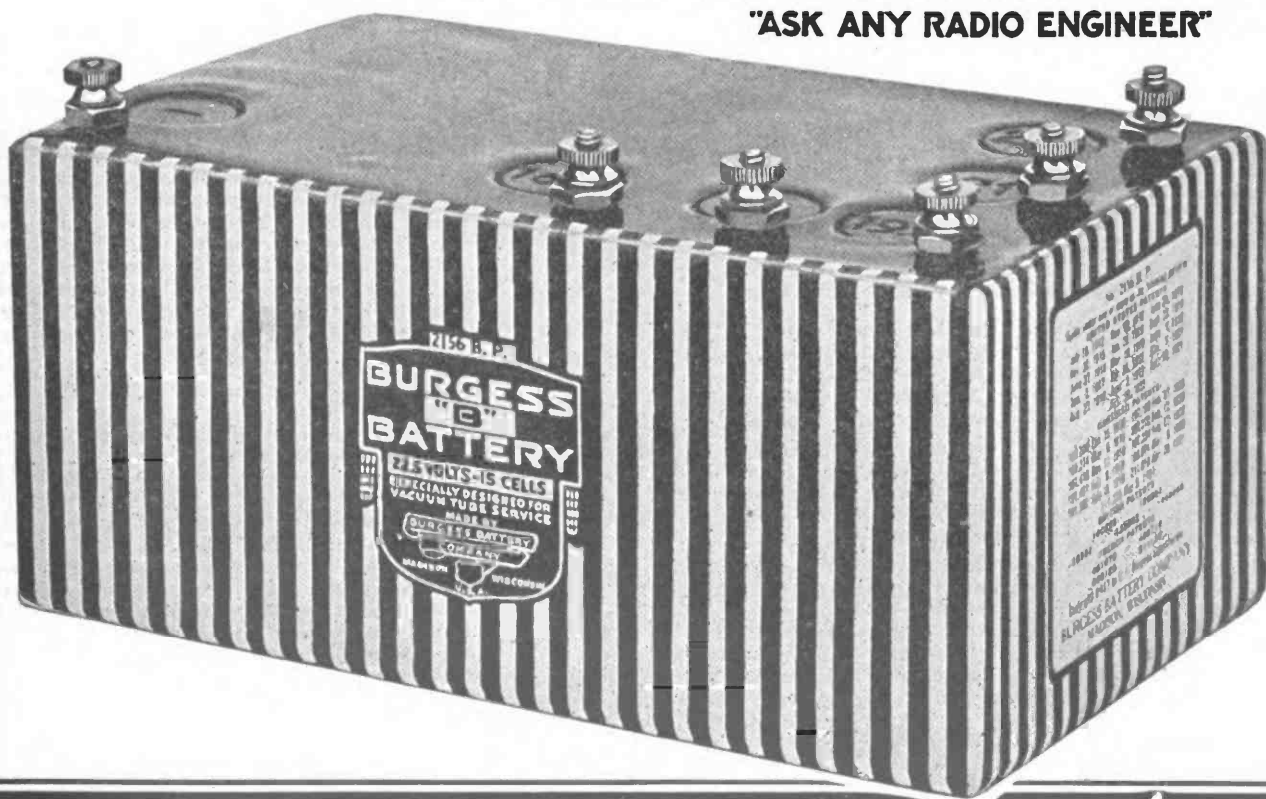

Tell them that you saw it in RADIO

# RADIO

Established 1917 as Pacific Radio News

Volume IV for NOVEMBER, 1922 Number 11

## CONTENTS for NOVEMBER, 1922

|   | Page |
|---|------|
| Radiatorial Comment.....                                  | 9    |
| Radio Directs Big Construction Job.....                   | 10   |
| <i>By CHARLES H. PEIRSON</i>                              |      |
| How to Become a Professional Radio Operator.....          | 11   |
| <i>By VOLNEY G. MATHISON</i>                              |      |
| Transmitters, Receivers and Tuning.....                   | 13   |
| <i>By ELLERY W. STONE</i>                                 |      |
| A 200 to 2000 Meter Radio Frequency Amplifier.....        | 15   |
| <i>By C. H. PARSONS</i>                                   |      |
| The Limitations of Radio .....                            | 17   |
| <i>By FRANK B. JEWETT</i>                                 |      |
| Scratchi Joins the Cluster .....                          | 18   |
| <i>By DAVID P. GIBBONS</i>                                |      |
| The Original "O. W." .....                                | 19   |
| <i>By LAWRENCE MOTT</i>                                   |      |
| Unusual DX for Hot Weather.....                           | 21   |
| <i>By LAWRENCE MOTT</i>                                   |      |
| Theory and Design of Amplifiers .....                     | 22   |
| <i>By LOUIS FRANK</i>                                     |      |
| A Concert Direction-Finder .....                          | 26   |
| <i>By STANLEY E. HYDE</i>                                 |      |
| 100,000 Watt Vacuum Tubes .....                           | 27   |
| Letters to The Editor.....                                | 28   |
| News of The Radio Clubs .....                             | 29   |
| News of the Broadcasters .....                            | 30   |
| With the U. S. Radio Inspector.....                       | 33   |
| Digest of Recent Radio Patents.....                       | 34   |
| Queries and Replies on C. W. Practice.....                | 35   |
| <i>By GERALD M. BEST</i>                                  |      |
| New Apparatus and Supplies From the Radio Manufacturers.. | 37   |
| Calls Heard .....   | 39   |

RADIO is Published Monthly by the  
Pacific Radio Publishing Co., Inc.,  
Pacific Building, San Francisco, Calif.

ARTHUR H. HALLORAN, *Editor.*  
LAWRENCE MOTT, *Associate Editor.*  
GERALD M. BEST, *Technical Adviser.*  
O. SCHUWENDT, *Engineering Draughtsman.*  
H. W. DICKOW, *Advertising Manager.*

Branch Offices: 17 West 42nd St., New York City, Telephone  
Longacre 8258; 6442 Ingleside Ave., Chicago; 761 Spitzer Bldg.,  
Toledo, Ohio; 52 Irving Street, Boston; 1102 Republic Bldg., Kan-  
sas City, Mo.; Suite 510, 456 So. Spring St., Los Angeles, Cal.;  
M. C. Mogensens & Co., Inc., Securities Bldg., Seattle, Wash.

Advertising Forms Close on the First of the Month  
Preceding Date of Issue

Issued Monthly, 25c a copy. Subscription price \$2.50 per year  
in the U. S., \$3.00 per year elsewhere. Instructions for change of  
address should be sent to the publisher two weeks before the date  
they are to go into effect. Both old and new addresses must  
always be given.

Entered as second-class matter at the Post Office at San Fran-  
cisco, Calif., under the Act of March 3, 1879.

Copyright, 1922, by the Pacific Radio Publishing Co.

## Forecast of Contributions for December Issue

December RADIO will be the annual Christ-  
mas number and will consist of at least 116  
pages of worth while information for the radio  
amateur. The Christmas spirit will be carried  
out in the story of "Sage Brush and Holly"  
by Earl Ennis, and in a dissertation on radio  
remembrances by S. P. Wright.

In the continuation of his excellent series on  
the practical radio operator, Volney G. Math-  
ison takes up the wireless school, correspon-  
dence courses and the question of passing the  
examination for license. These helpful sug-  
gestions from an old-time brass-pounder have  
been hailed as the best of their kind yet written.

From the theoretical standpoint, A. Ford  
Greaves, engineer Federal Telegraph Co., has  
an excellent paper on "Simplified Theory of  
the Federal Arc Transmitter," which makes the  
subject clearer than does anything else yet  
published. Jesse Marsten has analyzed a uni-  
versal formula for the design of inductance  
coils by which it is possible to figure the in-  
ductance of any closely wound coil with a  
minimum of calculation.

The next assignment of the University of  
California Extension Division correspondence  
course on Elementary Radio, prepared by El-  
lery W. Stone, will be somewhat more practi-  
cal than the preceding lessons which were nec-  
essary to lay the theoretical foundations. They  
are concerned with single and double-slide  
tuners, variable condensers, loose-couplers,  
variometers and honey-comb coils, emphasis  
being placed on methods of operation.

Several articles will be of especial value to  
present or prospective owners of sending sets.  
Chas. K. Fulghum will discuss practical meth-  
ods of obtaining high potential direct currents;  
Walter Emmett will try to answer the ques-  
tion as to whether shorter wavelengths are  
worth while and D. B. McGown will con-  
tribute on the subject of motor-generator sets.  
Mr. McGown is also writing a detailed de-  
scription of how to make a two stage a. f. re-  
ceiving set.

Some fine material will be presented on radio  
frequency application, including an announce-  
ment of the prize winners in the contest which  
closed on October 15th. Carlos S. Mundt will  
have a helpful article on the code and its diffi-  
culties. Donald K. Lippincott will analyze  
the use of auto-transformers for audio fre-  
quency. The usual departments and a host  
of other good articles will round out the issue  
to make it the best yet published. Because of  
the reported difficulties in getting copies from  
the newsstands we venture the suggestion that  
a personal subscription sent to your home will  
insure prompt receipt of all the good things  
in store during the year to come.

“Without going out of doors,  
said Lao Tzu,  
one may know the  
whole world!”

“Let a **Grebe Receiver**

bring the whole  
world to your  
evening fireside.”

*Doctor Mu*





*Paul F. Godley, designer of Paragon Radio Products, listening in*

## Godley Warns Radio Operators of Trouble This Winter

Paul F. Godley expects a chaotic situation in radio receiving this winter. Due to the delay in governmental regulation of broadcasting, operators of single circuit receivers are bound to have serious trouble. Mr. Godley says:—

“The coming season will see from ten to twenty times as many broadcasting stations as there were last year, all concentrating on one narrow band of wavelength. With a single circuit receiver, jamming and mixed messages are bound to result. Market reports, election returns, time signals, musical selections—all will be jumbled together in hopeless discord.

“The only way to cope with a situation like this is to use a three circuit regenerative receiver.

“For example, the Paragon three circuit receiver can select between broadcasting stations of about the same signal strength with less than one per cent differential.”

The Paragon receiver is easy to operate. It provides a simple solution for an extremely difficult problem.

Don't spoil your programs this winter with an obsolete receiver. You can only expect satisfactory results with an up-to-date receiver like the Paragon.

ADAMS-MORGAN CO., 2 Alvin Ave., Upper Montclair, N. J.

### Also Manufacturers of PARAGON

Radio Telephone  
Transmitters  
V. T. Control Units  
Rheostats  
Potentiometers  
V. T. Sockets  
Amplifier Transformers  
Detectors  
Control Dials  
Amplifiers  
Receivers  
Switches  
Variometers

# PARAGON

Reg. U. S. Pat. Off.

## RADIO PRODUCTS

Tell them that you saw it in RADIO

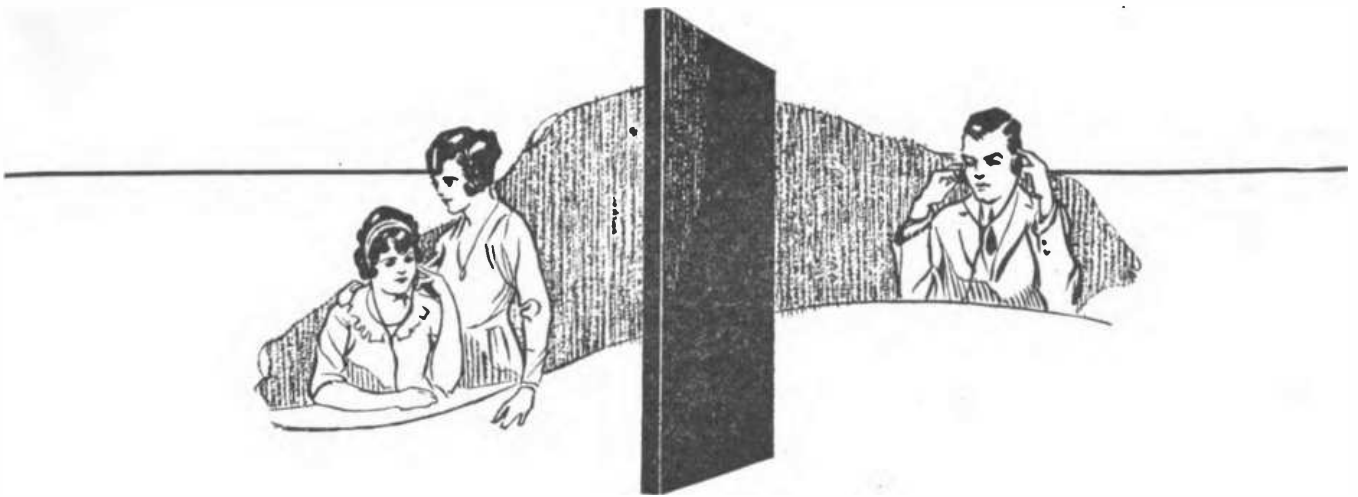

## Buy FORMICA Radio Panels

- Because they look better.
- Because they work more easily.
- Because they have the highest dielectric strength.
- Because they defy moisture, and do not warp.
- Because their uniformity is remarkable.
- Because they are approved by the navy and signal corps.
- Because radio men everywhere have come to prefer them.

Your dealer has Formica or can get it. We can refer him to a wholesale stock in his locality. Our own large capacity makes immediate delivery possible.

*DEALERS: A stock of Formica carries with it important advertising and sales cooperation. The demand for Formica quickly clears your shelves.*

THE FORMICA INSULATION COMPANY  
4616 Spring Grove Ave.  
Cincinnati, Ohio

SALES OFFICES

50 Church Street.....New York, N. Y.  
9 South Clinton Street...Chicago, Ill.  
415 Ohio Building.....Toledo, Ohio

414 Finance Bldg.....Cleveland, Ohio  
1042 Granite Bldg.....Rochester, N. Y.  
313 Title Building.....Baltimore, Md.

422 First Avenue.....Pittsburg, Pa.  
1210 Arch Street...Philadelphia, Pa.  
Sheldon Building San Francisco, Cal.

---

**FORMICA**  
A Laminated Phenolic Condensation Product  
**SHEETS TUBES RODS**

---

Tell them that you saw it in RADIO



ACT 4 OPERA CARMEN

*L* EADERS use the accepted rules and precedents, by which the majority bind their efforts, only as starting points for higher achievements. Mu-Rad Apparatus, embodying new principles, is the achievement of such a group of leading radio engineers. The very moderate prices of this apparatus makes the accomplishment the more noteworthy. Bulletin upon request.

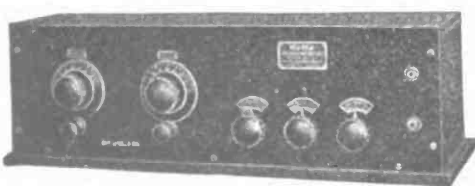

**MU-RAD**  
**LABORATORIES**  
INCORPORATED  
**ASBURY PARK**  
**NEW JERSEY**

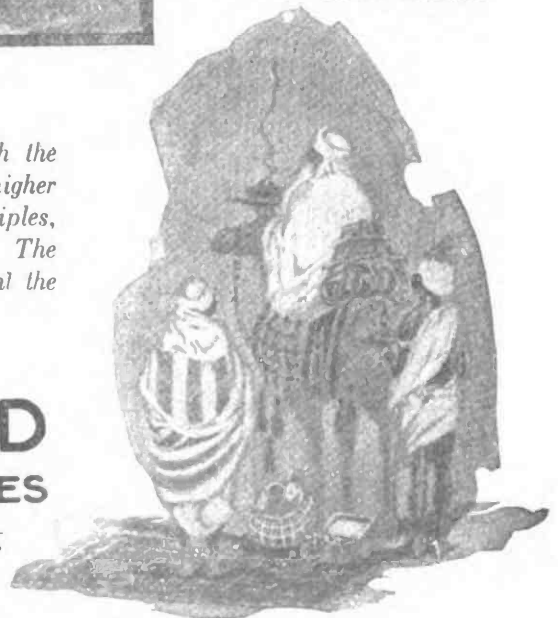

Tell them that you saw it in RADIO



**FROST  
ONES**

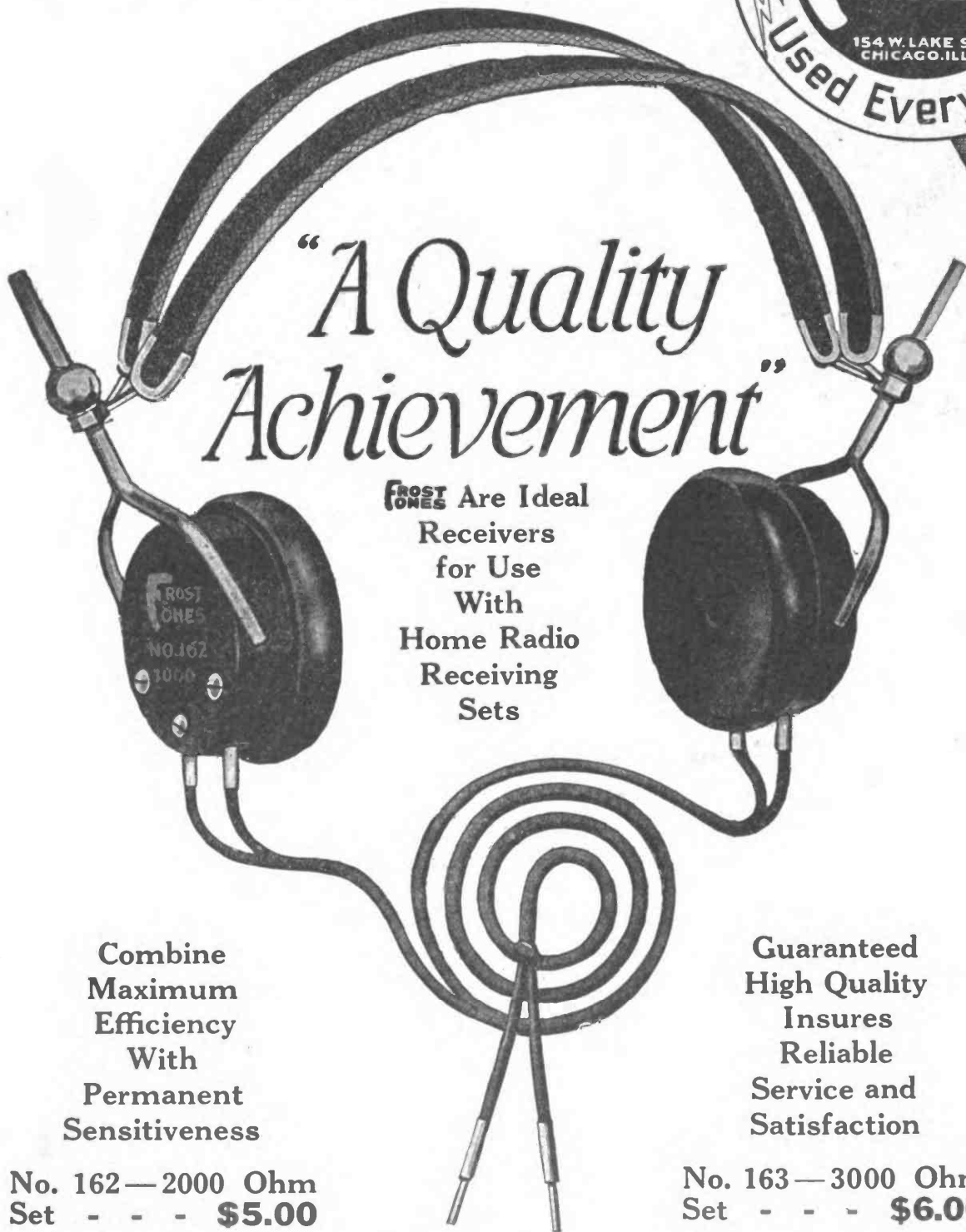

*"A Quality Achievement"*

**FROST** Are Ideal  
Receivers  
for Use  
With  
Home Radio  
Receiving  
Sets

Combine  
Maximum  
Efficiency  
With  
Permanent  
Sensitiveness

Guaranteed  
High Quality  
Insures  
Reliable  
Service and  
Satisfaction

No. 162 — 2000 Ohm  
Set - - - **\$5.00**

No. 163 — 3000 Ohm  
Set - - - **\$6.00**

**HERBERT H. FROST**  
**154 W. LAKE STREET, CHICAGO**

Tell them that you saw it in RADIO



## Low in Cost Simple to manipulate



**T**HE radio enthusiast who lives within ten to twenty miles of a broadcasting station has exactly what he wants in Radiola I (ER 753-A)—low cost, compactness, portability, and simplicity of manipulation.

Open the walnut cabinet, and on the front panel you find the tuning control, the crystal detector and the binding posts. In the body of the cabinet are the head-telephones. Tuck away the telephones, close the front panel, and you can carry the whole set as you would a satchel.

*Radiola I, at your dealer's, \$25.00*

### The Book that Brings Radio Into the Home

For 35 cents you can obtain from your dealer or from us a copy of the book "Radio Enters the Home." It explains the principles, the fascination of radio in plain English. It describes Radiolas and their accessories. It contains the most valuable wiring diagrams ever published.

*Opened like  
a book*



*This symbol of quality  
is your protection.*



*Carried like a  
satchel*

# Radio Corporation of America

Sales Department  
233 Broadway,  
New York, N. Y.

Suite 2069

District Office  
10 South La Salle St.,  
Chicago, Ill.

Tell them that you saw it in RADIO

## Radiotorial Comment

**T**HE encroachments of radio broadcasting on the privileges enjoyed by the amateur code operator are being met with a commendable spirit of co-operation by the amateurs. But the time is coming when an uninformed public will demand even greater concessions, unless steps are taken to impress the radiophone listeners with the value of the work that is being done by the amateur. To merit public consideration the amateur must serve the radio public to a greater extent than at present. How to do this is a problem worthy of the best minds in the amateur world.

A policy of aloofness, of grudging concession, and jealous backbiting will not accomplish the purpose. Better by far is it to welcome the novice into the radio ranks. Educate him to the amateur point of view. Get him interested by helping him.

Every amateur can do his individual part by being willing to help the novice install his set, by showing him how to operate it, and by telling him something about the theory of radio. Let him know of the amateur service in relaying messages free of charge, and in being prepared for national service in time of emergency. Collect and disseminate news in isolated communities. Hunt out the grouches, and find out if there is any reason for their complaints. If so, try to stop the cause. If not, tactfully show them where they are wrong. Let them know the amateurs are in the game to make radio a clean sport with no fouls and no hard feelings. Try to get people interested in better broadcasting and better programs. You can really get just as much fun and get far more for yourself in the form of information and friends by so doing than by asking Willie Jones, ten blocks away, how your signals are coming in. When you do transmit, ask Willie what he is doing to make the radio world safe for the rest of the people in it. By making your services invaluable to your neighbor, you can get anything you want from him.

All this can be better done collectively, than individually. Let the amateurs be the nucleus for radio clubs, whose membership shall be made up largely of novices. Every person who owns any kind of a receiving set will be the gainer by membership in such a club. The dealers will give you the names of all their customers if they

know that the purpose is to help the novice. Call on these customers and invite them to the next club meeting. Make the meeting worthwhile by simple talks and demonstrations. Furnish tools for making sets, and stand ready to help the novice in making his own. Hunt up the "shut-ins" in homes and hospitals and lend them a club set to hear the news, concerts and church services.

There is no reason why the radio club should not be the largest and most influential club in town. The peculiar fascination of radio interests everybody. It provides a common topic that is the basis of good fellowship. We suggest that you read in this issue about what the "Round and Rounders" are doing in a small way at San Diego. The radio club room can well be the social center of a town or neighborhood. For radio is something that interests young and old alike.

Such an organized spirit of helpfulness will gain public approval and support. The churches, the Y. M. C. A., the Rotary, Kiwanis, Lions and similar clubs, and even the Chamber of Commerce, are glad to lend their aid to such a plan of boy-building. Let them know what radio is doing in keeping the boy off the street,

and in keeping him busily engaged in improving his hand and mind.

Let the club be a leader rather than a follower in making and observing local regulations of the air. The Pacific Plan, for example, was initiated by the San Francisco Radio Club, and its members are the traffic officers in its enforcement. By stopping their sparks for a couple of hours nightly they are serving thousands of prospective radio fans, and incidentally the boys are getting a chance to prepare tomorrow's lessons and thus gain that parental approval which comes from good marks at school.

Talk and write about what you are doing. The local newspapers will be glad to publish it as human interest news, something that is making the town a better place in which to live. And when the time comes that you want something that votes or influence will get, you will have the backing of everybody.

In doing all this the amateur will be the gainer. He will learn two of the greatest lessons in life, that organized intelligent effort will get him further than by going it alone, and that "he profits most who serves best."

# Radio Directs Big Construction Job

By Charles Heston Peirson

*That radio is destined to win a commanding position as an industrial utility, besides its service as a home entertainer, is indicated in this story. What a boon would radio be in sustaining the spirits of imprisoned men in mine disasters as well as in supplementing the regular mine telephone service.*

**I**N the dizzy altitudes of the high Sierra Nevada Mountains of Fresno County, California, radio will be used this winter to direct the activities of 500 men who will go into camp behind thirty miles of impassible snowdrifts to push forward during the winter the greatest piece of tunnel construction now in progress on the Western hemisphere. This tunnel is a part of the gigantic hydroelectric development project of the Southern California Edison Company, which is carrying on a program for the development of a million and a quarter horsepower of water power electricity derived from the San Joaquin River and Big Creek and other mountain torrents. One magnificent mountain lake over seven miles long has been impounded, and the program includes the impounding of water which will add three more mountain lakes to the chain which will be connected by the Florence Lake tunnel and a tunnel from Huntington Lake to Shaver Lake.

This winter over 5000 men will be on the job, including the 500 who will be marooned on the upper end of the long tunnel over the crest of the Kaiser Range. The direction of the marooned men will be entirely given by radio from the headquarters of the resident engineer at Cascada, the construction headquarters; much of the other work will be done under radio communication.

The success of radio was so thoroughly demonstrated during last winter, not only in directing the work of the men who are beyond wire communication, but in picking up and carrying on communication with the general offices of the Southern California Edison Company in Los Angeles, a distance of 270 miles from the outposts of operation, that facilities have been greatly improved in preparation for this winter's work and new and expensive apparatus put into service.

Due to conditions during the winter when snow and sleet storms are prevalent, it was found the telephone lines did

not give reliable service. Therefore, the radio communication was decided upon and has proven satisfactory. There are now three combined radio, telegraph and telephone stations in operation and one more radio telegraph is being installed. The headquarters station at Cascada, is at an elevation of 5000 feet, in a canyon approximately 2000 feet deep, with abrupt walls on three sides. The second station is located at a construction camp on the shore of Florence Lake, which is the south portal of the great Florence Lake tunnel, at an elevation of 7000 feet, and about seven and one-half miles in an air line north-east of Cascada. The third is located at a construction entrance camp, over the Kaiser Range, which is about eight miles in an air line north of the south portal on Huntington Lake. This station is only about 300 feet higher than the portal station, but there is a mountain pass about 2000 feet high between them.

*Continued on page 102*

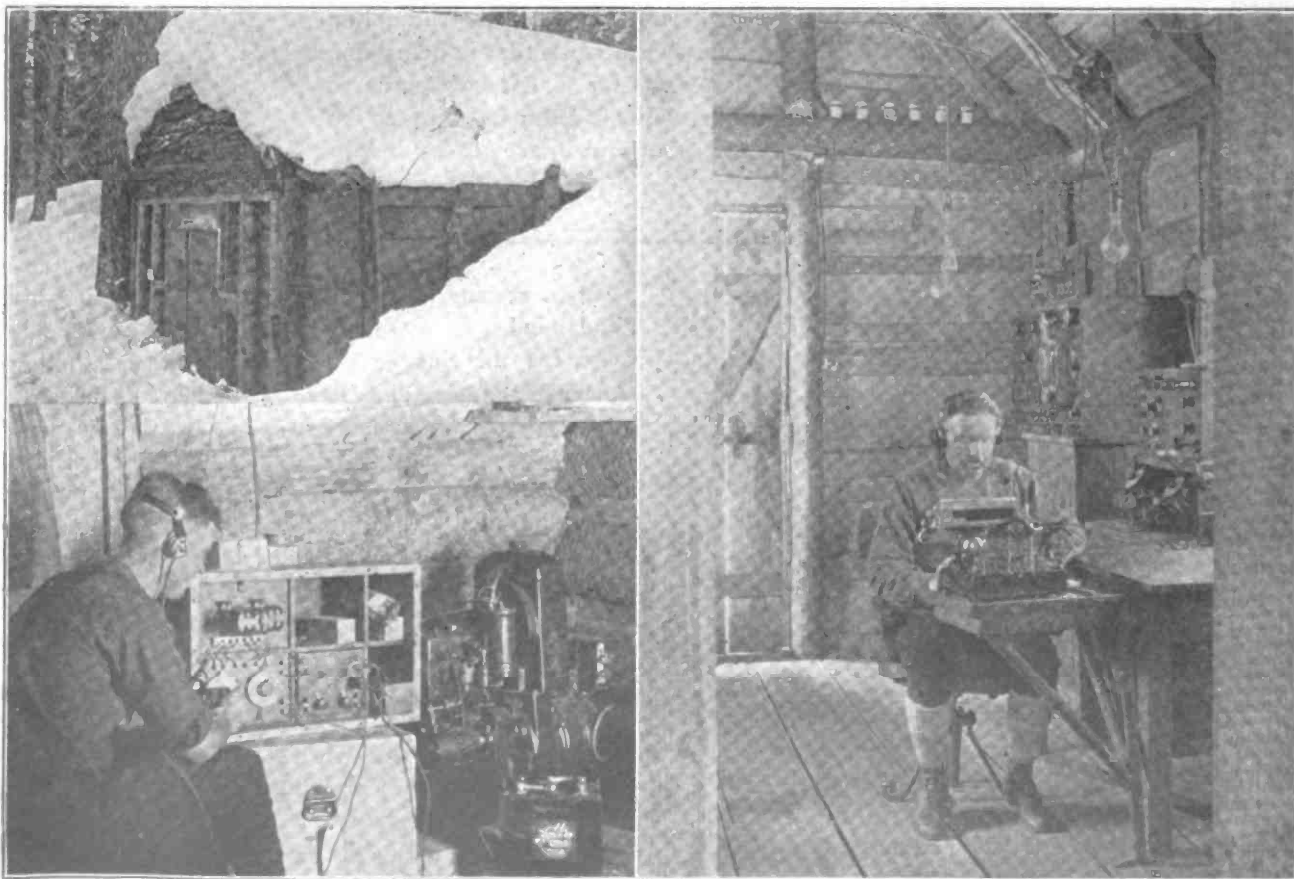

*Views of radio stations in the high Sierra Nevada Mountains of Fresno County, California, where orders will be received for the direction of 500 men who will be marooned next winter, working on the Southern California Edison Company's great electric waterpower development.*

# How to Become a Professional Radio Operator

By Volney G. Mathison

*Herein are practical directions whereby any boy from seven to seventy-seven can, with patience, learn to perfect himself at home in code sending and receiving. Many of the valuable hints given have not been published before. Even an experienced operator may gain some worth-while ideas by reading this article.*

FROM the general discussion of commercial radio operating with which the preceding section of this series of articles has been occupied, it is purposed now to turn in a more distinctly instructive vein to a consideration of how to become a professional wireless operator by giving the reader a more detailed conception of the requirements which are to be fulfilled by the radio operator in the course of his daily work.

In conformity with this composite aim, the present section has been arranged, beginning with a view of the amateur set at home as a means for learning professional radio operating; consideration of the wireless school; a description of the procedure followed by the government in conducting the commercial radio-operators' license examinations, and some special information bearing upon the operator's proper conduct aboard ship.

## The Amateur Set at Home

HERE is no better way to prepare to become a commercial radio operator than by experimenting at home with an amateur wireless outfit. By working with fellow amateurs a good sending hand is developed; receiving ability is rapidly acquired without tedious drill, and a certain ease and steadiness, an at-home-ness on the air, is attained. It is the lack of this last quality, it is that halting, stuttering, hesitating awkwardness, so exasperating to the old-timer who has to listen to it, that especially marks the operator trained entirely in a wireless school.

For this reason also—to gain a practical familiarity with commercial operating procedure—it is highly desirable that the prospective operator have a sending outfit as well as receiving apparatus. Where electric-lighting current

is available, this is not a very expensive requirement. The experimenter, even though he feels that he can not well afford to buy ready-made apparatus, can nearly always manage to scrape together enough materials and parts to make up some sort of an outfit for himself at comparatively small cost.

As to the size of transmitter the learner should have, this depends upon his particular location with regard to other amateurs; to be able to work with a few fellow experimenters is all that is really necessary. When the student operator plans to spend more than forty dollars for his sending outfit, it is strongly recommended that CW or vacuum-tube apparatus be bought in preference to spark equipment. It is not in order here to attempt to detail the many advantages of the undamped transmitter, but one important point for the prospective operator to consider is

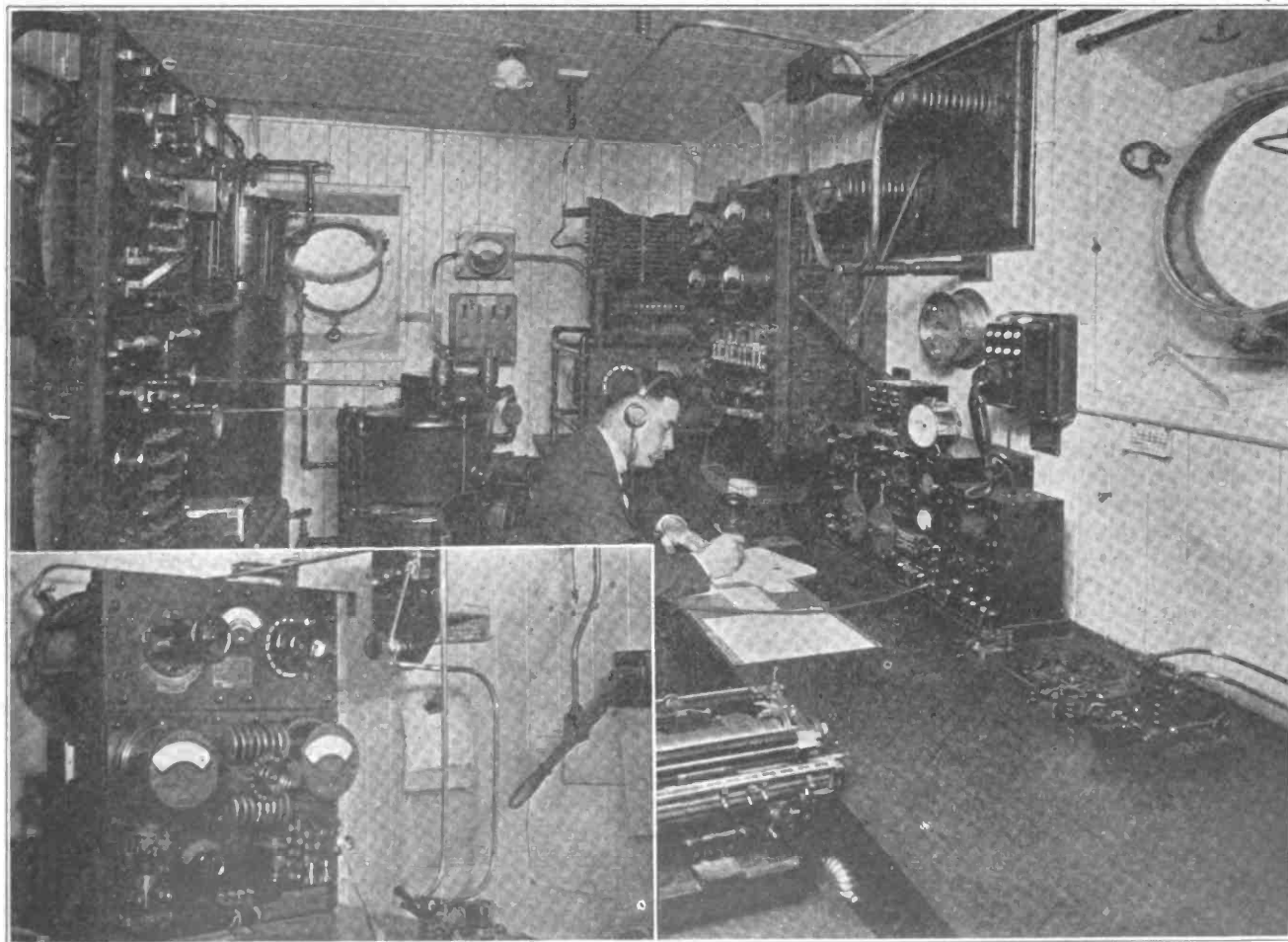

The elaborate radio room of a San Francisco-China greyhound. (U. S. Shipping Board "Lone Star State.") From left to right are audion and transmitter storage battery switchboards, five kilowatt arc, arc control panel, tuner, audion detector, and two-step amplifier. The inset shows a half-kilowatt auxiliary spark transmitter, which the cameraman had to stand in front of to get the big picture.

that a practical knowledge of vacuum-tube equipment is going to be valuable. Some home-made 10-watt tube sets costing hardly fifty dollars are working as many as a thousand miles.

For the learner, however, whose limited pocketbook obliges him to be contented with a very inexpensive outfit, and particularly for the country boy who has no electric current at hand, a small spark-coil set will be most suitable—provided, of course, that there are other amateur stations within its range. Where an audion detector and a one or two step amplifier is used at the receiving station, a quarter-inch coil, or a discarded automobile ignition-coil, will often cover twenty-five miles. Such coils are best connected directly across the aerial and ground, and if the aerial is short enough to permit the insertion of a small inductance (three to eight turns 6 ins. in diameter) in the lead-in, immediately next to the spark-gap, a sharp, legal wave will be obtained.

Desirable as is some sort of a sending set, however small, if the student's means are very limited, it may be dispensed with. But it is at least necessary to have a practice set, consisting of a buzzer, sending-key, and dry-battery, for drill in sending. Indeed, even when the operator has a transmitting outfit, he should not fail to practice conscientiously on a small buzzer set. Good sending is as hard, and for many operators much harder, to acquire than good receiving.

By sending, the writer does not mean the jerking, limping, hopping, miss-spaced, spluttering shower of dots and dashes that some "operators" fatuously imagine to be sending. During the war, when any sort of radio operators were scarce and the license examinations therefore relaxed, some of the stuff on the air was a maddening combination of a St. Vitus dance and a hen-cackle, and when an old shellback had the misfortune to get tangled up in a mess of it, he generally emerged in a frenzied frame of mind suitable to an assassin or a bomb-thrower.

It is true that there is much less poor sending on the air now than there was three or four years ago. The present slump in shipping has resulted in the weeding out of most of the war-time makeshift operators, but the improving quality of the "stuff" on the air is especially owing to the fact that since 1920 the government has required transmitting as well as receiving tests in the commercial license examinations. I have been informed by one radio inspector that in his office more candidates for commercial licenses fail in the sending than in the receiving tests.

There is only one way to acquire a good sending hand—by practice. Take a book, a magazine, any printed matter, and send it on the buzzer set; send it

by the page. About one hundred thousand words transmitted painstakingly and accurately ought to develop a respectable sending hand.

The student should never attempt a display of speed in sending; nothing else will ruin his style so quickly and so irretrievably as too much haste. It has been asserted that the learner should not send any faster than he is able accurately to receive—a better rule is to send no faster than can be done without breaking or making a mistake oftener than once in every fifty or one hundred words.

A great deal of mediocre sending is also due to an excessive sending-key tension and an incorrect grip on the key-knob. The proper position of the hand over the key is with the first finger on the center of the knob, the second finger resting also on top of the knob or against the right-hand edge, the two remaining fingers unused and gently relaxed, and—most important of all—the thumb resting underneath the rim on the left-hand side of the knob. This position of the thumb against the under side of the knob rim is essential; without it the sender has no true grip on his key. It is not material whether the third finger be kept lightly against the side of the key-knob or relaxed with the little finger, but I think the latter position is the easiest and fastest. If this key control feels awkward, it indicates that the operator has adopted an incorrect grip in the beginning, and if the correct position is maintained for a short time, it will become most natural.

The arm should never be held up in the air; it should lay on the desk, absolutely relaxed, and the key must be held with an easy firmness and with never the slightest straining of any muscle. The key tension, too, should always be light, the thumb under the rim of the knob being depended upon to bring the key up after each depression. A stiff key means not only stiff sending but a strained wrist, and this is possibly a cause of telegraphers' paralysis.

Some operators send readable stuff with only one finger on the key knob and without using the thumb under the rim, but this almost invariably results in a style of sending that has been aptly described as "tapping." It lacks the accuracy, the masterful smoothness, the full-rounded dots and dashes of the expert.

Another important point in sending, too, is to maintain an even speed and an even spacing between consecutive letters. The practice of spacing some letters too far apart and jamming others too close together, combined with a constantly varying speed, produces that unpleasantly manneristic "oil-tank swing" of which some operators who have been in the game long enough to know better

are inordinately proud. Really good sending flows along with the steady precision of a smooth-running machine.

### The Receiving Set

THE novice will naturally employ his buzzer practice set in memorizing the code, but beyond that, unless he has some one to send on it for him, the buzzer outfit is of no value in the acquirement of receiving ability. There is but one way to learn to receive, and that is by listening to some one else's sending. The best way to do this is with an amateur receiving outfit.

The student, after memorizing the code, will begin by listening to those amateurs within range of his receiving instruments who send most slowly, or—and this is incomparably better when the necessary apparatus can be afforded—to some of the slow speed high-power arc and alternator stations engaged in trans-oceanic work. As the learner's receiving speed approaches twenty words a minute, he may gradually turn from the slow senders to faster, and it will especially be worth his while then to listen in on shipboard stations, as by doing so he will become familiar with the procedures followed in handling the various classes of commercial traffic.

It is not necessary for the student to have a large and expensive receiving outfit, and, in fact, if he is a beginner in radio, it is best for him to commence with a simple set. The novice unaccustomed to handling wireless instruments—unless he has an experienced radio amateur friend to help him—is liable to have a great deal of trouble getting a complicated outfit to work. Beginning modestly, the experimenter with increasing knowledge can install additional units from time to time, and in this way gradually elaborate his set to whatever extent he desires.

For the student who lives in or near a coastal city where there are many commercial and amateur stations at close range, a double-slide tuning coil, or preferably a small loose-coupler, a fixed condenser, silicon detector, and a pair of telephone receivers are all the instruments necessary.

With the exception of the telephone receivers, this equipment may be constructed by the learner himself, but there is so much good apparatus on the market at reasonable prices that the student will effect no appreciable saving in making his own instruments. The apparatus mentioned above can be purchased in the radio stores for less than twenty-five dollars, and unless the student is an exceptionally good mechanic, the factory-built equipment will work and look better than anything he can make for himself for the same amount of money spent on materials and parts. The tuning-coil or loose-

*Continued on page 46*

# Transmitters, Receivers and Tuning

By Ellery W. Stone

*This constitutes the third and fourth assignments of the correspondence course in Elementary Radio being conducted in co-operation with the Extension Division of the University of California. Question sheets, corrected papers and supplementary data are supplied to students enrolled in the course. Full information may be obtained by writing to the Extension Division at 301 California Hall, Berkeley, Calif.*

IN our last assignment, we studied the great family of electromagnetic waves and observed that for the production of waves of any type—whether electrical, such as radio, heat or light waves, or mechanical, such as sound or water waves—it is necessary to have some vibratory or oscillatory source which, by virtue of its own vibration or oscillation, sets up a vibratory motion, or waves, in the medium which that particular oscillatory source can disturb. In the case of water waves, we have seen that it is only necessary to disturb the surface of a body of water by dropping a stone into it or by producing a similar disturbance. With sound waves, we disturb the air, which is the medium for transmission of these waves, by the vibration of the human vocal cords—in the case of speech—or by some similar action.

With electromagnetic waves, it is helpful to use the conception of the ether as the conducting medium, although, as we have seen, there is some question as to whether this mysterious ether really exists; and we have observed that for the production of waves in this medium it is necessary to have a vibrating electrical circuit or a circuit carrying a vibrating or alternating electrical current.

In the transmission of radio waves, then, we must generate electrical currents within the range of the frequencies which are necessary for the efficient propagation of radio waves, because the frequency of the waves is exactly that of the vibratory source which produces them. We learned in the last assignment that radio frequencies are those between approximately 10,000 and 1,500,000 cycles per second, so that our radio transmitter or transmitting station must contain electrical circuits capable of producing currents of frequencies within that range.

In the first assignment, we learned that a Leyden jar or condenser has the property or *capacity* of storing electrostatic energy: "A condenser is charged by connecting the two metallic coatings to a source of electricity so that one coating acquires a positive charge and the other a negative one. It is discharged by connecting the two coatings through a conducting wire." It is the nature of this *discharge* of a condenser which is of especial interest to us.

As early as 1842, Joseph Henry (after whom the unit of induction was named) discovered that when a condenser is discharged, the discharge current is not direct current, like the current which is used to charge the condenser, but *alternating* current. Furthermore, the frequency of this a. c.

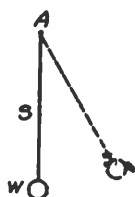

Fig. 7. Vibrating Pendulum

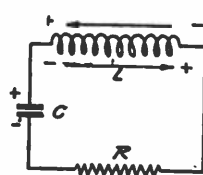

Fig. 8. Condenser Discharge

charge, with condensers and conductors of average dimensions, is within the range of radio frequencies specified above. The discharge of a condenser, therefore, is suitable for the generation of radio waves and we shall find that this fact forms the basis on which all radio transmission is conducted.

Before proceeding further, however, let us examine the nature of this oscillatory discharge of a condenser.

You are familiar with the fact that when an ordinary pendulum, simply a weight, *W*, suspended by a cord or stick, *S*, which is supported or pivoted at one end, *A*—see Fig. 7—is drawn to one side, it acquires potential or static energy by virtue of its displacement from the vertical. In other words, when the pendulum is pulled to the position shown in the dotted lines, the force of gravity tends to pull the weight back to its original vertical position at rest. This is similar to charging a condenser with *electrostatic* energy. The condenser may be considered at rest when it is uncharged but it acquires static energy when it is charged.

Now if we release our displacement pendulum, the weight or bob does not slowly settle down to its normal, vertical position, but vibrates back and forth, each swing becoming a little shorter in length, or *amplitude* as we say, until finally all of its energy is dissipated and it comes to rest. The pendulum would swing forever, giving perpetual motion, if it were not for the resistance or friction offered by the air to the bob and stick and for the lesser friction at the point of support, *A*.

The inertia of the bob and its sup-

port thus tends to carry the pendulum past the vertical position on its first and subsequent swings, so that a vibratory motion of the pendulum results. If the pendulum were dipped into a heavy oil or light grease, however, the additional friction offered it would cause the pendulum to settle down slowly to its normal position—it would not oscillate.

Let us suppose that we charge a condenser and proceed to discharge it through the circuit shown in Fig. 8, consisting of the condenser, *C*, in series with an inductance, *L*, and a resistance, *R*. Consider that the upper plate of the condenser is charged to a positive potential, as shown, and that the lower plate is charged negatively. Now, since there is an inductance in the discharge circuit, the momentary flow of current through it in the direction of the lower arrows, induces a back E.M.F. across its terminals (see first assignment) which is represented by the positive and negative signs at each end of the inductance, *L*, and above it. This back E.M.F., as we learned in the first assignment, tends to oppose the flow of discharge current as it builds up in the circuit by means of a counter current, whose flow is indicated by the upper arrow. The direction of the discharge current flow from positive to negative is indicated by the lower arrow. The reduction of the condenser charge and the dropping of the discharge current toward zero are equivalent to the pendulum's approaching the vertical position on its first downward swing, in which position the pull of gravity (so far as causing motion is concerned) is zero. As the condenser charge is reduced and the discharge current drops toward zero, the back E. M. F. reverses to the polarity shown by the positive and negative signs *below* the inductance. This new induced E. M. F. tends to set up a current flowing in the circuit in the same direction as the discharge current of the condenser, indicated by the lower arrow, so that the current in the circuit instead of stopping when all of the positive charge has left the upper plate of the condenser, continues until the induced E. M. F., indicated by the lower positive and negative signs, is dissipated.

The property of an inductance, therefore, by virtue of which it stores up

electromagnetic energy and restores it to the circuit, as evidenced by the above, may be likened to the inertia of the pendulum. In fact, it is sometimes called the electrical inertia of such a circuit.

Due to the fact that the induced E.M.F. across the inductance maintains a current in the circuit, after the initial positive and negative charges on the condenser have been dissipated, toward the lower plate and away from the upper one, the lower plate now acquires a positive charge and the upper plate a negative one. If it were not for the resistance of the inductance and the resistance of the circuit, represented by  $R$  in the figure, the new, reversed charges on the condenser plates would have the same values as the original charges. As a matter of fact, however, they are a little less, depending upon the resistance in the circuit, just as the pendulum on its first upward swing does not rise quite to the height of its original displacement. The resistance of the inductance and of the circuit is similar to the joint resistance or friction of the air and at the pivot in our pendulum experiment.

Now that our condenser has acquired a new charge, but of opposite polarity, it discharges again, but in the opposite direction. The whole process of charge and discharge of electromagnetic energy then repeats itself, and the current in the circuit continues to oscillate back and forth, similar to the swings of our pendulum, until the resistance of the circuit finally brings the circuit to rest—the oscillating current to zero.

We say that the friction of the air and the bearing checks or *damps* the vibrations of the pendulum, and its swings are called *damped vibrations*. If there were no friction offered to the vibration of the pendulum, or if fresh impulses were continually imparted to the pendulum at the end of each swing to compensate for the effect of friction, as in the case of a clock, the pendulum would swing constantly, with its vibration *undamped*.

The same terms are applied to the oscillatory discharge of a condenser. If an initial charge is imparted to a condenser and the condenser is then allowed to discharge itself fully without receiving additional charges before its original energy is dissipated, we call its oscillating discharge current a *damped* alternating or oscillating current. But if the condenser receives a fresh charge after each *cycle* of discharge current, without waiting for the electrostatic energy originally stored in the condenser to become completely dissipated, the discharge circuit will continue to oscillate as long as these recurring and properly timed fresh charges are imparted to it. The oscillations in the

latter case will be similar to the swinging of a clock pendulum. The clock "works" give a fresh impulse to the pendulum after each *complete* swing (both directions); since there is no decrease in amplitude, the oscillations are *undamped*.

We have seen in this assignment that the frequency of the electrical current set up by the oscillatory discharge of a condenser "is within the range of radio frequencies specified above" (10,000 to 1,500,000). The frequency of the oscillatory discharge of a condenser is given by the formula:

$$f = \frac{1}{2\pi\sqrt{CL}} \quad (2)$$

where  $f$  represents the frequency,  $\pi$  the numeric 3.1416 (the ratio of the circumference of a circle to its diameter),  $C$  the capacity, usually measured in microfarads, and  $L$  the inductance, measured in centimeters or milli-henries.

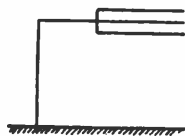

Fig. 9. Antenna

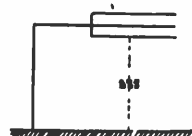

Fig. 10. Capacity Effect of Antenna

Thus, the resistance,  $B$ , of Fig. 8, is seen to have no effect upon the frequency of the discharge current of the condenser  $C$ .

We observed in the first assignment that the inductive reactance in an alternating current circuit can be neutralized or annulled if the capacitive reactance of a condenser in series with the inductance, as in Fig. 8, has the same value of reactance, but of course of opposite sign.

In the first assignment, we learned that the property of an inductance by virtue of which it tends to limit the passage of alternating current through it, is due to the back E.M.F. generated across its terminals. Since, as we have also seen, the induced E.M.F. depends upon the frequency of the alternating current generating it, it follows that the inductive reactance of a given coil increases with the frequency. Conversely, capacitive reactance decreases with the frequency.

In Fig. 8, in which the condenser is allowed to discharge itself after receiving an initial charge, the circuit is called a "freely oscillating" circuit. That is, the charging source having been disconnected from the condenser, the current in the circuit oscillates until the original energy is completely dissipated. It is interesting to note that the frequency of the discharge current, as given in equation (2), is that which automatically, we might say, gives equal values of inductive and capacitive reactance, so that in a freely oscillating circuit, the combined inductive and capaci-

tive reactance is zero and the impedance of the circuit is equal to its resistance. (See first assignment.)

In the above, we have seen that electrical currents of radio frequency can be generated by the oscillatory discharge of a condenser in a circuit containing inductance. As a matter of fact, however, the discharge current will not oscillate if the resistance of the circuit,  $R$  in Fig. 8, is greater than a certain value, just as the pendulum will not oscillate if it is immersed in a very heavy liquid. It is necessary, therefore, to have a condenser or capacity in all radio circuits in order that these radio frequency currents may be set up or may flow therein with minimum impedance. At the transmitter, the device or circuit which radiates the electromagnetic waves is simply an enormous condenser whose discharge gives rise to radio frequency currents in such a way that waves can be most efficiently generated. We call this large condenser the aerial or antenna.

#### The Antenna-Ground Circuit

WE learned in the first assignment that a condenser or capacity consists simply of two metallic surfaces, separated by an insulator or dielectric. We have learned in this assignment that the oscillatory discharge of a condenser through a circuit containing an average amount of inductance is of the proper frequency, anywhere between 10,000 to 1,500,000 cycles per second, to give rise to radio waves.

As shown in Fig. 9, the antenna or aerial in a radio transmitter consists of an elevated metallic portion, consisting of from one (in the case of receivers) or two (in the case of transmitters) wires to four or more. These are stretched between two supports some distance above the ground. In addition, the antenna comprises a wire leading down from the aerial wires and called the *lead-in*, and a connection to the earth. The elevated wires thus constitute one plate of the condenser, the ground is the other plate, and the air between the two acts as the insulator or dielectric. The capacity effect of the aerial is represented in Fig. 10, as shown, by a condenser drawn in dotted lines.

Under the subject of radio transmitters, we shall learn in a later assignment how energy is supplied the antenna circuit, the equivalent of charging a condenser, and how the oscillatory discharge current sets up radio waves. Before considering the actual imparting of energy to the antenna, however, we shall consider that the aerial has been charged and is now oscillating with a current of radio frequency flowing therein, and shall examine the phenomenon of wave radiation and propagation.

Continued on page 60



# A 200 to 20,000 Meter Radio Frequency Amplifier

By H. E. Parsons, Can. 5 E. H.

*This is one of the entries submitted in the radio frequency amplifier contest which closed Oct. 15th. For originality of design and construction it is an excellent model. The excellent results reported may be due in part to the author's use of French valves. This and the other entries are now in the hands of the judges, whose decisions will be published in December RADIO.*

THE main question confronting the amateur who desires to build a radio frequency amplifier is what type to use. From the point of view of wavelength range, the resistance coupled radio frequency amplifier would seem to be the best. Unfortunately, this type is of little use on short wavelengths. A little calculation will show the reason for this. Suppose, for example, we use a plate resistance of 100,000 ohms and that the stray capacity of the set, that is the capacity between the plate and the rest of the output circuit, is about .000011 mfd. The effective impedance at a wavelength of 6000 meters is then 76,100 ohms—a reduction of 24% as compared with the value of the plate resistance alone. At 200 meters the effective impedance would be 9697 ohms, a reduction of 90%. We find also that doubling the plate resistance will not increase this value by much, besides necessitating an increase in the B battery voltage.

The only other choice is either a transformer coupled or a tuned impedance coupled amplifier. Either of these types will respond to short wavelengths, but personally I prefer the transformer coupled type. Unfortunately, however, the transformer coupled amplifiers at present on the market will respond only to one narrow band of wavelengths.

If, however, we can design a radio frequency amplifier with as wide a range as the resistance coupled type, and including the short waves, we have an instrument which would combine advantages of both types.

The instrument to be described is a transformer coupled amplifier with a range of from 200 to 20,000 meters. Thus it combines the wide range of the

resistance type and, in addition, the short waves, with the advantages of greater sensitiveness and selectivity of a transformer coupled amplifier. This desirable result is accomplished by means of a special type of detachable air core transformer.

As the transformers are perhaps the most important part of the amplifier, I will take up their design and construction first, and then show how they can be incorporated into a set. They can be seen in Fig. 4. The center one is in place and the others have been removed

In order that the point of maximum amplification may be shifted over a band of wavelengths, the primary is shunted by a variable condenser of about .00025 mfd. The condensers may be made of five semicircular fixed plates  $3\frac{1}{2}$  ins. diameter and four movable plates  $2\frac{3}{8}$  ins. diameter. If you do not care to, or have not the tools to make these variables, a 21 plate "Tresco" with half the plates removed and two spacers between each plate will be about right. If these condensers are not used the winding of the transformer must be

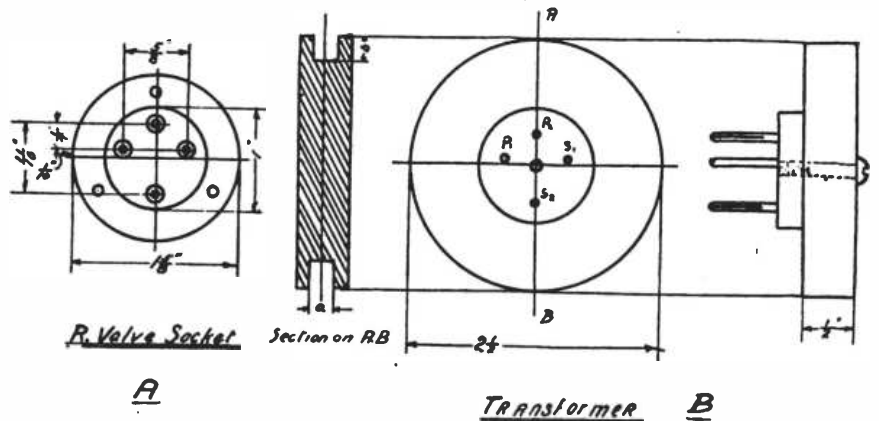

Fig. 1. Details of Transformer Mounting and Construction.

and put on top of the cabinet to show the mounting. As can be seen from Fig. 1, I use standard R valve sockets for the transformer mountings. If these cannot be obtained, any other style of four pin mounting could be used—say two honeycomb coil plugs mounted side by side, or an American valve socket, though in this case the plug on the transformer would be a little harder to make.

The bobbins, which may be made of bakelite, maple, or other hard wood, are all  $2\frac{1}{2}$  ins. outside diameter and  $\frac{1}{2}$  in. thick. Turned in the periphery is a groove varying from  $\frac{1}{8}$  to  $\frac{1}{4}$  ins. wide and from  $\frac{1}{8}$  to  $\frac{1}{2}$  ins. deep, depending on the wavelength. The primary and secondary are wound in this groove. Two methods of winding are available—first, the two wires may be wound in at once, or, and this is the way I prefer, the primary may be wound on first and then a few turns of varnished paper, followed by the secondary. The size of the wire may be from No. 38 to No. 40 enameled or single silk-covered. After the transformers have been permanently adjusted, a strip of thin fiber  $\frac{1}{2}$  inch wide should be shellaced over the groove.

adjusted accurately to the required wavelength and the amplification will fall off rapidly at each side of the maximum point. With the condensers the point of maximum amplification can be shifted over a band of about 200 meters. When the point of maximum amplification is adjusted in this manner so as to coincide with the wavelength of the signals to be received, there is, of course, a marked gain in selectivity, since signals on other wavelengths will not be amplified to the same extent.

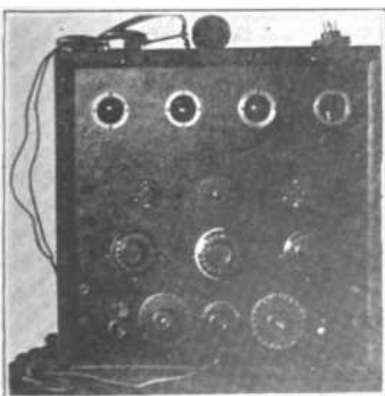

Fig. 4. Front View of Panel.

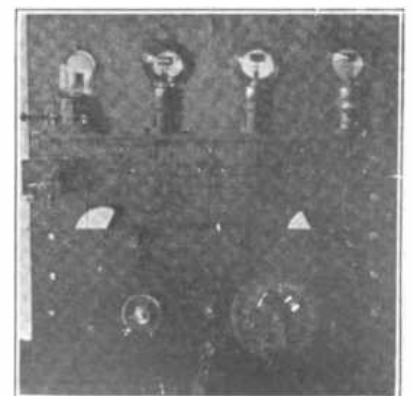

Fig. 5. Rear View of Panel.

Accurate details of the number of turns of wire for any particular wavelength cannot be given, as several factors influence this. The thickness of the paper between the coils and the tension on the wire, as well as the quantity of shellac on the winding affect the electrostatic capacity between primary and secondary and any change in the spacing of the two windings will alter the wavelength at which maximum amplification takes place. It is therefore impossible to give winding details which will without question, give any desired wavelength for maximum amplification, and so the final adjustment must be made experimentally. For around 300 meters I use 50 turns of No. 38 on the primary and the same number on the secondary, for 600 meters and 1000 turns of No. 38 on the primary and secondary. Other transformers have 200, 400, 650 and 1,000 turns each on the primary and secondary. For the very long wave stations, like Lyons and Bordeaux, 2500 turns of No. 40 are about right for each winding.

The wavelength of an individual transformer can be measured by the following method. Connect up one winding of the transformer across the grid and negative end of the filament of a valve and leave the other winding open. In the plate circuit of the valve connect the telephones and B battery. Place a buzzer actuated wavemeter near the

transformer and pick up its signals. Adjust the wavelength of the buzzer signals for the maximum sound in the phones, weaken the coupling and retune till there is no doubt about the point. The wavelength indicated by the wavemeter is the approximate natural wavelength of the transformer. When the transformer is mounted in the set the wavelength will be slightly different due to the capacity of the leads. On the shorter wavelengths the natural wavelength of the complete set will be considerably higher owing to the effect of the tickler coil. If no wavemeter is available the set will have to be tuned by experiment when completed by tuning in a station of known wavelength.

When the set is completed there is a fairly simple method of measuring the natural wavelength and the amplification constant, but it is rather beyond the scope of this article.

Figures 2, 4, and 5 give an example of these transformers applied to a four-valve set consisting of 3 radio frequency amplifiers and a detector, which, with eight or nine transformers to a stage, will cover all wavelengths from 200 to 20,000 meters. A wiring diagram is given in Fig. 3, and the layout, including the principal dimensions of the 18 in. by 18 in. by  $\frac{3}{8}$  in. panel in Fig. 2. The valves for which this set was designed are French "metal" type for the amplifiers and an A. P. or Radiotron for the detector. The only change

necessary to adapt the set for all American valves, would be to change the sockets on the valve shelf. Across the top of the panel are the four observation windows for the valves. The edges may be either beveled as is the case with this set, a brass ring  $\frac{1}{4}$  in. wide may be turned up and screwed to the panel. The valve sockets are mounted on a shelf 17 in. by  $2\frac{1}{2}$  in. by  $\frac{1}{4}$  in., which is fixed to the panel by brackets made of  $\frac{1}{2}$  in. by  $\frac{1}{8}$  in. brass strip. Mounted on the front of the panel and below the shelf are the three transformer sockets. No dimensions for these are given in Fig. 2, since the position of the mounting holes will depend on the type of mounting used. Fig. 1A, however, gives the dimensions of a standard R valve socket which is what I use. Directly below the transformers are the three tuning condensers  $C_2, C_3, C_4$ . The dimensions given in Fig. 2 are for "Tresco" condensers remade as previously mentioned.

The filament rheostats, of which two are required, are  $R_1$  for the three amplifying valves and  $R_2$  for the detector, being mounted as shown in Fig. 2. These should be the usual type of filament rheostat; my only reason for using the large one shown in Fig. 5 is that it was the only one I had to spare when I made the set. Of course, whatever rheostat is used on the radio frequency valves, it must be of sufficient size to carry the combined current

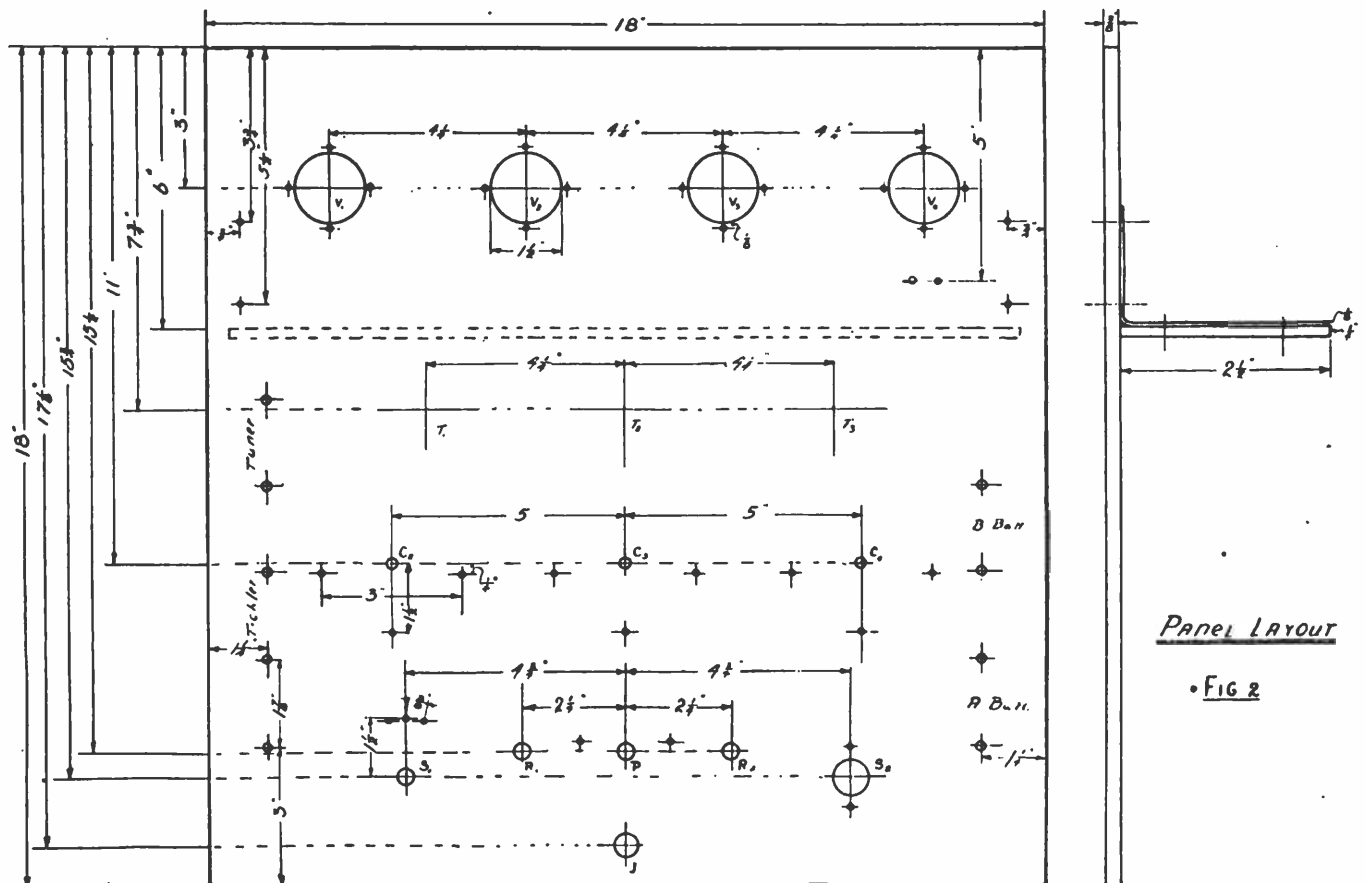

Fig. 2. Panel Layout for Transformer Coupled Radio Frequency Amplifier.

J.E.H.

of the three valves. Since control of the self-oscillating properties of the amplifier is obtained by the grid potentiometer P, which is mounted between the rheostats (Fig. 2). This potentiometer, which is a Remler, is fed from the filament battery, or, if desired, a separate battery can be employed, but the former is usually sufficient, since positive grid voltages are generally all that is required to stop the set oscillating. The small snap switch  $S_2$  is in series with the A battery circuit and is used to switch the set on and off. If this switch is not fitted the current will be left flowing through the potentiometer even when the set is not in use. The three-point switch  $S_1$ , is to change the tickler coil from the second to the detecting valve or to cut in the electrostatic reaction condenser  $C_6$ . The grid leak is of the pencil-line type, fitted

speaker, as required. On the left hand side are five binding posts. The top pair go to the tuner, the next pair to the tickler and the bottom one to one side of the reaction condenser. The upper two on the other side are the B battery terminals and the lower two the A battery.

Some little difficulty may be experienced at first when operating this set from oscillations. After a little practice, however, one can control the set just as easily as an ordinary audio frequency amplifier, and indeed it is much quieter in operation than an audio frequency set with an equivalent number of valves. After a little experience one can judge where to put the tuning condensers,  $C_2$ ,  $C_3$ , and  $C_4$ , for any desired station. When I first used a set of this type, I logged the stations heard together with their wavelength, when

## THE LIMITATIONS OF RADIO

By FRANK B. JEWETT

*Vice-President and Chief Engineer  
Western Electric Co.*

Radio is the latest practical application of scientific research in the physical laboratory. It is not the result of inventive creation, just out of somebody's imagination, but it is the step by step building up from physical researches which, when they were made, had practically no application to any existing thing. It is almost pre-eminent as an example of the commercial development of a thing which started in the research to determine the ultimate structure of matter, and to answer the question, "What is electricity?" With that kind of a background and with the results that have been obtained up to the present time, no man with any sanity would dare to predict what the future has, or has not, in store with regard to radio.

But at present there are certain very decided limitations on the use of radio, and unless these can be overcome by further discoveries, it is clear that the commercial use of radio is certainly bound to be restricted in certain directions.

In the first place, unlike electric power transmission and telegraph and telephone communication, where you direct the power or the communication from a given point to another specified given point or points, radio is essentially a broadcasting method. It is essentially a method of one-conductor distribution. It is as though we tried to do all of the communication and power business of the world over one pair of wires. So it is clear that the only way in which you can have a multitude of non-conflicting services wholly depends upon the character of apparatus at the sending and receiving ends. That being so, and because of the fact that so far as our knowledge goes to date, there is a limited range of wavelengths in the ether, means that there is a very distinct limit to the use of radio.

This might not be so bad were it not for the fact that there are certain commercial uses of radio which are paramount in the world's economic needs, and which are certain to take precedence over any other needs in the future. Radio is the only known method of communicating to places and things where you cannot run wires—ships at sea, airplanes, distant points on land, where it is impracticable to run wires, or distant islands. Thus it takes a first place in the national defense of every country.

Then there is a field of commercial use for radio, where weather reports or news bulletins can best be spread by broadcasting, even where wires can be run.

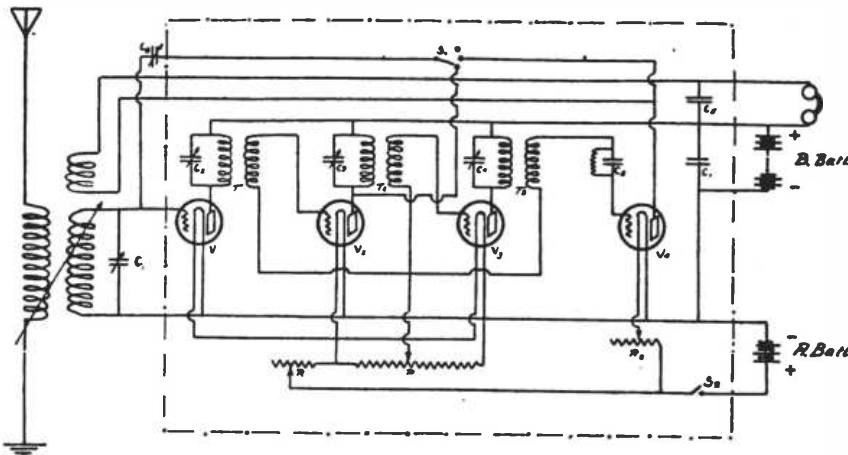

Fig. 3. Wiring Diagram for Three-Step Radio Frequency Amplifier.

below the detecting valve observation window. It, and the grid condenser  $C_6$ , should be of a type suited to the valve being used as a detector.

One of the disadvantages of a radio frequency amplifier is the great tendency to set up sustained oscillations by reason of the unavoidable reactions between the various coils and circuits. To limit this tendency to self-oscillation, the condenser  $C_7$ , is shunted across the B battery. This condenser should be as large as possible—1 microfarad at least, as this will tend to prevent magnified high frequency potentials occurring in the last valve of the series from being handed back to the earlier valves by reason of the potential drop in the resistance of the B battery. The presence of this condenser provides a path of low impedance to high frequency currents and hence reduces the effective high frequency potential difference between the common plate lead and the filament lead to a very small value.

As can be seen in Fig. 5, I use an ordinary telephone condenser of 1.5 mfd. for this purpose.

Directly under the potentiometer is mounted the open circuit jack J, for connecting in the phones or a loud

known, and also the transformer used and the condenser dial reading. After a little practice at this one can put the condensers very near the point of maximum amplification very readily, and a few slight adjustments when the required signal is brought in will enable it to be made as loud as possible.

### WHEN THERE'S AN "R" THERE'S RADIO

Oysters are now in season—and so is radio. Curiously, the two seasons coincide; if there is an "R" in the month, radio transmission is good. The radio season opened officially on September 1st, and is now in full blast. The radio season may be said to begin in September and close in April in the United States, according to W. D. Terrell, the Chief Radio Inspector.

The E. D. Manufacturing Company, Philadelphia, has been organized to sell radio equipment manufactured by the Electric-Dental Manufacturing Company. The officers of the company are E. W. Sprankle and R. W. Brown. The E. D. Company is offering to the market panel mountings and switches of new and unusual mechanical design. The unit design of the E. D. panels is particularly interesting as the set can be increased from time to time.

# Scratchi Joins the Cluster

By David P. Gibbons

To Editor "RADIO" (Magazine which dish up thought-food with pleasant, nutty flavor).

Dear Mr. Ed:—

I beg to acquire from you small amount of advice of a confident nature. Could you be kindly enough to recommend me to some reliable insane place where I may insert my Cousin Scratchi for brief period until he recover himself back again to normality? He are going around about, Mr. Editor, with dangerous signal light in both eyes, and mightbe should be confined up before he become quite bolshevicky. He are suffering sharp attack of new epidemical disease which are now spreading its fatally germs amongst all species of radio bugs. Mightbe you have been slightly touched yourself, Mr. Editor, with this affliction which are called the "Farmstrong Stupor Generator," and so you can emit brotherly-loving feelings for my poor cousin.

He return home about 7 evenings ago with armful of all latest-out radio magazines, which are now crowding Sloppy Stories and Fizzlebangs off the news boxes back into gutter.

"At last it have came!" my Cousin hoop with election-time banzai. "Most terrific discovery since Hon. Marconi got born. This are grand invention which the more or less intelligent public have been expecting for almost six months. It are now here freely to all and you cannot make mistakes if you follow after diagram number A1 on page 13. Send no money. We trust you. Cut out and sign—"

I see he are rapidly flipping pages of 4 or 5 magazines at same time, Mr. Editor, and when he hesitate to grasp some more breath, I stick in with don't-know expression.

"Are this magnificent invention worth something at all?"

He look severe daggers at me and snap over—"Should be worth one million cold dollar bills!"

"Should be, mightbe," I quack back with Charlie Chaplin movement of eyebrow, "but it are quite oddish happening for giant corporation to donate away one million fish whether hot or cold."

My Cousin shoot me pitiful glance and are too proud to argue against such silly remark.

"Observe these, my dumb relative," he go on, showing me numerous sketches, photos, black prints, green prints, outlines and diagrams of the marvelous Stupor Generator. "These all should prove how simple it are to construct by even amateur with hardly

any experience and experts who furnish written accompaniment to these are all highly agreed that results are only very slightly beyond belief. For an instant, this week-end magazine with fancy red-color topcoat say that their expert have amplified some very inaudible signals 4 billion times and for aerial all he use are two razor blades in serious. He report tuning quite sharp, also. Other weekly paper, which issue out without any coat like beach beauties, say that their trained scientist use only 2-inch



loop and bring in concerts 12 times more louder still than their 8 step self-geterofine."

"That are sufficient of that," I rupt him up, "but are not lofty degree of skill necessary to compose those many parts into work condition?"

"Not so," he talk back, "and if Colonel Farmstrong can induce such startled result, there are no reason that I cannot bring fourth similar success. Both two of us were in the glorious army." He add on, but my Cousin forget to inject that whilst the Colonel were wireless champion of A. E. F. he were only dog-robber champion of S. O. S.

I then detract his attention to strange-looking fact that each diagram are exactly different from all others, but he say "That are mere trifle matter as it are principle of thing which are important."

I desire to know what are this prin-

ciple, but my Cousin have become quite busy making up mathematical list of pieces which he must have to slap together trial set, and are subtracting from this such pieces which we now have on hands. New stock must include 2 or 4 oversize coils with 2 or 4 powerful tubes and 2 or 4 dozen additional dried cells for the B, C, and D batteries according to simplest uphook which he pick out. Several other various ends and odds are also necessity and Scratchi find, when he figure all upwards, that he will be able to leave single cash dollar with wealthy banker gent to keep old saving account from total loss. He then make shopping expedition amidst radio dealers and come back in late p. m. with full arms and empty pockets. I ask him if he have gathered up all the selected parts which he need with assistance of friendly clerical people in wireless store, and he say he have grabbed them up in spite of such resistance. One smartish little boy behind counter, where he hunt out some long-coiled honeycombs, tell my Cousin that honeycombs are year ago out of date, and what he must buy are spider's leg deductance or at least casket-sleeve veryometer. Scratchi require from other brite little fellow, in apartment store radio sector, some fixing condensers and griddle licks which he need to construct filtration serkit, and this highly priced salesman wrap him up one Hadley's Cat and 2 cat's mustaches.

My Cousin then unrobe those bundles and spread whole shooting matches on kitchen table and direct me to chop up flexy wire into sorted lengths for connecting purposes. For five or so hours, Mr. Editor, he follow diagram with one finger and one eye, while with other eye he tell me where to hook very loose ends around binded posts. At last he give the complete mess the General Dubblo and he mutter at himself, "Now we hook in the fones and we see."

We hook in both pair of cans but we don't see any more than formally and hear less than that. Scratchi shake up table and make new connection some place he don't think about, and at once come thick purry noise, very displeasent to the cardrums, like German airplains on foggy night.

My Cousin throw me victory look and say in careless tone, "See! Old vacuum! Works charmingly. Only need some adjusting now to arrive at proper point of degeneration."

Then he start adjusting. This are five days back, Mr. Editor, and he are

*Continued on page 80*

# The Original "OW"

By Major Lawrence Mott

*Many readers who noted Volney G. Mathison's opinion in October RADIO that the woman operator can not make good in real life will be interested in this tale of a maid who covers herself with glory in fiction. Read it and weep, ye woman-haters.*

"MISS MONTGOMERY, I compliment you on the excellence of your examination papers. You are marked 100%—perfect—and I took the liberty of asking you to come here today that I might have the pleasure of congratulating you in person!"

Thus spoke Radio Inspector Major Dirron, Signal Corps-Reserve, in charge of the 6th Radio District, with offices in San Francisco—and he looked at the girl in very evident admiration.

Neat, in well-fitting tailored frock, a wealth of chestnut hair caught up under a smart sailor straw hat, with big frank eyes, whose lids had most wonderful curling lashes, and with a complexion of creamy softness—Dorothy Montgomery was a charming picture—at which more than one man looked—in the busy inarts of men.

"Radio has always been a hobby, and now—that"—she searched for the word that she wanted—"I must earn a living, owing to the unfortunate condition of Dad's affairs—at his passing on—I might as well turn that which I learned by the generosity of his gifts to me, in the way of apparatus—and so forth—to good account. I wonder, Major, if you could give me a letter to anyone who might be of service to me in my quest—in N. Y.? I have some money, and I think that the chances of getting a billet there—are better than on this Coast."

"Hmmm!" the tall, kindly man pursed his lips thoughtfully—"hmmm; now let me see—. Have you considered this matter seriously, young lady? I do not wish to intrude myself in your private affairs, but for one so—so very—er—attractive as you, there might be annoyances—and—er—so forth, as a ship operator, supposing that we can land you in the berth of one."

"That does not worry me in the

least! The average man of today is rather much of a clean-thinking sort—Americans are, at any rate—and I am well able to take care of myself. But I am grateful to you for the considerate thought, good friend"—she put out her hand, impulsively. He took it, and from his six feet, two inches—looked down at the trim figure—strangely moved at the courage in the delicate, oval face.

"You shall have a letter to the Radio Inspector in New York—and to one

all of getting out of the fetid, humanity-reeking atmosphere of the lower parts of the city.

With white, wan face, Dorothy Montgomery wearily pushed herself in a small corner, where she might gain a moment's respite from the selfishly hastening throngs. The big eyes were tired, and there was a pathetic droop to the corners of the exquisite little mouth. She was dizzy—from the terrific temperature—and because of the fact that she had eaten nothing since morning.

Ever since her arrival in that which undoubtedly is the most cruel city in the world—from a sheerly business point of view—she had gone from one shipping company to another. At first—with heart full of courage and sublime in her faith in herself—as an operator of far more than average education and radio knowledge. And pardonable pride and ambition of youth—had wanted to "go it alone"—without using her letters of introduction. But the incredulous amusement with which she was met,

when her desires were known and, in some cases, the broad hints of lesser employes, in outer offices, sickened her, and she tried the smaller lines. So far, with but the same result: nothing.

The stereotyped: "We are very sorry, but all of our vessels have full complements of operators"—became as a ceaseless, monotonous dirge in her ears—much as the eternal rumble of a breaking sea on the shingle. The brief utterance of an office boy, in one of the last places that she had tried—haunted her: "G'wan!—the likes o' youse'll never git a berth poundin' brass! If youse was to ship on a vessel there'd be murder—inside o' a week! Nix—girlie! Get a job on the roof gardens—wit' at face and shape! Take it from me! When you land one—slip me its name and I'll come up—some night!"



*"By God, old as I am, I'll show them that a sailor's duty is to protect to the last ditch," he stammered—put his hands to his head.*

or two others—friends of military days. Where shall I send them?"

She gave an address and, with a cheery wave of hand, left him standing in the middle of the floor, as though rooted to it.

"By George, if I were not—well, if I had not a home, family, and more summers over my head than I care to count, I undoubtedly should . . . ! However!"—he coughed sharply to hide his embarrassment, as he saw that the stenographer was watching him—curiously. "Take some letters, please!"

**A**N unusually hot day was coming to its sweltering end—in New York. The reflected heat of the pavements beat against the hurrying crowds—that jostled and elbowed and fought to reach the subways, the elevated trains—means

These well-intended words careered through her mind with startling vividness, and—grimly enough—that dread grey Thing—despair—croaked dismally in her ears:—"Failed! Go home and get a position in a shop—or become stranded in NY, and . . . !"

"No! No!"—she exclaimed it aloud—unconsciously—and hastened from her shelter into the throngs—there to escape that which tormented her from within.

ARTHUR, Jr.,—only child of Arthur Carroll, owner of the famous Carroll & Carroll Line of steamships—whose boast was that they "*Carried Anything—Anywhere—at Any Time—for a Reasonable Price*"; that operated passenger as well as freight ships; whose house flag was known in every port of the world—Arthur Jr., who was rapidly following in his father's tracks—much to the elder's keen approbation—came hurrying down Broadway in his big runabout. Matters had delayed him at the offices and he was late for an appointment at Hempstead, Long Island.

A muscular, up-standing and entirely self-reliant young American was Carroll Jr.—with quick eyes for charms feminine—but with an exceedingly level head set firmly on his square shoulders.

"Darn the luck!" he ejaculated, as the traffic semaphore swung against him—at Broadway and 14th Street. After a seemingly endless space—it swung again and the big car shot forward. Thinking to get out of the jam, Carroll turned East—for 4th Avenue—speeding toward it as the side street was clear.

He did not see the slight figure until it had stepped directly in front of him—from between parked cars, half way down the block.

With a gasped—"My God!" he thrust on the brakes. But it was a physical impossibility to stop within the short distance. He saw the beautiful big eyes look beseechingly at him—in terror—as he swept on. And two little white hands were held out in pathetic effort to ward off the blow. He heard the faint—"O-o-hhh!"—as the flaring mudguard struck the soft body.

NERVOUSLY he paced up and down the big hospital's waiting room. He could see nothing but those eyes, with their expression of frightened appeal. And the lifting of her in his arms to his car—the supine passiveness of her slender body against his—the memory of these things moved him—strangely.

"She is strong enough to see you—and has asked who brought her here."

So quietly had the nurse approached that he started—nervously—when she spoke. "There is no serious damage done!" she added, quickly, seeing the set look on his face.

He followed her, unconsciously noting the grim spotlessness of everything. Up three flights in the elevator—then along a corridor that shimmered whitely in subdued electric lights. The nurse gently pushed open a door and stood aside. He entered. The door closed behind him—and the nurse went away.

So white that the pallor of her almost merged in the hue of the pillows, Arthur Carroll saw her face again—and it vividly flashed across his consciousness that it was the loveliest he had ever seen!

As he awkwardly approached the bed and began to say how sorry he was—she interrupted him softly:

"It was all my fault! I should have known better than to try and cross there—but I—I am a stranger in the city—and I was confused. It is I—who ask forgiveness, for having caused you all this trouble and annoyance."

He drew up the staid, white chair—and sat beside her—

"Miss . . . ?"

"Dorothy Montgomery of San Francisco full-fledged commercial radio operator, 1st class, in New York—looking for a berth"—and she smiled wistfully.

He stared at her—incredulously—"You?—commercial operator—?"

She nodded—"Yes, I am the original 'OW' of the Pacific Coast—at least the first to pass the required examinations for a first class—commercial."

"The—er—'original OW'—?"

She laughed outright—at the puzzled look in his fine eyes.

"Why, yes! In radio vernacular—of the air—'OM' is the abbreviation for 'Old Man'—as operators always call each other. Now that the—sex feminine has projected itself in the profession—its members have the title of 'OW'—meaning 'Old Woman'!"

But in your case, surely—'YG' would be more appropriate!"

"Very prettily said, Mr. . . . I do not yet know who—"

"Ran you down!"

"Don't put it that way—please!"

She reached out a little hand—that he instantly took.

"I am Arthur Carroll Jr."

"Not the—the shipping firm?"—she asked with a catch in her voice.

"The same—but why the surprise, Miss Montgomery? Do you know of us?"

"I went there—this morning—looking for a position." But she did not tell him that in those offices she had seen the ugly side of life—that a pretty woman sometimes sees—when seeking employment.

"And—they turned you down?"

"With definite brevity! In fact it was the—last place that I tried, and I was on my way to my room, when—." She stopped.

"What are your plans—now?" he inquired, gently.

She turned her head from him and looked out of the opened top of the window, through which the clean, bright stars peeped, and in which poured the muffled noises of a great, garish city.

"I—suppose that I shall have to go back to San Francisco—when I leave here. The nurse says that it is only bruises—nothing broken—and a matter of a week or so. But I hate to admit that I am—beaten! I hate to—give up! Just because I am a girl—the world thinks that I have nothing to give it—save to—to marry—somebody—maybe—and to increase the population! But I have brains, and I think that the world owes me at least a chance to use them!"

"Have you any friends in the city?"

"None. I have some letters of introduction to people here, but I wanted to make good—alone! Dad"—she bit her lips—"Dad always said—'walk on your own two feet! If you can't walk crawl! And if you can't even crawl—stay home!' And now—" her lips smiled, but her eyes did not—"now I cannot even 'crawl'—home."

"Please . . ." he began impetuously, holding her hand more tightly—"please let me . . ."

The door opened—the nurse came forward—"You will have to go, Sir. She needs rest after that shaking up. Fortunate for all concerned that it was no worse."

He leaned over and gently kissed the hand that he held—she looking at him wonderingly—but without the least alarm. There was something big and fine in Carroll Jr. that made for confidence.

"I shall be here the first thing in the morning—on my way downtown!"—he called to her.

And in the quiet of the hospital room she fell to recalling everything that he had said—the color of his eyes—the intonations of his voice—until consciousness slipped from its human shell—and she slept.

"HAD an accident today, Pater!"

Carroll Sr. and Jr. dined together at a club. Arthur's mother had passed on, in giving him birth, and neither he—nor his father—got on at all well with "the 2nd Mrs. Carroll" as the great shipowner's next venture on the matrimonial sea was generally known to intimates.

A beautiful, brilliant, domineering woman—intent on bending—or breaking—to her will everyone within reach. Those who sought the favors that she could bestow—fawned about her. But Carroll Sr.—and her stepson—took the course that water follows: the easiest—and maintained a semblance of peace by keeping out of her way. As Carroll Sr. was wont to remark—when especially

Continued on page 82



# Theory and Design of Amplifiers

By Louis Frank

BEFORE the advent of the electron tube the only amplifiers available were the Brown relay and Telefunken sound intensifier. At the most, these produced amplification insufficient to make any material difference in reception. The electron tube has large amplifying properties which can be used so that the amplified output of one tube can be still further amplified by succeeding tubes. In this way enormous amplifications result. At the same time the tube fulfills one of the most important conditions of a good amplifier: *amplification without distortion*.

It will be assumed in this discussion that the general features and characteristics of the vacuum tube are known, so that we can immediately take up the problem of the amplifier.

## SINGLE STAGE AMPLIFIER

When a voltage is applied to the grid of an amplifier tube a large current will flow in the plate circuit as a result of the relay action of the valve. This large current may be made to flow through a resistance or inductance placed in series with the plate, across which inductance or resistance a voltage will be developed which may be many times greater than the original grid voltage. Or from the point of view of energy a considerable amount of energy will be available in the plate circuit for operating a loud speaker, for example:

A good amplifier must fulfill one important condition: It must produce in the output circuit an *enlarged and exact copy* of the original signal impressed on the grid. This will be the case if the plate current is directly proportional to the grid voltage. From the general shape of the grid voltage-plate current characteristic of the valve, Fig. 1, it will be seen that this condition of direct proportionality obtains over the small range where the curve is a straight line, between points *A* and *B*. Operation within this range can be accomplished by adjusting the grid potential to a value midway between that of *A* and *B*. Under such conditions the amplification is directly proportional to the grid voltage and the proportionality factor is called the "theoretical amplification factor,"  $\mu_0$ .

This theoretical amplification factor  $\mu_0$  is one of the most important constants of the tube, for all true amplifications obtained in any amplifier depend upon it. It can be shown mathematically that  $E_g$  volts in the grid are equivalent to  $\mu_0 E_g$  volts in the plate. This factor then represents the theoretical quantitative effect of the grid voltage on the plate; and is the theoretical maxi-

mum amplification which the tube is capable of giving. It is dependent on the arrangement of the elements in the tube. The finer the grid wires and mesh of the grid, and the closer the grid is to the filament for a given separation of grid and plate, the greater will be  $\mu_0$ .

In contradistinction to the theoretical maximum amplifications there is the true amplification when the plate circuit is loaded, namely  $\mu$ . This is always less than the theoretical  $\mu_0$ . This is due to the fact that part of the amplified voltage must be consumed in the

true amplification and load resistance is shown in Fig. 3. It is seen that the practical maximum amplification, where the curve gets flat, is obtained if the load resistance is higher than the internal resistance of the valve.

In this discussion we have assumed that the plate battery has a definite voltage  $V$ . It should be noted that since the plate resistance of the valve depends upon the battery voltage, the true amplification will also depend upon this voltage. As soon as an external resistance is used, the d. c. through it results in a lower voltage being applied

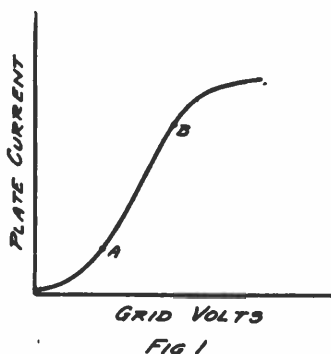

FIG 1

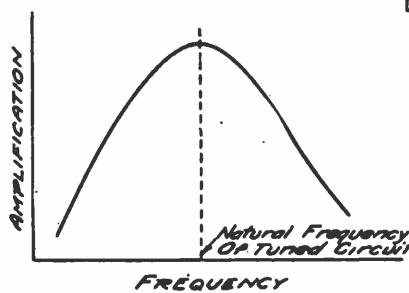

FIG 3

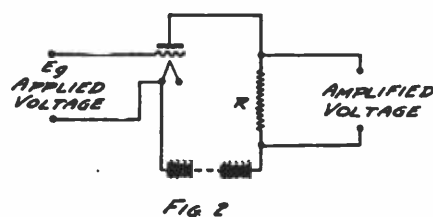

FIG 2

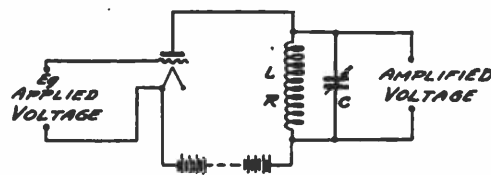

FIG 5

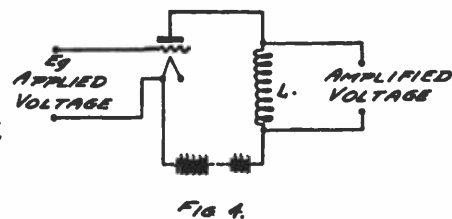

FIG 4

internal resistance of the tube, thus leaving the balance as available amplified voltage, which is therefore less than the theoretical maximum.

## SINGLE VALVE AMPLIFIER WITH RESISTANCE IN PLATE CIRCUIT

In this case the amplified voltage is obtained across a plate circuit resistance, Fig. 2. The true amplification depends upon the amplification constant and the plate resistance  $R$ . If the internal valve resistance (plate) is  $R_p$ , then the total plate circuit resistance is  $R_p + R$ . It can then be shown that the true amplification increases as  $R$  increases. When the external resistance  $R$  equals the internal valve resistance  $R_p$ , the true amplification will be given by one-half the theoretical maximum,  $\mu_0$ . As the value  $R$  decreases the true amplification also decreases, and vice versa. The theoretical maximum amplification is obtained when the external resistance  $R$  is infinity. The relationship between

to the plate. Hence the valve resistance will be less than expected and calculations of amplification will be in considerable error. Therefore, in designing resistance amplifiers compensation must be made by using "B" batteries of sufficient voltage.

As  $R$  increases the amplification increases, but at the same time the plate battery must be made larger to overcome the drop across the increased  $R$ . It therefore is costly to increase the "B" battery and a limitation must be placed on the value of  $R$ . From Fig. 3 we see that after point *A* is reached further increases in  $R$  produce only small increases in amplification. For these reasons in actual design it is not practical to exceed the value of  $R$  beyond point *A*.

## SINGLE VALVE AMPLIFIER WITH IMPEDANCE IN PLATE CIRCUIT

In this type of amplifier the voltage is developed across an inductance  $L$ ,



Fig. 4. In general, the resistance of the inductance is much lower than its reactance and may therefore be neglected. Mathematical analysis shows that the true amplification is directly proportional to  $L$ . By making  $L$  very large the true amplification can be made to approach the theoretical maximum  $\mu_0$ . This type of amplifier will give higher amplification than the resistance type, since  $L$  can be made very large and  $R$  is so small that there is no resistance drop across it, thus making the entire "B" battery voltage effective on the plate.

**SINGLE VALVE TUNED CIRCUIT AMPLIFIER**

In this type of amplifier a tuned r. f. circuit is used, as in Fig. 5, and the

and (2) the tuned r. f. circuit must be designed so that the ratio  $L/C$  is small, i. e., capacity in this circuit must be predominant. These are the conditions for minimum damping and maximum selectivity. If, on the other hand, a non-selective tuned circuit amplifier to tune equally well over a wider band of wavelengths is desired, the following design conditions must be met: (1) The resistance of the inductance should be high, and (2) the ratio of  $L/C$  should be high, i. e., inductance should predominate.

This system possesses great importance. For while we have thus far considered the tuned circuit to contain lumped inductance and capacity, it will be seen that this need not be the case. Thus we may have an apparent inductance

may be secured. In fact, the resultant amplification will be given by the expression  $\mu^n$ , where  $\mu$  is the amplification per tube, and  $n$  is the number of tubes employed.

We may have a multi-stage resistance, inductance, transformer or tuned circuit amplifier. These further may be used for either radio or audio frequency amplification. Radio frequency amplifiers will be found to be more difficult to build than audio for reasons which will be given later. However, radio amplification has important advantages over audio. First the detecting action of tubes is proportional to the square of the radio frequency voltage applied. Hence a r. f. amplifier which will increase the magnitude of the r. f. voltage before being applied to the detector is more advantageous than the audio amplifier. Second, atmospheric disturbances which result in audio currents, will be less amplified by r. f. amplifiers. For these reasons r. f. amplification is preferable to a. f., although limitations which will be mentioned restrict its use.

**AUDIO FREQUENCY MULTI-STAGE RESISTANCE AMPLIFIERS**

Such a two-step amplifier is shown in Fig. 7. Similarly any stage amplifier may be made. In each case it will be observed that a grid condenser is necessary, even though rectification and detection are not the object. The reason for this is unless this condenser is used the positive potential of the "B" battery will be impressed on the grids of the tubes through the resistances  $R$ , with harmful results. Since the condensers are used it is necessary also to use the leaks,  $r_1, r_2$ , etc., in order to prevent negative charges accumulating on the grids, thus blocking the tubes. As soon as one stage of a multi-stage amplifier is blocked, the entire amplifier

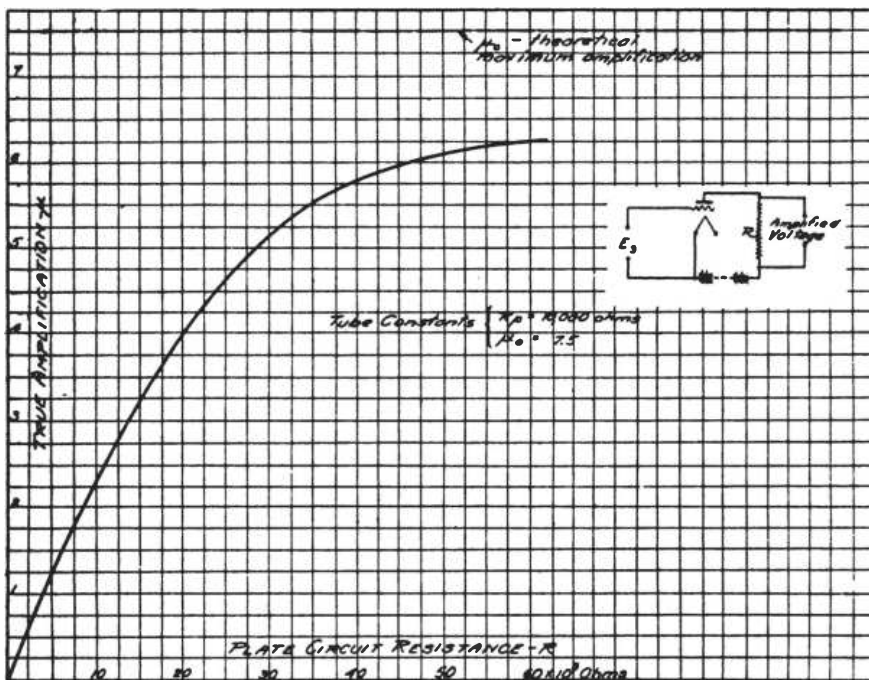

Fig. 3. Relation between Tube Amplification and Resistance

amplified voltage developed across it. The impedance of this circuit can be shown to be a maximum to currents having its own natural frequency, hence the maximum voltage will be generated across it for currents of this frequency.

The amplification curve for this circuit at different frequencies is shown by Fig. 6, which shows that maximum amplification occurs at the natural frequency of the r. f. circuit. Such an amplifier is different from the others, therefore, in that it is a "selective" amplifier. Hence this system will involve to some extent a so-called critical adjustment.

If amplification is desired solely on one wavelength or over a very narrow band of wavelengths, this circuit has a great advantage in that other frequencies will not be amplified much. The following conditions, in designing such an amplifier, must be met: (1) The resistance of the inductance must be very low,

amplifier, which in reality is a tuned circuit r. f. amplifier, due to the distributed capacity of the inductance acting as tuning condenser. This also holds for transformer coupled amplifiers.

**MULTI-STAGE AMPLIFIERS**

When a number of tubes are placed in cascade the amplified output of one tube being further amplified by the succeeding tubes, we have a multi-stage amplifier. It is obvious that with such an arrangement enormous amplifications

is useless. The grid leaks function by discharging this negative potential on the grid, preventing blocking and permitting operation of the amplifier.

The values of plate resistance and true amplification in multi-stage amplifiers are determined by exactly the same conditions as for single stage. For practical results the plate resistance should be about two or three times that of the valve resistance. The plate resistance in each of the stages is therefore the same.

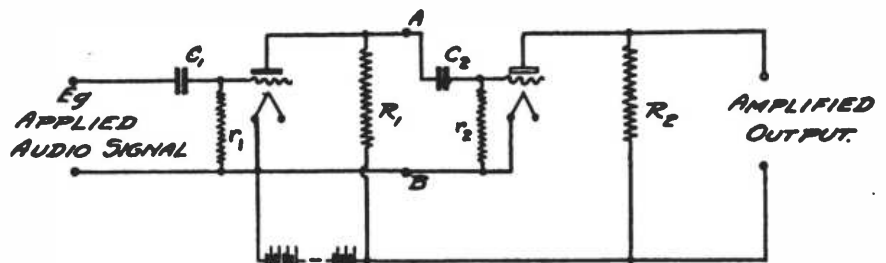

Fig. 7. Two-step Radio Frequency Amplifier.

Since the present valves usually have a resistance of about 10,000 ohms, the plate resistances will usually be between 20,000 and 30,000 ohms. These resistances must satisfy certain conditions. They must have a minimum of distributed capacity, since this capacity is in shunt to the resistance, thus reducing its impedance, which will result in reduced amplification. It must be able to carry the plate current without overheating, since overheating will alter its resistance and thus alter the amplification. But worse than that, if the resistance alters regularly with passage of current, the current will also be altered, thus producing objectionable tube noises.

The values for grid condensers and leaks are determined by definite considerations. In Fig. 7 it will be seen that the grid circuit of the second tube is in parallel with the plate resistance of the preceding tube, between points *A* and *B*. The impedance of the grid circuit must therefore be much greater than that of *R* in order not to affect the amplification. The impedance of the grid circuit depends upon the internal grid-filament impedance, which generally is of the order of a million ohms or more, and on the grid condenser and leak impedance, which depends mostly on the leak resistance. Since this is also of the order of a million ohms or more, thus showing that the grid circuit at *audio frequencies* is sufficiently high in impedance so as not to affect the amplification. Since the amplified voltage across *R* is applied to the next grid through condenser *C*, the reactance of this condenser must be low, enough not to take much of a drop in voltage across it. Since the effective resistance of the grid-filament circuit is of the order of a few hundred thousand ohms, the grid condenser may have a reactance of a few thousand ohms without altering the voltage applied to the grid very much.

#### RADIO FREQUENCY MULTI-STAGE RESISTANCE AMPLIFIERS

The same type of circuit and the same considerations apply in the resistance amplifier for r. f. as for a. f. circuits. The difficulty in the case of r. f. amplification is that the impedance of the grid-filament path is extremely low, and therefore alters the amplification adversely. The reason for this low impedance at r. f. is that the reactance of the tube capacity is much lower at r. f. than at a. f. Assuming that the capacity of grid-filament path is about 30 mfd., its reactance will be at 600 meters about 3000 ohms, which is so small that it would practically short-circuit the plate resistance and so destroy all amplification. It is therefore necessary to increase the value of the plate resistance, and for best results the wavelength worked on must be higher. In general,

using this amplifier on low waves will not yield good results and the over-all amplification will be much less than for a. f.

#### IMPEDANCE COUPLED MULTI-STAGE AMPLIFIER

The impedance coupling is similar in both action and connections to the resistance coupled amplifier, the only difference being that iron cored chokes are used instead of resistances (audio). This type of amplifier has the advantage that, since the resistance of the choke is small compared to its reactance, there is very little resistive drop in it and the full

a wavelength, say, of 1000 meters, is approximately 0.004 henrys, which is extremely high for a r. f. inductance. This would require, in order that it be built compactly, a large number of turns, resulting in high distributed capacity. The result would be a maximum amplification at the natural wavelength of the coil, which may be very different from that for which the amplifier is meant. This type of design is therefore to be avoided, unless means are available for adjusting the wavelength of the circuit, as for example the use of a variable condenser across the choke coil to tune it to a given period.

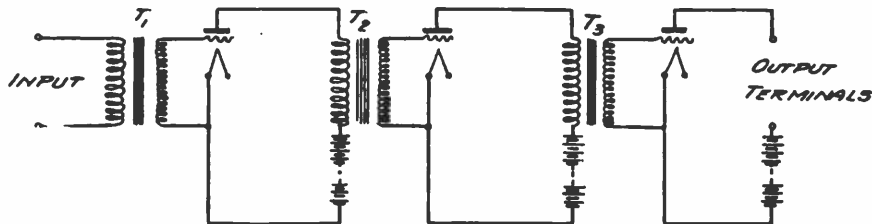

Fig. 8. Three Stage Audio Frequency Amplifier.

voltage of the battery is applied to the plate.

The amount of amplification obtained in each step is the same as was given for the single stage. The curve showing the amplification thus obtained is similar to the resistance curve, except that it is steeper, and hence, for a given ohmage the impedance amplifier will give greater amplification. No advantage is obtained in exceeding a value of two or three times the resistance of the valve for the reactance of the choke, for above that limit the amplification curve flattens out. For tubes generally used, such as the UV 201, the choke should be about 3 or 4 henrys in inductance, which would give reactances between 20,000 and 30,000 ohms at 1000 cycles.

In designing such an amplifier for radio amplification an important difficulty arises. Calculating on the same basis as for a. f. the necessary inductance to give 20,000 ohms reactance at

#### AUDIO FREQUENCY TRANSFORMER COUPLED MULTI-STAGE AMPLIFIERS

In Fig. 8 is shown a three-stage a. f. amplifier. Each stage is coupled to the following one by means of a transformer. There are two amplifying processes in this type of amplifier. First the voltage is amplified by means of step-up transformers; second, amplification takes place in the tube itself, since repetitions in the plate circuit are magnifications of the variations in the grid circuit. Now the tube amplification will inevitably take place if the tube has no defects. But unless the transformer is properly designed, not only may amplification *not* take place in the transformer, but if it is poorly designed *the amplification of the tubes may be destroyed*. The importance of considering the proper design of transformers is therefore clear.

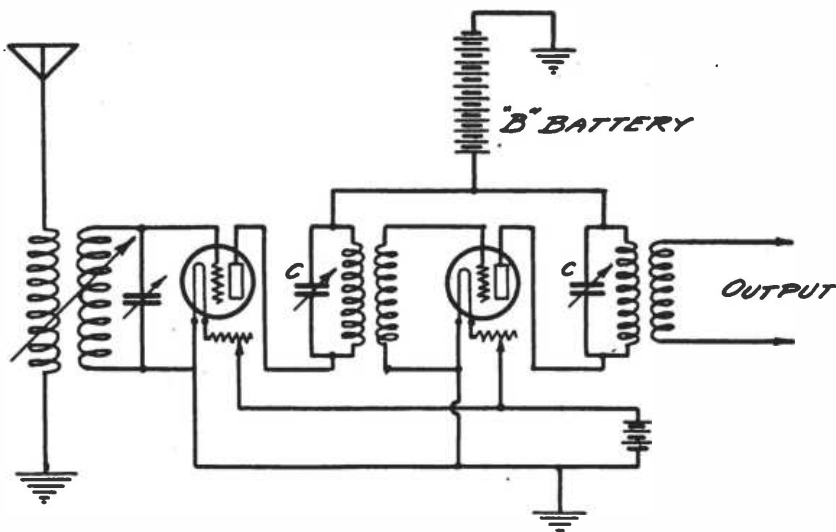

Fig. 9. Radio Frequency Transformer Amplifier.

Without going into the mathematics of the problem, it can be proved that the true amplification is directly proportional to the amplification constant of the tube,  $\mu_0$ . Hence, all other factors being equal, the larger this is the greater will be the actual amplification obtained. The amplification also increases as the grid-filament resistance increases and as the plate-filament resistance decreases. For maximum amplification the grid-filament resistance

by using the minimum number of turns which will give the required ratio and transformer reactance.

An analysis further shows that the greater the transformer ratio is the greater will be the amplification. There is, however, a limit to the transformer ratio which can be used. Increasing the ratio means increasing the secondary turns, resulting in increased distributed capacity and leakage. This results in lowered amplification. Experiment

If  $L_p$  is the reactance of transformer primary then the condition for maximum amplification is  $2\pi fL_p = R_p$ . It will be found that in most cases the inductance so calculated will be so high that it will be impossible to build the coil without high distributed capacity. Hence the primary coil will have a natural wave length which may fall within the ranges to be amplified. Amplification will be high at this wavelength, but may be very poor at the others.

In order to take care of this contingency there is but one alternative, and that is to modify the r. f. transformer coupling into a combination transformer and tuned circuit coupling. This can be done as shown in Fig. 12, by shunting the primary with a small variable condenser to permit tuning to various wavelengths. Thus, by tuning the circuit to the incoming wave the effective resistance is always adjusted to the best value and high amplifications are secured at each wavelength. This has certain advantages which will be evident from the following. Analysis shows that the amplification is inversely proportional to the primary inductance, hence the lower its inductance the greater the amplification. This means that capacity is preponderant, and since inductance is low, distributed capacity is low and losses are decreased. On the other hand, amplification is directly proportional to secondary inductance. Here the disadvantage is that building a high secondary inductance means high distributed capacity, which may result in destroying amplification. It is therefore advisable to keep the secondary inductance low. This means that amplification will therefore also be kept low, but this is preferable to destroying amplification, on account of high distributed capacity. It is for this reason that a. f. amplifiers invariably give much higher amplification than can be secured with r. f. transformer amplifiers.

One final consideration in this connection: Across the secondary of the r. f. transformer is the grid-filament path of the succeeding amplifier tube. The grid-filament circuit has in all tubes an appreciable capacity. At radio frequencies this capacity will have a very low reactance, and since it is directly in shunt with the applied voltage across the transformer secondary it acts as a short circuit. As already shown, a tube capacity of 30 mfd. at 600 meters has a reactance of about 3000 ohms, which would be an absolute short circuit on the applied voltage. This is the great bugbear in r. f. amplifiers, and no matter how well the other parts are designed, the tube capacity may destroy all the amplification. For this reason it is always best to make an audio frequency amplifier, as it will give better results and is somewhat easier to operate.

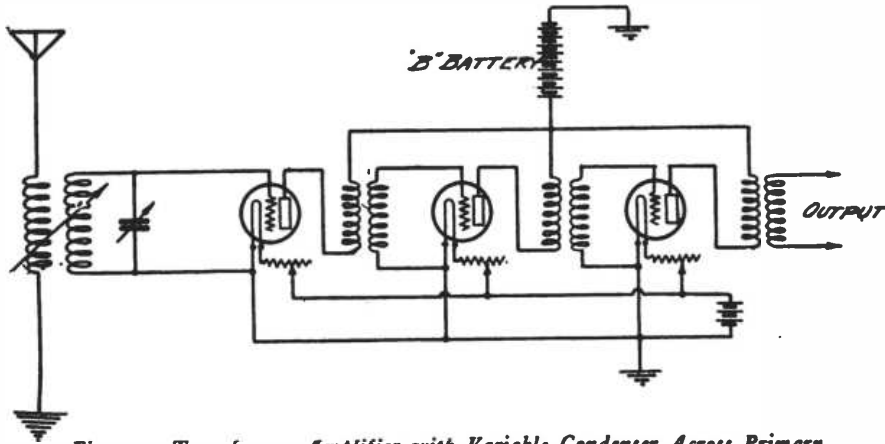

Fig. 10. Transformer Amplifier with Variable Condenser Across Primary

should be made as large as possible, compared to the plate-filament resistance.

The plate-filament resistance is determined by plate voltage and current for normal operation and is usually given by the manufacturers of the tube. The grid-filament resistance, theoretically, should be as high as possible, this being obtained by using a negative potential of suitable value. The theoretical conclusions and the resulting mathematical equations for the transformer ratio are based on the assumption of an ideal transformer having no leakage, no losses and no distributed capacity. Since no transformer is ideal, these factors will enter and alter the conclusions. Leakage can be minimized by building the transformer around a closed iron core, losses can be minimized by using proper size wire, by using good high-grade, low loss transformer steel, laminated and shellacked. The distributed capacity must be kept a minimum

shows that amplification in any given case increases with the ratio, but a point is reached when further increase in ratio does not bring further increase in amplification. This is the point where leakage and distributed capacity begin to play their role. Practice shows that the limit for transformation ratios should not be greater than 8 or 9.

RADIO FREQUENCY

The circuit and connections are the same here as for a. f. and are shown in Fig. 11. Transformers are air core, in order to eliminate eddy current and hysteresis losses at high frequencies. The design of these transformers cannot be considered on the same basis as for audio frequency because leakage plays a prominent part, since the lines of force travel through air. It can be shown that maximum amplification is obtained when the reactance of the transformer primary is equal to the plate-filament resistance.

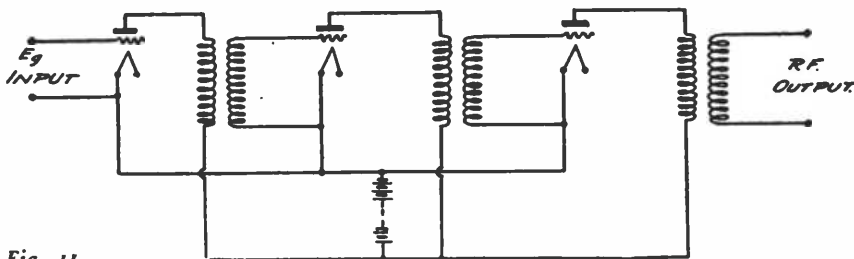

Fig. 11.

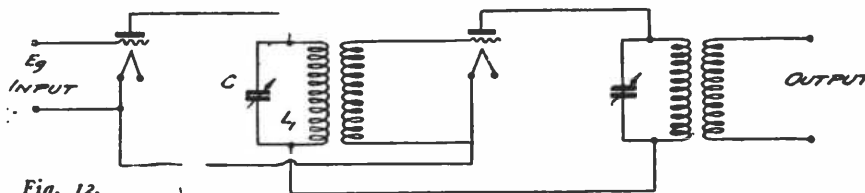

Fig. 12.

# A Concert Direction-Finder

By Stanley E. Hyde

FOR receiving broadcast stations a "direction finder" or coil antenna is especially desirable, in that it eliminates interference from other stations operating at the same time. When the coil is turned so that its plane is in the line of direction toward the transmitting station the loudest signals are received. When the plane of the coil is at right angles to this direction no signals are received, or at least they may be very weak.

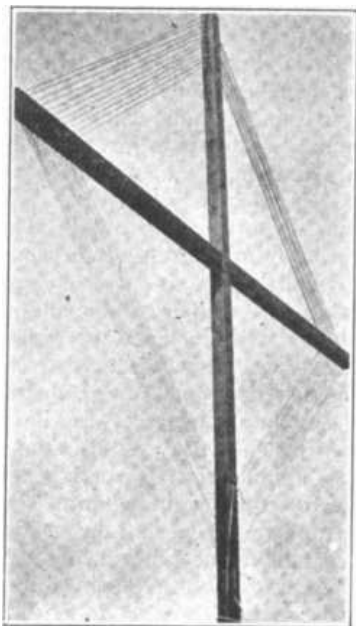

Fig. 1. Ten Turn Loop.

This makes it possible to receive from any one station even tho another may be transmitting on the same wavelength. If both stations are in a direct line with the plane of the coil they can not be tuned out; however this is not very apt to be the case.

For receiving on coil antennas it is desirable to employ an electron tube detector with one or two stages of audio frequency amplification.

Fig. 1 shows a concert direction finder constructed by the writer which works quite satisfactorily in eliminating interference from amateurs and other stations operating during the broadcasting period. It consists of a 6 foot wooden cross made from two pieces of wood  $1\frac{1}{2}$  in. x  $1\frac{1}{2}$  in. x 6 ft. Both pieces are "slotted" at the center and held together with a 2 in. stove bolt. It will be found that the pancake type coils have sharper directional properties than the flat-top coils. This is illustrated in Fig. 3. The face of the flat-top coil gives a greater receiving area from the distant transmitting station *T*, shown at *A*, than does that of the pancake coil shown at the right, which pre-

sents only the width of one turn of wire. For a given size of loop, signals may be received louder with the flat-top type, but this is compensated for in the greater sharpness of tuning, using the pancake coil.

Fig. 1 shows a ten turn loop. Later experiments, have shown that 4 or 6 turns are better for the short waves employed in broadcasting. The holes that the wire passes thru on the cross arms are drilled 1 in. apart, care being exercised that they are properly spaced. Seven No. 22 stranded antenna wires (bare) make up into a loop with little trouble as it is quite flexible and pulls taut upon the completion of the work.

Fig. 4 shows the method of securing the free ends of the coil to the frame. *D* and *E* are wood screws with brass washers, under which the ends are held. To these connections are also led the lead-in wires to the receiver.

This coil antenna in question is placed 6 feet above a sloping roof, is connected with a shaft which passes thru the roof, thru the ceiling and ends with a steering wheel handle (Ford type). Two small holes in the shaft are made to pass out the lead wires to the receiver. See Fig. 2. Fig 5 illustrates this procedure. The shaft consists of a 10 in.

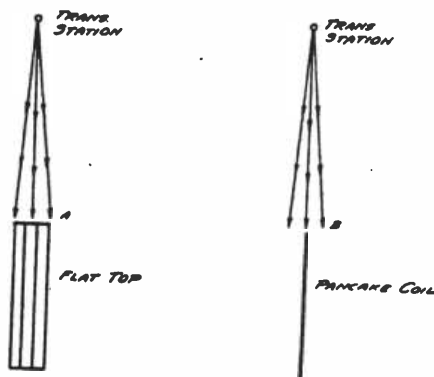

Fig. 3. Comparison of Flat-Top and Pancake Coils.

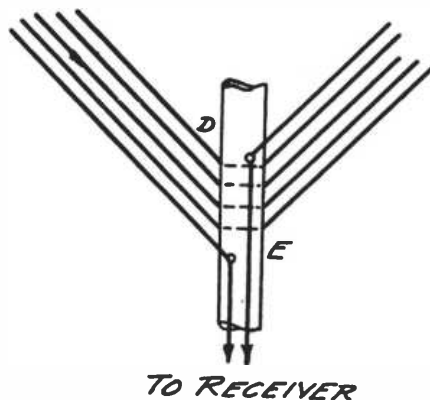

Fig. 4. Method of Securing Coil Ends to Frame.

length of black enameled  $\frac{1}{2}$  in. conduit. A  $\frac{3}{4}$  in. hole is drilled in the bottom of the cross arm for a distance of about 8 in. Into this is forced one end of the conduit. Two holes are then drilled in the wood diagonally so that they come out at the entrance of the conduit. See *H* Fig. 5. Another hole is drilled thru both wood and conduit for a  $\frac{1}{4}$ x $2\frac{1}{2}$  in. stove bolt, shown at *S*. This bolt prevents the shaft from slipping around inside the wood

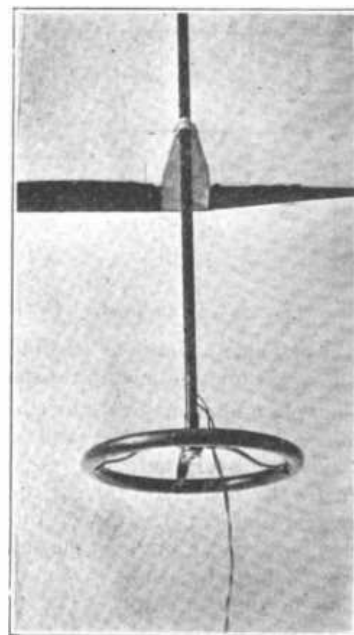

Fig. 2. Control Wheel for Loop.

arm. Untwist about 14 in. of flexible lamp cord and "fish" both of them thru the conduit, by first pushing two small copper wires thru the two holes into the conduit and out the bottom end. Connect the two leads of lamp cord to these fish wires and pull them out the holes and connect to the brass wood screws.

A hole is then drilled or bored thru the ceiling over the radio table or instruments, care being taken not to break the plaster. Then with a plumb-bob find the place to cut the hole thru the roof. The hole thru the ceiling is preferably bored in the center of two joists. The iron flange, which is secured to the conduit by the set screw, rests and turns on the piece of hard wood, supporting the entire weight of the coil antenna, shaft and handle. *P* is a brass or nickel plated pipe collar that conceals the hole in the plaster and keeps particles of plaster from falling onto the instruments or table.

Before slipping the shaft thru roof, a funnel shaped piece of tin is slipped on. This, with the addition of roof-

ing tar or paint, makes the arrangement water proof.

Fig. 6 depicts the method of securing the hand wheel to the end of the

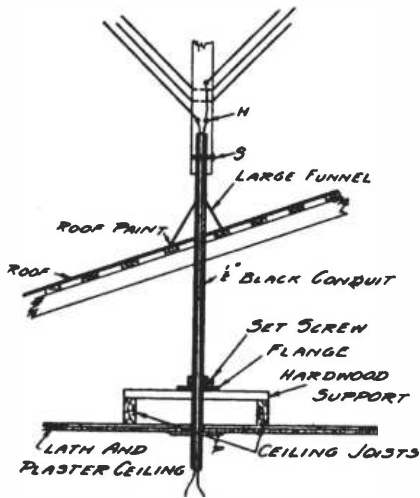

Fig. 5. Connection Through Roof.

shaft. A 1/2x3 in. expansion bolt butts the hand wheel center flange onto a 1/2 in. coupling. Tightening up this bolt securely holds the wheel tightly to the end of the shaft. Previous to this

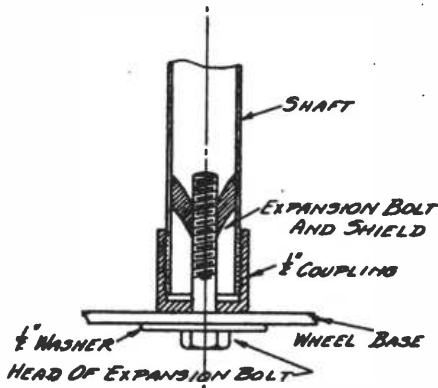

Fig. 6. Method of Fastening Wheel to Shaft

operation the lead wires are fished out from the shaft thru two holes as shown in the same figure.

A little lubricating oil placed under the supporting flange will make a shaft turn easily and prevent frictional noises. Fig. 7 shows a simple regenerative or feed-back circuit that works well with

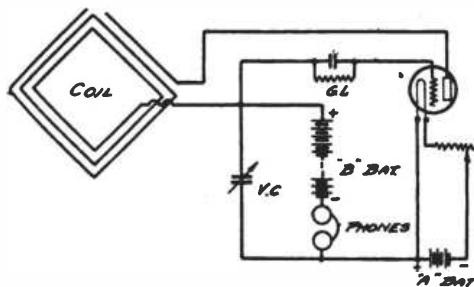

Fig. 7. Feed-Back Circuit for Loop Antenna

a coil antenna. In such a circuit a variable condenser should always be used in series with the loop, otherwise the "B" battery will be shorted out

thru the telephones. Any circuit that employs such a condenser may be used successfully with the loop antenna.

It is found advisable to have a shaft as short as possible and to connect it to ground. The only reason for having the coil on the roof is that it was rather too large to have in the room, and the space in attic was very limited for a 6 foot coil.

If the leads from the coil are too long they in themselves act as an antenna and spoil the directional effects of the loop. No doubt such an arrangement would work equally well if placed on the outside of a window with the shaft geared to a horizontal piece coming thru the wall.

### RADIO COMMUNICATION AT PAN-PACIFIC COMMERCIAL CONGRESS

Rear Admiral H. J. Zeigemeier, Director of Naval Communications, who has been designated to represent the Navy at the First Pan-Pacific Commercial Conference at Honolulu, October 25-31, will speak there on communication and transportation, giving special attention to a survey of the present cable and radio activities, and will discuss the establishment of lower special rates, fixing responsibility and granting improved facilities for the press.

### CARLTON SAYS RADIO WILL NOT HURT CABLES

The rapid growth of radio communication has led to considerable speculation in financial circles as to just what its effect might be on the future of the cable business. An analysis of the situation was sketched recently by Newcomb Carlton, president of the Western Union Telegraph Company, which created wide interest in Wall Street because of the authoritative position which Mr. Carlton holds in the telegraph industry.

"The Radio Corporation of America is today transmitting from 12 to 14 per cent of the eastward and westward business between the United States, Great Britain and Continental Europe," said Mr. Carlton in describing the relative positions of the two forms of communication, radio and cable. "While a considerable part of this business would no doubt have gone to the cable companies, an important part is newly created traffic. The radio rate from New York to London is 18 cents a word, competing against a cable rate of 25 cents. In other words, with rates 30 per cent cheaper, the radio is doing from 12 to 14 per cent of the business.

### 100,000 WATT VACUUM TUBES

In the telephone laboratories of the Western Electric Company has been developed a vacuum tube capable of supplying 100,000 watts. The essential feature of the new tube is that the "plate" is a copper cylinder forming the outer wall of the tube. In the customary tubes used in radio sets, the "plate" is an actual plate or small cylinder of thin metal enclosed in a glass tube. If even a small fraction of an ampere is passed through the plate circuit of one of the small tubes, the plate will become very hot. In the larger "power" tubes this heat becomes so great that some means other than radiation must be provided to carry it off, or the tube will collapse. This is easily done when the plate is the outer wall of the tube, for it can be put into a tank of water which circulates through a radiator. The tube is then water-cooled just like an automobile engine.

This sounds easy enough. The real difficulty was to make the whole tube air-tight and to get the wires for the filament and grid into the tube while keeping them insulated against about 20,000 volts. After much study, the problem was narrowed down to finding a way to make an air-tight joint between the heavy copper tube which forms the "plate" and the glass of the upper part of the tube, and to bring the heavy wires through this glass. Credit for the answer is due to Mr. W. G. Housekeeper, a Western Electric engineer, who discovered a way to seal copper to glass which would make an air-tight joint that would not crack at any ordinary working temperature.

The anode, which is made of a piece of seamless copper tubing closed by a copper disc welded into the end, is 14 in. long and 3 1/2 in. in diameter. The filament is of tungsten and is .06 in. in diameter and 63.5 in. long. The current required to heat it is 91 amperes and the power consumed in it 6. The filament leads are of copper rod 1/8 in. in diameter and are sealed through 1 in. copper disc seals. The grid is of molybdenum and is wound around three molybdenum supports.

One of these big tubes stands three feet high and is 3 1/2 inches in diameter at the bottom. To heat the filament, for which in radio receiving tubes a single dry-cell or a small storage battery is enough, this tube used 6,000 watts. For the plate circuit, instead of the familiar "B" battery, a high voltage direct-current generator is used, or an alternating current rectifier. The combination of vacuum tube and its current supply, it is expected, will be less costly, more rugged and more easily adapted to various wavelengths than any other source of radio power now in use.

## LETTERS TO THE EDITOR

## Scraps About Scrapping Sparks

Sir: Upon reading the Radiotorials of October RADIO I came across the article about radio dealers furnishing CW apparatus to amateurs at wholesale prices in order to do away with spark transmitters. The reason for their actions is that amateur spark transmitters interfere with the broadcasts.

In regards to this so called interference, I am in possession of a short wave regenerative set and one step amplifier and on it I have heard the concerts from all the principal radiophone stations on the coast, and on no occasion have I been interfered with by amateur spark sets. In fact I have very seldom heard one when I had my set tuned to 360 meters with the detector oscillating, and when I did they were so faint that they caused no interference, in spite of the fact that they were only about a mile away. The cause of the interference that broadcast listeners experience is caused by antiquated apparatus, such as tuning coils, loose couplers, etc; and modern apparatus that does not tune sharply, such as single circuit tuners.

So much for interference. In regards to junking the spark for CW. If you listen to the amateur stations that are handling relay traffic after 10 o'clock you will no doubt notice that the major portion of the relay messages are sent via spark stations. In fact I would say that three fourths of messages are handled by "sparks," and if the spark stations were closed down the messages would have to be sent via lowpower CW sets, and I claim that this is unreliable for nearly all the long distance work that is done by CW is one-way only; i. e., the sending station being "reported" by some distant listener and not "worked."

In regards to these relay messages (which, by the way, are the principle reason why most amateurs sit up after midnight) the majority of broadcast listeners do not know that any amateur is only too glad to relay a message for them or anyone else absolutely free of charge.

The gist of this proposal of the dealers is to eventually do away with amateur radio in order to enjoy a selfish monopoly of the air, which is the gracious thanks we get for making radio what it is today.

Sparks forever,

A BELLIGERENT HAM.

Alameda, Calif.

## Radio Frequency Amplification

Sir:—I have before me the September issue of "Radio" and I find that both the editorial comment and Mr. Lippincott's article on Radio Frequency Amplification are particularly interesting and are none the less so because I am so strongly in disagreement with many of the statements made. On hasty perusal of the editorial comment, I was left with a sense of the utter hopelessness of ever being able to devise successful radio frequency amplification. The effect of your editorial on me is due in

a large way, I suppose to its being exceptionally well written, so much so that the fallacious statements or inferences were wholly submerged by the sense of futility with which it left me. I must, however, take this opportunity of expressing my disagreement, if for no other reason than to regain for myself, my complete confidence in radio frequency amplification as the means for making available to the nation, the tremendous amount, both in effort and in dollars that is being spent on radio broadcasting today.

You would infer in your third editorial paragraph that the possibilities of amplification at radio frequencies are practically nil, since no gain in voltage can be secured in the intervalve transformer, and while I must agree that with the tubes that are available to the amateur and novice today, any worth-while voltage step-up in the transformers of the system cannot be secured I know, as do you, that the vacuum tube even at frequencies well in excess of a million cycles gives a very useful power amplification and that this power amplification is not of a degree to be on the verge of uselessness, but, on the contrary, can actually be taken advantage of to the extent of making possible degrees of amplification which would probably be impossible of attainment without the use of radio frequency amplifying transformers. I believe that you would be fairer to the radio frequency amplifier if you would see in it, not a substitute for the more commonly used audio frequency amplifier, but rather a scheme to supplement the audio frequency amplifier and hence, a scheme whereby communication is made possible over ranges and with such insignificant antennas that have in the past been quite impossible, and this without serious operational complication and without loss in stability.

I feel of course as you do, that we should have tubes whose characteristics are more nearly suited to the requirements of the radio frequency amplification. I believe that such tubes can quite easily be designed without seriously effecting their other useful properties and that the art of amplification will be greatly improved when such tubes are available. Such tubes will, however, merely simplify the matter of the design of effective radio frequency amplifying equipment rather than to remove it from the realm of the impossible into that of the possible as you would imply.

You of course, through the publicity which you control are well able to help to bring this state of affairs about and you have my heartiest good wishes and my offer of assistance in anything which you may do in this matter.

Let me point out, however, that with no tube, however well designed, will we get what you term "an efficient all-wave amplifier," even though in the extreme case, we were to limit ourselves to the relatively inefficient resistance coupled amplifier, and that we must continue to look forward to narrow band R. F. Amplifiers as compared with the breadth of band of A. F. Amplifier. The average radio frequency amplifying transformer of this day is admittedly low in efficiency or is of extremely narrow frequency band. A high degree of efficiency and broad frequency band are essentially inconsistent in any coupled circuits where resonance, or any approach to it is involved and this same lack of consistency between frequency range and efficiency is characteristic of all electrical or acoustical apparatus and we must in all fairness to any devices which we criticise certainly bear in mind that this inconsistency is quite naturally inherent and that only by especially careful design can the best compromise between frequency range and efficiency be realized. There are several methods by which this

may be done and the most effective device is one in which the best compromise is made. I am in hearty agreement with Mr. Lippincott that a high degree of workmanship and material is required in the radio frequency amplifier and that his "Chinese New Year Celebration" will be fatal to the operation of such an amplifier, but I must point out that no more careful choice of material and workmanship is required in the construction of a good radio frequency amplifier than is required in the tuning system of a good radio receiver. It is necessary perhaps that more care be taken to see that interconnections between parts are as short and as direct as possible and that good dielectric materials are in the dielectric fields that exist.

I object very seriously to Mr. Lippincott's point that enameled wire impregnated or unimpregnated in radio frequency transformers is quite fatal to their action. This is usually the fact but it need not be since an energy loss in such material can only exist when a voltage exist across that material. It is quite easily possible to build radio frequency transformers in which the voltages which exist between adjacent conductors are so small as to be utterly negligible and such transformers of the type I have in mind have extremely desirable characteristics in the way of gain and range and to which the low dielectric loss is merely incidental.

The schemes for making amplifiers interchangeable, as pointed out by Mr. Lippincott, are, of course, to be condemned wholeheartedly as are the sharply tuned amplifiers which he mentions, since such amplifiers have not only a narrow frequency band but a high degree of instability, which to my mind more than nullifies the possible advantage of their efficiency.

I disagree with the editorial statement that the Armstrong "Super-hetrodyne" is seriously at a disadvantage in that it requires a large number of tubes and I believe you will agree with me if you will review in your own mind the circuit arrangements, since you will find that with the exception of the local generating tube and the first rectifier, there is nothing more required than in the case of the R. F. Amplifier and under certain conditions, the function of generator or detector, or both can be combined in the first tube or may be accomplished with only one additional tube. I wish to correct you in this regard, since through the Armstrong super-hetrodyne scheme, many of the disadvantages of radio frequency amplification at the very high frequencies are eliminated and its actual effectiveness for increasing the signal voltage before rectification may then be taken advantage of in an extraordinary degree. I believe that this scheme of amplification will ultimately come into exceedingly general use and probably entirely replace the ordinary type of R. F. Amplification. Your criticism of the Armstrong super regenerator is quite in agreement with my own attitude toward the device, but since my experience with it is limited to a few trials I am not willing to put myself on record as saying that it is too critical for general use. I feel that with a year of development work behind us it, too, will have become a very practical scheme and that we may well look to this scheme for exceedingly high degrees of amplification with higher power output than has ever been possible in the past with relatively simple and cheap apparatus.

I would be indeed glad to have you publish this letter in the columns of your very worthy magazine and to hear from others of your readers as to their experience with and criticisms of the various amplification schemes here discussed.

Respectfully,

LAURENCE C. F. HORLE.

Buffalo, N. Y.

NEWS OF THE RADIO CLUBS

The North Shore Radio Club of Chicago issues a clever mimeographed paper known as the "Radiator Glues," of which 9BRE seems to be the chief instigator. The feature of the September number was "Thy and Ur Neighbor," wherein Brother Bill's new C. W. transmitter raises as much ire among the neighbors as did his old spark set. 9BDL is mourning the loss of a fine QRN collector because the landlord objects to his Ant Enna.

The American Radio Relay League announces another series of trans-Atlantic tests from Dec. 12th to 31st, during which time it is hoped to hear French and English amateurs on this side as well as to have American and Canadian stations heard on the other.

The Bay Counties Radio Club is holding weekly meetings on Friday evenings at Library Bldg., 52nd and Telegraph Ave., Oakland, Calif. The first meeting of each month is given over to a feed and social events, with prominent speakers addressing the other meetings on some subject of radio interest. Fred A. Anderson is president.

The organization meeting of the Piedmont High School Radio Club was held Sept. 14, about thirty prospective members being present. It was agreed to form Junior and Senior Sections of the club to accommodate the needs of various members, depending upon their experience. Officers elected: Arthur Merrill, president; David Atkins, vice-president. The club will meet weekly, Junior Section on Tuesdays, and Senior Section on Thursdays.

Meetings of the Sunset Radio Club at San Diego, Calif., were suspended during the summer, but will be resumed in October. Lester Picker, 6AJH, is getting a real wollup out of his new 20 watt C. W. and fone set. With 2 amps in the antenna on the initial adjustment he worked 70Z within ten minutes after the installation. With 1½ amps in the antenna and good voice modulation, his telephone promises much. Lester has already placed his spark set in the junk pile. Lex B. Benjamin, 6XQA, and W. Lindsay, 6ZF, visited San Diego recently. The "Round & Rounders Club" presented Mr. Benjamin with a loving cup beautifully engraved in charcoal with the emblem 5c. Lex B. made a blushing response. Elliott Pohl, the handsome young announcer at KDPT, has found a new voice lozenge which he recommends to broadcasters as producing the best imitation of a man talking, so far discovered. 6BJY leads all San Diegians in the C. W. miles per watt contest with his 10 watt transmitter. 6MZ has been in Mexican waters on his yacht, the "Spray," KDYB, for three months. It is rumored that on his return he will install C. W. to replace his famous sink set. Deputy Radio Inspector D. P. Trim has dismantled his set owing to change of residence, but promises the big noise again in the near future with straight C. W. The recent visit of Messrs. Cattell and Wisner to the NPL arc and spark stations have proven effective relief from mush and other interference. 6AHF having exhausted his spark, is rushing the completion of a 20 watt rectified A. C. transmitter. 6BJU has not lost any time during the summer months sending and receiving messages and promises much for the coming season's relay work. 6BJV, George Remington of Coronado, is reconstructing his station for winter traffic and will eliminate spark, according to reports. The club is planning to meet at San Ysidro at the station of 6AJH in the near future.

THE "ROUND AND ROUNDERS"

Radio has developed many sidelines. We have seen in the good old days, the three, four, and six inch spark hound entrenched in his thunder factory, the DX results being almost as audible via the air as the ether. The carborundum fiend was followed by the galena craze. At a later date came Fleming tubes, DeForest bulbs and circuits without end. Then Armstrong started brainstorming in the amateur ranks by bestowing his regenerative circuit. Rotary gaps superseded the straight ones. The law demanded an actual tune to 200 meters and not more. Antennae fearfully and wonderfully constructed and conforming to all possible variations broke up the land-



scape. Finally CW appeared. It is common practice among amateurs to attain a given result with receiver and transmitter and immediately become dissatisfied, with a result that the whole works is torn up and reconstructed.

In San Diego, not satisfied with the limited opportunities for argument afforded by monthly meetings of Sunset Radio Club a certain coterie of amateurs who had found themselves going "round and round" in the vain hunt for maximum transmitting and receiving efficiency, formed an informal association called the "Round & Rounders." Qualifications for admission to this circle are that an individual be a recognized amateur in radio or interested in the art. Meetings are held daily at noon at a restaurant, in a private box. Members come and go as they please, Dutch treat being the rule. Since the illusive ohm seemed to

be the main source of all radio difficulties this was given a center place in the emblem adopted. Encircling the ohm is found a resistance, an inductance and capacity in series. The circle with arrow points denotes the name. Whenever a visiting amateur arrives in town one member of the Round & Rounders is sure to grab him and hale him before the festive board in an endeavor to spoil his appetite. All who have set at the "Round & Rounders" table have ad-

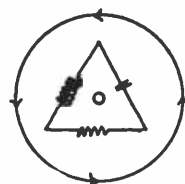

mitted that they have found this informal discussion-method of attacking radio one of the greatest helps they have experienced. When a member finds himself faced with a difficulty he springs it the next day. If the trouble is not cleared up that day someone is sure to dig up a remedy the day following. Some of the hottest arguments ever staged have been threshed out in this way. Some of the most firmly cemented friendships have been made possible through the "Round & Rounders."

It would seem that every city could have a "Round & Rounders" Club as there is not always time at a formal radio club meeting to dispose of individual needs of members. Since the "Round & Rounders" have flourished now for a period of over two years it is no longer an experiment. The members desire to pass a good thing along.

The San Diego Chapter has the following membership: Major John F. Dillon, Radio Inspector 6th District, San Francisco, Cal., D. B. McGown, Asst. Radio Inspector, San Francisco, Cal., Mr. Linden, Asst. Radio Inspector, San Francisco, Cal., Roy K. Freeman, Electrical Engineer, Long Beach, Cal., A. A. Hudgins, 6IZ, Coronado, Cal., John F. Gray, 6MZ, Del Mar, Cal., Coleman M. Gray, 6MZ, Del Mar, Cal., Milton Jackson, 6IZ, San Diego, Dr. A. E. Banks, 6ZB, San Diego, D. P. Trim, Deputy Radio Inspector San Diego, Lex B. Benjamin, 6XQA, Los Angeles, B. Lindsay, 6ZF, Reedley, Cal., Lawrence Mott, 6XAD, Catalina Island, A. E. Bessey, 6ZK, Sunnyvale, Cal., I. I. Mahler, Jr., Sunnyvale, Lt. F. S. Bennett, U. S. Navy Radio Aide, Mare Island, F. L. Wisner, Oakland, G. MacMullen, Coronado, Edward Banks, 6AAZ, San Diego, E. P. Merritt, KDPT, San Diego, F. K. Johnson, 7YJ, Corvallis, Ore., Chief Petty Officer Duane Stewart, U. S. Navy, San Diego, George Remington, 6BJV, Coronado, Lester Picker, 6AIH, San Ysidro, Al Frost, San Diego, F. Cattell, Mare Island, H. Berringer, 6ZR, Los Angeles, F. W. Van Why, 6ZG, Los Angeles, H. A. Duvall, 6EN, Los Angeles.

One attendance qualifies for a life membership. There are no dues. There is no policy, the sky is the limit. One may choose one's own diet—BUT—ARGUE ONE MUST.

No C. W. at 3BV

Sir:—I have been receiving numerous "QSL" cards for a station signing "3BV" on CW. In several instances the cards said that the station had been "Worked." There is no CW at 3BV, and if anyone can get in touch with this station, signing 3BV, and get a QRA they will be doing me a great favor if it is forwarded to me at once. I have been hearing the station myself, but have nothing but a vague location for it at present.

I would appreciate it if you would allow this letter to be published in your paper.

Yours for better radio,  
PAUL G. WATSON.

214 West Barnard St.  
West Chester, Pa.

NEWS OF THE AMATEUR OPERATORS

Radio call has been reissued to Clarence T. Stevens, 434 60th St., Oakland, Calif. Will any one hearing 6BRG-C. W., please QSL to 1708 W. 23d St., Los Angeles. The correct address of 6BDW is 232 N. Gower St., Los Angeles, Calif.

# News of the Broadcasters

## KSD, THE FIRST CLASS B STATION

AS KSD, the class B station of the St. Louis, (Mo.) *Post Dispatch* has been heard on both the Atlantic and Pacific coasts, on the Gulf and at Alberta, Canada, a description will be of wide interest. The transmitter is a standard Western Electric 500 watt outfit installed in a brick structure on top of the Post Dispatch Building. The studio is on the second floor of the same building. The

As the standard transmitter apparatus has been described several times in these columns its details as applied to this installation are omitted. The general arrangement is shown in the side view. Two 250-watt tubes are used in modulators and two as oscillators.

Among the many letter reporting distinct reception is one from WTD, G. E. Robinson, operation on the *F. H. Buck* who reported good reception on one step of audio frequency amplification while 30 miles off the California coast 50 miles north of Point Arguello.

## RADIO STATION K. F. B. K.

By Hugh R. Sprado

KFBK, the broadcast station of the Kimball-Upson Company and the Sacramento Union of Sacramento, Calif. started operations on September 2nd with the first four letter call letters heard in the west. Telephone calls from all parts of California reported unusual strength of signals and clearness of music and voice. For a week later letters kept pouring in from all parts of the West, some of the most interesting coming from San Diego, Calif., Alert Bay, B. C., Pueblo, Colo., Kingman, Ariz., Hanna, Alberta Canada, and Lorbhorn in Saskatchewan, Canada. All said that signals were wonderfully clear and distinct.



One of the Towers of KSD on the Roof.

4-wire antenna is supported by two 80 ft. steel towers on the roof 131 ft. apart. The lead-in comes from the center giving a T-aerial.

A 5 h. p. motor-generator set housed in a sound-proof compartment supplies 1600 volts for the plate circuit and 16 volts for the filament circuit of four 250-watt tubes.

The view of the operating room shows the speech input panel at the left, the transmitter set at the rear center and the power panel at the right. On the table may be seen the receiving set, loud speaker and two stage amplifier together with microphone transmitter.

## CLASS B APPLICATIONS

Several applications from larger broadcasting stations for the Class B License, permitting the use of the 400 meter wave, have been received by the Department of Commerce, but to date only two have been authorized to transmit on this wave. They are the St. Louis Post Dispatch and the Westinghouse Station at Chicago. The officials in charge of the licensing of radio stations do not anticipate that more than a dozen applications for the Class B license will be received, as only the most powerful stations carrying high-class entertainment regularly can hope to qualify.

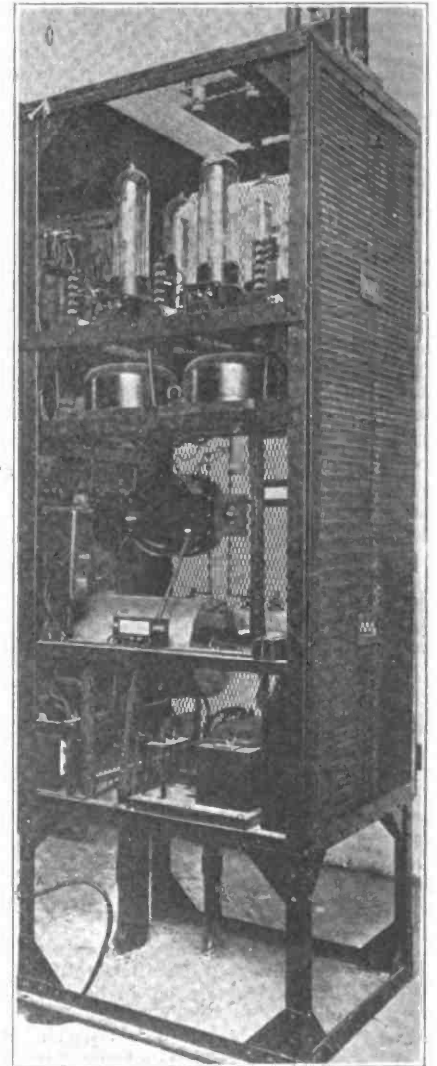

Side View of Transmitter at KSD.

KFBK is not a high powered station, its maximum output being 50 watts of radio frequency power. The great range of the transmitter is due to the unusual design, the entire transmitter being mounted in one complete unit as shown in accompanying pictures.

Three shelves in the rear of the panel contain all the parts making up the transmitter. The lower shelf contains the high and low tension line fuses, filter choke coils and filter condensers, and filament heating transformer. The second shelf holds a plate circuit reactance coil, grid biasing batteries, and modulation transformers. The upper shelf contains only radio frequency appa-



Operating Room of KSD.



atus and tubes. A large oscillation transformer is mounted on the rear and directly in front of this are three 50 watt vacuum tubes. One tube is used as the oscillation generator and two tubes as modulators to control the output. A 5 watt tube is also used for amplification of the speech currents which control the two modulator tubes. Numerous condensers, radio frequency chokes and other small but important parts are also mounted on this upper shelf. An electrically operated antenna send-receive switch is mounted in one forward corner of this upper shelf.

tortion due to potential surges which are common when using a potential transformer with an open circuited secondary. The potential drop across any portion of this load resistance can then be utilized for controlling the speech amplifier and permits of any degree of modulation.

The second resistance is made up of ten 4000 ohm units in series, and are used for

Probably the most unique feature of the set is the control table shown to the left of the transmitter panel. This table has mounted on it a board by which the operation of the transmitting equipment can be controlled. Push switches with red indicating lights control the antenna send-receive switch, the motor generator starting contactor, the filament supply contactor, and

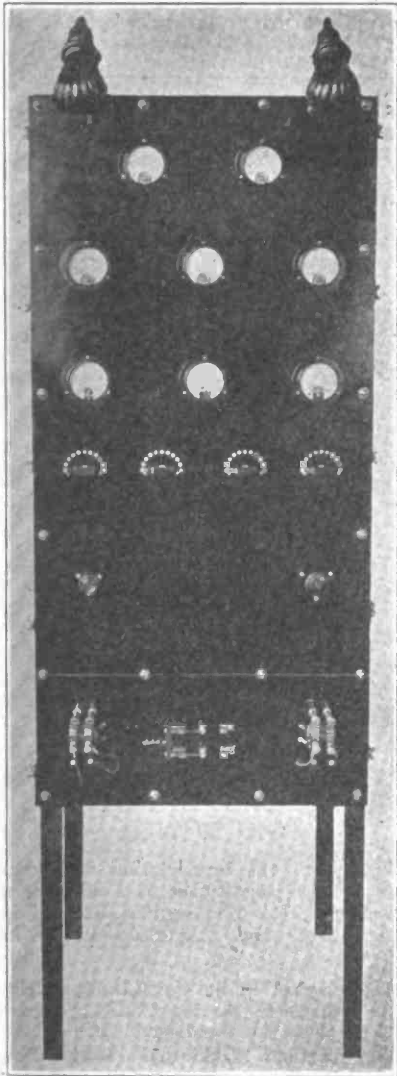

KFBK Panel Front.

The panel proper is of highly polished Formica. On it are mounted eight meters placed in the following circuits; antenna, for measuring radiation current; 1500 volt meter across high voltage generator; 500 volt meter across plate and filament of 5 watt speech amplifier; 200 milliamper meter in modulator plate circuit; another milliammeter in oscillator plate circuit; still another milliammeter in speech amplifier plate circuit; and two voltmeters for 5 watt and 50 watt filaments. With this outlay of meters, no guessing need be done as to what is happening in any circuit. Under-modulation, bad tubes, or any other defects are shown instantly by the meters.

Below the meters are mounted four variable resistances, the one on the extreme left being 500,000 ohms in ten steps of 50,000 ohms each and is shunted directly across the secondary of the modulation transformer. This resistance acts as a load for the transformer secondary, thereby eliminating dis-

cutting down the potential of the high voltage generator sufficiently to be used on the plate of the small 5 watt speech amplifier tube. By this method, any voltage from 150 to 1000 is available for speech amplification.

The third resistance is used for coupling the plate circuit of the speech amplifier to the grids of the modulators and can be varied to control the voice input to the modulator tubes. The last switch controls the grid leak resistances of the oscillator tube and is variable in ten steps of 1000 ohms each. It has been found that different tubes require different grid leak resistances, and a variable resistance allows adjustment for maximum output.

The two small knobs are filament rheostats. One rheostat is used in the filament circuit of the 5 watt speech amplifier, while the other controls the filaments of the three 50 watt tubes. The small switch in the center of the lower panel changes the ratio of primary to secondary voltage of the filament heating transformer. When thrown to the left, the transformer supplies 10 volts to the filament circuit, and when thrown to the right the transformer supplies 12 volts. This feature is of value when the 110 volt supply voltage drops too low to give full 10 volts across filaments.

Two small electrically operated contactors are seen on either side of the filament supply switch.

A Robbins and Myers 1/2 kw 1000-1500 volt motor generator supplies the high potential to the plates of the vacuum tube modulators and oscillator. This motor generator is installed in a room adjoining the studio and is mounted on felt pads to prevent any noise or vibration reaching the microphones.

Three microphones are provided, one hand microphone for the announcer and two special pick-up microphones for music or speeches. The pick-up microphones are of special design and are built to reproduce perfectly every sound that reaches them. Special precautions have been taken to eliminate "blasting" of musical notes of some particular frequency. The microphone proper is mounted in a small cabinet heavily lined with felt. Music or voice is picked up through a small hole in one side of the box. A horn can be attached to this box when necessary to record very weak sounds.

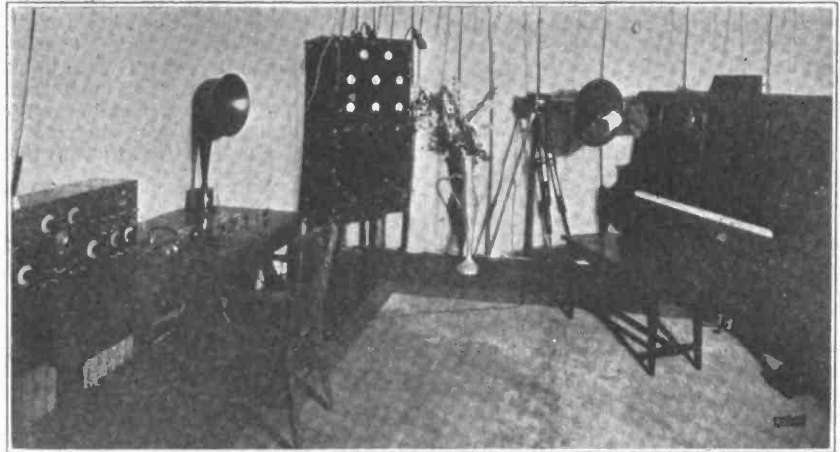

KFBK Operating Room and Studio

the plate supply contactor. This system of switches and contactors are also "interlocking," that is, they are so arranged and connected that no harm can be done to the tubes by throwing in the wrong contactor at the wrong time. The 1500 volt plate supply can not be connected to the tubes until the filaments have been lighted and until the antenna switch is in the "send" position. Should the tubes be excited while the antenna is disconnected from the oscillator tube, its plate would get white hot and finally melt. Through the above method of interlocking, this is impossible and will

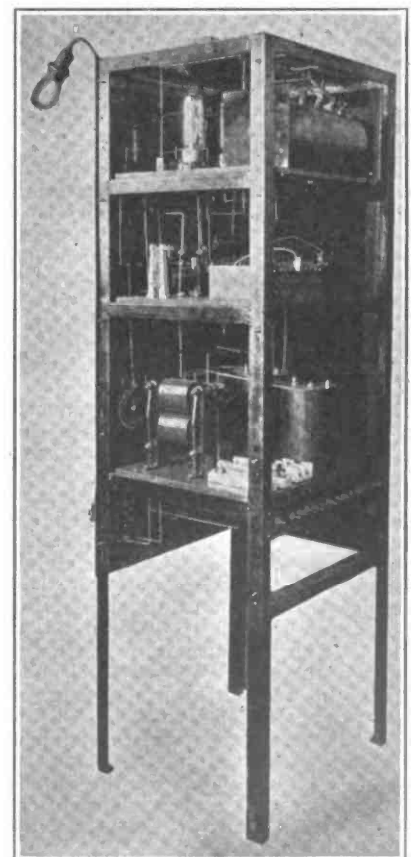

Rear of Panel.

probably save many tubes during the life of the set.

The control panel also contains switches and jacks for switching any microphone on or off. A potentiometer is placed in each microphone circuit to regulate the current flow thru its particular microphone. Means have also been provided for increasing or decreasing the modulation of any particular microphone. This is an advantage where two instruments or a singer with piano accompaniment are being broadcast; the singer's voice may be made louder than the piano or the piano louder than the singer or both can be made equal.

The antenna system consists of two 2 ft. cages each 85 ft. long and of six wires. They are supported by two 60 ft. poles on the roof of a 90 ft. building. The lead-in wires are approximately 80 ft. long. Directly beneath the antenna and 6 ft. from the roof is a twelve wire counterpoise. Both counterpoise and ground connection are used, by tuning the ground and counterpoise separately. The antenna current at 350 meters is 4 amperes when not modulating and rises 5 amperes at full modulation. No generator hum is noticeable when transmitting, even when listening in the studio with a detector and two stage amplifier, the filter circuits being designed for a "cut-off" frequency of 30 cycles. The absence of any foreign noises is probably one of the chief reasons for the excellent quality of modulation of this station.

No tone arm is used when transmitting phonograph music, as the full quality of the record is preserved and the needle scratch or "surface noise" is eliminated by recording the music through one pick-up microphone placed some distance from the phonograph. This complete station, designed by the writer, was built by the Radio Specialty Shop of Oakland, California. Before shipping the set to Sacramento it was given a thorough test in Oakland. A small single wire receiving antenna was used for transmitting, and with an antenna current so small that it would not flicker the radiation meter, reports were received from a point 95 miles east saying that test music was strong and clear.

### NEW SALT LAKE BROADCAST STATION

**KDYL**, the new broadcast station of the Salt Lake (Utah) *Telegram* installed on the top of the Newhouse Hotel came on the air Aug. 28th with some exceptionally fine operatic and instrumental programs which have been enjoyed by radio fans thruout the Rocky Mountains and Pacific Coast territory. The equipment was designed and installed by Mr. Ira J. Karr, an electrical engineering student at the University of Utah.

The antenna consists of 10 conductors of 7-22 copper wire arranged as a cage. The hoops are of copper band and are 18 in. in diameter. One of these hoops is placed every 15 ft. The antenna is insulated at either end by four 10 in. insulators in series. The lead in cage is taken off at the exact center and also consists of a 10 wire cage. This is brought down directly to the bushing which leads to the transmitter in the station. The antenna is supported 45 ft. above the roof by two steel masts making the total height above ground slightly over 240 feet and is 150 ft. long.

The counterpoise system is supported 12 ft. above the roof by the same two masts. It is a duplicate of the antenna with a similar cage lead-in. Ground connection is also made to the steel frame of the building.

The transmitter is designed to deliver 50 or 100 watts of reversed feed back

circuit being employed. The inductances are mounted on the front of the main panel thus assuring rapid and convenient change of wavelength. All meters are mounted on this panel and every vital circuit is metered. The Heising system of modulation is employed. A cam switch is used to determine whether undamped continuous waves, interrupted continuous waves or voice be transmitted. In this way code may be used when desired. Normal antenna current will be in the neighborhood of four amperes. A wavelength of 360 meters will be used for music, news and like matter, 485 meters will be used for weather reports.

The operating room has concrete walls and is made non-reverberatory by hang-

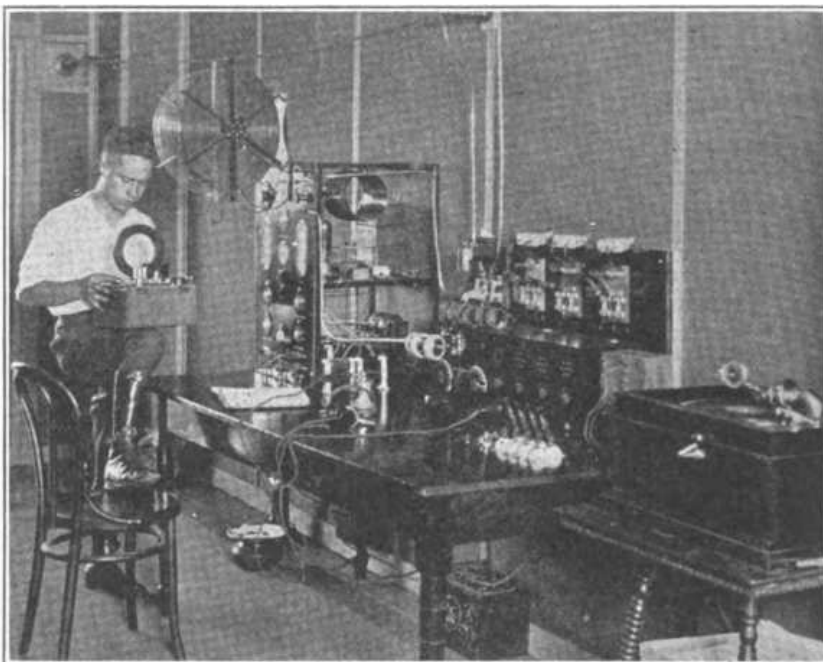

*Interior of KYDL, Showing Ira J. Karr as Operator.*

ing heavy cloth on all sides. All controls are mounted on a switchboard behind the operating table and convenient to the operator.

The studio adjoins the operating room and also has concrete walls hung with heavy cloth. Separate microphones are used for the collection of different kinds of music. These are all controlled from the operating room. Arrangement has been made for the accommodation of complete orchestras or bands. Piano accompaniment to vocal selections will also be clearly audible.

### NAVY DAY IN THE AIR

Radio broadcasting will be employed in connection with the celebration of Navy Day on Friday, October 27th by Assistant Secretary of the Navy Roosevelt at the instance of the Navy League. While representatives of the Navy League and Naval organizations throughout the country will undertake to promote general interest in the Navy and its gallant traditions through meetings, concerts, banquets and with the aid of the moving picture industry, a number of the large and more powerful broadcasting stations have been invited by the Navy League to put on a radio program. In this connection all Naval stations have been ordered to assist in making Navy Day a national celebration which shall be remembered by the radio fans. Either the Navy or the League will furnish speakers, glee clubs or other forms of entertainment to the radio stations cooperating.

### BROADCASTING STILL GROWING

On September 21, there were 510 active broadcasting stations, according to a survey by the Radio Section of its Limited Commercial Stations, operating on 360 meters. California still leads, with 66 stations sending entertainment, news and information; Ohio is second with 34; and New York third, having 28 stations—while Wyoming brings up the rear without a single station. Every other station of the Union has one or more transmitting stations carrying entertainment in some form for the owners of receiving sets.

### BROADCASTING STILL GROWING

There were 487 broadcasting stations licensed by the Department of Commerce up to August 26th. The stations licensed between July 29 and August 26 are as follows:

- WIAX—Capital Radio Co., Lincoln, Neb.
- KFBG—First Presbyterian Church, Tacoma, Wash.
- WIAV—New York Radio Laboratories, Binghamton, N. Y.
- WKAA—H. F. Paar and Republican Times, Cedar Rapids, Iowa.
- WKAC—Star Publishing Co., Lincoln, Nebr.
- WJAK—White Radio Laboratory, Stockdale, Ohio.
- WIAV—Woodward & Lothrop, Washington, D. C.
- WJAM—Central Park Amusement Co., Rockford, Ill.
- WIAZ—Electric Supply Sales Co., Miami, Fla.
- WJAP—Kelly-Duluth Co., Duluth, Minn.
- WKAD—Charles Loeff, East Providence, R. I.
- WJAP—The Outlet Co., Providence, R. I.
- WJAN—Peoria Star and Peoria Radio Sales Co., Peoria, Ill.
- WJAX—D. M. Perham, Cedar Rapids, Iowa.
- KDZT—Seattle Radio Association, Seattle, Wash.
- WJAL—Victor Radio Corp., Portland, Me.
- WKAF—W. S. Radio Supply Co., and Wm. Schack, Wichita Falls, Tex.
- WJAQ—Capper Publications, Topeka, Kans.

*Continued on page 33*

# With the U.S. Radio Inspector

Conducted by  
Major J. F. Dillon



May an amateur holding an operators' license, amateur first grade, operate at any amateur station other than his own?—H. J. K., Portland, Ore.

Yes, he may operate at any amateur station, provided he has the owner's consent. He may sign the call letters assigned to the station he is working, however, and not those of his own station, as call letters are assigned for a certain station, and not for the individual operator using the apparatus.

Why can't an amateur operate a broadcasting station?—Same.

The class and grade of license required for stations of all classes is set down in the Radio Laws and Regulations. Nothing is said in them distinguishing between operators of telephone and telegraph stations. Operators of limited commercial stations must hold at least second class third grade licenses.

How much experience credit will be allowed an amateur who has operated a station for 10 years when he appears for a commercial examination?—H. G. T., Kansas City.

Only 5 per cent is allowed for amateur experience.

If an amateur, licensed for 200 meters, uses his receiving set, while oscillating, to send a short distance on waves over 200 is he working in violation?—T. U. K., Riverside.

Yes, he may only do this on 200 meters, or below.

How long may an amateur operate without being charged with intentional interference, or "hogging" of the air?—R. W., Sacramento.

This depends entirely on local conditions. A man may be operating without any interference in a remote district, and his continual working may cause no trouble, while the same operation might cause great interference in a congested zone.

If one already holds an amateur license and desires to take a commercial examination, does he lose his amateur license if he fails?

No.

When reporting change of address, do you send anything back to the Radio Inspector?

You should return your station license, and fill out new forms 762 (Amateur Applicant's Description of Apparatus), which gives all details of the new station. It is unlawful to operate at the new address until the license has actually been corrected and returned to the licensee.

Is it necessary for me to take an examination to get a sixth district call if I hold a second district amateur license?—W. F., Los Angeles.

No. Merely file an application for a station license with the Radio Inspector, Custom House, San Francisco.

Can a person holding a second class third grade commercial license operate on ship?—P. F. P., Salem, Ore.

Yes, he may operate according to law on

certain ships, but there are so many men available with first class licenses that there is little chance of getting employment.

Are the call letters of a station changed if it is changed from D. W. to C. W.?—T. S., Claremont, Calif.

The changing from damped wave to continuous wave does not affect the call signals attached to the station.

## BROADCASTING STILL GROWING

*Continued from page 30*

WAJT—Kelley-Vawter Jewelry Co., Marshall, Mo.

KFBH—Thomas Musical Co., Marshfield, Ore.

WLAJ—Waco Electrical Supply Co., Waco, Tex.

WAJU—Yankton College, Yankton, S. D.

WJAS—Pittsburgh Radio Supply House, Pittsburgh, Pa.

WIAN—Chronicle & News Pub. Co., Allentown, Pa.

WIAQ—Chronicle Publishing Co., Maron, Ind.

WIAF—Gustav A. DeCortin, New Orleans, La.

KFBE—Reuben H. Horn, San Luis Obispo, Calif.

WJAD—Jackson's Radio Eng. Lab., Waco, Tex.

WIAG—Matthews Elect. Supply Co., Birmingham, Ala.

WIAD—Ocean City Yacht Club, Ocean City, N. J.

WHAW—Pierce Elect. Co., Tampa, Fla.

WIAP—J. A. Rudy & Sons, Paducah, Ky.

WIAC—School of Eng. of Milwaukee, Milwaukee, Wis.

WIAL—Standard Radio Service Co., Norwood, Ohio.

WHAV—Wilmington Elec. & Specialty Co., Wilmington, Del.

WIAE—Mrs. Robert E. Zimmerman, Venton, Iowa.

WJAB—American Radio Co., Lincoln, Nebr.

WIAS—Burlington Hawkeye-Home Elec. Co., Burlington, Iowa.

KPAV—Cooke & Chapman, Venice, Calif.

KFAW—The Radio Den, Ashford & White, Santa Ana, Calif.

KFBF—F. H. Smith, Butte, Mont.

WJAE—Texas Radio Syndicate, San Antonio, Tex.

WIAU—American Security & Savings Bank, Le Mars, Iowa.

WJAG—Huse Publishing Co., Norfolk, Nebr.

WIAT—Leon T. Noel, Tarkio, Mo.

WJAC—Rodoll Co., Joplin, Mo.

WIAW—Saginaw Radio & Elec. Co., Saginaw, Mich.

WJAJ—Y. M. C. A., Dayton, Ohio.

WKAN—Alabama Radio Mfg. Co., Montgomery, Ala.

KFBJ—Boise Radio Supply Co., Boise, Ida.

WKAP—Flint, Dutee Wilcox, Cranston, R. I.

KFAY—W. J. Virgin Milling Co., Central Point, Ore.

WJAZ—Chicago Radio Lab., Chicago, Ill.

WKAG—Edwin T. Bruce, M. D., Louisville, Ky.

KFBM—Cook & Foster, Astoria, Ore.

WKAJ—Fargo Plumbing & Heating Co., Fargo, N. D.

KFBL—Leese Bros., Everett, Wash.

WKAH—Planet Radio Co., West Palm Beach, Fla.

WJAX—Union Trust Co., Cleveland, Ohio.

WLAD—Arvanette Radio Supply Co., Hastings, Nebr.

KFBN—Borch Radio Corp., Oakland, Calif.

WLAJ—Johnson Radio Co., Lincoln, Nebr.

WKAM—Adam Breede, Hastings Daily Tribune, Hastings, Nebr.

WKAL—Gray & Gray, Orange, Tex.

WKAR—Michigan Agri. College, East Lansing, Mich.

WKAK—Okfuskee County News, Okemah, Okla.

WMAM—Beaumont Radio Equipment Co., Beaumont, Tex.

WKAT—Frankfort Morning Times, Frankfort, Ind.

WMAH—General Supply Co., Lincoln, Nebr.

WLAB—George F. Grossman, Carrollton, Mo.

WKAV—Laconia Radio Club, Laconia, N. H.

WKAS—L. E. Lines Music Co., Springfield, Mo.

KFDB—John D. McKee, Lombard & Kearney, San Francisco, Calif.

WNAL—John D. Rockwell, Omaha, Nebr.

WKAW—Turner Cycle Co., Beloit, Wis.

WLAX—Greencastle Community Broadcasting Station (Putnam Electric Company), Greencastle, Indiana.

WLAS—Hutchinson Grain Radio Co., Hutchinson, Kansas.

WPAN—Levy Bros. Dry Goods Co., Houston, Texas.

WMAG—The Tucker Electric Co., Liberal, Kansas.

WNAD—Atkinson County Mail, Rockport, Mo.

WKAY—Brenau College, Janesville, Ga.

WKAX—Wm. A. Macfarlane, Bridgeport, Conn.

WLAC—North Carolina State College, Raleigh, N. C.

WLAH—Samuel Woodworth, Syracuse, N. Y.

WLAO—Anthracite Radio Shop, Scranton, Pa.

WLAM—Morrow Radio Co., Springfield, Ohio.

WMAB—Radio Supply Co., Oklahoma City, Okla.

KFCC—Auto Supply Co., Wallace, Idaho.

WMAJ—Drovers Telegram Co., Kansas City, Mo.

KFBQ—Savage Electric Co., Prescott, Ariz.

WLAL—Tulsa Radio Co., Tulsa, Okla.

KFCB—Nielsen Radio Supply Co., Phoenix, Ariz.

WLAG—Cutting & Washington Radio Corporation, Minneapolis, Minn.

WKAZ—Landaus Music and Jewelry Co., Wilkes-Barre, Pa.

WLAN—Putnam Hardware Co., Houlton, Mo.

KFCD—Salem Elect. Co., Salem, Oregon.

# DIGEST OF RECENT RADIO PATENTS



Prepared by White, Prost & Evans, Patent Attorneys, San Francisco, who have been particularly active in the radio field for many years, and from whom may be obtained further information regarding any of the patents listed below.

**John H. Hammond, Jr., Pat. No. 1,418,788, June 6, 1922. System for Control of Bodies by Radiant Energy.**

The fluid pressure piston 23, connected to the rudder of the vessel steered may be controlled by energization of magnet 7 by radiant waves. This magnet causes piston 13 to rotate a rotary valve, not shown, by means of which fluid under pressure may enter either through pipe 20 or 21, and exhaust either through pipe 50 or 49. This control is only for changing the course, which is maintained normally by a gyro having a shaft 25 which turns relatively to the hull 37 in case there is a deviation. This control by the gyro involves the use of valves in a disk 36. While the control is effected by radiant energy, the valve disk 36 is disconnected from the gyro by the lifting up of the stem 28 out of a depression 34 in the disk. When the radiant energy reception ceases, this rod 28 is permitted to fall and to reconnect the gyro operatively with the valves.

**E. O. Scriven, Pat. No. 1,418,739, June 6, 1922. Oscillation Generator.**

An oscillation Generator is described which is especially adapted to maintain the amplitude of the oscillations constant. For this purpose a feed-back circuit is utilized for a vacuum tube device G, in which the direct current circuit for the plate includes a large resistance 13, whereby the space current in the tube is maintained constant irrespective of minor variations in the tube characteristics. The oscillations are taken off in a branch circuit including a large condenser 18 and a resistance 19. Since there is little reactance in this circuit, the oscillatory current does not vary materially with the frequency, so that the same intensity of current is obtained irrespective of

frequency used. An amplifier A is used to amplify the e. m. f. across resistance 19, and to pass the amplified oscillations to a receiving or transmitting circuit connected to transformer 27.

**E. F. W. Alexanderson, Pat. No. 1,419,797, June 13, 1922. Amplifying System.**

A multi-stage amplifier system is described, in which the tendency for the tubes to produce oscillations is effectively overcome, as well as any tendency for low frequency currents to flow in the d. c. paths. The amplifiers 3, 4, 5 and 6 have their filaments heated from a common battery 18. The plate circuit of the tube 3 includes a high resistance 23, and furthermore the generator 7 for the plate circuit is connected to filter circuits formed by resistances 14, 13, 12, 9 and 8, and condensers 10, 11, 15, 16 and 17. In this way it is possible to maintain the space current substantially free from variations. The high resistance 30 and condenser 29 branch this plate circuit, and the drop across the resistance is impressed on the input circuit of tube 4. Here again the plate circuit is protected by filter paths, but not by so many, since only elements 3, 9, 10, 11, 12, 13, 15 and 16 are active. Since the signals are stronger by amplification, however, this lessening is not detrimental. Succeeding stages may be added, as indicated. The last stage 6 is arranged as a detector also, and in order to prevent possible oscillations, it is made responsive to a double harmonic of the radio frequency waves transmitted, as by the aid of circuits 34, 35, and 36, 37. It has been found that the double harmonic tends to be amplified as well as the fundamental, and this fact is made use of to destroy the objectionable continuity of the identical frequency

currents in the amplifier circuits, which might cause oscillations.

**John H. Hammond, Jr., Pat. No. 1,420,258, June 20, 1922. System for Radiocontrol of Moving Bodies.**

A transmitting system is described so arranged that movement of a wheel 3 in one or the other directions causes radiation of waves to effect a receiving set which is connected to operate a pneumatic cylinder. The cylinder is in turn arranged to move the steering rudder. This steering mechanism is so controlled that each impulse received causes movement of the rudder from neutral to port or starboard or vice versa; these movements take place in a regular periodic cycle in accordance with the impulses received. In order that the correct number of impulses be sent to move the rudder to port or starboard, irrespective of the phase of this cycle, the transmitting switch is provided with an arm for contacting with contact points B, C, D, and E, which are movable to an active position in accordance with the number of times the arm moves to its extreme right or left hand position to contact with fixed contact F or A.

**John H. Hammond, Jr., Pat. No. 1,420,254, June 20, 1922. Electric Wave Transmission.**

In this system a conducting fluid such as salt water is used for the antenna A, the water being pumped through a coil L' coupled to a coil L which receives current impulses from a spark gap S. In order that variations in the antenna capacity due to wind, etc., have no effect on the tuned condition of the receiving antenna, the circuit therein is tuned to the group frequency of the impulses generated by the spark, and not to the radio frequency of the current.

Continued page 42

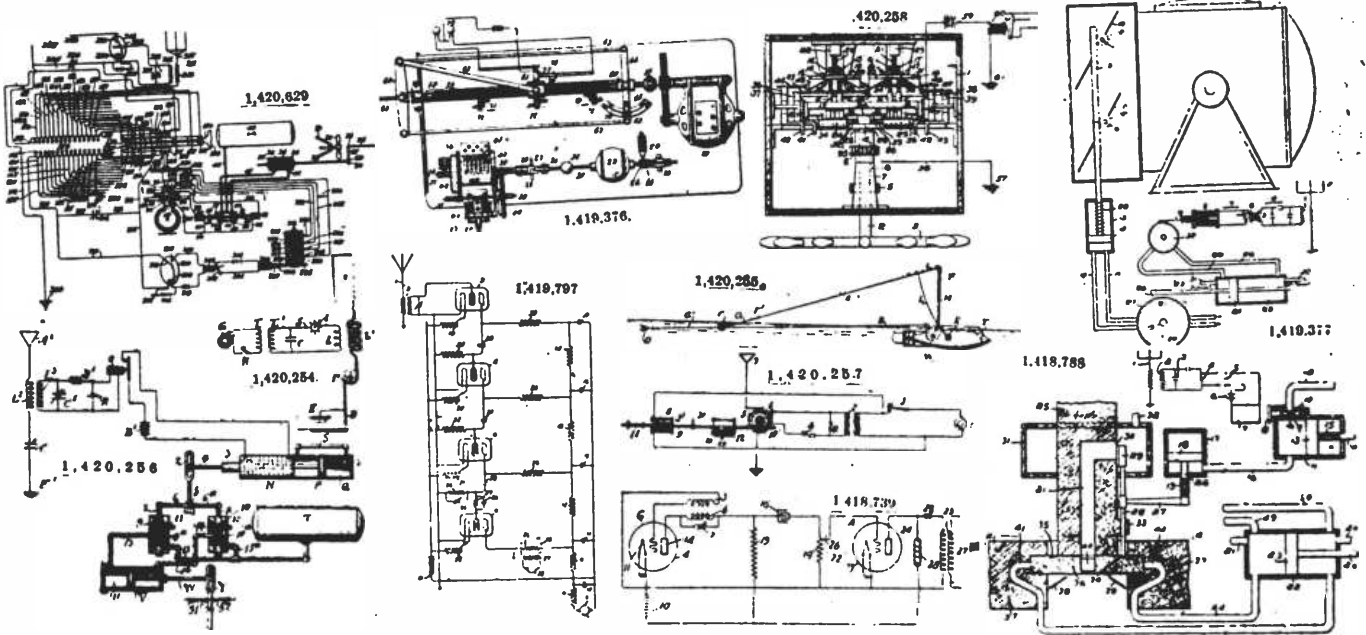

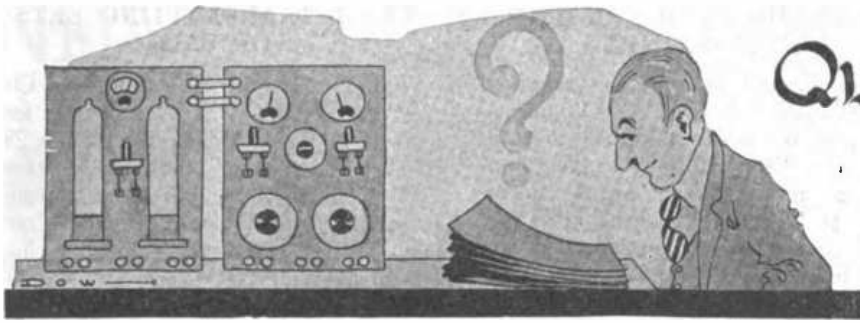

# Queries & Replies on C.W. practice by Gerald M. Best, Technical Advisor.

Questions submitted for answer in this department should be typewritten or in ink, written on one side of the paper. All answers of general interest will be published. Readers are invited to use this service without charge, except that 25 cents per question should be forwarded when personal answer by mail is wanted.

Please show a circuit employing three stages of radio frequency and three stages of audio frequency amplification, using a Paragon RA 10 receiver.

M. L. B., Pittsburgh, Pa.

It would be rather difficult to use the Paragon receiver for radio frequency work without altering the present wiring to a considerable amount. Fig. 1 shows

more difficult to tune than the single coil circuits, will give good satisfaction.

Please give the correct capacity values of the condensers shown in the Armstrong regenerative circuit in Fig. 1, Page 32 of September RADIO. Should the grid leak be variable? What size of wire is best for such a set?

C. M., Washington Court House, Ohio.

son transformer, two .004 sections of Murdock moulded condenser, set of pancake inductances, radiation meter, key, etc. Can any of this be used in constructing a 10 watt C. W. set?

R. O. J., Philadelphia, Pa.

Practically everything you have mentioned can be used in a 10 watt C. W. telegraph set. The circuit shown in Fig. 2 is the one best adapted for your use and is known as the reversed feed back system. Assuming that you have a 1/4 K. W. Thordarson of recent design, you can remove the high voltage secondary and build up a new winding of lower voltage. This winding should have 7500 turns of No. 30 or No. 32 B. and S. S. C. C. or enameled wire wound on empire cloth or other good insulating material. A center tap should be brought out at the 3750th turn. For the filament circuit, wind a separate secondary of 75 turns of No. 14 B. and S. S. C. C.

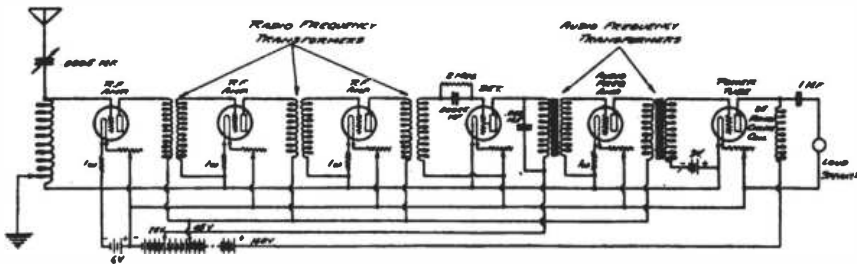

Fig. 1

a three stage radio frequency amplifier, with detector and three stage audio frequency amplifier, which, while not guaranteed to work with the particular apparatus you might select should give good results if properly handled, and if it is not used for amplifying local broadcasting or nearby signals.

Please publish the data on the construction and operation of synchronous rectifiers for obtaining high voltage dc for the plate supply of transmitting tubes. Can this instrument be used with 5 or 10 watt C. W. sets?

C. K. Provo, Utah.

An article on the design of a synchronous rectifier will be published in an early issue. This rectifier can be used for any C. W. set within the amateur power restrictions.

My receiver has Remler vario coupler and variometers, with .001 M. F. air condenser across the secondary. Can get 360 meter stations but cannot hear the 485 meter weather reports. Please tell me what the trouble is.

A. L. F., Chickasha, Okla.

With the air condenser you should be able to tune to seven or eight hundred meters. Perhaps there are no weather stations in your vicinity, and you have not yet learned to tune for the more distant ones. Try to obtain a wavemeter from some one near you, and calibrate your air condenser dial for the proper wavelengths.

What is the most efficient circuit for a 10 watt self rectifying C. W. transmitter.

W. L. G., Indianapolis, Ind.

The set described on Page 15 of June RADIO employs what is known as the reversed feed back system, and while

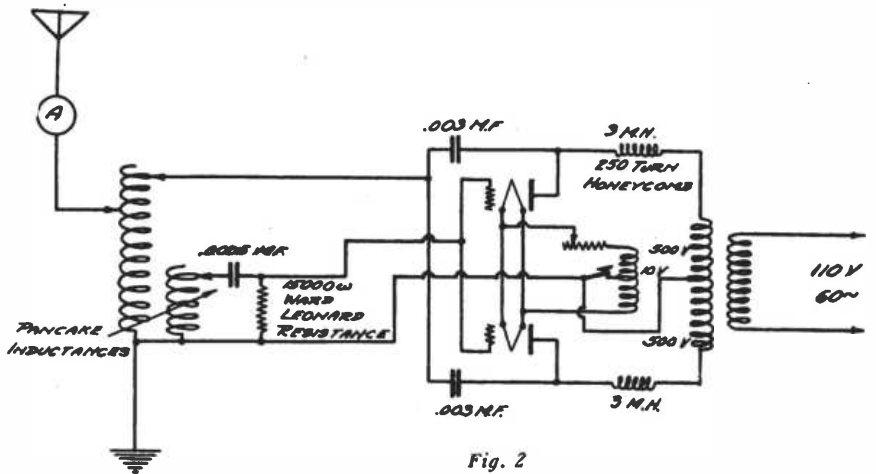

Fig. 2

The primary and secondary condensers should be .001 M. F., the grid condenser .00025 M. F., and the phone condenser .002 M. F. respectively. The size of the grid leak depends entirely upon what tube is used. Provide whatever size is recommended by the manufacturer of the tube. This value is generally around 2, megohms. No. 14 or 16 B. and S. wire is about right for the wiring.

Please publish an efficient circuit for two stages of radio frequency and detector, using honeycomb coils.

C. E. F., Cleveland, Ohio.

Elsewhere in this issue you will find an article by H. E. Parsons, which describes the set you wish to know about, in greater detail than possible here.

I have a 1/4-kw spark set consisting of the following material: One Thordar-

wire, with a tap at the 37th turn. Your condensers will serve very well in the plate circuits of the tubes, and the set of pancake inductances can be used according to the sketch. Of course, you will have to buy the necessary tubes, sockets and filament rheostats to complete the set.

Does the length of the leads in a C. W. set make any particular difference in the efficiency of the set?

J. F. B., San Francisco, Cal.

In any transmitting circuit, particularly those of such high frequencies as used in amateur transmitters, the shorter the connecting leads, the more efficient the transmitter will be. Long leads, and particularly adjacent ones, will introduce capacity and inductance into the circuit at points where least desired, and the most efficient C. W. set is the one having all the high frequency leads as short as is possible within reason.

### RADIO TYPING PERFECTED

The Bureau of Standards recently explained some experiments by F. W. Dunmore which indicated that a recently perfected radio relay recorder might do away with code operators by printing the code message on a tape, so that it could be read visibly by inexperienced men, but now the naval aerial and radio experts have gone the Bureau one better; they print radio messages automatically on a typewriter.

Co-operating with the Radio Laboratory of the Bureau, experts of the Navy successfully tested the operation of the line-wire teletype by radio a few months ago, and succeeded in printing messages from a distance of nine miles. The radio circuit was established between the Bureau of Standards near Chevy Chase and the Naval Air Station at Anacostia.

More recent experiments have established the fact that teletype messages printed on a machine installed in an airplane and transmitted by radio can be recorded on a typewriter in a ground station. Future experiments will undertake the reversal of this operation; the sending machine being on the ground and the receiving apparatus installed in a plane in flight. Great interest is manifest by naval experts as the new method will permit the sending and receipt of duplicate orders of record, eliminating errors and a knowledge of code, besides saving time of rewriting.

The practical tests made assure future commercial uses in aerial news reporting, when a correspondent covering an aquatic event, marine engagement, or sea maneuvers can send his copy straight to the desk. Another value, if aerial passenger lines are extended, would be the receipt and dispatch of typewritten telegrams, stock reports, news dispatches, etc., ready for delivery.

The sending instrument of the teletype resembles in general the commercial typewriter in that a keyboard having the letters of the alphabet and other conventional symbols on it is arranged so that it may be operated by hand. Each key is connected to the radio installation in the plane and when a letter is struck on the keyboard a radio impulse is sent out from the antennæ of the plane and is received at a ground station. The similarity to the typewriter is completed in the receiving device. When the letter A is struck on the keyboard in the air, the radioactive energy released travels to the recording instrument and selectively energizes the type-letter A, causing it to be reproduced on paper carried in the receiver. The teletype has been in use for eight years in connection with land-wire operations, but its application to radio use is a recent development. The tests at the Naval Air Station are the first that have ever been conducted in aircraft.

### AMATEUR RADIO IN THE PHILIPPINES

Great interest in radio has arisen in the Philippine Islands. A broadcasting station has been established at Manila by the Electric Supply Co., hundreds of receiving sets are being installed to "listen in" on the news and band concerts from Luneta that are being broadcasted. And about thirty amateur transmitting stations are in operation. Because of the difficulty in buying sets most of the boys are assembling their own. A flourishing radio club has been formed at Manila and a school of instruction is contemplated.

### APARTMENT HOUSE RADIO INSTALLATION

A choice of "listening in" to either of two programs being sent out by the big broadcasting stations will be a feature of an unique radio system being installed in a 72-family apartment house in Newark, N. J., by the Davis Electric Company. Two complete receiving sets will be installed, each with a large loop or directional aerial, pointed to a particular broadcasting station and the program received without interference from whatever may be coming in on the other loop. A special radio room in charge of a licensed operator will house the equipment. From this room will emanate two complete circuits connected to each of the 72 apartments and so arranged that the tenant may plug in his receiving set to whichever of two programs he may prefer. The apartment operator will tune in each evening to the two stations that offer the best programs or are heard the clearest, and in this way the tenants will be able to enjoy the best in the ether each night with the least of trouble. Two complete G-E receiving sets, each equipped with a detector tube, two stages of audio and two steps of radio frequency will be installed.

### NAVAL TRANSMITTING SETS FOR SALE

The U. S. Navy Central Sales Office offers 396 radio transmitting sets for sale by sealed bids on September 28. These sets are of short-range type, CW-396, with vacuum tubes, manufactured by the Western Electric Company for use on Naval submarine-chasers during the war.

This apparatus is said to be reliable for radio telephone communication within a distance of ten miles, but numerous instances have been noted where the sets have been used for distances up to 300 miles at sea. In the hands of competent operators, under favorable weather conditions, they should have a reliable land range of 50 miles.

### NEW ZEALAND RADIO HEARD IN BRITISH COLUMBIA

An unusual combination of atmospheric conditions is believed to have made it possible for the wireless station at Estaven, 150 miles southwest of Victoria, B. C. to work Raratonga, New Zealand, 6,500 miles away.

### NEW CHINESE STATIONS

The Federal Telegraph Co. of Delaware has been formed with R. P. Schwerin as president to construct high-powered stations in China for direct radio communication with the Pacific Coast of North America. Stock in the new company is held jointly by the Federal Telegraph Company of California and by the Radio Corporation of America. Duplicate 1000 k.w. arc transmitters are to be installed at Shanghai for trans-Pacific work and smaller sets are to be installed at Canton, Harbin and Peking. Two years will be required to finish the work, the cost being estimated at \$13,000,000.

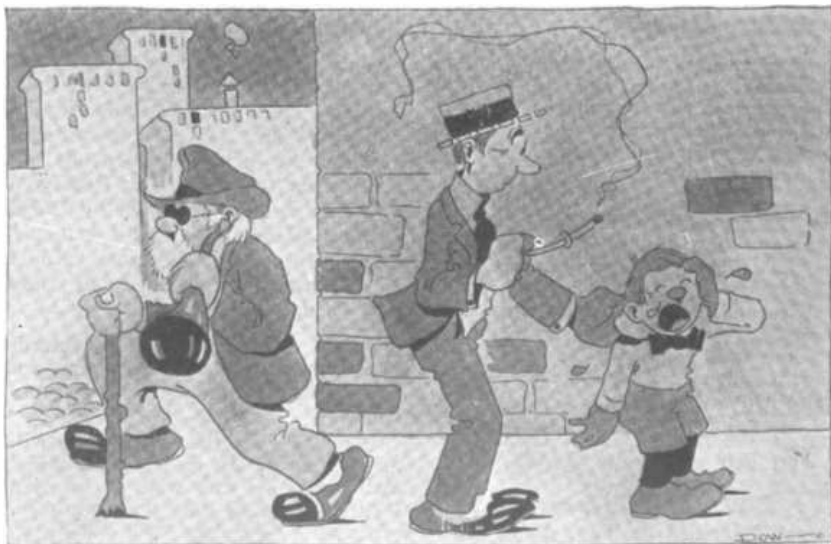

"I wanna—h—hear some m—music on that man's r-radio receiver."

# NEW APPARATUS AND SUPPLIES

## FROM THE RADIO MANUFACTURERS



### NEW WESTINGHOUSE "B" BATTERY

Service and convenience are the keynotes behind the new B battery which is just being placed on the market by the Westinghouse Union Battery Company, of Swissvale, Pa. It is a marvel of compactness and built to serve indefinitely. It will function noiselessly and with steadiness and dependability.

This new battery is a departure from the separate glass jar container for each element. The 2 volt elements, under the new construction, are placed in a one-piece, eleven-compartment glass container, and are arranged so as to be clearly visible and easily accessible for recharging. The improvement of this method over the old style is appar-

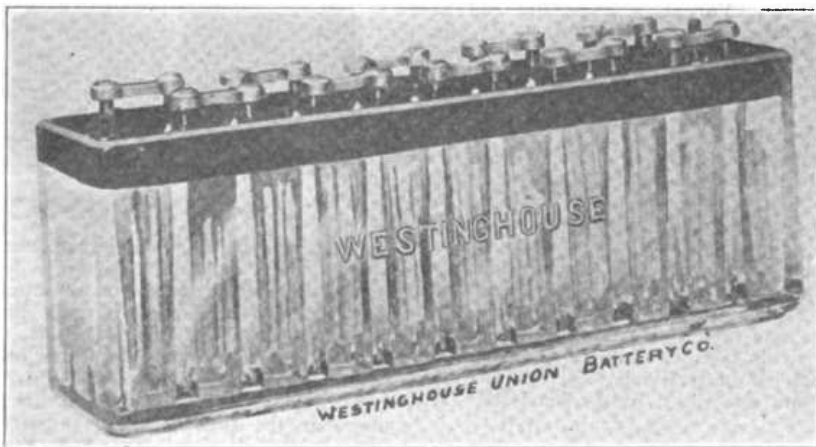

New Westinghouse "B" Battery

ent, as the integral glass jar arrangement makes it much easier to inspect the condition of the battery and the height of the electrolyte.

In addition to this battery, the company has two other types of B batteries and ten types of A batteries, ranging from 27 to 162 ampere hours' capacity, and in 4, 6 and 8 volt sizes. The accompanying picture shows the compactness of the new arrangement of elements, as well as the clear vision afforded of each cell.

### "MICON" NOISELESS MICA CONDENSER

Micon fixed mica condensers are a new departure in condenser design. The outer casing is of seamless brass or copper tubing. The interior is built up after the



best practice of alternate layers of mica and brass or copper sheets. The tubing is partially flattened, then the condenser elements are inserted and the presses complete the op-

eration of flattening into the final form. This process produces equal pressure over the entire plate area and does away with troublesome noises. The metal case protects the plates and reduces hysteresis losses to a minimum. These condensers are also made to stand several thousand volts if desired. MICON is manufactured by Charles Freshman Co., New York City.

### VERNIER POTENTIOMETER FOR EXPERIMENTAL WORK

The vernier potentiometer, recently placed on the market by the Central Radio Laboratories of Milwaukee, represents a new development in the radio field and is meeting

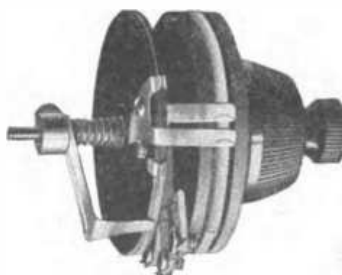

Vernier Potentiometer for Experimental Work

The resistor consists of a machine winding, the turns of which are anchored firmly on a substantial, insulated core. This wound core is retained in a groove between insulating discs. The use of enameled wire makes the short-circuiting of the adjacent turns impossible. This design insures smooth, noiseless action and a uniform change of circuit resistance.

The vernier wire for the fine adjustment is 6 in. long and is carried on the outer edge of a separate disc on which two contact shoes, which ride on the main winding, are mounted. This vernier wire shunts those turns of the main potentiometer winding

which lie between the two contact shoes and thus provides for very accurate adjustment of the potential.

A small thermoplax knob, located in front of the main knob, operates the vernier shoe. The relative sizes and shapes of the two operating knobs are such that they are easily manipulated.

A potentiometer of the plain type, manufactured by the same company, is of the same general design and construction as the vernier potentiometer already described, minus the vernier attachment. Both potentiometers have a resistance of 250 ohms.

### RADIO "B" STORAGE BATTERIES AND THEIR RECHARGE

Several battery manufacturers are now offering miniature storage batteries to take the place of the small dry "B" battery used with vacuum tube receiving sets and especially where power amplifiers and loud speakers are used. These batteries range anywhere from 8 to 60 small cells in the lead acid type, all connected in series, and about double this number if of the Edison alkaline type. The voltage, therefore, ranges from 16 to 120 volts or better, although the charging current required is very small as compared to the current required for the 6 volt "A" battery, varying from 0.1 to 1 ampere.

The France Mfg. Co., manufacturers of the new F-F radio rectifier have added a special winding to the regular "A" battery chargers so that by simply throwing a switch from the "A" position to the "B" position any voltage "B" storage battery can be quickly charged automatically. A special lamp socket is mounted on the frame of rectifier and into this is screwed a 60 watt tungsten lamp or any other wattage bulb, depending upon the ampere charging rate desired. A 60 watt lamp will cause approximately 0.2 ampere to flow when charging a 100 volt battery.

Since rectification of the current takes place thru carbon electrodes which are infusible and cannot burn, the high voltage required for charging is handled with absolute safety and the rectifying device can be operated continuously, if desired, for thousands of hours without renewal of electrodes.

In case one should accidentally turn on the receiving set with "B" battery connected to it while it was on charge, no harm would result to the audion tubes or other parts of the set or loud speaker, for the high voltage secondary "B" winding is well insulated from the line, there being no electrical or common ground connection between the two.

This makes the operation of charging a "B" storage battery as safe as could be expected and there is no way the operator can detract from the safety features by accidentally doing the wrong thing, for there are no alterations to make in changing from an "A" to a "B" battery except to connect up one battery in place of the other and throw the voltage switch. This rectifier operates independent of the condition or state of charge in the battery. Hence, no difficulty will be experienced in bringing up a completely discharged or dead battery.

## MISTAKE TO RATE RECEIVER SENSITIVITY IN OHMS

"Yes this is a very good receiver. It has a resistance of 4,000 ohms." This is a sales talk that many clerks in the radio shops give to unwary purchasers of headsets. In doing so, they not only show their ignorance concerning 'phone construction and design, but they help to create an impression that is entirely wrong. They are responsible for the notion that the sensitivity of a headset is indicated by the resistance of the receivers.

In commenting upon this, Mr. F. Dietrich, president of C. Brandes, Inc., recently said, "This policy of selling headsets on the strength of their resistance is wrong and should be discouraged by dealers. It not only hoodwinks a badly mis-informed public but it is a gross injustice to manufacturers who, for sound technical reasons, do not wish to carry the resistance of their headsets to such a high value. One might just as well measure the horsepower of an automobile by the size of its carburetor. The average 2000 ohm headset is as sensitive and in many cases more so than the receiver with a resistance of 4000 ohms. Radio receivers should be rated by their impedance. The Brandes headset is designed to have the same impedance as the average circuit in which it is used since it has been found that this gives maximum efficiency. This impedance varies, of course, with the frequency of the current. The Brandes company have taken as a standard 1000 cycles and at this frequency their headsets have an impedance of 22,000 ohms. It has been found that this is the resistance of the average crystal or tube circuit. This in itself however, does not guarantee the efficiency of a headset since there are many other requirements and features that determine the operating efficiency and sensitivity of a radio headset.

## TRADE NOTES

The Capitol Phonolier Corporation of New York City calls attention to the omission of the word "all" in the advertisement of their new all wave coupler in August RADIO.

The Signal Electric Manufacturing Company of Menominee, Mich., has acquired the Hulbert patents and taken over the Hulbert Electric Manufacturing Company of Chicago, Ill. Under this arrangement production of the Hulbert battery charger will be increased and others of the Hulbert patents will be developed and put into production. Mr. C. H. Hulbert will hereafter be identified with the Signal Electric Manufacturing Company, in the capacity of research and development engineer.

H. G. Cisin, author of *The Radio Telephone Handbook*, has been placed in charge of the Dictograph Products Corporation's radio sales promotion, advertising and publicity. He was formerly engineering editor of *Electrical Record*.

C. W. Horn, manager of the Radio Division Service Department, Westinghouse Electric & Manufacturing Company, has been appointed as superintendent of radio operations of the Westinghouse Company. Mr. Horn succeeds L. R. Krumm, who left the service of the Westinghouse Company to become manager of the radio department of the Erner-Hopkins Electric Company, of Columbus, Ohio. In his new position, Mr. Horn will have charge of all radio operations of the Westinghouse Company, including complete charge of the company's four radio broadcasting stations, KDKA, at East Pittsburgh; WJZ, at Newark, N. J.; KYW, at Chicago, Ill.; and WBZ, at Springfield, Mass.

## NEW RADIO CATALOGS

Catalog No. 10 from the Detroit Electric Co., Detroit, Mich., is a complete illustrated price list of Radio Material from a large number of manufacturers. As supplementary information the code and the "Q" signals are given.

"Paradex" Units are the subject of a bulletin from the Pacific Radio Exchange of San Francisco. They comprise a tuner, a detector, a radio frequency and an audio frequency unit.

Bulletin R, from the American Radio and Research Corporation of Medford Hillside, Mass., is devoted to Amrad Radio Frequency Amplifiers No. 3071 and No. 3045. The former is uniform in appearance and is especially designed for use with other Amrad units, while the latter may be employed with any tuner or detector units. The new Amrad radio frequency transformers, or "Radioformers," are employed with both, various sizes of which are available for different wavelengths. For 360 meter reception there are two designs, one for the first stage and another for subsequent stages.

Bulletin No. 250, from the Roller-Smith Co. of New York City, illustrates and describes their Types LGD and KGD Galvanometers, the former an instrument of high sensitivity and great accuracy, and the latter a lower priced instrument for the use of students.

Remler Radio Mfg. Co. of San Francisco are distributing their 1922-23 catalog of radio parts. These include variometers, vario-couplers, detectors and amplifier, control panels, dials, rheostats, tube sockets, potentiometers, inductance coils and mountings, coupling plugs, lever switches, knobs and binding post. In each case there is a clear picture and description of the device together with specifications and prices. Useful hook-ups of receiving sets, formulas and tables are also given in the handsome catalog.

"Radio in Your Home" is the subject of an attractive pamphlet from the Provision Equipment Co. of Cincinnati, Ohio.

## LINKING THE AMERICAS BY RADIO

The Radio Corporation of America announces that it has received orders from the United Fruit Company and the Tropical Radio Telegraph Company for five radio stations, three for Central America and two for the United States, each with a sending radius of more than 2000 miles. The erection of these five stations will fill an important and essential gap in the radio communication system of the Americas.

The three Central American stations will be located on the corners of the triangle embracing Honduras, Nicaragua and Panama. The Tropical Radio Telegraph's stations will be located at Managua, the capital of Nicaragua, and at Tegucigalpa, the capital of Honduras, the city designated as the capital of the new Central American Union. These stations will connect with the United Fruit Company's station at Almirante, Panama.

The United States terminals of this communication system will be at New Orleans, La., where the present station of the Tropical Radio Telegraph Company is to be enlarged and new apparatus installed, and at a new station which the Tropical Radio Telegraph Company will erect in the vicinity of Miami, Fla.

## PERSONALITIES IN THE RADIO TRADE

**ELMER T. CUNNINGHAM**, distributor of Cunningham vacuum tubes and manager of the Remler Mfg. Co. of San Francisco, is one of the pioneer radio manufacturers of the country. It was in 1915 that he entered the field as the Audiotron Mfg. Co. making vacuum tubes for amateur use. In the subsequent readjustment of the patent situation as regards the vacuum tube he discontinued manufacture of the tubular audiotron tube in order to become distributor of the Cunningham C-300 detector and C-301 amplifier made by the General Electric Co. for him.

As he possessed the vision to realize the future growth of the radio industry and



*Elmer T. Cunningham.*

the resultant demand for high-grade, reasonably priced amateur equipment, he also started the Remler Mfg. Co. to supply this need. It is of interest to note that the coined name "Remler" is formed R, the initial of "radio" and his first name reversed.

The immediate success of Remler parts constructed from moulded bakelite made necessary the present spacious quarters at Second and Howard St., San Francisco, where nearly 100 mechanics are engaged in the manufacture of Remler products.

In addition to his business duties he has served as a director of the Pacific Radio Trade Association since its inception. His business sagacity and initiative have been of the greatest value in conducting the affairs of the association in its efforts to stabilize, standardize and popularize the radio industry.

## TECHNICAL COURSE FOR RADIO SALESMEN

The Radio Corporation of America, which operates the Radio Institute of America, a school for commercial operators, announces a new course devoted in the amateur field. This course is intended primarily to meet the needs of the radio salesman, insofar as equipping him with the necessary technical knowledge is concerned. It has been so mapped out, however, that anyone interested in the radio art can, by completing it, obtain a sound working knowledge covering the theory of radio telephony, as well as the installation and operation of receiving sets. Day and night classes have been organized, and standard modern equipment has been installed. For further information, communicate with L. O. FASSETT, Radio Institute of America, 331 New Call Bldg., San Francisco.





Readers are invited to send in lists of calls heard from stations distant 250 miles or more from their own station

BY FRANK LA BARBA, 1537 SUNSET BLVD., LOS ANGELES, CALIF.

Ksn, kwv, kwg, kfaw.

BY B. C. ANDERSON, LONG BEACH, CALIF.

Kdyl, khj, kuo, kls, wosl, ksn, kgg, kfaf, kqw, kgw, kfc.

BY SAU, CANTON, OHIO.

Spark—6ax, 7fu, 7og, 7uv, 7xv, 7ya. C. W.—6ale, 6en, 6gl, 6hd, 6ob, 6ut, 6xad, 6zac, 6za, 7aa, 7cg, 7cw, 7dm, 7fk, 7fm, 7gm, 7go, 7gq, 7iv, 7ly, 7on, 7op, 7rf, 7tm, 7up, 7vc, 7wo, 7xd, 7zl.

BY GABE, 57 DOUGLASS ST., SAN FRANCISCO, CALIF.

C. W.—5za, (6aqw), (6atg), 6bir, 6fh, 6abx, (6apw), (6bjx), 6bjy, 6bqc, 6rd, 6nx, 7mf, 9af. Spark—6od, 6amn, 6ea, 6ol.

BY 6BKG, REDWOOD CITY, CALIF.

5za, 6xj, 6zq, 6abx, 6cp, 6atq, 6ajf, 6zaf, 6uw, 6ajh, 6ajf, 7ay, 7iq, 7lu, 7xl, (Fone) 7na, 8ft, 8zz, 9awm, 9bra, 9zac, 9amb, 9km, 9dky, 9xay, Can. 5bq, 9bd.

BY 6BAP, 670 WALSWORTH AVE, OAKLAND, CALIF.

Spark—6kc, 6ke, 6mh, 6od, 6ol, 6va, 6aak, 6ald, 7tj, 7to, 7aea, can. 9bd. C. W.—6bf, 6cu, 6ea, 6eb, 6en, 6ft, 6jd, 6ka, 6ku (cw and voice), 6alu, 6beg, 6bes, 6bqg, 6zf, 7mf, 7oz, 7ay, 7zb, 9zaf, kzn, kuy.

BY 6ABW, ROSEVILLE, CALIF.

C. W. 2fp, 4bv, 4kf, 4bq, 4eb, 5em, 5anx, 5za, 5zh, 5bwa, 8zz, 8cw, 8afy, 8ach, 8wr, 8av, 9av, 9ays, 9wp, 9yaj, 9aou, 9di, 9bag, 9zaf, 9aww, 9awm, (uyqsa), 9dcr, 9dsm, 9dky, 9io, 9amb, 9dpl, 9aou, 9ajh, 9hh, 9zaq, 9dn, 9hd, 9bxq, 9bcd, 9bro, 9dte, 9ctu, 9ags. Canadian Stations—CW 4cb, (9bd).

BY 4AX, 873 PEBSTON AVE, WINNIPEG, CANADA.

C. W.—7lu, 9cp, 9nx, 9amb, 9aon, 9aor, 9awm, 9bhd, 9bjv, 9bln, 9dky, 9dqm, 9dtm, 9yaj, 9bzi, 9afw, 9bva. Spark—9ayw, very qsa. Fone—wex, wok, and Sweeney Tractor School. Any one hearing 4ax 1/2-kw Spark please qsl.

BY RADIO 6BEW, OAKLAND, CALIF.

Spark—6cc, 6dd, 6gr, 6iv, 6kc, 6od, 6ol, 6qk, 6up, 6aak, 6acr, 6ahf, 6ajh, 6ajr, 6ald, 6ark, 6ars, 6asc, 6avr, 6zu, 7bh, 7bk, 7nw, 7vo, cl8. Canadian 9bd. C. W.—6ec, 6ef, 6en, 6ff, 6fh, 6gx, 6ka, 6oh, 6abx, 6alu, 6aqw, 6bbc, 6bjq, 6boe, 6bqc, 6bqz, 6brk, 6zb, 6zg, 6za, 6zz, 7lu, 7mf, 7nj, 9zaf.

BY 7LA, SOUTH TACOMA, WASH.

6cc, 6ep, 6fr, 6ft, 6ff, 6gr, 6tu, 6oh, 6xf, 6zf, 6aat, 6abg, 6acr, 6amz, 6aqf, 6aqu, 6awt, 6boe, 6bsa, 6zcc, 6fz, 7ge, 7kj, 7lu, 7nw, 7oz, 7qd, 7tj, 9aja, 9bxt, 9zaf. Canadian Stations 9ac, 9bd, 5ac. Any one hearing my call please drop me a card.

BY OW-6EB, 343 SO. FREMONT AVE., LOS ANGELES, CALIF.

C. W.—5di, 5za, 5zav, 6bf, 6cp, (6fh), 6gf, 6gr, (6gx), 6gy, 6ik, 6ku, 6lo, 6lv, 6nv, 6nx, (6oh), (6rd), 6ti, 6tw, 6za, 6zb, (6zf), 6zi, (6za), (6zx), (6abx), 6ada, 6ach, 6aiy, (6aoi), 6az, 6arb, (6asj), 6atc, 6aud, (6awt), (6bcd), 6bcj, 6bfc, 6bhk, 6bjy, 6bmd, 6bmu, 6boe, 6bob, 6boo, 6bpi, 6bqf, 6bsa, 6bum, 7aea, 7iy, 7lu, 7mf, 7na, 7zc, (7th), 9ac, 9aja, 9amb, 9aon, 9dtm, 9wd, (9zaf).

BY 6BQP, 1928 GREENSHAW BLVD., LOS ANGELES, CALIF.

C. W.—5za, 6bf, 6cp, 6fh, 6gr, 6gx, (6gy), 6ik, 6vz, (6rd), 6za, 6zb, 6zf, (6zj), 6za, 6zx, 6za, 6zam, 6aat, (6abx), 6ada, 6ach, 6agp, (6ahp), 6ajv, 6ajh, 6ake, 6aok, 6aom, (6arb), 6arp, 6aal, 6asv, 6atc, 6awt, (6bcd), (6bcu), (6buv), 6boe, (6bzf), 6bql, 7iy, 7lu, 7mf, 7na, 7zc, 7aea, 7aea, 9amb, 9dtm, 9zaf. Spark—5xd, 6cc, 6gr, 6vi, 6kc, 6tu, 6aak, 6acr, 6aog, 6ahf, 6aht, (6ajh), 6akl, 6amk, 6aqd, 6bdc, 6bv, 7ya. P.S.—Anyone hearing my CW please QSL.

BY 6EA, 343 SO. FREMONT AVE., LOS ANGELES, CALIF.

C. W. Only—5uo, 5za, (buzzer), (6bf), 6bk, 6cp, (6fh), (6gr), (6gx), 6ik, 6lv, 6nn, 6nx, (6rd), (6ti), 6zb, 6ze, (6zf), (6za), (6zx), (6xad), 6zaf, (6ajj), 6aot, 6aqw, 6arb, 6arc, (6asj), 6avv, (6awi), 6bcj, 6bmd, (6bqf), (6bwa), 6bjy, (7aea), 7jw, (7lu), (7mf), 7ot, 7oz, (7zc), 7xi, (voice and music), Canadian 9ac, 9aja, Canadian 9bd, (9zaf), (voice), kdpu, kdpv, kdpw, kfdk, (buzzer, voice, and music), dd5! (Voice at Denver, Colo.) my CW sigs were heard by 6zax on June 30th, also heard by 7fh, 7ge, 7lc, 7qw, 7sg, and 7bf.

BY 6IY, ARCATA, CALIF.

6ad, 6an, 6aw, 6bf, 6bk, 6cu, 6cp, 6ea, 6eb, 6ec, 6en, 6ff, 6fh, 6ft, 6gd, 6gr, 6gx, 6gy, 6ka, 6ku, 6lv, 6ni, 6nx, 6od, 6rd, 6rp, 6sa, 6vn, 6wa, 6xj, 6za, 6zb, 6ze, 6zf, 6zg, 6zq, 6za, 6zx, 6aat, 6arb, 6axz, 6agp, 6alu, 6aar, 6aoc, 6apw, 6aqc, 6arb, 6asj 6avv, 6awp, 6awt, 6baj, 6bbc, 6bcd, 6bcj, 6bqg, 6brp, 6bqz, 6bic, 6bir, 6bjc, 6bjq, 6bmd, 6bmj, 6boe, 6bog, 6bpw, 6bpx, 6bqc, 6bqd, 6bqf, 6bql, 6bp, 6brd, 6brg, 6brk, 6bsa, 6bum, 6xad. 7dp, 7iy, 7lr, 7lu, 7mf, 7nw, 7ot, 7oz, 7qd, 7th, 7tn, 7tt, 7xc, 7aea. 9zaf, 9ac (can). PHONE—6au, 6bdb, 6zal, 6bfd.

BY 6TI, 414 FAIRMONT AVE, OAKLAND, CALIF.

C. W.—5ih, 5is, 5ul, 5za, 5bms, 6cc, (6cu), (6ea), (6eb), (6en), (6fh), (6gf), 6jd, (6ka), (6rd), 6tw, 6zg, (6za), 6zw, 6zx, (6aat), (6ach), 6ajh, 6avd, (6awp), 6bcj, 7dp, 7ic, 7lr, 7lu, 7mf, 7oz, 7sn, 7zb, (7aea), (9amb), 9aog, 9awa, 9awm, 9bag, 9dtm, 9zaf. Spark—4ie, 5ar, 5hk, 5kc, 5la, 5tc, 5tk, (6eb), (6ke), (6oh), 6qr, (6aak), (6ahp), (6ajh), 7ac, 7aw, (7bb), 7bk, 7bj, 7dp, 7ed, 7ga, 7hf, 7in, (7iw), 7ka, 7kj, 7ly, 7mf, 7mi, 7pr, 7qk, 7qt, 7qu, 7tj, (7to), 7ya, 7ze, 7zn, 7zt, 7zz, (7aea), 8ac, 9nn, 9hi, 9xu, 9aya, 9bas, 9dva, 9bd, Can. cl8. 6ti five watt OW was heard by 9aiy in Milwaukee, Wis., a distance of 2,000 miles. All hearing my C. W. please qsl.

BY 6RE, 415 N. GOWER ST., LOS ANGELES, CALIF.

2pr, 4bf, 4bv, 5fv, 5il, 5kc, 5ql, 5qu, 5xy, (5za), 5zh, 5zak, 6ak, (6ar), 6fh, 6gr, 6gx, 6ik, 6ku, 6nz, 6oh, 6pgm, (6rd), 6uf, (6vz), 6aat, 6abx, 6ajh, 6ahf, 6aiy, 6aki, 6aof, 6aqd, 6ard, 6ars, 6atq, 6awt, 6bcd, 6bck, (6bdj), 6br, 6bic, 6bik, 6bir, 6bjq, (6bjy), 6bnv, 6boe, 6brd, 6bsa, 6bum, 6bwo, 6xh, 6hj, 6xt, 6zb, (6zf), 6za, (6zx), 6zac, 7ba, 7dp, 7hs, 7jw, 7ic, 7iw, 7lu, 7mf, 7nj, 7oz, 7zc, 7tn, 7aeh, 7aft, 7afw, 7ahv, 7alu, 7zc, 7xi, 7zb, 7zj, 7zo, 8ib, 8ue, 8wr, 8abr, 8amg, 8bvt, 8xj, 9dr, 9gk, 9ua, 9uu, 9wd, 9abv, 9agh, (9aj), 9amb, 9ams, 9aog, 9aon, 9aot, 9apw, 9aua, 9awm, 9awn, 9ays, 9ayu, 9ata, 9bed, 9bjv, 9bxa, 9dae, 9dkb, 9drk, 9dsm, 9dte, 9dvr, 9zaq, 9zac, 9zaf, Canadian 9bd, 9ac, 4bv, 5kc, 5za, 5xy, 6aaf, 6apl, 6avu, 6bfe, 6za, 7ba, 7oz, 9amb, 9ams, 9bjv, 9ua, 9agh, 9zaf. Anyone hearing 6rr 20 watts C. W. PSE QSL.

9BD, BARRON HOTEL, VANCOUVER, B. C.

C. W.—(Can.) (4bv), 4dq, 4gb, (5bq), (5ct). —U. S. 5di, 5qj, 5jl, 5kc, 5sa, (7ac), —fone. Vancouver. (9ac), Calgary, 9be, (cfcn), 6ak, 6ant, (6asj), (6awi), (6abx), 6apw, 6alu, 6alv, 6aot, 6akt, 6atq, 6aty, 6atc, 6aol, (6arb), (6bes), (6boe), 6bum, 6bog, 6bqz, 6bir, 6bf, 6boq, 6bfo, 6bcj, (6bcr), (6bsa), 6cu, (6cp), 6en, 6eb, (6fh), 6ft, 6jd, 6ka, 6lo, 6nx, 6rd, 6il, 6xj, 6xad, 6za, 6zf, 6zk, 6zs, 6zg, 6zaf, (7aea), (7agf), (7afw), (7dp), 7hm, 7lu, 7iy, (7jw), 7if, 7km, 7mf, 7na, 7nn, 7ny, 7oe, 7oj, 7qc, 7qw, (7th), 7tt, 7tn, 7ve, 7wm, 7xi, (7lu), 7xc, 7zb, 8alt, 8axb, 8ib, 8kg, 8kr, 9amb, 9aja, 9awm, 9aou, 9axr, 9ans, 9abv, 9aap, 9arz, 9bjv, 9bct, 9bf, 9bt, 9cs, 9dr, 9dpl, 9dsm, 9da, 9ri, 9ps, 9nu, 9xu, 9yaj, 9zaf, 9aon. Spark—(5dx), (6ark), (6acr), 6avd, (6abw), 6aqu, (6anq), 6ala, 6aor, (6cc), (6gr), 6hp, 6qr, (6tu), (6vx), 6za, (7agi), (7abs), (7aea), (7bk), (7bb), 7cc, 7fr, (7ge), (7af), 7iw, 7kj, 7km, 7ne, 7nw, (7ot), 7oh, 7tj, (7vf), 7zb, (7zk), (9q3), (9nd).

BY 6BQL, 575 21st AVE., SAN FRANCISCO

All C. W.—5za, 5sh, 6bf, 6cc, 6ou, 6ea, 6eb, 6en, 6ft, (6gx), 6ka, 6ku, 6pl, 6rr, 6sg, (6za), 6zb, 6zf, 6zg, 6zm, 6zac, 6xad, 6aq, 6zas, 6abx, 6ach, 6agp, 6ahp, 6ahq, 6alo, 6aj, 6ajh, 6alu, 6aos, 6apw, 6aqa, 6atc, 6atg, (6atq), 6avh, (6aqw), 6avd, 6bcd, 6bqg, 6bes, 6boe, 6bjq, 6bjp, 6bjz, 6bky, 6bko, 6bmd, 6bnv, 6bob, 6bod, 6bof, 6bpa, 6bqc, (6bqd), 6bqi, 6bqs, 6bqp, 6bqz, 6brf, 6brg, 6brk, 6bum, 6bvq, 6bzs, 7ap, 7dp, 7iy, 7jw, 7mf, 7nn, 7qn, 7qw, 7zc, 7th, 7tq, (7zb), 7zo, 7xc, 7aea, 7abs, 7azd, 9zn, 9amb, 9apa, 9avs, 9awm, 9ays, 9dtm, 9dug, 9xaq, 9yaj, 9za, Can. 9ac.

BY 6A0B, 2319 ASHBY AVE., BERKELEY, CALIF.

C. W.—5di, 5jl, 5ql, 5za, 6bf, (6cu), (6ea), 6eb, (6ft), 6gy, 6jd, 6en, 6ka, 6ach, 6abx, 6ajh, 6alu, 6amp, (6apw), 6aqw, 6atc, 6bcy, 6bec, 6beg, 6baq, 6bir, 6bko, 6bjy, 6blu, (6bps), 6bqf, 6bqg, 6bqz, (6brk), 6bum, 6bvq, 6zg, 6xad, 6zas, 7d, 7ir, 7iy, 7lu, 7mf, 7na, 7ni, 7oe, 7ot, 7qw, 7zc, 7ag, 7tq, 7ack, 7aea, 7afw, 7agx, 7zb, 7au, 8ib qra, 8wr, 8bcy qra vy qsa, 9cb, 9dr, 9wd, 9aja, 9aos, 9amb, 9ayu, 9awp, 9awm, 9ccj, 9dtm, 9zn gud note qsa. Above stns hrd on 1 tube audirton and Grebe hookup. Will all stns hearing 6aor-cw please qsl card.

BY 6A0I, RIVERBANK, CALIF.

Spark—Nao, (6cc), 6fh, 6cr, (6gt), 6ib, 6ic, 6km, 6od, 6qr, 6tu, 6tc, 6up, 6zc, 6wi, 6wi, 6xh, (6aak), 6aad, 6abx, 6acr, 6aca, 6adg, 6agk, 6ahf, 6aic, 6ajh, 6akt, 6ala, 6ald, 6amk, 6apl, 6aqa, 6aqz, 6ark, 6auc, 6avb, 6avy, 6awx, 6bas, 6bbv, 6bnn. (7tw), 7vf, 7zu, 7vc, 7abs, 7au, 7nn. 9bd, (can). C. W.—4bv, (can.), 5za, 5zav, 5zh, 5di, 6ak, 6av, 6cp, (6cb), 6cn, 6fh, 6gd, (6gx), (6km), (6ku), 6xj, 6zas, (6ait), (6gr), 6sm, 6zf, 6aat, (6abx), (6agp), 6ajh, 6apw, 6arb, 6asj, 6atq, 6awt, 6brd, 6bmd, 6bqc, 6bjq, 6bjy, 6beg, 6boe, 6bqd, 6bzg, 6bjc, 6bqg, 6bod, 6bes, 6bcj, (6bpx), 7xc, 7afu, 7vc, (7lu), 7afw, 7tn, 7we, 7zu, 9ac, 9amb, 9dtm, 9zaf, 9dpl, 9ani, 9dte, 9apw, 9bjv, 9ays, (9nx)! FONE—6au, (6ak), 6km, (6ku), 6nx, 6xv, 6xj, 6zd. WSB—Atlanta, Georgia. CFA—Alberta, Canada. Anyone Hearing My Five Watter PSC. QSL.

BY 6QU, 1512 OXFORD AVE., BERKELEY, CALIF.

Spark—(6ea), (6eb), (6gd), 6gi, (6gt), (6hy), 6lu, (6iv), (6kc), (6ke), (6lc), (6mh), (6od), (6ol), 6om, (6to), (6uo), (6up), (6wr), (6aak), (6acy), (6ada), (6adg), (6adl), (6aeh), 6afn, (6agf), (6ahf), (6ahp), (6ahq), 6ahv, (6aic), (6ajh), (6ajr), (6aki), (6ald), (6amn), (6apy), (6aqv), (6aqz), (6ark), (6asc), 6atf, (6avd), (6avr), (6aw), (6awx), 6bam, (6baj), 6bbc, (6bdz), 6bhg, (6ab), (6zu), 6zam, (7bb), (7bh), (7bk), (7ed), (7fi), (7fr), (7ga), (7ge), 7hd, (7hf), 7iw, 7jd, (7iw), (7kj), 7kz, (7mf), (7mp), (7na), (7nn), (7nw), (7ot), (7oh), (7oz), (7sa), (7ac), 7tj, (7to), (7tw), (7ve), (7vf), 7xh, 7ya, 7yg, 7yj, 7zg, 7sk, 7zm, 7za, 7zt, 7zu, Canadian: (5on), (9bd), cl8. C. W.—6bf, (6cu), 6ea, 6eb, (6en), (6ft), (6gd), (6jd), 6ka, 6pl, 6alo, 6alu, 6apw, 6atq, 6awp, 6beg, (6bes), 6bqf, 6xad, 6zb, 6zf, 6wu, 6za, 6zz, (6zcc), (7dp), 7mf, 7na, (7ac), 9su, 9amb, 9awm, 9zaf, voice wv6, voice Canadian: 4cb, 9bd.

BY 6EX, 1615 AROH ST., BERKELEY, CALIF.

Spark—5hk, 5tc, (6bv), (6da), 6df, (6ea), (6eb), (6ef), (6en), 6er, (6rk), (6ft), (6gp), (6gt), 6gv, 6gl, 6hn, (6hy), (6ia), 6iu, (6iv), 6jy, (6ka), (6kc), (6ke), (6ks), (6ky), (6lc), (6lu), (6mh), (6od), 6oh, 6ok, (6ol), 6om, 6pc, (6qk), 6sk, 6tf, (6to), (6tv), (6uo), (6up), 6vz, 6wh, (6wr), (6aak), (6abx), (6acy), (6ada), (6adl), 6aol, (6aeh), 6afw, 6aes, (6afn), 6afp, (6agf), (6agp), (6ahf), (6ahp), (6ahv), (6alb), (6alf), (6alo), (6alu), 6aix, (6ajh), (6ajr), (6aki), (6ald), 6ali, 6alp, (6alu), (6amn), 6amq, (6aoc), 6apv, (6apy), (6aqx), (6ars), 6aru, 6arw, (6asc), (6atf), 6ath, 6aud, (6avd), 6avr, 6awh, (6awi), (6awx), 6baf, (6baj), (6bbc), 6bce, (6bda), 6bem, (6bgh), 6bil, 6bin, 6bnd, 6bqc, 6zb, (6zj), (6zr), (6zu), (6za), (6zal), 6zam, 7ba, (7bb), (7bc), (7bd), (7bh), (7bk), (7bp), (7br), 7bz, (7ce), 7ck, 7cn, 7cu, (7ed), 7fe, (7fi), 7fj, 7fr, 7gd, 7ge, (7gj), 7gu, 7hd, (7hf), 7hg, 7hn, 7hp, (7in), (7iw), 7ju, (7jw), (7kb), 7ke, (7kj), 7ks, 7ly, (7mf), (7mp), (7my), 7nl, (7nn), (7nw), 7oh, 7ot, (7oz), 7rc, (7tc), (7tj), (7to), 7vf, 7vo, 7wg, 7wm, 7xh, (7ya), 7yg, (7yj), 7yl, (7z), 7sk, (7am), 7zp, 7zs, (7zt), 7zu, 7zv, 7xa, 9oa, 9rm, can. (9bd), 9bi, cl8. C. W.—(6cu), (6ea), 6eb, 6ef, (6en), (6ft), (6gd), 6gf, (6jd), 6jj, (6ka), 6ku, (6ky-voice), 6mn, 6pl, (6aag), 6acb, 6ach, 6ahg, 6aif, 6ale, 6alu, 6avx, 6avy, 6apw, 6aqa, 6aqf, 6awp, (6hea), 6bir, 6bjc, 6bqt, (6xad), 6zb, (6zf), (6zg), 6zn, 6ar, 6sa, 6zz, (6zsc), 7dp, 7hc, 7mf, (7na), 7nx, 7zc, 7sk, 7tq, 7xf—voice), 7zu, 9wd, 9wu, (9amb), 9dva, wv6—voice, Can. 9bd.



**E**NJOYABLE RADIO CONCERTS and maximum receiving range are obtained only when your battery is fully charged. Don't be bothered with the inconvenience and expense of taking your battery to a service station every few days for recharging. The

**RADIO  
HOMCHARGER  
DE LUXE**

has been designed especially for this purpose. It charges your "A" or "B" battery over night without removing from the living room, and is the only rectifier on the market combining the following essential HOMCHARGING features:

- 1—Simplicity itself—attach to any lamp socket and connect battery.
- 2—Self-polarizing. Battery may be connected either way and always charge.
- 3—Fully automatic in operation—gives taper charge—cannot overcharge or injure your battery.
- 4—Safe. All parts entirely enclosed. No danger from fire. APPROVED BY UNDERWRITERS EVERYWHERE.
- 5—Silent in operation. May be used in the home.
- 6—Constructed of the best material—genuine Bakelite Panel, Jewell Ammeter, closed Core Silicon Steel Transformer. No castings used, only the finest stampings throughout. UNQUALIFIEDLY GUARANTEED.
- 7—Only one moving and two wearing parts replaceable as a unit at small cost.
- 8—Uses Standard 15 Amp. Fuse Plug, obtainable at any electrical store.

**AN ORNAMENT FOR YOUR LIVING ROOM**

Beauty has been combined with utility in the NEW RADIO HOMCHARGER DE LUXE. The body is beautifully finished in rich Antique Mahogany—the base and fittings in a handsome dull gold. Equipped with rubber feet, it cannot mar polished surfaces. It harmonizes with the finest living room.

**OVER 50,000 HOMCHARGERS IN USE**

50,000 users have heartily endorsed the HOMCHARGER. Beware of imitations when buying as there is only one HOMCHARGER. Insist on the genuine which bears our registered trade name, HOMCHARGER.

Furnished complete. No extras to buy. Price \$18.50 at all good dealers, or shipped prepaid upon receipt of purchase price.

Booklet illustrating the NEW RADIO HOMCHARGER DE LUXE in actual colors is FREE for the asking. Send for your copy today.

DEALERS—JOBBER: Over 150,000 HOMCHARGERS will be sold this fall and winter. Send for your copy of "HOMCHARGER Business Builders" and see how you can get your share of this business.

**The Automatic Electrical Devices Co.**  
117 West Third Street Cincinnati, Ohio

Largest Manufacturers

of

Vibrating Rectifiers in the World



**BRANCH OFFICES**

- New York Chicago Pittsburgh
- Detroit Dallas
- Philadelphia Los Angeles
- Baltimore Minneapolis Atlanta
- St. Louis Kansas City

TYPE "A" FOR WALL MOUNTING

OVER 50,000 IN USE

**PARADEX UNITS**

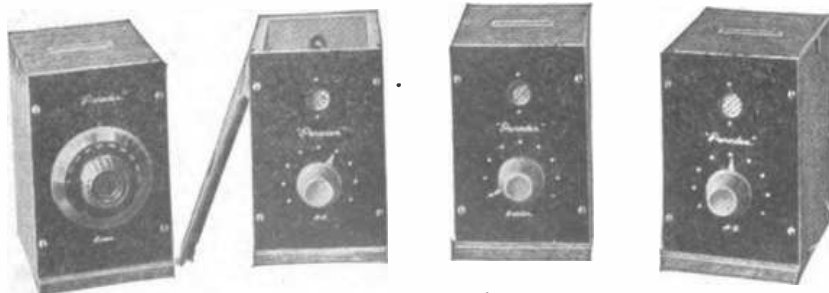

Write for full descriptive bulletin

- Tuner (Pats. Apld. for).....\$20.00
- Detector ..... 10.00
- Audio Freq. Amp. ....\$18.00
- Radio Freq. Amp. .... 20.00

Manufactured by

**PACIFIC RADIO EXCHANGE**

439 CALL BUILDING

SAN FRANCISCO, CAL.

Tell them that you saw it in RADIO

**LETTERS TO THE EDITOR**

Sir:—A word about your article concerning amateur spark transmitters on page 9 of October Radio. You invited readers to send in their opinion on this matter, so I am sending mine. Well, to start with, I think it's a fool idea. Next I can readily see that it is the idea of some radio manufacturer (fly-by-night), he—who thinks more of having the air to himself for advertising his business and putting a lot of cheap phonograph records on the air, which interfere with amateur relay traffic that actually want to give good, interesting programs and assist in co-operation between the amateur and novice. All broadcasting is understood to be now essential and A. R. R. L. relay traffic, which handles messages to and from all parts of the U. S. for the American people, free of charge, is more important and is essential. Another thing is the amateur spark transmitters do not transmit between the hours of 7:30 to 9:00 p. m., giving the novice sufficient time to hear his concerts. Do the concert people ever stop to think that their concerts might interfere with the amateur No; I should say not, and believe me, they surely do. This problem has developed through the constant complaints received from novices of whom 75% cannot read the code and are entirely ignorant of the importance and nature of telegraph conversations. Many attribute QRM from leaky "A & B" batteries, induction from electric and telephone lines, electric street cars and arc lights to the amateurs. Can any real dyed-in-the-wool hams stand for any such foolishness and ignorance as this? What do you think about it? Why not allow the concerts to be given between the hours of 7:30-9:00 p. m. only, and there would never be any complaints, as no spark transmitters are in operation under the Pacific plan during this period, or if this is not possible, publish in your magazine in letters about 6 ins. long that the air is reserved for concerts during 7:30-9:00 p. m., and that the amateurs do not interfere with the spark during that time, Hw? Practically all concert bugs are equipped with conductively coupled receivers, being very broad most of the fault being at the receivers end. All spark transmitters are licensed by law to use a wavelength of 200 meters with a decrement of 2. Such a transmitter should in no way interfere with concerts on the 360 meter wave (read D. B. McGowan's article about interference with concerts which appeared a month or so ago in your paper). Print it again, lay emphasis on these facts and assist in co-operation between the amateur and novice. Don't make your paper a one-sided affair and try to down the amateur; keep up your calls heard department; get an operating department and give us fellows what we want. About C. W. transmitters (impracticability)—Unless a considerable amount of power is used, it is necessary to oscillate the receiving tubes in order to pick up a C. W. man. This requires very delicate adjustments and sharp tuning such that unless work was arranged on schedule or a high-power spark wired QSP, it would be necessary to call a great many times. For instance, some of the 10 or 20 watt C. W. birds, who boast of working the east coast and have to call for a half hour before making connections Hi, think of all that QRM for a local spark man who only has to call three times de sine—3 times, as specified by law and in many instances less, gets his man, shoots his traffic and is off the air before you know it. And these C. W. birds locally, with self-rectifying circuits, rectified AC, generator hums cause more QRM than any spark man ever did. When one of these high-powered C. W. fellows around L. A., who boast of

Continued on page 42

# Selectivity and efficient operation are all Important

*In a Radio Receiver*

## KENNEDY

### *Regenerative Receivers*



possess this by reason of correct application of inductively coupled circuits. They are the standard by which all radio receivers are judged. *Remember it always is safer and cheaper to buy the best.*

WRITE FOR LATEST BULLETIN C-3

*Address our nearest office*

This Bulletin supersedes all others and illustrates and fully describes all Kennedy Radio Equipment.

*Kennedy Regenerative Receivers are licensed under Armstrong U. S. Patent No. 1,113,149 and are sold by good dealers everywhere.*

NEW FACTORY AT SAINT LOUIS

In order to meet the demand for Kennedy Radio Equipment we have opened a new factory at Saint Louis from which to supply the market east of the Rocky Mountains.

**Give a  
KENNEDY  
Receiver  
Christmas!  
Nothing  
Finer, or  
More  
Acceptable**

## THE COLIN B. KENNEDY COMPANY

INCORPORATED

SAN FRANCISCO

U. S. A.

SAINT LOUIS

Tell them that you saw it in RADIO

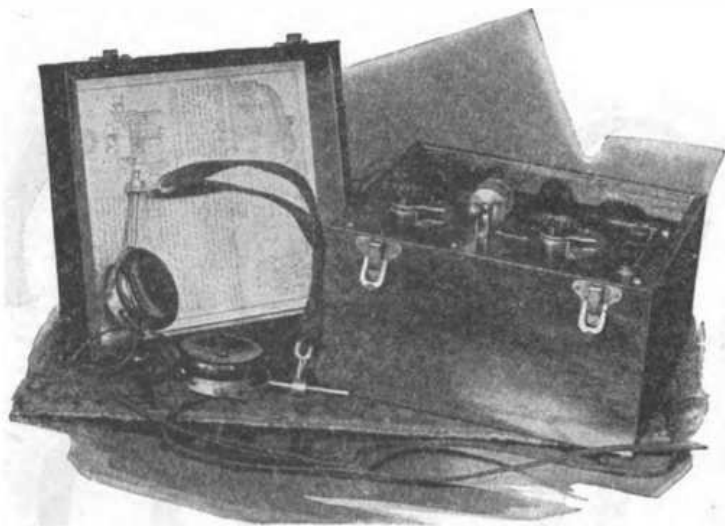

## LISTENING POSTS OF THE NATION

Through thousands of De Forest Everyman or Radiohome Receivers the American people are "listening in" on nearby broadcasting stations, adding De Forest honeycomb coils for longer wavelengths, adding De Forest Amplifiers when it is desired to entertain a room-full through loud speakers.

Some rest content with these remarkably efficient and compact but inexpensive sets, others go on to the MR-6 Set, with its greater distance range, or build for themselves, from De Forest parts, sets of greater elaboration. But the thing for you to remember is this: whatever your need—no matter how simply or how deeply you go into radio—De Forest will meet it.

You get from any De Forest apparatus the dependable service which the famous name implies.

**DE FOREST RADIO TEL. and TEL. CO.**  
JERSEY CITY, N. J.

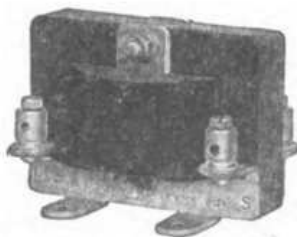

Amplifying Transformer  
Type 231A  
Price.....\$5.00

### No Howling---No Distortion

How often you have been obliged to reduce your amplification or eliminate it altogether in order to hear what the announcer said! In other words, you had to eliminate any distortion brought about by a poorly designed amplifying transformer.

The GENERAL RADIO CO. Type 231A amplifying transformer introduces no distortion. You may enjoy a good volume of sound and yet understand clearly every word spoken.

This company is the pioneer in the design and production of amplifying transformers. It was the first company in the United States to produce commercially such an instrument.

Bulletin 911C will be sent on request

## GENERAL RADIO COMPANY

Massachusetts Avenue and Windsor Street,

CAMBRIDGE 39,

MASSACHUSETTS

Standardize on GENERAL RADIO COMPANY equipment throughout—

DO NOT CONFUSE the products of the GENERAL RADIO CO. with those of other concerns using the words "General Radio." The GENERAL RADIO CO. has been manufacturing radio and scientific instruments for many years. It has no affiliations with any other company.

Tell them that you saw it in RADIO

*Continued from page 40*

15 and 20 amps. radiation, start up it is difficult to work around the bay, no kidding. If these manufacturers you speak of offer C. W. apparatus at wholesale prices, it even then will be so expensive that it will be out of reach for many of us, and of those who buy it 85% will get self-rectifying sets with those awful gurgles and howls, with resultant QRM. It is necessary to have 100 watts output of C. W. before any reliable work can be done. There have been ships at sea using C. W. outfits which have sunk because no one heard their S. O. S. Whereby, if they had had a spark set everyone likely would have been saved. Right today KPH is doing traffic with 2 kw. spark ships 5000 miles out on the Pacific and in summer, too, on 600 meters. Are there any C. W. sets of similar power who can duplicate this work reliably every night? Or beat it? No; it can't be did. I believe I have stated why sparks should stay and I do not see any reason why they should be abolished. I would like to hear from others on this matter. Those who want the sparks abolished are grafters who want to hog the air and make it a business paying proposition. Did Marconi invent wireless for such a purpose? No; I should say not! It was meant for a utility—a convenience. These manufacturers disguise their advertising by the names of broadcast and programs so as to pass government regulations. One man has as much right to the air as any other, provided he conducts himself courteously, which all spark men do. Through the use of the NA & IM signatures QRM has been reduced to a minimum and the air is no longer congested. Let's hear someone else's opinion.

Faithfully yours,

73—A READER.

San Mateo, Calif.

### RECENT PATENTS

*Continued from page 34*

John Hays Hammond, Jr., Pat. No. 1,420,629, June 27, 1922. Teledynamic Orientation System.

A rudder 25 on a moving object 19 is controlled from an air valve 41, the position of which is determined by the energization of solenoids 60 or 61, which in turn is determined by the position of an azimuth ring 80 with two semicircular segments relative to a brush controlled by the gyroscope 110. In this way the course steered is determined by properly locating this ring 80 with respect to the object 19. The positioning of this ring is made dependent upon the frequency of the energy waves received from a distant point by antenna 312, 313, etc. Thus, while the receiving system is unresponsively, a relay 200 is inactive, and a back contact 307 for solenoid 308 is made. This causes energization of magnet 296, and a shifting of a controller 271 so that motor 255 rotates both ring 80 as well as controllers 145 and 147. These controllers determine the amount of tuning inductance in the primary and secondary of transformer 179, respectively in circuit with detector 318 and with relay 200. When the rotation of controllers 145 and 147 is sufficient to tune these circuits to the received energy, magnet 308 is energized, magnet 296 is de-energized, and controller 271 reverses motor 255. As soon as the tuning is destroyed, the cycle begins again. Thus azimuth ring vibrates about a definite direction determined by the frequency of the radiated energy.

John H. Hammond, Jr., Pat. No. 1,419,376, June 13, 1922. Wireless Control Apparatus.

In this arrangement a wireless detector causes relay to operate, upon receipt of sig-

*Continued on page 44*

# Better Adjustment than any Vernier Rheostat

*Says* **Radio Editor Buffalo-Eve. News**

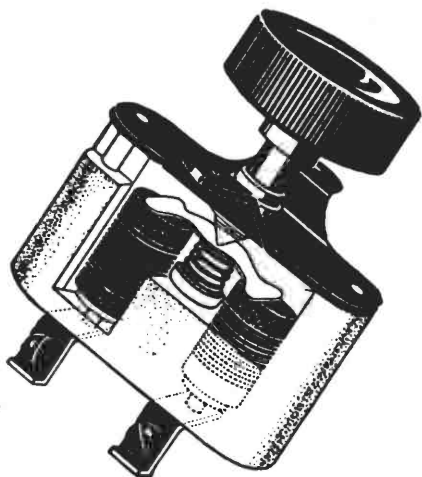

Retail Price  
**\$1.85**  
Postage 10c extra



**JOHN G. RIEGER**  
-RADIO EDITOR-

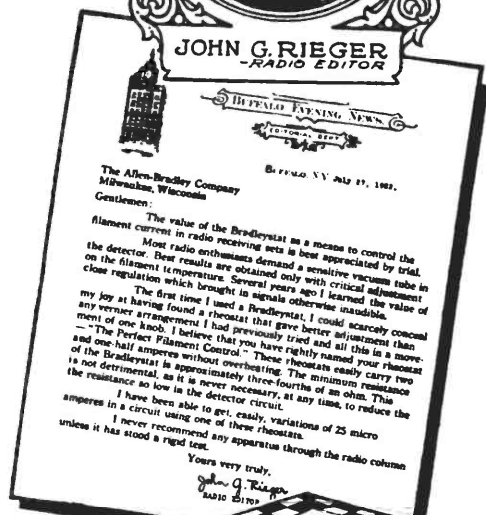

## The Secret of Bradleystat Control

A single knob varies the pressure on the two columns of graphite discs.

The change of filament current is so gradual and smooth that no vernier rheostat can duplicate the noiseless Bradleystat. An internal switch protects the A-battery.

The Bradleystat brings louder reproduction, quicker tuning, and a greater range. The adjustment is permanent and precise.

Remember the one-year guarantee and the twenty years of experience behind the Bradleystat. Write for latest bulletin, today!

**Allen-Bradley Co.**

Electric Controlling Apparatus  
288 Greenfield Ave., Milwaukee, Wis.

Member of the National Radio Chamber of Commerce



# Bradleystat

REGISTERED

U. S. PAT. OFF.

## PERFECT FILAMENT CONTROL

Tell them that you saw it in RADIO

# Listen to the World with Tresco Tuners

## Regenerative Type Tresco Super-Universal Tuner

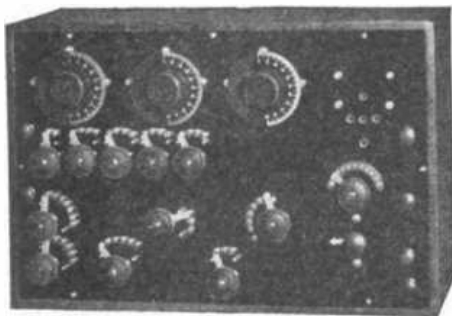

DE LUXE TYPE

Cabinet 12x17<sup>3</sup>/<sub>4</sub> inches.  
Formica or Hard Rubber Panel.  
Weight, 15 lbs.; shipping, 25 lbs.  
Wave length range, 150-25,000 M.  
Tuners inside—three, AS, BS, KS.

Recommended by users of the Bureau of Market Reports and guaranteed to get all the wireless signals, either CW, spark, or telephone within the range of the sending station. This is the only tuner in the world that has this range of wave lengths and gets the signals on the smallest possible single wire aerial. Arlington time, Annapolis, San Diego signals clearly read through even a violent thunder storm. Nearly all stations in the United States of the Bureau of Markets come in on this tuner in the center of the United States, and no point in the country would prevent the reception of these signals. It is recommended for the Farmer, Bureau of Markets, Schools, Colleges, etc. There is nothing about it to get out of order or need replacing except the high voltage batteries, a replacement of which costs only a few dollars. We ship only by express. You do not need to know anything about wireless to operate this tuner or to get the signals and telephone reports. Cabinet is highly polished and all parts nickel finish. If you wish extra loud signals you may use one or two step amplifier, as posts are provided on the tuner for this purpose. We only sell this tuner assembled and calibrated to your bulb ordered with the set. It is complete with all that is needed except a pair of phones and a few dry cells to light the filament of the Audion. Ready to use when it arrives with full directions, so that a child can operate it. Priced at \$125.00, F. O. B. Factory. Bulb, \$5.00.

Licensed under Armstrong Patent No. 1118149.

CIRCULAR FREE

**TRESCO, DAVENPORT, IOWA**  
BOX 148

*Continued from page 42*

nals. This in turn completes the circuit for the pilot motor 22 driving a controller 44. This controller affects a motor 58, operating a mechanism for moving a rudder 63. Various safety devices are installed, such as limit switches 68, and switches 71 for preventing the motor 58 from moving the rudder too far. Furthermore, an arrangement is also described for inserting rotating segments in the antenna circuit, whereby signals of a definite predetermined sequence can affect the detector.

John H. Hammond, Jr., Pat. No. 1,419,377, June 13, 1922. Radiodynamic Occulting System.

Shutters 10 for intercepting beams of light from a searchlight 1 are controlled by radiant energy from a distance. This is affected by the aid of receiving circuit 2, 3, 4 and magnet 8 operating a pneumatic cylinder 23. This cylinder in turn operates the valve 27 for admitting air into cylinder 15 or for permitting it to exhaust. The shutters 10 are directly operated by a rack 13 connected to piston 14 in cylinder 15.

John H. Hammond, Jr., Pat. No. 1,420,255, June 20, 1922. Antenna for Radiotransmission Systems.

In order that a sufficient length of antenna may be utilized even on small vessels, one end of an antenna A is attached to a float C, and the other end to a line F in mast M. Appropriate insulators I-I' are provided. To vary the length of the antenna A, a winch W may be connected to float C by means of a rope or cable B.

John H. Hammond, Jr., Pat. No. 1,420,256, June 20, 1922. System of Tele-dynamic Control.

A transmitting station is arranged to send groups of waves of a definite controllable frequency, which are received by a receiving system A<sup>1</sup>L<sup>2</sup>E<sup>1</sup>. The relay O is energized with a frequency depending upon the group frequency, and the solenoid N takes up a position which corresponds to this group frequency. If the frequency is high, the solenoid N pulls core 3 entirely to the right, if of an intermediate value, the core 3 stays central, and if of a low value, or if no radiations are received, the core 3 moves to the left. A piston P and cylinder Q damps these movements. These movements of the core 3 are caused to operate a rudder moving mechanism Y by the aid of cylinder U and valves 9 and 10, so that the rudder is moved to any desired position depending upon the frequency of the impulses received.

John H. Hammond, Jr., Pat. No. 1,420,257, June 20, 1922. System and Apparatus for Automatic Wave Selection.

In order to prevent interference, an arrangement is provided whereby the wave-lengths of transmission and of reception are synchronously varied. Thus at the transmitting station upon depression of a signaling key 3, a solenoid is energized which causes rotation of tuning coil 5. This rotation is such that contacts 6 on the periphery are changed to change the number of turns in the antenna circuit. At the receiving station a similar arrangement is provided to rotate the tuning coil as soon as a signal is received.

John H. Hammond, Jr., Pat. No. 1,418,869; June 6, 1922. Teledynamic control.

A magnet is energized in response to radiations received. The duration of the radiations determines the travel of a core and that of an attached roller. The core also carries a valve member for controlling the admission of fluid under pressure to various cylinders for causing the rudder of the body to be shifted, or for coupling a prime mover to a propeller shaft.

# "ILLINOIS" THE RELIABLE

## CONDENSER THAT IS MADE RIGHT AND STAYS RIGHT

|                 | Panel  | Cased  |                 | Panel  | Cased  |
|-----------------|--------|--------|-----------------|--------|--------|
| 67 Plates ..... | \$7.00 | \$8.50 | 23 Plates ..... | \$2.75 | \$4.00 |
| 43 " .....      | \$3.50 | \$4.75 | 13 " .....      | \$2.25 | \$3.50 |

Vernier with single movable plate applied to 13, 23 or 43 sizes, \$2.00 extra.

Above list is for our Regular Style with Knob, Pointer and Scale. We also furnish the Condenser with smooth 3/16 inch staff suitable for Dial at 15c off list.

A 3-inch Bakelite Dial with Condenser, add 50c to list.

Fully Assembled and Tested. IMMEDIATE SHIPMENT.

Money back if not satisfied. Just return within 10 days by insured Parcel Post.

Sent Prepaid on Receipt of Price, Except: Pacific States, Alaska,

Hawaii, Philippines and Canal Zone, add 10c. Canada add 25c.

No Discounts except 5 per cent on orders of 6 or more. Send for Bulletin.

## G. F. JOHNSON

625 Black Avenue

Springfield, Illinois

# Hear Radio Right!

Starnes Superadio Specials, same as used by Harry T. Starnes in his lecture-demonstrations on Chautauqua and Lyceum Circuits in United States and Canada, under all conditions. 2500 mile receiver, two stages, piano finish mahogany cabinet.....\$200.00  
Two stage radio frequency amplifier, the best..... \$75.00  
Detector, and one stage audio frequency amplifier..... \$40.00  
Detector, and two stage audio frequency amplifier..... \$50.00  
With automatic filament control..... \$60.00  
Clapp-Eastham, Westinghouse, and other standard outfits at regular prices.

**Starnes Superadio Service, Covington, Indiana**

Tell them that you saw it in RADIO

**Starts Nov. 1<sup>st</sup> Red Seal Battery Contest Closes Nov. 15<sup>th</sup>**

*For the Best Answer to THIS-*

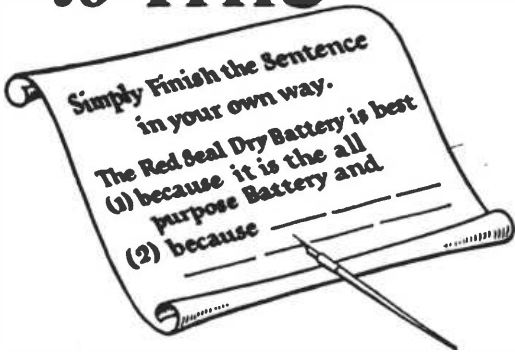

**You Win THIS \$725.00 Complete Radio Set-Free**

Hears broadcasted concerts 400 to 600 miles away; receives wireless telegraph from Europe, South America, from ships on the high seas, etc.

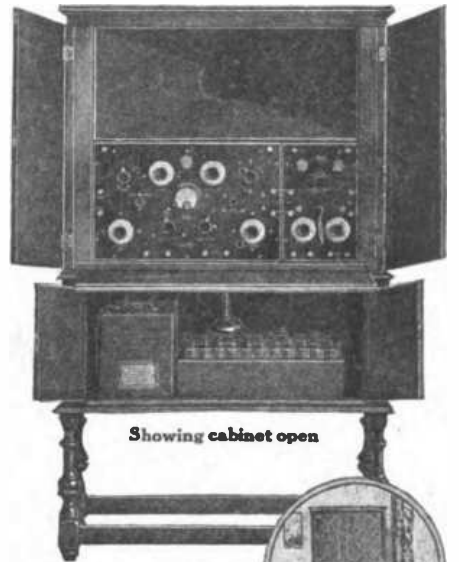

Showing cabinet open

The Red Seal Dry Battery is best—

1. because it is the all-purpose battery, and
2. because .....

**Important:**—Only those answers written on the official Contest Blanks will be considered. Mail as many answers as you like to: Red Seal Battery Contest, Manhattan Electrical Supply Co., Inc., 17 Park Place, New York City.

**The Judges**

The winners will be selected by the following Judges: Mr. Llew Soule, Editor of "Hardware Age," New York; Mr. Howard A. Lewis, Manager of "Electrical Merchandising," New York, and Mr. Joseph A. Richards, President, Joseph Richards Co., Inc., Advertising Agents, New York.

**Announcement of Winners**

The names of the winners will be published in the *Saturday Evening Post* as soon as possible after the contest closes.

In case two or more persons submit winning answers, prizes identical in character with those offered will be given to each successful contestant.

**Important to Dealers**

Duplicates of the 53 prizes are to be given to dealers having the BEST CONTEST WINDOWS. Write us at once for full information and free window display material if you haven't already done so.

**The Prizes**  
It is appropriate that the Manhattan Electrical Supply Company should be the first to offer such Radio Sets as these. This company was one of the pioneers in selling radio, as well as being the manufacturer of Red Seal Dry Batteries used so successfully in connection with radio sets.

**First Prize—\$725.00 Complete Kennedy Radio Set**

This Cabinet Type complete Radio Receiving Set is one of the finest and most up-to-date receiving sets yet produced. The cabinet is walnut and stands 58 inches high. Range from 400 to 600 miles for wireless telephone and 2,000 to 3,000 miles for wireless telegraph. Contained within the cabinet are all batteries, Radio Homcharger, De Luxe and Magnavox loud speaker with special horn. Installed free, in the home of the winner.

**Second Prize—\$408.50 Complete Westinghouse Radio Set**

It consists of the Westinghouse R. C. Receiving Set and Western Electric Loud Speaker, "Tungar" Battery Charger, Storage Battery, "B" Batteries, Set of Manhattan 3,000 ohm Headphones, 3 vacuum tubes, 2 telephone plugs and complete antenna equipment. Installed free in the home of the winner.

**Third Prize—\$256.50 Complete Grebe Radio Set**

A complete receiving outfit made up of the well known Grebe C. R.—9 Regenerative Receiver with Two Stage Amplifier, Magnavox Loud Speaker, Storage Battery, Radio Homcharger De Luxe "B" Batteries, set of Manhat-

tan 2,000 ohm Headphones, 3 vacuum tubes, 2 telephone plugs and complete antenna equipment. Installed free in the home of the winner.

**50 Other Prizes**

To each of 50 other contestants whose answers are meritorious will be given one of the famous Manhattan 2,000 ohm Radio Headsets. These headsets have great sensitiveness and high amplifying qualities.

**How to Enter the Contest**

Simply follow the instructions on the Contest Blanks given away by stores all over the U. S. A. Nov. 1 to Nov. 15. You will recognize these stores by the Red Seal Window Display pictured below.

The prizes will be awarded for the most appropriate answers completing in your own way, in not more than ten words the following sentence:



Look for this Window Display in Dealers' Windows Nov. 1 to Nov. 15. It identifies Dealers who will give you free Contest Entry Blanks.



**MANHATTAN**  
ELECTRICAL SUPPLY CO., INC. NEW YORK  
*Makers of the Famous Red Seal Dry Batteries and Manhattan Head Sets*



Tell them that you saw it in RADIO

## Leich Radio Head Phones

### Time

Accurate  
Reception  
Bakelite Cap  
Inside Terminals  
Weight 11 ozs.



### Tested

Protected  
Adjustment  
Unbreakable Shell  
Comfortable  
Head Band

Made from the best of materials  
A Quality Product at an Honest Price

2000 Ohm—\$7.50

3000 Ohm—\$10.00

## Leich Electric Co.

Genoa, Illinois

# BRACH VACUUM LIGHTNING ARRESTER

## Lessen Static Interference --- Increase Your Pleasure With Radio

The finest radio outfit you can buy may be rendered useless through the influence of lightning or static in the air.

Posted Radio users now take the precaution to protect their outfits by installing the Brach Vacuum Lightning Arrester—the one specified by experienced engineers.

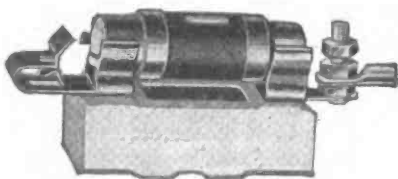

Indoor Type, \$2.50

The Brach Arrester has demonstrated its superiority and dependability in the service of great railroad and telegraph companies and the U. S. Army by faithful performance throughout many years. It is built up to a standard, not down to a price. Listed by the Underwriters' Laboratories. Sold by Leading Radio and Electrical Dealers



Outdoor Type, \$3

## L. S. BRACH MFG. CO., NEWARK, N. J.

16 years Specialists in Lightning Protective Apparatus  
Also Makers of Solderall—Best for Soldering Radio Connections

Coast Representatives—Pacific States Electric Co., San Francisco, Los Angeles, Oakland, Seattle, Portland, Spokane.

## M. P. M. The World's Greatest Radio Crystal

M. P. M. is revolutionizing radio. It is supersensitive and is the only crystal which reproduces from every point on its surface. Doubles your radius and greatly increases the audibility. Send 50c and the name of your Radio Dealer for two M. P. M. crystals, concert tested and guaranteed. Dealers: Write—today—for complete information about M. P. M. and our attractive sales proposition.

Dept. B

M. P. M. SALES COMPANY  
247 So. Central

Los Angeles, Cal.

Tell them that you saw it in RADIO

## HOW TO BECOME A PROFESSIONAL RADIO OPERATOR

Continued from page 12

coupler should be at least large enough to tune in the 600-meter shipboard sets and the 800-meter radio-compass stations. All but the very smallest instruments on the market will do this.

When the student can afford it, an audion detector is greatly to be desired, since it will tremendously increase the effective range of the receiving set and is so much more interesting to operate than a crystal device. An audion detector will make good receiving possible on a very small aerial, and will enable the experimenter to hear the amateurs with CW transmitters. More important still, when the student has an audion he may, with small additional expense, add a long-wave honeycomb-coil circuit to his outfit and listen in on the high-power arc stations.

With an audion detector the larger arcs and alternators can be received with good audibility anywhere in the United States, and, therefore, an outfit that will bring them in is of especial value to the youth living in an isolated section of the country where there are few stations close at hand to listen to. Indeed, a receiving set that will tune in long-wave CW signals cannot but be of inestimable value to any learner, since much of the high-power transmission is carried on at a comparatively slow rate of speed and many of the larger arcs are operating almost continuously, enabling the student to have receiving practice at almost any hour of the day or night. Some of the arcs, again, are operated on very fast circuits; and therefore the advanced learner is also afforded valuable practice on the long-wave receiving set. The student who can successfully copy the Federal Telegraph Company's overland arcs and the Radio Corporation's transoceanic alternators need have no fear of the radio inspector's omnigraph.

The country boy who has no electricity to charge a filament-lighting storage battery should not despair of having an audion detector. If he can afford to buy eight Edison primary cells, his filament-current problem will be solved. The cell referred to is known as the "Edison Type Q," and is widely used for igniting farm gasoline-engines, and in motor boats. These batteries can be bought in the electrical stores or in almost any large hardware store that handles gasoline engines.

Not less than eight of these cells should be used for lighting an audion filament, since their voltage on closed circuit is about 0.6 to 0.7 volt. The voltage is considerably higher on open circuit, however, and so it is very im-

Continued on page 48





*How Science has bridged  
with wireless the miles  
between city and country*

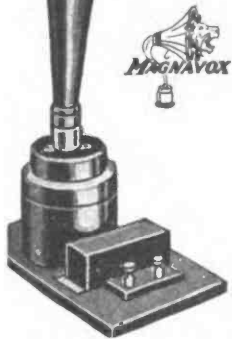

Type R-3  
with 14 inch horn  
(illustrated above)  
\$45.00

Type R-2  
with 18 inch horn  
\$85.00



Model C  
Power Amplifier  
2 stage  
AC-2-C . . \$80.00  
3 stage  
AC-3-C . . 110.00

**T**O the health and independence of farm or suburban life, Magnavox Radio adds the large city's most envied advantage—access to wholesome, inspiring entertainment.

Magnavox Radio, the Reproducer Supreme, brings out all that is finest and best in broadcasted programs—clearness, fidelity to the original; and above all, sufficient power to be enjoyed by the entire family and their guests.

When you purchase a Magnavox Radio or Magnavox Power Amplifier you possess an instrument of the very highest quality and efficiency. Without the Magnavox, no receiving set is really complete.

*The Magnavox products may be  
had of good dealers everywhere.*

THE MAGNAVOX COMPANY Oakland, California  
New York Office: 370 Seventh Avenue

**MAGNAVOX RADIO**  
*The Reproducer Supreme*

Tell them that you saw it in RADIO

# THE RADIO STORE

562 East Colorado Street

## Pasadena, California

Our 1922 Radio Manual is just off the press.

The price is 50c, but free if you send in the coupon at the bottom of this advertisement.

Please note the following corrections:

|                  |  |                         |
|------------------|--|-------------------------|
| Cover—           | ALTADENO, should be ALTADENA.                      |                         |
| Title page—      | add Radio 6XR at bottom.                           |                         |
| Page 61—         | Acme transformers, prices are f. o. b. factory.    |                         |
| Page 63—         | No. 384 Lightening switch.....                     | change \$4.40 to \$3.60 |
| Page 65—         | 12905 Acme filament transformer.....               | change 12.00 to 14.00   |
|                  | 12907 Acme filament transformer.....               | change 16.00 to 18.00   |
| Page 67—         | 12754 Acme C. W. power transformer.....            | change 20.00 to 23.00   |
|                  | 12756 Acme C. W. power transformer.....            | change 15.00 to 17.00   |
| Page 70—         | 13353 UP-1653 instead of UP-1626.....              | change 11.50 to 12.50   |
|                  | 13354 UP-1654 instead of UP-1627.....              | change 15.75 to 18.00   |
| Page 76—         | Motor generators, prices are f. o. b. factory.     |                         |
|                  | 13209 H-2 instead of J-2.....                      | change 47.00 to 52.00   |
|                  |  | change 48.00 to 52.00   |
| Page 77—         | 13316 Type A motor, 115 volts.....                 | change 12.50 to 13.50   |
| Page 79—         | 13355 UC-487 instead of UC-1631 condenser.         |                         |
|                  | 13356 UC-488 instead of UC-1632 condenser.         |                         |
|                  | 13357 UC-489 instead of UC-1634 condenser.         |                         |
|                  | 13358 UC-490 instead of UC-1635 condenser.         |                         |
| Page 83—         | 13595 Paragon Radio Telephone 2-5U.....            | change 70.00 to 72.00   |
| Page 86—         | 13246 UV-204 250 watt Raditron.....                | change 110.00 to 115.00 |
| Page 89—         | 12521 General Radio Socket.....                    | change 1.50 to 1.25     |
| Page 94—         | 12475 214-A & 214-B Gen. Radio Rheostats.....      | change 2.50 to 2.25     |
| Page 105—        | 6 ft. single silk cords.....                       | .70                     |
|                  | 6 ft. double silk cords.....                       | .80                     |
|                  | Others not stocked.                                |                         |
| Page 108—        | All types Baldwin headsets.....                    | 16.00                   |
|                  | All types Baldwin single units.....                | 7.50                    |
|                  | All types Baldwin single units with cord.....      | 8.00                    |
| Page 117—        | Add Westinghouse AD antenna equipment.....         | 7.50                    |
| Page 118—        | Add Westinghouse AD antenna equipment.....         | 7.50                    |
| Page 131—        | RA-10 Paragon Regenerative Receiver.....           | change 75.00 to 78.00   |
| Page 132—        | DA-2 Paragon Detector-Amplifier.....               | change 65.00 to 67.00   |
| Page 133—        | Make same changes as above.                        |                         |
| Page 148—        | 247-A General Radio Condenser .001 mfd.....        | change 5.50 to 6.00     |
|                  | 247-B General Radio Condenser.....                 | change 3.25 to 3.75     |
| Page 159—        | 13662 Federal Universal Plug.....                  | change 1.75 to 1.25     |
| Page 161—        | 12161 Federal Anticapacity Key, discontinued.      |                         |
| Page 164—        | 13610 Station type Vocaloud.....                   | change 35.00 to 40.00   |
| Page 172—        | 12124 Gen. Radio portable milliammeter.....        | change 8.50 to 10.00    |
|                  | 12125 Gen. Radio portable milliammeter.....        | change 8.50 to 9.00     |
|                  | 12126 General Radio portable milliammeter.....     | change 8.50 to 9.00     |
|                  | 12127 Gen. Radio portable milliammeter.....        | change 8.50 to 9.00     |
| Page 175—        | Type 54 and 74 Jewell meters.....                  | change 7.50 to 8.00     |
|                  | 13413 type 54 1500 volt Jewell meter.....          | change 28.50 to 29.00   |
| Page 181 to 185— | Prices on application.                             |                         |
| Page 187—        | All kinds of wire in stock, prices on application. |                         |
| Page 188—        | 13779 Homcharger either 50 or 60 cycle.....        | 18.00 to 20.00          |
| Page 189—        | 5 amp. 50 cycle Tungar Rectifier.....              | 36.00                   |
|                  | 2 amp. 50 cycle Tungar Rectifier.....              | 28.00                   |

We have many things in stock not shown in manual, in fact, everything worth while in radio.

## Paul Franklin Johnson

COUPON

The Radio Store,  
562 East Colorado St.,  
Pasadena, California.

As advertised in November RADIO, please send me without charge one copy of your 1922 Radio Manual. In return for which I give you the following information:

Call letters..... Signed.....

.....Street .....City .....State

I have a crystal (or vacuum tube) receiving set with.....step amplifier.

I have a spark (or vacuum tube) transmitting set.

I hear Radio KGO the Altadena Radio Fone, loudly, (medium, faintly).

I have no receiving set but am interested in a.....type set.

Tell them that you saw it in RADIO

Continued from page 48

portant that the experimenter employing them take care to cut in all his A-battery rheostat when first lighting his audion, or he is liable to have a burnt out filament. After the tube has been lighted for a few minutes, the voltage will begin to fall off and the filament rheostat must be readjusted every few moments until the cells become steady. I installed just such a battery outfit for a radio amateur in Alaska, wiring in a small double-pole double-throw switch to throw the current from the audion detector to the spark-coil transmitter or *vice versa*, and the arrangement proved remarkably successful.

Ordinary dry cells may also be used to light an audion filament, but they are not to be recommended for such work. Eight dry cells connected in series-parallel will give from 20 to 50 hours of intermittent service on a single detector tube.

The student operator who is so unfortunate as to live in a place where for some reason or another even a small aerial is impossible had best buy or assemble a good regenerative receiver and two-step amplifier. This is a somewhat expensive undertaking, it is true, but almost any of the better regenerative and amplifier outfits on the market will give astonishing results on a small indoor aerial or frame. The maker of one of these super-sets declares even that if the tyrant landlord prohibits wires and poles on the roof of the flat, you can "hook 'er to your bedspring, and let the rest of the world go by!"

### Automatic Sending Machines

A GREAT many radio amateurs and prospective operators who are anxious to learn to receive in the shortest possible time are buying one or another of the automatic transmitting devices. The various sending machines on the amateur market are virtually alike in principle, in that they employ spring-motor-driven metal discs or records, which have raised dots and dashes on their edges; these in turn operating a vibrating contact which may control a buzzer circuit and so reproduces the signals on the metal discs.

These machines are undoubtedly of value in learning to receive, since they will furnish code drill at any time and at any speed the learner wishes it, but their most serious shortcoming is the scant variety and the inflexibility of the practice material they afford. The metal discs carry only a few words, and when the student hears them transmitted a few times, he knows them by heart. The practice then becomes valueless. The learner must constantly have new and unanticipated material to work on; he may become able easily to recognize

Continued on page 50

# a New Willard "A" Battery for

A new Willard—at a new low price!  
That's the Willard FW Radio "A" Storage Battery.

It has Willard-quality plates, selected wood separators, tested rubber jars, well-built acid-proofed container.

It has specially-designed terminals that do away with clips and insure tight, easily-made connections.

It has a special marking for the positive terminal, so that there's no chance of your hooking up the battery in reverse.

It has patented soft-rubber gaskets around the terminal posts to prevent leakage.

It has a stout roller handle that's easy on your hand.

And remember this—

## All Willard Radio Batteries are Shipped Dry and Fully Charged

This means that you are always certain of a fresh battery—a battery in which there has been no deterioration—and *one you can put to work at once without charging*. All that is required is the adding of the electrolyte (a solution of pure sulphuric acid and water) which takes but a moment.

See the new Willard FW Battery at the nearest Willard Station or at your dealer's.

**WILLARD STORAGE BATTERY CO.**  
Cleveland, Ohio

*Made in Canada by the*

Willard Storage Battery Co. of Canada, Limited, Toronto, Ont.

**\$13.60**  
40  
ampere-hour  
capacity



### Made in Three Sizes

Capacity and prices of this new battery are as follows: 40 a. h., \$13.60; 80 a. h., \$17.50; 110 a. h., \$22.00. Prices slightly higher west of the Mississippi and in extreme South.

**Willard STORAGE BATTERY**

Tell them that you saw it in RADIO

# 'RED-HEADS'

*A Triumph in Radio Receiver Design*

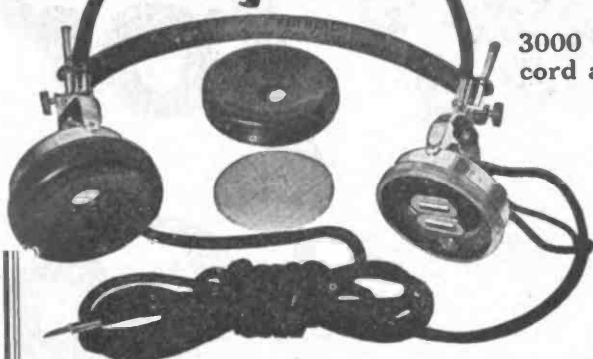

3000 ohms, complete with cord and military head-band

---Now \$6.50

At the new price of \$6.50 per pair, "Red Heads" represent today's biggest value in radio headsets.

### SPECIFICATIONS

Each "Red Head" receiver is wound to 1500 ohms (3000 ohms per pair) with highest quality electrolytic copper on accurately ground pole pieces attached to the best magnet steel procurable for the purpose. Machine-finished aluminum backs with strain posts and nicked binding posts. Ear caps of scientific design, moulded from our special red-brown composition, comfortably fitting the ear. High quality, fully adjustable military type head-band with seamless tape binding. Green mercerized cord. Careful workmanship and distinctive appearance. Fully guaranteed.

### It's a Fact That—

"RED-HEAD" Phones at \$6.50 are the lowest priced, high-grade, 3000-ohm, aluminum cup receivers on the market. The new price is possible only because of greatly increased production and cleverly improved facilities. Not one iota of quality has been sacrificed.

For sensitiveness, for mechanical perfection and for durability, "Red Heads" easily surpass any phones ever offered at anything like the \$6.50 price. Their genuine merit has created a country-wide demand for "Red Heads." Obtainable at your dealer's, or sent direct on receipt of price.

ASK FOR THE GENUINE "NAA" DETECTOR MINERALS These are the original tested crystals. They're distinguished by their tested sensitiveness—remember that!—and by the name "J. S. Newman" on each container. "NAA" Galena, Silicon or Goldite, unmounted, 25c; mounted (set in Woods metal in brass cup) 40c.

The Newman-Stern Building

**The Newman-Stern Co.**  
INCORPORATED

Cleveland, Ohio

**N.B.** Have you observed how the Teagle line of radio products is coming to the front? "Demonstrated merit" is the reason. We are the producers of Teagle Rheostats, Sockets, Condensers, Detectors, Crystal Receivers, Adaptaphones, etc. Like Newman-Stern "Red Heads," they're FULLY GUARANTEED.



Continued from page 48

constantly-repeated matter sent at a speed of even thirty words a minute when he can hardly copy ten words a minute of unfamiliar text.

There is a way, however, to get a great deal of valuable drill with one of these transmitters, and that is by putting on the dials upside down. Then, when the machine is operated, the dot and dash combinations on the discs will be sent backward, reversing not only the words, but also many of the letters—as, for an example, *B* will be changed to *V*, *F* to *L*, and so forth. The transmitter will thus reproduce groups of miscellaneous letters, virtually code, upon which the student can practice for weeks without memorizing the combinations to any great extent. It will be observed that the letters *C*, *J*, and *Z* sent backwards will form unused dot-and-dash combinations, and these must be simply disregarded. It would be a good thing perhaps if the manufacturers of automatic transmitters would furnish sets of code dials for them.

It is sometimes asserted that the sending of the automatic transmitter has a lifeless, machine-like sound, peculiarly different from hand sending. While it is true that the metal-dial type of machine lacks the personal touch of manual sending, I can not see that this is a very serious disadvantage. A typewritten letter lacks the individuality of handwriting; but it is nearly always more readable. The ultra perfect style of the dial transmitter greatly resembles good vibroplex sending, and at any rate it is easier and more pleasant to read than some of the hand-sent stuff that nightly rattles our receiver diaphragms like some one shaking a handful of pebbles in a tomato can.

The automatic transmitter is perhaps of greatest value to the beginner, not only as a means for fixing the code in mind, but especially in helping him to attain sufficient speed to read a little of what he hears on his receiving set. When he acquires a receiving speed of ten or twelve words a minute, he may lay aside the sending machine and devote his available time entirely to listening in.

In conclusion, no prospective radio operator should ever attempt to learn to receive solely by the use of a mere mechanical device. The accepted methods of handling commercial traffic; the heavy jam of interference encountered in actual work; an acquaintance with that old devil of the air, static, and skill in the manipulation of receiving apparatus—all these would be unknown to the operator who learned his receiving entirely with a sending machine. Even supposing he were to attain the speed necessary to pass the government examination for a commercial license, he would be in sorry confusion when he

Continued on page 54

## DAYTON RADIO PRODUCTS

Are the most complete and most accurate of any Radio apparatus made by one Company in America.

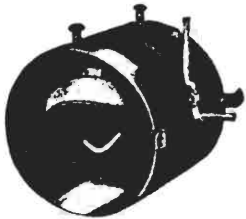

Type B Vario Coupler

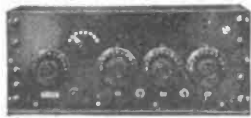

Dayton Phone Receiving Set

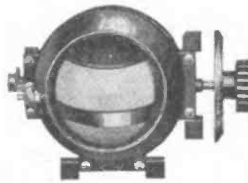

Moulded Bakelite Variometer

### VARIABLE CONDENSERS IN 4 SIZES

|  | List Price |
|--|------------|
| Type 9 P. C. S. Square and Round Plate .0003 Mf.   | \$3.00     |
| Type 17 P. C. S. " " " " .0005 Mf.                 | 3.60       |
| Type 31 P. C. S. " " " " .001 Mf.                  | 4.50       |
| Type 45 P. C. S. " " " " .0015 Mf.                 | 5.30       |
| Type 17 P. C. S. Condensers with Vernier attached. | 4.40       |
| Type 31 P. C. S. " " " " " " " "                   | 5.30       |
| Type A Variometer Moulded Bakelite.                | 6.75       |
| Type A Vario-Coupler Moulded Bakelite.             | 7.00       |
| Type B Variometer Bakelite Tube Type.              | 4.25       |
| Type B Vario-Coupler " " " " " " " "               | 4.75       |
| Type C Vario-Coupler " " " " " " " "               | 3.75       |
| Rheostats.   | 1.10       |
| Panel Switches, 8 Points.                          | .90        |
| Phone Jacks.                                       | .65        |
| Genuine Bakelite Knobs and Dials 3 Inch.           | .75        |
| Insulating Rubber Tubing, 10 ft. package.          | .45        |
| Radio Phone Receiving Sets.                        | 75.00      |

Jobbers and Manufacturers write for Catalog and Discounts

**The A-C Electrical Mfg. Co. Dayton, Ohio**

Makers of Electrical Devices for over 20 years

Tell them that you saw it in RADIO

**WESRAD**  
**WIRELESS MANUAL**  
 AND  
**CATALOGUE**  
 OF  
**RADIO TELEGRAPH**  
 AND  
**TELEPHONE APPARATUS**  
 208 PAGES

**THIS MANUAL CONTAINS 50 PAGES OF VALUABLE INFORMATION COVERING THE FOLLOWING SUBJECTS:**

- |  |   |  |
|--|---|--|
| General Theory<br>The Transmitter<br>The Aerial<br>Loop Aerials<br>Lightning Hazard<br>Tuning<br>The Receiving Set<br>The Detector | Vacuum Tube<br>The Radio Telephone<br>General Information for the Amateur<br>Radio Laws and Reg.<br>Radio Circuit Diagrams<br>Practical Use of the Transmitting Tubes | Short Wave Receivers<br>Long Wave Receivers<br>V. T. Detectors<br>V. T. Amplifiers<br>Freq. and W. L. Tables<br>Wireless Code<br>International Abbreviations<br>Copper Wire Tables |
|--|---|--|

**THE BALANCE OF OUR CATALOGUE**

ILLUSTRATES AND DESCRIBES THE ARTICLES LISTED IN A CLEAR AND CONCISE MANNER SO AS TO ENABLE ANY ONE TO SELECT EASILY AND INTELLIGENTLY THE MATERIAL REQUIRED

**Price Thirty-five Cents, prepaid**  
 CREDITED ON YOUR FIRST ORDER OF TWO DOLLARS OR MORE

**Western Radio Electric Co.**

**637 South Hope Street  
 LOS ANGELES, CALIF.**

**Franklin corner 12th  
 OAKLAND, CALIF.**

# REMLER *Cumingham* REMLER

**APPARATUS  
THAT RADIATES  
QUALITY**



Remler No 93 A Battery Potentiometer Price 75¢



Remler No 100 3" Bakelite Dial and Knob 3/16 or 1/4 shaft Price 75¢

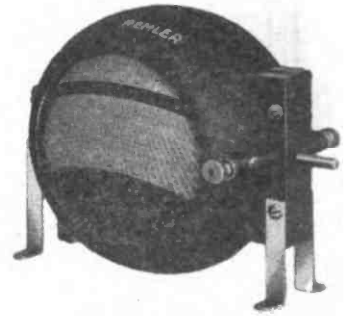

Remler Type 500 Bakelite Molded Variometer Price \$ 7.50



Remler No 40 Bakelite Coil Plug Price 60¢



Remler No 42 Bakelite Panel Plug Price 60¢



Remler No 43 Bakelite Coupling Plug Price 90¢



Remler No 46 Bakelite Coupling Plug with Binding Posts Price \$1.00



Giblin-Remler Inductance Coils 20 to 500 Turns Maximum Inductance and Minimum Distributed Capacity



Remler No 48 Coil Mounting 20 to 750 turn coils Price 60¢



Remler No 49 Coil Mounting 1000 to 1500 turn coils Price 75¢



Remler QS4 No 850 Lapped Coil Unit Price \$6.00



Remler No 810 Junior Rheostat Panel Type Price 1 1/2 amps. carrying capacity \$1.00



Remler No 83 Heavy Duty Rheostat Panel Type Price 3 amps. carrying capacity \$1.75

## WHY REMLER STANDS

Pictured on these two pages is the famous Remler line of Quality Radio Apparatus built to serve the needs of the Amateur—built from the Amateur's point of view. Look the Radio field over—you will find that Remler Apparatus is often copied in design, but never equalled in quality. It is designed right, built right, priced right, and works right. It is the Quality Apparatus—sold under a genuine guarantee.

We urge you to look the Radio market over—to test Remler alongside any make of

## REMLER RADIO

Home Office:  
248 . FIRST STREET, SAN FRANCISCO, CALIF.

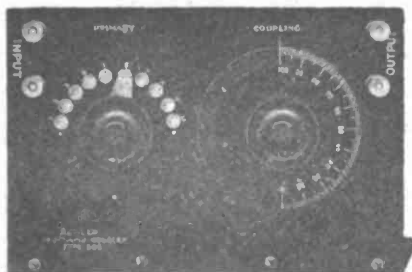

Remler Type 505 Panel Mounted Vario Coupler Price \$12.00

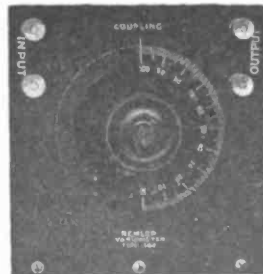

Remler Type 502 Panel Mounted Variometer Price \$10.50

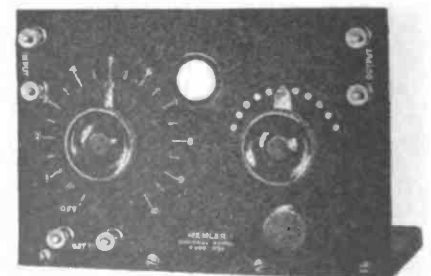

Remler Type 330 Detector Panel Price \$8.50

# APPARATUS *Radio*

**STANDARDIZE  
ON  
REMLER**

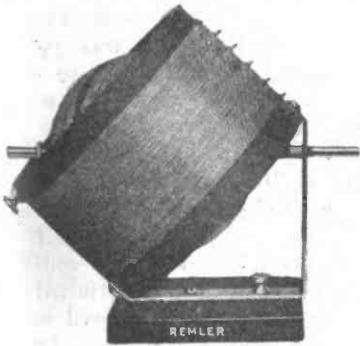

Remler Type 303-180° Vario Coupler  
Price \$5.40



Remler No 90 - 1/2" Bearing  
Switch Price 75¢



Remler No 82 - 1 1/2" Plain  
Lever Switch Price 50¢



Remler No 94 - 1 Plain Type Lever  
Switch 1/4" Collar Price 40¢



Remler No 91 - Bearing Type  
Lever Switch Price 60¢



Remler No 44 Extension Handle  
Price 30¢

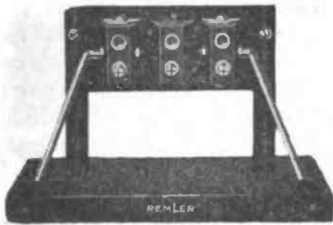

Remler No 400 3 - Coll Mounting  
Price \$7.50



Remler No 85 - N P Binding  
Post 3/8 x 1/2" Price 15¢

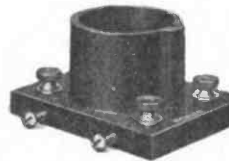

Remler No 92 Bakelite Molded  
VT Socket Price \$1.00



Remler No 83 - 1 Plain Type Lever  
Switch - 3/16" Collar Price 40¢

## FIRST IN THE RADIO FIELD

Radio Apparatus—results are its best sales argument—we leave it to your better judgment. See your nearest Radio dealer today—standardize on Remler Apparatus—it Radiates Quality.

### NEW REMLER CATALOG

Send 10c for new 40-page Remler Catalog just off the press, containing circuit diagrams for Remler Apparatus and other useful information, including a table of inductance, capacity and wave length.

## MFG. COMPANY

Eastern Representative:  
154 W. LAKE STREET, CHICAGO, ILLINOIS



Remler No 86 - N P Binding  
Post 1/2 x 3/4" Price 20¢



Remler No 84 - 1/4" One Piece  
Slider Price 25¢



Remler No 10 - 1 1/8" Bakelite  
Knob Price 20¢



Remler No 95 - 1 Plain Type Lever  
Switch with No 10 Knob Price 50¢



Remler No 97 Grid Condenser  
Price 20¢

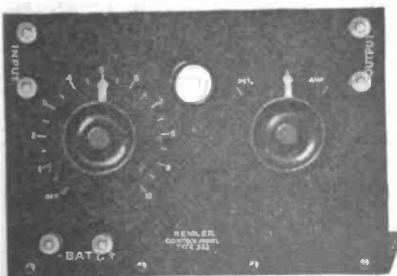

Remler Type 333 Amplifier Panel  
less transformer Price \$9.00

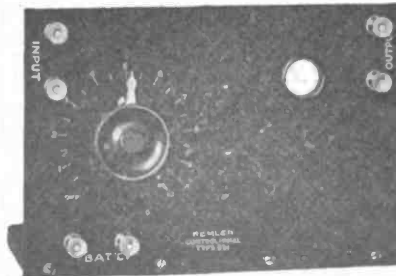

Remler Type 331 Amplifier Panel  
less transformer Price \$6.00



Remler No 96 Variable Grid Leak  
Price 40¢

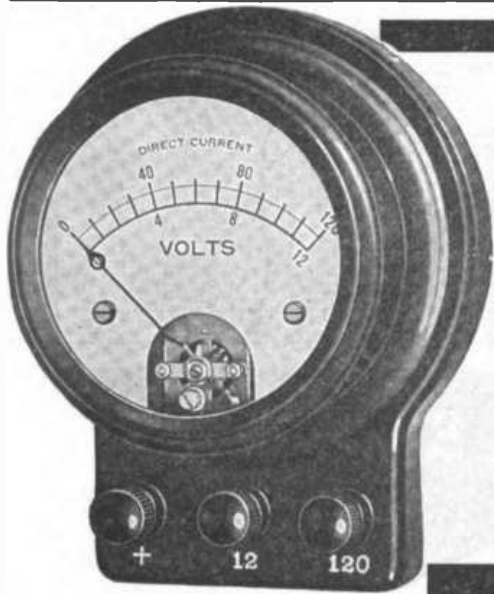

## A-B BATTERY TESTER

The Jewell A-B Battery tester fills a need for a low priced but accurate portable instrument for checking battery voltages. Double readings 0-12-120 volts is the range usually supplied, which takes care of the "A" battery under all conditions and the "B" battery up to the highest commonly used for receiving.

Price \$10.00

We were the first to supply a complete line of miniature radio instruments of uniform size. Ask your dealer or write to us for complete radio circular.

**JEWELL ELECTRICAL INSTRUMENT CO.**  
1650 WALNUT ST. CHICAGO

## IT'S HERE!

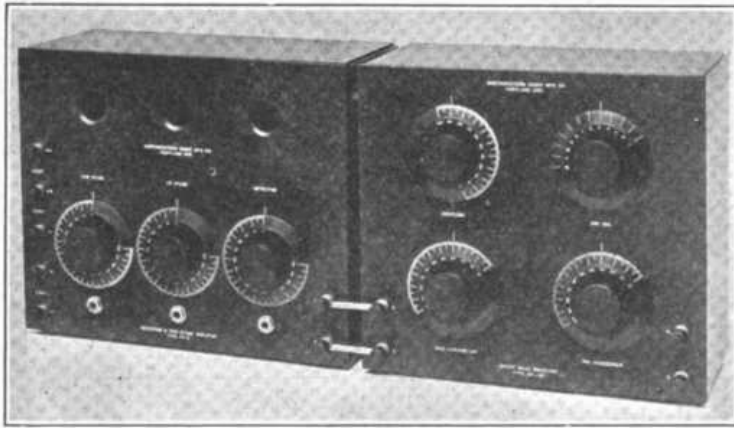

**THE NON-REGENERATIVE RECEIVER DE LUXE**  
FOR BROADCASTING RECEPTION—NEAR OR FAR

**Hallock & Watson Radio Service**

192 Park Street

"KGG"

Portland, Ore.

## RADIO DEALERS SELL B R E C O APPARATUS

It is dependable—and we can make *immediate deliveries*—We can supply you with:

|                         |                                   |
|-------------------------|-----------------------------------|
| Variometers             | Binding Posts                     |
| Variocouplers           | Sockets—Single, Double and Triple |
| Variable Condensers     | Knobs                             |
| Fixed Condensers        | Cabinets—Mahogany                 |
| Dials                   | Bakelite Sheets and Tubing        |
| Rheostats               | Tuning Coils                      |
| Crystal Detectors       | BRECO Two-Step Amplifiers         |
| Inductance Switches     | BRECO Detector and two-step amp.  |
| Amplifying Transformers | BRECO Tuners                      |
| Switch Points           | BRECO Vacuum Control Panels       |

**BRONX RADIO EQUIPMENT CO.**

687 Courtlandt Avenue

Bronx, N. Y. C.

MANUFACTURERS OF QUALITY

*Continued from page 50*

attempted to work on the air. As has already been said, the automatic transmitter is a very helpful device for the learner, but if the student can afford only a small sum for equipment, let him by all means buy receiving apparatus.

### Books to Study

LIKE piano playing and touch type-writing, telegraphic sending and receiving ability comes only by practice; it can not be learned from books. But in learning to send and receive, the prospective radio operator has traveled only a part of the way on the road to a commercial license. He has yet to learn the technical side of wireless operating; he must acquire a knowledge of electricity, especially with reference to the adaptations of electricity in the field of radio, and he must make himself familiar with every detail of the construction and use of the many different types of wireless equipment employed in commercial work. Herein we see the value of the study of books.

Not all the good books on radio can be named here, the aim being rather to mention in the order of their importance those books which are believed to be of cardinal value to any one studying to become a commercial radio operator.

It seems to be pretty well agreed that about the first book the tyro should study above all others is "Robison's Manual of Radio Telegraphy and Telephony," familiarly known as the "Navy Manual," and published by the Naval Institute at Baltimore. The text-book of many wireless schools, this volume has been a guiding beacon to more than one beginner. Its greatest worth lies in its clear and plain exposition of the theoretical groundwork of radio, whereby the student is prepared for the intelligent reading of other more intensive books, and books that specialize on particular types of apparatus. The beginner should by no means neglect the first few elementary chapters; if he will thoroughly study the first half of the book, he will have a good grasp of the principles of spark radio. If the book is bought at second hand, care should be taken to see that it is a 1919 edition, or later.

Another almost equally valuable book—on spark radio—is Bucher's "Practical Wireless Telegraphy" published by the Radio Corporation of America. This book is virtually a complete manual of the Radio Corporation's shipboard radio equipment, containing as it does not only much constructional information, but also specific and detailed instructions on the operation and maintenance of the apparatus. A complete circuit of a modern shipboard radio set, consisting of a quenched-spark transmit-

*Continued on page 56*

Tell them that you saw it in RADIO



# The Quality of the Parts of a Receiving Set Determines its Value Build Your Set With Kellogg Radio Equipment and Secure Maximum Results

## HEAD SETS



The value of extremely light and very small head sets in Radio receiving is most evident when using Kellogg head



receivers, which, however, have proved as sensitive and thoroughly efficient as they are light in weight and small in size. The band, too, is especially adaptable and the simple receiver holders which are held in place on the lower part of the head band by the spring tension of the metal, can be instantly adjusted so as to place the receivers over the ears for the best hearing.

- No. 69A Head Set 2400 ohms.....each, \$12.00
- No. 69C Head Set 2000 ohms.....each, 8.00
- No. 74A Head Set 1000 ohms.....each, 5.00

## MICROPHONES



No. 2 Microphone

Standard Microphone. Super-sensitive. The result of twenty-five years experience.

Kellogg No. 21 Microphone each .....\$7.35

## TUBE SOCKETS



No. 2

All Bakelite tube socket. Takes all standard tubes. "The Standard Socket."

No. 1 and No. 2 Tube Sockets...each, \$0.75

## PLUGS



The Kellogg plug fits all jacks. It is of strong construction and handsomely finished.

No. 501 Plug.....each, \$1.00

## SPRING JACKS

Positive contacts, constant spring tension. Durable insulated frame.



- |                      |        |
|----------------------|--------|
| No.                  | Each   |
| 501—4 Conductor....  | \$1.10 |
| 502—2 Conductor..... | .75    |
| 503—3 Conductor..... | .80    |
| 504—4 Conductor..... | 1.10   |
| 505—6 Conductor..... | 1.25   |

## CHOKE COILS



Air Choke Coil



Iron Core Choke Coil

- 5 millihenrie air choke coil.....each, \$1.00
- 10 millihenrie air choke coil.....each, 1.00
- 100 millihenrie iron core choke coil.....each, 1.35
- 1 henrie iron core choke coil.....each, 1.35

## RESISTANCES

- 12,000 ohm non-inductive wire wound resistance....\$1.75
- 12,000 ohm non-inductive moulder resistance ..... .50
- Mounting for moulded resistance..... .45

## KELLOGG SWITCHBOARD & SUPPLY COMPANY, Chicago, Ill.

If your dealer or jobber does not handle Kellogg equipment, write us for catalog, advising us of his name. Address Department A

## GRID AND PLATE CONDENSERS



Grid Condenser on Single Mounting No. 502

Kellogg Grid Condensers and Grid Leaks are 1 1/2 in. x 3/4 in. They are of the cartridge type, sealed in a moisture proof shell.



Grid Leak and Condenser on Double Mounting No. 503

- No. 501 .01 M. F. No. 503 .0025 M. F. No. 505 .0005 M.F.
- No. 502 .005 M. F. No. 504 .0010 M. F. No. 506 .00025 M.F.

Kellogg Grid and Plate Condensers, each, \$0.75

## GRID LEAKS

|                         |                 |                   |      |
|-------------------------|-----------------|-------------------|------|
| Radio Grid Leak, No. 1  | Resistance 5.   | Megohms 5,000,000 | ohms |
| Radio Grid Leak, No. 2  | Resistance 4.   | Megohms 4,000,000 | ohms |
| Radio Grid Leak, No. 8  | Resistance 8.   | Megohms 8,000,000 | ohms |
| Radio Grid Leak, No. 4  | Resistance 2.5  | Megohms 2,500,000 | ohms |
| Radio Grid Leak, No. 5  | Resistance 2.   | Megohms 2,000,000 | ohms |
| Radio Grid Leak, No. 6  | Resistance 1.75 | Megohms 1,750,000 | ohms |
| Radio Grid Leak, No. 7  | Resistance 1.5  | Megohms 1,500,000 | ohms |
| Radio Grid Leak, No. 8  | Resistance 1.25 | Megohms 1,250,000 | ohms |
| Radio Grid Leak, No. 9  | Resistance 1.   | Megohms 1,000,000 | ohms |
| Radio Grid Leak, No. 10 | Resistance .75  | Megohms 750,000   | ohms |
| Radio Grid Leak, No. 11 | Resistance .6   | Megohms 600,000   | ohms |
| Radio Grid Leak, No. 12 | Resistance .5   | Megohms 500,000   | ohms |
| Radio Grid Leak, No. 18 | Resistance .4   | Megohms 400,000   | ohms |
| Radio Grid Leak, No. 14 | Resistance .3   | Megohms 300,000   | ohms |
| Radio Grid Leak, No. 15 | Resistance .25  | Megohms 250,000   | ohms |
| Radio Grid Leak, No. 16 | Resistance .2   | Megohms 200,000   | ohms |
| Radio Grid Leak, No. 17 | Resistance .15  | Megohms 150,000   | ohms |
| Radio Grid Leak, No. 18 | Resistance .1   | Megohms 100,000   | ohms |
| Radio Grid Leak, No. 19 | Resistance .05  | Megohms 50,000    | ohms |

Kellogg Grid Leaks, each, \$0.25

Radio Grid Leaks Nos. 5, 7, 9 and 12 are most generally used

## MOUNTINGS

FOR GRID LEAKS AND CONDENSERS

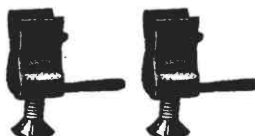

1 Set No. 501 Clips

- No. 501 .....per set, \$0.20
- No. 502, single mounting ..... each, 0.45
- No. 503, double mounting ..... each, 0.85

## STRAIN INSULATORS



Kellogg Bakelite Insulators will stand a pull of approximately 350 lbs.

- No. 4, Length 2 inches.....each, \$0.19 1/2
- No. 3, Length 3 inches.....each, .25
- No. 5, Length 4 inches.....each, .30.6
- No. 6, Length 6 inches.....each, .41.1

## Variometers, Variable Condensers

In production October 1st.

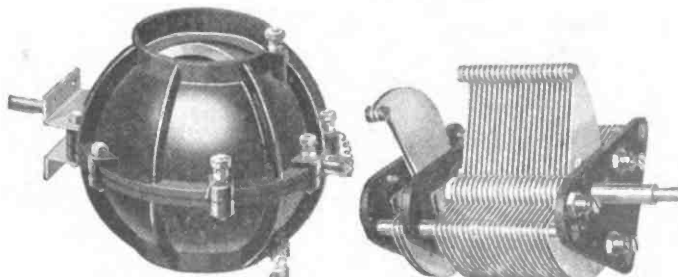

Trade  Mark

# The Set that Grows



Front View  
Panel No. 2



Rear View With  
Cover Removed  
Panel No. 9

There is the nucleus of your future set.

A 150 to 3000 meter bank wound tuner and an audion detector equipped with potentiometer.

Add other panels for loud speaking, greater distance and more select tuning.

Our Bulletin No. 302 describes these novel sets with their outstanding features.

Write for it!

**THE E.D. MANUFACTURING CO.**  
PHILADELPHIA, PA.

**"LISTEN IN WITH ED."**



*"The Party"*

Licensed Under Armstrong U.S. Pat. 1,113,149

**TRESCO RADIO**

J. Matthews Bell Sales Mgr.

Davenport, Iowa, U.S.A.

World All Over

The World

**Jerome Radio Corporation**

Manufacturers

**RADIO APPARATUS**

Factory 3136-S W. Chicago Ave. CHICAGO  
Gen. Sales Office 608 So. Dearborn

**FORMICA PANELS**

Black polished panels 3/16" thick made of this highest quality panel material, cut to any size for only 2 1/2 cents per sq. in. All sizes Formica tubing. Write for prices on size wanted.

Immediate Delivery—Postage Prepaid  
**HUGHES ENGINEERING CO.**  
P. O. Box 57 Terrace Park, Ohio

**C W**

The C. W. MANUAL; only book of its kind on the market; tells you everything about C. W. and how to construct many types of radio telephone and telegraph Vacuum Tube Transmitters. Price, \$1.00 per copy, postpaid. 112 PAGES

**PACIFIC RADIO PUBLISHING CO., Inc.**  
Pacific Bldg. San Francisco

**A POSTAL CARD**

Will Bring Our Latest

**RADIO FOLDER**

**THORDARSON ELECTRIC MFG. CO.**  
500 W. Huron St. CHICAGO

Tell them that you saw it in RADIO

Continued from page 54

ter, auxiliary battery and charging-panel, and a standardized receiver, is given, and this or some similar circuit must be drawn from memory in the commercial license examinations.

For the student who aspires to become an arc operator, the "Arc Manual," sold by the Pacific Radio Publishing Company, is indispensable. This up-to-date and profusely illustrated book has been prepared by the engineers of the Federal Telegraph Company, the sole manufacturers of arc radio equipment in America, and it is the only authoritative arc treatise in existence. Every student will find it well to understand arc apparatus, since a great number of the Shipping Board vessels have this type of equipment. No one can regard himself as an all-around operator when there is a system of radio being widely used about which he knows nothing, and not only this, but it is probable that questions pertaining to arc equipment will soon be included in the government license examinations.

"The Quiz Book," which is also sold by the Pacific Radio Publishing Company, will prove helpful to the prospective radio operator if used to put a sort of finishing touch on his technical study. It contains questions representative of those which the candidate for a commercial license is required to answer. Rightly used, this volume is of real service, but do not make the fatal mistake of many would-be operators who, instead of thoroughly studying good radio text-books, attempt to cram into their memory the contents entire of some question book, and then essay the government examination. Swallowing things whole causes indigestion. The radio inspector immediately recognizes and looks with disfavor upon the question-book candidate, whose answers have the cut-and-dried style of a stack of cordwood.

The applicant for a radio operator's license must be familiar with the radio laws and regulations and the international abbreviations, and these are best studied in the government pamphlet "Radio Communication Laws of the United States," obtainable from the local radio inspector, or from the government printing office at Washington, D. C.

As has been said already, there are many other good books on radio besides those considered here, but the writer believes that the books named above are among the best for the student wireless operator. Beware of the radio book that is out of date—there is more than one such. Some time ago a set of electrical books were announced in advertisements cleverly designed to give the impression that the books contained a great amount of ultra modern

Continued on page 58



**Announcement**

We are now carrying a complete stock of Grebe Radio Apparatus at our

**Western Branch**  
451 East 3rd Street,  
Los Angeles, Cal.

**A. H. GREBE & CO., Inc.**  
General Offices and Factory  
Van Wyck Boulevard, Richmond Hill, N. Y.

# Buy Direct from the Manufacturer

## SAVE 20%

PROMPT SHIPMENT FROM STOCK  
 QUALITY APPARATUS—SERVICE  
 THE "WIRELESS SHOP" NAME  
 IS YOUR GUARANTEE OF SATISFACTION  
 All Goods Sold at Net Prices—No Discount to the Trade

The Vernier Condenser shown is only one of our Quality Line of Instruments  
 IT IS REASONABLY PRICED—The 23 plate selling for \$6.00 complete with Gorton Engraved Dial. The 31 plate is \$6.50, and the 43 plate \$7.20. Can you beat this in either quality or price?

### For Your New Audio Amplifier . . . only \$4.00

#### Use the NEW "WIRELESS SHOP" QUALITY TRANSFORMER

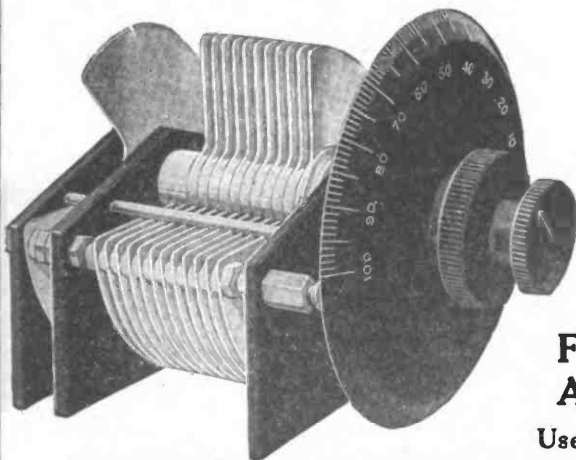

"Wireless Shop" 23 plate Vernier Condenser

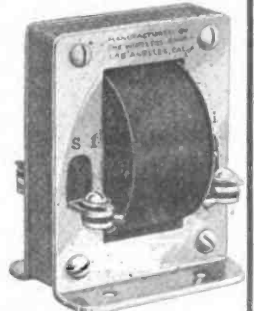

Endorsed by leading radio men from actual comparative tests as THE BEST YET

A few Accessories that are usually hard to get—WE HAVE 'EM!

|   |     |
|---|-----|
| Tinned No. 15 copper for wiring your new set—25 ft. coil..... | 20c |
| "Spagetti"—yellow or black—per 3 foot length.....             | 20c |
| Solder Lugs for No. 4, No. 6 or No. 8 screws—per doz.....     | 10c |

For the convenience of Los Angeles Amateurs we will open up a Branch Store located at Hope & Washington Sts., about Oct. 10th, directly opposite Poly High, on Hope Street

Address all communications to Factory—1262 W. 2nd Street  
 Postal charges and insurance should be included in your remittance.

"OUR QUALITY ALWAYS PREDOMINATES"



1262 W. 2nd St.

Los Angeles, Cal.

**THE WIRELESS SHOP** Radio 11  
 1262 W. 2nd St., Los Angeles, Cal.  
 Be sure and send my copy of the New Wireless Shop Catalogue with New List Prices to

NAME .....

Street .....

City .....

Tell them that you saw it in RADIO



## What *matched tone* means

Counterfeits strive to duplicate only the best. That is why many headsets are sold with the claim that they are "as good as Brandes."

But to be "as good as Brandes," the 'phones must be *matched in tone*. Otherwise, the listener concentrates on one, and the advantage of having two is lost.

Brandes headsets are *Matched Tone* headsets. Hence, the faintest sound is heard distinctly by *both ears*.

Reginald Fessenden, the father of the radio telephone, designed the first Brandes headset fourteen years ago. Ever since that time Brandes Matched Tone headsets have been the standard.

Send ten cents in stamps for the "Beginner's Book of Radio." It explains radio in terms that anyone can understand.

*Distributors and District Offices:*

Munsey Building, Washington, D. C.; 709 Mission St., San Francisco, Cal.; 33 South Clinton St., Chicago, Ill.; 76 Pearl Street, Boston, Mass.; 1220 Nicollet Ave., Minneapolis, Minn.; International Electric Company, Wellington, N. Z.

### C. Brandes, INC.

*Matched Tone* Headsets

237 Lafayette St., New York

Dept. R

Made in Canada by Canadian Brandes, Ltd., Toronto, and distributed by Perkins Electric, Ltd., Montreal.

RESULT OF 14 YEARS EXPERIENCE

### WIS-WIN

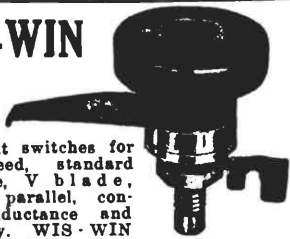

Instrument switches for every need, standard inductance, V blade, series parallel, concealed inductance and B. Battery. WIS-WIN switches are built upon sound mechanical principles and need not be taken apart to install.

Send for Circular S-1. If your dealer can't supply Wis-Win switches, send money order and we will ship postpaid.

**Willis Switch & Instrument Co.**  
8 Kingsbury St. Jamestown, N. Y.

### "EURACO PRODUCTS"

(Guaranteed)

Compact — Interchangeable — Accurate  
Most Efficient



Price 60 cents per Unit

Mfrs. of  
MICA CONDENSERS, GRID LEAKS,  
MOUNTINGS

Interesting Proposition for Dealers

**European Radio Company**

1342 East 22nd Street Brooklyn, N. Y.

Tell them that you saw it in RADIO

*Continued from page 56*

wireless data, a mysterious-looking receiving circuit that no one had ever seen before being reproduced in the advertisement for the gullible reader to bite on. The circuit in question was an antiquated experimental one of fifteen years ago, which has never been put to any practical use, and the contents of the books, so far as radio is concerned, were equally musty. Generally speaking, the radio amateur or student should not buy any book on wireless that has not been written or revised later than 1915.

As a last word on the subject of book study, however true it may be that the mere perusal of a few books on wireless will not enable anyone to step into a commercial radio station and immediately operate it, at the same time it is certainly a fact that the conscientious study of good books, carried on in conjunction with the operation of a small amateur set, will bring the prospective radio operator a surprising distance on toward his goal.

*To be continued.*

### CALLS HEARD

BY 7WM 1422 SO. J. ST., TACOMA, WASH.

CW—6aw, 6bs, 6cp, 6dp, 6gx, 6jd, 6ka, 6nx, 6zf, 6zx, 6aat, 6abx, 6akt, 6ajt, 6arb, 6awt, 6bbg, 6bqc, 6bum, 7dp, 7dx, 7iy, 7iu, 7mf, 7mr, 7jw, 7qn, 7oo, 7sc, 7th, 7tn, 7xc, 7xb, 7adp, 7agb, 7agx, 8ani, 2beb.

Spark—8dd, 8km, 8ic, 8qr, 8aba, 8acr, 8amk, 8ahl, 8ark, 8akt, 8avx, 8cka, 8qsm, 7fi, 7ki, 7ge, 7im, 7ro, 7vf, 7wg, 7jf, 7nw, 7wo, 7aea, 7aqu, can. 9bd, 8cn.

## KING Rheo-Socket

Another RADIO SURPRISE

Price \$3, f. o. b.

New York City

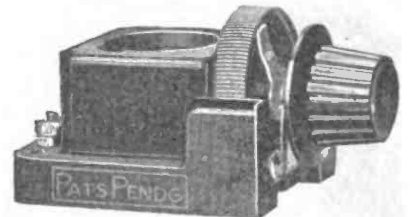

Compact, increased efficiency, shorter connections, less wiring—brings in stations you never heard before. Make this a part of your up-to-date set.

A high grade article in Red Bakelite with Phosphor-Bronze Contacts and Alloy Resistance Wire.

For Base or Panel Mounting

## KING AM-PLI-TONE

82 Church Street New York

Mfrs. of the Famous  
KING AM-PLI-TONE

Jobbers, wire or write for proposition

**Q A S T**  
**RADIO FANS**  
 Perfection in Radio  
 Headsets attained in  
**"ECHO HEADSETS"**

give clear distinct tones, reproduces perfectly, the most sensitive radio signals in music, speech and code.



No matter how perfect or expensive your apparatus; no matter how strong or perfect the waves; without "Echo Headsets" your results cannot be perfect.

We ship phones the day your order arrives.

Every pair tested, matched and guaranteed as sensitive as the most expensive headsets made.

Sold with money-back guarantee. Sent C. O. D. by express, who will hold money for 48 hours trial; if not satisfied express company will return money.

**S. PEARSON RADIO CO.**  
 142 Maple Street  
 RICHMOND HILL, L. I.

MT. TAMALPAIS, Marin County, California, whose inspiring peak is plainly visible from the plant where Parkin Parts are made.



—for constant  
 signal strength  
 put in a Parkin

**Dial Type Rheostat**

(Patd. Aug. 1, 1922)

If you want constant signal strength without the annoyance of constant adjusting, put in a Parkin Dial Type Rheostat. The resistance element is recessed in the back of a moulded Bakelite dial, outside the cabinet. It cannot overheat. The temperature remains constant. Thus you get a uniform flow of current to your tubes and a signal strength which does not vary. You know the importance of that. It also gives you more cabinet space and eliminates resistance heating from inside the cabinet. Saves you the cost of an extra part, too.

In the rear view at the lower right, note the resistance element—a flat, semi-circular core wound radially with non-corrosive resistance wire. Note how it is recessed in the Bakelite dial. Note also the stationary contacts which engage the dial at extreme positions. The resistance is 5 ohms, carrying capacity 1½ amperes. Mounting is extremely easy, only two small holes in the panel being required. Screw and nut are furnished. Order No. 100, at your dealer; price complete ..... **\$1.50**

**Parkin Mfg. Co.**  
 San Rafael, California

Quality dealers and jobbers, write us.

**OUT!**  
 The new illustrated guide and catalog to PARKIN Peak of Perfection PARTS is just out. Interesting and instructive. Send us your dealer's name and we will send you a copy absolutely free.



"The Peak of Perfection"

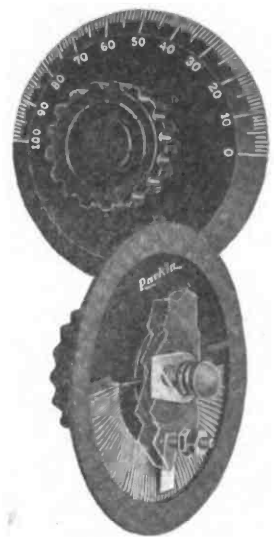

**GET**  
 distant  
 concerts too,  
 with a real  
**PEERLESS**  
 long distance receiver

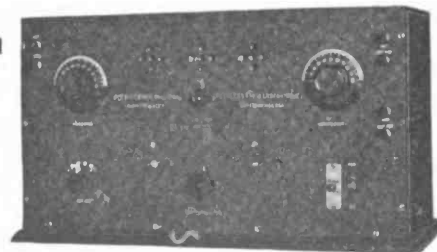

**PRICE \$175.00**

**Install a Peerless**

International Receiver and enjoy the vast variety of entertainment from distant stations as well as local. The PEERLESS International has two stages of radio frequency amplification, which gives extreme scope and range, and two stages of audio amplification, which gives maximum volume. Most easily operated quality set made. Every one tested for 500 miles, and fully guaranteed. Write for complete description and name of nearest PEERLESS dealer.

**PEERLESS RADIO LABORATORIES, 50 Second St., San Francisco**  
 DEALERS—Write for merchandising arrangements, mentioning your jobber's name

Tell them that you saw it in RADIO



## Dubilier Radio Products are good enough for Uncle Sam

Dubilier condensers have long been the standard equipment of the United States army and navy, as well as of the apparatus made by the principal radio manufacturers.

Dubilier Micadons are little receiving condensers of pressed mica, and are made like the condensers ordered by Uncle Sam. They are permanent in capacity and, hence, reduce tube noises. The price ranges from 35 cents to \$1.00 each, dependent on the type and the capacity.

Dubilier Micadon Type 601 Price 35 cents and 40 cents



### Radio Reception From any Lamp Socket

The Dubilier Ducon does away with troublesome antennae and loops. Simply screw it in any lamp-socket and the music, news and talks come in perfectly.

Price at your dealer, \$1.50

### Branch Offices

No outside antenna; no indoor loop. Just the Ducon in a lamp-socket

- San Francisco, Cal. . . . . 709 Mission St., Suite 701-704
- St. Louis, Mo. . . . . Syndicate Trust Bldg., Suite 1409
- Washington, D. C. . . . . Munsey Bldg.
- Chicago, Ill. . . . . 53 West Jackson Blvd.
- Atlanta, Ga. . . . . 802-3 Forsyth Bldg.

**DUBILIER** Condenser & Radio Corp.  
48-50 West 4<sup>th</sup> St. N.Y.

Canadian Distributors:  
Canadian General Electric Company, Toronto, Canada

## TRANSMITTERS, RECEIVERS AND TUNING

Continued from page 14

In the first assignment, we learned that light waves are in reality electromagnetic waves, exhibiting all the properties of radio and heat waves except that the frequency of light waves is very much greater than that of either of the other two types. Clerk Maxwell, an English physicist, advanced the hypothesis that light waves were electrical waves as far back as 1862 but it was not until 1884 that Hertz, a German scientist, was able physically to produce electrical waves and to measure their velocity and frequency, thus transforming Maxwell's unproved hypothe-

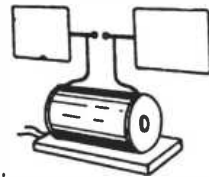

Fig. 11. Hertzian Oscillator



Fig. 12. Hertzian Receiver

sis into a proved theory. Hertz used two metallic vanes, as shown in Fig. 11, and by charging them to a high voltage by means of a spark coil, similar to the ignition coil on a Ford machine, he obtained an oscillatory discharge from the vanes in the form of a spark across the spark gap represented by the two small metallic balls in the figure.

We learned from equation (2) in this assignment, that the frequency of a condenser discharge varies inversely as the capacity  $C$  of the condenser; that is, as we decrease the capacity of a condenser, we increase the frequency of its discharge current. In the first assignment, we learned that the capacity of a condenser is increased by increasing the size of its plates, but while the plates or vanes of Fig. 11 may be fairly large, their capacity as a condenser is quite small since they are not facing each other, as are the plates of Fig. 3, but are placed some distance apart and end to end. With this small capacity, therefore, the frequency of the discharge current is very high and the wavelength of the waves produced is very short.

Hertz discovered that electrical waves were being radiated from this device because when he placed a loop of wire, in which was inserted a spark gap of very short length, as shown in Fig. 12, at some distance from his vanes, he obtained a small spark across the balls of his loop whenever a spark jumped across the gap of the device shown in Fig. 11. Fig. 11 thus represents crudely a small radio transmitter and Fig. 12 its companion receiver.

The waves produced and detected by Hertz in the manner described above were called Hertzian waves. They

Continued on page 64

## ATTENTION · RADIO AMATEURS

A good electrical connection is essential to hear clearly

**EBY** BINDING POSTS

Guarantee positive connections Demand them of your dealer



Commander "H" Ensign "H"



Buddy Sergeant "SS"



To satisfy the tremendous demands for EBY posts, we have arranged with responsible dealers every where to carry a complete stock. Dealers—place your order for EBY posts with your nearest jobber immediately.

**THE H. H. EBY MFG. CO., PHILADELPHIA, PA.**

Tell them that you saw it in RADIO

# New Method of Controlling Amplifying Tubes

Complete control and adjustment of each amplifier tube merely by turning a simple knob. Does away with all jacks, plugs, rheostats and switches. A turn of the Amplitrol knob switches on the plate circuit and adjusts the filament circuit at the same time.

Lengthens the life of the tube from one-third to one-half as it absolutely prevents the ruinous practice of suddenly throwing a heavy current onto the delicate tube filament. With the Amplitrol, the filament current is turned on GRADUALLY. Genuine indestructible condensite, white graduations on a black dial, phosphor bronze contacts. Strictly highest grade. Each of your expensive tubes deserves one. Complete with simple wiring instructions, retail price, \$4.00, from your dealer or from us direct.

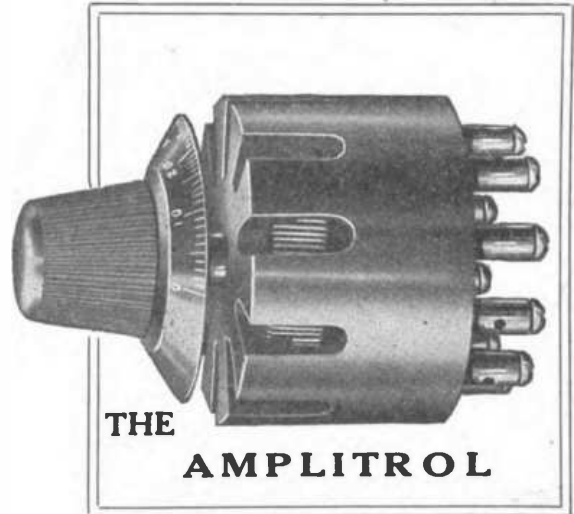

THE  
AMPLITROL

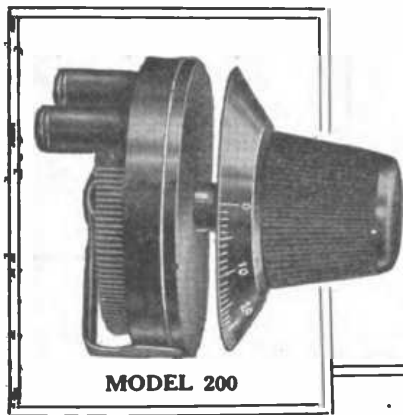

MODEL 200

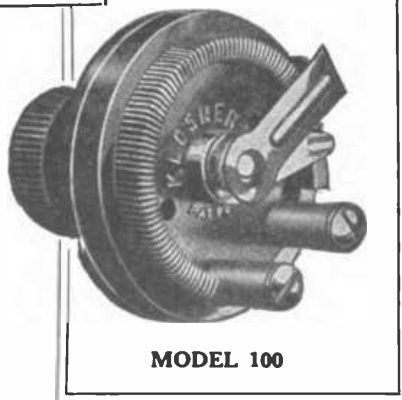

MODEL 100

## Detector Tubes demand a Rheostat with a VERNIER

It is simply impossible to get perfect reception unless you have perfect adjustment of your detector tube. No ordinary rheostat can be sensitive enough. It cannot give you the fine adjustment necessary for best results. This is why every detector tube should be controlled with a VERNIER rheostat.

The Klosner Vernier Rheostat Model 200 has a micrometer adjustment that permits getting EXACTLY on the very spot for perfect tuning.

The Klosner is the original Vernier Rheostat. No other operates both the coarse and fine adjustments with the ONE knob. No other can be so handy.

Also—the Klosner is wire-wound like all true electrical instruments—everything is where you can see it and repair it if ever necessary.

And it has a graduated DIAL to show at all times just where it is set. No guessing.

Genuine Condensite, phosphor bronze contacts, white graduations on black dial. Very high grade. Buy from your dealer. If from us, direct, \$1.80.

Klosner VERNIER Rheostat, Model 100, is the original VERNIER Model. It was first and still is best except only Model 200. Thousands and thousands are in use. Same high quality as Model 200, but equipped with a pointer instead of a dial. Greatly improved, but still priced at \$1.50. All dealers, or direct from us.

Klosner Improved Apparatus Co.  
2024 Boston Road, New York City

# K L O S N E R

# ATLANTA to CHICAGO with Loop Aerial

# and ERLA Transformer

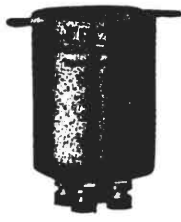
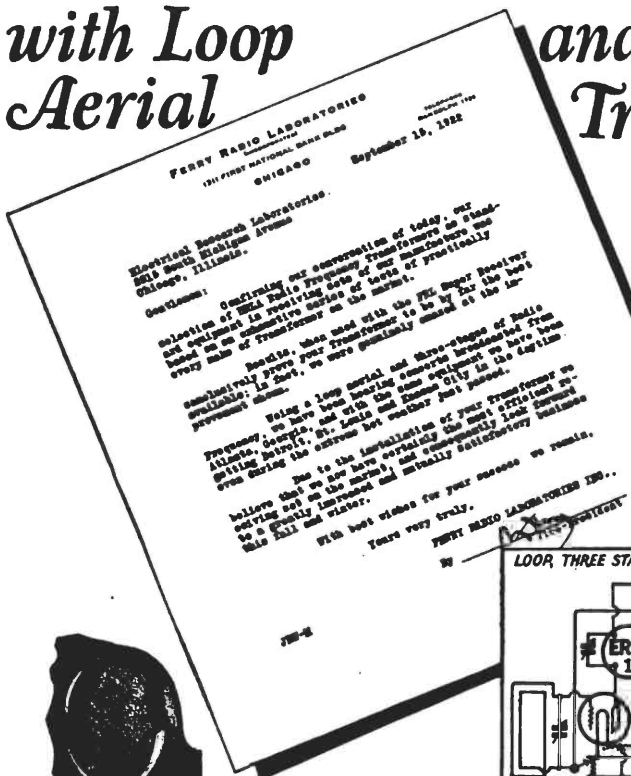

Manufactured in three types, AB1, AB2 and AB3. List price—\$4.00.

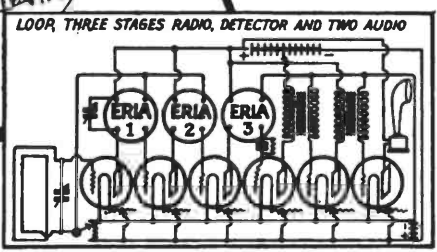

Erla bezels improve 100% the appearance of any receiving set, providing full view of filament, with ample ventilation. Telescoping rim fits 1 1/2 in. hole in any 1/4 in. to 3/4 in. panel. List price—20c.

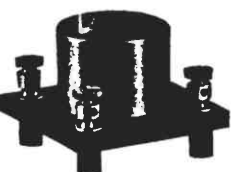

The strongest and most exquisitely finished socket made. Metal parts heavily nickel-plated. Polished Radion base. Insulated hard rubber feet. Special binding posts. Rugged springs. List price—\$1.00.

**JOBBERs**—Write for our liberal terms and discounts

## For Maximum Results Use ERLA

Following a series of exhaustive tests, Erla radio frequency transformers have been adopted as standard equipment by the Ferry Radio Laboratories of Chicago, in all receiving sets of their manufacture.

Whether employed for one, two or three stages of amplification, Erla transformers conclusively proved their superiority over other makes.

Using a loop aerial and the hook-up shown above, Atlanta, Denver and Schenectady, a thousand miles distant, are regularly heard in Chicago through a loud speaker. Nor is there a separate amplifier employed, ample volume being supplied by the receiving apparatus alone.

Old style regenerative receiving sets can be made genuinely efficient by substituting a single stage of Erla radio frequency for one of the two stages of radio frequency now employed. Ask your dealer for diagrams of guaranteed Erla circuits, or write us direct, giving your dealer's name.

Manufactured by **Electrical Research Laboratories**, Dept. H, 2515 Michigan Ave., Chicago  
 Coast Representative **Globe Commercial Co.**, 709 Mission St., San Francisco

# To Our Readers:

The special subscription premium offer advertised in the last issue of RADIO has been extended for another thirty days by request of numerous readers of RADIO.

You will receive premiums for all subscriptions that reach our office during the months of October and November.

If you have not seen a copy of the issue containing this extraordinary premium offer, be sure to write us today for complete information.

If you send us your own subscription for one year, you may have one of the following free premiums:

- Remler Bakelite Socket
- Pen Brand Grid Condenser
- Remler Filament Rheostat
- Somerville Navy Dial
- Remler 3 in. Dial
- C. W. Manual

Just send the names and addresses of subscribers with your remittance to us and you will immediately receive your premium.

**“RADIO”**  
Pacific Building,  
San Francisco

## GREWOL DETECTOR

Nothing Like It  
Nothing as Good

**\$2.00**

The Grewol Detector has taken its place among the standard, nationally advertised parts. In a class by itself because it does what no detector has yet been developed to do. Asked for by name, sold by reputation.

If your dealer cannot supply you, send \$2 and your dealer's name; we will fill your order.

- Permanent Adjustment
- 
- Always Set and Ready
- 
- Glass Enclosed

Dealers Write for Proposition  
**RANDEL WIRELESS CO.**  
 Sole United States Distributors  
 9 CENTRAL AVE. NEWARK, N. J.



(Actual Size)

Tell them that you saw it in RADIO



# At Last! The Perfect Radio Loud Speaker for the Home

THERE is no other Loud Speaker like the DIOTOGRAPH—made expressly for home use by the makers of world-famous Dictograph products—standard everywhere for the finest, most accurate and most sensitive sound-transmission and loud-speaking devices. No other organization in existence has the facilities, the skill, the experience of the Dictograph Products Corporation for producing a perfect Loud Speaker.

Years of experience in producing the marvelously sensitive "Acousticon" for the Deaf, the Detective Dictograph and the Dictograph System of Loud-Speaking Telephones have made possible this wonderful Radio Loud Speaker that reproduces every sound—singing, speaking, instrumental music—in crystal-clear, natural tones, full volume, and FREE FROM DISTORTION AND NOISE.

The Dictograph Radio Loud Speaker gives perfect results with any vacuum tube receiving set. No alterations; no extra batteries—you simply plug in and listen. The handsome appearance of this quality instrument harmonizes with any home.

Ask for FREE DEMONSTRATION of the Dictograph Radio Loud Speaker at any reliable radio shop. Get DIOTOGRAPH quality and still save money.



The Dictograph Radio Head Set has established a standard of quality impossible to secure in any other head set. Its use on any receiving set, crystal detector or vacuum tube improves reception immeasurably. 3000 ohms resistance. The best Head Set in the world. Regularly furnished as Standard Equipment with the Leading Receiving sets made.

Dealers—Order through your jobber or write for names of authorized distributors.



Price \$20

Complete with 5 ft. flexible cord

The Standard of the World

A beautiful instrument! Finely constructed, richly finished. Highly burnished, French lacquered, eleven inch spun copper bell horn attached to die cast black enamel tone arm, finished with nickel trimmings. Cabinet 6 x 5 inches base, 4 inches high, of solid ebony-finished hardwood, mounted upon rubber knobs. Furnished complete with 5-ft. flexible cord. No extra batteries required.

## Dictograph Products Corporation

220 WEST 42d STREET

(Branches in All Principal Cities)

NEW YORK CITY

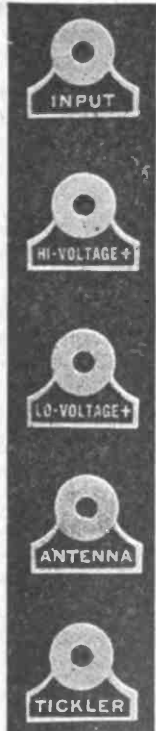

### SOMERVILLE TERMINAL INDICATORS

Now 5c each

Made possible by a large foreign contract, which doubles production.

They slip under the binding post like a washer—do away with engraving—and prevent mistakes in connecting.

Stock readings are: Antenna, Lo-Voltage—, Ground, Input, Hi-Voltage+ Output, Hi-Voltage—, Tickler, Lo-Voltage+, Modulation.

Also Telephone Jack Indicators—fit under the hexagonal jack heads—5c each.

Detector, 1st stage, 2nd stage, 3rd stage, CW key, voice.

### NEW—DIAL POINTER TAGS

With contactor spring which bears against back of our dial and connects to ground—thus eliminating capacity effects. Readings are:

Condenser 5c Variometer Coupling EACH—POSTPAID

### SOMERVILLE DIALS

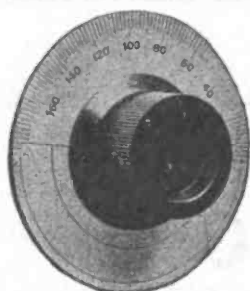

"The Silver Shield Which Wards Off the Howling Capacity Imps"

Make your Set quiet by removing the old lopsided "Moulded Mud" Dials, and equipping with truly distinctive Dials with "man size" knobs.

They fit 3/16" or 1/4" shafts  
4" Somerville Dial.....\$1.75  
3 1/4" Somerville Dial..... 1.00  
Flanged Knob only..... .60



Somerville Dial Pointer, 10¢  
Transparent celluloid with black hair-line assures accurate reading.

### SOMERVILLE CONDENSERS



.00025 Grid Condenser.....25c  
.0005 Grid Condenser.....25c  
With 1/2 Meg. Grid Leak, 10c extra.  
.001 Phone Condenser.....25c  
.002 Phone Condenser.....35c  
.005 Phone Condenser.....60c  
1000 Volt CW Type.....60c  
.0005 MFD. .001 MFD.  
.002 MFD. .005 MFD.

### SOMERVILLE GRID LEAKS

(Glass Tube Type)  
.2 meg. .5 meg. 1 meg. 2 meg. 3 meg.  
50c EACH POSTPAID  
Mounting for above.....40c

DEALERS! Our products are half-sold before you open your mouth!

Advertising—backed by facts—does it!

Real Radio Jobbers have our products, or you can buy direct on a cash basis.

"BE PREPARED"

## SOMERVILLE RADIO LABORATORY, 43 Cornhill, Boston, Mass.

Tell them that you saw it in RADIO

Continued from page 60

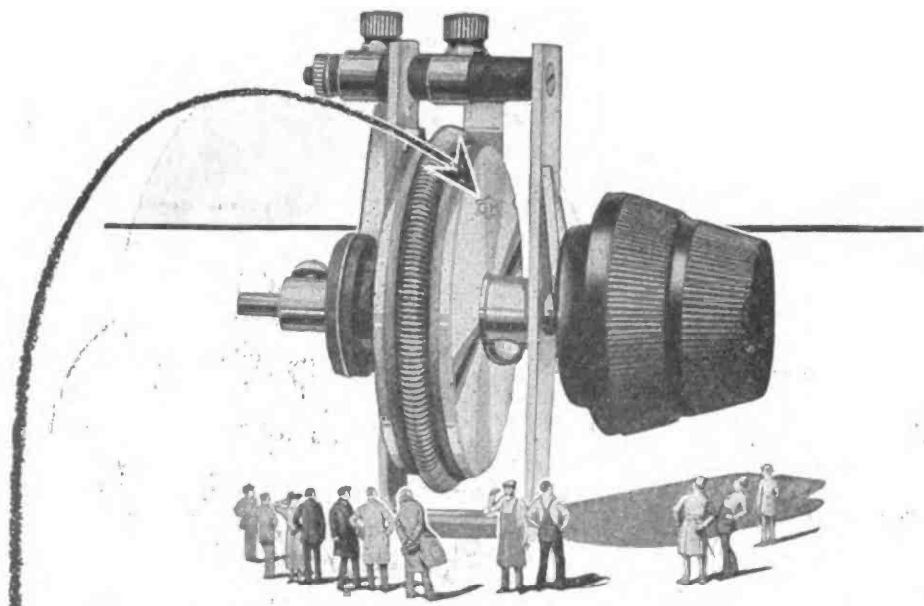

## The Mark of the Master Builder

ON every C-H Radio Rheostat is engraved a guarantee of satisfaction. The familiar C-H trademark, known by engineers the world over as unfailing assurance of electrical and mechanical perfection, today protects the buyer of radio equipment. In these times of uncertainty, when so much apparatus offered for sale is the result of hasty development, with insufficient engineering and manufacturing experience, this trademark has even increased value to the purchaser.

Cutler-Hammer, pioneers and largest builders of rheostatic control apparatus, mark with pride these radio rheostats, their latest development.

C-H Radio Rheostats are made in two styles. Type 11601-H1 is arranged with vernier for detector tube control. For amplifier tube control where such great accuracy is not essential, type 11601-H2 is furnished without the vernier feature. Both types are finished in highly finished nickel and are pointer indicating. Cone shaped knobs of genuine Thermoplas are furnished as standard equipment. The rheostats are packed in unit boxes with full instructions and template for easy mounting. Type 11601-H1 (with vernier) .....\$1.50 Type 11601-H2 (without vernier) .....\$1.00 For sale at all radio dealers and supply houses. Samples are available direct from factory at list price plus ten cents for carriage.

THE CUTLER-HAMMER MFG. CO.

Milwaukee, Wisconsin

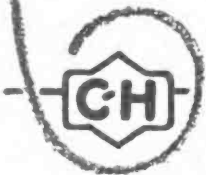

## FILAMENT CONTROL

Constant, steady voltage.  
No battery noise in your V. T.  
Easily recharged at home.  
A life of from 3 to 5 years.  
Jelly electrolyte, no spillage.  
Clip on for any required voltage.

—A FEW OF THE REASONS WHY

## SNELL CELLS Storage "B" Battery

should be on YOUR set.  
At your Radio Dealer, or

## MANN & SNELL

4733 Geary Street 6BQL San Francisco, Cal.

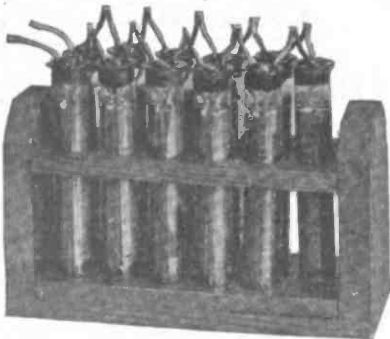

22 v., 11 cells.....\$ 6.50  
44 v., 22 cells..... 12.00  
Chemical Rectifier ..... 1.25  
F.O.B. San Francisco  
Order yours now for immediate shipment.

Tell them that you saw it in RADIO

mark the first step toward the modern development of radio transmission and reception. Because of his very crude apparatus, however, Hertz was not able to propagate his waves, or detect them, over distances greater than a few feet.

In 1896, the Italian, Guglielmo Marconi, at that time a young student of electricity, made the first great step toward modern radio by substituting for the metallic vanes used by Hertz an elevated vertical wire to replace one vane and a connection to the earth to take the place of the other. By this means, he was able to produce a radiating condenser of far greater capacity than that of the Hertzian vanes. He was able not only to increase the wavelength of the waves—to reduce the frequency—but also, through the increased electrostatic capacity of his radiator, to charge his transmitter with far greater power. This increase in power increased the transmitting range. By employing an aerial for receiving, in place of the loop used by Hertz, Marconi was able to detect the waves up to distances of a few miles.

There is a decided difference between the Hertzian waves and those obtained by Marconi. With the Hertzian oscillator, as the device shown in Fig. 11 is termed, the waves travel out from the vanes very much like sound or light waves; that is, unguided by any element and spreading out freely into space. With the Marconi waves, we may consider the two transmitting spark balls as inserted in the lead-in between aerial and ground. Since one end of the oscillator is grounded, as shown in Fig. 9, the waves are grounded at the lower end and hence move out from the antenna along the surface of the earth. Marconi waves are represented in Fig. 13 as leaving one side of an aerial. In reality these mounting waves completely surround the antenna in circular rows, similar to the amphitheater seats mentioned in the first assignment; they travel, as we say, "with their feet on the ground," and are thus guided by the surface of the earth not only around the curvature of the earth, but over mountains and down into valleys. Hertzian waves would shoot off on a tangent into free space, if not influenced by certain limiting factors such as the reflecting and conducting properties of the upper atmosphere.

The radio waves shown in Fig. 13 are simply electrostatic strains in the hypothetical ether, but since they are moving along the surface of the earth, they are accompanied by a movement of electrons, or an electrical current, in the earth itself. These electrons in the earth and the electrostatic strains in the space above the earth generate mag-

Continued on page 68



# Avoid That Embarrassing Moment!

**I**T TAKES long experience in "wireless" to insure production of efficient and dependable Radio Equipment. SIGNAL stands for that knowledge. SIGNAL—parts or sets—are the product of a plant that has been manufacturing telephone and telegraph equipment for over 30 years—that developed as "wireless" developed—that knows Radio from the very beginning—and whose output of Radio Equipment is made by men who have been making *that kind* of apparatus ever since it was discovered.

Radio becoming popular almost over night, created an instant demand far exceeding the supply, and brought onto the market a flood of unreliable, inadequate and disappointing material.

Avoid that "most embarrassing moment" when something goes wrong just as you expect to entertain your friends, by asking for SIGNAL when you want Radio parts or sets. You'll never be disappointed.

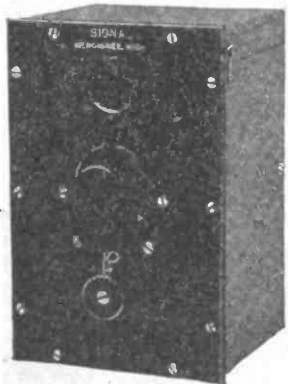

Signal Junior Detector Units. For the amateur and also the rapidly growing commercial field, we have developed an entirely new line of apparatus, in which is incorporated the very latest advancement of the science of Radio.

Each individual unit is primarily a separate and distinct device, complete in itself, yet by adding one to another any combination may be obtained, from the simple crystal detector through all the stages of radio frequency and audio frequency amplifications.

The instrument illustrated is a complete V. T. Detector Set, to be used in connection with our Midget Crystal Set, of like appearance and size, or separately with any of our standard tuners. It has our vernier type rheostat, one vacuum tube receptacle, and a potentiometer of the grid type, of great help in varying the plate potential. Every detail is in keeping with the latest requirements in radio reception. With our Midget Crystal Set it will pick up from a distance of 150 to 200 miles.

## SIGNAL Electric Mfg. Co.

Factory and General Offices:

1910 Broadway, Menominee, Mich.

Atlanta Boston Cleveland Chicago Minneapolis  
 Montreal New York Pittsburgh St. Louis  
 San Francisco Toronto

(You'll find our branch offices in the Telephone Directory)

### Coupon for Catalog of Radio Satisfaction

Signal Electric Mfg. Co., 1911 Broadway, Menominee, Mich.

Please send your interesting catalog of SIGNAL parts and sets to the name and address written on the margin of this page.



## Crosley Radio Receiving Apparatus

LINES OF FORCE to an electrician mean the invisible magnetic field set up about a magnet or coil of wire carrying an electric current. Were it not for these LINES OF FORCE, wireless communication would be impossible.

LINES OF FORCE to a manufacturer are the invisible field of Favorable Opinion set up about his product which insures steadily increasing sales. It is only when a manufacturer places on the market, articles of real merit at a legitimate cost, that his LINES OF FORCE become established.

The LINES OF FORCE created about CROSLEY Radio Instruments have made them the most attractive buy in the Radio field today. Study carefully the descriptions and prices on this and the opposite page and you will see why CROSLEY instruments carry with them the invisible LINES OF FORCE that overcome and break down sales resistance.

*Write for Catalog*

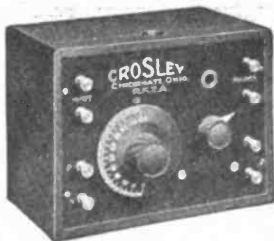

**CROSLEY RADIO FREQUENCY TUNED AMPLIFIER.** This is a unit that we have especially designed to be added to any audion detector set. This will enable you, at a very low cost, to add one stage of Tuned Radio Frequency Amplification without purchasing an entire new equipment. The R. F. T. A. not only amplifies the signals before they reach the detector, enabling it to work more efficiently, but also makes sharper tuning possible and eliminates interference to a wonderful degree. Will add at least six times the volume and range. Price, without tubes, batteries or phones.....\$15.00



**HARKO SENIOR MODEL V.** A combination Tuner and Audion Detector. Equivalent to a combination of the CROSLEY CRYSTAL RECEIVER MODEL I and CROSLEY DETECTOR UNIT. Will receive broadcasting stations up to one hundred miles. Under favorable conditions, a user in Denver has heard Schenectady with his Model. Price, without tubes, batteries or phones.....\$20.00



**TAP SWITCH**  
\$.30



**VARIO-COUPLER**  
PARTS \$1.50

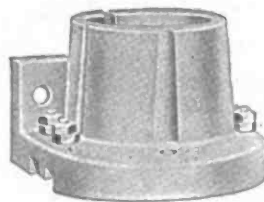

**V-T SOCKET**  
\$.50

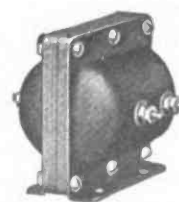

**SHELTRAN TRANSFORMER** \$4.00



**VARIO-COUPLER**  
\$3.00

Tell them that you saw it in RADIO



**MAGFON**  
\$10.00

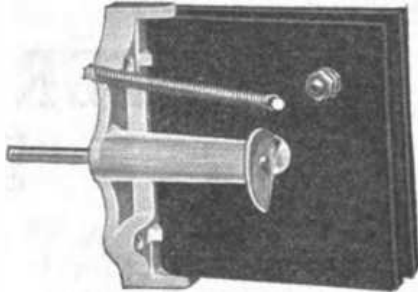

**VARIABLE CONDENSER**  
MODEL "A" \$1.25  
MODEL "B" 1.75  
MODEL "C" 2.25



**RADIO FREQUENCY  
AMPLIFYING TUNER**  
\$4.00

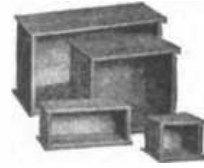

**RADIO CABINETS**  
\$2.50 to \$5.25



**BINDING POSTS**  
8c., 7½c., 10c.

THE CROSLY MANUFACTURING COMPANY makes a complete line of Radio Parts that are as good as money can buy and at about one-half the price you will pay anywhere else.

*Write for Catalog*

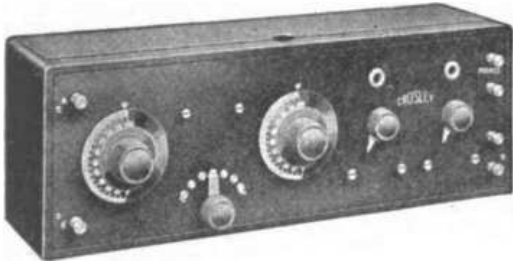

**CROSLY RECEIVER MODEL VI.** This set consists of one stage of Tuned Radio Frequency Amplification and Audion Detector. It is normally for use with head phones but is especially recommended to be used with any type of loud speaker. Additional amplification is unnecessary if head phones and horn are used in receiving local stations. Price, without phones, batteries or tubes.....\$30.00

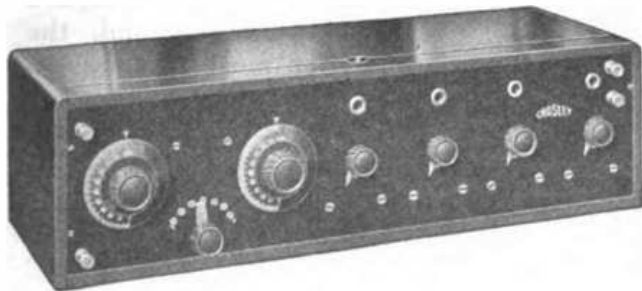

**CROSLY RECEIVER MODEL X.** Is the same as MODEL VI with two stages of Audio Frequency Amplification added. In placing this receiver on the market, we are offering you a unit whose range, volume and selectivity is remarkable. Nothing can compare with it at twice the price. Developed in the CROSLY laboratories, this unit is absolutely the last word in long range Radio Receiving Apparatus. Used with head phones and loud speaker, it will bring in distant stations all over the house. Price without phones, batteries or tubes.....\$55.00

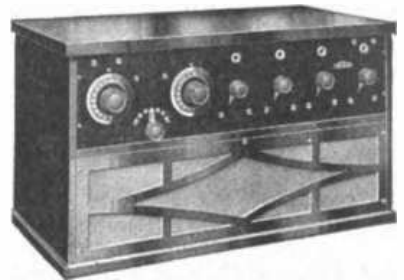

**CROSLY CRYSTAL RECEIVER MODEL XV.** A beautiful mahogany finished cabinet with amplifying compartment. The Receiver is the same as CROSLY RECEIVER MODEL X shown on this page and is the acme of efficient and beautiful construction. See below for description of RECEIVER MODEL X. Price, without phones, batteries or tubes.....\$70.00

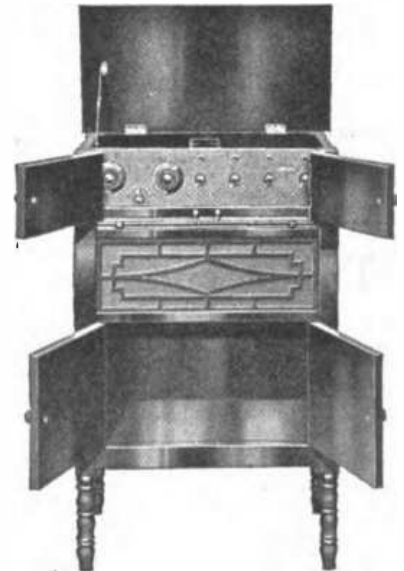

**CROSLY RECEIVER MODEL XX.** Same as the CROSLY RECEIVER MODEL XV shown above but with compartment for batteries and a board under the amplifying chamber that slips out forming a desk for the operator. Music received on these instruments will be heard through a large room and often through the entire house. Beautiful Mahogany finished cabinet. Without phones, batteries or tubes, Price.....\$100.00

### Jobbers and Dealers

If you offer CROSLY Apparatus to your trade, you will be working with the LINES OF FORCE instead of against them. The demand for CROSLY instruments is increasing by leaps and bounds. Write for our attractive discount sheet.

*Write for Catalog*

**CROSLY MANUFACTURING COMPANY**  
DEP'T. R3 CINCINNATI, OHIO

# The Triple Test Transformer

What does it mean to you?

In a market glutted with new radio products, some well made, some poorly and cheaply constructed, a few articles stand out prominently from the rest because the manufacturer employs highly competent engineers, the best of material and skilled workmanship. The RADIO SERVICE LABORATORIES goes a step further and submits each individual transformer to its famous triple test before shipping same to the jobber, dealer and ultimate user.

## The Triple Test

### First—Test of Windings

The bobbins when wound and sealed are tested for continuity of winding and for shorts and leaks.

### Second—Test of Inductance of Windings

After assembly of the bobbin within the container a careful test is made of the inductance of the primary and secondary windings and the mutual inductance of the windings to insure the consumer against any wrong connections or hasty, careless construction.

### Third—Test for Amplification

After the iron core is assembled and the transformer sealed, each transformer is given an actual circuit test in a radio amplifier; the gain in signal strength being noted over that of the detector tube alone and required to meet the gain of our standard laboratory model.

## The Result

is a Radio Frequency Transformer that increases the strength of Radio signals or waves before they are applied to the detector tube where they are made audible—

"Louder Signals with less noise  
Greater Range with same equipment."

RADIO SERVICE LABORATORIES Transformers by actual test are superior to any domestic or foreign make in the market. For sale at any electrical shop or store where Radio supplies are sold.

Special circular sent on request by the

**Rasla Sales Corporation**

National Distributors

Dept. C, 10 East 43d St., N. Y. City



The only completely shielded iron core

Continued from page 64

netic fields around them, as we learned in the first assignment. Hence radio wave propagation really consists of three factors—(1) electrostatic strains or lines of force in the space above the earth, represented by the waves of Fig. 13; (2) electrical currents in the earth, represented by the arrows of Fig. 13; (3) and electromagnetic fields both in and above the earth.

Since part of the energy of the radio wave flows through the earth, anything which will reduce the resistance of the earth or of the connection to the ground



Fig. 13. Representation of Radio Wave Propagation

at the transmitter or receiver will increase the range over which radio waves may be sent and received. Sea water is such a perfect conductor of electricity, due to the presence of salt which makes an ionized solution (see first assignment) that radio waves can be sent from two to five times as far over the ocean as over land, particularly if the latter is dry and rocky with consequent high resistance.

Aboard ship, the "ground" connection is obtained by fastening a wire to any of the steel bulkheads or decks. These form part of the complete metallic hull which is in perfect contact with the ocean water, a perfect conductor. Since resistance of the "ground" aboard ships, therefore, is usually very low, ship sets are generally very efficient in this respect. With wooden ships, it is necessary to fasten a metallic plate outboard on the hull, to which the necessary ground wire is connected.

Occasionally, where the soil is dry or the land rocky, it is necessary, in order to obtain the equivalent of the lower plate of our antenna "condenser," to string a large network of wire under the antenna, often insulated from the earth which is a poor conductor.

Such a "ground" connection is called a counterpoise.

In aircraft, where it is obviously impossible to secure a connection to the earth when in flight, a counterpoise effect is obtained by "grounding" the radio apparatus to the metallic engine, wire stays or struts, etc. The same practice is followed in installing radio equipment in automobiles. The aircraft antenna usually consists of a wire trailed below and behind the machine while in flight, although on large airplanes and dirigibles, it is possible to install a two or three wire miniature

Continued on page 70

Tell them that you saw it in RADIO

A new

# EVEREADY "B" BATTERY



No. 767

Made up of thirty large cells arranged in five rows of six cells each, gives 45 volts and is equipped with Fahnestock Spring Clips allowing the following voltages: 16½, 18, 19½, 21, 22½ and 45 volts. This is a remarkably high quality, long life battery. Dimensions: Length, 8¼"; width, 6¼"; height, 3½" over all. Weight 9 lbs. Price \$5.50.

Two important characteristics are necessary for a satisfactory "B" battery; first, the battery must be designed for long life; second, the operation must be noiseless. The Eveready "B" battery meets these exacting requirements.

## EVEREADY

Eveready "A" radio batteries are carried in stock by the best radio dealers in three different types—60, 80, and 100 ampere hour capacity. These Eveready "A" batteries have a larger capacity and give longer service and require less frequent recharge than most other batteries of this type.

Made on the Pacific Coast by the world's largest battery manufacturers.

**NATIONAL CARBON  
CO., INC.**

599 Eighth St.,  
San Francisco, Cal.

419 East 2nd St.,  
Los Angeles, Cal.

# Reliable and Beautiful RADIO-A Re-charger



The RADIO-A is a highly efficient dependable piece of apparatus, absolutely foolproof, easily attached by simply plugging into ordinary 110 volt lamp socket. In case of current failure, the unit cuts out automatically until current is resumed, without discharging battery.

It is designed expressly for re-charging radio filament batteries, but may be used for automobile or any other storage battery of reasonable size and capacity.

**PRICE \$18.50**

**DEALERS & DISTRIBUTORS**  
Here's a winner. Write us for full particulars

A compact portable Re-charging Unit that will fully charge a 100 A. H. Battery overnight, for from 5c to 10c according to prevailing rates.

**RADIO-A  
RE-CHARGER**

Simply screw into any 110 volt lamp socket and connect the terminals to your battery. Impossible to hook-up wrong. RADIO-A charges either way.

*Lasts A Lifetime*

**KING ELECTRIC MFG. CO., Inc.**  
1681 Fillmore Ave., Buffalo, N. Y.

## The New Loud Speaker Supreme!

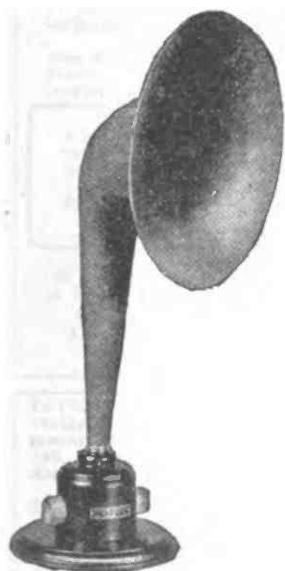

Type A-1

Scientifically designed of Non-Metallic Seamless Composition with approved wooden tone chamber in base, bringing out clear resonant Trutone values with maximum volume. Base of type A-1 is designed for ready reception of both Receivers without removing Head Band. Phones rest against Soft Rubber Ears. Horn and base finished in Black Crystalline Baked Enamel, Nickel Trimmings; 12 inch Bell stands 24 inches high.



PATENT PENDING

PRICE  
**\$6.50**  
EITHER TYPE  
Sent Postpaid  
\$7.00 East of Rockies  
Dealers: Write for discounts.

Price with both bases, \$8  
Horn without base, \$5  
Ferrule for Adapting  
Horn to Magnavox, 25c

Constructed of Seamless, Non-Metallic Composition — free from objectionable Metallic Ring. Light, durable and ornamental with base design allowing ready reception of Single Receivers — "Baldwin" and others. Horn and base finished in Black Crystalline Baked Enamel, Nickel Trimmings; 12 inch Bell stands 22 inches high. Horn fits either type base.



Type B-2

**A Perfect Radio Reproducer**

Mfgd. By **SADLER MANUFACTURING CO.**  
86 FOURTH STREET Phone Garfield 1076 SAN FRANCISCO

Tell them that you saw it in RADIO

**NOVO**  
"B"  
**BATTERIES FOR RADIO**

22½ - 45 & 105 VOLTS



**NOISELESS  
DEPENDABLE  
GUARANTEED**

**ASK YOUR DEALER**

NOVO MANUFACTURING CO.  
424-438 W. 33rd ST.  
NEW YORK  
531 SO. DEARBORN ST., CHICAGO.

## The Advice of An Expert



THIS sign on the clean plateglass window of a radio shop means that a competent radio expert is in charge within, who will gladly give you the benefit of his broad experience in selecting just the radio equipment to suit your purse and purpose.

*"It Pays to Buy at the Sorsinc Store"*  
Mr. Dealer:—If you are a progressive merchant you may display the Sorsinc sign. Let us tell you how.

**SHIP OWNERS RADIO SERVICE, Inc.**  
80 Washington St., New York  
Wholesale Distributors



**Na-ald**  
Small Space  
**V. T. Socket**  
35c. each 3 for \$1.00

Moulded genuine condensite. Requires but small space for mounting. Readily accessible binding posts. No excess metal to interfere with efficiency. Unaffected by heat of bulbs or soldering iron. Phosphor bronze contacts. Nickel plated brass binding screws. Slash cut slot. Price possible because of large production.

*Special proposition for dealers and jobbers.*

**Alden-Napier Co.**  
52 Willow St. Springfield, Mass.  
Dept. H

*Continued from page 68*  
aerial along the planes or within or on top of the gas bag itself.

We have seen that a circuit containing an alternating current of proper frequency produces an electrical wave of the same frequency. Radio reception is based on the reverse of this action. When a radio wave strikes the "condenser" of a receiving antenna, its "plates" become charged and an alternating current flows in the receiving antenna circuit, consisting of the antenna, lead-in and instruments, and ground. The frequency is equal to that of the voltage charge which builds up on the antenna and "ground plates." This frequency is that of the radio waves.

A high antenna is desirable for receiving purposes in order that as much as possible of the radio wave may be intercepted. A good ground is of paramount importance in view of the earth currents, natural and artificial, which comprise part of the wave transmission.

### FOURTH ASSIGNMENT Tuning

In the last assignment, we learned that since the discharge current of a condenser is oscillatory, it may be used as the generating current for the production of radio waves, and that it is customary to erect a huge condenser at the transmitting set in the form of an elevated aerial or antenna which serves as the radiator of these waves.

We also learned that an antenna may radiate two different types of waves—damped and undamped. The damped waves are those which are emitted from an antenna which has first been charged and has then been allowed to discharge until all of the original charge has been dissipated in the resistance of the antenna circuit and in the radiation of waves. The undamped waves are those which are radiated from an antenna which receives a fresh impulse or charge after each complete swing or cycle of antenna current, just as a clock pendulum receives a fresh impetus from the clock works after each complete swing. When the antenna receives a fresh charge after each cycle of antenna current, as is the case with transmitting sets which employ the Poulsen arc, the vacuum tube, or the Alexanderson generator as the charging source, the nature of the antenna current is very similar to that of the charging current. The difference in the radiated waves in the cases of radiotelegraphic and radiotelephonic transmission is due to the different types of transmitting apparatus which are used to charge the antenna.

With the radio telephone, in whose reception we are particularly interested, the transmitting apparatus is such that

*Continued on page 72*

Tell them that you saw it in RADIO

### "United" Radio Products

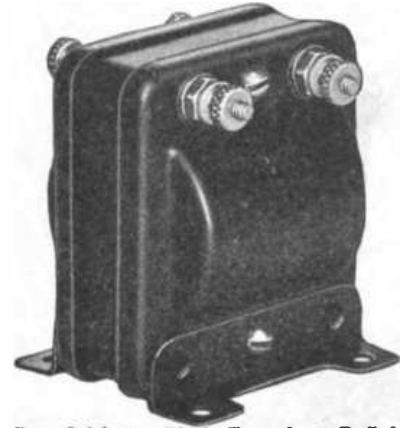

Two finishes: Black Enamel or Buffed Nickel Plated—\$4.50

### "United" Audio Frequency Transformers

The beauty of the outside of this transformer is but a reflection of the superb workmanship under the shell—no howling—no distortion—clear amplification for one or more stages.

### "United" Variable Condensers

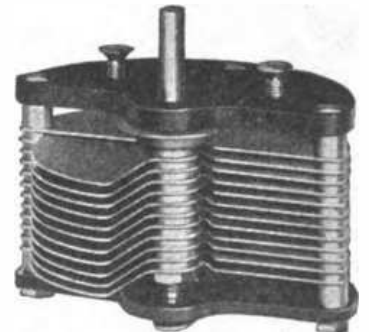

#### PRICES:

48 plate.....\$4.50 5 plate.....\$2.75  
28 plate..... 4.00 8 plate..... 2.25  
11 plate..... 3.50 without dial or knob

That "United" Condensers have become the standard with manufacturers of radio sets, by which all others are judged, is, in itself, the strongest endorsement of their superior construction and effectiveness.

Ask your dealer to show you this condenser. Then you, too, will appreciate why it has been accepted as the standard.



Mounting made easy by our template for locating panel holes; packed free with each condenser.

#### NOTE

Any advertised claim of having an arrangement with us to sell our products at special prices, is fraudulent.

**UNITED MFG. & DISTRIBUTING CO.**  
536 Lake Shore Drive, Chicago

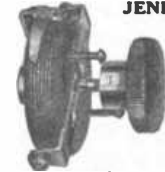

**JENKINS VERNIER RHEOSTAT**  
Indispensable for adjustment on Radio Frequency and Detector Tubes. Patent instant cut-off switch. Write for folder. Liberal discounts to dealers and jobbers.  
Manufactured and Guaranteed by  
**UNITY MANUFACTURING CO.**  
224 N. Halsted St., Chicago, Ill.  
Phone Haymarket 1519

**\$1.75**



1 to 5 springs;  
price 70c to  
\$1.10

New design: heavy phosphor-bronze springs; no spacer washers required. Write for Bulletin on these Jacks, Carter "TU-WAY" Plugs and other products.  
**CARTER RADIO CO., 209 S. State St., Chicago**



# RHAMSTINE★

## Radio Frequency Transformer

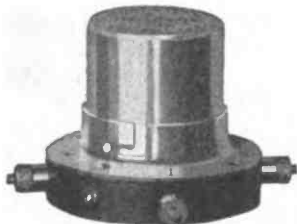

Pat. Apd. For

Complete with  
mounting

**\$4.50**  
POSTAGE 10c

Rhamstine\* has produced in this transformer every quality which you would naturally look for. In efficiency it is comparable with others costing much more and in design and finish it is doubtful if you can find its equal. Each transformer is equipped with a base mounting and sold at a price exceptionally low as compared with the high value of the unit.

Type 1, 200-500 meters, especially efficient for the present broadcasting services.  
Immediate deliveries.

## RHAMSTINE★ DETECTOR AMPLIFIER CABINET



Rhamstine\* now offers a very high grade detector-2-step amplifier cabinet composed of Rhamstine\* Products exclusively and correctly assembled in a genuine mahogany case. A number of advanced ideas are combined in this compact unit—such as the hinge panel opening forward and the sub-panel with all binding posts for rear connecting wires.

It bears the name RHAMSTINE\* which assures each purchaser that it is *guaranteed* to give *satisfaction*.

Write for complete catalog.

**\$50.00**

f. o. b. Detroit

Manufactured by

# J. THOS. RHAMSTINE★

2152 E. Larned St.

Detroit, Mich.

\*Maker of Radio Products.

Tell them that you saw it in RADIO

**"M P M"**  
MILLION POINT MINERAL

## THE WORLD'S SUPER-CRYSTAL

TESTED AND  
GUARANTEED FROM OUR OWN MINES

Sold in Red Boxes at all First-class Dealers  
—Price 40c Mounted, or Send \$1 Bill,  
M. O., or Check, for Liberal quantity  
Mounted and Unmounted Crystals,  
Tested.

San Francisco Office:

**Million Point Mineral Co.**  
1254 CLAY STREET

Dealers: Write for Prices on Highest Grades  
Mounted and Bulk Mineral.

### An All-Steel Aerial! Stronger, Safer, Lighter, Cheaper than Wood

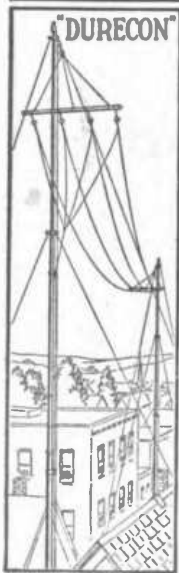

Half of radio trouble is caused by shaky, "leaky" antennae. Stop faulty operation forever with a Durecon Tubular Steel Aerial. Make your radio outfit efficient—safe—long-lived. Put it on a par with costly professional sets. Get full enjoyment out of it.

#### Easy and Quick to Erect

Light in weight—made of special analysis tubular steel. Easily put up—and stays rigid when put. This special steel resists rust and corrosion. All fittings fully covered by U. S. patents pending.

#### Comes Complete

with masts, guy anchors, plenty of tough galvanized strand wire, clamps, etc. All fittings, connections and bolts are of best quality—suitable accessories to this high grade radio necessity.

#### Get Yours Now

Avoid delays occasioned by the heavy demand already felt. Order yours now—get fullest benefit from your radio set. Write us today for complete information and prices.

#### DEALERS!

Write on your business stationery for dealer discounts. Dealers who know a good thing when they see it may be given exclusive distribution and territory rights. But act—another live-wire in your territory will if you don't, because good news spreads fast. Telegraph if you live in a city where radio trade competition is keen. Do one of the two NOW!

**Waukesha Steel Products Co.**  
Dept. 30, Waukesha, Wis.

Continued from page 70

the charging current very faithfully reproduces the vibrations of the human voice, as does the current of the ordinary wire telephone. The wave which travels out from the radiophone station is *modulated*, as we say, in accordance with the characteristic vibrations of the particular voice which is actuating it. So much for the transmitting set. We shall examine the different kinds of apparatus used for charging the antenna and for the consequent radiation of waves in later assignments. We are particularly concerned at present in providing means for their reception at some distant point.

You are probably familiar with the phenomenon of *resonance* in sound. By this we mean the "sympathetic" vibration of a body due to the vibration of another body of the same pitch. When a piano is being played, you have, no doubt, heard a vase or some similar object "hum" or vibrate when a certain key is struck. This is because the natural frequency of vibration or "pitch" of the vase is exactly the same as that of one of the strings of the piano. We say the vase is in *tune* or in resonance with that particular piano string.

In the study of sound in physics, it is a common experiment to take two tuning forks of the same pitch, to set one into vibration by striking one of its prongs on a table, then to stop it, after which it will be found that the other tuning fork is still vibrating. If the two tuning forks are not of the same pitch; however, the second fork will not respond to the sound waves emitted by the first.

This is exactly analogous to the reception of radio waves. Unless the receiving antenna circuit has the same frequency as the transmitting antenna, it will not respond to the transmitted waves, and no sound will be heard.

In the last assignment, we learned from equation (2) that the frequency of the antenna current depends upon the capacity and inductance of the antenna circuit. Obviously, unless the receiving antenna is an exact counterpart of the transmitting antenna, i. e., is of the same height and length with an equal number of wires and with all other conditions equal, it will not have the same values of capacity and inductance as the transmitting antenna. Also, in erecting a receiving antenna, it would be very difficult, if the capacity should turn out to be one-half of that of the transmitting aerial, to compensate for it with exactly twice the inductance value. We must supply some convenient means, therefore, at the receiving station so that we may make the natural frequency or wavelength of the receiving antenna equal to the frequency or wavelength of the waves from the

Continued on page 73

Tell them that you saw it in RADIO

MANUFACTURERS & JOBBERS

A  
MAILING LIST  
OF DEALERS  
to our Advertisers

The  
**RADIO RED BOOK**  
CIRCULATION 25,000

radio trade  
directory &  
buyers' guide  
120 PAGES — PRICE \$1.00

write for rates

**RADIO RED BOOK**  
PUBLISHING CO.  
406 West 31st., NEW YORK CITY

## Learn RADIO



#### At Home By Mail

Hundreds of attractive positions now open. Walter Van Nostrand is making \$3,000 a year as a Radio Inspector. George Staffa, one of our graduates, makes \$125 a month with all expenses paid. Positions up to \$10,000 a year for experts and executives. Opportunity to see the world as a ship operator, or to locate in fine position in land radio offices, or broadcasting stations. We train you by mail in a short time—Ernest Bostwick completed course, in 10 weeks. No previous experience necessary. America's first and largest Government-recognized Radio School teaches in spare time at home through personal instruction by Radio experts, and qualifies for First-Class Government License. Four automatic RADIO INSTRUMENTS loaned free while taking course. Send today for FREE Book "How to Learn Radio at Home." Give name, age, address.

National Radio Institute Dept. L-10 Washington, D. C.

**HYGRADE SPECIALS**

|   |        |
|---|--------|
| Radiotron Tubes, U.V.200-4.50-U.V. 201                  | \$5.75 |
| No. 766 Eveready Variable B. Battery                    | 1.98   |
| No. 774 Eveready Variable B. Battery                    | 3.98   |
| 45 volt Cyclone Variable B. Battery                     | 2.50   |
| Electrose Insulators, per dozen                         | 2.00   |
| 7-stranded Copper Aerial Wire, 200 ft.                  | 1.00   |
| Arkay Loud Speakers                                     | 3.89   |
| .001 M.F. Signal Variable Condensers with Dial and Knob | 3.98   |
| Thoradson Amplifying Transformers                       | 3.49   |
| Acme Amplifying Transformer (mounted)                   | 4.25   |
| Federal Amplifying Transformers                         | 5.95   |
| Skindervikin Transmitter Buttons                        | .75    |
| Firco Bull Dog Grip Phone Plug                          | .98    |
| Rheostats—Fada, 69c; De Forest                          | .98    |
| Klosner Vernier Rheostats                               | 1.15   |
| Federal 2200 Ohm Head Set                               | 6.95   |
| Dictograph 3000 Ohm Head Set                            | 9.75   |
| Western Electric Head Set                               | 11.95  |
| Baldwin Type "C" Head Set                               | 14.75  |
| Sterling Rectifier                                      | 13.95  |
| <b>"MARCO STORAGE BATTERIES"</b>                        |        |
| 6 volt 30 amp. guaranteed 2 years                       | 10.00  |
| 6 volt 60 amp. guaranteed 2 years                       | 12.95  |
| 6 volt 80 amp. guaranteed 2 years                       | 17.00  |
| 6 volt 100 amp. guaranteed 2 years                      | 21.00  |
| Above prices are F. O. B. New York                      |        |

HYGRADE ELECTRICAL NOVELTY CO.  
41 West 125th Street, New York, N. Y.

**"KELLY-DAYTON"**

VARIABLE CONDENSER with VERNIER

Most Scientifically Designed and Strongest Built

45 Plate \$5.50  
25 4.50

without Vernier, 43 Plate, \$4.00  
23 Plate, \$3.50

Made by AMERICA'S PIONEER WIRELESS EXPERT

Write for FREE copy of "Dots and Dashes"  
DAYTON RADIO MANUFACTURING CO.  
1601-7 Chapel St. DAYTON, OHIO

35c each 3 for \$1.00

**Na-ald**

Genuine CONDENSITE DIAL

The dial that runs true

Numbers engraved on bevel and knob so shaped that fingers do not hide them. Thin edge with clear graduation to make accurate reading easy. Concealed set screw in metal insert. Will not warp or chip. Finish and enamel permanent.

Low price with this quality possible only through quantity production.

Special dealer and jobber proposition. An opportunity.

Alden-Napier Co.  
52 Willow St., Springfield, Mass.  
Dept. H

**VARIABLE CONDENSERS**

PLATES 1/32" thick ALUMINUM

If in your opinion this condenser is not equal to the best on the market in workmanship, appearance and efficiency we will refund your money. Strongly built—Beautiful design—High efficiency.

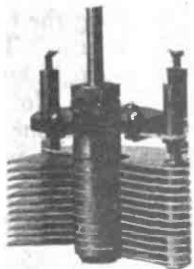

|                     |        |
|---------------------|--------|
| Type as illustrated |        |
| 48 plate .001,      | \$3.50 |
| 28 plate .0005,     | \$2.75 |
| 11 plate .00025,    | \$3    |
| 8 plate Vernier.    | \$1.25 |

**MONTROSE Mfg. Co.**

1200 Bedford Ave. Dept. P., Brooklyn, N. Y.



**Choke off that "squawk"**

**A**FTER all it is not always the bad vaudeville actors that "get the hook." Many owners have found an efficient hook to choke off the "squawk" of their radio sets and secure enjoyable music, by adding Acme Audio Frequency Amplifying Transformers to the ordinary detector unit. Acme Transformers cost but five dollars, yet the results are almost marvelous. Not only do they amplify sound, but they bring it naturally—realistically. They are necessary to the proper operation of the Acme Clear Speaker which enables a whole roomful of people to enjoy the broadcasting concerts.

In order to get more than one broadcasting station and there-by pick out the concert you like best, you should also add an

Acme Radio Frequency Transformer. This greatly increases the range of your set whether it be vacuum tube or crystal detector type. This wonderful little transformer sells for the same price as its twin brother the Acme Audio Frequency Amplifying Transformer. Your set is not complete without both these transformers and the Acme Clear Speaker.

The Acme Apparatus Company (pioneer transformer and radio engineers and manufacturers) also make detector units, the Acme-fone, Acme C. W. and Spark Transmitters, etc. Write for interesting transformer booklet if your own radio or electrical dealer cannot supply you. The Acme Apparatus Company, Cambridge, Mass., U.S.A., New York Sales Office, 1270 Broadway.

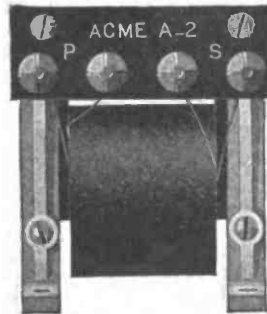

Type A-2 Acme Amplifying Transformer  
Price \$5 (East of Rocky Mts.)

**ACME**  
*for amplification*

Tell them that you saw it in RADIO

# Superior

**MASTER Radio Parts insure satisfactory reception for YOUR receiving set, no matter what make. MASTER Parts are SUPERIOR in design, workmanship and finish and are made to last. On the basis of Performance alone they are worthy your careful investigation.**

The MASTER Radio Dial is so finely finished—the knob is extra large and tapered just right to fit the fingers and thumb—the numerals are so clearly defined and easily read—that you realize, as soon as you see them, why they are called MASTER Dials. Made of genuine Bakelite, moulded in one piece and heavily reinforced to prevent warping. Look for this reinforcement: it is an exclusive feature. Diameter 3 inches; depth 1 3/8 inches.

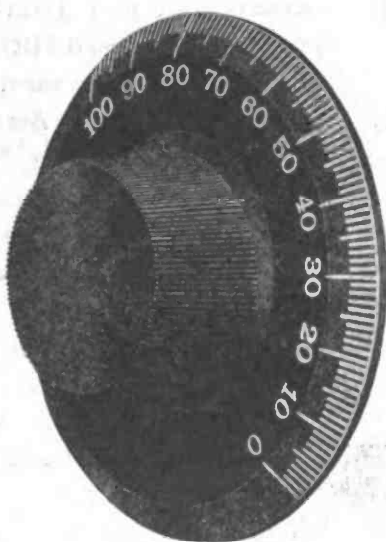

Note the depth and tapering of the knob.

Master Dials, 75c  
Master Rheostats with knob, \$1.25  
without knob, \$1.10

Jobbers: Write us for attractive proposition. Good territory open.



MASTER Rheostats positively eliminate the objectionable grating, or clicking of the contact arm. Their smooth, noiseless operation will prove a delight to Radio fans. MASTER Rheostats are made for regulation of filament current in receiving tubes, with a resistance of 6 ohms and a current carrying capacity of 1.6 amps; also for regulation of filament current in 5 watt transmitting tubes, with a resistance of 2.5 ohms and a current carrying capacity of 2.5 amps.



Trade Mark

**UNION CONSTRUCTION CO**

Oakland California

Tell them that you saw it in RADIO

Continued from page 72

transmitter which we desire to receive. Obviously, if the natural wavelength of the receiver is greater than that of the transmitter, we must be able to reduce it by the necessary amount, and if its wavelength is too low, we must be able to increase it to that of the transmitter.

Since frequency, as we have seen, depends upon the capacity and inductance of the circuit, we must supply either or both in such manner that we may vary them so as to make the receiver in resonance with the frequency of any particular wave which we desire to receive.

A variable condenser is one whose capacity may be varied by sliding or rotating one set of plates insulated by air from a set of stationary plates so that the active area of the opposing plates is increased or decreased. If we insert one of these condensers in series

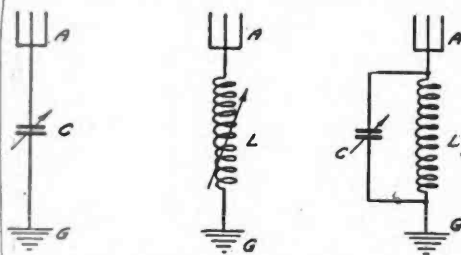

Fig. 14. Capacitive Reduction active circuit. Fig. 15. Inductive Increase active circuit. Fig. 16. Shunted active circuit.

with the receiving antenna as shown in Fig. 14, the wavelength of the receiving antenna may be reduced to almost one-half its natural wavelength. Its natural frequency of vibration will, therefore, be almost doubled.

On the other hand, if we insert variable inductance in series with the antenna and ground, as shown in Fig. 15, we may increase the natural wavelength of the antenna an indefinite amount, solely dependent upon the size and number of turns of wire in the inductance.

The variable inductance shown in Fig. 15 may take the form of a single slide tuning coil. This consists of a cardboard or fiber tube, from 2 to 4 ins. in diameter. On the tube is wound one layer of insulated wire, arranged with the insulation removed for a distance of about 1/2 in. on each turn and along the entire length of the coil, so that a slider may be run along the coil, making contact with each turn. The wire is usually "magnet wire," ranging in size from No. 22 to No. 28 B. & S. gauge, insulated with one or two layers of cotton or silk, or with enamel lacquer.

If the inductance is not variable, i. e. if it consists of a coil of wire of approximately the correct amount for increasing the wavelength of the antenna

Continued on page 75

Continued from page 74

circuit, we may *shunt* a variable condenser across the inductance as shown in Fig. 16. In this case the condenser will increase the wavelength above that of the antenna circuit with the coil included in it.

Thus, let us suppose that the natural wavelength of the antenna is 280 meters, and it is desired to receive from a broadcasting radiophone station whose transmitting antenna wavelength is 360 meters. We may add a fixed coil to the antenna as in Fig. 16, which may increase the wavelength of the antenna to 325 meters, and by means of a variable condenser whose maximum capacity is

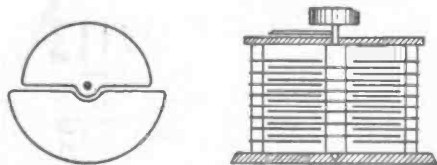

Fig. 17. Plan and Cross Section of Variable Condenser

0.001 microfarads (the customary abbreviation is 0.001 m. f.) we can increase the wavelength to exactly 360 meters without rotating all of the movable plates of the condenser within the fixed ones. Under the conditions noted above, we should probably be able to tune the antenna circuit to something more than 400 meters by using all of the capacity available in the condenser.

Fig. 17 shows the plan and cross-section views of a typical variable condenser, using air as the dielectric. Such a condenser may be enclosed in a glass case and castor oil used as the dielectric, in which case it will have a very much greater capacity.

In most receiving circuits, it is necessary to have some inductance in the circuit in order to transfer energy by inductive means to another circuit. (We shall go into this phase a little later in this assignment.) If the addition of this necessary inductance increases the wavelength of the antenna circuit above that of the wave which we desire to receive, a variable condenser may be inserted in series with the inductance as shown in Fig. 18. This will permit the wavelength to be reduced to the natural wavelength of the antenna, i. e., its wavelength before either the inductance or capacity were inserted, or even below this value.

Some times, in order to receive both long and short waves, it is desirable to connect the variable condenser both in series with the inductance for short waves and in shunt, or parallel, with the inductance for long waves. This is most easily effected by means of a series-parallel switch which is commonly supplied on many receivers. This switch consists of two switch blades

Continued on page 76

# Quality

The High **QUALITY** of **MASTER** Radio Products is so very apparent as to place them in a class by themselves. They are made by a company noted, in many other lines of industry, for the high character of its products. You will get best results by putting **MASTER** Radio Parts on your Radio Receiver.

**MASTER** V. T. Sockets incorporate many **NEW** and **EXCLUSIVE FEATURES** which develop efficient reception in a Radio Receiver. Side contacts not only hold the tube absolutely stationary and insure positive contact, but also serve to wipe clean, the prongs of the vacuum tube each time the tube is inserted. The base is genuine Bakelite.

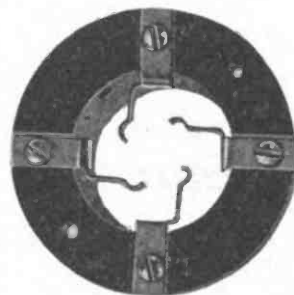

Take particular notice of the sturdy contacts—something new.

**MASTER** Audio Frequency Transformers do eliminate ordinary howling and distortion. Both mechanically and electrically they are as good as skilled engineers and workmen can produce. They are compact and rugged, the core is constructed of staggered laminations of the highest quality silicon steel, carefully assembled and by means of four projecting feet may be mounted in any position—a decided advantage.

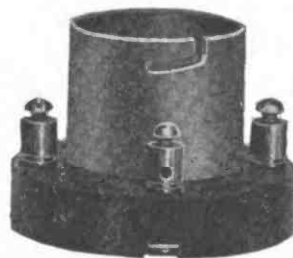

Master Sockets \$1.25



Master Audio Frequency Transformer \$5.00

**ALL MASTER RADIO PRODUCTS** are fully guaranteed free from all defects of any kind. The **MASTER** trademark is your assurance of quality. **ASK YOUR DEALER** to show you **MASTER RADIO PRODUCTS**—or write us direct for descriptive bulletins.



Trade Mark

**UNION CONSTRUCTION CO**

Oakland California

Tell them that you saw it in RADIO



**American Electric**  
HIGH EFFICIENCY  
**HEAD SETS**

Army and Navy Type:  
2500 ohm, per pair.....\$10.00  
2800 ohm, per pair.....\$12.00  
Swedish-American Type:  
2200 ohm, per pair.....\$8.00  
Victor Type:  
Double pole, single coil, per pair..\$6.00

**American Electric**  
COMPANY

CHICAGO, U. S. A.  
For 30 Years Makers of Good Telephones

**RADIO MAILING LISTS**

9270 Retail Radio Dealers by states.....per M. \$7.50  
1064 Radio Manufacturers.....per list 10.00  
1230 Radio Supply Jobbers.....per list 12.50  
260 Radio Stations.....per list 4.00  
14,000 Radio Mfrs. & Managers of Radio  
Stations.....per M. 7.50  
Guaranteed 96% correct. Send remittance for what you  
order.

**TRADE CIRCULAR ADDRESSING CO.**  
166 W. ADAMS ST., CHICAGO, ILL.

**ANTENELLA**

No antenna or aerial needed



Does away entirely with antenna and all outside wiring, lightning arresters, switches and all other inconveniences.

ANTENELLA enables you to enjoy Radio pleasures in any room in your house. Place your receiving set anywhere and merely attach Antenella to any electric light socket. No current consumed.

At your dealer's—\$2.00

If he can't supply you send purchase price and you will be supplied promptly without further charge.

**Chas. Freshman Company, Inc.**

290 Hudson Street New York City

Continued from page 75

operated simultaneously by a single knob, as shown in Figs. 19 and 20. If you will carefully trace the wiring of Fig. 19, you will see that when the switch is in the position shown the condenser is in parallel with the inductance as in Fig. 16, while in Fig. 20 it is in series with the inductance as in Fig. 18.

In the last assignment, we learned that the frequency of the discharge current of the transmitting condenser or antenna circuit "is that which automatically, we might say, gives equal values of inductive and capacitive reactance, so that in a freely oscillating circuit, the combined inductive and capaci-

antenna has a certain amount of inductance by virtue of its shape, just as every wire has a certain value of inductance although this value is increased if the wire is wound in the form of one or more turns. And similarly, in Fig. 15, the inductance shown offsets the natural capacity of the antenna. (See Fig. 10.)

In the first assignment we learned that an alternating current circuit is said to be in resonance when the inductive reactance is exactly balanced by the capacitive reactance and in this assignment we have learned that the receiving antenna is in resonance with the transmitting antenna when the in-

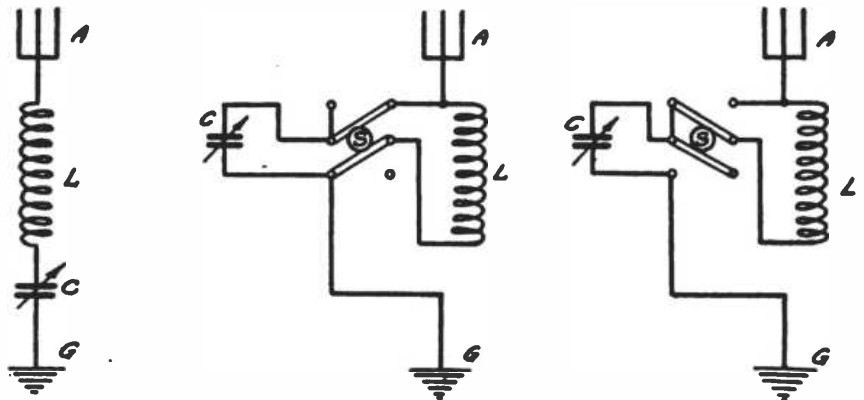

Fig. 18. Condenser in Series Fig. 19. Condenser in Paral- Fig. 20. Condenser in Series with Inductance lel with Inductance with Inductance

tive reactance is zero and the impedance of the circuit is equal to its resistance." Since we are tuning the receiving antenna circuit so that it will have the same frequency as the transmitting circuit, obviously we must be varying either the inductance or the condenser so that the inductive and capacitive reactances of the receiving antenna circuit will also be equal and hence neutralize each other for that particular frequency. Thus, we are eliminating all reactance from the impedance of the receiving antenna at the particular frequency which we are receiving, so that the only impedance offered the current set up in the receiving antenna by the radio wave is that of the resistance of the circuit.

While in Fig. 14 it would appear that we have only a condenser in the circuit and hence there is no inductance for it to offset, the fact is that every

ductive and capacitive reactances of the receiving antenna are balanced or equal for the particular frequency which the transmitting antenna is radiating. You can see, then, that the two definitions of resonance as we have learned them are really identical.

After all, radio circuits are simply alternating current circuits of higher frequency than we commonly meet in practice, so that the more you know or may learn about alternating current, the easier it will be for you to understand the operation of radio circuits.

With tuning forks, full advantage of the principle of resonance can be obtained only when the vibrations of the first fork are feebly damped, i. e., when they do not die out too suddenly. The vibrations picked up by the second fork will not reach any great strength or amplitude if the prongs of the first fork

Continued on page 78

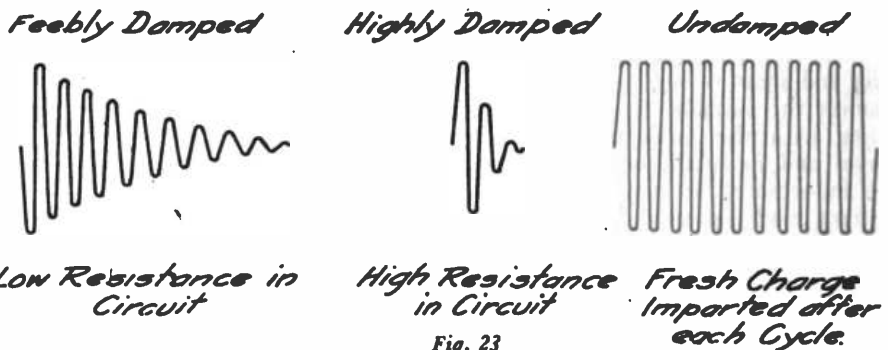

Fig. 23

Tell them that you saw it in RADIO



**STEINMETZ APPARATUS**  
STEINMETZ CRYSTAL SET \$9.50

A highly efficient set with an extremely neat appearance. Has bakelite panel with variometer tuning unit, all metal parts, nickel plated.

STEINMETZ crystal set unassembled, \$6.90  
STEINMETZ VACUUM TUBE DETECTOR UNIT, \$6.50; unassembled.....\$3.90  
STEINMETZ detector and two stage, \$22.50; unassembled.....\$16.80  
2000 ohm headsets, \$5.00; 3000 ohm, \$6.50;  
1000 ohm phone, \$1.75  
Catalog free at your dealer's, or  
STEINMETZ WIRELESS MFG. CO  
5706 Penn. Ave. Pittsburgh, Pa.

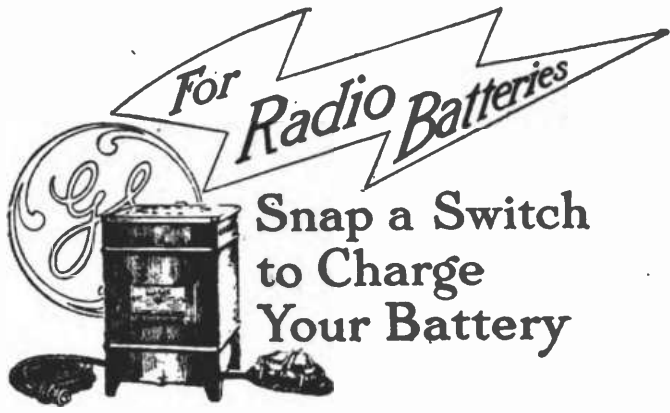

For Radio Batteries

Snap a Switch to Charge Your Battery

If you have a radio receiving set using a storage battery, haven't you often wished for a simple efficient means for recharging this battery without lugging it away to a service station?



charges storage batteries from any alternating current lighting circuit with a minimum of expense and trouble. You can do your charging right in your own home and without lifting the battery from its present position.

The Tungar is not new—thousands have been used for charging automobile starting and lighting batteries for years. Tungar has no moving parts to wear out or require oil. It requires no attention while charging but may safely be left on the battery all night.

If your dealer in radio or other electrical supplies does not carry Tungar, write us and we will send you literature and tell you where you can get one.

**General Electric Company**  
General Office Schenectady, N.Y. Sales Offices in all large cities 35A 80C

**Announcing**  
The Lamb Vacuum Tube Detector Set  
Type RVD-1

Complete assembly of parts all ready to BUILD YOUR OWN. A Vacuum Tube Receiver that produces wonderful results. A set that will give you real service. Shipped in attractive box complete with blue print of wiring connections and instructions for assembly.

You Will Be Proud of Your Set



RVD-1 Completed Assembly

**It's Perfect!**

And Only

**\$20.00**

(Code word READING)

**Build It Yourself**

With an approximate range of 100 miles Radius and often more. Can be used with 2 Stage Amplifier and loud speaker. Ask your dealer, if not available from him, order direct from us. Immediate delivery on receipt of remittance.

Special discount to dealers, of course!

**F. Jos. Lamb Co.**

Manufacturers of Radio Equipment

1940 Franklin St.,

Detroit, Mich.

**Most Complete Radio Stock in**

**DENVER**

Clapp-Eastham Receiving  
Grebe Receiving  
Kennedy Receiving  
Murdock Equipment

Jewell Meters  
Acme Transformers  
ESCO Motor Generators  
Eby Binding Posts

Send 15c for our "Radio Guide"—Refund on first order of \$5 or over

**Operating KLZ and 9ZAF**

**REYNOLDS RADIO CO., Inc.**

1524 Glenarm Street

**DENVER**

COLORADO

Tell them that you saw it in RADIO

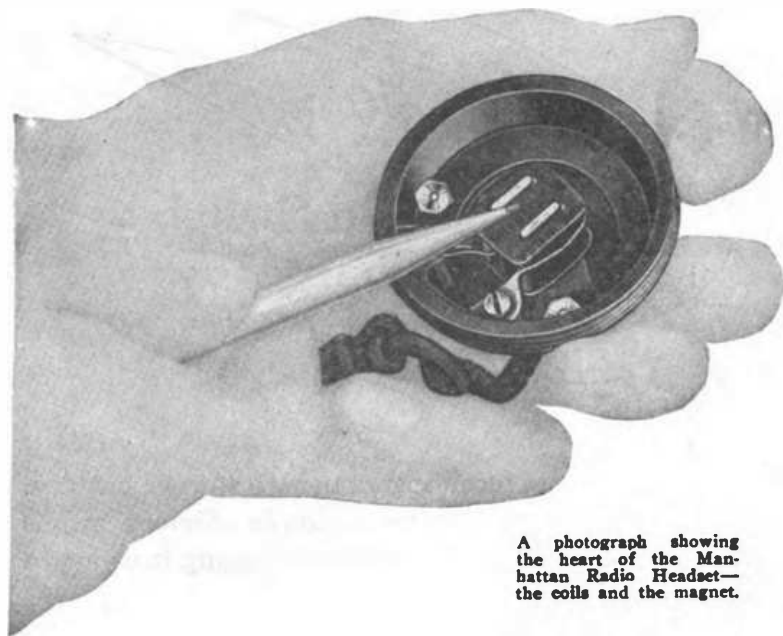

A photograph showing the heart of the Manhattan Radio Headset—the coils and the magnet.

## It's What's Inside the Receiver Case that Counts

**R**EMOVE the cover of a Manhattan Radio Headset. Note the large horse-shoe magnet. It is made of Tungsten Steel—the most expensive material for permanent magnets, and the best because of its hardness and property of retaining magnetism indefinitely.

In the center of the case is the electro-magnet with its pole pieces made of Silicon Steel. Energy received from a wireless message is exerted on the diaphragm through the pole pieces. If the pole pieces absorb any of this energy, the pull on the diaphragm is less and the performance of the Headset weakened. Silicon Steel pole pieces cut down energy loss, and give strong signals.

These are two points in the interior construction of Manhattan Headsets which make for superiority.

Look for the Manhattan Headset box on your radio dealer's shelf. It's illustrated below. All genuine Manhattan Radio Headsets may be identified by the "M-Seal-Flash" on the back of each receiver case. It's your guarantee of quality.

**MANHATTAN**  
ELECTRICAL SUPPLY CO., INC.  
*Makers of the Famous Red Seal Dry Batteries  
and Manhattan Headsets*

NEW YORK  
17 Park Place

CHICAGO  
114 So. Wells St.

ST. LOUIS  
1106 Pine St.

SAN FRANCISCO  
604 Mission St.



Next month we will tell you more about the "heart of the Manhattan Headset."

No. 2501  
3,000 Ohms  
**\$7.00**

No. 2500  
2,000 Ohms  
**\$6.00**

Tell them that you saw it in RADIO

*Continued from page 76*

vibrate only a few times. The vibrations of the second fork are built up only by the cumulative action of a series of waves striking it, each wave being of almost equal strength to that of the one which preceded it. If we should seize the prongs of the first fork after one or two vibrations have taken place so as to check or damp its vibrations, there would not be enough waves radiated to produce much effect on the second fork. Similarly, if we should hold the prongs of the second fork, even though those of the first fork were left free to vibrate, it would be impossible for the second fork to assume much vibration from the waves radiated by the first.

The same phenomena may be observed in radio circuits. We learned from the last assignment that if the resistance of a circuit is too great, its effect is equivalent to the damping effect of the hand upon the prongs. The circuit will not oscillate, or if at all—only feebly, i. e., for a few swings or cycles.

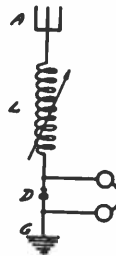

Fig. 21. Detector in Antenna Circuit

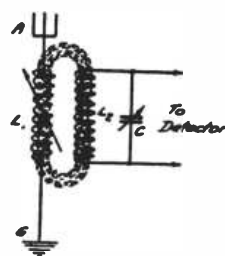

Fig. 22. Coupled Circuit

The detector is the device in the receiving set, which, after the received current is made as large as possible through the proper tuning, transforms the current into a form suitable for actuating the telephone receivers by means of which the sounds are actually heard. It is a characteristic feature of detectors that they all possess high resistance.

In the first receiving circuits which were invented by Marconi, the detector was inserted directly in the antenna circuit and the telephone receivers were connected directly across it, as shown in Fig. 21. The high resistance of the detector, however, not only greatly reduced the value of the current flowing in the antenna circuit, which resulted in the production of only very weak sounds in the telephone receivers, but the damping effect of this resistance prevented the antenna from oscillating except for a few cycles. The principle of resonance, therefore, could not be fully taken advantage of, and instead of responding to waves of only one frequency, for a particular value of inductance used, as an efficient receiver should, it responded almost equally well to waves of any frequency.

*Continued on page 79*



Continued from page 78

It became necessary, therefore, to remove the detector from the antenna circuit in order to reduce the antenna resistance and to couple it to the antenna circuit by means of another inductance, so that the antenna would have inserted in it only an inductance—and a condenser, if necessary.

Fig. 22 represents the arrangement by which the detector circuit may be coupled to the antenna through the medium of a two-coil combination, such a combination being variously termed a *receiving transformer*, *loose coupler*, or *vario-coupler*, according to the form in which these two coils are made and the manner in which they are operated.

We learned in the first assignment that an alternating current in one coil will induce an alternating potential across the terminals of another coil placed near enough to it so that the rising and falling magnetic field produced in the first coil, from the alternating current flowing in it, will intersect or pass through the second coil. This field is shown in dotted lines in Fig. 22. It is this principle of electromagnetic induction, which we studied in the first assignment, that makes it possible for us to transfer energy from the antenna circuit of the receiver to the detector circuit coupled to it, even though there is no actual electrical connection between the two circuits.

The frequency of the alternating potential induced across the second or *secondary* coil—the coil in the antenna circuit is called the *primary* coil, for obvious reasons—is exactly that of the current flowing in the antenna circuit. To secure a maximum flow of current in the detector circuit, therefore, we must supply the variable condenser shown in Fig. 22 in order that its reactance may neutralize the reactance of the secondary coil by means of proper tuning.

Thus, with a receiving transformer, and most receivers employ one in some form, we must not only tune the antenna or primary circuit to resonance with the incoming wave but we must also tune the secondary circuit to resonance with the primary. That is to say, we must tune each circuit so that its frequency will be equal to that of the radio wave which we desire to receive, or what is the same thing, we must balance the inductive and capacitive reactances of each circuit so that they will be neutralized at the frequency of the received radio wave.

The practical methods by which this is accomplished will be discussed in the next two assignments.

# Distortion Kills Music

## The Curves Show Why

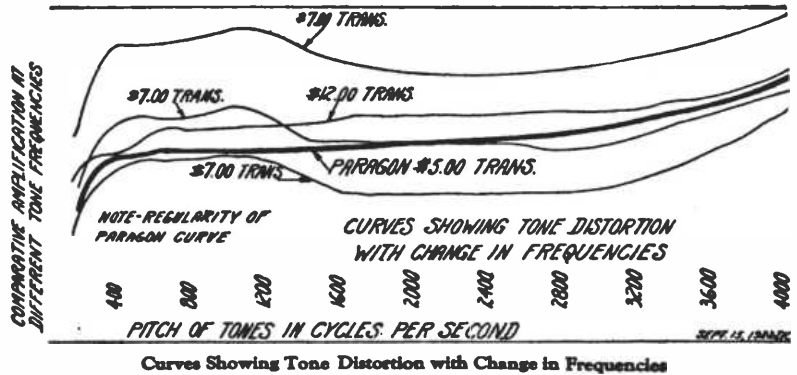

Unless the Amplifier Transformer favors all tones in exactly the same manner, distortion will result. Notwithstanding their high prices some of the transformers whose curves are

shown above are totally unsuited to radio-phone reception. When you build use PARAGON, the same as is used in the Famous Paragon DA-2 Amplifier.

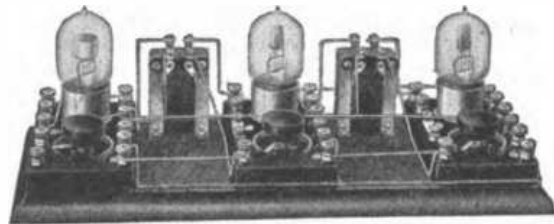

A Home-Built Paragon Amplifier

This illustration shows PARAGON VT Controls (Price \$6.00) and the PARAGON Amplifier Transformer (Price \$5.00) built into a Detector two step unit. The combination gives you a handsome high-grade instrument, low in price but highly efficient and absolutely without distortion.

PARAGON VT Controls (Patented) may be used to control vacuum tubes wherever they are used as detector, oscillator, trans-

mitter, and in cascade for radio and audio frequency amplifiers. An extremely useful and good looking unit. Comprises standard socket, famous PARAGON rheostat, grid condenser, provision for grid leak and all necessary circuit terminals. If your dealer does not stock these Paragon Products, we will see that you are promptly supplied. Write for booklet which will tell you the many uses for this efficient and compact mounting.

ADAMS-MORGAN CO., 2 Alvin Ave., Upper Montclair, N. J.

# PARAGON

Reg. U. S. Pat. Off.

## RADIO PRODUCTS

From San Francisco to New York is so far that the cuts for this advertisement did not reach "RADIO" in time. You can, however, get all the news about

### Roller-Smith Universal Phones and Loud Speakers

by sending for new Bulletin No. A1 twenty

Distributors write for attractive proposition

MAIN OFFICE  
20 Park Place, New York

**ROLLER-SMITH COMPANY**  
Electrical Instruments, Meters and Circuit Breakers

WORKS  
Bethlehem, Penna.

Offices in Principal Cities in U. S. and Canada

Tell them that you saw it 'n RADIO

A  
Better Rheostat  
for 75 cents

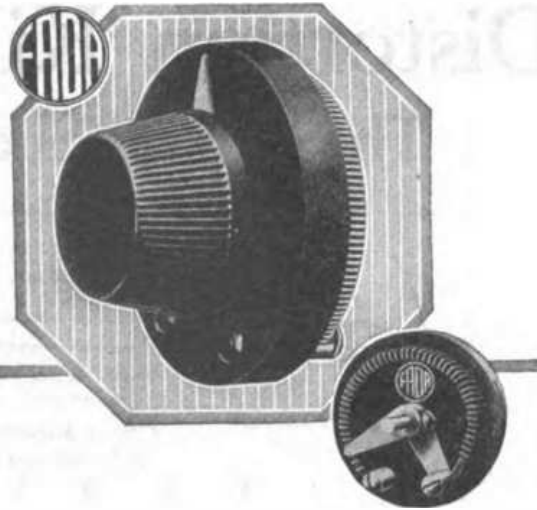

Half Million "Radio Fans" Bought  
Fada Rheostats in 1921

An unquestionable attribute to the merit of Fada rheostats is the universal approval of over half a million satisfied users.

As a parallel to this achievement, Fada announces a new rheostat—a better instrument for less money. This new Fada rheostat, using a special hard fiber resistor strip, represents the peak in rheostat design and finish.

This new fiber strip is specially treated and will not absorb moisture and corrode the wires. A notable advance in rheostat manufacture.

The new Fada rheostat, as a whole, is designed for use by those radio experts who love to construct and who take great interest in the appearance and efficiency of their set.

Truly, this is the rheostat you can buy with supreme confidence; one "you" can assemble in your radio set with genuine pride.

New grade hard fiber—  
will not absorb moisture  
and corrode wires.



FRANK A. D. ANDREA  
1581-F Jerome Ave. New York City

\$4.75

\$1.00

\$27.00



JEWELL  
VERNIER RHEOSTAT

The Jewell vernier rheostat is extremely simple and substantial in construction, employing a new principle of contact which we have patented. Made of the highest grade bakelite and using the best resistance wire obtainable. Very fine adjustments are obtained by a single turn of the knob. Ask your dealer or write to us for special circular.

Price \$1.00

Jewell Electrical Instrument Co.

1650 WALNUT ST. - CHICAGO

Tell them that you saw it in RADIO

SCRATCHI JOINS THE  
CLUSTER

Continued from page 18

still doing some adjusting with results that should not be mentioned. Much of time he get sound which resemble Chinese jazz-hound playing "Puppy on the Keyhole" with variation, and some more of time resemble saxafony solo by Broody Heesoft, mingled up with shriekings of the dying victims. He explanate to me very copiously how the radio freakwent griddle bias must be held down negatively or by force if necessary so as to give the intrushing positive electrons fine opportunity to snick across to hot plate serkit, and he quite gently turn each knob after the other, but nothing come in from outside. As every ham say sometime, "Not even static."

When my Cousin trot out for new something or another, like he do so every 40 or 37 minutes, I take turn at adjusting dials and filaments and other nknaks which overcrowd every squared inch of table top, and once or thrice I think I hear some music, but are not sure as power tube, which are really vicious animal, make most hair-curling moanings and groanings. I endeavor to cease these and vary the tickling and etc. but only change are for worse. If grand old General Sherman could hear such wearied squealings and squawkings and screamings and howlings that struggled fourth from this much spoke-about combination, he would modulate formal opinion about war.

I try to dissuade my Cousin to donate entire fitout to some sweetish charity, but he say that lots of other radio experts like himself tell him they have most astonished success, although when he ask to visit them and hear this wonderful loud-noiser, their battery are always in ran down condition.

My Cousin are spending more than I can afford, Mr. Editor, and are ruining his indigestion and my distemper. He have even sniggest to take aparts my Sphinx receiver, which are as good and a half as his Stupor Generator, and if he continue along these lines there are going to be social function held at our place by the Hon. Coroner, and the guest of honor will not be

Yours superstitiously,  
HILOLI NOGO.

CALLS HEARD

BY 7KH, ASTORIA, OREGON

- 5cn, 6zf, 6aas, 6xaq, 6oo, 6wj, 6pw, 6ajr, 6amk, 6asj, 6fh, 6ka, 6acr, 6ala, 6jd, 6bql, 6tu, 6sx, 6bqc, 6bog, 6ss, 6sm, 6ac, 6ku, 6bcj, 6awt, 6ajh, 6xad, 6cp, 6abx, 6gx, 6bum, 7ya, 7mp, 7mf, 7nf, 7sm, 7kc, 7yl, 7sa, 7hd, 7wg, 7sav, 7dp, 7jd, 7so, 7sj, 7go, 7qg, 7kj, 7wm, 7bk, 7ar, 7sc, 7jf, 7fr, 7qw, 7bq, 7jw, 7lw, 7os, 7zb, 7vo, 7mc, 7zg, 7lu, 7rd, 7su, 9bd.

Announcing —

# The New "All-American" Audio Frequency Transformers

(COMPLETELY SHIELDED)

*Amplification — the Soul of Radio*

However perfect your set may be, the least fault in your Radio or Audio Amplification takes the heart and soul out of your receiving set.

## "All-American" Transformers

Perfected, first, from the stand-point of *correct* engineering, by proper turns ratio, impedance and shielding — then, in our latest models, given the finishing touches of outward beauty that the more critical eye demanded. The shielding is a highly polished, heavily nickeled brass case.

The new R-21, Ratio 5 to 1 has an amplification constant approximately equal to that of our R-13 (10 to 1) but can be used on as high as three stages without distortion or howling.

Send for bulletin No. 22, showing successful Radio and Audio Frequency hook-ups. *Your dealer has "All-American" Transformers.*

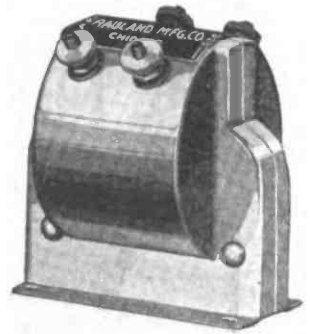

Type R-12  
Ratio 3-1  
**\$4.50**

Type R-13  
Ratio 10-1  
and  
Type R-21  
Ratio 5-1  
**\$4.75**



# RAULAND MFG. CO.

35 So. Dearborn St., Chicago, Ill.



## Frederick H. Pruden

Incorporated



A name in Radio that sets a new standard for Quality, Workmanship and Service. An organization of experienced radio men that have been conservative rather than impulsive.

In a business that has been literally "talked to death," a business that has been greatly damaged in public respect and support by insane publicity and ignorant merchandising methods, our organization has had the sense to work hard, use its intelligence and keep its mouth closed tight.

Now, for the first time in over seven months, we make our first announcement to the jobbers and dealers of the country—of the best products on the market, giving maximum satisfaction and service—at the right prices. That is why you will find the best radio jobbers and dealers featuring our

### QUALITY RADIO PRODUCTS

Dictograph Headsets      Dictograph Loudspeakers  
Cutting & Washington Radio Sets  
Universal 3 Plate Vernier  
23 and 43 plate condensers  
Keystone Moulded Variometers and Variocouplers  
Radio Storage "A" and "B" Batteries  
Rheostats—Sockets—Crystal Detectors  
Three-Inch Bakelite Dials

We are direct factors for manufacturers of products of the highest reputation. Demand these products from your dealer! If he cannot supply you, order direct from us and send us the name of your dealer. Jobbers and dealers, get acquainted with the biggest proposition in Radio—TODAY!

### Frederick H. Pruden, Incorporated

FREDERICK H. PRUDEN      GEORGE E. HOLMES  
President      Vice-President and Treasurer  
General Offices:  
Lerner Building, 997 Bergen Avenue, Jersey City, N. J.

*Heslar Radio makes the world your neighbor*



**HESLAR**  
Equa Tone  
**PHONES**

for clear  
Radio

Reception

2200 Ohm, \$10

3200 Ohm, \$12

Efficient, attractive, durable, sensitive. Heslar Phones register the most delicate sounds with clearness and the audibility of both phones is precisely the same. Comfortable to the head. Heslar Phones are on a par in every way with the most expensive head sets. Be sure you get HESLAR EQUA-TONE PHONES. You will notice a difference.

# HESLAR

Radio Corporation  
Indianapolis, U. S. A.

Tell them that you saw it in RADIO

TRADE MARK  
**METRO**



## The LITTLE GIANT Outfit

*The Gift That Everybody's Sure to Like*

**G**IVE someone the endless pleasures of radio entertainment with an outfit that anyone even if they know nothing of radio can operate ten minutes after unpacking. Give them the Little Giant that brings in the entertainment so marvelously clear and natural. Costs nothing to maintain and never gets out of order.

The attractive Holly Box contains everything needed to receive the radio programs. The Little Giant Set, Metro Headphones, aerial wire, insulator, ground clamp, ground wire and all accessories. The Little Giant is wonderfully compact and finished as beautifully as a high class phonograph. Every outfit is unconditionally guaranteed to operate perfectly. Can you think of anything you can give that would be more acceptable? It is the ideal gift.

Your dealer should have his stock of Little Giant Outfits by this time. In case he has not, send us your order, mentioning your dealer's name.

**Complete  
Outfit  
NET  
\$15**

**DEALERS: The Best Value For Them—The Most Profit For You**

**METROPOLITAN RADIO CORPORATION**

67-71 Goble Street

Newark, N. J.

**TRACO**

*Loud Speaker*

**Price \$40**

Complete F. O. B. San Francisco

Vernier Controls \$1.00

THE

**Radio Appliance Co.**

INC.

1352 Divisadero Street  
San Francisco

**The Riggs Rectifier**

for charging storage batteries

110 volt, A. C. 60 cycle.

6 volt, 5 amp. D. C.

**\$12.50**

prepaid anywhere.

**W. H. RIGGS**

Box 304, Everett, Wash.

**THE RIGGS MFG. CO.**

Urbana, Ohio

Discount to Dealers

### THE ORIGINAL O. W.

*Continued from page 30*

ruffled by her—"let her have her admirers—and rave on! She looks well—knows how to dress—and is a public credit to the firm! What outsiders don't know won't hurt 'em!" So he gave her a large bank account of her own—and let it go at that.

"I had an accident today, Pater"—repeated Jr.

"Heard you the first time—but you don't show any ill effects"—grunted the powerfully built, elder man.

"No—but the girl is in the hospital!"

"Huh?"—the other put his newspaper down hastily—what's that again? 'Girl'—'hospital'?"

He listened carefully while the details were given.

"Don't see as it's your fault! Damn-fool women—cross the streets at wrong places—of course get run over! Pay the hospital bill, but that's all!" He said it with an air of finality that his business associates knew was useless to attempt—even—to modify.

"But it isn't 'all'—at all!"

"For the Lord's sake, boy; what do you want to do—marry her because she's got a few black and blue spots? Never knew you to be a sentimental fool—such as I was a few years ago!"—he added, with bitter gruffness.

Arthur felt his cheeks getting hot—"Don't be silly, Pater!" he said quickly, to cover his embarrassment at his father's shrewd gaze—"But she is very proud—and friendless. And she has that which you have always said that a man wasn't worth a damn without: the courage of her own convictions! She has an A-1 commercial radio operator's license and came from San Francisco—looking for a berth on some ship—poor youngster. Her father died, leaving the family in rather bad way, financially, I suspect. Why not give her a billet on one of the boats—the South American run is very easy—scarcely anything to do."

"What?"—exploded, the other—so that other diners wondered why Old Man Carroll was "up in the air"—"Give a woman the job as radio operator on one of my boats? And be the laughing stock of shipping circles? NOT! I've made one fool of myself—where women are concerned—that's a great sufficiency!"

"But—don't you think—?"

"'But' me no 'buts'—and 'don't you thinks'—Arthur! Pay the hospital bills—slip her anything you like—tied up in a bunch of flowers—if you feel you must do something! NIX, however, for the female operator stuff! Not as long as I am boss of the Carroll Line—and that will be a good few years—yet! What—I ask you—would a woman do in a crises—something serious? Blow

*Continued on page 34*

Tell them that you saw it in RADIO

# CLARK Vario-Antenna

A SCIENTIFIC PRODUCT



**Entirely Eliminates the Aerial**  
**EASILY TUNED TO ALL CONDITIONS**

**Price \$10.00 each**

**Cord and Plug included**

Bakelite top and bottom.  
 Heavy nickel plated metal  
 cylinder. Height 6 in.  
 Weight 26 oz.

**Send for Folder D**

Dealers: Send for Sales Help,  
 Window Cards, Folders, Etc.

Attached to Any Electric Light Socket, the Vario-Antenna does away entirely with all outside wires or aerial.

By rotating the Vernier Knob the Vario-Antenna Mechanism actually tunes both the Antenna and Ground Circuits to their maximum receiving conditions, thereby producing the pure liquid tone which places the Vario-Antenna in a class by itself.

The Vario-Antenna makes it possible to operate many receiving sets at the same time in Apartments, Hotels and Office Buildings. Will operate on any voltage up to 220, totally eliminating the alternating current hum and controls static interference.

Use the Vario-Antenna with all standard receiving sets. No electric current used. **NO DANGER, Shock Proof**; is made to conform to the requirements of the National Board of Underwriters.

A scientific device, the result of thirty-two years' experience. Not to be confused with any lamp socket device that cannot be tuned.

*DEALERS: Know that the Clark Vario-Antenna will cause a vast increase in the sales and installations of Radio Receiving Sets*

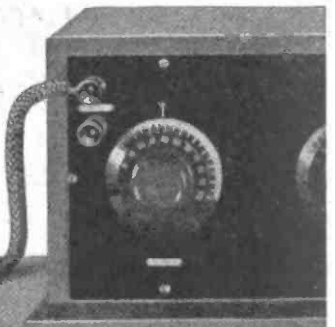

Manufactured by  
**Clark Radio Mfg. Corporation**  
 3045 Hopkins St. Oakland, Calif.

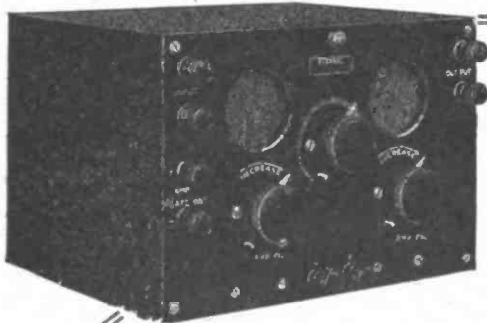

## Federal

—a  
**crowning  
 achievement**



### RADIO FREQUENCY AMPLIFYING APPARATUS INCLUDING

- |  |         |
|--|---------|
| No. 55 Federal Radio Frequency Amplifier.....                                    | \$58.00 |
| (Two Stages Radio Frequency Amplification)                                       |         |
| No. 56 Federal Radio Frequency Amplifier and Detector.....                       | 52.00   |
| (One Stage Radio Frequency and Detector)   |         |
| No. 57 Federal Radio Receiver—The Broadcast Receiver DeLuxe.....                 | 98.00   |
| (One Stage Radio Frequency—Detector—Two Stages Audio Frequency)                  |         |
| No. 58 Federal D. X. Radio Receiver—For Long Distance and Amateur Reception..... | 116.00  |
| (One Stage Radio Frequency—Detector—Two Stages Audio Frequency)                  |         |
| No. 8 Federal Audio Frequency Amplifier and Detector.....                        | 52.00   |
| (One Stage Audio Frequency and Detector)   |         |
| No. 9 Federal Audio Frequency Amplifier.....                                     | 58.00   |
| (Two Stages Audio Frequency Amplification)                                       |         |

A combination of No. 55, No. 56, No. 9, constituting three stages Radio Frequency, Detector and two stages Audio Frequency, is ideal for use with loop or other restricted antenna.

Write for Bulletin No. 119-W

## Federal Telephone & Telegraph Co.

Factory and General Offices—Buffalo, N. Y.

Western Branch—693 Mission St., San Francisco, Cal.

# ATWATER KENT

## COUPLED CIRCUIT TUNER

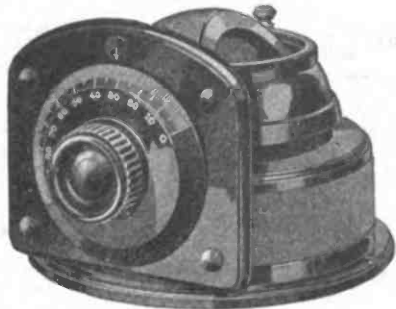

- § Simplest operation—maximum performance.
- § Takes the place of variometer and coupler.
- § Accomplishes the results with but one adjustment.
- § It is absolutely unaffected by body capacity at dial knob.

ALL INSULATING PARTS ARE STURDILY MADE OF MOULDED CONDENSITE AND THE WORKMANSHIP THROUGHOUT IS OF THE HIGHEST QUALITY.

Price \$14<sup>00</sup> An Excellent Merchandising Proposition

ATWATER KENT MANUFACTURING COMPANY

4947 STENTON AVE.

Radio Dept.

PHILADELPHIA, PA.

NOVEMBER

EMPIRE RADIO

BULLETIN

### A NEW EMPIRE PRODUCT

Built up to a standard, Not down to a price

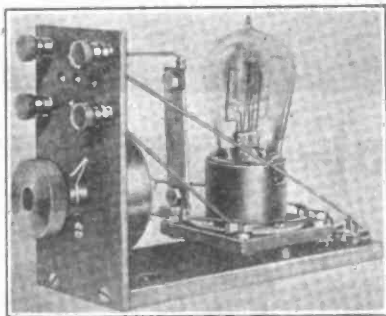

### EMPIRE AUDION DETECTOR PANEL

PRICE \$6.00

THE series of open panel units, which we usually call laboratory type instruments, are primarily designed for experimental work, tho many operators use them for short wave DX reception, broadcast, and long wave work. The idea behind these units was to make this ordinarily expensive equipment available at very low prices, yet maintain the highest quality of workmanship and materials.

We Manufacture

A COMPLETE LINE OF SETS IN UNIT FORM

Dealers and jobbers write for attractive proposition  
Amateurs send 10c for our new and complete catalog

EMPIRE RADIO CORPORATION

Manufacturers and Distributors of Radio Apparatus

271 West 125th Street

New York City

# FORMICA PANELS

CUT TO ORDER WITH SQUARE AND SMOOTH EDGES  
FROM HANDSOME, BLACK, POLISHED SHEETS 3/16" THICK

PRICE.....02 PER SQUARE INCH

IMMEDIATE SHIPMENT—POSTAGE PREPAID

DAVID RADIO SUPPLY CO.

P. O. Box 596

REEDLEY, CALIF.

Continued from page 82

up! Nothing doing! I'm off for a game of bridge—see you later." Carroll Sr. signed the check and stalked from the dining room, waiters scuttling from his path as chickens scurry at the shadow of a hawk.

Long did Arthur sit at the table, sipping his coffee, and smoking. Then he, too, arose and went to the telephone booths. Giving the operator a number—he waited.

"All ready in No. 3, Mr. Carroll, please."

When the young man came out there was a smile of satisfaction on his lips. Taking his hat from the attendant he went in the street and along the line of parked cars—to his own. A touch of the starting switch and he was soon passing along the upper reaches of Fifth Avenue—and he continued along it to a certain street—where he turned sharp west—proceeding until he came to a quiet block, but faintly lighted, that smelled of various cookings—and much humanity. But it was near deserted now. Moving slowly along the house fronts, he came to the number that he was in search of. A figure was standing at the sidewalk edge.

"I could have come downtown, sir!" expostulated Wilfred Brown, in charge of the personnel of the Carroll Line ships.

"No trouble, Brown—I needed the air, anyway! Some of it won't do you any harm. Hop in, and I'll tell you what it is that I want, as we go."

Wonderingly, the other obeyed.

Arthur did not speak until Williams-bridge was behind, and the car rolled noiselessly along the Hudson. Then he began to talk, the other listening intently.

"It'll mean my position, if your father ever finds out!"

"I'll be responsible, and see to it that you don't lose—either way. What do you say?"

"Oh—I'll—I'll do it, right enough, Mr. Arthur. But you know your father, and if he . . ."

"But he won't—not until I am ready to prove certain things to him! After that—we should worry!"

And no other word was spoken—until the dim side street was again reached.

"Good night, Brown—and many thanks!"

"That's all right, sir—good night. Thanks for the ride!"

"AND how are we, this lovely morning?" queried Arthur, cheerily, having been again piloted through the hospital corridors, carrying a bouquet of roses, that cast their delicate fragrance above the faint traces of disinfectants.

"This is kind of you, Mr. Carroll! Oh—nurse says that I shall be out sooner

Continued on page 86

Tell them that you saw it in RADIO

**BIG SUPPLY LATEST APPARATUS ON HAND READY FOR PROMPT DELIVERY**  
**FOUR HOUR MAIL ORDER SERVICE**

**WE ASSURE YOU OF THE MOST PROMPT SERVICE**

Our Radio Mail Order Service is gaining much popularity on account of the **FAST SERVICE**. We ship your order within four hours of its receipt. After you tire of waiting days—or maybe weeks—for your supplies, try Warner Brothers' Radio Mail Order Service and you will use no other. Following are a few items that we have in stock:

**VARIABLE CONDENSERS**

|                                 |        |
|---------------------------------|--------|
| .0003 17 Plates K & O Type..... | \$3.00 |
| .0005 23 Plates K & O Type..... | 3.50   |
| .001 43 Plates K & O Type.....  | 5.00   |
| .0015 63 Plates.....            | 7.20   |
| .001 43 Plate Warner.....       | 4.00   |
| .0005 23 Plate Warner.....      | 3.50   |

**LOUD SPEAKERS**

|                             |         |
|-----------------------------|---------|
| E3 Magnavox Radio Type..... | \$45.00 |
| E2 Magnavox.....            | \$5.00  |
| 38 inches long              |         |

**EVEREADY "B" BATTERIES**

|                                 |        |
|---------------------------------|--------|
| No. 765, 22½ Volts.....         | \$2.00 |
| No. 766, 22½ Volts, tapped..... | 3.00   |
| No. 774, 43 Volts, tapped.....  | 5.00   |

**REMLER APPARATUS**

|                                |        |
|--------------------------------|--------|
| 810 Jr. Rheostats.....         | \$1.00 |
| 811 Rheostats.....             | 1.75   |
| 813 3 Amp. Rheostats.....      | 1.75   |
| 330 Audion Detector Panel..... | 8.00   |
| 331 Amp. Panel.....            | 6.00   |
| 333 Amp. Panel.....            | 9.00   |
| 400 3 Coil Mounting.....       | 6.50   |
| 98 Variable Grid Leak.....     | .60    |
| 97 Grid Condenser.....         | .35    |

**SOCKETS**

|                                |      |
|--------------------------------|------|
| 154 GENERAL RADIO.....         | 1.50 |
| 550 MURDOCK.....               | 1.00 |
| DEFOREST Moulded Bakelite..... | 1.10 |
| GRONBY Porcelain.....          | .60  |
| KELLOGG.....                   | 1.00 |
| PARKIN.....                    | 1.50 |

**AMPLIFYING TRANSFORMERS**

|                               |        |
|-------------------------------|--------|
| UV-712 Radio Corporation..... | \$7.00 |
| 231A GENERAL RADIO.....       | 5.00   |
| 226W FEDERAL.....             | 7.00   |
| A2 ACME, semi-mounted.....    | 5.00   |
| Thordarson.....               | 4.00   |
| BRYANT.....                   | 5.00   |

**VARIOMETERS**

|                                  |        |
|----------------------------------|--------|
| REMLER 505 Moulded Bakelite..... | \$6.50 |
| OUB OWN TYPE.....                | 4.50   |
| ATWATER KENT.....                | 8.00   |

**JACKS AND PLUGS**

|   |        |
|---|--------|
| FEDERAL 1421 Open Circuit Jack.....               | \$ .70 |
| FEDERAL 1422 Single Circuit Jack.....             | .85    |
| FEDERAL 1423 Double Circuit Jack.....             | 1.00   |
| FEDERAL 1435 Automatic Filament Control Jack..... | 1.30   |
| FEDERAL 1438 Automatic Filament Control Jack..... | 1.30   |
| WESTERN ELECTRIC Plugs.....                       | 1.30   |
| FEDERAL Plugs.....                                | 2.00   |
| PACENT UNIVERSAL.....                             | 1.25   |
| NEW FEDERAL Universal Plug.....                   | 1.75   |
| FEDERAL PLEIPHONES.....                           | 14.00  |

**RHEOSTATS**

|   |        |
|---|--------|
| REMLER Jr.....                                    | \$1.00 |
| FADA—with new Knob.....                           | 1.00   |
| GENERAL RADIO No. 214 7 ohm or 2½ Amp. 2 ohm..... | 2.50   |
| DEFOREST, new type.....                           | 1.25   |
| PARAGON.....                                      | 1.50   |
| MURDOCK 500.....                                  | \$1.00 |

|                   |      |
|-------------------|------|
| KLOSNER.....      | 1.50 |
| JENKINS.....      | 2.00 |
| FRAMINGHAM.....   | 1.00 |
| HOWARD.....       | 1.25 |
| OUTLER HAMME..... | 1.00 |

**RADIO FREQUENCY TRANSFORMERS**

|                                    |        |
|------------------------------------|--------|
| MURAD T-11, 180 to 500 meters..... | \$8.00 |
| MURAD T-11A.....                   | 8.50   |
| MURAD T-11B.....                   | 7.00   |
| RADIO ENGE. CO.....                | 8.00   |
| UV1714.....                        | 8.50   |
| Radio Service Co.....              | 8.00   |
| Radio Instrument Co.....           | 8.00   |

**STORAGE BATTERIES**

|                                |         |
|--------------------------------|---------|
| 6 Volt 70 A. H.....            | \$16.00 |
| Philadelphia 6 V. 60 A. H..... | 16.00   |

**VARIO-COUPERS**

|                                       |        |
|---------------------------------------|--------|
| REMLER 503 Vario-Coupler.....         | \$5.40 |
| REMLER 505 Coupler on Unit Panel..... | 12.75  |
| OUB OWN TYPE.....                     | 3.50   |
| ATWATER KENT.....                     | 8.00   |

**PHONES**

|                                  |        |
|----------------------------------|--------|
| Federal, 2200 Ohms.....          | \$8.00 |
| Federal, 3200 Ohms.....          | 10.50  |
| Cory.....                        | 8.00   |
| Western Electric, 2200 Ohms..... | 12.00  |
| Dictograph, 3000 Ohms.....       | 12.00  |
| Manhattan, 2000 Ohms.....        | 6.00   |
| Manhattan, 3000 Ohms.....        | 7.00   |
| Brands, Superior.....            | 8.00   |
| Lincoln, 3000 Ohms.....          | 8.00   |
| Frost, 2000 Ohms.....            | 5.00   |
| Frost, 3000 Ohms.....            | 6.00   |

Now that you have read the list, get that order into the mails without delay. If there is something that you want and don't see it listed here, write us anyway and we will get it for you. Our two stores save still more time in getting your apparatus in a hurry. Enjoy the pleasure of real service for a change. Send us your orders.

**WARNER BROTHERS**  
**TWO STORES**

San Francisco.  
 350 Market Street  
 Phone Douglas 4039

Oakland, Cal.  
 22nd & Telegraph Ave.  
 Phone Lakeside 6223

**THE STANDARD IDEA**

**Assembled—But Not Wired**

Here is a new way to buy reliable radio equipment—a *cheaper way*. The STANDARD IDEA enables you to buy high-grade radio instruments, including a Detector and Two-Stage Amplifier and a Multiple Wave Tuner, completely equipped—but *not wired*. You do the wiring yourself in accordance with the diagrams and instructions furnished with every instrument.

**A Clear Saving of 20%**

The STANDARD IDEA was adopted to save money for the radio fan. It eliminates the expensive operation of hand wiring in our factory and makes it possible for the purchaser to lower his instrument costs by at least 20%. And there is a lot of fun in the job which can be done in odd moments without cost.

You will be interested in our offer to ship any instrument for inspection upon receipt of one-third of the purchase price. Ask us about this and request our descriptive literature without delay.

**STANDARD ASSEMBLING CO.**  
 6 Stone St. New York, N. Y.

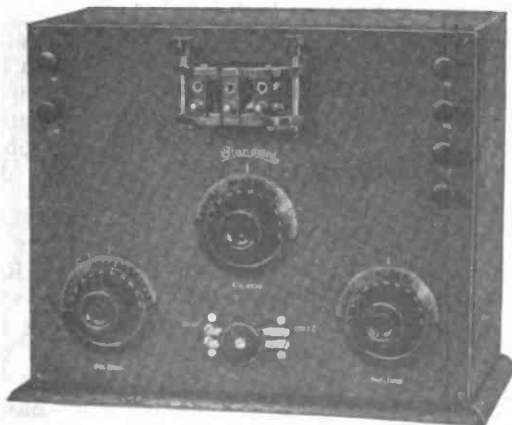

Tell them that you saw it in RADIO

The Hit of

New England



Radio

Products

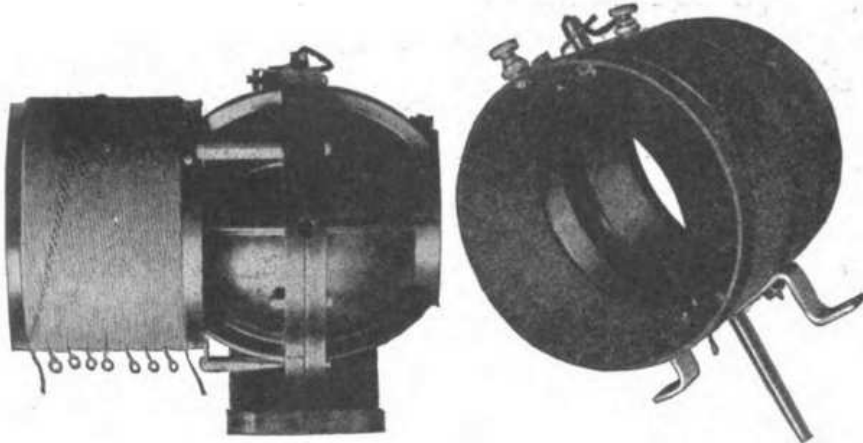

Catalogue No. 165.....\$13.00

SE-AR-DE Molded bakelite radio-meter with bank wound inductance, wave length range with No. 20 wire on stator 300 to 3280 meters, range with stator wound with No. 16 wire 180 to 3100 meters. Inductance is triple bank wound. Makes an ideal unit for single circuit tuner.

Catalogue No. 166.....\$5.50

SE-AR-DE Vario coupler (rotor in center) is designed for use in single circuit tuner, molded bakelite rotor, bakelite tube, all connections pig-tailed, wound with green silk wire. Wave length range 150 to 650 meters. All metal parts are brass, nickel plated.

Jobbers and Dealers write for discounts on the above. Also knob and dial, bakelite socket, vario coupler, bank wound inductance, variable condenser, insulated binding posts, contacts, C. W. Inductances, choppers and phonocaps.

**R. MITCHELL & CO.**

255 Atlantic Ave.

Boston, Mass.

For 47 yrs. Mfrs. of Scientific and other equipment.  
Look for trade mark on every piece.

Kearny 2778

## Pacific Radio School

ARC AND SPARK SYSTEMS

Hours—10 to 12 noon  
1 to 4 P. M.  
7 to 9 P. M.

Send for  
descriptive  
circular

433 Call Bldg.,  
San Francisco, Cal.

This school is equipped with KLEINSCHMIDT Automatic Telegraph System

### SPECIAL OFFER

Subscribe to "RADIO" for one year and we will send you one of the following free premiums:-

Remler Dial, Socket, Rheostat or Grid Condenser

Include 12c for mailing charges

"RADIO" Pacific Building

SAN FRANCISCO

Tell them that you saw it in RADIO

Continued from page 84

than she thought! I am much better!"

Her masses of hair fell in wavy rolls about her face—that held a normal freshness and color. She pressed it in the blooms—breathing deeply of them.

"Well"—he sat down—"I have news for you! Consider yourself engaged as Chief—and only!—operator on our *Blythedale*—sailing in three weeks for South American ports!"

For an instant she stared at him—then her eyes filled. "I couldn't!"—she whispered—hiding her face in the roses. "You have done this out of pity. When I went, straightforwardly, and asked—at your Company—for a chance, I was—refused. Now that I was so unfortunate as to get in the way of the car of one of the firm, however—your father, or you—think it only a fair thing to do! Neither of you really want to give a woman operator a try! I—I can't do it!"

"But you said that all you wanted was a chance! Here it is! 'Pity' has nothing to do with it! In fact, the pater has long been wishing that there were women operators, for the passenger runs!" (Thus did he lie, brazenly—and as a gentleman!) "Men are obstreperous—at times—they get loaded, down South—and we've had all kinds of trouble! So—you see—this is very fortunate—for us!"

And so—little by little—he gently, carefully, led her along, until the tide of her opposition turned, and she began to show enthusiasm.

"What about a uniform? I must wear the regular thing—that your officers wear—the only difference being a—skirt!" she laughed.

"Oh—er—yes!" Hadn't thought of that! Tell you what I'll do; I'll get the cap insignia—the braid of the sleeves is regulation—everywhere—as is the 'lightning' on the collar tabs. Very simple—you see!"

"Shall I meet your father? I want to thank him for my—'chance'!"

"Meet the pater? Oh—of course! He'll be delighted! Told me to be sure and arrange it! Wants to know his first—ah—'OW'—was it not?"

And they both laughed.

But, within himself, Arthur was far from laughing! If she persisted in her request to meet Carroll, Sr.—and were she to suspect that he were preventing this, Arthur foresaw more—trouble! However—that bridge was some distance off—at any rate!

**T**IME: Night.

Place: Claremont Restaurant, Riverside Drive.

Scene: A cosy dinner table, set for two—on the piazza, overlooking the Hudson.

Conditions: A brilliantly moon-

Continued on page 87



Continued from page 86

lighted night, with a soft, cool breeze blowing down the river—fresh with woody odor.

Dramatis Personae: Dorothy Montgomery and Arthur Carroll, Jr.

The meal had been finished. A discreetly-hovering waiter had been tipped—and had disappeared.

"Let's walk. I feel cramped under a roof—a night like this!"

He lingered over the putting her scarf about her. Along the well kept paths they strolled—slowly—her hand resting lightly on his arm.

"Tomorrow at this time you will long have cleared the Lightship—and be headed south," he said softly.

"Yes—'on the old trail, the out trail, the long trail—the trail that is always new'."

"And you will sometimes think of—remember—" he stammered. Turning swiftly, he took her in his arms, holding her to him. She did not struggle—rather, looked up in his face. Thus they swayed—for an instant and their lips met.

"Now you will not leave me!" announced he.

"Ah—but I shall! I came East—looking for a position as an 'OW.' It has come my way and I am going to make good at it, my dearest boy! It will prove to owners that a woman is perfectly able to handle the work, and so be an opening for less—fortunate—" she said it shyly—"ones than I! When I return, and it is but a matter of two months, then—if you still . . ."

But he put an effective stop to further words. And he knew her well enough—not to argue.

"Too bad that pater had to go to Montreal last week. He did so want to see you before you 'took over' radio charge of the ship!" (Thus did he right nobly keep up the steady stream of honorable subterfuges—that he had been so hard pushed for—at times—by her that he had taken to entering all the places that Carroll, Sr. was supposed to have gone, and all the "important matters" that claimed his every attention—lest he get them, and his dates—mixed! For Dorothy Montgomery was by no means a fool!)

"Do you think that he will be pleased at having an—'OW' as a daughter-in-law?"

"Pleased isn't the word for it, sweetheart! He always likes people who DO things!" (But his mind was sore troubled at the wondering what effect the paternal storm would have on her, should it break before the stage was properly set!)

"YOU will take good care of her, Skipper?"

"Indeed, yes!" answered Captain

Continued on page 88

# "REGAL" PRECISION BUILT PRODUCTS

Our thirty years' experience in the manufacturing of precision built instruments is your guarantee that every "Regal" radio product will stand up under the most rigid tests and service and give perfect satisfaction.



"Regal" Filament Rheostat

Exposed resistance wire, giving smooth working, even tension control at all times. 6 Ohms—2.2 Amperes. Handsome, efficient, scientific. Ask any radio engineer. Price (complete with Knob) ..... **\$1.25**

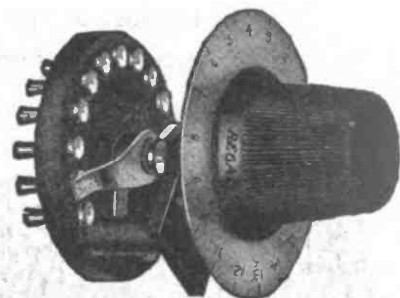

"Regal" Inductance Switch

15 point switch complete in one unit. Does away with all switch points. Requires but one hole to mount on panel. Biggest Hit in Radio. Price (complete with Knob & Dial) **\$2.00**

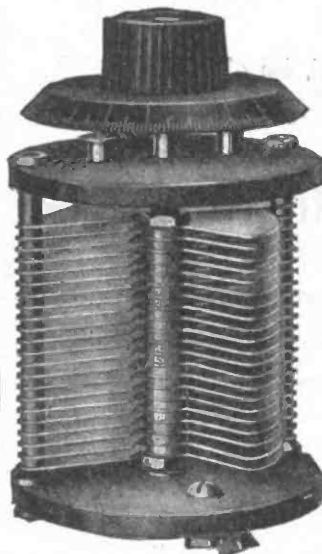

"Regal" Variable Condenser—Precision Built

|   |     |                        |              |
|---|-----|------------------------|--------------|
| Handsome metal dial with triple silver plate. In big demand. A fast seller. Price ..... | 75c | 43 Plate, .001-MF..... | \$4.50       |
|   |     | 23 " .0005-MF.....     | 3.50         |
|   |     | 11 " .00025-MF.....    | 3.00         |
|   |     | 3 " Vernier.....       | 2.50         |
|   |     | Knob and Dial....      | \$1.00 extra |

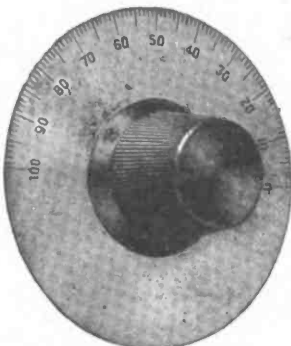

"Regal" Silvered Dial with Knob

Handsome metal dial with triple silver plate. In big demand. A fast seller. Price .....

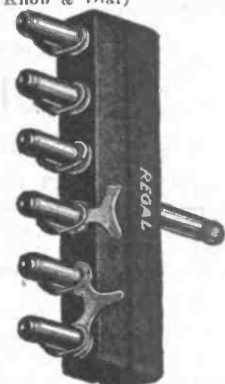

"Regal" Telephone Connector

Does away with all Binding Posts. Permits use of three sets of phones. Only two connections to be wired. For Panel Mounting, \$1.50 With Plug as shown, \$2.50

FREE CATALOG—The articles shown here are only a few of our products. Write today for handsome new catalog, No. 14, showing our complete line.

**American Specialty Mfg. Co.**  
Bridgeport, Conn.

**To the Trade**  
Jobbers and distributors are invited to write for our proposition. It is a good one.

## 3000 OHM SETS \$3.98

PLUS 20 CTS. POSTAGE AND PACKING  
Satisfaction Guaranteed or Money Back



We mail phones the day your order arrives. Every pair tested, matched, and guaranteed as sensitive as \$8 to \$10 Sets. Circular Free.

**Tower Mfg. Company**

108 STATION ST., BROOKLINE, MASS.

Tell them that you saw it in RADIO

## APEX SERVICE

All orders shipped same date as received. Try our service—you will like it. Price bulletin sent on receipt of 2c stamp.

|                                      |        |
|--------------------------------------|--------|
| Frost Phones 3000 ohms.....          | \$5.00 |
| Frost Phones 8000 ohms.....          | 6.00   |
| Brandes Superior 2000 ohms.....      | 8.00   |
| Western Electric 2400 ohms.....      | 12.00  |
| Baldwin Mica Diaphragm.....          | 16.00  |
| Radiotron UV200 Detector.....        | 5.00   |
| Radiotron UV201 Amplifier.....       | 6.50   |
| Radiotron UV202 5 Watt Power Tube    | 8.00   |
| Air-Way Variometer.....              | 4.50   |
| Air-Way Variocoupler.....            | 4.50   |
| Standard Variable Condenser 11       |        |
| (.00025 mfd.).....                   | 3.25   |
| Standard Variable Condenser 21       |        |
| (.0005 mfd.).....                    | 3.50   |
| Standard Variable Condenser 41       |        |
| (.001 mfd.).....                     | 4.00   |
| Apex Bakelite Dial 3", 1/4" or 3/16" | 75     |

**Apex Radio Co., Inc.**  
1105 W. 69th St., Dept. R, Chicago, Ill.

The Only Authentic Book on the Construction and Operation of

## "The Armstrong Super-Regenerative Circuit"

Described fully in 52 pages, including 21 Photographs and Hook-Ups, in simple, non-technical radio language. This set built by the author,

GEORGE J. ELTZ, Jr., E. E., A. I. E. E.

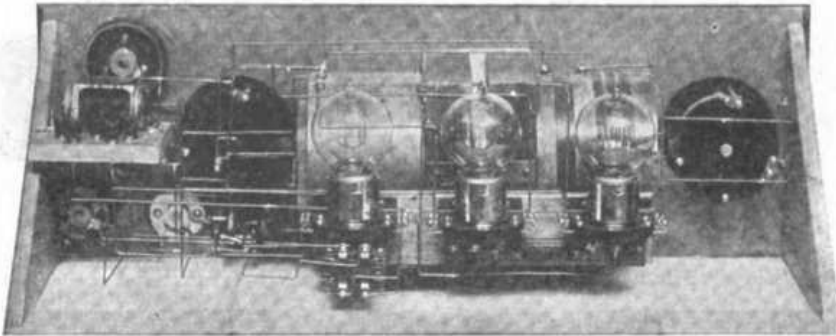

Complete Description of Each of the Three Circuits Invented by  
MAJOR E. H. ARMSTRONG, E. E.

How to Change a Regenerative Circuit to a Super-Regenerative Circuit

Price \$1.00 Per Copy Mailed or at your Dealer (Do Not Send Stamps)

## RADIO DIRECTORY and PUBLISHING CO.

DEALERS—Write for our Special Proposition

45 Vesey Street (Room 104) New York City

**NOTICE** The second edition of the AMATEUR RADIO CALL BOOK is now ready. Mailed to you on receipt of \$1.00. (Do not send stamps)

## THORKITE

### The Perfect Radiophone Detector

A new Silver-Copper-Bismuth Sulphide crystal composed of some twenty-one chemical elements and rare metals of assay value over one hundred times that of Galena. Vastly more sensitive—does not deteriorate but actually improves with use and lasts indefinitely.

Mounted in 1/2 inch nicked cup. Can be attached direct to panel, if desired. Special alloy used in mounting adds to the natural efficiency of this wonder crystal. Fully guaranteed. If you want the best radio reception use THORKITE.

Price \$1.00 by mail postpaid. Dealers' inquiries solicited

GILMOR-LAYNE CO.

Distributors

203 L. A. Railway Bldg., Los Angeles, Cal.

## For CORRECT RADIO MAILING LISTS Use THE POCKET LIST

Of Radio Manufacturers, Jobbers and Dealers in the United States and Canada. Issued quarterly—January, April, July and October. October, 1922, issue corrected to September 15, 1922. Classified under three different headings—manufacturers, jobbers and dealers—and alphabetically arranged by states, cities and towns and names of firms. Containing over 15,000 names and addresses.

We have been exceptionally careful to see to it that every manufacturer, jobber and dealer is listed and under the PROPER CLASSIFICATION. Most mailing list concerns charge more than \$100 for a list of this kind, and, as a rule, those supplied are far from being correct. Compare this list with any other and you will find it to be the very best obtainable anywhere at any price.

October number ready for distribution September 25th. Price \$5.00 per copy or \$10.00 per year (four issues, including monthly supplements which keep the list absolutely correct and up to date at all times). October edition limited, send in your order with remittance today.

F. D. PICKENS

1021 Carrington Street

JANESVILLE, WISCONSIN

Tell them that you saw it in RADIO

Continued from page 87

Sheffield, of the *Blythedale*—and "Admiral" of the Line, in view of his seniority of service. One who preferred the comparative ease and quiet of the South American run—what 'tho the salary was less—to the more arduous duties of the pretentious passenger ships of the Line.

The two were alone in his quarters, the girl stowing her things in the operator's cabin.

"Look here, Sheffield, I haven't—er—told you all about this matter!" blurted Carroll, Jr.—suddenly.

"Don't have to, my lad! I've worked for your father many years. I've known you, boy and man, from your birth, and I've never known you to do a crooked thing! I am kind o' partial to—love affairs"—and he laughed at the other's start of surprise—"having been in love with the same woman for twenty-nine years—or it would have been, had she been left to me until next Christmas Day. I saw through your little 'deal'—from the beginning—and I was with you—then! Having seen Miss Montgomery, I am more with you than ever—put her there!"

The men's hands clasped, and there was great relief in the eyes of the younger.

"Well, son—it will be daylight in an hour, and I must be getting out in the stream. So say your—'goodbye's'!"

The *Blythedale* backed slowly out over the oily, black waters of the Brooklyn Docks. A fussy little tug pushed the big freighter's nose 'round, and her looming bulk got slowly under way—outward bound.

Arthur Carroll stood on the end of the wharf and watched as long as he could see her—then he went back, up the empty, cavernous shed—that smelled of spices, and that echoed strangely to his footfalls, and where a few stevedores were getting their coats and hurrying home.

"UNUSUAL to have so heavy a wind here—at this time of the year," said Skipper Sheffield one night at dinner.

The *Blythedale* was making good—tho' very high-and-lofty tumbling

Continued on page 90

## Our 3 Factories

are dedicated to building only the finest radio apparatus. Every one of our complete outfits and separate parts carries our unqualified guarantee.

**MARVEL** Receives wireless telephone, music and speech in 30 miles radius, telegraph 300. With antennae and insulated wire, headphone, switches, etc. Range 180 to 2600 meters. Nothing additional required

**MARVEL** In cabinet, providing greater selectivity and range, with double headphones, antennae, switches, etc. Complete \$25.

**DE LUXE** Complete \$25.

Also a complete line of high grade separate parts guaranteed unconditionally as best

**FREED-EISEMANN RADIO CORPORATION**  
285 Fourth Avenue New York, N. Y.



**RADIO "A & B" STORAGE Batteries CHARGED at Home For Few Cents With "PATENTED FULL WAVE" 100-130 Volt 60 Cycle A. C. Automatic Magnetic F-F RADIO RECTIFIER**

It Charges All 6 Volt RADIO "A" & AUTO Batteries, and RADIO "B" Storage Batteries Up To 120 Volts. It Costs You Less To Buy An F-F RECTIFIER than To Be Without One. You Pay For One Whether You Buy One Or Not, for it Costs An Average of \$2.00 for Charging & Rentals Every Time An Auto Battery Is Charged By Others, but Only A Few Cents when You Charge Your Own From Lamp Socket, with F-F Battery Boosting RECTIFIER. Also By Keeping Batteries Charged, They Last So Much Longer, The Fewer Replacements Needed Saves More Than Rectifier's Cost. If You Have Never Known The Delightful Feeling Of Having All The Storage Battery Current You Desired For RADIO & AUTO All The Time, You Will Experience A New Thrill When You Have A RECTIFIER of Your Own, which Gives You A Fully Charged Battery Overnight At a Cost Of A Few Cents, a Joyful Feeling Of Things Well Done. Those Who Own Them Feel Their F-F RECTIFIER is Their Faithful Friend. It Charges Automatically & Being Clean Can Be Placed Anywhere. Nothing To Stop Over, Be Filled, Burn Out, Need Attention, Cause Trouble, or Require Skill. AMMETER Shows Amount of Current Flowing, Eliminating Guess Work. Both Ways of Current Are Rectified Through Fusible Carbon Rectifying Brushes, which Maintain CONSTANT EFFICIENCY uninterruptedly, while its FULL WAVE design Delivers The Rapid Taper Charge Recommended By All Storage Battery Manufacturers. The F-F RECTIFIER is a Complete Compact Portable Handy Charging Unit, which is Unfailing In Its Ability To Deliver Service Day & Night. It Will Charge A Dead Battery. Do Not Think Your Battery Is Dead & Worn Out Simply Because It Will Not Start Your Car. Buy An F-F RADIO RECTIFIER & Fill It With Life. Leave Your Battery In Car Or Where Ever It Is, Without Even Disconnecting It. Screw RECTIFIER Plug In Lamp Socket, Snap RECTIFIER Clips On Battery Terminals; Turn Switch & Battery Will Be Charged In Morning at a Cost of a Few Cents. Isn't Gratifying To Be Always Ready For RADIOPHONE BROADCAST, Music, Serenade News when Friends Call? Never Having To Tell Friends Your Batteries Are Dead & to Have Your Car Respond Like a Greyhound Spinning Engine With Power, when You Step On Your Starter. INSIST On The F-F RECTIFIER. It Is Built For The Job. Lasts a Lifetime. So Many Thousands Are Being Sold It Has Made Possible These



They Charge AUTO & BATTERIES Overnight Right In Your AUTO \$20

- POPULAR PRICES.**  
 Type 6 Charges Radio "A" & Auto 6 Volt Batteries at 6 Amperes \$18  
 Type 8 Charges Radio "B" Storage Batteries Up to 120 Volts... \$18  
 Type A-B Combination Charges "A & B" Radio & Auto Batteries \$20  
 Type 12 Charges All 12 Volt Batteries at 8 Amperes... \$18  
 Type 166 Charges All 6 Volt Batteries at 12 Amperes... \$20  
 Type 1613 Charges All 12 Volt Batteries at 7 Amperes... \$20  
 Type 1626 is a Combination of Types 166 & 1613... \$28

**CHARGES AUTO & RADIO BATTERIES.**  
 All Types But "B" Charge Auto Batteries. The Larger Types are Recommended for Heavy Batteries, or Where Time is Limited. Shipping Weights Complete With AMMETER & BATTERY CLIPS 11 to 15 lbs. Purchase From Your Dealer or Mail Check For Prompt Express Shipment. If via Parcel Post have remittance include Postage & Insurance Charges or WRITE Us to Ship TYPE Desired. C.O.D. Other F-F Battery Boosters Charge Batteries from Farm Lighting Plants & D.C. Circuits & GROUP CHARGING Economy & Service. Use Our 8 Ampere 12 Battery Capacity Automatic Full Wave F-F ROTARY RECTIFIER Described in ROTARY Bulletin 33-A. ORDER Now, or WRITE Immediately for FREE Descriptive RADIO & AUTO BOOSTER & ROTARY Bulletin 33 & 33A.

**FRANCE MFG. CO.** General OFFICES & WORKS: CLEVELAND, OHIO, U. S. A. Canadian Rep.: Battery Service & Sales Co., Hamilton, Ontario, Canada.

**PRMCO Control Units**  
 Insure Best Results  
 Scientifically correct Detector and Amplifier Units that are inexpensive, but that insure results equal to larger and far more expensive sets. Compact, attractive, easy to put into circuit. Correct capacity for latest type reception tubes.  
 PRMCO AMPLIFIER Units give maximum amplification without distortion—  
 Price ..... \$15.00  
 PRMCO DETECTOR UNITS ..... \$9.00  
 —Special Prices to Dealers and Jobbers  
 —Send for Descriptive Bulletins  
**Ports Radio Mfg. Co.**  
 —Distributed by QST Radio Shop, Fresno, Cal.  
 3305 Belmont Ave., Fresno, Cal.

**KNOTT Super-vernier Condenser**  
 (Trade Mark Registered)

Showing how you connect to your condenser  
 Tune your condenser to the whistle and bring in the message with this Micro.  
 It will stretch the critical adjustment on your condenser to two inches of adjustment.  
 Buy it of your dealer or send us \$3.00 for one by return mail postage paid complete with connecting wires and wrench-screwdriver.  
 Ask about Knott Sure Ground, Knott Radio Name Plates, Patent Dial, Rheostat, Quodecoil, Cinquoil, Microstat.  
 Jobbers write for our proposition, it will interest you.  
 E. R. Knott Machine Company, 1 Ellery St., Boston 27, Mass.

**RTS**  
 JOBBERS AND DEALERS  
 Now is the time to stock up on RTS Products. We have something of interest to you. Write at once.  
 RTS GRID CONDENSERS, \$0.30  
 Radio Testing Station, 25 Sturges St., Southampton, N. Y.

**TO RADIO DEALERS**  
 State Territories NOW open. Aggressive Dealers can make good profit selling Guaranteed Radio parts. Write for Complete Information  
**Ray-Di-Co. Organization, Inc.**  
 1215 Leland Ave., Chicago

**RADIO SUPPLIES**  
 Mail Orders Promptly Filled  
 WE PAY THE CHARGES  
 If It Is  
**RADIO**  
 We Can Supply It.  
**U. C. BATTERY and ELECTRIC CO.**  
 2158 Univ. Ave. Berkeley, Calif.

Continued from page 88  
 weather, of a sudden blow that had come up at sundown, when the vessel was some 800 miles off Porto Rico—according to the noon "shot."

"What was the latest weather report that you had—Miss 'Sparks'?"—and the skipper chuckled, for the girl had made a great favorite of herself on the big freighter—from firemen and oilers—upward through the ship's personnel.  
 "At 5 o'clock I picked up NAU, but his weather QST gave no indications of anything unusual. I hung a copy of it on the hook in the chartroom."

"I do not believe that it will amount to much, as the glass isn't seriously affected—but it certainly is blowing a gale now!"

To eat was a difficult matter, what tho' the table was a swinging one, and the racks were on—beside. Dinner was finished amid much laughter—the chief engineer having had especially bad luck with his soup!

From the lee side of the house the sight was a splendidly wild one, as the monster seas—high—maned with foam, white as snow in the moonlight, tore on at furious speed, the spindrift hissing and spattering viciously against the ship's upperwork and stack. Steadied by the skipper's arm, she went with him to his comfortable quarters. Indeed, she had gone there for a chat—after each evening's meal, finding in Sheffield a vast storehouse of information, incident and story, that—to her—was all as from another world. She liked Sheffield—much. A man, she had decided, of no great mental processes. One who avoided the deeper puzzles of life, and one who had reached—at rather long years—the stage when it was easier to take things as they came, rather than to investigate other, and possibly better, ways of attaining unto a desired end. But a splendid navigator, and one who believed—implicitly—in that adage of the sea: "Obey orders, if you break owners." Hence: an ideal seaman.

He braced her on the settee with cushions, while he took his swivel chair, that was bolted to the deck.

Suddenly there came, above the screaming drone of the wind through the rigging, four sharp blasts of the whistle.

"My God—fire!" he shouted, plunging through the door.

For an instant she sat very still. Then—quite calmly—she opened a lock- et that hung at her throat. Looking tenderly at the face therein, she whispered—"Arthur, laddie, I don't know if your 'OW' is going to see you again, but she—she is going to—make good!"

The wild fury of the storm tore at her as she stepped out and started for the radio shack—a bit farther along the bridge deck. Not a soul was in sight—

Continued on page 91

Tell them that you saw it in RADIO

*Continued from page 90*

even the officer of the watch having left the bridge. But—through the after windows of the chartroom she could see in the pilot house—and the figure of the quartermaster at the wheel was outlined by the reflected rays of the binnacle light. Although she was conscious of no fear—the sight of him, stolid in his duty, strengthened her.

Switching on the lights, she sat down at the operating table, bracing herself as well as she could against the plunging rolls. It was but an instant's work to test the power. All was in order.

Then she waited—many thoughts running riot through her mind, to the moaning distress, and the whining shrieks of the wind, the *hiissssss* of spray and the *whhoooooom*—when an unusually large sea struck the bows. She reached for the transmitting key and sent a few practice dots and dashes.

The door flew open. Sheffield came in.

"We—we—must hope for the best, Miss Montgomery," he said, controlling his voice with visible effort. "But fire is raging all through No. 4 hold. We can do nothing in this wind and sea—except to turn steam in. I am going to try and get the ship 'round with the wind. Do not be alarmed if she gives one or two very bad rolls. Listen-in and see what ships, if any, you can hear. Ask them their positions, but say nothing of the fire—yet. Then please stand by for further instructions."

He was gone again.

She donned the head harness and began to tune for signals on 600 meters. For a time—nothing. Then she picked one up—very far distant, by its weakness. Straining hard, she managed to ascertain that it was an American vessel—by its call letters—transmitting messages to NAU. As soon as he had cleared them, she threw the send switch and called the ship. Then she listened. Silence.

Only the hurtling of the gale stole—muffled—'neath the 'phone receivers. She called the ship again, and listened.

No answer.

She tried once more to raise him.

But ether space was dead of sound. Even QRN was a negligible quantity.

For the first time, the full realization of her situation flooded her senses, and there came a tightening at her throat. She put the phones down and balanced her way to one of the ports. Even as she stood there watching the gigantic hurtling of vast waters, she felt the *Blythedale* begin a roll that she instinctively knew would be worse than any of the others.

Down—down—down—(was she never to start up again?)—until swirling foam washed level with the edge of the deck—and there the ship hung, as

*Continued on page 92*



*Claude L. Yates*

# The SANDMAN'S STORY

On a Tuska Radio Receiver, every evening you can hear "The Sandman's Story". This delights the children. Later comes entertaining Radio Broadcasting for grown-ups.

Tuska Radio will bring dependable broadcasting into your home, A Tuska Radio Receiver makes a wonderful Christmas Present.

Tuska Radio is substantial, reliable, dependable and recognized. Inspect today at your dealer's.

**THE C. D. TUSKA COMPANY**  
30 Bartholomew Ave. Hartford, Conn.  
Pacific Coast Office, 711 Mission Street, San Francisco, Calif.

## TUSKA RADIO

*Established 1911*



Catalog Number Four contains *Marvelous* article on tuning Receiving Sets. **10 cents** brings it to you



**3000 OHMS**  
**\$4.25**

Postpaid any part of U. S.

Weight complete, 12½ ozs.

### "G-D" RADIO HEAD SETS

Satisfaction guaranteed or money back. Enclose money order or bank draft—currency by registered letter only. Every pair tested, matched and guaranteed as sensitive as eight to ten dollar phones. Adjustable Head-band, Nickel plated, special feature. Single phone, five foot cord, \$2.00.

**Gibbons-Dustin Radio Mfg. Co.**  
2859 W. 9th St., Los Angeles, Cal.

## Best by Test!

TRADE MARK

# GALENA ALL SENSITIVE CRYSTAL

Hundreds of manufacturers, dealers and owners of receiving sets everywhere have tested and found our crystals the most sensitive and efficient obtainable.

Double your pleasure and increase the efficiency of your set by using our

All-Sensitive Galena Crystals  
Galena Crystal, Mounted... 35c  
Galena Crystal, Unmounted... 25c

**IMMEDIATE DELIVERY**  
Every Crystal  
**GUARANTEED PERFECT**

*Manufacturers, Jobbers, Dealers, write for quantity prices*

**GALENA CRYSTAL MFG. CO.**  
465 Bushwick Ave. Brooklyn, N. Y.

Tell them that you saw it in RADIO

**Vernier Potentiometer**



**For  
EXPERIMENTAL WORK**

—in fact, for all sets on which extreme sensitiveness is desired—the CRL Vernier Potentiometer, a new development in the radio field, provides a very fine control for vacuum tubes. The resistor, a machine winding, the turns of which are anchored firmly on a substantial insulated core, is retained in a groove between insulating discs. Complete details are given in our *New Bulletin 101*. Write for your copy.

For smooth, noiseless operation, use CRL Potentiometers and Rheostats of both the plain and vernier types.

**CENTRAL RADIO LABORATORIES**  
305—16th Street  
Milwaukee Wisconsin

**QUEENS**  
*Vario Coupler*



**\$5.00**

**THE BEST THERE IS!**

Not just because we say so, but facts prove that Queens Variocouplers and Variometers are the best to be had regardless of price. They are designed and manufactured by men who have made radio their life work—beginning long before the days of BROADCASTING. This priceless experience coupled with huge production have made such a low price possible. The real proof of the efficiency of the Queens instruments is comparison. Compare the construction alone with any other and after you note their superiority—use them in your radio set—you will be immediately convinced that there is no better made regardless of price. \$5.00 each.

**FREE!** We have a very interesting leaflet on the Armstrong regenerative and super-regenerative circuits. A copy is waiting for you. Just drop us a line and ask for it, enclosing 2¢ stamp for postage.

Dealers:—Write for our discounts and let us tell you more about ourselves and our instruments.

**QUEENS RADIO COMPANY, Inc.**  
WINFIELD, L. I.

*Continued from page 91*

though hesitating which way to go. She held her breath. Then—very slowly—the *Blythedale* rolled back—and down the other side. Three of these rolls did she take, until her course was with the racing, hammering seas—and her motion was easier.

The girl went back to the apparatus—but not a signal could she hear.

And she idly fell to wondering if God—were looking down?

She was unaware of the skipper's entrance, until he touched her.

"Hear anything?" His face was very white—with a long streak of black across it—that made it ghastly.

"Not now. There was a vessel a few minutes ago working NAU—but he has stopped, and evidently cannot hear me, as I have tried three times to raise him."

Sheffield lurched on the transom—"Can you raise NAU?"

"No. We were out of touch with him at 8 this morning. I told you—don't you remember?" she asked gently—as to a child—for the big seafarer was a tragic picture—his years, that he carried well under normal conditions—seeming to have blossomed in all their strength, causing his face to be seared and lined—and very old.

"No—no," he muttered, "I—I don't remember—I don't remember."

She went over to him, put her cool young hands on his forehead—

"Is—is the danger very near?" And she was surprised at the steadiness of her voice.

He looked up at her—and the horror in his eyes struck her as a blow.

"The—the after hold is full of explosives—for Buenos Ayres—and if the bulkhead goes—we—we will be another ship that—'vanished.' Even if it does stand—the heat may set it all off!"—and his head dropped in his hands.

One of hers went from his bowed head—to the locket—on its little chain—and her lips quivered.

"Laddie—boy—mine!" she whispered. And a silent prayer went up through the mists of flying spray, the clouds of spume—out of the infernal clamor of the night—up through the storm wrack

*Continued on page 93*

*We manufacture—*

**Condensers  
Variometers  
Rheostats  
Sockets  
Crystal Detectors  
and other parts.**

Write for prices

**Butte Electric & Mfg. Co.**  
534 Folsom St. San Francisco, Calif.  
Phone Douglas 145



**The Loop That Solves So Many  
Radio Problems**

**Warren Radio Loop**  
Saves space. Makes any set portable.  
Entirely enclosed.  
Directional Loop, 18 inches square. For  
Armstrong Receiver, Portable Set  
and Mobile Sets

Pivoted so that you can pick out just the station you want using a honeycomb coil. Tunes to high power long wave length stations.

|   |         |
|---|---------|
| Type A-737 (300-700 meters) 6 inches square—non-directional.....                        | \$10.00 |
| Type A-7236 (175—1000 meters) 6 inches square—non-directional.....                      | 12.00   |
| Type B-2537 (300-700 meters) 18 inches square—directional.....                          | 20.00   |
| Type BL-2520 (200-18,000 meters) with honeycomb coil. 18 inches square—directional..... | 25.00   |

*Send for Bulletin S. 102*

**V-DE-CO RADIO MFG. CO.**  
ASBURY PARK, N. J.  
Dept. C

**Test Your Battery  
In 15 Seconds**



Your "A" battery was costly, yet you run a chance of ruining it every time you allow it to go dead or whenever the acid fails to cover the plates.

**Green—Lean**  
**White—Eight**  
**Red—Dead**

The success of an evening's entertainment depends upon the condition of your battery: test it every day, and see that it is fully charged and plates fully covered.

**Chaslyn  
"Sink-or-Swim"  
Ball Battery Tester**

makes this the work of a moment.

The Depth-Gauge tells you how much acid you have; the Ball Hydrometer tells its condition, and the Air-Controlled Stopper makes it easy to add just enough distilled water.

Hydrometer contains three Balls of differing specific gravities: "Float all three.... Charged fully  
Sinks the white... Charge still right  
Sinks the green... Charge is lean  
Sinks the red..... Charge is dead."

More accurate than the graduated scale hydrometer, and ten times as easy to read. Also saves your carpets and rugs from acid burns.

Order from your dealer. If he doesn't have it, send ONE DOLLAR and his name, and set of three parts, illustrated will be sent you postpaid.

**The Chaslyn Company**  
4309 Kenmore Ave. Chicago, Ill.

Tell them that you saw it in RADIO

*Continued from page 92*

—past the gardens of the stars—up, on the wings of faith in her God—fortified by the purity of her woman's love for her choice of this earth.

"Men have quit, sir!" gasped the first officer, lurching in.

His hands were bleeding, his clothes in scorched tatters. One ear was nearly torn from his head and hung by bits of skin.

The skipper looked up—"what's that?"

"Laid down, sir! Chief's broke his leg. God knows where the second is—and the men say it's no use! Flesh and blood can't stand that hell down there! I believe—that if they'd hang on a bit longer we might hold it back from—from the powders, sir, and with daylight this blow and sea 'ld go down—so's we could work better. But they've lost heart, sir!"

Slowly Captain Sheffield rose to his full height.

"Quit—have they? By God, old as I am I'll show them that a sailor's duty, above his life, is to protect to the last ditch—to—to—" he stammered, put his hands to his head—"to protect to—the—the—last ditch—his—his owner's—property—to—to—protect—Aaaaahhhh!" He crumpled to the lurching floor.

The first officer knelt over him—put a bleeding hand beneath the jacket.

"He's well out of it, Miss!" he said

*Continued on page 94*

**What's an Aerial?**  
*says Bobby*  
**Instead of wires it's**  
**MALTZ'S**  
**AERIAL PLUG**  
 MALTZ ELECTRIC CO. NEWARK, N.J.  
 DISTRIBUTORS WANTED



**Sensitive Tuning Range 200-600 meters**

**Price \$110**  
 without tubes



**The Most Sensitive Receiving Set on the Market!**

Embodying NEW inventions—affording higher RADIO FREQUENCY amplification per stage—and wider sensitive tuning range—than heretofore obtainable.

This remarkable 3-STAGE RADIO FREQUENCY AMPLIFIER-DETECTOR SET is now perfected and ready for distribution.

*Ware*  
**TYPE AD2**  
**R-F AMPLIFIER-DETECTOR RECEIVER**

With Clear, Crisp and Perfect Tone Reproduction, the AD2 Receiver will readily bring in the broadcasted programs hundreds of miles on 1 ft. indoor coil aerial—  
*Easily receives signals which are totally inaudible on the usual regenerative type receivers—*  
 For long distance reception the AD2 Receiver, loose-coupled to an outdoor aerial, has yet to be equalled—  
 An attractive and entirely reliable instrument—simple to operate—the result of over 5 years' continuous experiment and development by our engineers.

*Dealers' Correspondence Invited—Descriptive Folder on Request*

**WARE RADIO CORP'N** 160 - 162 Duane St. NEW YORK CITY

**Special KEYSTONE Audion Sets** **\$50** complete

**KEYSTONE QUALITY RADIO APPARATUS**  
 Everything bearing the Keystone Quality brand carries our unconditional guarantee. Keystone Crystal receiving sets \$10 up. Keystone Long Range Model, complete, including Magnavox, \$200. We install Aerials. (Telephone 824-358 & 64151)  
 Keystone Radio Service Co., Mfrs., Ground floor, Mason Opera House 125 S. BROADWAY, LOS ANGELES

**RADIO FREQUENCY AMPLIFIER**  
 For Loop Reception—Complete with Tuning Condenser and Detector, **\$125.00**  
**UNIVERSAL RADIO AND RESEARCH COMPANY**  
 199 S. Fair Oaks Ave., Pasadena, Cal.

Tell them that you saw it in RADIO

# TRADE **ESCO** MARK

QUALITY ALWAYS HAS BEEN AND ALWAYS WILL  
BE, THE WORLD'S SAFEST INVESTMENT

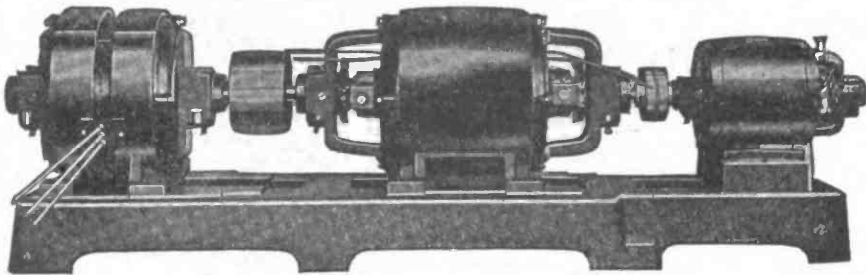

## ESCO

High Voltage Motor-Generators Stand Pre-eminent  
Used by leading educational institutions, U. S. Army and Navy  
academies, research laboratories, newspapers, department stores and  
broadcasting stations.

Bulletin 237 lists over 200 combinations  
Special apparatus developed for special requirements  
Motors, Dynamotors, Generators, Motor-Generators

Sold by principal dealers everywhere

**Electric Specialty  
Company**

211 South Street  
STAMFORD, CONN., U.S.A.

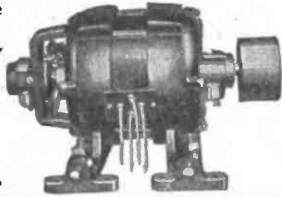

# TELMACOPHONE

*The Metal horn without the  
metallic sound*



Jobbers and Dealers—We are also distributors for several manufacturers of Quality Radio Apparatus. Write for our catalog.

Correctly Designed  
Fairly Priced  
Unreservedly Guaranteed

The Quality has been improved and the production increased, but the price remains the same.

With Baldwin Type C  
Unit, Price Complete **\$20.00**

RADIO DIVISION

**TELEPHONE MAINTENANCE CO.**

20 S. Wells Street

Dept. A

Chicago, Ill.

Tell them that you saw it in RADIO

*Continued from page 93*

slowly. Coughing, he rose. "We'll all be with him—soon—I'm thinkin'—unless you raised a ship? It's our last hope—to put courage in the men!" There was a vast, terrible hunger in the caricature of a human face that stared at her—waiting.

She stared back—and decided.

"Ship? Why, certainly! Just before you came in I had been giving him our position. He ought to be here by daylight—he's only about 100 miles to the east—or a little less. I'll call him again!" She said it coolly—easily—and went to the key, he lurching behind her—watching. She began to send—and this is what she sent:

*"From souls in peril on the sea—To the Creator of all things—Thou Who hast said that not a bird shall fall but that Thou knowest of it—receive this message, and help us in our extremity."*

She threw the switch to receive—and listened, while the first officer watched her face with awful tenseness.

To her ears the night spaces were void of sound. But she nodded several times—then jumped up—

"He says OK—coming as fast as possible!"

"Thank God!"—and the seaman seized her by the arm. "Come on!—you must! Come tell the men! They'll believe you and keep up the fight! It's our last chance!"

Down over the slippery decks—soaked by the whipped-off crests of seas—the two came at last to the engine room alley. And here, in the sickly sheen of one electric light, she saw—lying everywhere—almost naked bodies—streaked with blood—covered with soot—some with scorched, hairless heads—others with jagged cuts and fearful blisters. A few were praying. One was cursing—horribly. Another whimpered as a punished child whimpers. And there was an acrid reek of burning over everything. The men saw her—but they did not move.

"It's all right, boys! Our SOS has been heard! Help will be alongside by daylight! Glass is risin'—and the wind's fallin'—ain't that right, Miss? Tell them—for God's sake!" he whispered.

"Yes—help will be here by daylight—coming as fast as possible!" she called—her clear, young voice echoing above the turmoil.

"Let's go, boys! All hands! We'll hold her back—till daylight—all right! LET'S GO!"

As one man they were on their feet, shouting hoarsely with broken, cracked voices.

"Can you get back—alone—and keep in touch with that vessel?" the first officer croaked. She nodded. He disappeared after the others—somewhere

*Continued on page 98*



## Why They Come to "Chi-Rad"

—because "Chi-Rad" is the largest and oldest exclusive radio house in the Middle West.

—because there's no difficulty in getting those radio parts at "Chi-Rad" (see list below).

—and because every one of those radio parts bear the ever-satisfying guarantees of reputable manufacturers and of "Chi-Rad."

### DISTRIBUTORS FOR

- Amer. Radio & Research Corp.
- Acme Apparatus Co.
- Adams-Morgan Co.
- O. Brandes, Inc.
- Burgess Battery Co.
- Clapp-Eastham Co.
- DeForest Radio Tel. & Tel. Co.
- Federal Tel. & Tel. Co.
- General Radio Co.
- Wm. J. Murdock Co.
- Wireless Press, Inc.
- Chelsea Radio Co.
- A. H. Grebe & Co.
- Radio Corp. of America
- Thordarson Elec. Mfg. Co.
- Bemler Radio Mfg. Co.
- Westinghouse Elec. & Mfg. Co.
- Pacnet Electric Co.
- Electrical Research Laboratories
- Mu-Rad Laboratories, Inc.
- Lefax, Inc.

### A few "Chi-Rad" Specials—

- Moulded Variometer..... \$6.50
- Moulded Variocoupler..... 6.50
- Wooden Variometer..... 4.00
- Wooden Variocoupler..... 3.00
- Storage B Battery, per cell.. .50  
(See description)
- Storage B Battery,  
22 1/2 V Section..... 6.00
- Storage Battery Charger.... 1.90
- Lefax Radio Handbook..... 3.50

Write for your free copy of our new catalog.

**DEALERS:** Write for territory and discounts on "Chi-Rad" specials—there's a big demand.

Chicago Radio Apparatus Co.  
Inc.  
415 S. Dearborn St. Chicago



### RADIO LIGHTNING ARRESTER

Short-gap approved by underwriters. Safe — dependable — waterproof — absolute protection. No vacuum to lose. No samples. Guaranteed. At your dealers or by mail, postpaid.

**\$1.50** THE BRIGHTON RADIO CO.  
BEAVER FALLS, PA.

**PRICES SMASHED \$3.00 DOWN**

10 Days FREE Trial World's best makes—Underwood, Remington, Olivetti—at big saving. Every machine fully rebuilt to look and work like new. Guaranteed for 10 years. Send no money—big Free Catalog shows how to save money on type writers. Easy terms. Write today.

INTERNATIONAL TYPEWRITER EXCHANGE  
177 N. State St. Dept. 1042 Chicago

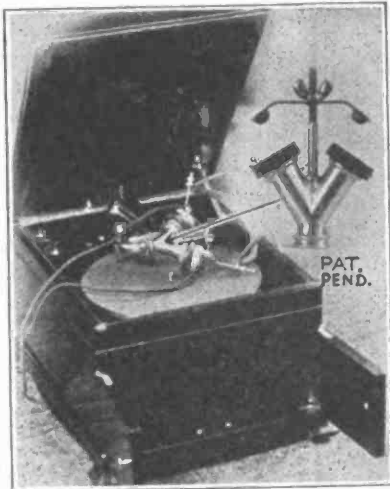

### DUPLEX VICTROLA ATTACHMENT NEW PRICE \$3.00

This attachment and a set of head phones will make a radio loud speaker of your talking machine. Made for Victor, Sonora, Silvertone, Edison, Brunswick, Columbia and other machines having tone arms like the above. At your dealer or post paid on receipt of price.

W. B. McMASTERS,  
Wheeling, W. Va.

## MICON

Tested Mica Condensers



### Assure—

Absolute noiselessness  
Clarity of tone  
Accuracy  
Constant fixed capacity

| Size   | Price  | Complete diagram of the Armstrong Super-Regenerative Circuit FREE with every purchase of MICONs. |
|--------|--------|--|
| .00025 | \$0.35 |  |
| .0005  | .35    |  |
| .001   | .40    |  |
| .002   | .40    |  |
| .0025  | .50    |  |
| .005   | .75    |  |
| .01    | 1.50   |  |

Sizes .0025 and .005 are especially adapted for the new Armstrong Super-Regenerative Circuits. Micons come in all capacities from .000025 to .01.

At your dealers—otherwise send purchase price and the desired Micons will be sent without further charge.

Chas. Freshman Company, Inc.  
290 Hudson Street New York City

# YOU

SHOULD  
HAVE  
A COPY  
OF  
THE

# C. W. MANUAL

By

JENNINGS  
B. DOW

**\$1.00**  
PER  
COPY

POST PAID

You Cannot Buy  
A Better Book

**RADIO**  
PACIFIC BUILDING  
SAN FRANCISCO



SOLD BY  
RELIABLE  
DEALERS

**\$10<sup>00</sup>**  
With Plug Attach  
\$11.50

## Automatic Electric Head Sets

must uphold the reputation acquired through thirty years of telephone engineering.

As the strength of a chain depends upon its individual links, so the prestige of a manufacturer rests, separately with each one of his products.

The Automatic Electric Company is an organization of experts who feel personal responsibility. Consequently Automatic Electric Head Sets are made with scrupulous care.

Weak or strong signals are reproduced with maximum clearness. There is no distortion or foreign noises whether used with crystal set, amplifier or loud speaker.

Jobbers and Dealers—Write for discounts and full particulars about our Jobber-Dealer plan.

## Automatic Electric Company

ENGINEERS, DESIGNERS & MANUFACTURERS OF THE AUTOMATIC TELEPHONE BY USE THE WORLD OVER  
HOME OFFICE AND FACTORY: CHICAGO, U.S.A.

# CONNECTICUT RADIO EQUIPMENT

Variable Condensers, Transmitters, Head Bands, Panel Switches, Etc.

Connecticut Tel. & Elec. Co., Meriden, Conn.

Tell them that you saw it in RADIO

## SELL IT!

Turn your spare apparatus into money by advertising it in the classified columns of RADIO.

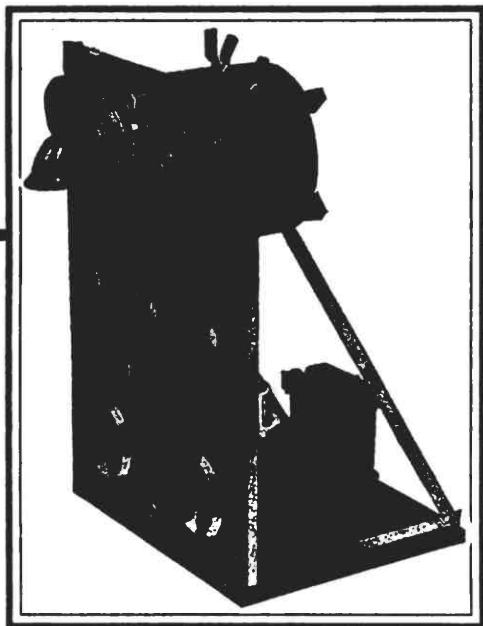

**The Benwood  
CW Transmitter**

Simple, compact, up-to-the-minute construction—incorporating all the improvements made possible by our years of experimenting—AND IT GETS RESULTS

**1500 MILES WITH CW!  
1100 MILES VOICE!**

*Music Heard 40 Feet From Phones by  
Stations in 300 to 400 Mile Radius*

THESE are actual results obtained by our testing station WEB, using the Benwood CW Transmitter shown herewith. You can get just as good results with it. This high-class set is just the thing for your broadcasting and DX work—using CW, ICW, Modulated Buzzer or Voice Transmission. An ideal set for the local radio club or the more progressive amateur. Think of the range this set will give you! If centrally located, you will be heard in almost every state in the Union. It is manufactured exclusively by and for the Benwood Co. and combines the best in material, workmanship and design.

**Radiates 1½ to 3 Amps. on Average Antenna**

We guarantee that this outfit will radiate 1½ amperes on the average amateur antenna when assembled in accordance with our instructions. It will radiate 3 to 3 amperes when used with an antenna whose fundamental wave length is 225 to 275 meters. That is why you can get such wonderful results. The set comes to you completely assembled with all parts mounted on panel, as shown, but not wired. Full instructions and wiring diagrams are furnished. You can wire it and start sending in less than an hour after you receive it. The outfit is complete with motor generator minus tubes, and consists of the following: Panel 12x18x4, angle supports, hardwood base, 3 tube sockets, 1 power rheostat, 1 80-watt filament trans., 1 modulation trans., 1 CW inductance, 1 hand transmitter, 1 0-3 Radiation meter, 1 0-500 milliammeter, 1 21-plate condenser, 1 45-plate condenser, 1 tapped condenser, 11-300 choke coil, 1 2000-volt filter condenser, 1 10,000 ohm grid leak, plug and jack connection for microphone buzzer and CW, 1 500-volt 220 watt motor-generator. Boxed for shipment, \$350.00 f. o. b. St. Louis, Mo.

**CATALOG:** Send 10c in stamps for the Benwood catalog and price list, also complete catalog and price list of DeForest radio equipment.

**DEALERS:** We manufacture a complete line of radio apparatus, and have stock on hand and ready to ship. Write or wire for our attractive proposition. New price list just issued.



1113 OLIVE STREET

ST. LOUIS, MO.

**CALLS HEARD**

BY 5DI, 2209 AZLE AVE.,  
FT. WORTH, TEXAS

C. W.—(4eb), 4ez, 4kf, 4zf, 5ac, 5bm, 5cy, 5dw, (5eh), (5ek), (5el), (5es), (5hv), 5ix, (5jb), 5jw, 5kc, 5me, 5ns, 5rr, 5rx, (5qs), (5sm), (5uy), 5aaw, 5aej, 5acf, 5op, (5jd), 6ka, (6avd), (6awu), (6awt), 6boe, (6bsa), 7lu, (8ib), 8ap, (8sb), 8ui, 8vy, (8zx), 8aim, (8adt), (8akp), 8all, 8anb, 8auk, 8axb, (8axn), 8bcy, 8bke, 8brr, 8btl, 8brt, 8ckk, 8cqx, 8dif, (9ei), 9fm, 9ii, 9ll, 9oe, (9ox), 9uu, (9sl on fone), (9abu), 9aes, 9ajp, 9ajs, (9aly), (9amb), 9anq, 9ans, 9aou, 9api, 9aps, 9apw, 9aql, (9aqm), 9aqq, (9arr), (9ars), 9aua, (9aue), 9avn, 9awn, 9ays, 9bbf, (9bcf), 9bds, (9bed), 9bjv, 9bjv, 9boa, (9bsq), (9btt), (9bwk), (9bxt), (9cfl), 9cji, 9cjj, 9ctr, 9dah, (9dam), 9dbi, (9dqu on fone), (9dam), (9dxd), 9dxt, 9dsq, (9xac), (9saa), (9saf), 9zif, cyl.

BY 6BCA, 363 S. ELEVENTH SE.,  
SAN JOSE, CALIF.

4oi, 5za, 6aag, 6aak, 6aat, 6abw, 6abx, 6acr, 6adl, 6app, 6ahf, 6ahp, 6aio, 6ait, 6ajh, 6aju, 6akl, 6ali, 6alu, 6amn, 6aol, 6apw, 6aqq, 6ark, 6aum, 6avv, 6bcd, 6bcj, 6beg, 6bf, 6bgl, 6bgh, 6bic, 6bjq, 6bjx, 6bmd, 6boe, 6bps, 6bqc, 6bqd, 6bqe, 6bqk, 6bqs, 6cc, 6dd, 6es, 6eb, 6ec, 6en, 6ff, 6fh, 6fu, 6gx, 6ka, 6ke, 6od, 6ol, 6pi, 6qr, 6rd, 6up, 6xad, 6xh, 6zf, 6za, 6zt, 6zx, 7aea, 7lf, 7lu, 7mf, 7nw, 7qd, 7th, 7vf, 7xg, 7yj, 7zs, 8wr, 9amb, 9bjv, 9dug, 9ps, 9saf, Canadian 9bd, bqs, wgy.  
Phones—kdyl, kfca, kfc, kfi, kiz, ksdk, kuv, kvq, kwh, kyj, kzn, 7yj.



**World Batteries**  
for  
**RADIO OR AUTOMOBILE**  
**SAVE YOU 50%**  
Buy direct from factory. Get highest quality—lowest prices and 100% battery service.

**WRITTEN TWO-YEAR GUARANTEE**

**AUTOMOBILE PRICES**  
6 Volt, 11 Plate - \$12.50  
Ford, Dorr, Chev.  
6 Volt, 13 Plate - 14.50  
Overland, Buick  
12 Volt, 7 Plate - 18.00  
Maxwell, Dodge  
Same 50% saving on all cars. (Five make car

Batteries shipped immediately express C.O.D. Thousands of satisfied users. Mail your order today!

**RADIO PRICES**  
6 Volt, 40 Amper. - \$ 8.50  
6 " 60 " - 10.00  
6 " 80 " - 12.50  
6 " 100 " - 14.50

**World Battery Company** 1219 S. Wabash Ave., Dept. X  
CHICAGO, ILL.

**A New Perfected Crystal**



Every STAND-ARD CRYSTAL is tested on the Radio Waves before and after mounting. We guarantee every crystal we sell. Jobbers and dealers be convinced.

send for a free sample of the STANDARD SPECIAL CRYSTAL, sold mounted and unmounted. All orders shipped the same day received.

**STANDARD CRYSTAL CO.**  
274 Halsey St. Newark, N. J.

For any make of phone

**PUT MICA DIAPHRAGMS ON YOUR PHONES**

Ask your dealer or send direct for free illustrated circular No. 22

LIBERAL DISCOUNTS to DEALERS and JOBBERS  
Eliminate noises  
CLEARER-BETTER-PURE TONE  
Immediate Delivery

**RADIO MICA PRODUCTS CO.**  
156 East 43rd St., New York City

**Radio Supplies**  
**All Standard Goods**  
**Immediate Deliveries**

Distributors for  
**BALDWIN, BRANDES and FROST PHONES.**  
**MONROE RECEIVING SETS.** Atwater Kent, Chelton, Chelsea Thordarson, Burgess, Cunningham, Magnavox, and many others.

A COMPLETE line. Largest stock in the middle west.  
Write for Catalogue  
**DEALERS' ATTRACTIVE DISCOUNT**  
**American Radio Mfg. Co.**  
Dept. H  
107 E. 13th St. Kansas City, Mo.

**Na-ald**  
De Luxe  
**V. T. Socket**

Contact strips of laminated Phosphor bronze press firmly against contact pins, regardless of variation in length. No open current trouble possible. Socket moulded from genuine Condensite. Practically unbreakable. Special protected slot, with exterior reinforcement. Unaffected by heat of bulbs or soldering iron. All excess metal eliminated, aiding reception. May be used for 5 Watt power tube. Highest quality throughout. Price 75c.

Special proposition to dealers and jobbers  
**Alden-Napier Co.**  
52 Willow St. Dept. H Springfield, Mass.

Tell them that you saw it in RADIO



# THE QUALITY MARK ON PLUGS AND JACKS

The PACENT Trade Mark on RADIO ESSENTIALS means that they have been designed to meet most efficiently a definite radio need. It means that over fifteen years of practical radio experience and the best radio engineering principles are responsible for every PACENT unit. It means QUALITY, ACCURACY and DEPENDABILITY.



### PACENT Universal Plug

The FIRST radio plug made. Special features make it the BEST. Phone cord can be attached instantly: No tools necessary. Perfect biting contact. Perfect insulation. Can be used with any standard jack, but made especially to fit PACENT jacks. The best radio plug at ANY PRICE now offered at a REDUCED PRICE.

Cat. No. 50 . . . . Price, NOW \$1.00

**DON'T IMPROVISE—PACENTIZE**

*Write for Descriptive Bulletin, M N 103*

### Specifications: PACENT Jacks

- Coin Silver Contacts
- Genuine German Silver Springs
- Nickel Plated Brass
- Frames (not Iron)
- Micarta Insulation (not Fibre)
- Extra Booster Springs
- Husky Nipples
- Rugged Construction Thruout
- All Details Precisely Accurate
- Provided with THREE WASHERS

Will fit any panel from 1/8" to 3/8"



No. 61 PACENT Open Circuit Jack . . . . . \$ .70



No. 62 PACENT Closed Circuit Jack . . . . . .85



No. 63 PACENT Double Circuit Jack . . . . . 1.00



No. 65 PACENT Three Spring Automatic Jack . . . . . 1.00

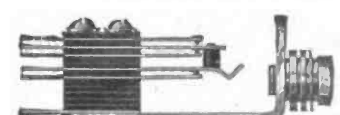

No. 66 PACENT Five Spring Automatic Jack . . . . . 1.20

## PACENT ELECTRIC COMPANY

I N C O R P O R A T E D

Manufacturers and Distributors of Radio and Electrical Essentials  
Executive Offices: 22 Park Place, New York, N. Y.

### BRANCHES

Philadelphia, Bourse Bldg.  
Chicago, 33 So. Clinton Street



Washington, D. C., Munsey Bldg.  
San Francisco, Sheldon Bldg.,

Members, Radio Section, Associated  
Manufacturers of Electrical Supplies

Canadian and British Licensees:  
COLONIAL RADIO, Ltd., Hamilton, Canada

# The AMERTRAN



## Amplification Extraordinary

A good amplifying transformer in one stage might give audibility amplification of 20; in two stages, 400.

Price \$7

Ask your  
Electrical  
Dealer  
Or, sent  
carriage charges  
collect  
(Wt. 1 lb.)

One AMERTRAN with Radiotrons gives 38.6; two stages, 1490, or nearly four times the ordinary type—and without distortion.

In volume and pure tone quality, for nearby broadcasting as well as for long distance reception, its supremacy is immediately apparent.

## American Transformer Company

Designers and builders of radio transformers  
for over 20 years

174 Emmet Street, Newark, N. J.

# Duck's Radio Catalog

No. 16—256 Pages

Continuously since 1909 Duck's Radio Catalogs have never been equalled for completeness and great wealth of radio data.

Bend 25c in coin, carefully wrapped, for your copy of this wonderful book, the most unusual and complete catalog ever put between two covers. Not sent otherwise. It is not only a catalog, but a wonderful text book on radio. Enormous cost and tremendous demand

prevent further distribution at a less retainer.

Over 50 pages of latest hook-ups (wiring diagrams) and invaluable and up-to-date data and information on radio, including important instructions for building antennas.

Our new moulded variometer speaks for itself. For a comprehensive description of the design and radio thought back of our variometers, we invite your attention to our exhaustive description in catalog. In prettiness of design, compactness and lightness of weight, we have not seen any variometer that we believe compares with ours. The forms, unlike many others, positively will not warp. No. A900 plate variometer, with knob and dial \$7.25. No. A901 grid variometer, with knob and dial, \$7.25. Note.—If knob and dial are not desired deduct 75c.

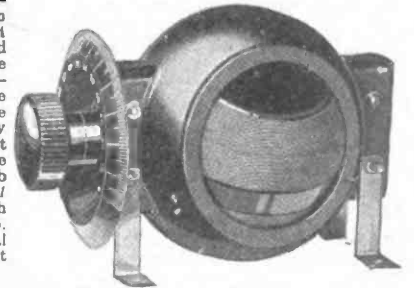

Duck Products have stood the test of time.  
The largest line in America—62 complete instruments—58 parts

Dealers  
We want live, responsible dealers in every city and town in the United States, both for the sale of our extensive line of radio apparatus and all other worth-while lines of radio goods, on all of which we can quote attractive dealers' discounts. We can offer you facilities and advantages that no other radio house can offer.

**THE WILLIAM B. DUCK CO.**  
248-250 Superior St.: Toledo, Ohio

Tell them that you saw it in RADIO

# DEALERS

Are you ready for the holiday trade? Are your connections of such a nature that you can depend on RUSH ORDERS being put through on time? We can guarantee prompt delivery, and our discounts are most liberal.

**We Are Jobbers For**  
**Grebe Receiving Sets**  
**Murdock Products**  
**Baldwin Phones**  
**Federal, Fada and**  
**Radio Shop Products**

Write for our special proposition "A"

## The Radio Shop OF NEWARK

415 Orange Ave., Newark, N. J.



# RADIO FANS

Have you a detector set?  
Then Listen In with our

## \$5.00 ROYALFONE

It gives best results on a detector set because it's made for a detector set.

Ask your radio dealer to let you listen in with a

## ROYALFONE

You will note the difference. If he hasn't one, write to

ROYAL ELECTRICAL LABORATORIES  
207 Market St. Newark, N. J.

*Royalfone*

# "B" BATTERIES

AN  
**EVEREADY**  
PRODUCT

48V. Batteries, tapped.....\$5.00  
 22½V. Batteries, Navy Type..... 3.00  
 22½V. Batteries, Commercial Type..... 3.00  
 Latter two types especially adapted to  
 Cunningham and Radiotop Tubes.

Postage Prepaid Anywhere in U. S.

**ETS-HOKIN & GALVAN**  
Wireless Engineers

10 Mission Street San Francisco

## Compare These Prices Why Pay More When You Can Get Rock Bottom Prices from Us? \$Save \$Save \$Save

Just glance over our list and send us your money order. Twenty-four hours after receiving your order, it is on its way to you.

| List Price  | Our Price |
|---|-----------|
| \$5.00 Radiotrons UV-200  | \$4.24    |
| 6.50 Radiotrons UV-201  | 5.75      |
| 16.00 Baldwin Phones Type C                                       | 14.75     |
| 7.75 Baldwin Unit Loud Speakers                                   | 6.75      |
| 45.00 Magnavox  | 38.00     |
| 6.00 Murdock 3,000 ohm Phones                                     | 5.00      |
| 5.00 Murdock 2,000 ohm Phones                                     | 4.25      |
| 8.00 Federal 2,200 ohm Phones                                     | 6.00      |
| 8.00 Brandes Superior Phones                                      | 7.00      |
| 5.00 Acme Transformers  | 4.25      |
| 1.00 Double Jacks   | .60       |
| .70 Single Jacks  | .50       |
| 2.50 Bull-Dog Plugs   | 1.25      |
| 1.50 100 ft. stranded Aerial Wire                                 | .50       |
| .50 Aerial Insulators   | .30       |
| 1.00 100 ft. stranded Aerial Wire                                 | .40       |
| 75.00 Paragon RA-10   | 68.00     |
| 25.00 90 Amperes guaranteed storage Battery                       | 16.00     |
| 8.00 Westinghouse W. D. 11 Tubes, 1½ Volts operated on 1 Dry Cell | 7.25      |
| Can be used as Detector or Amplifier                              |           |
| 1.50 Sockets for W. D. 11 Tubes                                   | 1.00      |
| 1.00 Rheostats  | .75       |
| 1.00 Fada Rheostats   | .65       |
| 1.00 Vacuum Tube Socket   | .50       |
| 18.50 Homechargers  | 15.50     |
| 3.50 B Batteries Volt Meters, 0-50 V                              | 2.75      |
| 4.50 Murdock Enclosed 48 plate Variable Condensers                | 4.00      |
| 4.00 Murdock Enclosed 28 plate Variable Condensers                | 3.75      |
| 3.25 Murdock Panel Mounting 28 plate Variable Condensers          | 3.00      |
| 4.00 Murdock Panel Mounting 48 plate Variable Condensers          | 3.60      |
| 3.75 Arrow 28 plate Variable Condensers                           | 3.25      |
| 4.75 Arrow 48 plate Panel Mounting Variable Condensers            | 3.50      |
| Contact Points, per doz.  | .15       |
| Switch Levers, 1½" radius   | .25       |
| Honeycomb Coils, all sizes, 20% discount                          |           |

Space being limited we are obliged to omit many items.

Remember, we guarantee to undersell any Radio House in the U. S. Write for our quotations.

We prepay charges East of the Rocky Mountains, West of the Rocky Mountains we pay half charges.

**Cut Rate Radio Co.**  
P. O. Box 472  
Dept. R. Newark, N. J.

**JOY-KELSEY CORPORATION**  
RADIO EQUIPMENT  
4021 West Kinzie St. Chicago 111.



"Keco" Radio "A" Batteries  
ARE GUARANTEED  
We build all sizes from \$10.55 to \$38.00.

Write for Catalog

"KECO"  
7323 Manchester St. Louis, Mo

Tell them that you saw it in RADIO,

Continued from page 94

in the smoke haze and murk and noisome gloom.

She fought her way back to the radio shack.

Just as he had fallen, Skipper Sheffield lay. She looked at the fine old face, over which there had come an expression of utter—peace. She bent—crossed the hands—

"I've done my best for your ship—and for us all. You know, now, what the answer will be to my message—and if it reached—Him!"

She put the head harness on—tuned—but there was no sound. Then she took the little locket from its fragile chain—opened it—

"Boy—mine—your 'OW' has done all that she could. If this is—good bye—we will—meet in—in Happier Places—boy—mine—I love you so!"

And then nature had its way. She fainted—and her tired little head fell across the white hands—on the operating table—while in the inferno below heartened men slaved and fought and scorched and blistered—hurling blasphemous blessings on her.

And—very gradually—the wind began to drop—and the seas to run in lesser mountains.

"WHO is this—'D. Montgomery'?" Sounds like a new name to me! But it's of no consequence—anyway! Nothing is too good for 'D. Montgomery'!"

Thus spoke Carroll, Sr.—as he strode up and down his huge private office—to Carroll, Jr., and to Brown, the personnel manager.

"By Heaven!" the big man exploded, "to think of the magnificent nerve of it! Throw a bluff that his SOS had been heard—when he hadn't heard a damned thing! And couldn't raise a ship—anywhere! With the *Blythedale* burning under his feet—and the after-hold full of explosive—knowing this, to calmly bluff the crew into taking heart—and working the ship to port—with the poor old skipper gone—is the finest thing I ever heard of. How about it?"—glaring at Arthur and Brown—as though daring them to contradict him.

The two looked at one another from the corners of their eyes—and agreed.

"Well—well!" continued the senior member of Carroll & Carroll—looking impatiently at the clock. "Montgomery is due here—now! I've got this watch, properly inscribed—a comfortable check—and a guaranteed position with us as long as he cares to stay! I want 'D. Montgomery' in Carroll & Carroll!"

The other two turned their heads away.

A light tap at the door.

Continued on page 100

# Static Defeated and Loop Aerials Practical for All

## Cotoco

TRADE MARK REG. U. S. PAT. OFF.

Buy by the name Cotoco and you buy Radio supplies that are scientifically and mechanically right. Buy by the name Cotoco and you buy abreast of the latest developments in Radio.

One of the nation's greatest weeklies, in an editorial article, speaks of the "growing popularity of radio frequency." The reason for this nation-wide popularity is that Radio Frequency sets alone have weathered the summer whirlpool of static. Cotoco Radio Frequency Transformer is of tapped type. Gives great selectivity and little amplification of static. The obvious advantages of Loop Aerials are fully enjoyed by those who use this method.

The name Cotoco is to be found on the best amateur and professional Radio Frequency Sets throughout the land.

**Buy Always by the Name**

**COTOCO**

**Connection Diagrams Are Wrapped**

with every Cotoco Amplifying Transformer for Radio Frequency for both two and three stages of Amplification.

If your Dealer cannot supply you, send us his name.

**Coto-Coil Co.**

87 WILLARD AVENUE  
PROVIDENCE, R. I.

*Write for Free Connection Diagrams*

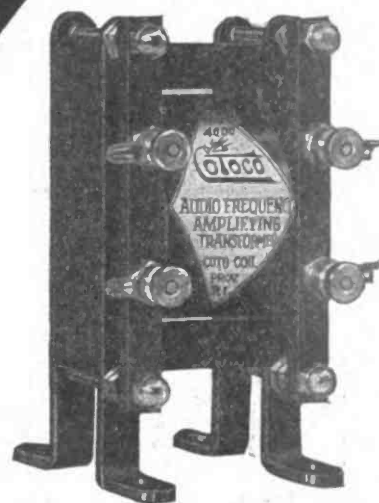

*Cotoco Amplifying Transformer for Audio Frequency*

**Static and Distortion Yield to These Scientifically Designed Transformers**

Above is our Audio Frequency Amplifying Transformer. Distortion is practically unknown to its users. Variation of audibility is at a minimum over a wide band of frequencies.

Below is the wonder working tapped type transformer for Radio Frequency that has had so much to do with the growing popularity of Radio Frequency as opposed to the regenerative principle. Many of the most efficient radio sets made this fall and winter will be built around these compact and efficient units mounted for two stages (as illustrated) or three stages of Amplification.

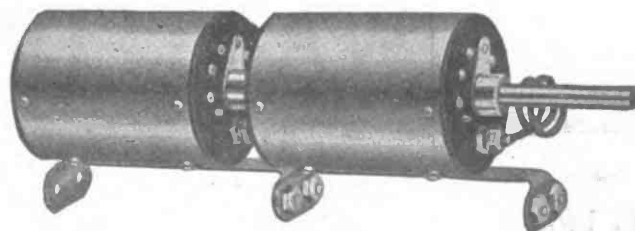

*Cotoco Amplifying Transformer for Radio Frequency*

Tell them that you saw it in RADIO

# The Book You Need C. W. MANUAL

By Jennings B. Dow, U. S. N.

**\$1.00 Per Copy**  
POSTPAID ANYWHERE

A Complete Textbook  
Containing 112 Pages  
of Valuable Data on  
Vacuum Tube Transmitters

**T**ELLS you how to construct various types of radio telephone and telegraph continuous wave sets. Many diagrams and illustrations. Nothing like it on the market. Acknowledged by the better class of radio men to be one of the best radio books yet published. Get a copy from your dealer or order direct.

The Following Dealers  
Carry The C. W. Manual

Heintz and Kohlmoos,  
San Francisco  
Leo J. Meyberg,  
San Francisco  
Radio Institute of America,  
San Francisco  
Western Radio Electric Co.,  
Oakland, Calif.  
U. C. Battery & Electric Co.,  
Berkeley, Calif.  
J. C. Hohrecht & Co.,  
Sacramento, Calif.  
Western Radio Elec. Co.,  
Los Angeles, Calif.  
Paul F. Johnson,  
Pasadena, Calif.  
Southern Electric Co.,  
San Diego, Calif.  
Northern Radio & Elec. Co.,  
Seattle, Wash.  
Western Radio Distributing Co.,  
Seattle, Wash.  
Pacific Telegraph Institute,  
Spokane, Wash.  
John W. Graham & Co.,  
Spokane, Wash.  
Nielsen Radio Supply Co.,  
Phoenix, Ariz.  
Erie Book Store,  
Erie, Penna.  
Mutual Telephone Co.,  
Honolulu  
Wm. Guard & Co.,  
London, Ontario, Canada

**DEALERS** ORDER A SUPPLY  
OF THESE BOOKS

Write for Trade Prices

**PACIFIC RADIO PUB. CO., Inc.**  
Pacific Building — San Francisco  
17 West 42nd St. — New York

Continued from page 98

"The radio—operator of the *Blythedale* is outside, Mr. Carroll."

"Show him in, man! Good God—don't keep him waiting—show him in!"  
The clerk disappeared.

Silence in the great, map-lined office. And then she entered it—gracefully—quietly—and stopped, just across the threshold, a lovely picture.

"You sent for me—Mr. Carroll?"  
Carroll, Sr., gasped—once—came forward—one pace—"But—but who are—you?"

"I am Dorothy Montgomery, lately radio operator on your vessel—the *Blythedale*."

Moments passed.

Then the look of bewilderment on the big man's face changed slowly to one of understanding. He turned to his son.

"You—young—scamp! You scally-wag! To play a trick like this on your trusting old father! And you, Brown!"—he roared at the personnel manager—"you had a finger in this—this put-up job! I ought to fire you—but I won't!"

He walked to the girl—put his big hands on her slight shoulders.

"I said—before you came in—that I wanted 'D. Montgomery' to be with Carroll & Carroll as long as he desired to stay! And I stick to it—tho' the gender is changed to feminine! So—you are the girl that my reckless lad tried to kill—with his go-devil car—eh? Come to me—child! You have eyes and hair like his mother's—" he coughed. "Beat it—you lucky dog! And you, too, Brown!—vanish!"

Arthur and the personnel manager disappeared—while the great shipmaster gathered the slight figure in his arms.

"The original 'OW' of Carroll & Carroll!" he whispered tenderly. "But—tell me—child—the chief officer says that he heard you—saw you—send a message! What was it—a broadcast of your own—in the hope of being heard?"

She looked up at him. "Yes, it was a broadcast—of my own—to God—and He heard it."

A shaft of golden sunlight shot from beneath a cloud—glowing softly on their figures.

## WANTED!

Radio Experimenters to earn money in spare time by securing subscriptions to **RADIO** on a liberal commission basis.

Write today for full details to

**EASTERN SALES DIRECTOR**  
Suite 212, McOrory Bldg., E. E.  
Pittsburgh, Pennsylvania

Tell them that you saw it in **RADIO**

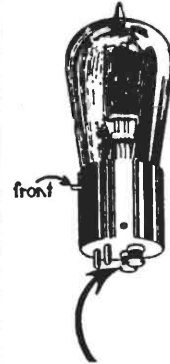
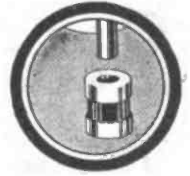

**This fuse**

(costing twenty-five cents)

**placed here**

(on the filament terminals)

**Saves the tube**  
(costing at least \$5.00)

**Positive and Reliable**

Not a makeshift, nor an untried new radio device, but a tried, tested protection for vacuum tubes.

# RADECO Safety Fuse

(pat. pending)

now in use on thousands of sets throughout the country makes "burning out" absolutely impossible—even when an accidental "short" is set up at any point in your set.

Attached easily to any standard bulb used in any standard socket, this tiny device will make your tube last indefinitely.

In standard packages of

By **4 for \$1** At your  
Mail **Dealer's**

We have Fuses in stock for the following tubes Electron Relay, A-P Amplifying Double Filament Audiotron, Cunningham C300 and 301, Radio Corp UV200, UV201, UV202, and Western Elect VT-1 and VT2. State, when ordering, what tube fuses are for.

We carry a stock of standard radio goods. Order from any standard catalog at standard prices.

## RADIO EQUIPMENT CO.

630 Washington Street  
**BOSTON, MASS.**

Oldest Exclusive Radio Store in  
New England

**RADIO FOR CONSTRUCTION JOB**

*Continued from page 10*

The construction entrance camp is at an altitude of over 9000 feet. Due to the location of the stations and the topography of the country and the fact that little was known regarding radio communication in a mountainous territory, it was necessary to do considerable experimenting before satisfactory results were obtained. Portable radio telephone sets which had given satisfactory service in the vicinity of Los Angeles were first taken into this territory. Tests showed that to communicate a certain distance it was necessary to use about twenty-five times more power than was needed near Los Angeles.

The three 500-watt transmitters were built on special order in about twelve days. One oscillion tube is used in each set. They were designed originally for continuous wave telegraph, but have been equipped for telephone or buzzer modulated telegraph. All three methods of communication work well.

To furnish power for the boring of tunnels for the hydraulic development a thirty kilovolt volt transmission line has been built between Cascada and the two outpost mountain camps. The radio sets give a rapid and reliable means of communication during transmission line trouble and handle switching and operating line orders. The transmitter at Cascada obtains its filament current from the 110-volt supply and plate current from a 1500-volt generator belt driven by a 2-h. p. induction motor. The radio power plant at Huntington Lake portal camp and the construction entrance camp consist of a 220-volt, three-phase motor, coupled to a 32-volt direct current generator and belted to a 1500-volt direct current generator from the coupling. Under normal operation the 32-volt direct current generator furnishes power for the filament and the 1500-volt direct current supplies the plate. During a failure of the 30-volt transmission line, the 32-volt direct current generator operates as a motor from the storage batteries of the mine locomotives used in the tunnel work.

The antenna at Cascada is of the inverted L type, 140 feet high at the free end, 90 feet at the station end, and 120 feet between spreaders. Five No. 8 copper wires spaced 4 feet apart are used. At Florence Lake portal camp a T aerial is installed, being 140 feet high and 175 feet between spreaders. The same wire and dimensions are used. At the construction entrance a T aerial 90 feet high and 150 feet between spreaders. The radiation from each of these antenna is about 2.4 amperes at 540

*Continued on page 102*

**WESTINGHOUSE**  
RADIO "A" and "B" BATTERIES



*Westinghouse has a  
new Radio "B" Battery*

that is a marvel for long, steady, dependable, noiseless service. Compactly built, with the 2-volt elements visibly arranged in a one-piece, eleven-compartment glass container. Lasts indefinitely; easily recharged. Get it from your radio dealer or the nearest Westinghouse Battery Service Station.

There are also two other types of Westinghouse "B" Batteries; and ten types of "A" Batteries, ranging from 27 to 162 ampere hours' capacity and in 4, 6 and 8 volts. There's a correct type for *your* set.

"B" Battery  
22-MG-2

WESTINGHOUSE UNION BATTERY COMPANY  
Swissvale, Pa.

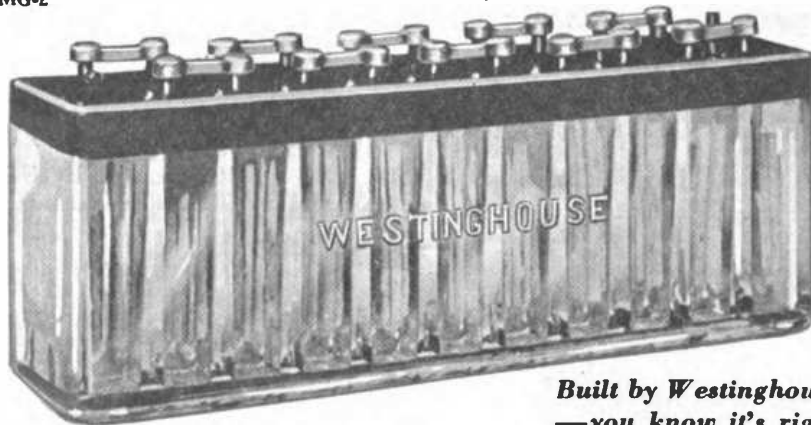

*Built by Westinghouse  
—you know it's right*



**—RADIO INSTITUTE—**  
OF AMERICA

Conducted by the greatest and most experienced radio telegraph organization in the world.

Thorough training given in radio operating, traffic, all systems, including the latest successful commercial radio development of the G. E. Company, which, in one set, combines radio telephony, continuous wave telegraphy, and interrupted continuous wave telegraphy. This apparatus now installed in our school room.

Tuition Ten Dollars per month, for either the day or evening sessions, or both combined.

*Prospectus mailed on request*

RADIO CORPORATION OF AMERICA

Phone Douglas 3030

331 New Call Bldg., San Francisco

98 Worth St., New York. Phone Franklin 1144

Tell them that you saw it in RADIO

# YOU EXPECT IT

When you place your order for ACE equipment, you naturally expect the finest made. We supply it and the results is lasting satisfaction. If you haven't tried our product, order an Ace Panel Lever Switch as a starter. You'll be convinced.

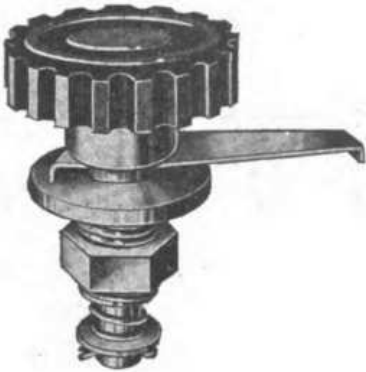

Our own switch is a new product, and one which was given much careful thought in design. The result is found in the following features: moulded in shaft, therefore Knob cannot work loose; hexagonal shoulder absolutely guarantees blade against turning on shaft; perfect self-cleaning wipe contact at EACH end; spring and cotter pin tension; no nuts to loosen. You cannot buy a better switch. This and our other products described in our general catalog, forwarded upon receipt of 10c.

Dept. NL

**The Precision Equipment Co.**  
2437-39 Gilbert Ave. Cincinnati, Ohio

## ★ ★ RADIOADS ★ ★

A CLASSIFIED ADVERTISING SECTION READ BY BETTER BUYERS

The rate per word is five cents, net. Remittance must accompany all advertisements. Include name and address when counting words.

ADS FOR THE DECEMBER ISSUE MUST REACH US BY NOVEMBER FIRST

### TRANSMITTING APPARATUS

**FOR SALE: TEN (10) DYNAMOTORS**, Motor side 8 volts, Generator side 600 volts, manufactured for the United States Aviation Service. Price, \$35.00. EKSAF TRADING COMPANY, 1515 EASTERN PARKWAY, BROOKLYN, N. Y.

**MOTOR GENERATOR**—Ideal for fone or portable fone, weight 85 lbs., size about 10x8x24 in.—one unit, two bearing. Generator 400 volts, 200 watts D. C. Motor 8 volts, 80 amp. D. C. Can be operated from 6 volt automobile starting battery. Worth about \$150.00. Will trade for large Magnavox or \$80.00 cash. BOX 101, RADIO, PACIFIC BLDG., SAN FRANCISCO, CALIF.

**A SACRIFICE OF THREE COMMERCIAL 500 CYCLE RADIO TRANSMITTERS**. Two 2 kw. Kilbourne & Clark and one ½ kw. Telefunken. These sets comprise the essential motor-generator, transformer, condenser, inductances, starting and control panels, etc. Price of either set \$225.00 or the three for \$600.00. The real value of these sets is about \$1800.00. These sets would make a wonderful equipment for school and educational purposes or for ship or shore stations. BOX 102, RADIO, PACIFIC BLDG., SAN FRANCISCO, CALIF.

### RECEIVING APPARATUS

**UNMOUNTED HONEYCOMB COILS**: Cheapest on the market. Immediate delivery on the following sizes: 25 turns, 40c; 35 turns, 40c; 50 turns, 50c; 75 turns, 55c; 100 turns, 60c; 150 turns, 65c; 200 turns, 70c; 250 turns, 75c; 300 turns, 80c; 400 turns, 85c. Postage extra. The Quality Coil Co., 605 19th Ave., San Francisco, Calif.

**VARIOMETERS AND VARIOCOUPERS**: "Bilt Rite" Variometers and Variocouplers, \$5.00; With dial, \$6.00; Fada Rheostats, \$1.00; Bakelite Sockets, \$1.00; UV-200, \$5.00; UV-201, \$6.50; Federal Standard Jacks; Jenkins Vernier Rheostat, \$2.00; Facnet Plug, \$1.25; Complete Line of Parts. Westinghouse, DeForest, Grebe Sets at Standard Prices. SCHUYLKILL RADIO CO., 105 W. MARKET ST., POTTSVILLE, PA.

**LIGHTNING-STRANGE BATTERY COMPOUND** startles the world. Better than sulphuric acid. Charges discharge batteries instantly. Gallon free to agents. LIGHTNING CO., ST. PAUL, MINN.

**FOR QUICK SALE**—New Olapp Eastman \$14.00 loose coupler \$10.00. Also almost new single tube receiver \$19.00—receives New York. Also Murdock 8000 phones, \$4.50. FRANKLIN CAMPBELL, JR., 414 High Street. W. Medford, Mass.

**\$1.00 RADIO FREQUENCY TRANSFORMERS**—Hear distant stations. Designed to fit any standard socket. Three sizes 160-500M; 500-1000M; 1000-2000M. Complete set of parts and full directions for assembling, postpaid \$1.00. 8 for \$2.75; 6 for \$5.00. Arkenberg Agency, 702 World Bldg., N. Y.

### MISCELLANEOUS

**WE BUY**, sell and trade slightly used apparatus, books and parts. Send those old parts lying around your shop and state your wants. Edison Dictaphone model D needs new rubber tube to ear pieces, otherwise good condition. Will trade or sell. SOUTHWEST EXCHANGE, BOX 87, TUCSON, ARIZONA.

**"ARCO" MAGNET WIRES**, (see July, Aug., Sept. Radio News). VT'S 5 to 500 watt. Request Quotations. A-P, RAC-3, UV-200 Detectors, Amplifiers, \$4.45, \$5.80. ANTENNAE WIRE 7-22 100 ft. tinned \$0.70. "ARCO" moulded Variometers, \$5.90. Audio Amplifying Transformers, \$3.80, \$4.75. Signal Condensers .001—\$3.75; .0005—\$3.00; Mahogany Horns, \$5.00; 3 in. Dials—\$0.40, \$0.65. Large stocks Prompt Service. Low prices. Your inquiries solicited. BULLETINS FOR .08 WHOLESALE—RETAIL. Postage Extra. AMERICAN RADIO CO., Box 183, BALTIMORE, MD.

**BLACK FIBRE PANELS** nicely finished 7x18 x3-16—\$1.25. Cut to order any size .01 square inch. Immediate delivery. Geo. H. Mollahan, Lowell, Mass.

**FOR SALE: APPARATUS IN VERY GOOD CONDITION**: Jewell 64-1 Ampere Meter \$10.00; Spider Webs, \$4.50; Navy Receiving Transformer, cost \$18.00, \$10.00; Baldy C Unit (New), \$6.50; Remler 50-Crystal Det., \$1.50; Skinderviken Button, \$0.50; One-half kilowatt open core Transformer, \$5.00; 3 sections spark coil Condensers, \$3.00; Also have two Rheostats used in small generating stations; one Hammer 8-4 ampere, \$12.50; one Westinghouse 4-1.5 ampere, \$9.00. First come first served. Geo. E. Conner, Lewiston, Calif.

**SWITCH POINTS**—Nickel plated 1-8x4 in. two cents each. C. S. GLEASON, 650 California St., VENICE, CALIF.

Tell them that you saw it in RADIO

Continued from page 101

meters, which is the normal operating wavelength.

Involved in the work of developing the full electric potentiality of the streams of the High Sierras and conserving their flow for irrigating lands in the San Joaquin Valley are many more daring engineering problems, which will necessitate the drilling of other tunnels, the erection of enormous storage dams in the mountain ranges and far beyond lines of transportation and the constant employment of thousands of men for several years to come. Radio is probably being put and continuing to be put to one of its most practical uses in becoming the medium for transmitting the instructions for the work of this great project.

### UNUSUAL DX WORK

Continued from page 21

formerly 6KY, will be associate operator at 6XAD through December and January. During January a series of tests will be conducted between 6XAD and the new station of the Amalgamated Wireless, Ltd. at Sydney Australia.

It is to be hoped that the CW and ICW men will "make good" during the coming radio season, and it gives me much pleasure to state that if 6XAD can be of any use, for DX tests—and so forth—I shall be only too happy to render such assistance as I may.

Additional stations heard and worked by 6xad since the above was written are as follows:

(9bjv), (9zaf), 9yas, 9bds, 9ays, (9bhd), (9awm), 9ajm, 9dr, 9drd, 9ajs, 9tps, 9kp, (9xaq), 9ww, 9api, (9hvj) 9yaj, 9bds, 9ajm, 9bqw, 9djo, (9djo), (8bke), 8bb, (8cko), (8bux), 8cak, 8sc, 8zy, (8zy), 7qd, 7zu, 7gn, (6xas), (6xj), (6byj), (6mda), (6beg), (6gr), 5qs, (5za), 5nv, 5qs, (4bf), 4jy, 3bit, 3bhm, (3bhm) Robert C. Valentine, Marshalltown, Pa., Zapd, 2awa, (2awf).

### CANADA TAXES AMATEURS

In Canada it is necessary to pay a tax of \$1 for all experimental amateur radio sets. Over 400 licenses have been granted by the Ottawa government thus far. Applicants for licenses are required to get in touch with the Dominion Naval Service. Prosecutions will follow unless applications are filed within ten days of the sets being installed.

### RADIO BUSES

The radio-equipped stages which travel on the California highways, are the inspiration of equipping sight-seeing buses on Broadway, New York, in a similar manner. The Greeley Sightseeing Car Co. plan to equip all their buses with radio receiving sets in 1923.



# Miller Radio Frequency Amplifiers

**M**ILLER Radio Frequency Amplifiers (either complete set or units) are produced by us under license from Dr. John M. Miller of the Naval Radio Research Laboratory, Bureau of Standards, Washington, D. C. Miller Radio Frequency Amplifiers accomplish the following hitherto unknown feats:

- 1 Give actual, true r. f. amplification from step to step of approximately 5 per step.
- 2 Amplify at radio frequency at equal efficiency on all wave-lengths from 150 to 24,000 meters.
- 3 Require no biasing potentiometers and are not critical in operation.



Don't buy any make-shift radio frequency transformer—fill out the coupon below and let us tell you about the Miller—by far the best radio frequency amplifier on the market.

## COAST RADIO CO.

RADIO APPARATUS

EL MONTE  
CALIFORNIA

BAKELITE MOULDING

COAST RADIO CO.,  
EL MONTE, CALIF.

Please forward immediately full details of the  
**MILLER RADIO FREQUENCY AMPLIFIER**

*Mail  
This  
Right  
Now  
!*

Name ..... Address .....



—and now  
 harmony replaces discord!

**M**USIC—clear as a bell; speech—so that every word is marvelously distinct; jazz—in uninterrupted syncopation; opera—with that transcending, full-toned quality which brings its remarkable beauty into strong relief.

This sort of radio reception is a matter of *batteries*. Elimination of most *noises* is a matter of batteries, rather than static or other interference.

These noises are caused by the *irregular* voltage output, natural in ordinary "B" batteries. Where the current output becomes unvarying, these noises cease—and this marvelously clear and life-like reception results.

And it is because RADIOBATS "A" and "B" are the only batteries which act as radio batteries *should*, that we urge you to listen to a demonstration at your dealer's.

Until you have actually heard reception through RADIOBATS "A" and "B" you cannot imagine how wonderful radio can be—and there is *no way* to hear it, till these epoch-making, new-principle batteries are hooked in.

RADIOBATS "B"—as well as "A"—are *leak-proof* because they have the only solid electrolyte; and they are more economical, because, like "A" Batteries, they are indefinitely *rechargeable at home*.

Send now for the intensely instructive booklet "The permanent Power Unit for Radio" and send your dealer's name and address so that we may arrange an immediate demonstration. There is absolutely no obligation.

MULTIPLE STORAGE BATTERY CORPORATION  
 350-A Madison Avenue, New York

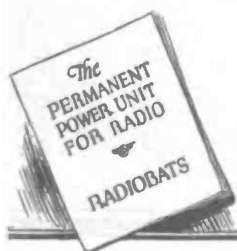

"A" and "B" **RADIOBATS**  
*The Permanent Radio Power-UNIT*

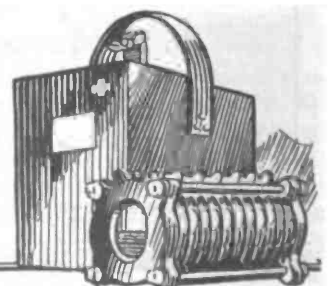

# REMLER

*Cumingham*

APPARATUS THAT RADIATES QUALITY

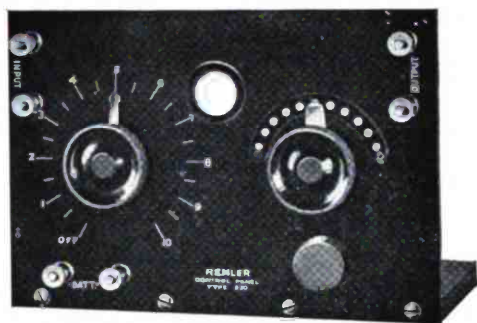

Remler Type 330 Detector Panel. Price \$8.50

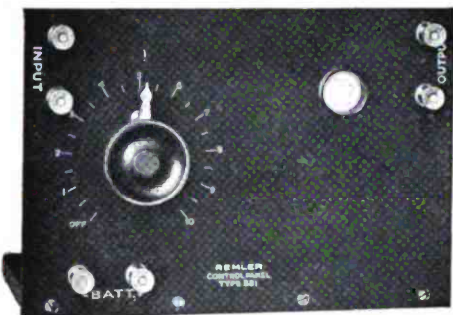

Remler Type 331 Amplifier Panel less transformer Price \$6.00

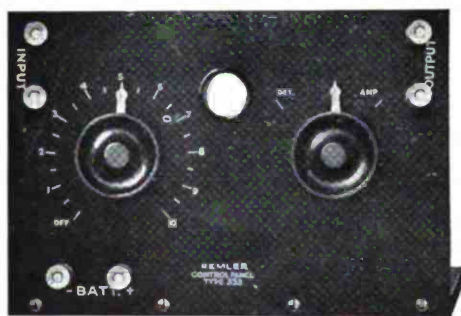

Remler Type 333 Amplifier Panel less transformer Price \$9.00

THE MOST POPULAR

## Panels

ON THE MARKET

**I**N designing these Remler Control Panels, Remler Engineers combined every point necessary for efficient detector and amplifier tube control with special features of construction for the convenience of the user. No process of manufacture that would make these panels efficient in operation and beautiful in appearance has been neglected.

Each panel is a complete unit, mounted on a hardwood base for table use, but so designed that it may be easily mounted in a cabinet. The input and output binding posts are located on opposite sides of the panel at a standard height to facilitate the neat and easy connection of other Remler units.

The 330 Detector Panel contains the Remler Grid Condenser and Variable Grid Leak unit. Also the patented Remler "A" Battery Potentiometer for plate voltage control—an item very necessary for obtaining maximum efficiency from the sensitive gas filled detector tubes.

The 333 Amplifier Panel contains the Remler Rotary Cam Switch which does the work of two jacks and plug in cutting in or out steps of amplification.

All panels are of highly polished black Bakelite and only Remler standard Quality parts are used in the assembling of the unit. All lettering is recessed and filled with a special white enamel that will not discolor or chip out.

### NEW REMLER CATALOGUE

Send 10c for new 42 page Remler Catalog just off the press containing circuit diagrams for Remler Apparatus and other useful information, including a table of inductance, capacity and wave length.

# REMLER RADIO MFG. CO.

FACTORY AND HOME OFFICE  
248 FIRST ST. SAN FRANCISCO, CAL.

EASTERN REPRESENTATIVE  
154 W. LAKE ST. CHICAGO, ILL.

**Type AP-3 two-stage Audio Frequency Amplifier**  
(Companion piece for Type AP-4)



**Type AP-4 Short Wave Receiver**



*Dealers  
recommend*

**A-P**

THE QUALITY LINE

**for performance**



**Card PHANTOM Receptor**  
(Also called the A-P Special)  
View open and closed, showing compactness

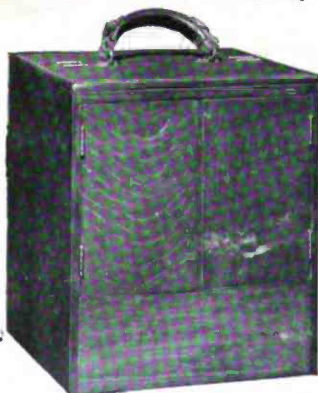

A-P sets make good. The years of radio experience behind the name A-P guarantee excellence of manufacture. That is why dealers recommend A-P apparatus for performance. There is an A-P set to fit every purpose and pocketbook. Ask your dealer to show you the A-P quality line, or write us for Catalog R-4, mentioning your dealer's name and the kind of set you are particularly interested in.

**Atlantic-Pacific  
Radio Supplies Co.**

646-50 Mission Street, San Francisco

Jobbers and Dealers invited to  
stock A-P quality.

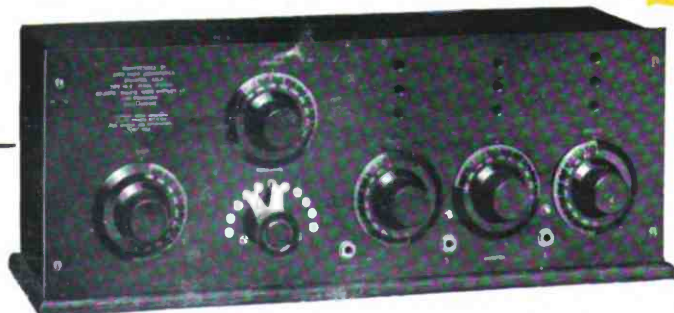

**Type AR-2 Receiver Detector and two-stage Amplifier**



**Type DR-5 Receiver Detector**