

AUGUST  
1937 25c

LATEST NO-DRAW METERS

# RADIO WORLD

REG. U.S. PAT. OFF.

## MODERNIZING OLD MAJESTICS

*OSCILLATOR INVERSE FEEDBACK  
IMPEDENCE MATCHING*

(See Page 7)

DIAL DEAD, 70 UP, DUE TO SHORTED PLATES

MODEL 70 and 70 B  
MAJESTIC

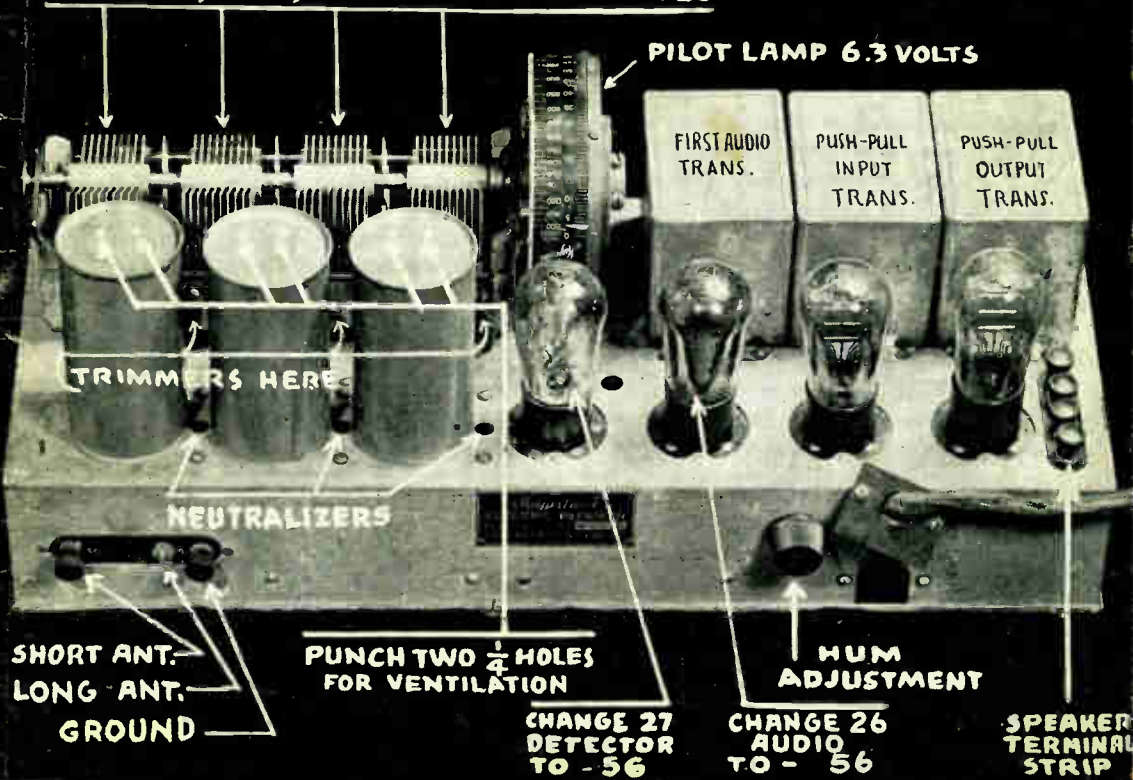

TRIMMERS HERE

NEUTRALIZERS

SHORT ANT.  
LONG ANT.  
GROUND

PUNCH TWO  $\frac{1}{4}$  HOLES  
FOR VENTILATION

CHANGE 27  
DETECTOR  
TO -56

CHANGE 26  
AUDIO  
TO -56

HUM  
ADJUSTMENT

PILOT LAMP 6.3 VOLTS

FIRST AUDIO  
TRANS.

PUSH-PULL  
INPUT  
TRANS.

PUSH-PULL  
OUTPUT  
TRANS.

SPEAKER  
TERMINAL  
STRIP



## *In Universal Use*

# **CORNELL-DUBILIER CAPACITORS**

The freighter plying tropic seas—the giant Clipper ship flying the Pacific—the “ham” in Timbuctoo, the broadcast station in Radio City in New York, and the Arctic expedition at the North Pole all standardize on Cornell-Dubilier capacitors.

For more than 27 years C-D capacitors have consistently delivered the utmost in condenser performance. It is this utter dependability that has brought to C-D the recognition of the engineering fraternity the world over.

There is no radio circuit or combination of circuits for which a Cornell-Dubilier fixed condenser has not already been developed. For complete information write for Catalog 127.

**MICA • DYKANOL • PAPER • WET AND DRY ELECTROLYTIC CAPACITORS**

CORNELL-DUBILIER CORPORATION, 1024 Hamilton Blvd., South Plainfield, New Jersey

# **CORNELL-DUBILIER**

# I'LL SEND MY FIRST LESSON FREE

*It Shows How I Train You  
at Home in Your Spare Time for a*

# GOOD JOB IN RADIO



**J. E. Smith, President  
National Radio Institute**

The man who has directed the home study training of more men for the Radio industry than any other man in America.



**Service  
Manager  
For Four  
Stores**



"I was working in a garage when I enrolled with N. R. I. In a few months I made enough to pay for the course three or four times. I am now Radio service manager for the M— Furniture Co., for their four stores."—**JAMES E. RYAN**, 1535 Slade St., Fall River, Mass.

**\$10 Week  
in  
Spare Time**



"My work has consisted of Radio set servicing, with some Public Address Systems work—all in my spare time. My earnings in Radio amount to about \$10 a week."—**WILLIAM MEYER**, 705 Ridge Road, Hobart, Ind.



**Earnings  
Tripled  
By N.R.I.  
Training**

"I have been doing nicely, thanks to N. R. I. Training. My present earnings are about three times what they were before I took the Course. I consider N. R. I. Training the finest in the world."—**BERNARD COSTA**, 201 Kent St., Brooklyn, N. Y.

Clip the coupon and mail it. I will prove to you that I can train you at home in your spare time to be a RADIO EXPERT. I will send you my first lesson FREE. Examine it, read it, see how clear and easy it is to understand—how practical I make learning Radio at home. Then you will know why men without Radio or electrical experience have become Radio Experts and are earning more money than ever as a result of my Training.

**Many Radio Experts Make  
\$30, \$50, \$75 a Week**

Radio broadcasting stations employ engineers, operators, station managers and pay up to \$5,000 a year. Spare time Radio set servicing pays as much as \$200 to \$500 a year—full time jobs with Radio jobbers, manufacturers and dealers as much as \$30, \$50, \$75 a week. Many Radio Experts operate their own full time or part time Radio sales and service businesses. Radio manufacturers and jobbers employ testers, inspectors, foremen, engineers, servicemen, paying up to \$6,000 a year. Radio operators on ships get good pay and see the world besides. Automobile, police, aviation, commercial Radio, and loud speaker systems are newer fields offering good opportunities now and for the future. Television promises to open many good jobs soon. Men I have trained are holding good jobs in these branches of Radio. Read their statements. Mail the coupon.

**There's a Real Future in Radio  
for Well Trained Men**

Radio already gives good jobs to more than 300,000 people. And in 1936, Radio enjoyed one of its most prosperous years. More than \$500,000,000 worth of sets, tubes and parts were sold—an increase of more than 60% over 1935. Over a million Auto Radios were sold, a big increase over 1935. 24,000,000 homes now have one or more Radio sets, and more than 4,000,000 autos are Radio equipped. Every year millions of these sets go out of date and are replaced with newer models. More millions need servicing, new tubes, repairs, etc. A few hundred \$30, \$50, \$75 a week jobs have grown to thousands in 20 years.

**Many Make \$5, \$10, \$15 a Week Extra  
in Spare Time While Learning**

Practically every neighborhood needs a good spare time serviceman. The day you enroll I start sending you Extra Money Job Sheets. They show you how to do Radio repair jobs that you can cash in on quickly. Throughout your training I send you plans that made good spare time money—\$200 to \$500 a year—for hundreds of fellows. My Training is famous as "the Course that pays for itself."

**I Give You Practical Experience**

My Course is not all book training. I send you special Radio equipment and show you how to conduct experiments and build circuits which illustrate important principles used in modern Radio receivers, broadcast stations and loud speaker



installations. I show you how to build testing apparatus for use in spare time work from this equipment. Read about this 50-50 method of training—how it makes learning at home interesting, quick, fascinating, practical. Mail coupon.

**Money Back Agreement Protects You**  
I am so sure that I can train you successfully that I agree in writing to refund every penny you pay me if you are not satisfied with my Lessons and Instruction Service when you finish. I'll send you a copy of this agreement with my Free Book.

**Find Out What Radio Offers You**

Mail coupon for sample lesson and 64-page book. Both are free to anyone over 16 years old. My book describes Radio's spare time and full time opportunities and those coming in Television; tells about my training in Radio and Television; shows you actual letters from men I have trained, telling what they are doing and earning. Find out what Radio offers YOU! MAIL THE COUPON in an envelope, or paste it on a penny post card—NOW!

**J. E. SMITH, President, Dept. 7HM4  
National Radio Institute, Washington, D. C.**

**MAIL  
COUPON  
NOW!**



**GOOD FOR BOTH 64 PAGE BOOK FREE  
SAMPLE LESSON FREE**

**J. E. SMITH, President, Dept. 7HM4  
National Radio Institute, Washington, D. C.**

Dear Mr. Smith: Without obligating me, send the sample lesson and your book which tells about the spare time and full time opportunities in Radio and explains your 50-50 method of training men at home in spare time to become Radio Experts. (Please write plainly.)

NAME.....AGE.....  
ADDRESS.....  
CITY.....STATE.....14x1

**The Tested Way  
to BETTER PAY**

## "AN HOUR A DAY WITH RIDER"

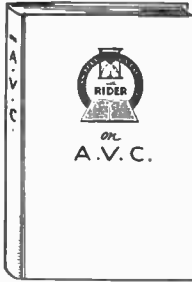

John F. Rider has written a series of pocket-sized books, 60c each, with the idea readers will spend an hour a day reading and studying them, and thus acquiring a full servicing knowledge. Latest of these is devoted to automatic volume control (a.v.c.). The subject is fully covered. 64 pages. Well illustrated. Order Cat. RAVC postpaid @ 60c.

### "ALTERNATING CURRENTS"

"Alternating Currents in Radio Receivers," Hour-a-Day, is a comprehensive book covering the basic functions of the various components of a radio receiver, what each unit does and how it works. Various types of parallel and series resonant circuits, different kinds of coupling, inductance, reactance, impedance, and how these electrical phenomena are employed in radio practice, are fully explained. 80 pages. Order Cat. RAC, postpaid, @ 50c.

A clear explanation of what happens when a circuit is tuned to resonance. All types of circuits described and how and why they work. How these circuits should be aligned so that maximum efficiency is obtained. Knowledge of the latest high-fidelity I-F amplifiers is becoming more and more necessary and "Resonance and Alignment" tells what you should know about all this. 64 pages. Order Cat. RRA, postpaid, @ 60c.

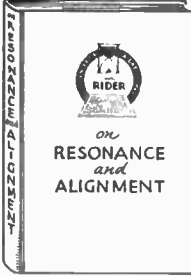

### "D. C. VOLTAGE DISTRIBUTION"

Every receiver contains some sort of d.c. distribution system supplying the d.c. voltages from the power unit to the elements of the tubes. The many different forms these systems take are thoroughly described in Rider's "D.C. Voltage Distribution," which explains networks from the simplest to the most complicated. The calculations of the value of the resistors and their wattage ratings are more clearly described than ever before, in this brand new combination of theory and practice. 64 pages. Order Cat. RDCVD, postpaid, @ 60c.

[Above four "Hour-a-Day" books are all of the series published to date. All have hard covers. The order of their publication is No. 1 A.C.; No. 2, Resonance; No. 3, D.C.; No. 4, A.V.C.]

### RIDER'S MANUALS

Vol. VII—(new) Rider's Volume VII has 1600 pages! This is the biggest and best Manual that has ever been published. In Volume VII the number of manufacturers has been increased and therefore the size of the book was increased. The greatest collection of servicing data ever gathered and not only from the large manufacturers, but the smaller ones as well. Not only 1936-37 sets, but many old timers. 100-page Index . . . . . \$10.00

Vol. VI—Data on sets produced up to October, 1935—from the start of the metal tube era—are contained in this Manual. Double-Spread pages are used for the more complicated receivers. 1240 pages, \$7.50

Vol. V—Sets manufactured up to October, 1934—and older sets, too—are covered in this volume. Electrical and mechanical data are given so that everything is where you want it. 1,200 pages. . . . . \$7.50

Vol. IV—In this volume will be found information on receivers manufactured up to March, 1934. 1,060 pages . . . . . \$7.50

Vol. III—Sets released from the middle of 1932 to June, 1933 are presented in this volume. 1,070 pages . . . . . \$7.50

Vol. II—Data are here contained on sets manufactured between early 1931 and the middle of 1932. Many sets unavailable when Vol. I was published will be found in Vol. II. 800 pages. . . . . \$6.50

Vol. I—This volume contains information on the old timers—from 1919 up to 1931—and there are still many of these in use today. 1,000 pages. . . . . \$7.50

[Order Rider Manuals by volume numbers as listed above. Remit with order. Books will be sent postpaid.]

Radio World, 145 W. 45 St., N. Y. City

## INDUCTANCE BOOK

**Free!** Every solenoid for every radio-frequency or intermediate frequency may be wound of standard wire on standard form diameters without any computations by using "The Inductance Authority," by Edward M. Shiepe. This \$2 book sent free, postpaid, with supplement, on receipt of \$5 for a 2-year subscription for RADIO WORLD.

RADIO WORLD, 145 W. 45th St., N. Y. C.

**RADIO WORLD AND POPULAR MECHANICS MAGAZINE**—Radio World is \$2.50 a year, and Popular Mechanics Magazine is \$2.50 a year. Popular Mechanics Magazine does not cut rates, but Radio World will send both publications to you for one year for \$3.75. RADIO WORLD, 145 West 45th Street, New York City.



Everything in Radio

**THE NEWEST BOOK IN RADIO**  
The Radolek 1937 Radio Profit Guide is the most complete Radio Parts Book ever published. Includes new merchandise shown during the June Radio Show. Over 12,000 parts—the right replacement item for every radio that you will service—Test Instruments, P. A. equipment, Home and Auto radios, Books, Tools, etc.

### RADOLEK'S SERVICE IS FASTER

There's no Sit-Down, Lay-Down, or Slow-Down at Radolek—Our organization gives you what you want when you want it—and at the Right Prices.

**AUTO RADIO HEADQUARTERS**  
Everything in Auto Radio—Universal control heads . . . Dash mounting adapter Kits . . . Auto aerials . . . Cables and Vibrators. Send for your FREE Profit Guide NOW!

## RADOLEK

601 W. Randolph, Chicago, Dept. G-9  
Send me the Radolek Radio Profit Guide FREE.

Name .....

Address .....

Service man?  Dealer?  Experimenter?

*Now—a high powered*



## Radio Engineering Library

*—especially selected by radio specialists of McGraw-Hill publications*

*—to give most complete, dependable coverage of facts needed by all whose fields are grounded on radio fundamentals*

*—available at a special price and terms.*

These books cover circuit phenomena, tube theory, networks, measurements, and other subjects—give specialized treatment of all fields of practical design and application. They are books of recognized position in the literature—books you will refer to and be referred to often. If you are practical designer, researcher or engineer in any field based on radio, you want these books for the help they give in hundreds of problems throughout the whole field of radio engineering.

5 volumes, 2891 pages, 2000 illustrations

1. Everitt's COMMUNICATION ENGINEERING
2. Terman's RADIO ENGINEERING
3. Chaffee's THEORY OF THERMIONIC VACUUM TUBES
4. Hund's HIGH-FREQUENCY MEASUREMENTS
5. Henney's RADIO ENGINEERING HANDBOOK

10 days' examination. Special price. Monthly payments \$26.00 worth of books cost you only \$23.50 under this offer. Add these standard works to your library now; pay small monthly installments, while you use the books.

### SEND THIS ON-APPROVAL COUPON

McGraw-Hill Book Co., Inc.  
350 W. 42nd St., New York, N. Y.

Send me Radio Engineering Library, 5 vols., for 10 days' examination on approval. In 10 days I will send \$3.50, plus few cents postage, and \$3.00 monthly till \$23.50 is paid, or return books postpaid. (We pay postage on orders accompanied by remittance of first installment.)

Name .....

Address .....

City and State .....

Position .....

Company ..... R.W. 8-37

## TELEVISION

"TELEVISION WITH CATHODE RAYS," by Arthur H. Halloran, Farnsworth and Zworykin systems fully explained. The treatment is mathematical. It is a book for the well-grounded radio man who has vision, the man who wants to be among the first to cash in when the pictures go on the air commercially, but is not for novices. 100 pages or more of supplementary data. Price \$2.75 postpaid including Supplements).

### RADIO WORLD

145 West 45th Street, New York City, N. Y.

## CHASSIS-CABINETS PANELS & CANS

STANDARD SIZES ON HAND  
SPECIAL SIZES MADE TO ORDER

KORROL RADIO PRODUCTS CO.

232 Greenwich St. R.W.-8-37 New York City

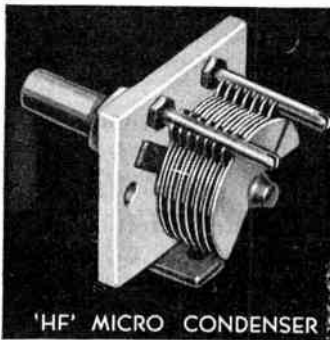

'HF' MICRO CONDENSER

## For Better Radio

For better radio, use the new "HF" micro condensers with their many advanced features guaranteeing highest efficiency in tuning or trimming critical high frequency circuits. Cadmium plated, soldered brass plates and Isolantite insulation insure rigidity, stability and lowest losses. Noiseless operation. Single and dual types—10 sizes—15 to 140 mmf.

Write Dept. RW-8 for "HF" Bulletin.

HAMMARLUND MFG. CO., Inc.  
424-438 West 33rd St., New York City

- Please send me "HF" Bulletin.
- Please send me "37" Catalog.

Name .....

Address .....

City .....

State .....

RW-8



**HAMMARLUND**

# RADIO WORLD

## SERVICING AND MEASUREMENTS

*Sixteenth Year*

ROLAND BURKE HENNESSY  
*Editor*

H. J. BERNARD  
*Managing Editor*

HERBERT E. HAYDEN  
*Advertising Manager*

---

### Table of Contents for AUGUST, 1937

---

<b>Modernizing 70 and 70B Majestics</b> 7 <i>A Few Changes Reap Real Results</i> By Jack Goldstein	<b>A 5-Megacycle Bridge</b> ..... 39 <i>Difficult Grounding Problems Solved</i> By C. H. Young
<b>Right or Wrong?</b> ..... 10 <i>Try Your Hand at Five Friendly Propositions</i>	<b>Inverse Feedback Analyzed</b> .... 43 <i>Simple Exposition, with Applications</i> By Capt. Peter V. O'Rourke
<b>The Infinite Impedance Meters.</b> 11 <i>Recent Developments for Measuring D.C. and A.C.</i> By H. J. Bernard	<b>A Multi-Purpose Meter</b> ..... 47 <i>Switch Type, Based on 0-1 Mu</i> By Percy Warren
<b>New Servicing Technique</b> ..... 24 <i>Being Built Up Around Zero-Draw Meters</i>	<b>Automatic A-F Curve Tracer</b> ... 51 <i>Uses Ray Tube with Lagging Screen</i>
<b>Sizing Up Meter Facts</b> ..... 31 <i>A Short Discussion for Beginners</i> By F. E. Wenger	<b>Measuring H-F Attenuation</b> .... 54 <i>High Accuracy Is Achieved</i> By F. R. Dennis
<b>There's No Surface Wave, After All</b> ..... 32 <i>Traditional Belief Is Upset</i> By C. R. Burrows	<b>Ground Not What It Used to Be</b> 58 <i>Because of High Sensitivity of Sets</i> By A. J. Ward
<b>Large, Projected Television</b> .... 38 <i>Laboratory Stunt Is Striking</i>	<b>Radio University</b> ..... 60 <i>Questions Answered</i>
	<b>New Products</b> ..... 63

---

Vol. XXX, August, 1937. No. 5. Whole No. 707. RADIO WORLD, published monthly by Hennessy Radio Publications Corporation, 145 West 45th Street, New York, N. Y. Editorial and executive offices, 145 West 45th Street, New York, N. Y. Executives of RADIO WORLD: Roland Burke Hennessy, editor and business manager; H. J. Bernard, managing editor; Herbert E. Hayden, advertising manager. Officers of corporation: Roland Burke Hennessy, president-treasurer; Roland Burke Hennessy, Jr., vice-president, H. J. Bernard, secretary. Entered as second-class matter March, 1922, at the Post Office at New York, N. Y., under Act of March 3rd, 1879.

---

#### SUBSCRIPTION RATE

Price 25 cents per copy. Subscription \$2.50 per year (12 issues); \$1.25 per six months (6 issues); postpaid in United States and Possessions; \$3.00 per year, \$1.50 per six months, postpaid in all other countries. Remittance for foreign subscription should be by international money-order (postal or express) or draft against or discountable at New York bank.

---

RADIO WORLD is distributed by the American News Company and its Branches

# MAJESTIC

## Works Very Much Better Now— THANK YOU!

[ **A Startling Renovation** ]  
By Jack Goldstein

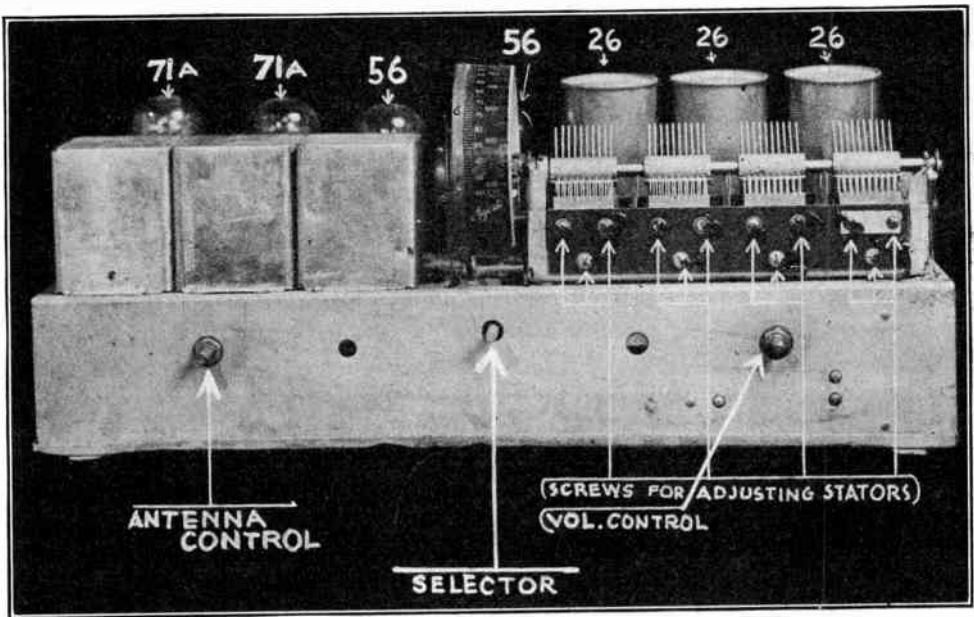

Rear view, with explanatory legends.

**T**WO very popular model Majestic receivers were the No. 70 and the later model No. 70B. Very minor difference marked them. For instance, the 70B had a 1,000-ohm resistor in the chassis to reduce the maximum B feed from the separate power supply to 220 from 260 volts, also a first-stage grid suppressor. Those were about the only structural differences.

There is no telling how many tens of thousands of these receivers are still in use. It is a certainty, however, that in the decade between the introduction of the first Model 70, and the present writing, there have been improvements in tubes and parts, and as the receiver was well designed and sturdily built, many owners might feel willing to spend \$10 to have the set modernized.

The improvement was actually worked out. The receiver was so much better in performance after leaving RADIO WORLD's laboratories that nobody who made simply a listening comparison (without seeing the source of the difference) would think it was the same set. In a real sense it was not the same set that had been delivered, because new parts had put new life into it.

### RENEUTRALIZATION METHOD

The diagram of the 70B is given herewith, the 70 being the same except for the changes noted, and possibly a different power pack that is no source of concern, as the pack is part of the console installation and is one thing that does not need to be touched at all.

(Continued on following page)

(Continued from preceding page)

It can be seen that the receiver is a seven-tube Neutrodyne, eight tubes when the tube in the power supply unit is counted, and that a four-gang condenser is used. It will be remembered that the Neutrodynes were tuned-radio-frequency sets wherein the r-f tube capacity was balanced out in a bridge circuit, so there wouldn't be any squealing. Taking the first stage, at left, it will be seen there is a condenser from the grid downward, leading to a small part of the secondary of the next stage. This condenser actually is adjustable, in fact is the neutralizing condenser, but once set is

filament circuit is restored and the second r-f tube's filament now is rendered dead for the while, and the second neutralizing adjustment made, on the same basis as before. Next the second tube's circuit is reinstated and the third tube is treated as had been its predecessors. Now the circuit is aligned, using the parallel trimmers, at 1,450 to 1,500 kc.

If squealing, seemingly eliminated, returns when this alignment is performed, then the trouble is due to inductive feedback and can not be cured by neutralizing of the tube capacity, hence grid suppressor resistance may be increased. The suppressor, in the first stage, is

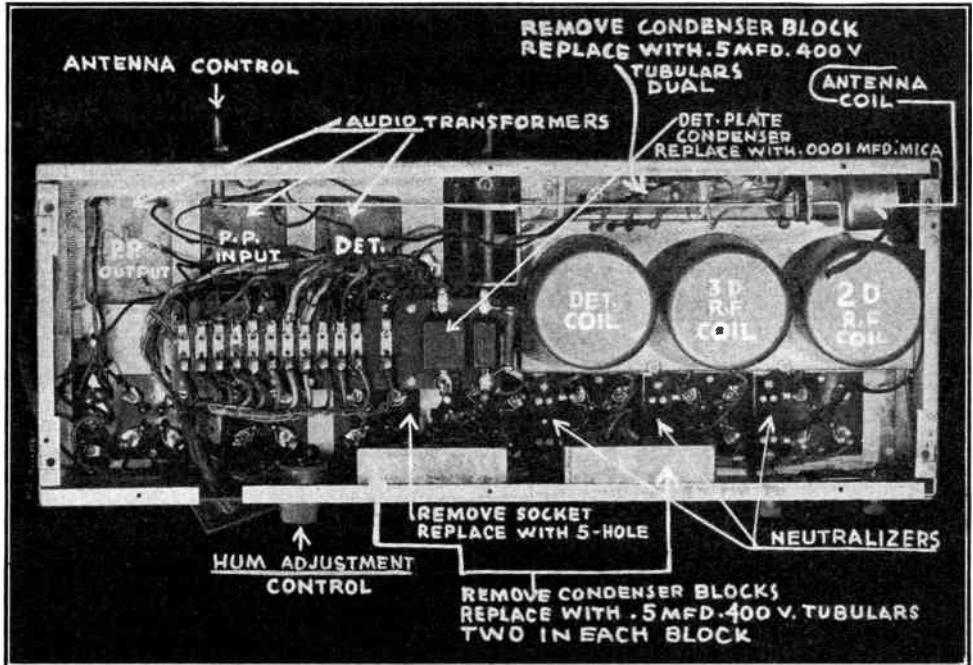

Bottom view, disclosing location of other parts and directions connected with them.

left thus, hence is shown as fixed. There are three neutralizing condensers.

Two small ventilation holes are drilled in the r-f tube shields. No other change is made in the r-f section at all, unless the receiver squeals, when it is assumed that neutralization settings have drifted, and the work must be redone. A station is tuned in at any point on the dial where reception free of self-oscillation is practical, then the first r-f tube is inserted without the filament connected. A decade back this was often done by putting a piece of paper around one filament prong of the tube, thus introducing the necessary insulation.

### ADJUSTING CONDENSERS

It may be handier to unsolder one of the leads to the filament at the socket of this tube. Then the neutralizing condenser is adjusted until the sound from the station disappears or at least is at minimum. Then the first tube's

marked 50 to 100 ohms. Or a resistor may be put across the antenna coil of a value that stops squealing at the highest frequency station the set tunes in. A 5,000-ohm rheostat may be adjusted until the squeal stops, the rheostat removed, its resistance measured, and replaced with a fixed resistor of the same value.

### HUM CURES

One of the improvements is to bypass the radio frequencies in the a-c line by putting across the line a series of two .1 mfd. condensers, 300-volt rating (not electrolytics), the juncture of the series grounded. This immediately clears up gurgling or choppy reception and practically eliminates modulation hum, which may be present only when a station is tuned in, but be absent when no station is being received.

However, hum as steady interference is a



great likelihood, and to make a big improvement, replace the 27 detector with a 56, requiring no socket or other change; and also replace the 226 first audio tube with a 56. This does require a new socket (five holes instead of four) and a new heater voltage for this socket position, 2.5 volts instead of 1.5 volts. This 2.5-volt service is taken from the same winding that serves the detector, and the 1.5-volt winding that had been devoted to the audio tube is left open. The potentiometer (see pointer) is used across the 2.5 volts as hum adjuster, fixed center tapped unit removed.

**VARIABLE CONDENSER TROUBLE**

There was a 1,400-ohm resistor used for biasing the 226 first audio tube. This same

to accommodate three sections of the condenser gang, but what about the fourth section? Well, that is really the first one, for it tunes the antenna coil, which was known as an impedance coil. In other words, it had no primary. There was more hop that way, but antenna length and capacity had such a strong effect on tuning that it was necessary to introduce compensation. This is present in the set now, consisting of a mechanical control reaching a long way over the chassis width to get at the shield of the antenna coil. By moving this shield in and out the effective inductance of the coil is changed, so that a new adjustment is required for practically every station tuned in. This makes the set much more selective and sensitive than otherwise. It should not be

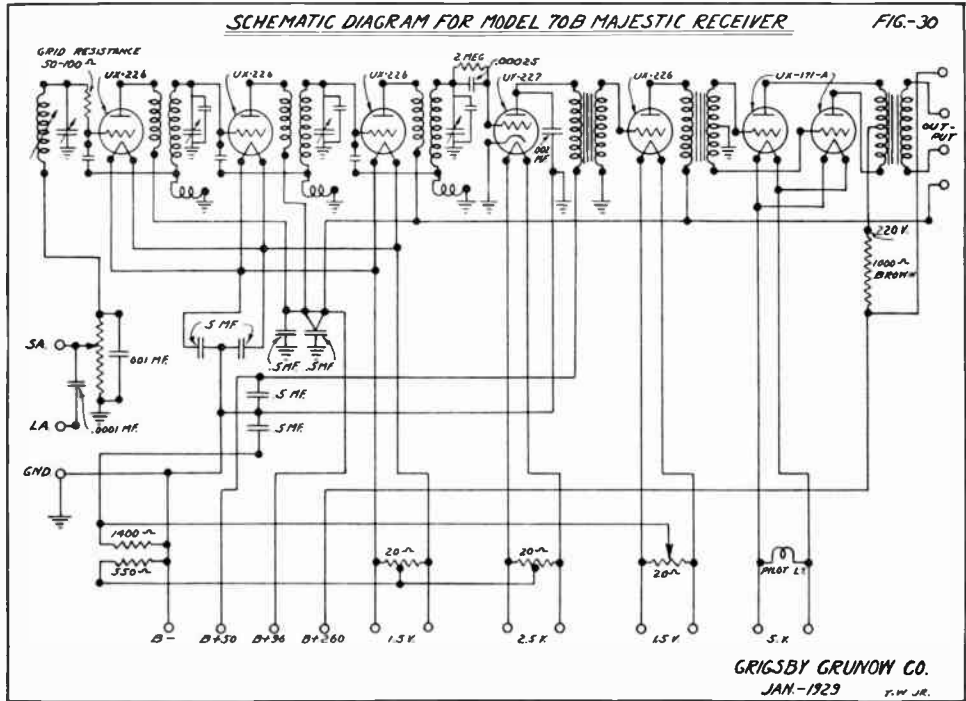

The 70B, above, differed from the 70 circuit in that 70B included the 1,000-ohm resistor at right center, and the 50-100-ohm suppressor at upper left.

value is satisfactory for the new first audio tube, but is connected instead from 56 cathode to B minus, and across it is put a condenser of .25 mfd.

When these sets were built the plates of the variable condensers were purposely bent at the factory to provide better tracking, but time has worked its obstinacy, and the plates are back in the former position. An adjustment may be made by loosening the setscrews holding the stators, permitting individual adjustment per section, but beyond this, the bending of plates need not be practised, as it has been found to be generally unsatisfactory over the years, and the makeshift solution should be avoided.

There are three shield cans obviously present,

mistaken as a renovation idea, for it is in the set now, and is merely mentioned in line with the argument that there is enough front panel adjustment to permit leaving the condenser bending aside.

**REMOVAL OF SHORT**

But if the condenser section is shorted that's different. The sign of such short is usually no reception from 700 kc to 550 kc. To cure a short, and only to cure a short, plate bending is permissible, or the adjustment may be made for stator position, using the setscrews, as explained. If the plates touch at or near the middle of the displacement, it is necessary to

*(Continued on following page)*

# RIGHT OR WRONG?

## PROPOSITIONS

1. When speaking before a double-button carbon microphone, it is necessary to face the front of the microphone, so that the sound waves strike the diaphragm at right angles, otherwise there will be much emphasis of the hissing consonants and speech will sound unnatural.
2. The general method of broadcasting is to transmit the carrier and two sidebands, upper and lower. However, it is practical to suppress the carrier, and send only the sidebands, or suppress the carrier and one side band, and send only the other sideband. The most reliable of the special methods is to suppress the carrier and send both sidebands.
3. Chassis pickup of interference on an automobile receiver may be greatly reduced or eliminated by the use of a radio-frequency choke in the high side of the A lead.
4. A simple resistor-capacity filter in the power output stage of a receiver can be introduced so that the impedance load on the output tube or tubes is practically constant for the middle and upper audio frequencies.
5. Frequency modulation consists of varying the frequency instead of the amplitude of the carrier, and requires a receiver that responds peculiarly to small frequency differences. The amplitude of responses is proportional to the frequency of modulation, e.g., 1,000 cycles is ten times as strong as 100 cycles modulation.

## ANSWERS

1. Wrong. When addressing a carbon microphone, whether of the single- or double-button type, talk across the microphone. Thus you will be standing to one side, and not in front or, at least, your head will be turned so that the sound wave advances parallel with the plane of the microphone diaphragm. Otherwise the high audio frequencies will be cut off and speech will lose much of its intelligibility.
2. Right. The special transmission methods require special receivers and raise special problems. The suppressed-carrier method gives more reliable reception because for any frequency drift in the receiver or selective fading, if nothing is obtained from one sideband, something may be obtained from the other sideband. You get the same sense out of listening to one sideband as from listening to the other, or to both sidebands.
3. Right. The coil may consist of 50 turns of bell wire (No. 18) wound on a two-inch diameter, and carefully insulated all around, being placed close at possible to the set.
4. Right. The corrective filter consists of an .05 mfd. condenser in series with a resistor, the chain in parallel with the output tube or tubes (plate to B plus). The resistor value is chosen to achieve the desired effect. Pentode tubes are the ones mostly concerned, and the method is introduced only where there is no inverse feedback. The resistor is 1.3 times the recommended load, plate-to-plate for push-pull, plate to B plus for single-sided circuit.
5. Right. The mathematical expression for frequency modulation is the same as for amplitude modulation, but as the modulation amplitudes are based on a frequency difference, the greater amplitude results when the difference is greatest.

*(Continued from preceding page)*

bend them away, to get rid of what passes for a "dead spot". It is as dead as can be but not due to the usual absorption.

We have improved the set by reducing the hum. Now let us consider fading and tone.

Fading may be caused by the drying up of dual .5 mfd. condensers. There are three such blocks. Replace them with new condensers of similar structure and capacity. Do not touch the dual .5 mfd. condenser across the 226 r-f filament, however.

The rating of all condensers used should be at least 400 volts. Remove the .002 mfd. detector plate bypass condenser if set's tone is too deep, and replace with .0001 mfd.

There are other facts about the receivers that are well to know. The pilot lamp is 5 volts and is across the power tubes' filament. A 6.3-volt type lamp used here lasts longer

and gives plenty of illumination. The line ballast may be replaced as a further effort to eradicate hum, the replacement being standard for Majestics. As a final resort if bad hum prevails the power transformer has to be replaced.

The speaker is a good one, but the cone may have dried up, and tone can be improved by putting on a new cone for 8" speaker. The spider is attached to the new cone at the factory. The cone is very easy to center, due to wide tolerance at the bobbin.

Dial cable trouble requires that best grade dial cable be used for replacement, but if you're not experienced at this cable work it is well to have the job done by someone who is, otherwise it might take you five hours to fool around with the delicate assembly before you get this one small defect fixed.

*[Other illustration on front cover]*

# The Hunger for Sensitivity

## Satisfied by Recently Developed Meters

### Drawing Little or No Current

By H. J. Bernard

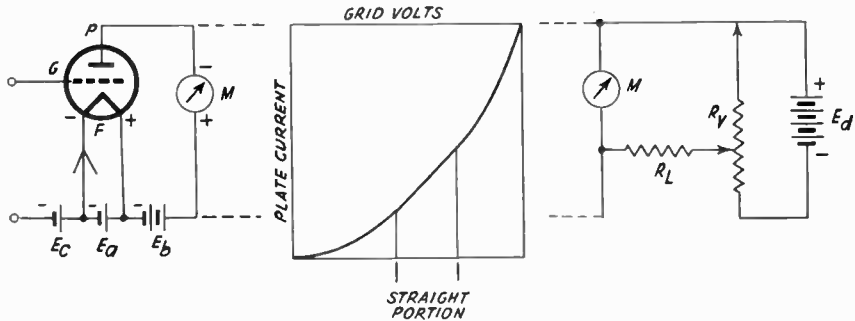

FIG. 1.

A simple vacuum-tube voltmeter, at left, with a method of balancing the idling current out of the meter  $M$ , at right. In center is a representative characteristic curve of a tube.

SUCH small direct current flows in certain parts of modern receivers that it is very difficult to ascertain what the voltage drop is across any resistance carrying this current, even if one uses a very sensitive voltmeter. Suppose the sensitivity is 20,000 ohms per volt. Suppose the resistance is 500,000 ohms in the circuit to be measured and the current through it one microampere. The voltage drop would be half a volt, yet even on the 20,000-ohm-per-volt instrument you would not get any reading, on any scale. In automatic volume control circuits, also in automatic frequency control and automatic selectivity control circuits, the very small current conditions obtain, not usually quite as bad as depicted. And even some receivers without the latest innovations have plate load resistors of high value in biased detector circuits, where only a few microamperes flow. That is the reason for infinite impedance meters.

So much for d.c. Some new meters are specially designed for zero current draw in d-c circuits, with 1 ma sensitivity on a.c. Others measure a.c., without full-cycle loading, but do not measure d.c. Others measure both. The kind responding to a.c. or to a.c. and d.c. are invariably vacuum-tube voltmeters.

### BIG ACTIVITY NOW

The vacuum-tube voltmeter becomes valuable in service work because it, too, can be so arranged not to draw any current from the measured circuit. Also in some forms it may be used for measurement of both alternating and direct current without loading either circuit. If measurement of a. c. is not requisite

then no tube need be used, and an electromagnetic meter may be put into a balance circuit that measures d-c voltage without drawing any current, either.

For quite a few years the servicing industry has overlooked the tube voltmeter. Its value lies not only in the measurements concerning a.v.c., a.f.c., etc., but of stage functioning and gain, as well as other comparisons, whether relative or absolute.

Right now manufacturers are extraordinarily active with their new tube voltmeters for service and laboratory work, and so it seems that the tube voltmeter at long last is about to come into its own in servicing.

### THE THREE FORMS

Let us examine an elementary tube voltmeter, Fig. 1. This consists of a tube, with meter  $M$  in the plate circuit, and positive voltage  $E_b$  applied to the plate. The filament is heated by the battery  $E_a$ .  $E_c$  is the grid bias battery, negative toward grid, so that when a conductive circuit is connected across input, grid is returned to minus  $C$ . For a short circuit between grid and  $C$  bias the plate current, as read on the meter, is due to the static operating point. If a d-c voltage is introduced across the input, positive to grid, then the needle will disclose more current flowing in the plate circuit. Thus for fixed voltages  $E_a$ ,  $E_b$  and  $E_c$ , a calibration may be run for d.c. Also, a-c increases the plate current, so another curve may be run for a-c., and the unknown input voltage, either type, ascertained.

(Continued on following page)

(Continued from preceding page)

Commercially the special scale is imprinted on the meter.

Even this simple tube voltmeter may take three forms, using performance as the criterion:

1 The tube may be given normal bias for detection, and the performance is on the basis of a half-wave detector, with plate current change proportionate to the square of the change of input r-m-s volts.

2 The tube may be overbiased negatively, practically to the point where plate current is cut off, and the unknown voltage input is depended on for deflection of the meter needle past zero. The device responds to peak volts, half wave.

3 The tube may be biased for amplification, but used as a voltmeter, with greatly reduced sensitivity, affording square law full-wave detection of r.m.s.

Aside from the accepted fact that practically no current is to be drawn from the circuit we are measuring, all major problems are contained in the three classifications.

All three methods are so-called infinite impedance; none of the methods produces a linear scale, i.e., the plate current indication is not directly proportionate in the voltage introduced at the input. There is no law that such linearity must prevail, but it is considered handy to have equal spread for equal volts, on the meter scale. The range of all three is distinctly limited. Take an average example. For a 0-1 milliammeter the minimum plate voltage would be 15 volts, the negative bias perhaps 1.5 volts. To cover higher ranges it would be necessary to increase the negative bias and the positive plate voltage so that with input terminals shorted the same plate current flows as before. Then for a third range the same process is repeated, again the same operating plate current established. If batteries are used, this is quite a consideration. To get a range reaching 15 volts input requires that the plate voltage be 150 volts, and soon it would be theoretically necessary to apply a higher plate voltage than is safe to exist between the tube elements.

### PRECAUTION ON SWITCHING

Also, the needle unfortunately does not start

at zero to measure differences, but starts at whatever is the current for the operating point. This may be half a milliampere. At right in Fig. 1 is shown a method of balancing out the idling current through the meter. Ed is a small battery of dry cells, Rv is a potentiometer, and RL is a limiting resistor, usually 2,000 ohms or more. Rv may be a few hundred ohms, but must be switched open, lest the resistance be left across and therefore drain the battery during periods of non-measurement.

The curve shows at extreme lower left what would be the operating point (a) for a peak-measuring tube voltmeter, biased to cutoff of plate current, or nearly to that extent. Farther up on the curve, one encounters the so-called straight portion, and if the center (b) of this portion is selected as the operating point, then and only then the full-wave detector comes into play. This point is selected by bias apportionment, both as to grid and plate. Filament temperature or emission has something to do with it, too.

It would appear that for small difference of a-c input from the operating point there is no change in the plate current as read on the d-c meter, because there is as much decrease of current as there is increase, and the net difference is zero. This is certainly true in theory only the theory assumes that a tube biased for what we term straight-line amplification can not at the same time be a detector, whereas all amplifiers do some detecting. It is only a question of how much or how little.

### OUR STRAIGHTNESS CROOKED TO NATURE

What we measure and communicate to a graph, and appears to us as a straight line, even over a portion of a curve, is at best a clumsy attempt, compared with the infinite precision of Nature. That is, we cherish our straight line as an accomplishment, but to Nature there is a curvature where we think it is not. Nature is more observing. There is detection, a little of it, hence the very low sensitivity, and it happens to be on a full-wave basis. Therefore the input may be connected either way, producing the same measurement, and either simple sine or distorted waves may be measured accurately.

Now the full-wave consideration would have no importance if we were to measure only d.c.,

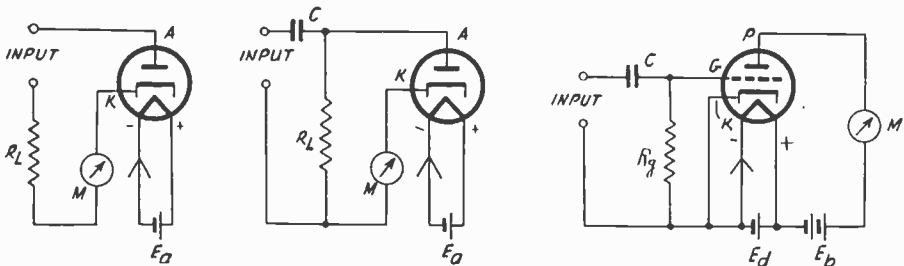

FIG. 2.

The diode family. At left, simple diode with series input.  $R_L$  is the load resistor. At center, shunt input to condenser-diode rectifier. At right, leak-condenser detector, equalling shunt input to diode GK, with amplification in triode PGK.

as that has only one direction; nor would full-wave mean anything if all a-c measurements were to be made on pure waves (i.e., of sine shape). The advantage of full-wave detector is that it will make measurements of waves of any shape, and give the correct voltage values, whereas all the other types of detectors are for sine wave only, or peaks only, and give erroneous readings for distorted waves, the error percentage being usually about equal to the percentage of total harmonic distortion.

We found in the curve a seemingly straight portion, but this was on a square-law basis, that is, plate current change was proportional to the r-m-s grid volts input change. The kind of a straight line we are seeking for the moment is one that is linear, i.e., the plate current change is directly proportional to the input voltage. There are no squares involved.

All along we have been told that the diode is, or can be, a linear detector. What is required is that the load resistance be substantial. Linearity is attained if the load is more than 25,000 ohms, preferably 50,000 ohms or more. With a 0-1 milliammeter 50,000 ohms would mean 50 volts full scale, far too high for the lowest range.

General Radio Company's explanation of such a tube voltmeter is given by W. N. Tuttle in the "Experimenter" as follows:

The voltmeter consists of a familiar combination—a diode-condenser rectifier and a d-c amplifier. A condenser becomes charged by the rectifier to a voltage very closely equal to the

peak value of applied alternating voltage, and the d-c amplifier and a milliammeter provide a means of measuring the voltage appearing across the condenser. There are new features in both the rectifier and amplifier circuits, however, which are very important in achieving high input impedance, permanency of calibration, and a calibration very nearly independent of the constants of the rectifier and amplifier tubes. These advantages are obtained, moreover, in an instrument covering a wide range of voltages.

### THE RECTIFIER CIRCUIT

The rectifier circuit<sup>1</sup> is shown on the left-hand side of Fig. 4. The resistances  $R_1$  and  $R_2$  are of high value so that they do not affect the operation of the acorn diode and the condenser  $C_1$  in the input loop of the circuit. If  $C_1$  has sufficient capacitance so that no a-c voltage appears across it, its charge will build up until the voltage is equal to the peak value of the applied a-c voltage, after which the time the anode will never be positive with respect to the cathode and no further rectified current can flow. When

(Continued on following page)

<sup>1</sup> For a discussion of diode circuits, see "Crest Voltmeters" by C. H. Sharp and E. D. Doyle, Trans. A.I.E.E., 35 pp. 99-107, February, 1916.

FIG. 4.

This shows the rectifier mounted in the probe with cover removed. The extremely short leads and low shunt capacitance obtained are responsible for the excellent frequency characteristic.



FIG. 3.

Front view of General Radio Company's new tube voltmeter.

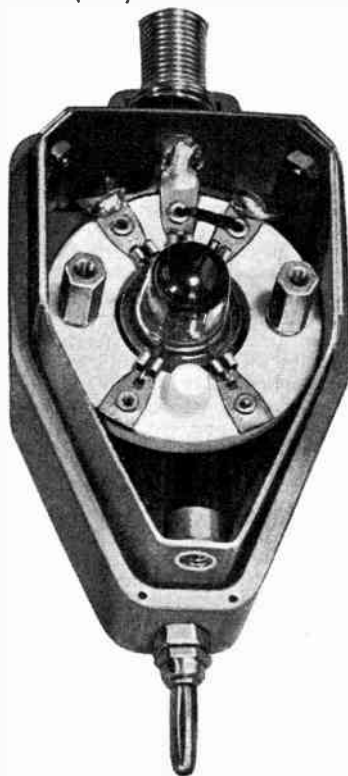

(Continued from preceding page)

equilibrium is reached, in other words, the rectifier will approach the conducting condition only at the time of the positive peak of the applied alternating voltage. For the rest of the cycle the plate will be negative with respect to the cathode. The voltage across the diode thus consists of a negatively-biasing direct voltage in series with the applied alternating voltage, and it will be seen that the average plate potential is negative with respect to the cathode.

The purpose of  $R_1$  is to permit the discharge

The d-c amplifier circuit is shown in the right-hand section of Fig. 4. The resistor in the cathode lead is particularly important. This provides degenerative coupling between the input and output circuits and not only accomplishes in the d-c case improvements analogous to those resulting from the use of degeneration in a-c amplification,<sup>2</sup> but also has other important results. Before the manner of operation is explained, the important improvements resulting from the use of degeneration in the present case will be outlined:

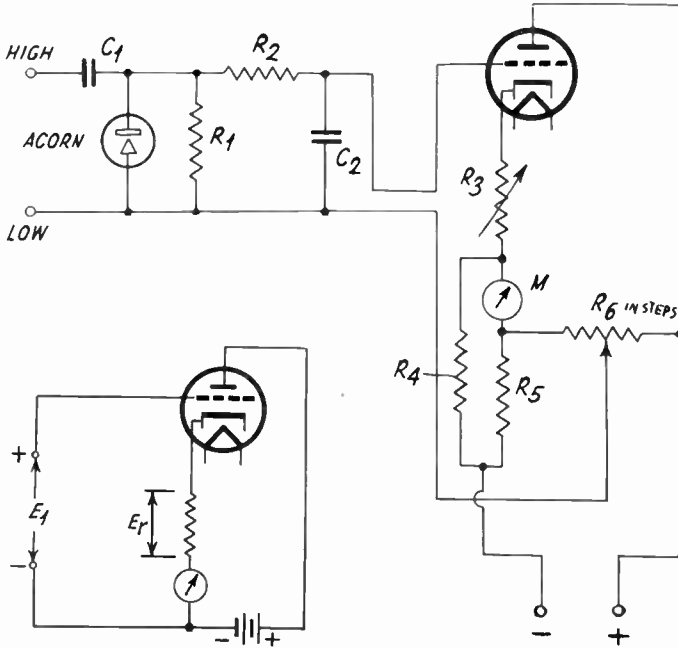

FIG. 5  
Condenser-diode rectifier, with direct-coupled amplifier. The 955 is used as diode.

of condensers  $C_1$  and  $C_2$  when the input voltage is reduced. This resistor is placed across the rectifier rather than across  $C_2$ , so that no direct current will flow through  $R_2$  except when the input voltage is varied and new equilibrium conditions must be established. No correction need be made, consequently, for voltage drop across this resistor, and the entire d-c voltage is applied to the amplifier tube. This feature contributes considerably to the stability of the instrument and the permanence of its calibration.

### THE AMPLIFIER CIRCUIT

The direct component of the voltage across the diode is equal to the peak value of the applied alternating voltage. The resistance  $R_2$  and condenser  $C_2$  remove the alternating component so that only the direct component is applied to the d-c amplifier. Elaborate filtering is not necessary due to the extreme linearity of the amplifier resulting from degeneration. Unless the alternating voltage is sufficient to swing the plate current to cut-off, only a negligible amount of rectification can take place. The simple filtering arrangement shown is, therefore, entirely adequate.

(a) The meter indication within very close limits is made proportional to the direct voltage introduced into the grid circuit.

(b) The sensitivity is made practically independent of the constants of the tube.

(c) The grid circuit is rendered capable of handling directly voltages hundreds of times greater than the normal cut-off bias. Hence no voltage-dividing network is required.

(d) The sensitivity can be changed for the various desired voltage ranges merely by changing the value of the cathode resistor and the value of the grid-bias voltage.

The inset in Fig. 4 is a simplified diagram to illustrate the degenerative effect of the cathode resistor.

### NET CHANGE EXPLAINED

If a voltage  $E_1$  is introduced into the grid circuit, the plate current will tend to increase, causing a voltage drop  $E_2$  across the cathode resistor in opposition to the introduced voltage. The net change in grid voltage is the difference between the two. If the cathode resistor is large

<sup>2</sup> See "Stabilized Feedback Amplifiers," H. S. Black. B.S.T.J. 13, pp. 1-18, January, 1934.

in value, only a very slight increase in plate current is required to develop a voltage equal to the introduced voltage. The net grid voltage, therefore, can change only slightly, and  $E_R$  must always be very nearly equal to  $E_1$ . The larger the value of the cathode resistor, the smaller must be the increment in plate current and the more nearly equal must  $E_R$  be to the introduced voltage  $E_1$ .

Whenever the cathode resistor is large enough to bring about this condition, the change in plate current, indicated on the meter, will be directly proportional to the introduced voltage, and the tube constants will be of very little importance.

The same simple consideration shows that the sensitivity of the arrangement, considered as the d-c voltmeter, can be changed by varying the cathode resistor. If this resistor is increased in value ten times, only one-tenth of the change in plate current will be required to develop a given opposing voltage. If the plate milliammeter has a certain full-scale sensitivity, consequently, ten times the voltage must be introduced into the grid circuit to cause full-scale deflection. For sufficiently high values of the cathode resistor, the full-scale voltage is directly proportional to the cathode resistance and depends only on this quantity and on the sensitivity of the milliammeter.

The polarity of the direct voltage developed by the rectifier circuit and applied to the d-c amplifier is such that the grid of the amplifier  $T_2$  is made negative with respect to the cathode. This is important in preventing damage to the meter due to overload. The plate current decreases when voltage is applied and can be reduced only to zero. The maximum possible change in plate current does not greatly exceed the milliammeter full-scale current, so that serious overload is not possible, no matter what input voltage is applied. The milliammeter, of course, is connected in the circuit backwards, so that a decrease in plate current is indicated as a positive deflection.

The three resistances,  $R_1$ ,  $R_6$  and  $R_8$ , shown in Fig. 4, but not in the inset, make it possible to balance out the initial plate current and to furnish the desired grid bias. The resistance  $R_8$  and the position of the tap on the resistance  $R_6$  are changed simultaneously when the range of the instrument is changed.

## POWER ABSORPTION

The power which must be drawn from the voltage source can readily be calculated from the known voltages appearing across the resistors  $R_1$  and  $R_2$ . In the filter circuit  $R_2C_2$  just considered, the entire alternating voltage appears across  $R_2$ . The same voltage appears across  $R_1$  as appears across the rectifier, namely, the full alternating voltage in series with a direct voltage equal to its peak value. The a-c fraction of the power loss is the same which would result if  $R_1$  and  $R_2$  in parallel were placed directly across the voltage source. In addition, sufficient power must be drawn to supply the d-c loss in  $R_1$  corresponding to the peak value of the a-c voltage. Short pulses of current flow through the rectifier to supply this power, so

for this component of the loss the voltage source is loaded relatively heavily during a very small part of the cycle, and not at all during the rest of the cycle.

Due to the shortness and intensity of the pulses through the rectifier any resistance in the input branch reduces seriously the flow of rectified current and lowers correspondingly the meter reading. It is this reduction in meter reading due to the impedance of the voltage source, rather than the total power consumption, which is important in most applications. This effect can be made negligible only by reducing the d-c power absorbed to the lowest possible value. In the Type 721-A Vacuum-Tube Voltmeter the resistor  $R_1$  has the value 50 megohms. About 4 megohms in series with the applied voltage is sufficient, however, to halve the voltmeter reading. From the voltage reduction standpoint the input resistance, therefore, can be said to be 4 megohms. The power absorption, however, is determined mainly by a-c losses in  $R_2$  (10 megohms), and from this standpoint the input resistance is appreciably greater—about 6 megohms. At high frequencies other factors become important, so that the simple analysis here given is no longer applicable. These factors are discussed below.

## OPERATION AT HIGH FREQUENCIES

To achieve satisfactory operation at high frequencies, the elements which make up the rectifier circuit are made as small as possible and are mounted in a separate housing (Fig. 3) at the end of a flexible cord. Probe terminals are provided so that the measuring circuit may be placed close to the voltage source. A 955-type acorn tube is used as the diode rectifier. The probe terminals can be removed to reduce still further the inductance of the input loop.

As a result of these details of construction, the resonant frequency of the input loop is about 380 megacycles, and 500 megacycles with the probe terminals removed. The frequency error in the reading is only 3 per cent at 100 megacycles.

The power consumed from the source at high frequencies is no longer determined by the values of resistances  $R_1$  and  $R_2$ , but by the total stray capacitance across the input and the losses in this capacitance. The total capacitance is about 6 mmfd. and the power factor about 2.5 per cent, the losses occurring principally in the envelope and socket of the tube and in the material surrounding the resistance elements  $R_1$  and  $R_2$ . It is interesting that at high frequencies the input impedance is not affected by turning on or off the heater of the diode  $T_1$ .

## OTHER ADVANTAGES

By including a power-supply voltage regulator, the meter indication has been made as stable as that of a d-c instrument. Fluctuations in line voltage have no effect, nor do long period drifts which would otherwise change the reading through changes in filament temperature.

Although the diode rectifier is mounted in a probe, the probe can be mounted inside the cabinet for low frequency measurements, if de-

*(Continued on following page)*

(Continued from preceding page)

sired, and the voltage source under measurement connected directly to terminals on the panel.

The Low terminal on the panel is not connected directly to panel, but is isolated by a blocking condenser. This is convenient in measuring voltages across plate tank circuits, for instance where the voltmeter can be grounded without damage.

The meter reads directly the r-m-s value of a sinusoidal voltage. As has been shown above, however, it is the peak value of the waveform which determines the reading. The instrument is very useful for determining the peak values of complex waveforms, these values being obtained by multiplying the reading by 1.414.

This ends Mr. Tuttle's remarks. We now turn to another type of tube voltmeter.

## TRIPLETT MODEL 1250 TUBE VOLT METER

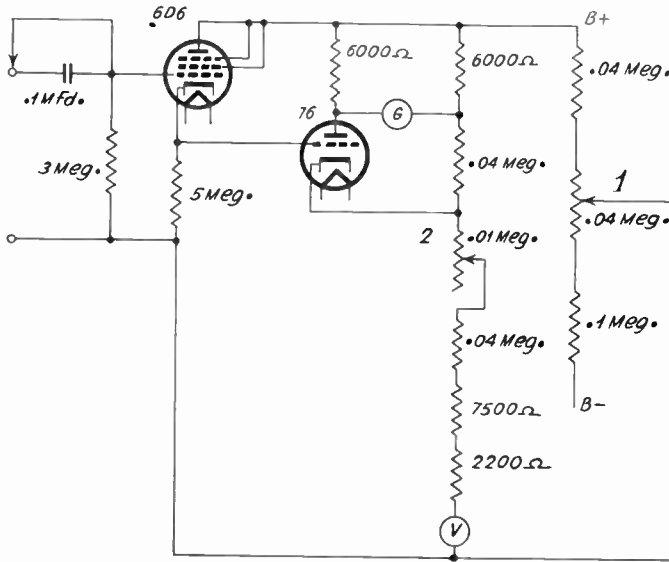

FIG. 6

The basis of the Triplet vacuum-tube voltmeter. The 6D6 is used as a triode. The circuit is balanced, by using Control 1, and the unknown, a.c. or d.c., unbalances the bridge. The voltmeter reads the bucking voltage to restore balance.

The vacuum tube voltmeter manufactured by the Triplet Electrical Instrument Company, Model 1250, a new product, uses a linear triode, instead of diode, as input tube, consisting of a 6C6 with plate, suppressor and screen interconnected to form the plate, and followed by a 76 amplifier tube. The third tube is an 84 rectifier.

The detector is of the infinite impedance type that became popular within the last year or so in radio receivers because of its linear characteristic, like that of a diode, and better quality than diodes afford from deeply-modulated carriers, due to no loading. In the receiver instance the secondary of an intermediate-frequency transformer was the sole connection between control grid and return, so there was no loading, the tube input being a purely capacitive reactance. In the present application to tube voltmeter practice it is necessary to provide a d-c continuity, as it is not known whether the circuit to be measured is able to close this path for bias application. The bias is to be negative and is due to the idling plate current passing through the cathode resistor of 5 meg.

The input resistor is made as large as consistent with tube stability, 3 meg., and a stopping condenser is used between grid and high output post. The circuit is therefore gaited for a-c measurements, but closing the switch across

the .1 mfd. condenser makes it possible to measure d-c also.

### CONSTANT LOAD

The frequencies of the voltages are assumed to be so large that .1 mfd. presents to them a negligible impedance, or, as has been said in previous discussion, there should be no voltage drop across this condenser. Therefore 3 meg. may be considered across the a-c circuit being measured, or across the d-c circuit when the switch is closed. The effect of the 3 meg. is very slight on any circuit being measured and may be neglected.

The detector tube works into a constant load established by the balanced bridge circuit of which the amplifier tube is one leg. To facilitate the balance, and the measurement, Triplet has taken the pains to include two separate meters, one a sensitive galvanometer, the other a three-range voltmeter. The galvanometer is marked G and the voltmeter marked V in the diagram, Fig. 5.

Maximum plate voltage is applied to the detector. The same plate voltage is applied to the amplifier, but through a 6,000-ohm resistor. As part of a resistance chain finally reaching B minus, and including on the way a rheostat in the series, is another 6,000-ohm resistor. Between amplifier plate and the lower terminal



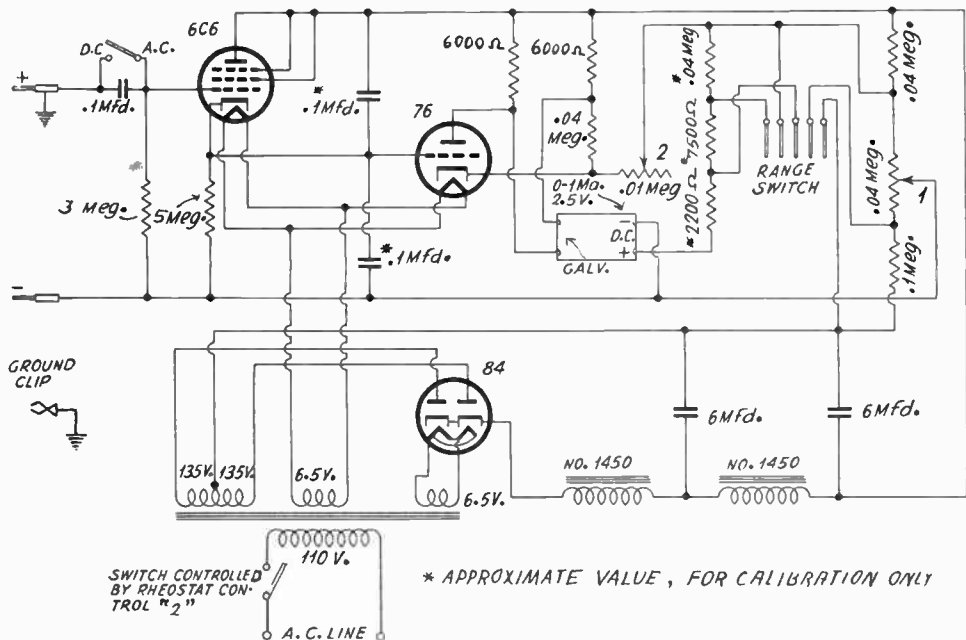

\* APPROXIMATE VALUE, FOR CALIBRATION ONLY

FIG. 6A

Complete diagram of the Triplet Model 1250 vacuum-tube voltmeter.



FIG. 7

The Triplet Model 1250 vacuum-tube voltmeter.

of the series network 6,000-ohm resistor, the galvanometer is connected. The galvanometer is used for determining when the circuit is in balance at the zero center position, i.e., zero is in the middle of the scale of this instrument. This balance is achieved by working Control No. 2, which is used at the start of the test.

**TUBE OPERATION EXPLAINED**

We have a Wheatstone bridge consisting of two 6,000-ohm resistors, one 40,000-ohm resistor and the amplifier tube as the fourth

arm. The tube is treated as a variable resistance, the quantity of resisting being adjusted by Control No. 1 (10,000 ohms).

When a signal is applied to the grid of the detector tube the grid becomes positive, upsetting the normal plate and cathode current of this tube and in turn upsetting the balance of the bridge. The rectification current through the 5 meg. load resistor in the detector cathode leg can be cancelled by adjustment of the divider voltage externally applied, by manipulation of Control No. 1 (40,000 ohms). The voltage drop originally produced across the 3 meg. is exactly equal to the a-c voltage input, therefore when the auxiliary d-c voltage is used for cancelling the d-c quantity from the resistor, the entire effect of upsetting the bridge has been removed, and balance again is restored. This restoration may be established and read with very fine closeness, and the accuracy is constantly recurrent with each reading. This overcomes a serious drawback of numerous tube voltmeters of the past, where uncertain registrations had to be taken as final, for instance reliance placed on a definite cut-off, whereas a tube might have a very indefinite or variable cutoff, and scarcely two tubes would be alike, except by accident. The present method is one that is independent of tube characteristics.

**TRULY DIRECT READING**

Since the bucking out voltage is equal to the unknown voltage, and the comparisons are reduced to d-c equality, an electromagnetic voltmeter will read the cancellation voltage, hence  
(Continued on following page)

(Continued from preceding page)

the unknown voltage. Three resistors are shown, all in circuit, but a selector switch shorting out one or two of these will provide three-range service, say, 2.5, 10 and 50 volts full-scale, as in the Model 1250.

Thus a slideback method is introduced, but it is applicable to a bridge circuit, with a very definite and stable registration point.

It will be noticed that the instrument is direct-reading in the true sense of that expression. Generally we think of anything as direct-reading that has the calibration on the scale or dial, so we read the quantities directly, instead of referring to a graph or table. However, in instrument practice direct reading means that the instrument does not require any special calibration, but is self-calibrating. Here the true sense of direct reading is achieved, the voltmeter that does all the fine measuring being a d-c voltmeter with conventional scale, linear of course, and naturally a meter of precision type.

In a circular giving a general description of this instrument Triplett lists seven important uses for a vacuum-tube voltmeter as follows:

- 1—Measurement of signal voltages in the various stages of the intermediate-frequency amplifier.
- 2—Measurement of filter ripple.
- 3—Measurement of signal voltage in the audio amplifier.
- 4—Measurement of signal gain per stage in either the audio-frequency or radio-frequency amplifier.
- 5—Measurement of signal voltage across resistors, coils, etc.
- 6—Measurement of d-c automatic-volume-control voltages across the diode and the automatic volume control resistors.
- 7—Measurement of grid bias as supplied by the automatic volume control system.

### A THIRD TYPE, BUT NOT VTVM

Of the two instruments that have been discussed, the first, the General Radio tube voltmeter, was for measuring a-c only; the second, Triplett's Model 1250, was for both a-c and d-c and used an entirely different, but also original, method; while the third type instrument to be described is not a tube voltmeter at all, but is strictly infinite impedance for d-c measurements.

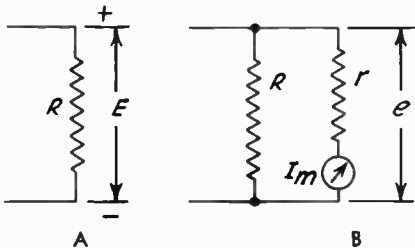

## Infinite Impedance On D-C Tests Only

Reverting to the example of the effect of draining current from the measured circuit, in Fig. 8A the voltage across the resistance  $R$  is  $E$ , but if the current through  $R$  is small, a current-drawing voltmeter  $rIm$ , when placed across  $R$ , as in Fig. 7B, reduces the voltage  $E$  to  $e$ . Now the voltage is not the same as before, it is less, because the resistance is less, and the resistance is less because we have two parallel resistors,  $R$  and  $r + R_m$ , where  $R_m$  is the meter resistance. But the voltmeter, though reducing the voltage, does read accurately the voltage that actually exists when the meter is in circuit. We do not want to know that voltage, however, but the voltage existing when the meter is not in circuit, though read when the meter is in circuit. The requirement, most simply stated, is that the meter must not change the voltage and therefore should draw no current.

Fig. 8C shows a method of avoiding current draw.  $E_1$  is the unknown voltage, which must be d.c. only, developed across  $R$ , which is the external circuit. At the positive end of  $R$  is placed one terminal of a voltmeter,  $R_1 IM$ . The other side of the voltmeter is connected to the arm of a potentiometer,  $R_2$ , which is across a battery having the same polarity as  $R$ . Thus, upper part of the battery, like upper part of  $R$ , is positive. Negative of unknown and negative of battery are interconnected.

### ACCURATE BALANCE NEEDED

$R_1$  is simply a limiting resistance, harmlessly left in circuit for current determination. Now, the slider may be adjusted, once the unknown d. c. is injected at left, until the current through the meter  $Im$  is zero. That is, so much voltage is taken from the battery,  $E_b$ , that the voltage taken off, or  $E_2$ , is the same as  $E_1$ . Therefore the circuit is balanced. Also, when this balance exists, although the two d-c voltages are equal, it is not known what either is quantitatively. So the voltmeter  $Em$ , is used for measuring the voltage  $E_2$ , and therefore without any special calibration being required, an unknown d-c voltage is measured without drawing any current.

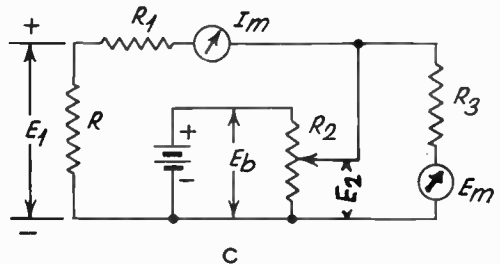

FIG. 8

The voltage  $E$ , developed across  $R$  due to current flow through  $R$ , is shown at A. Notice that when, as at B, the voltmeter  $rIm$  is connected across the same  $R$ , the voltage is no longer  $E$  but  $e$ . However, the voltmeter does read  $e$ . At B is a scheme for measuring  $E_1$  in terms of  $E_2$ , drawing no current.

It should be remembered that under conditions of no current flow, the magnitude of any resistors in circuit is of no consequence, since there is no voltage drop across it. Hence this method requires very accurate balance, and the meter for that purpose had better have a sensitivity of at least 350 microamperes (2,880 ohms per volt). Since this is an expensive instrument, the same one would be used for the voltmeter. How this is accomplished is shown in Fig. 9, which epitomizes the system used in the Hickok instrument.

The bucking voltage is obtained from a rectifier, so this device has to be used on a. c. for this purpose. A high-inductance choke and two filter condensers, 2 mfd. next to rectifier and .5 mfd. after the choke, comprise the filter. An excellent filter like this is required, otherwise stray hum would be applied to a-v-c circuits attempted to be measured, with rectification of hum voltage and consequent false readings. Three voltage-range resistors are picked up, with three different taps of the supply.

**"REAL VOLTAGE" FORMULA**

The object of the no-current-draw instrument is to measure d. c. voltages in circuits having very high resistance, e. g., from grid to cathode, without shorting, completely or partly, the source of this voltage. If there were only the cathode biasing resistor, with relatively large current through it, there would be no problem. But when some of the voltage is derived from a-v-c circuits, where the current is extremely tiny, then there must be no current draw or there will be no reading perhaps. Really, nothing read, because shorting has actually reduced the bias to zero.

Even sensitivities of 5,000 or 20,000 ohms per volt would be utterly insufficient. Errors of 75

per cent. would be common. Imagine getting a reading 75 per cent. off! Couldn't one guess the voltage more closely than that?

There is a formula for finding out the real voltage, even if the meter draws current, but unfortunately if there is a reading of zero, or nearly so, the formula can't be worked.

Let E represent the voltage to be determined, let Em represent the voltage that is read when the meter is connected to the circuit, let Rx be the resistance of the circuit across which the unknown voltage E appears, and let Rm be the resistance of the meter, practically the multiplier resistance. Then

$$E = \frac{E_m (R_x + R_m)}{R_m}$$

**EXTENT OF ERROR FOUND**

Let us see how far off a 0-1 milliammeter would be, used as voltmeter on the 10-volt range, when the voltage read is .118 volt, the resistance across which it is developed is 500,000 ohms and the meter resistance is 10,000 ohms (multiplier). Then  $E = .118 \times 51$  or 6.018 volts. Yet we read (if possible) .118 volt, an error of around 500 per cent.

If the voltage is known in advance, what the reading will be when the voltmeter of particular sensitivity is used, can be determined by revising the preceding expression to be

$$E_m = \frac{E}{R_x + R_m} \times R_m$$

That gives the true reading when the meter is across the circuit, a reading that is grossly false in respect to the voltage when the meter is not across the circuit, and the formula is handy merely to show how far off the reading will be from the free circuit voltage.

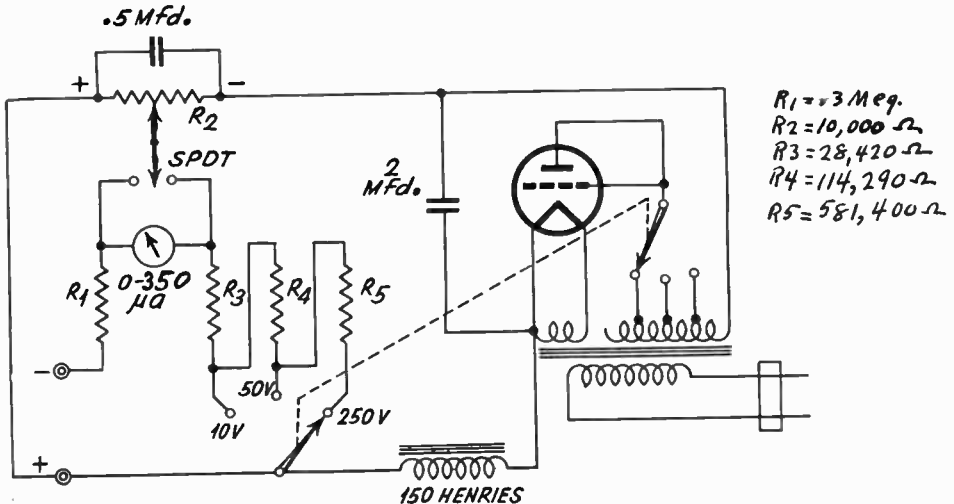

- R1 = 3 Meg.
- R2 = 10,000 Ω
- R3 = 28,420 Ω
- R4 = 114,290 Ω
- R5 = 581,400 Ω

FIG. 9

The no-current-draw instrument, applicable only to direct-current and direct-voltage measurements (no a.c. measured). This is a practical application of Fig. 8C, using a single meter for balancing and for voltage measurement.

## Performance Data on Diode Rectifiers

The ordinary diode, with the series load resistor, draws current from the measured circuit all the time that the input voltage exceeds the lag in the rectifier. This lag may be a fraction of a volt, and diminishes as the load resistance increases, another reason for favoring high load resistance. The ordinary diode with series load resistor responds to the average a-c volts, but to what extent depends on the load resistance  $RL$ , the heater voltage and whether the load resistor is shunted by a condenser, and if so of what capacity. The voltage increases as capacity is included, but the presence of capacity makes the circuit reactive. No longer is it independent of frequency nor eligible to vacuum-tube voltmeter distinction, which infers non-reactive performance. To get around that, the condenser must be very large for the lowest frequency.

First, the simple diode with series load resistor is shown in Fig. 2 (page 12). Next the diode again is used, but a seemingly small difference has been introduced into the circuit, whereby the resistor  $RL$  is placed across the diode, and there is a stopping condenser,  $C$ , isolating the continuous diode path from the unknown voltage source being examined. Now, this was a small change, but it creates a considerable difference.

The right-hand member of Fig. 2 shows the familiar leak-condenser detector. This, too, is a diode with parallel resistor, for grid to cathode constitutes diode, and plate to grid to cathode constitutes the triode amplifier. The reason why the circuit is not favored as shown for VTVM use is that the amplifier can not be segregated from the diode for range extension and self-bias.

### PEAKS THIS TIME

The diode with stopping condenser and high resistance paralleling the rectifier is called a condenser-diode rectifier. It behaves as a *peak* type linear voltmeter, not an *average* type, and it works into the measured circuit without any appreciable loading effect. It is being used in several new commercial tube voltmeters of the better sort. No doubt it will strike many as strange that the firm requirement of infinite impedance has been overlooked in favor of linearity. Moreover the meter is good on a.c. for sine waves only. Therefore some explanations are in order.

Linearity is handy, not completely controlling, but if it can be attained readily it should be included. Manufacturers are going to great lengths to make everything linear, if practical. What is far more important is that the measured circuit must not be substantially loaded, and the tube voltmeter should have both sensitivity and wide range.

Few indeed have been the tube voltmeters that combined all the stated advantages: linearity, inappreciable loading, sensitivity, wide range and no turnover. Inappreciable loading means that if there is any loading it is not active for the full cycle nor upsetting to the accuracy of the measurement. Sensitivity

means the same thing, that there is practically no loading, but the meaning is somewhat distorted in commercial literature. Sensitivity as a term applied to a tube voltmeter is mistakenly taken to be the same as when applied to a receiver. A meter's sensitivity depends on how much or how little current it draws from the circuit it measures and has nothing to do with the smallness of the voltage or current that can be measured. Only range affects the absolute volts. So here we should have a good range, say, up to 150 volts and down to a few volts, full scale. Turnover means you get a different reading depending on which way the test prods are connected to the unknown, harmonics being the cause.

### THE POSITIVE THAT'S NEGATIVE

A diode-condenser rectifier circuit must now be explained as one that does not draw any appreciable current, although we perhaps have been thinking for years that the only thing that resulted in any meter deflection in such a rectifier was the fact that current was constantly taken from the measured source.

If an a-c voltage is applied to the input, middle diagram of Fig. 2, the condenser, if large enough to present negligible impedance, is charged to the peak value of the input a.c. Now all that is necessary is either to set up a circuit that has a tube as amplifier or as balancing agency.

To go back to the totally infinite impedance detector, so-called, since it is designed to work mostly at radio frequencies, and to include very high ones, where measurements are most difficult, the capacity across the input, and introduced by external adjuncts as tube elements, wiring, sockets, etc., soon becomes ratable compared to the high frequencies attempted to be measured. When this is so there is a certain charging current that is drawn from the measured circuit, but this is ignored as a rule, because if the tube voltmeter is carefully designed the error introduced will be too small to require attention. Nevertheless a condition is realized to exist.

Now, if this may be true of an infinite impedance detector, why may it not be true too of a diode, if the diode also is so circuited that only a charging current is used, even though this time at all frequencies? That is exactly what is done. The peak of the wave being measured actuates the diode circuit by the charge on the condenser, and for a brief, a very brief, period the anode is positive. That it must be, in respect to cathode, for any current to flow whatever.

### COMMERCIAL APPLICATION

But after that the anode is negative in respect to the cathode, and the period of negativity is such a great preponderance of the duration of the cycle that the exciting peak moment may be forgotten and forgiven. The meter indication is obtained and the circuit has linearity, constancy, range and sensitivity. The charging does not upset the accuracy, and measurements have been made to very high frequencies (few hundred megacycles, with acorn tube).

The Type 726-A vacuum tube voltmeter, manufactured by General Radio Company, in a de luxe form, uses the diode-condenser rectifier. The resistor across the diode is very large, so as not to affect the operation of the diode itself, while across the stopping condenser  $C_1$  there should be no voltage drop. Then only will its charge build up until the voltage across the diode is equal to the peak of the applied voltage.

"The General Radio Experimenter" sets forth:

"When equilibrium is reached, in other words, the rectifier will approach the conducting condition only at the time of the positive peak of the applied alternating voltage. For the rest of the cycle the plate will be negative with respect to the cathode. The voltage across the diode thus consists of a negatively-biasing direct voltage in series with the applied alternating voltage, and it will be seen that the average plate potential is negative with respect to the cathode."

### BACK TO NATURE

Now this same explanation may be applied to the grid leak detector, the kind familiar in short-wave and other sets. Readers understand that the tube detects and amplifies, also that it loads the circuit somewhat, but want to know how can it be true that the grid must be positive before grid current can flow, and detection thus take place, whereas the plate milliammeter shows the grid is made negative by the signal, for plate current decreases. So

which is it—is grid positive or negative, or doesn't anybody know?

Well, the laws of Nature have a certain elementary simplicity about them, which should be utilized whenever one gets stuck on a problem like that. The first law of rectifiers is that the anode must be positive, otherwise there will be no rectification. So the signal makes the grid positive, no matter what happens later on, no matter if the plate milliammeter reads down and never up when the signal comes along. We know the law—positive anode, or no rectification. The grid is the operating anode. So the grid is made positive in respect to cathode—positive over and above everything and for all purposes. If there is some d.c. flowing and some a.c. superposed, the net effect is that the grid is positive.

That being the fact, we can follow the same reasoning as before, and say that the grid condenser is charged to the peak voltage of the input, that there is considerable current drain for that very brief period, but the moment that flick is over, the grid is negative in respect to the cathode, and remains negative for nearly all of the duration of the cycle, *and while negative does not draw any current.* The direct current that was caused to flow found, as usual, cathode at the positive end, so d.c. made the grid negative, and since the peak that influenced the grid current was greater than any other part of the voltage alternation, the grid current effect predominates over the a.c. in series with it, and the grid stays negative. Therefore the plate milliammeter is bound to kick down, and not up.

## WHAT ONE CAN'T DO THE OTHER CAN

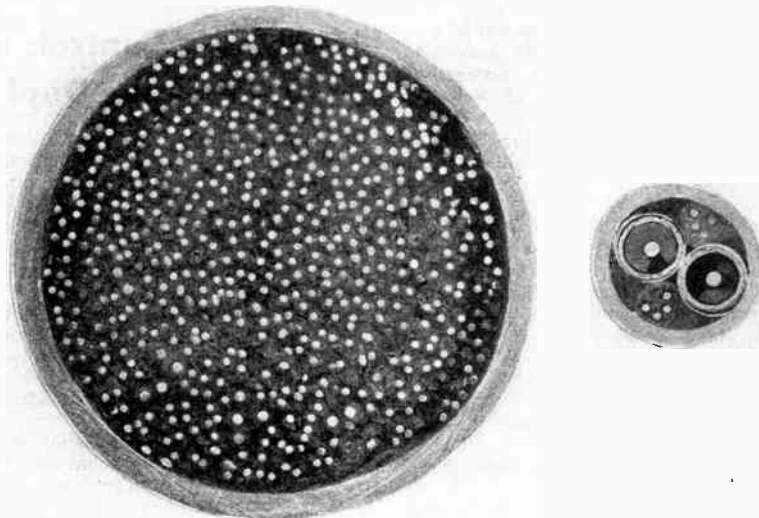

Comparative sizes of standard cable (at left) and coaxial cable (at right) to handle the same number of channels simultaneously.

## Mallory Announces 6-Volt Power Supplies

To provide portable power for radio transmitters, P. A. equipment and similar apparatus, P. R. Mallory & Co., Inc., have introduced a line of six-volt power supplies, called Vibrapacks, designed to give dependable service in heavy-duty application.

The two high-voltage models of Vibrapacks have a maximum rated output of 300 volts 100

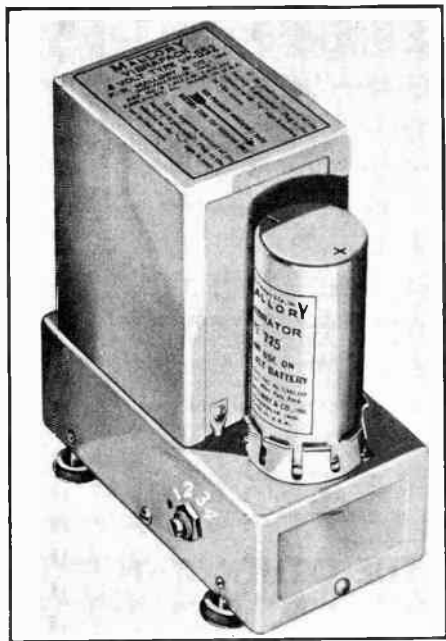

A new contribution to mobile and portable set purposes is this supply of power from a six-volt source. Thus an automobile storage battery is made to supply A and B power, as well as C voltage, for a receiver or amplifier. Other uses are numerous. Various models are offered, some (as shown) requiring no tube.

ma of easily filtered, rectified d.c., with three lower voltages of 275, 250 and 225 volts instantly available at the turn of a convenient tap switch. The variable voltage is obtained by means of taps on the transformer windings.

The lower voltage models of the Vibrapacks deliver 200, 175, 150 and 125 volts output and are intended for converting 110 volt a.c. receivers for 6-volt battery operation.

Mallory Vibrapacks are manufactured in both synchronous and self-rectifying types, and in interrupter or tube rectifying type. The tube type is required only when B minus can not be at ground potential. All Vibrapacks are supplied complete with long-life vibrators, designed specially for this particular application.

Mallory Vibrapacks are sold by authorized Mallory-Yaxley distributors.

## RCA Issues Elaborate New Parts Catalogue

A comprehensive and profusely illustrated parts catalogue, crammed with a wealth of valuable information for the radio serviceman and dealer, has just been issued by the RCA Manufacturing Company for selective distribution through RCA radio, parts and amateur equipment distributors.

In it are pictured and described all of the numerous radio replacement parts, test and measuring equipment, amateur apparatus, tubes, radio accessories and specialty apparatus. The new RCA parts catalogue measures 8½ by 11 inches in size, with a brilliantly colored, lacquered cover on which the wholesale jobber's name is imprinted. Substantial high-grade paper stock has been used and each page is remarkably dramatized by an unusual layout of type and illustration in large display.

The cross-indexed guide of all the important replacement parts for the RCA Victor radio receivers and the corresponding models of the General Electric, Graybar and Westinghouse Companies, which was an extraordinarily popular feature of the previous catalogue, has been brought completely up-to-date and included in the new volume.

Among the products featured in the new RCA catalogue are the various types of cathode-ray oscillographs, test oscillator, calibrating and modulator devices, service engineering tools, phonograph modernization and hard-of-hearing equipment, the various type of transformers, and new auto antennas and short and all-wave antenna kits, a full line of amateur receiving and transmitting apparatus, including amateur tubes, and many other pieces of equipment important to the service engineer and amateur radio enthusiast.

## IRC Volume Controls to Be All-Inclusive Duplicates

A complete line of IRC metallized volume controls in exact duplicate replacement types, including dual and other special units, is being prepared for distribution September 1 by International Resistance Company, 401 North Broad St., Philadelphia.

Previously IRC metallized controls have been made in thirty-five standard types. The present expansion comes as a result of the widespread popularity of these units and the demand for a complete line of exact duplicate types for all the wide variety of receivers on which servicemen are called upon to make control replacements.

In addition to this expansion of the IRC jobbing control line, new dual and triple controls as well as a new development of the IRC Type C control capable of carrying up to 2 watts, are being introduced in the radio manufacturing and industrial fields.

A circular is obtainable by addressing the company at address given above.

## Exclusive Features in Triplett 2" Oscilloscope

A new complete oscilloscope with 2-inch screen is announced by Triplett Electrical Instrument Co., 277 Harmon Ave., Bluffton, O. It was designed to meet every requirement of the servicing engineer for the visual study and adjustment of receiver circuit problems. In addition to radio servicing, it has invaluable applications in radio transmitter, sound equipment, industrial and educational fields.

The cathode-ray tube with exclusive Triplett turret type mounting can be moved up or down or to either side for adjustment of the screen to an angle always in direct alignment with the user's line of vision.

An extremely brilliant pattern is provided on the two-inch graph screen. An adjustable shield can be pulled out to project beyond the screen to enable easy reading in brightest daylight and permit accurate photography.

The oscilloscope incorporates separately controlled resistance-coupled vertical and horizontal amplifiers. Both vertical and horizontal plates can be either direct-coupled with amplitude control, or through amplifiers with amplitude control. The 'scope can be used with any type frequency modulated signal generator.

Linear sweep is from 15 to 20,000 cycles. Sweep (either internal, external or 60 cycle) may be used through amplifier or direct with amplitude control for study of r-f, a-f and other phenomena. Positive lock is provided (pattern stands still when ratios are harmonic).

## New Edition of Lathe Manual by South Bend

The 33rd edition of "How to Run a Lathe" is announced by the publisher, The South Bend Lathe Works, South Bend, Indiana. The new edition has 160 pages. Instructions on every phase of lathe work are given in detail in easily understandable language and accompanied with more than 300 illustrations.

The book was originally introduced in 1907 in the form of a 16-page manual. The last thirty years more than 1,500,000 copies have been printed and are in use throughout the world.

Besides dealing with all types of lathe work and showing the proper setup for doing every kind of a lathe job, the book also includes a great amount of useful shop information of a general nature, such as reference tables and formulas, tables of cutting speeds of metals, application of lathe tools, cutting screw threads, metric screw threads, taper turning and boring, milling and keyway cutting, bushing work, gear cutting, proper application and types of drives.

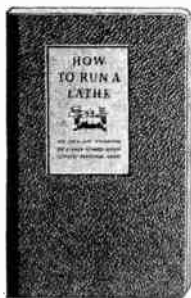

## Homer H. Kunkler Named National Union Sales Chief



HOMER H. KUNKLER

National Union has recently opened a Chicago office, at 540 North Michigan Avenue, and Mr. Kunkler will divide his time between these and the New York headquarters.

S. W. Muldowny, chairman of the board of National Union Radio Corporation, announced that Homer H. Kunkler has been appointed general sales manager of the Corporation. Mr. Kunkler is well known to the radio trade. He was manager of distribution for the U. S. Radio & Television Corp., assistant general sales manager of General Household Utilities and held a similar position with Stewart Warner.

## Customer Instructions About Short Waves

Servicemen should briefly instruct customers new to short-wave reception concerning the time zones of the world, otherwise many will be trying to get stations not on the air. An explanation like the following is sufficient:

"When attempting to receive distant or foreign short-wave stations, the time standards observed throughout the world must be considered. At 8 p.m. in New York or 7 p.m. in Chicago, it is 1 a.m. of the next day in London, 2 a.m. in most of Europe and 11 a.m. in Australia. On the American continents, therefore, regular evening broadcasts from Europe will be received in the late afternoon and from Australia in the early morning. Special programs, however, designed for evening reception in America, are daily transmitted from European stations."

Facts about reception conditions may be explained thus:

"Although reception on the short wavelengths is less affected by atmospherics or static, and good results may be had in mid-summer even during a thunder storm, the reverse is true of man-made interference. Electrical machinery, such as trolleys, dial telephones, motors, electric fans, automobiles, airplanes, electrical appliances, flashing signs and oil burners, create far more interference to the shorter waves than to frequencies in the standard broadcast band (200 to 555 meters).

"Many other factors may so influence the transmission of short waves that exceptions may occur in certain locations. Experience in the operation of short-wave receivers in a given location soon reveals what to expect in reception at various times."

# NEW SERVICING TECHNIQUE

## Developing Around the Zero-Draw Instruments

By H. J. Bernard

THE voltage measurement that requires putting resistance across the unknown will introduce an error in the reading, because of the current flowing through the meter. Hence, of the total current flowing, not all goes through the circuit being measured, hence not all of the voltage is measured, or the reading is too low, compared to the true voltages with meter removed.

In the earliest days of radio, meters with resistances of a few hundred ohms per volt

full-scale deflection current, whereupon one milliampere accounts for case of 1,000 ohms per volt, 200 microamperes describes the 5,000 ohms per volt instrument, while the equivalent of 20,000 ohms per volt is a 50 microamperes and of 25,000 ohms per volt 40 microamperes.

It should be remembered that the instrument acquires a sort of added fragility as the sensitivity is increased in that manner, and the likelihood of damaging the meter by using it unintentionally as a voltmeter when set for a cur-

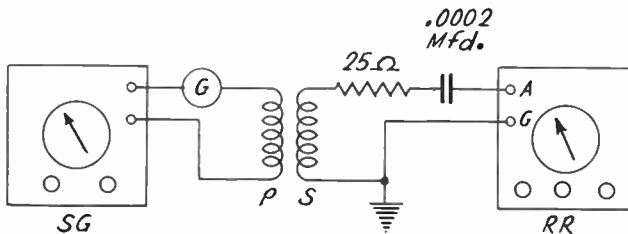

The signal generator output is shown with thermocouple galvanometer in series with primary P of the output transformer, while secondary S may have the 25-ohm resistance in the winding, inductance being 20 microhenries

were used, but were not very satisfactory. Or, rather, according to the easy standards of the times, they sufficed. Today they would be ruled out, even for measurements on the receivers of another day. These low resistance meters gave passable readings for batteries, but for the rest of the circuit were not of much account.

Finally the servicing industry more or less settled on a resistance of 1,000 ohms per volt, which meant that a 0.1 milliammeter was used as a voltmeter. Ohms per volt =  $1 \div I$ , where I is full-scale deflection in amperes.

### FROM LITTLE TO NOTHING

The standard for the electromagnetic meter is climbing. Now we hear considerably about meters with 5,000 ohms per volt, 20,000 ohms per volt, and 25,000 ohms per volt. Such types of meters are also used for current measurements, and with rectifiers for a-c measurements and reactive components generally, including capacity and inductance. However, the capacities must not be minute and neither must the inductances, otherwise they couldn't be read by the impedance method, using the line frequency and voltages low enough to be safe in inexpensive layouts.

The sensitivities may be rated in terms of the

rent reading increases somewhat. However, it is almost standard practice not to expose the meter in its most sensitive condition to current purposes. For instance, seldom does an instrument of even 1,000 ohms per volt render access to the meter for reading the most sensitive range, 0.1 milliamperes. Perhaps the lowest range would be 10 milliamperes. Thus at full scale 9 milliamperes goes through the shunt and only 1 milliamperes through the meter, and if there is an overload, the same proportionality prevails.

### APPLICABLE TO HIGH FREQUENCIES

The next step is to have a meter that does not draw any current from the unknown. Of course, the meter draws some current from somewhere, but the voltage supply in the instrument does not count. The taboo against extraction of current applies to the circuit connected across the input terminals of the meter.

Since a vacuum tube negatively grid biased, and having input small compared to the d-c bias, for most frequencies draws no current, it is referred to as an infinite impedance. This type of circuit is suitable for a tube voltmeter. The tube reaches saturation finally, or cutoff, in such a way as to limit the range.



As tube voltmeters are intended for radio frequencies mostly, naturally attempts are made to have them perform at as high frequencies as practical. Every example of a tube at the end of a cable, as in the goose-neck and other probe constructions, represents an effort to attain higher frequencies than those which the tube voltmeter ordinarily measures with 5 per cent accuracy.

Tubes especially designed for high frequencies find favor in some commercial applications, for instance the acorn tube. This may be used either as a triode, or as a diode by interconnecting control grid and plate. Also, the idling current in such a diode is negligible, i. e., when input terminals are closed, the voltmeter reads zero.

The trouble with diodes is in two classes: (1) you get a reading although there is no input, just so long as you short the terminals, or connect them to an unknown, even though there is no voltage across the unknown; (2) you don't get any reading until you apply considerably more voltage than you expected would be necessary. The first case is that of idling current, caused by the anode being made positive by stray electrons escaped from the cathode, and the second case is that of a high load resistor (.5 meg. or more), causing the self-same anode to be a bit negative in respect to the cathode, and the condition is augmented by phase shift. The idling case affords quick starting. The delay case does quite the opposite, hence reduces sensitivity to weak signals.

### THE 6C6 HAS ADVANTAGES

It can be seen, therefore, that between one and the other type of trouble there is mainly the matter of tube and load resistance. If that resistance is high, there may be some negative bias on the plate at no intended input, but terminals must be closed. If the load resistance is low, there will be some positive bias on the plate. Here low means less than 50,000 ohms.

The situation as outlined applies to the run of diodes, but not to the acorn tube, either as triode-connected or diode-connected, nor quite so forcibly to the 6C6 as to any other standard large-sized tube. The engineers of various instrument companies have tried out all the larger glass tubes and found that the 6C6 is the best performer, having very small idling current and still not building up much of a delay on high resistance loading.

The series resistance has been the common choice for load, but new instruments are favor-

ing the shunted diode, i. e., a very high resistance (multiple megohms) connected between anode and cathode. A condenser is put between one input post and anode. The cathode may be connected to the other input post directly or through a similar condenser. The unknown voltage is practically across the resistor. For tube voltmeters to be used in ac-dc supply (of which type there is practically none), two condensers would be necessary. However, some VTVM with power transformer, for a-c use only, also have both condensers.

The diode curve is substantially linear for this condenser-diode circuit, and the same is true for the series method when the load resistance is more than 50,000 ohms.

### EFFECT OF CAPACITY

The usual diode, with load in series with the input, measures the average of the voltage, so if condenser were omitted and d-c applied, the a-c scale would not be repeated. But for the condenser-diode circuit, the peak volts are measured, d-c volts are substantially the same, so the one calibration suffices for both. However, the tube voltmeter is primarily intended for a-c measurements, and the d-c service is just a gratuity. Therefore the calibration might well be made for a-c rather than for d-c, and of course if the a-c volts are to be of the root-mean-square type, then the a-c scale can not be repeated for the d-c scale.

So the a-c purposes to which the tube voltmeter would be put would be the measurement of voltages under circumstances such that even the slightest current drain would produce a large error in the reading. Hence the tube voltmeter could be put across tuned circuits, or across the untuned circuits carrying current of a particular frequency, as the primary of an r-f or i-f coupling transformer.

### AVOIDING FEEDBACK

At the intermediate and standard broadcast frequencies the capacity thus introduced is small, and could be neglected, except for its effect on detuning. It is therefore necessary to retune the circuit across which the tube voltmeter is put, if the voltage at a particular frequency is desired, or if there is a cascaded chain of tuned circuits, and the circuit being measured must be kept in tune, because the accuracy of a gain ratio depends on resonance. A circuit thus purposely retuned to enable maximum response when the tube voltmeter is in circuit must be

(Continued on following page)

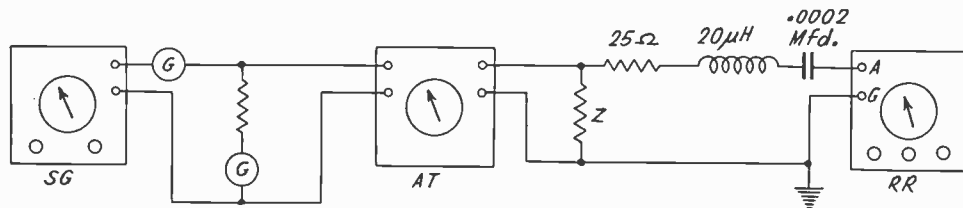

Instead of transformer coupling there may be impedance coupling. Here upper G is a thermal galvanometer to read current, lower G in connection with its limiting resistor, reading voltage. SG is the signal generator, AT is the attenuator. Z is the output impedance, and RR is the receiver.

(Continued from preceding page)

tuned back after the measurement is made. Now, if the connection is made across an untuned primary, still a retuning of the secondary may be necessary, for the detuning influence may be reflected into the secondary, although the reflection is not as large as the original effect, e. g., if the tube voltmeter were directly across the grid circuit.

Another precaution regarding tube voltmeters is that the readings taken should be for conditions of the same, if any feedback, that exists normally. At radio and intermediate frequencies, coupling the tube voltmeter may introduce feedback that for the usual case increases the gain. The increase is not present when the voltmeter is absent. The signal should be shorted out of the preceding amplifier for r-f and i-f measurements, by using of a large condenser, .01 mfd. up, between control grid and ground. Usually connection between control grid and chassis suffices.

Not only r-f and i-f voltages are measurable, but audio voltages as well. Therefore, with high resistance plate loads and especially with grid loads in the megohm range, it is convenient to use the tube voltmeter for comparison of voltages at input and output, to obtain, by division, the gain per stage. With audio frequencies, unless very high ones are used for test frequencies, feedback and attenuation troubles are small, and no signal shorting need be done.

The various gains may be expressed as simple voltage ratios, but it is perhaps better that the international transmission unit be applied. This is the decibel. Like gain per state, it is a ratio, but it does not depend on a linear ratio, but a logarithmic one, and for voltages (or currents) the number of decibels equals 20 times the logarithm, to the base 10, of the higher divided by the lower voltage (or current):

$$db = 20 \log_{10} \frac{E_2}{E_1} = 20 \log_{10} \frac{I_2}{I_1}$$

The effect may be gleaned from the following table, which accepts a zero level, and gives ratings down (representing loss) and ratings up (representing gain). It may be remarked that amplifiers read "up," while speakers and microphones are "down."

**DECIBEL TABLE**

<i>Voltage or Current Ratio (Linear)</i>	<i>Transmission Units in Decibels (Logarithmic)</i>	<i>Voltage or Current Ratio (Linear)</i>	<i>Transmission Units in Decibels (Logarithmic)</i>
0.001	-60.00	2	+ 3.52
0.005	-46.02	5	+ 6.02
0.01	-40.00	10	+13.98
0.05	-26.02	20	+20.00
0.1	-20.00	50	+26.02
0.5	-13.98	100	+33.98
1.0	- 6.02	500	+40.00
1.5	0.00	1000	+60.00

For the present it is not necessary to select any particular voltage to be the zero level, the

only requirement being that an input be established to a receiver from a signal generator, preferably unmodulated, and that the generator's attenuator be set so that the decibel meter reads zero. All amplifiers read up, therefore the primary circuit reads zero (although based on some particular voltage in the original calibration) and the secondary voltage reads "up," after the detuning effect, if any, has been remedied. If, as is assumed, the meter is calibrated in decibels, there is no calculation to perform, but the gain in db is read directly. Say it is nearly 14 db up, which equals a gain of 10. That might indicate everything is all right, or it might mean there is a little trouble. The nature of the circuit would determine that. Much higher gain might have been the manufacturer's intention and his information to servicemen would have to include that detail, or, the cases could be generalized. R-f stages with triode tubes, up 10 db; i-f stages with triode tubes, up 15 db; r-f stages with pentode tubes, up 20 db; i-f stages with pentode tubes (primary and secondary tuned), up 40 db. Those could conceivably constitute excellent bases for comparison, and if the figures are attained, the stage is functioning perfectly; if they are not, there is trouble, and the serviceman's job is localized to the spotting of the exact trouble source and cause in a single stage. This stage-to-stage comparison he can make without the aid of a diagram. The gain might easily be too high and that could constitute trouble, as where a band-pass effect is intended.

The same zero level remains, i. e., the signal generator need not be disturbed, only the tube voltmeter must have higher ranges, so that the progressive gains are measured. Fortunately the decibel notation comes in decidedly handy. Not only is it related to the response of the human ear, and therefore closely tied in with the enduring test of listening, but also the gains may be added or losses subtracted. It is unnecessary either to compute ratios or to relate already computed ratios, except to follow the simple add-or-subtract rule that applies to decibels. So from the zero level the amplification is carried on at radio and intermediate frequencies to 60 db up (a gain of 1,000), or more.

**CHECKING AUDIO LEVEL**

Since the tube voltmeter draws no current at audio frequencies, either, it may be used at the audio level, right across circuits, and again the decibel notation applies. It may still be the same voltage notation that we have been considering, because only voltage gain is ever desired in the tuner, and scarcely ever anything save voltage gain in the audio amplifier, up to but not including the last tube or tubes, when power becomes a consideration, though voltage may retain significance, as shall appear. The difference is that amplification is a boosting of the signal, a raising or elevating of its level, whereas power is a measure of how much work can be done in a given time, for the output circuit has to do work, i. e., operate an electro-mechanical device, the reproducer. Power may be defined as the time rate of energy and energy may be regarded as work done.

However, for the audio voltage gain meas-

urement we need audio voltage input. This we may obtain without molestation of the signal generator, if it is possible to introduce modulation into the generator. However, an audio oscillator may be at hand, and if so it may be connected to the input of the audio amplifier, either directly or through a transformer, depending on the type of audio oscillator and the load on the input to the amplifier (which is practically always high impedance). The big advantage of the audio oscillator is that it will afford the full range of audio frequencies, which may be from 40 cycles to 10,000 cycles, although the usual receiver is not required to do better than 100 to 8,000 cycles, for reasonably flat response. Some signal generators have variable audio frequencies for modulation, and this type is satisfactory.

### OVERALL GAIN MEASURED

Unfortunately, not all of the modulation methods produce a sine wave, and therefore it

Now the power output of the receiver RR is measured, using the constants shown, in connection with a vacuum-tube voltmeter. For overall sensitivity measurements output is adjusted to .05 watt

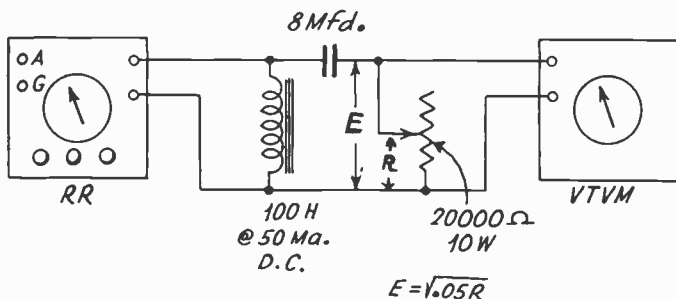

is well to omit the modulation for r-f and i-f, since it is unnecessary, and risky, if the wave form is seriously upset by modulation. For the audio voltage test the sine wave is not required, though handiest to use for some methods of checking, e. g., oscilloscope.

So the gain may be measured from the first stage up to and including the last, although gain is not the main requirement of the power tube. Yet every tube except a rectifier or regulator has some gain, even if it is only 4, whereas modern tubes, like beam power amplifiers, have large gain, perhaps 100 or more, and there is every reason to include the gain measurement to the very end. It is important to know that the standard gain is being realized, for if it is not, trouble exists somewhere, and the very stage that is the seat of the trouble becomes known. The standard should be expressed in db, not simple ratio, e. g., not 4 or 20 as amplification factor but 11.3 and 23.3 db.

If the gain per stage is all right from start to finish there isn't much that can be the matter with a set, and therefore the progressive measurement from input to output, or from output to input, for it is just as easy to work backwards, will fill the need. It will be necessary that the tube voltmeter have an exceedingly low range, as even .1 volt would be too large input to the first stage.

So far the work has been done without any assignment of a particular voltage for the zero level. There is no particular need for a uni-

versal zero level for voltage considerations because the ratios themselves disclose the facts, i. e., db speak for themselves. But it is possible to have the system include sensitivity test. So, for a standard input voltage, at some selected frequency in each band, or three in each band with results averaged, the rated output is measured in watts.

### DUMMY ANTENNA USED

It is standard to operate the receiver at test output (.05 watt), and find out how small a signal can be used to attain that output, when the generator is modulated 30 per cent at 400 cycles. That would be a measure of the sensitivity, and the answer would be in microvolts, not microvolts per meter. Although the inclusive phrase is nearly always used, it has no meaning. There is no wavelength concerned. The "per meter" designation applies to field intensity measurements, but not to receiver sensitivity measurements.

The input is through a dummy antenna of designated constants, e. g., a coil of 20 microhenries inductance, a condenser of 200 mfd. capacity (.0002 mfd.), plus a resistance of 25 ohms, which maybe is built into the coil.

It is not easy to meet the requirement of measurement in microvolts, as one does not possess a tube voltmeter that goes down to microvolts, which are millionths of a volt. About the best to be expected is millivolts, or thousandths of a volt. However, a receiver with substantial gain at a single level may be used, with good generator output put into a stage, input and output measured, then the next stage in the amplifier added, the db added also, whereupon the signal generator's output may be reduced until the same reading obtains as prior to measurement of the cumulative gains of the stages. Then the generator output itself is down as many db as the measured amplifier stages are up, an easy way of measuring the lower generator output levels, beyond the range of the VTVM alone.

### SELECTIVITY MEASUREMENT

Also this is a way of calibrating the generator output control in decibels, each stage gain in db representing equal db down on the attenuator to keep the meter readings finally constant, say, at the zero level, as elsewhere. Present standard methods include noise as signal and produce higher sensitivity ratings than justified.

(Continued on following page)

(Continued from preceding page)

It should be remembered signals were meant to be heard.

Not only the gain and sensitivity may be expressed in db, but also the selectivity may be measured. The gain method has been explained as simple voltage ratios transformed into logarithmic ratios. The sensitivity test was the db gain test, with a standard input signal consisting of a signal generator's output modulated 30 per cent by a sine wave, preferably 400 cycles, if a single frequency is used for modulation.

The maximum rated power output is one of those requirements that find their way into print but that the person receiving the advice can not follow for lack of equipment. What serviceman is fully equipped to measure the power output of a receiver, in terms of watts and total harmonic distortion? Maximum rated power output therefore may be considered for the time being as something beyond what the serviceman can be expected to measure and the db voltage change may be measured regardless of the power output.

### TACKLING SELECTIVITY NEXT

The measurement is confined to sensitivity, and the power output is not directly related to sensitivity, but is only so related by definition. The voltage-amplifying stages can be practically distortionless. The power-handling stage or stages are the perilous ones. The power rating may be considered therefore as another rating, obtainable separately, if needed, by loading the input to the final stage with the maximum allowable voltage, and then observing the power output by measurement, with a determination also of the total harmonic content.

The selectivity measurement may be carried on in the same manner as the db determinations, the fact being realized that a selectivity curve is simply an attenuation curve, or loss curve, the voltage (or current) declining as the amplifier is detuned from the injected frequency, or the injected frequency is detuned from the frequency of the amplifier under test. This decline from the resonance point may be expressed in decibels just as well as any other decline of voltages. It is usually easier, at the i-f level, to change the injected voltage, while at the r-f level it is about fifty-fifty as to whether the injected voltage or the amplifier frequency is to be altered.

Resonance may be defined as the condition wherein the injected frequency and the amplifier frequency are equal; off resonance when they are unequal; the selectivity expressed finally as a number (not db).

### NOT PERFECT, BUT GOOD

This is practically measurement of the  $Q$  of the circuit, which perhaps might be taken as a substitute for selectivity as usually stated. About the best expression of selectivity as such is in the form of a curve, based on voltages 10, 100, 1,000 and 10,000 times down, on both sides. It is handier, however, to have selectivity expressible as a single factor, so one may utter something, like "965," and the number has

selectivity significance. The way to do that is by measuring the  $Q$ .

This is no easy measurement to make, and the method proposed is subject to error, since it assumes that the current in one leg is equal to that in the other, which it isn't, because on the side of lower frequency the reactance is inductive and the current is larger. But the method is good enough to warrant adoption in service practice and good enough to find respectable mention in authoritative text books.

That method also requires that three voltage or current readings be taken. One is at resonance. Another is at a frequency removed from resonance on one side sufficiently to reduce the voltage (or current) to .7 of its former value. The third is to measure the frequency off resonance in the other direction that likewise reduces the voltage (or current) to .7 of the resonant value. Now, if the measurement was made accurately, and if the current, hence voltage, were the same for equal attenuation levels in the selectivity curve, the test would be highly accurate. As it is, the measurement is acceptable in the difficult field of  $Q$  determination.

### THE EXPRESSION FOR $Q$

The method is borrowed from the procedure applicable to a coil alone, where the frequency of resonance is divided by the difference between the two off-resonance frequencies that establish .7 resonant voltage. For any good coil the impedance  $Z$  is practically the same as the inductive reactance,  $X_L$ . So instead of  $X_L$  we have impedance  $Z$  and for  $f_1$ - $f_2$  the frequency difference, we substitute  $R$ , for the resistance has been increased by the square root of one-half. Then we get  $Z \div R$ , which is the  $Q$ .

As  $Q$  turns out to be a number, which we can pass on by word of mouth, rather than a selectivity curve that we would have to draw, trace, duplicate and have inspected, it is handy to deal with  $Q$ , and it probably will be done in service work in the future. The  $Q$  may not be assigned values in decibels.

If the voltage can not be read on the tube voltmeter because we have been assuming decibel calibration throughout, then the equivalent of .7 the resonant voltage is 3.1 db down.

### THE POWER RATIO FOR DB

The methods proposed have been kept in line with the voltmeter method of servicing and alignment. It is a fact the voltmeter may be a cathode-ray oscilloscope, but that is not as good a voltmeter as the regular tube voltmeter, nor can it be read as closely. However, the selectivity determinations may be better made with the ray tube, for servicing purposes, but not for recording, unless traces are drawn or photographed. The result is never a number, always a pattern. And of course the band width requirements of high-fidelity channels can be met, a wobbler (wobulator, frequency modulator) being additional required equipment. Then instead of getting a number representing selectivity, you get a picture, and the wobbler permits the contraction or expansion of the channel width of the injection. (Continued on page 30)

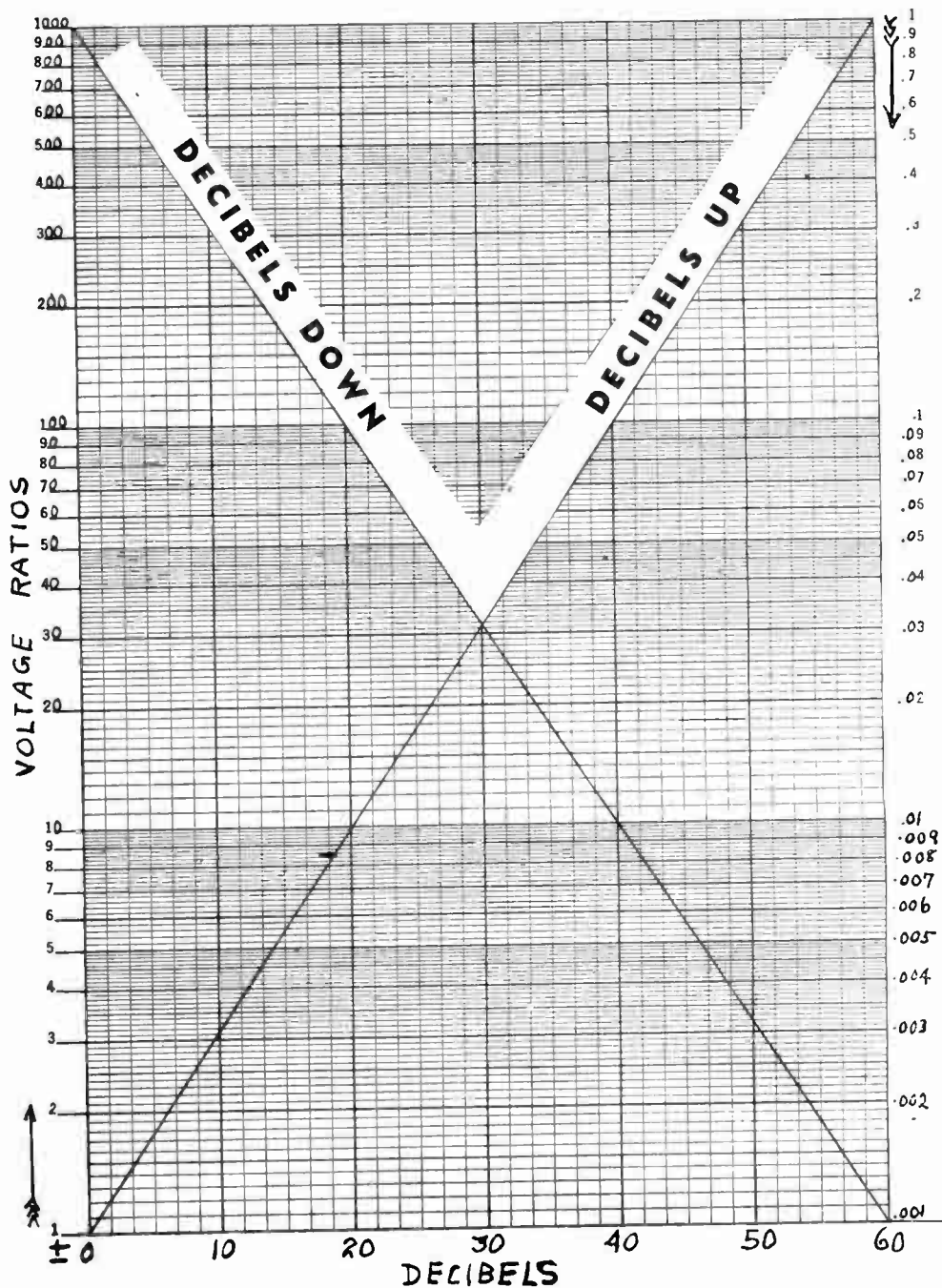

Curves relating decibel gain and loss with voltage ratios only. At left, arrow pointing upward, refers to db gain. The curve is the one starting from 0 and ending at 1, lower left to upper right. For db down, ratios are in perpendicular column at right, read as arrow at upper right indicates, the curve applied being the one from lower right to upper left, with .001 and 1,000 at extremes. For any power ratios treat as if voltage ratios, find decibels on horizontal, and divide by 2.

(Continued from preceding page)

The power ratio has been avoided right along, because not until the output stage are we concerned with power. However, the transmission unit is based on power. The bel, the standard unit, as the logarithm to the base 10 of the ratio of one power to another. Thus, the decibel, one-tenth bel, is equal to 10 times the logarithm of the ratio of one power to another. Thus

$$db = 10 \log_{10} \frac{P_2}{P_1}$$

where db is in decibels,  $P_2$  is the larger and  $P_1$  the smaller of the two powers being compared, which keeps the characteristic positive, and makes for convenience, especially as the direction of change is known to the operator.

The decibel is used because it is handier, and avoids a lot of fractions or decimals.

It can be seen that the power ratio is equal to half the db of the voltage or current ratio. Hence the db scale based on voltages, the scale we have been considering, has to be divided in half for any reading, where power is the consideration, and not voltage alone, or current alone.

For the power example the reference point must be stated. That is, zero level equals so much power, and into such-and-such a load. Unfortunately there is no single standard. In the fields of lighter original currents and voltages (smaller original powers) the rating is naturally low. In telephone practice a zero level of .001 watt (one milliwatt) is often met. In radio receivers, considering the medium amplifiers used in sets, the level is often .006 watt (6 milliwatts), while at the broadcast studio and in microphone practice it is commonly .012 watt (12.5 milliwatts). Now, the ratio is the same, and the decibel change is the same, no matter what the rating of zero may be, but the quantities considered are relative, and to make them absolute, so that they conform to real watts, it is necessary to know the level. Otherwise it is like saying that Joe Louis delivers a punch 60 db up, compared to — and not fill in the blank, i. e., not say compared to whom.

It was said earlier that in the comparison of voltages the zero level was not important, as the relative values sufficed. If the gain was all that it should be, the actual value of the voltage at the final output would not be of consequence, because depending on the input.

## Book on Interference

An interference detective reports the results of his years of activities for a power company in the compact volume, "The Causes and Elimination of Radio Interference." The author is Joseph Everett Foster and the publisher C. W. Nelson Company, South Braintree, Mass.

Mr. Foster used a Tobe interference locator in much of his work, but there was always the need to keep one's wits about him, because of false clues. To a radio serviceman this true account reads like a gripping detective story. And like the detectives of fiction, the hero was not to be outwitted.

## 12,000 Letters a Year Are Milbourne's Meat

Samuel C. Milbourne, service engineer for the Supreme Instruments Corporation, is a native New Yorker. Graduate of RCA



Samuel C. Milbourne

Institutes, and former correspondent of Wholesale Radio Service Company in New York City, Mr. Milbourne joined the executive personnel of the Supreme Instruments Corporation in June, 1935. He has written numerous articles for the trade magazines on testing equipment, as well as operating data for Supreme instruments. His daily mail averages over 12,000 letters annually

and come from service men all over the world.

Many servicemen believe that large firms with whom they correspond are "cold" and "heartless." Although each concern must operate according to certain general rules and policies, Mr. Milbourne wishes to emphasize the fact that large corporations are made up of individuals and are, therefore, very human, being always willing and anxious to help the serviceman in every way possible.

"It is this spirit of friendliness and co-operation that helps to put and keep the radio servicing industry on a high moral level," he added.

## Old Sweater a Remedy for Acoustic Feedback

A bad case of acoustical feedback was encountered in a public-address installation using two speakers. The installation men tried all their bag of tricks, to no avail. Speakers were placed and faced differently, rounded instead of squared baffles were substituted, other remedies applied, still the trouble endured.

Finally, in disgust, as one perhaps claps palm across the mouth of a crying infant, expecting it will do no good, one of the men threw his sweater over the front of one of the speakers. Well, the trouble completely disappeared. Some loss was suffered, to be sure, but the sound was diffused much better, and the gain control could be turned all the way up, without resultant howling. Also, comparing operation with either speaker in and out of operation the sound level was very much higher with speaker on, so the benefit was clear. Also, the management, disgusted with previous installations, was mightily pleased with this one, according to H. Melchior Bishop, who was there when it all happened.

# Sizing Up Meter Facts FOR BEGINNERS

By F. E. Wenger

*Engineer, Triplett Electrical Instrument Co.*

A METER is essentially a current-consuming device and the wattage requirement is in minute fractions for a given movement to cause full-scale deflection. Where measuring voltage of batteries, motors, generators, transformers, etc., the current consumed is only a fraction of the power flowing in the circuit.

A meter of 100 ohms per volt, together with its multipliers, would consume at 100 volts full scale, 1 watt of current, (.01 current  $\times$  100 volts = 1 watts). At 1,000 volts the meter would consume 10 watts. This would offer no serious problem when sufficient power is available and when no resistance other than that associated with the meter is in series with the line.

Any resistance that has current flowing through it consumes power and also has a definite voltage drop depending upon the value of current.

## POPULAR SENSITIVITY RANGES

In radio work we encounter power of very small values and these frequently have resistance in series. We therefore must reduce the power consumed by the meter and its multipliers to some practical value, as it would be impossible to measure voltage having 1 watt of power with a device that consumes 10 watts of power. Therefore, the sensitivity of the meter is increased and the ohms per volt are raised. It is common practice to use a meter either having 1 milliamperes full scale deflection, or 1,000 ohms per volt rating, or a meter having 500 microamperes full-scale deflection, or 2,000 ohms per volt.

Measuring 100 volts with a 1,000-ohms per-volt meter, 100 volts full-scale deflection, the power consumed is .1 watt, and measuring 1,000 volts, the power becomes 1 watt. With a 2,000-ohms-per-volt meter, the power would be halved.

Measuring under the conditions outlined above the preceding is written with the understanding that the readings are full-scale deflection. Any time the meter and its associated multipliers do not cause full-scale deflection, the power consumed is less. Therefore, if the

meter reads one-half scale, the power consumption is one-half. Likewise reading one-fourth of full scale, power consumption is one-fourth of full scale.

There is an additional factor that enters here, i.e., any resistance in series with the meter acts as a multiplier and decreases the reading in direct proportion to the resistance value and the ohms per volt of the meter. So 1,000 ohms in series with 1 volt and a 1,000 ohms-per-volt 0-1 voltmeter would decrease the reading to one-half volt and the power consumption would likewise decrease. The same analogy holds true of any current-consuming volt meter. Any resistance which is in series when the meter is placed across a resistor acts as an extra multiplier and reduces the meter reading, while putting the meter across an unobstructed circuit reduces the effective resistance of the total circuit according to the formula for determining parallel resistance values.



F. E. WENGER

## WHEN ZERO CURRENT IS NEEDED

Of the two errors mentioned, the power error is very small on all radio measurements except diode a. v. c. However, the resistor error must be given serious consideration for all measurements where there is a resistance in series and voltage is being measured. Knowing the value of this resistor and the ohms per volt of the meter, it is very easy to calculate the correct voltage.

There are some circuits in a radio where the power is so minute that the most infinitesimal power drawn will lower the voltage and there is no way of accurately determining or calculating this voltage without a no-current-draw instrument. A. v. c. and grid bias cells are striking examples of the above.

In summing up—

1—The usual indicating instrument is a current-consuming device.

2—Errors result when there is insufficient power to operate the meter. (A vacuum tube voltmeter should be used).

3—Errors result when a resistor is in series with the measured voltage.

4—A meter of 1,000 ohms per volt or higher can be used with good results, and accurate conclusions reached when measuring is done as in either 1 or 3.

The above holds true for any meter that consumes current, and no matter whether the resistance is 1,000 ohms per volt or higher the resistor error can easily be calculated by use of Ohms law.

# There's No Surface Wave

## Tests Riddle a Mathematical Error

By C. R. Burrows

*Radio Research, Bell Telephone Laboratories, Inc.*

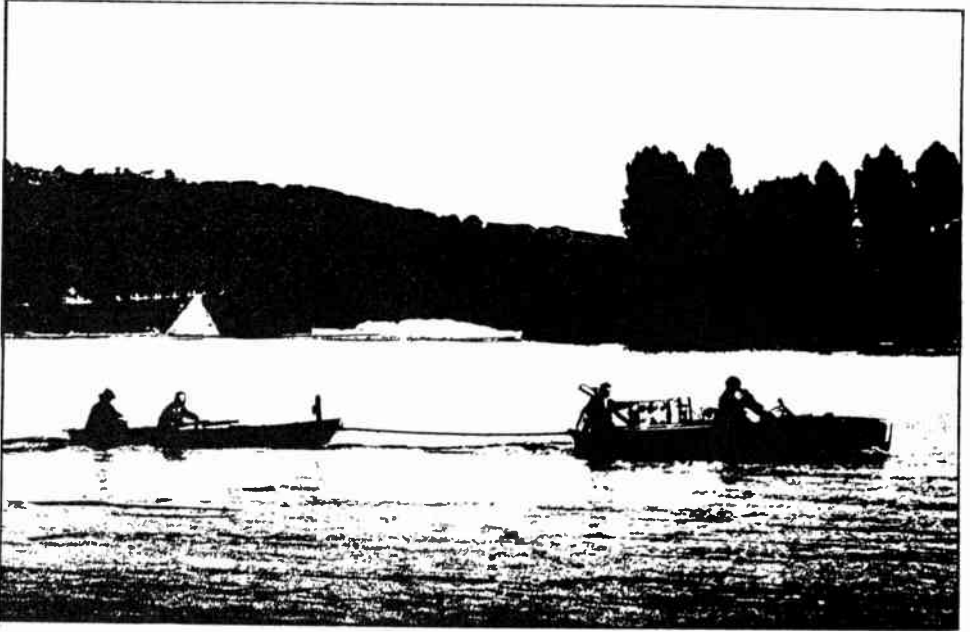

FIG. 1

A receiver was put in a motorboat and the motorboat towed a rowboat containing transmitter. Distances between the two boats were varied from one to 150 meters and received field strength measured. The results showed there was no surface radio wave, in the sense engineers have long assumed its existence

RADIO engineers have believed for a number of years that the radiation from a vertical antenna has a component which is guided by the earth as waves are guided by a pair of wires. Recent experiments and mathematical studies by the Laboratories indicate that this component, which has been called "the surface wave," is not present in ordinary radio transmission.

Some years ago, theoretical studies by Zenneck and Commerfeld suggested that a surface wave existed in radio transmission, and in spite of the fact that an independent theoretical study by Weyl gave quite different results from Sommerfeld's, the surface-wave concept came to be widely accepted because it gave a plausible explanation of the propagation of radio waves to great distances and around the curvature of the earth. Only since the development of ultra-short wave radio, however, has it been possible for Laboratories' engineers to perform a crucial

experiment which would settle the question as to which result was correct. The decision, which has since been confirmed theoretically by S. O. Rice, was found to be in favor of Weyl's formula, which does not contain any term corresponding to the surface wave.

### WATER ROUTE CHOSEN

If there were a surface wave of this type it would be most pronounced when transmitted over a good dielectric, the nearest practical approach to which is fresh water. Accordingly the first attempt was made over Budd Lake, New Jersey. The tests indicated that the water was so shallow that the transmission resembled that over land instead of over fresh water. An experiment over deep fresh water was therefore planned and was successfully performed at Seneca Lake.

There are two properties of the surface wave by which its presence should be observable: It



# GENEROUS FREE OFFER MARKS OUR THIRD ANNIVERSARY

## DeLuxe Superior GENEMETER

100 Kc to 100 Mc  
With Variable Audio

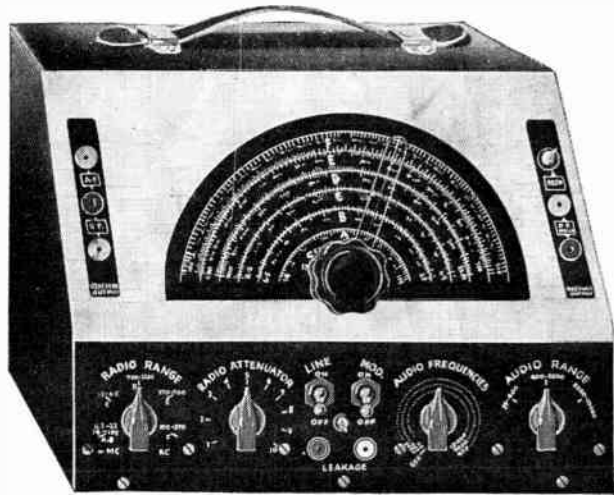

A Thing of Beauty and a Joy Forever Is Our New Genemeter, an All-Wave Signal Generator, with Variable Audio. Its Front Panel Slopes at the Pitch of a Cash Register. And Servicemen Equipped with Our New Instrument Will Ring the Bell Often and Every Time!

ALL the refinements that you would demand of a costly Signal Generator are embodied in our new GENEMETER. First in importance is accuracy. The GENEMETER has it— $\frac{1}{2}\%$  on intermediate and broadcast bands, 2% on short waves. Modulation must be present or absent by switching. It is. And, besides, the audio is variable. Direct reading in frequencies, it permits response measurements of amplifiers.

Beauty? The picture tells the story. Output meter? That is included, too. Even condenser and other leakage may be tested. All frequencies, radio and audio, are direct-reading. The large dial is 4-to-1 vernier, with costly planetary drive.

Outstanding is the word for GENEMETER.

### FEATURES:

1. Direct reading in frequencies, 100 kc —22 mc, in five bands, all fundamentals, by front-panel switching. Ultra band by harmonics to 105 mc, also direct-reading.
2. Direct reading in frequencies, 25—10,000 cycles, in three bands, all fundamentals, by front-panel switching.
3. R.F. and A.F. outputs independently obtainable alone, or with A.F. (any frequency) modulating R.F.
4. Output meter for connection across primary of receivers' output transformer for peaking with modulation "on."
5. R.F. is subject to attenuation, and oscillation leakage is minimum.
6. Condenser and other leakages tested, to 100 megohms.
7. Main dial protracted on  $7\frac{1}{2}$ " diameter, used full size, with precision pointer (no parallax), and 4-to-1 vernier planetary drive.
8. All services on 90-130 volts a.c. or d.c.

Shipping weight, 10 lbs.

# \$14.40

Complete with Four Tubes

## THIS BOOK FREE

WITH EACH ORDER FOR ANY PRODUCT  
ADVERTISED ON THIS PAGE

**S**OLENOIDS for all radio frequencies, from the fringe of the ultra highs, to the fringe of audio, may be wound, using popular wire sizes and form diameters, with no computation, yet at 1% accuracy. This is made possible by a series of quick-answer charts constituting "The Inductance Authority," by Edward M. Shiepe, plus an 18 x 20" supplement.

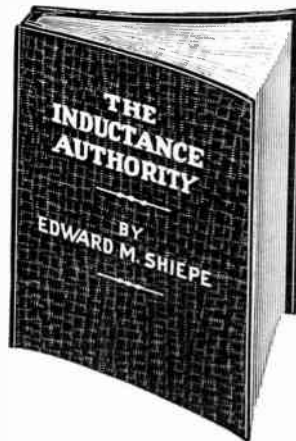

Winding solenoid coils for radio frequencies requires knowledge of the number of turns of any selected type of wire on any sensible diameter to attain an inductance suitable for the tuning condenser and lowest frequency. Hence, with capacity and frequency known, there are two unknowns: (1), the required inductance; (2), the number of turns to establish that inductance. The answers are obtained by consulting "The Inductance Authority," and the supplement. On the large supplement are

plotted the "curves of frequency, capacity and inductance in straight lines, so for a desired low frequency and known capacity the unknown inductance is solved by mere inspection. The number of turns for attainment of that inductance, for all popular tubing diameters and all generally used wire diameters and wire insulations, is read from the inductance-turns charts which are in the bound volume. Coil and set manufacturers, as well as home and shop experimenters, students and teachers freely use this book. The only book of its kind in the world.



## Dependable Tube Tester

The Superior Tube Tester  
Price is only.. **\$10.40**  
Shipping weight, 10 lbs.

### \* FEATURES \*

- ★ Tests all 4, 5, 6, 7s-7L and octal base tubes.
- ★ Tests all Diodes, Triodes, Pentodes and Tetrode receiving tubes, as well as many transmitting types.
- ★ Will check diode, triode and pentode sections of composite tubes separately.
- ★ Separate Neon Test for leakage or shorts between elements.
- ★ English reading meter, with "BAD-?-GOOD" scale.
- ★ Minimum number of adjustments, without impairing efficiency or accuracy of test.
- ★ Rugged, foolproof construction. Built for a lifetime of use.

ORDER DIRECT FROM

**SUPERIOR INSTRUMENTS COMPANY**  
DEPT. RW8 — 136 LIBERTY ST., NEW YORK, N. Y.

# The Year's Sensation

## ALLMETER

Marvelous Multi-Tester



Volt-Ohm-  
Ammeter  
PLUS  
A.C. Volts  
A.C. Currents  
Capacities  
Very Low Ohms  
**22**

Instruments in One

# \$10.40

1—A-C Currents, 15-150-750 ma. This extremely valuable service is practically never afforded by multi-test instruments. Instruments, 3.

2—A-C Volts, 15-150-750 volts. Affords also output meter service. Instruments, 3.

3—CAPACITY, .01-50 mfd., all condensers, including electrolytics. Instruments, 1.

4—5-1,000 Henries, coil loaded or not. Instruments, 1.

5—LOW ohms, .03-500 ohms. Extremely valuable. Instruments, 1.

6—HIGH ohms, to 0.5 meg., covering all practical values. Instruments, 1.

7—D-C Volts, 15-150-750 volts. Simplified scale uses same calibration as for a.c. Instruments, 3.

8—D-C Currents, 15-150-750 ma. The same scale simplification. Instruments, 3.

9—Decibels, -12 to +10, also foregoing plus 20. Instruments, 2.

10—Vacuum-tube voltmeter, 0-15-150-750 volts. Instruments, 3.

11—Short tester, including condensers. Instruments, 1.

1,000 ohms per volt, d'Arsonval movement, direct reading.

Send for our free Catalogue PV, in colors, describing our complete line.

(Continued from page 33)  
strength was determined as a function of the receiving antenna height. These experimental results are compared with theory in Fig. 4, which shows how the field strength varies with the height of the receiving antenna above the water, when separated 1,800 meters from the transmitter.

### ANOTHER CONFIRMATION

Curves 1 and 2 give values of the field strength which would be expected from transmitting an-

Again the evidence is against the existence of a surface wave. Indeed, the measured value of field strength actually decreased as the height of the receiving antenna decreased. The oscillations in the experimental points are presumably due to reflections from the cliffs and trees behind the receiving antenna.

### Basis of Calibration

Since we know definitely that no surface wave exists for transmission with horizontal antennas, measurements made with them may be used to

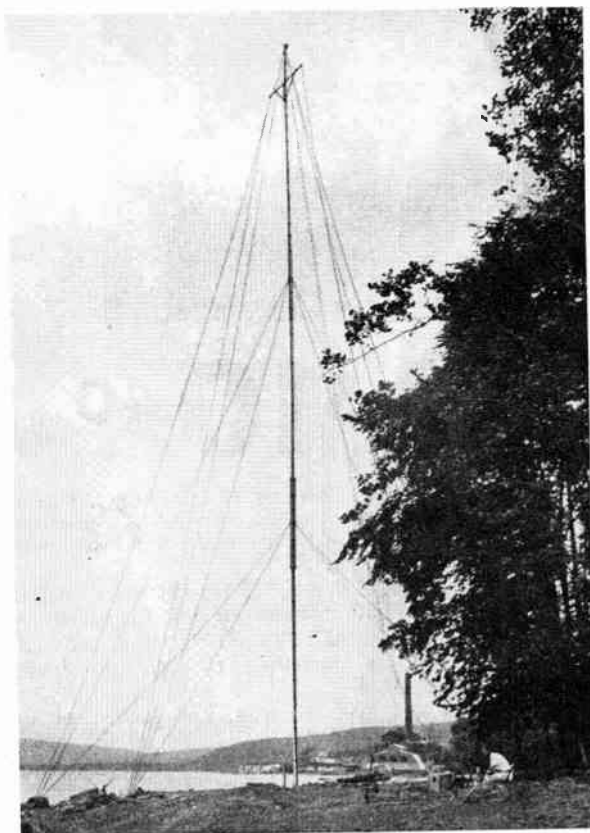

FIG. 3  
To determine the variation of the field strength with the height of the antenna above water, portable masts 25 meters high were erected on opposite sides of a lake. One mast, with suspended transmitting antennas, is shown. The two masts were 1,800 meters apart. Experimental results are compared with theory in Fig. 4, horizontal, and divide by 2.

tenna 2.5 and 24.8 meters above the water, if both transmitting and receiving antennas were vertical and assuming no surface wave was present. Curve 3 shows the variation of the field strength which calculations indicate would be received with a sending antenna 24.8 meters above the water if both antennas were horizontal. Curves 4 and 5 give the magnitude of Sommerfeld's surface wave for transmitting antennas at heights of 2.5 and 24.8 meters respectively. The two sets of open circles show experimental values for sending antennas 2.5 and 24.8 meters above the water and the solid circles represent data taken at an elevation of 24.8 meters when both antennas were horizontal.

calibrate the measuring equipment. This is done in Fig. 3 by fitting curve (3) to the solid circles. The position of all the other smooth curves is thus fixed and they show that the absolute magnitude of the received field strength is of the order of a hundredth of the value which would be expected from the formula which includes a surface wave.

Taken together with Rice's recent review of the work of Sommerfeld and Weyl, which has brought the two in agreement and established the fact that the prediction of a surface wave was due to a mathematical error, these tests prove conclusively that simple antennas do not

(Continued on following page)

would attenuate rapidly with height above the earth's surface, and it would not diminish in intensity as quickly with distance as an unguided wave. Calculations from the two conflicting formulas indicate that at a distance of one kilometer over Seneca Lake the received field strength, on a wavelength of two meters, should be forty-four db greater with a surface wave than without it, and that raising the receiving antenna twenty-five meters above the water would diminish the field three db with a sur-

poles on the shore a known distance apart; one at, the other near, the receiver. The angle between the line joining the two poles and the direction to the boat was also determined by means of the transit. The open circles shown in Fig. 2 represent a plot of the variation of relative field strength with distance from the transmitter as found in these experiments.

### WHAT THE CURVES SHOW

The smooth curves 1 and 2 shown in this

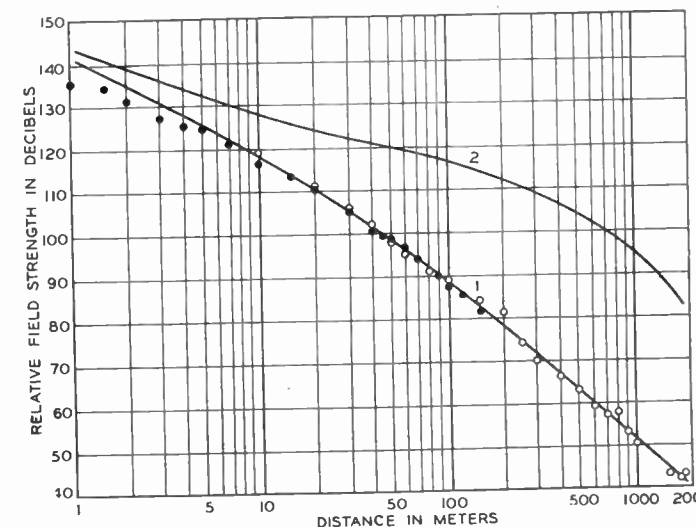

FIG. 2  
Experimental points show the actual field strength. They agree with Curve 1 which applies if there is no surface wave. Curve 2 gives calculated values of what the field strength would be if there were a surface wave

face wave, whereas this added antenna height would increase the field an amount equal to seventeen db if no surface wave were present.

### COPPER ROD ANTENNAS USED

To determine the variation of the field strength with distance from the transmitter the experimental arrangement shown by Fig. 1 was used. The receiver was installed in a small motor boat and the transmitter towed slowly behind in a row boat, at distances from one to 150 meters. The antennas consisted of two copper rods each ten inches long placed end to end and connected by a coil. The solid circles of Fig. 2 are a plot of the experimental data obtained in this manner.

For distances greater than 150 meters it was necessary to change the experimental procedure slightly. In this case the receiver was located at the end of a pier and the transmitter carried in the motor boat. This introduced additional difficulty in measuring the distance. To minimize the uncertainty in our knowledge of the distance it was measured by three independent methods. First, the motor boat was driven at a constant speed and in a fixed direction across the lake between two points a known distance apart. Second, the distance to a stadia rod erected on the motor boat was measured by a transit located on the receiving pier. And third, the distance was found by determining with a sextant the angle subtended at the boat by two

figure were calculated with the value of the dielectric constant determined from measurements of the temperature of the water and that of the conductivity as measured by L. A. Wooten of our Chemical Laboratories on sample of the lake water. Curve 1, which is plotted from Weyl's formula, is in agreement with the experimental data. As has been stated his formula contains no term corresponding to the surface wave. At distances less than five meters ( $2\frac{1}{2}$  wavelengths) the experimental points lie slightly below the theoretical curve and show a tendency toward oscillation. This is presumably due to the combined effect of the finite size of the antennas and their finite height above the water's surface.

These oscillations may be a vestige of the pronounced interference pattern that extends to greater distances with higher antennas. The experimental points lie far below curve 2, which is plotted from Sommerfeld's formula and includes the surface wave. This shows that no such surface wave was present.

### Portable Masts Used

To determine the variation of the field strength with the height of the antenna above the water, portable masts 25 meters high were erected at opposite sides of the lake, 1,800 meters apart. Fig. 3 shows the location of the transmitter. With vertical transmitting antennas located 2.5 and 24.8 meters above the water the field

(Continued on page 36)

# Literature Wanted

Readers whose names and addresses are printed herewith desire trade literature on parts and apparatus for use in radio construction. Readers desiring their names and addresses listed should send their request on postcard or in letter to Literature Editor, Radio World, 145 West Forty-fifth Street, New York, N. Y.

- J. A. Caldwell, Corning, Arkansas.
- Francis E. Andrew, Box 592, Louisiana State University, Baton Rouge, La.
- C. A. Doane, Jr., 166 S. 10th St., Marshfield, Oregon.
- Anselme Laperriere, 39 Chateauguay St., Quebec City, P. Q., Canada.
- Frank P. Govern, 304 Kishwaukee St., Rockford, Ill.
- Emanuel Romberg, 1470 Wilkins Ave., Bronx, N. Y.
- George Sangrik, 2498 W. 7th St., Cleveland, Ohio.
- Hudstow Engineering Co., 1735 14th St., N. W., Washington, D. C.
- American Equipment Co., 55 Yuen Ming Yuen Rd., Shanghai, China.
- Edmond J. Brown, Crumpler, N. C.
- Harold M. Morse, W97FZ, 1908 E. State St., Rockford, Ill.
- L. R. Burns, 904 E. 28th St., Kansas City, Mo.
- Percy Lemon, Tiffin, Ohio.
- Tom Elliott, Deer Lodge, Mont.
- C. W. Botsford, 411 Cherry St., Grand Rapids, Mich.
- Deller's Radio Service, 235 Mechanic St., Boonton, N. J.
- Godfrey Deuchler, No. 5, South Omaha, Nebr.
- L. Meisel, 266 W. Chemung Pl., Elmira, N. Y.
- Augustine Supka, 96 Brown St., Johnson City, N. Y.
- C. H. Rollins, 975 18th St., Marion, Iowa.
- William Dixon, 1035 W. C. Cross St., Baltimore, Md.
- Edward McGrath, 43 Dustin St., Brighton, Mass.

# Three New Tubes Out; Two Glass, One Metal

Three new tubes recently announced are: 6J5, Detector-Amplifier Triode. This all-metal type, except for its higher transconductance, is similar to the 6C5.

6U5, Electron-Ray Tube. This glass type, except for its tubular bulb, is similar to the 6G5.

25L6-G, Beam Power Amplifier. This glass type is similar to the 25L6.

The 6J5 tentative data, as supplied by RCA Radiotron Co., Inc., show low output capacitance and high transconductance:

Heater voltage (a.c. or d.c.)..... 6.3 Volts  
 Heater current ..... 0.3 Ampere  
 Direct interelectrode capacitance

(Approx.):\*  
 Grid to plate..... 3.4 Mmfd.  
 Grid to cathode..... 3.4 Mmfd.  
 Plate to cathode..... 3.6 Mmfd.  
 Maximum overall length..... 2 $\frac{5}{8}$ "  
 Maximum diameter..... 1 $\frac{1}{8}$ "

Base ..... Small wafer octal 6-pin  
 As Class A<sub>1</sub> amplifier:

Operating conditions and Characteristics:  
 Plate voltage..... 250 Max. Volts  
 Grid voltage..... -8 Volts  
 Plate current..... 9 Milliampere  
 Plate resistance..... 7,700 Ohms  
 Amplification factor..... 20  
 Transconductance ..... 2,600 Micromhos

\*With shell connected to cathode.

(Continued from preceding page)

generate a surface wave and that this time-honored concept must be given up, at least in the sense that radio engineers have customarily used it.

**FIG. 4**  
 Calculated and experimental values of the field strength for antennas at different heights above the level of the water and with the transmitter at a distance of 1800 meters. The circles show the experimental results

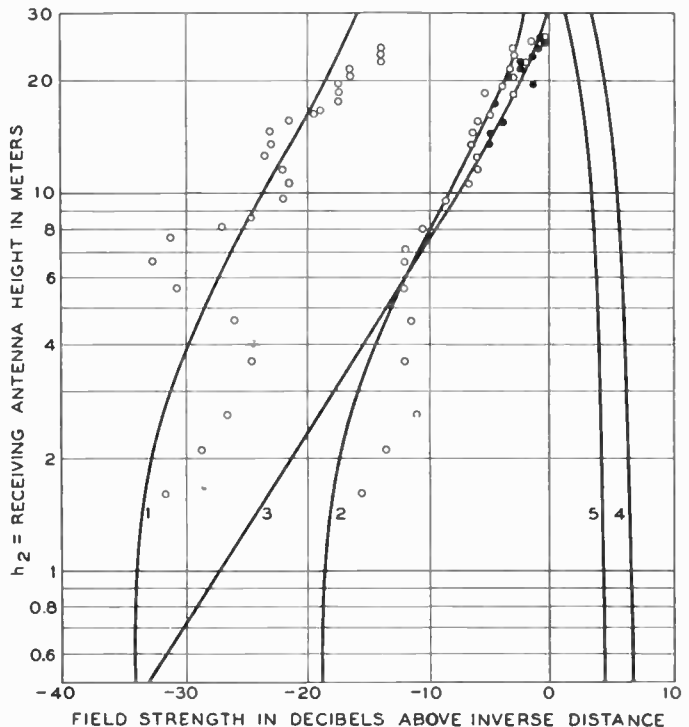

(Continued from preceding page)

a pair of double-shielded ratio arms, repeating coils for the oscillator and detector, and a set of six coaxial jacks by which the detector, oscillator, and the standard and test impedances are connected. These components are assembled on a seven by sixteen inch panel, and enclosed in an aluminum housing, which serves as a shield.

A photograph of this balance unit from the rear, with the covers removed from the double shielded ratio arms, is shown in Fig. 2. The ratio arms, each of 75 ohms, employ the

The double shielded repeating coils, which serve to isolate the bridge circuit electrostatically from the power source and the detector circuits, are scarcely less important than the ratio arms in their contribution to the satisfactory performance of the bridge. With an impedance ratio of one to one, they are designed and constructed with special care to insure a low value of intershield capacitance, and to minimize the capacitance between the elements separated by the ground shield.

**SYMMETRY IS HIGH**

As is partly evident in Fig. 2, a very high

**FIG. 1**  
Schematic diagram of the new high-frequency balance unit. It consists primarily of a pair of double-shielded ratio arms, repeating coils for the oscillator and detector, and a set of six coaxial jacks by which impedances are connected

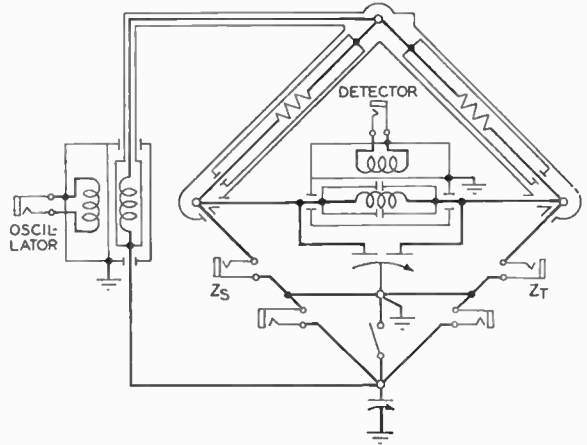

woven-wire\*\* resistor element, which is ideally suited for the purpose because of its very small distributed inductance and capacitance. They maintain their impedance balance or ratio to within one one-hundredth of one per cent for resistance and to a thousandth of a microhenry for inductance, over the entire frequency range from 10 to 5,000 kilocycles.

degree of symmetry is maintained throughout the balance unit in mechanical layout, in wiring, and in the disposition of the ground admittance of the elements. The electrical symmetry obviates many of the errors that are peculiar to high-frequency measurements.

Two impedance standards have been designed for use with the new balance unit. One is a six-dial resistance standard and the other an

\*\*Bell Laboratories Record, January, 1935, p. 136.

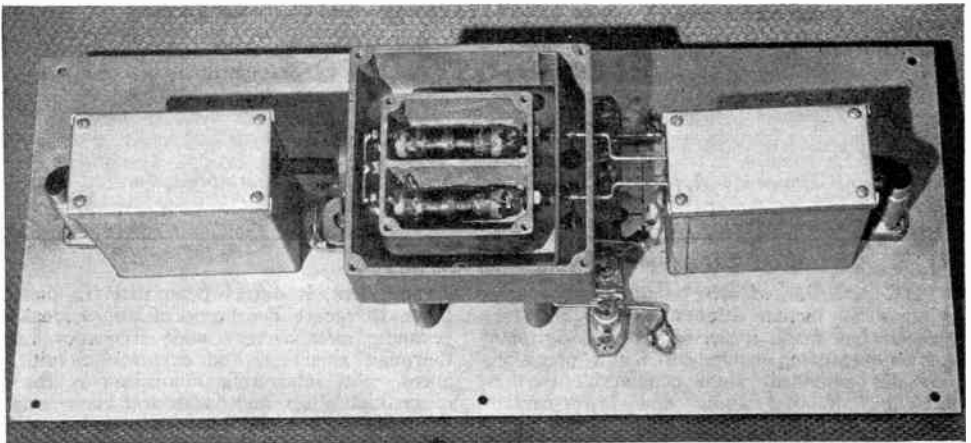

**FIG. 2**  
Thorough double-shielding and symmetrical arrangement are featured in the balance unit of the five-megacycle impedance bridge

# Literature Wanted

Readers whose names and addresses are printed herewith desire trade literature on parts and apparatus for use in radio construction. Readers desiring their names and addresses listed should send their request on postcard or in letter to Literature Editor, Radio World, 145 West Forty-fifth Street, New York, N. Y.

- J. A. Caldwell, Corning, Arkansas.
- Francis E. Andrew, Box 592, Louisiana State University, Baton Rouge, La.
- C. A. Doane, Jr., 166 S. 10th St., Marshfield, Oregon.
- Anselme Laperriere, 39 Chateauguay St., Quebec City, P. Q., Canada.
- Frank P. Govern, 304 Kishwaukee St., Rockford, Ill.
- Emanuel Romberg, 1470 Wilkins Ave., Bronx, N. Y.
- George Sangrik, 2498 W. 7th St., Cleveland, Ohio.
- Hudstow Engineering Co., 1735 14th St., N. W., Washington, D. C.
- American Equipment Co., 55 Yuen Ming Yuen Rd., Shanghai, China.
- Edmond J. Brown, Crumpler, N. C.
- Harold M. Morse, W97FZ, 1908 E. State St., Rockford, Ill.
- L. R. Burns, 904 E. 28th St., Kansas City, Mo.
- Percy Lemon, Tiffin, Ohio.
- Tom Elliott, Deer Lodge, Mont.
- C. W. Botsford, 411 Cherry St., Grand Rapids, Mich.
- Deller's Radio Service, 235 Mechanic St., Boonton, N. J.
- Godfrey Deuchler, No. 5, South Omaha, Nebr.
- L. Meisel, 266 W. Chemung Pl., Elmira, N. Y.
- Augustine Supka, 96 Brown St., Johnson City, N. Y.
- C. H. Rollins, 975 18th St., Marion, Iowa.
- William Dixon, 1035 W. C. Cross St., Baltimore, Md.
- Edward McGrath, 43 Dustin St., Brighton, Mass.

# Three New Tubes Out; Two Glass, One Metal

Three new tubes recently announced are:  
 6J5, Detector-Amplifier Triode. This all-metal type, except for its higher transconductance, is similar to the 6C5.

6U5, Electron-Ray Tube. This glass type, except for its tubular bulb, is similar to the 6G5.

25L6-G, Beam Power Amplifier. This glass type is similar to the 25L6.

The 6J5 tentative data, as supplied by RCA Radiotron Co., Inc., show low output capacitance and high transconductance:

Heater voltage (a.c. or d.c.)..... 6.3 Volts  
 Heater current ..... 0.3 Ampere  
 Direct interelectrode capacitances

(Approx.):\*  
 Grid to plate..... 3.4 Mmfd.  
 Grid to cathode..... 3.4 Mmfd.  
 Plate to cathode..... 3.6 Mmfd.  
 Maximum overall length..... 2 $\frac{5}{8}$ "  
 Maximum diameter..... 1 $\frac{1}{8}$ "  
 Base ..... Small wafer octal 6-pin

As Class A<sub>1</sub> amplifier:  
 Operating conditions and Characteristics:  
 Plate voltage..... 250 Max. Volts  
 Grid voltage..... -8 Volts  
 Plate current..... 9 Milliampères  
 Plate resistance..... 7,700 Ohms  
 Amplification factor..... 20  
 Transconductance ..... 2,600 Micromhos

\*With shell connected to cathode.

(Continued from preceding page)

generate a surface wave and that this time-honored concept must be given up, at least in the sense that radio engineers have customarily used it.

FIG. 4  
 Calculated and experimental values of the field strength for antennas at different heights above the level of the water and with the transmitter at a distance of 1800 meters. The circles show the experimental results

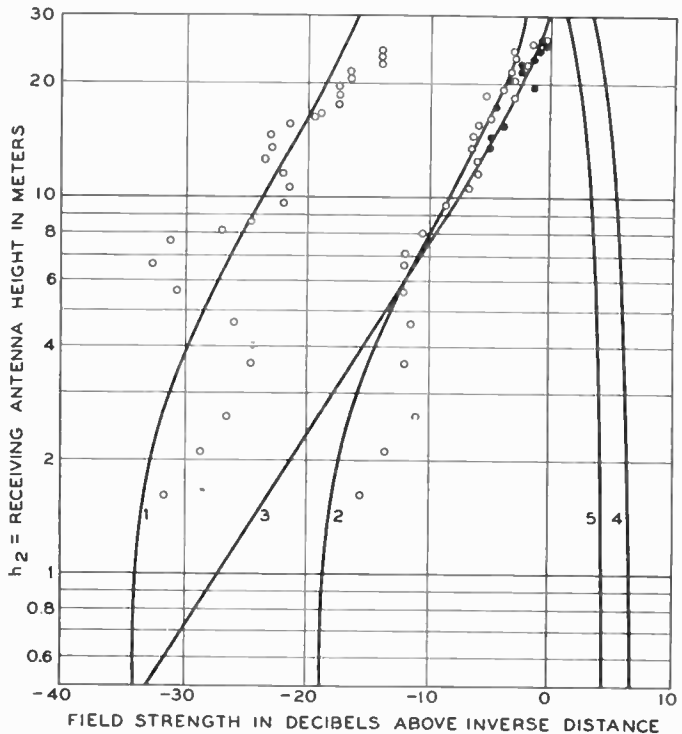

# PROJECTED TELEVISION BETTER

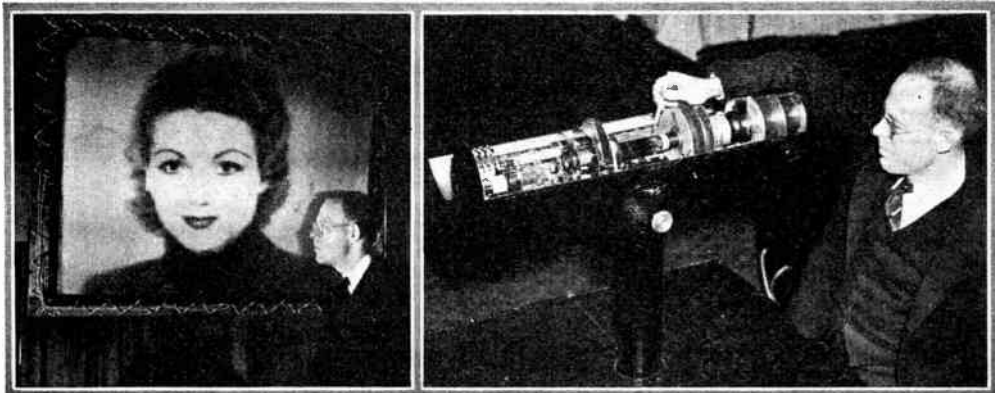

The latest thing in television is a clear, bright, large-sized projected picture, as at left. Compare it to size of the man's head. At right the same man, Dr. R. R. Law, of RCA Laboratories, designating electron gun that renders such projection possible

DAVID SARNOFF, president of Radio Corporation of America, and Grover Whalen, president of the 1939 New York World's Fair, signed an agreement whereby television will be given public demonstrations by the Radio Corporation of America and the National Broadcasting Company at the World's Fair.

Millions of visitors will be able to watch demonstrations of every aspect of radio and television. Mr. Sarnoff said:

"The progress we are making daily in the development of transmitting sight through space gives promise that by the time the World's Fair opens in 1939 television will be greatly advanced. Whatever its status may be at that time, we propose to demonstrate to the public at the World's Fair the workings and the possibilities of television.

"While the problems of developing a nationwide television system are enormous, we have faith in the future of this new radio art. Television is bound to have a profound influence on the lives of all of us. It will extend but not replace our present-day system of radio broadcasting."

One of the features of television two years hence is certain to be demonstration of projected pictures worth seeing—enough light, enough definition.

New television projection tubes capable of reproducing televised scenes brightly on a relatively large screen were described recently before the Institute of Radio Engineers by V. K. Zworykin, W. H. Painter and R. R. Law of the Radio Corporation of America's laboratories. Dr. Zworykin and Mr. Painter disclosed that present achievements with such tubes result from research directed to this end which has been carried on for years.

A demonstration was given by Dr. Law, using

the new tubes, which is about 18 inches in length and produces an image about  $1\frac{1}{2} \times 2\frac{1}{4}$  inches on its fluorescent screen. This is so brilliant that a simple optical system will project it on a large screen. A still picture projected 18 x 24 inches by this method compared favorably in brightness with home motion pictures. In the demonstration, a picture 3 x 4 feet in size was shown, which was bright enough to be seen by the gathering of 700 engineers.

The principal feature of the demonstrated device is a new type of "electron gun," developed by Dr. Law and associates. The gun is the structure in a television receiving tube which focuses flying electrons into an extremely slender beam. In projection it is necessary to start with a much smaller and brighter picture than in the case of a "Kinescope" which is viewed directly. Since the brightness is dependent on the current in the beam, the smaller picture requires a much larger beam current in a smaller "spot."

The television images shown were on the 441-line standard which RCA adopted some months ago for its practical field tests. Despite the enlargement, it was difficult if not impossible for the eye to detect line-scanning or other details by which illusion of direct vision was accomplished.

Although it is regarded in scientific circles as a distinct technical advance in RCA's television developments, engineering opinion is that Dr. Law's contribution could not at this stage be incorporated in home television receivers. The achievement is possible only under special conditions employing special laboratory equipment. The intense bombardment by the electrons from this gun has required research to produce a luminescent material to withstand it. This work continues.

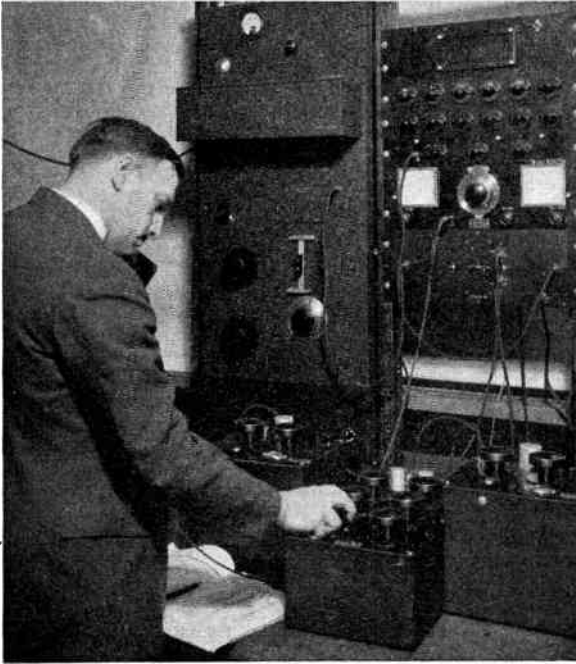

# A 5-Mc Impedance Bridge

## Difficult Grounding and Other Problems Solved

By C. H. Young

*Telephone Apparatus Development, Bell Telephone Laboratories, Inc.*

THE extension of wire communication systems to include higher and higher frequencies has made it necessary to design impedance-measuring equipment for a precision, over this extended range, comparable to that obtainable in the audio and lower-carrier ranges. For this purpose, the familiar alternating-current Wheatstone bridge\* was refined to meet the severe requirements imposed by the higher frequencies. While essentially the same as other a-c impedance bridges in circuit

arrangement, it differs from them in the care taken to secure constancy of all residual impedances over a very wide frequency range, thorough shielding, and accurate circuit balances. An interesting innovation is the use of coaxial plugs and jacks for connecting to the standard impedances, to the unknown impedance and to the oscillator and detector.

### THE BALANCE UNIT

The circuit for the new bridge is shown schematically in Fig. 1. It consists primarily of  
(Continued on following page)

\*Bell Laboratories Record, January, 1932, p. 179.

(Continued from preceding page)

a pair of double-shielded ratio arms, repeating coils for the oscillator and detector, and a set of six coaxial jacks by which the detector, oscillator, and the standard and test impedances are connected. These components are assembled on a seven by sixteen inch panel, and enclosed in an aluminum housing, which serves as a shield.

A photograph of this balance unit from the rear, with the covers removed from the double shielded ratio arms, is shown in Fig. 2. The ratio arms, each of 75 ohms, employ the

The double shielded repeating coils, which serve to isolate the bridge circuit electrostatically from the power source and the detector circuits, are scarcely less important than the ratio arms in their contribution to the satisfactory performance of the bridge. With an impedance ratio of one to one, they are designed and constructed with special care to insure a low value of intershield capacitance, and to minimize the capacitance between the elements separated by the ground shield.

### SYMMETRY IS HIGH

As is partly evident in Fig. 2, a very high

**FIG. 1**  
Schematic diagram of the new high-frequency balance unit. It consists primarily of a pair of double-shielded ratio arms, repeating coils for the oscillator and detector, and a set of six coaxial jacks by which impedances are connected

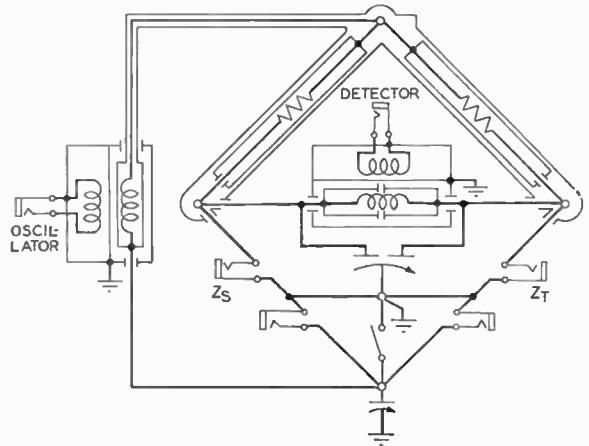

woven-wire\*\* resistor element, which is ideally suited for the purpose because of its very small distributed inductance and capacitance. They maintain their impedance balance or ratio to within one one-hundredth of one per cent for resistance and to a thousandth of a microhenry for inductance, over the entire frequency range from 10 to 5,000 kilocycles.

degree of symmetry is maintained throughout the balance unit in mechanical layout, in wiring, and in the disposition of the ground admittance of the elements. The electrical symmetry obviates many of the errors that are peculiar to high-frequency measurements.

Two impedance standards have been designed for use with the new balance unit. One is a six-dial resistance standard and the other an

\*\*Bell Laboratories Record, January, 1935, p. 136.

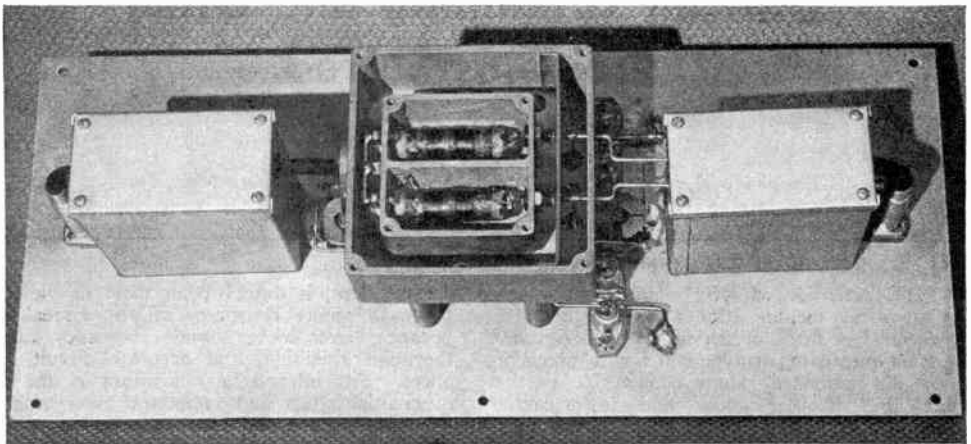

**FIG. 2**

Thorough double-shielding and symmetrical arrangement are featured in the balance unit of the five-megacycle impedance bridge



adjustable capacitance standard. Both are equipped with coaxial jacks to permit them to be readily connected to the balance unit in a series arrangement or in a parallel arrangement.

The resistance standard, Fig. 3, is similar to the six-dial rotor-decade already described in the *Record*.† The resistors are mounted in

the condenser unit to be accurately aligned with those of the rotor.

The larger dial has a click detent mechanism arranged to stop the rotor at 100 mmfd. intervals as the dial is turned. The detents are individually adjustable so that the resulting steps may be made to agree with the nominal value to within  $\pm 0.1$  mmfd. Settings are re-

FIG. 3

The resistance standard differs from others of the same type chiefly in the provision of coaxial jacks and in the care taken to reduce and equalize the inductance and capacitance of the individual units

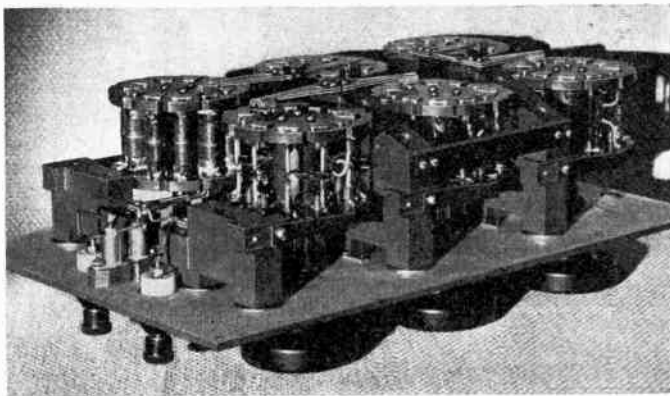

drums, which are rotated between fixed brushes so that only one resistor unit per decade is in the circuit at a time. The three larger decades employ resistors of the woven-wire type. In each of the three smaller decades, the resistor elements are made to have as nearly as possible identical inductance residuals, so that the total inductance of the bridge is maintained substantially constant for any setting.

### DATA ON CAPACITANCES

The capacitance standard has a rotor-decade of mica condensers with step values of 1,000 micro-microfarads and a special two-dial air condenser. One of the component air condensers has step values of 100 mmfd and the other is continuously variable over a range of 110 mmfd. The mica condenser is similar to the resistance decades in inserting only one unit in the circuit at a time. This arrangement not only minimizes stray internal capacitances, but keeps the series inductance of the leads and wiring to a small constant value which may be compensated by adding an equal inductance in the opposite arm of the bridge. The complete capacitance standard removed from its case is shown in Fig. 4, where the mica decade is at the left.

The air condenser unit, which is of exceptionally rugged design, has a single stator that is common to two rotors. Self-adjusting bearings are used on the rotors to compensate for wear and also to assure a low electrical contact resistance in the connections to the rotors. The stator is supported on three ceramic spheres, which minimize leakage by providing what are essentially point contacts with the frame, and which permit the stator plates of

produced to within  $\pm 0.03$  mmfd. The continuously variable dial, at the right of Fig. 4, carries an engine-engraved scale with a vernier that allows direct reading to within 0.1 mmfd.

Although there is no need for observations of the condenser to better than .1 mmfd., it is essential when measuring high impedances having a large ratio of reactance to resistance to be able to adjust the condenser with much greater precision. For this purpose a slow motion device operating on the main dial of the condenser has been provided which permits easy adjustment to within .002 mmfd. Rapid preliminary adjustment to within 1 mmfd. may be made by means of the large knob on the condenser shaft in the usual manner, and as smoothly as though the slow motion device were absent.

### COAXIAL CORDS USED

A novel feature of the bridge is the use of equal-length coaxial cords for connecting the standard and unknown impedances to the balance unit. In addition a small terminal unit, fitted with coaxial jacks, is plugged to the extremity of the leads for the test impedance to balance the residual impedances of the standards. In this way the symmetry of the bridge network is extended to the unknown impedance, and the uncertainty and the inconvenience of corrections due to the use of random leads are avoided. Moreover, since the potential drop in the sheath conductor of the coaxial leads is practically nil, the shields of the standards and of the unknown impedance are brought to the same potential as that of the bridge ground.

The balance unit is arranged for both grounded and balanced-to-ground measure-

(Continued on following page)

†Bell Laboratories Record, January, 1935, p. 136.

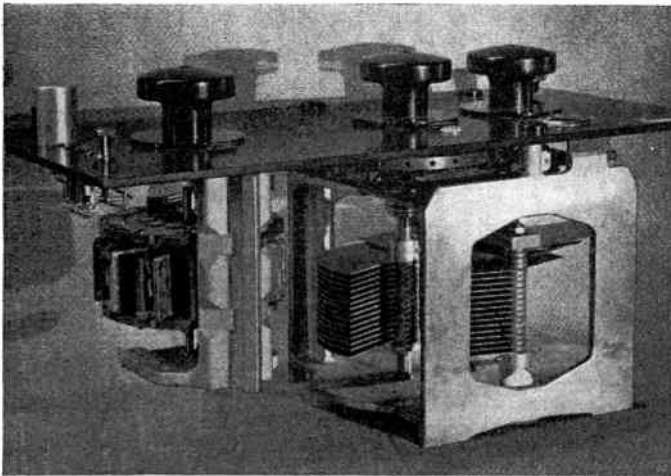

**FIG. 4**  
The capacitance standard is ruggedly constructed to insure precise setting

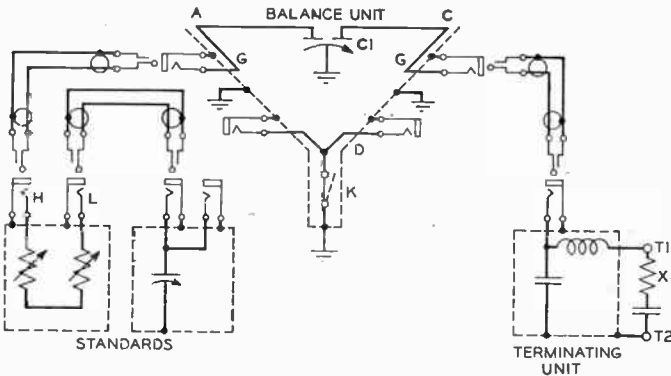

**FIG. 5**  
Schematic for a grounded measurement

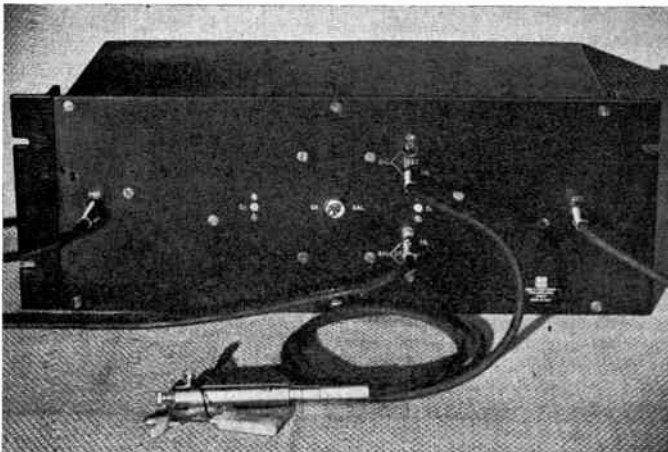

**FIG. 6**  
The terminating unit is in the form of a small cylinder with binding posts to which the unknown is attached

*(Continued from preceding page)*

ments; the switch just above the bottom corner of the bridge in Fig. 1 is closed for grounded measurements and left open for balanced-to-ground measurements. For grounded measurements only the upper of the two jacks on each side and a single cord are used to connect the bridge to the standards and to the unknown. Such an arrangement is shown schematically in Fig. 5. A photograph of such a set-up is given in Fig. 6. For balanced-to-ground measurements two cords are used from each side of the balance unit, and the standards used, although similar to those used for grounded measurements, have elements that are symmetrical with respect to ground.

A complete set-up for a high-frequency measurement is shown in the photograph at the head of this article. In the bay at the left is a precision type oscillator already described in the *Record*. The balance unit is the lower panel of the right hand bay and above it is the detector. The capacitance and resistance standards are in the right foreground. A second capacitance standard is shown being calibrated.

The impedance range of this equipment is limited, of course, by the standards rather than by the balance unit. With the standards described above, the widest range is obtained with the parallel connection, where capacitances from practically zero up to .01 mfd., with a wide range of power factor, may be measured. Inductances that can be resonated within this capacitance range may be measured also, provided the detector has adequate dis-

*(Continued on next page)*

# Inverse Feedback in Prose

## How It Works and How Far You Can Go

By Captain Peter V. O'Rourke

**I**NVERSE feedback may be used where the quality of the sound reproduced is more important than the quantity of the sound, or where at extra expense the reduced gain is compensated, so that the total quantity of sound is the same as before, but the distortion is less.

To achieve inverse audio feedback either of two methods may be followed. One consists of omitting the bypass condenser from the self-biasing resistor of the output tube. The same method may be followed for more than one stage, omitting the bypass condensers from all.

Both methods do the following:

1. Reduce distortion due to curvature of the plate characteristic.
2. Render amplifier gain practically independent of terminal voltages.

Besides the common effects there are the following individual aspects:

1. Separate external feedback method lowers plate resistance and permits practical independence of frequency because of stabilizing the load characteristic.
2. Unbypassed resistor method increases

**FIG. 1.**  
A push-pull beam power amplifier, with some reversed feedback, also cathode feed. The quality is particularly good. The two cathode returns should go to B minus.

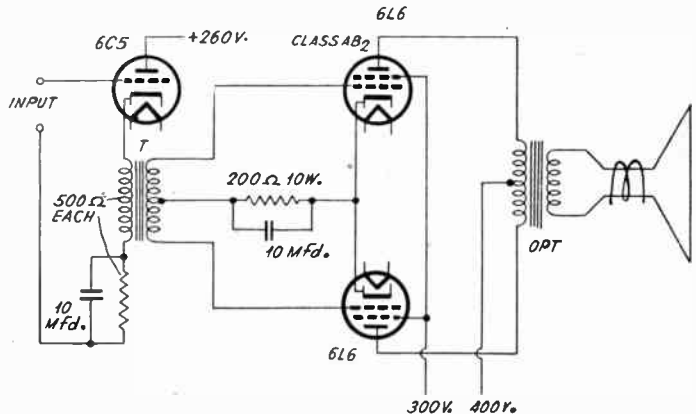

While this way provides utmost economy—since it permits using fewer parts than otherwise—it may have its attractions, but it does not go so far as does the other method. If some of the signal voltage is actually taken from the plate circuit and fed back to the grid circuit in reverse phase, then we have a better result.

### THEIR INDIVIDUALISM AND COMMONNESS

The omitted-bypass-condenser method increases the plate resistance, so speaker responses due to voice-coil transients may be serious. The segregated or external feedback method lowers the plate resistance, flattens out the idiosyncrasies of the voice coil and permits better application of design factors, although requiring cautious hum filtration.

plate resistance and is not independent of frequency because the load characteristic is not stabilized.

There are numerous factors concerning the output stage of a receiver, and the amplifier feeding it, that have to be considered, so much so that there is no single inclusive criterion for rating them. Expression of gain in decibels tells only one fact. The power output has to be given, and the percentage distortion. Besides, the frequency characteristic is required, as an amplifier is concerned, so we finally have to read a chart or curve, in addition to the rest, so complex is the consideration.

However, the general sense of inverse feedback may be fully appreciated, and the method applied for the reduction of distortion, hum and reactive response, using only an audio oscillator and an output measuring device.

### THE LEVELLING EFFECT

But first there has to be an explanation of how the gain is reduced and the power output capabilities are increased.

*(Continued on following page)*

*(Continued from preceding page)*  
crimination against harmonics originating in the power source. An inductive standard of suitable range may be substituted for the capacitance where it is undesirable to employ resonance methods.

(Continued from preceding page)

The gain is the increase of voltage per stage, or for the whole amplifier, for the total number of stages. The amplifier as constituted has a given power output. Now, if by inverse feedback the gain is reduced, the distortion is reduced, because inverse feedback functions as a levelling effect, a sort of governor.

If there are resonances in the system, and the voltage tends to rise greatly, the inverse feedback rises proportionately, and therefore, since

response is flatter, as the inverse feedback is increased. The temptation might be to increase it to 100 per cent, but then the amplifier would be all quality and no gain. Therefore we must face the law of diminishing returns.

### FEEDBACK MAY TURN POSITIVE

If the inverse feedback is made rather higher than the largest value above recommended, there is danger of positive feedback, due to phase shifts in high-gain systems. In the simple ex-

FIG. 2

Single-ended output stage has a driver, and the feedback loop is between them, consisting of the signal voltage in the plate circuit being fed back through R4C3 to the cathode circuit of the driver, the quantity of feedback variable. An adjustment, once made, need not be disturbed. R1 plus R2 is equal to the usual value of the biasing resistor.

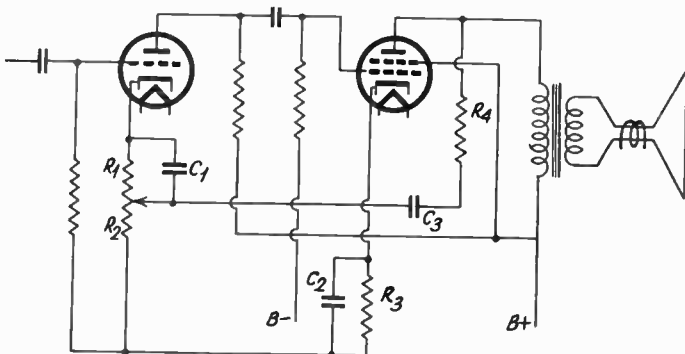

it bucks the gain, it stabilizes the amplifier. Naturally the total quantity of sound output will not be so large, since there has been a sacrifice of gain due to inverse feedback, but the power handling capability of the output stage has been increased. That means the output stage could be made to do more work on a loudspeaker with the same applied voltages as before, at far less distortion, by introducing compensating gain. The biasing is the same value either way.

Therefore inverse feedback has its compelling advantages, and the question to decide is: How much inverse feedback should be introduced? About 10 per cent is a pretty good average. Up to 20 per cent may be introduced without serious difficulty. The distortion is less, and the

ample of a single tube with bypass condenser omitted from self-biasing resistor in the cathode leg, no positive feedback could arise. None would be present if the simple external feedback circuit were used. But, with two-stage and other amplifiers subject to the remedial application, positive feedback perils are real, and motorboating may result. If n is a ratio equaling the sum of two feedback resistors divided by one of them, then for gain G, one should make nG as high as possible to have the circuit O. K. This would tempt one to have a two-stage system. This has its advantages because there is no need for the feedback resistance values being additional. They are right in the receiver. Advantage is seized of the fact that the tube reverses the phase 180 degrees, there-

FIG. 3.

A push-pull stage, with values given, where besides the feedback loop for each side, there are connections for the rectifier and filter, so that maximum B voltage is applied to the plate, and a somewhat lower voltage to the screen, where two equal chokes have a round 150 ohms d-c resistance (200 ma).

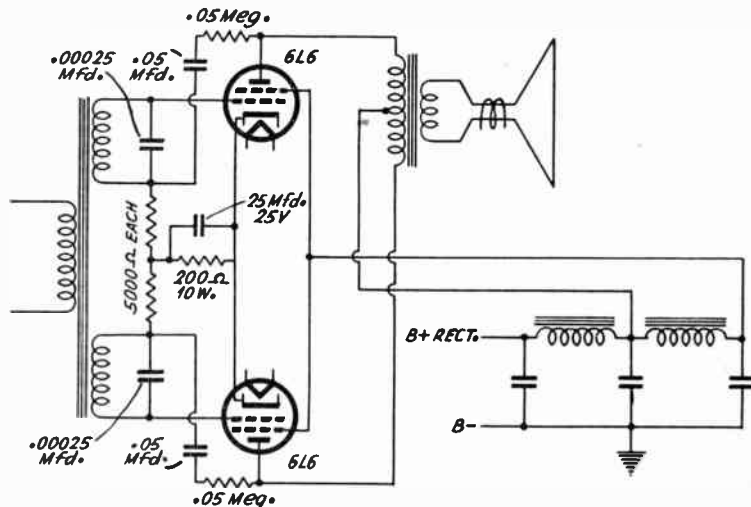

fore two successive plate circuits in a cascade are of the right phases for inverse feedback.

We have found out, therefore, that inverse feedback reduces gain and distortion in exactly the same proportion. Inferentially we have found out that the gain may be compensated by extra amplification purposely introduced, and still the reduction in distortion survives, although gain now is not reduced but may be actually increased. Approximately, if  $G$  is the gain and  $S$  is the inverse feedback, then the distortion is reduced to  $1 \div SG$ . Hence  $S$  and  $G$  are made as large as practical, so the distortion will be small.

### APPLIED TO DRIVER

Negative feedback may be applied to the driver stage to reduce distortion there, especially for driving Class  $AB_2$  output. The transformer primary is put in the cathode leg and not bypassed. Resistance is 500 ohms. Also an external resistor in the cathode leg is 500 ohms. So the total biasing resistance is 1,000 ohms, half bypassed, half not bypassed (negative feedback). Negative and inverse mean the same thing in this respect.

The transformer ratio is about 1-to-1. Since this type of amplifier is degenerative, the signal input to the driver grid circuit is necessarily much larger than when the interstage transformer is connected in the plate circuit. Nevertheless, the low inherent distortion and low output impedance contributes to marked improvement in performance. The circuit is shown in Fig. 1.

### NOT A CURE-ALL

It is believed by many that if there is any

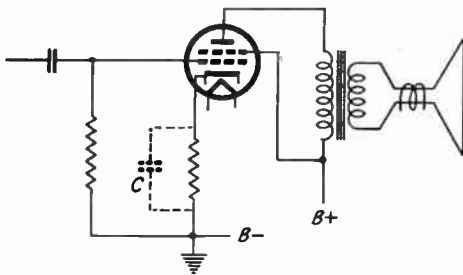

FIG. 4.

ahead of the feedback stage, that distortion also remains. Inverse feedback is not a cure-all. What it does is to prevent the generation of distortion by the amplifier itself under certain conditions, and it does this to a notable degree.

No matter that sensitivity is sacrificed. It can be atoned for. Tubes are cheap and if worked distortionlessly they can bring the amplitude up to a higher level than it was before, with even less distortion than there was before, if the inverse feedback remedy is applied.

### IT IS WORTH WHILE

Therefore, the idea should be firmly grasped that tubes of themselves have a non-linear operating characteristic, and that loads have resonances, so that trouble is in store, unless remedy is applied, and for these particular ailments, but not for any and all ailments, inverse feedback is a worthwhile and much-sought remedy.

In Fig. 1 the values for feedback were given, as the tubes were cited, and other conditions known. Returns are deemed grounded. For Fig. 2 no particular additional data are needed. For Fig. 3, however, if  $R_2$  is large enough not to dissipate much power, then  $C_1$  would be correspondingly small, values of .035 mfd. and 3,500 ohms being suitable for a tube with 7,000 ohms plate resistance.

### TRIODE CASES

In general, not much is gained by introducing inverse feedback in output tube circuits where the tubes have a low amplification constant, meaning that triodes are used. These have a better plate characteristic than most pentodes. The tone is said to be better. There is a slang phrase for it, "a good toner." It should be

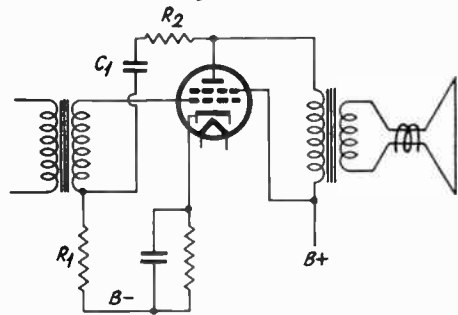

FIG. 5.

The inverse feedback method that is simplest and least expensive, in fact costs less to include than exclude, is that of omitting the bypass condenser  $C$  from the biasing resistor, in Fig. 4. Transformer coupling is needed for use of the better method, whereby some of the output voltage is fed back to the input.  $C_1 R_2$  is the feedback to  $R_1$  in Fig. 5.

distortion in the amplifier that the inverse feedback method will get rid of it, but this is not true. The distortion that is introduced into the amplifier as part of the input stays there. If the distortion originates in the amplifier, but

noticed that the gain tends to go down toward that of the triode level, when the pentode is fed back in reverse, although the net result usually is greater power efficiency and greater undistorted power output.

# Television Seeks Distribution

ONE of the many problems of television is how to distribute a program over a wide area. So expensive would a worthwhile television program be, that to assume it could be sustained by a local audience or vice versa is considered almost irrational. Therefore means of distribution are being considered. One is short-wave relays, the other coaxial cables. Against both there is at present much valid argument. The cables do not exist, except for short distances, and are so expensive that the very thought of covering the United States with them would stagger even a movie producer's imagination. The radio relay system for television network service is non-existent, and besides there is no known method of making it work for such magnitude, exactitude and quality as demanded by television. So, from the broad viewpoint, there is no known scientific method of disseminating radio programs over a coast-to-coast television network, and no known method of obtaining programs of satisfactory variety and quality unless a nationwide audience could be obtained, to make television attractive to sponsors. The technical developers of television have gone almost as far as they can with financial expenditures, and would like to see some revenue source before starting to budget more and more millions for the fascinating but punishing game.

Coaxial cable has been laid between New York City and Philadelphia, and has proved successful in the field, almost as laboratory results predicted. A recent advance in this line of work has been the insulation between the center wire and the outer shell. This is in the form of slotted discs of hard rubber, an improved compound developed by Chemical Research Laboratories.

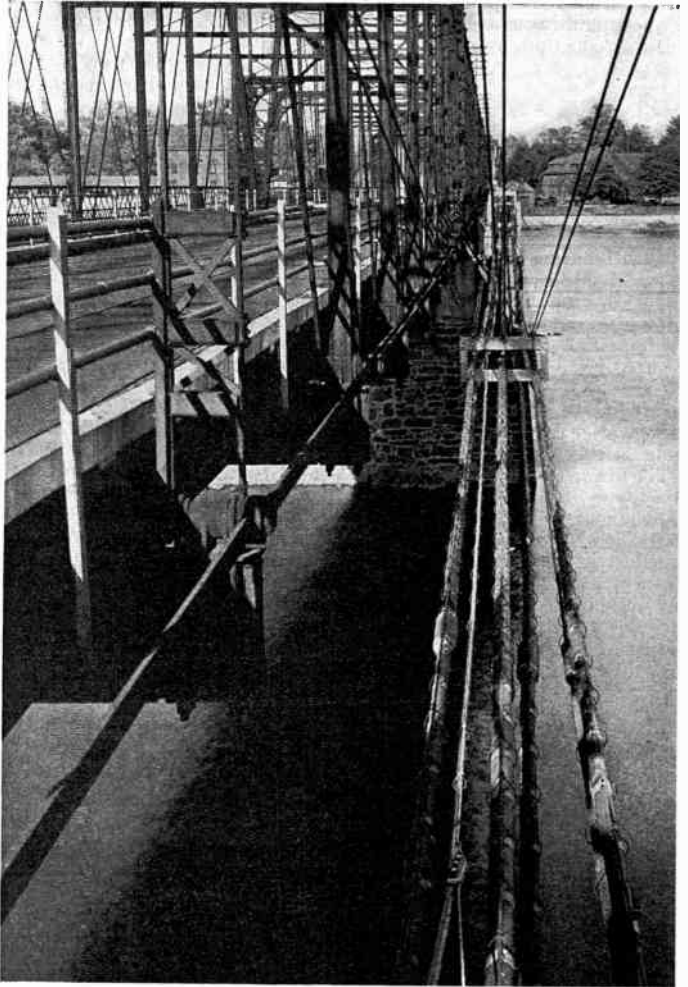

Fourth from right crossing the Delaware River, Camden to Philadelphia, is the coaxial cable.

## The Two Acorn Devices

There are two acorn-shaped devices in radio. One is the acorn tube, a small valve for high and ultra frequencies. The other is the Malloy grid bias cell.

The tube requires a special socket and contacts of high conductivity. It may be a triode or a pentode, even with remote cutoff characteristic.

The bias cell has a one-volt no-current potential of 10 per cent. accuracy. It is used for biasing and should not be in any circuit where the current flow exceeds one microampere.

# Multi-Purpose Meter With Simplest Switching Circuit

By Percy Warren

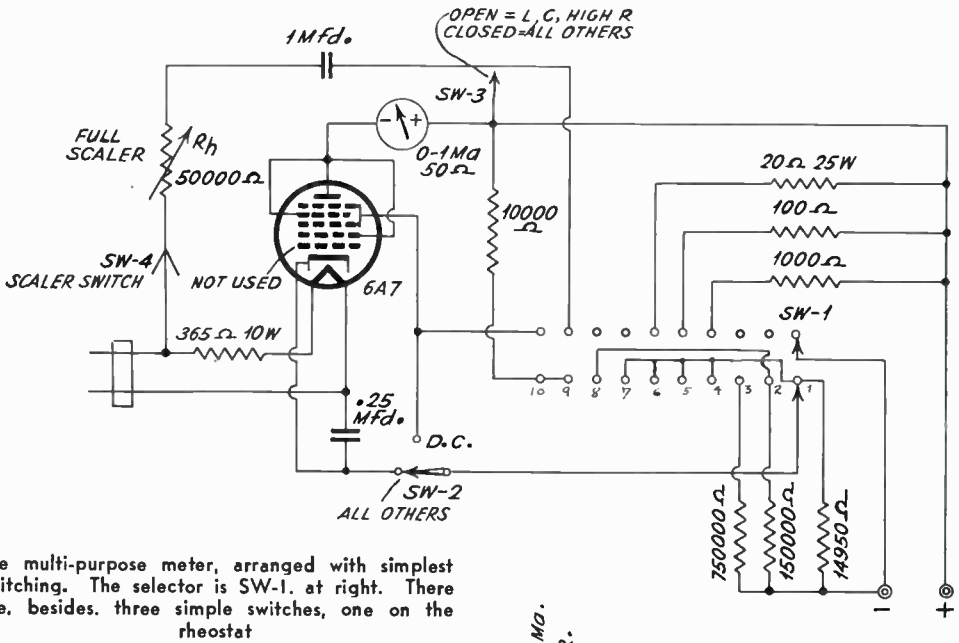

The multi-purpose meter, arranged with simplest switching. The selector is SW-1, at right. There are, besides, three simple switches, one on the rheostat

REDUCED commercially to the very simplest imaginable circuit, an instrument based on a 0-1 milliammeter and a rectifier tube provides, at the same two outlets, the following services:

- 1, 2, 3, 0-15-150-750 volts d.c.
- 4, 5, 6, 0-15-150-750 ma d. c.
- 7, 8, 9, 0-15-150-750 volts a. c.
- 10, 11, 12, 0-15-150-750 ma a. c.
- 13, 14, 0-500-500,000 ohms.
- 15, 0-1 milliampere, d. c.
- 16, Continuity and short tests.
- 17, 18, -12, +10 db; +8, +30 db.
- 19, 5-1,000 henries.
- 20, .002-50 mfd.

The selector switch consists of two decks, ten positions to each deck, and there are three small auxiliary switches. The selector and a rheostat are the two main controls, and on the rheostat is the line switch, not to turn off the heater of the tube rectifier, but to remove the a. c. from the impedance-measuring circuit.

### SAME SCALES REPEATED

Of the minor switches, another is a single-pole, double-throw switch for shifting from a-c

LOW R, 0-1 MA.  
L, C, HIGH R.  
DB { +10, +32  
-10, +12  
AC-DC { 0-750  
0-150  
MA.  
AC-DC { 0-750  
0-150  
VOLTS

to d-c measurements. That is, the rectifier is included at one position (a. c.) and excluded at the other (d. c.) Naturally, at the d-c position only d-c measurements are made. All a-c measurements require the rectifier, but so do all impedance measurements, because the rectifier is then put across the modified line, to supply the potentials for capacity, inductance and resistance measurements, and for sort tests, in fact, continuity checking generally.

### SPECIAL RECTIFIER METHOD

It is interesting to note that the same d-c scale is used for the a-c ranges, and that the a-c is substantially nonreactive to 10 megacycles, as no phasing condensers are used. Also, the current drain on the vacuum-tube voltmeter measurements is not serious.

(Continued on following page)

(Continued from preceding page)

The tube voltmeter service therefore is at a 1 ma sensitivity. Moreover, the position for a-c volts is the same for commercial frequencies as it is for radio frequencies, so line voltage is measured just as well as higher frequencies of alternating current.

Although the peaks influence the voltmeter, the calibration may be in any terms. The more usual value of the a-c cycle is the r-m-s voltage. It has been said that the same d-c scale is used for a. c. The r-m-s value is .707 of the peak, and it is only necessary to limit the current constantly by .3, which may be done in the rectifier. This is accomplished by leaving the first grid of the 6A7 rectifier unconnected, as otherwise there would be no object in using such a tube as rectifier.

### THE DECIBEL RANGES

The 0-15-150-750 positions on the selector switch are the same for a. c. or d. c. volts of this series, also as to currents, three other positions are used, common for a. c. and d. c., thus using up six positions. As two of the a-c ranges are for the decibel calibration, a span of 42 db, eight positions are used, leaving two. One of the remaining stops is for high resistance, capacity and inductance. The other is for low resistance and 0-1 milliamperes d. c.

The method of measuring current, although introducing some resistance in the process, was adopted for economy and current simplicity. Three resistors are shunted across the input, one at a time. When current of 15 milliamperes is to be determined, full-scale, the resistor across the input is 1,000 ohms, so the 0-15 scale is read, since the resultant full-scale voltage drop is 15 volts. For the 150 milliamperes range the resistor is one-tenth as much, or 100 ohms, while for the highest current range the resistor is only 20 ohms, but of heavy wattage. Even considering the wattage, which is unimportant because applying seriously only to the highest-current range, which is very seldom used, the system works out excellently, in line with the requirements of the instrument as to performance and price.



The instrument as made commercially and known as the Allmeter.

Both a-c and d-c currents are measured by this method.

### THE IMPEDANCE MEASUREMENTS

The ohmmeter service is standard for the medium-high range, to 500,000 ohms, except that a.c. is passed through the unknown instead of d.c. This was done because the a.c. was needed for measuring other constants at 60 cycles, the frequency for which the reactive unknowns—capacities and henries—were measured or computed. It is not the frequencies of the unknown voltages that are concerned at all, as these measurements have already been explained as nonreactive.

The measurements of the reactive components are made by interrupting a series circuit with the unknown. This series circuit meets the line at each side through a condenser, so there is no d-c continuity. This is of great importance for inductance measurements, because the inductance depends on several factors, one of them the quantity of d.c. (if any) flowing through the unknown coil. Often this coil is a speaker field and is in a receiver. The measurement should be practical (a) with the receiver shut off, and coil alone tested; (b) with the receiver in operation, antenna-ground shorted, so that the speaker field is measured on load. With direct current through the winding the inductance measures much less.

### THE INDUCTANCE METHOD

Often a measurement is made of a center-tapped device, like a high-voltage secondary of a power transformer, and the inductance between extremes, meaning full turns, shows up about five times as great as that through half the number of turns. That is correct, as in theory the inductance should be four times as great, but the d-c resistance more greatly affects half the winding, and there is absorption.

Hence coils, 5 to 1,000 henries, may be measured, loaded or unloaded with d-c. Above 10 henries the accuracy is very good, because the d-c resistance of the winding then is of negligible effect.

The d-c resistance scale, 500-500,000 ohms, is treated as inductive reactance, and converted to henries. Since the inductive reactance of one henry is  $6.28 \times f$ , or 376.8 ohms for 60 cycles, and for correspondingly higher values of henries is equal to  $R \div 376.8$ , readings for 1,000 henries are easy, since 376,800 ohms are well within the range of the ohms scale used for this purpose.

### STANDARDS OF CAPACITY

The capacities were obtained by using precision standards in series with the circuit after full-scale deflection had been obtained. The 50,000-ohm rheostat enabled the full-scale adjustment. The range was .002-50 mfd, with good spreadover the values commonly used, and crowding above 10 mfd.

The decibel scale is based on voltage because the 0-15-volt a-c range is considered, and 4.75 volts used as the zero level. The object is to



## 0-15-Volt A-C Scale Expressed in Decibels

The decibel application to the 0-15-volt a-c range is based on 0 db = 4.75 volt. This was selected because the arithmetic center of the scale is not the logarithmic center, but 4.75 is close enough to the log center. The 1% accurate values are compared on the table:

+ DB	Volts	- DB	Volts
1.....	5.33	1.....	4.27
2.....	6.	2.....	3.8
3.....	6.75	3.....	3.37
4.....	7.5	4.....	3.
5.....	8.4	5.....	2.66
6.....	9.2	6.....	2.37
7.....	10.9	7.....	2.11
8.....	12.	8.....	1.9
9.....	13.1	9.....	1.67
10.....	15.	10.....	1.5
		11.....	1.33
		12.....	1.17

These are comparisons of voltage and decibels. For the next range of the a-c meter, 0-150 volts, add 20 to the db shown above, level remaining 4.75 volts.

Just as in the case of a voltmeter, the decibel meter repeats part of the preceding range, as 0-150 volts includes 0-15 volts of the lower range, for instance +8 db may be read on the +20 db scale as +20-12 db, but, as usual, the low values are preferably read on the low scale, where crowding is avoided.

Decibels applied to power ratios equal one-half the decibel change shown for voltage, though the ratios themselves are equal. For example, volts are 4.75 and 12, ratio up is  $12 \div 4.75 = 2.527 = 8$  db up: For power = 4.75 and 12 watts, ratio up is  $(12 \div 4.75) \div 2 = 4$  db.

enable measurements in any a-c systems that develop enough voltage and voltage change to permit them. For instance, the potential, if exceeding 0 zero db. on the minus 12 to plus 10 db. range may be adjusted until the reading is zero, by using the control on the circuit being measured. This is convenient but not vital. Then changes are read directly in db. and only then may different sets be compared. If gain is being measured, 10 db up may soon be exceeded, and then the selector switch is turned to "plus 20 db." This means the same d.b. scale as before is read, but 20 db is added. Suppose the previous reading was up 8 db. On the new scale it is minus 4 db. We have been instructed to add 20 for the second d.b. range, so  $20 - 4 = 16$  db, hence reading is 16 db up. Decibels may be added and subtracted. They represent logarithmic ratio changes.

Low resistance readings are obtained by shunting the meter, therefore instead of putting

resistance across the meter, the line cord is pulled out of the convenience outlet, and the meter used in series with an unknown to measure current, 0-1 milliamperes. However, there is no 0-1 scale, as no room exists on the meter to include it, so for any such special measurements, the 0-15 scale is read. Subtract one-third from the reading, and multiply by 100, to get an answer in microamperes. Thus, reading is 15, one-third is 5, so  $15 - 5 = 10$ , and multiply 10 by 100 to get 1,000 microamperes. Another example: Reading is 2.6, take one-third, or .83 away, equals 1.77, and multiply by 100, equals 177 microamperes.

The low-resistance setting, used normally, with a-c applied, meaning the plug is in the socket and the rheostat switch is turned on, is useful for continuity testing and also for determining shorted condensers, because the reading for a short is zero. This particular reading, for low resistance, continuity and shorts, requires that the needle be adjusted for full-scale deflection, and left thus, the unknowns causing the needle to kick back. The other resistance measurement, to 500,000 ohms, requires full-scaling, then needle returned to zero, and all resistances measured by the usual kicking up of the needle.

### DIRECTIONS FOR USE

The selector switch, SW-1, at extreme right, is used for obtaining the range and service desired.

The line plug is not used for any d-c purposes. It is, however, always used when any a-c measurement is to be made, or any measurement of resistance, inductance or capacity, or decibels. Besides, there is a control on the front panel, to be turned to "D.C." for d-c measurements, and to "ALL OTHERS" when anything beside d-c is to be measured. Note that resistance, inductance, and capacity can be measured only when the house line is a-c, and should be 60 cycles. The line voltage may be 90-130 volts. Even though the line voltage is d.c., still a.c. may be measured, but not inductance, resistance or capacity.

Therefore, to work the instrument, if d.c. is to be measured, i.e., d-c volts or d-c currents, select the proper switch point at extreme right, throw the second switch from left (SW-2) to "D.C.," and connect test prods to the two binding posts. Red post is plus, black minus. The instrument need not be connected to any line.

If a.c. is to be measured, the rectifier tube's heater has to be supplied, therefore connection is made to a-c or d-c house line, by inserting the plug in a wall socket. The switch formerly set at "D.C." is now set at "ALL OTHERS."

### CONVERTING TO POWER RATIO

The decibel notation is based on a voltage ratio, but may be converted to lower ratio by dividing by 2. Readings from zero to minus 12 and from zero to plus 10, a total of 22 db, would then be -6 to +5 for power. It is not necessary to use the selected zero level, for any other reading may be selected, and the decibel change noted by addition or subtraction. For

(Continued on following page)

(Continued from preceding page)

instance, if you start at 6 db voltage for one stage and find the next stage is 8 db the gain is 2 db, or if you start at a high level stage, reading 4, and work backwards to a stage reading minus 6, the second stage is down 6 plus 4, or 10 db. To extend the range upward use the other db switch setting, which adds 20 to any reading obtained on the first db band. For instance, starting at zero on the first band gain is off scale, go to the second band and read minus 6. We know the addition is 20, so 20 minus 6 is 14, therefore the reading, compared to zero on the first band, is up 14 db.

The high ohms, capacity and resistance scales require that the third switch from left (SW-3) be set to afford full-scale deflection, adjusted by extreme left-hand control Rh, and then this third-from-left switch is moved to its other position, and the unknown read from test prods. Low resistance is read from full scale by the kickback method.

All measurements are made from the same two posts. But for electrolytic capacity measurements, reverse the polarities, i.e., black takes the positive of condenser and red the negative.

*On measurement of a.c. there may be no reading when plug is in one direction. Reverse the plug connection in the convenience outlet.*

#### DIRECTIONS BY POSITIONS

Since the selector is a ten-position switch the actual use of the instrument may be detailed in terms of switch positions, and the accompanying services, as follows:

**Position 1.** Reads 0-15 volts. Have scaler switch off and LCR switch at ALL OTHERS. Have d-c switch at DC for measuring d-c volts. Put this switch at ALL OTHERS for measuring a-c volts, and also connect plug to a-c or d-c line. For a-c volts, for this range, if the unknown is developed across an impedance one side of which is grounded, there will be no reading if the plug is connected in reverse. Therefore in case of no reading, make the necessary reversal.

**Position 2.** Same as for Position 1, except that the voltage range is 0-150 volts, and that even if reversed connection of plug or leads is made on a-c readings, there may be a small reading. An easy way to avoid doubt is to make the connections one way and then the other and accept the higher of the two readings.

**Position 3.** Same as for Position 2, except that the voltage range is 0-750 volts. The small reading in reverse requires the same precaution for unknown a-c as for the 150-volt range.

**Position 4.** Here 0-15 milliamperes are read. For d-c point SW-2 to DC, scaler switch at off, LCR switch at ALL OTHERS. For a-c point the d-c switch at ALL OTHERS.

**Position 5.** Same as for Position 4, except that the range is 0-150 milliamperes, a-c or d-c.

**Position 6.** Same as for Position 4, except that the range is 0-750 milliamperes a-c or d-c.

**Position 7.** This reads decibels up and down from a zero level of 4.75 volts and is calibrated

for voltage and not for power. Scaler switch is off, d-c switch and LCR switch both at ALL OTHERS. Plug is correctly connected to the line. For decibel readings it is necessary that there be a change of a-c voltages, either between stages or at input. The first adjustment is made by volume control in the amplifier under test, or in the signal generator, so that zero db is read. Decibels up, representing gain or plus, take place when the meter is moved to a higher voltage level, db down, or minus, when meter is moved to a lower voltage level. If the impedance across which the unknown is developed has one side grounded, then the db on this range can be read only when plug is correctly connected to the wall socket.

**Position 8.** Same as Position 7, except that the db are read as 20 higher than appears on the db scale. The addition may be made to minus quantities as well as to plus quantities, e.g., if reading is minus 4 db, the gain is  $20 - 4 = 16$  db compared to zero level established at Position 7. Even for wrong plug connection to line there may be a small reading on this range. An easy way to avoid doubt is to make the plug connection one way and then the other and accept the higher of the two readings.

**Position 9.** This is for measuring inductance, capacity and resistance. The plug is in the line. The scaler switch is now at on, for the first time, the d-c switch is at ALL OTHERS, and the LCR switch is at LCR for the first time. Make sure test leads are not touching, then turn to Position 10 temporarily, and adjust the full-scaler so that the needle reads 15 on the lowest scale. Then return to Position 9, and connect the unknown across the test terminals. Do not permit the fingers or any part of the body to make continuity between terminals, as the body impedance on tight grip is around 20,000 ohms and shunts the unknown, causing large error. The ranges are 5-1,000 henries inductance, 500- 500,000 ohms and .002-50 mfd.

**Position 10.** Again set the rheostat so that there is accurate full-scale deflection, and measure the unknown small resistance, .03 to 500 ohms, across the test leads. In this instance, contrasted to the method in the ohmmeter readings at Position 9, the needle moves back from full scale. Do not let hand touch the test tips.

The basis of all the operations is a 0-1 milliammeter, having the d'Arsonval movement, so voltage readings are at 1,000 ohms per volt. There is no calibration for 0-1 milliampere, for lack of room, but using 1,000 microamperes as representing full-scale, the readings for 0-1,000 microamperes are taken at Position 10, for d-c only, with d-c switch at DC, plug not in the line, and LCR switch at ALL OTHERS. Note the reading on the 0-15 scale, subtract one-third, and multiply by 100, for answer in microamperes.

(The above article was prepared from data supplied by Superior Instruments Company, 136 Liberty Street, New York City, who manufacture the instrument described therein, and known commercially as the Allmeter.—Editor).



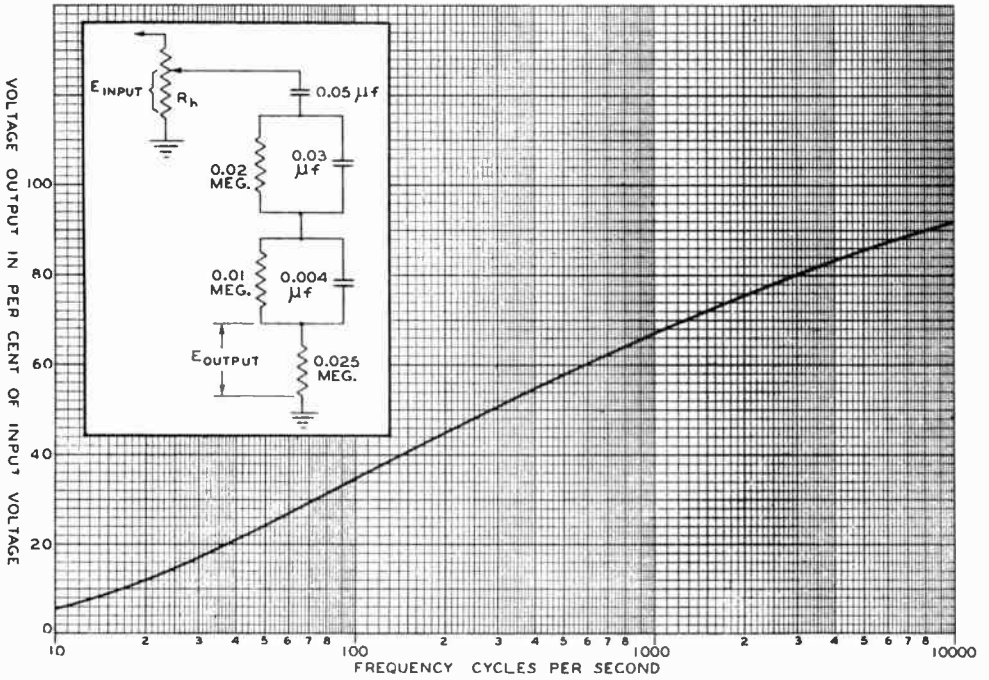

FIG. 2

Characteristic of the resistance-capacity network is practically a straight line on semi-log paper. The network is shown in inset.

(Continued from preceding page)

The time constants of the d-c amplifier restrict the time required to make a trace. When the oscillator dial is turned through a desired range too quickly, the trace will not show rapid changes in output due, for example, to resonant conditions in the amplifier. For the values shown in Fig. 1, about 30 seconds is required to make a trace.

### OSCILLOGRAMS SHOWN

The oscillograms in Fig 3 show typical results. At left is shown the effect of disconnecting the voice coil of the speaker from an amplifier. Resonant frequencies are indicated by the peaks. At right is shown the effect of by-

passing high audio frequencies with a tone control. Quantitative data may be obtained by calibrating the ordinate in terms of voltage and the abscissa in terms of frequency, as shown in these figures.

This curve tracer is suitable in the laboratory for determining quickly and with fair accuracy the effect of changes in amplifier design. It is also suitable for production testing of a-f amplifiers because of the relatively short time in which a characteristic can be obtained. A single test yields data on the gain of the amplifier throughout a frequency range of interest. The accuracy of the results is ample for most practical applications.

Copyright, 1937, by RCA Manufacturing Co., Inc

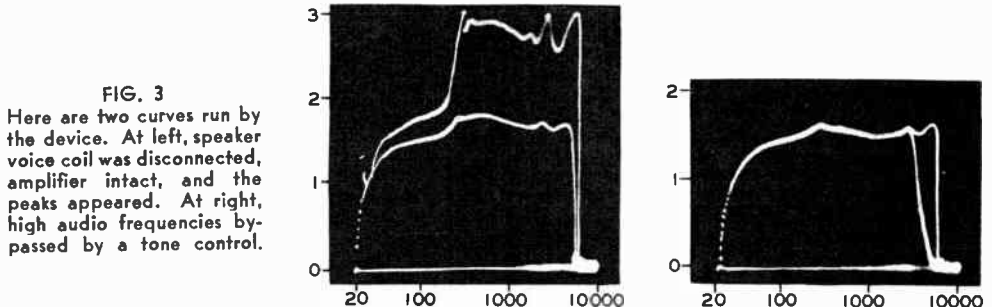
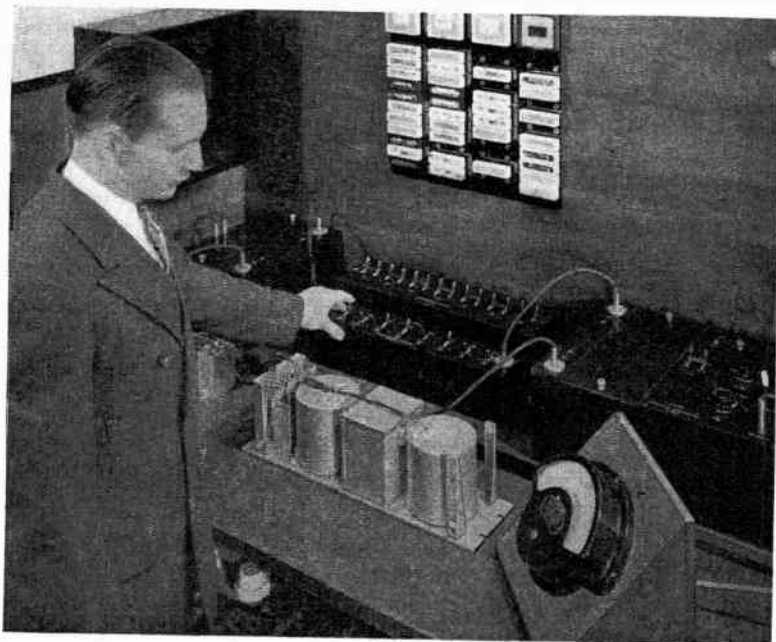

FIG. 3

Here are two curves run by the device. At left, speaker voice coil was disconnected, amplifier intact, and the peaks appeared. At right, high audio frequencies bypassed by a tone control.



# Measurement of Attenuation at High Frequencies

By F. R. Dennis

*Apparatus Development, Bell Telephone Laboratories, Inc.*

**A**PPARATUS for measuring attenuation loss at high frequencies has received considerable attention by the Laboratories during the past few years. This has been found necessary because of new requirements imposed by broad-band carrier telephone systems. These systems include a large number of filters and equalizers, the design and production of which depend in part on having available accurate means of measuring their loss-frequency characteristics. The measurements are made by applying an electromotive force of known frequency to the equipment under test and to a standard attenuator and adjusting the attenuator

until the loss is the same in both circuits. The attenuation of the equipment under test can then be read directly on the standard attenuator.

A fundamental circuit of the type used is shown in Fig. 1. The output of an oscillator, which can be varied continuously in frequency from 50 to 5,000 kc, is applied simultaneously to the input of the apparatus under test and the standard attenuator through terminating resistances. The apparatus and attenuator terminate at the other ends in resistances which are equal to the characteristic impedances of the

*(Continued on following page)*

(Continued from preceding page)

apparatus and attenuator respectively. The detector is a super-heterodyne and a microammeter indicates the point of balance because the ear cannot detect small enough differences in sound level to make headphones satisfactory for precision work.

### COMPROMISE FOR ACCURACY

The errors due to the inherent inductance and capacitance of the circuit increase with frequency. If the circuit impedance is made high, the error due to the shunt capacitance becomes predominant, and conversely if low the error due to the series inductance predominates. For the frequency range of this circuit, an impedance of 100 ohms was chosen as the best compromise. These limitations also prohibit the use of decade resistances for terminations and small plug-in resistors were, therefore, developed for the purpose. These resistors have a smaller phase angle than the decade type and allow the set to be kept more compact.

Losses of at least 80 db have to be measured to determine the attenuation peaks of filters. In making balanced-to-ground measurements of losses of this magnitude, longitudinal currents, which flow down both sides of the circuit and return through ground or by some other path, are the principal cause of error. Since these currents are not in general the same in either phase or magnitude in the two branches of the circuit, they result in a false balance if they flow into the detector. To reduce this error, the circuit is isolated at input and output with carefully shielded and balanced repeating coils. A grounded center tap on the measuring set side of the output coil gives a low impedance path to ground for the longitudinal currents.

### MULTIPLE GROUNDS ELIMINATED

In addition to this it was found necessary to use wire having a very tightly woven copper-braid shield for all leads between the com-

ponent parts of the set-up and to make sure that these wire shields are continuous with the external shields of the apparatus. This was done in the latest set constructed by using recently developed coaxial plugs and jacks for making all connections between the necessary leads and the apparatus.

In attempting to make high loss unbalanced measurements it was found necessary to construct the input and output sections of the measuring set in separate shielded compartments which were insulated from each other. This was required to eliminate multiple ground paths.

The absolute accuracy of the measurements made with a circuit of this kind is dependent upon the accuracy of the attenuator used as a standard. It has, therefore, been necessary to develop attenuators having negligible frequency errors along with suitable measuring circuits. These attenuators are made of constant-impedance resistance networks provided with suitable means for switching. Any reactance in these resistances or in the associated switches and wiring results in increasing departure from the theoretical value of the attenuator as the frequency is increased. This undesirable effect has been reduced by taking advantage of recent improvements in winding low-phase-angle resistances.

### THE SUPERIOR RESISTORS

Two types are being used at present; one with a parallel-opposed winding on a small glass tube and the other, which may be wound to higher resistance values, of the woven wire type. In both forms the phase angle is negligible except for very low or very high resistance values.

Two types of both balanced and unbalanced attenuators which use these resistors have been developed. In one type, shown in Figs. 2 and 3, the networks are cut in or out by means of double-pole double-throw keys. These are relatively inexpensive but have the disadvantage that the reactance of the keys and wiring of

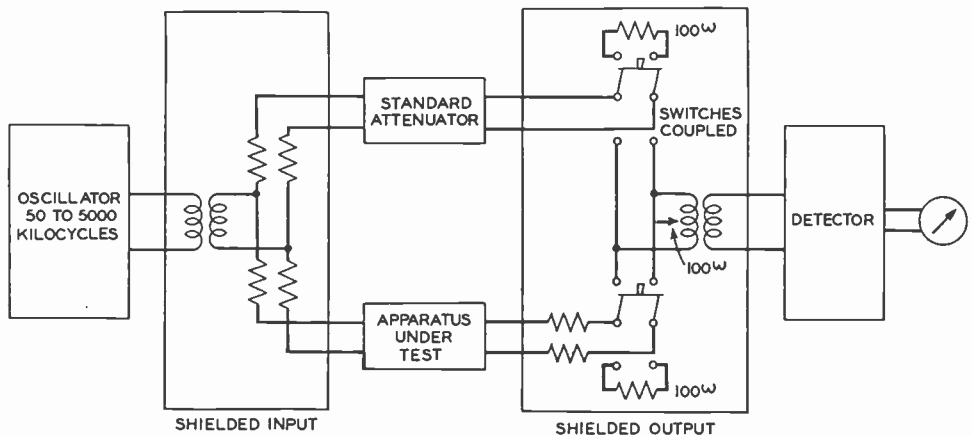

FIG. 1

Attenuation at radio frequencies is measured by comparing the loss in the apparatus under test with that of a standard attenuator

the networks not in use is still in the circuit. Rotary switches are used in the other type which represents a distinct improvement over previous switching methods.

An unbalanced attenuator of this type is shown in Fig. 4. As may be seen the networks are connected directly between the switch contacts; this allows the wiring to be kept at a minimum. The construction of the switch is such that the spurious capacitances are extremely small; otherwise they would be very

now possible to measure losses of 90 db at 5,000 kc with an accuracy of 1 db. This is a considerable improvement over equipment previously available.

The oscillator must be extremely well shielded and must have high stability in amplitude and frequency if precision measurements are to be obtained. The detector must likewise be well shielded and must have high sensitivity and also stability. A tuned detector is necessary to prevent errors due to oscillator har-

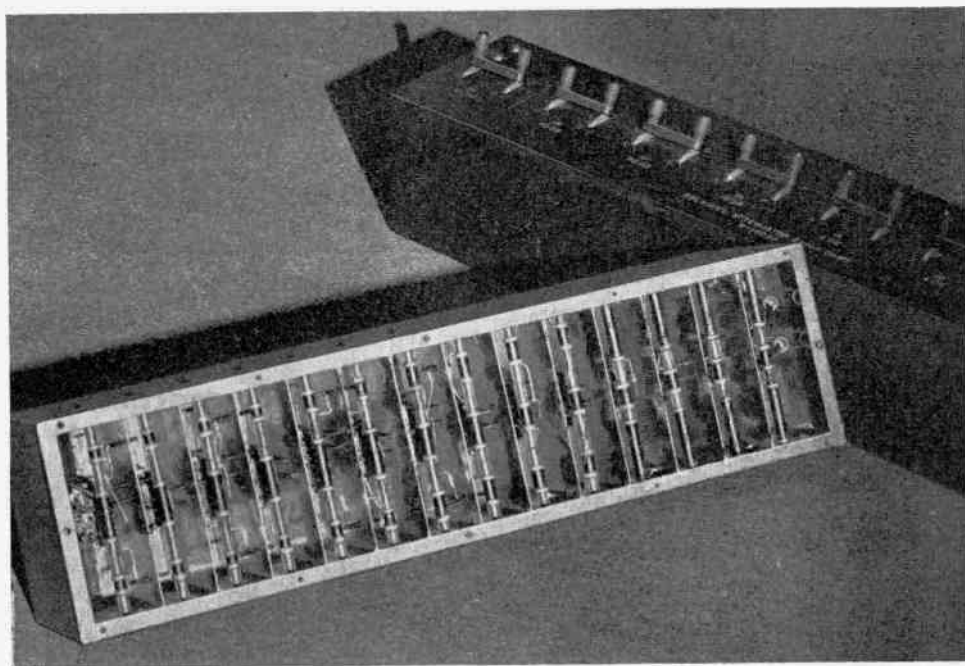

FIG. 2

Standard attenuator constructed with parallel-opposed resistance units wound on small glass tubes

troublesome at the higher frequencies. The switch which has 10 db steps is double decked with a network in each deck for losses above 30 db. Splitting the higher losses into two networks in this manner keeps the series resistances from becoming unduly high and also helps to decrease the direct capacitance between input and output. A shield plate is inserted between the two decks and the complete switch is enclosed in a shielding box.

#### UNUSED NETWORKS GROUNDED

To reduce still further the direct capacitance between input and output of the switch it was necessary to include additional brushes to ground the adjacent network on either side of the one in use. Much thought and experimentation was required to work out the proper method of making the various ground connections on this attenuator, since the ground impedance must be properly placed in the circuit if accuracy is to be obtained at the higher loss settings. With attenuators of this type it is

monics for measurement in the attenuating range of networks. A superheterodyne type of detector seems to meet all the requirements in the simplest manner. The intermediate frequency is modulated by a built-in oscillator so that a frequency of approximately 1,000 cycles is obtained in the output. In the latest form the indicator consists of a diode-triode rectifier tube with a microammeter connected in the plate circuit of the triode section. By proper choice of circuit constants a 3 db linear scale can be obtained on this meter which makes it possible to read a balance with a precision of 0.05 db. This meter can be calibrated at 1000 cycles and then serves as a check on the accuracy of the attenuator in the high-frequency circuit for small increases in attenuation. The use of a calibrated meter makes steps smaller than one or two db unnecessary on the attenuator and thus saves the expense of several additional keys or one decade. A further advantage is that the tube cuts off on overload

(Continued on following page)

(Continued from preceding page)

so that it is impossible to damage the meter. An attenuation measuring set embodying the

new equipment will make it useful in development work where precise measurements of insertion loss at high frequencies are required.

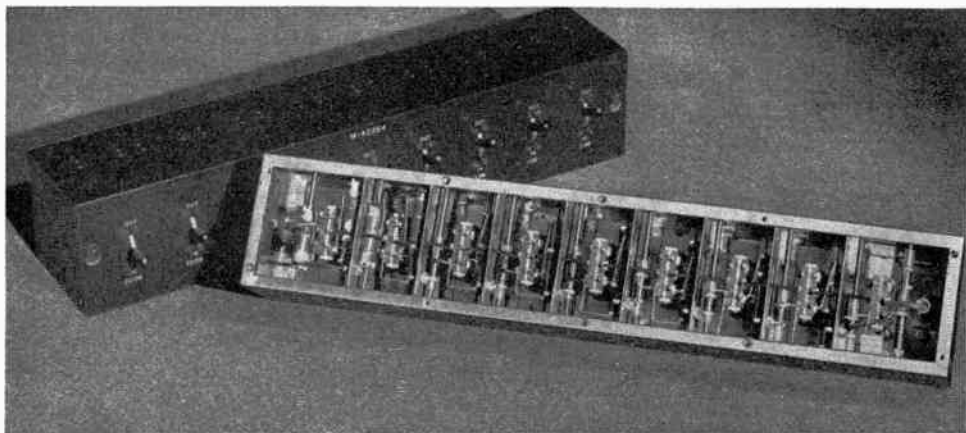

FIG. 3

The resistances of this standard attenuator are mounted in two rows with keys between to cut the units in and out

latest developments is shown in Fig. 4. The repeating coils are provided with plugs and are inserted in different jacks for balanced and unbalanced measurements. Two sets of coils are provided, one covering a nominal frequency range of 50 to 1,500 kc and the other from 1,500 to 10,000 kc. By the lower key the output coil is switched from the attenuator to the apparatus under test; the upper key gives a 180-degree phase shift in the input to the detector and thus serves as a check on the presence of longitudinal currents when measuring balanced apparatus. The equipment to be measured is connected between the jacks in the lower corners and those above either to a balanced attenuator or an unbalanced one.

The increased accuracy attainable with the

## Ether a Conundrum, Though Daily Word

When we do not know what a thing is we give it a name. Since a name is something the unknown is therefore not nothing. At least it is a name. So it is with the ether. Nobody knows what it is, whether it exists, whether it is imperishable or subject to birth and death. But it is known there is something through which radio waves travel and which provides a path with linear characteristics. As with electricity itself, we know something about the characteristics of the ether, but nobody has ever seen electricity or ether, but manifestations of one in the other.

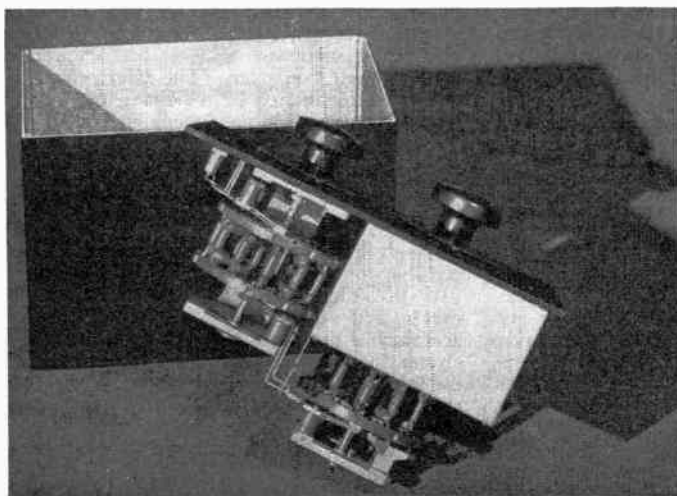
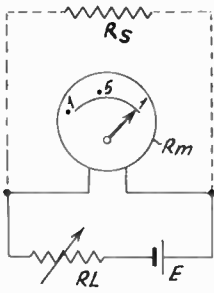

FIG. 4

Standard attenuator of the unbalanced type with rotary switches and woven-wire resistance units. The networks are connected directly between the switch contacts. This allows the wiring to be kept at a minimum. Spurious switch capacities are extremely small



MAKE  $R_S$  SMALL ENOUGH  
SO NEEDLE POINTS TO .1



$$R_S = R_m \div (n-1)$$

## METER SHUNTS

To increase the current range of the meter a resistor is put across the meter and is called a Shunt ( $R_S$ ).  $R_L$  is the limiting resistor,  $E$  the voltage supply. To increase the 1 milliampere range to 10 milliamperes proceed as shown. At right is a ring shunt.

RING SHUNT

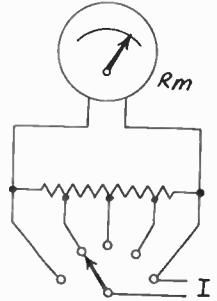

## HOW METER IS ORGANIZED

Separate shunts and separate multipliers are used. The shunts afford the different current ranges and may be selected by a simple formula or by trial. The multipliers are 1,000 ohms for each full-scale volt, assuming  $R_m$  is a 0.1 milliammeter.

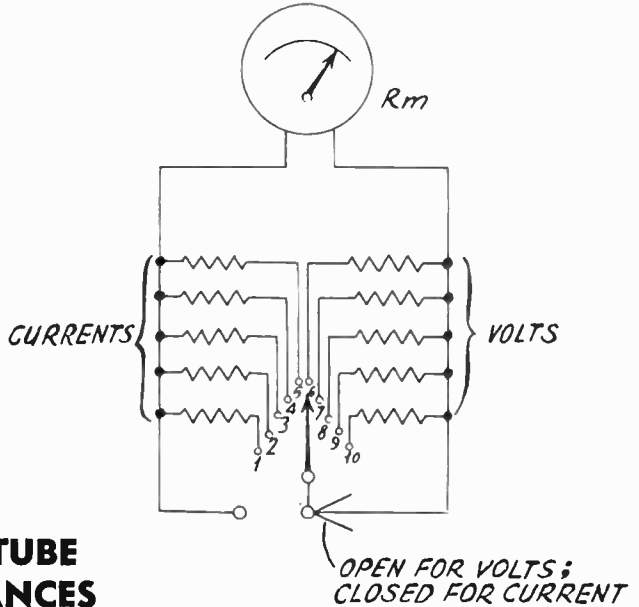

## D-C. METER AND TUBE MEASURE IMPEDANCES

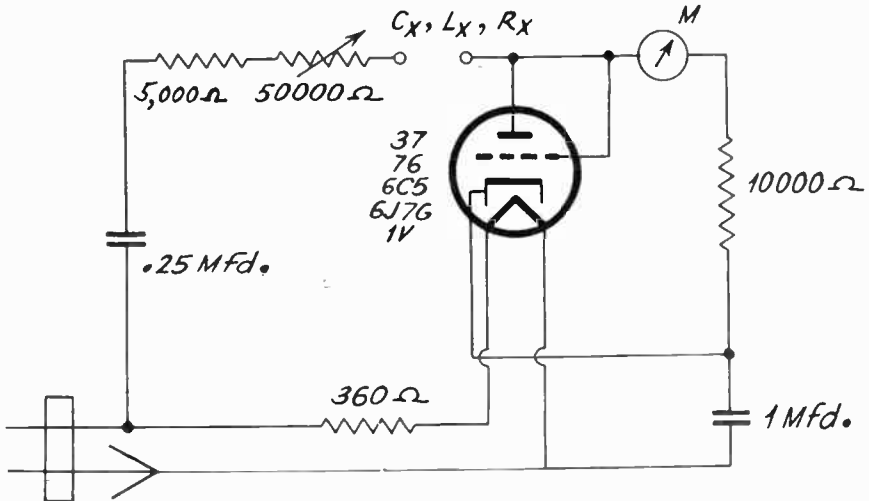

Capacity, inductance and resistance are measured on a 0.1 d-c milliammeter.

# Ground Isn't What It Used to Be

*Elusive to Engineers;  
No Problem to Fakers*

By A. J. Ward

EVERYBODY knows what a ground post is. It is the post to which the external ground lead is connected. That lead helps to increase the signal strength of the received stations. But what is a ground? When is a ground? Those are difficult questions.

Ordinarily we think of the ground as representing the return electrical circuit. We attempt to make it the return, anyway. If we have an alternating-current circuit, even the 60-cycle lighting company line, one side is normally connected to earth, and this is the grounded side. Thus a lamp connected, one side to earth, other side to the ungrounded potential of the line, will light. Two wires from the power station would not be necessary, except to put the transmission up on poles.

Now, 60 cycles constitute a very low frequency. You don't have to go down much lower before you have zero frequency, which is direct current. The frequencies used for carriers in broadcasting may be called medium. Those used for television carriers may be called ultra-high. Consider the question: How does ground behave in respect to each of these three?

## DIRECT AND INDIRECT GROUNDS

For the commercial power line frequencies, ground is readily obtainable and effective. It represents one side of the a-c circuit, and any tap or set served by the same line would be sufficiently grounded if connected to earth, directly through an iron pipe, or indirectly, through a ground clamp, thick wire and cold water pipe that ultimately reaches ground.

Also on the broadcast band the ground connection is usually effective, perhaps more as a sort of counterpoise than as a ground itself. Or perhaps we do not have our transmitters and receivers close enough to the literal ground, and there is a good deal of pickup in the connecting system. What we may need is a transmission line for the ground lead as well as for the antenna.

Anyway, one is not surprised at this late time to be told that many a set will pick up local stations with more volume if the ground lead, so-called, is connected to the antenna post, and the antenna is not used at all, or, if used, is connected for some silly reason, or no reason, to the ground post and does not create any difference.

If any meters suitable to the purpose are at hand, the voltage at the detector input for all

the local stations may be measured when (a) antenna is connected to antenna post, ground to ground post; (b), ground is connected to antenna post and antenna to ground post; (c), ground is connected to antenna post, antenna not used; (d) antenna is connected to antenna post, ground not used. A comparison will show the effects, which may be marked. Especially does the comparison of antenna post picking up first antenna and then ground bear watching. The relative effectiveness of the antenna's pickup versus the ground's pickup is thus ascertained.

## GROUND OFF, SOMETIMES REMEDY

It is usual to recommend that the ground be connected to the set, and in many instances this is necessary for stability at the r-f level. However, where interference is suffered, particularly of the type produced by electric motors, omission of the ground connection sometimes aids clarity. There may be a small reduction of r-f input to the set, but it is so small you might not have even noticed it unless your attention was called to it, and besides the quiet that results, compared to previous noise, is most welcome.

It is not so easy to ground a broadcast set effectively, even in the standard band. For persons in rural places this may be easier, but urban folk have their troubles. First, they often are far removed from a true ground. Imagine grounding a set in an office building, say, on the top floor of the Empire State Building in New York City, 1,000 feet above ground! Even in apartment houses only a few stories high, there is no true ground available. The cold water pipe, the steam heat radiator, and any other suggested medium is at a relatively high radio-frequency potential. Proof: connect the so-called ground to the antenna post of set and notice what a great deal of input you obtain!

Nobody should recommend the use of these improvised grounds as aerials, except as an emergency, as they are decidedly reactive, usually approximating a low-pass filter of very broad characteristics.

## THE AGE OF MIRACLES

So long is the antenna that the natural period of the system, when the antenna coil primary is made part of it, that there may be antenna resonance somewhere around the low-frequency end of the broadcast band. This makes for considerable broadness of reception due to exaggerated input, for low radio frequencies (550-

1,000 kc), and weak reception for the higher frequencies (1,000-1,700 kc), besides reduced selectivity throughout, since the resistance of this unintentional antenna may run very high, even to hundreds of ohms.

There are commercial devices that are supposed to be wonder antennas of the built-in type. The story is that a small object, several of which you could hold in your hand at once, comprises a very efficient special antenna, dispensing with the need of outdoor aerial, messy wires, leadin, connectors, insulators, poles, etc. A very marvelous device, ladies and gentlemen, recently developed by one of the leading radio scientists, and marking a revolution in radio progress! Directions: disconnect the present antenna wire from the antenna post, stick this device in the a-c outlet, and connect a wire from a post on the device to the antenna post of the set. Connect the a-c plug of the receiver into the female socket built into the new marvelous device, and results are splendid. They are not too bad for utterance. But you may have spent a few dollars merely to permit (a) connection of your antenna post to one side of the a-c house wiring, through a fixed mica condenser; (b), connection of the a-c supply to your set through two joints instead of one. The lighting wires, including grounded one, are aeriels, but not good ones.

### GROUND ELUSIVE ON AUTOS

Now this marvelous little series condenser on some occasions is made tubular and variable, and a little push and you get improvement. Just what, exactly? Well, all sorts of static noises are filtered out miraculously. Of course they are not. Selectivity is improved. That's true. A variable series condenser has some such good effect on short waves. but not much on the broadcast band.

If you have seen the street demonstrators working a set that is very noisy, and then introducing some device, after which the noise disappears, the device did not do the trick, but the motor or vibrator or buzzer purposely put into the set to create racket was shut off at the time the miracle device was inserted, and the good old swtching operation put on the quietus. There are various ways of working this trick, but you would not want to know what they are, because you aren't going into that business, although the police don't bother you much.

Now, automobiles also have their ground problems. Suppose some one said to you, "My good friend, ground this point, will you?" and pointed to a particular juncture of a car set that had been installed. What would you do? You wouldn't ground it, because so far as a car is concerned there isn't any such thing as a good ground. No, the ground is what you're traveling over, and you can't have a fixed connection to it from a moving vehicle. So grounds on car sets are figures of speech.

### AT THE ULTRA HIGHS

We shall take the motor as the basis, and see that the car chassis is conductive to frame, and that any substitute for grounding shall be bonding to the frame. That consists of making a

very well-soldered connection between the point to be "grounded" and the nearest access of chassis or frame. The bonding element usually is thatched copper wire, tinned or otherwise coated, and the solder is permitted to run the whole thickness of the braid at the joint. Bonding may be defined then as about the best connection that you can possibly make.

We have found the broadcast band not so easy to handle on the grounding proposition. When we consider ground of an alternating current as the lowest potential, practically zero, so that if the high side of an open circuit were connected to it there would be no pickup, or excitation, then we must confess we have half a ground, at best, because we pick up an admitted quantity.

As we go to short waves the ground myth becomes more mythy. It is almost impossible again, or, rather, less possible. At ultra-high frequencies, around one meter, the ground (so-called) is as peppy as the grid, everything you touch is hot, in the technical and not thermal sense, and you just throw all ground considerations to the winds and go about your business of trying to find something that has no impedence to these frequencies.

When dealing with oscillators, ground is again elusive. It practically does not exist. You'd have to be outdoors, on moist earth, with rod sunk into it, to yet any decent sort of ground.

So maybe transmission line is inevitable for a true ground at a distance, for any carrier frequency, or, for receivers and transmitters, the counterpoise system had better be experimented on some more. There are numerous sets with built-in aeriels that use the counterpoise system.

## PUFFS

I haven't found another magazine that is as efficient as yours in bringing the latest developments to the radio man.

SAM PAYNE,  
1157 Osecola St., Denver, Colorado.

\* \* \*

I like RADIO WORLD tremendously, because it belongs in a class of its own—it teaches more than it amuses. Good luck!

GEO. MERRIMAN,  
VS6HH, P. O. Box 414,  
Hong Kong, China

\* \* \*

I get twice as much useful information out of RADIO WORLD as out of any other radio paper for which I subscribe.

T. KELSON BUTLER,  
Karapiro, Cambridge, N. Z.

\* \* \*

We are well pleased with your paper.

THE ENGINEERING SERVICE Co.,  
C. R. Russell, Manager,  
100 Gloucester Street, Christchurch, Cl, N. Z.

# RADIO CONSTRUCTION UNIVERSITY

Answers to Questions on the Building and Servicing  
of Radio and Allied Devices.

## RECTIFIER MYSTERIES

WHEN a rectifier tube is used on low voltage scale, I find that it is hard to get current started through the rectifier and meter. There is some such sluggishness even in a copper oxide rectifier, but it is worse in a tube. Have you any suggestions, particularly as the scales therefore won't multiply?—M. N. S.

The commonest tube trouble is with binding posts shorted, there is some current flow, hence reading, when there is no external input. Then also, if there is considerable retardation due to the density of current in the rectifier, it is hard to get started, as you express it. This is sometimes called a sticky rectifier. If there is current reading before application of any external voltage, though terminals must be closed, this reading, you will find, reduces practically to zero as soon as the rectifier is sufficiently loaded. For instance, the 150-volt scale would be nearly perfect, but the 15-volt scale unreliable for multiplication. It is possible to introduce a small bucking voltage, as from a 1.5 volt cell, with negative toward the plate, to cancel this idling current. If the tube is sticky that is considered a defect, due to poor emission. The standard test voltage in tube testers has been made 30 volts so that there will be some current flow even if the tube is pretty poor on emission.

\* \* \*

## DECIBELS IN ABSOLUTE UNITS

CAN the decibel notation be used for absolute comparison of receivers as to voltage gain or power output, and if so why?—M. B.

Since the response of the human ear is not on a linear basis but more nearly logarithmic, ratios of logarithms of numbers are used instead of percentages, for expressing more nearly the difference in amplification as it affects the ear. To compare the difference between linear and non-linear results, let us take the example of money loaned. Say it draws 6 per cent. interest per annum. Therefore, just \$6 is paid per annum for each \$100 borrowed, and if the amount is \$200 the interest is \$12, if \$300 it is \$18 etc. But suppose the loan is for a period of years, and the interest is compounded. Then it is \$6 per \$100 for the first year, \$6.36 per original \$100 for the second year, etc. and is no longer linear, but exponential, the same law applying as to an exponential speaker. Therefore the interest rates, simple or compound, apply generally, but they

do not reveal how much has been loaned or borrowed. If, however, \$1,000 were taken as the zero level, it would be possible to know the amount loaned by a statement or reading of whether the amount was up or down, and by what ratio, from \$1,000. The same holds true of decibels. They express a ratio. If all measurements on all different devices are referred to the same level, then the power (or voltage or current) comparisons are absolute. Unfortunately it is very difficult to obtain any agreement on level, and besides somewhat difficult to maintain the level. For usual radio purposes the zero level is taken as .006 watt (6 milliwatts). For power considerations this usually applies (if so stated) to a load of 500 ohms. In telephone practice .001 watt is a common reference, whereas in other fields .012 watt (12 milliwatts) is favored. If the zero levels are known the readings can be reconciled to any base for absolute values.

\* \* \*

## UNKNOWN SMALL RESISTOR

KINDLY give the formula for measuring an unknown small resistance, by shunting the meter with the resistance.—E. W. C.

This is the same general formula as for the unknown shunt where the current reading is to be multiplied. See answer to L. I. R. If  $R_x$  is the unknown shunt, and  $R_m$  is the meter resistance, and  $n$  is the multiplier, the formula is  $R_x = R_m \div (n-1)$ . However, for unknown resistance, instead of  $n$  representing just a multiplier, it represents the ratio of two readings taken on the meter. If one is considered always full scale, then there is only a single practical reading. Use microamperes as handier. Then for  $R_x$  unknown,  $R_m$  meter resistance,  $I_m$  full-scale current and  $I_o$  the reduced reading occasioned by the unknown shunt, the formula is

$$R_x = \frac{R_m}{(I_m \div I_o) - 1}$$

\* \* \*

## INTER-OFFICE CIRCUIT

WILL you please show the diagram of an inter-office communication system that works well?—E. V. L.

The diagram appears on this page and was drawn from a circuit supplied by Radolek. The master station is the crux of the system and contains the main amplifier unit and is the only unit that is connected to 110 volts a.c. or d.c. The front panel has a combination speaker-mi-

crophone, volume control switch for all stations, selector switch with natural position, bull's eye indicator, and a push-to-talk button. Outlying stations have a button to call the master station, but carry a two-way conversation without the use of this button switch. Plug-in cables connect the units. When the desired outlying station is selected you merely push the button of

### METER RANGE EXTENSION

**P**LEASE state a method of making a 0-1 milliammeter read larger currents, not requiring any computation, as I am not handy at mathematics.—L. I. R.

The method to apply is to shunt the meter. Decide how much you want to increase the reading. Suppose it is ten times. Then full

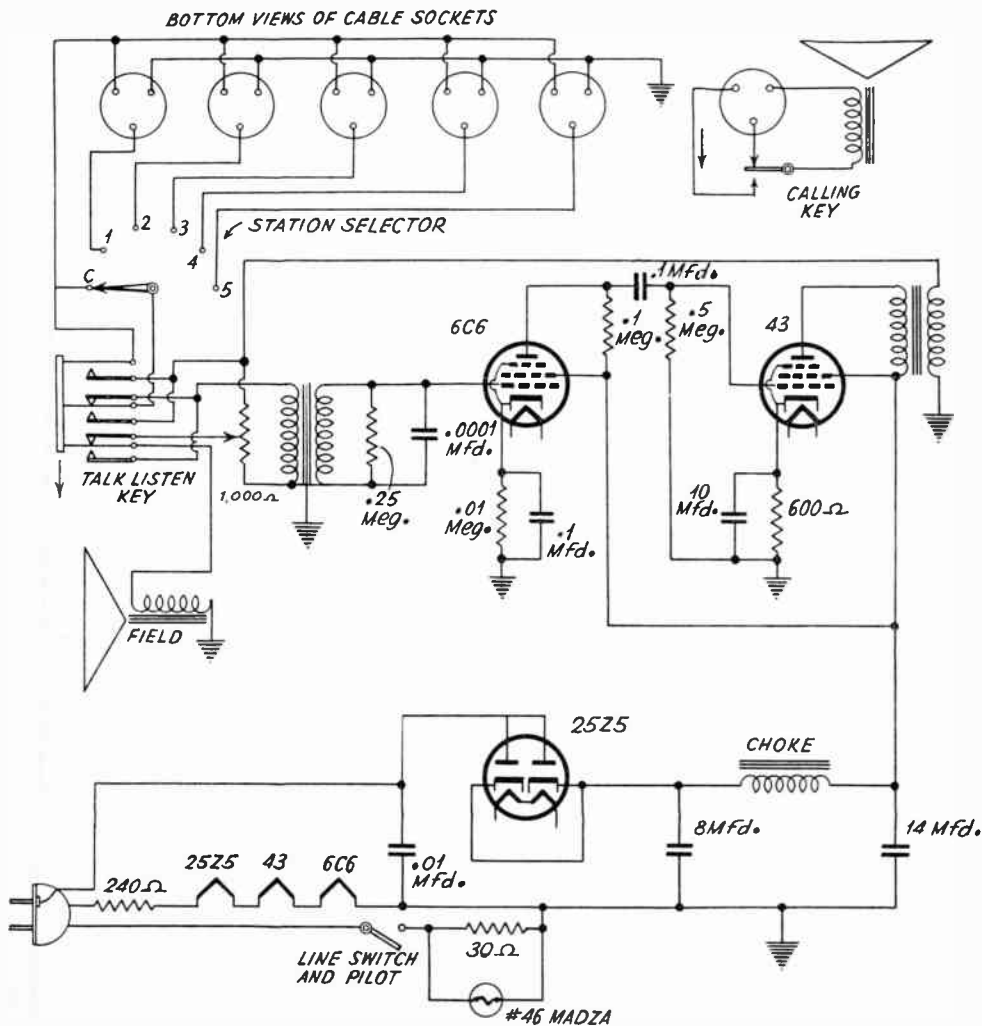

Circuit of Radolek Inter-Office Communicator.

the master station to talk and release to listen. When an outlying station is selected, the person called may answer without leaving his work if he is within ten feet of the station unit. Outlying stations calling to the master station must press a button until identification is made, after that both sides of the conversation are easily controlled at the master station. The complete system is regularly supplied with one outlying station, but up to five stations may be used. The use of two conductor, shielded cable eliminates undesirable pickup and reduces the cost.

scale will represent 10 milliamperes. The setting for one milliamperere would be one-tenth of full scale, so with one milliamperere flowing, as read on the untouched meter, shunt the meter until the full-scale reading of 1 is reduced to .1. This method is not very accurate, because it assumes that the meter itself is as accurate at the low settings as at full scale, which is nearly always a false assumption. A better way would be to apply some computation. You can handle it. Find out the re-

*(Continued on following page)*

(Continued from preceding page)

sistance of the meter. Catalogues give it, or write to the meter manufacturer, giving model and serial numbers. Knowing the resistance of the meter, and the full-scale current of the meter, and also the quantity by which you want to multiply the reading, the shunt resistance required equals the meter resistance divided by one less than the multiplier. Suppose the meter resistance is 100 ohms, current 1 milliampere, and it is desired to increase the reading to 10 milliamperes. The multiplier is 10, the meter resistance is divided by one less than 10, or 9, and the shunt equals  $100 \div 9 = 11.1$  ohms. For various ranges it is practical to use different shunts, smaller resistance values for larger current readings. As the range is multiplied the sensitivity is decreased proportionately. Also, the current through the meter is always within the capabilities of the meter, assuming no overload, because the excess of meter current is passed through the shunt. Thus in the example, for 10 milliamperes total, the meter itself requires still only one milliampere, hence 9 milliamperes must pass through the shunt. Hence arises the condition of "multiplier less one" divided into the meter resistance equals the required shunt resistance. Besides individual shunts, ring shunts sometimes are used. These consist of what amounts to a single shunt tapped, although made up normally of individual units soldered together. A disadvantage of this system is that if an open occurs anywhere in the branch, and the meter is set assumptively to some large current position, the whole current is passed through the meter, and therefore may seriously damage or ruin the instrument. A diagram shows a voltmeter switching arrangement on page 11.

\* \* \*

### CAPACITY MEASURED

AS I desire to make a capacity meter, please inform me what would be a good circuit for measuring .01 to 10 mfd. or so, and let me know some easy way to establish the values.—K. C. N.

The impedance method is satisfactory, and consists of connecting a rectifier, meter, limiting resistor and the unknown condenser in series with the a-c house line, and noting the meter reading, when various known capacities are inserted. It is entirely satisfactory to obtain condensers of very reputable manufacture, and use the rated capacities of mica and small paper condensers. The large capacity condensers, both paper and electrolytic, will not be quite so accurately rated. In an actual case, Cornell-Dubilier mica condensers, .005, .01, .05 and .1 mfd. were used for obtaining points, read on the voltage scale, and ten .1 mfd. used, one at a time, first one alone, then two in parallel, three in parallel, etc., and the rated capacities were exactly as read on a Hickok capacity meter. Hence the assertion these condensers served as suitable standards. Four condensers, of 4, 8, 16 and 20 mfd., should be measured on a capacity meter for their true value, and after being marked, used as standards. Then the whole gamut is accomplished

and excellent accuracy obtains for points with which to run a curve. The series resistor should be adjustable, as in any ohmmeter. Unknown resistances may be read the same way, 500 ohms to 500,000 ohms, and if the ohms scale is protracted, then henries may be read, from 5 to 1,000 henries conveniently, with accuracy good above 10 henries. The value in henries equals the resistance divided by 377, where known resistors have been used for the calibration. See page 11.

\* \* \*

### IMPEDANCE MATCHING

FOR voltage transfer circuits, where matching of impedances is to be accomplished, and practically no equipment is on hand for measurements to determine match, what simple method could be applied that is reliable nevertheless?—W. E.

Where the matching problem exists for voltage amplifiers, and impedances connect stages, the match is best when the stage output voltage is greatest, so a tube hooked up to serve as a vacuum-tube voltmeter, not necessarily calibrated, would suffice. The maximum deflection denotes best match for the impedances tested. An input of a given frequency is used and the circumstances apply to that frequency. For tests embodying a range of audio frequencies, no standard can be set up, since the match may be better for some frequencies than for others. You could average the readings for frequencies of 40, 100, 400, 1,000, 2,000, 5,000 and 10,000 cycles, if you had a supply source and wanted to make the test more elaborate.

\* \* \*

### HOW MICROPHONE WORKS

WILL you please explain on what principle the microphone works, and also compare the carbon microphone with the velocity, condenser and dynamic types?—P. F. B.

When sound waves are generated in air they cause changes of pressure. If a diaphragm is established in any instrument these pressure changes affect the diaphragm. If this diaphragm is mechanically connected to some medium that changes its resistance with changes in pressure, then if we put a steady current through this medium, the pressures on the diaphragm will change this steady current according to the same pattern as the original sound waves. The medium is a stack of carbon granules, called a button, and thus we have a single-button microphone. Notice that the original sound waves have been changed to electric pulses. As the frequencies of the sound waves are changed, the frequencies of the pulsating currents are changed; and as the intensities of the sound waves are changed, so are the intensities of the pulsating currents changed. Instead of using a single-button device, two carbon piles may be used, in full-wave fashion, with a common connection, i.e. double-button microphone. But in any instance, since the resistance per button may be 200 to 400 ohms, a transformer is used, with primary to match, and with secondary of high

(Continued on following page)

# NEW PRODUCTS

## Ohmite Offers Improved Heavy-Duty Resistors

Heavy-duty resistors of an improved type have been developed by the Ohmite Manufacturing Company, 4835 West Flournoy Street, Chicago, as shown in the accompanying cut-away illustration.

At (1) the evenness of windings, which is a characteristic of these resistors, is clearly depicted. This feature prevents "hot spots." At

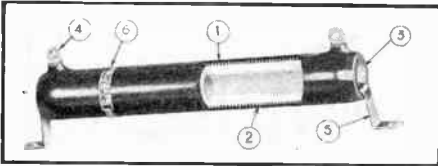

The new Ohmite resistor.

(2) the vitreous enamel, specially developed, holds the wire in place exactly as it was wound and forms a ready path to conduct heat away. The core is porcelain (3) and the copper terminals (4) are tin-dipped. The resistors are equipped with mounting brackets (5). The brackets are easily demounted by a slight upward pressure at the base. An aluminum band has the resistance stamped (6) on it.

## New Jensen Combinations With Four Speaker Sizes

Jensen is introducing a new line of Peri-Dynamic reproducers, using 8-inch, 10-inch, 12-inch and 15-inch speakers.

The Peri-Dynamic principle, developed by Jensen's laboratories, utilizes a speaker in conjunction with an enclosure. It is claimed that the effect approaches that of an infinite baffle. The speaker and correct enclosure must be used together.

This line of reproducers is moderate in price and will find wide use in all radio and public address applications. The Model KM-8, shown here, is for general use, special models are made for voice only. Write to Dept. RW, Jensen Radio Manufacturing Company, 6601 South Laramie Ave., Chicago, Ill., for further information.

## List Catalogue by Radolek

A new list price public address catalog is announced by the Radolek Company, 601 West Randolph St., Chicago. This book is intended to assist the radio dealers and servicemen in selling P-A equipment. A complete selection of P-A systems ranging in size from 5 to 60 watts is given, as well as special recording, hearing aid, inter-office communication, and paging systems.

## Compactness without Sacrifice in C-D Etched Foil Condensers

This photograph illustrates the comparative sizes of the small etched foil dry electrolytic capacitors and equivalent plain foil types. Cornell-Dubilier's line of electrolytics include the type KR metal container and JR silver cardboard container etched foil series in a complete capacity range from four to sixteen microfarads, including the popular multiples, rated at 200 to 525 volts. Despite compactness, the small units are triply sealed for protection from humidity and abnormal temperatures. The electrical characteristics are on par with equivalent plain foil types. Power factor and leakage losses are negligible.



Etched foil condensers are in left hand

(Continued from preceding page)  
impedance for best transfer when feeding the grid circuit of an amplifier. The carbon microphone is not the best for quality, but if the sensitivity, which is high, is sacrificed considerably by stretching the diaphragm, then the carbon type becomes suitable for broadcast studio work of some types, although microphones with far less sensitivity, but better fre-

quency characteristics, are used in the best stations, such as the velocity (ribbon), condenser and crystal microphones. These and the dynamic microphone are so insensitive that much more amplification is required than for carbon microphone use. Where cost is an imperative consideration, quality secondary, the carbon microphone would be the choice. It always has spring suspension.

# THE NEW R-9 SIGNAL BOOSTER!

**GIVES THOSE WEAK DX SIGNALS A  
TREMENDOUS BOOST AND ACTUALLY  
REDUCES STATIC AND NOISE!**

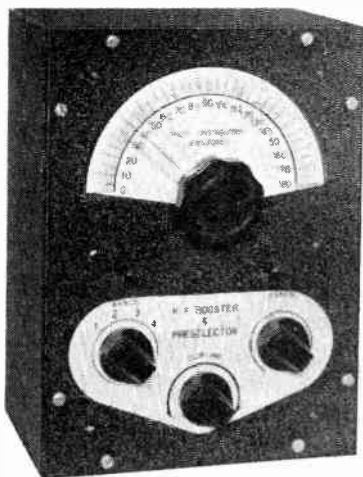

**COMPLETE PRICE \$11.25**

**H**ERE is a sure-fire, inexpensive means of increasing the range of your receiver. When used with any AC operated set the R-9 will give you greatly improved long distance reception. It amplifies the weak signal you are after before it reaches your receiver and at the same time rejects other signals and noise on adjacent frequencies.

Signals which were hopelessly buried in the general noise level can be brought out clearly and distinctly above it. This is not just theory; you can really hear the difference—up comes the signal and down goes the noise as soon as the R-9 goes into action. The addition of this Booster will put even a single tube, broad tuning receiver into the DX class.

If you are seriously interested in long distance radio reception the R-9 will actually add more miles-per-dollar to your range than any investment you could possibly make.

**CAN BE USED WITH ANY AC RECEIVER**

- \* Brings in stations you have never heard before.
- \* Weak, long distance stations brought up to good speaker volume.
- \* Tremendous increase in selectivity. Gives you the station you want, AND NO OTHERS.
- \* Bandswitch operation—No plug-in coils.
- \* Tunes from 14 to 560 meters in four separate bands with generous overlaps.

## SPECIAL FEATURES

**A** high gain stage of regenerative radio frequency amplification uses a 6K7 Super-control Pentode in an electron coupled circuit. This tube has an amplification factor of over 1000 and is used with regeneration to provide the greatest possible gain when needed. The regenerative control is not critical and shows good gain even when not fully advanced.

Variable antenna coupling with panel control allows the R-9 to be properly matched to any antenna at all frequencies.

The large 4½ inch dial gives smooth tuning and easy logging.

Four separate bands with individual band-switch coils provide complete wavelength coverage from 14 to 560 meters without any skips.

Operates from the power pack of any AC receiver. The entire current consumption of the R-9 is less than two watts! (The average set draws from 50 to 150 watts from the line so that the slight additional load of the R-9 is negligible).

When ordering the R-9 state what output tube is used in your receiver. Shipping weight—7 lbs.

**R-9 SIGNAL BOOSTER** with 6K7 tube complete in cabinet ready to operate. List price.....\$18.75

**Special Experimenter's Introductory Price ..... \$11.25**

**RADIO CONSTRUCTORS LABORATORIES** Dept. SB-1, 136 Liberty Street  
New York, N. Y.





# National Radio Products

Descriptive price list Bulletin No. 261

If you are without a copy of the new National General Catalog, write us and we will gladly send you one. Or better, visit your dealer. He will welcome the opportunity to give you a copy of this new catalog and to demonstrate the latest National products.

**NATIONAL CO., INC., MALDEN, MASS.**

## SPECIAL 2-FOR-1 OFFER RADIO WORLD

Radio World is \$2.50 a year (12 issues), 25c. per copy. Canada and foreign, \$3.00 yearly. Offers of Radio World and other worthwhile publications for one full year on each (NET):

- RADIO WORLD and SHORT-WAVE and TELEVISION, \$3.50.
- RADIO WORLD and POPULAR SCIENCE MONTHLY, \$3.50.
- RADIO WORLD and RADIO, (Los Angeles), \$3.50.
- RADIO WORLD and RADIO-CRAFT (12 issues), \$3.50.
- RADIO WORLD and RADIO INDEX (monthly, 10 issues), stations, programs, etc., \$3.50.
- RADIO WORLD and SERVICE (monthly), \$3.50.
- RADIO WORLD and EVERYDAY SCIENCE AND MECHANICS (monthly), \$3.50.
- RADIO WORLD and BOYS' LIFE (monthly, 12 issues), \$3.50.
- RADIO WORLD and TRUE STORY (monthly), \$3.00.
- RADIO WORLD and LIBERTY (weekly), \$3.00, U. S. only.

Select any one of these magazines and get for an entire year by sending in a year's subscription for RADIO WORLD at the regular price, \$2.50, plus a small additional amount, per quotations above. (Add \$1.50 for extra foreign or Canadian postage for both publications.)

Name .....

Address .....

City and State.....

- If renewing an existing or expiring subscription for RADIO WORLD, put cross in square.
- If renewing an existing or expiring subscription for other magazines, put cross in square.

Special Trial Offer for Radio World only: \$1.00 for 5 months. postpaid. Mail order with remittance to Radio World Office. NET.

**RADIO WORLD, 145 W. 45th St., New York**

# COILS for

## SERVICEMEN, SET-BUILDERS AND EXPERIMENTERS

- Shielded double tuned high-gain 175-456-465 K.C. I.F. trans. in square shields; size 3 3/8 x 1 1/2. Each ..... 85c
- Shielded double tuned IRON-CORE 456-465 K.C. I.F. trans. in square shields; size 3 3/8 x 1 1/2. Each ..... \$1.05
- Unshielded OSC. coils for 175-456-465 K.C. for use with .000365 var. cond. with or without tracking section; size 1 x 1/2. Each ..... 50c
- Padding cond., adjustable for 456-465 K.C.; latest type ..... 50c
- Padding cond. for 175 K.C., adjustable; latest type ..... 60c
- Four gang var. cond. .000365 with trimmers; small size. Each ..... \$1.95
- Unshielded Band-Pass (Pre-selector) Ant. coils for use with .000365 var. cond.; size 3 x 1/2. Each ..... 75c
- 2-GANG VAR. COND. .000365 latest bar type, no trimmers, for dual band sets. Each \$1.00

COILS FOR ALL TYPE CIRCUITS CAN BE FURNISHED IN MATCHED SETS.

Enclose 3c postage for free circuit diagrams of T.R.F. and SUPERHET. sets for home construction.

## RADIO DESIGN CO.

1353 STERLING PLACE, BROOKLYN, N. Y.  
Dept. 165RW

# MAILING LISTS



GET OUR FREE REFERENCE BOOK and MAILING LIST CATALOG

**FREE**

Gives names and prices on accurate guaranteed mailing lists of all classes of business enterprises in the U. S. Wholesalers—Retailers—Manufacturers by classification and state. Also hundreds of selections of individuals such as professional men, auto owners, income lists, etc.

Write today for your copy

## R. L. POLK & CO.

Polk Bldg.—Detroit, Mich.  
Branches in Principal Cities

World's Largest City Directory Publishers  
Mailing List Compilers. Business Statistics. Producers of Direct Mail Advertising.

# CHINESE COPY



An authentic reproduction of an imported lamp carton label. Due to lack of knowledge of the underlying design principles only 10% of such "Chinese copies" will pass Federal specifications.

*"Free from Engineering"*

As leaders in transformer development, the UTC Research Staff prides itself on the many revolutionary designs released during the last few years. It is only natural that competitive manufacturers copy these new developments. Some of these copies, however, have low efficiency and poor frequency response. Some have a new gadget, case or terminal arrangement to give the impression of originality, but which only detract from the simplicity and efficiency of the original design. The inferior characteristics of duplicates only bolster the progress of UTC... the line which is a year ahead.

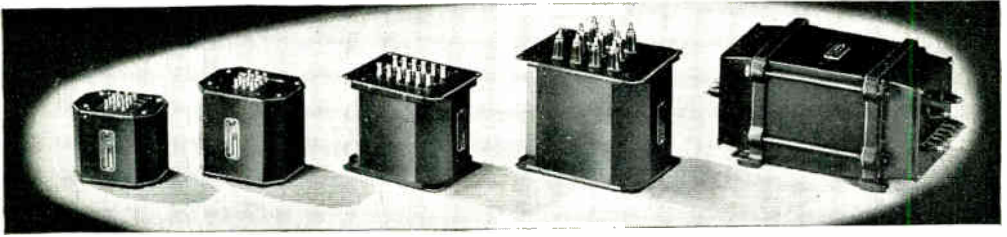

## VARIMATCH MODULATION TRANSFORMERS

UTC VARIMATCH Modulation Transformers Will Match ANY Modulator Tubes to ANY RF Load...

VM-0 Maximum audio output 20 watts	\$3.00
VM-1 Maximum audio output 30 watts	\$4.80
VM-2 Maximum audio output 60 watts	\$7.50
VM-3 Maximum audio output 125 watts	\$12.00
VM-4 Maximum audio output 300 watts	\$19.50
VM-5 Maximum audio output 600 watts	\$42.00

## VARIMATCH INPUT TRANSFORMERS

Varimatch Input Transformers will take care of Practically every driver requirement.

PA-50AX Single 89, 53, 56, 6C5, etc. to class B 53, 6A6, 89, etc.	\$3.30
PA-51AX Single 56, 6C5, 45, 59, 6L6, 2A3, etc. to class B 46, 59, 79, or A prime 42's, 45's, etc.	\$3.30

PA-52AX Push Pull 45, 59, 2A3, etc. to class B 46, 59, 841, etc. \$3.90

PA-53AX Push Pull 45, 59, 2A3, 6L6, etc. to class B 210, 801, 800, 35T, RK-18, 203A, ZB-120, etc. \$4.50

PA-59AX 500 ohms line to 805, 838, 203A, 210, 800, ZB-120, etc. \$4.50

PA-238AX Push Pull Parallel 45, 2A3, 6L6, etc. to push pull parallel 838, 203A, ZB-120, or to class B 204A, HF-300, 849, etc. \$10.50

PA-512 500 ohms line to class B, 150T, HF-300, 204A, etc. \$12.00

## PA VARIMATCH TRANSFORMERS

The new UTC PA Varimatch transformers will match practically any tube in their power range to a 200/500 ohm line or to any voice coil.

PVM-1 For all audio tubes up to 12 watts	\$3.00
PVM-2 For all audio tubes up to 30 watts	\$4.80
PVM-3 For all audio tubes up to 60 watts	\$7.50
PVM-4 For all audio tubes up to 125 watts	\$12.00
PVM-5 For all audio tubes up to 300 watts	\$19.50

## LINE VARIMATCH TRANSFORMERS

The UTC LINE VARIMATCH units will match any single or group of voice coils to a 500 ohm line. Impedance range is from .2 to 75 ohms in 50 combinations... UTC LINE VARIMATCH AUTOFORMERS will match one to ten 500 ohm lines or LVM 500 ohm windings to the 500 ohm output of an audio amplifier.

LVM-1 12 watt Line Varimatch unit	\$2.70
LVM-2 30 watt Line Varimatch unit	\$4.20
LVM-3 50 watt Line Varimatch unit	\$6.00
LVM-10 12 watt Line Varimatch Auto-former 500, 250, 167, 125, 100, 83, 71, 62, 50 ohms.	\$2.70
LVM-11 30 watt Line Varimatch Auto-former	\$4.20
LVM-12 60 watt Line Varimatch Auto-former	\$6.00
LVM-13 125 watt Line Varimatch Auto-former	\$10.80
LVM-14 300 watt Line Varimatch Auto-former	\$15.00

In addition to our complete stock of UTC components, we carry such nationally known products as National, Cardwell, Taylor, AmpereX, Hammarlund, Biley, Hallcrafters, RCA, etc.

## VISIT OUR NEW CAMERA DEPARTMENT

When in New York, visit our newly decorated and enlarged store... listen to all the new radio sets, see the latest developments... You are especially invited to inspect our new Camera Department. Should you have photographic equipment that you are anxious to trade in, we will offer liberal allowances on purchases of radio apparatus. Details can be furnished by mail.

**HARVEY RADIO COMPANY**  
103 WEST 43rd STREET  
NEW YORK, N. Y.

# NEW SQUARE METERS RUGGEDLY CONSTRUCTED RELIABLE • LOW COST

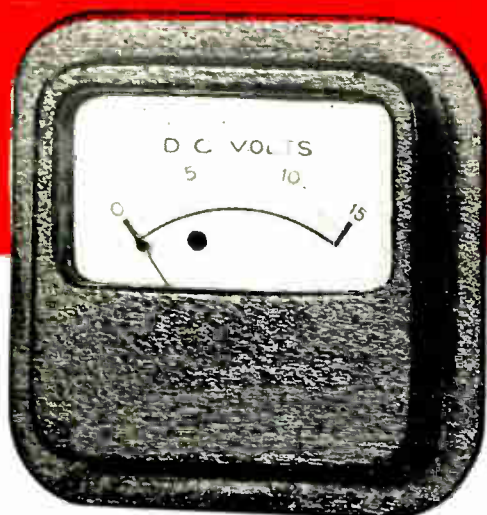

For amateurs, radio servicemen, soundmen, engineers, manufacturers . . . wherever reliability is desired at low cost.

Case Size: 2-9/16" x 2-5/8"  
3/8" in front of Panel  
7/16" in back of Flange

Voltmeters, ammeters, milliammeters, in all popular ranges—A.C. and D.C.

## MODEL 95 DEALER NET \$ .81 Only for 0-15 Voltmeter

This new line of meters has been developed by Readrite to fill the popular demand for square modernistic cases. Especial care has been taken to achieve the most suitable size and to give attractive proportions. Cases are finished in the black, baked enamel.

As in all Readrite meters this new line is ruggedly constructed and dependably accurate. D. C. are the polarized

vane, solenoid type; A. C. are the double vane repulsion type. Easy to read . . . black figures on white scales.

READRITE is one of the oldest manufacturers of meters and has done a consistent business over a long period of years with some of the largest manufacturers in the country. Readrite quality is thoroughly reliable.

# Readrite

TESTERS AND METERS

READRITE METER WORKS  
827 College Dr., Bluffton, Ohio

Without obligation please send me more information on  
..... Readrite Square Meters.

..... I am also interested in.....

Name .....

Address .....

City ..... State .....