

APRIL '37
25c Per Copy

LISTENERS' VOTING DEVICE

RADIO WORLD

REG. U.S. PAT. OFF.

'SCOPE WORKS IN BROAD DAYLIGHT (See Page 33)

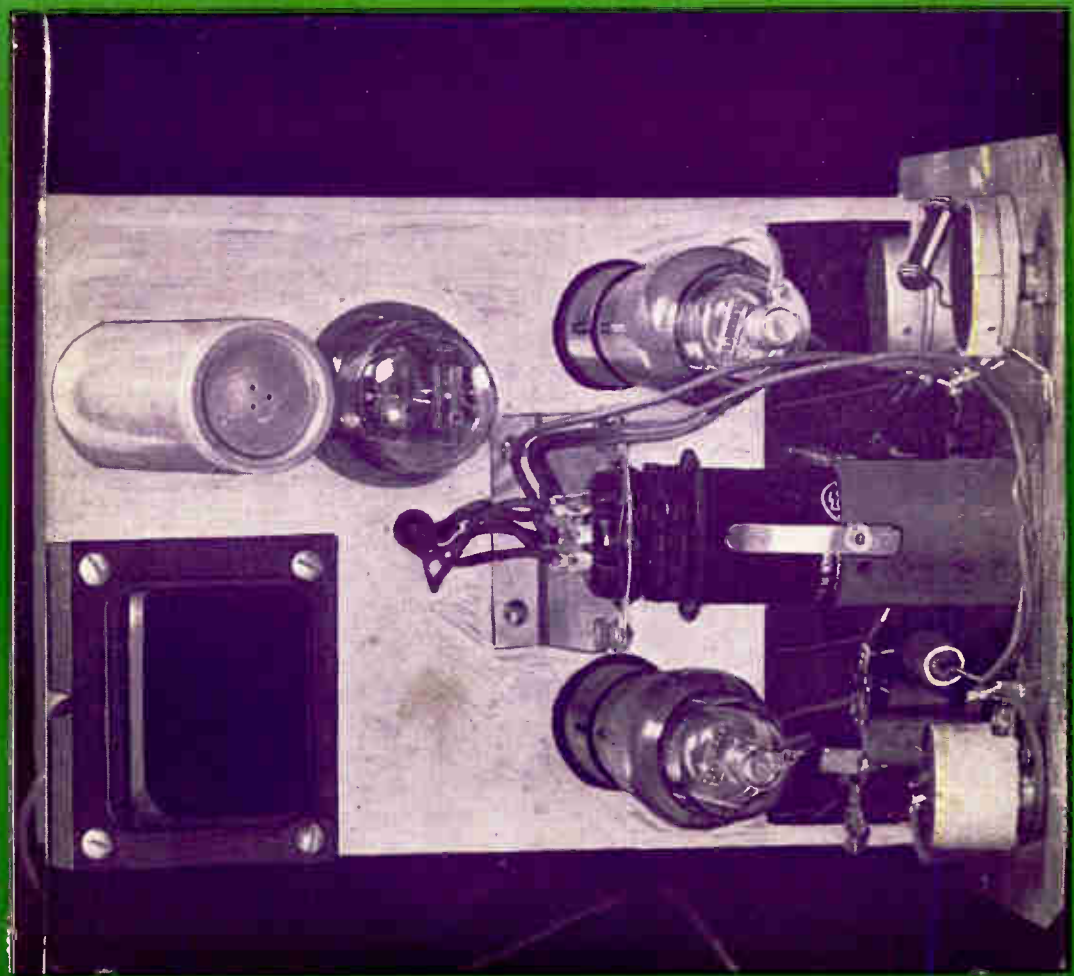

AN OUTSTANDING

INDUSTRIAL ACHIEVEMENT

TYPE TL



A bright achievement—the new Type TL condenser! New in design . . . new in construction, it is the proud inheritor of over a quarter of a century of Cornell-Dubilier specialization in condenser manufacture. For Type TL stands for something more than just a very fine engineering achievement. The INTEGRITY and VISION which is part of every product we make, is a part of it. It is this INTEGRITY and VISION which we believe will win universal approval for the Type TL, to maintain the Cornell-Dubilier

trademark as a "Badge of Honor"!

The Type TL capacitors are impregnated and filled with Dykanol and hermetically sealed in round aluminum containers. Designed for inverted mounting with one terminal insulated from the container and the other connected thereto. They also can be used in any position required, without affecting the unit available in a complete range from 600 to 1500 volts D.C. Complete information contained in catalog 135A free on request.

CORNELL-DUBILIER

CORNELL-DUBILIER CORPORATION

SOUTH PLAINFIELD, N. J.

READ THESE 8 True Experiences of Men I Trained at Home For RADIO



I NOW HAVE MY OWN RADIO BUSINESS AND AVERAGE \$55 TO \$70 A WEEK.
JAMES SKLAYOS
 333 THIRD ST.
 SAN FRANCISCO, CALIF.





I DO RADIO SERVICE WORK IN SPARE TIME AND AVERAGE ABOUT \$12.50 A WEEK.
J. B. MILBY
 BOX 95
 UTICA, MICH





AFTER COMPLETING TWENTY LESSONS I JOINED STATION WMPC WHERE I AM NOW CHIEF OPERATOR.
HOLLIS F. HAYES
 85 MADISON ST.
 LAPEER, MICH



I AM NOW FOREMAN OVER PRODUCTION OF RADIOS FOR THE W-----CORP
OTTO CLIFFORD
 312 W. SEMMERY ST.
 CHARLOTTE, N.C.

I AM EMPLOYED BY A RADIO STORE, AND EARNED ABOUT \$2,500 LAST YEAR.
CHARLES L. TORREY
 125 S. 12TH ST.
 SAN JOSE, CALIF.



AUTO RADIO AND N.R.I. TRAINING ARE A GOOD COMBINATION I AM BUILDING A FINE BUSINESS.
A.C. HENDRIKSEN
 125 S. MELROSE AVE
 ELGIN, ILLINOIS



MY LOUDSPEAKER SYSTEM PAYS ME ABOUT \$35 A WEEK, BESIDES MY RADIO WORK
MILTON L. LEIBY, JR.
 TOPTON, PENNA

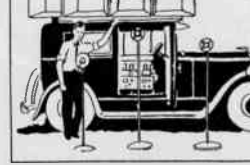

I AM NOW GROUND STATION OPERATOR FOR THE AMERICAN AIRWAYS, INC. AT CINCINNATI
WALTER B. MURRAY
 LUKKEN AIRPORT
 CINCINNATI, OHIO



I WILL TRAIN YOU AT HOME in Spare Time FOR A GOOD RADIO JOB



J. E. SMITH, President National Radio Institute

Many Radio Experts Make \$30, \$50, \$75 a Week

Do you want to make more money? Broadcasting stations employ engineers, operators, station managers and pay up to \$5,000 a year. Spare time Radio set servicing pays as much as \$200 to \$500 a year—full time servicing jobs pay as much as \$30, \$50, \$75 a week. Many Radio Experts own their own full time or part time Radio businesses. Radio manufacturers and jobbers employ testers, inspectors, foremen, engineers, servicemen, paying up to \$6,000 a year. Radio operators on ships get good pay and see the world besides. Automobile, police, aviation, commercial radio, and loud speaker systems offer good opportunities now and for the future. Television promises many good jobs soon. Men I trained at home are holding good jobs in all these branches of Radio.

Many Make \$5, \$10, \$15 a Week Extra in Their Spare Time While Learning
 Practically every neighborhood needs a good spare time service-

man. The day you enroll I start sending you Extra Money Job Sheets. They show you how to do Radio repair jobs that you can cash in on quickly. Throughout your training I send you plans and ideas that have made good spare time money for hundreds of fellows. I send you special equipment which gives you practical Radio experience—shows you how to conduct experiments and build circuits which illustrate important principles used in modern Radio sets. My Free Book tells all about this.

Find Out What Radio Offers You

Mail the coupon now for "Rich Rewards in Radio." It's free to any fellow over 16 years old." It describes Radio's spare time and full time opportunities, also those coming in Television; tells about my training in Radio and Television; shows you actual letters from men I have trained, telling what they are doing and earning; tells

about my Money Back Agreement. MAIL THE COUPON in an envelope, or paste it on a penny postcard—NOW!

J. E. SMITH, President
 National Radio Institute, Dept. 7DM4
 Washington, D. C.



MAIL COUPON NOW

THIS FREE BOOK HAS HELPED HUNDREDS OF MEN MAKE MORE MONEY

J. E. SMITH, President
 National Radio Institute, Dept. 7DM4
 Washington, D. C.

Dear Mr. Smith: Without obligating me, send "Rich Rewards in Radio," which points out the spare time and full time opportunities in Radio and explains your 50-50 method of training men at home in spare time to become Radio Experts. (Please Write Plainly.)

NAME.....AGE.....
 ADDRESS.....
 CITY.....STATE.....

AGAIN!

AN OUTSTANDING CHASSIS VALUE!

In response to the terrific demand for modern all-wave factory made chassis and in appreciation of the gratifying results on our previous offering, Thor represents these BRAND-NEW factory built receivers at an exceptional price and guaranteed 1 full year. Quantities are limited—Buy now and Save.

7 TUBE - ALL METAL - ALL WAVE SUPERHETERODYNE

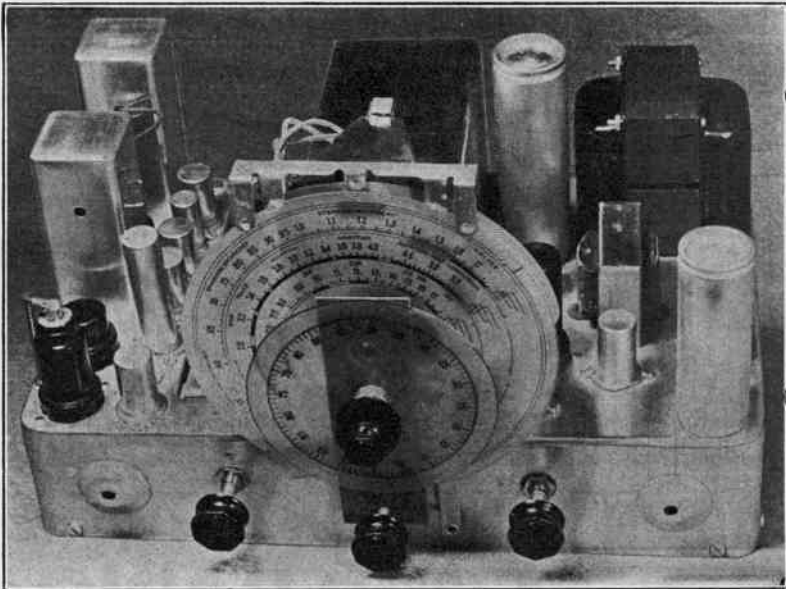

Photography by Herbert E. Hayden

A genuine ARVIN product, designed and produced by ARVIN, country's leading car heater and radio manufacturer whose merchandise is noted for solidity of construction and efficiency of operation. Chassis is of processed steel with full rubber-cushion mounting and measures 14½" long, 9" high, and 9" deep. Circuit is the latest development in all-wave superheterodyne with 3 full tuning ranges covering from 16 meters to 550 meters inclusive. This range tunes complete foreign broadcast, amateur, police, ship to shore, and standard domestic stations. Such features as: 3-gang condenser, pre-selection on all bands, driver audio system, automatic volume control, triple-tuned intermediate transformers, double filtering, and double antenna connections are but a few of its noteworthy design. Tuner, consisting of all-wave band switching coils and 3-gang condenser are fully shielded and mounted on separate chassis rubber-cushioned from complete chassis. Mechanical band-spread, separate dial-ratio 10-1 over main tuning, and Beam-lite range indicator all on complete celluloid disc illuminated from rear. Plate and mounting bolts furnished complete with chassis, 10" Dynamic speaker, and 7 metal tubes. 1-6K7, 1-6A8, 1-6K7, 1-6H6, 1-6F5, 1-6F6, 1-5Z4. Shipping weight, 35 lbs. Sold in chassis form only. Complete with tubes and spkr. Ready to operate. AC only

\$24.50

20% Deposit
required
on all mail
orders

THOR RADIO CO., Inc.

"Everything in Radio"

65 Cortlandt Street, New York City

Order
direct
from
this ad

Now



**TEN METERS WITH
NEW SUPER-PRO!**

- ★ TWO STEPS OF RF!
- ★ REAL SENSITIVITY!
- ★ REAL IMAGE REJECTION!

HAMMARLUND now announces a special "Super-Pro" receiver to cover from 7½ to 240 meters—that affords new outstanding results!

The new 7½ to 15 meter range in this latest model is the result of painstaking research and engineering, and is not just a casual makeshift! Two steps of R. F. amplification are used in this range as well as in the remaining four ranges from 15 to 240 meters. This provides an image rejection ratio of 150 to 1, and a sensitivity of 0.8 micro-volt (30% modulated) with a signal-to-noise ratio of 6 to 1 at 10 meters!

The 2,000 kilocycle span on the ten meter band is covered by 90 degrees of the band spread dial. Similar wide band spread is available on the other popular high frequency bands.

All of the popular features that contribute to the success of the standard 15 to 560 meter "Super-Pro" also have been retained in this model, viz.—direct tuning, accurately calibrated 3 to 16

kc. band-width panel control, graduated audio and sensitivity controls, calibrated beat oscillator control, 8 metal and 8 glass tubes, stand-by switch, AVC—manual switch, rugged self-contained tuning unit with trouble-free cam operated knife switch, variable crystal filter, etc.

Complete details on this model and the standard model, appear in a special booklet. Mail coupon below for your copy!

MAIL THIS COUPON!

HAMMARLUND MFG. CO., INC.		RW-4
424-438 W. 33d St., New York		
<input type="checkbox"/> Please send me new "Super-Pro" booklet. <input type="checkbox"/> Please send me new "37" catalog.		
Name	
Address	
City	State

HAMMARLUND'S 25TH YEAR



Superior Oscilloscope Complete with Amplifiers \$24.60

HERE is real news, hot news, spot news! A genuine cathode-ray oscilloscope, with built-in amplifiers, complete with five tubes, at only \$24.60. You've always wanted one, but it had to be good and it had to be inexpensive. The engineering staff of Superior Instruments Co. spent three months designing and perfecting this instrument, and now it is ready. And not only ready but *right!* And because of our adjustable insulating hood for the 913 the device may be used in broad daylight.

Here, at a glance, is what the Superior Cathode-Ray Oscilloscope provides:

CONTROLS

- 1—Focus, to get a sharp spot.
- 2—Intensity, to govern brilliance (line switch attached).
- 3—Saw-tooth range switch, five positions, for rough frequency selection.
- 4—Saw-tooth frequency vernier, for fine frequency selection.
- 5—Saw-tooth on-off switch.
- 6—Internal 60-cycle and external "any frequency" synchronization.
- 7—Vertical amplifier gain.
- 8—Horizontal amplifier gain.

INPUTS

- 1—For vertical deflection (red insulation for "high" side).
- 2—For independent horizontal input, when saw sweep is "off." Same color scheme.
- 3—For external synchronization.

GROUND POST

- 1—Connected to the totally shielding cabinet.



A fetching appearance marks the front view of the Superior Oscilloscope that sets the all-time record for lowest price of a complete oscilloscope with amplifiers. Cabinet is 7½" wide, 10" high, 10¾" front to back. Front panel is sloping. The 913 has an adjustable insulating hood enabling viewing in broad daylight.

Significant Results at Insignificant Cost

DESIGNED and manufactured with great care, the Model S-10 Superior Oscilloscope gives you the biggest break of your life! My, how service men and experimenters do need an oscilloscope! Flat-top peaking, distortion location and remedy, push-pull balancing, frequency, amplitude and modulation measurements—these and thousands of other uses establish the oscilloscope first among your new-equipment needs.

One of the simple tests of oscilloscope design is how finely the spot can be adjusted. Our focus control permits pin-point spotting! This is particularly important when using a tube like the 913.

The circuit permits grounding of the total-shielding cabinet at the zero d.c. potential and therefore insures 100 per cent safety in the device itself and to external circuits being analyzed.

Built-in is our special saw-tooth oscillator, feeding the horizontal amplifier. The saw-tooth oscillator's return trace is either invisible or negligible. And our own LC interlock makes correctly adjusted patterns stand still!

In a word, the refinements expected of expensive instruments are found in our nice new product, twice as nice because of the price. No longer need you deprive yourself of excellent service you really need. Order a Model S-10 now and service sets with it in broad daylight.

Model S-10 Cathode-Ray Oscilloscope, wired, tested and equipped with one 913, one 80, two 57's or 6C6's, and one saw-tooth sweep oscillator tube, in totally-shielding black wrinkle-finish metal cabinet, with sloping front panel and adjustable insulating hood for 913. Shipping weight 13 lbs. Net price **\$24.60**

SUPERIOR INSTRUMENTS CO.

136 Liberty Street, New York, N. Y.
Dept. 103

METAL CHASSIS

We can supply chassis for any make receiver, experimental or otherwise.

Inquiries should be accompanied with sketch and complete details enabling us to give quick service as to prices and delivery.

KORROL MFG. CO., Inc.

232 Greenwich St. Dept. RW-437 N. Y. City

The EXPERIMENTERS TREASURE HOUSE

Since 1923, we have been catering to the needs of Radio and Electrical Experimenters. From cat-whisker to television tubes, miniature motors, relays from 29c to \$6.50—photoelectric cells, neon lamps from 15c to \$1.50, in fact anything and everything you may need, in stock or know where to obtain for you. We have been shopping agents for well-known schools and institutions for many years, why not for you?

Headquarters for Parts—Since 1923

BLAN

THE RADIO MAN, INC.

W-177 Greenwich St., New York, N. Y.

NO CATALOGUE — BUT LOWEST PRICES

Can't figure it out?



**SERVICEMEN
YOU NEED
THESE 2
BOOKS**

MATHEMATICS of Radio Servicing

Introduces and explains the use of practical arithmetic and elementary algebra in connection with units, color code, meter scales, Ohm's Law, A.C., testing, wattage, series, parallel, mixed circuits, tubes, curves, D.B., etc., etc., and has numerous examples. Plainly written, easy to understand. M. N. Beitman, author. Size 8½x11 in.

PRINCIPLES of PUBLIC ADDRESS SYSTEMS

A practical handbook, fully illustrated, covering in detail the complete P.A. information. Practical data from Microphones to Loudspeakers. Latest circuits and explanations of amplifiers and systems. Written by M. N. Beitman, noted engineer authority on audio amplifiers.

Price, 50c each book.

SUPREME PUBLICATIONS

3727 West 13th St., Chicago, Illinois

WHEN WRITING TO ADVERTISERS
PLEASE MENTION THAT YOU SAW THE
ADVERTISEMENT IN RADIO WORLD.

SEE THE NEW AMATEUR GEAR

IN ALLIED'S NEW Spring CATALOG

EVERY AMATEUR AND RADIO BUILDER

156 PAGES OF INTEREST FOR Send for the new Spring 1937 ALLIED Radio Catalog—Join the Daily Hamfest! See:

NEW!

I.P.S. "RUBBER CRYSTAL"

The newest development in X-mitting accessories! Permits continuously variable frequency control with more output than the conventional X-tal oscillator. Can be used with any X-mitter.

NEW!

NATIONAL OSCILLOSCOPE

Essential equipment in every Amateur station! Features the RCA-913 tube having a one-inch screen. Efficient and low-priced, it permits checking X-mitter operation in accordance with the new FCC regulations.

NEW! UTAH X-MITTER

Build this inexpensive, dependable Add-A-Unit x-mitter! Operates on 20-40-80 and 160 meter bands. Start with the powerful 60 watt output C.W. X-mitter and build by easy stages until you have a complete ½ K.W. phone x-mitter—at low cost!

NEW! HALLCRAFTERS

"SKY-CHALLENGER"

One of the finest of the new Amateur Communications Receivers. Features five bands—40,000 KC to 535 KC—with no gaps; continuous electrical bandspread; iron core I.F.'s; air trimmed R.F.'s; single signal crystal action, etc. Low in price, high in quality.

EVERYTHING IN RADIO

The new ALLIED Catalog is packed with Everything in Radio!—10,000 exact duplicate and replacement parts; Amateur gear; Build-Your-Own kits; Test Instruments; Public Address; 50 new Knight Radios; books, tools, etc. For fastest service and lowest prices

—order from your Allied Catalog—
Radio's Leading Supply Guide!

FREE CATALOG



BUILD-YOUR-OWN
Write for Free parts lists. We can supply matched kits for building any circuit described in our radio magazine or handbook.



ALLIED RADIO CORPORATION

833 W. Jackson Blvd.
Chicago, Ill.
Dept. 16-D

Send me your new Spring 1937 ALLIED Catalog

Send me parts list for.....

Name

Address

City..... State.....

RADIO WORLD

Sixteenth Year

ROLAND BURKE HENNESSY
Editor

H. J. BERNARD
Managing Editor

HERBERT E. HAYDEN
Advertising Manager

Table of Contents for April, 1937

Device Lets Listeners Vote..... 9 <i>Set Owners Can Applaud Without Cost</i> By Percival K. Lumley	A Kit Type Converter..... 31 <i>Commercial Coil Assembly Used</i> By Gustave L. Klein
How to Make a Close Pointer.. 11 <i>Simple Index for Measuring Circuits</i> By Jack Tully	A Practical 913 Oscilloscope... 33 <i>Easy Sweep Oscillator a Novelty</i>
Television Draws Near..... 13 <i>Leaders Showing Clear Pictures</i>	Phase Angles Measured..... 36 <i>With Cathode-Ray Oscilloscope</i> By Leonard W. Walters
A 25-Watt Transmitter..... 15 <i>Using the 6L6 Beam Power Tube</i> By M. N. Beitman	Close Standards for Audio.... 38 <i>By Using Stations and Generator</i> By H. J. Bernard
Frank Facts on Aerials..... 17 <i>Including Limitations for Wide Coverage</i> By Thomas Waite and George V. DuBuc	High Attainment on 20-40 Mc.. 41 <i>New Super-Pro Described</i> By Donald Lewis
Elimination of Hum..... 20 <i>Types Analyzed and Remedies Given</i>	Right or Wrong?..... 43 <i>Six Tests of Radio Knowledge</i>
Parallel Output Boosts Power. 21 <i>Universal Set Uses Two 43's</i>	Full Analysis of Squeals in Supers 44 <i>With Remedies, Usual and Original</i> By H. J. Bernard
Capacity Voltage Division..... 22 <i>How to Meet Four Requirements</i>	Tradiograms of the Month.... 57
Valuable Formulas 25 <i>Symposium Begun Last Month Is Completed</i> By J. E. Anderson	Radio University 58 <i>General-interest Questions Answered</i>
	Forum 60 <i>Readers Have Their Day in Type</i>
	Life of William Dubilier..... 62 <i>Famed Inventor's Rise Described</i>

Vol. XXX, April, 1937. No. 1. Whole No. 703. RADIO WORLD, published monthly by Hennessy Radio Publications Corporation, 145 West 45th Street, New York, N. Y. Editorial and executive offices, 145 West 45th Street, New York, N. Y. Executives of RADIO WORLD: Roland Burke Hennessy, editor and business manager; H. J. Bernard, managing editor; Herbert E. Hayden, advertising manager. Officers of corporation: Roland Burke Hennessy, president-treasurer; Roland Burke Hennessy, Jr., vice-president; H. J. Bernard, secretary. Entered as second-class matter March, 1922, at the Post Office at New York, N. Y., under Act of March 3rd, 1879.

SUBSCRIPTION RATE

Price 25 cents per copy. Subscription \$2.50 per year (12 issues); \$1.25 per six months (6 issues); postpaid in United States and Possessions; \$3.00 per year, \$1.50 per six months, postpaid in all other countries. Remittance for foreign subscription should be by International money-order (postal or express) or draft against or discountable at New York bank.

RADIO WORLD is distributed by the American News Company and its Branches

Device Lets Listeners Vote

Wattless Power Key to New Invention

By Percival K. Lumley

VOTING by radio to determine the popularity of programs and to ascertain the desires of the public on national questions will soon be possible, if research work which Dr. Nevil Monroe Hopkins, former member of the faculty of New York University, has been conducting for several years, is finally successful in the field. If the devices now being perfected prove practical each radio receiver could be equipped with one, and any listener to a radio so equipped could instantly record his vote for or against any proposition at the request of the announcer or master of ceremonies.

The details of the invention have not yet been disclosed, but the basic idea has been known for a long time.

When the possibilities of radio voting were first investigated several years ago, a lamp of given wattage was turned on by each voter when the announcer made the request and was retained in the circuit for a few seconds. During this time there was a sudden increase in the power drawn from the line, and this increase was measurable at the power house by the usual meters on the instrument panel. Clearly, if all lamps thrown into the circuit were of the same wattage, the increase in power drawn would be directly proportional to the number of persons voting. Two such votes, one for and the other against, would in a few seconds register public reaction to any question posed.

WATTLess LOAD NOW

The lamp method of voting, however, did not prove practical because it took additional power from the line. It was pay load at the voters' expense and introduced such sudden and large loads that the power companies could not be prepared for such exigencies at all times, especially as radio use grew so fast. The cost to the voter, of course, was negligible, but the cost to the power company, even though it was paid for the power used, was prohibitive, for it required emergency equipment capable of handling large, momentary peak loads.

The latest method of voting by radio is based on an increase in the "wattless load" when the voter registers his stand on any question stated by the announcer. For the "wattless" load the voter pays nothing, as the wattless power is not registered on the user's watt-hour meter. Neither does it cost the power company much more, for even though a very large number of persons voted simultaneously there would be practically no increase in the power demanded of the power station. There would only be an increase in the current demand, current which did no work and hence which did not require

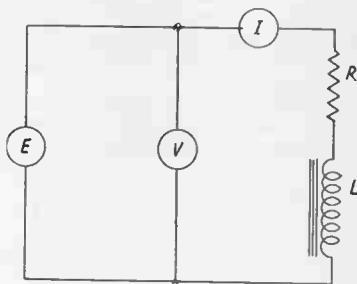

FIG. 1

Inductance and resistance in series. Such reactance the voting listener would cut into circuit.

additional generators. An item of increased cost to the power company would be the extra losses in the line as a result of the increased current, but these losses would be negligibly small compared to the added power required when a large number of lamps are suddenly thrown into the electrical circuit.

HOW IT CAN BE DONE

The "wattless load" can be increased by putting reactors into the line, and these reactors may be either condensers or high-grade inductance coils. A reactor draws current, but no power, provided that it does not also have considerable resistance. The current through the coil or condenser changes the power factor of the line, and this change can be measured at the power station.

Under normal conditions the power factor is maintained at unity, or as nearly so as possible, for this makes the line most efficient. All the load is then pay load. For a variable load it is not possible to keep the power factor at unity, but whatever it may be at a given instant a sudden change from that value can be determined by the instruments.

If the change is the result of the sudden insertion into the line of a large number of reactors of predetermined value per unit, the meters will measure the number of such units inserted. Thus if each voter inserts one unit, and if all voters of the same opinion vote simultaneously, the meters will register the number of votes cast. The result of a poll could be announced over the radio five minutes, or less, after the voting started. Even a national poll on a controversial political question, like the Supreme Court bill, could be quickly taken and announced.

(Continued on following page)

(Continued from preceding page)

Tampering with the votes would be quite easy for any one who understood electrical circuits and was bent on mischief. He could add more votes to his side than a dozen repeaters voting at the polls all day. He could even nullify the votes of others. Before any voting-by-radio scheme can be successful, a method must be worked out which precludes all possibility of tampering with bona-fide voting.

If and when the voting-by-radio system is installed, every power sub-station will be a polling place where all the voters in the district vote without going there. The meter readings of the sub-stations would then have to be transmitted to the broadcasting studio for final tabulation.

Two methods could be employed for registering the votes. One is to have the same reactor for both the affirmative and the nega-

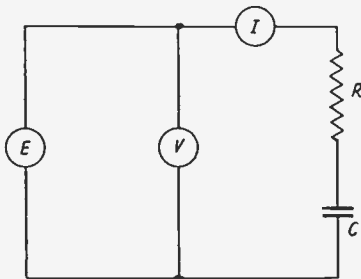

FIG. 2

Here instead of a coil a condenser is used for its "wattless power" effect.

tive votes, or one type of reactor for the affirmative and the other for the negative. In case the same type is used for both—and this would be the more practical way—the meter readings at the sub-stations would be the same in kind for both affirmative and negative votes and would differ only in amount, except in a tie vote.

In case different reactors are used for the two votes the readings at the sub-stations would be of opposite kind. For example, a positive vote would make the power factor greater and a negative vote would make it less. In case the phase angle is measured, a positive vote could make the phase angle positive and a negative vote could make it negative.

POSSIBLE METHODS

In Fig. 1 is a simplified circuit in which the load consists of a resistance R and an inductance L in series. Somewhere in the line, say at the power station, is an ammeter I in series and a voltmeter V in parallel with the line. A voltage E is acting in the line. The indicated power is VI, the product of the voltage and the current. The current is E divided by Z, or V divided by Z. Z is the square root of R² plus L²ω². But the power delivered to the line is Vicosθ, where θ phase angle and cosθ is the power factor. The "wattless power" is VIsinθ. θ is defined as the angle whose tangent is Lω divided by R, or by cosθ R ÷ Z or by

sinθ = Lω ÷ Z. Thus the smaller R is compared with Lω the larger is the wattless component.

Fig. 2 is the case when there is a condenser C in series with the resistance R. The same formula holds as for the inductance case if -1 ÷ Cω is substituted for Lω.

CONNECTION METHODS

The simplest way to insert the reactor is to put it across the line, just as any other device would be connected. Fig. 3 shows a condenser

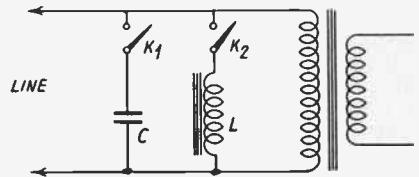

FIG. 3

Method for actuating phase meter for yea and nay.

and an inductance coil across the primary of the transformer supplying the receiver. If key K₁ is pressed down, the condenser C is put across the line, and if key K₂ is pressed down, the coil L is connected. Either one of these alone could be used. The original load will be nearly a pure resistance for most of it will be lamps and heating devices. Even the transformer in the radio set will look like a nearly pure resistance to the line. Therefore when either key is depressed a pure reactance is put across a pure resistance.

If R is the original load and X is the reactance put in shunt with it, the change in the phase angle will become such that the tangent is R divided by X. Thus it depends not only on the added reactance but also on the previous load. This, of course, will not be the same twice in succession, and for that reason the "total vote" will not appear the same even though it may be numerically the same. However, since the affirmative and the negative votes will be taken within a minute or less of each other, the resistance will not change appreciably between the two parts of the vote, and the ratio will be correct. This difficulty does not entirely preclude the possibility of determining

(Continued on following page)

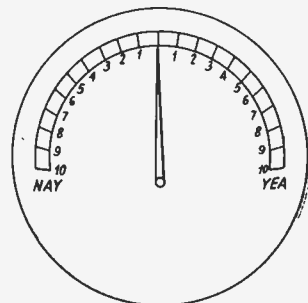

PHASE METER

A Close-Reading Pointer

Home-Made Device for Measurements

By Jack Tully

ONE of the problems that frequently confront an experimenter is to devise a pointer that will be close-reading and permanent. For measurement work particularly most pointers as found in commercial dials are inadequate. The specialized dials, such as constitute the line manufactured by National Company, of Malden, Mass., using fixed indexing and moving scales, are of course just the thing for very close readings and permanence of relative position.

For the impromptu development of a moving pointer, as where one has calibrated a scale, or desires to index a protractor for calibration purposes, quite a good job can be done by using the acetate base familiar to photographic film users, scratching a line on it, and affixing this pointer to a knob. Such a device is illustrated herewith, and is easily and quickly made. When certain precautions are exercised it does a very excellent job.

SCRATCHING TECHNIQUE

The first step is to line up the pointer carefully for the size to which it is to be cut, deciding whether it is to be a double pointer of a single pointer, i. e., index a scale that appears only above the central hole or also one that appears below. Then on the concave side of the slightly curling material the line is scratched, and this requires a little technique.

If a sharp cutting edge is used, as for instance a knife or safety razor blade, the ruler should be metal-edged, and should be held firmly in place, as the acetate, which is a transparent strip, is slippery, and the ruler will tend to slide. Some one should hold the ruler tightly to the acetate for you, as the whole operation is a three-handed job at least. Then when the scratch is to be made, the blade must be held exactly perpendicularly, to avoid a slanting cut that broadens the line, and this perpendicular position must be held for the full duration of the scratching.

The next operation is to fill in the scratch. While the act may be done with India ink, ordinary writing ink is not practical, and any ink suffers from the difficulty of unintentional removal from the groove when wiping off the excess. Therefore a colored pencil may be used, of the chalk or carbon type, but not wax. Then

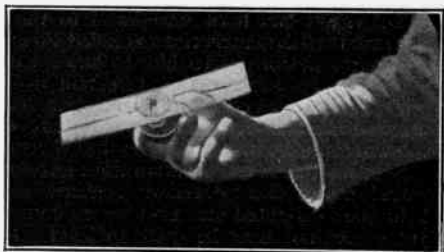

Transparent pointer, cemented to a wooden knob, permits accurate readings and permanence of position

the embedded deposit will remain when the surface marks are being effaced. The reason there are such marks is that the coloring is more easily made uniform when the penciling is done at right angles to the direction of the scratched line. A red line proves very distinctive and sharply indicating, which rules out carbon.

ROUGH TREATMENT NEEDED

Next a hole is cut or drilled large enough to pass any fixture on the knob to be used. Such a fixture is necessarily present as foundation piece for the setscrew. The knob preferably should be wood, as affixing the pointer then is easier, but Bakelite or other material, except hard rubber, may be used, if it is roughened sufficiently, as with a file or emery wheel.

If the hole is to be drilled, some one should hold the piece fast to the drill bed, so that the acetate does not climb up the drill when the drill is nearly through. If a circle cutter is used, the cut may be cleaner, for unless the drill is sharper than a long-used tool would be, the hole may take on a somewhat jagged appearance.

After the hole is made, a scribe, knife or similar tool is run along the intended outside of the pointer, in the long directions, a deep cut being made. Then the acetate may be bent back and forth, one side at a time, until the break occurs. It will be found that the break is clean, as they say in boxing. The shorter dimensions may be cut off very readily with scissors, es-

(Continued on following page)

(Continued from preceding page)

the number of voters. At any time the various meters in the sub-stations will tell just how much power is being drawn, which is equivalent to telling the value of R. If that is known

and the phase meter, or wattless load meter, shows what the change in the non-paying load is, it is possible to determine the number of voters. A graph could tell this without any computation whatever

Why Not Television Now?

CAUTION is exercised by those responsibly connected with television because it would be disastrous if the public were offered something tiring. Only those who have no authority to speak risk any prophesy as to when television will be offered to the public. The television developers themselves do not know the answer.

He who wants a fine dinner must wait until it is cooked.

Television has been introduced to the public before in a sadly makeshift state, by adventurers whose enterprise exceeded their probity. The less said about that the better.

Hungry patrons often like to know why they are being kept waiting. Probably a great many persons suppose that powerful radio corporations have conspired to postpone public television so as not to interfere with the present vast sale of sound receivers, and until massive storehouses of radio parts are depleted. The real reason why we do not have commercial television to-day is that the radio corporations do not want to go broke.

Suppose that a radio corporation introduced a television receiver, say, at \$350. The buyer would expect that television programs would be transmitted, and that the reception would hold one's delighted attention for an hour or more. That would be a reasonable expectation, yet it can not now be quite fulfilled. Programs will have to be more than merely experimental and informally disjointed.

To make the programs outstanding it is necessary to have them prepared and served up by persons of outstanding ability, and therefore, especially with scenic effects, the program cost will be enormous. Such a program lasting an hour might cost \$50,000. Whose \$50,000?

For bright pictures, with abundance of detail, transmission on high radio frequencies is required. The reliable penetration range of these frequencies is limited to much less than 50 miles. So a television program could not be disseminated over a wide enough area to serve a vast audience, or let us say, visience. These slower pulses are the cargo of pictures transported by the carrier. A means has been found to conduct the picture pulses by transmission line, particularly a wire inside a grounded cable, permitting the conducting of frequencies that have great width of variation. Some of this co-axial cable has been laid as part of the field work following most encouraging results in the laboratory. When some distance-traversing conductor actually is installed for carrying the television pulses then chain stations may resort to television just as readily as they do now to sound, though certainly not so nonchalantly for a while. Each station will use its own carrier, while the same cargo of shared picture pulses will be mixed with the individual carriers. The short range of the radio-frequency transmission then will not matter.

So receivers and stations go together. You have neither or both. The stations must have programs and channels and there must be an economic basis for everything.

(Continued from preceding page)

pecially if a rounded end is desired, or corners are to be sliced off for the sake of appearance.

Now on the side opposite to the one where the scratch exists; i. e., the convex side, about the hole, some cellulose cement is put, and the same is done on what is to be the companion position at back of the knob. If a wooden knob is used, since wood is absorbent, excellent sticking results are almost certain at the first attempt.

THE DRYING PROCESS

The cement on each piece is permitted to dry sufficiently to become tacky, then the two pieces are pressed together, and preferably left to dry under pressure. This need not be great, as too much pressure will squeeze out too much cement, so some light work with the vise will turn the trick.

The drying seems to be finished in a quarter of an hour, but beware! The two pieces are not stuck until the drying is utterly complete, and you might as well let that process take place overnight, or, if in a hurry, wait at least an

hour. How to wait an hour when in a hurry is beyond the scope of this article.

Now, if the pointer was trued up, its center coincides exactly with the center of the knob, and you have a useful device, which, when put on a condenser shaft far enough in to glide over the front panel, registers with no parallax, as the scratched line is right up against the scale that is to be read, and the concavity is removed by the grazing pressure.

It is interesting to note that the cementing is so successful that the acetate will tear before the joint will give. But don't be too hasty to try tearing the transparency, but test only whether the pointer can be peeled off with less pressure, mind you, than will tear the pointer!

The acetate base is manufactured by the Eastman Kodak Company and is commercially obtainable. The cement referred to, which is in general of the same material, is known commercially as Duco cement. While the acetate sheets are transparent, the cement is translucent.

There is no emulsion on the acetate, therefore the removal precautions necessary as when cementing movie film need not be taken.



The electric eye of the television camera is being held in the right hand by P. J. Konkle, Philco engineer. Below is the camera, manned by Charles Stee

**T
E
L
E
V
I
S
I
O
N

D
R
A
W
S

N
E
A
R**

The recent demonstration by Philco Radio & Television Corporation of its 441-line scanning, and 7½x10-inch black-and-white pictures, convinced members of the press that television has advanced considerably. While some refinements are necessary, it was obvious that technical attainment of commercial quality television pictures is close at hand.

The camera picks up the object, producing an image scanned by the electric eye. The resultant current pulses modulate the transmitter, while at the receiving end the process is reversed, i.e., the video separated from the radio frequencies, and scanned by a cathode-ray tube.

The receiver has provision for sound and picture reproduction. Philco's set has 26 tubes and 10 controls.



Television Matter of Months, Not Years, RCA Believes

In the seventeenth annual report to stockholders the Board of Directors of Radio Corporation of America says that television needs "additional experimentation" which must last "for some months to come," and strikes another optimistic note: "we are moving toward ultimate realization of satisfactory high-definition television for public service." The fact that the duration of experimentation is coupled with the word "months" instead of "years" was taken as significant. The report was signed by James G. Harbord, chairman, and David Sarnoff, president. The television part of it follows in full:

"RCA television was taken from the laboratory in 1936 for practical field tests under everyday working conditions. These tests are continuing with gratifying success.

"The tests began on June 29, 1936, on the basis of 343 lines to the picture. Later, those engaged in the research agreed that 441 lines would be a more desirable standard for ultimate public service. Accordingly, the new standard was adopted. Successful field tests on the new, 441-line standard have been in progress since January 19, 1937. The need for additional experimentation indicates that this work will continue for some months to come.

45-MILE EXAMPLE

"In the field tests now in progress, images of motion pictures as well as living talent are being successfully transmitted to approximately 100 receivers located in the homes of RCA technicians in the greater metropolitan area of

New York City. The distance over which these television programs have been received has exceeded our immediate expectations. In one favorable location programs have been consistently received as far as 45 miles from the television transmitter.

"The tests have been highly instructive. Much has been learned about the behavior of ultra-short waves and how to handle them. More is known about interferences, most of which are man-made and susceptible of elimination. The difficulties of making apparatus function efficiently outside the laboratory are being surmounted. The technical fundamentals of our system have been confirmed. Theory has been put into practice, and the experience gained thereby is enabling the laboratories to chart the needs of a practical television service.

NETWORK IS PROBLEM

"A major problem in television is that of network program distribution. The present facilities for distributing sound broadcasting cover the vast area of the United States and serve its 128,000,000 people. Similar coverage for television programs in the present state of the television art would require a multiplicity of transmitters and network interconnections by wire or by radio facilities still to be developed.

"The field tests are not completed, but the capabilities of the RCA television system are being constantly expanded, and we are moving toward ultimate realization of satisfactory high-definition television for public service."

A 441-line demonstration is expected.

Decibel Equivalents of Ratios

The following table gives the numerical value of power, voltage and current ratios corresponding to particular numbers of decibels:

Power Ratio	Decibels
1	0
1.259	1
10	10
100	20
1000	30
* * *	

Voltage or Current Ratio	Decibels
0.001	60.
0.005	46.02
0.01	40.

Voltage or Current Ratio	Decibels
0.05	26.02
0.1	20.
0.2	13.98
0.5	6.02
1.0	0.00
1.5	3.52
2.	6.02
5.	13.98
10.	20.
20.	26.02
50.	33.98
100.	40.
500.	53.98
1000	60.

A 6L6 Transmitter

Simple Circuit for 25 Watts Output

By M. N. Beitman

Engineer, Radolek

THE new type 6L6 beam power tube has been tried for transmitting purposes since the day of its birth by a large number of active amateurs. The results reported definitely proved the adaptability of the beam principle for transmitting-tube requirements. A few additional tubes have been released along the lines of the 6L6 and recently a leading tube manufacturer announced two new "beam" tubes of higher power rating especially designed for transmitting use.

A simple 25-watt transmitter was evolved after considerable experimentation by the trial and error method. The transmitter uses two 6L6's in the triode oscillator and doubler-buffer stages. (The second stage may be considered final and coupled to the antenna).

The transmitter is easy to build, uses inexpensive parts, and requires a few simple adjustments for correct operation.

Plug-in type inductances are in all the stages. This enables efficient changing from one frequency to another. If the transmitter is to be used on the actual frequency of the crystal,



The power transformer is at right and the B choke at left in this rear view of the 25-watt 6L6 transmitter. Plug-in coils are used. Winding data appear at bottom of this page.

coil L should be shorted out. Complete coil data are given in the table.

CONTRASTY TREATMENT

The final model illustrated was built on a sturdy metal chassis. The panel is made of three-ply wood for economy, and the front is painted with aluminum paint in contrast to the black dials and the cases of the meters. A red bull's eye indicates when the power is on.

This two-stage unit may be used as a complete transmitter for 'phone, or c.m. or may be employed to excite a larger final amplifier. For 'phone work a modulation transformer should be used to couple the audio amplifier to the transmitter. The transformer should be connected in the B plus lead to the final tank coil L₂.

(Continued on following page)

COIL INFORMATION

All coil forms: 1¼-in. diameter, 1½-in. long

Band in Meter	L in Turns	L ₁ in Turns	L ₂ In Turns
20	13	13	15
40	20	20	23
80	42	42	47
160	60	60	66

Use No. 18, or 20 plain enameled wire. Close-wound coils are intended. Output is a 2-turn coupling link near L₂, on the same form.

The transmitter (top) and power supply (bottom).

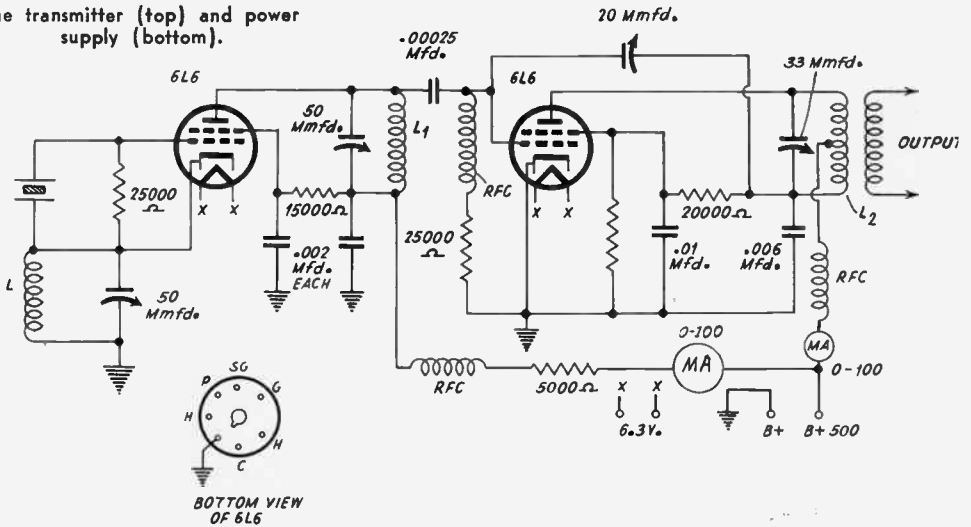

Transmitter

- Two .002 mfd. mica
- One .006 mfd. mica
- One .00025 mfd. mica
- One .01 mfd. paper, 600 v.
- Two 50 mmfd. variable, midget
- One 33 mmfd. variable transmitting type
- One 20 mmfd. variable midget
- [Fixed condensers products of Cornell-Dubilier]
- One 25,000 ohms, 1/4 watt
- One 15,000 ohms, 2 watts
- One 25,000 ohms, 1/2 watt
- One 5,000 ohms, 10 watts
- One 20,000 ohms, 10 watts
- One 30,000 ohms, 10 watts
- Two 1000 m.a. meters
- Two Octal sockets
- One 5 prong socket for crystal

- One crystal in holder
- Coil forms (L₂ is 6L6 plate tank coil)
- Three 4 prong sockets for coils
- 3 R. F. choke coils
- Chassis, panel, wire, etc.
- Tubes: Two type 6L6, or two glass type 6L6G

Power Supply

- One power transformer, 105-115 volt primary, H. V. secondary, 5 v. @ 3 amp., and 6.3 v. at 1.5 amp.
- One four-prong socket
- One type 83 tube (or type 5Z3)
- Two chokes, 250 ma capacity, swinging type recommended
- Two 8 mfd. 550 volts Cornell-Dubilier electrolytic condensers
- One 20,000-ohm, 10-watt bleeder resistor.

(Continued from preceding page)

A standard design choke-input power supply is used with either type 83 or 5Z3 rectifier tube. Choke input is included, to give superior regulation. The chokes should be of the low resistance type and capable of carrying 250 ma of current without overloading.

Two 8 mfd. electrolytic condensers are used in the filter. Since these condensers operate

at fairly high potentials only the best units should be employed.

For the ham who wants an inexpensive, easily constructed and adjusted transmitter this rig should prove attractive. You can use this unit for a regular transmitter in the 25-watt class, and add at any later date a final stage of greater power, using a hundred watts then, or even more.

Frank Facts on Aerials

Including Limitations for Wide Coverage

By Thomas Waite and George V. Du Buc

Douglas Radio

MANY radio fans have become antenna conscious—matched antenna conscious. They are desirous of taking advantage of the many developments in this field in recent years. They understand that an antenna that incorporates all the latest scientific improvements does not cost much, that it is only a matter of getting the right constants, such as number of turns on a transformer, size of wire, height above something or other. Sometimes it is also to have mysterious property which only the esoteric few are able to utilize, but which makes all the difference between advertised and actual performance.

Scientific antenna design is something for the radio amateurs and designers of stations to worry about. When the antenna is designed for a single frequency, whether it is for reception or transmission, then it is of first importance to design the antenna properly for that frequency. Impedances can be matched and circuits can be tuned with great improvement in the efficiency. But when the antenna is intended for use with an all-wave receiver there is very little sense in making any precise adjustments, if any at all are possible.

WHAT IS RIGHT?

What, for example, is the correct design of an antenna that is to be used on a receiver that tunes in all frequencies from 530 kc to 60 megacycles? Is the design to be based on the mean frequency in this vast range? If it is, the antenna will be absolutely correct for the mean frequency and no other. It will be nearly right for a narrow band of frequencies about the mean. It will be virtually useless at the extreme frequencies. Sure, signals will be picked up with it.

If the receiver is sensitive enough it does not take much of an antenna to pick up signals strong enough to overload the power tube. But there is no need for worrying about the proper design of such a pick-up. Attach a wire to the set and see that it is not grounded at both ends or that it is not completely inclosed in a grounded cage or box. That wire will be adequate, if the receiver is as sensitive as most receivers now are. If a long wire is attached to the receiver and strung up in the air, that wire will be a more effective pick-up just because it is exposed to the incident radio waves over a greater vertical distance. It will not be tuned to all the frequencies covered by the all-wave tuner, but it will be tuned to just about as many, provided it is not too long.

One thing that can be done to advantage is use a transmission line from the exposed part of the antenna high on the roof down to the set

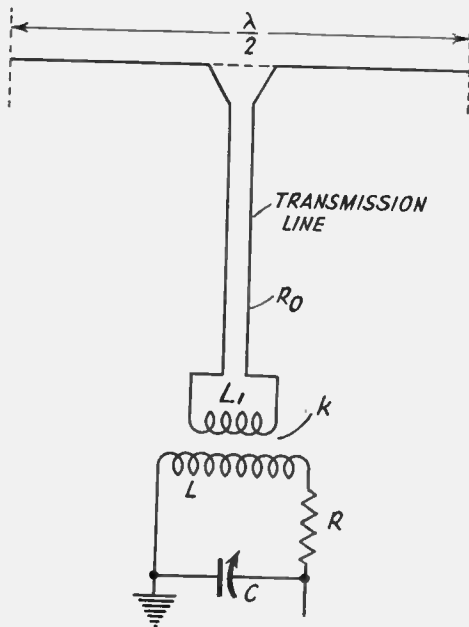

FIG. 1

A half-wave antenna connected to the first tuned circuit in the receiver by means of a transmission line. The triangular flare at the top matches the line impedance to that of the antenna and the coupling coefficient k matches the line impedance to that of the tuned circuit.

This line will not pick up so much of the electrical noise which is always present in a tall building as will a single wire lead-in.

PERMITS HIGH ANTENNA

The line does not increase the strength of the signals picked up. If it did it would not be effective in excluding stray noises. But indirectly it does help in this respect because it permits mounting the real antenna high up in the open where it is exposed to radio waves. If the line were not used, and if the antenna were erected in the same apartment as that in which the set is placed, very little radio energy would be picked up because of local metallic screens and grounds.

Suppose a long line is necessary. What kind of line should be used? In very noisy locations the line should preferably be of the concentric conductor type, with the sheath grounded at

(Continued on following page)

(Continued from preceding page)
 intervals. This is most effective in excluding strays. In place of the concentric line a two-conductor cable with a grounded metallic sheath could be used. Such cables exist. Next to the concentric conductor or the sheathed twin-conductor line, a twisted pair line is the best for excluding strays.

There are different types of twisted pair,

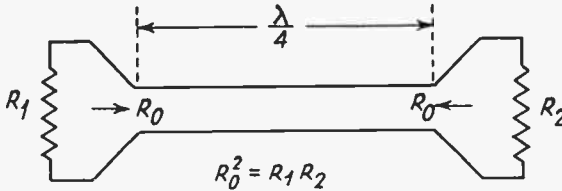

FIG. 2

A quarter-wave transmission line of resistance R_0 acts as a matching transformer between two resistances R_1 and R_2 . The matching "ratio" is right when the line resistance equals the square root of the product of load and source resistance.

some especially made for radio transmission lines. They are constructed so that the losses are low. But ordinary twisted pair such as is used for lamp extension cords is not so bad. In the class of twisted pair comes the transposed parallel wires. In so far as excluding stray noise is concerned, it is not as good as ordinary twisted pair, since it is more open to strays, but it is superior in respect to losses.

EASY GOING

Losses in the line become of some importance when the length of the line is several wavelengths. The parallel wire line, not transposed, is a great improvement over a single wire, but it picks up more noise than the transposed line. The close-twisted pair line is easiest to run from the set to the antenna. It can easily be bent around corners when that is necessary, and it is easy to anchor to walls.

One question that always arises is how the

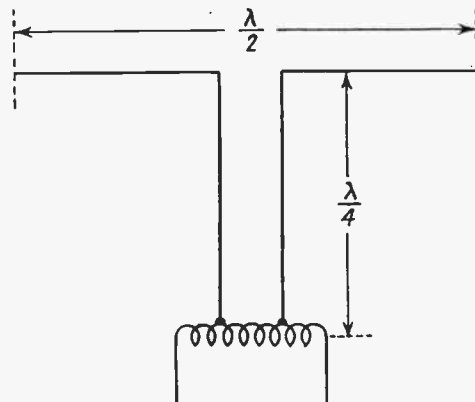

FIG. 3

Here a quarter-wave matching section is used between a half-wave antenna and the coil of a tuned circuit. The matching here can be done either by varying the turns between the two connections on the coil or by varying the distance between the two line conductors.

it does not make a great deal of difference, for the variation in line resistances is not wide.

If there is a tuner in front of the first tube we naturally wish to take advantage of it, not only because of the added selectivity which accrues but also for the added sensitivity. In this case the best way of coupling is by mutual inductance. The line is terminated in a few turns of wire which are placed on the form

line is to be coupled to the receiver. It cannot be answered without making assumptions regarding the kind of receiver. If the grid of the first tube in the set is accessible, one way of making the connection is to connect the line directly to the tube and use a grid leak, across the line, equal to the characteristic resistance. This is more suitable for lines of high than of low characteristic resistance. But really of the tuned winding. The question now arises as to the number of turns.

AN ANSWERLESS ANSWER

The answer, which is really no answer, is that the effective ratio of turns should be such that there is a match between the line resistance and the tuned series resistance of the circuit. Why is it no answer? Because we do not know the resistance in the secondary circuit. It varies throughout each tuning band, and it varies for each coil. Incidentally, it would be necessary to provide a switch for connecting the line to different coils, and that is not so desirable.

The best way of getting a match is by trial and error, until maximum response obtains, which may be done at the mean frequency in each tuning band, by varying the coupling. It might pay to add a tube so that the line can terminate in a fixed grid leak of correct value and then to couple the plate of the tube, through a suitable isolating coupler, to the regular antenna post on the receiver.

Another alternative for the resistance coupler is to use a fixed transformer. The coupling of this transformer should be as tight as it can be made, and the ratio of the primary to the secondary inductances should be the same as that of the characteristic resistance, R_0 , of the line and the grid leaks resistance, R . In other words, $R_0 L$ should equal $R L_0$, in which the subscript refers to the primary. The difficulty here is to get a coupling transformer that is effective over a wide range, or that has so close coupling that there is no leakage.

WHICH FREQUENCY TO SELECT

At the antenna end there is less uncertainty. The antenna must be of a certain fixed length.

It may be vertical or horizontal. In either case the conductors will resonate at only one frequency if it is to act at its fundamental mode only. At the frequency of resonance we can match the antenna to the line that feeds it. It can be done in one of several ways. A line can be selected which has the same surge resistance as the impedance of the antenna, measured at its center point. If there is a slight mismatch it may be corrected by spreading the last few inches of the transmission line, that is, provide a short length of line with tapered characteristics.

What should the frequency be at which the antenna is resonant and at which the pick-up system as a whole is most effective? It should be the highest frequency to which the receiver tunes, or which is like to be tuned in with any regularity. Because the sensitivity of the receiver gradually decreases as the frequency increases, and therefore matching at the highest frequency tends to equalize conditions. It is admitted that almost any kind of antenna is all right in the broadcast band, as long as it does not pick up a lot of noise locally, for the signals are very strong and, in a superheterodyne, the oscillator is strong in this band.

As the frequency goes up, reception conditions become less favorable. The inductance-to-capacity ratio is decreased, the intensity of the oscillator becomes less, the resistance in the

tuned circuits greater, signal strengths from stations weaker.

A PRACTICAL CASE

In a typical installation the antenna was of the horizontal doublet type, 20 feet each side of the center, 10 feet above the roof, and 30 feet of twisted pair transmission were used to conduct the pick-up to the receiver. No information as to the height of the antenna above the ground, either effective or actual, is available, but it will be assumed that it was 30 feet.

Since the antenna had 20 feet each side of center, half a wavelength of its natural mode of oscillation is 40 feet, and a full wave 80 feet. Five per cent will be allowed for end-effect. The actual wavelength is therefore 84 feet. This is equivalent to 25.6 meters, or 11,250 kilocycles.

The assumed height of the antenna was 30 feet, which is .305 of one wavelength. At this height the resistance at the center of the antenna is 95 ohms. If a transmission line of 72 ohms is connected to the center directly there will be considerable mismatch. Hence it will be necessary to taper a short distance. If the tapering takes the form of an equilateral triangle the length of each side should be nearly 12 inches.

The insulation at the bottom of the V of the taper should be as good as possible, and it should be waterproof. In wet weather water will run down the sides of the triangle and will keep the croch wet. If the insulation is not waterproof some water will seep into the line and permanently damage it.

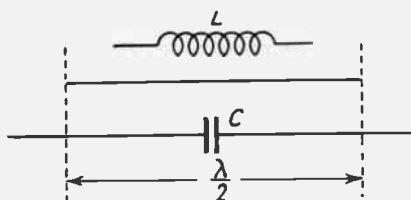

FIG. 4

An antenna can be "lengthened" by inserting a loading coil and "shortened" by inserting a condenser. Thus each of the three conductors in this figure is resonant to the same wavelength.

DESIGN MANUAL ISSUED

A tube and radio test instrument Design Manual, 60 pages, has just been released by Supreme Instruments Corporation, Greenwood, Miss. The manual describes meters and circuits used in the present line of Supreme instruments.

FIG. 5

A Zeppelin voltage-fed antenna. One conductor of the quarter-wave line is connected to the end of a half-wave antenna. The high impedances at the junction match. The condensers are used for tuning the quarter-wave line.

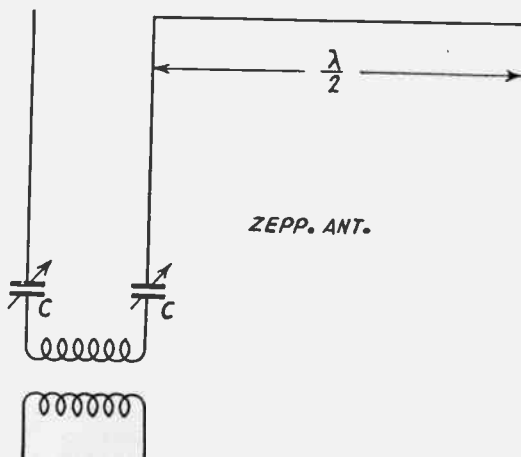

-And All Hum Disappeared!

How to Justify That Happy Boast

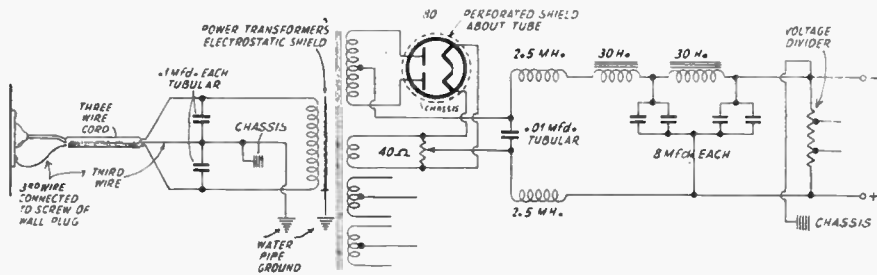

Methods of eradicating general and special causes of hum

ONE of the exasperating "bugs" the radio experimenter often encounters in his work is that nuisance vaguely labeled "hum."

While hum in the output of a receiver is not usually a serious offense, it sometimes can become quite annoying, particularly in high-fidelity or DX work.

The causes of a 60-cycle hum (or some harmonic of it) can be listed in an elementary fashion as follows, receiver defects:

(a)—An annoyingly peculiar hum which increases in intensity as a station carrier is tuned in (tunable hum), which is sometimes very difficult to eliminate in small receivers.

This is caused principally by a secondary r-f signal which gets into the receiver through the a.c. power line and is modulated by the 60 cycle current.

(b)—A constant hum which manifests itself over all the wave bands. This, of course, is the result of insufficient filtering at the power pack.

(c)—A variable hum which increases in intensity as a circuit is tuned towards the higher frequency end of any particular band. This particular hum is more a symptom of a fault than a fault in itself, and is caused by mild oscillation of the r-f circuits.

(d)—Individual hums which modulate the carriers of various transmitters slightly. This type of hum is of course the stations' own hum, caused by a ripple in the plate supply of its power units. Nothing much can be done about this, outside of a comment in a DX report.

Looking at the power pack diagram the reader will see how the two important causes of hum are eliminated, i.e., types (a) and (b).

Starting at the wall socket, the first thing is a bit of a novel stunt. A *three-wire* cord is employed instead of the universal two-wire cord. This third wire serves a three-fold purpose. Since it connects the chassis of the power pack

to the grounded wall plate, it shields the electric cord from r-f currents. It helps the two .1 mfd. tubulars to by-pass r-f signals coming in through the power source. It adds an auxiliary ground to the receiver, an important consideration in DX work. The wall plate grounding, mentioned above, is due to connection of the BX cable to ground as part of the house wiring installation.

Next the two .1 mfd. tubulars and the electrostatic shield between the power transformer's primary and secondaries do their bit to squelch r-f signals.

Then come the two 2.5-millihenry chokes and their associate .01 mfd. tubular condenser. These choke back and by-pass any r-f current getting past the other precautions.

Then we have the perforated metal shield about the power tube. This is a bit difficult to explain, and perhaps in ninety-nine cases out of a hundred it is absolutely useless. But then many experimenters have found cases of hum which were reduced considerably by simply shielding the power tube after other things have failed. This is especially true of small, partly-shielded regenerative type of receivers. The hum pickup may be supposed due to an electrostatic field from the rectifier tube modulating the stray field of r-f in the set.

Finally we come to the power filter section. The consideration here lies in one little word—capacity—and plenty of it. Four aluminum canned 8 mfd. electrolytics distributed between the two 30-henry chokes as shown will squelch the ripple out of the filtered d.c. effectively enough so that the constructor will have to bury his head in the speaker cone to detect any hum.

In the case where a power transformer has no center tap on the 80's filament winding. (Continued on following page)

Capacity Voltage Division

How to Meet Four Basic Requirements

By Engineering Staff, Aerovox Corp.

THERE are many cases where a capacity voltage divider is preferable to a resistance voltage divider. This may happen in applications of voltage dividers to cathode-ray oscillographs, vacuum-tube voltmeters or the attenuators for signal generators. The capacity type is often of greater advantage where high-frequency signals must be attenuated or when the frequency varies over a wide range.

A good voltage divider must satisfy the following requirements:

1. The step-down ratio must be constant regardless of the amplitude of the applied voltage or the frequency.

some series resistance but they introduce similar effects to a much lesser extent.

The most general type of capacity voltage divider is shown in Fig. 1. This is a circuit designed for use in connection with a cathode-ray oscillograph for observing the wave shape of ignition spark discharges. In this case it is required to make oscillograms of transient voltages between the points P and Q when both P and Q have potential differences with respect to ground and the circuit is not balanced with respect to ground.

What conditions have to be fulfilled to obtain at the points X and Y voltages which bear

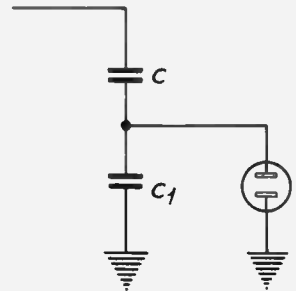
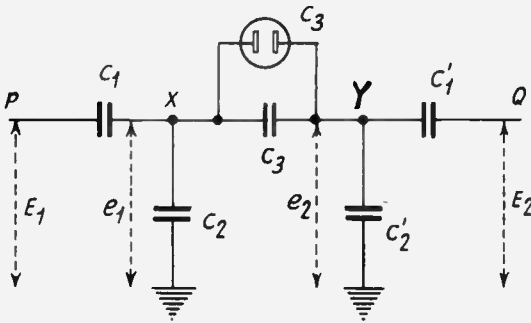

FIG. 2

2. There must not be any phenomena of natural oscillation in any part of the circuit, discrimination and resonance effects, especially at high frequencies. Condensers usually have

a constant ratio to the potential difference existing between the points P and Q? It is beyond the scope of this article to go into details regarding the derivation, but the voltage e between X and Y is given by the equation

$$e = e_1 - e_2 = \frac{(E_1 - E_2) \left[C_1 C_2' + \frac{C_1 C_2^2 + C_1^2 C_2}{2} \right] + \frac{E_1 + E_2}{2} [C_1 C_2^2 - C_1^2 C_2]}{(C_1 + C_2) (C_1^2 + C_2^2 + C_2 + C_2^2) + (C_1^2 + C_2^2) (C_2 + C_2^2)}$$

3. The divider must reduce the voltage to the required level; low enough to come within the range of the measuring instrument.

4. When used in connection with measuring instruments, the addition of the voltage divider should not change the characteristics of the circuit appreciably.

OSCILLOSCOPE APPLICATION

The resistance type of attenuator often fails in the first requirement because the stray capacity of the leads introduces undesired pickup, while many resistors have appreciable inductance. Thus the attenuator introduces frequency

This expression shows that the voltage between X and Y is not only dependent on the potential difference between P and Q but also depends on the average potential difference between P and ground and between Q and ground.

OBJECTION ELIMINATED

In order to eliminate this objection we must make

$$\frac{E_1 + E_2}{2} (C_1 C_2^2 - C_1^2 C_2) = 0$$

or

$$C_1 C_2^2 - C_1^2 C_2 = 0 \qquad \frac{C_2}{C_1} = \frac{C_2^2}{C_1^2}$$

The first equation can then be simplified so as to give the reduction factor K in terms of the condenser values.

$$K = \frac{E_1 - E_2}{e_1 - e_2} = \left[1 + (C_2 + C_1^2) \left(\frac{1}{C_1} + \frac{1}{C_1^2} \right) + \frac{C_2}{C_1} \right]$$

Most readers will have little need for such a complicated circuit as Fig. 1. Those who are

A similar divider system may be used in connection with a vacuum-tube voltmeter but here it becomes necessary to close the grid circuit by means of a leak. In general, the connection of a grid leak across C_1 as in Fig. 3 will result in frequency discrimination but it can be kept to a minimum if the proper values are chosen.

SIMPLIFYING THE APPLICATION

If the error is to be kept below 5% the resistance of the grid leak should be at least three times the impedance of the condenser at the lower frequency to be observed. To keep the error to less than 2% the grid leak should have five times the impedance of the condenser C_1 . These figures can be found for any combination of resistance and capacity in parallel by means

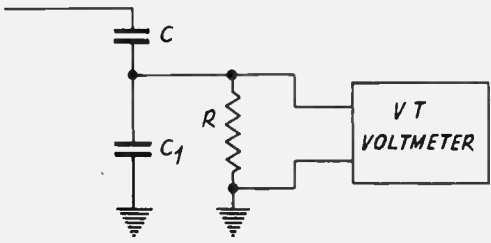

FIG. 3

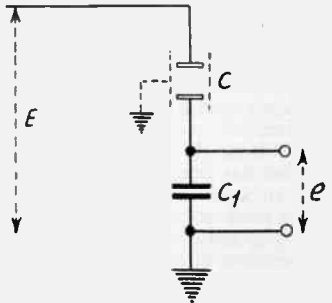

FIG. 4

interested can find a complete treatment in an article entitled "Voltage Dividers for Cathode-Ray Oscillographs," by M. F. Peters, G. F. Blackburn and P. T. Hannen, in the Bureau of Standards Journal of Research, Vol. 9, RP460.

The usual small cathode-ray oscillograph has one of each pair of deflecting plates connected to ground. This greatly simplifies the circuit and it now becomes like Fig. 2. Usually, the capacity between the deflecting plates is small compared with the capacity C_1 and the reduction factor then becomes

$$K = \frac{C}{C_1 + C}$$

This ratio will remain the same for all frequencies so long as the circuit contains nothing but capacity.

of the chart published in the Aerovox Research Worker for January, 1936.

Designers of signal generators have had much difficulty constructing an attenuator which would work at high frequencies. The usual resistance type ladder attenuators have not proven satisfactory for short waves, due to stray pick-up. The cheaper attenuators employed in serviceman's oscillators frequently do not work at all at high frequencies. In such cases the capacity type or mutual-inductance attenuator solves the problem. The capacity type of attenuator again consists of two condensers in series but now the attenuation ratio must be variable, which means that one of the condensers must be variable. Besides, the minimum-to-maximum capacity ratio must be large enough so as to provide considerable amplitude range.

(Continued on following page)

FIG. 5

The plunger type condenser, utilizing a grounded cylinder. The attenuation is 20.9 db per radius of displacement, reduction to 1 microvolt even at a frequency as high as 20 mc.

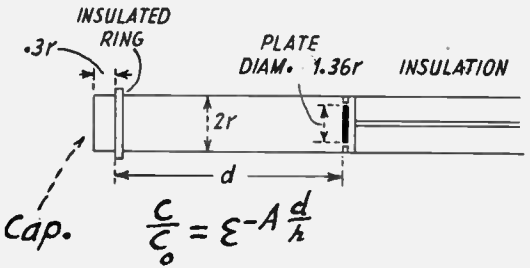

(Continued from preceding page)

when R_x is in the circuit in series with R_o . The limiting resistor should be adjustable over a small range to compensate for variations in the internal resistance of the battery. Before each time a measurement is to be made the resistance should be adjusted until the current I_m when R_x is shorted reads full scale. The resistance of the meter is negligible, but whatever its value, it is a part of R_o . These two formulas can be used for designing ohmmeters. Formula (5) determines the limiting resistor and the (6) the added unknown resistor. It is customary to make a scale from the second equation and to attach this directly on the milliammeter, thus making a direct-reading ohmmeter.

This formula is suitable for measuring resistances from about 500 ohms up to 100,000 ohms, the practical limits being determined by R_o , since this enters as a factor. If the same meter is to be used for measuring very low resistance values, the parallel connection is preferable to the series connection. The same milliammeter may be used for this purpose. The formula applicable to this case is given in (2). The large external resistor and the voltage applied are adjusted so that the current I_o , measured with the shunt open, reads full scale. The same variable limiting resistor can be used for adjusting for zero setting when the shunt is open as was used in the series connection.

FREQUENCY AND HARMONICS

When the ordinary frequency formula, that is, $F^2 = .02533 \div LC$, is applied for measuring one of the three quantities involved in terms of the other two, the complete values must be known, and not merely the apparent values. Suppose, for example, that it is required to measure L in terms of F and C . There is no difficulty in getting the value of F to a high degree of accuracy, but that of C is not so easy, as there is always distributed capacity present. To eliminate unknown capacities it is simplest to take two readings and the difference in such a manner that a known difference of capacity enters into the formula, with all distributed capacities eliminated. Such a difference formula for inductance is

$$L = \frac{.02533}{(C_2 - C_1)} \left(\frac{1}{F_2^2} - \frac{1}{F_1^2} \right) \dots\dots\dots (7)$$

in which L is given in henries, C_2 and C_1 in farads, and F_2 and F_1 in cycles per second. If the inductance is given in microhenries, the capacities in micromicrofarads, and the frequencies in kilocycles, the formula has the same form, or the numerical constant is the same.

This formula can be put into a different form involving the harmonics of a common fundamental. Suppose the $F_2 = nf$ and $F_1 = mf$, where f is the fundamental of a low frequency oscillator, the formula becomes

$$L = \frac{.02533}{(C_2 - C_1) f^2} \left(\frac{1}{n^2} - \frac{1}{m^2} \right) \dots\dots\dots (8)$$

If $m = 1$ and $n = 2$, the formula reduces to

.019

$$L = \frac{.019}{(C_1 - C_2) F_1^2} \dots\dots\dots (9)$$

As before, the inductance is in henries, the capacities in farads, and the frequency in cycles per second; or the inductance is in microhenries, the capacities micromicrofarads, and the frequency in kilocycles per second. All these formulas are differential and therefore the true inductance is obtained even if the two capacities are only readings on the calibrated condenser. Stray capacities are eliminated by taking the difference between C_1 and C_2 .

CAPACITY MEASUREMENT

An unknown capacity in a circuit can be measured with the aid of a calibrated condenser and two frequencies. Suppose the unknown capacity is C . Let F_1 be the frequency of the circuit when C_1 is added to the unknown and let F_2 be the frequency when C_2 is added to it. Then by proportion we have

$$\frac{C_2 + C}{C_1 + C} = \frac{F_1^2}{F_2^2}$$

Solving this for C we get

$$C = \frac{C_1 F_1^2 - C_2 F_2^2}{F_2^2 - F_1^2} \dots\dots\dots (10)$$

This formula is often used for determining the distributed capacity of a coil and of a circuit, in which case F_2 is usually the second harmonic of F_1 . It works just as well when the circuit capacity not taken into account by the calibrated condenser is large as when it is very small.

Part of the capacity in a tuned circuit connected to a tube is due to the grid-cathode capacity of that tube. Sometimes this capacity is many times larger than the input capacity given in tube characteristics. The difference is due to the fact that the nature of the load on the tube is reflected back into the grid circuit through the grid-plate capacity. The total effective capacity C_e is

$$C_e = C_s + (1 + A) C_{gp} \dots\dots\dots (11)$$

in which C_s is the static input capacity, A is the voltage amplification of the tube and circuit, and C_{gp} is the grid-plate capacity. The voltage amplification A for a resistance-coupled circuit is given by

$$A = \frac{\mu R}{R + r_p}$$

In some applications it is permissible to make the voltage amplification zero, which can be done by connecting a very large condenser from the plate to the cathode. This may be done, for example, if the tube is used as a plate bend detector or as a vacuum tube voltmeter. When this is done the effective input capacity is only the sum of the static input and the grid-plate capacity. That the effective input capacity may be large can be shown by an example. Suppose that $C_s = 2.5$ mmfd. and $C_{gp} = 5$ mmfd. Also suppose that the amplification constant μ is 100, the internal

(Continued on page 28)

Finding I.F. for a Tracking Condenser

SUPPOSE a tracking type of gang condenser (specially cut plates) is available and it is not known for what intermediate frequency it is designed nor what the oscillator inductance should be. Is there any simple way of determining the intermediate frequency and the inductance?

One thing we do know is that the difference between the highest and the lowest radio frequency in the tuning band should be the same as the difference between the corresponding maximum and minimum oscillator frequencies. Suppose, for example, that the lowest signal frequency is to be 530 kc and the highest 1,750 kc. The difference between these two is 1,220 kc. This difference is not affected by adding the same amount to each of the frequencies involved. Thus if the intermediate frequency is f , the two oscillator frequencies $1,750 + f$ and $530 + f$, differ by 1,220 kc, the same amount as the station frequencies differ.

Another factor that should be known before the value of the intended f can be found is the frequency ratio of the oscillator, that is, $(1,750 + f) \div (530 + f)$. This, however, is not known, for if it were, f would also be known. Hence we have to resort to measurement. We know that a frequency ratio of an oscillator, or of any tuner, is equal to the square root of the corresponding capacity ratio. This suggests that we measure the minimum and the maximum values of capacity of the tracking condenser section, with some sensible amount of trimmer in circuit. Let the measured capacities be C_{o1} and C_{o2} , where the subscript o refers to the oscillator and the subscripts 1 and 2 refer to lower and higher frequencies respectively, or specifically where C_{o1} is the maximum capacity of the condenser and C_{o2} is the minimum. Let the square root of the ratio of these two be designated by r . Thus $r = (C_{o1} \div C_{o2})^{1/2}$. This is equal to the oscillator frequency ratio regardless of what the oscillator inductance may be.

Now if F_2 is the lowest radio frequency and F_1 is the highest and f is the intermediate frequency, it can be shown that

$$f = \frac{F_2 - F_1 r}{r - 1}$$

in which r has the value already defined. Thus if we know the limiting radio frequencies and if we measure the maximum and minimum capacities in the oscillator section of the gang condenser, we can compute the intermediate frequency for which the condenser was designed.

The determined value will not be exact, because F_2 and F_1 may not correspond exactly to the settings at which the two values of capacity are measured, and besides there will be errors of observation. The result will be close, however, and with the aid of a list of intermediate frequencies used in the past and at present, the frequency intended can be determined. Such a list was printed on page 21 of last month's issue.

A numerical example will help to illustrate the method and to show what accuracy may be expected. The radio-frequency tuner is to cover a range from 530 to 1,750 kc. At the same settings the maximum and minimum capacities, including all distributed, of the oscillator condenser measured 200 and 36 mmfd. The ratio of these is 5.555. Hence $r = 2.36$. Putting this into the formula for f gives $f = 369$. Now 370 kc is one frequency which has been used in many receivers, the nearest others in the table being 260 and 445 kc. Hence we conclude that the intended intermediate in this case is 370 kc, since it is by far the nearest to the one computed.

Since both F_2 and F_1 are known, their ratio is also known. Let R be this ratio so that $R = F_2 \div F_1$. Then the formula for f can be written

$$f = \frac{(R - r) F_1}{r - 1}$$

After the intermediate frequency has been found the proper transformers for the intermediate tuner can be specified. But it is also necessary to know the oscillator inductance. This is found by the usual frequency formula which in this case assumes the form

$$L_o = \frac{.02533}{C_m (F_1 + f)^2}$$

We have already found that $C_m = 200$ mmfd. and that $F_1 + f = 530 + 370 = 900$ kc. Therefore we get from the inductance formula, $L_o = 156.2$ microhenries.

(Continued from page 26)

resistance r_p is 250,000 ohms and that the load resistance R is 750,000 ohms. Then A is 25. Hence $C_0 = 132.5$ mmfd.

A conducting path across a condenser also adds to the effective capacity of that condenser. The effective capacity is

$$C_e = C + \frac{1}{\omega^2 R^2 C} \dots\dots\dots (12)$$

in which R is the resistance shunting C and ω is the 2π -frequency. The second term is that added by the resistance. It will be noticed that the term diminishes rapidly as the frequency and the resistance increase, also that the added term is relatively larger for small values of C .

An inductance or capacity can be measured with the aid of an a-c voltmeter and an a-c ammeter. The voltage across the coil or condenser is measured and also the current that flows in the circuit. The impedance is then obtained by Ohm's generalized law, that is, $Z = E/I$, where Z is the effective impedance, E the voltage across the coil or condenser, and I is the current. For a condenser the reactance may be taken equal to the impedance, and the reactance is $1/C\omega$. Therefore the capacity is given by

$$C = I \div E\omega \dots\dots\dots (13)$$

For an inductance the resistance of the coil should also be taken into account. If, however, this is neglected, the impedance is equal to the reactance $L\omega$, whence

$$L = E \div I\omega \dots\dots\dots (14)$$

When the resistance is not negligible, an approximate value of the inductance can be obtained by first measuring the d-c resistance and then assuming that it is equal to the a-c resistance. Suppose the measured resistance is R . Then the impedance squared is $Z^2 = R^2 + L^2\omega^2 = E^2/I^2$, which gives for the inductance

$$L = \frac{[(E/I)^2 - R^2]^{\frac{1}{2}}}{\omega} \dots\dots\dots (15)$$

This equation yields a value for L that is slightly high, for the d-c resistance R is smaller than the a-c resistance that should be used. At 60 cycles per second, however, the error is slight. At 60 cycles the preceding three formulas take the approximate form

$$\begin{aligned} C &= .159I \div E \\ L &= .159E \div I \\ L &= .159 [(E/I)^2 - R^2]^{\frac{1}{2}} \end{aligned}$$

APPARENT INDUCTANCE

When an inductance coil is inserted in a bridge or other device for the purpose of measuring its inductance, the measurement seldom yields the pure inductance of that coil, but only the apparent. The difference is due to the fact that the coil has distributed capacity as well as inductance. If L_a is the apparent inductance, L the pure inductance, C_0 the distributed capacity, and ω the 2π -frequency, then

$$L_a = \frac{L\omega}{1 - LC_0\omega^2} \dots\dots\dots (16)$$

It is clear from this formula that the apparent inductance may be infinite. This occurs at the natural frequency of the coil, that is, at the frequency at which the pure inductance resonates with the self-capacity of the coil. At frequencies higher than this the coil is not effectively an inductance but a condenser.

FORMULAS FOR UNIFORM LINES

Transmission lines are used more and more in radio. Sometimes they are used to control the frequency of an ultra-high frequency oscillator, sometimes for conducting radio energy from the oscillator to the radiating antenna, and sometimes for wavelength measurements. Simple formulas apply to such lines. Let L and C represent, respectively, the inductance and capacity per unit length of conductor pair of the line, or simply, per unit length of line. Let the resistance and leakage be negligible. Then the characteristic impedance, or in this case, resistance, of the line is given by

$$Z_0 = R = (L \div C)^{\frac{1}{2}} \dots\dots\dots (17)$$

That is, the characteristic resistance of a uniform transmission line is equal to the square root of the ratio of the inductance per unit length to the capacity per unit length.

If a uniform transmission line is cut anywhere and a resistance equal to the characteristic resistance is put at its end, no reflection occurs at the end and all energy that comes up is dissipated as soon as it arrives. When the line is used for transmitting power, it should be terminated by the characteristic resistance, that is, the load resistance should be equal to the characteristic resistance. If necessary, the matching can be done with a step-up or step-down transformer, which may be either of the auto-transformer or mutual type.

REFLECTIONS

When the transmission line as described above is either open or shorted at the remote end and the impedance at the near end is a pure reactance. Standing waves are then set up on the line if it is excited by a suitable oscillator. Waves travel down the line to the end and are there reflected. When they return to the starting point they are again reflected. As a result of repeated reflections high amplitudes are built up, and there is practically no loss. The distance between current or voltage nodes is half wavelength. The wavelength determined in this manner is almost the same as the length in free space for a wave of the same frequency. The velocity of the wave is slightly less on the line than in free space and therefore the wave length is slightly shorter.

If the line is shorted at the remote end the reactance at the near end is

$$Z_i = jZ_0 \tan \beta l$$

in which βl is defined

$$\beta l = \frac{2\pi l}{\lambda} = \omega l (LC)^{\frac{1}{2}} \dots\dots\dots (18)$$

βl is the electrical length of the line, l the actual length, λ the wavelength on the line, that is, twice the distance between two adjacent

nodes, and ω is 2π -frequency of the current or voltage.

If the line is open at the far end the reactance measured at the near end is

$$Z_1 = -jZ_0 \cotan \beta l \dots\dots\dots (19)$$

The shorted line is equivalent to a condenser and an inductance connected in parallel across the energy source, and the open line is equivalent to a condenser and an inductance connected in series.

REACTANCES COMPARED

If L_0 and C_0 are the effective inductance and capacity, respectively, we have

$$Z_1 = \frac{j\omega L_0}{1 - \omega^2 C_0 L_0} \dots\dots\dots (20)$$

for the shorted line, and

$$Z_1 = -j \frac{1 - \omega^2 C_0 L_0}{\omega C_0} \dots\dots\dots (21)$$

for the open line. These two equations hold particularly for the first quarter wave.

Whenever the reactance of the shorted line is infinite, that of the open line is zero, and vice versa. The reactance of the shorted line is infinite whenever βl is an odd multiple of $\pi/2$ and is zero whenever βl is an even multiple of $\pi/2$.

For uniform transmission lines the characteristic resistance is most easily computed from the measured dimensions of the line. Two types of transmission lines are common, the parallel wire and the concentric conductor. If the distance between the parallel, bare wires is not less than ten times the diameter of either, and if the frequency is at least 20 megacycles per second, then the inductance L' and the capacity C' of a length l of line are given by

$$L' = 4 \times 10^{-9} l \log_e (2a/d) \text{ henries} \dots\dots\dots (22)$$

for the shorted line, and

$$C' = \frac{l}{4 \times 10^9 v_0^2 \log_e (2a/d)} \text{ farads} \dots\dots\dots (23)$$

in which a is the distance in centimeters between the centers of the wires, d is the diameter in centimeters of each wire, and v_0 is the velocity of the wave on the wires. If the wires are bare and in air, v_0 is practically the same as the velocity of light. To get L and C , L' and C' are divided by l . By multiplying L' and C' we obtain

$$v_0 = 1/(LC)^{\frac{1}{2}}$$

and by dividing L' by C' we obtain

$$Z_0 = (L \div C)^{\frac{1}{2}} = 4 \times 10^9 \log_e (2a \div d) \cdot v_0 \dots\dots\dots (24)$$

$$Z_0 = 276.2 \log_{10} (2a \div d) \dots\dots\dots (25)$$

The characteristic impedance is expressed in ohms when the logarithm is to the base 10, and when a and d are measured in centimeters or inches.

COAXIAL LINE

If the line consists of two concentric conductors the inductance and capacity per unit length are given by

$$L = 2 \times 10^{-9} \log_e (r_2 \div r_1) \text{ henries} \dots\dots\dots (26)$$

$$C = \frac{10^9}{2v_0^2 \log_e (r_2 \div r_1)} \text{ farads} \dots\dots\dots (27)$$

in which r_2 is the inner radius of the outer conductor and r_1 is the outer radius of the inner conductor. The ratio L/C gives for characteristic resistance

$$Z_0 = 2v_0 10^9 \log_e (r_2 \div r_1) = 138.2 \log_{10} (r_2 \div r_1) \dots\dots\dots (28)$$

(Continued on following page)

Decibels from Voltage or Current Ratios, Also for Power

The decibel curve (March issue) can be used for finding the decibel attenuation for any voltage or current ratio, although it covers only the range from 1 to 10. The reason why it can be used for higher ratios of voltage or current is that the decibel is based on 10, or on common logarithms, and that the decimal fractions repeat. It is only necessary to add 20 to the attenuation, as given by the curve, for each time 10 occurs in the voltage or current ratio as a factor. Suppose, for example, the ratio is 30. We look up on the curve the decibels for 3, which is 9.542 and add 20, making it 29.542. Had the number been 300 instead of 30, we would have added 20 + 20, or 40. Again, suppose the number is 15. We look up the decibels for 1.5, which is 3.522 and add 20, making the total 23.522.

The curve applies directly to cases of voltage and current ratios only. To find the attenuation when the power ratio is given, it is only necessary to assume that the number is a voltage ratio, look up the attenuation for that, and then divide the result by two. For example, suppose that the power ratio is 4.2. If this were a voltage ratio, we would get 12.5 db from the lower part of the curve in the graph. But since it is a power ratio, the actual attenuation is only 6.25 db.

The graph has been broken up into two sections because it was desirable to make the decibel scale as long as possible. The bottom scale, 0 to 14 db, pertains to the lower section of the curve, and the top scale, 13 to 20, to the higher section. See table on page 14.



Not a squirrel cage or a toy Ferris wheel, but a new antenna erected by American Airlines, Inc., Los Angeles, Calif., at Glendale.

(Continued from preceding page)

When the oscillator in a superheterodyne is put on the same tuning control as the radio-

frequency circuits and the same type and capacity available condenser is used for all the circuits, it is necessary to alter the condenser section in the oscillator circuit so that the generated frequency shall always be a certain amount greater, or sometimes less, than the radio frequency. In other words, the difference between the generated frequency and the frequency to which the radio circuits are tuned must be as nearly constant as possible. The treatment of the oscillator circuit is called padding, which consists of both changing the inductance and the rate of change of the capacity.

Let all inductances be measured in microhenries, all capacities in micromicrofarads, and all frequencies in megacycles per second. Let L be the inductance in the radio-frequency tuner and L_1 the required inductance in the oscillator circuit. Let f_0 be the intermediate frequency, F_1 , F_2 , and F_3 the three frequencies at which the tracking is to be exact, and F_0 any other radio frequency within the tuning range, preferably the lowest. Let C_0 be the value of the variable condenser in the radio-frequency circuit when this is tuned to F_0 , let C_2 be the series padding capacity, C_3 a small adjustable capacity in shunt with the main variable condenser of the oscillator, and C_4 the coil self-capacity. The following formulas and definitions are useful in the computation of L_1 ,

$$C_2, C_3 \text{ and } C_4:$$

$$a = F_1 + F_2 + F_3$$

$$b_2 = F_1F_2 + F_1F_3 + F_2F_3$$

$$c^2 = F_1F_2F_3$$

$$d = a + 2f_0$$

$$I^2 = (b^2d - c^2) \div 2f_0$$

$$m^2 = I^2 + f_0^2 + ad - b^2$$

$$n^2 = (c^2d + f_0^2I^2) \div m^2$$

$$L = 25330 \div C_0 F_0^2 \text{ (if } L \text{ is not known)}$$

$$C_0 F_0^2 = 25330 \div L \text{ (if } L \text{ is known)}$$

$$A = C_0 F_0^2 [(1 \div n^2) - (1 \div I^2)] \quad \text{Required only for Case 3)}$$

$$B = (C_0 F_0^2 \div I^2) - C_2 \quad \text{(Required only for Case 4)}$$

CASE 1: When $C_4 = 0$, or is negligible compared to C_3 (usual case), then

$$C_2 = C_0 F_0^2 [(1 \div n^2) - (1 \div I^2)]$$

$$C_3 = C_0 F_0^2 \div I^2$$

$$L_1 = L(I^2 + m^2) (C_2 + C_3) \div C_2$$

CASE 2: When C_3 is zero.

$$C_2 = C_0 F_0^2 \div n^2$$

$$C_4 = C_0 F_0^2 \div (I^2 - n^2)$$

$$L_1 = L(I^2 + m^2) C_2 \div (C_2 + C_4)$$

CASE 3: When C_4 is known.

$$C_2 = A [1/2 + (1/4 + C_4 \div A)^{1/2}]$$

$$C_3 = (C_0 F_0^2 \div I^2) - C_2 C_4 \div (C_2 + C_4)$$

$$L_1 = L(I^2 + m^2) (C_2 + C_3) \div (C_2 + C_4)$$

CASE 4: When C_3 is known.

$$C_2 = (C_0 F_0^2 \div n^2) - C_3$$

$$C_4 = C_2 B \div (C_2 - B)$$

$$L_1 = L(I^2 + m^2) (C_2 + C_3) \div (C_2 + C_4)$$

Check formulas.

Equation for oscillator frequency:

$$f_1 = m [(I^2 + n^2) \div (I^2 + I^2)]^{1/2}$$

Equations for I^2 , m^2 , and n^2 in terms of oscillator constants:

$$I^2 = C_0 F_0^2 \div [C_2 + \{C_2 C_4 \div (C_2 + C_4)\}]$$

$$m^2 = C_0 F_0^2 \div (L_1 \div L)$$

$$n^2 = C_0 F_0^2 \div (C_2 + C_3)$$

A Kit-Type Converter

Covers 540 to 25,000 Kc With Any Set

By **Gustave L. Klein**

Thor Radio Co.

THIS is a frequency converter the tuner of which contains a three-gang condenser and three ranges. One of the ranges covers the so-called short-wave band, another the police band, and the third the broadcast band. The converter can be used with any radio receiver whether it be a t-r-f set or a superheterodyne and its use is advantageous when the broadcast set is not sufficiently sensitive or selective or when it does not cover the desired tuning ranges.

It will be noticed that in switching from the broadcast set to the converter a three-pole gang-switch is thrown to the left. This act disconnects the antenna from the antenna post on the broadcast set and connects it to the primary of the first coil in the converter. At the same time the lead from the antenna post on the broadcast set is connected to the output of the converter mixer tube and also at the same time the power is turned on the recti-

(Continued on following page)

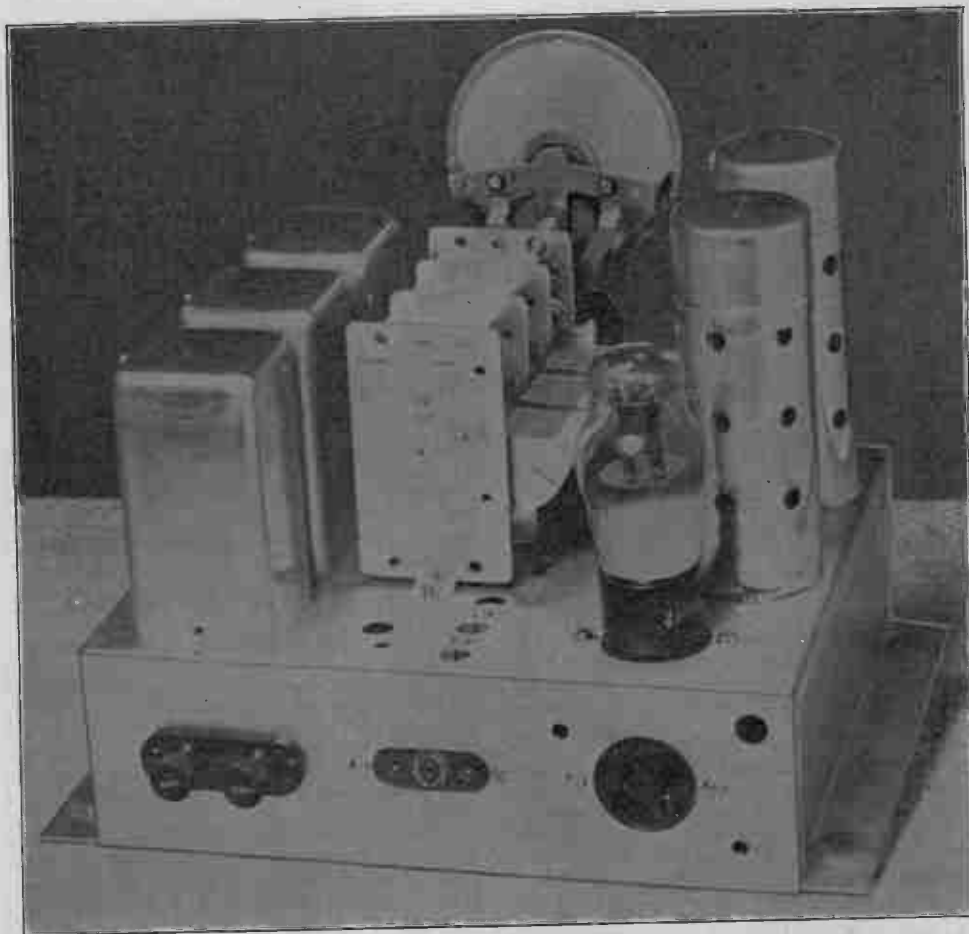

Rear view of Thor's converter.

(Continued from preceding page)
 fier plates and on the filaments of the three tubes. Two isolating condensers are used to make the switching safe, one of .01 mfd. in the antenna and one of .0005 mfd. in the lead to the plate of the mixer tube.

INTERCONNECTING THE RIGS

It will be observed that all returns are made to the chassis of the converter assembly, including the low side of the power line. But only one connection is shown between the broadcast set and the converter. A connection should also be made between the two chasses, which is best done through a condenser of about .01 mfd.

It was stated above that the converter could be used with a superheterodyne as well as with a t-r-f broadcast receiver. This requires explanation. If the receiver is already of the superheterodyne type there is a practical limitation on the choice of intermediate frequency.

one for which the oscillator (of the converter) has been designed.

It will be noticed that in each of the three oscillator coils there is a trimmer condenser and that in series with each coil is an adjustable padding condenser. For the two smaller coils the variable portion of the padder is a trimmer connected across a fixed condenser. Individual trimmers are also used on the radio-frequency coils. It is therefore possible to adjust the circuit accurately at two different frequencies in each of the three bands.

In the short-wave and police-band r-f coils the coupling between the primaries and secondaries is by mutual inductance only, while in the broadcast coils both inductive and capacitive coupling is employed, the type being what is usually referred to as high-gain coupling.

Due to a high intermediate frequency generated by the converter there is likelihood that interference will result with stations near this

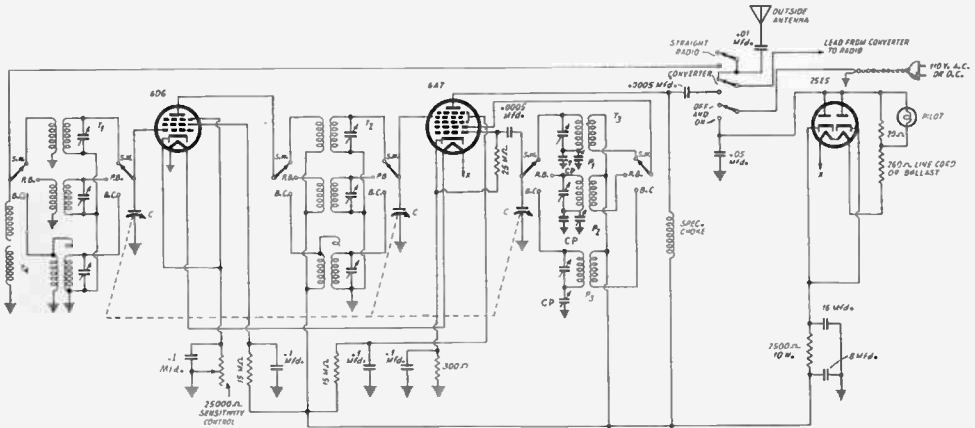

Circuit diagram of the converter.

First of all, it should not be in the band covered by the converter tuner. Neither should it be equal to the intermediate frequency already used in the receiver. The lowest broadcast frequency might be 530 kc and the intermediate frequency might be 465 kc. The intermediate chosen for the converter should be between these two. It should also be within range of the radio-frequency tuner in the superheterodyne. It is not likely that the tuner goes below 525 kc. If it goes as low as that, that frequency should be selected, for it is well to get as far away from the 540 kc limit of the converter as possible.

It is also possible to skip the r-f tuner in the superheterodyne, including the oscillator, and this is done by connecting the output of the mixer tube to the plate of the mixer tube in the broadcast set. In that case the i.f. of the converter should be the same as that in the broadcast set.

SINGLE I.F. PRACTICAL

As the oscillator in the converter is padded, only one i.f. is practical, and that will be the

frequency. To prevent the trouble a wave trap is inserted from the antenna to ground in such a manner that it always remains in the circuit regardless of which band is being used. This trap is of the series-tuned shunt and consists of two coils.

HOW WAVE TRAP WORKS

The two coils constituting this trap are indicated by T. A series-tuned shunt of this type acts as a short circuit to ground for one frequency only but does not affect appreciably any other frequency. Thus if it is tuned to the intermediate frequency interference on that frequency will be prevented. This is a feature of first importance in a converter as well as in a superheterodyne.

In the output of the 6A7 converter tube is a special radio-frequency choke through which the plate is fed. It is special in that its inductance is such that it resonates with the total stray capacity at the intermediate frequency selected for the converter. This seems to be a minor

(Continued on page 43)

Hood Makes 'Scope Useful in Broad Daylight

Full Service from Economical Device That Includes Separate Amplifiers

(Continued from preceding page)

the otherwise easy objective of fine spot, and of intensity control from no visibility to excessive visibility.

OVERLAP CONTROLLABLE

The relaxation oscillator, used for generating saw-tooth pulses, and marked Neon in the diagram, produces any desired frequency within range, by being subjected first to a rough adjustment at the saw-sweep range control, and then fine adjustment. The rough control introduces condensers of various capacities, and these are charged up by the tube, and their discharge or displacement current is introduced into the horizontal amplifier circuit.

The frequencies can easily overlap a good deal, and in fact there should be some overlap to prevent missout, but the amount of overlap is easily selected by choice of proper value of the limiting resistor in the saw-sweep circuit. The d-c voltage on the relaxation oscillator is changed, and this alters the frequency, but the amount of change is governed to a considerable extent by the limiting resistor, shown as .1 meg. If this is made somewhat smaller the overlap is greater. If made too large there will be little if any effect due to the saw-sweep frequency potential adjustment, as the potential changes little. The values given have proved satisfactory experimentally.

Besides the focus, intensity and two sweep-frequency controls, there is an on-off switch attached to the focus control and governing the line voltage, also there are independent gain controls for the two amplifiers, a switch for introducing internal 60-cycle synchronization or external any frequency synchronization, and a switch for omitting the saw-sweep oscillation when some other type voltage for horizontal deflection is desired, e.g., 60 cycles obtained externally. Any frequency may thus be injected into the vertical circuit, any frequency into the horizontal circuit, and any frequency into the synchronization circuit.

OBJECT OF SYNCHRONIZATION

The purpose of synchronization is to produce lock-in, so that the pattern stands still. This will take place when the vertical frequency is a multiple or submultiple of the horizontal frequency, hence the adjustment to proper frequency within these requirements must be made before the pattern will stand perfectly still, even though the circuit in general permits such stillness.

Preferably the horizontal frequency is lower

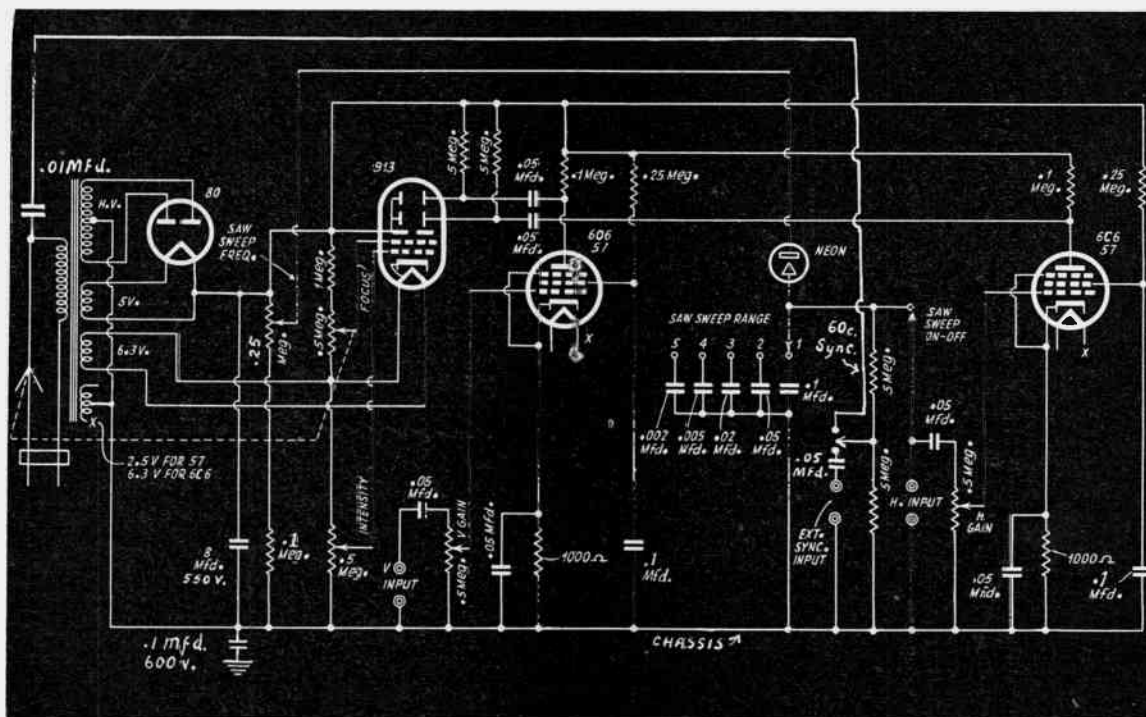

Reduced to utmost simplicity consistent with wide service, this cathode-ray oscilloscope has amplifiers for both sets of deflecting plates, and also permits internal 60-cycle as well as external synchronization. A new feature is the saw-tooth oscillator frequency control by limited potential adjustment.

than the vertical frequency, whereby the cycles repeat themselves left to right, instead of bottom to top.

The 913 must be installed at first so that the intended horizontal deflection is really horizontal, or, if it is vertical, the 90-degree change can be made by reversing connections to the deflecting plates, shown at upper right in the 913 diagram.

An oscilloscope of just this type is manufactured by Superior Instruments Company, and is provided with a sloping front panel, with proper indications of the controls and their functions, as well as with an adjustable insulating hood for the 913, permitting use of the instrument in broad daylight.

This insulator also protects the B supply, since the shell of the 913 is at highest d. c. potential.

THE ELECTROLYTIC CONDENSER

Ordinarily the d. c. voltage may be around 350 to 400 volts, and care should be exercised that the electrolytic filter condenser of 8 mfd.

will stand the resultant voltage. In fact, the instantaneous starting voltage will be higher, and even the peak voltage will be continuously higher. If the electrolytic gets warm it is a sign that it is being worked at too high a voltage. In lieu of substituting another condenser, of higher voltage rating, one may put a limiting resistor of 3,000 to 5,000 ohms, between the 5-volt rectifier filament winding of the transformer and the place where positive of the electrolytic is connected. This filament point is the one shown in the diagram, from which B plus is derived, and it may be either side of the winding, but do not make the change unless the power is shut off, and do not turn it on again until you are sure the resistor is in place and reads continuity. Its wattage should be 3 watts for utter safety, which assumes that the electrolytic's leakage still will be somewhat greater than normal.

The synchronization at 60 cycles, obtained by throwing a switch, was particularly good with the circuit as shown, although up to that time no special method of interlocking had been introduced.

Adjustable Insulator Also Prevents B Supply Being Shorted by the 913

Since it obtained as an inherent merit of the circuit, no extra method was necessary to effectuate the synchronization, which apparently was due to static fields. By this is not meant, of course, the synchronizing pulses themselves were thus derived, but that enough voltage from one amplifier appeared in the other to provide the necessary mixing of the two so that the one could lock in the other, and produce fixation of the pattern on the viewing screen.

VOLTAGES NOTED

As for the voltages, the primary is standard on the power transformer (115 volts, 50-60 cycles); the rectifier takes 5 volts on the filament, the amplifier tubes 6.3 volts for 6C6 or 2.5 volts for 57's; the 913 takes 6.3 volts, which must be independently supplied, and therefore requires an individual winding; while the high-voltage depends on how the transformer is wound, and will be somewhat higher than the rating of the transformer as made for small a. c. sets, as the present device draws very little B current, even when bleeders are considered.

The grid bias on the 913, effected by positioning of the intensity control, ranges from 0 to 90 volts, and any change thereof may require some slight change elsewhere on the instrument board.

The grid bias on the amplifier tubes is 6.3 volts, which should not be exceeded. The relaxation oscillator will strike at 60 volts or a little less, but subject to some variations at a striking voltage, depending on factors that enter into the manufacture of the tube. The limiting resistance is so high that the magnitude of the d. c. voltage from the rectifier is of no moment to the sweep oscillator's safety. The screen voltage on the amplifiers, effective at the screen itself, will be around 130 volts, but can not be measured accurately with instruments most readers will have, as readings will be far too low on a voltmeter of 1,000 ohms per volt sensitivity, but readings taken on the 250-volt range of such an instrument may be roughly doubled to get somewhere near the true voltage.

CURRENT FOR AMPLIFIERS

If economy in the power transformer is a requirement, the 6.3-volt amplifier tubes may be used, with center-tapped 6.3-volt winding rated at 3 amperes, as the 2.5-volt heaters draw about an ampere, the power difference per tube being about .6 watt, or 1.2 watts for the two tubes. The 913 heater takes .6 ampere or dissipates about 3.8 watts.—H. J. Bernard.

Phase Angles Measured With a Cathode-Ray Oscilloscope

By Leonard W. Walters

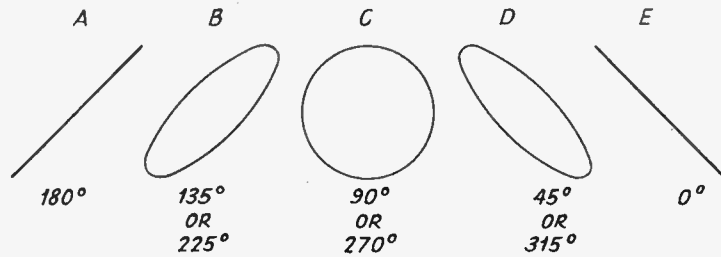

FIG. 1

Five different patterns, A, B, C, D and E, which may appear on the oscilloscope screen with equal sinusoidal voltages applied to deflecting plates. The eccentricity of the ellipses may have any value between zero and infinity depending on the phase difference.

ONE of the many useful applications of the cathode-ray tube is to measure phase differences between currents and voltages, and therefore, also, the power factors of circuits.

When the phase difference between two voltages is to be measured one voltage is impressed on the horizontal and the other on the vertical deflection plates. They should be adjusted so that their deflection effects are equal, which is not necessarily the same as equality of the voltages. It can then be shown that figures such as those shown in Fig. 1 will be traced on the screen.

If the phase difference between the two voltages is 180 degrees the figure will be a straight line with a positive slope. If the phase difference is between 180 degrees and 135, or between 180 and 225, the figure will be an ellipse with a positive slope of the major axis. The eccentricity of this ellipse will depend on the amount of phase difference. If the phase difference is 90 degrees, either plus or minus, the figure will be a circle. If the phase difference is zero the figure will be a straight line with a negative slope, and if the phase difference lies between zero and plus or minus 90 degrees the figure will again be an ellipse, but with a negative slope of the major axis. The two ellipses in the figure are for phase differences of plus and minus 45 degrees and for plus and minus 135 degrees.

THE EQUATIONS

The figures illustrated in Fig. 1 are for the case of two equal effective voltages on the two sets of deflection plates. If the voltages are unequal the central figure will also be an ellipse but its axes will be vertical and horizontal. The straight lines will remain straight and the in-

termediate ellipses will remain elliptical but somewhat distorted. The main slopes will be unaltered.

In the theory that follows it is assumed that the two voltages have equal effects on the beam of electrons.

Let $x = -E \cos \omega t$ be the voltage applied to the horizontal plates and let $y = E \cos(\omega t + \theta)$ be that applied to the vertical plates, where E is the amplitude, as seen on the fluorescent screen, ω the 2π frequency of the voltages, t the time, and θ the phase difference between the two. The minus sign is used with the horizontal deflection expression to account for the fact that the patterns are viewed facing the beam rather than looking with it. The signs agree with the patterns in Fig. 1, which have been observed experimentally.

If t is eliminated from the two equations for x and y , there results the single equation

$$x^2 + y^2 + 2\cos\theta xy = E^2 \sin^2\theta \dots \dots \dots (1)$$

If we let θ equal zero in this equation we get $(x + y) = 0$, which is an equation for a straight line with a slope of 135 degrees, as illustrated at the extreme right in Fig. 1. If we let θ equal 180 degrees we get $(x - y) = 0$, which is the equation of a straight line with a slope of 45 degrees, as shown at the extreme left in Fig. 1. If we let θ equal 90 or 270 degrees the equation reduces to $x^2 + y^2 = E^2$, which is that of a circle as illustrated in the center of Fig. 1. The equations for the ellipses are obtained from the general formula by substituting the indicated angles.

COMPUTATION OF PHASE ANGLE

The value of any intermediate phase angle must be calculated from the eccentricity of the

A New Sweep Control Used in Simple, Inexpensive 'Scope

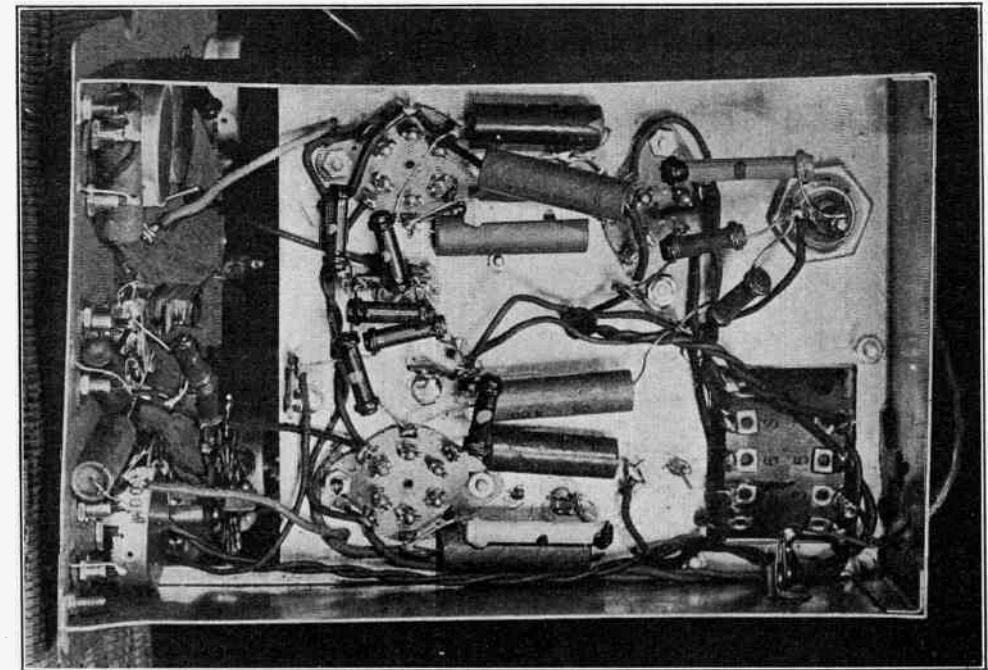

Bottom view of the wiring of the cathode-ray oscilloscope. Other illustration is on front cover.

HERE is a cathode-ray oscilloscope, using the 913 tube with its approximately one-inch viewing screen, and reduced to the simplest possible form, even though it includes an amplifier for the vertical deflection and an amplifier for the horizontal deflection. The third input is for external synchronization, where the vertical frequency is to be some multiple of the frequency of this external supply.

Despite the few parts there is considerable flexibility. Although a saw-tooth sweep frequency oscillator is built in, there is an independent on-off switch for this, and when the switch is at "off" position, voltages of any frequency may be introduced externally for the sweep purposes, and replace therefore the saw-tooth sweep supply. Thus 60-cycle sweep may be introduced externally.

The reason for using a saw-tooth sweep is that there is no double image, as the return trace of the sweep cycle is either entirely wiped out, so far as the eye notices, or is negligible.

The vertical input posts have the usual freedom for any supply being introduced, as this is the voltage to be studied. All three inputs must be of alternating current, because there is

always a stopping condenser, which prevents introduction of d. c., which is the usual commercial practice, and is of a safeguarding nature.

ZERO D.C. VOLTAGE GROUNDED

Also along the lines of safety to instrument itself and circuit being analyzed—not to mention safety to the operator—the grounding is done to the shield metal cabinet at zero d. c. potential. The B supply naturally is returned to zero d. c., whereas the center tap of the winding for the two amplifier tubes likewise is connected to B minus, which is common with the chassis. Ground is established through a .1 mfd. condenser of 600 volts rating (c. w. v.). Biasing resistors and all bypassing capacities are returned also to B minus.

The B supply is standard, and the hookup for the 913 is likewise, but the three resistors, one a 1 meg. fixed, and two .5 meg. potentiometers for focus and intensity control, must be carefully checked, so that they are just as close to the stated values as possible. Even a small change in these constants will defeat

(Continued on following page)

ellipse. It can be shown that the axes of the ellipses coincide with the straight lines for zero and 180 degree phase difference. On these lines x and y are numerically equal. Hence the length of a semi-axis can be obtained from (1). Letting $x = y$ we have

$$a = (2x^2)^{\frac{1}{2}} = (2)^{\frac{1}{2}} E \sin(\theta \div 2) \dots \dots \dots (2)$$

Letting $x = -y$ we have

$$b = (2x^2)^{\frac{1}{2}} = (2)^{\frac{1}{2}} E \cos(\theta \div 2) \dots \dots \dots (3)$$

In these formulas a is measured along the 180-degree phase line and b along the zero phase line.

Equations (2) and (3) enable us to compute the phase angle in terms of a and b . Dividing (2) by (3) we get

$$\frac{a}{b} = \tan\left(\frac{\theta}{2}\right) \dots \dots \dots (4)$$

whence

$$\theta = 2 \tan^{-1}\left(\frac{a}{b}\right) \dots \dots \dots (5)$$

FIG. 2

This circuit can be used for retarding or advancing the phase of a voltage. Variation in phase is effected by varying R . This device is suitable for use in the grid circuit of a vacuum tube. For 60 cycles, C may be 1 mfd., L 15 henries and R 10,000 ohms, for a change of nearly 30 degrees. As R is reduced the phase angle increases to a maximum of 90 degrees.

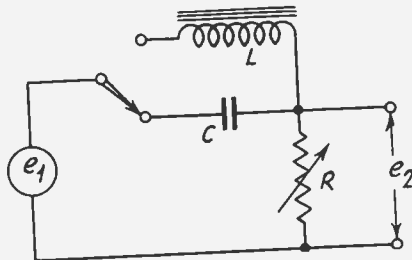

Both a and b can be measured in terms of any convenient units directly on the fluorescent screen.

The axes of the ellipses will be tilted 45 degrees in each direction from the vertical. This is not very convenient for measurements. Is it possible to turn the axes and still have the formula hold true? If the axes are turned 45 degrees in equation (1), the new equation is that of an ellipse referred to its own axes. From this equation a and b as given by equations (2) and (3), respectively, can be written out directly. There is no change in the values, naturally. The turning of the axes can be done in either direction, but it is convenient to turn so that b is horizontal.

TURN THE TUBE ITSELF

Since the only reason for turning the axes is to make readings convenient, there is no object of turning the scale of reference on the screen. The best way is to turn the cathode ray tube through 45 degrees one way or the other. The lines of the coordinate system which is read should be vertical and horizontal.

A convenient way of providing a scale is to mount a translucent, two-way graduated screen as close to the tube as possible—close enough to minimize parallax effects.

An interesting property of the ellipses is disclosed when the intercepts on the axes are determined from (1). Let $x = 0$. Then $y = \pm E \sin \theta$. Let $y = 0$. Then $x = \pm E \sin \theta$. In other words, the X and Y intercepts are equal in magnitude. If these intercepts are equal in magnitude, and if E is known, the phase angle can also be obtained from the sine of the angle. E is the radius of the circle obtained when the phase difference is 90 degrees. It is clear that more accurate results can be obtained if the diameter of the circle is measured. If this is used in place of E the sum of the arithmetic sum of the positive and negative intercept should be substituted for x and y .

THE METHOD OF GROWTH

Greater accuracy is also obtained by measuring the whole axes of the ellipse than the semi-axes alone. Since the ratio of a and b occurs in (5) there is no reason why $2a$ and $2b$ should not be used in the equation.

When one first examines the patterns in Fig. 1 one is likely to assume that the axes of the ellipses turn as the phase angle varies. This is not the case, as the equations clearly show. What happens is that the ellipse grows about an axis until it becomes a circle and then it diminishes again until it becomes a line. The process may be looked upon in another light. At left in Fig. 1 a plane circular figure is viewed on its edge. The circle then gradually rotates about a line in its original plane until the plane has been turned 90 degrees from the original position. At this instant the line of rotation is changed through 90 degrees. About the new axis the circle continues to rotate until it again is seen as a line. However, no matter in what way the change of the pattern occurs, equation (5) gives the phase angle difference between the two voltages impressed on the deflection plates in terms of two quantities measurable on the fluorescent screen.

Ambiguities will arise in many instances. For example, when there is a circle on the screen it may be due to either a lag of 90 degrees or a lead of the same amount. Something else known

(Continued on following page)

Close Standards for A.F.

By Using Stations and a Generator

By H. J. Bernard

AN article on radio-frequency harmonics, of which Table II, referred to in the test this month, was a part, was developed last month to the point where audio frequencies were considered. The following article is therefore a natural sequence to the other.—EDITOR.

IT is possible to get accurate audio frequencies based on difference in radio frequencies, where a signal generator and two station frequencies are used. The method is to zero beat with one station, then leaving the generator unmolested, tune in the other station, one that results in an audible difference frequency. The unknown audio frequency may be computed or read from the generator, by noting the difference between generator frequencies for zero beating with both stations. Few generators have enough bandspread to render that practical. In all instances generator harmonics are used.

Most persons interested in technical radio are familiar with the theory of an audio beat frequency oscillator. A fixed radio frequency is generated and a small change of radio frequency is obtained from another r-f oscillator, the two loosely coupled. If the difference is kept within the audio range, the result is audio. Thus for 100 kc fixed, and for variable of 100 to 110 kc, the audio range would be 0 to 10 kc, or 0 to 10,000 cycles.

Besides stated terminals, all frequencies in between may be encompassed, e.g., r-f standard-range setting is still 110 kc., the other and small-range variable oscillator is at 101, 102, 103, 104, 105, 106 and 107 kc., and the notes are the differences, or $110-101 = 9$ kc. =

9,000 cycles; $110-108 = 2$ kc. = 2,000 cycles, etc., accomplishing also 3,000, 4,000, 5,000, 6,000, 7,000 and 8,000 cycles, and of course values intermediate to the steps of 1,000 cycles, depending on the calibration of the adjustable oscillator.

A point about the beat is that the amplitude is constant, if the r-f regular-range oscillator is constant, and the small-range special oscillator is constant. Both qualifications are attainable, particularly will the small-range oscillator tend to stability, because the tuned circuit would be normally composed of a high ratio of capacity to inductance.

USING STATION DIFFERENCES

Zero beats have been discussed and defined in respect to generator low frequencies producing harmonics compared for radio-frequency checking. It will be noticed from Table II that, though some stations have cross harmonics, e.g., the same generator low radio frequency produces a zero beat with two stations of different frequencies, due to different harmonic orders of the same generator fundamental frequency, it is also true that some single generator frequency will produce slightly different beats with two different stations. This fact may be capitalized also, if one desires to calibrate for audio frequencies, the accuracy being excellent for the higher audio frequencies particularly, and very gratifying for the lower ones, although getting below 200 cycles is impractical. The resultant note is fed to one set of deflecting plates of an oscilloscope, an unknown audio oscillator connected to the other set of deflecting plates, and the unknown adjusted to equal the known, so that one wave is seen as a "cycle." In the absence of an oscilloscope, listening may be practised, with less accuracy, or two neon lamps
(Continued on following page)

Phase-Shifting Circuit for 'Scope

(Continued from preceding page)

about the case will determine which it is. The same, of course, applies to the elliptical patterns.

PHASE-CHANGING CIRCUIT

Sometimes there may be occasion for introducing a change of phase. A circuit such as that in Fig. 2 will effect a change, which will be a lag when the coil is used and an advance when the condenser is inserted. Unfortunately, the phase and the output vary at the same time. There are other devices which can be

used for changing phase, such as electrical wave filters.

The tangent of the angle of lag, in Fig. 2, is

$$\tan\phi = \frac{L\omega}{R}$$

and the tangent of the angle of advance is

$$\tan\phi = \frac{1}{RC\omega}$$

(Continued from preceding page)

lit, one by the known, the other by the unknown, and the unknown changed until the lamps work in unison, if an amplifier is used.

The audio note is known because the generator fundamental and the harmonic order of that fundamental, and moreover, the two station frequencies are known. For instance, if one

into A equals the true generator frequency. Also it shows the harmonic order of generator's frequency that affects station B must be known, which it isn't, so Table II is necessary, or its equivalent. So the table, published in last month's issue, acquires added significance.

Now let us turn the tables. Using the same stations, let us zero beat the generator's har-

Where metal is in the field of the oscillation coil the effect of the metal on the coil's inductance must be considered. If the coil position is altered in respect to what it was when a calibration was run, the changed distance from the metal objects changes the inductances. Particularly where audio differences of radio frequencies are used must this phenomenon be respected. Coil at right, when moved under the condenser, lost 2 per cent inductance. Position to which it was moved is shown below.

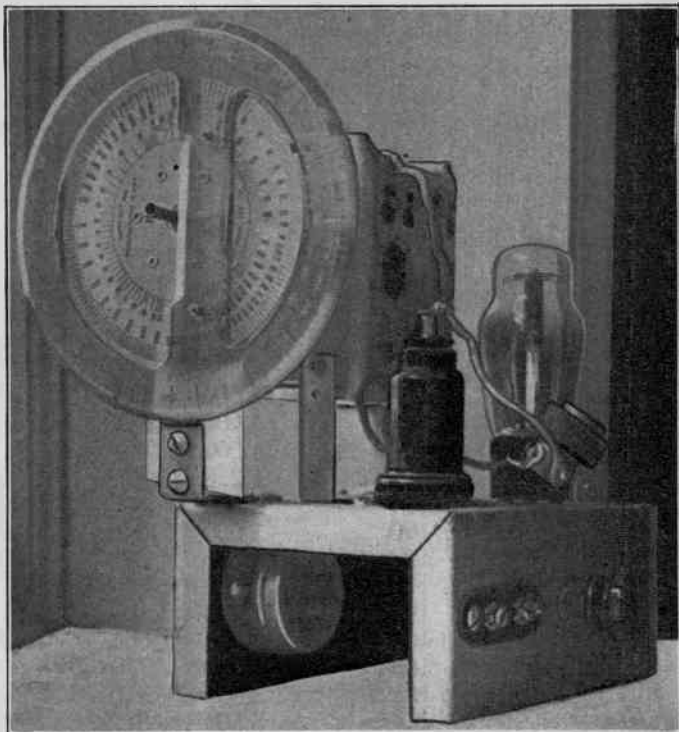

station is 710 kc., and generator's 71 kc. beats with it, then the tenth harmonic is being used, and when a note is heard from another station beating with the same harmonic of 71 kc., the unknown frequency is the difference.

Suppose the second station is 570 kc., equaling the eighth harmonic of 71.25, then the difference between the two frequencies of the generator is .25 kc. and the note is 250 cycles. If now the generator is turned to zero beat with 570 kc., e.g., set at 71.25 kc., then the first station, 710 kc., tuned in again on the receiver, will cause a note to be reproduced because of the difference established.

VALUES TABULATED

Let us set up the values in tabular form:

Station kc.	Gen. Harmonic	Gen. Fund. kc.	Diff. kc.
A = 710	10th	71	} .25
B = 570	8th	71.25	

The foregoing shows that the harmonic order of the generator's apparent frequency must be known for station A, which it is, by dividing generator's read frequency into A, and using the nearest whole number, which when divided

monic with station B, instead of with station A:

Station	Gen. Harmonic	Gen. Fund.	Diff.
	kc.	kc.	kc.
B = 570	8th	71.25	} .25
A = 710	10th	71	

It can be seen that the same result accrues in either direction. The difference is .25 kc, or 250 cycles, in both instances.

The formula is

$$F_x = (f_2 \div m) - (f_1 \div n)$$

where F_x is the unknown audio frequency, f_2 is one station frequency and f_1 is the other station frequency, m and n being the harmonic orders of the generator frequencies that zero beat with the respective stations. In some instances m and n may be equal.

THE AUDIO LIST

If the generator can be read closely and accurately enough, F_x may be read as the difference between the frequency readings on the generator, when zero beat exists for both settings, as to a pair of stations. The sound can not be heard (F_x) but then when one station is zero beated and with generator unmolested the re-

(Continued on following page)

Actual Examples of A.F. from R.F.

TABLE I

Audio notes developed by zero-beating signal generator harmonic with Station A and tuning receiver next to station B. Carriers A and B are station fundamentals, in kilocycles; generator frequencies also in kilocycles; audio in cycles. Generator is made to zero beat with A, hence is always a subharmonic of A, or $nG = A$, where n is the harmonic order, G the generator frequency and A the station frequency.

Carriers		Gen. Zero Beats "A"	Audio Result	Carriers		Gen. Zero Beats "A"	Audio Result
A	B			A	B		
1,180	1,010	168.555	222	1,180	1,450	295	5,000
810	1,010	101.250	250	1,180	570	295	5,000
860	1,500	107.5	357	1,180	1,500	295	5,000
760	1,010	126.666	416	810	1,100	270	5,000
810	1,100	202.5	500	660	860	220	5,000
570	710	142.5	500	710	860	177.5	5,500
940	1,500	188	500	1,180	1,500	131.111	6,111
1,180	710	236	666	1,450	1,500	181.25	6,250
1,010	1,450	144.286	833	570	860	114	6,500
940	1,250	313.333	833	660	1,250	132	7,000
940	1,180	235	1,000	660	860	165	7,000
1,010	1,100	101	1,000	710	810	142	7,000
1,010	1,500	101	1,000	570	810	142.5	7,500
810	1,500	101.25	1,250	570	1,500	142.5	7,500
570	940	190	2,000	660	940	110	7,500
570	1,500	190	2,000	660	1,180	110	8,000
760	1,500	152	2,000	710	1,500	142	8,000
660	860	110	2,500	660	1,010	110	9,000
570	1,450	142.5	2,500	1,100	1,010	101	9,000
660	810	165	3,000	660	1,500	110	10,000
810	660	162	3,000	710	1,500	177.5	10,000
810	660	135	3,000	810	860	162	10,000
570	940	114	3,500	810	1,250	135	10,000
570	660	114	4,000	810	1,450	135	10,000
570	1,180	114	4,000	760	810	152	10,000
570	1,180	142.5	5,000	570	1,100	285	10,000

(Continued from preceding page)

ceiver is tuned to pick up the other station, the resultant audio beat is known in advance.

Audio frequencies are developed from generator and thirteen metropolitan stations are tabulated this month as Table I. The resultant audio notes are given in numerical order (see right-hand column of table). They arise from generator zero beating with station A, set tuned to A, then set tuned to B with generator unchanged. It is not obvious from Table I how the audio was computed, but it is due to generator's harmonic zero-beating with A, and a response due to the same or another harmonic order of generator beating with B, resultant audio frequencies restricted to 10,000 cycles maximum. Unfortunately, frequencies below 200 cycles are almost unattainable, absolutely so from the 13 station frequencies considered, when the lowest frequency of the generator is assumed to be 100 kc. Besides the few values

below 1,000 cycles there are even thousands from 1,000 to 10,000 excepting 6,000 cycles. The closest attainable to fill that gap was 6,111 cycles. As protraction is to be expected with resultant charted curve, the audio spectrum will have 1,000-step points, plus some 500-step points. Various combinations to attain some particular frequencies are included. Thus there are seven varieties for 10,000 cycles.

So one may attain very high standards of audio accuracy, especially if not dependent on the ear for indication of response. Meters, ray-indicating tubes (6E5, 6G5), gas discharge tubes and cathode-ray oscilloscope tubes permit much greater accuracy. The reason is that the very closest to zero beat that one's pains and ingenuity can obtain is required. The standards are high—a small fraction of one per cent.—but their application subject to such error as missing of true or almost true zero beat introduces.

High Attainment on 20-40 Mc

New Super-Pro Favors Amateurs

By Donald Lewis

AFTER an intensive period of experimenting, the engineers of Hammarlund have just produced an additional new model of the 16-tube Super-Pro with a 20 to 40 megacycle band that is unusually efficient. I operated the receiver for quite a while and found results to be most outstanding.

Before going into a description of the receiver, I should like to emphasize a few points that I believe are most important. This model, like the other Super-Pro types, has been carefully engineered, with the additional frequency range incorporated only after considerable thought, laboratory work and modeling. For instance, specially-built measuring equipment permitted an accuracy of construction heretofore impossible. Then theoretical and practical tests were checked against each other with painstaking care to insure perfection.

Where standard materials were found to be objectionable due to losses, selected low-loss substances were substituted. In other words, the same care of design and production followed for the standard "Super-Pro" was duplicated in this new model. The natural result is that its efficiency is remarkably high.

HIGH REJECTION CAPABILITIES

In this new model, two steps of radio-frequency amplification have been included for all the five ranges. This affords a gain never before available and an image rejection ratio exceedingly high. To be more specific, on a test on 28 megacycles, the image rejection ratio was found to be 150 to 1, while the sensitivity on the same frequency with a 6-1 signal to noise ratio was .8 microvolt. Such a high image re-

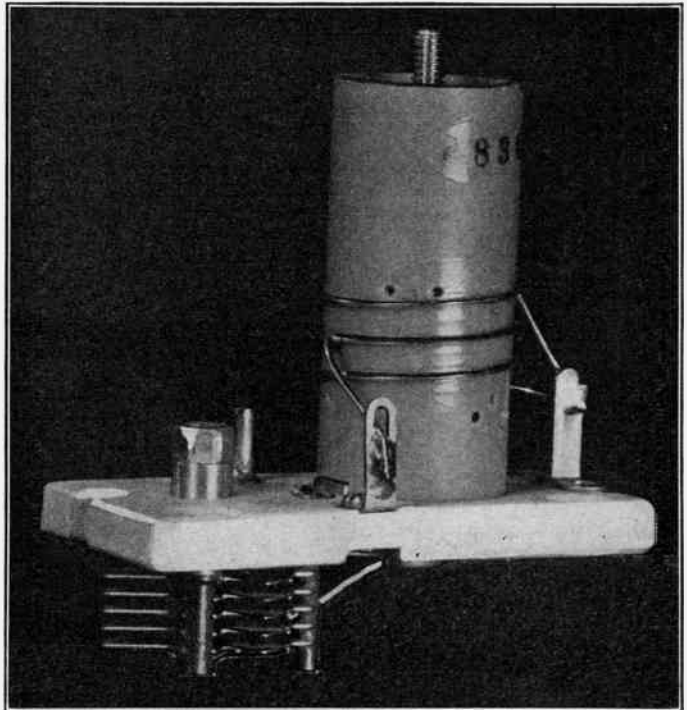

The oscillator coil for the 20-40 mc band, with capacity and inductance (top) adjuster, is in a low-loss assembly.

jection ratio definitely eliminates all fear of the "two-three spot tuning." There just isn't any such "spotty" tuning with this model. It is one-spot all the time! The high gain affords signal coverage that will crowd the old log book.

RETAINS OTHER FEATURES

Another interesting characteristic of this new receiver is the tremendous bandspread possible the 28 to 30 mc band. This 2,000 kc spectrum is covered by 90 degrees of the bandspread dial. Thus it becomes quite simple to discriminate even the most crowded sections. Due to the design of this receiver, all the amateur bands fall in the center of the tuning range of each band. Thus it is possible simply to set the tuning dial at any particular amateur band and turn

(Continued on following page)

(Continued from preceding page)

the band switch. You will promptly reach the next amateur channel without further adjustment. Then by turning the bandspread dial you will bring in the stations desired.

As in the standard Super-Pro, there are five tuning ranges. Here, of course, the tuning begins at 40 mc. The bands are 20 to 40 mc, 10 to 20 mc, 5 to 10 mc, 2.5 to 5 mc, and 1250 to 2500 kc. This coverage provides complete control of the most popular high-frequency channels.

Of course all of the many unusual features that contribute to the success of the standard Super-Pro have been retained. That is, the accurately calibrated 3 to 16 kilocycle continuously variable bandwidth panel control is still used not only to afford selectivity control, but also fidelity and tone control. The graduated audio and sensitivity controls permit, as before, accurate adjustment and simplified logging. With the zero to 2,500 cycle beat note panel control it is possible to select a frequency within this range on either side of zero beat.

For those who require additional hairbreadth selectivity for c.w. a crystal model is also made. Additional selectivity for 'phone or other modulated signals can then be obtained.

No Fadeout Expected For the Coronation

The British Broadcasting Company has no fear of a fadeout during radiation of the coronation ceremonies in May, due to sun spots. A statement from a BBC engineer sets forth:

"The chances of such a fadeout during the actual coronation ceremony are almost negligible. There was a complete fadeout on December 3 which affected all daylight transmissions and lasted for half an hour. This was not caused by sunspots but by bright hydrogen eruptions, which have nothing to do with sunspots.

"There is a great increase of solar activity this year, and sunspots are larger and more numerous than usual; but this will not be prejudicial to the reception of the coronation broadcasts. The BBC engineers have found that the effect of sunspots on night-time Empire transmissions is generally beneficial. As regards day-time transmissions, the sunspots have less effect, but they too are beneficial, and there is only a very remote possibility of bright hydrogen eruptions."

Putting the spotlight on the chassis of Hammarlund's newest model Super Pro, which covers from 1.25 to 40 mc in five bands, all switch-controlled from the front panel.

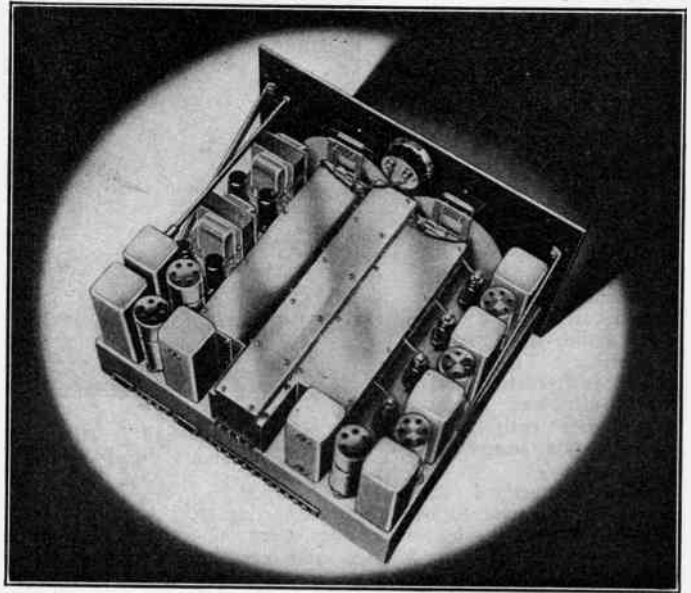

Improvements at 2RO

Improvements being made at 2RO include special antennas. Italy's enlarged Imperial short-wave center will boost the power of the present two transmitters from 25 to 40 kilowatts, and build two new 100 kw transmitters and a 50 kw reserve transmitter.

Each of the four principal outfits will be able to work on either of the two wavelengths, each carrying a separate program, while the 5th (reserve) transmitter will be able to oper-

ate anywhere between 14 and 60 meters, either as a substitute for one of the four principal transmitters or as a completely separate experimental station.

The new antenna system, both directional and omni-directional, will include fourteen lattice-work towers, some 240 feet high, while particular care will be given to the beam array for Italian East Africa, to antidote homesickness by colonists.

RIGHT OR WRONG?

PROPOSITIONS

1. A wave trap is effective because it offers practically infinite impedance to the interfering frequency.
2. The baffle area of a speaker is no more effective for low notes than the shortest distance between the front of the cone and the rear of the cone.
3. An oscillator starts oscillating for the following reason: A circuit composed of tube and tank is energized when the d-c supply is turned on, a small field is created and this r-f is fed back to reinforce the grid, the action increasing and sustaining itself as long as the d-c supply is furnished.
4. Static electricity is electricity that stands still, and can be discharged only through a medium or object polarized to an opposite potential, because only unlike charges attract.
5. A storage battery is a condenser of very large capacity, possibly hundreds of microfarads, and is charged by potential developed across the plates through the chemical change in the electrolyte when current is sent through the fluid, and discharged across the plate terminals for practical use.
6. The object of inverse feedback in an audio amplifier output stage is to increase the power sensitivity.

ANSWERS

1. Right. But this is true only of the parallel circuit in series with the line. It is not true of a tuned shunt trap, where the condenser and coil for trapping are in series.
2. Right. This is substantially true. The baffle should be extended in both directions, as any short distance around defeats the purpose.
3. Wrong. Just why an oscillator starts oscillating is not truly known yet. Words that describe an acknowledged condition are plentiful but the real information is still awaited.
4. Right. The law of discharge applies to static electricity as well as to electricity in motion.
5. Right. This is an acceptable viewpoint, though not critically accurate. The charge Q on a true condenser equals the capacity C times the voltage V , so the voltage changes during the discharge, not substantially true of a storage battery.
6. Wrong. The object is to reduce distortion. The power sensitivity is sacrificed considerably to attain this end.

Thor's Converter

(Continued from page 32)

point in the design of a converter, but usually it makes all the difference between a first-rate converter and a mediocre one.

The converter is self-powered. A 25Z5 is used for rectifying the a-c supply and the rectified current is filtered one 16 mfd. and one 8 mfd. condenser, with a 2,500-ohm resistor between them in the line. The voltage obtained after this filter is applied directly to the plates of the two tubes and to the anode of the oscillator. For the screens the voltage is reduced by individual resistance of 15,000 ohms and additionally filtered by two .1 mfd. condensers.

The grid bias for the r-f tube is provided by a variable resistor of 25,000 ohms, which also serves as a sensitivity control. It is shunted by a .1 mfd. condenser. The bias for the mixer tube is provided by a 300-ohm resistor shunted by another .1 mfd. condenser.

25L6G Announced

Hygrade Sylvania Corporation announces the 25L6G, a new double-grid power output tube designed for use in a.c.-d.c. receivers. This new tube is a glass counterpart of the metal type 25L6 and is similar to this type in characteristics, providing a high power output at comparatively low plate and screen voltages.

C-D Announces All Its Products Are Union-Made

Octave Blake, president of the Cornell-Dubilier Corporation, announces that all C-D condensers are union-made under a contract with the International Brotherhood of Electrical Workers, affiliated with the A. F. of L. "Cornell-Dubilier condensers are the first and only condensers that are union-made," he added.

(Continued from preceding page)

mediate frequency is generated. This response, even if perhaps only a squeal, is called the image.

WHY MORE SQUEALS

The only way to avoid this clashing of two different frequencies is to improve the r-f selectivity in the tuner, until the possibility of the unwanted frequency causing any disturbance is negligible. As the band to be covered, and the frequencies of the band, become higher, the greater is the peril of image interference, because of the smaller difference between the local oscillator frequency and the wanted station's frequency. Any pre-selection becomes less effective the nearer together are the local oscillator and the receivable frequencies. The difference becomes a smaller percentage of the

frequency higher than the original one by twice the i.f. Now there is or could be a new image, definitely separated higher than the present object frequency on exactly the same basis as before, except for the new numerical values. We are tuning the receiver in ascending frequency order in steps of double the intermediate frequency, so both image and object increase in frequency by the same amount.

It now becomes a very simple operation to discover images as the cause of squeals. If we know the frequency to which the set is intentionally tuned, either by reading it on the receiver dial or by measuring it with a signal generator, we need only increase the signal generator frequency by an amount equal to twice the intermediate frequency, and the squeal will become very much louder, due to the greater amplitude of the interfering carrier, now sup-

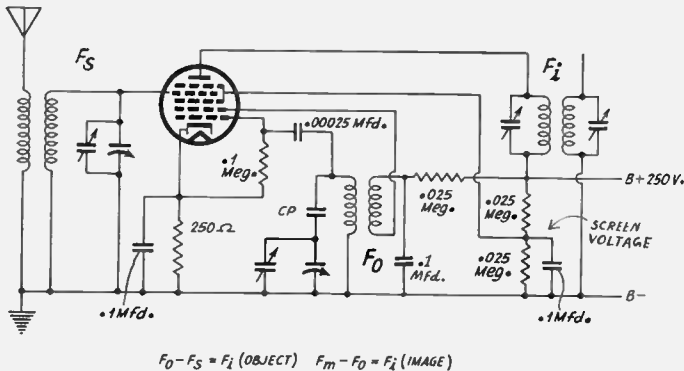

The mixer of a superheterodyne. The first circuit, at left, tunes to the desired station's carrier frequency, F_s . The next circuit tunes to a higher frequency, that of the oscillator, F_o . The mixing results in the difference between them, which is the intermediate frequency, F_i .

i.f. The closer together any two frequencies the greater is the difficulty of discriminating between them with simple tuned circuits. Hence more squeals appear at high frequencies.

Because of the cumulative effect of the sum and difference, as in the example of the nickels, the intruding image frequency differs from the desired frequency by twice the intermediate frequency. In that way a fine clue is obtained to squeal identification, because the acceptable frequency F_o is known, and the intruding image frequency F_m is higher than F_o by $2F_i$, where F_i is the intermediate frequency.

Since no station need be present, and the effect is comparable to reflection in optics, this interfering frequency is called the image frequency or just image. The desired frequency is called the object frequency.

Note carefully that this is an example of the receiver being *correctly* tuned, in a mathematical sense, to receive both stations, hence with inadequate pre-selection both may be heard at once, or the beat may create such disturbance that no station, just a howl or a scream, is heard.

SYMBOLS SHOW CHANGES

Since the image is always higher than the object frequency, the difference being equal to twice the intermediate frequency, we may change the present image to the object frequency by turning the receiver dial to a fre-

quency higher than the original one by twice the i.f. Also, if we did not know what the intermediate frequency was, we could determine it by measuring the difference in frequency between the first and the second readings, and dividing this by 2 to obtain the result.

F_i , intermediate frequency.

F_o , local oscillator frequency.

F_s , desired station frequency (object).

F_m , undesired station frequency (image).

For the usual case, $F_i = F_o - F_s$ (object).

For interference, $F_i = F_m - F_o$ (image).

For finding spread, $F_m - F_s = 2F_i$.

For finding i.f. $F_i = (F_m - F_s) \div 2$.

REMEDIES FOR IMAGES

So if squeals on high-frequency bands, i.e. short waves, are due to images, and if the only requirement is greater r-f selectivity, assuming tracking is good, then the only solutions concern the antenna, or regeneration, or installation of an extra unit for pre-selection.

Image trouble being directly due to insufficient selectivity at the r-f level, any method that increases the selectivity will tend toward a solution. Admittedly the extra unit is awkward, and many persons might object to paying the necessary amount and perhaps also to having some random gadget defacing the appearance of their console. So one recalls that as the aerial is electrically shortened, the selectivity is in-

RIGHT OR WRONG?

PROPOSITIONS

1. A wave trap is effective because it offers practically infinite impedance to the interfering frequency.
2. The baffle area of a speaker is no more effective for low notes than the shortest distance between the front of the cone and the rear of the cone.
3. An oscillator starts oscillating for the following reason: A circuit composed of tube and tank is energized when the d-c supply is turned on, a small field is created and this r-f is fed back to reinforce the grid, the action increasing and sustaining itself as long as the d-c supply is furnished.
4. Static electricity is electricity that stands still, and can be discharged only through a medium or object polarized to an opposite potential, because only unlike charges attract.
5. A storage battery is a condenser of very large capacity, possibly hundreds of microfarads, and is charged by potential developed across the plates through the chemical change in the electrolyte when current is sent through the fluid, and discharged across the plate terminals for practical use.
6. The object of inverse feedback in an audio amplifier output stage is to increase the power sensitivity.

ANSWERS

1. Right. But this is true only of the parallel circuit in series with the line. It is not true of a tuned shunt trap, where the condenser and coil for trapping are in series.
2. Right. This is substantially true. The baffle should be extended in both directions, as any short distance around defeats the purpose.
3. Wrong. Just why an oscillator starts oscillating is not truly known yet. Words that describe an acknowledged condition are plentiful but the real information is still awaited.
4. Right. The law of discharge applies to static electricity as well as to electricity in motion.
5. Right. This is an acceptable viewpoint, though not critically accurate. The charge Q on a true condenser equals the capacity C times the voltage V , so the voltage changes during the discharge, not substantially true of a storage battery.
6. Wrong. The object is to reduce distortion. The power sensitivity is sacrificed considerably to attain this end.

Thor's Converter

(Continued from page 32)

point in the design of a converter, but usually it makes all the difference between a first-rate converter and a mediocre one.

The converter is self-powered. A 25Z5 is used for rectifying the a-c supply and the rectified current is filtered one 16 mfd. and one 8 mfd condenser, with a 2,500-ohm resistor between them in the line. The voltage obtained after this filter is applied directly to the plates of the two tubes and to the anode of the oscillator. For the screens the voltage is reduced by individual resistance of 15,000 ohms and additionally filtered by two .1 mfd. condensers.

The grid bias for the r-f tube is provided by a variable resistor of 25,000 ohms, which also serves as a sensitivity control. It is shunted by a .1 mfd. condenser. The bias for the mixer tube is provided by a 300-ohm resistor shunted by another .1 mfd. condenser.

25L6G Announced

Hygrade Sylvania Corporation announces the 25L6G, a new double-grid power output tube designed for use in a.c.-d.c. receivers. This new tube is a glass counterpart of the metal type 25L6 and is similar to this type in characteristics, providing a high power output at comparatively low plate and screen voltages.

C-D Announces All Its Products Are Union-Made

Octave Blake, president of the Cornell-Dubilier Corporation, announces that all C-D condensers are union-made under a contract with the International Brotherhood of Electrical Workers, affiliated with the A. F. of L. "Cornell-Dubilier condensers are the first and only condensers that are union-made," he added.

Full Analysis of Super Squeals

Methods of Tracing and Curing Troubles

By H. J. Bernard

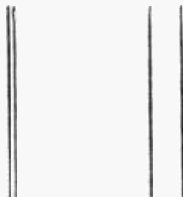

When two lines are close together, as at left, it is more difficult for the eye to distinguish between them than if they are well spaced apart, as at right. So when the station and oscillator frequencies are close together the receiver's resolving power, like that of the eye, tends to make them one, or discrimination is reduced or lost

THE complexity of modern receivers rightly makes service men feel as if they were under fire. From all directions come new difficulties. Keeping abreast of new developments, and finding the cures for troubles that afflict the innovations, not only takes considerable time but requires a higher order of technical background than most service men possess. It therefore behooves every service man who feels the higher requirements are pinching him to improve his technical standing. This he must do by study. Being disdainful of the theoretical side of radio is really a hampering attitude. It may make a man feel comfortable to meditate that the only facts on radio he does not understand are unimportant ones, but he might alter his mind finally, if one after another of his competitors could repair a set that stumped him.

As an illustration of how important is a good knowledge of the theoretical aspects of radio reception, and how that turns out to be of remunerative value, the subject of interference due to radio frequencies will be discussed. In general one may say that the problem is to rid a receiver of pernicious squeals that seem to have no relationship to a sensible order and to defy eradication.

SIX QUESTIONS

Few indeed will be the service men who can answer the following questions, all based on such interference and its cure:

1. What is the difference between cross-modulation and intermodulation?
2. For three-point tracking, if frequencies near the ends of the dials are tied

Selectivity Mystery

If a receiver has "10 kc selectivity," or the set will separate stations 10 kc apart, although one is a strong local, why is a second strong local heard as a weak background when the set is tuned to the first strong local, though the two are 50 kc apart? Why, if a set has a given selectivity, can not the benefit be universally enjoyed? What is the cause of this apparent loss of selectivity and why does it take place only for given circumstances and apply usually to a pair of stations 50 kc apart? Answers are supplied in the accompanying text.

down, by parallel and series capacity adjustment, what is the third frequency, and what control has a service man over it? In other words, what is adjusted to make the third point track?

3. How can a receiver, correctly tuned to a particular frequency, receive some response from two stations of entirely different frequency, both at this same setting, which is apparently grossly incorrect for both?

4. How can an intermediate-frequency amplifier be quiet while the set is tuned over most of the frequency coverage of the standard broadcast band, yet oscillate badly when the set is tuned over the small remaining portion of the band?

5. Why are intermediate frequencies preferred that end in a 5, such as 465, 455 175 kc?

6. Why are squeals likely to become most numerous at the high-frequency end of the highest-frequency band to which an all-wave set tunes?

There you have half a dozen questions of sufficient gravity to cause any service man to ponder their answers. In the course of what follows the answers will be distributed throughout the text, also some interference sources revealed that must come as a surprise to many.

LIKE A BUSINESS MACHINE

When we consider that all modern receivers of any consequence, and some of small conse-

quence, are superheterodynes, and that every superheterodyne is something like an adding, subtracting and multiplying machine, and handles many frequencies or numbers, we can understand that many other frequencies or numbers can arise, almost without limit, for what the business machine can do the radio machine can do, although in another way. Also, the result of these automatic "calculations" are, with one exception, pernicious in the radio example, though the business machine produces desired results in all operations.

How does this analogy hold? Well, the superheterodyne consists of a tuned-radio-frequency channel to which is added a local oscillator that generates a frequency differing from the one to which the r-f section is tuned. This difference is called the intermediate frequency, and it should be carefully noted that the i.f. is the intended resultant when two frequencies

Just as two different frequencies put into a detecting type tube will produce a new frequency equal to the difference, so will the same two frequencies of injection produce still another frequency, equal to the sum. This of course will be higher than the difference, and may be off scale, i.e., so high that the receiver when worked on any one band can not respond to the sum frequency directly or indirectly, but the sum effect can cause interference under certain conditions.

Also, there is a weak amplitude product frequency, which never causes any concern, because always far too high in frequency compared to the span covered by receivable frequencies.

THE DOUBLED DIFFERENCE

Besides these adding-machine aspects of the superheterodyne, there is the special case of

Dual function control at left cuts down input and gain simultaneously, but loads the antenna. Change to circuit at right helps eliminate crossmodulation. R may be around 25,000 ohms for most tubes, but for 6K7 or 6K7G should be 250,000 ohms

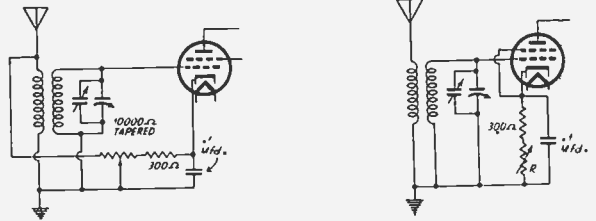

beat—1, the desired station frequency, and 2, the local oscillator frequency.

Usually the local oscillator frequency is higher, so that the station frequency is subtracted from the oscillator frequency, to yield the difference or intermediate frequency generated. No matter what frequency the intermediate amplifier is tuned to, the generated i.f. is what it is. So great care must be exercised in any theoretical discussion to distinguish between generated i.f. and the frequency of the i.f. amplifier. Obviously if the amplifier is mistuned the two are not the same, also the i.f. amplifier helps determine the frequency to which the united system responds.

TWO TERMS DISTINGUISHED

Therefore we have a plain example of subtraction. The operation is performed in the mixer stage, usually associated with a single tube, a pentagrid converter, whereby the station frequency, F_s , is put into the control grid of the pentode section, the oscillation voltage of frequency F_o is injected into the oscillator grid of the triode section, and a plate circuit common to both is used as output, with enough capacity across that output to reject frequencies higher than the generated i.f. Therefore the filtered output favors greatly the intermediate frequency, as the generation will be called. The frequency to which the i.f. channel is tuned will be called the i.f. amplifier frequency. They should be the same, but we must discuss conditions under which they are or may be quite different

the difference frequency arising from the station frequency being higher, instead of lower, than the local oscillator frequency. This, too, is unintentional and troublesome, because at a single setting of the receiver the local oscillator's frequency differs correctly from a station of a frequency intended to be received, and irksomely from a station equally higher in frequency than the oscillator.

Imagine there are six nickels on a table, and that you first add two, then return to the original six, and then subtract two. In one instance there are eight nickels ($F_s + F_o$), in the other there are four ($F_s - F_o$). The total difference, comparing the number of nickels present when addition was practised with those on the table when subtraction was introduced, is twice the amount of change introduced in any one operation. There were two operations, of equal amounts, and in opposite directions. Hence the doubling effect.

In the superheterodyne the same condition obtains. The intermediate frequency is intentionally produced by having an oscillator frequency higher than the frequency of a station one desires to tune in. But that same oscillator frequency is lower than some other frequency by the same amount. That other or lower frequency may not be a station, but any disturbance in the ether of that frequency, or of heterogeneous frequencies that include this particular one, and the r-f section may be out of tune with the repugnant frequency, nevertheless there can be a response, for the same inter-

(Continued on following page)

(Continued from preceding page)
mediate frequency is generated. This response, even if perhaps only a squeal, is called the image.

WHY MORE SQUEALS

The only way to avoid this clashing of two different frequencies is to improve the r-f selectivity in the tuner, until the possibility of the unwanted frequency causing any disturbance is negligible. As the band to be covered, and the frequencies of the band, become higher, the greater is the peril of image interference, because of the smaller difference between the local oscillator frequency and the wanted station's frequency. Any pre-selection becomes less effective the nearer together are the local oscillator and the receivable frequencies. The difference becomes a smaller percentage of the

frequency higher than the original one by twice the i.f. Now there is or could be a new image, definitely separated higher than the present object frequency on exactly the same basis as before, except for the new numerical values. We are tuning the receiver in ascending frequency order in steps of double the intermediate frequency, so both image and object increase in frequency by the same amount.

It now becomes a very simple operation to discover images as the cause of squeals. If we know the frequency to which the set is intentionally tuned, either by reading it on the receiver dial or by measuring it with a signal generator, we need only increase the signal generator frequency by an amount equal to twice the intermediate frequency, and the squeal will become very much louder, due to the greater amplitude of the interfering carrier, now sup-

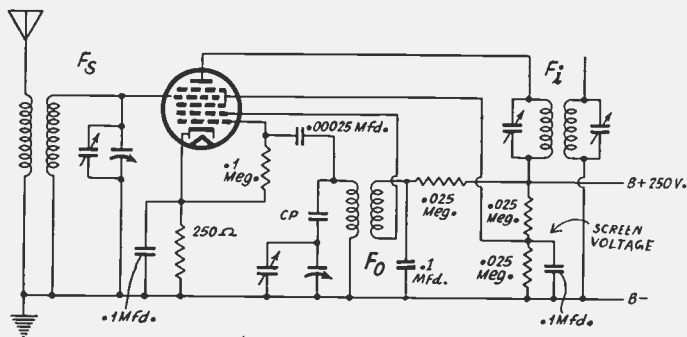

$$F_0 - F_s = F_i \text{ (OBJECT)} \quad F_m - F_0 = F_i \text{ (IMAGE)}$$

i.f. The closer together any two frequencies the greater is the difficulty of discriminating between them with simple tuned circuits. Hence more squeals appear at high frequencies.

Because of the cumulative effect of the sum and difference, as in the example of the nickels, the intruding image frequency differs from the desired frequency by twice the intermediate frequency. In that way a fine clue is obtained to squeal identification, because the acceptable frequency F_o is known, and the intruding image frequency F_m is higher than F_o by $2F_i$, where F_i is the intermediate frequency.

Since no station need be present, and the effect is comparable to reflection in optics, this interfering frequency is called the image frequency or just image. The desired frequency is called the object frequency.

Note carefully that this is an example of the receiver being *correctly* tuned, in a mathematical sense, to receive both stations, hence with inadequate pre-selection both may be heard at once, or the beat may create such disturbance that no station, just a howl or a scream, is heard.

SYMBOLS SHOW CHANGES

Since the image is always higher than the object frequency, the difference being equal to twice the intermediate frequency, we may change the present image to the object frequency by turning the receiver dial to a fre-

The mixer of a superheterodyne. The first circuit, at left, tunes to the desired station's carrier frequency, F_s . The next circuit tunes to a higher frequency, that of the oscillator, F_0 . The mixing results in the difference between them, which is the intermediate frequency, F_i

quency higher than the original one by twice the i.f. Also, if we did not know what the intermediate frequency was, we could determine it by measuring the difference in frequency between the first and the second readings, and dividing this by 2 to obtain the result.

- F_i , intermediate frequency.
- F_o , local oscillator frequency.
- F_s , desired station frequency (object).
- F_m , undesired station frequency (image).
- For the usual case, $F_i = F_o - F_s$ (object).
- For interference, $F_i = F_m - F_o$ (image).
- For finding spread, $F_m - F_s = 2F_i$.
- For finding i.f. $F_i = (F_m - F_s) \div 2$.

REMEDIES FOR IMAGES

So if squeals on high-frequency bands, i.e. short waves, are due to images, and if the only requirement is greater r-f selectivity, assuming tracking is good, then the only solutions concern the antenna, or regeneration, or installation of an extra unit for pre-selection.

Image trouble being directly due to insufficient selectivity at the r-f level, any method that increases the selectivity will tend toward a solution. Admittedly the extra unit is awkward, and many persons might object to paying the necessary amount and perhaps also to having some random gadget defacing the appearance of their console. So one recalls that as the aerial is electrically shortened, the selectivity is in-

creased, because the loading effect on the receiver is reduced. If the receiver is sensitive enough to stand it, the reduction may be practiced, by physically shortening the antenna or by putting a small condenser in series with the antenna, preferably between the antenna binding post and the proper lug of the antenna transformer's primary under the chassis. This capacity would be .0001 mfd. or less.

Since the quantity of pickup is reduced, the set noises become a greater percentage of the total sound heard, therefore general noise is a limiting factor. Yet, for "selective" noise, particularly of the type due to motor buses and trolley cars, the shorter antenna reduces the interference. The excitation is at low radio frequencies, which the receiver brings within its own tuning range by harmonics. The overloading caused by the interfering pulse makes the first r-f tube rectify, creating harmonics. The short antenna, or small series condenser, causes the antenna circuit to be very poorly matched to these low frequencies, offer a very low impedance to them so that their amplitude

Adjacent-channel selectivity is the easiest to understand. Its name tells practically all that need be said in definition of it. Recall that the receiver is *correctly tuned to only one of them*, but brings in both, particularly if tuned to a distant station, so that a local interferes. In the case of image interference, the oscillator was *correctly tuned to both*, though image reception was unintentional.

In the superheterodyne both adjacent-channel

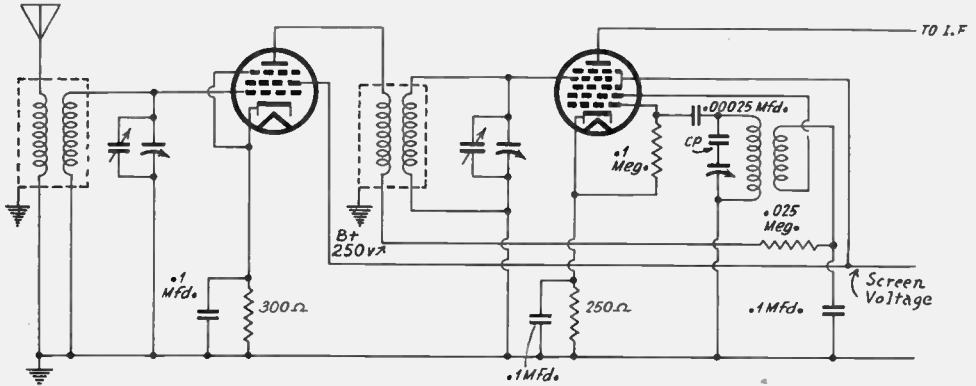
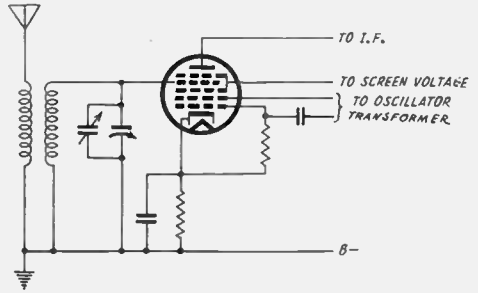

Improving selectivity in the circuit at top improves the discriminating faculty in respect to station-level frequencies, hence tends to cure image trouble. Or selectivity and gain may be both increased by adding a tuned stage (lower). With three coils shielding is imperative. With three coils shielding is imperative. Cp is the padding condenser in local oscillator diagrams.

may not be enough to cause the generation of harmonics, and thus a customer afflicted with particular noise may think a service man has worked a miracle.

ADJACENT CHANNEL INTERFERENCE

Poor selectivity in any set may result in bringing in two stations at once. In a t-r-f set, for instance, it may be impossible to separate two stations that are spaced 10 kc apart in the spectrum, especially where one is a local and the other a distant station. The type of selectivity required to effectuate such separation is called adjacent-channel selectivity, and it is something very difficult to attain in a t-r-f set. While such a receiver may be as sensitive as a superheterodyne, it has always proved less selective than urban users require. That, plus interest in short waves, has resulted in concentration on the superheterodyne.

and intermediate-amplifier selectivity are important. The i-f amplifier can not reject any interference that it receives in the form of modulation of the i-f carrier, and with a little deviation in the oscillator from ideal tracking, the effect of both stations could carry through, very forcefully if the i.f. is broadly tuned.

Besides the simple cases of adjacent-channel and intermediate-amplifier selectivity we have in all sets the possibility of two stations of substantially different frequencies being heard when the receiver is correctly adjusted to the frequency of *only one of them*. In urban areas the separation of stations is 50 kc or more, but as some stations may be using very high power, the field strength about the receiving antennas near either or both of these stations may be enormous. Even when the stations are several miles removed from the receiving loca-

(Continued on following page)

(Continued from preceding page)
tion, the trouble may arise, due to too-high r-f gain or poor design of the receiver.

Assume two stations are operating on 710 and 660 kc, a separation of 50 kc, and the receiver has what is called 10 kc selectivity, i.e., normally will separate stations even as close together as the law allows. Why should two stations so greatly spaced apart as 50 kc be received at the correct setting of one of these stations? If a receiver generally provides 10 kc discrimination what causes it to lose that asset and mar reception of two important stations?

CROSSMODULATION DEFINED

If stations deliver inordinately high carrier voltage to the first tube then that tube may act as a rectifier, plainly evident by sensitive

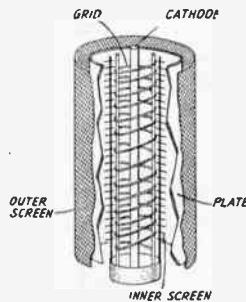

The super-control tube by a special characteristic permits wide differences of input voltage with little detection. At left is a cross-section of such a tube's elemental structure, the grid wound with coarse spacing at center and closer spacing at ends. The super-control tube is superior to the screen-grid tube because of the way the grid turns are wound. Comparative curves are at right.

true rectifier, i.e., does not draw current, it may act as a detector. In general, the word detection is applied to elimination of the carrier, to leave only the audio component, but the distinction must be made for the present purpose, as in tube voltmeter technique, that a rectifier is a device that permits more current flow in one direction than in the other, while itself drawing current, and a detector is a device that does the same thing without drawing any current from the frequency source.

VARIABLE MU TUBE

So we find that if we are working a volume control that increases the negative bias on the first tube, we may make that bias unintentionally so high that plate detection takes place. That is, the first tube is given a non-linear amplitude response. As before, the audio com-

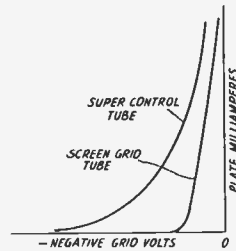

meter measurement by the presence of grid current. Therefore overload of the first tube will introduce rectification where it is not desired, and since a rectifier may eliminate a carrier while retaining its modulation, if there is considerable intensity from two stations, though they are 50 kc apart, the modulation of one station may be distinctly present in the first tube circuit, and become mixed with the carrier of the other station. So the first tube acts as a rectifier and mixer, and the audio component of one carrier is modulated upon the other. Hence a particular carrier to which the set is tuned brings in the desired station on that carrier and modulates that carrier with the audio pulses extracted from the other station's carrier. This is a case of crossmodulation, which may be defined as the modulation of an interfering station riding through on the carrier of another station, to the frequency of which the receiver is tuned.

Crossmodulation of the type just set forth may be considered a rare trouble, because the first tube would have to be biased at a voltage far lower than the values found in practice. For instance, a negative bias of 3 volts is usual, and no grid signal voltage that high is to be expected, even allowing for a 1-to-4 transformation voltage in the antenna transformer.

Even if the first tube does not behave as a

ponent of one station's carrier may be present in the plate circuit as a distinct current that modulates the carrier of another station to which the receiver is tuned.

The remote-cutoff type of tube was developed to reduce the effects of cross-modulation. The special grid structure provides the tube with a variable-mu characteristic with change of grid bias. At the ends the spacing between the turns of the grid structure is close, while at the middle it is coarse. When the input to the tube and the bias on the tube are low the control effect over the entire grid structure's span is practically uniform. As the signal intensity is increased and the negative bias is made still greater, the current is practically cut off at the closely-spaced ends of the grid winding, and the tube then functions on the basis of the current-control by the coarsely-spaced part. Thus the gain of the tube is greatly reduced for large input voltages, and operation is enjoyed at minimum distortion. The change in current is very gradual for large negative biases, or there is little curvature of the characteristic.

If the remote-cutoff type tube, so-called because it takes a great deal of negative bias to stop the plate current flow entirely, were a complete solution there would be no cross-modulation trouble ascribable to the receiver if those tubes were used in a proper circuit, but

Answers to the Six Questions

Near the beginning of the accompanying article six questions were put. The answers follow:

1. Crossmodulation is the introduction into a carrier desired to be received, of the modulation component of a carrier not desired to be received, so when the receiver is tuned to the desired signal carrier the undesired signal is heard simultaneously. Crossmodulation may result from rectification in the first r.f. amplifier particularly, or from rectification outside the receiver, resulting in re-radiation of the twice-modulated desired carrier. Intermodulation is the mixing of two or more carriers, due to inadequate inter-channel selectivity, or to the relationship of the carriers to one another or to local oscillator, either fundamentals or harmonics being concerned.

2. The third frequency is the geometric mean of the communication band, taken as 1,000 kc in practice, for the standard broadcast band. The control over it is by local oscillator coil's secondary inductance adjustment or by change of the intermediate frequency.

3. The two frequencies far different than the resonant frequency are so related that the sum or the difference between their frequencies or local oscillator frequency, produces the frequency of resonance. Harmonics as well as fundamentals must be considered.

4. When the r.f. is so high that it is near the low-frequency end of the broadcast band (e.g., i.f. = 480 kc, r.f. = 530 kc, difference = 50 kc) the r.f. is coupled to a degree to the i.f., and the multi-stage circuit oscillates at either or both frequencies.

5. There is no good reason for this. In theory squeals are supposed to be reduced, because even harmonics of the r.f. zero-beat with station frequencies. However, odd harmonics yield 5,000-cycle notes. Besides, some stations outside the United States, but within range, also end in 5, so even harmonics of the r.f. produce 5,000 cycles, odd harmonics zero beat. The theory also supposes perfect tracking, but such "perfection" is attainable even in theory only at three points out of about 100 station points on the dial.

6. Because the higher the station frequency the smaller the difference between it and the local oscillator frequency, the poorer the effective preselection and the lower the r-f selectivity generally, for the r-f resistance increases about at the rate the frequency increases.

the beneficial contribution to reception free of interference of this type is not quite 100 per cent.

SELECTIVITY FACTOR

Since cross-modulation is related to the amount of voltage developed in the grid circuit of the preponderatingly offending first tube, if a high-gain antenna coil is used the peril of such interference is heightened, because the voltage developed across the high-inductance, primary, and therefore across the tuned secondary, is far greater. Moreover, the natural period of the antenna circuit, of which this high-inductance primary is considered a part, is much closer to the frequencies of the most powerful stations, since these carriers are nearer the low-frequency end of the dial on the standard broadcast band.

Moreover, selectivity, or Q , of the first circuit has much to do with the trouble, because the lower the Q or smaller the discriminating ability of the first circuit, the larger the input voltage of the undesired station, compared to the input voltage of the desired station. This is true because selectivity is consistent with large amplitude for a particular frequency and large attenuation for all other frequencies, and low Q has a leveling effect, in the direction of uniform reception of all frequencies, or no discrimination.

Q OF 5 ENCOUNTERED

It is therefore desirable to have the first circuit of high Q . Thus all loading devices across primary or secondary must be avoided, including volume controls of the type that reduce the input at the same time that they reduce the gain. Such controls as return a potentiometer through the antenna winding, whereby the control shorts that winding as the negative bias is increased to reduce both signal input and gain, at low resistance settings leave the first circuit with hardly any Q at all, values as low as 10 being not uncommon under that condition, and sometimes 5 is the figure, although some manufacturers specify minimum Q around 65 for the coils put into these receivers. It is the selectivity factor or Q of the circuit that counts. A coil that, of itself, has a high Q , but is loaded with a resistor so that the circuit Q is low, contributes nothing much.

We therefore come to the conclusion that, where crossmodulation is suffered, remedies that could be applied to advantage are (1), reduction of the antenna length, physically or electrically, as for the case of image interference; (2), removal of loading constants, including changing the volume control connections if the control shunts primary or secondary, particularly if adjustable or low resistance; (3) reducing the number of primary turns, if a high-gain antenna coil is used; (4) having the normal operating bias of the tube of standard value, to insure particularly that the bias will not be too low; (5), putting filter capacity across the power transformer primary.

Special mention has been made of the first r-f tube, not because it is the only offender

(Continued on following page)

(Continued from preceding page)

but because it is the principal offender, and cures applied in this circuit have been very satisfactory. One need not seek far for the reason, since any cross-modulation in the first tube consists of impressing on one carrier the modulation of a second carrier, or mixing two carriers, subject to all the amplification that the set affords in the case of first-tube rectification, and all the amplification, save that of the first tube, for plate rectification therein.

MODULATION DISTORTION

In passing, it is well to point out that besides cross-modulation there is possibility of modulation distortion, determined most readily in the second detector. It causes the whole audio rendition to be blurred and tinny. It is due to

satisfactorily explains the reason for the mysterious outside trouble. If two stations 50 kc apart lay down a carrier of considerable field strength at any locality, or if at least one of the stations does so, then any wires strung about, as trolley feeds and telephone and lighting company wires, may serve as antennas. They will pick up the carriers of strong stations and since rectification may take place in very numerous agencies, including perhaps some not known, a strong station's modulation may be present in this stray rectifier, and since the same wires pick up the weaker carriers that may not develop rectified output there will be impressed on the weak the full modulation of the strong station. Now the weak station carries its own modulation on its carrier, and also the modulation extracted from the strong

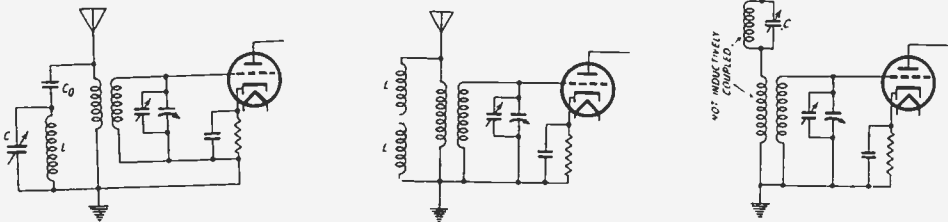

For direct interference at the intermediate level, usually code, wave traps are effective in the antenna circuit. At left is a parallel so-called trap, occasionally suggested, but does not work. The two-coil method commercially used, shown as LL, is effective. The capacity coupling between windings enters. The series trap is LC at right.

operation of r-f and i-f amplifier tubes on a curved portion of the characteristic—too high a negative bias for the type of tubes used. It is another example of non-linearity to which radio or intermediate frequency or both are subjected, and is readily cured by substituting remote cutoff tubes and arranging the biasing system so as to avoid the excess that causes the ailment.

So far we have considered all ailments entirely from the viewpoint of receiver defects, but there are kindred troubles that may be ascribed to conditions outside the receiver. Frankly, there must have been considerable guesswork published as authenticated facts, to enable all the fantastic explanations that have been given of this outside trouble source. A particular receiver has responded as one cross-modulated when used in one location, yet the trouble entirely disappeared when the receiver was moved to another location nearby, where another antenna was used, perhaps even in the same building! Therefore it is very sensible to conclude that the receiver itself was not the offender, also that the trouble could not be remedied in the receiver itself, but had to be circumvented externally.

THE RERADIATION THEORY

One viewpoint, at least, may be offered that

station's carrier. If both stations are strong enough the crossmodulation is compounded.

The only question that remains to be answered is how the weak station's carrier, bearing the dual modulation, gets into the ether in that form. The answer would be, by reradiation. When a carrier is originally sent out it is radiated. There is always originality in radiation. When a radiated carrier is picked up by some agency and then cast out again, so there is a sort of electrical reflection, the carrier is said to be reradiated. Since a wire serving as a receiving antenna also can transmit, the double-modulated weak station may be reradiated, and that would explain the disappearance of trouble when the receiver or antenna is moved, because the new antenna is outside the field of reradiation.

RECTIFIER POSSIBILITIES

So rearrangement of antenna proper, and lead-in, with particular favor for a transmission line, or lead-in that picks up no energy and radiates none, are solutions that have proved abundant and have tended to justify the theoretical explanation just given. This, by the way, is the first presentation of the viewpoint that reradiation is a cause of exterior cross-modulation.

The rectification that would have to take place could arise from so many causes that there would not be room to print them all. As a suggestion, dissimilar metals, when in contact, may rectify; so may high-resistance joints, as commonly found in ground leads; so may joints at which electrolysis has taken place, especially as one remembers that the electrolytic rectifier was one of the popular types antedating the invention of the vacuum tube. Even lamps used for lighting purposes may rectify, particularly gas types, where there are two elements, as in the neon and argon tubes, for the conductivity through one leg is hardly ever exactly the same as that through the other.

A questionable point about the reradiation theory is that even with reradiation the direct wave would be much stronger, and the reradiation so weak as to be relatively ineffective. The answer lies in two directions. First, if there is reradiation with the cross-modulation impression on the carrier, and if the direct wave is free of this trouble, nevertheless the combined wave still would be marred by the interference, for the receiving antenna could pick up both. It is only a question of the relative intensity of the interference. Second, it is quite possible that the receiving antenna, by some circumstance of location, is at least partly screened from reception of the direct wave, and therefore the receiver may get as much or more voltage from the reradiated and disfigured wave, hence the interference would be marked.

WHEN INTERMODULATION ARISES

The modulation aspects begin to get rather ponderous when we consider the superheterodyne as akin to a business machine, with wide capabilities as to addition, subtraction and multiplication.

It has been noted that for all examples of crossmodulation, or the reproduction of the modulation of one carrier upon another carrier, or the mixing of the two carriers, the receiver was *correctly tuned to bring in one of the stations*, although unfortunately both were heard. We now come to examples having to do with the receiver not being tuned to bring in either station, yet both are heard, or a clash results, so that reception is marred because the two frequencies, set tuned to neither, produce a beat. This is the condition that obtains when there is intermodulation, i.e., carriers or harmonics of carriers are mixed, a third frequency is produced, and when the receiver is tuned to this third frequency the interference is suffered.

It sometimes happens, also, that this third frequency is the same as some station frequency, or, so to speak, the beat frequency has call letters. Thus with the receiver tuned to the third frequency we have three sources of interference, and of course the station can be heard, for the receiver is tuned to it, although it does not always follow that the program can be understood, due to fierce distortion. This example seems to introduce an exception, in that we have intermodulation although the receiver is tuned to one of the interfering frequencies, but the mixture takes place in the second detector, and is an audio function, as the synthetic

carrier and the station fundamental carrier simply have the same frequency. This is no receiver fault, as such, any more than it would be if there were two locals operating on exactly the same frequency simultaneously. The two carriers would be tuned in together, their frequency would be the same, and the modulation of both would disappear in the output, which is audio, just as modulation distortion so appeared.

The integral multiples are harmonics of fundamental frequencies and we are therefore about to consider a special form of harmonic distortion, where distortion is taken as anything that mars reception quality and therefore broadly includes interference. Also included is the possibility of reception of a station at a higher frequency setting of the receiver in the same band than the station actually occupies, as this reception is usually distorted, and certainly introduces interference if there is a receivable station at this higher frequency.

INTERFERENCE BY HARMONICS

There are many ways in which harmonics can cause responses in a superheterodyne, but by restricting the examples to the commonest ones we have the following:

CASE I. Two stations influence the r-f tuner. One of these stations is intentionally tuned in, the other is a powerful local that lays down an antenna input sufficient to break through the selector, and a second harmonic of this second strong local station is created in the tuner by detection or rectification. The frequency difference between the second harmonic of the second station and the fundamental of the first station equals the frequency of some other station, which either is heard distortedly, or causes a squeal. In symbols, where $2f_1$ is the harmonic example of the first station, and f_2 is the fundamental of the second station frequency, the interference is due to $2f_1 - f_2$.

Example: The receiver is tuned to 660 kc and there is a second harmonic content thereof in the tuner, or 1,320 kc. The seepage voltage of a strong local on 710 kc affects a tuner tube so that interference with 610 kc, the third station, to which frequency the receiver is not tuned, results from 1320—710 kc equalling 610 kc.

CASE II. There may be a disturbance at the i-f level due to the second harmonic of a difference, even where the difference itself arises from a second harmonic. We found such a difference due to second harmonic as one of the terms in Case I. Now suppose a second harmonic figures in creating the difference, and there is second harmonic of the difference. Then in symbols $2(2f_1 - f_2)$ causes the interference.

Example: A station operating on 570 kc is tuned in properly, yielding a second harmonic of 1,140 kc. A second station, a strong local, gets some of its 660 kc fundamental into the circuit, and the difference is 1,140—660 or 480 kc. If the intermediate frequency is actually or nearly 480 kc there will be interference.

HARMONICS OF THE I.F.

CASE III. The intermediate frequency's own
(Continued on following page)

(Continued from preceding page)

harmonics may be generated in the i-f channel and affect the tuner because of common coupling between the two levels. In symbols, $2f_1 - f_2$ represents the frequency of interference, where the first term is the subduplicate of the i.f. and the second is the frequency of a station. Should the i.f. be 465 kc then the second harmonic is 930 kc and there would be interference with a station on 930 kc, when the set is tuned to bring in a station at 930 kc. While the second harmonic of the i.f. was considered, the harmonic order may be anything within reason, so the order n is applied for the general case, and n may be 2, 3, 4, 5 etc. This reveals that the interference may follow the integral multiples of the i.f., of which the first interference source was $2f_1$, accounting for 930 kc interference, and the others would be $3f_1$, for 1,395 kc interference, and the remaining one, assuming the possibility of reaching that frequency in the standard broadcast band, 1,850 kc. Hence the lower the i.f. the more numerous the instances where such type of interference may result, and for 175 kc n may be finally as high as 9 or 10.

CASE IV. Also, the sum of harmonics of the intermediate frequency and the fundamental of a station frequency may cause interference with a station of a third frequency. In symbols, $2f_1 + f_2$ is the interfering frequency. By example, $f_1 = 465$ kc, $2f_1 = 930$ kc, and the station f_2 to which the receiver is tuned is 550 kc. The sum, $930 + 550$, is 1,480 kc. The interference would be caused by beating of seepage voltage from a strong local of that frequency.

LOCAL OSCILLATOR'S HARMONICS

CASE V. The local oscillator is naturally replete with harmonics. Hence it generates freely frequencies that are integral multiples of the many frequencies to which it is tuned, one at a time. In symbols the interference is due to $2f_0 \pm f_s$, where f_s is a station delivering some voltage to the system. By example, for $f_1 = 175$ kc, receiver tuned to 550 kc, the oscillator f_0 is $550 + 175$, or 725 kc, oscillator's second harmonic is 1,450 kc, and there is interference possible on 1,450 - 175, or 1,275 kc, and on $1,450 + 175$, or 1,625 kc.

CASE VI. Interference may result from twice the frequency of one station being diminished by the frequency of another station, that is, $2f_{s1} - f_{s2} = f_1$, as when one station is 570 kc, with second harmonic 1,140 kc, the other station, fundamental alone considered, is 660 kc, and furnishes a strong enough input to allow seepage voltage through the selector, and the difference, $1,140 - 660$, is 480 kc, and equals the intermediate frequency.

THE PRACTICAL SITUATION

There may be interference in all of the foregoing examples. Even if the two frequencies are equal in the equations, they may not be or remain equal in nature, because of oscillator drift and of slow shifts in the intermediate amplifier frequency, due to compression type condensers in the i-f coil assemblies, or due to voltage changes in the receiver. That is, were true zero beat established there would be no

interference, but it may be regarded as practically impossible ever to establish true zero beat, and all examples produce squeals really, because the beat is so far from zero that even the resultant frequency is within the range of the audio amplifier, the speaker and the ear.

The fact that zero beat may exist mathematically, and may by some unbelievable accident exist in one of these interference examples, does not of itself guarantee freedom from interference, because so many of the extraneous sounds are due to crossing the interference point, so that sounds are heard when tuning approaches and leaves the station. That is, the interference comes under the heading of "birdies." At true resonance with the expected interference say there is no interference, but in all the audio spectrum on either side, in the tuning process, the offending sounds assail the ear.

UNCOMMON TROUBLES

CASE VII. Besides the interference due to harmonics there may be interference due to fundamentals mixing. Suppose there are two stations, f_{s1} and f_{s2} , then if there is any rectification or detection at the r-f level, and there is practically always a stray quantity of one or the other, then if the two station frequencies are added there is a third frequency present, so the interference is between this sum frequency and the frequency of the third station. In symbols, $f_{s1} + f_{s2} = f_{s3}$, the receiver is tuned to f_{s3} . This is not a common cause of trouble, because the two frequencies that are mixed to produce the third must come through by seepage, for the set is tuned to a completely different frequency, that is, a frequency far removed, and even a fair order of selectivity should be sufficient to safeguard against this kind of trouble. In the case cited, there would have to be seepage voltage in two instances, which renders the likelihood of trouble very remote. This is true even if the receiver is tuned to f_{s1} or f_{s2} instead of to f_{s3} , since always there must be seepage voltage from two other stations. The result may be a gurgle, murmur or other beat, but the modulation of the interfering stations that beat to cause a frequency equal to that of the third station can not be resolved into anything understandable. The case applies to t-r-f sets as well as to tuners.

Example: Two strong local stations operate at 660 and 710 kc, and when the receiver is tuned to 1,370 kc, where a station is assumed receivable, there is a beat with the sum of the frequencies of the two other stations ($660 + 710 = 1,370$).

SECOND "OSCILLATOR" FREQUENCY

CASE VIII. In supers the seepage voltage may produce interference also by the mixing of signal carrier frequencies. The sum of or difference between these two carrier frequencies then is acted upon by the modulator tube just as if a second oscillation frequency were introduced. In fact, it is so introduced, except that it does not come from the local oscillator but indirectly from the two stations. The waves the stations send out are of the same general nature as those produced by the local oscillator,

the mixture of the station carriers is of the same general nature, and the mixer circuit can not distinguish between them. If the two station frequencies are f_{s1} and f_{s2} , then the interference would be due to $f_{s1} + f_{s2} = f_i$, where f_i is again the intermediate frequency. The third station frequency is f_{s3} and there must be seepage voltage from it to produce beat interference. Again there must be seepage voltage from two stations, when the receiver is tuned to any one of the two others.

By example the stations are 550 and 610 kc, their sum frequency is 1,160 kc, the i.f. is 175 kc, hence the 1,160 kc appears to the modulator as an oscillation frequency, and affects a station of 1,160—175 kc or 985 kc. There may be a Mexican or Cuban or other station on a frequency ending in 5, but even so, stations

that results in plate-circuit detection in r-f amplifier tubes increases the selectivity, but since detection takes place, it is of not much consequence in a sensitive receiver that the amount of interfering voltage is small, or amplification at one level is made small, because first the detection efficiency is increased by the increased negative bias; and second, no matter how small the interference at the first-tube level, it turns out to be an offending sound in the speaker.

When selectivity is to be improved by methods that do not require any extra tubes or tuned circuits, as by using devices previously outlined, the consequences of lessened quantity of sound output must be tolerated. However, the decrease may not be considerable for sets that have a.v.c., particularly delayed a.v.c.

Devices that have a.c. on the plate can not be used with complete satisfaction in adjusting for the third tie-down point in a superheterodyne because the beat response may be weak, and the strong audio modulation, or hum, might mask or drown it. The diagram is that of a positive mu signal generator

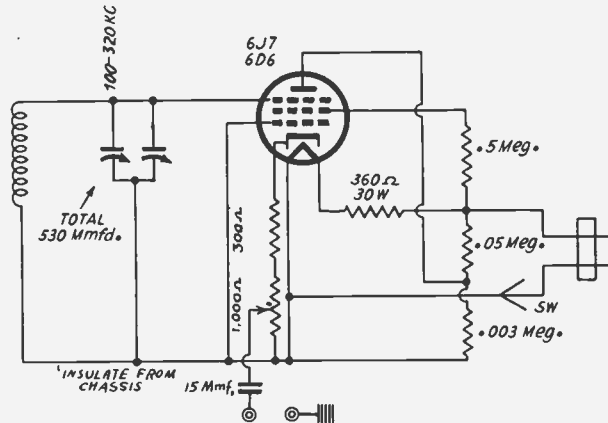

5 kc removed on either side will produce a 5,000-cycle note. This example is not the same as image interference, which, it will be recalled, also is found at a frequency higher than the one the set is tuned to. Twice the intermediate frequency is added to the station frequency to find the interfering image frequency.

Here the image would be, for 550 kc tuned in on the receiver purposely, $550 + 350 = 900$ kc. For the other station, 610 kc, the image would be $610 + 350 = 960$ kc. Hence the images 900 and 960 kc, of the same two stations are close to the interference frequency of 985 kc due to the same two stations uniting to form what appears to the modulator as another oscillation frequency. If the suspected image therefore is off by 20 to 50 kc or so, the image theory may be rejected, and the seepage trouble as set forth in the present case may be suspected.

SELECTIVITY CONSIDERATIONS

It can be seen that there is a companionship between insufficient selectivity and the presence of rectification or detection in the tuner. The case of crossmodulation may be one in which no selectivity improvement in the set will be of any benefit, as where there is external rectification and reradiation. But for the usual cases selectivity improvement is in order.

It so happens that the increased negative bias

Naturally the worst troubles arise in the worst sets. For instance, midget supers, with no pre-selection, may suffer from image trouble even on the standard broadcast band, if the intermediate frequency is low. And for a single-band set of that type it may be expected to be low, since then the i-f selectivity is much higher than if 456 kc or some other such i-f were used, and the gain is greater, two considerations important in the design of one of those little things. It is out of the question to add pre-selecting gadgets to such a small receiver, as the gadget might be almost as big as the set, and might cost as much, or more. Hence the remedies that require no extra stages would be applied.

QUESTION OF SHIELDING

Such a small set hardly would have shielded coils. The set is more selective when there is no shielding, if there are only two coils, i.e., a two-gang condenser is used. At least the antenna coil need not be shielded, though the oscillator coil could be, with small reduction of sensitivity. If any set having unshielded coils is to be improved as to selectivity, as by adding a tuned stage, then all three coils should be shielded, to make the set workable. Also the loop effect becomes pronounced as the stage is added so that there is pickup by the

(Continued on following page)

(Continued from preceding page)

coils sufficient to produce reception, say without any intentional antenna. This is to be avoided, where possible, as the pickup should be confined exclusively to the primary winding of the antenna coil, so that all carriers brought in are subject to the r-f selectivity of the receiver.

Besides all the forms of interference discussed, it is possible for the intermediate amplifier to pick up a carrier on its own frequency. If the channel is very sensitive it may do this by the antenna effect of its grid leads. Also, the voltage of the intermediate frequency is picked up by the antenna and gets through a tuner, reaching the intermediate amplifier in reduced quantity, but nevertheless sufficient to cause pronounced interference. This type of interference is likely to be code, and may be eliminated by insertion of a wave trap at the antenna input, tuned to the intermediate frequency, or to the frequency of interference, which may be slightly different. It is the interfering frequency that counts. Also, it is entirely practical to change the intermediate frequency so as to get past the frequency of interference.

While great precautions have been recommended by many that the intermediate frequency must be exactly as specified, there is nothing sacred about any particular intermediate frequency, since a moderate change is always in order, especially to cure a trouble simply.

CHANGING THE I.F.

The way to do this is to turn down the trimmer condensers a little, one at a time, until the interference disappears, even when antenna is connected loosely to the input of the i-f channel. Then the channel is resonated and series padding condenser has to be reset in the local oscillator circuit, and a small adjustment made of the oscillator's parallel trimmer condenser. No change of the r-f trimmer condensers need be considered adamant, unless the local oscillator is so closely coupled to the r-f tube ahead that a change of oscillator trimmer

capacity introduces a capacity change in the other circuit. This is generally true of pentagrid converter tubes, so the r-f trimmer should be reset where such a tube is used.

The dial readings on the receiver normally should not change, but for an i-f lowered by more than 10 kc, some change representing a slight departure from tracking may appear at the very low frequency end of the dial. The receiver is tied down at 600 kc as before, and may read a little differently than before around 550 kc. At the high-frequency end there should be no change—tied down at 1,450 kc or 1,500 kc or as manufacturer recommended, and dial settings to 600 kc unchanged.

THE THIRD TIEDOWN POINT

Poor tracking is a cause of squeals because the preselection is of a low order, perhaps merely makes matters worse instead of better. Hence "birdies" abound. Assuming that a padding circuit is used in the local oscillator, there are tiedown points at two near-end frequencies, and the tracking formulas take care of these, but also there is the third point that appears in the formulas, but concerning which nothing much is ever done practically. Therefore unless some control is exercised over the third point, the excellence of tracking, which the formulas indicate, probably will not be realized.

If certain capacities are assumed for the r.f. and the local oscillator, for certain inductance for both, then there remains to fix only the intermediate frequency. Of course all considerations are taken at once, but we are dealing with the case where there has been failure of the theory to comply with practice. In other words, something is wrong, as since there is freedom of capacity choice for series padding and parallel trimming, we have only to consider the intermediate frequency and the local oscillator inductance. The r-f inductance is ruled out because it is practically standard at around 238 microhenries secondary for the customary condensers, nominally .00035 mfd.

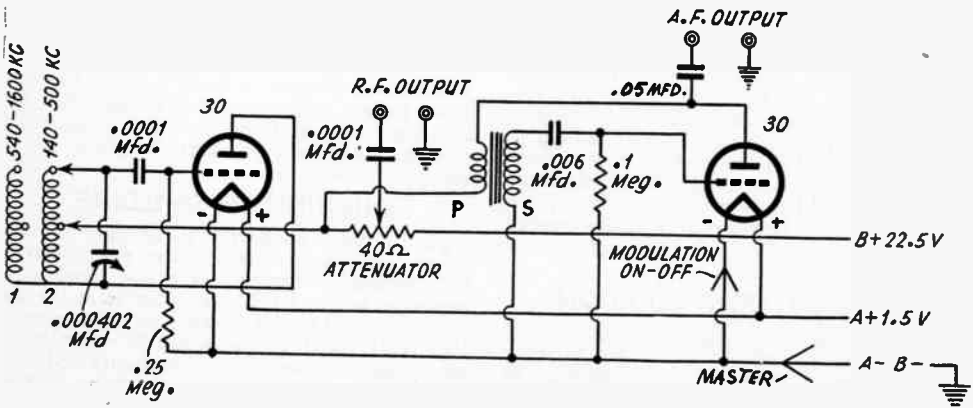

If a signal generator has modulator built in, as does this two-band battery-operated device for which commercial calibrated equipment is obtainable, then modulation is to be shut off in testing for the third tie-down point in a superheterodyne. R.F. output would be weakly coupled to the i.f. channel, generator set at the i.f.

Now, the first importance attaches to what the third tiedown point is, and it happens to be the geometric mean of the standard broadcast band, for instance. For practical reasons this is taken as 1,000 kc.

Therefore since we may tie down readily for 1,450 or 1,500 kc by parallel trimming capacity, and at 600 kc or thereabouts for the other near-extreme, we must address ourselves to the problem of tackling the midpoint.

A PRACTICAL APPLICATION

It is a sure sign there is something wrong around this region if there are squeals present, though absent at other points of the tuning, or if, even without squeals, sensitivity is inordinately low. So some method must be used of ascertaining whether the tracking fails.

The most practical way the author has found of doing this is to couple a signal generator weakly to the intermediate amplifier, at the intended intermediate frequency, not usually the frequency to which the intermediate amplifier is tuned. With a sufficiently sensitive receiver, as the dial of the receiver is turned, beats are produced with numerous stations. If the tiedown is complete at 600 kc, no particular attention need be paid to frequencies lower than that, due to absence of control over them, and

described, when the station is tuned in a definite frequency will result at resonance. This may be selected as any sensible value, say, 5,000 cycles, by generator adjustment, and the note is memorized. Now as the receiver dial is turned, listen to the beats when the stations are resonated in, and if the first selected note was 5,000 cycles it should be possible to hear a beat for every recognizable station, because for good tracking the beat should never then get beyond the audio spectrum, otherwise it means deviation exceeds 5,000 cycles. In any set properly tracked, including receivers with specially-cut plates for the oscillator capacity section, it is quite a simple matter to register and discern these beats, and feel satisfied that the tracking

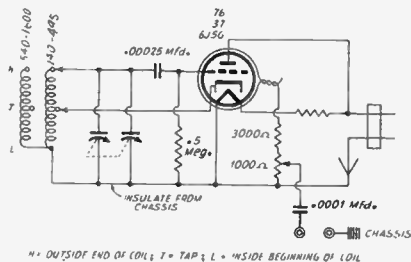

H = OUTSIDE END OF COIL; T = TAP; L = INSIDE BEGINNING OF COIL

Modulation is constant for the generator at upper right, if a.c. is the supply, as the hum is heard at resonance, whereas if d.c. is applied there is no modulation. The larger diagram is for a.c.-d.c. operation, the right-hand tube a rectifier for a.c., and a floating resistor for d.c.

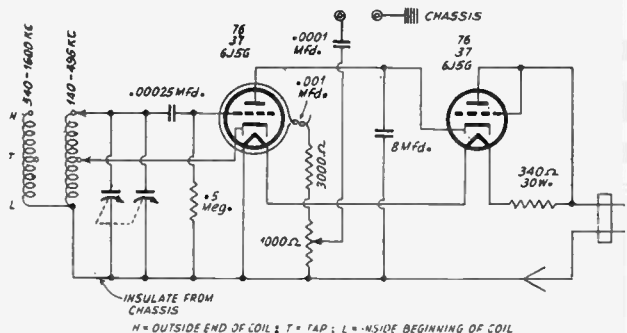

H = OUTSIDE END OF COIL; T = TAP; L = INSIDE BEGINNING OF COIL

slight departure, anyway, even if there is any deviation. Then, tuning in higher frequencies, more beats are heard, and there are enough stations receivable to encompass the whole dial.

It is not necessary that the station's program be audible, for the beat will be present even if the modulation of the station can not be separately heard. This is due to the signal generator producing an amplitude sufficient to create a sound due to beating even with a station too weak to be heard alone.

WHAT TO DO

Now, if there is perfect tracking there will be the same beat all the time, for resonance of each and every station. But tracking is never perfect, and even the theoretical case admits a deviation of 4 kc as maximum, while practice compels a greater variation than that.

While there will be "birdies" in the use of the beat-frequency oscillator, as the signal generator now used without modulation may be

job is satisfactory. If it is not, work is ahead. What shall be done when the beat changes a great deal, say, goes beyond audibility, due to too large a frequency deviation? We know what to do for near-terminal frequencies, and are now concerned with the central part of the tuning.

Since there is something wrong, and tuner capacity control has been exhausted at the near-ends, we have left two companion devices. The local oscillator coil is wrong for the frequency of the intermediate amplifier, or, if the coil is assumed correct, the intermediate frequency generated is not the frequency of the intermediate amplifier, hence amplifier is off resonance. This is not an option in the form of a guess, but simply a statement that either may be considered wrong, and not both, therefore either may be corrected. Since tackling the oscillator inductance is much more difficult practically, that hard job is avoided, and instead the inter-

(Continued on following page)

Literature Wanted

Readers whose names and addresses are printed herewith desire trade literature on parts and apparatus for use in radio construction. Readers desiring their names and addresses listed should send their request on postcard or in letter to Literature Editor, Radio World, 145 West Forty-fifth Street, New York, N. Y.

Geminiano F. Victa, 10 Yacal, Manila, P. I.—re amplifiers, speakers, replacement parts, and testing instruments.

Frederick Blust, 628 Broadway, Sheboygan Falls, Wis.

C. P. Rust, c/o Bear Sound System, 2519 Gladiolus St., New Orleans, La.—of interest to service engineer and P.A. construction coverage.

Berger Ek., R.R. No. 1, Macedonia, Ohio.

Mickey Vargo, c/o Mickey's Radio Service, 1913 West 24th St., Cleveland, Ohio.

Elwood P. Brooks, 1636 East 36th St., Cleveland, Ohio.

Harry Valentine, W8LAM, 2142 W. 54th St., Cleveland, Ohio.

Edward A. Roberts, W8HC, 2699 Endicott Rd., Shaker Heights, Ohio.

Dale Nestlerode, 12 Washington St., West Pittston, Pa.

Wm. H. H. Massy, 105 W. 55th St., Apt. 7E, New York, N. Y.—everything appertaining to radio and kindred arts.

Leo G. Sands, 2119 McDougall Avenue, Everett, Wash. Art Davidson's Radio Service, 623 W. Calvert St., South Bend, Ind.

H. P. Oakenfull, 97 Filleul Street, Dunedin, C. 1, New Zealand—particularly catalogs, information, price lists on Radio and Noise-suppression Equipment.

Ray De O'Callihan, 3355 Harrison, Brookfield, Ill.—on Research, Service and Construction.

The Rajput Trading Company, Post Box No. 32, Chowk Farid, Amritsar, British India—radio receivers, and radio parts and accessories for import—also radiogram motors and pickups, also converters for 220 v. D.C. to 220 v. A.C. Interested in buying secondhand, surplus and re-conditioned radio sets at low prices.

Billie C. White, Hdqtrs. Co., 21st Inf., Schofield Bks., T.H.

Anselmo Laperriere, 39 Chateauguay Street, Quebec City, P.Q., Canada.

Melvin A. Schuler, R.F.D. No. 2, Box 10, Delano, Minn.—New 1937 radio catalogues.

Rupert Electric Company, Rupert, Ind.

Morris M. Silver, 3871 Sedgwick Ave., Bronx, New York City.

James J. McCartin, 437 E. Merrimack Street, Lowell, Mass.

Rongo's Radio Service, 2819 S. Warnock St., Philadelphia, Pa.

Dave Myerson, 7 E. Gun Hill Road, Bronx, New York City.

E. T. Clark, Radio Service, 5315 Oakwood St., Dallas, Tex.

F. J. Marquez, 906 33rd St., Denver, Colo.

Radio Service Co., Box 32, Fayetteville, N. C.

(Continued from preceding page)

mediate frequency is changed. To what is it changed, and in what direction? With signal generator feeding the antenna post, loose coupling again, at 1,000 kc this time, the receiver is tuned to pick this up, and one of the intermediate coils, preferably the one serving the second detector, is retuned in the grid circuit. This is identifiable usually as the one that has little potential or no potential difference between shield can and adjustable condenser, whereas a high d-c voltage exists between the can and the plate condenser.

COMPLETING THE JOB

Tuning the grid tuning condenser of this coil one way or the other should produce a change in response. If the change is downward the direction is wrong, so reverse it (counterclockwise). If the condenser is continuously rotatable, one may keep turning until an increase takes place. This change should be noted on a meter in series with the second detector plate or anode, or across the biasing resistor of an i. f. tube that is subject to a v. c., which would mean any voltmeter of 0-5 range, or thereabouts, or a ray indicator tube could be used. When the proper indication is obtained the plate circuit is retuned and then the entire intermediate amplifier is changed to this new frequency (and one need not know in reality what the frequency is). Also the series padding adjustment is repeated at 600 kc and, if need be, oscillator and r-f trimmers reset likewise. Now the intermediate amplifier's frequency may be measured by using the signal generator fundamentally. Also, the receiver is known to have the oscillator inductance properly related to the generated i. f. and tracking errors will be minimized.

The foregoing gives details of causes of squeals in supers and remedies to apply. Naturally, if one has to service a set in which this trouble is present he should be able to understand the theory, otherwise he can attain a remedy only by hit or miss, and it will be miss, miss, miss, nearly all the time, and a hit may result only after costly hours of work, so the job must be done at less than the real value of the time expended. Customers, after all, can not be expected to pay in this direct way for the service man's education. And the sad part of it is that after he has remedied one receiver this way the repair man is no better fitted to fix the next receiver that has the same trouble, because he did not understand what he was doing.

So it is necessary to understand circuit theory, and to the extent that squeals are concerned, if the foregoing information is fully learned, one has a working basis that is satisfactory for practically all r-f squeal-elimination. And it should be considered necessary to have familiarity with that much theory of the super-heterodyne, otherwise one does not understand the circuit, and not understanding it, will be unable to cope with the far more complicated systems that are being rapidly introduced into supers.

All Circuits We Print Can Be Readily Duplicated

ALL parts for circuits described in RADIO WORLD constructionally are obtainable. Most of them are stocked by supply sources. Address questions to Trade Editor, RADIO WORLD, 145 West Forty-fifth Street, New York.

TRADIOGRAMS of the MONTH

Readrite's Tube Tester Provides Accurate Tests

Model 440 Ranger-Examiner Tube Tester incorporates the latest engineering improvements for checking any type radio tube for value, shorts and inter-element leakages under actual load conditions.

The instrument has an approved emission type circuit for speedy and highly-accurate testing. Only four simple operations are required. Results are shown on the direct-reading good-bad scale of a Triplett Model 221 precision instrument.

A unique shadowgraph a-c meter for line voltage adjustment is another feature. In addition to showing the actual line voltage setting, this meter serves as a pilot light in indicating when tester is connected to the power supply.

Model 440 has a sturdy metal case with black electro-enamel finish. Size is 5 $\frac{7}{8}$ " x 7 $\frac{7}{8}$ " x 4 $\frac{1}{8}$ ". Panel is modernistic silver and black. Carrying handle folds against the case when not in use. The manufacturer is The Readrite Meter Works, Bluffton, Ohio.



Front view of the Model 440 Readrite Tube Tester, a new precision instrument.

Radolek Offers New Combination P.A. Unit

The Radolek Company of Chicago, manufacturers of sound amplifiers, announces another addition to its line of public-address equipment, a combination 20-watt amplifier, phonograph turntable, 6-volt d. c. and 110-volt a. c. power supply, all contained in one covered portable case. This combination is said to be superior to previous similar units because completely electrically operated, including the phonograph motor.

The amplifier incorporates a high-gain circuit which permits the use of a crystal, velocity or carbon microphone. Dual-channel input for microphone and phonograph or radio with separate volume control for each input is provided. A complete mixing and fading system is built-in. There is a variable tone control. Two volume controls are installed in a detachable remote control head that can be mounted at a distance from the amplifier, for greater operating convenience. Adjustable legs permit this unit to be placed on the driver's seat or other desired locations. Input and output connections are by means of polarized plugs and sockets. Separate on and off switches are provided for the B supply generator and the filament supply. The complete unit draws only 12 amperes from a 6-volt storage battery. Further details can be obtained by writing to The Radolek Company, 601 W. Randolph Street, Chicago, Ill.

New Catalogue Announced By Wholesale Radio

The Wholesale Radio Service Co., Inc., of 100 Sixth Avenue, N. Y. City, announces the release of the new Spring and Summer 1937 catalog, No. 68. This catalog, like its predecessors, is distributed free.

It has 116 pages and contains more than 2,000 illustrations. All - wave and short-wave receivers, transmitters, and transmitter parts, experimenter parts, service replacement parts, a complete line of service test equipment and the latest 1937 Lafayette radios are listed in the most comprehensive collection of radio items.

Featured are the Lafayette Co-Ordinated Sound Systems, a new idea in public address equipment.

Copies may be obtained by writing to or calling at any of the six branches of Wholesale Radio Service Co., Inc., 100 Sixth Avenue, New York; 430 West Peachtree Street, N. W., Atlanta, Ga.; 901 West Jackson Boulevard, Chicago; 219 Central Avenue, Newark, N. J.; 542 East Fordham Road, Bronx, N. Y.

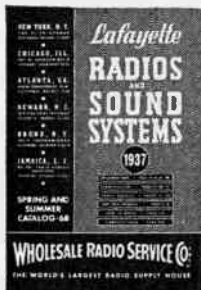

FORUM

SIMPLE INDUCTANCE FORMULA

HEREWITH are some data on inductance calculation that I believe will be of interest to many of your readers, judging from the number of inquiries constantly seen in radio publications. I have used this formula for a number of years, and have found it very convenient and accurate.

The formula usually published is a somewhat cumbersome affair, involving the use of a form factor K which is not readily determined, and is subject to serious errors if not calculated with extreme care.

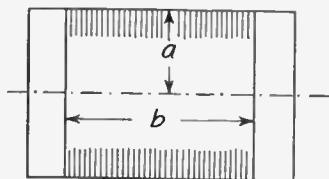

$$L = \frac{a^2 N^2}{9a + 10b}$$

N = NUMBER OF TURNS

The methods shown above, developed several years ago by Harold Wheeler, of Hazeltine Laboratories, are the simplest formulas yet evolved and at the same time are very accurate. If all dimensions are measured in inches, the result will be the number of microhenries of pure inductance.

In the case of the solenoid coil, the dimension b is more accurately determined by calculation from a wire table, rather than by actual measurement. However, it is obvious from the formula that b does not greatly affect the result. If the figuring is done with ordinary care the result in the case of the solenoid will be accurate within 1% when the winding length is greater than .8 the diameter. In the case of the multilayer coil, this accuracy is obtained when the three terms below the line in the formula at right are nearly equal.

If space-wound coils are desired the amount of inductance may be approximated by the following method, the result being about 5% too low. However, this is not a serious error, as it is unlikely that coils will be wound in practice to attain this accuracy.

First the inductance Lc (c indicating close-wound) is calculated, using the number of turns Nc, in the formula that would be required to fill up the space b that the space-wound coil will occupy.

Then:

$$L_s = L_c \left(\frac{N_s}{N_c} \right)^2$$

Ls = Inductance of space-wound coil.
Lc = Inductance of close-wound coil.
Ns = Number of space-wound turns.
Nc = Number of close-wound turns.

If shielding is used on any coil, allowance will have to be made for the reduction of inductance, referring to the article on this subject as published in August, 1935, issue of RADIO WORLD.

R. K. WHEELER
2308 Park Ave.
Indianapolis, Ind.

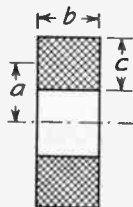

$$L = \frac{.8a^2 N^2}{6a + 9b + 10c}$$

Simple formulas for the computation of inductance of single-layer solenoid and multilayer coils in terms of dimensions easily measured. The advantage of these formulas is that they do not require any tables for their use. The accuracy of the formulas is sufficient for ordinary purpose.

CHASSIS, NOT BANK, CONGESTED

MANY good service men are drifting into other fields. To service a set nowadays one must have the combined intelligence of all the best radio engineers in all the factories all over the United States. A glance at a service manual would make an angel weep. So many gadgets are built into the sets today that it is impossible to make a living servicing them for some slight ailment that will take hours to find and for repairing which you will not get paid the value of your time. Long hours of picking around under a congested chassis, and study all night long aren't alluring.

Remuneration would have to be better, to make all the travail worth while, not to mention the outlay for service equipment.

Radio sets should be standardized, otherwise each factory will have to have special service stations all over the United States.

W. HARVEY MERWIN
Jensen, Fla.

* * *

MUD IN THE EYE

I HAVE been reading your magazine for several years and as a serviceman I think you have a very fine magazine, and it's really

TRADIOGRAMS of the MONTH

Readrite's Tube Tester Provides Accurate Tests

Model 440 Ranger-Examiner Tube Tester incorporates the latest engineering improvements for checking any type radio tube for value, shorts and inter-element leakages under actual load conditions.

The instrument has an approved emission type circuit for speedy and highly-accurate testing. Only four simple operations are required. Results are shown on the direct-reading good-bad scale of a Triplett Model 221 precision instrument.

A unique shadowgraph a-c meter for line voltage adjustment is another feature. In addition to showing the actual line voltage setting, this meter serves as a pilot light in indicating when tester is connected to the power supply.

Model 440 has a sturdy metal case with black electro-enamel finish. Size is 5 $\frac{1}{8}$ " x 7 $\frac{1}{2}$ " x 4 $\frac{1}{8}$ ". Panel is modernistic silver and black. Carrying handle folds against the case when not in use. The manufacturer is The Readrite Meter Works, Bluffton, Ohio.



Front view of the Model 440 Readrite Tube Tester, a new precision instrument.

Radolek Offers New Combination P.A. Unit

The Radolek Company of Chicago, manufacturers of sound amplifiers, announces another addition to its line of public-address equipment, a combination 20-watt amplifier, phonograph turntable, 6-volt d. c. and 110-volt a. c. power supply, all contained in one covered portable case. This combination is said to be superior to previous similar units because completely electrically operated, including the phonograph motor.

The amplifier incorporates a high-gain circuit which permits the use of a crystal, velocity or carbon microphone. Dual-channel input for microphone and phonograph or radio with separate volume control for each input is provided. A complete mixing and fading system is built-in. There is a variable tone control. Two volume controls are installed in a detachable remote control head that can be mounted at a distance from the amplifier, for greater operating convenience. Adjustable legs permit this unit to be placed on the driver's seat or other desired locations. Input and output connections are by means of polarized plugs and sockets. Separate on and off switches are provided for the B supply generator and the filament supply. The complete unit draws only 12 amperes from a 6-volt storage battery. Further details can be obtained by writing to The Radolek Company, 601 W. Randolph Street, Chicago, Ill.

New Catalogue Announced By Wholesale Radio

The Wholesale Radio Service Co., Inc., of 100 Sixth Avenue, N. Y. City, announces the release of the new Spring and Summer 1937 catalog, No. 68. This catalog, like its predecessors, is distributed free.

It has 116 pages and contains more than 2,000 illustrations. All-wave and short-wave receivers, transmitters, and transmitter parts, experimenter parts, service replacement parts, a complete line of service test equipment and the latest 1937 Lafayette radios are listed in the most comprehensive collection of radio items.

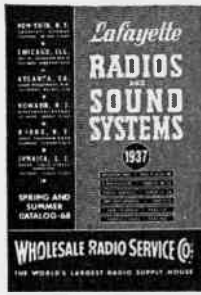

Featured are the Lafayette Co-Ordinated Sound Systems, a new idea in public address equipment.

Copies may be obtained by writing to or calling at any of the six branches of Wholesale Radio Service Co., Inc., 100 Sixth Avenue, New York; 430 West Peachtree Street, N. W., Atlanta, Ga.; 901 West Jackson Boulevard, Chicago; 219 Central Avenue, Newark, N. J.; 542 East Fordham Road, Bronx, N. Y.

RADIO CONSTRUCTION UNIVERSITY

**Answers to Questions on the Building and Servicing
of Radio and Allied Devices.**

STOPPING I-F OSCILLATION

MY two-stage intermediate-frequency amplifier oscillates unless it is mistuned. I have tried many methods to overcome this trouble, all without avail. At long last I appeal to you.—E. W. M.

Remove the bypass condenser from the biasing resistor of one of the i-f tubes. This will stop the trouble unless the oscillation is prodigious. Remove both bypass condensers, if necessary. With the feedback squelched you will be able to tune the i-f channel to resonance and obtain better selectivity and sensitivity.

RAY TUBE "TWINKLES"

WHEN I tune in a station and a person is talking into the microphone, my ray-indicating tube, used as tuning aid, as I have a. v. c., does not hold a given value, but the shadow angle changes as the intensity of the sound changes. Please let me know, is there anything wrong with the 6E5 tube?—O. L. C.

Nothing. Since all broadcasting stations introduce the effect of the sound by modulating the carrier so as to change the amplitude, a station using deep modulation may thus introduce considerable change in amplitude, and as the ray tube is connected to the set's detector circuit, and is at an audio level, the changes in amplitude may be reflected in the tube itself. A talker may make a considerable amplitude change, change back and forth rather rapidly. If the oddity in any way inconveniences you in tuning, you may put a 2-meg. resistor between 6E5 grid and the a. v. c. common lead, and a condenser from that grid to ground large enough to remove the modulation. The reason for the high resistance in series with the a. v. c. is to uphold the audio impedance of the detector, which would be very low if there were not that isolator between the detector and the 6E5.

NO SAVING HERE

I HAVE a set I built some eight years ago in a small console, and using an r-f stage and a regenerative detector, with transformer audio. I was wondering if there were some simple way to bring the set up to date?—F. G. S.

No, it is far better to build or buy a new set.

The selectivity of the circuit you describe does not come up to requirements of today, and besides you have an old-style speaker, and a too-small baffle area, with much cavity resonance, and poor tone generally. Modernization of such old equipment is never simple. It is a more difficult task than designing a circuit anew, or following one of the standard circuits as used by manufacturers. The temptation of getting fine results at small extra cost, by a renovation process, usually is expensive and time-consuming.

PARALLEL CONDENSER

WHAT is the object of putting a condenser of .05 mfd. or thereabouts across the series resistor for the low-range a.c. reading of a universal meter?—I. E.

The condenser reduces the limiting impedance, to compensate for the resistance of the copper-oxide rectifier, which resistance is large enough to require such compensation on low-voltage a.c. ranges, but not at medium and high-voltage ranges.

INDUCTANCE FORMULAS

IN the group of formulas printed last month, I did (22d), (22e), (26) and (27) refer to the pure inductance or the apparent inductance?—W. R. D.

Apparent inductance in the cases of (22d) and (22e), and pure inductance in the other instances. Wherever capacity differences are shown in these formulas the pure inductance applies. See this week's final installment for more formulas concerning pure inductance.

LAMP ECONOMY DESIRED

WHILE this is not a radio question, it has to do with facts you are familiar with. I have a very powerful lamp used for photography (1,000 watts). This gives more light than is imperative, but frankly what I want to do is use the same lamp but reduce the cost of operating it. I thought of putting a resistance in series with the lamp, to reduce the power consumption 50 per cent. Present current is 3 amperes. What do you suggest?—L. W.

The thought you seem to have in mind is that you can put a resistance in series with the lamp, equal to the resistance of the lamp itself, so that the total resistance will be doubled, the

power halved, and the cost of operating the lamp halved. If the wattage is 1,000 watts now, the current for 110 volts applied is $P \div E$ or $1,000 \div 110$ or a little more than 9 amperes, not 3 amperes. The resistance of the lamp is $E \div I$ or $110 \div 9$, or about 12 ohms. If a resistor of 12 ohms is put in series with the lamp, since the voltage is constant, the current is halved, and so is the wattage. Now we have 110×4.5 or 495 as the wattage. But this half of the former total is equally divided between the lamp and the limiting resistor, and the lamp itself has only one-quarter of the former power. The drop in the series resistor is a complete loss. Better use a 2-1, primary to secondary, transformer, of 500 watts rating or so, as the loss in the transformer is negligible. And, by the way, power is never "consumed." Power is the time rate of energy, and thus may be thought of as something akin to velocity in other branches of physics, and one never says velocity is consumed. Nor is the energy consumed, either, in a strict sense, as it constitutes the work done. If the consumption idea is to be applied, one might say that the electricity was consumed.

* * *

TROUBLE USING NEW HOOKUP

YOU have published some data on detectors that do not load the circuit, e. g., highly negatively-biased tubes, also the "infinite impedance" diode. I switched over from a regular diode second detector to the infinite impedance type, and then the i-f channel squealed. I. L.

If the components of the i-f channel were properly shielded, bypassed and filtered there would be no squealing, but the removal of the load was equivalent to eliminating a parallel resistance, and so the gain increased and there was squealing. An improvised method of getting rid of squeals was given in answer to a previous question. Attacking the problem differently, if the overhead leads from shield cans to i-f grids are shielded and shield grounded (using the customary sheath-covered wire with insulation between sheath and conductor); if leads are short and parts properly placed, and if by-pass condensers are large enough, and filtering introduced into individual plate return legs especially, and into screen legs, if need be, the squeals can be eliminated that way.

* * *

DECIBELS APPROXIMATED

SOMETIMES when I am measuring voltage ratios in amplifiers within the range of 1-1 and 1-5 I would like to know some simple method whereby I could get a fair idea of the decibel relationship for power, and as I am not familiar with mathematics, and have no decibel meter.—I. W.

Last month a graph was published, plotting the relationship between voltage ratios and current ratios on the one hand—they are the same—and decibel attenuation on the other, from 0 to 20 db and you may consult that curve, for no knowledge of mathematics is required. If you want something approximate that you

can remember easily, for the ratios 1-2 to 1-5, multiply the ratio by 3 and the result is approximately the decibel attenuation (or gain) in respect to power. For higher or lower ratios the error would be far too great for applying this simple test, and finally you should get around to learning the decibel notation thoroughly. See decibel table on page 14.

* * *

LOSSES IN LINES

WHAT causes losses in transmission lines and how can they be reduced? Is it not customary to discuss transmission lines as if they had no losses? If this is true the losses cannot amount to much, or else those who discuss them theoretically shut their eyes to a disagreeable subject.—W. B. N.

Losses in transmission lines arise from several factors. First, there is the ordinary high-frequency resistance in the conductors. Second, losses occur as a result of leakage through the insulation. Third, losses of some magnitude occur as a result of dielectric absorption. Fourth, radiation from open lines accounts for some loss. Losses due to series resistance are reduced by reducing the current and increasing the voltage as well as by selecting lines with low resistance. Losses due to dielectric absorption are reduced by increasing the current and reducing the voltage. These two factors work in opposite directions and it is necessary to compromise. Radiation losses are reduced by using shield lines or concentric conductor type of lines. The leakage loss is usually negligible when the frequency is high. No, they do not shut their eyes to a disagreeable subject. They simply avoid it when doing so will not affect the accuracy of their deductions.

* * *

ATTENUATION UNITS

WHAT is a neper? I know it is some kind of attenuation unit, but not how it is defined. In what way is it related to the decibel?—F. W. K.

The neper is based on the natural system of logarithms, whereas the decibel is based on common logarithms. If P_1 and P_2 are two powers

$$A_n = \frac{1}{2} \log_e (P_1 \div P_2)$$

defines the number of nepers, A_n , by which the two powers differ on a percentage basis. In terms of decibels the same powers would differ by

$$A_d = 10 \log_{10} (P_1 \div P_2)$$

In the first case the base of the logarithm is "e" and in the second case 10. The factor $\frac{1}{2}$ is used in the definition of the neper because the unit was first used to define relative differences between currents and voltages. Hence when the ratio is that of two currents or voltages the factor is unity. The decibel is one-tenth of a bel, and the number of bels is the common logarithm of the ratio of two powers. When the ratio is of either two currents or two voltages the factor is 20. To find the ratio of the neper and the decibel we can reduce the neper expression to common logarithms. It is

$$A_n = 1.152 \log_{10} (P_1 \div P_2).$$

$$\text{Hence } A_n = .1152 A_d.$$

FORUM

SIMPLE INDUCTANCE FORMULA

$$L_s = L_c \left(\frac{N_s}{N_c} \right)^2$$

L_s = Inductance of space-wound coil.
 L_c = Inductance of close-wound coil.
 N_s = Number of space-wound turns.
 N_c = Number of close-wound turns.

If shielding is used on any coil, allowance will have to be made for the reduction of inductance, referring to the article on this subject as published in August, 1935, issue of RADIO WORLD.

R. K. WHEELER
 2308 Park Ave.
 Indianapolis, Ind.

HEREWITH are some data on inductance calculation that I believe will be of interest to many of your readers, judging from the number of inquiries constantly seen in radio publications. I have used this formula for a number of years, and have found it very convenient and accurate.

The formula usually published is a somewhat cumbersome affair, involving the use of a form factor K which is not readily determined, and is subject to serious errors if not calculated with extreme care.

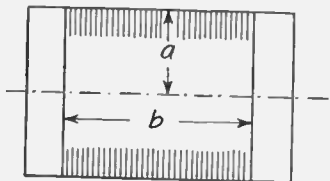

$$L = \frac{a^2 N^2}{9a + 10b}$$

N = NUMBER OF TURNS

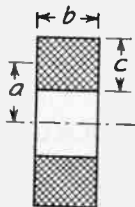

$$L = \frac{.8a^2 N^2}{6a + 9b + 10c}$$

Simple formulas for the computation of inductance of single-layer solenoid and multilayer coils in terms of dimensions easily measured. The advantage of these formulas is that they do not require any tables for their use. The accuracy of the formulas is sufficient for ordinary purpose.

The methods shown above, developed several years ago by Harold Wheeler, of Hazeltine Laboratories, are the simplest formulas yet evolved and at the same time are very accurate. If all dimensions are measured in inches, the result will be the number of microhenries of pure inductance.

In the case of the solenoid coil, the dimension b is more accurately determined by calculation from a wire table, rather than by actual measurement. However, it is obvious from the formula that b does not greatly affect the result. If the figuring is done with ordinary care the result in the case of the solenoid will be accurate within 1% when the winding length is greater than .8 the diameter. In the case of the multilayer coil, this accuracy is obtained when the three terms below the line in the formula at right are nearly equal.

If space-wound coils are desired the amount of inductance may be approximated by the following method, the result being about 5% too low. However, this is not a serious error, as it is unlikely that coils will be wound in practice to attain this accuracy.

First the inductance L_c (c indicating close-wound) is calculated, using the number of turns N_c , in the formula that would be required to fill up the space b that the space-wound coil will occupy.

Then:

CHASSIS, NOT BANK, CONGESTED

MANY good service men are drifting into other fields. To service a set nowadays one must have the combined intelligence of all the best radio engineers in all the factories all over the United States. A glance at a service manual would make an angel weep. So many gadgets are built into the sets today that it is impossible to make a living servicing them for some slight ailment that will take hours to find and for repairing which you will not get paid the value of your time. Long hours of picking around under a congested chassis, and study all night long aren't alluring.

Remuneration would have to be better, to make all the travail worth while, not to mention the outlay for service equipment.

Radio sets should be standardized, otherwise each factory will have to have special service stations all over the United States.

W. HARVEY MERWIN
 Jensen, Fla.

* * *

MUD IN THE EYE

I HAVE been reading your magazine for several years and as a serviceman I think you have a very fine magazine, and it's really

got a lot of good dope in it that keeps the serviceman up on the latest circuits and tubes. But, there is an opinion I'd like to express concerning a small section of an article in the February issue, by A. J. M. Warren, on "Special Fidelity Detectors."

This section is entitled "The Phase Reversal," and I must say, as much as I hate to, that all three paragraphs in this section are about as clear as mud, as far as explaining anything is concerned. I do not consider myself a first class radio engineer, but I do think I know enough to see that it looks to me like the author didn't understand the action clearly himself and undertook to explain his undertaking in a makeshift or disillusioned method.

May I express what I think would be a much clearer way of getting across to the readers the action that takes place in this circuit. For example:

We are interested in points K and P, and to secure 180° voltage phase differences between these points. If an incoming signal, *unmodulated*, is applied between grid and cathode (this tube biased as a detector), the *average* plate current increases, causing a greater current through the plate resistor and a larger voltage drop across the resistor, thus causing point P to become more *negative*. At the same time increased plate current through the cathode resistor causes a greater voltage to be developed across this resistor, causing point K to become more *positive*; hence, we have a volt-

age phase reversal of 180° between points P and K.

Therefore, if a *modulated* r-f signal is impressed on the input, points P and K are modulated also, at an audio frequency and a half cycle out of phase with respect to each other. The audio signal may be coupled from points P and K by small coupling condensers of .05 mfd or larger. The plate and cathode resistors require small by-pass condensers to by-pass the r.f. from the audio circuit.

Thanking you very kindly for your attention,
 JAMES B. MATTHEWS
 611 N. 3rd Ave.
 Phoenix, Arizona.

* * *

WHAT ABOUT THE PHOTOS?

MANY thanks for that very comprehensive article on the cathode-ray oscilloscope in your January issue.

G. BOLTON,
 Sussex, N. B., Canada

* * *

SO HAVE WE

BEING a novice in radio, I have gained more information in the past from reading your magazine than from any other. Here's to a bigger and better RADIO WORLD.

ROBERT KELLER,
 262 Hemlock St., Brooklyn, N. Y.

**PHILCO
 SIGNAL
 GENERATOR**

LIST PRICE \$22.50

A neat, compact and accurate portable signal generator especially designed for adjusting standard broadcast and auto-radio sets, the Model 024 is the outstanding buy on the market in this type unit. Completely self-contained; operates from dry batteries (1—22½ volt standard b battery and 1—Flashlight cell) and requires no outside power supply connection. Covers a range of 105 kc. to 2000 kc. ball-bearing tuning condenser makes for quick accurate operation.

**OUR
 PRICE \$4.95**

PHILCO MODEL 024



THOR RADIO, Inc. 65 CORTLANDT ST. NEW YORK CITY

William Dubilier's Rise Wins World-Wide Fame

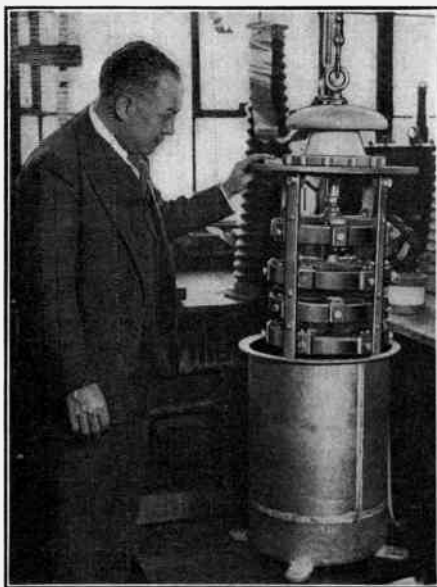

William Dubilier, noted inventor, an official and the technical director of Cornell-Dubilier Corp., inspects the world's largest mica condenser, made under his supervision.

WILLIAM DUBILIER, known to his many friends as "Bill," began his remarkable technical career as an inventor and scientist when, as a mere boy of ten years, he invented a "shocking door knob" which actually resulted in the capture of a thief who had been terrorizing the neighborhood.

Since the first invention, almost 40 years ago, a long string of patents—over three hundred of them—has been issued to him by the patent office, a tribute to his practical inventive genius.

Oddly enough, William Dubilier originally had planned to become a lawyer, until he found out that at that time, when degrees to practice law were comparatively easy to get, lawyers were a drug on the market and most of them were having a hard time making a living.

A CONTRACTOR AT 15

When he was 13 years old, therefore, he decided to follow an inclination to experiment with electrical circuits and gadgets and by the time he was 15 he became a regular electrical contractor—and a prosperous one at that, doing his contracting work in the evenings and attending classes during the day to complete his technical education.

After his graduation from The Technical

Institute, of New York, he joined the Western Electric Co., and later became connected with the American Telephone & Telegraph Co. where he worked the shift from 4 p. m. to midnight so that he could attend the day school sessions at Cooper Union.

In 1908 he became chief engineer of a wireless company and proceeded to design, build and demonstrate some of the first practical wireless transmitting and receiving instruments.

While engaged in this work, his experiments and demonstrations gained such wide notice that he was commissioned to make a complete wireless installation at the Czar's palace in Russian. After completing this installation personally, he went to England and helped to form a wireless company there.

HIS WAR WORK

Soon after the World War broke out, Dubilier went to Cherbourg, France, where experiments were being carried on to develop an effective submarine detector. He was responsible for perfecting an amplifier which made it possible to detect the location, speed and course of submarines at a distance of 10 miles instead of the mile limit which had been possible previous to that time.

From the very beginning of his experimental career, Dubilier had bent his efforts to the problem of developing a really practical condenser.

In 1910 he evolved a mica condenser that was so far superior in every way to the Leyden jars then in common use that it paved the way for rapid development in the radio and electrical arts wherever condensers were required.

ADVISOR TO U. S. GOVERNMENT

Since 1913, William Dubilier has been called time and again to consult with the U. S. and Allied governments in solving problems connected with the development of military radio and electrical equipment, and Dubilier condensers became standard equipment for use in U. S. and Allied radio and electrical installations.

Today, the Dubilier Electric Co., in England, occupies a factory of over 100,000 square feet, with a separate building devoted to laboratory development. In the United States, the Cornell-Dubilier Corp. factories occupy over 200,000 square feet in South Plainfield, N. J. Both plants are tributes to the inventive genius, perseverance and business ability of William Dubilier.

TRIP ENDS IN SURPRISES

Many of the radio store owners who recently made a trip to Bermuda, were treated to a surprise on their return when they learned the cash register figures covering their absence.

THE METAL TUBE SELF POWERED FIVE BAND PRESELECTOR BOOSTER



- Continuous Band Spread
- Built-in Power Supply 110-V AC-DC
- Pre-Adjusted Low Loss Coils
- Calibrated Tuning Dial
- Volume Control and AC Switch
- Black Crackle Metal Housing
- Operates with Doublet or Single Ant.
- Tuning Range 9 to 560 Meters
- Boosts Weak and Fading Signals, for use with T.R.F. Regenerative or Super Receivers, by Amateurs or Short Wave Fans. Builds up tremendous increase in signal strength, also sensitivity and selectivity. Decreases noise to signal ratio and assures low image frequency response.

Kit of all parts, chassis, housing, diagram..... \$4.95
 Kit of 6 Coils 9 to 560 M..... 2.05
 Kit of 3 Tubes 6J7-6C5-K105A..... 2.50
 Wired and tested, all coils, tubes, ready to operate \$12.00
STANDARD RADIO, RW-116 West St., N. Y. City

The Remedy for... ANNOYING COIL PROBLEMS!

WINDING solenoid coils for radio frequencies requires knowledge of the number of turns of any selected type of wire on any sensible diameter to attain an inductance suitable for the tuning condenser and lowest frequency. Hence, with capacity and frequency known, there are two unknowns: (1), the required inductance; (2), the number of turns to establish that inductance. The answers are obtained without computation by use of "The Inductance Authority," by Edward M. Shiepe, and an 18 x 20" supplement. On the large supplement are plotted the "curves" of frequency, capacity and inductance in straight lines, so for a desired low frequency and known capacity the unknown inductance is solved by mere inspection. The number of turns for attainment of that inductance, for all popular tubing diameters and all generally used wire diameters and wire insulations, is read from the inductance-turns charts which are in the bound volume. Coil and set manufacturers, as well as home and shop experimenters, students and teachers freely use this book. Accuracy is 1%. The only book of its kind in the world.

Order Cat. INA (price includes bound volume and supplement) postpaid anywhere **\$2.00** on earth

The supplement chart is obtainable separately, CAT. SIA @ 25c postpaid.

Or send \$5.00 for a two-year subscription for RADIO WORLD, regular rate, and this valuable book and supplement will be sent FREE and postpaid. Order Cat. PR-IAC.

Those specially interested in coil data for the standard broadcast band will find extremely valuable a straight-line chart of frequency, capacity and inductance, 500 to 2,500 kc very closely plotted, 2,500 to 12,000 less closely, published in the October, 1936, issue of RADIO WORLD. Order Cat. 695. 25c per copy (extra).

BOOK DEPARTMENT RADIO WORLD

145 West 45th Street, New York City

BETTER SELECTIVITY with Iron-Core I.F.'s

USERS of our iron-core intermediate-frequency transformers are delighted with the increased selectivity, also the improved gain.

We also have tuner coils, for t.r.f. sets and supers using two-gang to four-gang .000365 mfd. condensers. We do not have tuner coils for 140 mmfd. condensers. Our tuner coils are of the shielded or unshielded types, as preferred. For two-gang sets the unshielded type give better results. For three- or four-gang sets the shielded type are necessary. Either type obtainable in high-gain or low-gain models.

- Iron-core, doubly-tuned i.f. transformers, 456 or 465 kc.....\$1.15
- High-gain r.f. coils, for .000365 mfd., for two-gang t.r.f. set, unshielded, ~~90¢~~ a pair. High-gain r.f. coils for three-gang t.r.f. set, shielded.....\$1.80 for three.
- Low-gain r.f. coils for four-gang t.r.f. set, shielded.....\$2.00 for four.
- Local oscillator coil, shielded, for 175, 456 or 465 kc.....~~60¢~~
- Local oscillator coil, unshielded, 456 or 465 kc. only.....~~45¢~~
- Set of matched shielded coils for three-gang super (specify i.f.).....\$1.80
- Set of matched shielded coils for four-gang super (specify i.f.).....\$2.00
- SHIELDED WAVE TRAP 456-465 kc. Air-Core Mica Tuned.....\$1.00
- Designed to eliminate code and any other interference by tuning the coil to provide resonance to the undesired frequency.
- Padding condenser for 465 or 456 kc....~~50¢~~
- Padding condenser for 175 kc.....~~55¢~~

All the above prices are postpaid.

SEND FOR FREE CIRCUIT DIAGRAMS, T.R.F. AND SUPERS Please include 3c stamp.

RADIO DESIGN CO.

Dept. R-1234
 1353 Sterling Place Brooklyn, N. Y.

Just published—New 2nd edition

Communication Engineering

by W. L. Everitt
 Published by McGraw Hill
 727 pages, illustrated, \$5.00



WHAT are your particular problems? — interference due to resonance or reflection? in filters, equalizers, bridge circuits? Look them up in this new book. In taking up each topic the author first gives general principles and definitions; and then what he terms "machine tools" of network theory—theorems which apply fundamental similarities of simple networks to new complicated structures.

RADIO WORLD

145 West 45th Street, New York City

FOR TONE REALISM
MODERNIZE

Your Radio or Amplifier with the Douglas "Baby" Volume Expander, as described in Radio World, March 1937, issue.

Instrument, complete, measures
8 x 5½ x 7½ inches.

Acclaimed by critics as one of radio's greatest advancements in the field of fidelity. Easy to wire. Easy to connect to your radio or amplifier.

Complete kit of quality parts,
less tubes \$7.95
Wired and tested.....\$2.50 extra
Kit of 4 tubes.....\$3.80 extra

DOUGLAS RADIO CO.

(TOM AND GEORGE)
PARTS — AMPLIFIERS — TUBES
89 Cortlandt St., N. Y. C.
MAIL ORDERS FILLED 24 HOURS
20% Deposit With Order. Balance C.O.D.

TELEVISION BOOKS

"TELEVISION RECEPTION," by Manfred von Ardenne. First publication of English translation of a constructional book by Germany's outstanding television scientist. Tells how to build a sight-sound receiver and describes problems authoritatively but simply. Many illustrations of apparatus the author constructed, with circuit diagrams and parts lists. Treatment is non-mathematical. Even novices can derive much from this noteworthy book. Price \$2.75 postpaid.

"TELEVISION WITH CATHODE RAYS," by Arthur H. Halloran. Farnsworth and Zworykin systems fully explained. The treatment is mathematical. It is a book for the well-grounded radio man who has vision, the man who wants to be among the first to cash in when the pictures go on the air commercially, but is not for novices. 100 pages or more of supplementary data. Price \$2.75 postpaid (including Supplements).

RADIO WORLD

145 West 45th Street, New York City, N. Y.

CLASSIFIED ADVERTISEMENTS

7 cents a word. \$1.00 minimum.

AMATEUR RADIO. Commercial Radiotelephone and Radiotelegraph licenses, complete training. Resident and correspondence courses. Every graduate a licensed operator. NEW YORK WIRELESS SCHOOL, 1123 Broadway, New York.

AMATEUR CARTOONISTS WIN \$25.00
No drawing ability necessary to win. 28 prizes in all. Rush name on postcard for valuable tips on "How to Make Money With Simple Cartoons," cash prize entry blank and rules. Send no money. Cartoonists' Exchange, Dept. 1454, Pleasant Hill, Ohio.

TRAINED RADIO SINGER AVAILABLE: Ballads and descriptive numbers. Folk songs. Baritone with appealing quality of tone. Offers numbers rendered by Frank Munn, Richard Crooks, John Charles Thomas. Some of John McCormack's and a few old Chauncey Olcott hits. Address principal: Peter A. Rogers, 1619 Third Ave., Watervliet, N. Y.

RADIO WORLD AND POPULAR MECHANICS MAGAZINE
—Radio World is \$2.50 a year, and Popular Mechanics Magazine is \$2.50 a year. Popular Mechanics Magazine does not cut rates, but Radio World will send both publications to you for one year for \$3.75. RADIO WORLD, 145 West 45th Street, New York City.

HAVE YOU BACK NUMBERS of Radio World, August, 1925, or June, 1926, issues? If so, please communicate with Radio World, 145 West 45th Street, New York, N. Y.

SPECIAL 2-FOR-1 OFFER RADIO WORLD

Radio World is \$2.50 a year (12 issues), 25c per copy. Canada and foreign, \$3.00 yearly. Trial sub., 5 issues, \$1.00. Offers of Radio World and other worthwhile publications for one full year on each, (NET), as follows:

- RADIO WORLD and SHORT-WAVE CRAFT, \$3.50.
- RADIO WORLD and POPULAR SCIENCE MONTHLY, \$3.50.
- RADIO WORLD and RADIO-CRAFT (12 issues), \$3.50.
- RADIO WORLD and SERVICE (monthly), \$3.50.
- RADIO WORLD and EVERYDAY SCIENCE and MECHANICS (monthly), \$3.50.
- RADIO WORLD and BOYS' LIFE (monthly), \$3.50.
- RADIO WORLD and RADIO INDEX (monthly, 10 issues) stations, programs, etc., \$3.50.
- RADIO WORLD and TRUE STORY (monthly), \$3.00.
- RADIO WORLD and LIBERTY (weekly), \$3.00 U. S. only.

Select any one of these magazines and get for an entire year by sending in a year's subscription for RADIO WORLD at the regular price, \$2.50, plus the additional amount, per quotations above. (Add \$1.50 for extra foreign or Canadian postage for both publications.)

Name

Address

City and State.....

SHORT WAVE CONVERTER AND Remote Control TUNER

3-tube self-powered unit connects to any broadcast receiver by only 1 wire and tunes full short wave frequencies from 16 to 550 meters. This range covers all foreign, amateur, police, ship to shore and domestic broadcasts. Makes a super out of any T.R.F., and sharpens tuning, increases sensitivity and selectivity. Built-in coil system with hand switching totally shielded. Can be used as remote control unit by placing unit any required distance from main receiver with all tuning effected on small aeroplane dial. Complete kit of parts ready to wire, including full instructions. Unit measures 7½ x 10 x 8 inches. Shipping weight 18 lbs. For AC or DC operation..... Also sold completely wired ready to operate, with tubes.....

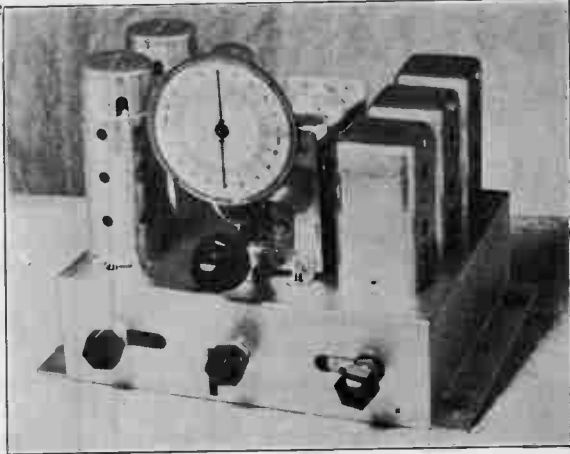

\$10⁹⁵
\$14.95

Send for
Free
Thor Kit
Diagrams

THOR RADIO, Inc.

"Everything in Radio"

65 CORTLANDT ST., NEW YORK CITY

Mail Orders
Require
20%
Deposit

MAILING LISTS



GET OUR FREE
**REFERENCE
BOOK and
MAILING
LIST CATALOG**
FREE

Gives counts and prices on accurate guaranteed mailing lists of all classes of business enterprises in the U. S. Wholesalers—Retailers—Manufacturers by classification and state. Also hundreds of selections of individuals such as professional men, auto owners, income lists, etc.

Write today for your copy

R. L. POLK & CO.

Polk Bldg.—Detroit, Mich.
Branches in Principal Cities

World's Largest City Directory Publishers
Mailing List Compilers. Business Statistics. Producers of Direct Mail Advertising.

Electricity at your finger ends

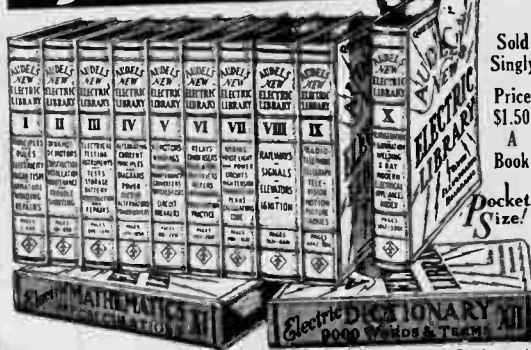

AUDELS NEW ELECTRIC LIBRARY—A progressive Home Study and Reference Course in applied electricity. Easy to understand. Questions and answers plainly written for a complete working knowledge of modern electrical practice, necessary to every electrician, engineer, electrician and student.

LEARN THE AUDEL WAY! You ask the question—Audels New Electric Library gives the answer—3500 simplified outlines, graphic illustrations and precise explanations covering Construction, Operation and Machine Maintenance.
BOOK A MONTH PLAN—Order the volume that interests you—today! We will send that volume on 7 days' free trial. If the book helps you, send us \$1.50. If it does not help you, mail book back to us. On receipt of your first payment, we will send you second book. We allow 30 days to pay for this and for each following book until you complete the Series.
If you are not satisfied, you may cancel your subscription at any time.

**FREE
EXAMINATION
COUPON**

Theo. Audel & Co., 49 W. 23rd St., New York City
Mail Vol. I, Electric Library on 7 days' free trial. If O. K. I will remit \$1.50, otherwise I will return it. I also request you to mail one book each month on same terms. No obligation unless I am satisfied.

Name

Address

Occupation

DELTA KITS

For Precision and Outstanding Performance

WE make all our own coils and many of the other products in our kits and conduct a real laboratory, with finest measuring equipment which, plus painstaking workmanship, insures best results.

SELF-ALIGNING SIGNAL GENERATORS

A technique has been developed that enables you to build a signal generator that is self-aligning, by using equipment we supply. The dial scales are direct-reading in frequencies, and all you need do is tighten a setscrew as directed, and you have a 1 per cent accurate generator.

KIT FB consists of a precision tuning condenser with 4-1 vernier ratio and planetary drive; two precision coils for covering 140-495 kc and 540-1,600 kc, all on fundamentals; frequency-calibrated direct-reading etched metal precision dial scale; precision pointer; two precision coils; diagrams. Shipping weight, 3 lbs.

Add parcel postage extra. Price..... **\$2.20**

KIT WVB consists of a precision tuning condenser, with 4-1 vernier, and planetary drive; five precision coils for covering 100 kc to 32 mc in five bands, all on fundamentals; frequency-calibrated direct-reading scale; diagrams and instructions. Shipping weight, 3 lbs. Add parcel postage extra.

Net price..... **\$3.60**

Finished shield cabinet, chassis, for FB or WVB, order KAB, 3 lbs. extra, @.....**\$2.00**

SELF-TRACKING BROADCAST TUNER

KIT RB consists of a precision two-gang condenser, 4-1 vernier, with planetary drive; one section for the standard broadcast band, 530-1750 kc, the smaller section with cut plates for tracking at 370 kc i.f.; unshielded high-gain antenna coil and unshielded high-gain oscillator coil; frequency-calibrated direct-reading scale and precision pointer. Shipping weight, 3 lbs. Remit parcel postage extra. Net price..... **\$3.60**

INTERMEDIATE FREQUENCY COILS

Coil A for 175 kc. Coil B for 370 kc. Coil C for 456 kc. Coil D for 465 kc. Price 93c each. Shipping weight up to 12 coils 1 lb.

HIGH-GAIN TUNER COILS

Set of three high-gain, for t-r-f set, shielded**\$1.00**
Set of three shielded (2 r.f. and oscillator) for 175 kc i.f.....**1.00**

Note: We wind special coils to order. Send in your specifications. We can attain inductance of any required percentage accuracy, also Q values up to 150 or more.

DELTA RADIO COMPANY

Edward M. Shieps, Manager

135 Liberty St. New York, N. Y.

BUILD SALES

WITH

**This
FREE
160
Page**



RADOLEK PROFIT GUIDE

New 1937 Edition. Just off the press . . . the most complete Radio Parts Catalog ever published . . . completely revised, bigger and better. Everything in radio . . . at the right prices. Over 160 pages of valuable, money-saving "radio-buying" information. Over 12,000 Radio Repair Parts—hundreds of new items—a complete, new selection of Radio Receivers and Sound Amplifiers . . . contains the most complete, exact duplicate replacement parts listings, of volume controls, condensers, transformers, vibrators. Every page of this New Radio Supply Catalog brings you extra profits. This is your book—it's FREE. Send for your copy NOW!

R A D O L E K

601 W. Randolph, Chicago, Dept. G5

Send me the Radolek Radio Profit Guide FREE.

Name

Address

Service man? Dealer? Experimenter?

EVERYTHING FOR HAMS! And SWFANS.

We issue no general catalog, but we can supply anything—Receivers—parts—tubes—wire—etc., etc., at lowest WHOLESALE prices! All standard lines in stock.

JUST ORDER! We'll do the rest! Or write for information. Prompt shipment to any part of the world. Friendly, reliable service that you're bound to like.

W2AVA

HARRISON RADIO CO.
"The Friendly Ham Supply House"
12 WEST BROADWAY • NEW YORK CITY

WHEN WRITING TO ADVERTISERS
PLEASE MENTION THAT YOU SAW THE
ADVERTISEMENT IN RADIO WORLD.

The
new
edition

NATIONAL



RADIO PRODUCTS

DESCRIPTIVE
PRICE LIST

261
TUB SET NO.

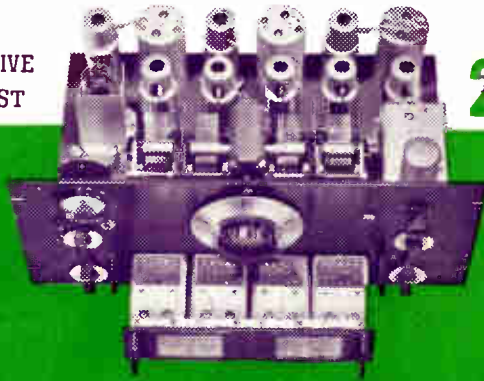

NATIONAL COMPANY INCORPORATED
61 SHERMAN STREET • MALDEN, MASSACHUSETTS

Engineers and Manufacturers

ESTABLISHED 1904

If you are without a copy of the new National General Catalog, write us and we will gladly send you one. Or better, visit your dealer. He will welcome the opportunity to give you a copy of this new catalog and to demonstrate the latest National products.

NATIONAL COMPANY, INC., MALDEN, MASS.

PRECISION MADE . . . YOU CAN TRUST IT

This POCKET VOLT-
OHM-MILLIAMMETER
Does All Your D.C.
Testing

★
MOLDED CASE
3" x 6" x 2" (Approx.)

★
SELECTOR SWITCH FOR
ALL RANGES

★
BATTERY, TEST LEADS
AND ACCESSORIES INCLUDED

★
ACCURACY WITHIN 2%



MODEL
735

A Precision Tester at the
Sensational Dealer Price of

\$10.80

FREE

Model 735 has a Triplett D'Arsonval type precision instrument with easily readable scales. Ranges are 15-150-750 volts at 1000 ohms per volt; 1.5-15-150 M.A.; 1/2-1000 low ohms; 0-100,000 high ohms at 1.5 volts. Provisions for external batteries for higher resistance measurements. Has selector switch for all ranges and individual zero adjustment for resistance measurements.

Sturdy black molded case, 3 1/16" x 5 7/8" x 2 1/8" high. Attractive silver and black panel. Battery and test leads with alligator clips are included. Dealer Net Price, Complete, \$10.80.

Booklet. Lists 101 most frequent Radio Troubles, How to Detect and How to Cure. Nothing like it before. Greatly simplifies everyday servicing. Send coupon now.

RANGER EXAMINER

READRITE METER WORKS
127 College Drive, Bluffton, Ohio

Without obligation please send me more information on Model 735. Free Booklet—"101 Radio Troubles and Their Cures."

Name

Address

City State