

THIS EDITION 53,500

RADIO WORLD

REG. U.S. PAT. OFF.

THE HOW-TO-MAKE-IT MONTHLY 14th Year 25c Per Copy

DECEMBER

1935

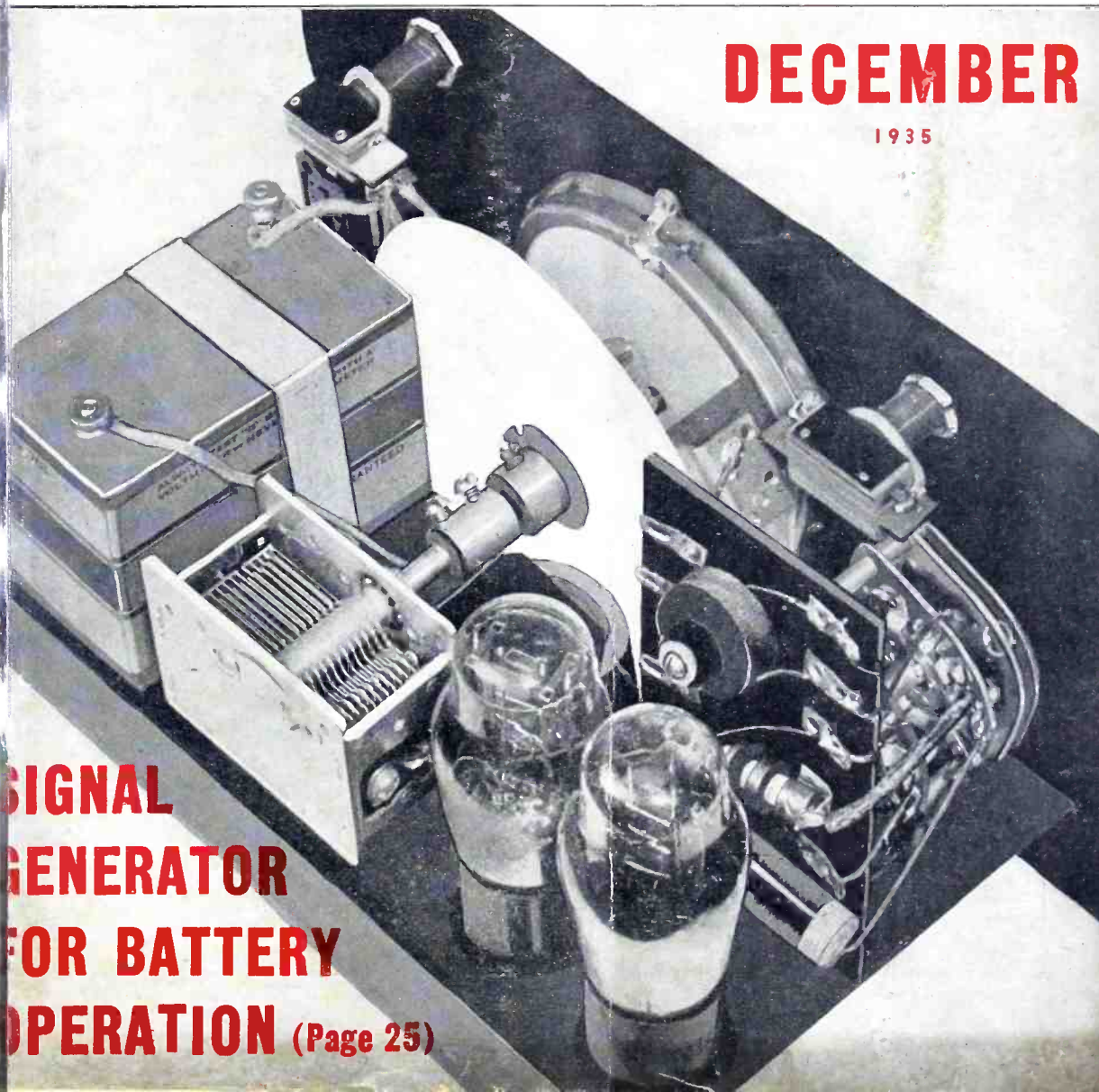

**SIGNAL
GENERATOR
FOR BATTERY
OPERATION (Page 25)**

LOOK INSIDE...

before you buy

A Cornell-Dubilier Trade Mark on the Outside is as Good as a Look Inside.

The continuous progress of C-D engineers in the development and perfection of dependable condensers is clearly illustrated by the Dykanol series of high voltage transmitting condensers. Look for these special "inside" features:

● DYKANOL, because of its high dielectric strength and dielectric constant, has made possible the reduction of the cubic volume of these condensers, by as much as 50% overtypes (available on the market today) of comparable capacity and voltage characteristics.

● DYKANOL condensers can be operated continuously at voltages 10% above rating. The leakage resistance and power factor change of Dykanol transmitting condenser is far less at high temperatures than that of types currently in use.

● DYKANOL condensers are hermetically sealed in steel containers, and are supplied with high glazed porcelain insulators.

● DYKANOL is non-inflammable, eliminating fire hazards.

● DYKANOL condensers are available in a complete capacity range from 600 to 100,000 V. D. C.

● Last but not least, DYKANOL oil impregnated and oil filled condensers are most *inexpensive*.



"The C-D name on a condenser is good enough for me. Been using 'em for years and never had a bit of trouble."



"Handsome! finished in aluminum — boy, do they make my rig look like a million bucks!"

"High porcelain terminals allows for plenty of safety factor against flash overs."

Write for a copy of the 1936 No. 128 descriptive catalog to-day. Free for the asking.



CORNELL-DUBILIER

C O R P O R A T I O N

4343 BRONX BOULEVARD • NEW YORK

EVERYTHING IN RADIO!

If you build or experiment with radio, you need the new 1936 ALLIED Catalog. Write now for your FREE copy of this leading Radio Supply Guide. ALLIED can supply all of your radio needs for less money.

Build Your Own RADIO

We can help you to easily and quickly build any set that you see described in this and any other magazine. We offer you only approved parts, put up for your convenience in kit form, and at lowest wholesale prices. Write us for our Free Parts Lists covering all the latest popular circuits. Because we have everything in radio all under one great roof we can help you promptly and efficiently. Before you buy, write for our parts lists. We are "Radio Parts Headquarters," prepared to supply every Radio Builder's and Amateur's needs at lowest prices.

Send for this GREAT CATALOG

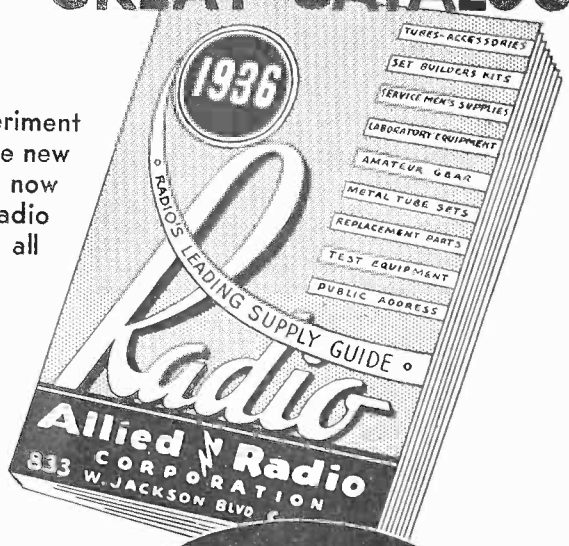

FREE

RADIO'S LEADING SUPPLY GUIDE

There are more than 10,000 quality radio items in the 1936 ALLIED Catalog—each an unbeatable value. Five great sections feature newest metal tube and glass tube receivers—battery, 32 volt and auto radios; latest Short Wave and Amateur Receiving and Transmitting gear; dozens of new amazing new array of the most advanced Public kits to warm every Set-Builder's heart; an Address Systems, amplifiers, microphones, recording equipment, etc. Also thousands of exact duplicate and replacement radio parts, radio tools and latest test equipment. Everything you need in radio is in this FREE Catalog at the lowest wholesale prices. Send for your copy now.



SEND
FOR
YOUR
COPY

ALLIED SELLS FOR LESS!

When you order from your new 1936 ALLIED Catalog you will get bigger value than ever before. That's saying a lot—when you consider that we've had a great reputation for selling the best radio equipment for less money since the early days of radio. We say that you can't buy identical brand and quality anywhere for less—if you can—we'll refund the difference in a dollar. Send for the new 1936 ALLIED Catalog right now. Page after page, it will prove to you that we sell for less.

Allied Radio

CORPORATION
833 W. JACKSON BLVD.
CHICAGO, ILLINOIS

ALLIED RADIO
CORPORATION

833 W. Jackson Blvd.
Chicago, Ill., Dept. WR

Send your FREE 1936 Radio Catalog.

Name

Address

City..... State.....



RADIO WORLD

The How-to-Make-It-Monthly—Fourteenth Year

ROLAND BURKE HENNESSY
Editor

HERMAN BERNARD
Managing Editor

HERBERT E. HAYDEN
Advertising Manager

Table of Contents for DECEMBER, 1935

Edition, 53,500

| | |
|--|---|
| A Mobile "Ultra" Transceiver.. 6 <i>Used in Police Car, 30.1 Mc.</i> <i>By E. H. Morgan</i> | How High R. F. Can You Measure? 31 <i>Maybe Frequencies 100 Times More Than You Suppose</i> <i>By Eric Janssen</i> |
| Grid Condenser 0.000005 Mfd.... 9 <i>Substantial for Centimeter Transceiver</i> <i>By Herman Bernard</i> | Practical Hints for Experimenters 33 <i>Preventing Loose Iron Tip—Accommodating Electrolytics</i> |
| A Foreign Band Converter..... 13 <i>Universal Model, SFL Tuning</i> <i>By W. C. Barry</i> | A. V. C. Since 1920! 36 <i>Grid Leak Detector Analyzed in Four Tube All Wave Set</i> <i>By Edwin K. Butler</i> |
| Repair of Dynamic Speakers.... 18 <i>Precautions Save Time, Assure Success</i> <i>By Herbert E. Hayden</i> | Measurement of R. F. Capacities 39 <i>Few Micro-microfarads to .01 Mfd.</i> <i>By Capt. Peter V. O'Rourke</i> |
| A Phonograph Amplifier..... 20 <i>Four Tubes, Push Pull 6B5's</i> <i>By Leonard C. Worcester</i> | Five and Ten Meter Circuits.... 45 <i>Receiver and Two Transceivers</i> <i>By Max Steir</i> |
| Antennas for Home and Car.... 22 <i>Less Noise, More Signal</i> <i>By Morris N. Beitman</i> | Decibel Attenuation in Steps.... 48 <i>How to Compute Resistors</i> <i>By J. E. Anderson</i> |
| A Battery Signal Generator..... 25 <i>Frequency of Modulation Continuously Variable</i> <i>By Maxwell M. Hauben</i> | An Extra Set for the Home.... 50 <i>Broadcast and Police Universal, Four Tubes</i> <i>By Jack Golstein</i> |
| Major Tests with Minor Devices. 29 <i>Frequency Measurements, Simplest Circuits</i> <i>By Harold G. Branford</i> | An Audio Beat Oscillator..... 52 <i>19 Tube Is Used</i> <i>By Louis Krans</i> |
| | Radio University..... 55 <i>Questions Answered</i> |

Vol. XXVII, December, 1935. No. 11. Whole No. 687. RADIO WORLD, published monthly by Hennessy Radio Publications Corporation, 145 West 45th Street, New York, N. Y. Editorial and executive offices, 145 West 45th Street, New York, N. Y. Executives of RADIO WORLD: Roland Burke Hennessy, editor and business manager; Herman Bernard, managing editor; Herbert E. Hayden, advertising manager. Officers of corporation: Roland Burke Hennessy, president-treasurer; Roland Burke Hennessy, Jr., vice-president; Herman Bernard, secretary. Entered as second-class matter March, 1922, at the Post Office at New York, N. Y., under Act of March 3d, 1879.

SUBSCRIPTION RATE

Price 25 cents per copy. Subscription \$2.50 per year (12 issues), postpaid in United States and Possessions; \$3.00 per year postpaid in all other countries. Remittance for foreign subscription should be by International money-order (postal or express) or draft against or discountable at New York bank.

RADIO WORLD is distributed by the American News Company and its Branches

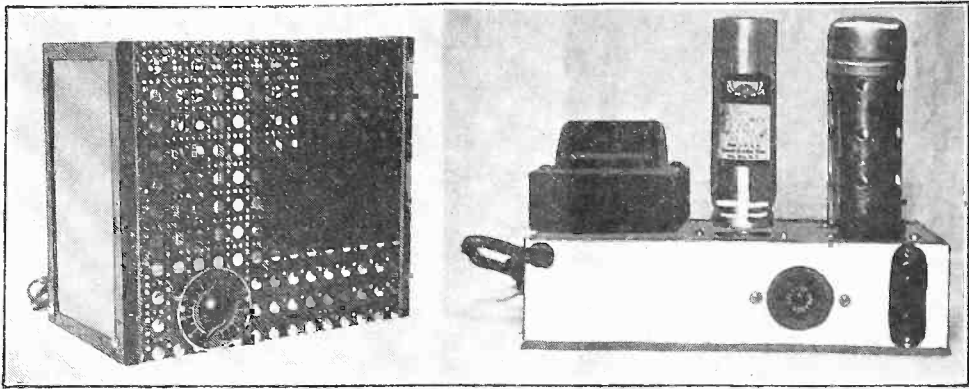

THE NEW RSL-5 AMPLIFIER

A MODERN UNIT TO MEET MODERN NEEDS

An ideal unit for lodge halls, class rooms, restaurants, taverns and many other places where an inexpensive powerful amplifier is needed. A radio tuner or phonograph pickup can be used for entertainment purposes.

The RSL-5 uses, 1-57, 1-2B6, 1-83 in a circuit designed to give high gain and true reproduction. Output 5 watts. The unit is enclosed in a strong black crackle finished case and cover which have been designed to provide proper ventilation and easy access to all controls and jacks.

COMPLETE KIT OF PARTS—LESS TUBES AND SPEAKER.....\$7.95
8½" DYNAMIC SPEAKER (not illustrated).....\$2.79

SEND 3c STAMP FOR FREE CIRCUIT DIAGRAM

RADIO SCIENCE LABORATORIES

126 LIBERTY STREET
NEW YORK, N. Y.

Thrilling

FOREIGN RECEPTION

with the

New 1936 Find-All Four Receiver

WITH NEW METAL TUBE

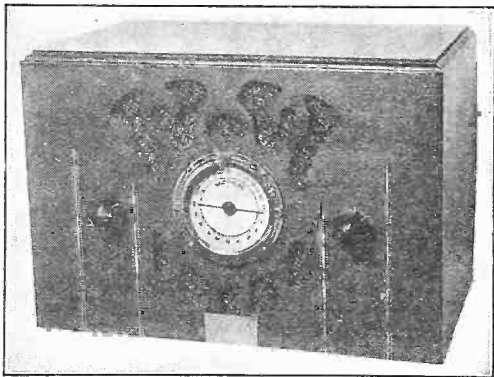

Pat. Pend. U. S. Serial No. 592,585

Covers ALL WAVES from 10 to 600 Meters! Including Standard Broadcast, Police Calls, Weather Reports, Aeroplans, Trans-Atlantic Phone and Amateur Bands. Direct Foreign Broadcast entertainment under suitable conditions. Operates from any 105-125 volt house lighting circuit, direct or alternating current. Works with any outdoor aerial, local broadcasts on short indoor aerial.

Complete Kit, including dynamic speaker, diagrams and instructions..... **\$7.95**

Wired and Laboratory Tested \$2.25 extra. Cabinet, Professional Finish, with Illuminated Aeroplane Dial \$1.50. Kit of Matched Tubes, Metal 6K7-6C6-43-25Z5, Total \$2.75. Kit of Five Matched Low-Loss Coils, 15 to 550 Meters, \$1.95 per kit. Special Long Wave Coil and Assembly \$0.95. Find-All Aerial Kit \$1.

Find-All Radio Company, Dept. WR1
 98 Park Place New York, N. Y.

WHEN WRITING TO ADVERTISERS
PLEASE MENTION THAT YOU SAW THE
ADVERTISEMENT IN RADIO WORLD.

Want a Steady Job?

\$1260 to \$3400 a year

Work for "Uncle Sam" Paid Vacation

Men—Boys 18 to 50

Common Education unusually sufficient, Valuable Coupon

Mail It Today SURE

FRANKLIN INSTITUTE, Dept. E-30, Rochester, N. Y.
 Rush to me FREE OF CHARGE, flat of U. S. Government job, now obtainable. Send FREE 32 page book telling salaries, duties, hours, etc. Tell me how I can get a position.
 Name _____
 Address _____

A Mobile "Ultra" Transmitter

Effectively Used in Police Car on 30.1 Megacycles

By E. H. Morgan

Chief Engineer, K9PW, Salt Lake City Police Department

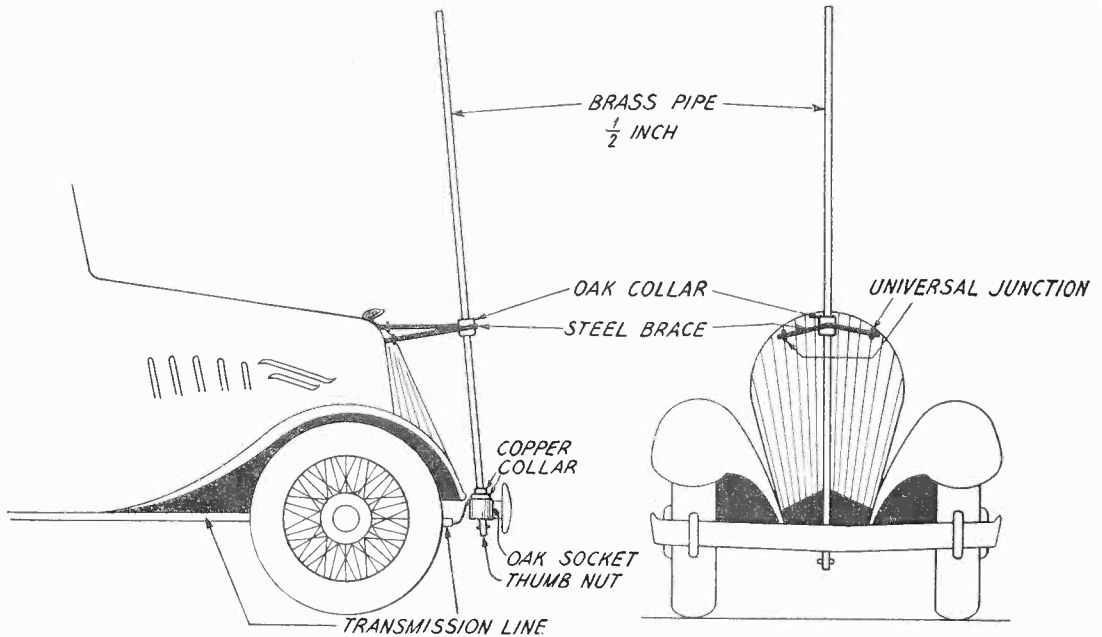

Details of how the antenna is placed and erected.

THE author for the past two years has been interested in the possibilities of two way communication for use in conjunction with existing police radio facilities. Considerable development work has been done under experimental license W6XEG on 30,100 kc. The present stage of this work forms the basis of this article.

As others working in this field no doubt know, there has been a complete lack of practical data in current literature on this subject; in fact, the author can not call to mind a single article dealing with this. It has been necessary to rely chiefly on experimental methods and such data as have come to light in ultra high frequency work from sources intended for far different use.

It is fairly well recognized that the success of ultra high frequency equipment depends on simplicity of operation and design. Exhaustive tests have shown that beyond a certain point, the effectiveness of an ultra high frequency transmitter is not increased by further increasing power. Far greater gain can be made in this direction by paying special attention to

the radiating system, stability and quality of the transmitter.

Limitations Are Onerous

For mobile use severe limitations are imposed on both the radiation system and the power supply, especially if economy and simplicity are to be retained. The maximum power practical to take from the car battery for equipment of this kind is approximately 50 watts; this must include filament current as well as plate power.

The antenna system possible is limited practically to a vertical quarter wave radiator working against the car as ground. The power radiated from any type of horizontal antenna is negligible in comparison with the vertical due to the high capacity to the car frame and the appreciable losses due to eddy currents, etc.

During the development period at KGPW many more complicated arrangements were tried, such as MOPA [master oscillator power amplifier] type in an effort to better stability and eliminate frequency modulation, higher power inputs obtained from belt

driven generators, practically all possible types of antennas, etc.

Practical System Achieved

As a result, the system about to be described has emerged as the most practical, economical, and simple, giving a high quality signal of reasonable power, and with stability well within the .05% tolerance set by the Federal Communications Commission, although still possessing frequency modulation to some degree, determined chiefly by the degree or percentage of modulation.

The transmitter consists of three sections: (1), the oscillator and coupling line and antenna system; (2), the modulator and speech amplifier, and (3), the power supply unit. The oscillator and speech equipment are housed in a steel case measuring 8 inches x 6 inches x 14 inches and mount in the car just behind the front seat. The power unit, a police type motor generator, is mounted directly alongside and connected by cord and plug with the transmitter unit.

The concentric transmission line feeding the antenna is made of $\frac{7}{8}$ inch thin-wall conduit, having a center conductor of $\frac{1}{4}$ -inch copper tubing held in oak spacers each of 6 inches length. The line projects up through the floor boards at the transmitter housing for connection and then is carried under the car and welded to the frame, ending just under the apron at the front end of the motor.

The antenna proper is made of $\frac{1}{2}$ -inch brass pipe mounted on a steel brace at the base of the radiator and extending vertically upward, being again braced with two steel braces at the top of the radiator.

Impedances Nearly the Same Naturally

At the base the antenna is set into an insulating socket made of oak, and passes through a similar oak collar at the top brace. The antenna is rigid and fairly clear of the car, resulting in high efficiency. The antenna can be completely demounted in about two minutes, a feature made necessary when the car is desired for other than radio service.

At this frequency the natural impedance of the line is so near to the impedance of the antenna that no matching device is necessary, which results in far greater ease in maintenance and tuning.

The oscillator unit consists of a unity coupled push-pull circuit using two type 71-A tubes. These are mounted in high grade sockets to keep losses down. The tank inductance, L1, is made of five turns of $\frac{3}{16}$ inch copper tubing wound on a two inch form and spaced $\frac{1}{4}$ inches between turns; the grid winding is inside the tubing and is wound with wire having very high insulation quality.

Dielectric Must Be A-1

This is very important in this type oscillator. (Continued on next page)

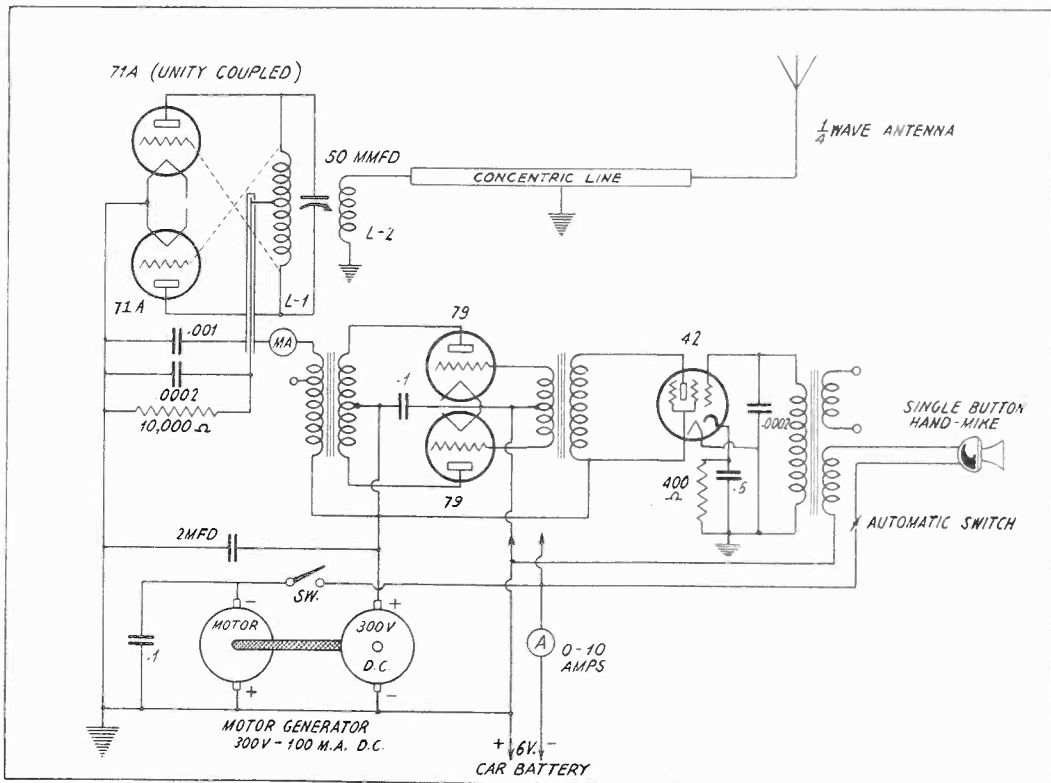

Stability, good efficiency and simplicity mark this ultra frequency mobile transmitter, operating from a car storage battery, and used in police work.

(Continued from preceding page)

as even a small amount of leakage due to poor dielectric or insulation will greatly impair the efficiency and may result in destruction of the tubes.

In mounting the apparatus it is important to keep the leads from the tuned circuit as short as possible and to have the tank condenser between the tank coil and the tubes. This will prevent excessive excitation, a common fault of this type oscillator, and improve stability greatly. The coupling coil, L2, consists of two turns of 3/16 inch tubing rigidly mounted and wound the same diameter as L1. This will give approximately the proper impedance to match the line, and may be varied slightly by varying coupling.

The 71's are biased by the 10,000 ohm wire wound resistor and bypassed by a .0002 mfd. condenser. The .001 mfd. bypass shown on the plate lead may be made smaller if it is desired to handle very high audio frequencies for high quality; in most cases it is desirable to attenuate the highs.

The modulator and speech amplifier unit consists of a type 42 pentode excited by the mike, and a type 79 class B acting as the modulator. The transformers are the small open case type made for this class of service.

The 79 gives good quality with ample power for modulation and is easily excited by the 42 in class A. The 42 is self-biased in order to eliminate batteries, and the microphone current is supplied from the filament circuit by the storage battery.

Gravity Switch in Microphone

It may be necessary to connect a 2 mfd. condenser across the supply line to the mike to eliminate commutator and other noises getting into the speech unit from this source.

The power unit is so connected that the plate voltage is applied only when in use, while the filaments and heaters burn at all times, being ready for instant use. The microphone, a single button carbon hand unit, has a mercury gravity switch built in which automatically removes it from the circuit when it is in any other position than the vertical. This feature greatly prolongs the life of the mike, which would otherwise pack, as it must stand some rough handling at times in police service.

The total input to the plates of the oscillator is usually between 10 and 15 watts and the plate efficiency about 50%, resulting in a useful output of around 7 watts. The losses in the line and coupling system are too small to be measured, hence practically all of this power is delivered to the antenna. Definite figures for the efficiency of the antenna have not been obtained. However, a rough check indicates that about 80% of the input is radiated, which is quite good for such a unit.

Percentage Modulation

The modulation percentage is generally held at or less than 60%. While the 79 can do much better than this the frequency modulation becomes very objectionable with higher per-

centages and may even cause the transmitter to exceed the licensed tolerance of frequency stability. However, a low percentage of modulation in this type work is not objectionable, since practically all receivers at this frequency are super-regenerators and a strong carrier tends to suppress the inherent noise in the receiver.

Most superheterodynes, while having greater sensitivity, have such high selectivity that the frequency modulation in the transmitter causes very serious distortion. This can be overcome by using an intermediate amplifier in the superheterodyne having broad resonance curve or double peaks. Such a receiver is now under construction at this station, and preliminary tests tend to show that it will be far superior to the receiver now in use, which is a super-regenerator with a 58 r.f. stage.

Hints About New Set

In use the new system draws approximately 7 amperes total from the battery while transmitting; the idling drain is around 2½ amperes.

The regulation of the dynamotor power supply is really excellent, and very necessary with a class E modulator. The average voltage delivered under load is 275 volts. The system is simplicity itself to operate. Turn on the switch for B power and talk into the mike. The unit has been surprisingly stable, and has given no more difficulty in maintenance than an average receiver. It provides reliable communication inside a four mile radius, rain or shine, and has the desirable features of simplicity, economy and utility.

All Circuits We Print Can Be Readily Duplicated

ALL parts for circuits described in RADIO WORLD constructionally are obtainable. Any information concerning parts may be obtained by addressing Information Editor, RADIO WORLD, 145 West Forty-fifth Street, New York, and enclosing stamped, addressed envelope.

Moreover, all of the circuits have been constructed and tested, and the photographic illustrations should be followed as closely as possible, as location of parts sometimes plays an important role in determining results, especially on short waves. —EDITOR.

Antenna Lengths Critical

When a small set is built, using a two gang condenser in a tuned radio frequency circuit, and the trimmers on the condenser are set for a certain antenna length, any considerably longer aerial will destroy tracking.

This is due to the extra capacity from the longer aerial.

Grid Condenser Only

0.000005 Mfd.!

Yet That's Substantial for Centimeter Transceiver

By Herman Bernard

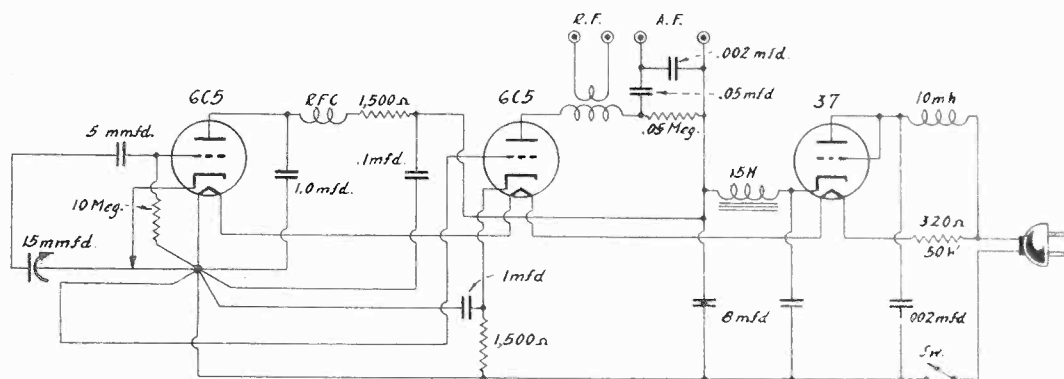

The tube at left is the oscillator, worked at one meter and a little below. The center tube is the amplifier, the one at right the rectifier. No coils are used in the oscillator, only short, straight wires. The cathode return is slid along one of them until the most stable operating point is located.

IN the parlance of the day this circuit may be described as a one meter transceiver. But it is really intended as a frequency meter and monitor. That intention coincides with transceiving, except that measurement is a predominant purpose. With the regular transceiver there is no measurement, and, it might be added, it is a bad thing there is none, as a great deal of off-band operation would be disclosed.

The distinguishing feature of the circuit is that conventional tubes are made to work at one meter. In general, this had not been accomplished before, except with circuits of short tube life, and in the direction of so-called electron oscillations. The present circuit is regenerative, has the appearance of being a Hartley of the parallel feed type, though it behaves as a Colpitts. It yields more output than the others, though still small; can be loaded, however, and the tube lasts as long as if operated at low frequencies.

One Meter Activities to Grow

Experimental work that was the background of this design was detailed in the November issue. The oscillator, the tube at left, was the subject of discussion. The circuit was worked with a 76 tube instead of the metal tube during one stage of the development, with small amplitude difference, and the variable tuning condenser was inordinately large, 35 mmfd. maximum, to corroborate the presence of oscillations

at wavelengths much higher than those at which operation is intended.

The one meter field is about to open up to larger activities, and while special tubes will yield splendid results, a great deal more incentive will accrue if something can be accomplished with conventional tubes. The zest will become contagious and operators may then proceed to more extensive and powerful rigs.

In the direction of putting more into the antenna, and also removing the oscillator from the influence of the external load, the amplifier tube, another 6C5, was included. The plate voltage was kept low purposely, its d.c. value being about equal to the r.m.s. a.c. line voltage, further to put an imposition on the circuit.

The Oscillator Diagram

Diagrams for ultra waves are unconventional, and must be, if they are to reflect even a little of the literality. It is therefore necessary to explain the oscillator part of the diagram.

A common point of return is selected. This is one side of the heater of the first tube, right at the socket. This connection point is common for the oscillator returns, in a mechanical sense. It may be called the common ground, although it is not literally grounded. At such a low wavelength grounding is more suppositious than real. But it should be the lowest radio frequency potential point.

The 10 meg. grid leak should be of the $\frac{1}{4}$
(Continued on next page)

(Continued from preceding page)

watt capacity, so that the pigtails can be cropped to permit the leak to be connected from grid to common return. However, the 10 meg. leak in $\frac{1}{4}$ watt capacity is a rarity to radio stores, therefore $\frac{1}{2}$ watt would be used, or 1 watt if that is the smallest physical size obtainable. The one watt resistor will be longer than the distance between the grid and heater prongs of the socket. The objective is

shunt capacity than would a condenser several times the value. But for the wavelengths in which we are interested 5 mmfd. reduces this shunting and still suffers only a very small voltage drop.

No. 20 Wire Large Enough

The tuning condenser rotor, a common connection with its frame, is insulated from the metal cabinet in which the rig was contained,

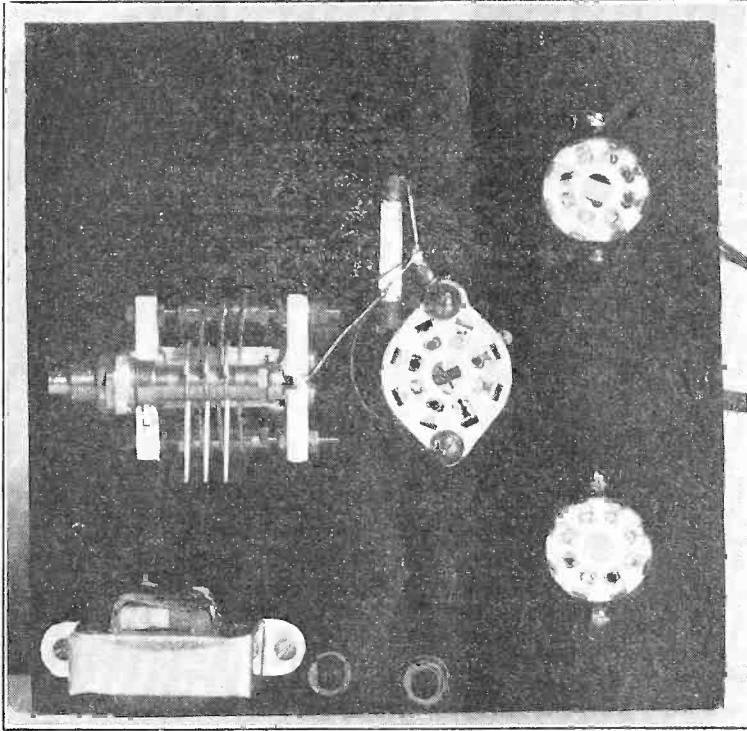

The tuning condenser used is the National Company's SEU-15, and the length of the wires constituting the inductance may be judged from this top view of the chassis. The inductance is necessarily greater if a one watt grid leak is used, as shown, because of the extra length of the connecting wire. The socket above is for the amplifier, the one below for the rectifier.

to keep the terminals of the leak in a short, direct path.

Very Small Capacity Grid Condenser

The grid condenser is 5 mmfd. (0.000005 mfd.), an unusually small capacity for the commercial market, but such a condenser in a moulded mica construction is manufactured by Cornell-Dubilier Corporation, Cat. No. 5W-5V5. It is connected from the grid terminal of the socket to the stator of the 15 mmfd. variable condenser, which was a National Company product, Cat. No. SEU-15.

The amplitude of oscillation was greater when a small grid condenser was used, as in this way the input capacity to the tube was kept lower, also the terminal wavelength was lower.

The effect of the grid condenser is to put a capacity across the input of much smaller capacity than the grid condenser's own. This effect is reactive, however, so that for low frequencies, say, the standard broadcast band, such a small condenser might contribute an effect that shows up as a larger equivalent

by mounting bushings and a shaft coupler. The cabinet is insulated from the line as well. A wire is run from the condenser frame lug to the common return. No. 20 solid wire is large enough. One V branch is 3 inches, other 4 inches, to meet the mechanical requirements. Much larger diameter wire reduces the amplitude.

All leads must be considered in the oscillatory circuit. Every piece of wire has capacity and inductance of noticeable effect.

The cathode is connected to some point along the wire from condenser frame lug to common return. Some point is found that supports oscillation. The preferable position can be selected later.

So the inductance consists of straight wires, and these may be arranged V-shaped from frame lug and one stator lug, with the focal point the heater. One stator lug of the condenser is used for a terminal of a branch of the V. The other stator lug has one side of the grid condenser connected to it.

A radio frequency choke in the plate leg need have only a medium number of turns, and may

be constructed of 30 turns of any fine wire, even No. 30, on $\frac{1}{4}$ inch diameter, using insulated tubing or solid insulation shaft. Much higher inductance may be used, so long as the choke's distributed capacity is low. A 1 mfd. condenser is connected directly from plate to heater. In series with the r.f. choke has been added a resistance of 1,500 ohms, which increased the field about the choke. The com-

use coupling of the usual sort, because the oscillator becomes too greatly loaded and then stops oscillating.

Output Coupling

The coupling inductance, represented by the roundabout-looking lead in the diagram, may be associated capacitatively with the RFC field, in about the same manner, but the grid coupling

The black form at left center is the one on which the output transformer is wound, for connection to "R. F. Output" in the diagram. Only a few turns are needed. The plate leg r. f. choke inductance is not critical, but the distributed capacity should not be more than 1 mmfd. across it. That is one reason for using either a pie-wound choke, as shown, or a choke wound on a small diameter, say, quarter inch.

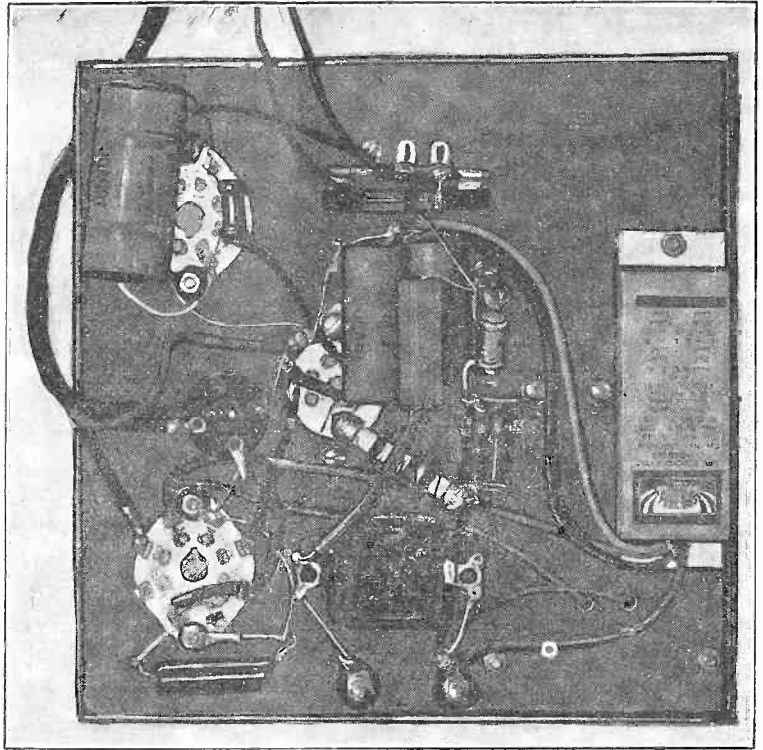

pleting condenser of .1 mfd. further elevated the oscillation potential, although only a trifle.

Coupling to Amplifier

The choke field is sufficient to enable output coupling by capacity or inductance, but coupling at this point might disturb the frequency of the generator, due to loading the oscillator plate leg. Although the diagram suggests the idea of an output circuit shorted to the waves under discussion, the plate circuit actually is highly loaded.

Nevertheless, it is from the grid circuit that the r.f. voltage is taken to supply the amplifier tube. The lines at bottom of the oscillator, drawn seemingly too long, and out of their accustomed path, represent a single straight wire, from amplifier grid to common return, run near the straight wire from rotor to heater, thus combining capacity and inductive coupling. If the wire is too close the oscillator stops oscillating, so select the shortest distance between these physically parallel branches that retains oscillation, with hardly any change in plate current in the oscillator tube. It is not practical to

may prove more attractive if medium voltage output suffices.

A few extra turns are used on $\frac{1}{4}$ inch diameter for a 1 to 1 output transformer. The windings may be adjacent (not one over the other), with separation between them adjustable. In many instances the actual coupling will be merely the capacity between the two windings, that is, only one post of the r.f. output is used. Use of two posts would serve a doublet system. Or one of the two posts may be grounded and the other used as high potential for a theoretical Marconi system.

It is necessary to experiment with the actual number of turns and the distance or separation between windings, for connection to any critical impedance, such as another winding in a receiver being measured, a transmission line interposed between. The impedance scarcely can be measured at these frequencies.

Division of Plate Activities

In series with the larger winding is a resistor of .05 meg. The coil has practically no impedance to audio frequencies, but the re-

(Continued on next page)

(Continued from preceding page)

sistor has appreciable, so a large condenser is connected from the high side of the resistor to a.f. output, the other a.f. output post being B plus. Since phones may be put across the a.f. posts, a condenser of .002 mfd. is used to bypass the radio frequencies. Thus all the r.f. drop takes place in the primary coil of the output coil, and all the audio drop in the .05 meg. resistor.

The B supply rectifier is standard, except that an r.f. choke of 10 millihenries or thereabouts is used, with a condenser of .002 mfd., to prevent modulation hum and otherwise provide r.f. filtration.

The adjustment of the tap position on the rotor-heater leg has to be made for best results. In this instance best results means best frequency stability. It is increasingly difficult to maintain frequency stability as the frequency is increased, but the present system accomplishes about as much as can be expected, since no special correctives are included for changes of temperature, position, moisture, etc.

The Two Uses

The stabilization is aided by adjustment of the wire from cathode to that position on the rotor-heater lead that results in the smallest change in plate current in the oscillator as the tuning condenser is rotated from maximum to minimum. The meter should be connected with one side to B plus itself, other side to the lead going to oscillator tube, so that the bypass condensers are effective on the meter, which would not be true if the meter were placed between oscillator plate and RFC.

No attempt has been made to introduce chokes in the grid leads to hold up the impedance, and of course the impedance in the amplifier grid circuit is particularly low. In the oscillator the plate choke coil is partly effective in the grid circuit, though unintentionally so. The cathode-ground circuit is common to part of the grid circuit and to part of the plate circuit.

Since reception is of the beat type, the monitoring, that is, listening at the device itself to measure a transmitter frequency, may be done with phones in the a.f. posts, and the incoming signal applied to the r.f. posts. Frequency metering, that is, use of the device for creating a response in an external receiver or transmitter, is accomplished by using the r.f. posts only, since the indicating is done in the external set.

Measurement Process

What frequencies are generated should be the subject of calibration. The easiest method is to set up a standard broadcast band signal generator but with a very small variable capacity (35 mmfd. suggested), for tuning this generator, covering, say, from 1,250 to 1,500 kc, and provide at least one amplifier stage, taking the output from the last tube. The small band is calibrated carefully, and since the frequency difference is only 250 kc, divided over 180 degrees at least, it is easy to register on a 4 inch disc frequency differences of 1 kc,

and if a true vernier dial is used, with reading to 1 part in 1,000, kc differences to .25 kc could be noted.

Beats with stations may be used in large cities for quite an assortment of registration points. In more remote places the few stations receivable do help, and a low frequency generator is used, say at 50 kc when beating with 1,250 kc.

The receiver is fed both the station frequency (say, 1,250 kc to which set is tuned) and an external generator frequency, (say, 50 kc). Then as the set dial is turned some more, toward higher frequencies, responses will be heard at 1,300, 1,350, 1,400, 1,450, and 1,500 kc. Here is a total of six, against which the small condenser type oscillator is compared.

Use of Other Stations

Besides, any other stations in the band may be used. Also, some other station may serve for other points, by operating the additional signal generator at some known subharmonic of the second station's frequency. There might be five more points. Then on very large plotting paper, not less than 2 feet square, the known points are set down and the curve drawn.

The frequencies may be converted to wavelengths from a precision conversion table. Such a table is printed by the Federal Government. It appeared in the December 22, 1934, issue of RADIO WORLD.

The frequencies compared to dial settings result in a practically straight line, due to the plate shape of the National condenser used. The wavelength comparison will not be straight line.

Beats Can Be Heard

The harmonics of the newly calibrated generator would be used, and as it is conceivable one would need harmonics up to the 200th, it is plain that listening has to be carefully and alertly done. [Another article in this issue tells how to use harmonics for measurements.]

With a husky tickler on the 1,250-1,500 kc generator the oscillation intensity may be very strong. A grid leak and condenser are requisite. The beats can and will be heard, the only defeating condition being molesting the measured circuit (here the oscillator shown in the diagram), and the drowning effect of the hum on a.c. What the hum quantity will be is hard to say, but it will be more than one would desire. Use of larger than 8 mfd. filter condensers (say, 24 mfd. in each position) assists the hum reduction in some instances. But it may be necessary to connect one side of the amplifier 6C5 heater to the line, then run a wire from other side of that tube's heater, to one side of the oscillator heater, other side of oscillator's heater to the 37, remaining side of the 37 as shown. All returns are now made to the same common point, which is one side of the line, but no longer is the oscillator heater common with that focal point, as the amplifier heater acquires that status, and the wavelength is raised by the long leads.

A Foreign Band Converter

Universal Model with Straight Frequency Line Tuning

By W. C. Barry

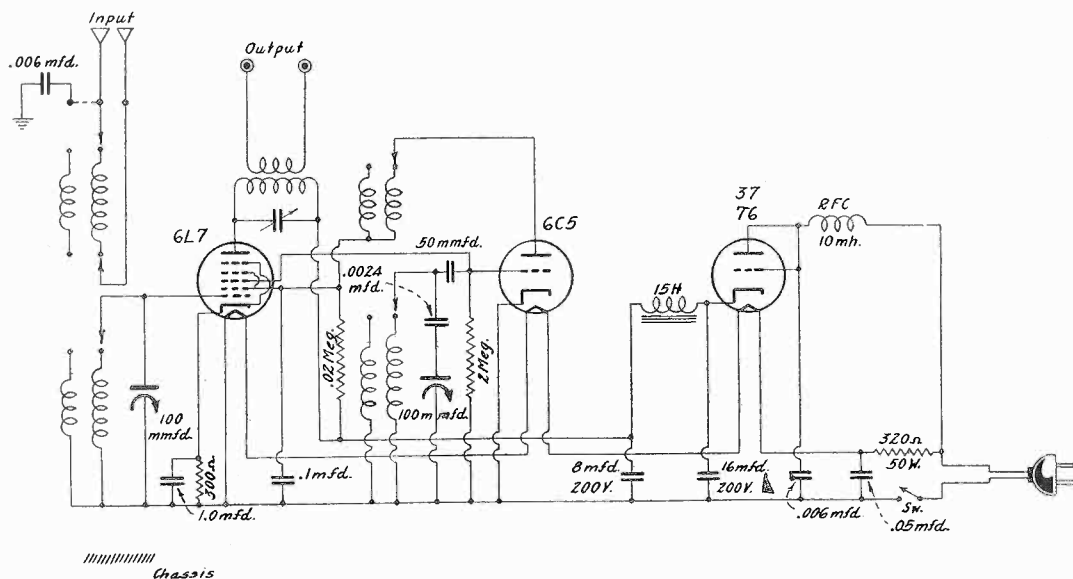

Straight frequency line tuning is present in this foreign band converter. Instead of the large frequency ratio and dial crowding ordinarily present, good spreadout is obtained, as the band is covered in two steps, by coil selector switch control.

IT is of great advantage to the experimenter, who not only likes to possess something different but also something better, that the tuning ratio be less than what is found in receivers using tuning condensers of .00035 mfd. or so, where the frequency ratio is more than 3 to 1.

Even in the broadcast band there is an advantage in taking it in two strides, as it were, because the gain can be increased consistent with stability, at the radio frequency level, and besides a marked dial reading distinction may be made between stations 10 kc or 5 kc apart even at the high frequency end of the band.

With the large ratio the 10 kc distinction on the dial is not only rendered more or less fictitious, because the dial pointer is "10 kc wide," or, even if the pointer is a hairline or knife edge, the etching can not register the real distinctions.

What Would the Farmer Do?

Some improvement arises from the very fact of coupling. Any given coupling approaches the ideal for one frequency only, so the greater the frequency ratio the greater part of the band is deprived of sensitivity or selectivity at the expense of the rest of the band at variably tuned levels. When the ratio is held down to 2 to 1 the coupling ratio is improved one-third. If you told a farmer of some way to make his hens lay four eggs during the period they now lay three he would become greatly inter-

ested and, if the method proposed seemed a reasonable one, he would be quick to adopt it. So radio builders have an incentive to resort to smaller frequency ratios to improve results.

Aside from improved gain, one must not forget that if any short waves are to be tuned in, the absolute crowding becomes worse in a direct proportion, so if the frequency ratio is 3 to 1 for the broadcast band, and remains the same for the other bands, the one next to the broadcast band has three times the absolute condition of crowding that existed in the prior band, the third band has three times as much as the second or nine times as much as the first, the fourth band 27 times as much as the first, and thus the evil is crushingly cumulative.

The present device is a converter for tuning in the foreign short wave broadcast band and covers 5,000 to 20,000 kc (5 to 20 mc) in two steps, that is, 2 to 1 tuning ratio. A coil switch is used for band selection, 5,000 to 10,000 and 10,000 to 20,000 kc. Moreover, the tuning is straight frequency line, accomplished in this instance by using a two gang condenser that has plates specially shaped for that type of curve.

A Common Padding Condenser

Since the local oscillator frequency is higher than the intended station carrier frequency, and since the two condenser sections are equal in capacity, though the required capacity ratios
(Continued on next page)

(Continued from preceding page)

are slightly different, the compensation of ratios is made with a single padding condenser, .0024 mfd. With straight frequency line tuning this can be done. With any other shape tuning curve it can not be done. In effect, then, the oscillator section is made to tune to a slightly smaller frequency ratio than the r.f. input, the reduction being accomplished by the series capacity, so that all that need to be done is to pad inductively for the proper tracking of the two circuits, barring a capacity detail to be taken up later.

The tuning condenser sections are 100 mmfd. each. The minimum of the condenser is taken as 10 mmfd. and the additional distributed capacity arising from the tube, wiring, etc., is about 20 mmfd., so that the resulting capacity terminals are 30 and 120 mmfd.

The Disappearance of a Minimum

The condensers' own minimum disappears, so to speak, the moment that the shaft is moved the least bit in the only possible direction, a fact sometimes lost to sight, and, if so, resulting in erroneous computations. The condenser's minimum, being an exclusive quantity, therefore never is added to any of the higher capacities of these other settings, hence is not added to the maximum, either.

So we get a capacity ratio of 120/3, which is 4, and the frequency ratio is the square root of that, or 2. If we select the inductances properly we can tune from 5,000 to 10,000 kc and from 10,000 to 20,000 kc, and a calibration we make for the lower scale can be applied to the higher one, by using 2 as the multiplication factor.

If a certain dial position on the lower frequency band represents 6,200 kc, for the higher frequency band the same dial position creates most sensitivity at 12,400 kc, after all adjustments have been made properly.

Winding the Four Coils

If the tuning is straight frequency line, and we calibrate the dial for only a single frequency in the lower frequency band, we can draw the complete line on plotting paper representing the tuning curve, and thus consult the curve for other frequencies in this band, related to dial position in all instances just as the single frequency was related. For the higher frequency band, using the same curve, we multiply the read frequencies by 2, for co-ordination with the single scale, or, of course, the method may be worked the other way, the higher band used first, the lower one representing frequencies of half the values of frequencies for the same dial settings.

Getting results such as these depends on the coils, and these have been wound of No. 28 enamel wire for both s bands, for establishment of proper secondary inductions. Since the coils are so important, the details are closely given for winding them:

Form diameter, 1 inch. All turns close together.

Antenna coil, 5 to 10 mc band: Primary, 8 turns of No. 28 enamel wire. Leave $\frac{1}{4}$ inch

space, wind secondary, consisting of 15 turns of No. 28 enamel wire.

Oscillator coil, 5 to 10 mc band: Put a turn of wrapping paper on the intended form, wind over the paper 10 turns of any fine wire of the insulated type, put on some binder, such as National Coil dope, which is a Victron based fluid, and before fully dry, remove from the coil from the form and disengage the paper, so that the coil when dry can be slid along the tubing later on.

Coils Have Good Shape Factor

Remembering that the tickler is to be put at one end of the coil, allow room for it, and half an inch extra, then begin winding the secondary directly on the form, 14 turns of No. 28 enamel wire, which winds 73 turns to the inch, so the winding length of the secondary here, as in the case of the antenna coil, will be under a quarter inch, so the coils have a good shape factor. In general, a coil is assumed to have a good commercial shape factor if the axial length of the winding (along the tubing) is not greater than the winding diameter, which is the distance between the outside extremes of the wire.

Antenna coil, 10 x 20 mc band: The primary consists of five turns of No. 28 enamel insulated wire, a space of $\frac{1}{4}$ inch is left, and the secondary is wound, consisting of 6.5 turns of No. 28 enamel wire.

Oscillator coil, 10 x 20 mc band: The tickler is prepared the same way as was the tickler for the other band, so that it will have an inside diameter a trifle larger than the outside diameter of the tubing onto which it will be fitted, and consists this time of 10 turns of any fine insulated wire, while the secondary consists of 6.5 turns of No. 28 enamel wire, the same as for the antenna coil for this band.

Tickler Adjustments

Adjustment of both ticklers: The object of making the ticklers adjustable by sliding along the tubing is to enable a capacity adjustment previously mentioned. The closer the tickler is to the secondary the greater will be the capacity across the secondary, accompanied by a very slight decrease in secondary inductance. In the antenna circuit there is considerable antenna capacity reflected in the secondary associated with the primary winding, so that it is quite easy to establish comparatively smaller capacity in the oscillator circuit. The high frequency adjustment of both bands is therefore made by pushing the tickler to and fro, the limit to which it may be separated from the secondary being prescribed by the length of the coil form and the discontinuance of oscillation, but neither of these extremes is encountered in the adjustment, which is of a slight nature mechanically, although of great frequency influence. The very terminal frequency is never used for adjustment, but some frequency not far removed from it, e.g., 9,000 to 9,500 kc for one band, and frequencies double those, for the higher frequency band, although any stations coming in with tuning condenser

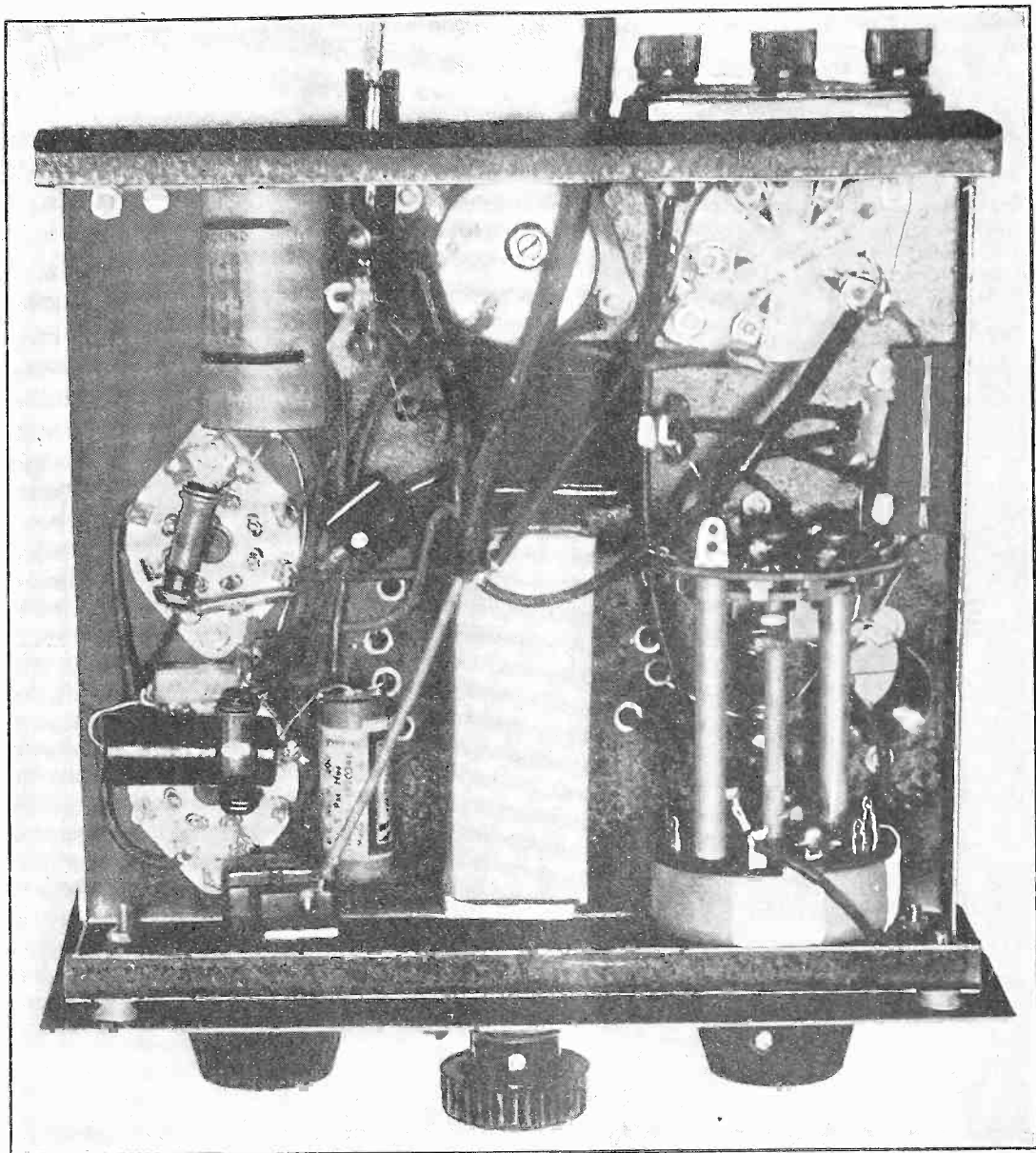

The bottom view of the converter reveals most of the wiring and discloses the layout of the principal parts outside of those concerned with tuning.

near minimum capacity may be used. It is preferable to do the work with a signal generator that enables alignment at a selected frequency, but the station method is passable.

How Output is Taken

When this adjustment is made for each band, the coil is held in position. It is then advisable to shorten the leads to the tickler lugs and solder them anew. Be careful, when intending binding the tickler to its proper position, use coil dope as before, do not molest the position of the tickler, and indeed it is well to verify the result by a reception test after the work is assumptively carefully completed. The right setting yields ever so much more sensitivity

than the wrong one, and if there are seemingly equal sensitivities for two tickler positions, use the position that requires the tickler to be farther removed from the secondary.

The 6L7 metal tube is used as the frequency converter, receiving the carrier that the circuit is tuned to, and providing the output, which is taken through a transformer with tuned primary. This transformer is a honeycomb coil, such as used in test oscillators for a band of around 140 to 500 kc, and when the larger winding, which when such test devices is the secondary, is put in the plate circuit of the present device it is the primary, tuned with a small capacity, the frequency to which the

(Continued on next page)

(Continued from preceding page)

receiver is tuned is established. The output energy is communicated to the secondary, which is the smaller winding in the converter use, for average impedance connection to a receiver's antenna-ground posts, or to doublet posts.

Matching Receiver Frequency

The actual capacity externally required across the primary winding of this honeycomb transformer is around 20 mmfd., so that air dielectric condensers of 35, 50, 75 or even 100 mmfd.

higher than 560 kc, and make all adjustments on the basis of the selected intermediate frequency.

Use of Shielded Wire

The coil system is such, and the adjustment directions are sufficiently blanketing, to take care of frequencies to about as low as you can tune your receiver in the broadcast band. Select 560 kc, however, as a preference, if you can. It is also possible to reduce or eliminate

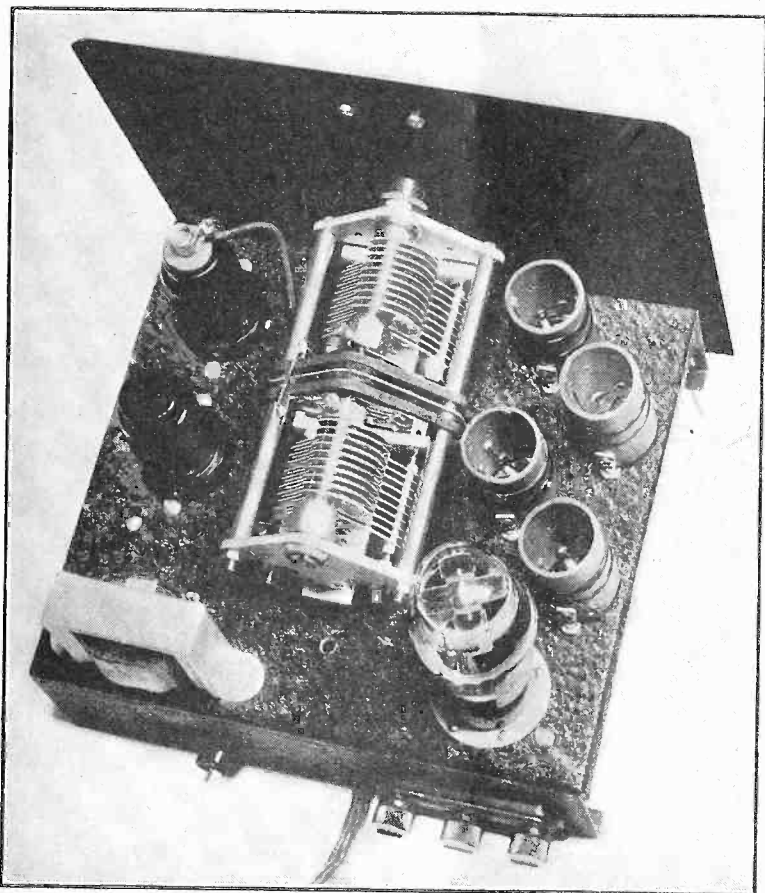

The coils, though close together, did not produce any dead spots, as there are no trimmers across the coils to make the natural period of the trimmed circuit of the lower frequency pair fall in the frequency spectrum covered by the other inductances. The primaries on the coils are adjustable by being wound on a somewhat slightly larger diameter than the secondaries, and when the correct position is determined, the primaries are adhered.

maximum may be used, whatever you may have handy, or, if one is to be purchased, it may be of the 75 mmfd. type. The converter will work with this condenser at any capacity setting within the values within the extreme stated, 100 mmfd., which is .0001 mfd., but when the converter is operating, in conjunction with the receiver, which is set at a particular frequency, 560 kc or close thereto, rotation of the shaft of this trimmer will result in one reaching a particular setting that yields somewhat stronger results than any other, and at this position the condenser shaft is left. Once that condition is established, and in fact, once the converter is lined up at the other levels, the same receiver frequency should be used time and again.

Of course in some locations there may be interference from a local at or near the 560 kc recommended, and if so move toward the lower frequencies as far as practical, rather than to

local broadcast station pickup by using shielded wire from output of connector, but it must have at least $\frac{1}{2}$ inch thick insulation and sheath must be grounded. Thin insulation introduces severe loss.

The 6L7 requires an independent oscillator, and in the converter the 6C5 is used for that purpose, with a small grid condenser (50 mmfd.) and a large grid leak (2 meg.). The padding condenser, .0024 mfd., as stated, remains in circuit for both switch positions, as the comparative frequency ratios of the oscillator are 1.9 and 1.91, a difference taken up by adjustment of parallel capacity effect, as explained. The adjustment on the higher frequency band is very critical, since about 1/64 inch difference in tickler position may displace the frequency 2 mc. closest coupling as starter. The frequency difference per inch (or perhaps we

(Continued from preceding page)

should say microinch) becomes much less as the tickler is moved nearer to the position that it must actually occupy.

The rectifier tube is a 37 or a 76, or some may prefer to use the 1V, which requires instead a four hole socket, and stands up to 50 milliamperes. Of course the present circuit draws nothing like that amount of plate current, nearer 15 ma, and the triode used as diode, as diagramed, does nicely as B supply rectifier.

The .05 mfd. condenser from limiting resistor of the heater supply to one side of the line is put there to bypass radio frequencies to which the limiting resistor otherwise becomes an impedance on occasion, resulting in degenerative action. The radio frequency choke in the diode anode leg is to prevent modulation of the rectifier by carriers put in through the line, while the .006 mfd. condenser completes the filtration for this purpose. How any carrier results can follow from putting the line voltage across the B rectifier tube is not so clear in theory as it is in fact. One suggestion is that the electrolytic condensers may present sizable impedance to short waves, while the 15 henry B choke is as if a solid wire length to these frequencies because of the high distributed capacity across that choke.

The .02 Meg. Limiting Resistor

The voltage applied to the plate of the mixer tube is about 100 volts, and the resultant bias on the tube, due to the voltage drop across the 300 ohms, will be about 2 volts. This is sufficient in view of the plate voltage, and any much higher negative bias would reduce the sensitivity considerably. The plate voltage is high enough, because the suppressor grid (5) severely reduces space charge and thus permits wide plate swing, constant, because derived directly from the rectifier, but the screen voltage on this tube is inconstant, as follows: There is a limiting resistor of 20,000 ohms between screen and B plus, so as the plate current drops the screen current drops, for the two work in the same direction. The drop in screen current decreases the voltage drop in the limiting resistor, hence increases the screen voltages, so that the plate current rises again, and thus the operation is in the direction of current equilibrium. When the plate current rises, the screen voltage falls, also to the same stable effect.

The oscillator, a separate tube, puts its plate current through the same limiting resistor. As the oscillator's intensity increases the plate current is decreased in the 6C5, on account of the grid leak, so for increased oscillation amplitude the screen voltage on the 6L7 is increased, and between the two tubes, relative constancy of plate current is maintained in both. This is also a modified form of automatic volume control.

The Coupling Between Tubes

The method of injecting the oscillator voltage into the mixer tube is to tie the third grid of the 6L7 to the grid of the 6C5. This makes

the voltage on G3 of the 6L7 always negative, because it is the same voltage as is on the oscillator grid, and that is always negative.

During the positive alternation of the oscillator the grid rectification takes place, and the current driven through the 2 meg. leak biases the tube. The cathode is always positive to d.c. values in a rectifier tube, and so the grid is negative. During the negative a.c. alternation the grid is also negative, even though no rectification takes place now. The grid condenser is discharging through the leak. In this way an average negative potential is established on the oscillator grid, hence in this circuit on the grids of two tubes.

Notice has been taken of the additional capacity across the 6C5 input due to the capacity between G3 and cathode of the 6L7 being in parallel with the oscillator's tuned circuit. Also the conversion conductance of the 6L7 is less by the direct coupling to oscillator than if a method of .00025 mfd. condenser were put between Gr of 6L7 and grid of 6C5, with .05 meg. leak in G3 leg, returned to minus 6 volts of a biasing battery. The method shown in the diagram avoids the use of battery or additional rectifier.

Matching Output Important

The output coupling is shown as consisting of a small secondary inductively related to a tuned primary. It is imperative that the impedance of this secondary be suitable for the input impedance of the receiver. If there is considerable mismatch there will be severe loss, and one may be baffled by weak results. There will be a very marked loss if the impedance of the secondary of the converter's output transformer is very small compared to the antenna circuit input of the receiver.

One way out of the difficulty is to use a tapped output coil with tapped secondary, and by trial select the proper tap. National Company has such a device. For home construction the secondary may have half the number of turns of the primary, secondary tapped at four or five places, about evenly distributed as to number of turns. A standard broadcast coil with rewound primary may be used, with around .003 mfd. capacity across large primary. For maximum power transfer the impedances should be equal, but for maximum voltage transfer the load impedance (primary of set coil) should be twice that of the other (converter secondary). Here we are not interested in power but in voltage, and in general the impedance may be compared relatively in terms of the apparent inductance. The more inductance, the higher the impedance.

The antenna input primary impedance is in general an unknown quantity with builders and experimenters, and there are vast differences, some inputs being of high, others of low or medium impedance, considering a frequency in the broadcast band alone, and especially the frequency at which the receiver is to be worked for the present converter application.

List of parts sent on request.

Repair of Dynamic Speakers

Proper Precautions Save Time, Assure Success

By Herbert E. Hayden

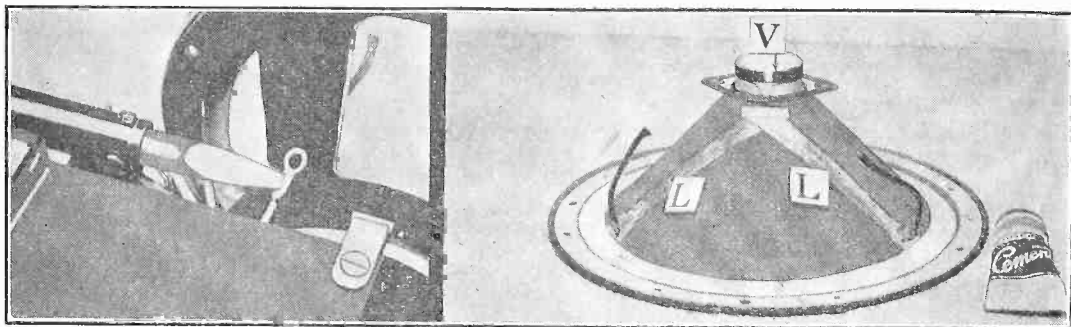

In repairing speakers of the dynamic type it is often necessary to unsolder the voice coil connection from the insulated lugs usually found on the frame (left), thus leaving the two leads (L and L at right). V represents the voice coil, which consists of the few turns of wire. The socket-like device below the voice coil is the "spider."

TWO things supposed to require no particular attention in a radio set are tubes and speakers. As for the tubes, how many persons keep the original installation until the receiver positively stops playing? Now, the majority of persons will do that, unless they replace an old receiver.

There are two sides to this. Persons who wait until the set functions no longer at least begin to have an urge to get a new set, and that has its commercial attractions, as well as its benefits to the consumer. On the other hand, assuming a set is used for a year, the tubes usually last that long as good performers, but the tubes should be checked every few months, and particularly if there seems to be a sign of weakness in the receiver that was not there originally.

Admittedly a great deal of tube checking goes on, especially under the stores' incentive, whereby there is no charge for checking tubes.

Speakers Need Testing

But did you ever see a sign reading: "Speakers tested free.?"

No, it seems that speakers do not need to be tested. They are supposed to keep right on doing their best, at all times, in all weather, as if they were made of some imperishable, changeless and eternal substance, which they are not. Each speaker, magnetic or dynamic, has a cone, and this cone is of paper or fabric, and moisture has an effect on both.

Long use has its effect, too, because dust, grit and other foreign substances get between the moving parts, and change the mechanical impedance. This change may result in scratchy or popping sounds, or merely in reduction of

sensitivity. It is therefore advantageous to give the speaker a test. Let us consider the case of the dynamic speaker principally.

The speaker may be dissembled with safety. The first step is to remove the wires connecting to voice coil, then remove cone.

There will be two wires leading from the voice coil to lugs on the speaker frame. These must be unsoldered. The cone is the funnel-like structure. The voice coil is the few turns of wire on a bobbin.

At the center of the magnetized area in which the voice coil worked is the pole piece. This is likely to get dusty. To remove the accumulation a small air pump is recommended, and in the absence of such a pump some experimenters with great lung power blow on the pole piece. This is all right for adhesions of non-magnetic material, but if there is iron dust present the strongest lungs can blow their darndest, all to no avail. A bicycle pump may serve as a handy substitute.

Changes Time Worked

Experimentally the cone is placed against the speaker frame in the intended position. Time may have changed the mounting requirements. Perhaps the cone shrank a bit and now a felt washer or ring is necessary, so that there is a snug fit. Or perhaps a ring was present previously and isn't needed now. Experience and a few knowing glances will teach one the answer. Mount the cone, with or within the washer, as circumstances require.

The cone should be held fast. Cement will do it. This is applied about the edge. Usually a sizing of cement is put on the frame, and when dried to the extent of tackiness, is then

ready for the cone that has been similarly treated about its periphery. Then the assembly is allowed to dry thoroughly. If a ring is needed, that is cemented to the frame, and the cone to the ring.

Now we come to a delicate piece of work. It is necessary to mount the voice coil just right. For some speakers this job is so critical that professional speaker repair factories have centering rigs. Lacking any such equipment, one may use an assortment of shims.

How Shims Are Used

These are thin metal strips of various thicknesses, say, .0002 to .01 inch. The voice on its bobbin may be experimentally placed inside the opening, and the shim used on one side of the assembly when the voice coil is pressed against the other. The shim thickness now is at least twice as great as the clearance all around, and this may be a guide. So with the right shims mount the voice coil provisionally. The closer the adherence to exactly the same and correct clearance all around, the greater the safety from distortion due to swaying of the voice coil in action. If one has no precision shims he may use shim metal from a hardware store, or procure feeler gauges from the local 5 and 10.

If one has duplicate sizes the work is far easier, and may be done as it should be, with shims of equal thickness spaced around the opening. Then the centering may be accomplished quickly and exactly.

The voice coil is held in its proper position by these shims disposed about the circumference.

Final Operation

Now look at the spider. This is the device that ultimately will hold the voice coil in position, by cementing bobbin to the spider, and supplied the "floating power" mounting, giving a resilient suspension that offers small mechanical impedance to the motion that the electromagnetic forces of the working speaker will apply to the voice coil.

Now tighten down the screws on the spider. These are the first screws to tighten, since the job is to put the voice coil in place, and the angulation will be controlled by the spider. Next tighten the screws about the speaker frame. Now remove the speaker shims from about the voice coil. Next restore the voice coil leads to their lugs and listen to the speaker with no program coming in. There should be a low hum. If the resultant sound is unequal, scratchy, ploppy or interrupted, then there is still trouble in the speaker, and, if the foregoing work has been done properly, the field coil and other parts, including the output transformer, should be tested.

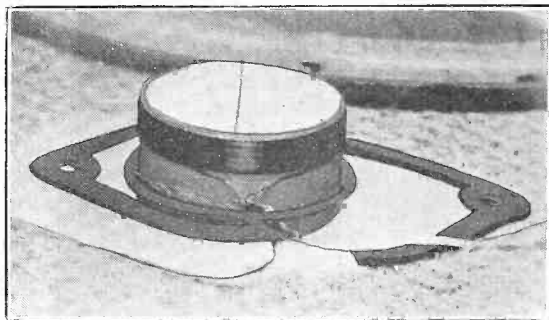

One of the frequent causes of complaint is a damaged spider. Here the rent is plainly visible.

The trouble in the field coil may be that it is open or shorted, or, if an intermittent trouble arises, there may be a broken wire, not quite severed, that becomes an open when current surges are present. This is a particularly annoying form of interference. The output transformer may have the same kind of trouble, shorted or open, or intermittent. However, both the field coil and the output transformer are not usually sources of trouble. If they are in a receiver in which the rectifier tube "blew out," then there is some likelihood of trouble in field or transformer.

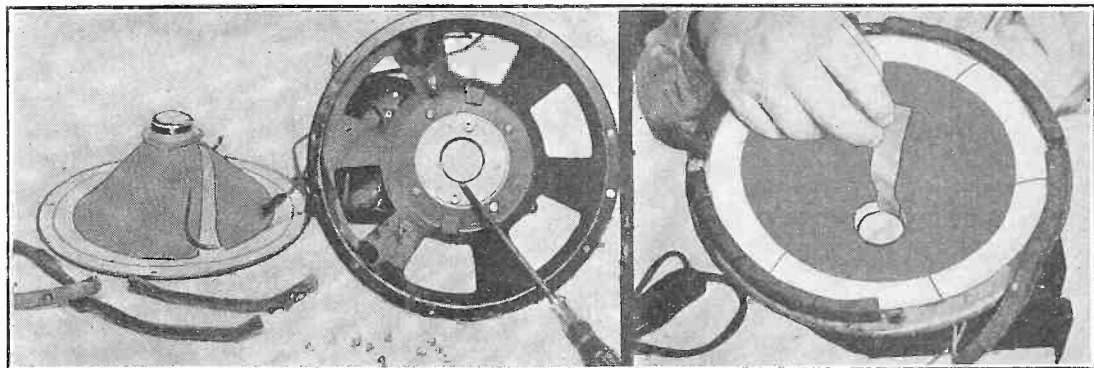

When the speaker is dissembled the cone and felt washers are free of the assembly. Screwdriver points to the voice coil bobbin, which has to make a precise fit (left). There are assorted strips of thin metal, called shims, for developing clearance of just the right amount, for mounting voice coil assemblies. In the absence of such equipment foil of about .002 inch thickness may be used (right).

Push Pull Phonograph Amplifier

Four Tube Device Has 6B5's in Output

By Leonard C. Worcester

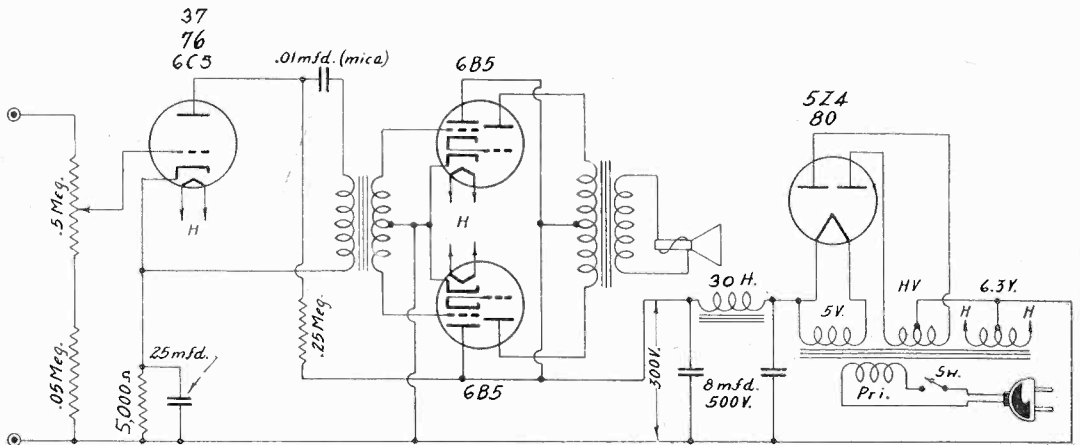

A simple amplifier for use with a phonograph pickup. Radio tuner output may be connected to the input through a stopping condenser. Also a microphone input may be used. There are three stages of audio: first, the 37, etc., next the driver part of the 6B5's, and finally the output sections, or power tube units, of the 6B5's. The fourth tube is the rectifier.

AN amplifier with considerable gain is advantageous when one desires to play phonograph music, conduct small scale public address work, or amplify the output from the radio set's detector. Many persons have tuners, and if the present device is connected to a tuner there will be splendid results.

The diagram assumes that a phonograph pickup will be connected directly to the pair of posts at left. If a radio set's detector or first audio output is to be delivered to the amplifier, then a stopping condenser is put between the upper post at left and the plate of the detector, which plate must be loaded in the tuner, that

is, have a resistor or audio coil going to B plus. If a microphone is to be used, it should be of the high impedance velocity type, as made by Bruno, or a Brush crystal type, as these suit the grid circuit directly. A carbon microphone would require a stepup transformer, with a 1.5 volt dry cell as microphone exciter, in series with a connection to the primary. For some microphones 4.5 volts or more would be used for excitation.

Taking No Chances

So the main requirements are fulfilled. The gain is more than ordinary, because of the first amplifier tube. Usually no such amplifier is included, because there is plenty of hop to the direct coupled two stage circuit incorporated in the 6B5, but we do not know just how much volume will be required, or how small the sensitivity of a high impedance pickup may be, whether crystal or other type, or even whether a low impedance one may be connected to the input without the precaution of a matching transformer, thus causing the circuit to be much less sensitive, and therefore the first audio amplifier comes in handy. The total sound level will be high enough.

It is necessary therefore to have a volume control. Perhaps the simplest one consistent with fairly good audio frequency response even at minimum volume is a potentiometer in series with a resistance at least 10 per cent. of the total. This method does not permit attenuat-

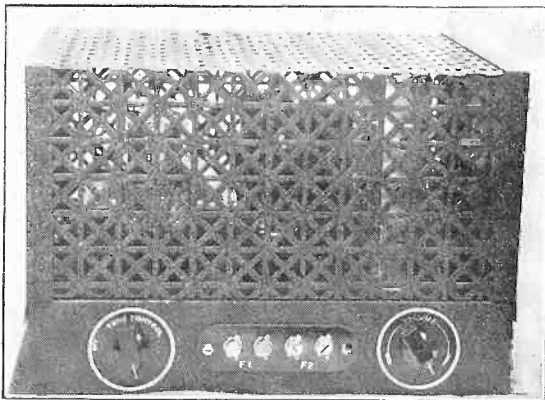

Housing used for containing the amplifier.

tion to zero, but it does prevent practical shorting of the grid circuit, by low impedance loading, which would cause the low notes to suffer severely.

May Be Made Portable

The circuit is very simple, practically fool-proof, and gives 10 watts at 2 per cent. distortion. If not so much power output is required, a single 6B5 would be used, no center tap on the coupling transformer between the first and second audio tubes, and no tap on the

LAYOUT FOR PORTABLE

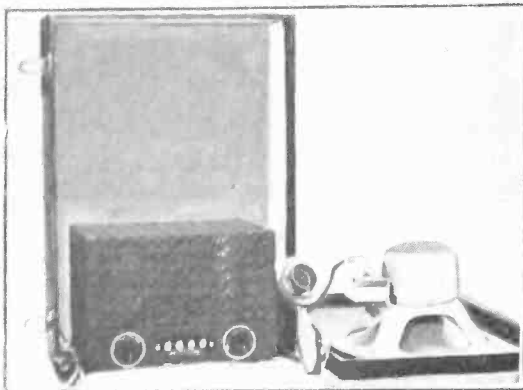

The amplifier may be constructed for portable use with room for speaker. This was done in the assembly shown.

primary of the output transformer. Both circuits fit into the same assembly, which, if housed in a large cabinet, with roof for speaker, may be made portable.

Comparison of Outputs

The hum is lower for the same filter capacities and chokes, while the output is at least twice as great as from the single sided circuit, using the same voltages. No biasing resistor is needed for the 6B5, single or push pull, if the total voltage does not exceed 300 volts.

In some instances there is radio frequency pickup in amplifiers. Two .01 mfd. condensers in series across the line, on set side of switch, juncture of condensers to ground, usually gets rid of this trouble.

Perhaps a word about the 6B5 would be appreciated.

The Tube Is Actually a Circuit

The 6B5 in one tube combines the desired qualities of many of the common types of power tubes. The designer of small household receiver or the most elaborate console can make use of the 6B5. It is conservatively rated, the output rating being for a distortion level comparable to Class A triode. In addition it does not have the overload characteristics of a triode or pentode, for it can be driven to almost double rated output before the quality is

seriously impaired due to grid circuit rectification. It requires no power driver tube or interstage transformer and its input impedance is high, lending itself readily to resistance coupled or similar drivers. It requires no bias and due to lack of impedance in the cathode circuit its frequency characteristic is practically flat. The startling features of the 6B5 and the circuit used with it are its simplicity and lack of component parts. The tube actually is a circuit comprising two triodes so designed and connected as to form a direct-coupled amplifier. The idea of direct coupling is not new but the particular design of elements to eliminate circuit components is new. The circuit in the 6B5 is one in which two triodes are so connected that the load for the first or input triode is the grid to cathode impedance of the second or output triode, this impedance or load being connected between cathode and ground of the first triode. This is accomplished by connecting internally the cathode of the input triode to the grid of the output triode. The plate of the input triode is tied to the positive voltage supply.

High Efficiency Obtained

The output load is the conventional load of an output transformer and speaker. The direct coupled principle takes full advantage of the high efficiency obtained with a high mu triode operating in positive grid regions. The plate current curves of a triode similar to the output triode of the 6B5 show in positive grid regions approximately the maximum theoretical efficiency of the Class A amplifier. If the grid current is not excessive, the triode has the advantage over the pentode because the pentode has a positive element, the screen, which draws considerable current and lowers the overall efficiency. The screen current vs grid voltage curve is not linear and, as the screen potential must remain constant, additional by-passing is often necessary.

PUSH-PULL OR SINGLE

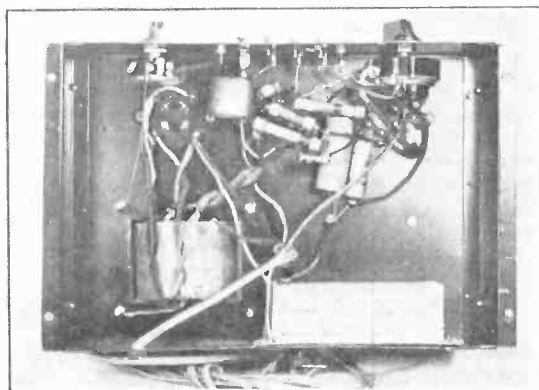

If one does not require push pull output a single 6B5 may be used, as was done in this instance (bottom view). The same chassis layout is used for push pull, save for the extra socket.

Push Pull Phonograph Amplifier

Four Tube Device Has 6B5's in Output

By Leonard C. Worcester

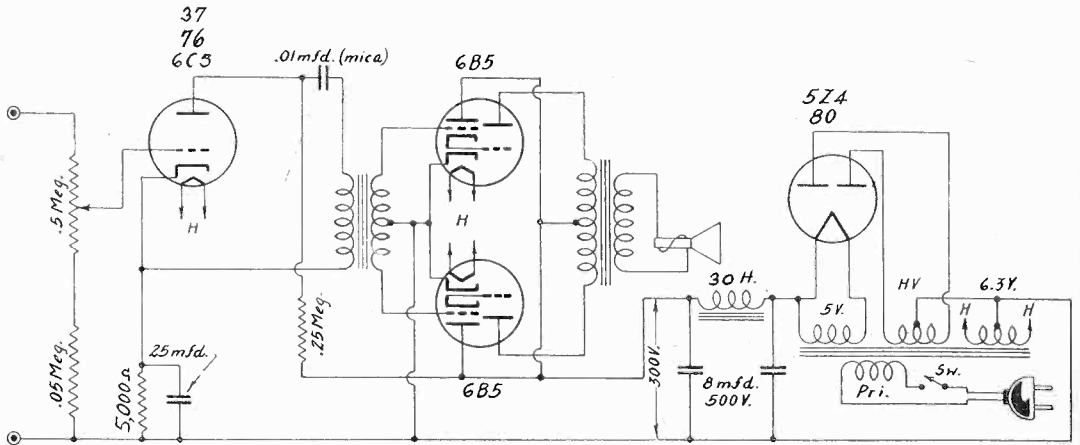

A simple amplifier for use with a phonograph pickup. Radio tuner output may be connected to the input through a stopping condenser. Also a microphone input may be used. There are three stages of audio: first, the 37, etc., next the driver part of the 6B5's, and finally the output sections, or power tube units, of the 6B5's. The fourth tube is the rectifier.

AN amplifier with considerable gain is advantageous when one desires to play phonograph music, conduct small scale public address work, or amplify the output from the radio set's detector. Many persons have tuners, and if the present device is connected to a tuner there will be splendid results.

The diagram assumes that a phonograph pickup will be connected directly to the pair of posts at left. If a radio set's detector or first audio output is to be delivered to the amplifier, then a stopping condenser is put between the upper post at left and the plate of the detector, which plate must be loaded in the tuner, that

is, have a resistor or audio coil going to B plus. If a microphone is to be used, it should be of the high impedance velocity type, as made by Bruno, or a Brush crystal type, as these suit the grid circuit directly. A carbon microphone would require a stepup transformer, with a 1.5 volt dry cell as microphone exciter, in series with a connection to the primary. For some microphones 4.5 volts or more would be used for excitation.

Taking No Chances

So the main requirements are fulfilled. The gain is more than ordinary, because of the first amplifier tube. Usually no such amplifier is included, because there is plenty of hop to the direct coupled two stage circuit incorporated in the 6B5, but we do not know just how much volume will be required, or how small the sensitivity of a high impedance pickup may be, whether crystal or other type, or even whether a low impedance one may be connected to the input without the precaution of a matching transformer, thus causing the circuit to be much less sensitive, and therefore the first audio amplifier comes in handy. The total sound level will be high enough.

It is necessary therefore to have a volume control. Perhaps the simplest one consistent with fairly good audio frequency response even at minimum volume is a potentiometer in series with a resistance at least 10 per cent. of the total. This method does not permit attenu-

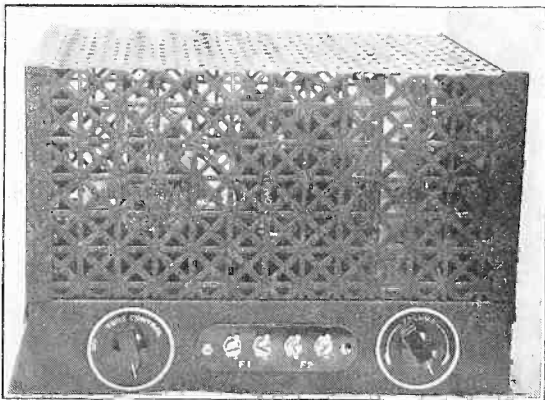

Housing used for containing the amplifier.

tion to zero, but it does prevent practical shorting of the grid circuit, by low impedance loading, which would cause the low notes to suffer severely.

May Be Made Portable

The circuit is very simple, practically fool-proof, and gives 10 watts at 2 per cent. distortion. If not so much power output is required, a single 6B5 would be used, no center tap on the coupling transformer between the first and second audio tubes, and no tap on the

LAYOUT FOR PORTABLE

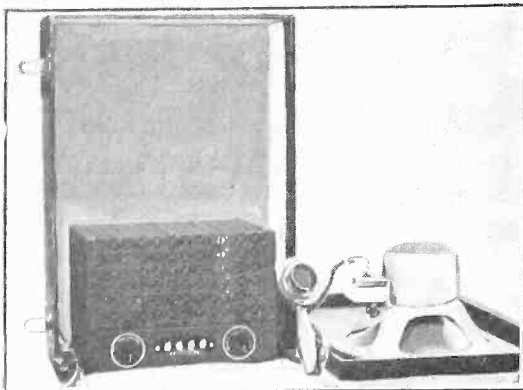

The amplifier may be constructed for portable use with room for speaker. This was done in the assembly shown.

primary of the output transformer. Both circuits fit into the same assembly, which, if housed in a large cabinet, with roof for speaker, may be made portable.

Comparison of Outputs

The hum is lower for the same filter capacities and chokes, while the output is at least twice as great as from the single sided circuit, using the same voltages. No biasing resistor is needed for the 6B5, single or push pull, if the total voltage does not exceed 300 volts.

In some instances there is radio frequency pickup in amplifiers. Two .01 mfd. condensers in series across the line, on set side of switch, juncture of condensers to ground, usually gets rid of this trouble.

Perhaps a word about the 6B5 would be appreciated.

The Tube Is Actually a Circuit

The 6B5 in one tube combines the desired qualities of many of the common types of power tubes. The designer of small household receiver or the most elaborate console can make use of the 6B5. It is conservatively rated, the output rating being for a distortion level comparable to Class A triode. In addition it does not have the overload characteristics of a triode or pentode, for it can be driven to almost double rated output before the quality is

seriously impaired due to grid circuit rectification. It requires no power driver tube or interstage transformer and its input impedance is high, lending itself readily to resistance coupled or similar drivers. It requires no bias and due to lack of impedance in the cathode circuit its frequency characteristic is practically flat. The startling features of the 6B5 and the circuit used with it are its simplicity and lack of component parts. The tube actually is a circuit comprising two triodes so designed and connected as to form a direct-coupled amplifier. The idea of direct coupling is not new but the particular design of elements to eliminate circuit components is new. The circuit in the 6B5 is one in which two triodes are so connected that the load for the first or input triode is the grid to cathode impedance of the second or output triode, this impedance or load being connected between cathode and ground of the first triode. This is accomplished by connecting internally the cathode of the input triode to the grid of the output triode. The plate of the input triode is tied to the positive voltage supply.

High Efficiency Obtained

The output load is the conventional load of an output transformer and speaker. The direct coupled principle takes full advantage of the high efficiency obtained with a high mu triode operating in positive grid regions. The plate current curves of a triode similar to the output triode of the 6B5 show in positive grid regions approximately the maximum theoretical efficiency of the Class A amplifier. If the grid current is not excessive, the triode has the advantage over the pentode because the pentode has a positive element, the screen, which draws considerable current and lowers the overall efficiency. The screen current vs grid voltage curve is not linear and, as the screen potential must remain constant, additional by-passing is often necessary.

PUSH-PULL OR SINGLE

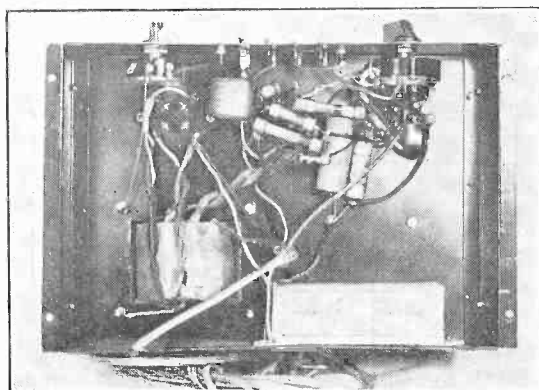

If one does not require push pull output a single 6B5 may be used, as was done in this instance (bottom view). The same chassis layout is used for push pull, save for the extra socket.

Antennas for Home and Car

Less Noise, More Signal, by Few Precautions

By Morris N. Beitman

Engineer, Allied Radio

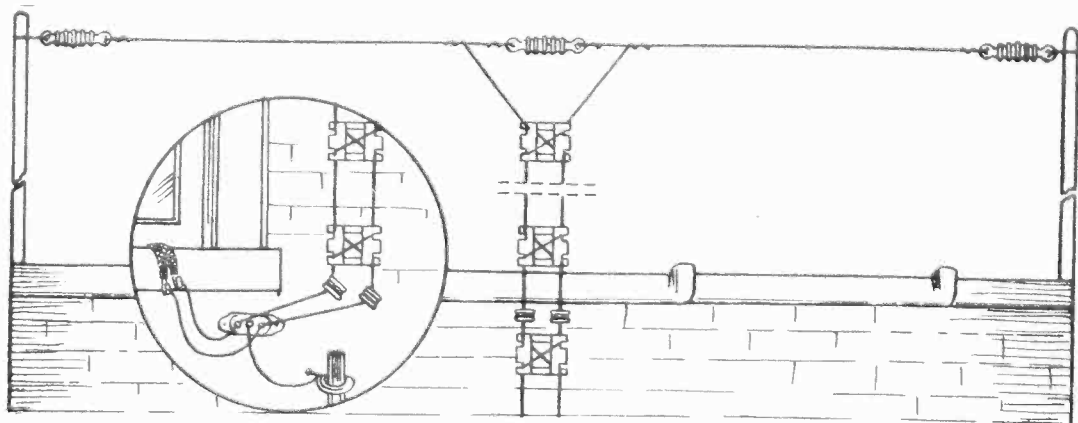

The roof, with doublet antenna erected. The antenna wire proper is run in a straight stretch, interrupted at center by an insulator, from the extremes of which the two down leads come. The wire transposition on the insulating blocks (suarish objects) is plain. The fields are at right angles to the parallel down lead wires (dash lines) and opposite in phase. Inset shows lightning arrester, its center grounded, and the way the feed is brought into the house. The objects under the lower block are standoff insulators.

THE attention given to the antenna systems of radios declined when screen grid tubes came into use. "A few feet of wire under the carpet" would serve as antenna. True, little energy pickup is needed with modern high gain sets, but when a set is made to operate at its maximum sensitivity certain noises developed in the set proper become much more pronounced. It is also known that the noise to signal ratio may be decreased with a suitable antenna. Further, short wave reception calls for a more efficient antenna system.

An ideal antenna would be nondirectional, pick up very little background noises of man made static in comparison to energy pickup, and be equally effective on all frequencies that the receiver is capable of receiving. There is hardly any need to say that such an antenna does not exist. Modern antennas with their associated special leadins and coupling systems do, however, approach the ideal case.

Where to Locate Antenna

To eliminate undesirable pickup and insure satisfactory signal energy, the antenna should be erected as far away as possible from interference sources, such as power lines, transformers, street car or elevated lines, or any other electrical devices, and at the same time the antenna should be placed as high as practical above the roof or other structures.

Another way to reduce the pickup of man made static is to employ a leadin of such a type that pickup by the leadin is eliminated. While it is physically possible to place the antenna wire sufficiently high and away from sources of interference, it may not be possible to have the leadin wire do likewise. Because of its purpose the leadin wire will naturally be closer to the ground than the antenna wire, and at the same time in running down along the building wall will encounter losses and pickup that will be detrimental to excellency of the antenna wire itself. We see why it is important to eliminate all pickup by the leadin.

Two Leadin Types

There are two types of leadin systems that possess no pickup qualities: (1) the shielded type, and (2) the balanced transposed line. Although a shielded line is suitable for ordinary broadcast frequencies it is not so suitable for higher frequencies. Since almost all modern sets are designed to receive one or more high frequency bands, we will consider the transposed balanced line. When employed in connection with a correctly designed coupling unit the line makes the pickup of the leadin negligible.

Generally a modern all wave doublet antenna system consists of two antenna wires of equal and suitable length suspended in a straight

line between two supports and insulated therefrom and between themselves. From the point where both wires join the insulator, two separate leadin wires are connected to the two wires respectively. These wires may be twisted, but for best results they should be transposed every couple of feet with the aid of transposition blocks.

Two Currents Out of Phase

The two leadin wires will carry two distinct antenna currents, out of phase, while the pickup of the two wires of the leadin will be in-phase. Now if a transformer is used to transform energy to the radio set the in-phase components will balance each other out. The signal component of each wire being out of phase will add up in the transformer. This action is very similar to the action of a push-pull audio amplifier. To insure no presence of out of phase component in the leadin line, transposition at the shortest practical intervals is advisable. If the line is not transposed for any considerable distance, one of the wires may pick up signals that the other wire will not, and pickup of the undesired out of phase component will result.

We have already seen how the coupling transformer eliminates the in-phase current, but the transformer also matches the impedance of the antenna to that of the set so that energy transfer occurs without large losses. It is also possible by properly designing the coupling transformer to make the antenna almost equally effective for all useful frequencies, although the antenna pickup will be peaked at its natural wavelength and multiples of the natural frequency.

Effect of a Swaying Antenna

The antenna supports should be sturdy and firmly secured. The antenna wire should be tightly stretched. Many antennas constructed with neglect in this connection sway and cause the set to reproduce sharp clicking noises or fade on and off. The clicking is due to some

connection moving, while the fading effect is due to the antenna, which is really an electrical network of capacity, inductance and resistance, changing its characteristics.

When parts of the antenna system are joined to others many times soldering is avoided. It is no simple matter to dash up to the roof with a hot soldering iron, but when we take into consideration the evil effects of corrosion of the unsoldered joint, this extra precaution of soldering becomes worth while, and the wire may be taken into the house and soldered at the workbench.

For outdoor antennas a lightning arrester is always recommended. The chance of lightning causing any damage is very slight, but why risk an expensive radio and the possibility of a fire?

Automobile Set Antennas

With the advent of auto radios certain new requirements as well as limitations had to be considered. While on one hand an antenna placed in an auto is limited in height, shielded undesirably by the metal parts of the car body, and usually must be comparatively small, it must possess the theoretical requirements of fixed house antennas previously described.

Auto radio antennas are either mounted under the car between the axles or spring or under the running boards, or they are run along the roof of the car.

The auto radio antennas, however, are usually required to receive only the broadcast band, thereby considerably simplifying the problem. An antenna consisting of a plate of thin copper or a wire mesh placed in a roof of a sedan would serve satisfactorily in connection with a sensitive set. Certain losses are of course encountered in the shielded leadin, but usually the pickup is sufficient to overcome these losses.

With the advent of the all metal turret top cars, placing of the antenna on the roof of the car became an impossibility since the metal of the roof itself would act as a close shield.

To provide suitable pickup in cars of this

(Continued on next page)

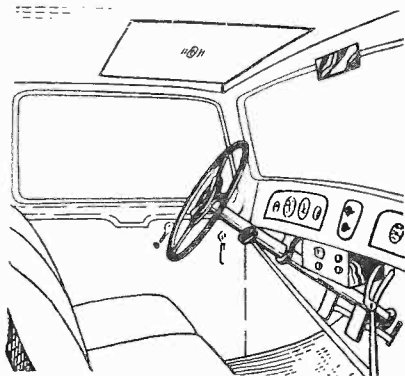

The permanently located car set is usually accessible to the driver. It is shown here mounted to the fire-board and protruding below the dash.

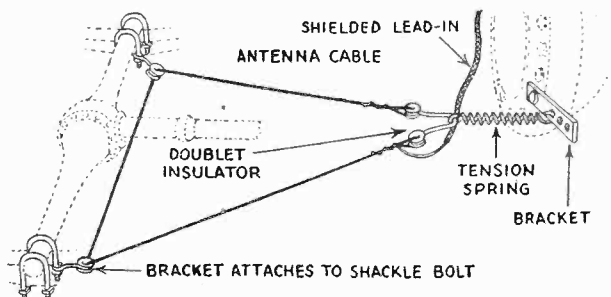

Auto antennas may be located on the roof, under the running board or beneath the body. Illustration shows delta type antenna obtaining physical support at two points on the axle and two points from a bracketed tension spring.

Transmitter Very Powerful; Stove So-So



A shack out in the country, with nobody to bother an earnest experimenter. This is the "informal" rig of James Millen (WIHRX), of Malden, Mass. Much high frequency experimenting is going on. Operation on from one to ten meters has been conducted during recent weeks. New facts have been gleaned about transmitters and receivers in this promising region. The station is equipped to work all amateur bands.

Business calls James Millen, of Malden, Mass., to various parts of the country, indeed, the world, and just now he happens to be in the Southwest. However, he can't feel very far from home, because out in the country, miles from Malden, is a very communicative experimental station of note, where, when he is at home, he is surrounded by engineers working on high frequency problems at present. This is his station, the one pictured, and while it is equipped for sending on all amateur bands, it is now being worked much between one and ten meters. However, when Mr. Millen is far away, as now, such low waves don't come to him, but on higher ones he can enjoy hearing his own station, and may even talk back, a privilege he enjoys by virtue of his position.

Antennas for Automobile Use

(Continued from preceding page)
type, receivers were made with higher and higher gain until ignition pickup difficulties were encountered. The solution to this was to suspend the antenna under the car. Although, of course, an antenna installed under a car is not quite as satisfactory as one placed in a

suitable roof, with proper precautions in connection with leadin and impedance matching transformer, very satisfactory performance may be obtained.

Acknowledgement is hereby made to Consolidated Wire and Associated Corporations, of Chicago, for furnishing the illustrations.

A Battery Signal Generator

Dial Reads R.F. Directly, Audio Tone is Adjustable

By Maxwell M. Hauben

Radio Constructors Laboratories

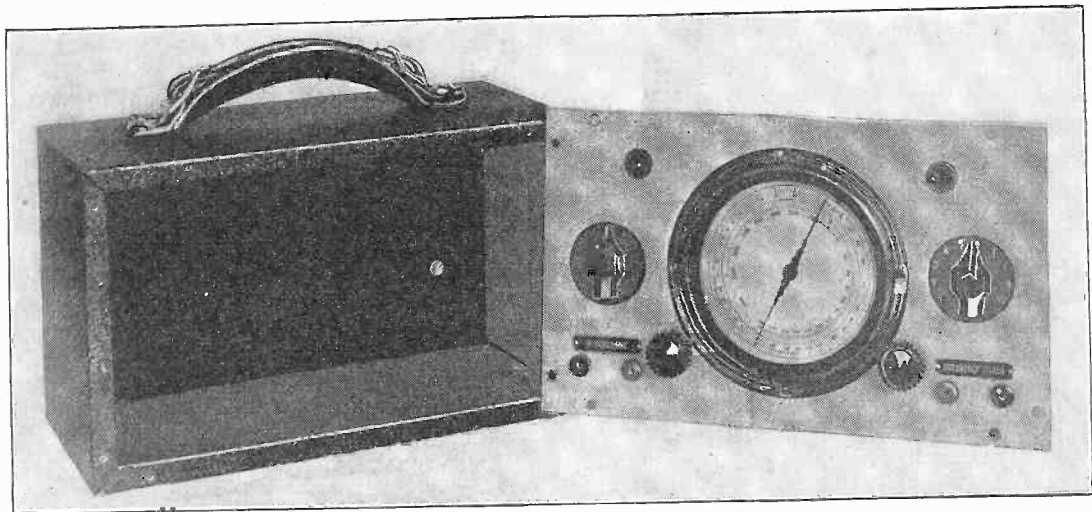

Cabinet with carrying handle, and chassis-front panel assembly that fits into it.

A FREQUENCY meter is a device for measuring frequencies. Therefore a calibrated oscillator that enables determination of unknown frequencies is a frequency meter, and this terminology is familiar to amateurs.

The circuit that delivers audio tone or tones to the radio frequency oscillator or amplifier is called the modulator. When a frequency meter is modulated it is now called a signal generator, although only a few years ago that term was reserved for precision measuring equipment and the less pretentious devices were called test oscillators, and formerly industrial oscillators.

The battery operated circuit shown herewith contains a radio frequency oscillator covering from 53 kc to 16,800 kc in five steps, by switch selection of coils, and also contains an audio frequency oscillator, the generation from which may be introduced into the radio frequency oscillator, or may be connected to some external circuit. The radio frequency oscillator, the dial for which is direct reading in frequencies and wavelengths, is the frequency meter. The audio oscillator is the modulator.

Series Hartley Used

The radio frequency circuit is a series Hartley oscillator. Grid leak and condenser are used for stabilization. The grid condenser should be .00025 mmfd.

The audio oscillator, or modulator, is of the tuned grid type. The coil used has two windings, and is suitable for inserting an iron core, but no such core is used, because the inductance would then be much higher than necessary. Instead, a condenser is put across the secondary winding. In this way also, by increasing the leak value, the audio frequency may be altered. Thus the advantage of selection of different audio frequencies is afforded.

Stabilization Aided

The presence of the condenser across the coil serves a stabilizing effect, also, so that the same audio frequency is generated at a particular setting of the audio control, no matter how much or little capacity is in the tuned circuit of the radio frequency oscillator. Otherwise at one extreme of the r.f. dial the modulation will be one note, at the other extreme a different note, with an assortment of audio frequencies in between.

Moreover, the radio frequency output attenuator, a low resistance potentiometer, enables maintenance of the same frequency of radio generation, no matter where the control is set. That is, the generator is not detuned by the load to which it is connected externally. An easy way to verify this is to, tune in a station on a receiver and beat the generator fundamentally or harmonically, until some high

(Continued on next page)

(Continued from preceding page)
pitched note is heard. Then turn the control, which will change the intensity but not the pitch of the beat, proving there is no detuning by the generator control.

The Hartley circuit is not often shown for battery operation, so a word of explanation. Perhaps the best way is to compare the present circuit with familiar practice in a.c. sets. There we have a heater type tube, connecting the cathode to the tap on the r.f. coil, one extreme of coil to grid or grid condenser, other extreme of coil to B minus. It is usual to ground B minus in a.c. sets, A minus in battery sets.

B Plus to Tap

So to institute the battery type Hartley, on

establishing a battery Hartley is to put tap to A minus. By this method two-winding coils may be used, but in the present instance tapped coils accurately adjusted as to inductance are incorporated.

The Five Bands

The radio frequencies generated in the five different switch positions follow this order:
No. 5.....53 to 168 kc.
No. 4.....168 to 530 kc.
No. 3.....530 to 1,680 kc.
No. 2.....1,680 to 5,300 kc.
No. 1.....5,300 to 16,800 kc.

It can be seen that there are two basic frequencies, 53 to 168 and 168 to 530, that the first and third are decimal multiples of the

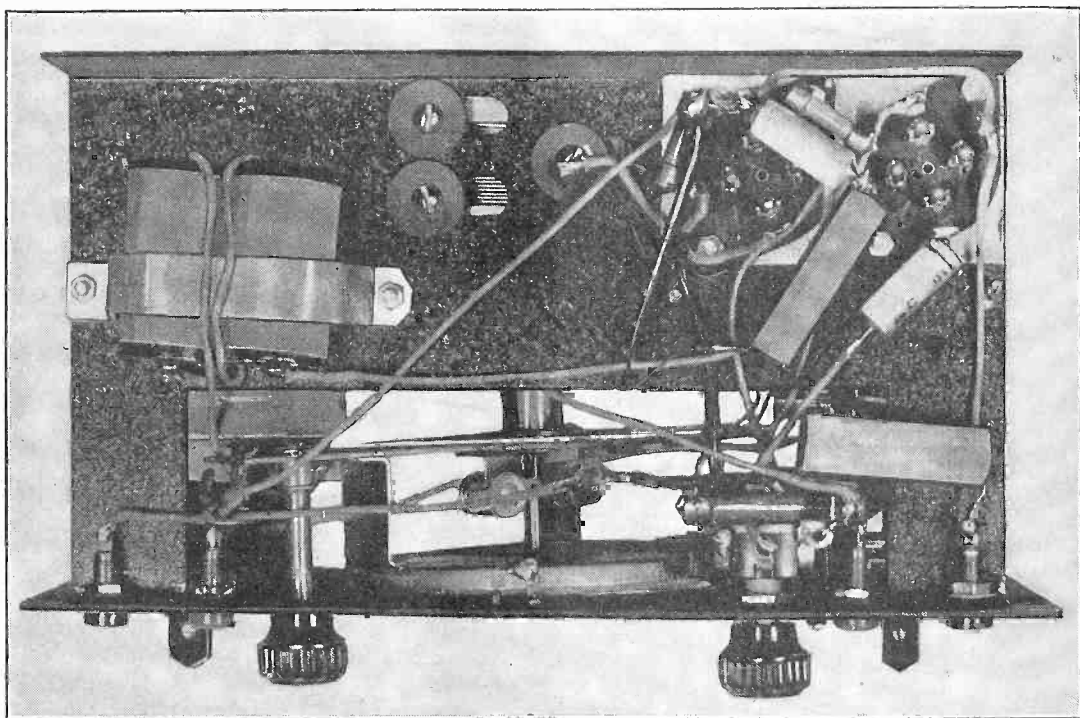

Two large size flashlight batteries are located at left. Actually the batteries used are one size larger than shown, the advantage being the somewhat larger capacity, making for longer life. The tuning condenser has to be insulated from the chassis, also the condenser shaft on top (not seen), by means of a shaft coupler and insulated quarter inch rod. The insulating washers are shown at center rear.

the same pattern, we follow the same practice of grounding B minus as found in a.c. experience. This is the most negative potential of the supply sources. Now, the cathode has to be at an elevated potential, to duplicate the familiar a.c. case, and the tap will provide such elevation. But in a battery type tube like the 30 where the electron emitter is the filament, heater and cathode are one unit, to put it differently, we connect B plus to the tap.

Therefore the inductance between tap and plate carries the B current, or serves to make the A and B batteries common, and this B current produces the feedback. Another way of

fifth and that the second is a decimal multiple of the fourth. Hence only two frequency calibrations are needed, one being multiplied by ten and next time by 100, the other being multiplied by 10 only, to constitute the five bands. This decimal repeating feature is valuable, in that the maximum amount of dial space is used for all bands, the calibrations in frequencies being on the outside circumference of an air-plane dial.

How Dial Is Tracked

This method has been used for more than a year. The question is sometimes raised as to

how the dial can be tracked for bands higher than those originally calibrated, since the honeycomb type coils on the two low frequency bands have a larger distributed capacity than solenoids for succeeding bands and there is no trimmer for each separate band.

The answer lies in the fact that trimmer service is present in the coils for those who have enough ingenuity to use it. There is a capacity between the two sections of the tapped coil, considering the winding, though continuous, as that of two different inductances. By apportioning the turns between tap and plate, the capacity can be adjusted to a value that is large enough to match the circuit capacity when the low frequency coils were used. This location is an arduous task, for very close tracking, but once done, may be copied in production, and result in splendid tracking all the way.

Accuracy Cited

As an example, the original calibration was for 53 to 168 kc, yet a broadcast coil, properly made, was simply switched in, and WMCA came in at 57 on the dial (representing 570), with an accuracy close to 0 per cent, since an error of $\frac{1}{8}$ per cent. could be observed at this part of the tuning, if it were present, while 1,450 kc came in at 145, this being at a scale position where frequencies are more crowded, and the observable error factor is $\frac{1}{2}$ per cent, so the accuracy was in this instance classed as $\frac{1}{2}$ per cent. for this frequency.

The maximum error in the band was 5 kc. off at 710 kc. an error of a trifle more than 0.7 per cent. It was not difficult to maintain an accuracy of 1 per cent. throughout, meaning that no frequency was off more than that percentage.

Directions for Use

The generator is operated as follows:

The master switch is turned on. Then the radio frequency oscillator is functioning. The audio frequency oscillator may be or may not be working, depending on the position of its own independent switch. When the switches, of the toggle type, are flipped to the right, they are at "on" position. It is not possible for the audio tube filament to be heated unless the radio tube filament is heated, thus removing

one possibility of having a tube going overnight, say, to the ruin of the batteries. Nevertheless it is well to be cautious and not accidentally leave the generator turned on, since it is possible to have *both* tubes going, and you mightn't know it.

Just see that both toggles are pointing to the left for the assurance of "all off."

Fundamentals Used

The radio frequency selector switch is turned to the intended band. Starting from the highest frequency of that band, tune to lower frequencies until a response is heard. If the channel to be measured is in the same band, then the unknown frequency is equal to the frequency read on the generator.

Sometimes it is practical to get another response, by turning the condenser to a higher capacity position, but this would be due to the second harmonic of the succeeding fundamental, or in case of a third response, (very unlikely) to the third harmonic of the new fundamental. In any event the harmonics are not used, only the fundamentals, unless one desires to check up, and this may be done by a method detailed elsewhere in this issue.

Attenuation Described

The r.f. attenuator may be worked at any desired output level, and the required setting will depend on the sensitivity of the receiver or channel being measured or peaked, and on the amount of mistuning present, which is about the same thing, practically. For badly misaligned channels use full output. This holds true even for sets having automatic volume control. After the alignment is made approximately right, the output is reduced in the signal generator. For final peaking of i.f. intermediate channels having a.v.c., the attenuator is used nearly all the way down, because only small input is permissible, otherwise peaking becomes almost impossible, due to a.v.c. on strong input making the quantity of output about the same.

The connections are as follows:

For working into a receiver at the selector frequencies (those at which stations may be brought in), leave the antenna at the set binding post, and connect a wire from the red "Frequency Meter" red jack to the antenna

(Continued on next page)

52 Studios in German Plant

John Royal, of N.B.C., returning from Europe said:

"Every place I went I found them clamoring for more American dance music. You don't know what the term 'popular music' means until you see how popular our dance tunes are abroad. In Russia they asked me for broadcasts that would feature week-old tunes. They can't get the new tunes quick enough or hot enough, it seems."

As for programs NBC will broadcast, Mr. Royal admitted NBC would try to bring direct broadcasts from the Ethiopian battlefield when, as and if there should be one.

Another experiment probably will take the

form of ancient history lessons, to be broadcast from the Colosseum, the Acropolis, the Appian Way and other Greek and Roman historic spots.

There will be interesting pickups from Greenland, Iceland and more frequent exchanges from the British Broadcasting Corporation.

Mr. Royal also reported:

Germany is planning a huge new building for short wave broadcasting only. This will contain forty-four small and eight large studios; two new transmitters. Its purpose is to "sell Germany to the world."

(Continued from preceding page)

post of the set. Connect a ground wire from set ground post to the black jack of the Frequency Meter. If the coupling is too strong, remove the direct connection at set antenna post and simply wrap the output wire around the antenna leadin for a few turns. This may be desirable when checking a very strong local.

Eliminating Confusion

For frequencies of 16,800 kc and lower, to 53 kc, all confusion is eliminated, no matter if one has no idea of the unknown, if one

starts at switch position No. 1 (using highest frequency, 16,800 kc), traverses the band, goes to the next switch position, etc., until a response is picked up. In this way the Signal Generator may be used as a station finder, particularly if the modulation is removed from the Generator, done by throwing the Modulator switch to the left.

When checking and lining up intermediate frequency levels in a receiver, remove the antenna from the set antenna post, and connect the output wire from the red Frequency Meter post of the Generator to the grid of the modulator tube.

LIST OF PARTS

Coils

Five coils, each one tapped. The two low frequency coils are honeycombs and the three others are solenoids.
One uncored audio frequency transformer.

Condensers

One .0004 mfd. tuning condenser.
One .00025 mfd. grid condenser.
One .0001 mfd. mica condenser.
Three .01 mfd. paper condensers (tubular).

Resistors

One .2 meg. grid leak for oscillator.
One 1,000 ohm potentiometer.
One 380 ohm resistor.
One .02 Meg.
One .05 meg. resistor.
One .5 meg. potentiometer, used as rheostat.

Other Requirements

One chassis and cabinet, with handle.
One frequency calibrated airplane dial escutcheon.
Two knobs.
Two bar handles.
Two numerical plates (one for coil switch, 1 to 5; other 1-10 for guide in audio tone selection).
One Frequency Meter plate and one Modulator plate.
Two red tip jacks and two black tip jacks.
Two switches.
One five position, two deck switch (two pole, quintuple throw).
One small 22.5 volt B battery.
Two 1.5 volt large size flashlight cells, to be connected in parallel.
Two four hole sockets.
Two 30 tubes.

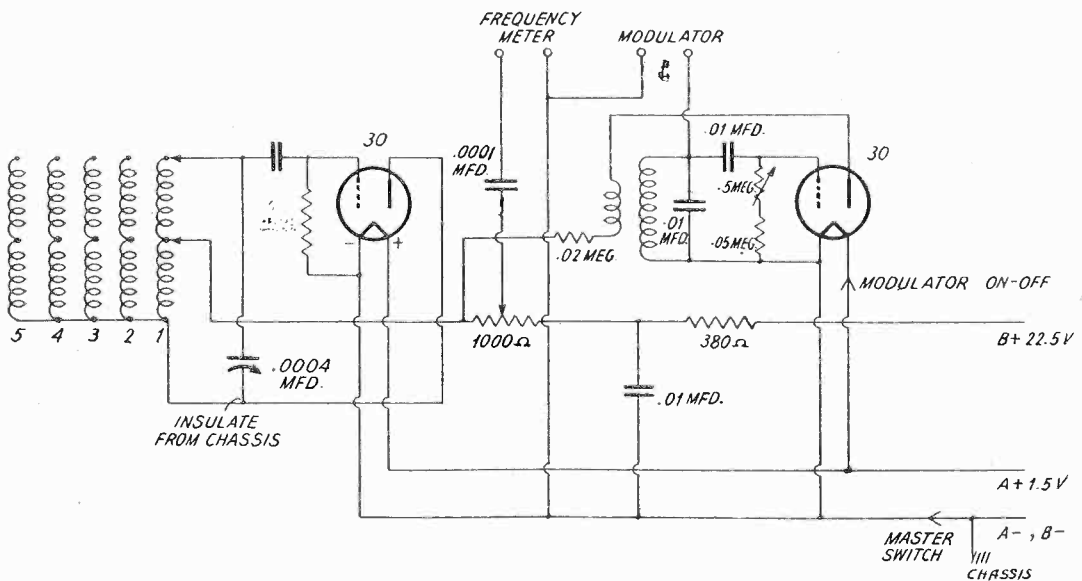

Use of a tapped coil in a Hartley circuit for battery operation sometimes presents a connection problem to the constructor. One method that works well is shown above (left tube). The tuning condenser is across the total winding. The tap goes to B plus. The 30 tube (right) is the audio oscillator. Modulation is present or absent, by switching.

Major Tests with Minor Devices

Frequencies Measurable with Simplest Circuits

By Harold G. Branford

IN the absence of any kind of a signal generator a great deal of guesswork goes on, to the detriment of the constructional work that experimenters do, especially on super-heterodynes. Therefore it is far better to have some sort of generator, rather than none at all, and moreover, the accuracy of the frequency calibration, and the stability of the oscillator, may be very good indeed. Only a few parts are needed.

One way of connecting the remote control super-amplifier tubes in an oscillator is to have the screen serve as the plate, with the formal plate used as pickup element. This method has been suggested in these columns for three years, and now the 6L7 comes along, using about the same principle. However, for economy one may stick to the glass tubes for test oscillator purposes.

Ingenious Coil Method

Since there is a definite capacity between tickler and secondary, the adjustment for reduced capacity, the only direction in which it is necessary to move, is to place the tickler farther from the secondary, or remove tickler turns until the reading is so increased in frequency that there is coincidence of dial reading with generated high end frequency (500 or 1600 kc for stated examples, or a bit lower).

This capacity adjustment substantially affects only the high frequency end of each band, and since introduced through the coil, separate adjustment for each band may be made. The low frequency determination is made principally by the correct inductance of any band, the series condenser, if required, not being very critical, but should be selected to tie down a response around 600 kc for one band, then serving for all other bands.

The 20 mmfd. grid condenser C consists of hookup wire, about 6 inches of it, twisted together and doubled up on itself for compactness, then held by some binder after being snipped to form the condenser.

A.V.C. Channels Adjusted

The stopping condenser looking toward the output is shown as .05 mfd. may be any value of .0001 mfd. up.

By using a broadcast coil backwards, as output, small winding to output, coupling to doublets is made handy, and, more important, the attenuator on the generator leaves the receiver sensitively intact, and does not reflect back as a detuning agent upon the generator. Both the tube use, with screen for feedback or effective plate, and usual plate as a pickup ele-

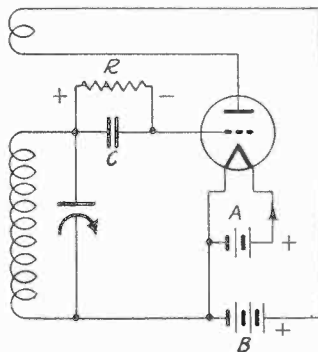
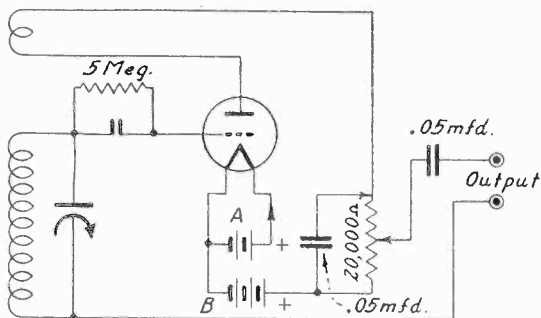

A practical generator with attenuator (above) and polarity of grid leak (below).

ment for electron coupling, were specially developed for generator practice.

Whereas the very simplest generator fills a need where one's requirements are merely lining up intermediate channels, and there is scarcely any commercial aspect to the work, anybody who makes a business of radio servicing naturally would require a generator of greater capabilities.

The first extra requirement is that an attenuator be present, as in lining up sets using automatic volume control, since the general effect of such control is to level the output, changes from resonance have a smaller effect than expected. If the input to the second detector is increased the output is not increased much, nor if the input is decreased is there much decrease in output, because of the very leveling by a. v. c.

For that reason the maximum output of the generator is not desired. It so happens that a. v. c. is in general least effective for very small

(Continued on next page)

(Continued from preceding page)

values of input, and many receivers are purposely so constructed to delay the a. v. c. action until the intermediate frequency input to the second detector attains a certain value of voltage.

Not Suitable for Small Ones

These considerations permit the use of a signal generator at small output, at a level that is either unaffected by a. v. c., or, if effected, not sensibly so, but an attenuator is required.

Also for sets generally, as sensitivities vary, some control over generator output is desirable.

In general, an attenuator will not work well on the diagram shown below, but there is fairly good control of the output in the one-tube device using the triode, as shown on preceding page.

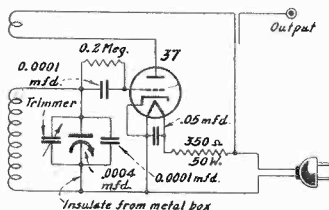

If a .0001 mfd. fixed condenser is put across a .0004 mfd. tuning condenser the frequency ratio is about 1.9 to 1. With proper coil 109 to 200 kc would be covered. The circuit is "universal," modulation absent on d.c.

For any universal use the one-tube signal generator should not have a violent oscillator, and the amplitude is restricted by using the screen as the feedback element, as violent oscillation produces pronounced line feed and makes frequency stability difficult to attain.

Alternating current from the line is used on the plate, and this works satisfactorily for low radio frequencies, those encompassed by the two bands represented, say, 140 to 500 kc and 540 to 1,600 kc. In fact, a. c. is satisfactory for much higher frequencies, perhaps even beyond 10 mc., but as the frequencies become still higher, as they would in an all-wave signal generator, a. c. on the plate becomes less useful, and premature reduction of oscillation is experienced on a high frequency band. This is because the tube is oscillating during only half of the cycle of the line frequency, called the alternation.

Works Only Half Time

Only during that alternation when the plate is positive (screen is used as plate in the diagram) does the oscillator function. Therefore when the circuit losses at high frequencies accumulate, the half cycle voltaging of the plate is insufficient. During the negative alternation the tube is not conducting, as the plate has to be positive to attract the electrons from the cathode.

Another fact about a. c. on the plate is that

the hum modulation is always more than 100 per cent. by definition and the harmonics are exceedingly strong. Measurements have been made up to the 150th harmonic on such a generator. Moreover, the oscillator may be amplitude and frequency modulated, although the frequency of modulation is so low compared to the generated frequency that the frequency modulation need not be considered disadvantageous this time.

Inclusion of Rectifier Tube

Naturally the strong modulation due to a. c. produces a very husky signal, beyond control as to the amount of modulation, but if a rectifier tube is used, the generator will oscillate more steadily, and independent modulation of any desired percentage may be introduced. Usually about 30 per cent. modulation is applied.

The modulation as commonly introduced consists of the audio tone, made to vary the amplitude of the generated radio frequency, a steadier method than frequency modulation. The principal difference is that when amplitude modulation is used the carrier or generated r. f. wave is of constant frequency, or should be, and the amplitude or voltage rise and fall of the constant carrier frequency is controlled by the modulator or audio tone supply tube. The audio pattern therefore becomes a radio frequency difference in amplitude, and the audibility aspect of the modulation becomes lost in the r. f. oscillator. To bring about audibility again the modulated carrier from the generator has to be detected, as it is in all receivers, i. e., carrier removed, audio tone retained.

Frequency modulation consists of a carrier of inconstant frequency, that is, the device producing the modulation works upon a constant amplitude, but variable frequency system.

All signal generators are amplitude modulated at present.

Neon Tube as Modulator

One of the handy methods of introducing modulation when there is sufficient d. c. voltage present, say, more than 65 volts, is to use a neon tube. If such a tube is obtained that has no limiting resistor built in, audio tone will be produced when the external series resistance is large enough, and a fixed condenser across either the lamp or the resistor is large enough also. A good combination is 4 meg. and .0005 mfd. The tone is of about 2,000 cycles, not consisting of a sine wave, or regular pattern, but of a saw tooth wave form, except for very low amplitudes, lower than those used in practice. For the present purpose the shape of the wave form is of no consequence, but the limitation of the modulation percentage to less than 100 is of great importance, as under the modulating process now under discussion the r. f. generator could produce responses for a given setting of the receiver at two settings of the generator close together. They might be a degree apart on the dial. This is confusing, as the frequency of generation cannot be accurately determined from any dial disclosure, but the remedy is to introduce less of the audio tone.

How High R.F. Can You Measure?

Maybe 100 Times Higher Than You Suppose, If Relying Only on Fundamentals

By Eric Janssen

IT is not at all difficult to build a signal generator, for it is only an oscillator to which also some audio tone (modulation) is usually applied. The oscillator thus modulated is called a signal generator. As to difficulty of construction, the device is simply a one tube or two tube set usually, but the drawback to many is the calibration. That means the disclosure of actual fundamental frequencies generated.

While directions for accomplishing calibration do not make very peppy reading, and sometimes sound involved, this is true only if the subject is treated by the reader as theoretical. As soon as a serious attempt is made to correlate the directions with practice an almost amazing revelation takes place, and the process is reduced to a simplicity that attends everything we understand. So we shall take up the calibration. First we shall consider generator frequencies lower than the lowest broadcast frequency, so that generator harmonics will cause response in a receiver set to the broadcast band.

Harmonic Practice

Therefore to extend the usefulness of the generator to higher frequencies than the highest fundamental produced it is necessary to have a knowledge of harmonic technique. A single formula comprehends the entire situation, and may be expressed in various forms, and the operator may select the one he finds handiest, except that one with a high order of manipulative accuracy is to be preferred.

The process of determining an unknown higher frequency on the basis of harmonics is predicated on creating a response in the receiver due to some harmonic of one known fundamental frequency of the generator, slowly and carefully turning the generator dial in either direction, meanwhile listening alertly for the next consecutive response, receiver unmolested, and use of these two known fundamental generator frequencies to determine the unknown.

The Basic Formula

The basic formula is that the unknown is equal to the product of the two fundamental frequencies, divided by the difference between these two same frequencies, that is,

$$F_x = \frac{F_2 \times F_1}{F_2 - F_1}$$

where F_x is the unknown, F_1 the lower and F_2 the higher consecutive response creating fundamentals.

This is mathematically accurate, indeed, perfect, but has some manipulative drawbacks, principally that mental arithmetic may not yield the answer readily for the numerator, where relatively large or awkward numbers are concerned, and second small reading differences may produce rather large error in the answer. Of course if the generator could be read to perfection of accuracy, then there would be no error in the result, since the formula itself is faultless.

Improving Generator Accuracy

The mathematics becomes a little bit more than most persons might care to devote to the subject, and therefore a simplified form is shown later, but it is well to consider the case of the product divided by the difference as equalling the unknown, even if the generator readings are not themselves highly accurate, so that the generator may be corrected.

Suppose two readings are obtained, 940 and 1,140 kc. It must be recognized that in many ranges the readings will not be close enough to make the formula work out with a pat solution, that is, "strange" harmonic orders are obtained. The product is 1,071,600 and the difference is 200, so the unknown turns out to be 5,358 kc. However, each of the read fundamentals should be divisible by the difference between them, for the result is the harmonic order in each instance, and this must be a whole number (no fractions or decimals). In the previous instance we computed a result, 5,358 kc, which when divided by the difference produced "strange" harmonic orders of 4.7 and 5.7.

A Good Compromise

The error, as stated, is in the reading or calibration of the measuring device, and not in the formula. The correct frequencies of the generator may be estimated, especially if the decimals are near one or the other whole number, and here they are closer to 5 and 6 than to 4 and 5, and 200 is too great a difference. Hence there is not really as much frequency difference between the two readings as appears from the generator.

Although the error is due to the generator or the reading thereof, a compromise may be effected by selecting the nearest whole numbers to the "strangers" that the calculation produces for the harmonic orders, multiplying in this instance 940 x 6 to yield 5,640, and dividing this by 5 to establish the next nearest frequency, read as 1,140 but used now as 1,128. If there is any station with which to check the generator,

(Continued on next page)

(Continued from preceding page)

the error can be eliminated as to one reading by beating, and as to the other by estimation as just outlined.

Another Form of Equation

Meanwhile we have encroached on another form of the equation, to be discussed presently, but we have established a means that checks out, and that, if one generator frequency is truly known, other generator frequencies may be exactly established by reference to the unknown solved by our formula. Hence in the present instance $940 \times 1,128 = 1,060,012$, divided by the difference, 188, equals 5,639, closely, or a difference of about 1 kc from the product of each of the read frequencies and their respective harmonic orders, 5,640 kc.

A handier method, and one that eliminates the troubles encountered in the other, is to determine the harmonic orders, which in our case are always small numbers, and multiply either of the read frequencies by the appropriate harmonic order.

Harmonic Order Determination

The formula for this is to ascertain the two consecutive response fundamentals as before, take the difference between these two frequencies, divide each of the two frequencies by the difference, and the answer is the harmonic orders of the fundamentals. Obviously the higher harmonic order applies to the lower read frequency, and the lower harmonic order applies to the higher read frequency, since the product of harmonic order and read frequency in either case is the same. Moreover, since consecutive responses in the unmolested receiver were considered, the harmonic orders always are consecutive. The formula is

$$n = \frac{F_2}{F_2 - F_1}$$

$$n + 1 = \frac{F_1}{F_2 - F_1}$$

Where n is the harmonic order of the higher read fundamental (F_2) and $n + 1$ the harmonic order of the lower read fundamental (F_1).

Therefore, when one frequency is divided by the difference between the two read frequencies, the answer is the harmonic order of the other.

An operative improvement on the harmonic order method would dispense with the necessity of thinking about which harmonic order applies to which read frequency.

Less Thinking Required

The formula for this method is that the two fundamentals are read as before, the difference between them is obtained, one read frequency is divided by this difference, so is the other read frequency, and the unknown is the product of the difference and the two quotients. The harmonic orders are present in the computation, and are consecutive, of course, and may be applied as a check, if desired. The expression for the "less thinking" method follows:

$$F_x = \left(\frac{F_1}{F_2 - F_1} \right) \left(\frac{F_2}{F_2 - F_1} \right) F_2 - F_1$$

Taking two examples, the first very theoretical:

F_1 is 100 kc, F_2 is 111.11 kc.

$F_2 - F_1 = 11.11$ kc.

$$F_x = \frac{100}{11.11} \times \frac{111.11}{11.11} \times 11.11$$

$F_x = 9 \times 10 \times 11.11 = 999.9$ kc.

Actually the unknown is 1,000 kc, the small difference being due to generator not readable to 0% accuracy.

F_1 is 4,800 kc, F_2 is 5,000 kc.

$F_2 - F_1 = 200$ kc.

$F_x = 24 \times 25 \times 200 = 120,000$ kc = 120 mcg.

Augend and Addend

The consecutive nature of the harmonic orders also enables the use of another expression of the same general formula, which is based on the augend and addend, and is useful at least as a further check, if any is desired by those mathematically minded.

In the case of $A + B$, A is the augend and B is the addend. Hence the augend is the number to which addition is made and the addend is the number that is added to the augend. However, it is not necessary to remember this terminology to apply the method.

Take the two generator frequencies that produce the responses as before, strike the difference and also the sum. Divide the sum by the difference and the result is the sum of the harmonic orders. This is always an odd number, for consecutive responses, and the harmonic orders are the sum ± 1 , divided by 2.

Symbols for Odd Method

In the augend-addend method the symbols are

$$n = \frac{\left(\frac{F_2 + F_1}{F_2 - F_1} \right)}{2} + 1$$

$$n + 1 = \frac{\left(\frac{F_2 + F_1}{F_2 - F_1} \right)}{2} - 1$$

Where n is the harmonic of F_2 and $n + 1$ the harmonic of F_1 .

From the above assortment perhaps the preferred method is the one that takes the difference between the two fundamentals, divides each fundamental by that difference, and multiplies the difference by the two quotients. This is the method described as requiring less thinking.

METAL TUBE GRID CLIPS

When metal tubes with overhead grid caps are used small clips are necessary. The type used for glass tubes is much too large. Radio stores now supply the clips for metal tubes.

HOW TO JAIL IRON TIP SECURELY

Here's the way you do it. You remove the tip from the iron's socket. You insert a little cylindrical copper plug. Then you — Oh, well, you can imagine the rest. Only don't do this job when the iron is hot or you'll regret the tip. (No pun intended.)

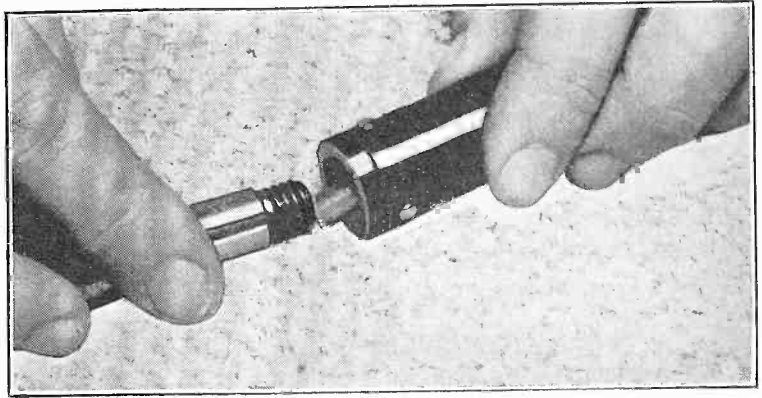

Those who use electric soldering irons will appreciate this little kink contributed by Eugene Kingrey, 757 Parkview Avenue, Dayton, Ohio.

After an iron has been heated for some time an expansion takes place in the metal surrounding the heating element and likewise the threaded section into which the tip of the iron is screwed. This expansion or swelling may cause the tip to work loose easily, and unless care is exercised the tip will actually work its way out and become detached from the heating element. Of course, a cross rivet or screw would anchor the tip in its housing normally, but this would lead to difficulties in replacement when tips become worn out.

By placing a small plug of one-quarter inch copper rod in the tip socket, and then screwing the tip up hard against this plug, when expansion takes place the newly added plug expands with the rest of the entire assembly, thus taking up on the internal "slack" so to speak. It is by no means a failure of duty on the part of the manufacturer of soldering irons to prevent the tips working loose while in heated use, for if tips are not constructed to be readily removable, a worse annoyance is presented in the form of frozen tips which break off when the owner tries to remove them to insert a new tip. Hammer the old one loose before resorting to vise and pliers.

NO CAPACITY CLIPPED OFF CARDBOARD!

Even though condenser manufacturers have packed a big filter capacity in a small cardboard container service men and builders generally may find it desirable on occa-

sion to cram this big farad tank into a still smaller space. An easy plan is to snip off the mounting lugs which protrude at each end, and through which normally a screw is passed.

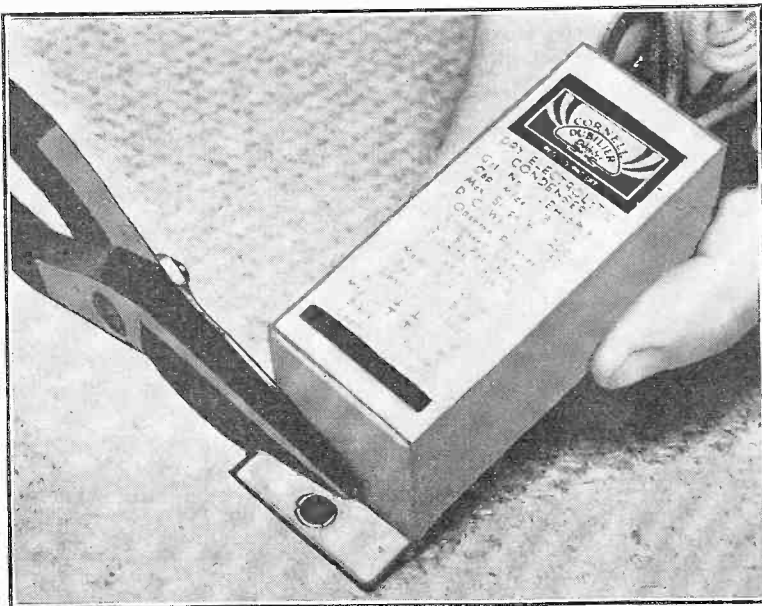

In building a midget set it is sometimes necessary to economize space so fervently that cardboard condenser mounting flaps must be cut off. No harm at all. In fact, it's a pleasure. A strap, then, may hold the condenser to chassis, instead of screws through eyelets.

THOR RADIO

167 GREENWICH ST.

NEW YORK

THE LARGEST RADIO STORE IN NEW YORK PARTS AND EXPERIMENTAL

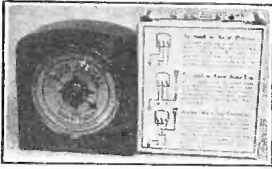

Combination eliminator and wave trap. Compact and efficient - - - - - 79c

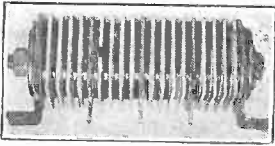

Elkon U-20 speaker rectifier, 2 1/2 amperes - - 98c



Audak high impedance, light weight, scratchless phono pickup - - - - \$3.65

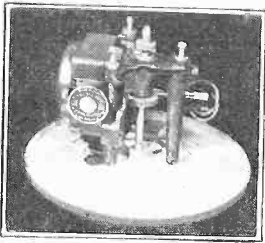

Blue Flyer, 110 volt, 60 cycle A.C. phonomotor with 10" turntable. \$1.89 complete.



Ballasts for every type set, \$1.25



A.C. speaker rectifier tube - - - - -

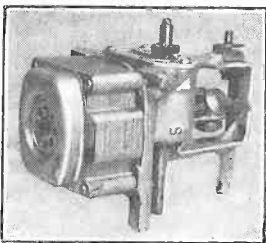

110 volt, 60 cycle phonomotor, complete with speed governor and 10" turntable - - - - - \$3.25

Also in 110 volt, 25 cycle at same price.



Auto vibrators for auto sets at cut prices.

ALL WAVE P

6-tube Super het all metal tubes. 2-6K7, 1-6J7. Individual coils for selective contact band with monel metal detector stage on a micromaster banders complete spec 550 meters. (Set

Complete kit of without tubes and

\$21

8-inch Dynamic Sp Free Circuit

COMPANY

near CORTLANDT ST.

NEW YORK CITY

NEW YORK DEVOTED EXCLUSIVELY TO
RADIOMEN'S SUPPLIES



60-watt soldering irons
made by Vulcan Electric
Co. ----- 89c

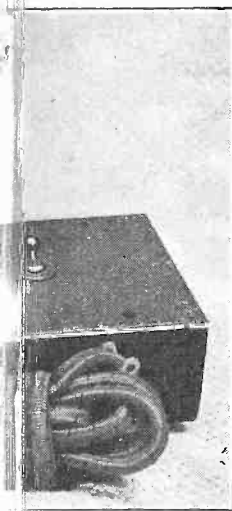

Complete with 25Z5
----- \$2.49

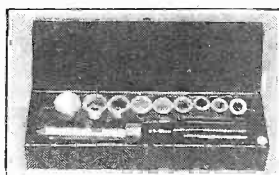

A kit of 9 sizes of Hex-
agonal wrenches, put up
in a compact metal con-
tainer ----- 85c

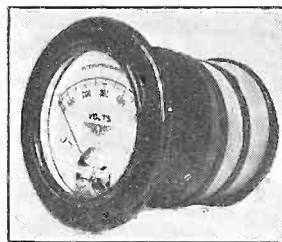

Jewel O—500 volt A.C.
meter ----- \$2.95



Famous Ambassador 3000
ohm phones, complete,
\$1.19

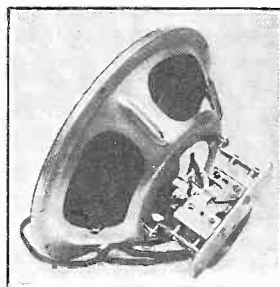

8 1/2" magnetic chassis
double coil unit, complete
with cord ----- \$1.69

TRIFINDER

one, featuring
tubes 1—6A8,
6F6, 1—5Z4.
wide band. Posi-
sector switch,
contacts. Pre-se-
lectors. Crowe
dial. Cover
from 16 to
(illustrated).
not wired,
speaker,

50
----- \$2.95
on request.

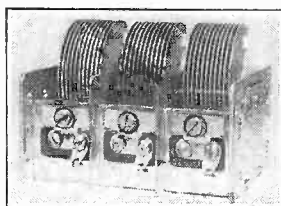

3-gang .00035 General
instrument condensers, 3/8
or 1/4" shaft ----- 89c

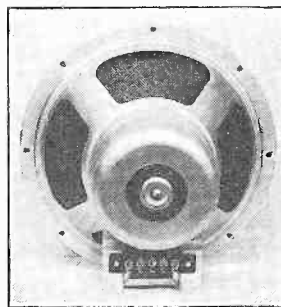

Rola speakers, 5" to 12",
all fields and outputs in
stock ----- \$1.79 up

Asleep All These Years?

Did We Use A.V.C. Since 1920 and Not Know It?

By Edwin K. Butler

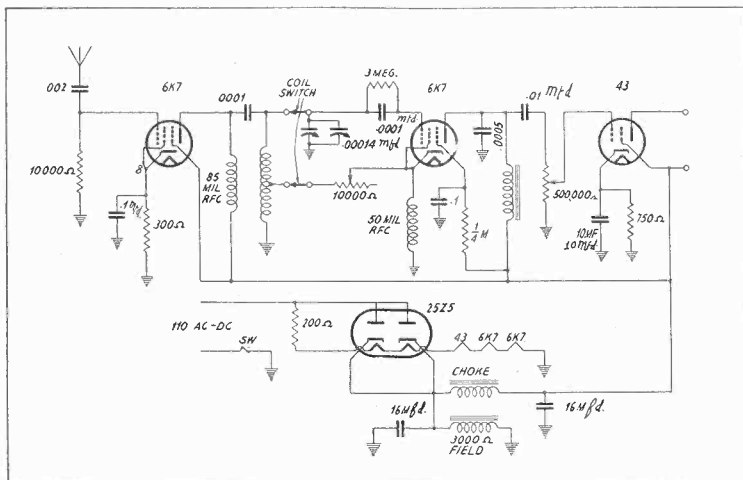

An untuned stage, and then a regenerative detector of the Hartley type, provide good results with a coil switch assembly, 15 to 550 meters. The usual .00014 mfd. condenser is used, but is knob controlled. The variable to its left is a three plate condenser (nominally 15 mfd.) and is the one to which a bar handle is affixed, for bandsread action throughout.

THE regenerative detector represents the maximum in radio's efficiency attainments, and so may be used where results are required, consistent with use of only a few tubes. It is advantageous to isolate the detector from the antenna circuit, to minimize radiation, and also for the selfish reason that the capacity effect of a swaying antenna does not introduce frequency modulation in the detector circuit, and the detector may be calibrated in frequencies by the user, and calibration hold.

The circuit herewith is that of a universal four-tube model, covering 15 to 550 meters, using a selector switch. It is not customary to have a switch in such a circuit, as a switch puts a certain drag on most of the regenerative detectors, which are squeamish when it comes to a little more resistance here or there. In fact, the tube may fail of regeneration at the higher frequencies, particularly on the smallest coil.

How Switch Coils Were Used

This fact is freely admitted for the run of regenerative sets and therefore you see very little of the switch type coil assembly for this use. However, there is a way out. Suppose that the detector were of the infallible oscillator type. The feedback of course is controllable, so that regeneration, which is a degree just under generation, is present. Then would not one have a satisfactory basis?

While the circuit is familiar in many respects, it is unfamiliar in regard to the regenerative detector, for here we have a Hartley of the series fed type. The radio frequency voltage drop across the 50 millihenry r. f. choke coil is large, since such a high inductance presents a high impedance to all the frequencies concerned. Since the inductance is always very large in this choke compared to any tuning inductance on any band within the spectra allotted, especially between tap and ground of the detector grid coil, the shunting effect is negligible. That is, the inductance from tap to ground stands up.

By interposing a lead from cathode to tap the familiar Hartley circuit is present. But if this lead is interrupted by a rheostat of sufficient range, then the radio frequency plate current may be sent through the tuning coil, tap to ground, or almost entirely through the choke, as extreme possibilities, and in between there would be continuously variable quantities of selective feedback. Hence regeneration control is introduced into an otherwise infallible oscillator.

Regeneration Control Non-Detuning

For a long while the Hartley was hidebound to oscillation, designers shunning it for regenerative use because of the floppy control. Now you would have intense oscillation. Next you

(Continued from preceding page)

would have no regeneration. How to get in between these values was a problem. The present method allows the use of the Hartley and the solution of smooth regeneration. Moreover, the detuning effect of regeneration control is at a minimum. It might be said there is no detuning, and that is an important advantage.

The untuned radio frequency amplifier is a 6K7, while the same type of metal tube is used as the detector. The 6J7, not the 6K7, is the detector of this series, but in the present circuit the input voltage due to regenerative ac-

we have a. v. c., although it is not of the complete type, since for full effect a number of tubes would have to be controlled.

1,000 Henries Inductance

The 6K7 detector plate is audio choke loaded. This is unusual, too. The difficulty lies in presenting a sufficiently high impedance to the plate circuit. Fortunately, the plate current is small, the permeability of the core is kept very high, and it is practical to wind an inductance of the order of 1,000 henries. Put a few milliamperes through the choke and

Straighten out the dual filter condenser, if you like, and then go to the completion of the four tube receiver. The performance is equal to that from a plug-in type regenerative set, which is saying a lot, because switch type coils are used, and heretofore there wasn't an unbroken record of good luck with this convenience. Read the text for details of reasons why, and solution

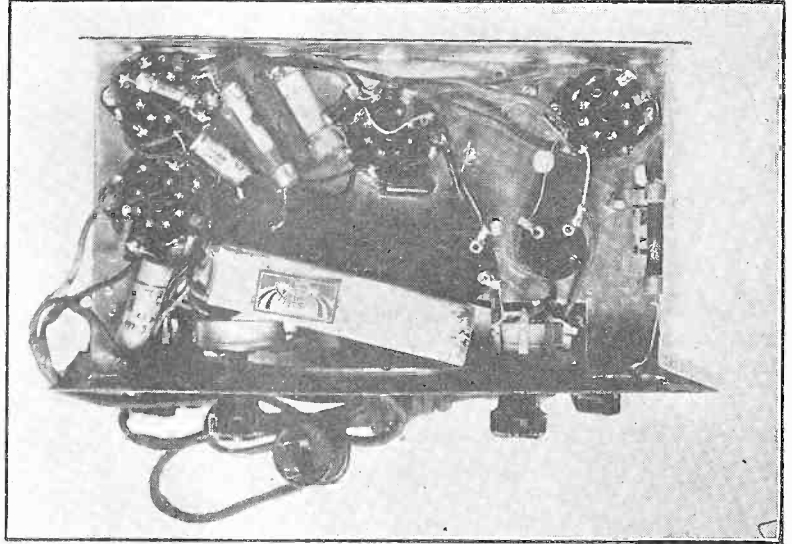

tion may be quite high, and therefore the remote cutoff tube is preferable, especially when smoothness of regenerative action is of outstanding importance.

Automatic Volume Control

The fact has been mentioned often that regeneration is more effective on weak signals than on strong ones. The technical expression for this is that regeneration varies as the two-thirds power of the grid space. In very simple language the grid leak detector may be said to be an automatic volume control device. Is it possible that for years and years before a.v.c. came into vogue that we were using it and didn't know it? Well, the answer is yes.

It will be recalled that an a. v. c. circuit consists of a diode rectifier, the rectified or d. c. voltage being referred back to the controlled tubes, to increase their negative bias. The stronger the signal, the greater the a. v. c. action, so that very weak signals, since they develop small a. v. c. voltage, are amplified without depression of the sensitivity. That is what happens in a. v. c. and also what happens in a grid leak detector circuit. Why, even the diode is there. It consists of the grid to cathode circuit. The rectified signal voltage is the grid current through the leak. The higher the leak the more acute the control. So

the inductance no longer rests at that lofty altitude. But here the current is low, because the leak is high, and, as stated, the leak acts as an automatic biasing adjunct, or a. v. c. device. The stronger the signal the greater the grid current, the greater the voltage drop across the leak and the higher the negative bias. So when hearing loudest results, detector plate current is least.

There is a commercial choke that has a rated inductance of 1,040 henries for this service.

The stopping condenser, .01 mfd., leading to the power tube, is high enough, in view of the 0.5 meg. grid leak in the 43 circuit, and the common coupling for low frequencies through the B supply filter choke.

The series antenna condenser of .002 mfd. is simply a safeguarding device, to insulate the antenna from d. c. continuity with the return (which is one side of the line). Therefore if a metal chassis is used, the tuning condensers being grounded, the metal chassis must be insulated, or "floated," as a further precaution against line shorting.

The "mil" designation on coils in the diagram refers to millihenries.

Check Up on Squeak

In the detector circuit, the grid condenser may be left at .0001 mfd., but if there is self
(Continued on next page)

(Continued from preceding page)

excitation at high frequencies (squeaky tone modulating the reception), the leak value will have to be reduced until this tone disappears. The tube when yielding this interference is super-regenerating, and the auxiliary frequency, or interrupter, is audible. Neither such audible interference nor super-regeneration, with its broadness of tuning not suited to these bands, is desired.

The rectifier is a 25Z5, two sections paralleled. The filter capacities of 16 mfd. are satisfactory, hum level being tolerable, but there is obvious improvement when the capacity is raised to 25 mfd. For this reason 25 mfd. is the recommended capacity for the fastidious. The final answer perhaps depends as much on the speaker as on the filter, for if a saucer type speaker is used, the low frequency response may be poor enough to make hum reproduction very feeble. This indeed is a form of filtration, is it not?

The resistor in the detector screen leg is .25 meg., bypassed by .1 mfd. If the filter capacity is increased to 25 mfd. the condenser across the .25 meg. resistor may be made larger than .1 mfd. (8 mfd. suggested), but this also depends somewhat on what room there is. Low frequency reproduction is materially aided by a capacity very large in respect to the negative feedback to audio frequencies through the resistor.

Chosen After Several Trials

The circuit is well authenticated. The coil system works without dead spots. In fact, there were several different models built, with the intention of getting a good four tube universal circuit, and this was the one selected.

As intimated, some of the others did not even regenerate at the high frequencies. This one did. Therefore it gave fairly selective results even on the standard broadcast band, although not sufficient for riddance of adjacent channel interference.

As the frequencies become higher, the efficiency and selectivity improve, especially if on short waves the antenna is not too long. The

length and height of antenna will depend a good deal on one's location, but around 50 feet strung outdoors, 12 feet above ground potential, proved satisfactory.

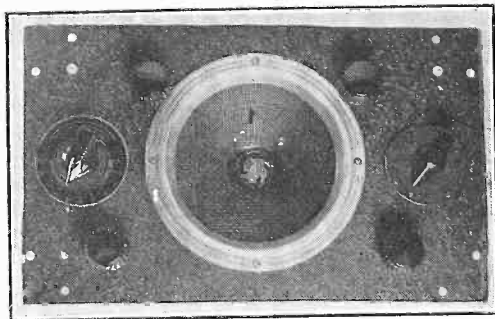

The regeneration control is the knob at left, with plate behind it, and the tuning bar handle has the small graduated dial plate at right. The larger tuning condenser is actuated by the upper right hand knob. This is the front panel for the metal tube universal receiver.

Corrections in Transceiver Circuit of Eggensperger's

In my article entitled "A De Luxe Transceiver" in the November issue of RADIO WORLD I noticed the following errors:

(1) The arm of the Send-Receive switch in the oscillator grid leak circuit should be grounded. This ground on the arm shorts out the .1 meg. receiving grid leak when the switch is in the "S" position and places a ground on one side of the output circuit (output transformer) when the switch is in the "R" position.

(2) The 400 ohm resistance in series with the microphone transformer should be shown as variable. This is the variable gain control.

(3) You have not shown the arms of all switches dotted together. If this were done it would be apparent from the diagram that all switches were controlled from the same knob.

A. R. EGGENSBERGER.

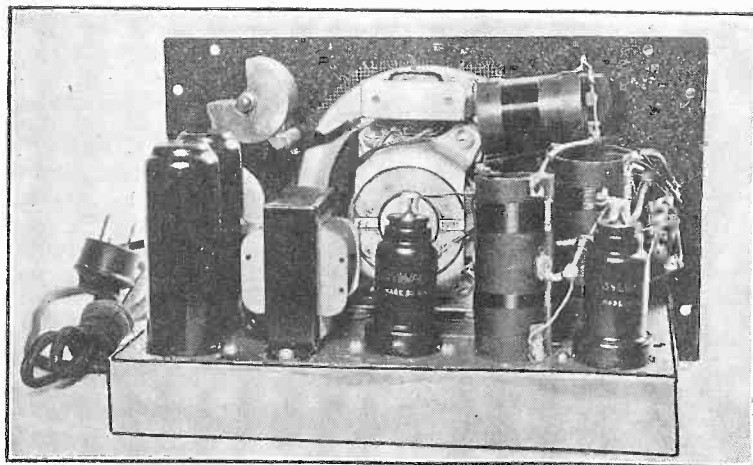

The two metal tubes are seen at the center and at the right, where also is the coil assembly. At upper left is the .00014 mfd. "master" condenser, while below it, not visible, is a three plate condenser used in connection with a dial scale for bandspread tuning.

Measurement of R. F. Capacities

Few Micromicrofarads to .01 Mfd. Encompassed

By Capt. Peter V. O'Rourke

The two condensers for which capacity in mmfd. is plotted against dial settings in the curves illustrating this article are shown herewith. Both have 270 degree rotation, for the best practical spreadout, and may be used with National dials N, NW, A and H, scale type No. 4 (150-0 clockwise.)

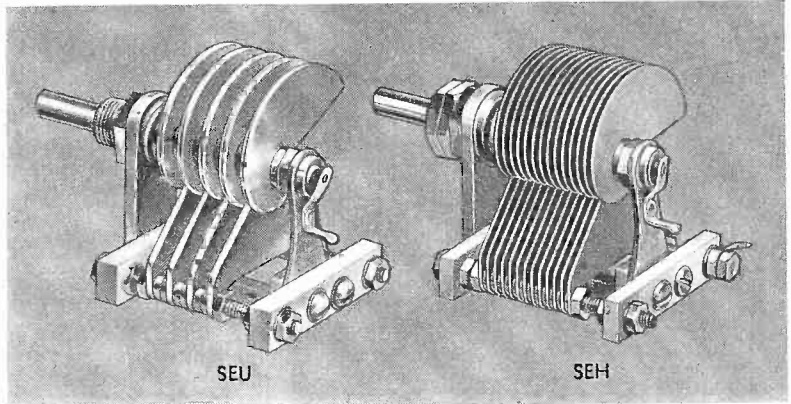

MEASUREMENT of the capacity of a fixed mica condenser, or of a compression type mica condenser, or settings of a variable air condenser, is occasionally highly necessary, and the serious experimenter would like to have some means of accomplishing that end.

There are obstacles. They usually induce the conclusion that one would have to possess an expensive calibrated variable condenser, so that, in conjunction with a wave meter or generator, unknown capacities could be determined by the substitution method. So one may decide that some day he will acquire a calibrated condenser, honestly enough of course, but time goes on and somehow the desired addition to the measuring equipment does not augment the collection. However, some parts manufacturers hold their normal production of condensers to such close tolerance that these capacitors may be used as standards.

It is well to keep the calibrated condenser out of the generating circuit, except indirectly as the coupling between generator and an extra circuit requires, but this coupling need have no significant capacity effect.

Start With Two Equal Coils

So it is proposed that two coils of preliminary equal inductance be used, and that they be very loosely coupled. One is used in a generator and is tuned by any variable condenser. If capacities up to .01 mfd. or so are to be measured, then the generator tuning condenser should be of a maximum of 300 to 400 mmfd., whereupon a change of about one tenth of the maximum capacity would be effected for .01 mfd. unknown.

It is not proposed that the unknown be connected directly in the generator circuit, but, that there be at first equal inductances very loosely coupled, so that the unknown may be connected later in the coupled circuit, in series with a permanent condenser, C_f . The reason for, and the establishment of the correct capacity of, the series condenser will be considered later, even its measurement.

Since we desire to measure small capacities with good accuracy, at least we need a system that will enable comparison of small capacities with the generator's oscillation stoppage. It is obvious that the generator has considerably more distributed capacity than the coupled circuit, due to tube capacity, more wiring, grid condenser, and probably also has a tuning condenser of 15 mmfd. minimum or more. Let us say that the total capacity at minimum setting of the generator condenser, including all the stray capacities, is 50 mmfd.

Coils Now Made Dissimilar

If the coils remain equal it would be impossible to measure definitely capacities of less than 50 mmfd., because the generator does not provide a frequency high enough to match the resonant frequency of the intended trap circuit. The series condenser, C_f , by the way, will have little effect on small capacities across the C_x terminals, and so may be disregarded for the moment.

Therefore, to match the highest frequency of the generator, with an external circuit having smaller capacity, the inductance of the external coil has to be raised, or generator inductance lowered, because then the smaller minimum

(Continued on next page)

(Continued from preceding page)

capacity of the coupled circuit can be made to strike the same frequency as the larger minimum capacity in the generator. Now with the generator at minimum capacity, trap circuit consisting merely of minimum of the standard put across the coil, all leads in place, including posts, remove turns from the grid-connected end of the oscillator coil until the coupled circuit, which has not been molested, acts as a trap to extract enough energy to put out the light.

Getting Something That's Known

Now the two circuits strike about the same frequency for "zero setting," so that values of unknown capacity, below the minimum capacity of the generator circuit, can be measured. A good deal of wire had to be taken off, because the frequency change is small for turn removals at the high frequency end.

Some time or other it becomes necessary to have something that is definitely known, and

now is the time. Manufacturers of excellent variable condensers give the maximum capacity of their products in values so close that they exceed the accuracy of secondary types of dial-calibrated condensers, and other manufacturers give also the minimum capacities, while still others give complete capacity curves. The maximum capacity in these instances is accurate to better than 2 per cent, usually around 1 per cent, and while any single capacity definitely known like this may be used, some further measurements and calculations would be necessary, and for simplicity we are presenting curves of condensers of types widely used, so that you may proceed on the basis of a condenser you have, or can obtain.

Establishing Series Condenser

The reason why not so many turns had to be removed from the coil was that the condenser to be put in service which will be called the standard, has a minimum capacity around 5 to 7 mmfd, and now the generator may have

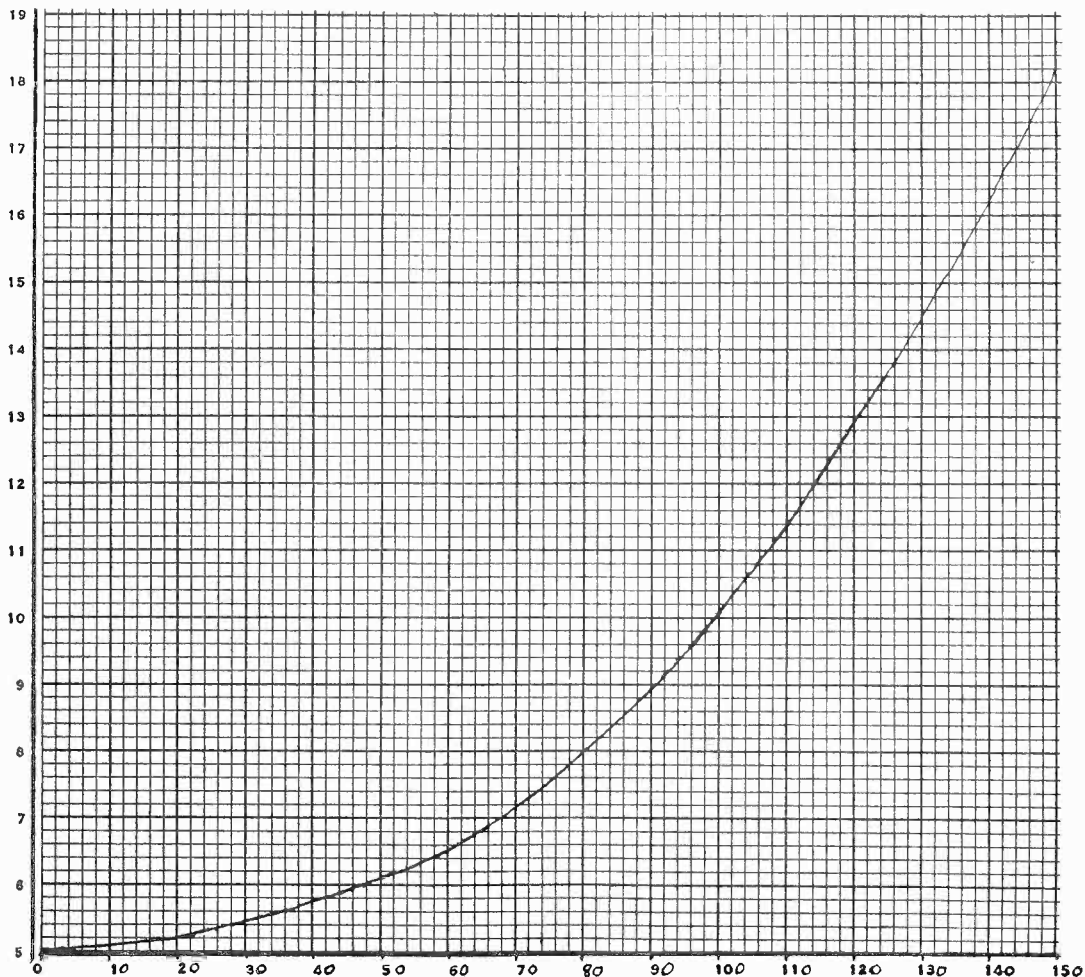

For small capacity measurements there should be good overlap compared to the next larger calibrated capacity. The above curve is for the SEU-20 straight frequency line condenser made by National Company, Malden, Mass. Capacity (left, perpendicular) is in micro-microfarads. Dial settings, 0-150, are on the horizontal (bottom). The points used in establishing this curve were 0 = 5, 20 = 5.2, 40 = 5.8, 60 = 6.5, 80 = 8, 100 = 10.1, 120 = 13, 150 = 18.2.

to be turned just a bit beyond its own minimum capacity to cause the coupled circuit to behave as a trap when the standard condenser is introduced across the coil in the coupled circuit.

However, we have not yet provided for the series condenser Cf. The generator is set now at the opposite extreme, maximum capacity, lowest frequency, the Cx terminals are shorted in the intended trap circuit, and the series condenser is selected of such value as to put out the neon light. Notice that for this result the future series condenser is used simply in parallel with the coil, but it is well to have the binding posts and leads thereto for the Cx of future reference in the circuit, as the capacity they contribute will be present always.

Since the inductance of the trap circuit is now greater than the inductance of the generator circuit, the value of Cf will be smaller than the total capacity in the generator circuit with generator condenser at maximum, though not much smaller.

Assuming that the generator condenser is rated at 300 mmfd. or more capacity, build up fixed mica capacities to equal half of that or a bit more, and then put a variable condenser across the bank of fixed capacities and see how far the plates have to be engaged to put out the light.

Registration on Generator Dial

From this observation it will become apparent whether considerably more or only a little more capacity has to be added. If only a little more, put an air dielectric trimmer across to provide that little, and the adjustment is finished. If considerably more, add small mica fixed capacities until the air dielectric trimmer (say, 75 or 100 mmfd.) at some setting enables putting out the neon lamp.

Now open the Cx terminals and insert the standard condenser for which capacity settings are known. Of course the generator has a dial, and for the present purpose at least, the standard condenser should have a dial, reading 100-0 or 15-0, or so, preferably with increased numerical values on the dial representing increases in capacity. Known capacity settings thus obtained from the calibrated condenser are referred to the generator dial, and a sufficient number of points obtained to give good coverage at close differences. It is handy to take each even division of the generator dial, and find out the capacity in the matching circuit, so that any curve run for the generator can be on the basis of every single division, within the capacity allowed by the calibrated instrument.

Building Up Capacity

Small variable condensers, of capacity equal to or smaller than the standard, are about the workplace undoubtedly, and from the information already at hand, these may be affixed to a dial and calibrated and when the known maximum of the standard is added to various known capacities from the spare, the higher resultant capacities may be ascribed to the

generator dial. Fixed condensers may be measured, of capacity not greater than that of the standard, the resultant capacity of condensers in parallel being the sum of the individual capacities. In this way capacity up to 200 mmfd. or 250 mmfd. is accounted for, the region in which the fixed series condenser begins to become effective in a real sense.

Now we can find out what is the capacity of Cf. We short out Cf and insert at Cx the standard at maximum capacity, which value we know. Then we remove the short from Cf and measure the capacity by referring to the generator dial. It will be smaller than the first measurement, of course. Now we have two known values, those of the standard and of the standard with an unknown in series. From this information we can compute the value of the series condenser Cf. It is equal to the product of the two knowns divided by their difference. Thus if the two knowns are 230 mmfd. and 225 mmfd. the unknown would be $230 \times 225 / 5$ or 51,750/5 = 10,350 mmfd., or .01035 mfd. In actual practice the series condenser will be about three quarters or so of the maximum capacity of the generator condenser. If the maximum of the standard is 200 mmfd. and the effective capacity with the unknown series in circuit is 146 mmfd., then the series condenser is $(200 \times 146) / 54$ or 541 mmfd.

Larger Capacities

It should be clearly borne in mind that the data assembled are all for the immediate benefit of the generator dial, and after sufficient points are established, one might draw out a scale representing the capacities, and thus have the device direct reading.

However, thus far we have proceeded only to the recording of dial positions on the generator for capacities up to maximum of the standard, whereas we desire to proceed to .01 mfd. or more. There are numerous ways of doing this. Let us select the method that requires no computation. We get an assortment of fixed condensers from 50 mmfd. to the maximum of the standard, or close to that maximum. If the standard's maximum is 200 mmfd., capacities from 50 to 200 mmfd. would be used. We measure these with the system already instituted, connecting at Cx.

Two Questions Answered

Then we put capacities in parallel at Cx to get good distribution of points, remembering we may add also the standard, so that if we are working with a rated 250 mmfd. fixed condenser the capacity of which we accurately determined to be 235 mmfd., we add to the standard for each setting 235 mmfd. and proceed to 555 mmfd., getting plenty of points, then add another fixed condenser, and to the capacity settings of the rotated standard add the sum of the two fixed condensers, and so on until we get even beyond .01 mfd., if we like, though even the difference between .01

(Continued on next page)

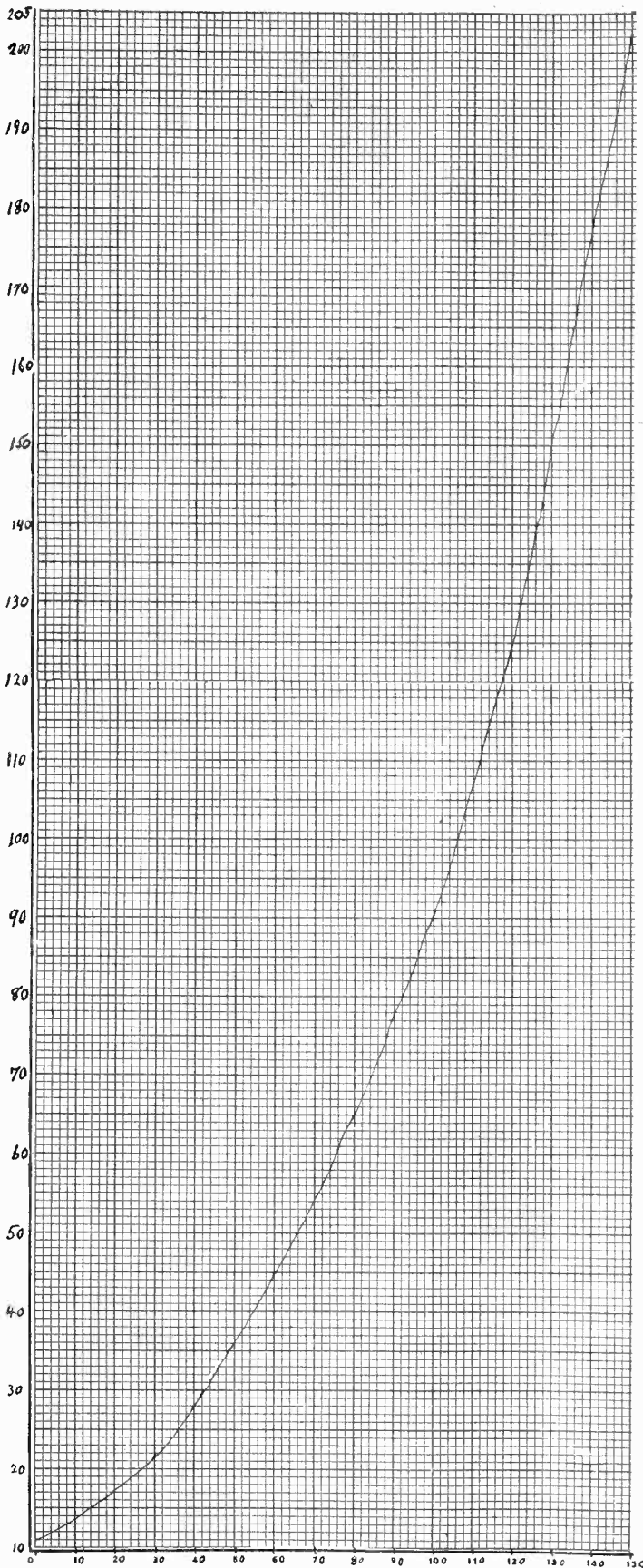

The capacity curve of the SEH-200 variable condenser manufactured by the National Company, Malden, Mass. The capacity values in the vertical column (left) are in micro-microfarads, plotted against 0-150 dial settings (horizontal notations at bottom.) The points on which this calibration are based follow:

| | |
|---------|-----------|
| 0 = 11 | 80 = 65 |
| 20 = 16 | 100 = 90 |
| 40 = 28 | 120 = 124 |
| 60 = 45 | 150 = 202 |

Correct the curve at bottom to make dial reading of 20 equal 16 mmfd. It equals 17 mmfd. on the curve.

The use of this curve for medium capacities and of the preceding curve for small capacities gives one all the close values needed for high frequency work, and permits extension of capacity measurements, as set forth in the text. The other curve is for the SEU-20, which has seven plates.

(Continued from preceding page)

and .02 mfd. would not be an appreciable spread on the generator dial.

Two questions might be asked. One is, if all we desire is the measurement of capacities within the scope of the standard alone, what was the necessity of the generator? And the other question might concern the reason for including the series condenser Cf.

The distributed capacity of the trap circuit has no disturbing effect on the calibration of measurement, and some indicating system is needed anyway. The generator shown is certainly one that requires the minimum of parts. Also, we might add, since the generator is present, it may be used for measurement of frequencies equal to or greater than its fundamentals.

The second question, about the series condenser, is answered as follows: By including a series condenser, any other capacity connected in series with it will result in an effective capacity less than that of the permanent series condenser alone, and of less than that of either series component. Hence if we establish a circuit that resonates with the generator at the generator's lowest frequency, any unknown (and the unknown is always in series) will require a higher generator frequency, lower generator capacity, hence we encompass a wide range of capacities.

Wide Range on One Scale

We do not accomplish this without sacrifice, because when a capacity ratio of say 1,000 to 1 is covered, we do not get as much dial separation per unit capacity as if we covered a ratio of 100 to 1, but we do maintain a fairly good relative displacement, because small capacities may be measured well, and the percentage accuracy does not decline very much for relatively high capacity measurements.

The standard condenser is no longer needed in the test circuit, but we might desire to be able to measure extremely small capacities, including the distributed capacity of coils. Let us

assign ourselves the task of discovering all the distributed capacity of the generator circuit.

If a standard (calibrated) variable condenser is used with fixed capacity in parallel, the frequency ratio or capacity ratio will be reduced for the same angular displacement of the dial on the standard. Thus, if the capacity ratio is 2 to 1 between two given points of the standard, if a fixed condenser is put across the standard, between those points the ratio will be less, and the greater the fixed capacity, the smaller the ratio of capacity or frequency between those points. Hence the dial on the standard would have to be turned over a greater number of degrees, the more fixed capacity is added.

Small Capacities Measured

The solution can be worked out for any inductance, or frequencies, as neither need be known, but it is handy to apply fundamental and second harmonic, although even then what the actual frequencies are need not be known, only that fundamental is fed to a circuit of the same frequency, so that the next response, with generator capacity increased, would be due to the second harmonic of the new frequency.

We need a standard that has at least a ratio of capacity ratio of 4, and since if it were only 4 we would have encompassed the whole dial span, we really need a ratio greater than four. How much greater would depend on the values of small capacity that we desire to read, but, because the difference in capacity between the theoretical and actual stopping points is due to the unknown. The necessity is fully met by a condenser of 100 mmfd. or greater capacity.

Remove the tuning condenser that is in the generator and replace it with the standard variable condenser. Generate a frequency that zero beats its fundamental with the frequency of a station tuned in on the receiver. This is most readily accomplished in the broadcast band, generator coupled to the receiver, which may result automatically because of the line

(Continued on next page)

Iron "Not So Hot" Needs More Power

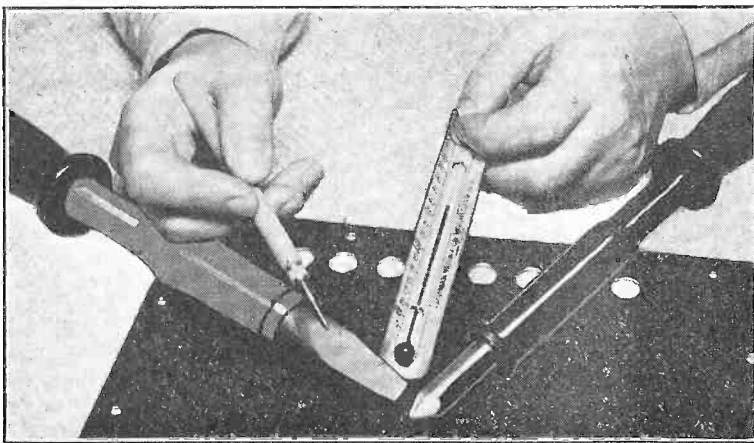

When it comes to soldering to a chassis a heavy duty iron is needed if security of the joint is to be assured. The difference in heat radiation between irons can be read in terms of comparative temperatures on a thermometer as shown. At left, the iron that will do the job. At right, the iron that won't.

Magnetized Melody from a Banjo

A permanent magnet, a magnet coil underneath, is positioned on a banjo, whereupon the music is changed from sound radiation to its electrical counterpart, for feeding into an amplifier. Greatly improved tone is claimed by the inventor. The magnet assembly acts as a microphone.

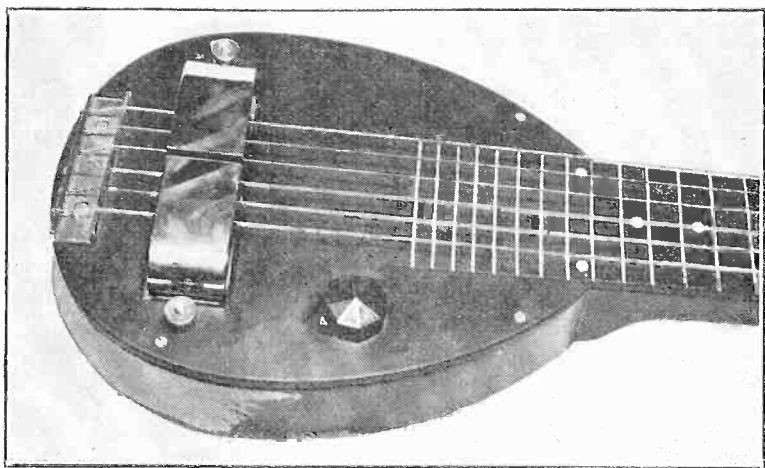

(Continued from preceding page)

cord serving as transmitting antenna, or the r.f. output post may be used. Use a station in the higher frequencies of the band, so that much less than the generator condenser's maximum capacity is in circuit.

Note the capacity reading (it represents condenser only). Then turn the generator condenser to higher capacity until the next response is tuned in, without disturbing the receiver in any way. Again note the capacity reading (again it represents the condenser only). Now, what is the total distributed capacity in the circuit? For this second harmonic comparison with fundamental multiply the low capacity reading by 4, subtract this product from the high capacity reading, and divide by 3. The answer is the total distributed capacity.

An example: The first capacity reading is 290 mmfd., the second capacity reading is 50 mmfd., the difference between 290 and 200 is 90, and one-third this difference is 30. That is the distributed or added capacity. Verification: Reading of 290 represented 30 more than that, or 320 actually in circuit; reading of 50 really represented 30 more, or 80, and $320/4 = 80$.

The general formula on which the above is based, where Cd is the distributed or other small unknown capacity, Cmax is the high capacity setting of the standard Cmin the low capacity setting; and k is the ratio Cmax/Cmin:

$$Cd = \frac{Cmax - (k \times Cmin)}{k - 1}$$

If the distributed capacity of the coil alone is to be measured, the coil should be removed from the generator and loosely coupled to the new generator coil, standard condenser across the removed inductance.

Instead of using a divisor, $k - 1$, this may be converted into a multiplier when real values

are used. Thus for first and second harmonics, multiply by .333 instead of dividing by 3.

If the harmonics of generator fundamentals are known as to their order, the above measurement method may be applied for values up to 11th and 12th harmonics from the following:

| Harmonic Orders | Distributed Capacity Equals |
|--------------------|--------------------------------|
| 1st and 2nd..... | .333 [Cmax—(4 Cmin)] |
| 2nd and 3rd..... | .4 [Cmax—(2.25 Cmin)] |
| 3rd and 4th..... | 1.286 [Cmax—(1.777 Cmin)] |
| 4th and 5th..... | 2 [Cmax—(1.5 Cmin)] |
| 5th and 6th..... | 2.271 [Cmax—(1.44 Cmin)] |
| 6th and 7th..... | 2.77 [Cmax—(1.361 Cmin)] |
| 7th and 8th..... | 3.226 [Cmax—(1.31 Cmin)] |
| 8th and 9th..... | 3.77 [Cmax—(1.265 Cmin)] |
| 9th and 10th..... | 4.27 [Cmax—(1.234 Cmin)] |
| 10th and 11th..... | 4.76 [Cmax—(1.21 Cmin)] |
| 11th and 12th..... | 5.26 [Cmax—(1.19 Cmin)] |

[Diagram of the generator will be supplied on request.]

ALL WAVE COIL DATA

The plugin coils for a 15-2,000 meter receiver, using .00014 mfd. for tuning, are wound on 1.25 inch form diameter. The following table gives the necessary information for tight winding:

| NUMBER OF TURNS | | Size of Wire | Range in Meters with .00014 Mfd. |
|--------------------|-----------|--------------|--|
| Tickler | Secondary | | |
| 7 | 7 | 24 En. | 15-26 |
| 9 | 10 | 24 En. | 25-47 |
| 15 | 21 | 26 En. | 45-96 |
| 22 | 49 | 26 En. | 95-210 |
| 28 | 131 | 30 En. | 200-490 |
| 80 | 245* | 34 En. | 485-1,115 |
| 120 | 475* | 34 En. | 1,000-2,100 |

*These two coils layer wound.

Five and Ten Meter Circuits

Receiver and Two Transceivers of Proved Worth and Simplicity

By Max Steir

A "unity coupled" transceiver. When the switch is at "S" the circuit is a transmitter, at "R" a receiver. The 3 meg. return to B plus should hop over the horizontal ground line. This set is produced commercially and is very successful.

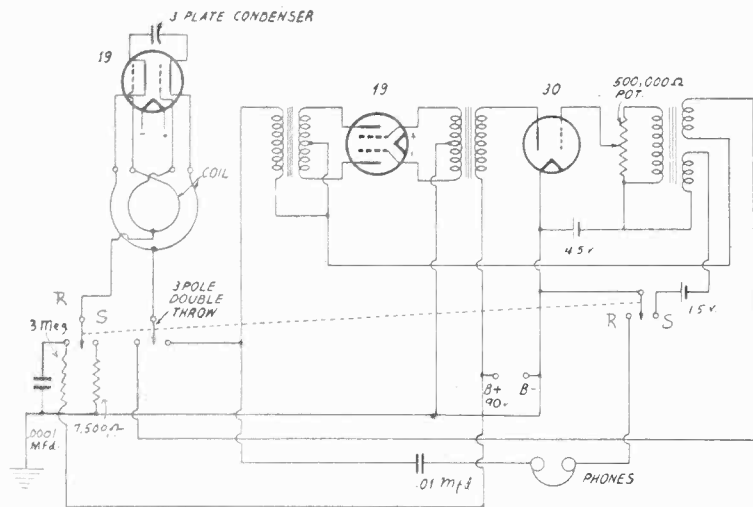

IT is my business to design and produce coils for high frequency work, and here are three of the circuits in which these coils are used.

The actual construction and testing of such receivers and transceivers is not within my scope, and the circuit drawings are supplied by the design engineer. However, much of the design depends on the coils. The question of wavelength coverage and sustaining oscillation finally come into my jurisdiction, and it is necessary then to have the coils just right for the purpose, and even to suggest now and again a change in some of the other constants, especially where super-regeneration is used.

Ah, Those Gracious Smiles!

Not always does the most gracious smile attend such suggestions, but the net result is that the circuit as a whole becomes well authenticated, and the performance of the three shown herewith can be guaranteed.

The first is called a unity coupled transceiver because of the 100% coupling of r.f. coils. The grid coil is wound inside the flexible hollow plate coil. The tap on the grid coil is at center. The plate coil consists of two turns of $\frac{3}{8}$ -inch diameter copper tubing, 2 inch inside winding diameter. Of course no form is used, as the coil is strong enough mechanically to be self-supporting. A hole is drilled to permit taking the lead out of the plate wire for the grid center tap. The grid wire length is of course about the same, since this winding is simply inside the other. Flexible stranded wire is used for the grid coil. Care must be exercised not to develop a shorting condition where the center

tap of the grid coil is brought out. The specifications for the unity coupled coil are for five meter operation and the coil system is permanently installed.

The send-receive switch, turned to the left, gives reception, turned to the right affords transmission. R stands for receive and S for send in the diagram. We have been using 3 volts directly on the tubes, A minus to ground and filament, A plus to positive filament, B minus to A minus, 90 volts on the plates, although somewhat better sensitivity may be developed if 135 volts are used.

The B plus lead as it rises one side of the left hand earpiece should hop over the ground lead, which the diagram does not definitely bring out, even though the diagram does not suggest a connection, as there is no dot there.

What Tubes Do

The tubes used are two 19's and a 30. The first tube, at left, is the oscillator or regenerator. For reception the tube is super-regenerative, and the interruption frequency is supplied by the grid circuit of one of the sections of this 19, where the time constant of the leak-condenser combination, 3 meg. and .0001 mfd., is high enough to produce a low frequency.

The next or center tube is the 19 audio amplifier, to which is connected a transformer of the push-pull output type. That is, the small winding is the center-tapped one and is in the plate circuits.

The next transformer to the right is of the push-pull input type. The right hand trans-

(Continued on next page)

(Continued from preceding page)

former has three windings, one large one for input to the right hand 30 tube, or modulator, the smaller of the primary windings being for a single button carbon microphone, which the 1.5 volt cell excites, and the other winding for audio input from the detector circuit.

The second circuit is just a receiver, for universal operation.

Five and Ten Plug-in Coils

This circuit uses plugin coils for five or ten

ing diamter, no form, same one inch winding length, and one inch separation between the two equal coils.

The coil system as used in a universal model is shown symbolically in the rear view, where the position and location of the coils just described may be seen, though the turns for another reason are not as stated. The tubes used are a 76 and a 12A7. For aiding beginners the 12A7's two separate tubes in one envelope are shown as if in two separate envelopes, the pentode part on top in the circuit diagram, the

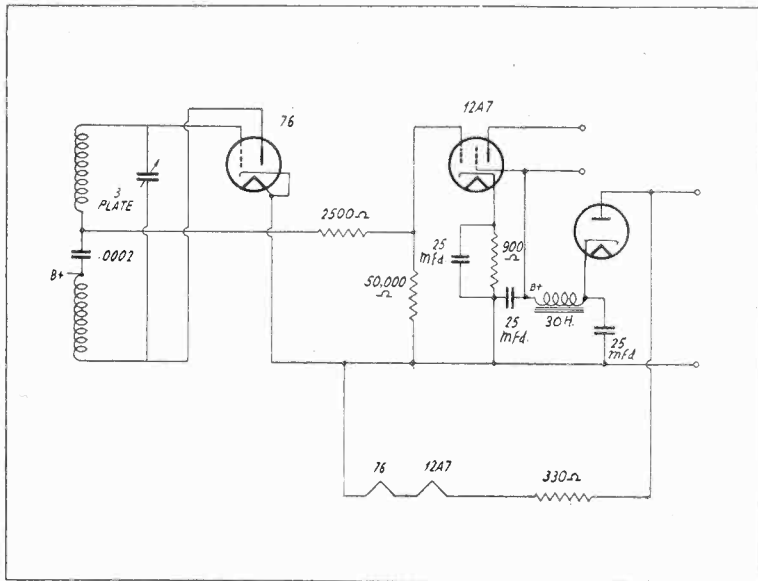

The second circuit (left) consists of a five and ten meter design for universal operation reception only. The coil winding data for this receiver, as well as for the other circuits, are given in the text. This is about the simplest five and ten meter receiver a fellow can build for universal operation. Be sure that the filter capacities are 25 mfd.

meters. For five meters use four turns of No. 14 wire, 5/8-inch inside winding diameter. There is no form, the wire being self supporting, and the total length of the winding is one inch, to introduce spacing. The plate and grid coils are equal, positioned on the same axis, as shown in the rear view, and are one inch apart.

The ten meter inductance consists of eight turns of No. 14 wire on 5/8-inch inside wind-

diode rectifier part on bottom, to bring out the fact that there are separate cathodes.

Use a Tube Manual

Any one building sets should have a tube manual at hand, where the elements are identified and connections to socket lugs shown, and this separation of the two functions of rec-

The plugin coils for the two bands are represented by the inductances shown, which have different number of turns than specified, however. The tuning is done with a three plate condenser. This view is the rear of the built-up universal circuit above.

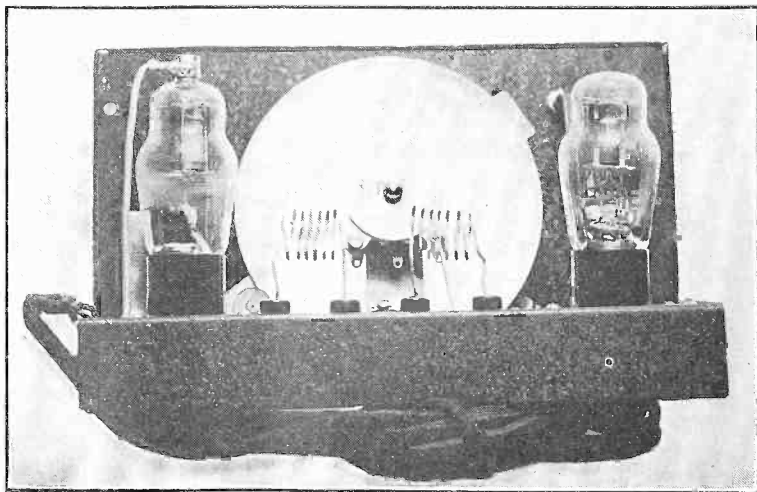

THESE CIRCUITS HAVE BEEN TESTED WITH SPECIAL CARE IN RADIO WORLD'S LABORATORIES AND HAVE BEEN FOUND EXCELLENT.—EDITOR.

tification and amplification will help the novices avoid misconnecting this tube.

The two binding posts at top are for output, while the two other posts, shown going to diode plate and to circuit returns, is the line, normally around 110 volts, either a.c. or d.c. being suitable. There will be no hum if the filter capacities are 25 mfd. as prescribed.

Super-regeneration for All Reception

The a.c. model transceiver is a counterpart of the familiar battery model that uses a single 19 tube. Here we use the equivalent a.c. tube, the 53, and of course the rectifier is needed. The results are better from the a.c. model, because the B voltage is higher.

The receiver, and the transceivers at receiving position of the switch, are super-regenerative. This means that the sensitivity is very high, but that the circuits are somewhat broad in tuning. This broadness for reception is an

advantage at present, because the frequency stability of the transmitters other fellows use—and your own, perhaps—is not all that it might be.

All r.f. chokes in the 5 and 10 meter circuits herewith consist of 70 turns No. 28 DSC wire on quarter inch Bakelite rod.

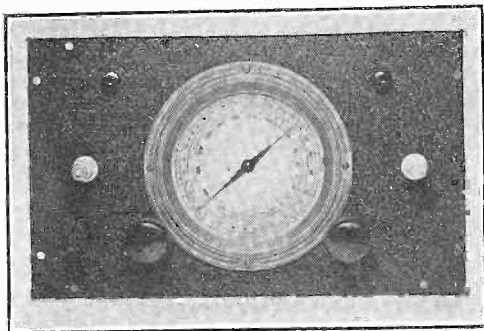

Two porcelain insulators are on the front panel for connection to antenna and ground. The use of a ground is not usually of any importance, as the wave that is received or sent may be classed as a ground wave. There is hardly any sky wave, none reliably present anyway, at these wavelengths.

The third circuit is for a five and ten meter transceiver for a.c. operation. The same coil system is used as in the previous diagram. The 8 mfd. filter capacities are usually sufficient in this circuit. Otherwise use 16 mfd. next to the rectifier. The B choke is 30 henries. The 125 ma rating is not material. X and X refer to heater secondary.

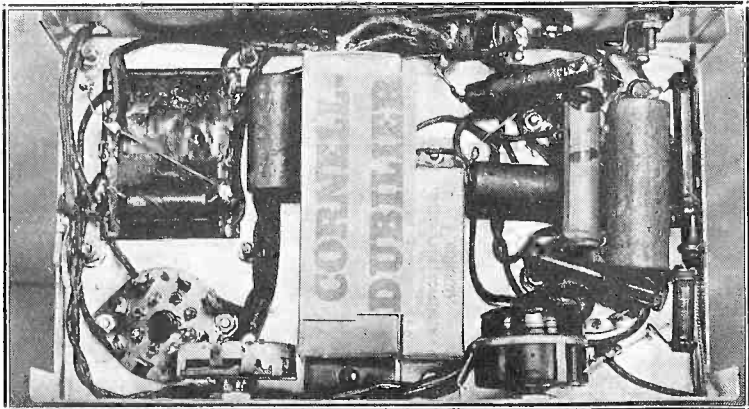
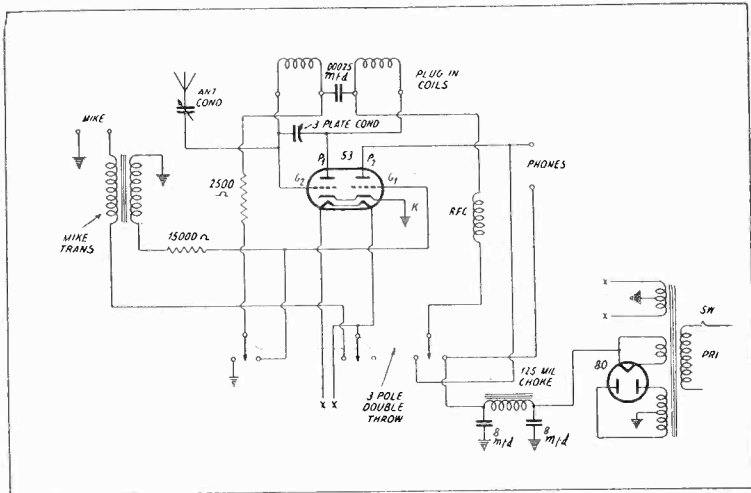

A good place to put the electrolytic condenser in a compact receiver is under the tuning condenser. There need be no fear of hum from this placement.

DB Attenuation in Steps

How to Compute Required Resistance Ratios

By J. E. Anderson

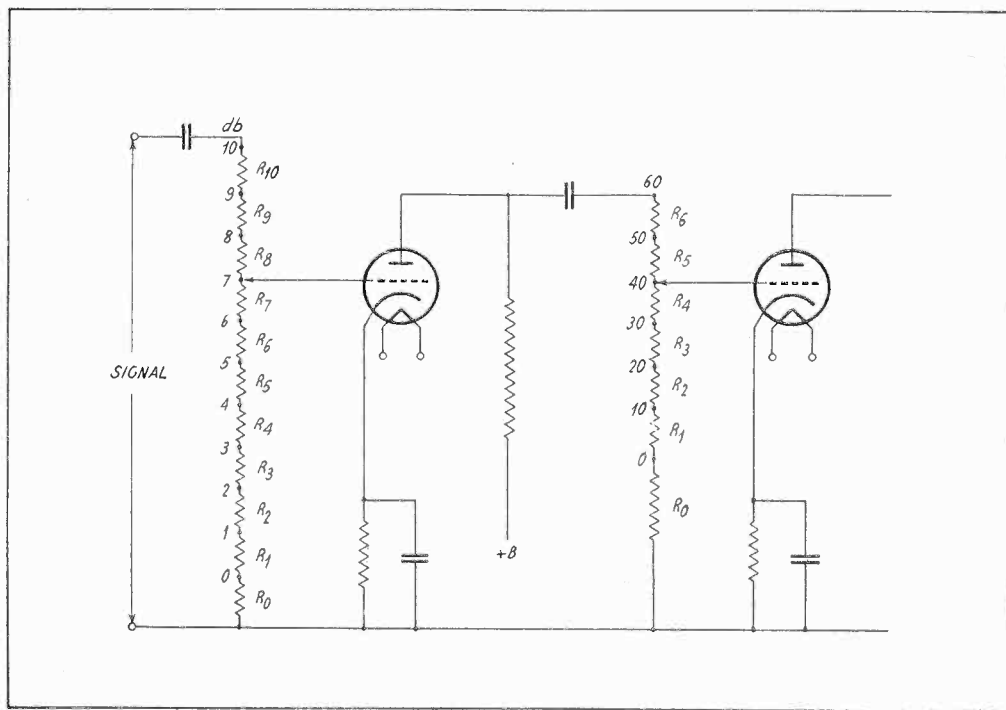

1-db Attenuator

10-db Attenuator

An arrangement of potentiometers in an attenuation circuit covering a total of 70 db in steps of 1 db. The attenuation in each leg is the difference between maximum and the setting. The coarse adjuster is in the second tube's input circuit, steps of 10 db. The fine adjuster is in the other tube's grid circuit, steps of 1 db. The attenuation in db is cumulative. So the range is 0 to 70 db in steps of 1 db.

WHEN the output of an amplifier is varied by means of a potentiometer in the grid circuit of one of the stages, and when this potentiometer is so constructed that the resistances between the various steps are equal, the output does not change by the same amount at every step. It changes very rapidly at the lower steps and very slowly at the upper. A potentiometer of this type changes the signal voltage by the same amount at each step, but this is not sufficient.

For apparent equal changes in the output power, the resistances in the potentiometer should have such values that the signal voltage changes by the same *percentage* at every step. That is to say, it should be so arranged that signal voltage, or output power, changes on a decibel basis.

The decibel is defined by the equation $20 \log(V_2/V_1)$ equals the number of decibels difference between the two output powers result-

ing from impressing the two signal voltages V_2 and V_1 .

If the same signal current flows through two resistances, such as R_0 and R_1 in the figure, the resistances can be substituted for the voltages in the equation. If we say that the output level is zero when the moving arm on the potentiometer is on step zero then the power is up by $20 \log(R_0+R_1)/R_0$ decibels when it is on step 1. As was stated above, this assumes that the same signal current flows through the two resistances.

It is possible to select such values for the various resistances in the potentiometer that the increase in the output volume at each step is any desired number of decibels. Let us work the resistances out for an attenuator in which the change shall be 10 decibels at each step.

The choice of R_0 is entirely arbitrary and for that reason we shall leave it simply as R_0 and then find all the other resistance as multiples

of this. The first equation is $20 \log (R_0+R_1)/R_0=10$. With the aid of a table of common logarithms we find that the ratio of R_0+R_1 and R_0 should be 3.1623, which, incidentally, is the square root of 10. From this ratio we get the first relation $R_1=2.1623R_0$.

Resistance Values Tabulated

The next equation is $20 \log (R_0+R_1+R_2)/(R_0+R_1)=20$. Again with the aid of a table of common logarithms we find that the ratio of the two sums of resistances should be 10. From this value and the value for R_0+R_1 already found, we can determine R_2 in terms of R_0 . It is $R_2=6.8368R_0$. The same process is continued until all the resistances have been found.

It is not necessary, however, to do all this work, for as soon as we have found R_1 we can make use of the obvious relationship that each resistance is obtained from the one before it by multiplying it by the square root of 10, that is, by 3.1623. Moreover, as soon as R_1 and R_2 have been obtained all the remaining resistance can be written down at once, for there are only two number sequences. After R_2 has been obtained it is only a matter of writing down the number sequences and putting the decimal point in the right place. For example, R_3 is obtained by multiplying R_1 by 10 and R_4 by multiplying R_2 by 10.

The first six resistances are given in the following table:

| |
|-----------------|
| $R_1=2.1623R_0$ |
| $R_2=6.8368R_0$ |
| $R_3=21.623R_0$ |
| $R_4=68.368R_0$ |
| $R_5=216.23R_0$ |
| $R_6=683.68R_0$ |

Selection of Some Even Values

The value of R_0 may be assigned at pleasure. It may be 10 ohms, in which case each of the resistances is multiplied by 10, or it may be 100, in which case each resistance is multiplied by 100. Any other value may also be selected, the choice being made on the requirements in the circuit in which the attenuator is to be used.

Now it is convenient to select a value for R_0 that will make the other resistances simple numerically. For example, we might make R_0 such that R_1 will become 250 ohms. In that case we have the following series of resistances:

| |
|-------------------|
| $R_0=115.62$ ohms |
| $R_1=250$ ohms |
| $R_2=790.57$ ohms |
| $R_3=2500$ ohms |
| $R_4=7905.7$ ohms |
| $R_5=25,000$ ohms |
| $R_6=79,057$ ohms |

Case of Steps of One DB

It will be observed that in this series of resistances also there are only two sequences and that as soon as R_1 and R_2 have been found the remaining may be written down at once. This holds true for any other combination of values in which the change in output volume from step to step is to be 10 decibels.

An attenuation of 60 decibels represents a

power ratio of 1,000,000 to one, or a voltage ratio of 1,000 to one.

Steps of 10 decibels in a volume control are too coarse, especially if the purpose of the potentiometer is to measure the characteristics of amplifiers and speakers. Means should then be provided for steps of only 1 decibel. The resistances for such an attenuator are worked out in exactly the same manner as was used above.

Unfortunately, there is no simple sequence of numbers in this case, and therefore all the values must be calculated. To save the work involved in the computation we reproduce one set of resistances for a ten-step attenuator which each step changes the power output by one decibel.

$$R_0=82 \text{ ohms}$$

[Multiply above resistance by following factors]

| | |
|--------------|-----------------|
| $R_1=10$ | $R_6=17.793$ |
| $R_2=11.22$ | $R_7=19.953$ |
| $R_3=12.599$ | $R_8=22.387$ |
| $R_4=14.126$ | $R_9=25.119$ |
| $R_5=15.849$ | $R_{10}=28.184$ |

The total power change in this case, from step zero to step 10, is 10 decibels, and at each step there is a change of one decibel. Therefore an attenuator of this kind is a natural adjunct to that previously given. The present fine adjustment potentiometer can be placed in one grid circuit and the coarse adjustment attenuator in another. The attenuations of the two would add numerically. For example, suppose the 10 db attenuator were set at 50 db and the 1 db attenuator at 8 db, the total attenuation would be 58 db. With these two potentiometers in the circuit only five steps are required in the 10 db attenuator to cover a total attenuation of 60 db.

Nonreactive Resistors Required

Although the values of the various resistances in the 1 db attenuator are low, they can have any value consistent with the requirements of the circuit in which they will be placed. To get other values it is only necessary to multiply all the resistances, including R_0 , by the same factor. For example, the values given may be considered as thousands of ohms instead of ohms.

The resistances used in the attenuators should be non-reactive. If they are not, power levels at different frequencies cannot be compared, and even at a single frequency the attenuations will not be as computed.

What the output power should be at zero level depends on the circumstances in which the attenuator will be used. It can be varied at will by varying the total voltage across the potentiometer. If a tube is used between the two potentiometers, the maximum power level should be such that the voltage will not overload the tube. This requirement would make the zero level very low. Suppose, for example that the total attenuation is 60 db and the input to a grid is limited to 20 volts. The voltage ratio represented by 60 db is 1,000. Therefore the voltage across R_0 is 0.02 volt when the voltage at the sixth step is 20 volts.

An Extra Set for the Home

Small Universal Four Tube Model Uses 6J7 and 6K7

By Jack Goldstein

Radio Design Company

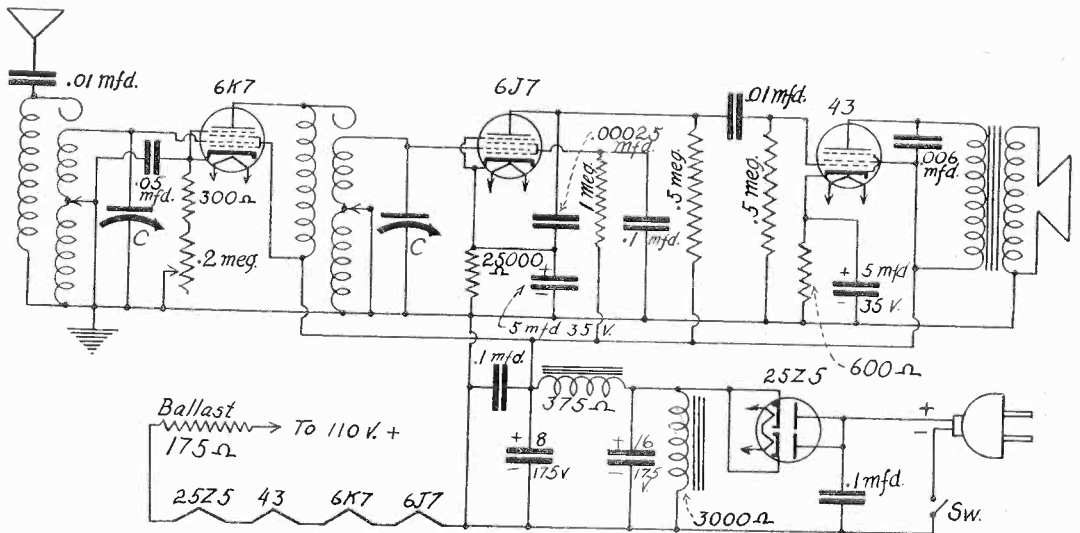

Four tube universal t.r.f. receiver, using two metal tubes.

THIS little four tube receiver is remarkable in two respects. First, it has the sensitivity and the selectivity of many receivers having more tubes and tuners. Second, it has real output of force and fidelity.

The high gain is due partly to the use of the metal tubes 6K7 and 6J7 and partly to the use of high gain coils. Of course, the use of a power pentode in the output stage adds

both to the gain and to the output. Besides these main factors, the constants of the circuit have been selected with the object of getting the greatest possible output with the number of tubes and other parts used.

Uses for the Little Set

The receiver is really a dual band circuit for it tunes in not only all the broadcast range

LIST OF PARTS

Coils

- Two high gain, dual band r.f. coils (75-200 meters and 200-560 meters)
- One 375 ohm filter choke
- One 5 inch dynamic speaker with a 3,000-ohm field coil

Condensers

- One two gang tuning condenser (.00035 mfd.)
- One 16 mfd. and one 8 mfd., 175 volt electrolytic
- One dual 5 mfd., 35 volt electrolytic
- Three .1 mfd.
- Two .01 mfd.
- One .05 mfd.
- One .00025 mfd.
- One .006 mfd.

Resistors

- One 300 ohm
- One 25,000 ohm
- Two .5 meg.
- One 1 meg.
- One 10,000 ohm volume control
- One 175 ohm ballast resistor and line cord

Other Requirements

- Four tube sockets (two sixes and two eights)
- One gang of two on-off switches, low capacity
- Two grid clips
- Three small control knobs
- One small chassis
- One dual binding post strip

but also the so called police band. To change the tuners from one band to the other a switch is turned and this short circuits the larger portion of the coil in each tuner. The exact coverage is 75 to 200 meters in one band and 540 to 1,500 kc in the other. In other words, the total coverage is from 540 kc to 4,000 kc.

Although this receiver is built along modest lines, it fills many needs. It is a useful adjunct to a larger receiver. It frequently happens that the large, pretentious receiver in the house

monopolize the big receiver in the living room, for they can have their own receiver in their own room.

Adults who move about a good deal will find that a little receiver like this one is very useful. It is so small that it can almost be slipped into an overcoat pocket. It can be plugged into any 105-130 volt electric outlet whether the electric supply is direct or alternating. The set works equally well on either type of current.

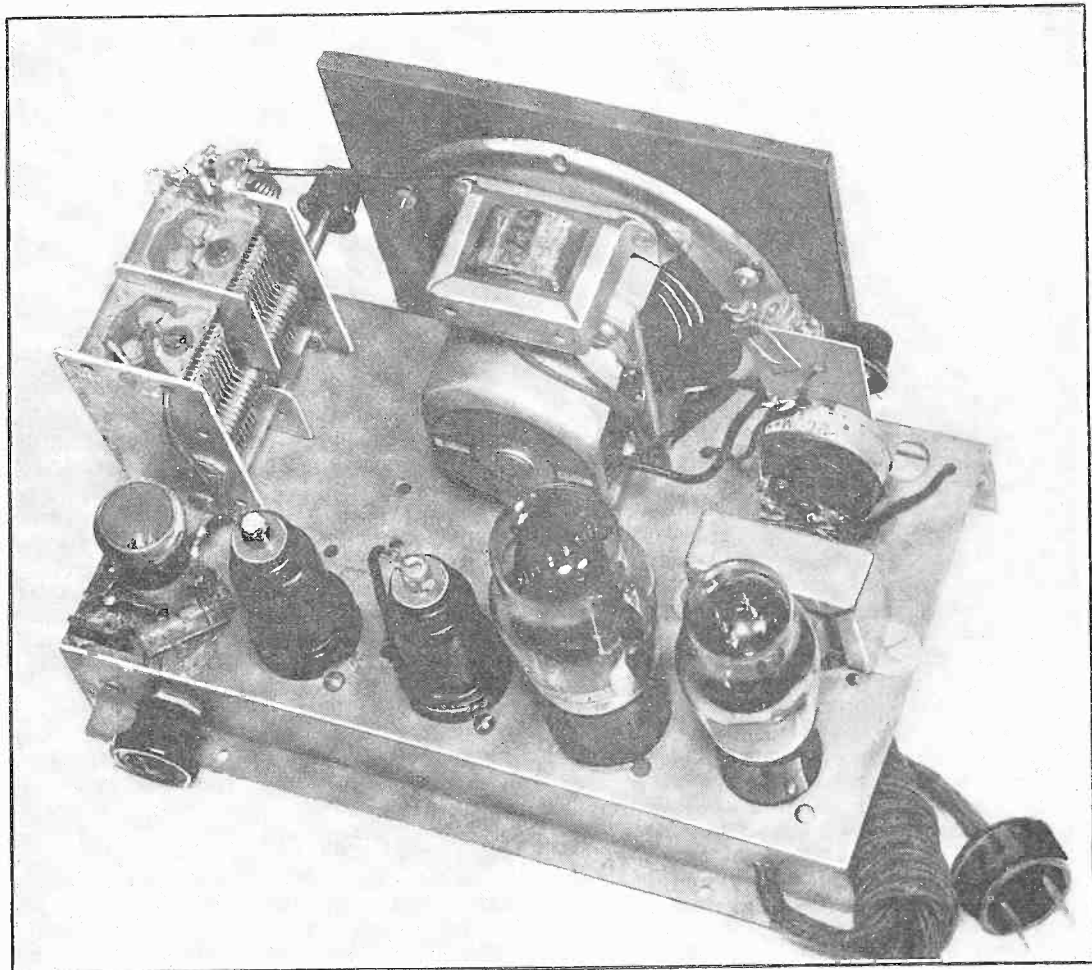

Looking down from the rear of the receiver. This view shows the layout distinctly.

goes out of order. A receiver of the present type will serve the family well while the main set is being repaired.

It may be that one of the family prefers a different type of program from that preferred by the others. In such cases a little receiver like the present one comes in handy, for the family member who is out of step with the others can take this little receiver to his room and listen to programs of his own choice without in the least interfering with the remainder of the family.

The little set is especially adaptable to the needs of children. With a receiver like this four tube t.r.f. circuit in the house, it is not necessary for junior and his little sister to

There is a certain intimacy about a little set like this one. It can be placed close to the bed in the evening and the volume turned low. Thus the owner of the set can have at his ear any one of a large number of program sources, and he can listen to his choice without in the least disturbing his next door, or next room, neighbor.

The use of metal tubes throughout was not practical because there is no metal tube in the 25Z5 class and none in the 43 class. It is possible that tubes of this kind will be brought out in the near future, in which case the circuit can be made all-metal tube changing two sockets and two tubes. Hence one 6K7 and one 6J7 are the metal tubes used.

An Extra Set for the Home

Small Universal Four Tube Model Uses 6J7 and 6K7

By Jack Goldstein

Radio Design Company

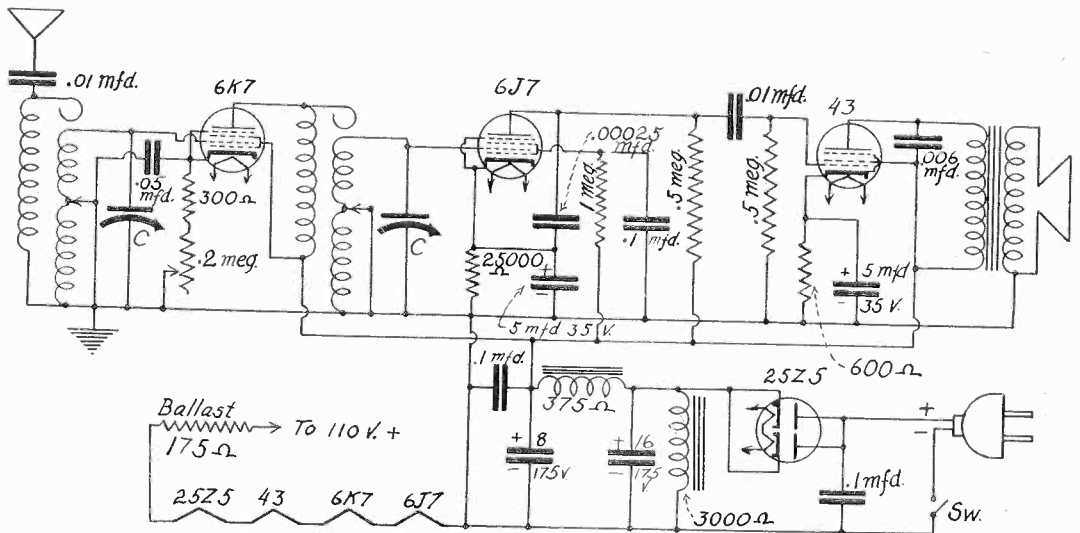

Four tube universal t.r.f. receiver, using two metal tubes.

THIS little four tube receiver is remarkable in two respects. First, it has the sensitivity and the selectivity of many receivers having more tubes and tuners. Second, it has real output of force and fidelity.

The high gain is due partly to the use of the metal tubes 6K7 and 6J7 and partly to the use of high gain coils. Of course, the use of a power pentode in the output stage adds

both to the gain and to the output. Besides these main factors, the constants of the circuit have been selected with the object of getting the greatest possible output with the number of tubes and other parts used.

Uses for the Little Set

The receiver is really a dual band circuit for it tunes in not only all the broadcast range

LIST OF PARTS

Coils

- Two high gain, dual band r.f. coils (75-200 meters and 200-560 meters)
- One 375 ohm filter choke
- One 5 inch dynamic speaker with a 3,000-ohm field coil

Condensers

- One two gang tuning condenser (.00035 mfd.)
- One 16 mfd. and one 8 mfd., 175 volt electrolytic
- One dual 5 mfd., 35 volt electrolytic
- Three .1 mfd.
- Two .01 mfd.
- One .05 mfd.
- One .00025 mfd.
- One .006 mfd.

Resistors

- One 300 ohm
- One 25,000 ohm
- Two .5 meg.
- One 1 meg.
- One 10,000 ohm volume control
- One 175 ohm ballast resistor and line cord

Other Requirements

- Four tube sockets (two sixes and two eights)
- One gang of two on-off switches, low capacity
- Two grid clips
- Three small control knobs
- One small chassis
- One dual binding post strip

but also the so called police band. To change the tuners from one band to the other a switch is turned and this short circuits the larger portion of the coil in each tuner. The exact coverage is 75 to 200 meters in one band and 540 to 1,500 kc in the other. In other words, the total coverage is from 540 kc to 4,000 kc.

Although this receiver is built along modest lines, it fills many needs. It is a useful adjunct to a larger receiver. It frequently happens that the large, pretentious receiver in the house

monopolize the big receiver in the living room, for they can have their own receiver in their own room.

Adults who move about a good deal will find that a little receiver like this one is very useful. It is so small that it can almost be slipped into an overcoat pocket. It can be plugged into any 105-130 volt electric outlet whether the electric supply is direct or alternating. The set works equally well on either type of current.

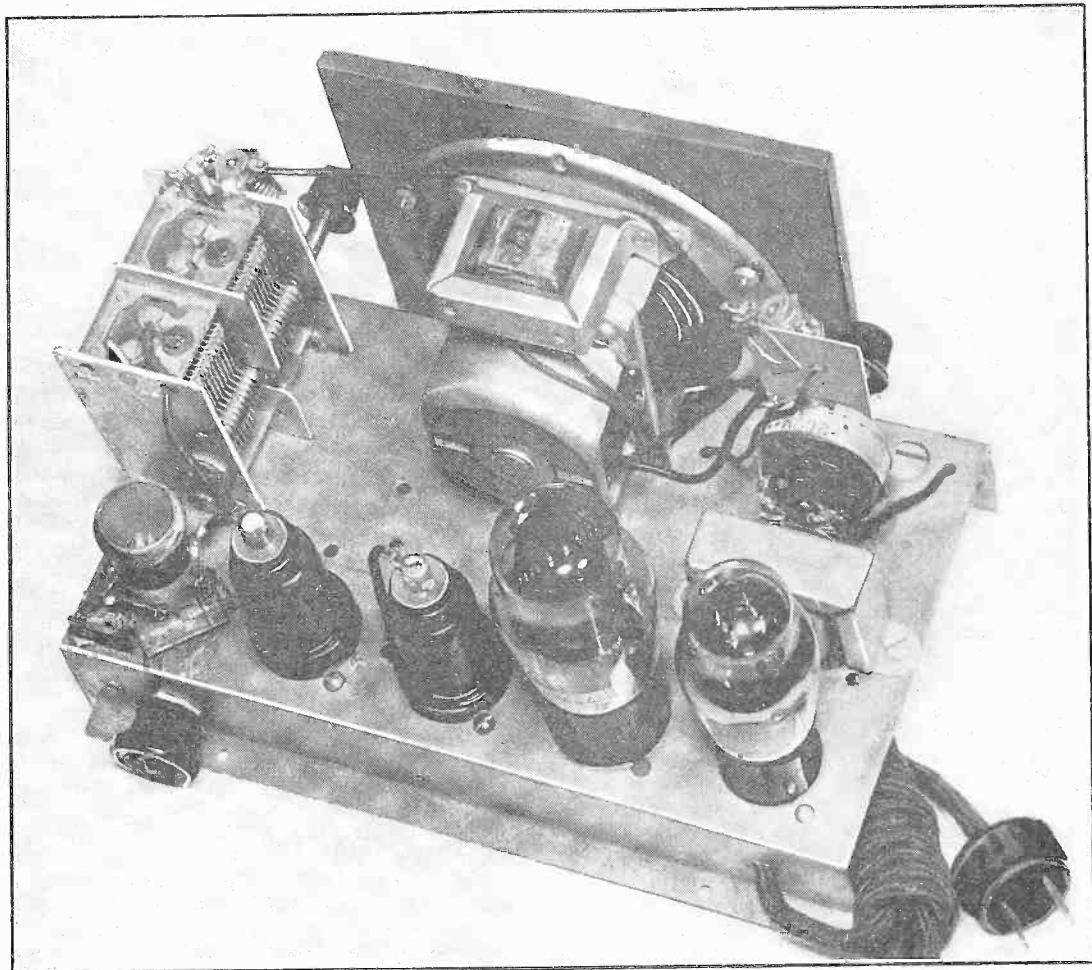

Looking down from the rear of the receiver. This view shows the layout distinctly.

goes out of order. A receiver of the present type will serve the family well while the main set is being repaired.

It may be that one of the family prefers a different type of program from that preferred by the others. In such cases a little receiver like the present one comes in handy, for the family member who is out of step with the others can take this little receiver to his room and listen to programs of his own choice without in the least interfering with the remainder of the family.

The little set is especially adaptable to the needs of children. With a receiver like this four tube t.r.f. circuit in the house, it is not necessary for junior and his little sister to

There is a certain intimacy about a little set like this one. It can be placed close to the bed in the evening and the volume turned low. Thus the owner of the set can have at his ear any one of a large number of program sources, and he can listen to his choice without in the least disturbing his next door, or next room, neighbor.

The use of metal tubes throughout was not practical because there is no metal tube in the 25Z5 class and none in the 43 class. It is possible that tubes of this kind will be brought out in the near future, in which case the circuit can be made all-metal tube changing two sockets and two tubes. Hence one 6K7 and one 6J7 are the metal tubes used.

An Audio Beat Oscillator with 19

Why Low Radio Frequencies of Tuning Are Preferred

By Louis Kranz

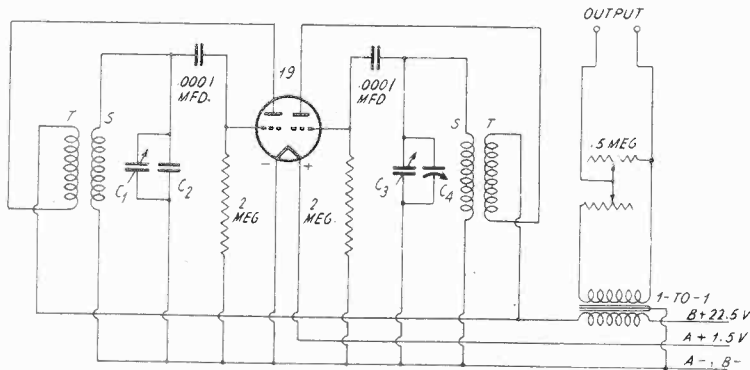

Audio beat frequency oscillator, using a single 19 tube, operated from batteries. The coupling is three fold, mostly through the primary of the audio output transformer, which will have a sufficient impedance to the radio frequencies. Each of the generators acts as a detector, and from the combined output the audio tones are derived.

WHEN a source of audio frequencies is desired for measurement purposes the audio beat oscillator is usually selected because it is simple and has a relatively constant amplitude of output. This constancy is due to the fact that there is small difference in frequency between the fixed frequency oscillator and the variably tuned frequency oscillator. Both of these work at radio frequencies, but the output is at audio frequencies, because the output utilized is the difference between the two radio frequencies.

Instability Peril

There is one drawback, however, that is the peril of frequency instability of a large order, at audio values, due to small frequency instability at the radio levels. This arises from the fact that what is utilized is the difference. If two quantities of 100 and 110 vary by 1 per cent. this variation may be opposite in phase at any instant, that is, one is 1 per cent. too high in frequency (111.1) and the other is 1 per cent. too low (99). The total variation is the sum of those two variations, equaling 2.1 in absolute values, or 2 per cent. in relative value. So for an audio beat frequency intended to be the difference, or 10 kc, the actual value would be 12.1 cycles, an error of more than 20 per cent.

Aiding R.F. Stability

For this reason it is imperative to have the radio frequency oscillators as constant as possible. One way of working toward that end is to use a low radio frequency. Something of the order of 50 to 100 kc would be satisfactory. The low radio frequency oscillators are more stable as a rule.

It is well known that grid leak and condenser help maintain stability, and so the radio

frequency oscillators should be so circulated, if not provided with even superior means of assuring steadiness.

Of course one of the best methods would be to have the fixed frequency oscillator crystal controlled and to utilize a somewhat elaborate setup of stabilization of the variably tuned radio frequency oscillator, including a constant temperature oven. But these considerations are beyond the intent of a very simple device, and the one presented uses only a single tube, a 19, battery operated.

The circuit diagram shows that this tube, which consists of two high mu triodes in one envelope, has one triode set up as a fixed frequency oscillator (left) and the other as a variable frequency oscillator.

Three Fold Coupling

The coupling between the two tubes is three-fold. There is a little due to the common filament serving the two triodes. There is some more due to the capacity between the elements of one tube and the elements of the other within the same envelope. Mostly, the coupling is due to the impedance of the primary of the audio output coupling transformer to radio frequencies. This impedance may be considerable.

The circuit is set up without much regard to the inductance of the coils, except to note that it is large and that the two coils are apparently equal. Honeycomb coils may be used. If two-winding coils of such type are not at hand they may be improvised from two larger equal coils for secondaries and smaller equal ones for ticklers, forms joined mechanically with machine screw and nut. T represents the tickler and S the secondary in the diagram.

Setting the Condensers

In the circuit at left the fixed frequency is

established. Just what the frequency is need not be known. However, since the inductances are about the same, the capacities have to be related, at least to the extent that the same frequency may be generated in both circuits, with the variable condenser at one extreme or the other of its rotation. So if C4 is the variable condenser in the circuit at right, C2, the fixed condenser in circuit at left may be of the same capacity or somewhat less.

even for medium grade audio work. The device shown is an L pad of the inexpensive type. When the arm is moved the same total resistance is supposed to remain across secondary, although the amount of voltage taken off naturally is different. If measurement of resistance is made it may be found that the resistance does not remain constant. But the device comes much closer than does the ordinary potentiometer and so the substitution is

Something to think over. If two grid coils are properly phased, can not a common tickler be used, assuming all three windings are coupled? In each circuit the phase is right for oscillation but the question propounded is, will there be any oscillation at all? The author asks the reader to think it over but not lose any sleep over the proposition.

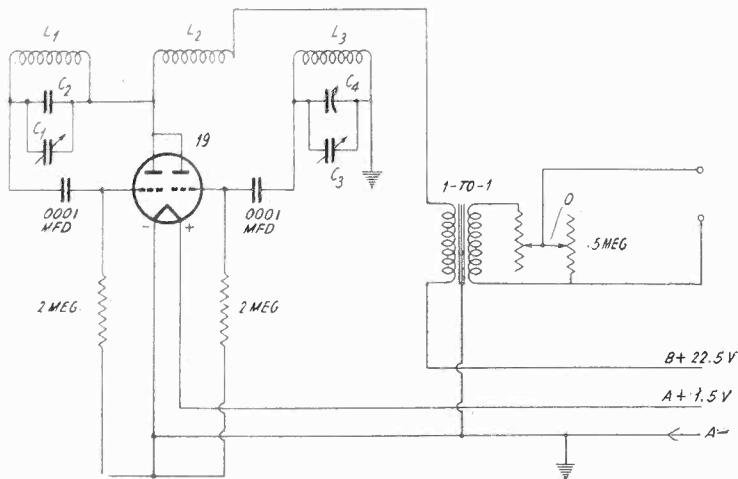

Since a small total frequency difference is finally desired, a small condenser may be used for variable tuning, even 15 mmfd., whereupon C2 would be 15 mmfd. or a little less. However, larger capacities are to be expected in practice, therefore trimmers C1 and C3 are used, to cut down the ratio. If when beating is developed it is found that at half of the displacement of the variable condenser the sound becomes too high for audibility, the frequency ratio is too high, so more trimmer capacity is added, until the audibility just about disappears at full displacement of the tuning condenser.

Pad for Attenuator

Since the tubes are leak-condenser circuited, they will detect, and while it is not the best technique to have the generators themselves act as the intentional detectors to convert their mixture of frequencies to audio values, it is practical and economical. The audio will appear across the primary of the output transformer, of 1-to-1 ratio, the object of the secondary being to isolate the audio output from the inherent circuit.

One of the problems concerning any audio oscillator is the attenuator. Practically there is probably no such thing as a really constant impedance attenuator, and it is not pretended that the double potentiometer shown is that, for it simply represents an improvement over the single potentiometer, which is never suitable

an improvement and is well worth while. The device may be used even though not calibrated. This is so because the extreme of audibility is somewhere around 10 kc or beyond, depending on one's eye and other factors, while the lowest audible frequency would be low enough. And of course the frequencies in between are numerous and all-inclusive within the limits. So if an audio channel is to be tested, one may ascertain at a glance, by reading an output meter connected to the set, whether the output voltage changes much through the span of frequencies. By ear one may tell, if listening to the output, whether the frequencies are high, medium or low. This does not give much useful information, but some results are obtained, and if an amplifier is supposed to be flat the test will show whether the claim is well founded. Relative values suffice for that purpose.

Question of Calibration

It is so simple to build an audio beat note oscillator that perhaps the reason why so few experimenters have one—and when they badly need one, rely on their borrowing capacity—is that they are at a loss as to how to calibrate. It so happens that two sources aid materially.

If one has a low radio frequency generator, he may beat this generator with a station of known frequency, and resolve the beat to zero. He knows the frequency of the generator's fundamental and also the station frequency.

(Continued on next page)

(Continued from preceding page)

Really, if the generator is very accurate he does not need to know the station frequency, but it is well to divide the generator frequency into the station frequency to get the harmonic order, and if it comes out other than a whole number, divide the station frequency by the nearest whole number, and then the generator frequency is accurately known.

Now turn the receiver until other beats are picked up with stations of known frequency, preferably working as near as practical at the lower frequency part of the set dial (530-1,000 kc). These beats seldom are zero, and when finite can be identified as equaling the difference between the generator frequency and the frequency the generator would have to be at to establish zero beat with the new stations.

Now for Low Notes

In this way, by putting the audio beat oscillator outputs into a detector to which is also fed the audio frequency from the receiver, the two may be compared, preferably not aurally, but by meter observation when the two are equal and the needle deflects most, in one direction or another. So numerous frequencies are obtained, although low ones will not be found, except in rare instances.

However, the a.c. line may be used then. With a large stepdown, transformer ratio, use the low voltage side for input to the separate detector, a few volts at most, and work the audio beat oscillator into the same detector, again using the meter. Some frequency formerly found that was a multiple of 60 or thereabouts would be splendid, especially if the line frequency is off a bit. Then it could be measured on the known part of the calibration for what it is, and as each successive needle kick is noted, in conjunction with dial setting, the known line frequency is deducted until one reaches the last response. This will be equal to the line frequency, and while not the end of the dial, it is so close to it that values lower than 60 may be ignored as non-calibratable.

If no check is possible on the line frequency, perhaps some arrangement may be made with the power company, so that a phone call to

the right person when you are making your run will get you the exact information you want.

A Poser for the Learned

The frequency is always close to 60, but not always close enough for precision calibration work. Still, if the assumed 60 cycles curve points check well with the others, as to smoothness of curve, no irregularities or "sharp turns," 60 cycles may be accepted as right, especially as the device shown in the diagram is not usually capable of the highest order of accuracy.

In connection with the radio frequency portion of the circuit, a little problem will be presented that may get a rise out of the reader. Since two tubes are to oscillate at the same time, and since the grid windings may be connected oppositely, that is, comparable ends of different coils to ground and grid, suppose then that the tickler were common, as in the second diagram. The plates then are common. The phase in the tickler L2 is right for oscillation in both grid circuits. There is no catch in the bare theory of that. Now, the question is, will the circuit work? If so, why? If not, why not? Think it over but don't lose any sleep over it.

LITERATURE WANTED

- Russell Beck, 956 Nobleshire Road, Cleveland Heights, Ohio.
 Harold Becker, 9418 Avenue A, Brooklyn, N. Y.
 S. Arthur Reynolds, 35 First St., Stamford, Conn.—trade lit. pertaining to new apparatus and their uses.
 J. H. Cason, 211 Camp St., New Orleans, La.
 O. Brown, 57 E. 118th St., New York, N. Y.
 Fernand Levesque, Radio Operator, Charlesbourg, Que., Can.
 Wm. B. Fiedler, 439 E. 7th St., Moscow, Idaho.
 Sylvan Ejencweig, 343 McKee Place, Pittsburgh, Pa.
 Allan S. Larsen (W9GRC), Box 335, Chapman, Kans.
 Robert Ochs, 315 Burch Hall, S.S.S.S., Wahpeton, No. Dak.—radio parts and apparatus.
 M. Berthelot, 21 Avenue Maurice, Maeterlinck, Brussels, Belgium—especially amplifiers, cathode ray, mikes, etc.
 E. L. Radin, c/o L. O. & T. Co., Ltd., Orumba, Dutch West Indies.
 S. A. Shelton, Box 1674, Westwood, Calif.
 Karl Tetzner, Leipzig—N 22, Gohliserstr., 40, Germany.
 A. S. Groom, Red Deer, Alta., Canada
 R. K. Wittenberg, Box 2543, Reno, Nev.

B Supply for Exciting Dynamic's Field

A dynamic speaker field exciter. This consists merely of a 25Z5 rectifier, with large capacity filter. A small B choke usually is included. Two output posts permit exciting two speakers, although the total drain should not exceed 100 milliamperes for this tube. There is practically nothing to the wiring, and the photograph amounts to a "blueprint."

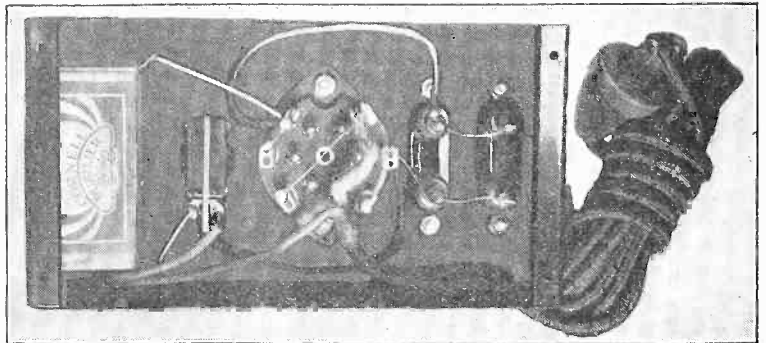

(Continued from preceding page)

Really, if the generator is very accurate he does not need to know the station frequency, but it is well to divide the generator frequency into the station frequency to get the harmonic order, and if it comes out other than a whole number, divide the station frequency by the nearest whole number, and then the generator frequency is accurately known.

Now turn the receiver until other beats are picked up with stations of known frequency, preferably working as near as practical at the lower frequency part of the set dial (530-1,000 kc). These beats seldom are zero, and when finite can be identified as equaling the difference between the generator frequency and the frequency the generator would have to be at to establish zero beat with the new stations.

Now for Low Notes

In this way, by putting the audio beat oscillator outputs into a detector to which is also fed the audio frequency from the receiver, the two may be compared, preferably not aurally, but by meter observation when the two are equal and the needle deflects most, in one direction or another. So numerous frequencies are obtained, although low ones will not be found, except in rare instances.

However, the a.c. line may be used then. With a large stepdown, transformer ratio, use the low voltage side for input to the separate detector, a few volts at most, and work the audio beat oscillator into the same detector, again using the meter. Some frequency formerly found that was a multiple of 60 or thereabouts would be splendid, especially if the line frequency is off a bit. Then it could be measured on the known part of the calibration for what it is, and as each successive needle kick is noted, in conjunction with dial setting, the known line frequency is deducted until one reaches the last response. This will be equal to the line frequency, and while not the end of the dial, it is so close to it that values lower than 60 may be ignored as non-calibratable.

If no check is possible on the line frequency, perhaps some arrangement may be made with the power company, so that a phone call to

the right person when you are making your run will get you the exact information you want.

A Poser for the Learned

The frequency is always close to 60, but not always close enough for precision calibration work. Still, if the assumed 60 cycles curve points check well with the others, as to smoothness of curve, no irregularities or "sharp turns," 60 cycles may be accepted as right, especially as the device shown in the diagram is not usually capable of the highest order of accuracy.

In connection with the radio frequency portion of the circuit, a little problem will be presented that may get a rise out of the reader. Since two tubes are to oscillate at the same time, and since the grid windings may be connected oppositely, that is, comparable ends of different coils to ground and grid, suppose then that the tickler were common, as in the second diagram. The plates then are common. The phase in the tickler L2 is right for oscillation in both grid circuits. There is no catch in the bare theory of that. Now, the question is, will the circuit work? If so, why? If not, why not? Think it over but don't lose any sleep over it.

LITERATURE WANTED

- Russell Beck, 956 Nobleshire Road, Cleveland Heights, Ohio.
 Harold Becker, 9418 Avenue A, Brooklyn, N. Y.
 S. Arthur Reynolds, 35 First St., Stamford, Conn.—trade lit. pertaining to new apparatus and their uses.
 J. H. Cason, 211 Camp St., New Orleans, La.
 O. Brown, 57 E. 118th St., New York, N. Y.
 Fernand Levesque, Radio Operator, Charlesbourg, Que., Can.
 Wm. B. Fiedler, 439 E. 7th St., Moscow, Idaho.
 Sylvan Elencweig, 343 McKee Place, Pittsburgh, Pa.
 Allan S. Larsen (W9GRC), Box 335, Chapman, Kans.
 Robert Ochs, 315 Burch Hall, S.S.S.S., Wahpeton, No. Dak.—radio parts and apparatus.
 M. Berthelot, 21 Avenue Maurice, Maeterlinck, Brussels, Belgium—especially amplifiers, cathode ray, mikes, etc.
 E. L. Radin, c/o L. O. & T. Co., Ltd., Orumba, Dutch West Indies.
 S. A. Shelton, Box 1674, Westwood, Calif.
 Karl Tetzner, Leipzig—N 22, Gohliserstr, 40, Germany.
 A. S. Groom, Red Deer, Alta., Canada
 R. K. Wittenberg, Box 2543, Reno, Nev.

B Supply for Exciting Dynamic's Field

A dynamic speaker field exciter. This consists merely of a 25Z5 rectifier, with large capacity filter. A small B choke usually is included. Two output posts permit exciting two speakers, although the total drain should not exceed 100 milliamperes for this tube. There is practically nothing to the wiring, and the photograph amounts to a "blueprint."

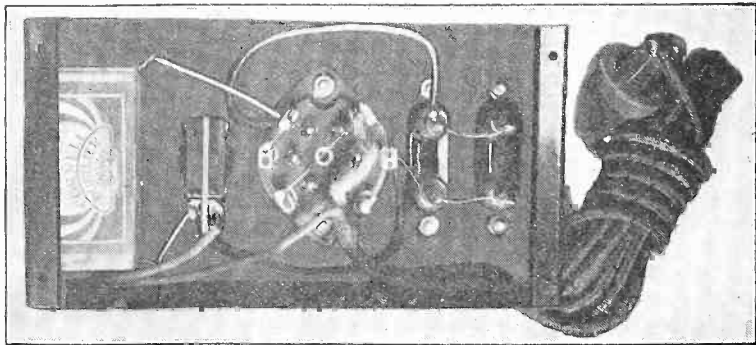

RADIO CONSTRUCTION UNIVERSITY

Answers to Questions by Readers on the Building of Radio and Allied Devices. Readers Should Address Questions to Radio Construction University, Radio World, 145 West 45th Street, New York, N. Y.

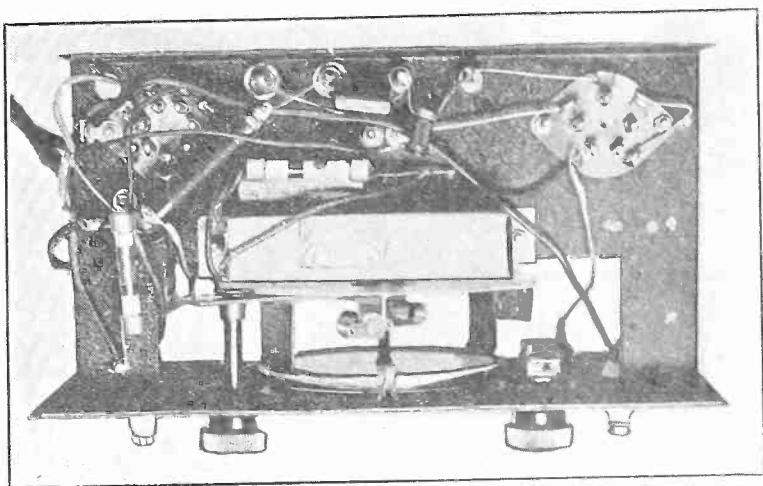

This is a more or less standard layout for a two tube universal transceiver, five and ten meter type, and may be followed in regard to the circuit covering this kind of set as described by Max Steir. See page 45.

Changing to Two Volt Tubes

IS IT practical to change six volt battery sets for use of two volt tubes, principally for purposes of current economy?—K. L. S.

Yes, this change can be made. If the six volt battery is to be retained, the voltage has to be reduced by four volts so that the resultant voltage across the filament will be two volts. Therefore the same external drop has to be introduced in all instances for inclusion of the six-volt source, but the current is not the same through the filaments of all tubes. Most of the tubes draw 60 milliamperes (.06 ampere), e. g., 1A6, 30, 32 and 34. Hence for these,

applying Ohm's law that the resistance in ohms equals the voltage in volts divided by the current in amperes, 4 divided by .06 equals 66 2/3 ohms. The 1C6 draws .12 ampere, hence requires half as much resistance, or 33 1/3 ohms. The 19 draws .26 ampere, as does the 33, requiring a limiting resistor of 15.4 ohms. The 31 draws .13 ampere, or half as much current as the 19 or 33, so requires twice as much limiting resistance, or 30.9 ohms. It is possible to use parallel filament connections for tubes requiring the same filament current and for

(Continued on next page)

A battery operated receiver, using plugin coils, for coverage of as great a frequency span as desired, although the performance is of not much merit if the frequencies are lower than the broadcast band. For 15-550 meters the circuit is all right, though just fair standard broadcast performance may be expected. Coil data on page 44.

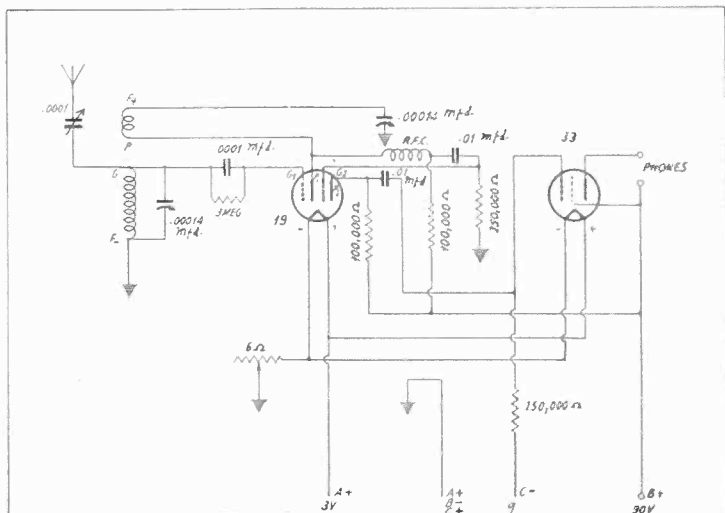

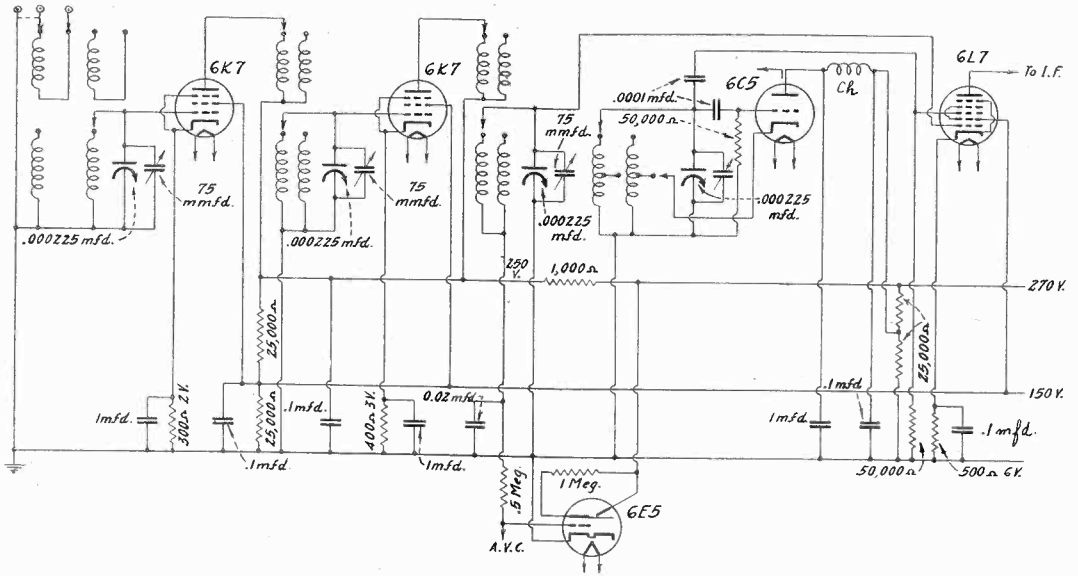

The 1,000 ohm resistor looking into the tuner level aids stability.

(Continued from preceding page)

two tubes use half, for three tubes use one third, etc., of the resistance required for one tube. In the same way tubes taking another equal current value may be combined. Likewise, since two-volt taps are present on the storage battery, limiting resistors may be omitted by connecting from the adjacent battery poles directly to filaments, regardless of the current requirements, as these are small compared to the normal battery capacity. To use all three cells some tubes may be fed from one cell, other tubes from the second and still others from the third. Another possibility, this one applicable only to tubes drawing the same filament current, three filaments may be connected in series across 6 volts, so that each filament gets 2 volts. If possible, the series method is to be avoided, as it introduces some inequalities, for instance the sum of the plate currents of three tubes passes through the fila-

ment of the tube closest to the minus A connection. Resistance shunting the filaments may be introduced to compensate for this. A more serious trouble is unwanted r. f. coupling thus introduced, hard to eliminate because the resistance across which it is developed is so low, and the bypass capacity has to be very large.

* * *

6C5 Connections

KINDLY let me have the diagram of the socket connections for the 6C5, giving the pin numbers of the tube in relation to the socket springs.—P. L. E.

The diagram is given herewith. There was a complete exposition of all the metal tubes, with characteristics, socket connections, and extensive technical analysis, in the October issue.

* * *

Series Resistor's Use

WHAT is the reason that a series resistor is so often noticed in the plate leg of a set where the voltage at the source is not higher than what the tubes can stand? I mean that if a tube as an r.f. or i.f. amplifier will take 250 plate volts, what is the sense of interposing a common series B resistor, to drop the voltage, say to 200 or thereabouts?—I. M. C.

The sensitivity is reduced very little by the voltage reduction, especially if the remote cut-off type tubes are used. But the resistor is included to serve as a filter in conjunction with a large capacity condenser. In that way r.f. amplifiers in supers often are quieted whereas otherwise they would oscillate. Also some aid against oscillation trouble at the i.f. level is served by the same means, applied to the i.f. tubes.

6C5

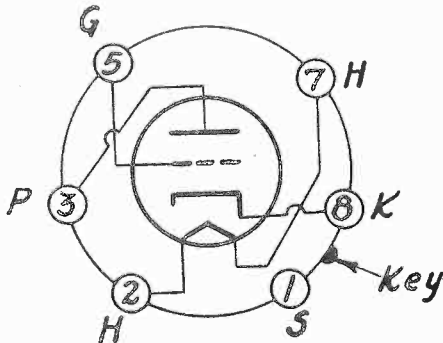

Bottom view of connections.

30-49 Transceiver

WILL you please show a diagram of a 30-49 transceiver, and give the values of the constants?

The diagram herewith gives the information you desire.

* * *

34 Generator

THE 34 may be used in an oscillator for measurement purposes, so will you please show the diagram?—K. L.

The circuit herewith may be used. There will be somewhat more hop to it this way, with the plate for feedback, because the coupling is tighter, yet if you want to isolate the generator more completely from frequency effect due to the load to which it is connected, you may use the screen for feedback and connect the potentiometer from plate to ground, output condenser to arm as it is. The output is taken from the screen, in the diagram, which is in the direction of isolation, as maximum that could be taken from the tube is not extracted, but of course there is plenty of oscillation strength, perhaps more than will be needed under most circumstances. The output coupling condenser may be increased almost without limit, if stronger coupling is desired.

* * *

Inductance Load

CAN an inductance be used as load for a high mu tube?—E. L.

Yes. This practice is growing. See diagram on next page.

(Continued on page 59)

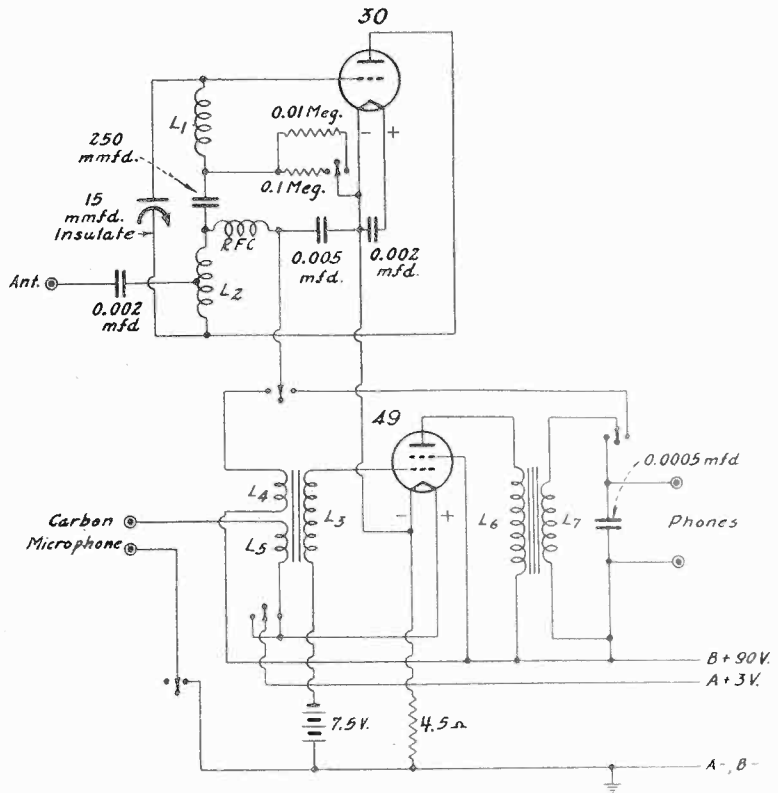

A "30-49" tube combination.

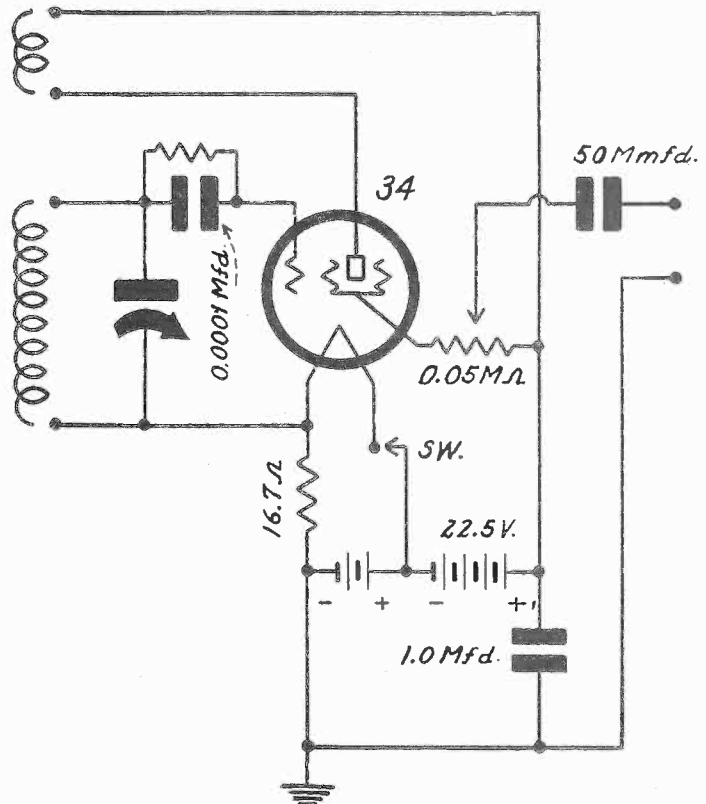

Plug-in coils in an oscillator.

High Inductance Load on Detector Plate

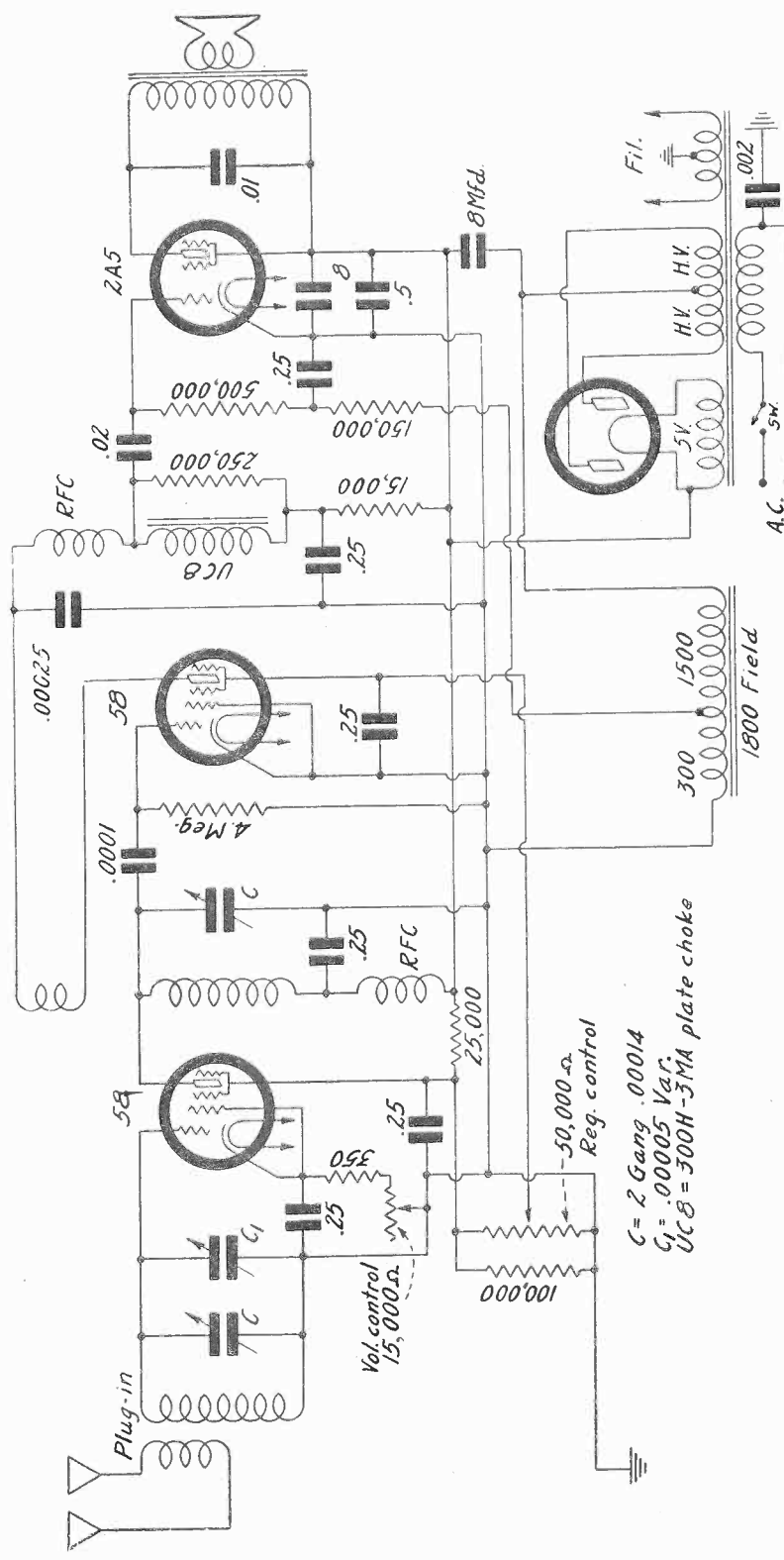

Whereas formerly high resistance plates of tubes, such as high mu tubes and particularly the screen grid tubes, were resistance loaded, because of the difficulty of getting a high enough inductance, now the practice is growing of using a high inductance in this position, as the products are available. The diagram of a four tube a.c. set, using plug-in coils, has a 300 henry load, for 3 milliamperes, but the tube draws much less, and the inductance at 1 ma may be 400 to 500 henries. Even chokes of a thousand henries are used nowadays.

RADIO UNIVERSITY

(Continued from preceding page)

Untuned Transformers

IS IT practical to use untuned transformers and get a very good gain over a very wide band of radio frequencies, even perhaps the all wave coverage so popular nowadays?—L. O.

The use of untuned transformers is scarcely better than resistance coupling at radio frequencies, because you get gain without selectivity improvement. By tuning you get both increased gain and increased selectivity, and the gain is much greater than when the untuned stage is used. In a strict sense the transformer will not be untuned, but will have a resonance period, even though perhaps broad, so that in this region the gain would be far greater than in regions far removed in frequency from resonance of the coil-distributed capacity circuit. So for some frequencies there might be a loss. It is possible, however, to set up a parallel circuit that will be resonant to all frequencies, if by resonance we mean that the reactance of the parallel circuit is made zero. The reactance, the opposition to current flow, is expressed in ohms, and is equal to $1/(\pi fC)$ for a condenser, and $2\pi fL$ for an inductance. It is distinguished from impedance, which is an expression of the current flowing at one frequency, hence the impedance takes in the reactance and the resistance. In a coil for radio frequencies the resistance may be sizeable. In a condenser the resistance may be negligible. So if a condenser is in parallel with a coil the resistances will be unequal, but they may be made equal, by insertion of external constants, and if these two effective resistances are equal to $\sqrt{L/C}$, then the condition of parallel resonance exists for all frequencies, since the reactance of the circuit is zero for all frequencies, moreover for all frequencies the circuit resistance is constant and is of course equal to the resistance of either branch. In operation, at low frequencies the condenser is a high impedance, the current through the condenser is small, but the current through the coil is large. The opposite holds true at very high frequencies. In between, the seesaw effect continues, and as the current phases are opposite, the reactance for all frequencies is zero.

* * *

Making Receiver "Supe"

IN a superregenerative five meter receiver that I have built, and for which I also have coils for the 10 meter band, I do not get the circuit to "super" at the very high frequency end of the five meter band, and not at the very low frequency end of the 10 meter band. Can you offer a suggestion?—L.M.

Since the effectiveness is inversely proportionate to the interruption frequency of oscillation, it is suggested that you lower the interruption

The ONLY TWO Companion Devices
for Reducing Noise on ALL Waves

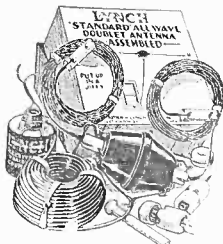

LYNCH HI-FI Assembled Antenna

All ready to hang. Saves 90% of installation time. Any novice can install it—quickly, easily, correctly. Makes every set perform better. Results are amazing.

LYNCH HI-FI
ASSEMBLED
ANTENNA **\$6.75**
list

NOISE REDUCING TWINS

LYNCH FILTERADIO

Cuts out objectionable noise from the light line. Makes interference from circuit breakers, motor generators, etc., practically negligible. Easy to install; simple to adjust. One type serves all purposes. **\$5.00**
list

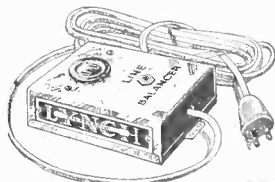

Be sure and see these NOISE-REDUCING TWINS at your jobber's or dealer's. If they cannot supply you, order direct. Write for folder.

ARTHUR H. LYNCH, Inc., 227 Fulton St., New York
Pioneer of Noise-Reducing Aerials

frequency, as this method should be particularly appropriate to the five meter band extreme that you mention. As for the other band, test if the stoppage of "suping" is below 28 mc, and if it is, the condition may be ignored, as lower frequencies are outside the amateur 10 meter band. Otherwise move the r.f. coil farther away from any metal objects.

* * *

Trap for Intermediate Frequencies

WILL you please tell me how I can introduce a trap to keep out the intermediate frequency now received directly, as there is code almost constantly coming in, and it appears to be on a carrier about equal to that of the i.f., so I suffer interference.—K.W.C.

One way of accomplishing this is to take an intermediate frequency transformer of commercial manufacture, intended for use at the frequency of your i.f. amplifier, and, using one winding only, wrap a few turns of an outlead from this winding around the grid lead of the transformer feeding the second detector. Conductive connection is avoided, notice. Ground the other terminal of this winding. Tune in a station and then adjust the condenser across the winding of the trap coil until the signal completely disappears. Then remove the i.f. transformer that is being converted into a trap and connect it between antenna and ground

(Continued on page 61)

QUICK-ACTION CLASSIFIED ADVERTISEMENTS

7 cents a word. \$1.00 minimum.

BUILD YOUR PROSPERITY WITH SELF HELP. Opportunities on smallest capital, no experience. Write A. ROMATKA, 25 West 3rd St., New York.

WANTED; ORIGINAL POEMS, SONGS for immediate consideration. MMM Publishers, Studio Bldg., Portland, Ore.

FILMS DEVELOPED—Any size, 25c coin, including 2 enlargements. Century Photo Service, Box 338, La Crosse, Wisconsin.

DEVELOPS YOUR OWN FILMS—PRINTS. Easy instructions. 10c. Larsons Laboratory, R-3410, North Avenue, Chicago.

A WEALTH OF RADIO KNOWLEDGE—Second Edition of "FUNDAMENTALS OF RADIO," 426 pp., 430 figures, by Prof. R. R. Ramsey. Revised, enlarged, reprinted, new cover. Price \$2.75, postpaid. Book Dept., Radio World, 145 W. 45th St., New York.

GIRLS! Marry the man, you want our book, "How to Win a Husband" will tell you how it's done. Will give you power to hold and win any man. Sent postpaid, 75c. Publishers Service Bureau, 76 Woodside Terrace, Springfield, Mass.

EXTRA! Car owners. Put this in your auto radiator and your winter troubles are over. It won't freeze at 40° below. Send 30c in coin. Freeze Not, Box 351, Oelwein, Iowa.

POSITIVE NOISE REDUCTION—SIMPLE. Tested. Booklet with complete drawings. 25c. Alworth, 757 Markle Marion, Ohio.

A Xmas Gift for HIM

Is your husband, son or nephew interested in radio? Why not send him RADIO WORLD for the coming year? We will send him a card so that he will receive it the day before Christmas telling him of your generosity and thoughtfulness. \$2.50 a year.

I. F. TRANSFORMERS for either 450-470 kc or 170-180 kc, primaries and secondaries tuned, 65c each. Audio Transformers, Silver Marshall, 1 - to - 1, @ 39c. Raco, 136 Liberty Street, New York City.

DIVORCES IN MEXICO

Ten days. Free information.

International Law Office, 441 First National Bank Building, El Paso, Texas.

PRACTICAL HOOKUPS WITH DATA

Illustrate unique method of headphone application to any receiver with output transformer, 15c.

HOWARD CHANDLER, R. R. 1, Ravenna, O.

WHEN WRITING TO ADVERTISERS
PLEASE MENTION THAT YOU SAW THE
ADVERTISEMENT IN RADIO WORLD.

STATEMENT OF THE OWNERSHIP, MANAGEMENT, CIRCULATION, ETC., REQUIRED BY THE ACT OF MARCH 3, 1933.

Of Radio World published monthly at New York, N. Y., for October 1, 1935.
State of New York, } ss.:
County of New York, }

Before me, a Notary Public in and for the State and county aforesaid, personally appeared Roland Burke Hennessy, who, having been duly sworn according to law, deposes and says that he is the Editor of the Radio World, and that the following is, to the best of his knowledge and belief, a true statement of the ownership, management (and if a daily paper, the circulation), etc., of the aforesaid publication for the date shown in the above caption, required by the Act of Aug. 24, 1912, embodied in section 537, Postal Laws and Regulations, printed on the reverse of this form, to wit:

1. That the names and addresses of the publisher, editor, managing editor and business managers are: Publisher Hennessy Radio Publications Corp., 145 West 45th St., N. Y. C. Editor, Roland Burke Hennessy, 145 West 45th St., N. Y. C. Managing Editor, Herman Bernard, 145 West 45th St., N. Y. C. Business Manager, Roland Burke Hennessy, 145 West 45th St., N. Y. C.

2. That the owner is: (If owned by a corporation, its name and address must be stated and also immediately thereunder the names and addresses of the stockholders owning or holding one per cent or more of total amount of stock. If not owned by a corporation, the names and addresses of the individual owners must be given. If owned by a firm, company, or other unincorporated concern, its name and address, as well as those of each individual member, must be given.) Hennessy Radio Publications Corp., 145 West 45th St., N. Y. C. Roland Burke Hennessy, 145 West 45th St., N. Y. C.

3. That the known bondholders, mortgagees, and other security holders owning or holding 1 per cent or more of total amount of bonds, mortgages, or other securities are: (If there are none, so state.) None.

4. That the two paragraphs next above, giving the names of the owners, stockholders, and security holders, if any, contain not only the list of stockholders and security holders as they appear upon the books of the company but also, in cases where the stockholder or security holder appears upon the books of the company as trustee or in any other fiduciary relation, the name of the person or corporation for whom such trustee is acting, is given; also that the said two paragraphs contain statements embracing affiant's full knowledge and belief as to the circumstances and conditions under which stockholders and security holders who do not appear upon the books of the company as trustees, hold stock and securities in a capacity other than that of a bona fide owner; and this affiant has no reason to believe that any other person, association, or corporation has any interest direct or indirect in the said stock, bonds, or other securities than as so stated by him.

5. That the average number of copies of each issue of this publication sold or distributed, through the mails or otherwise, to paid subscribers, during the months preceding the date shown above is..... monthly magazine (This information is required from daily publications only.)

ROLAND BURKE HENNESSY

(Signature of Editor.)

Sworn to and subscribed before me this 30th day of September, 1935.

(Seal.)

ELIZABETH ANSBACHER.

Notary Public, New York Co., No. 68. Reg. 6A144. My commission expires March 30, 1936.

Note.—This statement must be made in duplicate and both copies delivered by the publisher to the postmaster, who shall send one copy to the Third Assistant Postmaster General (Division of Classification), Washington, D. C., and retain the other in the files of the post office. The publisher must publish a copy of this statement in the second issue printed next after its filing.

RADIO UNIVERSITY

(Continued from page 59)

the same way as it was connected before, this time wrapping the few turns of the outlead around the antenna wire or lead inside or outside the set, grounding the other end of this winding, but not molesting the condenser across it. Then, ground one terminal of the other winding of the i.f.t., and when the interference is heard, tune the condenser across this other winding until the interference disappears. If desired, the second winding may be ignored, but in that case when the single winding is connected between antenna and ground as stated, a slight readjustment might have to be made of the condenser across the already tuned winding. Very critical adjustment must be expected in any instance, but once made need not be changed.

* * *

Padding Superheterodynes

WILL you please give me some good approximation method for establishing the proper inductance required for padding circuits, particularly broadcast and higher frequencies in a superheterodyne?—L.M.

The problem is easiest for the frequencies higher than those of the broadcast band, but the method is the same, and so you may apply it as follows: Knowing the tuned-in extremes of the broadcast band frequencies, you know the frequency ratio, which is the highest divided by the lowest frequency. Add the intermediate frequency to these terminal values and now divide the lower into the higher frequency for the new ratio, which will be a smaller ratio always, in practice. Square the two ratios. Suppose the frequency ratios were 3:1 and 2:07. The squared terms would be 9 and 4.2849, call it 4.3. Knowing the maximum capacity of the condenser, allow 30 mmfd. for the total capacities of coils, switches, tube, etc., and therefore for a condenser of 350 mmfd. use the value 380 mmfd. To ascertain the minimum, divide by the capacity ratio, 9, which is always the square of the frequency ratio, so the minimum is taken as 42.2 for r.f. Since the oscillator frequency will be higher, we can assign a slightly smaller minimum, say, 40 mmfd. for the oscillator, the maximum of which has to be 40 x 4.3, or 172 mmfd. Thus the inductance may be computed (or read from charts printed in the book, "The Inductance Authority"), since the capacity and frequency are known. Taking the broadcast band, to strike 533.3 kc (the figure resulting when 1,600 kc is divided by 3), add the oscillator i.f. (say, 465 kc), and the low frequency needed is 998.3 kc. Add or subtract not more than 4 kc to make the number convenient, so here we may use 1,000 kc, and the required inductance is 155 microhenries, and the series capacity required for padding is $(380 \times 172) / (380 - 172)$, or about 315 mmfd. The minimum capacity of the condenser should not be added to the maximum capacity at any time, and this was not done above, because the minimum applies to only one setting, so-called "zero" setting. By the same

(Continued on page 64)

It's a WOW!

Four Tube Universal Circuit Designed by Our Mr. Jack Goldstein. Send for particulars.—Radio Design Co., 98 Park Place, New York City.

BOOKS By JOHN F. RIDER

Sent Postpaid at Quoted Prices.
Remit With Order.

MANUALS

- VOL. V.** Sets manufactured up to October, 1934, with data on older models, hitherto unavailable. Data on more than 940 models—not only electrical data, but also mechanical information. 1,200 pages.....\$7.50
- VOL. IV.** Sets manufactured up to March, 1934, including complicated superhets with QAVC noise gates, duo-diode pentodes, automatic tone controls, and all the other new designs. A special 24-page section explains some complicated sets. 1,060 pages.....\$7.50
- VOL. III.** Sets manufactured between the middle of 1932 up to June, 1933. Superheterodyne receivers were introduced in this period. 1,070 pages.....\$7.50
- VOL. II.** Sets manufactured early in 1931 and the middle of 1932. Data on sets manufactured before 1931 that were unavailable when Volume I was published. 800 pages.....\$6.50
- VOL. I.** Sets manufactured between 1919 and 1931. Majority of the old receivers. 1,000 pages.....\$7.50

Specialized Auto Radio Manuals

- VOL. I.** Sets manufactured up to September, 1933. General installation instructions and servicing hints in special section. 350 pages.....\$3.50
- VOL. II.** Sets manufactured September, 1933, to April, 1935. All the installation instructions, as issued by manufacturers, are given along with the usual servicing data. 410 pages.....\$3.50

[No Duplication in Any Manual]

Other Books for Servicemen

- The Cathode-Ray Tube at Work.** 336 pages. Over 450 illustrations.\$2.50
- Servicing Superheterodynes.** A comprehensive and easily understood explanation of this most widely used circuit, which every serviceman should read. The subject is thoroughly covered and will mean dollars in your pocket in time saved in shooting trouble. 288 pages.....\$1.00
- Servicing Receivers by Means of Resistance Measurement.** Take the guesswork out of servicing by using an ohmmeter in your diagnosis. The method explained fully in this book represents the logical solution to radio servicing problems. 203 pages.....\$1.00
- VOLS. I, II, III, IV and V of "Manuals"** give circuit of diagrams of commercial receivers, eliminate guesswork in servicing, save time. **VOL. VI** is in preparation. It will be the greatest Manual that Rider has ever published. In it will be data on the new metal-tube sets of all the prominent manufacturers, as well as data on receivers which have not previously been published. New, oversized pages will be used to show those schematics which have 16 to 25 tubes, so that all the information will be easily read and found. An index covering all six volumes of Rider's Manuals will enable you to find any data you need in an instant. Order now for shipment immediately on publication. 1,250 pages.....\$7.50

[No Duplication in Any Manual]

BOOK DEPARTMENT

RADIO WORLD 145 W. 45th St.
New York, N. Y.

Books Sent Postpaid at Quoted Prices.
Remit With Order.

NEW! "RACO" PORTABLE SIGNAL GENERATOR

1% Accuracy

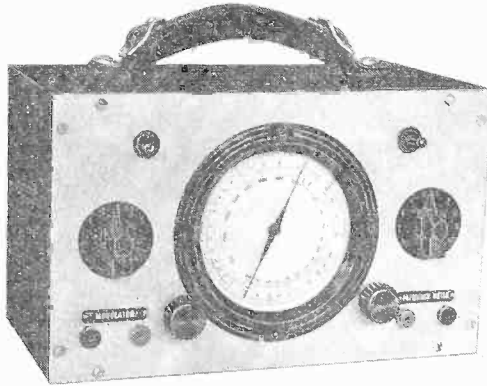

Direct Reading Airplane Dial

The latest product of Radio Constructors Laboratories, Model 339-B Signal Generator, operated from self-contained batteries. The frequencies, 53 kc to 16,800 kc, are direct reading, all on fundamentals (no harmonics used). The modulation frequency is continuously adjustable. Two 30 tubes are used.

EIGHT OUTSTANDING FEATURES!

- (1)—Frequencies are direct reading to an accuracy of 1 per cent., using Raco's own calibrated dial and precision inductances, and a precision variable condenser.
- (2)—Radio frequency output has an attenuator that does not molest the frequency generated, no matter where the attenuator is set. This attenuator allows selection of radio frequency output voltage from maximum to minimum.
- (3)—A tone is impressed on the radio frequency generated, or not, as you prefer, to allow for both methods of alignment. A throw of a switch introduces or removes the tone.
- (4)—The audio frequency generated may be continuously varied over a wide range, by adjustment of a control marked in arbitrary graduations, 1 to 10. This advantage of selection of any frequency within the audio range of the modulator circuit enables introducing a tone that can be distinguished from any interfering beat due to poor selectivity of a receiver, hence enables measurement though interference.

- (5)—Besides the radio frequency output jacks, there are separate jacks for the audio frequency output, and since this audio frequency may be adjusted over a wide range, tests may be made of response characteristics of audio amplifiers.
- (6)—Stabilization of the radio frequency oscillator is established by proper constants of grid leak and condenser, aided by the effect of the r.f. output attenuator, a series resistance in the plate circuit.
- (7)—Stabilization of the audio frequency, and independence of the audio frequency from any setting of the radio frequency tuning condenser, are effected by a large capacity across the grid winding of the audio oscillation transformer.
- (8)—Modulation is constant, about 50 per cent., when introduced in the r.f. oscillator, double peaks are thus completely avoided, where otherwise present due to the distortion of overmodulation, and the audio oscillation is stabilized.

The Model 339-B Portable Signal Generator is contained in a handle-equipped black wrinkle finish shield cabinet, the front panel finished in "Raco Wrinkle Illuminite," and is supplied wired, complete with A and B batteries, two 30 tubes, r.f. attenuator, variable audio frequency control, selector switch, r.f. and a.f. output jacks, and "Frequency Meter" and "Modulator" nameplates. (Shipping weight, 11 lbs.).....

\$15^{.10} NET

RADIO CONSTRUCTORS LABORATORIES

136 LIBERTY STREET

Dept. RW

N9W YORK, N. Y.

Telephone: REctor 2-3247

Universal 5 & 10 Meter Receiver

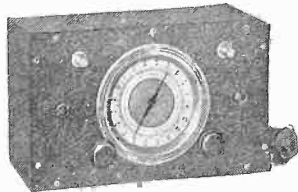

Here again Raco triumphs in introducing a complete A.C.-D.C. operated 5 & 10 meter receiver only. This extremely efficient receiver is recommended to amateur beginners as well as the professional ham. The super regenerative circuit consists of 1-12A7 pentode rectifier and 1-76 detector tube.

Due to perfect layout and circuit design absolutely no hum is encountered when listening in on the latest dope and signals.

- Complete Kit of Parts.....\$7.95
(including both 5 & 10 meter coils)
- Wired and Assembled..... 2.00
- Crystallized Cabinet 1.00
- Kit of Matched Tubes..... 1.00
- Wiring diagram and instructions with each Kit.

All Electric 2-Tube Transceiver

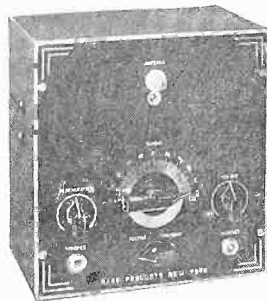

For the ham or beginner looking for a permanent installation, completely A.C. operated, we recommend this 3 in 1 balanced combination transceiver. The tubes used are 1-6A6 dual purpose triode, 1-80 rectifier. Absolutely humless when working 5 and

10 meter bands. Extremely sensitive, and extraordinary long tuning and receiving range.

- Complete Kit of Parts.....\$8.95
- Wired and Assembled..... 2.00
- Crystallized Cabinet 1.50
- Kit of Tubes..... 1.10
- Wiring diagram and instructions with each Kit.

A.C.-D.C. 5 Band (15-550) Metal Tube Switch Receiver

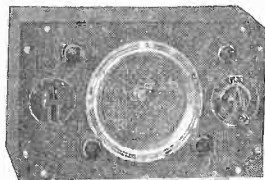

Only Raco can give you such value. No more plug in coils. No more groping for that elusive coil socket. Easy to

make, easy to tune. All band switching done by the new Raco all-wave unit. Covers all broadcast, police, amateur and foreign short-wave bands. The new all-metal tubes used are 2-6K7, 1-MG43, 1-MG2525 in a perfectly symmetrical layout for high efficiency. Latest in our laboratory design—switch coils—metal tubes—A.C.-D.C. operated—built in dynamic speaker.

- Complete Kit of Parts, Including Dynamic Speaker and Crystallized Cabinet.....\$10.95
- Wired and Assembled..... 2.50
- Matched Kit of Tubes..... 2.35
- Wiring diagrams with each Kit.

3-Tube Battery Operated Transceiver
Raco Presents

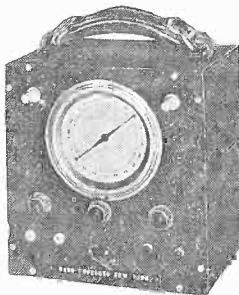

This powerful, portable unity coupled combination super regenerative transceiver for the 56 to 60 M.C. This unit is capable of maintaining communications up to 100 miles, depending on localities. Tubes used are 2-19 dual purpose and 1-30 as the output. Batteries required are 2 No. 6 dry cells and 3-45 volt B batteries.

The result of years of experience in circuit and layout design have been incorporated in this go-getter rig.

- Complete Kit of Parts.....\$10.95
- Assembled and Wired..... 3.00
- Crystallized Cabinet 1.50
- Kit of Matched Tubes..... 1.65
- Wiring diagram with each Kit.

One Tube (19-Tube) Transceiver

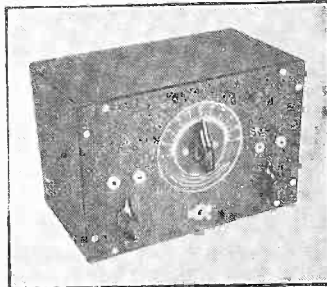

An inexpensive 1-tube 5 and 10 meter transceiver. This extremely efficient transceiver is recommended for the short-wave enthusiast who is interested in exploring the fascinating 5 and 10 meter bands. This circuit utilizes the type 19 two volt twin tube, and is ex-

ceedingly sensitive since the super regenerative principle is employed, when the receiving position is switched on. Batteries required are two 1½ volt dry cells and 90 to 135 B supply. Complete kit, \$4.75. Cabinet, 75c. 10 meter coil, 50c. Wiring, assembly, \$1.50. Tube, 65c.

Raco "True Fidelity" Allwave Switch Super

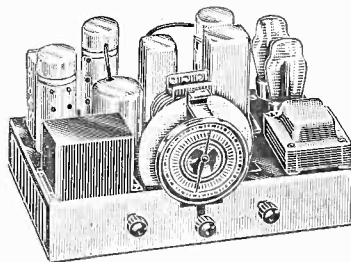

Here we present the ideal superhet—one that you can assemble in your home in an evening—it's fun to build and you will thrill at the astounding performance. Build the Raco way and you

save money and headaches. A true fidelity super using 6A7—1st det. and osc. 78 as IF amplifier, 75 as 2nd det. and 1st audio, 42 as power stage, 80 as rectifier. All band switching done by the new Raco all-wave unit. Covers all broadcast, police, amateur and foreign S.W. bands. Complete coverage 15-550 meters.

- Complete Kit, Including Wiring Diagram and Hardware\$15.95
- Laboratory Wired and Tested.....extra 3.75
- Matched Dynamic Speaker.....extra 2.95
- Matched Set of R.C.A. Lic. Tubes..... 3.25

**RADIO CONSTRUCTORS
LABORATORIES**



**136 LIBERTY STREET
Dept. RW, New York, N. Y.**

RADIO UNIVERSITY

(Continued from page 61)

method all other bands may be computed. It is not necessary, however, to assign a smaller capacity to the oscillator. It is customary to have the oscillator minimum higher than the r.f. minimum capacity, that is, by trimmer adjustment. So if a minimum of 50 mmfd. total is ascribed the results for the broadcast band would be obtained as follows: Minimum is 50 mmfd. but includes minimum of condenser, which immediately disappears, so maximum is taken as condenser capacity plus 40 mmfd., that is, 10 mmfd. minimum is ascribed to the condenser alone. So 350 plus 40 mmfd. equals 390 mmfd., total minimum and as the capacity ratio is to be 4.3, the maximum would be 4.2×50 or 215 mmfd. The inductance required for 215 mmfd. and 1,000 kc is 115 microhenries, and the series padding condenser required to reduce the 390 mmfd. to 215 mmfd. is $(390 \times 315) / (390 - 315)$ or about 480 mmfd. For the broadcast band the capacity of the padder is always adjustable. In general it is

well to keep in mind that as the bands become higher in frequency the oscillator inductance required comes closer to the r.f. inductance, and the series padding condenser must be larger, until for some bands it is required to be so large it may even be omitted, although around .003 to .007 mfd. are used at times.

* * *

Simple Capacity Measurement

WILL you kindly let me know if there is any method by which, with the use of a certain inductance, it is possible to measure capacity in connection with known frequency, without elaborate computation?—C. L.

If you will wind an inductance of 253.3 microhenries and tune it with a variable condenser, the capacity in microfarads will equal 100 divided by the square of the frequency in kilocycles. The frequencies for nearly all uses will fall in the broadcast band. Example: frequency is 500 kc. Square that, equals 250,000. Divide into 100, equals .0004 mfd. If the capacities are known, the frequency squared (kc) equals 100 divided by the capacity in mfd.

RADIO FIELD SERVICE DATA AND ANSWER BOOK

(Supplement to "Modern Radio Servicing")
by A. A. GHIRARDI and B. M. FREED

A hardy time-saving reference data book, 240 pages, 41 illustrations, for service men to keep in their tool kits. Data for use on the job, such as listing of intermediate frequencies of over 3000 models of superhets; comprehensive Trouble Shooting compilation of Symptoms and Remedies for troubles in over 750 models of broadcast and all-wave receivers; remedies for ignition interference in various makes of cars (with electrical diagrams of all cars); complete tube charts; wire tables; RMA Color Codes; and a comprehensive collection of other useful charts, diagrams and tables. Price, \$1.50

SPECIAL OFFER: Supplement Book in combination with MODERN RADIO SERVICING, \$5

MODERN RADIO SERVICING

(2nd Revised and Greatly Enlarged Edition of Radio Servicing Course)
by ALFRED A. GHIRARDI

JUST RELEASED. The greatest text ever published on Radio Servicing. 1300 pages, 706 illustrations, hundreds of practical facts on the most up-to-date methods, construction and operation of all kinds of equipment; servicing of all forms of receivers; auto radio, all wave, high fidelity, locating and eliminating noise and interference; special servicing problems; construction and use of new Cathode-Ray Oscilloscopes for aligning superhets.

Written in clear, simple style.
Price, \$4.00



Coil Winding Made Easy

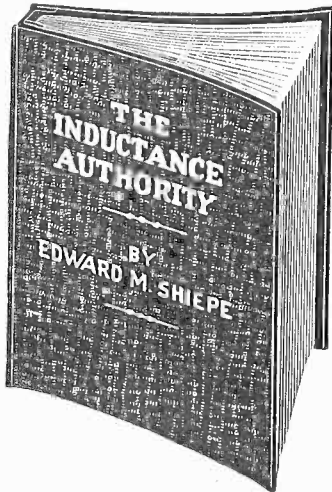

The biggest help anyone can get who desires to wind radio-frequency coils for any frequency from just below the audio range to the fringe of ultra frequencies is to have a book that tells just what inductance is required for the condenser one possesses, and just how many turns of any kind of wire on any sensible diameter are needed to produce that inductance. "The Inductance Authority," by Edward M. Shiepe, gives you all that information, to an accuracy of 0.1 per cent. Send \$2.00 and book will be mailed you postpaid; or send \$5.00 for a two-year subscription for Radio World and this valuable book will be sent free.

RADIO WORLD

145 WEST 45TH STREET, NEW YORK CITY

A HIT AS A MONTHLY SPECIAL 2-FOR-1 OFFER

RADIO WORLD

The How-To-Make-It Magazine.

In Its New Monthly Form.

Radio World is \$2.50 a year (12 issues), 25c per copy. Canada and foreign, \$3.00 yearly. Offers of Radio World and other worthwhile publications for one full year on each, (NET):

- RADIO WORLD and SHORT-WAVE CRAFT, \$3.50.
- RADIO WORLD and POPULAR SCIENCE MONTHLY, \$3.50.
- RADIO WORLD and RADIO-CRAFT (12 issues) \$3.50.
- RADIO WORLD and RADIO INDEX (monthly, 10 issues) stations, programs, etc., \$3.50.
- RADIO WORLD and SERVICE (monthly) \$3.50.
- RADIO WORLD and EVERYDAY SCIENCE AND MECHANICS (monthly) \$3.50.
- RADIO WORLD and BOYS' LIFE (monthly, 12 issues) \$3.50.
- RADIO WORLD and MOTION PICTURE MAGAZINE (monthly) \$3.50.
- RADIO WORLD and MOVIE CLASSIC (monthly) \$3.50.
- RADIO WORLD and PICTORIAL REVIEW (monthly) \$3.00.
- RADIO WORLD and SCREENLAND (monthly) \$3.50.
- RADIO WORLD and TRUE STORY (monthly) \$3.00.
- RADIO WORLD and LIBERTY (weekly) \$3.00 U. S. only.

Select any one of these magazines and get for an entire year by sending in a year's subscription for RADIO WORLD at the regular price, \$2.50, plus a small additional amount, per quotations above. (Add \$1.50 for extra foreign or Canadian postage for both publications.)

Name

Address

City and State

- If renewing an existing or expiring subscription for RADIO WORLD, put cross in square.
- If renewing an existing or expiring subscription for other magazines, put cross in square

Special Trial Offer for Radio World only: \$1.00 for 5 months, postpaid. Mail order with remittance to Radio World Office. NET.

RADIO WORLD, 145 W. 45th St., New York

NOW! H. G. Cisin's METAL TUBE ALL ELECTRIC AIR SCOUT

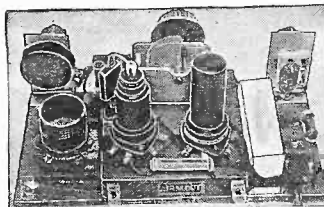

Rear View Showing New Metal Tubes

Only Set of its kind in the world

Pat. Pending U. S. Serial No. 592,586. Operates on A.C. or D.C. Self-Contained Power Supply.

POWERFUL—Many Air Scout owners report reception from England, Germany, Spain, Rome and other foreign stations. Wonderful short wave reception. Broadcast reception on indoor aerial. Police calls, code, aeroplane and Trans-Atlantic phone conversations. **NEW METAL TUBES—GREATER SENSITIVITY.** Four plug-in coils cover 10 to 200 meters. Extra coils for Broadcast Reception, also special Long Wave unit. Operates several headsets simultaneously. Speaker on strong stations.

Complete, Assembled Kit, with Instructions and picture diagram, and all four short wave coils, ready to wire..... **\$3.95**

| | | | |
|-------------------------------------|--------|-----------------------------|--------|
| Set of Matched Metal Tubes | \$2.50 | Broadcast Coils (Two) | \$1.45 |
| Special Long Wave Unit w. Coil..... | .95 | Earphone (Single) .. | .50 |
| Total | | \$9.35 | |

Special Combination Offer—Assembled Kit, metal tubes, 7 coils including Long Wave Unit, earphone

Above, Custom-Built. Wired and Laboratory Tested, ready to use, \$1.00 extra.

H. G. CISIN, Chief Engineer, Allied Engineering Institute Dept. RW-1 98 Park Place, New York, N. Y.

METAL CHASSIS

We can supply chassis for any make receiver, experimental or otherwise.

Inquiries should be accompanied with sketch and complete details enabling us to give quick service as to prices and delivery.

KORROL MFG. CO., Inc. Dept. R.W.-36
232 GREENWICH ST. NEW YORK CITY

When writing to advertisers, please mention Radio World.

P. A.

PRINCIPLES of PUBLIC ADDRESS SYSTEMS

A practical handbook, full of useful information, fully illustrated, written by M. N. Beitman, an engineer and noted authority on audio amplifiers.

Considers in detail two-button and condenser microphones, radio and phono input, acoustic feed back, mixing and volume controls, use of vacuum tubes, interstage coupling, power amplifiers, output coupling, loud speaker placement, the decibel, P.A. measurements, power level, and other points of importance, including actual circuit diagrams of P. A. systems. (Size, 8 1/2 x 11 in.)

Either book, price only 50c, post free.

MATHEMATICS of Radio Servicing

Introduces and explains the use of arithmetic and elementary algebra in connection with units, color code, meter scales, Ohm's Law, alternating currents, ohmmeter testing, wattage rating, series and parallel connections, capacity, inductance, mixed circuits, vacuum tubes, curves, the decibel, etc., etc., and has numerous examples.

Plainly written and easy to understand. Only useful data included. M. N. Beitman, author. Size, 8 1/2 x 11 in.

SUPREME PUBLICATIONS

3727 WEST 13th STREET CHICAGO, ILLINOIS

CONTENTS OF MONTHLY ISSUES OF

RADIO WORLD

MAY NO., 1935

Metal Shell Tubes—By Conrad L. Morrow.
 More Gain from New Tubes—By Harry Miller.
 Try a Whisk Broom on Your Soldering Iron—
 By Jack Tully.
 Plain Talk on Aerials—By Connie Andover.
 Boondoggling.
 Alignment, All Levels—By Martin A. Gobin.
 Getting the Harmonic Habit—By Albert J. Pierce.
 Armchair Portable—By J. C. Wall.
 Tuned Radio Frequency Set with Pentode or
 Triode Output—By Henry L. Maks.
 Portable for All Waves—By Tom Bidwell.
 What Air Condensers Do—By John Braden.
 What Pep—By Jack Sullivan.
 Neon Gadgets—By Will Ellington.
 B-u-z-z-e-r—By Leon Wolf.
 Organizing A Meter—By B. M. L. Ferris.
 Fundamentals Most Useful—By Herman Bernard.
 A Filter for High Fidelity—By Sidney Wald, E.E.
 Radio University.

JUNE NO., 1935

Illus. features in that issue: Coil Switch Assembly
 —Ultra Frequency Measure with Photocell and
 Lamp—Seventh Metal Shell Tube—Pin Numbering
 on Octal Bases—Finding CX Easily—Equal Gain
 on T.R.F.—A Beat Oscillator—High Fidelity Tuning—
 It's the Set, not the Car—New Police Radio—
 Car Sets on Peak Road—False Alarms with Universal
 Sets—Dual Range Super—Wave Trap Does
 the Trick — Measuring Low Resistance — Three
 Tube S.W. Set—An Effective Transceiver—A Battery
 Signal Generator—War on Static Succeeding
 —Circuits We Print Readily Duplicated—Straight
 Frequency Liner—The Velocity Microphone, etc.,
 etc.

JULY NO., 1935

Illus. features in that issue: Television in
 Natural Colors—Technique for 'Phone Tip Soldering—
 T.R.F. Tuner Made High Grain—A 5 Meter
 Sending Aerial—Getting Things Into Places Where
 They Don't Fit—A Four Tube Portable—A Transmitter
 Class \$750—The Saturated Pentode—A Service
 Wand for Light—A Marine Radio Compass—
 VTVM Capacity Meter—Pretuned I. F. Amplifiers
 —Compact Four Tube Set—Neon Tube's Average
 Current, etc. Radio University Dept.,—Harmonic
 Practice for Calibrating or Checking a Generator—
 Articles by Capt. V. O'Rourke, Herman Bernard,
 J. E. Anderson, Louis Pouy, Jack Goldstein,
 Harvey E. Sampson, B. Herbert Russ, Earle
 Branker, etc., etc.

AUGUST NO., 1935

Illus. features in that issue: An Electron Ray
 Indicator, Ultra Wave in Wall Street; Graphic
 Help to Constructor; Shield Effect on Inductance;
 All Hail the Grid Leak; Receiver Detuning Avoided;
 Short Wave Converter Factors; How to Use the
 New Tubes; An Experimenter's Super 4; High
 Fidelity R.F. Tuner; Television on Six Meters;
 The Thyatron Tube; Radio Construction University:
 Articles by Neal Fitzalan, J. E. Anderson,
 Herman Bernard, Lionel Rivers, Arthur H. Lynch,
 Morris N. Beitman, L. M. Loughboro, S. G.
 Bradley, Maxwell M. Hauben, etc. etc.

25c a Copy. \$2.50 Yearly in U. S. Include as part of New Subscription if you wish.

RADIO WORLD

145 WEST 45th STREET

NEW YORK CITY

SEPTEMBER NO., 1935

Illus. features in that issue: Television Race
 Gets Hotter—RCA and Philco Negotiating for
 Coaxial Line—Farnsworth Demonstrates Progress
 in Television—The Multivibrator—Short Wave
 Battery Portable Circuit—Power Amplifier Taxes
 Ingenuity—Correct Ohmmeter Practice—Highly Accurate
 Resistance Formula—Underwriters' Rules
 For Transmitters—6B5, Most Interesting Tube
 Since Variable Mu—Utilizing an Old Console—
 Filter Design and Application—Small Rectifiers for
 B Supply—High Fidelity Power Amplifier—
 Diode-Amplifier Tube in T.R.F. Set—Directional
 Transmission; How Applied to Ultra Waves—
 New Balanced Detector—Radio University—A 5
 Meter Pilgrim's Progress. Articles by Arthur H.
 Lynch, J. E. Anderson, Herman Bernard, Neal
 Fitzalan, Morris N. Beitman, Herbert E. Hayden,
 George Dubuc, etc.

OCTOBER NO. 1935

Illus. features in that issue: 23 pages devoted
 to the latest facts and figures in the development
 of the Metal tube, with illustrations that help to
 tell the story of this important new angle of 1935
 radio; A Hum Banished T.R.F. Set, by J. E.
 Anderson; A 5 Meter Transmitter, by Arthur H.
 Lynch; Signal Generator Circuits; Is Television
 Really Good as This?, by L. W. Wheaton; The
 "High" 12, by Samuel Miller; Insight into Radio
 for Laymen, by Herbert E. Hayden; "Avoiding
 Mistakes With A.V.C.", by Barclay Forrest; Try
 This Trick With Diode, by Edward C. Sturgis; A
 Precision Tuning System, by Herman Bernard;
 Ship's Hull Used for Talking; Radio University,
 etc.

NOVEMBER NO. 1935

DeLuxe Five Meter Transceiver, with circuit diagrams,
 photographic illustrations and layout plan;
 very efficient, the kind of rig the police use.

Making Conventional Tubes Oscillate Down to
 One Meter. A complete article, dealing with generators,
 5 to 1 meters.

Balanced Detector Circuits. The so-called push-pull
 detector reduced to practice, enabling non-reactive
 coupling. Great stuff for high fidelity enthusiasts.
 Five pages of intensely interesting discussion of this
 fascinating subject.

11-Tube Broadcast Superheterodyne, the utmost in
 selectivity and sensitivity, the kind of circuit that
 suits the most discriminating radioists.

A Small Universal P. A. System, for use with
 carbon microphone, using only two tubes.

A Precision Rotary Protractor. Device constructed
 on an airplane dial, for measuring angular displacements,
 as in calibrating frequencies and capacities.

Two Portables for Battery Operation. One is a
 superheterodyne, for broadcast band, other a
 regenerative circuit for all waves.

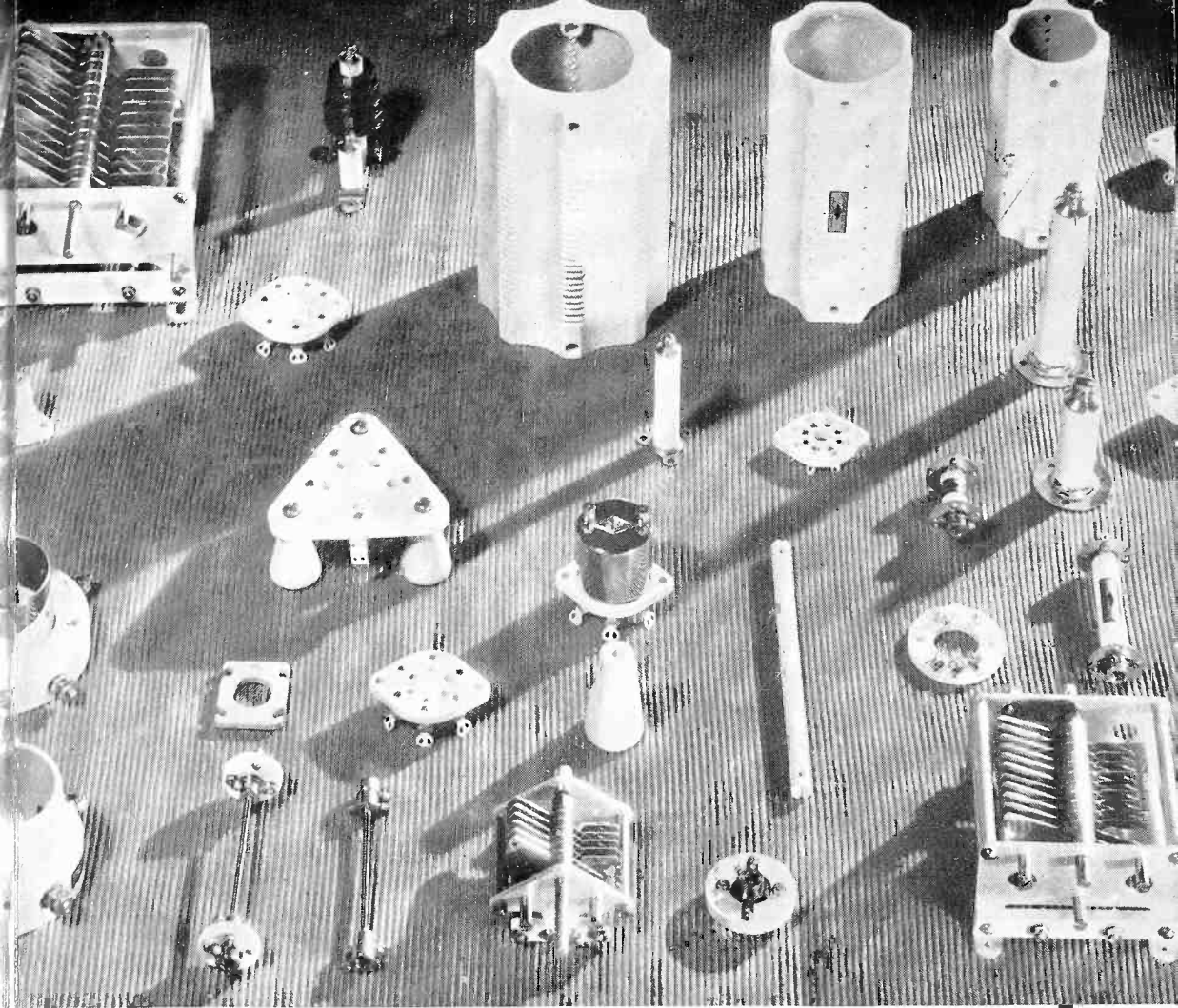

• National offers a thoroughly engineered part for nearly every radio purpose. The entire line cannot be compressed into our twenty-page catalogue, much less a single page. But look over the group above. Transmitting condensers from the little 1000 volt TMS in the foreground to the 12,000 volt TMA at the rear. Low loss ceramic coil forms for every amateur band. Low loss sockets for nearly every tube type, from acorns to power pentodes. Flexible couplings from the little TX-12, which will work around a corner, to the big fellows for heavy condensers, high voltages, and low-losses. Strain insulators, spreaders, lead-ins for the antenna; stand-offs, chokes, dials for the rig. National has what it takes.

NATIONAL  COMPANY

3.00

NEW

Readrite

SET TESTERS

MODEL 710-A

This popular three meter Set Tester checks all parts of radio tube circuits by plugging directly into the receiving set socket.

Dealer net. **\$16.50**
Price only



Readrite

Meters and Testers, Like Tools, Must Fit the Needs of the User

Where reliability is desired at low cost, turn to Readrite—all Readrite merchandise is built rugged—it will stand up—it will give dependable performance over a long period of time.

OTHER PRODUCTS

Readrite manufactures all types of testers used for servicing Radio Sets, including Set Testers, Tube Testers, Resistance, Continuity and Capacity Testers, Point-to-point Testers and inexpensive Indicating Meters.

SEE YOUR JOBBER

RELIABILITY AT LOW COST

Handles set using either glass or glass-metal tubes.

D.C. Voltmeter scale reads 20-60-300-600;
D.C. Milliammeter scale 15-150, and
A.C. Voltmeter scale 10-140-700.

A special positive contact selector switch connects all D.C. circuits to the D.C. voltmeter. Panel jacks are provided to make individual range connections for the three meters.

Complete with instructions, resistance and capacity tests charts, and necessary accessories.

Model 710-A—Complete in Black Leatherette Covered case. Dealer Net Price. **\$16.50**

Model 712-A, same as Model 710-A, but with Triplett Moving Coil Model 223, 2" D.C. voltmeter having 1000 ohms resistance per volt, and scale reading 15-60-300-600. Dealer Net Price **\$22.20**

THIS COUPON BRINGS FACTS

READRITE METER WORKS

2712 College Drive, Bluffton, Ohio

Please send me full information on Model 710-A.

Readrite Complete Set Tester Catalogue.....

Name

Street Address

City..... State.....

