

SEPT.
30th
1933

DO YOU KNOW HOW TO SOLDER?

15 Cents
Per
Copy

RADIO

REG. U.S. PAT. OFF.

WORLD

The First and Only National Radio Weekly

601st
Consecutive
Issue



Twelfth
Year

PHOTOTUBE CALIBRATION

—
DISTORTIONLESS RELAY
TO PREVENT OVERLOAD

—
5-TUBE A-C
SHORT-WAVE SET

—
NON-REACTIVE AUDIO

SET STRESSES TONE QUALITY

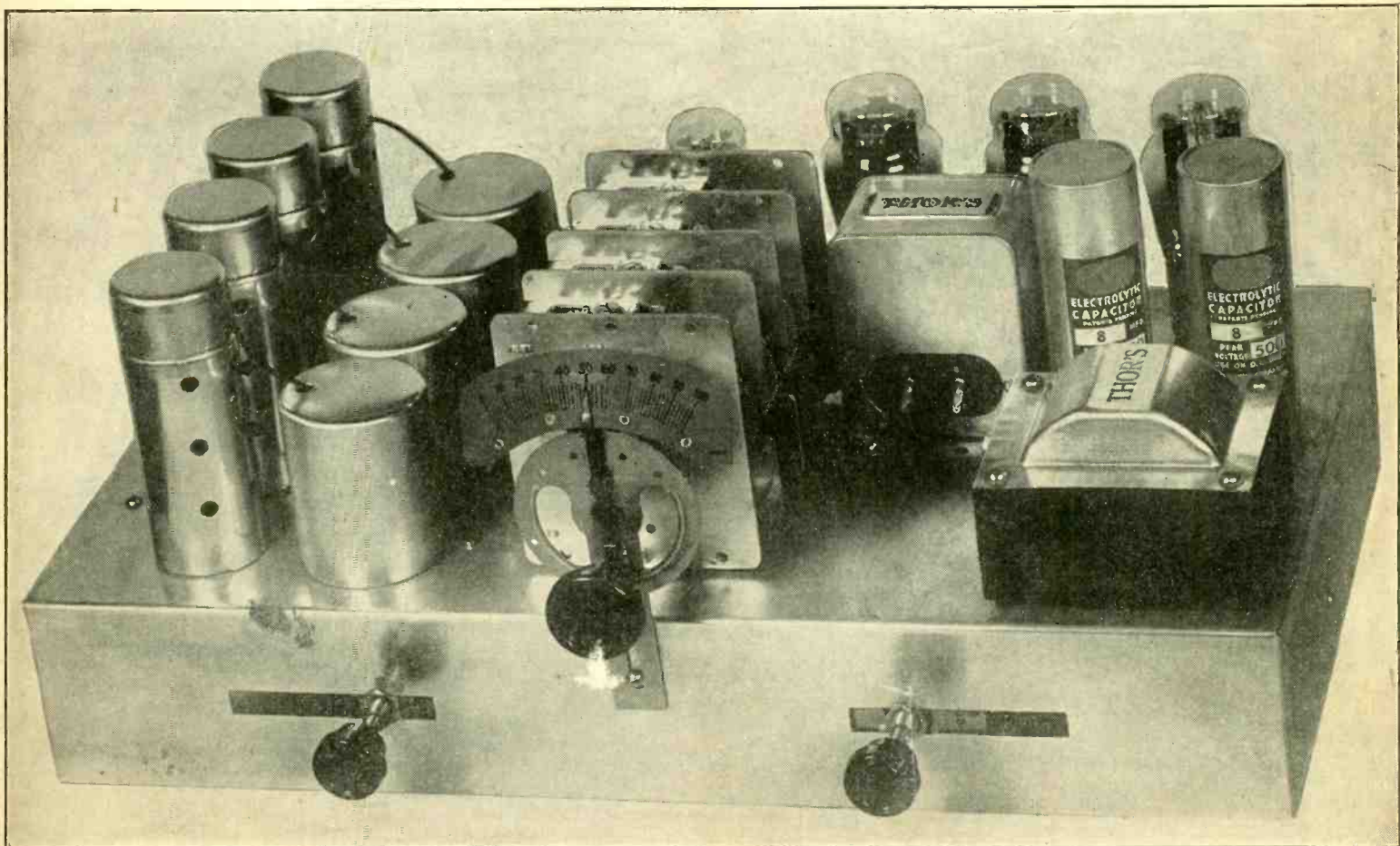

A set designed for quality of reproduction. It is a tuned radio frequency design, with four-gang condenser and well-filtered circuits. The detector is a 57. The output is 45's in push-pull, driven by a 56.

See pages 12 and 13.

The "THOR" BLUE EAGLE

as described in this issue of Radio World

"Modernized 1934 A.C. T.R.F."

UNCHALLENGED TONE SUPREMACY

Kit of complete parts including DRILLED CHASSIS—ACCURATELY \$17.75
DESIGNED—ALL PARTS TO BUILD and Dynamic Speaker

Using 2-57, 2-58, 1-56, 2-45, 1-80

SET ON DEMONSTRATION

FREE DIAGRAM

MAIL ORDERS FILLED

THOR'S BARGAIN BASEMENT

167 GREENWICH STREET

NEW YORK CITY

New Genuine Makalot S-W and B-C Coils

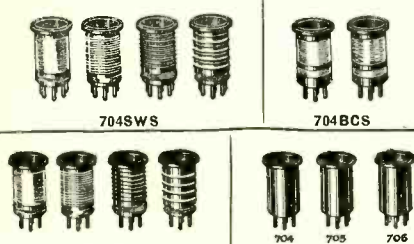

704SWS 704BCS

706SWS

704 705 706

Here are the new genuine Makalot wound coils and coil forms for your new S-W receiver.

704SWS—4-pin S-W Set.....	List \$2.00
704BCS—4-pin B-C Set.....	List 1.50
706SWS—6-pin S-W Set.....	List 3.00
704—4-pin Form.....	List 25c
705—5-pin Form.....	List 25c
706—6-pin Form.....	List 30c

Order your requirements today. Send for new Catalog Sheets showing how to modernize obsolete test equipment and how to use the new tubes in old sets.

NA-ALD
Mention Dept. W3
Alden Products Co., 715 Center St., Brockton, Mass.

SPECIAL SMALL POWER TRANSFORMER

Filament-plate transformer, for oscillators, 1 or 2-tube sets, etc.

Primary, 110 volts a-c.

Secondary A, 2.5 volts, center-tapped; stands up to 3 amperes.

Secondary B, 110 volts, not center-tapped.

Excellent for test oscillators with a-c in plate.

Price, \$1.10

RADIO WORLD
145 West 45th Street New York, N. Y.

115 DIAGRAMS FREE

115 Circuit Diagrams of Commercial Receivers and Power Supplies supplementing the diagrams in John F. Rider's "Trouble Shooter's Manual." These schematic diagrams of factory-made receivers, giving the manufacturer's name and model number on each diagram, include the MOST IMPORTANT SCREEN GRID RECEIVERS.

The 115 diagrams, each in black and white, on sheets 8 1/2 x 11 inches, punched with three standard holes for loose-leaf binding, constitute a supplement that must be obtained by all possessors of "Trouble Shooter's Manual" to make the manual complete.

Circuits include Bosch 64 D. C. screen grid; Balkite Model F. Crosley 20, 21, 22 screen grid; Eveready series 50 screen grid; Eria 224 A. C. screen grid; Peerless Electrostatic series; Philco 76 screen grid.

Subscribe for Radio World for 3 months at the regular subscription rate of \$1.50, and have these diagrams delivered to you FREE!

Present subscribers may take advantage of this offer. Please put a cross here to expedite extending your expiration date.

Radio World, 145 West 45th St., New York, N. Y.

ANDERSON'S AUTO SET

Designed by J. E. ANDERSON

FOREIGN RECEPTION ON 6-INCH AERIAL

This new auto set is the most sensitive ear receiver we have ever come across. Mexican and Canadian stations were tuned in from New York City on a 6-inch aerial. The circuit, an 8-tube superheterodyne, with automatic volume control. The complete parts, including set chassis and set shield, battery box, remote control, battery cable, all condensers, resistors and coils, speaker with shielded cable, and a kit of RCA tubes (two 259, two 236, two 237, one 89, and one 85), are supplied less aerial. Cat. 898-K @ \$34.86

Wired model, licensed by RCA, with complete equipment, less aerial, but including RCA tubes. Cat. 898-W \$37.40

Hennessy Radio Pubs. Corp.
145 West 45th St. N. Y. City

WAFER SOCKETS

6/32 mounting holes, 1-11/16 inches apart, central socket hole recommended, 1 3/4 inches, although 1 1/4 inches may be used.

UX, with insulator.....	10c
UY, with insulator.....	10c
Six-pin, with insulator.....	11c
Seven-pin, with insulator.....	12c

HENNESSY RADIO PUBS. CORP.
145 WEST 45TH STREET, N. Y. CITY

PADDING CONDENSERS



Either capacity, 50c

A HIGH-CLASS padding condenser is required for a superheterodyne's oscillator, one that will hold its capacity setting and will not introduce losses in the circuit, for losses create frequency instability. The Hammarlund padding condensers are of single-condenser construction on Isolantite base, with set-screw easily accessible, and non-stripping thread. For 175 kc. intermediate frequency use the 850-1350 mmfd. model. For i-f. from 460 to 365 kc., use the 350-450 mmfd.

0.0005 HAMMARLUND S. F. L. at 98c.

A sturdy, precision straight frequency line condenser, no end stops. The removable shaft protrudes front and rear and permits ganging with coupling device, also use of clockwise or anti-clockwise dials, or two either side of drum dial. Front panel and chassis-top mounting facilities. True straight line. This rugged condenser has Hammarlund's high quality workmanship and is suitable for precision work. It is a most excellent condenser for calibrated radio frequency test oscillators, any frequency region, 100 to 60,000 kc., short-wave converters and adapters and TRF or Superheterodyne broadcast receivers. Lowest loss construction. rigidity: Hammarlund's perfection throughout.

Order Cat. H05 @98c net

Reliable Radio Co., 143 West 45th Street, New York, N. Y.

LAPEL MICROPHONE



A single-button carbon-granule lapel microphone, impedance 200 ohms, requiring 4.5-volt excitation, of good frequency characteristics, and both handy and inconspicuous. Outside diameter, 1 3/4 inches. The case is chromium-plated brass. The excitation may be provided by introducing the microphone in a cathode circuit carrying around 20 to 25 milliamperes, or a 4.5-volt C biasing battery may be used. Net price, \$2.95.

RELIABLE RADIO COMPANY
145 West 45th Street, New York, N. Y.

SOLDERING IRON FREE!

Works on 110-120 volts AC or DC, power, 50 watts. A serviceable iron, with copper tip, 5 ft. cable and male plug. Send \$1.50 for 13 weeks' subscription for Radio World and get these free! Please state if you are renewing existing subscription.

RADIO WORLD
145 West 45th St. N. Y. City

RADIO WORLD AND RADIO NEWS. Both for one year, \$7.00. Foreign, \$8.50. Radio World, 145 W. 45th St., N. Y. City.

ROLAND BURKE HENNESSY
Editor

HERMAN BERNARD
Managing Editor

RADIO WORLD

The First and Only National Radio Weekly
TWELFTH YEAR

J. E. ANDERSON
Technical Editor

J. MURRAY BARRON
Advertising Manager

Vol. XXIV

SEPTEMBER 30th, 1933

No. 3. Whole No. 601

Published Weekly by Hennessy Radio Publications Corporation, 145 West 45th Street, New York, N. Y.

Editorial and Executive Offices: 145 West 45th Street, New York

Telephone: BR-yant 9-0558

OFFICERS: Roland Burke Hennessy, *President* and *Treasurer*; M. B. Hennessy, *Vice-President*; Herman Bernard, *Secretary*.

Entered as second-class matter March, 1922, at the Post Office at New York, N. Y., under Act of March 3, 1879. Title registered in U. S. Patent Office. Printed in the United States of America. We do not assume any responsibility for unsolicited manuscripts, photographs, drawings, etc., although we are careful with them.

Price, 15c per Copy; \$6.00 per Year by mail. \$1.00 extra per year in Foreign countries. Subscribers' change of address becomes effective two weeks after receipt of notice.

THE DISTORTIONLESS RELAY

D-C Amplifier Tube Alters Plate Voltage to Meet Requirements of Signal and Bias

By Wayne L. Hemstreet

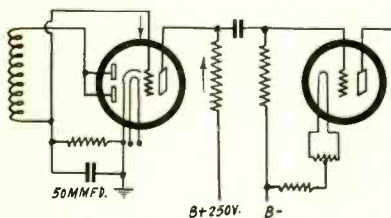

FIG. 1

This circuit is open to two troubles: low signal intensities respond distortedly and high signal intensities saturate the triode of the tube at left. The other tube is the power tube. At any instant at left the signal voltages in grid and plate circuits are opposite in their direction

A SHORTCOMING of the diode rectifier as used in receivers to-day is that at low signal intensities there is considerable distortion. The curves of the diode alone do not confirm this, but the condition exists nevertheless. Thus, a volume control connected anywhere ahead of the diode would introduce this distortion no matter what station was being heard, provided the volume was reduced sufficiently.

Associated with the diode is a triode or other amplifier tube, which even may be in the same envelope. The normal diode may be operated up to about 20 volts of rectification, without overload, but any triode, other than a power tube, would then be overloaded, no matter how connected.

Suppose that grid leak and stopping condenser were used for developing the pulsating value of the rectified carrier across the triode grid. The negative bias would have to be 21 volts on the driven tube. At 21 volts all the triodes will distort badly, excepting power tubes, during most of their operating conditions, for the input would be about 5 volts of signal, as an average, or an effective bias of the difference, 16 volts, which is still too much. The pentode and high run associates in duo-diode tubes take biases of around 1.5

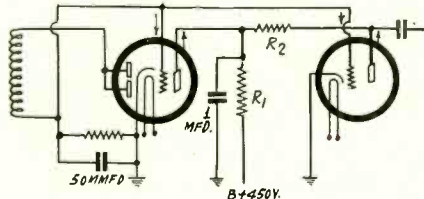

FIG. 2

A cure for saturation of the driven tube, as devised by the author. The triode in the tube at left is used as a d-c amplifier. R2 is the plate load resistor of the driven tube. At high signal intensities the B voltage applied to R2 is highest. There is a very wide swing. This is the distortionless relay

to 3 volts. They would be badly overloaded. Distortion therefore is inevitable.

Diode-Biased Triode

Suppose a diode-biased triode is used, as in Fig. 1. Cathode is grounded. The grid is directly connected to the coil return. The signal current flows in the direction denoted by the arrow, in the grid circuit let us say from top to bottom. The equivalent plate circuit direction at the same instant is from bottom to top, as the tube reverses the phase practically 180 degrees.

Since the negative bias is equal to the signal, the diode section of the 55 has a negative bias of perhaps 20 volts when loudest locals are tuned in. While the rectifier will just about stand this without distortion, though 17 volts would be safer from a distortionless consideration, certainly the triode will not.

The plate current is reduced as the signal increases, and in a practical circuit biases developed by the diode in excess of 15 volts nearly cut off the plate current, hence result in operation on a distorting portion of the tube's characteristic curve. The operation is that of a squelch circuit working in the wrong direction, that is, a strong signal input to the diode-biased triode will

stop the amplification, instead of a no-signal input stopping it.

Both Ends in Trouble

Hence there are two serious objections, one the failure of the diode properly to rectify at low signal voltages, the other the choking up of the following amplifier at high signal voltages. The troubles are at the extremes.

Both disadvantages may be removed. Naturally, if the signal input is too low the circuit ahead of the detector may be made more sensitive, until any audible station will deliver enough voltage to exceed the required threshold value. Automatic volume control should be used, as it is without much effect on weak signals, most effective on strongest signals, hence helps protect the driven triode from saturation while not interfering much with the sensitivity when weak stations are received.

If automatic volume control were fully effective perhaps no further remedy need be applied, but neither is it fully effective nor would it be practical to introduce so much of it that the loudest local could not saturate the diode, for then sensitivity would be so greatly reduced that only loud locals could be received.

Solution of Worse Difficulty

It will be noticed that the applied plate voltage does not change when the bias changes, because the bias is derived from the signal and is independent of the B supply, in Fig. 1. There would be no saturation current if the plate voltage were high enough, and it might be 350 or 400 volts, but what would be the current through the triode at 400 volts and little or no negative bias? Some 30 milliamperes in the case of the 55, the normal operating condition of which is 8 milliamperes.

For weak and medium signals a plate voltage of 100 would be fully adequate, while for loudest signals some 300 to 400 volts would be acceptable, and if we could introduce some system that would change the plate voltage in the right direction within the required general limits we would have a solution of the saturation difficulty also.

The solution, original with the author, (Continued on next page)

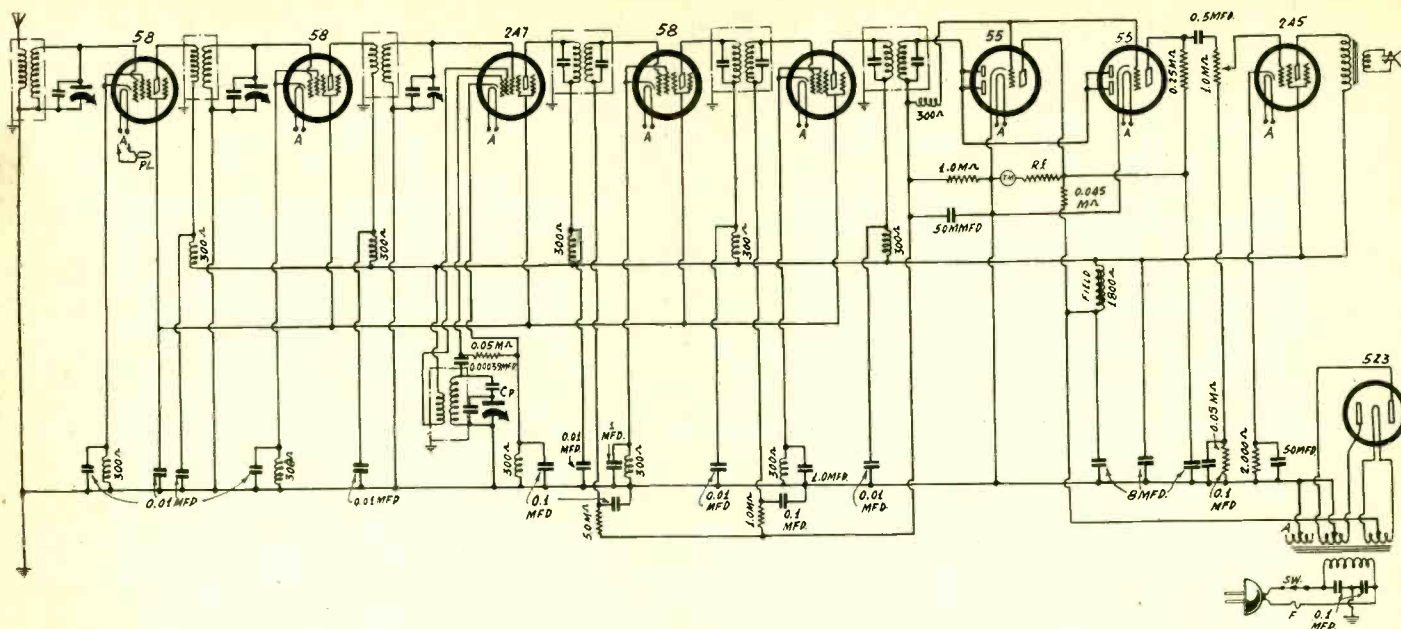

FIG. 3

Circuit designed by the author, including his distortionless relay. The automatic volume control can be only in the diode load or subsequent circuit, to prevent distortion of weak inputs. The choke coils designated by resistance values serve also as biasing resistors. The two intermediate stages are subject to full automatic volume control. A tuning meter may be connected in series with the d-c amplifier plate (0.25 ma) or used as shown as a voltmeter, with suitable limiting resistor, R1.

(Continued from preceding page)
is shown in Fig. 2. The input to the tube's diode and triode are the same as in Fig. 1.

Resistors and Condensers

The plate load resistor, R1, instead of being high, is made low, and across it is a bypass condenser at least large enough to remove the signal. It may be 1.0 mfd., but if the plate resistor is returned to a very high voltage, for many receivers this would necessitate connection to the filament of the rectifier, and 8.0 mfd. then becomes necessary for hum removal, since one is utilizing the voltage without benefit of choking by the B coil and of bypassing by the last condenser in the B supply filter.

The same condition of operation exists as before in the entire circuit associated with the left-hand tube, except that the signal has been removed from the plate circuit and the plate load resistor lowered. We have, in other words, a filtered d-c amplifier.

Now we are ready to drive another tube. We may connect the grid of the second tube to the grid of the first, as here again we desire only the signal. The plate load resistor R2 of the second tube, a high resistance, instead of going to B plus directly, goes there indirectly, through R1.

We have made R1 low, necessarily R2 is high, so that the plate current through R2 will be small. The effectiveness of the control is directly proportionate to the disproportion of the two resistors, assuming equal tubes.

200-Volt Swing

Now as the signal increases in the diode input coil the current increases in the diode load resistor, the signal voltage across that resistor increases, the grid of the left-hand tube becomes more negative, the current in the plate circuit of that tube decreases, and the voltage at the plate of that tube increases. In fact, since saturation takes place so early—meaning thereby reduction of plate current below utility to support modulation clearly—there will be a very wide swing in this plate circuit. For instance, with R1-25,000 ohms, returned to 450 volts, R2-250,000 ohms, the voltage at the juncture of the two resistors swung from 100 volts at no signal to 300 volts at maximum signal, during diode-rectified voltages of 0 to 15 volts.

Since it is not difficult to maintain excellent quality as far as the diode, even unto its output, and since the limiting factor on continuation of this desired condition is direct voltage, and the innovation provides voltages that vary directly with the signal to prevent distortion, one may call the new device a distortionless relay. The object of the relay is to keep up the good work of excluding distortion. Since every vacuum tube in the set is a relay, the term also includes the tube at left in Fig. 1, because enabling operation of its triode without distortion, a condition not otherwise practical.

No Overloading Now

When the distortionless relay was introduced there was no overloading at high volume levels, even though strong locals developed diode-rectified voltages of 15 to 17 volts. These voltages easily could be increased simply by increasing the value of the diode load resistor, and since the tube was near its maximum condition of satisfactory operation, the two diodes are tied together to double the current-handling capacity. In fact, if the tube at right in Fig. 2 is also a 55, then the four diodes may be paralleled, and still more put into the combination without danger of saturating the tube. Expressed in volts, the rms a-c input may be 60 volts or so, an unlikely quantity in practice, before the diode would be overloaded. However, there is no ready way to use so much rectification of carrier, since that would require a plate voltage of around 1,000 volts applied to R1. With 400 volts applied to the plate resistor R1 the diode rectification may be 20 volts, and with 350 applied may be 17 volts, without danger of distortion.

It is unfortunate that the splendid diode detector, the best detector we have, should have associated with it and with the tube it drives, two troubles that cause so many sets to sound harsh and repelling.

What Causes Rectifier Trouble?

The saturation by rectification of high signal voltage is readily understood, but the distortion at low input levels of the diode is not so obvious. It may be due to flow of grid current which is present in heater type tubes when the bias is below 0.8 negative. Grid current would flow through the diode load resistor and thus act as a time delay, preventing rectification, until this voltage

was overcome. The condition would exist whether non-reactive or reactive coupling were used, as in either case there is the high resistance grid load with continuous current path. The theory of the cause is stated by the author though not believed by him, for when an actual time delay by a 3-volt cathode self-bias was introduced, when there could be no grid current at input values of 1 and 2 volts signal, the trouble still endured, indicating that it is concerned with the rectifier alone, or that the triode is a distorting amplifier at low voltages.

The triode's plate current-plate voltage curve shows that for 0 bias, between 0 and 25 plate volts, there is a bad hump, in the upward direction, or opposite to the general contour of the rest of the curve, the current changing from 4 to 36 microamperes, whereas for the next 25 plate volts it changes from 36 to 46 microamperes, and so on upward in plate voltage. Of course the bias in practice does not constitute zero, but for small inputs it is close enough to zero to be within the danger area of the curve, and anything, including grid current, that delayed the rectification would simply shift the trouble but not cure it or reduce it in any way.

2A5 and 2A3 Outputs

The distortionless relay is used in a receiver, Fig. 3. The circuit has been worked out very carefully, to insure highest standards of performance. During the experiments automatic volume control was omitted, then added, and when added caused the sensitivity to be reduced so that a 2A3 output tube had to be replaced by a 2A5 to restore the original kick. In fact, the pentode output tube made with the circuit more sensitive than it had been without a.v.c. and with the 2A3 output tube.

There is no danger of overloading the system anywhere ahead of the 2A5, therefore the volume control is in the grid circuit of the power tube.

It has been explained why it is bad practice in such a circuit to have the control ahead of the detector, so it would have to be in the diode load circuit or in the pentode grid circuit, and if the distortionless relay is used, location in the pentode grid circuit appears preferable, as the danger of scratchy sounds when turning the volume control knob is minimized, because dis-

(Continued on next page)

VOLTAGE VALUES

For Non-Reactive Audio Channels

By Einar Andrews

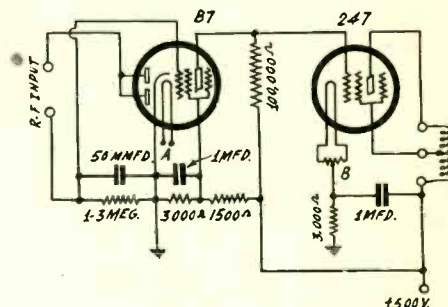
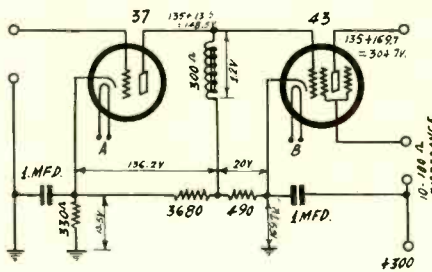
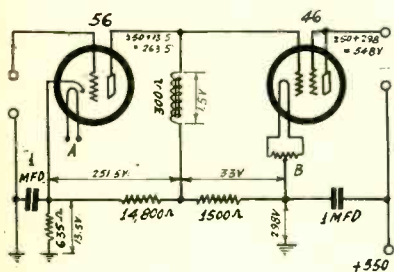

THE Loftin-White type amplifier has been popular ever since it was first brought out, and many variations and adaptations of the original circuits have been published. For the three designs given in this article we are indebted to Ariel D'Angelo, of Toronto, Canada. These circuits have been worked out carefully, and we have the assurance of the designer that they function as they should.

We admit tampering with the diagrams slightly, but not with the design. All we have done is to rearrange the voltage values a little. This does not involve any actual change in values, since we have done nothing to the designs that would change values.

It is not to be supposed that all these values would be duplicated exactly, for there are too many variations in tubes and other parts to make this likely. However, they would be duplicated accurately enough to make any circuit function, since a considerable deviation is quite permissible.

Examination of Design

Let us consider the first circuit, which consists of a 56 and a 46, the second being operated as a Class A amplifier. First the 56 is given a bias of 13.5 volts by means of a 535-ohm resistor. This assumes a total current of 22 milliamperes, which is the current in the plate circuit of the power tube. This current is divided so that 5 milliamperes flow through the 56 and 17 milliamperes through 14,800-ohm bleeder. The effective voltage on the plate of the 56 is 250 volts. Allowance has been made for a 1.5-volt drop in the choke load on the 56 tube.

The total bias on the 46 power tube is 33.5 volts, which is obtained from a 33-volt drop in a 1,500-ohm resistor and a 1.5-volt drop in the choke load on the 56 tube.

The total effective voltage provided for the plate of the 46 is 250 volts. Thus the total voltage measured between the plate of this tube and ground is 548 volts.

The diagrams of the three direct-coupled amplifiers designed by Ariel D'Angelo. The third is especially interesting because in the manner negative grid bias is provided for the power tube.

This is only two volts less than the indicated voltage supply and does not leave much for the load impedance on the output tube. This can be compensated for by increasing the voltage supply, and the best way is to increase it until the total current supplied the amplifier is 22 milliamperes. However, if the supply voltage is about 550 volts, there will be an automatic readjustment of the voltages all around the circuit.

Using Smaller Tubes

The second circuit is similar to the first but employs smaller tubes, the first being a 37 and the second a 43. The supply voltage in this instance is only 300 volts. By tracing out the various voltage drops as we did in the preceding case, we arrive at the result that the voltage between the plate of the power tube and ground is 304.7 volts, which is higher than the indicated supply voltage. As before, the supply voltage can be adjusted until the total plate current is that which is required by the 43 tube, or 41 milliamperes. This should be measured so as to include the screen current.

Or, as before, about 300 volts may be applied and then let the various voltages readjust themselves.

A Non-reactive Circuit

It will be noticed that the screen and the plate return are brought out to different points on the load impedance. This is a feature which the designer has found to be particularly advantageous. The manner in which the screen is brought out to the load impedance is more clearly indicated in the third circuit. Here the screen is connected to the center tap

of the primary of the transformer.

The third circuit is somewhat different from the other two in that the first tube also functions as a diode detector. The control grid of this tube, a 2B7, is diode-biased. Hence this bias need not be taken into account in considering the voltage distribution.

The pentode section of the 2B7 is operated with a comparatively high screen voltage. Of the 500 volts applied, 333 volts are sent to the screen and the entire 500 volts put in the plate circuit. However, the effective plate voltage is very low because of the drop in the 100,000-ohm load resistance.

When Current Flows

At first thought it appears that the bias on the 247 pentode is excessive, as there is a 3,000-ohm resistor between the filament and ground. If we assume a screen and plate current of 37 milliamperes, which is the rated value, then the drop in the resistor is 111 volts. This does not mean that the bias on the tube is 111 volts. It will be observed that the grid of the 47 returns to the highest voltage available. Therefore, if the 2B7 drew no plate current, there would be a positive voltage of 500 volts on the grid, measured from ground, or a positive voltage of 389 volts, measured from the cathode. The tube would not function under those conditions.

When current flows through the 100,000-ohm load resistance the situation is altered. The grid of the 247 now may be negative with respect to its filament. It all depends on which is the greater, the voltage drop in the 3,000-ohm resistor or the drop in the internal resistance of the 2B7. If the drop in the 2B7 is less than the drop in the 3,000-ohm resistor, the grid of the 247 is negative with respect to its filament.

For the sake of argument, we shall assume that the drop in the 3,000-ohm resistor is 111 volts. Assume now that the plate current in the 2B7 is one milliamperes.
(Continued on next page)

Resistance of R-F Chokes Used for Bias

(Continued from preceding page)

sociated completely from the intermediate level which, when keen, may respond to such scratching as modulation.

A screen grid tube was tried as the driven tube (58), with bad results, as at 50 to 150 volts on the screen the distortion was severe, unless the plate load resistor was reduced to 25,000 ohms, when there was not as much volume as from the 55 with 250,000 ohms. This had been a previous experience also with the 58 as a resistance-coupled

audio tube, so the rapidly changing plate voltage, with fixed screen voltage, probably had nothing to do with it. Perhaps if the screen were tied to the maximum B voltage, e. g., to the juncture of R2 and R1 in Fig. 2, or even to a higher voltage, the tube would be all right as audio amplifier, used in a new way, as a high-screen-voltage amplifier, somewhat like the output tube.

Increasing the gain ahead of the power tube by 3 would permit the use of a 2A3

output tube, and the substitution for the second 55 (at right) a 2A6 tube (high-mu diode-triode) would enable this change for those who prefer it.

The radio-frequency choke coils designated by resistance values represent chokes of no particular inductance, although of course it would be rather high, since they are wound instead to d-c resistance specifications, principally because some cathode legs required chokes, and if these coils had enough d.c. resistance for bias, an extra

PHOTOTUBE CALIBRATION

Light Intensity May Then Be Measured with the Lamp

By J. E. Anderson

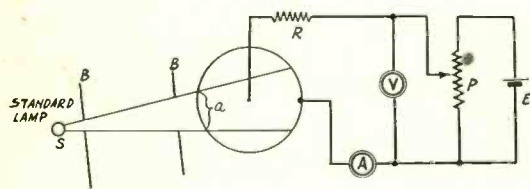

FIG. 1

An arrangement for taking characteristic curves on a phototube. A relation is found between the current and the light flux and is plotted.

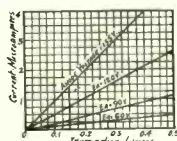

FIG. 2

Characteristic curves taken on a typical phototube by an arrangement such as that shown in Fig. 1.

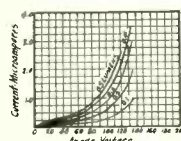

FIG. 3

Another set of curves showing characteristics of the phototube. The curves show the variation of current.

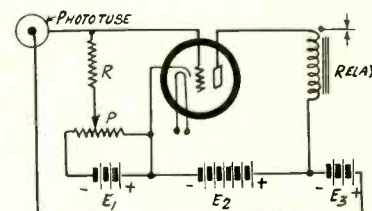

FIG. 4

This is a typical circuit showing how to use a phototube in connection with a vacuum tube and a relay.

THE photo-electric cell has now definitely joined the thermionic tubes in the radio experimenter's laboratory. The phototube is being put into radio circuits. But before it can be put into a circuit its characteristics must be known, just as the characteristics of a thermionic vacuum tube must be known before it can be used advantageously.

There are three ways of getting the characteristics of a tube. The first is to take them from the manufacturer. He supplies the average characteristics for a large number of typical tubes. The second way is to get the characteristics by experience with the tube, a method depended on by many experimenters who spurn more accurate methods. The third method is to run experiments with the tube in special set-ups, which yields accurate information about that particular tube, and it is valuable information.

Set-up for Phototube

Characteristics of phototubes can be obtained just as easily as those of the thermionic vacuum tube. Suppose we wish to know the relation between light flux and the electric current through the cell for a given anode voltage. We need, besides the cell to be measured, a standard lamp, a means for measuring distance accurately, a multi-range microammeter, a voltmeter, a voltage divider, a source of high steady voltage, a source of steady voltage for the lamp, a high resistance to constitute the load on the cell and a photometric box. The arrangement of all these devices is shown in Fig. 1.

A standard lamp can be obtained from scientific instrument houses. The manufac-

turer will supply the candle power of the lamp and the conditions of operation that will give this candle power. For example, he will specify the filament current at which the lamp should be operated if it is to give the rated candle power. This current must be adjusted accurately, for a slight change in the current will produce a large change in the candle power.

In the set-up of the lamp and the phototube, all extraneous light should be excluded. That is, all light not from the standard lamp should be prevented from entering the phototube. This can be done by means of baffles or boxes, B in Fig. 1. For example, the lamp may be placed in one box and the phototube in another. All surfaces of these boxes or baffles should be blackened.

Light Flux

If the entire aperture, a , on the phototube is illuminated by the lamp, the amount of light flux entering the phototube is $F = AC/D^2$, in which F is the flux in lumens, A is the area of the aperture, C the candle power of the lamp, and D is the distance between the lamp and the aperture. All lengths entering into the formula must be measured in the same units.

The amount of flux is varied by varying the distance D , and this can be done easily if the lamp is mounted on a carriage, the track of which is provided with a scale for measuring D .

The voltage on the phototube is provided by means of a battery E , and it is adjusted to the desired value with voltage divider P . Of course, V measures the voltage actually applied, provided this voltmeter is left in the circuit all the time.

R is a high resistance of about 1,000,000 ohms which is used to limit current in case a glow should occur, and also to simulate actual working conditions of the tube. The voltage drop in this resistance is so small that it may be neglected. When it is not, it can be corrected for. A is the multi-range microammeter with which the current is measured.

The taking of a characteristic curve consists of obtaining the values of the current for a large number of values of light flux, as computed by the formula given previously, for a particular value of the anode voltage, as indicated by the voltmeter. Curves can be taken for a large number of different anode voltages. A set of such curves is shown in Fig. 2, in which the abscissas are the values of illumination and the ordinates are the corresponding values of current. Curves are given for four different anode voltages.

Current-Voltage Curves

Curves can also be taken with fixed illumination and variable anode voltage. In this case the illumination is adjusted to have any desired value and then left at that value while the experiment is made. The anode voltage is adjusted in suitable steps and the current at each step observed. The voltage is increased until the point of ionization is approached, or reached. As the point is approached the current increases very rapidly.

When a run has been made at a given illumination, other runs should be made at other values of light flux in the same manner. The result of such a test on a given

(Continued on next page)

Biassing 47 in Non-Reactive Audio

(Continued from preceding page)

pere. Then the drop in the load resistance is 100 volts. That makes the drop in R_x 400 volts. The grid of the 247 is positive. Now suppose that the plate current is 5 milliamperes. The drop in the load resistance is 500 volts, and the drop in the 2B7 is zero. Now the grid of the 247 is negative. Of course, this combination is an impossibility. But we have shown that the grid may be either positive or negative depending on the current through the load resistance.

Now let us compute what the current

through the load resistance must be in order that the grid of the 47 should be 16.5 volts negative with respect to the filament. The drop in the 2B7 should be 111 less 16.5 volts, that is, 94.5 volts. Therefore the drop in the load resistance should be 500 less 94.5 volts, or 405.5 volts. This requires that the current through the 100,000-ohm resistance should be 4.055 milliamperes. This is possible.

The 50 mmfd. condenser across the diode load resistance was not included in the designer's drawing. We suggest it because it lifts the rectified voltage.

There may be enough stray capacity in the circuit at this point to make the circuit function without the condensers.

In each circuit there are two independent filament windings indicated. The use of two, even though the filament voltages do not require separate windings, is advisable because of the high voltage that would exist between the filaments and the cathodes. This applies particularly to the first two circuits.

Mr. D'Angelo points out that in the second circuit the filaments may be connected in series.

(Continued from preceding page)

cell is shown in Fig. 3. The curves terminate as soon as the rapid current increase indicates that the point of ionization is approached.

Use of Curves

After such curves have been obtained, to what use can they be put? Well, one obvious use is to measure light intensity. Suppose the cell set up with 90 volts in the anode circuit and the current is one microampere. How much light flux enters the cell? Referring to Fig. 2 we find for this particular combination 0.44 lumen. Again, we might know the illumination and the current required to operate a certain relay. Then what should the anode voltage be? As an illustration let us assume that the light flux is 0.25 lumen and that it requires 3 microamperes to operate a certain relay. Can we find an anode voltage that will give the required current with the cell we have at our disposal. By extrapolation in Fig. 3 we estimate that the voltage required is 140 volts. However, we are working a long way up the curve and the circuit would be very unstable. It would be better to increase the illumination and then use a slightly lower voltage. It would be still better to increase the sensitivity of the relay.

Spectral Sensitivity

Phototubes are not equally sensitive to all colors, nor are all phototubes sensitive at the same color. One cell, for example, is most sensitive at a wavelength of 430 millimicrons, which lies in the blue region near the violet. Another cell is most sensitive at a longer wavelength, toward the yellow. There are several factors determining at what color the tube is most sensitive. First, it depends on the kind of metal that constitutes the cathode, or light sensitive surface. Second, it depends on the glass that is used for the bulb.

Ordinary glass will not pass the ultra violet light and for that reason, mainly, the sensitivity falls off as the wavelength gets shorter. If the phototube is to be most sensitive it is clear that the light used should be rich in those colors to which the phototube is most sensitive. Or, if there is no choice in the light, a cell should be selected that is sensitive to the particular light that is available. Unfortunately, the taking of spectral sensitivity curves is not so simple as the taking of the other characteristics, for it requires much more complicated equipment.

Application of Cell

A typical circuit in which a phototube is used in conjunction with a thermionic amplifier tube and a relay is shown in Fig. 4. The load resistance on the cell is R, which also serves as the grid leak for the vacuum tube. A suitable negative bias can be given the control grid by means of the battery E_1 and the voltage divider P. The anode voltage on the phototube is the sum of the voltages of E_2 and E_3 . The anode voltage for the amplifier is only the voltage of E_2 . The load on the amplifier is the winding of the relay.

Suppose now that no light enters the phototube and that there is no leakage current through it. Then the bias on the amplifier is determined entirely by the setting of P. Let this be such that there is no current flowing in the plate circuit. The relay is then in the open, or non-operative condition. This may leave the relay circuit open or closed, depending on the connections.

Now let a strong signal of light strike the phototube. Current will begin to flow through R, making the grid less negative. There will be a large increase in the plate current, and the relay will operate. Thus a light pulse will cause the relay circuit to function one way or the other.

Modulated Signal

It may be that the light signal is modulated with voice. In that case it is only necessary to substitute a loudspeaker or an

The Review

Questions and Answers Based on Articles Printed in Last Week's Issue

Questions

1. What is the principle of operation of the photo-electric cell?
2. How is a photo-electric cell used to control the operation of a drinking fountain?
3. How is the push-pull relationship developed by use of a phase-shifting tube?
4. What is the requirement in terms of revolutions per minute of a television motor for transmission and reception of talking moving picture film that has 24 complete pictures per second?
5. What problem is involved in the operation of a synchronous motor for talking movie film transmission and reception, and who solved it?
6. What are the standard requirements for the operation of the 227 tube as a biased detector?
7. On what is the operation of the vacuum tube based, considered from the viewpoint of electrons?
8. What is the relationship between the electrons and the physical properties of inertia and weight?
9. What is the effect of automatic volume control on the fading of very weak signals?
10. What is the general comparison of the 2A3 and 2A5 at rated voltages?

Answers

1. The principle of the operation of the photo-electric cell is that the cell responds to light values, with output in electric current values directly proportionate, or nearly so, to the input of light. The cell converts varying light values into correspondingly varying electric values. Some express this as changing light into electricity.
2. A beam of light is directed so that when no one is in a position intended for drinking, the light actuates a cell to keep the faucet shut. If a person stoops to drink, the beam of light is cut off, the faucet immediately opens, and stays open until the person, finished drinking, removes the obstruction to the beam.
3. Since a tube changes the direction of the signal or carrier voltage almost exactly 180 degrees, if one intended push-pull tube is connected to input of a previous tube, and another intended push-pull tube to the output of the same previous tube, the phases of the inputs to the push-pull pair will be 180 degrees apart. By adjusting to overcome the signal voltage disparity due to the amplification by the feeding tube, the push-pull input voltages may be equalized. Thus we would have equal voltages but opposite in phase, the push-pull symmetry. The method is useful in resistance-coupled push-pull amplifiers.
4. Since the talking movie film consists of pictures to be projected 24 per second, and since there are 60 seconds in a minute, the motor revolutions per minute would have to be 60×24 or 1,440.
5. The problem involved in the development of a synchronous motor for 1,440

r.p.m. relates to the poles of the motor because there must be two opposite poles at any instant to complete the circuit, or even number of poles. If there are two poles the frequencies can be 60, 120, etc., cycles per second; if there are four poles, 30, 60, 90, 210, etc.; six poles, 20, 40, 60, 80, 100, 120, etc. The picture frequency 24, is not represented on the list, but would be between 4 and 6 poles. William Hoyt Peck solved the problem, but did not reveal completely the method used.

6. Plate voltage 250 volts, negative bias 30 volts. If the tube is self-biased the resistor may have to be around 100,000 ohms, and if the plate circuit is resistance loaded, the plate resistor may even be lower than the biasing resistor.

7. The operation of the vacuum tube is based on the control of the flow of electrons.

8. A vacuum tube is so useful because the electrons, smallest negative particles of electricity, have practically no inertia and practically no weight.

9. The effect of automatic volume control on the fading of very weak signals is small, because the control itself is based on the amplitude of the carrier, and the bias changes resulting are too little to be of much effect.

10. The 2A3 will stand a much bigger input signal voltage, but hasn't much sensitivity, so does not increase the voltage much. The 2A5 will stand only a relatively small signal voltage input but is very sensitive, so amplifies the voltage greatly. The power output is about the same when the total harmonic distortion of the 2A3 is 2 per cent. and that of the 2A5 is 5 per cent.

Supersonic Wave Used To Aid Hard of Hearing

Madison, Wis.

The Executive Committee of the Regents of the University of Wisconsin has approved a plan to establish, in the Milwaukee Center of the University Extension Division, a department for the training of the hard of hearing for the purpose of carrying on an experiment in the improvement of hearing.

Sam Snead, chairman of the radio department of the Milwaukee Extension Center, devised the method and has been carrying on preliminary experimentation in collaboration with several members of the medical profession. As the method is still in the experimental stage, no guarantee of improvement can be made. Records of the department up to this time, however, show that some types of hard of hearing have been helped. It is the purpose of the department to carry on this experiment and at the same time render a service to those who can benefit by it.

The method consist of receiving certain audible and supersonic tones by air conduction with the use of earphones, which are worn only during the appointments. The impressions received are pleasant.

Supersonic Wave Used To Aid Hard of Hearing

Madison, Wis.

The Executive Committee of the Regents of the University of Wisconsin has approved a plan to establish, in the Milwaukee Center of the University Extension Division, a department for the training of the hard of hearing for the purpose of carrying on an experiment in the improvement of hearing.

Sam Snead, chairman of the radio department of the Milwaukee Extension Center, devised the method and has been carrying on preliminary experimentation in collaboration with several members of the medical profession. As the method is still in the experimental stage, no guarantee of improvement can be made. Records of the department up to this time, however, show that some types of hard of hearing have been helped. It is the purpose of the department to carry on this experiment and at the same time render a service to those who can benefit by it.

The method consist of receiving certain audible and supersonic tones by air conduction with the use of earphones, which are worn only during the appointments. The impressions received are pleasant.

conducted over a beam of light. Of course, this is essentially the same as that of the talking film, except that the beam is longer and that the modulation is brought about differently. In a case like this it is necessary to use an optical system that collects as much of the light as possible and direct it into the phototube. The sensitivity of the amplifier will have to be adjusted to suit the amount of modulated light that can be collected.

This is a slight operation.

LATEST TUBE DATA

On 2A6, 2B7, 6B7, 55, 75, 77 and 85 in Resistance-Coupled Audio

By Louis Pouy

OPERATING CONDITIONS FOR RESISTANCE-COUPLED AMPLIFIERS

TUBE	PLATE SUPPLY [∞] (Volts)	SCREEN SUPPLY (Volts)	GRID BIAS (Volts)	100				135				180				250			
				1	2	3	4	1	2	3	4	1	2	3	4	1	2	3	4
2A6 and 75	CATHODE RESISTOR (Ohms)	10500	15400	11550	15000	8200	9150	5850	10000	4900	7100	5450	9000	3170	5200	3380	5600		
	PLATE RESISTOR (Megohm)	0.25	0.50	0.25	0.50	0.25	0.50	0.25	0.50	0.25	0.50	0.25	0.50	0.25	0.50	0.25	0.50		
	GRID RESISTOR* (Megohm)	0.25	0.25	0.50	0.50	0.25	0.25	0.50	0.50	0.25	0.25	0.50	0.50	0.25	0.25	0.50	0.50		
	PLATE CURRENT (Milliamp.)	0.10	0.07	0.09	0.07	0.17	0.12	0.18	0.11	0.25	0.17	0.24	0.14	0.41	0.25	0.40	0.24		
	VOLT. OUTPUT** (Peak Volts)	11-14	10-14	15-19	14-19	17-23	17-21	20-30	18-27	26-33	24-30	32-40	30-38	33-38	28-35	36-46	35-44		
	VOLTAGE AMPLIFICATION	30	29	38	37	42	38	50	48	48	48	56	55	51	48	59	58		

	2B7 and 6B7	CATHODE RESISTOR (Ohms)	5550	12200	9350	19250	3800	8300	4850	10900	3700	7800	3500	7300	5500	11400	5500	11400	
PLATE RESISTOR (Megohm)		0.25	0.50	0.25	0.50	0.25	0.50	0.25	0.50	0.25	0.50	0.25	0.50	0.25	0.50	0.25	0.50		
GRID RESISTOR* (Megohm)		0.25	0.25	0.50	0.50	0.25	0.25	0.50	0.50	0.25	0.25	0.50	0.50	0.25	0.25	0.50	0.50		
PLATE CURRENT (Milliamp.)		0.27	0.15	0.23	0.13	0.35	0.20	0.30	0.18	0.43	0.26	0.45	0.26	0.65	0.35	0.65	0.35		
VOLT. OUTPUT** (Peak Volts)		28-30	25-27	36-38	32-33	38-40	32-35	48-50	42-44	50-53	45-48	65-68	64-66	55-65	55-60	65-70	66-75		
VOLTAGE AMPLIFICATION		35	36	47	46	36	38	63	66	50	53	63	70	54	55	65	75		

55 and 85		CATHODE RESISTOR (Ohms)	16800	25800	21200	46000	21200	24300	22000	42500	16300	28000	14900	31200	17600	28500	25200	38600	
	PLATE RESISTOR (Megohm)	0.25	0.50	0.25	0.50	0.25	0.50	0.25	0.50	0.25	0.50	0.25	0.50	0.25	0.50	0.25	0.50		
	GRID RESISTOR* (Megohm)	0.25	0.25	0.50	0.50	0.25	0.25	0.50	0.50	0.25	0.25	0.50	0.50	0.25	0.25	0.50	0.50		
	PLATE CURRENT (Milliamp.)	0.28	0.14	0.23	0.12	0.32	0.19	0.31	0.18	0.46	0.25	0.47	0.24	0.63	0.35	0.65	0.32		
	VOLT. OUTPUT** (Peak Volts)	24-26	17-22	27-29	26-27	34-36	27-30	38-42	36-40	38-40	36-38	40-44	40-45	55-60	45-55	65-75	65-70		
	VOLTAGE AMPLIFICATION	6.1	6.0	6.6	6.2	6.1	6.1	6.5	6.3	6.4	6.4	6.7	6.5	6.4	6.3	6.7	6.6		

	75	CATHODE RESISTOR (Ohms)	3760	6450	3400	7250	3100	5600	3750	6300	2180	4550	2600	4850	3100	5700	3500	6200	
PLATE RESISTOR (Megohm)		0.25	0.50	0.25	0.50	0.25	0.50	0.25	0.50	0.25	0.50	0.25	0.50	0.25	0.50	0.25	0.50		
GRID RESISTOR* (Megohm)		0.25	0.25	0.50	0.50	0.25	0.25	0.50	0.50	0.25	0.25	0.50	0.50	0.25	0.25	0.50	0.50		
PLATE CURRENT (Milliamp.)		0.22	0.14	0.23	0.13	0.29	0.18	0.25	0.17	0.43	0.25	0.38	0.24	0.52	0.31	0.48	0.30		
VOLT. OUTPUT** (Peak Volts)		15-23	17-22	16-29	18-28	21-32	27-31	29-37	34-38	31-43	36-41	36-52	45-52	50-60	50-55	60-70	60-70		
VOLTAGE AMPLIFICATION		40	39	54	53	54	52	61	62	76	65	92	93	80	75	100	110		

[∞] Voltage at plate will be PLATE SUPPLY voltage minus voltage drop in plate resistor caused by plate current.
 * For the following amplifier tube. The tabulated values illustrate design practice. For any particular set of conditions, however, the grid resistor for the following amplifier tube should conform to the recommendations given on the DATA page of the type involved.
 ** Developed across plate resistor of inter-stage coupling circuit including grid resistor of following tube. Value to left is maximum undistorted output voltage obtainable; value to right is maximum output voltage obtainable with some distortion.
 Note: In the above data, the use of a coupling condenser between the plate resistor and the grid resistor of the following tube is assumed. A 0.1 microfarad condenser is usually adequate to insure good low-frequency response.

Table from RCA Radiotron Co. and E. T. Cunningham, Inc.

New data on the operation of the 2B7, 6B7, 55, 77 and 85 with 250-volt plate supply are included in this tabulation of application of these tubes to various conditions.

WHEN new tubes are announced the best available data on their use are furnished, but experience usually causes some changes in the recommendations. Therefore, the early announcements almost always contain "tentative characteristics," but in another sense all characteristics are tentative for a few years, or until there is developed a body of technique regarding the tube that compels general acceptance of its high degree of authentication.

This condition reflects in no way upon the tube manufacturers or tube engineers, but has to do with the conformity of recommendations to the results attained in actual practice, as well as in testing over a long period, and introduces factors that scarcely could be totally encompassed when the tube was introduced.

The Tubes Tabulated

Therefore data are now presented in tabulated form regarding seven tubes in four groups: (1) the 2A6 and 75 duode-triode high mu type; (2) the 2B7 and 6B7 duo-diode pentodes; (3) the 55 and 85, duo-diode medium-mu triodes; and (4), the 77, the 6.3-volt equivalent of the 57.

The table gives the plate supply voltage, the screen supply, the grid bias, cathode resistor, plate resistor, grid resistor, plate current, voltage output and amplification factor.

The plate supply voltage is the amount of voltage fed to the entire plate circuit, measured at the B plus end of the load, from where the bypass condenser is. The voltage at the plate, also called the effective plate voltage, is always less, due to the drop caused by current through the direct-current resistance of the load. The effective plate voltage is not given in the table, but can be computed, since the plate current and the plate load resistance are given. All tubes in the table concern resistance coupling.

The screen supply voltage refers to the voltage at the screen itself, for there is always a signal-removing condenser at this point, so even if a series resistor connects from screen to a much higher B voltage, the supply to the screen, the point where the signal effect begins, is the voltage at the screen, since there is no effective external load to the signal or carrier. Unless this point is borne in mind there might be some confusion regarding the "plate supply voltage" not

taking into account the drop in the load, and the "screen supply" taking into account the drop in a resistor which is not a load.

Grid Resistor Factors

Not only is the grid bias voltage given, but also the value of the cathode resistor in ohms, to develop this static bias. The measurement of bias should be made at no signal.

The plate resistor and the grid resistor are given in megohms. The grid resistor referred to is not the one that may be in the grid circuit of the tube under discussion, but the one in the grid circuit of the following amplifier tube, which may be the power output tube.

It may happen that the grid resistor specified in the table herewith is of a value different from that recommended in tube data sheets. The grid resistor usually is not specified in the characteristics charts, but is found in discussions of applications of the tube. The resistance values as found in the data sheets and application notes should be followed, provided the data sheets are authentic and up-to-date.

The only important recent change has

been in respect to the 38, 41, 43, 89 and 2A5 power tubes, which now may have a 1.0 meg. grid resistor. This is from two to four times as high as formerly regarded as safe, and the reason is a reduction in the grid emission of these tubes, lower leak values in the past having been specified to prevent premature overloading, though they mitigated low-note response.

The voltage output is given in peak volts, for peak volts are what are actually put into the following tube. The root-mean-square value of this voltage can be computed by multiplying the peak volts by 0.707.

Output Voltages

The output voltage is that developed across the output, and since resistance coupling is considered, the measurement may be taken either across the plate load resistor, with 0.1 mfd. stopping condenser in circuit and leak in place in the following tube, or across the leak under the same conditions. There would be a slight difference, perhaps, due to phase shift in the condenser, as to where the measurement is made, but the data contained in the table deal with measurement across the plate resistor, with the rest of the circuit included as stated.

In all the statements of output voltage two values are given. The one to the left is lower than the one to the right and represents undistorted output, while the higher value at right includes some distortion.

It will be noticed that the grid bias voltages in several instances are defined to a digit in the second decimal place, for instance the 2A6-75 combination, minus 1.05 volts bias.

Screen Current Considerations

This should not prove confusing, since the value of cathode resistor is given, also the plate current. If the tube is a heater triode, then the plate current alone passes through the cathode circuit, and the voltage computation may be made, if one hasn't a low-range voltmeter that would define small differences. If the tube has a screen grid, then the screen current may be assumed to be one-third the plate current, and therefore the total cathode current would be the sum of the two. It should be noticed that the plate current always is given, but never the screen current, hence any screen grid tube would have current in the cathode circuit additional to mere plate current, and for computations this fact must be considered. For other purposes it need not be considered.

Characteristics Chart

For the benefit of those who may not have at hand the characteristics of the seven tubes the essential data are given herewith:

Type	Name	Base	Cathode Type*	Rating		Plate Max. Volts	Screen Max. Volts	Use Values to right give operating conditions and characteristics for indicated typical use	Plate Supply Volts	Grid Volts*	Screen Volts	Screen Milli-Amp.	Plate Milli-Amp.
				Heater Volts	Amperes								
2A6	Duplex-Diode High-Mu Triode	Small 6-pin	Heater	2.5	0.8	250	...	Triode Unit as Class A Amplifier	250#	-1.35	0.4
75	Duplex-Diode High-Mu Triode	Small 6-pin	Heater	6.3	0.3	250	...	Triode Unit as Class A Amplifier	250#	-1.35	0.4
2B7	Duplex-Diode Pentode	Small 7-pin	Heater	2.5	0.8	250	125	Pentode Unit as R-F Amplifier	100	-2.0	100	1.7	5.8
								Pentode Unit as A-F Amplifier	250	-3.0	125	2.3	9.0
6B7	Duplex-Diode Pentode	Small 7-pin	Heater	6.3	0.3	250	125	Pentode Unit as R-F Amplifier	100	-2.0	100	1.7	5.8
								Pentode Unit as A-F Amplifier	250	-3.0	125	2.3	9.0
55	Duplex-Diode Triode	Small 6-pin	Heater	2.5	1.0	250	...	Triode Unit as Class A Amplifier	250†	-4.5	50	...	0.65
								Triode Unit as Class A Amplifier	135	-10.5	3.7
								Triode Unit as Class A Amplifier	180	-13.5	6.0
								Triode Unit as Class A Amplifier	250	-20.0	8.0
85	Duplex-Diode Triode	Small 6-pin	Heater	6.3	0.3	250	...	Triode Unit as Class A Amplifier	135	-10.5	3.7
								Triode Unit as Class A Amplifier	180	-13.5	6.0
								Triode Unit as Class A Amplifier	250	-20.0	8.0
77	Triple-Grid Amplifier Detector	Small 6-pin	Heater	6.3	0.3	250	100	R-F Amplifier Bias Detector	250	-3.0	100	0.6	2.3
								R-F Amplifier Bias Detector	250	-1.95	50	...	0.65 ma.

*Either A. C. or D. C. may be used on filament or heater, except as specially noted. For use of D. C. on A-C filament types, decrease stated grid volts by 1/2 (approximately) of filament voltage.

SOCKET CONNECTIONS FOR THE SEVEN TUBES

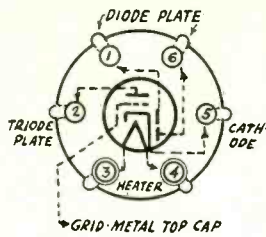

2A6
75
55
85

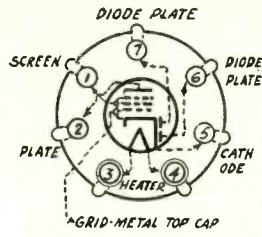

2B7
6B7

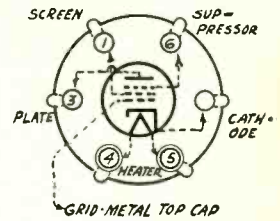

77

ATLANTIC RADIO CLUB, GLENSIDE, PENNA.

DX PROGRAMS FOR OCTOBER 1-7

E.S.T. (a.m.)	From	To	kc.	Call	Power	Location
October 1						
4:50	5:10	890	KARK	250	Little Rock, Ark.	
5:30	5:50	880	KFKA	500	Greeley, Colo.	
5:40	6:00	1260	KUOA	1000	Fayetteville, Ark.	
October 2						
2:00	2:20	1500	WMIL	100	Brooklyn, N. Y.	
2:10	2:30	1370	WRAC	100	Williamsport, Pa.	
2:30	2:50	1370	WBTM	100	Danville, Va.	
3:10	3:30	1500	WSYB	100	Rutland, Vt.	
3:30	3:50	1370	WQDM	100	St. Albans, Vt.	
3:50	4:10	1370	WGLC	100	Hudson Falls, N. Y.	
4:10	4:30	1260	WNBX	250	Springfield, Vt.	
October 3						
2:40	3:00	1500	WKUE	100	LaGrange, Ga.	
5:00	5:20	1370	WRAM	100	Wilmington, N. C.	
October 4						
4:40	5:00	1070	WCAZ	50	Carthage, Ill.	
5:00	5:20	1070	WDZ	100	Tuscola, Ill.	
5:20	5:40	940	WHA	1000	Madison, Wisc.	
October 5						
4:10	4:30	1500	WMPC	100	Lapeer, Mich.	
4:20	4:40	560	WQAM	1000	Miami, Florida.	
4:50	5:10	880	WCOC	500	Meridan, Miss.	
5:10	5:30	1260	WTOC	500	Savannah, Ga.	
5:30	5:50	1370	WIBM	100	Jackson, Mich.	
October 6						
4:30	4:50	1370	KGFG	100	Oklahoma City, Okla.	
5:30	5:50	1500	KGKB	100	Tyler, Texas.	
5:40	6:00	1370	WRJN	100	Racine, Wisc.	
5:50	6:10	1500	KGFK	100	Moorhead, Minn.	
October 7						
2:40	3:00	1500	WMBQ	100	Brooklyn, N. Y.	
5:20	5:40	760	WEW	1000	St. Louis, Miss.	
5:40	6:00	880	WSUI	500	Iowa City, Iowa.	

A THOUGHT FOR THE WEEK

SOMEbody suggests a prize for the Federal official who is the first over the air to pronounce "gov-ern-ment" correctly and clearly. How about President Roosevelt's pronunciation of this word and almost every other one he utters before the microphone? When it comes to enunciation, you can't beat our own F. D. R., whether on the air or in any other social or official contact with the American people. The average announcer's delivery sounds like the devil himself when compared with President Roosevelt's (and by the way, exactly what language is the Luciferian tongue?)

The New Lamps Made by Westinghouse

The Westinghouse Lamp Company, Bloomfield, New Jersey, announces three new neon glow lamps for low power consumption:

Watts	Bulb	Volts	Base
1/2	G-10	110-120	Med. Screw
1	G-10	110-120	Med. Screw
2	S-14	110-120	Med. Screw

The lamps have a resistance built into the base. With the exception of the 1/2-watt lamp, which operates on alternating current only, these lamps may be burned either on alternating or on direct current. When the voltage is within the range of 105 to 125 volts approximately, the lamps may be expected to live for some 3,000 hours.

The Type N-1 lamp, bulb G-6, 160-550 volts, candelabra-screw, introduced late last year, must be operated with a separate resistance in series, and for that reason the voltage rating has wide and rather indeterminate limits. The absence of a fixed resistance in the base of the type N-1 lamp permits lower manufacturing costs and accounts for a lower list price. If the lamp were to be burned continuously 24 hours per day a series resistance of 50,000 ohms would be desirable, but if it were to be burned or flashed for short intervals, a resistance of 10,000 ohms would be used.

Grid Leak Effect

When alternating current is used on the plate of a test oscillator, and grid leak-condenser type of tube circuit is used, the percentage of modulation can be regulated by the value of the leak. For battery-type tubes particularly, as where a-c is on the filament likewise, if the leak value is made high, the amount of hum present as modulation will not be nearly so large as if the leak were low. The reason is that a high resistance between grid and a-c is a damper on the a-c reaching the grid from the line.

EASE OF HANDLING

Developed in a Short-Wave Set

By Barry Montrose

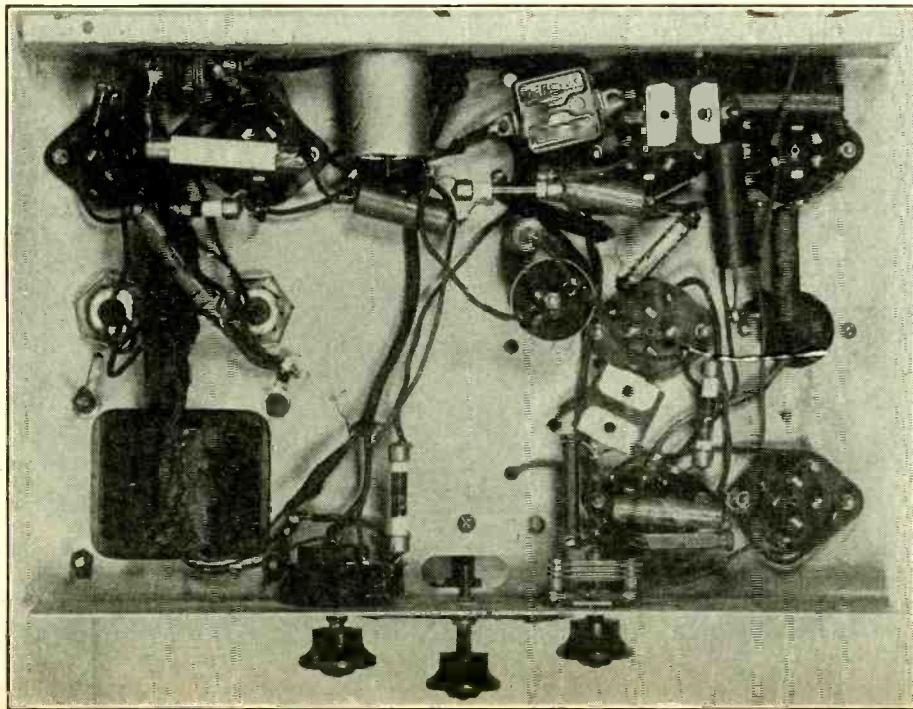
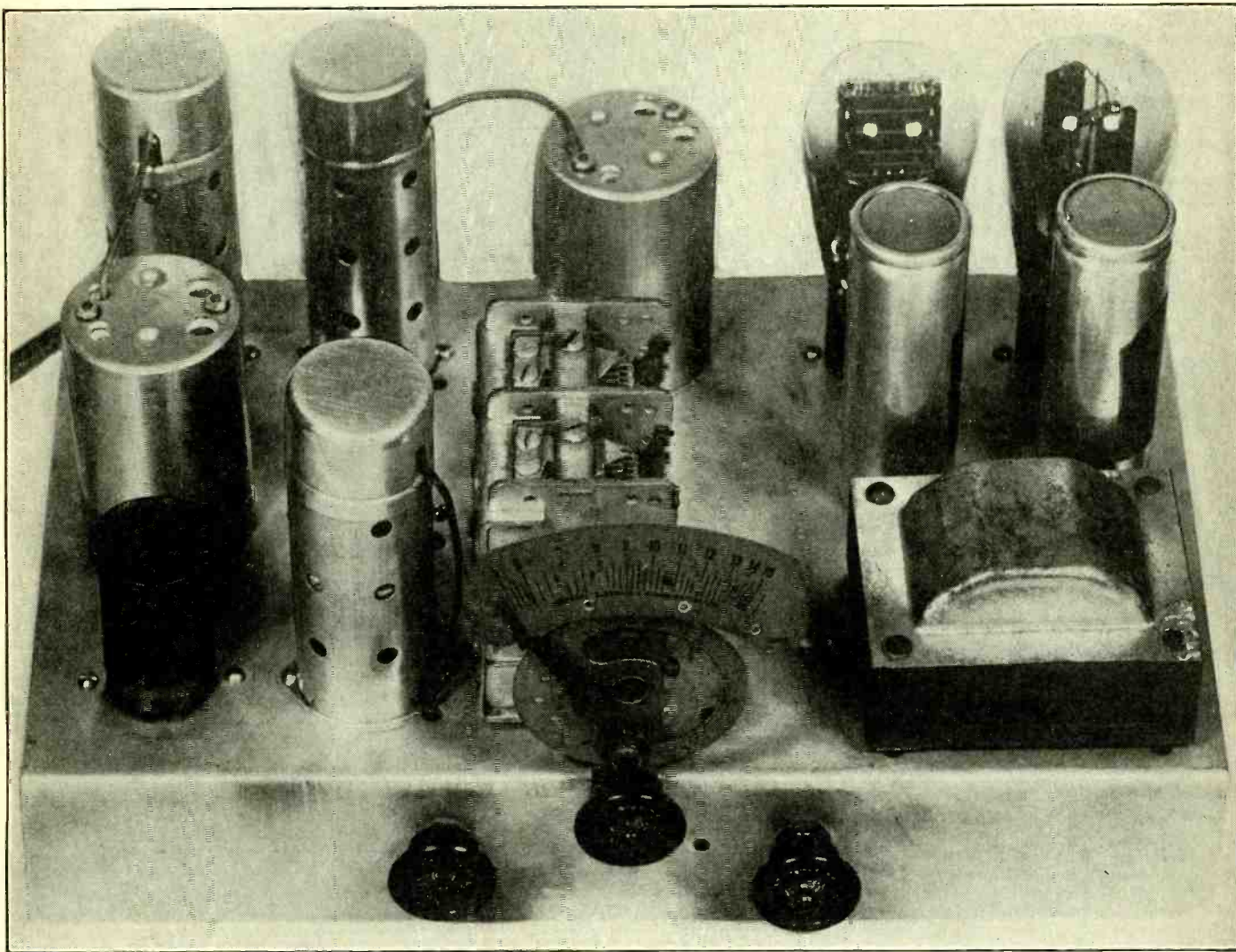

HERE WE HAVE a five-tube, short-wave superheterodyne that is simple to build, simple to adjust, and equally simple to operate after it has been finished. But is it sensitive? Indeed, it is. Exceptionally so. There are several reasons why it is sensitive. First of all, it is a short-wave set, and the coils in the oscillator and modulator circuits have been designed for high sensitivity on short waves. Then the oscillator-modulator tube is a 2A7, which is really two tubes in one, and for that reason the circuit is equivalent to one having six ordinary tubes. The oscillator and modulator grids are independently biased for most efficient operation.

High Audio Gain

Besides the effective mixer we have a very effective intermediate amplifier. The pentagrid tube feeds into a doubly tuned intermediate transformer, tuned to 465 kilocycles, and this in turn feeds a 58 amplifier. This is followed by another 465 kc intermediate transformer of the same type as the other. The transformers are matched to the tubes and they are designed for high gain. Hence the amplifi-

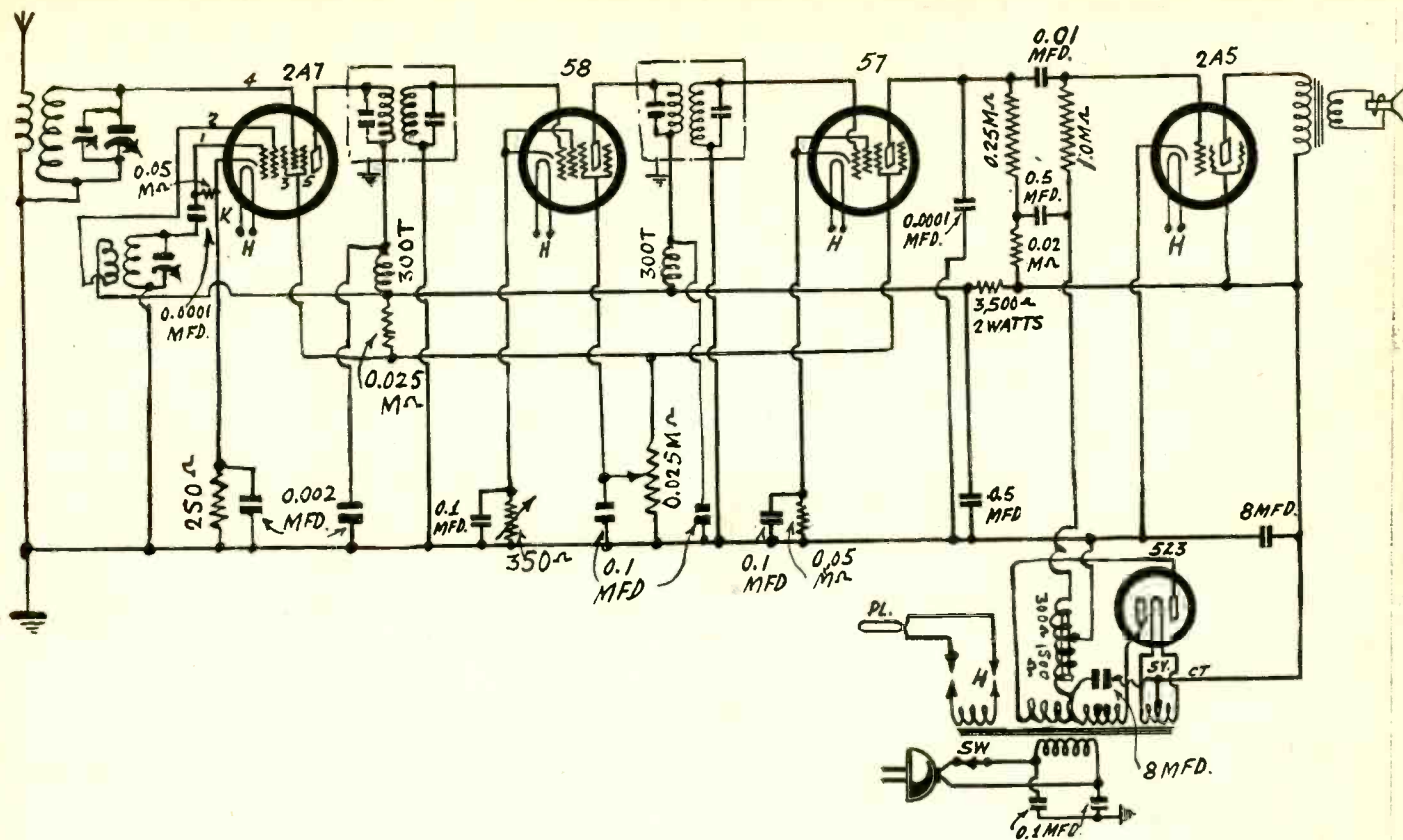

This five-tube, short-wave superheterodyne has been designed for high sensitivity and ease of tuning

cation in the intermediate frequency level is enormous.

But this is not all. The detector is a 2A7 tube, which is one of the most effective detectors of all. And this tube is followed by a 2A5 power pentode, which has a very high gain. Hence from the antenna binding post to the speaker terminals the circuit has been designed for high sensitivity.

There is a manual volume control for this sensitivity, which takes the form of a 250,000-ohm potentiometer in the screen circuit of the intermediate amplifier, and by means of which the screen voltage can be varied from practically zero up to the value at which the tube functions best as an amplifier.

The Tuner

For each frequency range there are two equal coil systems, one for the r-f tuner and the other for the oscillator. Both are of the plug-in type, and the tuning condensers are such that the short-wave range is covered by four coil sets. The design of these coils, as wound on UX plug-in forms, is given in an accompanying table.

The two tuning condensers are ganged in order to simplify operation of the circuit. Since the r-f and oscillator circuits must not be tuned to exactly the same frequency, but to frequencies differing by the intermediate frequency, a trimmer condenser is put across the r-f coil, and this condenser has such a value that the difference may be brought about even when the circuit is set at the lowest frequency.

The placing of a trimmer across the r-f condenser does not complicate tuning, because, even when this is not touched, stations can be tuned in with the ganged condensers. The trimmer merely acts as a vernier control for increasing the sensitivity by tuning the r-f circuit to a frequency less than the oscillator frequency by the intermediate frequency.

On the highest signal frequencies the difference between the two frequencies is

relatively so small that there is little need of using the trimmer.

Connections of Pentagrid

The grid of the oscillation section of the 2A7 is returned to the cathode directly as this is necessary to make the oscillations self-starting. The stopping condenser in the grid lead makes it possible to ground the tuning condenser. The grid of the modulator section of the tube is returned to ground, which is negative with respect to the cathode by the amount of voltage drop in the 250-ohm resistor in the cathode lead.

The oscillator is of the tuned grid type, which allows the simplest connections.

Filtering

Thorough filtering is employed in order to eliminate hum and straying of high and intermediate frequency currents. Thus in the plate circuit of the pentagrid is a 300-turn choke coil, and this is shunted by a 0.002 mfd. condenser. In the plate circuit of the 58 intermediate is another 300-turn choke, but this is shunted by a 0.1 mfd. condenser, since at this point the frequency is lower. Another feature which aids in preventing tunable hum is the filter across the primary of the power transformer. Two condensers of 0.01 mfd. each are connected across the winding and the junction of these is grounded. Therefore if any signal comes in on the line it is shunted to ground.

Biasing Other Tubes

The B supply is also well filtered. First there is an eight mfd. condenser across the line next to the 5Z3 rectifier and then another of the same value on the opposite side of the choke. The choke is the field of the loudspeaker winding, which has a total resistance of 1,800 ohms. It is tapped so that 300 ohms are in the grid circuit of the power tube, thus establishing the correct bias for this tube.

The second detector is biased by means

of a 50,000-ohm resistor in the cathode lead in the customary manner. The reason for this high bias resistor is, first, that the tube is operated as a plate bend detector and hence requires a high bias, and, second, the plate load resistance is high, making the plate current, which flows through the bias resistor, very small. This is an experimental rather than a theoretic value.

A 350-ohm bias resistor is employed for the 58 intermediate tube. This is the value that gives highest sensitivity combined with good stability of the circuit.

The coupling between the detector and the power tube is designed to give an effective transfer of signal voltage without any appreciable discrimination of the various audio frequencies. The 0.01 mfd. stopping condenser is large enough to insure transfer on the lowest audio frequencies in view of the one megohm grid leak preceding the power tube. The 0.0001 mfd. by-pass condenser in the plate circuit of the detector is sufficiently large to insure thorough suppression of the intermediate carrier, yet it is not so large that there will be appreciable suppression of the high audio frequencies. Hence the signal reaches the grid of the power tube unimpaired.

Tuning Hints

When tuning the receiver the ganged condenser should be turned very slow. This is especially necessary for the higher frequencies, that is, when the smaller coils are used, because the slightest displacement may be sufficient to pass over a station entirely. After a station has been located, with the condenser "right on the nose," the trimmer condenser should be turned with the object of making the signal as loud as possible. In view of the fact that the trimmer affects to some degree the oscillator required for greatest response, the oscillator should also be readjusted after the trimmer has been turned. This may not yield any im-

(Continued on page 19)

TY —AND HERE'S THE SET!

56 Driver and 45 Push-Pull Output

erzog, B.S., E.E.

or Radio Company

LIST OF PARTS

Coils

One shielded antenna coil.
Three shielded r-f coils.
One push-pull input transformer.
One power transformer.
Four 8-inch r-f chokes.
One 50 mlh i-f choke.

Condensers

One 4-gang condenser, 0.00035 mfd.
Two 8 mfd. electrolytics, 500-volt rating.
One dual 5 mfd. 35-volt electrolytic condenser.
Two 0.5 mfd. 110-volt condensers.
Two 0.1 mfd. condensers.
Two 0.25 mfd. condensers.
One 0.05 mfd. condenser.
One 0.5 mfd. condenser.
Two 0.00015 mfd. condenser.
One bypass block.

Resistors

One 10,000-ohm volume control.
One 500,000-ohm tone control and switch.
One 15,000-ohm, 10-watt resistor.
One 25,000-ohm, 2-watt resistor.
Two 500-ohm, 1-watt resistor.
One 1,500-ohm, 1-watt resistor.
One 2,500-ohm, 1 watt resistor.
One 800-ohm, 5-watt resistor.
One 100,000-ohm, ½-watt resistor.
Two 25,000-ohm, ½-watt resistor.
One 200,000-ohm ½-watt resistor.
Two 50,000-ohm ½-watt resistors.
Two 250,000-ohm, ½-watt resistors.

Other Requirements

One Resistor mounting block.
One 1,250-ohm dynamic speaker with output transformer for 45's.
One full-vision dial.
Three knobs.
Nine sockets.
One drilled chassis.
Four tube shields.
Four screen-grid caps.
Antenna-ground posts.
Phono posts.
A-c cord and plug.
Hardware.
Hook Up Wire.

The coils used have a secondary inductance of 250 microhenries, for tuning with the specified capacities, but the primaries consist of radio-frequency choke coils, not inductively related to the secondary, but coupled by the self-capacity between a very small extra winding on the secondary, and the secondary itself.

Few Coupling Turns

It sometimes surprises constructors to find that coils of this type have perhaps one turn or two turns for the capacity coupling effect.

BOTTOM VIEW OF QUALITY SET; PARTS IN NEAT ARRANGEMENT

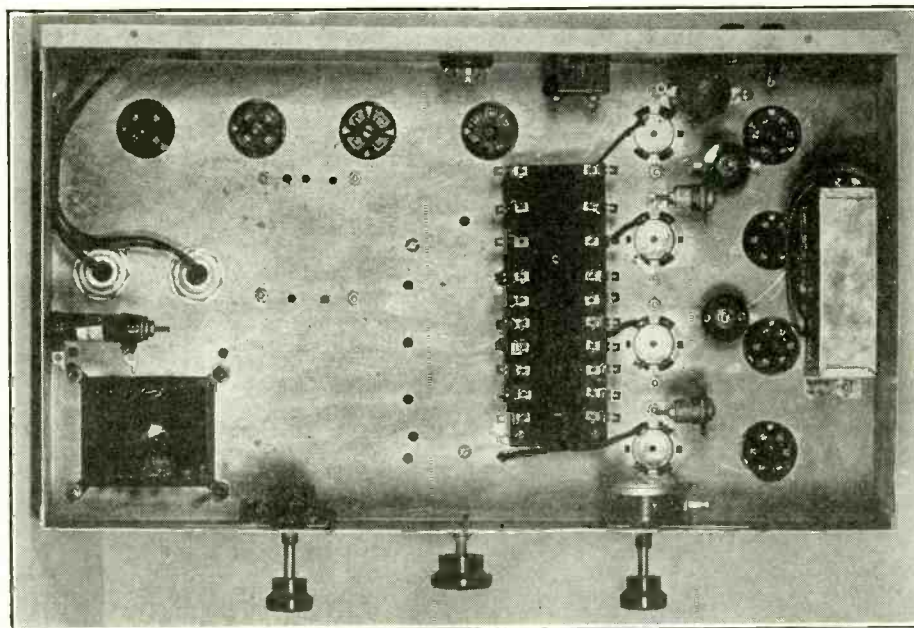

The volume control is at right, the tone control switch at left. The central knob is attached to dial shaft. The resistors should be pre-mounted on the under side of the strip. Choke coils where adjacent should be at right angles. New self-mounting type sockets are used. The photograph was taken before any wiring was done.

The reasons for using this type of coil are that there is additional filtration, as the choke in the plate circuit aids in preventing feedback, even though the choke is a utilized load, and also the response is levelled to a considerable degree. Ordinarily there would be a sharply-increased sensitivity at the high radio-frequency end, with neglect of the amplification at the low-frequency end, a familiar vice of tuned radio frequency systems that lack compensation. The inductance of the plate load chokes, and of the antenna equivalent, is so selected that the low frequencies are given a break practically equal to that of the high radio frequencies of the broadcast band. This type of benefit is of advantage especially to those who want to hear certain low-frequency stations well that are quite far away, or who want fullest results from stations in this spectrum, whether locals or not, rather than gross patronization of the high frequencies, where

sometimes the most interesting programs of the hour are not to be found.

Delightful to Tune

It is a delightful experience to tune this receiver, as it is utterly free from squeals, howls or other extraneous noises of any sort arising in the receiver, and therefore has the ascendancy over some other types of receivers which are characteristically noisy and sort of self-interfering.

Unless the stability of the set at radio frequencies is fully protected, of course the tone may not be much better than that of an ordinary receiver, so it is necessary to include the chokes and bypass condensers.

Moreover the negative bias on the first radio-frequency tube is a bit higher than normally found, as a preservative of utmost stability, and the same value of resistance may be used whether the first tube is a 57 or a 58.

SOLDERING DIRECTIONS

See if You Do Your Work This Way

By Jack Tully

IF any one were asked what is the easiest thing in radio, the answer might well be, soldering. If it is so easy it is easy to do it well. Then why are there so many poor examples of soldering? Appearance may be against a certain soldering job, but more important is the security of the joint. However, when the appearances are bad some of the joints are likely to be bad, also.

Since even a good mechanic will complain of his tools, though the rule states he should not, the first consideration is the iron. It should develop enough heat to meet the requirements. For general work in radio there will be enough heat from a 65-watt iron. In factories that make sets 85-watt irons are common.

If there is to be considerable soldering to thick metal pieces, somewhat of the serious proportions of "sweating," then an iron of greater power is needed, for the large, thick surfaces tend to cool the iron anyway, at a faster rate than does ordinary work. If one were to buy a new iron he would not make a mistake in getting one of the 85-watt rating. The 100 and 125-watt irons cost considerably more and are not needed in the run of work.

Solder and Flux

Having the proper iron, the next thing to get is the right solder and flux. Acid-core solder is out of the question, as it is too corrosive, although for plumbing work and the like it may be satisfactory. Rosin-core solder should be used, if self-fluxing type is preferred, or 50-50 solder, with separate fluxing material which will be referred to about the shop or lab as the "pot of goo," or by some other nickname. Non-corrosion is of the utmost importance, but strictly radio stores seldom handle any other but non-corrosive fluxes.

Solder should be of such consistency that even with a 50-watt iron it will melt freely and quickly, and the 50-50 proportion of lead and tin is excellent. The thick bars of solder used by plumbers and the like generally are unsatisfactory, as well as are the ¼-inch diameter dowels, as not melting fast enough, or well enough, hence often resulting in crinkly joints called "cold solder joints." These joints have very little tenacity and can not be relied on at all.

Finding Faulty Spots

While the iron is in use it begins to disintegrate at the tip. The flux, no matter what type, causes pitting, and the iron tip has to be cleaned.

It is well to start each soldering job with a freshly-filed or scraped tip. The filing should restore the shape of the tip point to what it was when new, as this has gravitational advantages. The file must not be oily, and since it is to be applied to a surface that itself may be filmed, the file has to be kept clean. This can be done with gasoline. The file should be completely dry when used.

After the tip has been filed down to a sunset brightness, the iron is heated and the barely-warm tip is stuck into the "pot of goo," which has the effect of protection against impurities. Then the tip is completely tinned for its entire length, which consists of making molten solder adhere to it. The test of a bad spot in the tip is that the solder runs away from it, instead of sticking, and that is your cue that you have to do some new filing or sandpapering to get the tip clean at this point.

Check-up

Although less handy, sandpaper is serviceable, especially as it is discarded after use, and thus cleanliness is served.

After the tip has been tinned at all over

its surface, and there are no small dents or round spots or black "pits" in the iron, a rag may be rubbed over the surface as a check-up, and it will be found that the solder will stick to the iron, and not come off on the rag, and when this adhesion to the tip is verified for the entire surface of the tip, the iron is ready for the "plating" process. This consists of getting out of harm's way and giving the iron a jerk from the handle end to cast off the surplus solder on the tip, whereupon the rag, or steel wool or other substance, may be used to bring the surface to a bright finish, not so much different from chrome plating, except not so brilliant. Anyway, you will know when your tip is in good condition when it responds to this polishing effort, and therefore not a dark spot is peeking through anywhere.

The absence of film aids the conduction of heat to the joint, as a dirty tip seems never hot enough. The heat doesn't get out sufficiently.

In the actual performance of the soldering one may consult his own preference. That is, he may carry solder over on the iron tip, which will now hold it, or he may apply solder directly at the joint. The better practice, of course, is to heat the joint and then, leaving the iron in the same position, melt the solder at the joint sufficiently to accomplish the purpose of union.

Mechanical Assistance

Besides the solder joint, there should be mechanical assistance. Just as a matter of principle it is bad to hold a springy wire to a point from which it seems eager to get away, apply some solder, and call that a good joint. It is preferable to make the connection mechanically secure before applying any solder.

For instance, if the lug on a solder is being worked, the wire should be passed through the lug, bent, passed in the opposite direction, and then tightened with dull-edged pliers (so as not to cut or abrade the wire), and then the soldering done. One of the compliments attached to such an operation is that if any one ever has to service the set, say, because the socket went bad, he will say things under his breath about the fellow who did the soldering in the first instance. But the imprecation implies an even higher compliment.

During all the soldering operations it may be quite sufficient to use the flux that is in the self-fluxing solder (provided it is not the so-called household type solder or other acid-core), but in set factories it is common practice to dip the iron occasionally into the "pot of goo," to "clean it off." This, like the carry-over method of soldering, has to be mentioned without being encouraged. If the iron is clean enough the assistance of external flux should not be necessary. If the tip is corroded, naturally it becomes harder to carry over the solder, for finally there may be only a small point where the solder will stick to the tip. Hence it indicates a laxity of operation if the pot has to be resorted to quite often, although if ever an oily surface is encountered, the extra flux may be necessary to the cleaning process. That is, the flux may be used as a cleaning substance, for it is always advisable to rub off the foreign matter with a rag or steel wool.

Object of Flux

The primary object is to have the joint clean at the beginning, and, strictly speaking, flux is not a cleansing agent, but a keep-clean agent, preserving the surface against contamination and corrosion, in the case of resin-core. However, when the heat of the

iron is applied to flux at a soiled joint, a cleansing effect takes place, for the joint is washed in "boiling" flux, much as clothes are washed in boiling water.

The use of flux has a corroding effect on the copper tip of the iron, nevertheless, and the tip should be removed every week or so, to be sure that it does not become corrosively wedged in so tight that it is almost impossible to get it out for renewal. A wedged tip may require a few hours work to remove, including drilling out the sawed-off tip by hand, for unless you have access to a machine shop or some of the drill presses and vises therein contained, you'll not only have a job on your hands but also will run the danger of breaking the coil of resistance wire in the iron.

Servicing An Iron

If it becomes necessary to service your iron you may run into difficulties because unable to locate the terminals of the resistance coil. That is, an ohmmeter will give you confusing (although correct) information. This might be due to the practice followed in some of the better type of irons of having two coils in parallel, a mica tubing between the parallel coils, and one terminal of the conductor being brought out to a central position at the end of an insulator, the other somewhere else, usually observable on inspection, and differing in different types of irons. In no instance figure on the iron itself being either a-c conductor or return.

Don't Solder to Chassis

The mere act of soldering alone is not so important, but the effect of good soldering is. For instance, the performance of a receiver depends on the value of the soldering work in it, the care bestowed on that work, the sufficiency of heat in the iron, and the mechanical assistance from supported elements of a joint.

It is in general bad practice to solder to a chassis for a return, even for audio frequencies, and usually unpardonable for radio frequencies, as chassis usually are treated with some finishing substance, that causes the solder finally to corrode and the joint to break loose completely.

An exception may exist in the case of copper chassis, but since the depression the vogue for copper chassis has been in the descendent, to say the least, and one may expect occasionally aluminum, to which a radio worker can't solder, for lack of the special equipment, or, most likely, cadmium-plated iron. The cadmium is itself a corrosive agency in connection with solder, and if a joint has to be made to chassis, a mechanical one should be made securely, and a lug attached, soldering being done to the lug, and a wire run from lug to the ground post of the set. There may be a common wire, so long as short waves are not involved concerned.

Radio Size of a Pin

Shown at Century Fair

A radio so diminutive that its "works" are supported by an ordinary straight-pin is being shown among the radio exhibits at the Century of Progress Exposition.

It brings in local stations and weighs much less than an ounce.

The straight-pin midget was built by Rufus P. Turner of Washington, D. C. Turner holds amateur and commercial radio licenses, operates an amateur station at 1243 Kenyon St. N. W., and recently completed a book, "The Story of Amateur Radio."

Radio University

A QUESTION and Answer Department. Only questions from Radio University members are answered. Such membership is obtained by sending subscription order direct to RADIO WORLD for one year (52 issues) at \$6, without any other premium.

RADIO WORLD, 145 WEST 45th STREET, NEW YORK, N. Y.

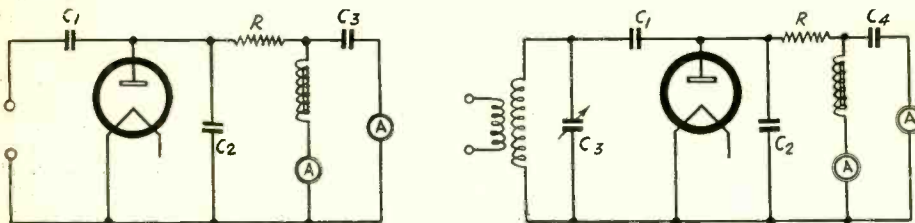

Two rectifiers that measure the peak values of the carrier amplitude. The one at left is for use when the rectifier presents a high impedance at speech frequencies, the one at right when it presents a low impedance. Percentage modulation (complex tones) may be measured with the aid of an oscillograph, effective percentage modulation (single tone) more simply, by separation of the currents, and their independent a.c. and d.c. measurements, as shown.

High-Grade Testing

FOR A HIGHER GRADE of receiver selectivity and tonal testing than is done commercially, will you please give the requirements of the test oscillator?—K. E. C.

Assuming that the oscillator is to be modulated, a mechanical oscillator of a fixed frequency, say, 400 cycles per second, may be used, but a vacuum tube oscillator having a frequency range at least from 40 to 10,000 cycles per second is preferred and for the fidelity test is necessary. The total harmonic output of this oscillator should not exceed 5 per cent. The audio-frequency oscillator is arranged to modulate the radio-frequency oscillator by a known amount, and preferably should furnish the same degree of modulation, without readjustment, at all carrier frequencies and all modulation frequencies. Means should be provided for adjusting the degree of modulation for at least the normal value of 30 per cent. The radio-frequency source consists of a vacuum tube oscillator, supplied preferably from batteries, either fully-shielded of itself, or so shielded from the radio receiver under test that there is no direct radiation to the receiver. If the power supply is external to the shielding system which encloses the oscillator all ungrounded leads to the oscillator should pass through shielded low-pass filters, shields grounded. The frequency should be adjustable by an external control to any desired value, 500 to 1,500 kc, and the frequency should not be affected by changes in output power. Means should be provided for varying the frequency in small steps on each side of any specified frequency. A second external control should be provided for varying the modulated radio-frequency output applied to the transfer circuit, and an instrument should be provided that indicates the effective value of this output. The oscillator in conjunction with a transfer system should be capable of supplying in series with the receiving antenna at least 200,000 microvolts at all carrier frequencies. The transfer circuit may consist of a loop antenna or a dummy antenna. In the dummy or artificial antenna system two coils are coupled electromagnetically, one connected to modulated oscillator output, other to a series circuit of resistance and capacity which goes to antenna post, the other end of this coil being grounded. The capacity value is 200 mmfd., the non-inductive resistor's value 25 ohms. The secondary coil is 20 mch. The inductance of the primary and the degree of

coupling have not been standardized yet.

Vacuum Tube Voltmeters

PLEASE SHOW a simple design for a vacuum tube voltmeter. The battery connections I can arrange.—O. P.

Two vacuum tube voltmeters are shown. The one at left is for use if the rectifier presents a high impedance at speech frequencies, the one at right if the rectifier presents a low impedance at speech frequencies. The input is at left in both diagrams. These rectifiers are essentially vacuum tube peak voltmeters which reproduce the carrier envelope. The impedance of R is high compared to the internal impedance of the tube when the tube is conducting. Compared to C2, the impedance of R is also high at the carrier frequency and low at speech frequencies. The current through R therefore is proportional to the amplitude of the radio-frequency voltage and follows variations in it at an audible rate. Since the instrument operates on peak voltages it reproduces the envelope of the radio-frequency wave and provides a detector of very satisfactory fidelity. Measurements of percentage modulation may be obtained by recording the instantaneous values of the current in R by means of an oscillograph. Effective percentage modulation, or the equivalent modulation of a single tone, may be measured by much simpler instruments. The direct current and alternating current may be separated, as in the figures, and measurements made with thermocouple instruments or a low impedance VTVM. Modulation by a single tone is $100\sqrt{2} I_2/I_1$, where I_1 is the d.c., I_2 the rms.

Squealless Super

IS IT NECESSARY that there be heterodyne squeals in a superheterodyne, or may the set be operated as quietly as a tuned radio frequency receiver?—I. K.

It is entirely unnecessary to have the squeals you refer to, and they will not be present if (1) the tracking is excellent; (2), there is sufficient selectivity ahead of the modulator; (3), the intermediate or radio-frequency amplifier is not oscillating, and (4) the detectors are not overloaded. On the question of overload, the first detector may be overloaded by the oscillator, in which case looser coupling should be used between modulator and oscillator. If the second detector is overloaded the manual

volume control, which is usually ahead of this tube, may be used to correct the condition.

R-F and I-F Chokes

ARE RADIO-FREQUENCY chokes necessary in amplifiers? Sometimes they are included, but in other circuits they are omitted? What is their effect?—H. W.

Whether the chokes are necessary depends on the design of the set and the sensitivity developed. In all highly-sensitive receivers the chokes are advisable, and should be bypassed by suitably large condensers, so that the tuned circuit thus formed is of a much lower frequency than that of the circuit filtered. If two circuits unite in a given lead, into which a choke is introduced, the capacity should be higher, say, 0.1 mfd. up. The chokes, and filters generally, isolate the circuit in which they are connected, to prevent feedback.

Thin and Tinny Signals

THE SIGNALS from a receiver which I have just completed are very thin and tinny. All tests I have made have failed to reveal the source of the trouble. What do you think is the trouble?—W. E. A.

What could we think? There are many possibilities, but chances are that you have already checked up on many of them. The first thing to look to are the grid bias values. Measure them with a vacuum tube voltmeter or by the plate current. If you use the plate current method, first check up on the plate voltages. Check the speaker. Make sure that the filament currents are sufficiently high. If the grid voltage in one of the audio tubes is either too high or too low, you can expect a lot of distortion.

High Bias on Power Tubes

WHY IS IT that a push-pull stage may be overbiased greatly without any appreciable change in the quality whereas a single tube of the same type must be biased much less if the quality is to be good? I refer especially to the power stage.—J. M. B.

When two equal tubes are in push-pull, a high negative bias converts the circuits to a Class B amplifier, and such an amplifier will work well even if the tubes are biased to the cut-off point. A single tube, on the other hand, will not work well unless the bias is such that the plate current can decrease by about the same amount as it can increase, for it must be operated as a Class A amplifier.

25Z5 as Detector

IS IT POSSIBLE to use a 25Z5 tube as a diode detector in an ordinary radio receiver? It seems to me that such a tube should work very well and that there should be no overloading regardless of the strength to the signal.—N. I. N.

Yes, this tube can be used as diode detector and there would be little likelihood of its overloading on any reasonable signal. However, if it is to work directly into a power tube, there must be considerable amplification ahead of the detector, say an extra stage of radio or intermediate. This should not offer any difficulties at all. The extra amplification should be about equal to the amplification in the triode element of the usual diode detector, such as the 55.

Selectivity of Superheterodynes

THEORETICALLY a superheterodyne should be very selective, but practically it never is as selective as it ought to be, considering the selectivity of the various coils that are used in it. What is the reason?—W. H. P.

There are many reasons. First, the individual coils are not as selective as they are supposed to be. Second, the coupling between the primary and secondary is closer than it should be and that reduces selectivity. It is considered that high gain is more important than high selectivity. Third, the several intermediate and radio frequency circuits are not tuned as accurately as they

(Continued on next page)

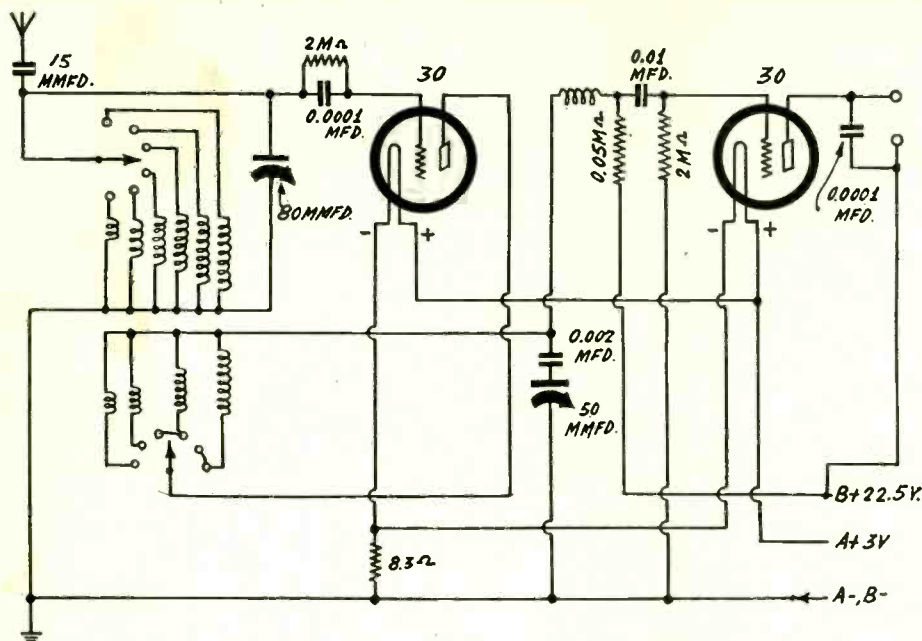

Fine results have been obtained with this simple short-wave receiver, which employs two 30 type tubes and can be operated with small batteries.

(Continued from preceding page)
might. Fourth, the padding or tracking is not as good as it should be at most points of the dial. This, perhaps, is the main cause for lack of selectivity. Again, much of the squealing by which the lack of selectivity is judged is the result of harmonics. In some instances selectivity alone is not capable of differentiating between the desired and the undesired signals. Still another reason for lack of selectivity is that the signal does not have to go through all the tuners because the signal is picked up all along the line. Shielding of the individual stages from each other and from the external signal helps in this case.

Regenerative Short-wave Set

IF YOU HAVE a two-tube regenerative short-wave receiver employing battery tubes will you kindly publish it. I prefer to use tapped coils in the tuner but if the circuit is for plug-in coils it is all right. I have a two-deck switch which I plan to use.—W. H. C.

We show a circuit of the tapped coil type and using two 30 type tubes. The regeneration is controlled by means of a small variable condenser. The circuit will work on a plate voltage as low as 22.5 volts, assuming that the tickler windings have been worked out so that the circuit will oscillate readily.

Overloading of Detector Triode

WHEN A TRIODE or pentode is diode biased it often happens that the amplifier is badly overloaded on strong signal so that the output is nearly all distortion. What is the cause of this and how can it be remedied?—A. B. N.

The grid bias on the amplifier is always proportional to the carrier voltage that is applied to the diode. On a very strong signal this bias may be greater than the cut-off bias on the amplifier tube. When that is the case there is overloading and distortion. To prevent it it is necessary to prevent the carrier voltage from exceeding the value at which the overloading begins. This can be done with the manual volume control if this is placed before the detector or by the automatic volume control. It is assumed, of course, that the gain after the detector is sufficient to give the desired signal strength when the carrier impressed on the detector is thus limited. If the power tube is a pentode and if this follows the triode of the detector the amplification is usually sufficient, but if the power tube is a low gain tube, it is usually necessary to use an intermediate amplifier tube. It should be pointed out, however, that by increasing the voltage in the plate circuit of the amplifier section of

the detector, a much stronger signal can be impressed without overloading the grid. As a matter of fact, the strength of the signal that may be impressed is directly proportional to the voltage in the plate circuit. But the plate voltage cannot be increased indefinitely since the tube will break down if it is too high. When the voltage is increased the load resistance should be increased proportionately to limit the plate current.

Stabilizing Oscillators

CAN YOU GIVE in a few words the principle underlying the frequency stabilization of oscillators? What factors affect the frequency, outside of the inductance and capacity used to determine it?—B. M. A.

It is difficult to give in a few words a subject about which many scientific papers have been written. However, it can be said that isolation of the tube from the inductance and capacity is of first importance. One way of doing this is to tune both the plate and the grid circuit in addition to tuning the resonator. Prevention of grid current is another method of improving the stability. This, of course, does not take into account changes in frequency that may result from changes in the inductance and capacity of the resonator. Such changes may follow changes in the temperature of the coil and the condenser. Hence it is necessary for highest stability to maintain the temperature of the resonator constant by some thermostatic means.

Measuring Small Resistance

IS IT POSSIBLE to measure a small resistance by using it as a shunt across a milliammeter? If so, how is it done and how can the resistance be determined?—A. G. B.

It can be if there is such a high resistance in the external circuit so that the addition of the shunt does not appreciably change the total current flowing in the circuit. First measure the current through the meter without the shunt. Then put the shunt across the meter and again note the meter current. Let the internal resistance of the meter be r and let the shunt resistance be R . Also let the original current in the meter be I_0 . Let the current through the meter when the shunt is used be I_1 . Then the current through the shunt is $I_0 - I_1$. But $(I_0 - I_1)R = I_1 r$, whence $R = I_1 r / (I_0 - I_1)$. Thus the shunt resistance can be measured in terms of the internal resistance of the meter and two current observations. As an illustration, let us assume that the meter resistance is 40 ohms and that the two currents are 1 and 0.2 milliamperes. Then $I_0 = 1$ and $I_0 - I_1 = 0.8$. The formula then gives

$R = 0.2 \times 40 / 0.8$, or 10 ohms. Note well that this method assumes that the current in the circuit does not change appreciably as the shunt is put across the meter, and hence that there is a high resistance in the circuit outside the meter. The error committed is in assuming the current constant is larger the smaller the shunt resistance compared with the internal resistance of the meter.

* * *

Speaker Distortion

THERE IS A very disagreeable sound in the output of my receiver on certain frequencies, and I am convinced that it is the loudspeaker that is at fault. The noise appears on very low frequencies only, such as those of the tuba and the bass viol. Could you give a suggestion as to the possible cause?—T. H. Y.

If you have traced the noise down to a definite range of low frequencies and to the speaker, it is very likely a mechanical resonance of the speaker that is at fault. Perhaps the supports of the diaphragm vibrate laterally at certain frequencies, or rather at some frequency. This might cause the armature coil to strike against the pole pieces. Then, again, the vibration may be in the other direction, that is, in the direction that the armature normally moves. In this case the resonance may be so severe that the slight disturbance of the proper frequency might cause the armature to swing widely. A way to test this is to set up a low frequency oscillator the frequency of which can be varied over the range in which the noise appears, impress the output of this oscillator on the speaker and then note the vibrations. At some frequency the resonance may show up strongly. It will then be easier to damp the armature at that frequency so that it will not respond any more strongly at that than at any other. All natural resonances must be eliminated if the speaker is to give a true reproduction.

* * *

Impedance and Resistance

IS IT CORRECT to speak of a-c resistance as impedance? In order to have impedance is it not necessary to have either inductance or capacity in the circuit as well as resistance?—T. E. W.

It is correct to speak of a-c resistance as impedance. Impedance is defined as the ratio of alternating voltage impressed to the alternating current flowing as a result of that voltage. This definition does not exclude pure a-c resistance but rather includes it. We might also regard a-c resistance as a limiting case of impedance in which either capacity or inductance is involved. Suppose we have a circuit in which there is inductance and resistance. That circuit has a certain impedance. If we gradually decrease the inductance the impedance becomes less and less, but the limiting value is the a-c resistance. Impedance is composed of two parts, a-c resistance and reactance. A reactance alone can be regarded as an impedance, the limiting value when the resistance is zero.

* * *

Biassing the 53

THE 53 TUBE has only one cathode, yet it is a dual tube. Now if one of the sections is used for a grid bias detector and the other for an oscillator, is it possible to bias the two grids differently to suit the two different applications? If so, will you kindly suggest how it can be done?—T. R. M.

A cathode resistor can be used for biasing the detector portion. This will give too much bias for the oscillator, but it is only necessary to return the oscillator grid to a suitable tap on the resistor. Another way of accomplishing the same result is to use the same bias on the two sections and then to adjust the plate voltages so that one is correct for detection and one for amplification. Still another way is to use a grid leak and stopping condenser for the oscillator, in which case the grid leak can be connected to the cathode, to a tap on the bias resistor, or to ground, as the case may require. The connections of the circuit when a grid leak and stopping condenser are used will be

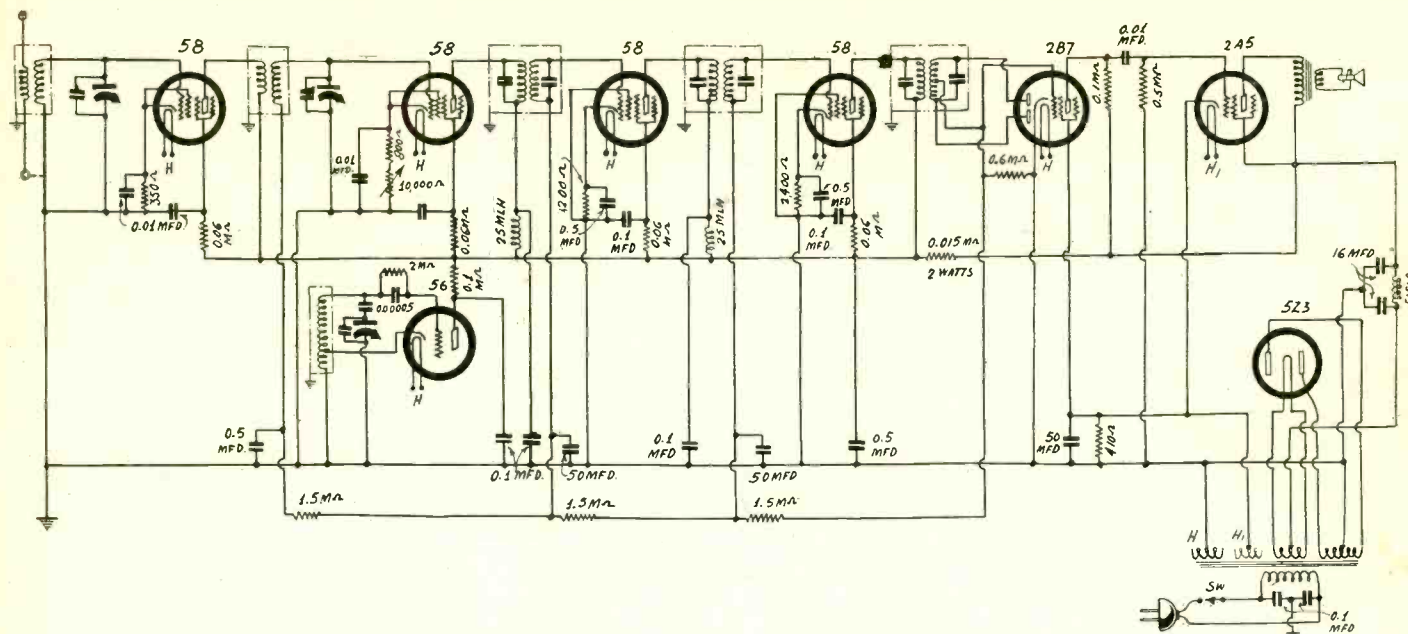

An eight-tube superheterodyne equipped with automatic and manual volume controls and full-wave detection. The use of a 2A5 output tube insures great volume.

found on page 9, Sept. 23, issue of RADIO WORLD.

Terminology of Relays

IN REFERENCE to electric relays I have seen the terms "operate" and "non-operate" positions used. Just what is the significance of these terms?—S. D. T.

A relay is usually said to be in the operate position when the armature is pulled down to the magnet and in the non-operate position when the armature is not so pulled down. But this terminology is not standardized. In the case of a balanced relay there are two positions which may be called operate, for the current may throw the armature in either direction, depending on the direction of the current through the winding.

Effects of Shields

WHEN A SHIELD is put over a tuned circuit, either an r-f or an i-f, what is the effect on the natural frequency of that circuit? Does it increase or decrease that frequency?—E. W. H.

In general it is difficult to say what the effect on the frequency the shield will have. As a rule, the capacity of the coil is increased, and this would tend to decrease the natural frequency. But also as a rule, the inductance of the coil is decreased by the shield, and this would tend to increase the natural frequency. The reduction of the

inductance depends on how the coil is oriented with respect to the longer dimension of the shield and also on the relative dimensions of the coil and the shield. In many cases measured, the net change in the natural frequency of the circuit has been an increase, showing that the decrease in the inductance more than offsets the increase in the capacity.

Choke Bias Resistors

IS IT BETTER to have a radio frequency choke with sufficient resistance to give the correct bias than to have a pure resistance for this purpose? I have seen some circuits in which the resistors have been wirewound so that the inductance would be considerable.—E. R. N.

No doubt it is better to have some inductance in addition to the necessary resistance. However, it is essential to have adequate by-pass condensers from the cathode to ground if the choke is to be employed.

Screen Voltage

WHY IS IT that the screen voltage in a detector and audio amplifier in which the plate load resistance is high must be comparatively very low? I have tried the recommended voltages many times but have always found that if the screen voltage is not low the tube will not function correctly.—G. W. A.

The idea is that the actual screen voltage

should never exceed the effective plate voltage. If the load resistance is high there is a high voltage drop in it and the effective plate voltage becomes very low. If then the screen voltage is high it will happen that the plate voltage is less than the screen voltage. This can be seen from both the static curves of the tube and from the results of experiments such as you have conducted. It may be objected to the low screen voltage on the ground that when it is low the tube no longer functions as a screen grid tube to the fullest extent. That objection is well taken, but the object of the tube is not to function as a screen grid tube but to function as a detector or an amplifier.

An Eight-tube Super

PLEASE SHOW an eight tube super using a 56 as oscillator, a 2B7 as second detector, and a 2A5 power tube. I prefer to use full wave detection in the second detector. Which do you recommend for first detector, a 57 or a 58?—A. B.

The 58 tube is used as first detector in the eight-tube super which we reproduce. It makes a good detector although it is not quite so sensitive as the 57. It will probably give better results for all that. A feature of the circuit shown is that the screen voltage on the 2B7 is the same as the grid bias on the power tube, but with the proper polarity, of course. The circuit is also equipped with automatic volume control.

A Special Issue of Real Interest and Importance!

RADIO WORLD'S NATIONAL RECOVERY NUMBER

Dated October 14. Issued October 10. Last form closes October 3.

The publishers of RADIO WORLD believe that they can give special service to the radio trade, by issuing this National Recovery Number.

Advertisers in the radio field will have an opportunity of telling their sales stories to RADIO WORLD's thousands of subscription and newsstand readers throughout the radio field, at no extra cost for space. In fact, our special summer rates of \$100 a page, half, quarter and eighth

pro rata, and \$3.50 an inch (instead of the regular rates of \$150 a page and \$5.00 an inch), will be held open for this issue.

Every reader of RADIO WORLD is a potential buyer of your goods.

May we serve you?

Advertising Department, RADIO WORLD, 145 West 45th St., N. Y. City

FEEDBACK WAR AGAIN TO GO TO HIGHEST COURT

A decision in the suit against Radio Engineering Laboratories, concerning the feedback patent, wherein Maj. Edwin H. Armstrong was upheld by the United States Circuit of Appeals as the inventor, casts anew a doubt as to whether Maj. Armstrong or Dr. Lee DeForest is entitled to the patent.

The Supreme Court of the United States decided about two years ago that Dr. DeForest was entitled to the patent, but Maj. Armstrong did not give up hope, and he contends that the Supreme Court decision was based solely on a question of law, and that no question of fact came up for review. The Radio Engineering Laboratories case, he says, involves a question of fact, and therefore the suit may come properly before the Supreme Court on its merits.

Samuel Darby, jr., attorney for De Forest, says that preparations are being made to have the case on the calendar of the Supreme Court at the session soon to be convened.

Maj. Armstrong Prevailed Often

The question of who was the inventor of regeneration has been before the courts for a decade, and during nearly all that time Maj. Armstrong prevailed. He was recognized by engineering and other societies, as well as by governments, as the inventor, and was honored with medals and other decorations. He is therefore interested in prevailing at law and, in fact, mostly as a matter of pride and reputation, and to re-establish the significance of the honors showered on him. The financial features of the question are not important any more, especially as Radio Corporation of America acquired the DeForest Company, and even prior thereto, in its own right, was entitled to use of the patent no matter which way any court decided the debated patent question.

The significant point about the Supreme Court decision was that it added eight years to the life of the patent, whereas validation of the Armstrong patent would have been financially academic, also, since the life of Maj. Armstrong's patent had expired.

Statement by RCA

The following statement was made by the Radio Corporation of America:

"The decision of the United States Circuit Court of Appeals of the Second Circuit in the suit against Radio Engineering Laboratories for infringement of the DeForest feedback patents is in effect an adherence to its position that this basic invention was made by Major Edwin H. Armstrong rather than Dr. Lee DeForest. In the earlier litigation in the Circuit the DeForest Company was held to infringe a feedback patent issued to Major Armstrong, which was owned by Westinghouse Company.

"The decision of this Circuit seems in sharp conflict with decisions of the Court of Appeals of the District of Columbia and the Court of Appeals of the Third Circuit, each of which held that DeForest is the originator of the feedback invention. This invention is regarded by engi-

Another Ultra-Wave Transceiver Developed

An ultra-frequency transceiver has been developed by Dr. Carlton D. Haigis, of 106 Terris Avenue, Maple Shade, N. J., intended primarily for two-way communication between aircraft and ground station. He used a frequency of 52.5 megacycles (around 6 meters) for communication with the Navy rigid dirigible Macon while it was cruising over Sandy Hook.

Transceivers are common with amateurs, but inventors have been busy trying to perfect one that would be light, portable, efficient and dependable. Dr. Haigis claims that his outfit meets these requirements, and besides sends a call carrier that can operate a buzzer to signal the receiving station.

The transceiver is a battery-operated transmitter and receiver of an effective radius of about eighty miles.

Guglielmo Marconi's work in the ultra frequencies centered about a transceiver. He reached distances of around 170 miles and, like Dr. Haigis and other experimenters in the ultra frequencies, experienced no fading or static.

Reception of short-wave signals 170 miles from the transmitter is contrary to the assumption that short waves travel in straight lines like light waves. In view of the fact that reception has been reported at points "far below the horizon" the radio waves cannot follow the straight lines that light waves follow. There is a bending of the waves, or a tendency for them to follow the surface of the earth. Of course, the short waves could be reflected by the Heaviside layer, just as the somewhat longer waves are, but this assumption is not supported by experiments on the Heaviside layer with the ultra-short waves. Tests have shown that the shortest waves are not reflected by the layer, but that they are either absorbed in it, or that they pass through it into space beyond.

Thimble-Sized Tubes for Ultra Frequencies

RCA Radiotron Company, Inc., is experimenting with tubes much smaller than a thimble and intended for use on the ultra frequencies. There is no present or impending intention of marketing them, although so far results have been encouraging.

The characteristics are somewhat like those of standard receiving tubes for voltage amplification and detection.

neers as the line of demarcation between old-time and modern radio.

Judges' Viewpoint

"Although the United States Supreme Court affirmed the decision of the Third Circuit, the majority of the judges of the Second Circuit are now of the opinion that in its affirmance the Supreme Court did not decide on matters of fact, but held its decision to matters of law peculiarly applicable to interference suits.

"It is anticipated that the Supreme Court, if asked, will grant a petition for a writ of certiorari and thereby clarify the situation so that the owners of the respective patent rights and the radio industry may know how to deal with the conflicting decisions.

"Radio Corporation of America is licensed under both the DeForest and Armstrong patents through agreements with American Telephone and Telegraph Company and Westinghouse Company."

MUCH HIGHER POWER IS RULE OF MEXICANS

Heterodyne interference experienced in all types of receivers may be due in many instances to high-powered Mexican stations, especially as these stations operate at or near frequencies used by United States stations. For instance, XEZ uses 711 kc, or 1 kc removed from WOR. Newark, N. J., and XEM uses 660 kc, the same frequency at WEAf, New York City.

It is possible to suffer interference though both stations are on the same wave, due to slight departure from assigned frequency, and especially as the requirement of frequency adherence is not as strict in Mexico as it is in the United States. Also, a phase shift introduces interference in the form of fading.

The problem of interference by Mexican stations with broadcasters in the United States and Canada was discussed at the recent North and Central American Radio Conference, held in Mexico City, Mex., but the conference could not get the Mexican government to consent to a proposed code for ridding the areas of interference, as certain modification of Mexican activities were involved.

The following list of stations, with their high power noted, has been released from Mexico City, and includes some transmitters proposed for early operation, but that have not yet taken the air:

XEN, Matamoros, 711 kc., 150,000 watts.
XEM, Matamoros, 660 kc., 500,000 watts.
XEF, Villa Acuna, 665 kc., 500,000 watts.
XET, Monterey, 690 kc., 500,000 watts.
XER, Villa Acuna, 735 kc., 500,000 watts.
XETM, Matamoros, 845 kc., 150,000 watts.
XENT, Nueva Laredo, 1,115 kc., 150,000 watts.

With such high-power stations south of the Rio Grande there will necessarily be much interference with American stations.

Board Scans WMCA Deal with Millionaires

Washington.

Some interest was shown at the Federal Radio Commission in the contract between a group of millionaires' sons, and Donald Flamm, for control of WMCA, without actual transfer of the station license. The new management intends to make the station one of importance and value in the community, according to its expressed declaration, and has elected Alfred E. Smith as chairman of the board.

At the Commission it was pointed out that there is a strict policy there against trafficking in licenses, and that the arrangement carried out at WMCA did not seem to be consistent with that policy. However, no official action has been taken, but it is understood that the Commission is being consulted as to a future course affecting the station, now that the deal has been completed. Commission sanction would be necessary ultimately.

The entry of Mr. Smith into the broadcasting board followed closely the identification of Curtis Dall, son-in-law of President Roosevelt, with a broadcasting chain.

20 MORE 50 KW STATIONS LOOM IN A NEW MOVE

Washington.

Doubling the number of 50 kw stations in the United States, now limited to twenty, is recommended by Federal Radio Commissioner Harold A. Lafount. Such extension of high power was sought by stations a few years ago, but they were deterred by a lack of encouragement from the Commission, and by the growing seriousness of economic conditions. However, since then the stations' economic situation has shown signs of improvement and the membership of the Commission has changed, so that now there is a better likelihood of success.

The suggestion was renewed by Commissioner Lafount after the few years of dormancy, following the failure of the recent inter-government radio conference in Mexico City to get co-operation from the Mexican Government for riddance of interference conditions. With Mexico going to higher and higher power, some United States stations feel that their power should be increased.

Stations Have Opportunity

Since the disposition of the Commission membership is said now to be favorable to the forty-station plan, it is now up to the stations to say whether they want the extra power. It is believed that they will come forward lustily, as they did some years ago, when twice as many applicants appeared than it was even remotely possible would be accommodated.

An added incentive to enlargement of power output is the fact that an outstanding effort will be made by WLW, Cincinnati, O., to effectuate continental coverage with a single station, by using 400 or 500 kw. This tremendously-powered transmitter will be on the air in a few months. The idea is to constitute the equivalent of a "single-station chain."

Smaller Stations Hopeful, Too

Meanwhile there are scores of smaller stations in the United States that would like to use greater power, but are prevented both by economic conditions and by the Commission's classification. However, a review of the radio broadcasting setup, as affecting power of stations, is said to be contemplated by the Commission.

While large hopes always have been held forth for super-power, the general experience so far has been, comparing 5 kw to 50 kw, that the service area was enlarged, signal quality was improved and more consistent reception assured, but the penetration of great distances on a dependable basis has not been one of the results, although at first expected. However, a 100-fold increase, compared to a 10-fold increase, may reveal a different story, in the case of WLW's new transmitter, compared to the original power of some stations now on 50 kw. WLW is one of the present twenty 50 kw stations.

BLAN THE RADIO MAN DID IT

The phototube relay described in last week's issue was made up by Blan the Radio Man, 177 Greenwich Street, New York City. He has demonstrated it for various uses in his store at that address.

Ease of Handling in a Short-Wave Set

(Continued from page 11)

provement in the sensitivity, and then all is well, but if the trimmer has been turned a great deal, the readjustment of the oscillator may effect an improvement that may justify the extra work.

When the larger coils are used, the trimmer will affect the setting of the oscillator more than the smaller coils are used, for a reason that has already been pointed out. Likewise, on these coils the trimmer will have to be used more in order to get greatest sensitivity out of the set.

Layout of Circuit

The circuit is built on a regular chassis so that there is plenty of room. A top view of the subpanel is shown in Fig. 1. In the center is the gang condenser. To the left of this is the pentagrid tube. Directly behind the tube, but not visible, is the oscillator coil. The rear section of the condenser serves this coil. The radio frequency coil is in the left, front corner and is clearly visible. Back of the r-f coil is the first intermediate frequency transformer and in the left, rear corner is the 58 intermediate amplifier. The second tube from the left, in the rear, is the second detector and back of the gang condenser is the second intermediate frequency coil.

On the right of the condenser we have the power supply and the audio amplifier. In front is the power transformer and back of this are the two 8 mfd. filter condensers in the B supply. Back of these condensers are the power tube and the rectifier. Which is which is clearly visible.

In Fig. 2 we have a view of the subpanel from underneath. From this figure we note that the manual volume control is the right hand knob in Fig. 1 and that the trimmer condenser is the left hand knob. The central knob, of course, is the tuning control.

The locations of the two 300-turn chokes are also shown. One choke is near the

oscillator coil socket and the other is attached to the rear side of the chassis. Various resistors and small by-pass condensers are distributed in the most convenient positions and each unit is placed so that leads are shortest practicable.

Sales of Songs Cut by Broadcasting, Is Claim

The American Society of Composers, Authors and Publishers has issued a little booklet entitled "The Murder of Music," which contains a number of charts showing the increase in the radio audience, the sale of radio sets, expenditures for broadcast advertising, sales of pianos, of phonographs, of sheet music, royalties received from sales of records, employment of musicians in motion picture theaters, the average life of song hits, and the distribution of the money spent by the American public for entertainment. The charts cover the period from 1925 to 1932, both inclusive.

The object of the charts is to show that the mechanization of music "murders music" by depriving thousands of professional musicians of their means of livelihood and by inadequately remunerating the composers for their efforts. The major blame is laid to radio, because it plays all song hits to death in the short period of three months, whereas before 1925 the average life of a song hit was sixteen months. But motion pictures also are blamed, because, it is claimed, this industry could not continue without music, yet it receives a vastly disproportionate part of the money spent for amusements.

Most of the charts indicate that the growth of radio has been parallel with the decline of factors favorable to music and musicians. The rapid decline in the sale of radio receivers, from the dollar viewpoint, which set in during 1930, is attributed to the increase in midget sets.

Two for the price of One

Get, EXTRA, one-year subscription for any One of these magazines:

- POPULAR SCIENCE MONTHLY.
- RADIO-CRAFT (monthly, 12 issues).
- RADIO INDEX (monthly, 12 issues), stations, programs, etc.
- RADIO (monthly, 12 issues; exclusively trade magazine).
- EVERYDAY SCIENCE AND MECHANICS (monthly).
- RADIO LOG AND LORE. Bi-monthly; 5 issues. Full station lists, cross indexed, etc.
- AMERICAN BOY-YOUTH'S COMPANION (monthly, 12 issues; popular magazine).
- BOYS' LIFE (monthly, 12 issues; popular magazine).
- OPEN ROAD FOR BOYS (monthly, 12 issues).

Select any one of these magazines and get it free for an entire year by sending in a year's subscription for RADIO WORLD at the regular price, \$6.00. Cash in now on this opportunity to get RADIO WORLD WEEKLY, 52 weeks at the standard price for such subscription, plus a full year's subscription for any ONE of the other enumerated magazines FREE. Put a cross in the square next to the magazine of your choice, in the above list, fill out the coupon below, and mail \$6 check, money order or stamps to RADIO WORLD, 145 West 45th Street, New York, N. Y. (Add \$1.50, making \$7.50 in all, for extra foreign or Canadian postage for both publications.)

Your Name.....

Your Street Address.....

City..... State.....

DOUBLE VALUE!

- If renewing an existing or expiring subscription for RADIO WORLD, please put a cross in square at beginning of this sentence.
- If renewing an existing or expiring subscription for other magazines, please put a cross in square at the beginning of this sentence.

RADIO WORLD, 145 West 45th Street, New York. (Just East of Broadway)

CIVILIAN CAMP LIFE ENRICHED BY AMATEURS

One of the most important factors in maintaining the morale of the 300,000 young men now enrolled in Civilian Conservation Camps is the free communications service being provided by amateur radio.

A good proportion of the more than 1,400 camps established throughout the country either have amateur radio stations on the grounds, operated by enlisted amateur operators, or neighboring stations have been opened to message traffic from the "forest boys."

The utilization of amateur communications both for personal and official traffic has been encouraged by the War Department, which early in the mobilization was faced with a great overload on its existing radio networks.

Extra Equipment Provided

The commanding officer of the 9th corps area, in which 459, or nearly one-third, of the camps are located, elected to meet this situation with the services of the Army Amateur Radio System, organized in 1925 through the cooperation of the American Radio Relay League.

Sanction of the Federal Radio Commission and the Chief Signal Officer of the Army was obtained. In some instances amateurs possessing advanced stations, who were available for service, were provided with transportation and necessary tube and antenna equipment to get the system operating on an efficient basis.

Not only is official traffic handled with accuracy and dispatch over this system, but the radio communication is proving a large factor in the success of the administration of the forest camps.

Boosts Morale

According to Capt. Garland C. Black, of the Signal Corps, it is also doing a great deal toward boosting the morale of the camp personnel by affording a direct channel of communication between home and camp. Some of the forest camps located in the western states are more than a hundred miles from a railroad station and in such instances the roads are not always of the best.

Literature Wanted

Readers desiring radio literature from manufacturers and jobbers should send a request for publication of their name and address. Address Literature Editor, RADIO WORLD, 145 West 45th Street, New York, N. Y.

Barr Radio Service, Rugby, No. Dak.
Howard Tyson, 432 Fulton, Denton, Texas.
Jakie Lichtenberg, 107 So. Broadway, Oklahoma City, Okla.
T. C. Reid, Orofino, Idaho.
B. F. Start (books giving details on the latest Superlet designs), 110 Northumberland Pk., Tottenham, N. 17, London, England.
Alvin Siegler, 76 Nagle Avenue, New York City.
W. Chas. Sachse, 3437 Pierce Avenue, Chicago, Ill.
C. W. Grass, R. F. D. No. 3, Box 167, Beaumont, Texas.
Willis C. Eberst, 3815 Beale Avenue, Altoona, Pa.
H. R. Troth, 906 Kimbrough, Springfield, Ohio.
Frank Connally, Waxahachie, Texas.
Charles F. Erk, 1711 Luty Avenue, N. S., Pittsburgh, Pa.
Benj. Veneski, Radio Replacement Service Co., 208 Broadway, Camden, N. J.
Joseph F. Sabol, 1406 Ravine Street, Munhall, Pa.
R. A. Street, Vicksburg Sanitarium and Crawford Street Hospital, Vicksburg, Miss.
Arthur M. Wengel, Wengel Radio, 616 So. Brearly Street, Madison, Wisc.

They Say

N. G. SYMONDS, vice-president and general manager of sales, Westinghouse Electric & Mfg. Co.: The tremendous increase in business which has followed along in the wake of the NRA activity means that every salesman has got to buckle down to real selling and not just to order-taking. The National Recovery Act has somewhat altered old-fashioned methods of selling, so that we have got to keep on our toes if we want to get business under the new set-up. With the majority of the important industries working under a Code and with the price problem relegated to the background as a problem of sales, we must view our prospective customer from a different angle.

"It is extremely important to remember, however, that regardless of how the NRA activity may affect business practices, it will not destroy human nature in the customer. Consequently, every prospective purchaser will be trying to strike a bargain as always in the past."

ABS ANNOUNCES FEATURE SPOTS

The Amalgamated Broadcasting System, of which Ed Wynn is president, has added WCNW, Brooklyn, N. Y., the former WMIL, whose call letters were changed and WFAS, White Plains, N. Y., the Westchester county unit station in the metropolitan area, said Ota Gygi, vice-president.

Amalgamated will offer the following regularly:

Dr. Carl Van Doren, literary authority in a series of dramatized book reviews for a 15-minute afternoon period beginning at 2:30.

Dr. Charles Fleischer, theologian, editor, speaker, writer and publicist, 6:45-7:00 p.m. for new comments.

Emile Gauvreau, editor of the New York "Daily Mirror," author of newspaper novels, and tabloid expert. He will discuss "The News of Tomorrow."

A slap-bang revue of the kind conceived by Ed Wynn. "Big Meetin' Time," enlisting Rosamund Johnson and his colored choir, with Catherine Tiff Jones and an orchestral and dramatic background.

As a collateral feature to "Big Meetin' Time," there will appear a new quartet, "Four Deacons From Dixie."

The Amalgamated Symphony Orchestra, directed by Adolphe Kornspan.

"Sunny Jim" Rich at the organ.

The Amalgamated Broadcasting System Dance Orchestra. The Amalgamated Broadcasting System Choristers.

The present active scope of the ABS is encompassed by the following stations:

Station—Location	Watts	kc
WBNX(*)—New York	250	1350
WTNJ—Trenton, N. J.	500	1280
WPEN—Philadelphia, Pa.	250 (Day)	
	100 (Night)	1500
WDEL—Wilmington, Del.	500 (Day)	
	250 (Night)	1120
WCBM—Baltimore, Md.	250 (Day)	
	100 (Night)	1370
WOL—Washington, D. C.	100	1310
WCNW—Brooklyn, N. Y.	100	1500
WFAS—White Plains, N. Y.	100	1210
WCAM—Camden, N. J.	500	1280
WCAP—Ashbury Park, N. J.	500	1280
WJBT—Ded Bank, N. J.	100	1210

(*) Stations WBNX, WCDA and WMSG have been grouped under WBNX call letters.

MICKEY MOUSE RADIO

Walt Disney, creator of Mickey Mouse, has appointed the Emerson Radio and Phonograph Corporation as exclusive manufacturers and distributors of Mickey Mouse receiving sets. This new idea in receiving sets will be introduced by Emerson along with eleven other new models.

SALE OF RADIO "SONG SHEETS" HELD RACKET

Illegal sale of song sheets in violation of copyright constitutes a racket which is rapidly becoming a nation-wide training school of crime, according to E. C. Mills, general manager of the American Society of Composers, Authors and Publishers.

In a letter to Senator Royal S. Copeland, chairman of the Senate Committee investigating racketeering in the United States, Mr. Mills appeals to the public to assist in combating the practice of illegally printing and selling on the streets hundreds of thousands of song sheets without regard to the rights of the composer.

Says Thousands Do It

"During the last few years, thousands of persons, mostly young men, all over the country, have been enlisted by unscrupulous printers and racketeers in the sale of illegal song sheets containing the words of popular music heard over the radio," said Mills. "Turning out these song sheets in quantities of hundreds of thousands, the racketeering printers and their accomplices sell their product to young men at a few cents a piece, after explaining the glowing prospects of considerable profit by selling them on street corners to the public at five and ten cents a copy. Unwittingly, these innocent youths thereby get their first taste of crime."

"The American Society of Composers, Authors and Publishers, to protect its members against this form of piracy, has been waging a relentless war against these racketeers. Since one of our duties is prosecution of infringements, it has become necessary for us to ask the assistance of Federal, state and county authorities in stamping out these illicit sales. Approached by a police officer, the young salesman is terrified by the possibility of a fine, which he most probably cannot pay, or a jail sentence. Immediately he begins to lie. He says he does not know the person from whom he bought the sheets, and very rightly declares he did not know he was committing a crime."

Magistrates Called Lenient

"Because magistrates in such cases are usually sympathetic, the youth believes that he can get away with it again, and so he buys more song sheets and begins an active life in dodging the police, lying, giving evasive answers, and other fundamentals of a reckless life. Racketeering of this kind may lead to rackets of a more serious nature, involving bootlegging, robbery, forgery, assault and any other of the crimes so prevalent in the country today."

"We ask the assistance of your committee in bringing to the attention of the public this temptation facing the youth of this country, thousands of whom become the pupils of racketeers in large cities throughout the United States. If the public will refuse to buy these song sheets, the temptation will be removed. We earnestly hope that this assistance will be forthcoming."

READRITE BOOKLET

Even to an established organization with a reputation, it is encouraging to hear others sing your praise. An interesting booklet, entitled "Let Others Tell You," is just off the press for free distribution to the trade and contains testimonials from all parts of the country by users of the Readrite meters. It is a striking piece of printed matter and a good advertisement from satisfied customers.

Station Sparks

By Alice Remsen

THOSE BOYS AT WTAM

Spent a few hours in Cleveland last week, met some charming folk at Station WTAM, and sang a couple of songs on the Ford dealers program; enjoyed the experience immensely and hope to repeat it in the near future. . . . WTAM is one of the finest broadcasting stations in the Middle West—spacious, well-equipped, and well-managed, with an excellent staff of competent artists; the Ford program features are those two lovable rural characters, Lum and Abner; the first four days of the week, Monday, Tuesday, Wednesday and Thursday, they are heard over WEA and the red network at 7:15 p. m., EDST, and on a fifteen-minute program; on Friday, however, the boys put on an ambitious half-hour program, during which two guest stars are heard; when you hear this unique program you may think that Lum and Abner are a couple of old fossils, but they're not; Lum (Chester Laucke) is tall, dark-haired, slender, modest, and 31 years old; Abner (Norris Goff) is shorter, lighter-haired, heavier and younger—27 years old; very charming boys; both married and both born in the little town of Mena, Ark. . . . Johnny Marvin is in Cleveland, making personal appearances and singing over WTAM; he has sung on the Lum and Abner program several times; and one cannot think of WTAM without thinking at the same time of Warren Wade, who is the genial head of the Artists Bureau; Mr. Wade is well known on Broadway for his acting and producing ability, and is equally well known in the "sticks" for his dramatic stock companies; since he was nine years old Warren Wade has trouped with many different theatrical organizations, from medicine shows to barnstorming rep shows, carnivals, circus and dramatic stock; in fact, when he succumbed to the lure of radio five years ago. Mr. Wade had no less than five dramatic stock companies running in Cleveland alone; now, he is jack-of-all-trades at WTAM, writing special continuities, producing shows, pinch-hitting for an actor once in a while and managing the artists' bureau; quite a job, keeps him busy, as you can imagine, but not too busy to be gracious to a visiting artist. . . .

FORD RUSH AT WCAU

Ford Rush, who was "Old Man Sunshine" of WLW for a long time, has transferred his activities to WCAU in Philadelphia, where he is being sponsored by his old bosses, the Wheatena Company; Ford is doing the same kind of stuff as before—a novelty presentation for children, using the same idea for band; he has just changed title of program, calling it Ye Happy Minstrel and the Tiny Band; you may hear him five times weekly, from WCAU, over WABC, each Sunday, Monday, Tuesday, Wednesday and Thursday, from 6:45 to 7:00 p. m. . . . October 4th is the starting date for a new weekly half-hour series which will feature Albert Spalding, leading American violinist, over WABC, each Wednesday from 8:30 to 9:00 p. m.; this series will be a presentation of the Centaur Company, makers of Fletcher's Castoria. . . . Fred Smith, the original "March of Time" dramatist, will return from Europe for the 1933 series of news dramatizations which come back to the WABC-Columbia network in October. . . . Harry Richman is commuting by plane from Chicago, where he is singing at the Chez Paris, to New York, where he sings on the Fred Waring show. . . .

THEY'RE BACK AGAIN

Another show has returned to the air, and a very welcome return it is—"Threads of Happiness" sponsored by the Spool Cotton Company in the interests of J. and P. Coats and Clark's ONT thread; Andre Kostelanetz has the orchestra again this season, and Tommy McLaughlin, youthful baritone, will again be featured; David Ross will contribute brief poetic readings, and will also do the announcing; each Friday, at 9:15 p. m., WABC. . . . Another news program, giving the highlight of domestic and foreign news and supplied by the Columbia News Service, may now be heard daily, except Sunday, over WABC at 12:30 p. m., sponsored by General Mills, Inc. . . . Big Freddy Miller, a six-foot-two, 190-pound baritone from the Middle West, will be heard over the WABC-Columbia network for the first time when he inaugurates a new series of programs on Tuesday, October 3rd, at 11:15 a. m.; he will be on the air at this time every Tuesday and Friday under the sponsorship of the National Oil Products Company; he was formerly on a local spot for the same sponsor. . . . "Easy Aces," that gay air comedy of domestic felicity, featuring Goodman Ace and his wife Jane, will return to an enlarged WABC-Columbia network on Tuesday, October 10th, from 1:30 to 1:45 p. m., and every Tuesday, Wednesday, Thursday, and Friday thereafter at the same time. . . . "Roses and Drums" back again, every Sunday at 7:30 p. m. WABC; isn't that good news? . . . Joe Venuti was seen on Broadway last Saturday; Joe was in from a run in Detroit with his band; went out of town again almost at once. . . . Jack and Loretta Clemens, who bill themselves as "Fourth Cousins of Mark Twain," are brother and sister, eighteen and twenty years old; nice kids, and clever. . . . Those "Horatio Alger Boys" (vide Nellie Revell) the Sizzlers, are broadcasting from WTAM; their manager, Charlie Bayha, moved his family from New York to Cleveland; he likes it out there. . . .

THE MARKS TO CELEBRATE

Edward B. Marks, well-known music publisher, celebrates his fortieth year in the business this winter; E. B. started in with Joseph W. Stern in 1894; in 1920 he bought Stern out; his brothers Max and Mitchell and son Herbert will celebrate with him. . . . You're liable to hear another Calloway over the air soon; Blanche, a sister of Cab, now has her own band, touring the Southern towns which have not yet seen Cab. . . . Have you heard Dick Humber's Orchestra from the Hotel Essex, NBC-WEA network? Great stuff! I like the way he uses harp for interludes. . . . Howard Lanin, an old sidekick of mine, is now in his twentieth week at the Atlantic Beach Club. . . . A new child artist for the ether has been discovered by that indefatigable Eddie Wolfe; she's eleven-year old Mary Small from Baltimore; this youngster has the nonchalance of a grown-up, the technique of a veteran and the voice of an adult; she'll go far, especially if piloted by Eddie. . . . Ruppert is the latest brewer to go radio, WOR; one hour show, once weekly, with guest talent. . . . And now Ford Frick, the sports commentator on WINS, is playing vaudeville. . . . Carl Fenton is back in town after a summer at Bear Mountain Inn. . . . There are two very excellent reasons why the daily Ohio Farm Bureau broadcasts over the micro-

STUDIO NOTES

Owen D. Young is the ideal radio speaker, according to Vernon Radcliffe, NBC production man who was in charge of the studio recently when the industrialist broadcast his NRA appeal over NBC networks. Mr. Young had his talk timed to the second and ended "on the nose."

"Never before in my long experience in radio," Radcliffe said, "have I had the pleasure of observing any public personality who had such an excellent radio delivery and who timed his talk perfectly."

* * *

Edwin Franko Goldman, conductor and founder, first President of the American Bandmasters' Association, retired from the active presidency of the organization at the fourth annual convention held in Chicago recently. The organization thereupon elected him Honorary Life President. Mr. Goldman succeeds the late John Philip Sousa who held the position of Honorary Life President.

* * *

Rosaline Greene, dramatic actress, took a stroll down Fifth Avenue the day before New York put on its NRA parade. Two engineers of the NBC field department were testing portable equipment, which they later used to broadcast a description of the parade.

She paused to watch their preparations. One of the men observed her interest and invited the young lady to speak into the microphone, which she did, then she strolled on.

"Boy, I bet that girl got a great kick out of that," the engineer declared.

"Kick, my eye," the other told him. "That's Rosaline Greene who has been broadcasting for ten years."

* * *

Lanny Ross, star of NBC's Show Boat program, established a precedent in his appearance at the New York Paramount Theater recently by singing semi-classical music. His selections included "Take a Pair of Sparkling Eyes" from the Gilbert and Sullivan operetta "Gondoliers." Said Boris Morros, Paramount musical director, and manager of the theater:

"This is the first time that a popular singer has presented successfully light opera music at the Paramount."

phones of WLW have, in a short space of time, become one of the Middle West radio's most popular periods; one of these is Ed Bath, agricultural expert, and his intensely interesting discussions; the other is Virginio Marucci and his Ohio Farm Bureau Orchestra; Marucci is an artist of rare individuality and charm, having that invaluable gift of inspiring his men and bringing out the best in them; he writes most of the orchestral arrangements used during the program; thus bringing to the broadcasts an enchanting originality and a definite freshness which is delightful. . . .

MOSTLY WMCA

Tom Probert has joined the dramatic staff of WMCA. . . . Elmo Russ, well-known organist, may now be heard daily in a sponsored organ recital over WMCA, at 10:00 a. m.; Helen Leighton, popular stylist, will give an interesting and informative talk on styles in jewelry; Miss Leighton is a speaker of infinite charm, and her talks are usually well balanced and well worth a listen. . . . Another item of interest from WMCA is the fact that their "Five Star Final," a daily news dramatization, has returned to the air and may now be heard five times weekly, Tuesday through to Saturday, at 7:15 p. m. . . . Time to stop! My finger is getting tired. Yes, I'm a two-fingered typist, but I use the right finger much more than the left and bang a little bit harder with it—and besides, those "b's," "h's" and "Y's" are cutting up again, so must quit before I lose my temper.

SETS PLAYED AT N. Y. SHOW THRILL CROWD

Ten days' exhibiting at the 1933 Radio-Electrical Exposition, Madison Square Garden, New York City, gave great encouragement to receiver manufacturers, especially as the exhibition was well attended, was replete with crowd enthusiasm, and marked for the first time the demonstration of receivers. Special sound-proof booths were erected, so that instead of merely accepting or rejecting the standardized claims of tone quality, selectivity or sensitivity, the public could enter one of the special booths and get a demonstration.

Besides utility, beauty was served. The hangings were purple, gold and crimson, and were illuminated with colored floodlights, investing dome and walls with a beautiful and even fantastic aspect.

There were seating accommodations for 600, and the scene was so colorful that at night sessions most of the seats were occupied by devotees of optic leisure, although the manufacturers would have preferred to have had these folk in the demonstration booths, with pen handy.

Favorites Seen at Mike

It has been the custom to have crystal studios, or ornate broadcasting rooms, and this year the custom was more than followed, for there were two such places. The public could see through the glass walls the familiar countenances and statures of their favorites as these appeared before the microphone. Special broadcasting took place in celebration of the exhibition, especially on Sunday, which was officially "Broadcasting Day." Honors were bestowed as evenly as possible in fixing these "days," being apportioned to NRA, electrical science, Army-Navy, lighting, police, radio industry and Miss Radio.

The exposition would not be complete without its "Miss Radio, 1933," and so a queen was chosen by popular ballot, and reigned with the accustomed grace and beauty of such decorative notables, being honored without measure and put to great expense for ornate dresses befitting her temporary station.

There were ninety-four manufacturers represented at the exposition, all having imposing displays, and among them were 26 radio set manufacturers. The strictly radio show was abandoned a few years ago, as the industry was not active or prosperous enough to support it, but the combined radio-electrical show took its place, and this year was conducted by the management of the Garden, instead of by the industries.

Police Do Their Stuff

One of the features that interested the attending throngs the most was the exhibit of the New York Police Department, revealing how police radio works. A map at headquarters locates each car in the radio patrol, and as the car is dispatched to destinations by orders transmitted over the police wave and received in the car sets, the marker is moved. This map was duplicated in the exhibit, and the general atmosphere of police headquarters, in its nicer aspects, prevailed. Besides, there were statistics to show that in eight months the police radio division alone had caused the recovery of \$723,000 in stolen property.

The object of the exhibit was not merely

TRADIOGRAMS

By J. Murray Barron

When one figures the number of small communities in the United States and their purchasing power, it is difficult to understand just why more local persons do not take advantage of an unusually fine opportunity to supply the wants and demands of their neighbors. Many, through force of circumstances and the necessity of earning money without going to other towns or cities, take on the selling of various articles, as agents or local representatives. In many cases they do quite well. The items handled are generally ones bought by the woman of the house, although there are numerous articles sold direct to the men folk. The radio mail order houses do some selling to those who resell in their respective communities, but even when one takes into consideration the dozen or more houses doing a radio mail order business and the total number of customers who either buy for personal use, for resale or as servicemen, one hasn't as yet even commenced to cut into the thousands of small communities that are potential sites for personal representatives or agents. To be organized to even cover half of these towns and villages would be a large undertaking for a healthy organization. To the readers of radio publications who may have never given this idea a thought it might not be such a bad idea to take this message to heart personally, for after all you will be doing well by the town folk in supplying their wants and giving them worthwhile merchandise. If perhaps the idea of selling is a new one to you, there need be no holding back because of lack of experience. Any organization which would supply agents with radio receivers would supply instructions, hints and general information on selling to the public. In this respect any one interested in representing a reliable radio manufacturer in his community and who does not know how to go about it, may address this column and receive information.

A special RMA committee, headed by E. T. Cunningham, of Camden, N. J., as chairman, has been appointed to make a special study of the future broadcasting of television. His associates on the committee

to give the crowds a good idea of what is being done in police radio, but to encourage them to assist the police by telephoning headquarters any time they see a crime committed, or suspect that one is about to be committed. Consistent with this public education campaign, the New York Police Commissioner advertises on billboards, in street cars, and elsewhere, lending the same encouragement of cooperation.

There are 350 police cars in New York City associated with the radio criminal-catching network, and the messages sent to some of them, as circumstances required, were heard at the Garden, just as if the attendants had been at police headquarters as voluntary guests.

Fortunately for the exposition, since most of the attendance was at night, so most of the police radio activity was at night, for between sundown and 1 a.m. the nefarious folk are busiest, and Friday is a particularly busy day for them, because holdup men and robbers have their eyes on payroll money being assembled for Saturday payoff.

Wednesday was police day, in honor of what the police of the country are doing for a specialized branch of the radio business, as well as for their contribution to law and order by ether assistance.

The final day was devoted to the radio industry, and its purpose was to emphasize the merits of the new crop of receivers, but as to all the manufacturers in the radio group, every day seemed to be radio industry day.

Radio exhibitors included Atwater-Kent,

are W. Roy McCanne, of Rochester, N. Y.; Powel Crosley, of Cincinnati, and James M. Skinner, of Philadelphia. The committee will study the desirability of various broadcast frequencies for the future broadcasting of television as it gradually develops. It will consider recommendations to the Federal Radio Commission in Washington in connection with television frequencies.

LeRoi J. Williams, of Chicago, a director of Radio Manufacturers Association, is the new chairman of the Association's engineering committee. Mr. Williams succeeds George K. Throckmorton, of Harrison, N. J., who resigned.

"Bracelet" labels on every five feet of appliance cord use in installing a radio receiving set throughout North Carolina are required under the new law and ruling of state authorities. The recently-enacted sales control law of North Carolina requires that all appliance cords must bear the underwriters "bracelet" label which is applied to such cordage every five feet, according to information of the RMA. North Carolina and other localities require use of "bracelet" labels on power supply cords and RMA engineers expect other states will adopt similar regulations. The situation is regarded as a part of a national drive gradually to eliminate sub-standard and hazardous power supply cords.

E. C. Cannady, North Carolina State Electrical Engineer and Inspector, has stated that this ruling applies to all radio receivers, regardless of whether or not they have been listed by the Underwriters' Laboratories. That is, the listing of a receiver by the Laboratories does not enable it to be sold in North Carolina without the bracelet label on the power supply cord.

Edge Radio, Ltd., a subsidiary of Messrs. William Edge & Sons, manufacturers of "Drummer" cotton goods, is converting its cotton mill into a radio factory, at Bolton, Lancashire, Eng. The highest class range of sets are to be made, and radio phonographs will be included in a comprehensive series.

Colonial, Crosley, Fada, General Electric, Graybar, International, Majestic, Motorola, Philco, RCA Victor, Sparks-Withington, Stewart-Warner, Stromberg-Carlson and Westinghouse.

"OREGONIAN" BUYS KEX

KEX, Portland, Ore., has been bought by "The Portland Oregonian." The station operates on 1,180 kc, 5 kw. The newspaper also owns KGW, in the same city, 620 kc, 1 kw.

CORPORATE ACTIVITIES

BANKRUPTCY PROCEEDINGS

Against

Musique Radio Co., Inc., 142 Liberty Street, New York, N. Y., for \$184, by Hans C. Klonka; for \$306, by Cunard Stationery & Printing Co.; for \$175 by H. Bernard Weissman.

CORPORATION REPORT

Keith-Albee-Orpheum Corporation and subsidiaries—Net loss for six months ended June 30, after depreciation, amortization and other charges, \$355,695. In the same period of 1932 the net loss was \$1,119,051. For three months ended June 30, 1933, net loss after same deductions, \$278,952. In preceding quarter the net loss was \$76,742, and in second quarter for 1932, net loss was \$733,986. Net loss of Orpheum Circuit, Inc., and its subsidiaries is included in the net loss shown in the first quarter, amounting to \$124,836 from Jan. 1, 1933, to Jan. 27, on which latter date the Orpheum Circuit, Inc., was adjudged bankrupt.

Quick-Action Classified Advertisements

7c a Word—\$1.00 Minimum

CHEMISTS, ELECTRICIANS, AMATEUR SCIENTISTS—join Experimenters Club. Apparatus given free! Big monthly magazine. Send 25c for 3 months' subscription and particulars. Science-craft, 5049-N. Bernard, Chicago.

"THE CHEVROLET SIX CAR AND TRUCK" (Construction—Operation—Repair) by Victor W. Pagé, author of "Modern Gasoline Automobile," "Ford Model A Car and AA Truck," etc., etc. 450 pages, price \$2.00. Radio World, 145 W. 45th St., N. Y. City.

THE FORD MODEL—"A" Car and Model "AA" Truck—Construction, Operation and Repair—Revised New Edition. Ford Car authority. Victor W. Page. 708 pages, 318 illustrations. Price \$2.50. Radio World, 145 W. 45th St., New York.

"MATHEMATICS FOR SELF STUDY," by J. E. Thompson, B.S. in E.E., A.M. A complete course in four inexpensive books: Arithmetic, Algebra, Trigonometry, Calculus, for the Practical Man. 1240 pages, cloth, illustrated, \$7.65. Radio World, 145 W. 45th St., New York City.

RADIO WORLD AND POPULAR MECHANICS MAGAZINE—Radio World is \$6.00 a year, and Popular Mechanics Magazine is \$2.50 a year. Popular Mechanics Magazine does not cut rates, but Radio World will send both publications to you for one year for \$7.00. Radio World, 145 West 45th St., New York City.

HENLEY'S "TWENTIETH CENTURY BOOK OF RECIPES, FORMULAS & PROCESSES." New 1933 Edition. Ten thousand processes, recipes, trade secrets and money-making formulas. For the laboratory, workshop, factory and home. Some subjects fully covered: Dyes, Inks, Waterproofing, Perfumes, Cement, Plating, Glass, Dentifrices, Varnishes, Soaps, Glues, Paints, Adhesives, Enamelling, Hairdressings, Cosmetics, Oils. Price, \$4.00. Book Dept., Radio World, 145 W. 45th St., New York City.

NEW RADIO AMATEUR'S HANDBOOK, 180,000 words, 207 illustrations, 218 pages (10th edition, issued 1933). Issued by the American Radio Relay League. Price, \$1.00 per copy. Radio World, 145 West 45th Street, New York, N. Y.

BLUEPRINT

627. Five-tube tuned radio frequency, A-C operated; covers 200 to 550 meters (broadcast band), with optional additional coverage from 80 to 204 meters, for police calls, television, airplane, amateurs, etc. Variable mu and pentode tubes. Order BP-627 @.....25c

RADIO WORLD, 145 W. 45th St., New York, N. Y.

"THE INDUCTANCE AUTHORITY"

By EDWARD M. SHIEPE, B.S., M.E.E.

[A NEW BOOK]

Published by HERMAN BERNARD

THE ONLY BOOK OF ITS KIND IN THE WORLD, "The Inductance Authority" entirely dispenses with any and all computation for the construction of solenoid coils for tuning with variable or fixed condensers of any capacity, covering from ultra frequencies to the borderline of audio frequencies. All one has to do is to read the charts. Accuracy to 1 per cent. may be attained. It is the first time that any system dispensing with computation has achieved such very high accuracy and at the same time covered such a wide band of frequencies.

A condensed chart in the book itself gives the relationship between frequency, capacity and inductance, while a much larger chart, issued as a supplement with the book, at no extra charge, gives the same information, although covering a wider range, and the "curves" are straight lines. The condensed chart is in the book so that when one has the book with him away from home or laboratory he still has sufficient information for everyday work, while the supplement, 18 x 20 inches, is preferable for the most exacting demands of accuracy and wide frequency coverage.

From the tri-relationship chart (either one), the required inductance value is read, since frequency and capacity are known by the consultant. The size and insulation of wire, as well as the diameter of the tubing on which the coil is to be wound, are selected by the user, and by referring to turns charts for such wires the number of turns on a particular diameter for the desired inductance is ascertained.

There are thirty-eight charts, of which thirty-six cover the numbers of turns and inductive results for the various wire sizes used in commercial practice (Nos. 14 to 32), as well as the different types of covering (single silk, single cotton, double silk, double cotton and enamel) and diameters of $\frac{3}{4}$, $\frac{7}{8}$, 1, $1\frac{1}{8}$, $1\frac{1}{4}$, $1\frac{3}{8}$, $1\frac{1}{2}$, $1\frac{3}{4}$, 2, $2\frac{1}{4}$, $2\frac{1}{2}$, $2\frac{3}{4}$ and 3 inches.

Each turns chart for a given wire has a separate curve for each of the thirteen form diameters.

The two other charts are the tri-relationship one and a frequency-ratio chart, which gives the frequency ratio of tuning with any inductance when using any condenser the maximum and minimum capacities of which are known.

The book contains all the necessary information to give the final word on coil construction to service men engaged in replacement work, home experimenters, short-wave enthusiasts, amateurs, engineers, teachers, students, etc.

There are ten pages of textual discussion by Mr. Shiepe, graduate of the Massachusetts Institute of Technology and of the Polytechnic Institute of Brooklyn, in which the considerations for accuracy in attaining inductive values are set forth. These include original methods.

The curves are for close-wound inductances, but the text includes information on correction factors for use of spaced winding, as well as for inclusion of the coils in shields.

The publisher considers this the most useful and practical book so far published in the radio field, in that it dispenses with the great amount of computation otherwise necessary for obtaining inductance values, and disposes of the problem with speed that sacrifices no accuracy.

The book has a flexible fiber black cover, the page size is 9 x 12 inches and the legibility of all curves (black lines on white field) is excellent.

Order Cat. IA @ \$2.00 (book and supplement). Remit with order and these will be sent postpaid to any destination. Order C.O.D. and you pay the postage.

HENNESSY RADIO PUBLICATIONS CORP.

145 WEST 45th STREET, NEW YORK CITY

NEW MODEL SHIELDED TEST OSCILLATOR!

Either 50-150 kc Fundamental Model, a-c or battery; or 500 to 1,500 kc Fundamental Model, (broadcast band) a-c or battery, available.

Either model FREE with two-year subscription for Radio World (104 issues) \$12.00

An improved modulated test oscillator, fundamental frequencies, 50 to 150 kc, enabling lining up of intermediate frequency amplifier, i-f and oscillator circuits, is now ready. It is shielded in a metal box $9\frac{1}{2}$ " wide x $6\frac{1}{2}$ " deep x $4\frac{1}{2}$ " high, with beautiful Japanese finish. The test oscillator is obtainable in two models, one for a-c operation, the other for battery operation. The same cabinet is used for both.

The a-c model not only is shielded but has the line blocked, that is, radio frequencies generated by the oscillator cannot be communicated to the tested set by way of the a-c line. This is a necessary counterpart to shielding, and a special circuit had to be devised to solve the problem.

The modulation in the a-c model is the a-c line frequency, 60 cycles, effected by using the line voltage on the plate of the tube. In the cabinet there is a very high resistance between the shield cabinet and the a-c, a double preventive of line shorting and application of a-c line voltage to the user.

The oscillator is equipped with an output post. No ground connection need be used, as the circuit is sufficiently grounded through the power transformer capacity to prevent body capacity effects in tuning.

The frequencies are more accurately read than normal use requires, being never more than 2% off, and usually not more than 1% off, many readings being right on the dot (no discernible difference). The frequency stability is of a high order from 100 to 50 kc, and somewhat less from 100 to 150 kc. Zero beats are guaranteed at all frequencies.

The oscillator was designed by Herman Bernard and is manufactured under the supervision of graduates of the Massachusetts Institute of Technology.

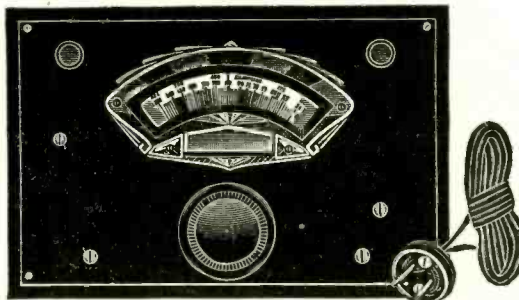

The test oscillator has a frequency-calibrated dial, 150 to 50 kc, with 1 kc separation between 50 and 80 kc and 2 kc separation between 80 and 150 kc. Intermediate frequencies are imprinted on the upper tier. Broadcast frequencies are obtainable on tenth harmonics (500 to 1,500 kc).

THE a-c model is completely self-operated and requires 2 56 tubes. The battery model requires external 22.5-volt small B battery and 1.5-volt dry cell, besides a 230 tube. The use of 1.5 volts instead of 2 volts on the filament increases the plate impedance and the operating stability. The battery model is modulated by a high-pitched note. Zero beats are not obtainable with the battery model.

Directions for Use

Remove the four screws and the slip cover, insert the 56 tube in its socket, restore the cover and screws, connect the a-c attachment plug to the wall socket, and the a-c test oscillator is ready for service.

For testing some particular set, follow the directions given by the designer or manufacturer. In the absence of such directions, use the following method.

Mentally affix a cipher to the registered frequencies on the lower tier (so 50 is read as 500, and 150 as 1,500), and set the dial for any desired broadcast frequency. Connect a wire from output post of test oscillator to antenna post of set. Leave aerial on for zero beats, off otherwise. At resonance the hum will be heard. Off resonance it will not be heard. For testing intermediate frequencies, connect the wire to plate of the first detector socket. The first detector tube may be left in place and bared wire pushed into the plate spring. The intermediates then are tuned for strongest hum response. If an output meter is used, tune for greatest needle deflection.

The battery model is connected to voltage sources as marked on oscillator outleads and is used the same way.

RADIO WORLD

145 West 45th St., New York, N. Y.

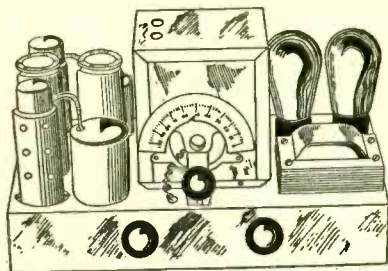

BLUEPRINTS, COILS and CHASSIS FOR THE TUNED R-F **DIAMOND OF THE AIR**

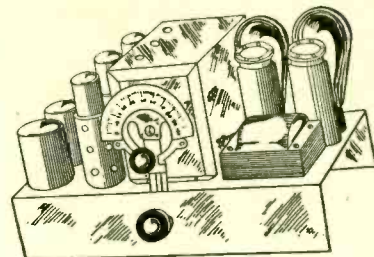

FOUR-TUBE DIAMOND

Extremely fine performance, including fetching tone quality, marks the Four-Tube A-C 1933 Diamond of the Air, blueprint of which is now available (half-scale). Many have been surprised that so much can be accomplished on a t-r-f set that costs so little to build. The circuit uses a two-gang 0.00035 mfd. condenser. Special coils are required. The chassis is metal, 13.75 x 6.75 x 2.5 inches.

Send \$3.00 for six months subscription (26 issues) and get the blueprint, two official shielded coils and the drilled metal chassis free. Order PRE-D-4-COMB.

FIVE-TUBE DIAMOND

The Five-Tube A-C 1933 Diamond of the Air provides greater sensitivity than the four-tube model, also somewhat more selectivity, as a three-gang condenser is used. An infallible method of permanently suppressing oscillation is introduced, so that besides having a sensitive and selective set one will have a stable receiver. The tone is most excellent. Send \$4.00 for 34 weeks subscription (34 issues) and get the blueprint, three shielded coils and drilled metal chassis free. Chassis is 13.75 x 9 x 3 inches. Order Cat. PRE-D-5-COMB.

Analyzer Plug and Adapters

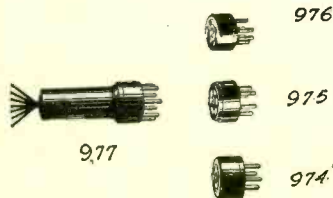

For constructing a set analyzer, an analyzer plug, to go into a receiver socket, is necessary. We offer the exclusive seven-pin analyzer plug, plain long handle as illustrated, and three adapters that enable putting the plug

connections into UX, UY and six-pin receiver sockets. The plug has 5-foot 7-lead cable. All four parts sent free on receipt of \$6.00 for one-year's subscription (52 issues). Order Cat. PRE-ANPLAD.

0-10,000-Ohm Resistance Meter

A 0-10,000-ohm ohmmeter and continuity tester. A rheostat is built in for correct zero resistance adjustment. The unit contains a three-cell flashlight battery. Supplied with two 5-foot-long wire leads with tip plugs. Case is 4-inch diameter baked enamel. Sent you for an order for one year's subscription for RADIO WORLD (52 weeks) at the regular rate of \$6. Order Cat. PRE-500.

We do not pay postage on resistance meter. Average postage 17c.

RADIO WORLD and } \$7.00 RADIO NEWS }

Get both of these magazines for one year for \$7.00, although the regular subscription price of RADIO WORLD alone is \$6.00 a year and that of "Radio News" alone is \$2.50 a year. Instead of paying \$8.50 you pay \$7 and you get 52 issues of RADIO WORLD (one a week) and 12 issues of "Radio News" (one a month). "Radio News" recently bought "Citizens Radio Call Book," and "Technical Review" and consolidated them with "Radio News." This offer at this combination price applies only to United States and possessions. Send \$7.00 and order Cat. PRE-RWRN. To Canadian and other Foreign subscribers the combination price offer is at \$8.50 for these two magazines. Order Cat. PRE-FOR-RWRN.

RIDER'S MANUAL

The standby of the service man is John F. Rider's "Perpetual Trouble Shooter's Manual."

Vol. 2 contains additional diagrams on the same basis as above, but in Vol. 2 there is no duplication of any of the diagrams printed in Vol. 1.

To get Vol. 2 free, send \$9.00 for 1½-year subscription (78 weeks) and order Cat. PRE-RM-2.

PHONOGRAPH MOTOR

Allen-Hough synchronous phonograph motor, 78 revolutions per minute; takes up to 12-inch records. Works from a-c line, 50-60 cycles, 105-120 volts. Equipped with felt-covered turntable. To start the motor give it a slight impetus. Fits into 3-inch depth, hence handy for compact installations. Given free with 34-weeks subscription at \$4.00. Order Cat. PRE-PHOMO.

A-C, D-C SOLDERING IRON



A serviceable iron that works on a-c (any frequency) and d-c, 105-120 volts. Sent free on receipt of \$1.50 for three-months subscription (13 issues). Order Cat. PRE-SOLIN.

R-F CHOKE COILS

These coils have 50, 100, 200, 400 and 800 turns, diameter 1 inch, and are suitable for detector plate filtering, screen filtering, grid and plate loads, etc. The 50 is for short waves, 100 for television band, 200 for broadcast band, 400 for high intermediate frequencies (450 to 300) and 800 for lower intermediate frequencies. Any four, or four of a kind, or combinations not exceeding total of four, sent free on receipt of \$1.00 for 8 weeks trial subscription. Order Cat. PRE-4-CH and state chokes desired, by quantity and number of turns.

TWO BOOKS BY ANDERSON AND BERNARD

some receiver circuits and an explanation of their functioning. Both books sent free on receipt of \$1.00 for 8 weeks trial subscription. Order Cats. PRE-SH-FH.

CHOICE OF PANEL TYPE METERS

One meter sent free with each \$1.00 trial subscription (8 weeks). Order Cat. PRE-MTR and add the number of the meter to the catalogue number. Any number of meters may be ordered on the equivalent extended subscription basis.

0-6 Voltmeter D.C.	No. 326
0-50 Voltmeter D.C.	No. 337
6-Volt Charge Tester D.C.	No. 23
0-10 Amperes D.C.	No. 338
0-25 Milliampers D.C.	No. 325
0-50 Milliampers D.C.	No. 350
0-100 Milliampers D.C.	No. 390
0-300 Milliampers D.C.	No. 399
0-400 Milliampers D.C.	No. 394

HANDY PACKAGE OF PARTS

One grid condenser of 0.00025 mfd., with clips; one 5-to-7 meg. fixed grid leak; one knob with ¼-inch shaft; one a-c cable and plug. All sent on receipt of \$1.00 for 8-weeks trial subscription. Order Cat. PRE-HANPKG.

SHIELDS FOR 57, 58 TUBES

Aluminium shields of the type specified by the tube manufacturers for sensitive circuits, so that the shield top fits snugly about the tube dome, are obtainable, six free on receipt of \$1.00 for 8 weeks trial subscription. Order Cat. PRE-TUBSH.

RADIO WORLD, 145 West 45th Street, New York, N. Y.
(WE PAY POSTAGE ON ALL PRODUCTS LISTED ON THIS PAGE, EXCEPT OHMMETER).