

JULY  
25

1931

RADIO

REG. U.S. PAT. OFF.

WORLD

Price  
15c

Per Copy

The First and Only National Radio Weekly

487th Consecutive Issue—TENTH YEAR

*e.u.*

---

**New Way  
To Rate  
Selectivity**



# EVEREADY RAYTHEON

## 4-PILLAR RADIO TUBES

TRADE MARKS

### ALL THE NEW TUBES—

235, the new sensational variable mu radio frequency amplifier tube for great reduction or elimination of crosstalk, direct inter-station interference and hissing background noises. It has a high mu for low bias and a low mu for high bias. Net price, \$1.54.  
 551, variable mu, substantially the same operation. Net price, \$2.20.  
 247, power pentode for use in the last stage, either alone or in push-pull. It has a greater power sensitivity than any other tube available. Net price, \$1.28.  
 233, a 2-volt power pentode tube for use as output tube in circuits utilizing the 231 and the 232. Net price, \$1.83.  
 237, a 6.3-volt general purpose tube of the heater type, suitable for use in automobile receivers. It may be used as detector, oscillator or amplifier. It may be heated with either direct or alternating current. Net price, \$1.23.  
 236, a 6.3-volt screen grid tube of the heater type which may be used for amplification in receivers utilizing the 237. Net price, \$1.83.  
 238, a 6.3-volt power pentode tube for use as output tube, singly or in push-pull, in receivers utilizing the 236 and 237. Net price, \$1.93.

**ALSO THE STANDBYS—**

227 @ \$0.88	V-199 @ 1.93	232 @ 3.15
224 @ 1.40	X-199 @ 1.75	230 @ 1.12
226 @ .88	120 @ 2.10	231 @ 1.12
171A @ .98	201A @ .77	232 @ 1.61
310 @ 4.90	200A @ 2.80	280 @ \$0.98
245 @ .88	249 @ 1.10	281 @ 3.50
250 @ 4.20	112A @ 1.05	31X @ 3.10
Kino Lamp @ \$4.75	BA @ 5.20	

*Every Tube Guaranteed Electrically and Mechanically Perfect*

EVEREADY RAYTHEON 4-pillar radio tubes are built to give consistently good service over long periods of time. Their performance is uniform day after day and they can be depended on to give maximum results.

These highly desirable qualities are obtained through the use of the unique "Four Pillar Construction" (see illustration) in which the elements are cross anchored at top and bottom. In this way, support is obtained at 8 points instead of 4 as in ordinary tubes.

This rugged trouble-proof feature enables Eveready Raytheon tubes to "stand up" under the most severe conditions and insures the same high degree of performance in the set of the consumer as they exhibit on factory tests.

These tubes have gained recognition for their precision workmanship and long life and are guaranteed to be electrically and mechanically perfect. Also, they are especially well packed in sturdy boxes.



**DIRECT RADIO COMPANY**  
143 WEST 45th STREET, NEW YORK, N. Y.

**NEW!** for AUTO Radio  
Types to Fit All Makes of Cars

## LYNCH

Spark Plug and Distributor Suppressors  
Metallized principle insures dependability and long life.  
Write for illustrated catalog W.S.  
LYNCH MFG. CO., Inc., 1775 Broadway, N. Y. C.

### Three 0.1 mfd. in One Case

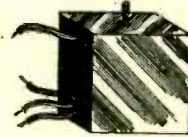

Three Supertone non-inductive fixed condensers of 0.1 mfd. each, (250 v.) in steel case, provided with a 6/32 mounting screw, built in. The black lead is common to the three condensers, the three red leads are the other sides of the respective

capacities. Size, 1 1/2" square by 7/8" wide. Order Cat. SUP-31. list price, \$1.00; net price, 57c.  
**GUARANTY RADIO GOODS CO.**  
143 West 45th St. New York, N. Y.

## Tubes at 50¢ Each

280	200A
226	245
171	

Sold on basis of remittance with order. We will pay the postage.

**RELIABLE RADIO CO.**  
143 West 45th Street New York, N. Y.

## SOLDERING IRON FREE!



Works on 110-120 volts, AC or DC; power, 50 watts. A serviceable iron, with copper tip, 5 ft. cable and male plug. Send \$1.50 for 13 weeks' subscription for Radio World and get these free! Please state if you are renewing existing subscription.

**RADIO WORLD**  
145 West 45th St. N. Y. City

"RADIO TROUBLE SHOOTING," E R. Haan. 328 pages, 300 illustrations, \$3. Guaranty Radio Goods Co., 143 W. 45th St., New York.

## NATIONAL DRUM DIAL



National Velvet Vernier drum dial, type H, for 3/4" shaft. An automatic spring take-up assures positive drive at all times. Numbers are projected on a ground glass. Rainbow wheel changes colors in tuning. Modernistic es-cutcheon. Order Cat. ND-H @ \$3.13.

**GUARANTY RADIO GOODS CO.**  
143 West 45th Street, New York, N. Y.

### "A" BATTERY SWITCH

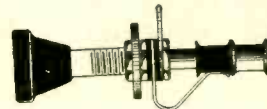

A push-pull switch for battery-operated sets. Made by Bend Sin. Firm, sure contact, extremely long life. Price, 25c

**GUARANTY RADIO GOODS CO.**  
143 West 45th St., New York, N. Y.

## THREE-IN-ONE TESTER FREE!

EVERYBODY who does any radio work whatsoever, whether for fun or for pay or for both, needs a continuity tester, so he can discover opens or shorts when testing.

A mere continuity tester is all right, but—

Often it is desired to determine the resistance value of a unit, to determine if it is correct, or to measure a low voltage, and then a continuity tester that is also a direct-reading ohmmeter and a DC voltmeter comes in triply handy.

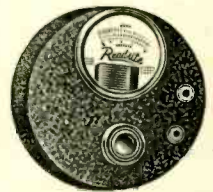

So here is the combination of all three:

A 0-4 1/2-volt DC voltmeter, a 0-10,000-ohm ohmmeter and a continuity tester. A rheostat is built in for correct zero resistance adjustment or maximum voltage adjustment. The unit contains a three-cell flashlight battery. Supplied with two 5-foot-long wire leads with tip plugs. Case is 4-inch diameter baked enamel. Weight, 1 lb. Sent free with an order for one year's subscription for RADIO WORLD (52 weeks) at the regular rate of \$6. Order Cat. PR-500.

Radio World, 145 W. 45th Street, New York, N. Y.

Enclosed please find \$6 for one year's subscription for Radio World (one copy a week, 52 issues). Send Cat. PR-500 as premium.

Name .....  
 Address .....  
 City..... State.....

## Two for the price of One

Get a FREE one-year subscription for any ONE of these magazines:

- CITIZENS RADIO CALL BOOK AND SCIENTIFIC DIGEST (quarterly, four issues).
  - RADIO LOG AND LORE. Quarterly. Full station lists, cross indexed, etc.
  - RADIO (monthly, 12 issues; exclusively trade magazine).
  - RADIO INDEX (monthly, 12 issues) Stations, programs, etc.
  - SCIENCE & INVENTION (monthly, 12 issues; scientific magazine, with some radio technical articles).
  - AMERICAN BOY—YOUTH'S COMPANION (monthly, 12 issues; popular magazine).
  - BOYS' LIFE (monthly, 12 issues; popular magazine).
- Select any one of these magazines and get it FREE for an entire year by sending in a year's subscription for RADIO WORLD at the regular price, \$6.00. Cash in now on this opportunity to get RADIO WORLD WEEKLY, 52 weeks at the standard price for such subscription, plus a full year's subscription for any ONE of the other enumerated magazines FREE! Put a cross in the square next to the magazine of your choice, in the above list, fill out the coupon below, and mail \$6 check, money order or stamps to RADIO WORLD, 145 West 45th Street, New York, N. Y. (Just East of Broadway).

Your Name.....  
 Your Street Address .....  
 City..... State.....

- If renewing an existing or expiring subscription for RADIO WORLD, please put a cross in square at beginning of this sentence.
- If renewing an existing or expiring subscription for other magazine, please put a cross in square at the beginning of this sentence.

**RADIO WORLD, 145 West 45th Street, New York, N. Y. ( Just East of Broadway)**

## DOUBLE VALUE!





Vol. XIX No. 19 Whole No. 487  
 July 25, 1931  
 [Entered as second-class matter, March, 1922, at the Post Office at New York, N. Y., under act of March, 1879] 15c per Copy. \$6 per Year.

TENTH YEAR  
 Technical Accuracy Second to None  
 Latest Circuits and News

A weekly Paper Published by Hennessy Radio Publications Corporation, from Publication Office, 145 West 45th Street, New York, N. Y. (Just East of Broadway) Telephone, BRyant 9-0558 and 9-0559

RADIO WORLD, owned and published by Hennessy Radio Publications Corporation, 145 West 45th Street, New York, N. Y. Roland Burke Hennessy, president and treasurer, 145 West 45th Street, New York, N. Y.; M. B. Hennessy, vice-president, 145 West 45th Street, New York, N. Y.; Herman Bernard, secretary, 145 West 45th Street, New York, N. Y.; Roland Burke Hennessy, editor; Herman Bernard, managing editor; J. E. Anderson, technical editor; L. C. Tobin, Advertising Manager

# Selectivity in Decibels

## New Method of Expression is Advantageous

By J. E. Anderson

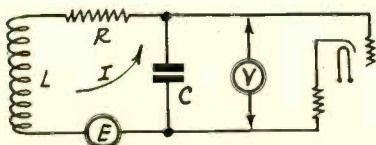

FIG. 1

A simple resonant circuit containing resistance, inductance, and capacity, with an e.m.f. in series with the circuit. In most cases the voltage is induced in the coil L.

THERE are several methods of expressing the selectivity of a simple tuned circuit or that of a more complex selector. One is to give the  $Q$  of the circuit, which is defined as the ratio of the inductive reactance at the resonant frequency to the resistance in the tuned circuit at that frequency. That is, if  $L$  is the inductance of the coil and  $w$  is the frequency at resonance measured in radians and  $R$  is the resistance,  $Q=Lw/R$ .

### Condenser Resistance Neglected

As usually applied the resistance of the condenser is neglected so that  $R$  is the effective radio frequency resistance of the coil alone. Over small frequency bands about the resonant frequency  $Q$  is considered to be a constant, for  $R$  varies approximately in proportion to the frequency. Another way of expressing the selectivity is to give the decrement of the circuit. The decrement is a measure of the rapidity with which free oscillations started in the circuit die down. The smaller the decrement the more selective is the circuit and the longer oscillations continue in the circuit after they have been started. Also, the smaller the decrement is, the longer it takes to build up oscillations of maximum amplitude. The  $Q$  of the circuit is almost the reciprocal of the decrement as far as the effect is concerned for the larger  $Q$  is the more selective is the circuit. In fact the decrement  $d$  is equal to pi divided by  $Q$ , that is to  $3.1416/Q$ .

### Measurement of $Q$ and $d$

Since the two quantities are so simply related it is possible to obtain either by measuring the other. The  $Q$  of the circuit can be obtained by measuring, or calculating, the value of the inductance and by measuring the value of the radio frequency resistance of the circuit at resonance. The value of  $Q$  is then obtained by dividing the inductive reactance  $Lw$  by the resistance. The value of  $w$  is that used in measuring the resistance and the circuit should be adjusted to resonance with this frequency.

Another experimental method of measuring the decrement or the  $Q$  of the circuit is to measure the effective value of the current at resonance and then vary the frequency until the square of the effective value of the current is one-half the value of the square of the resonant current. When this is done we have the relation  $Q [1 - (f_0/f)^2] = 1$ , in which  $f_0$  is the frequency of resonance and  $f$  is that frequency, either above or below resonance, for which the square of the current is one-half as great as the square of the

$$I = \frac{E}{\sqrt{R^2 + (Lw - \frac{1}{Cw})^2}} \dots\dots 1$$

$$V = \frac{E}{Cw \sqrt{R^2 + (Lw - \frac{1}{Cw})^2}} \dots\dots 2$$

$$V = \frac{E}{\sqrt{\frac{K^2}{Q^2} + (K^2 - 1)^2}} \dots\dots 3$$

$$\frac{Vr}{V} = \sqrt{R^2 + Q^2(R^2 - 1)^2} \dots\dots 4$$

$$A = 10 \log_{10} [k^2 + Q^2(k^2 - 1)^2] \dots\dots 5$$

resonant current. This is the usual method of measuring decrement because it is very simple. If the meter used for measuring the current is of the current squared type, for example, a thermocouple meter with a linear scale, the deflections may be used in place of the currents squared, for the deflections are proportional to the current squared.

### A High $Q$ Circuit

As an example of the measurement of  $Q$  or  $d$  let us assume we are using a thermocouple galvanometer. At first we adjust the voltage in the circuit under measurement until the resonant current just gives full-scale deflection. Then without making any other changes we alter the frequency until the current is just half scale. We note the two frequencies in the case. Let us assume that the resonant frequency is 1,000 kc and that the frequency at which the deflection is one half is 1,050 kc. Then applying the formula we have  $Q [1 - (1,000/1,050)^2] = 1$ . From this we get  $Q = 10.75$ . Since the decrement of the circuit is obtained by dividing 3.1416 by  $Q$ , the decrement in this case is 0.293. Our assumed circuit is a very poor one, indeed.

Let us use the same frequency of resonance and the same current squared galvanometer, but now let us assume that the deflection is one-half at 1,005 kc. Putting these values in the formula we obtain 100, very nearly, for  $Q$  and 0.00314 for the decrement. That is more like the circuits used in radio receivers, but it may have a considerably higher selectivity than any one coil used in receivers having many tuned circuits in tandem, especially if the coils are shielded closely.

### Sideband Suppression

When the tuner is to cover a wide range of frequencies, as a broadcast receiver tuner, a single quantity is not adequate to express the selectivity, for it will vary with the frequency of resonance. The only practical way of expressing the selectivity in such cases is to plot curves at selected frequencies in the band. For the broadcast band these curves may be plotted at 550, 750, 1,000, and 1,500 kc, or at the standard test frequencies, 600, 800, 1,000, 1,200, and 1,400 kc. Such curves should not represent a single tuned circuit in the receiver but the entire tuner from the antenna to the detector. For such a complex tuner the simple expression of the selectivity does not have much significance, but the curves show the actual frequency discrimination.

(Continued on next page)



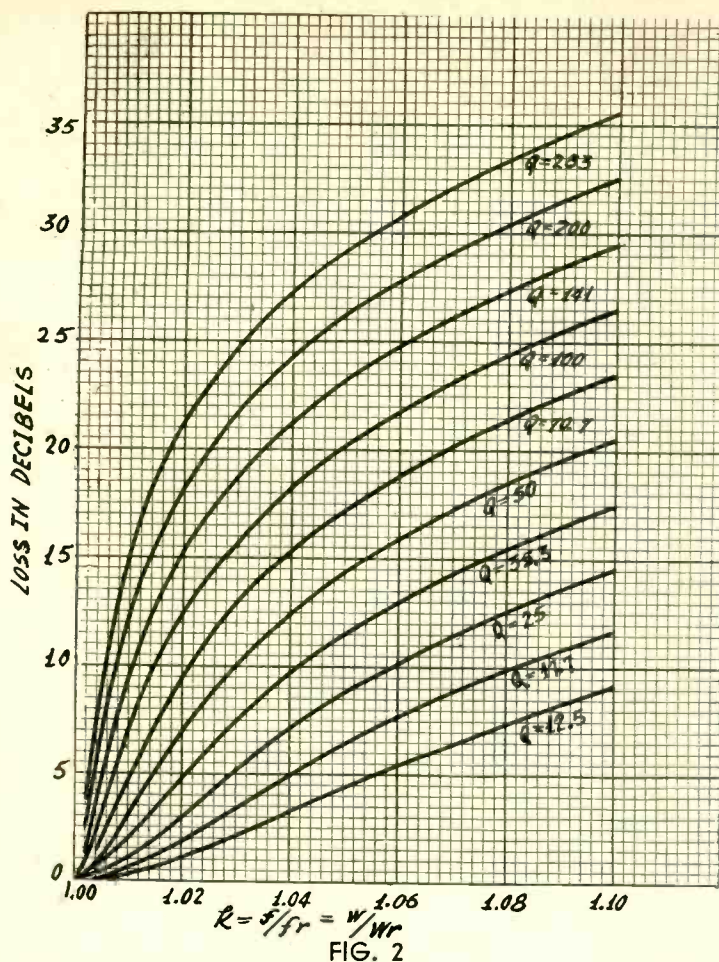

Loss curves for different frequency ratios and selectivity values, applicable especially to a circuit like that in Fig. 1.

(Continued from preceding page)

The selectivity not only determines the suppression of carriers on channels adjacent to the channel that is tuned in but also the suppression of the side frequencies in the signal, for these side frequencies are radio frequencies in so far as the effect of the tuner on them is concerned. In determining the suppression of a side frequency representing a 5,000 cycle note we may consider the suppression of a carrier differing from the desired carrier by 5 kilocycles. The suppression of the side frequency is approximately the same.

The ordinary expression for selectivity or decrement does not apply directly to a coupling transformer, either being a property of the simple circuit alone. When the ratio between the voltage impressed on one tube to the electromotive force in the circuit is considered, the characteristics are somewhat different. First, the primary introduces an effect on the secondary circuit, and second, the reactance of the tuning condenser, assumed to be in the grid circuit, must be included in the formula. That is, the voltage across the condenser, which is the voltage across the grid circuit, is the product of the effective value of the current in the secondary circuit and the reactance of the condenser. If the effective value of the current is  $I$ , the capacity  $C$ , and the frequency in radians  $w$ , then the voltage across the condenser is  $I/Cw$ . Since this involves the frequency the curve is changed from the form obtained when the current alone is considered. In obtaining the selectivity the effective constants in the circuit must be considered, that is, the effective inductance and the effective resistance. If the selectivity is obtained by the thermo-galvanometer method just explained, the effective value is obtained.

#### Selectivity in Transmission Units

A useful method of expressing the selectivity of a circuit employing decibels is described by B. de F. Bayly, of the University of Toronto, in the May, 1931, issue of "Proceedings of the Institute of Radio Engineers." This method possesses many advantages over the older methods and it deserves widespread attention. Hence we shall explain it in detail.

Consider the circuit in Fig. 1. An electromotive force  $E$  is induced in the circuit by another coil coupled to  $L$ , which is the effective value of the inductance in the presence of the primary circuit.  $R$  is the effective value of the resistance in the circuit and  $C$  is the capacity required to tune  $L$  to resonance.  $V$  is the voltage developed across the condenser by the current  $I$ , and it is this voltage which is impressed on the tube following the tuned circuit. We are to find the value of this voltage in terms of the input voltage and the circuit constants.

The effective value of the current at any frequency is given by formula (1) and if we multiply this by  $1/Cw$  we get the effective voltage across the condenser. Formula (2) gives this. Let the

resonant frequency be  $w_r$ . Then  $Lw_r = 1/Cw_r$ . Let the ratio of any frequency to the resonant frequency be  $k$ , that is,  $k = w/w_r$ . Also let  $Q = Lw_r/R$ . Substituting these values in (2) and simplifying we arrive at formula (3). Thus we have the voltage of the condenser in terms of the impressed voltage, the frequency ratio, and the selectivity factor of the circuit.

At resonance the frequency ratio is unity. That is  $k = 1$ . If the resonant voltage across the condenser is  $V_r$ , we have  $V_r = QE$ . The ratio of the resonant voltage to the voltage across the condenser at any other frequency is  $V_r/V$ , which when expressed in terms of the circuit constants is given by equation (4). This formula expresses the loss of voltage at frequencies off resonance and by assigning different values to  $Q$  and  $k$ , resonance curves can be constructed.

#### Decibels

It is now customary to express ratios in terms of logarithms, or in terms of decibels. The loss, or gain, in terms of decibels is defined as 20 times the common logarithm of the ratio of the two quantities. We have  $V_r/V$ . The loss in decibels is therefore  $20 \log (V_r/V)$ . Let us call the loss  $A$ , meaning the attenuation. Taking the logarithm of the right hand member of equation (4) we obtain equation (5). The coefficient 20 changes to 10 because the logarithm of the square root of a quantity is equal to one-half the logarithm of that quantity. All logarithms here are understood to be to the base 10, which is the base in the common system.  $A$  is given in decibels, when the logarithm is multiplied by 20.

Equation (5) gives a very simple way of computing resonance characteristics if we know the selectivity factor  $Q$  of the circuit and the frequency ratio  $k$ . To simplify the computation a table giving  $k$  squared and  $(k^2 - 1)^2$  should be prepared and tabulated against  $k$ .

From such a table a resonance curve can quickly be constructed for any value of  $Q$ . As a further convenience in determining losses due to tuning a set of curves could be constructed for a definite frequency range and several different values of the selectivity. Thus knowing any frequency ratio the loss in any circuit of known selectivity factor can be obtained without any calculation.

#### Many Tuned Circuits

Let us illustrate the use of the formula in equation (5). Let us suppose a carrier frequency of 1,000 kc, a selectivity factor of 100. What is the loss in decibels of a carrier of 1,010 kc? Here the frequency ratio is 1,010/1,000, or  $k$  equals 1.01. Therefore  $k$  squared is 1.0201 and  $(k^2 - 1)^2$  is 0.000404. Since  $Q$  is 100 we multiply this by 10,000 and obtain 4.04. Adding the values of the two squares in the brackets of (5) we get 5.05, approximately. The common logarithm of 5.05 is 0.703, and therefore the loss  $A$  is 7.03 db. Expressed as a ratio, the 1,000 kc carrier voltage is 5.05 times as strong as the 1,010 carrier voltage provided that the two are equally strong at the beginning. The interfering signal would have to be 5.05 times as strong if they are to be equally strong after they have passed through the tuned circuit.

If we have many tuned circuits we can obtain the loss due to all of them by adding the losses of the individual circuits, providing the loss is expressed in decibels. Thus if one tuned circuit causes a loss of 7.03 db, another of 10 db, and a third of 12 db, the total loss is 29.03 db. The voltage ratio in this case would be 800. That is, the interfering carrier voltage would have to be 800 times as strong as the desired carrier voltage if the two are to be equal after they have passed the selector. If all the tuned circuits are the same, the total loss can be obtained by multiplying the loss of one by the number of circuits. Thus if each of the three circuits above had a loss of 10 db, the total loss would be 30 db, which is equivalent to a voltage ratio of 1,000.

#### Loss in Staggered Circuits

Sometimes the tuned circuits are staggered so that they are not in resonance at exactly the same frequency. When the circuit is in tune one of them may be in exact resonance while one of the other may be below resonance and the third above. The formula, or the curves constructed from it, may be used to determine the loss at any frequency off resonance with respect to the middle frequency. As an example, let three circuits be tuned to 1,005, 1,000, and 995 kc.

The carrier is 1,000 kc. It is clear that the maximum voltage after the signal has gone through all the tuners is not as great as it would have been had all the circuits been in resonance with the 1,000 kc carrier. How much is the loss, assuming that the selectivity factor of each circuit is 100? The relative loss in the middle circuit is zero. In each of the other circuits the signal is 5 kc off resonance, one below and the other above. But the losses are so nearly the same that if we get one we just multiply by two to get the total.

If we apply formula (5) we obtain a loss for each circuit of 3.03 db and a loss for the two of 6.06 db. That is the total loss as compared with the voltage if all the circuits were exactly in tune with the 1,000 kc carrier.

#### Loss at 10 kc

Let us now find the loss at 10kc on one side of the peak, that is, the loss to an adjacent carrier. In this case the frequency ratios are different but the loss must be compared with the result already obtained, not with the voltage that would result if all the tuned circuits were in resonance with the desired carrier.

Let us assume that the interfering carrier is on the upper  
(Continued on next page)



# Right or Wrong?

## Try to Answer Before Consulting the Replies

### Questions

- (1)—A band pass filter increases the selectivity of a receiver when the filter is used as the tuner in the circuit.
- (2)—The hissing noise heard in many radio receivers is due to irregular emission of electrons from the cathode. It increases with increased gas pressure in the tube and also with a decrease in the heater or filament current.
- (3)—A 0.0005 mfd. by-pass condenser in the plate circuit of a detector which is followed by a resistance coupler of high ohmic value produces no appreciable reduction in the transmission of the high audio frequency notes.
- (4)—If the isolating condenser in a resistance-capacity coupler is as small as 0.01 mfd. nothing can pass through it below 100 cycles per second because it offers virtually an open circuit to these low frequencies.
- (5)—It is impossible to get as good amplification, that is, free from wave form distortion, from a screen grid tube as from a three-element tube.
- (6)—For short-wave reception coils should be wound with heavy wire because the high frequency resistance of such coils is less than that of coils wound with fine wire.
- (7)—In an automatic volume control the tube used for this purpose should be fed with the carrier frequency because if it is fed by the audio frequency voltage it will only control the modulation. If it is fed with radio frequency voltage, it will control the sensitivity.
- (8)—The cause of motorboating may result in a receiver becoming paralyzed for considerable periods because the fluctuation is so wide that the grid will swing negative to the point where the amplification is entirely shut off.
- (9)—Broadcast receivers are usually more sensitive at the high frequency end of the tuning band because the coupling between the primary and the secondary is proportional to the frequency.
- (10)—A vacuum tube voltmeter is just as accurate on extremely high radio frequencies as on direct current and on audio frequencies because it does not draw any current.

### Answers

- (1)—Wrong. It does just the reverse as the name indicates. Instead of passing a single frequency it passes a band of frequencies, and that is contrary to selectivity. However, it may cause sharper cut-off at the sides of the passed band.
- (2)—Right. It has been found experimentally that gas in the tube increases the hissing noise. It has also been found that the hiss is considerable when the cathode temperature is so low that the plate current is near the saturation current. The noise is due to irregularity of electron emission and it is usually called the schrot-effect, or small shot effect.
- (3)—Wrong. A 0.0005 mfd. condenser across a resistance of

about 250,000 ohms has a very considerable effect in suppressing the high audio frequencies. At 10,000 cycles per second the impedance of a 0.0005 mfd. condenser and a 250,000 ohm resistance is only 31,600 ohms, and the amplification is approximately proportional to the impedance in the plate circuit.

- (4)—Wrong. The voltage drop across the condenser determines the signal that gets through. If the grid leak resistance is of the order of one megohm and if the conductance of the grid to filament circuit can be neglected, the frequency will have to be as low as 15.9 cycles per second before the drop across the condenser is equal to that across the resistance, that is, before the condenser cuts in half the signal transmitted to the tube.
- (5)—Wrong. If the effective voltages on the screen and the plate are maintained properly throughout the signal cycle there is practically no difference between the two types of tubes in respect to wave form distortion. If, however, the screen voltage becomes equal to or exceeds the plate voltage, the distortion is very great.
- (6)—Right. The determining factor is the ratio of the radio frequency resistance to the direct current resistance. While this ratio is small for fine wire and very large for heavy wire, the d-c resistance of the heavy wire is so low that even though the resistance ratio is high the total radio frequency resistance of the heavy wire coil is smaller than that of the coil wound with fine wire.
- (7)—Right. If the automatic volume control tube is fed with carrier frequency voltage the bias on the controlled tubes will increase when the carrier increases and so the amplification will decrease when the signal increases. If the tube is fed with audio frequency voltage the bias will vary directly as the modulation. The amplification will therefore go down when loud passages appear in the signal. This is not what is wanted if the reproduction is to be natural.
- (8)—Right. This trouble is often experienced in receivers, and it usually develops as the tubes in the audio frequency amplifier or the detector become exhausted, developing a high internal resistance. The quickest way to cure the trouble is to put in new tubes. Perhaps only one tube is causing the trouble.
- (9)—Right. The voltage induced in the secondary is proportional to primary current, the inductance of the primary, and the mutual inductance between the two windings. The primary current and the mutual inductance remain constant as the frequency increases. Hence the voltage induced in the secondary is directly proportional to the frequency. To equalize the transmission it is necessary to arrange the primary circuit so that the current through the effective coil decreases inversely with the frequency. This can be done in many different ways.
- (10)—Wrong. At high frequencies the grid to filament conductance of the vacuum tube, nor the interelectrode capacities, cannot be neglected. They pass so much current from the source that large errors result.

## Comprehensive Selectivity Measurement

(Continued from preceding page)

side of the desired carrier. Then the interfering carrier is 5 kc, 10 kc, and 15 kc off resonance with respect to the three circuits. The three losses are 3.04 db, 7.04 db and 15.74 db. The sum is 25.82 db. This is really the loss compared with the case if all the circuits were in tune with the desired carrier. But we already found a loss of 6.06 db because the circuits were staggered. Hence the loss to the interfering carrier is 19.76 db. That is, the voltage ratio is 94.6 on the assumption that the two carriers were equally strong at the start. Had the circuits not been staggered the voltage ratio would have been 382. Thus from the point of view of selectivity nothing is gained by staggering even by as little as 5 kc. It will be noted that the staggering was done at 1,000 kc. At 175 kc the loss due to staggering would have been very much greater.

As an example of the great loss to side frequencies in superheterodynes let us take an intermediate frequency of 175 kc and calculate the loss to a 5 kc side frequency in a tuner having three tuned circuits each with a selectivity of 15. The frequency ratio is now 180/175 for the upper 5 kc side frequency. Applying formula (5) with this value of  $k$  we obtain a loss of 7.77 db. That represents a voltage ratio of nearly 6. While this is small when we are considering selectivity, it is very large when we are dealing with side frequencies. And the selectivity of each circuit was assumed to be only 15!

The loss at the 5 kc side frequency on the low side is somewhat less, being only 6.6 db. Hence the average loss 7.18 db. When the ratio of the two frequencies is so large as in the case of the superheterodyne the losses at the upper and lower side frequencies are considerably different, while at the radio frequencies they are sensibly the same.

The selectivity of a circuit may be described either in terms

of its decrement or of its ratio of inductive reactance to its resistance. But either way gives a pure number that does not immediately call to mind the effect. Moreover, neither method is directly applicable to complex circuits. The method of curves is more descriptive, and for that reason it is recommended by the Institute of Radio Engineers for describing the performance of receivers in this respect. But this method is not suitable for stating in words what the selectivity is. The new method suggested by Mr. Bayly is more comprehensive. The selectivity may be given in decibels. For example, the selectivity of a circuit may be 7 db at 5 kc off resonance from a carrier of 1,000 kc, or it may be 15 db 10 kc off resonance at the same carrier. The two interesting points are the next carrier frequency, which for broadcast frequencies is always 10 kc, and the highest essential audio frequency, which is usually regarded as 5 kc.

The ideal selector should be such that it has a very great loss at 10 off resonance and practically no loss at 5 kc. That is ideal for broadcast signals. For television signals the sharp cut-off must be much higher up, say around 50 kc off resonance. Between zero and 50 kc off resonance there should not be any loss. Simple tuners will not satisfy the conditions in either case.

The curves in Fig. 2 show the losses in decibels for frequency ratios from unity to 1.1 and for values of the selectivity factor from 12.5 to 283. These show very clearly the rapid increase in the selectivity as the  $Q$  of the circuit increases. The range of frequency ratio is so wide that it covers practically all cases met.

In superheterodynes where the intermediate frequency is less than 100 kc the frequency ratio will be greater than 1.1 for 10 kc off resonance but for all higher frequencies the curves cover at least the range between the carrier and the highest side frequency in broadcasting as well as the nearest carrier.



# A Contrast in Circuits

## Detector As Output Suggested in One

By Herman

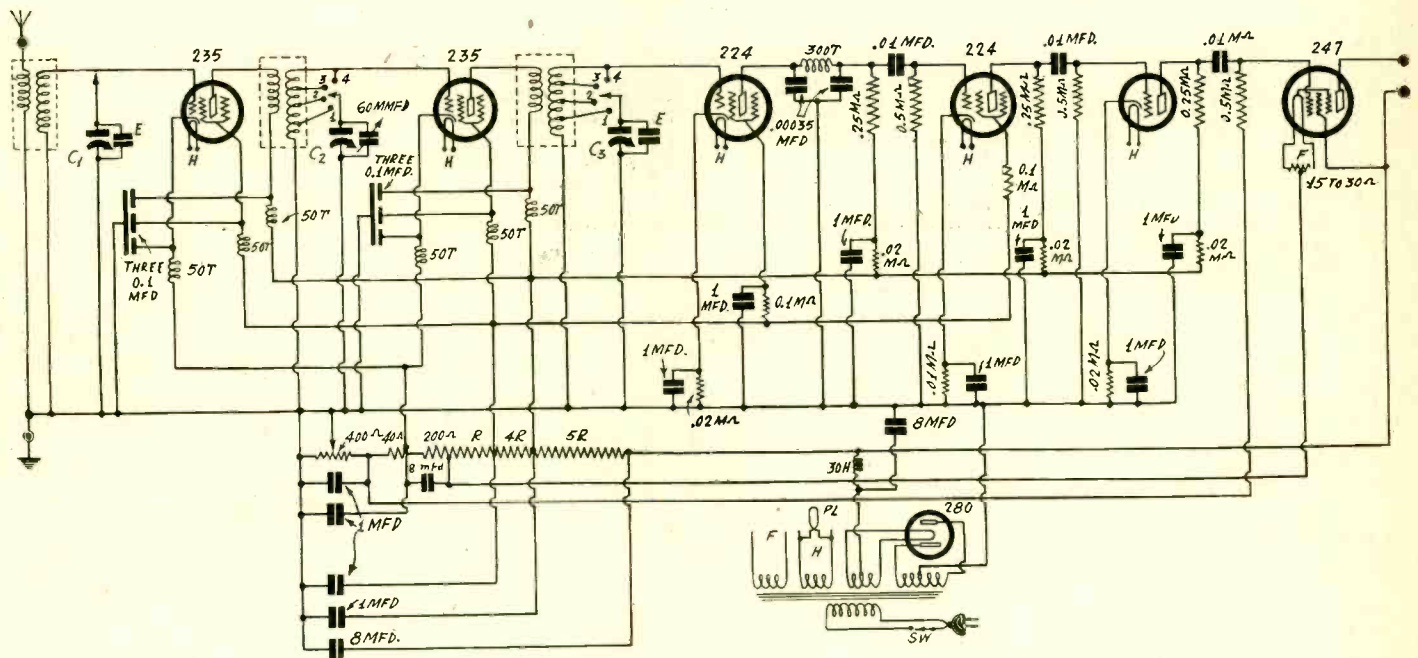

FIG. 1

A tuned radio frequency all-wave receiver, using three stages of audio frequency amplification and a pentode output.

[The circuit diagrammed in Fig. 2 is most interesting. It was designed and invented by the author and is in the process of construction and testing.—EDITOR.]

HERE are two circuits that represent diverse thought in the field of receiver design. Both are all-wave receivers. One is of the tuned radio frequency variety (Fig. 1) with bountiful audio frequency amplification, while the other is a superheterodyne (Fig. 2) with no audio amplifier.

There is considerable in common in the two circuits, besides the all-wave coverage. Both use new types of tubes, with pentode output, both afford front panel wave band selection, both use a three-gang tuning condenser and the same number of tuning coils, and both are calculated to be about the same in sensitivity.

There are many differences, too. Fig. 1 is orthodox. Fig. 2 shows a design never before given, so far as the author knows. The power handling capability of the last tube in Fig. 1 considerably exceeds that of the last tube in Fig. 2. There is no voltage divider in Fig. 2, although one is used in Fig. 1. There are a great many parts in Fig. 1, comparatively few in Fig. 2. The heaters are in parallel in Fig. 1, but in series in Fig. 2. The detector is also the output tube in Fig. 2, but it is third from the output in Fig. 1. Variable mu tubes are used in Fig. 1, none in Fig. 2 which has automotive series tubes exclusively, as there is no vari-mu tube in that series.

### Two Sides Stated

The two distinct schools of thought represented by these diagrams are:

1. For short-wave reception particularly you need large audio frequency amplification, because the signal level originally is low, and is too low at the detector for adequate loudness. To attempt to build up the volume at radio frequencies results in danger of having a squealing circuit, of pernicious instability, and leaves no adequate detector tube that also has power characteristics.
2. The necessity for providing adequate gain can be met in either way, by combination of audio and radio frequency amplification, or by radio frequency amplification alone, save that the output tube provides some audio amplification in either instance. If that tube is a pentode, the gain would be at least equal to one stage of audio were some other type output tube used. There is one tube that offers possibilities of a combination of detection and output characteristics, and that is the 238, because not only is it a pentode but it is also a heater type tube, the only heater pentode made. Hence no hum trouble

need be experienced. It is admitted that the filament type tubes will not do for detection, whether the detector is the output tube or whether there is little or much audio gain following.

Now let us examine the main goal.

One object in regard to both circuits, of course, is the attainment of excellent quality, indeed, a quality good enough for television, since the receivers will tune in television signals.

### Time to Think of Television

Moreover, the commercial introduction of television is said to be not far off—the National Broadcasting Company thinks such receivers for public delight will arrive next year—and it is well now to consider circuits in the light of this possible impending development. Therefore if audio amplification is included it should be resistance coupled. All the manufacturers of experimental television apparatus call for a resistance coupled audio amplifier.

The question is whether any audio amplification is needed at all, and why the astuteness of the radio engineering fraternity is not great enough to provide an audioless circuit, especially as no matter what type of audio amplifier is used, the quality will never be as good as that obtained from the detector.

Those desiring to build the circuit Fig. 1, or one like it, will find the values of constants stated on the diagram, with a few exceptions. One of the exceptions is the capacity of the three-gang condenser, which unit is represented by C1, C2 and C3. The values in use today are in general .0005 mfd. and .00035 mfd., with some special condensers of a value in between, say, .00046 mfd.

For .0005 mfd. the total number of secondary turns should be 85 for a shielded transformer, for .00046 the total number should be 100, and for .00035 mfd. the total number should be 115. Three taps are put on the secondary. In all cases (3) to (4) is two-thirds the total number of turns, while (3) to (2) is two-thirds the remaining number of turns. From (1) to (0) may be 2 turns, and from (2) to (1) what is left. The wire is No. 28 enamel and the tubing is 1.75 inch diameter bakelite.

The same data apply to Fig. 2, except that the tickler coil for the oscillator has 30 turns, and the pickup coil has four turns, these four added to the number of secondary turns otherwise used.

### Switching Operation

The switching device is the same. Suppose the broadcast band is to be tuned in. Then the switch from C1 stator to grid is closed and the selector switch for the other inductances is at



# Designed for Quality

## Hookup that Comprises New Invention

Bernard

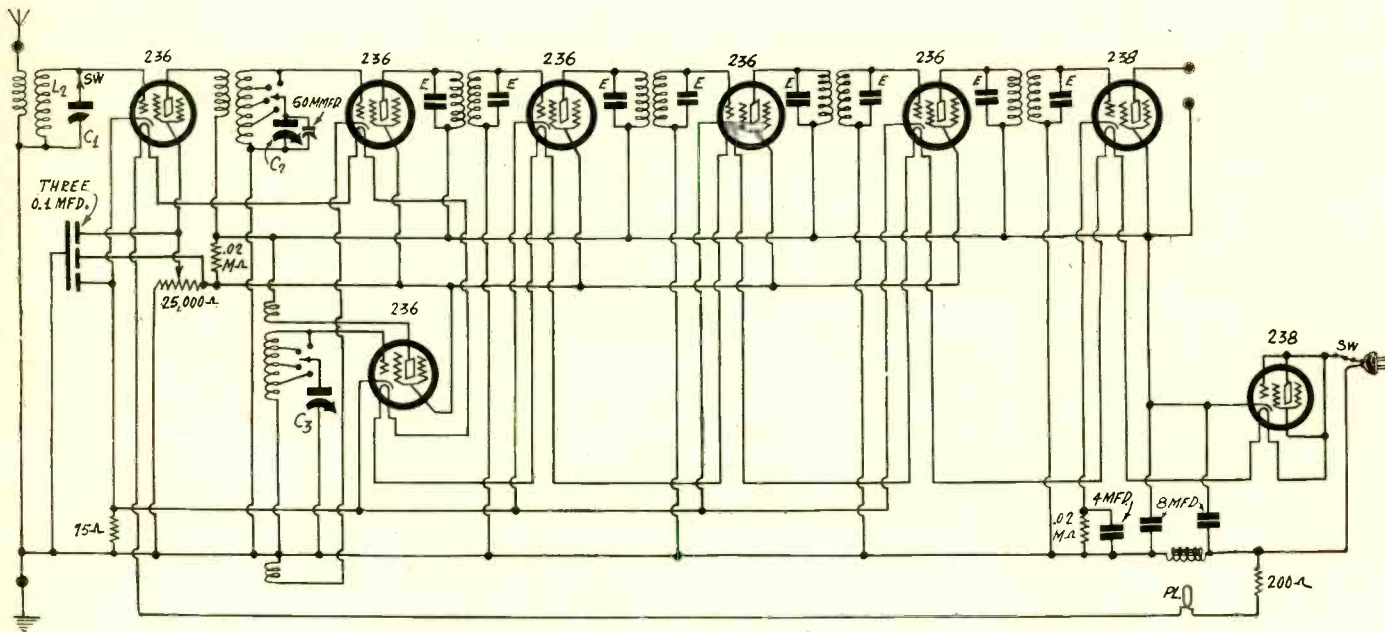

FIG. 2

Something entirely new, a series heater circuit, with the a.c. for the B supply taken from the line, so that no power transformer is used, and rendering the circuit applicable to all commercial frequencies, 25, 40 and 60 cycles, without change, as well as for 110 or 220 volts (with an extra resistor), and operable also on d.c. of 110 or 220 volts, with slight change.

point (4). To tune in frequencies higher than those in the broadcast band, the selector switch is thrown to lower numerical positions, (3), (2) or (1), when C1 switch is opened and the antenna coupler is untuned. That is a satisfactory condition for short-wave reception and also avoids the difficulty of wiring in a triple pole switch, yet retaining the input tuning for broadcast frequencies, where it is needed.

The resistance values for biasing the radio frequency tubes are given, a 400 ohm potentiometer being used as volume control and a 40-ohm fixed resistor to afford a minimum negative bias, which the potentiometer can exceed for volume control. For power tube bias 200 ohms is used. The rest of the resistance network here is the fixed voltage divider, which should have a total of at least 15,000 ohms, not exceeding 20,000 ohms, comprising R plus 4R plus 5R. The proportion is thus indicated. Suppose that R is 1,500 ohms. Then 4R is 6,000 ohms and 5R is 7,500 ohms, and the total is 15,000 ohms. Approximately the correct voltages will result: 75 volts for the screens, 180 volts for the plates of all tubes save the power tube, where about 265 volts will be utilized if the bias voltage is around 16 volts, due to the current through the 200 ohms fixed resistor. If you have the proper voltage divider the 200 ohms may be a part thereof, otherwise would be separate, and of a rating of 25 watts.

The 50-turn and 300-turn coils are honeycomb inductances.

### Special Type of Circuit

The plate voltages are much lower in Fig. 2, where a very special type of circuit is offered. The heaters are in series, and the total voltage drop across them would be about 50 volts, so if the line voltage is 110 volts, 60 volts must be taken care of in a series resistor. The current is .3 ampere, therefore the series resistor should be 200 ohms. A 25-watt resistor will be all right. Some 400 ohm potentiometers will stand 25 watts.

Notice that the heater voltage is obtained directly from the line.

Also the plate voltage is obtained from a 238 pentode tube used as rectifier, the AC line voltage being introduced into this tube, the output being from the cathode. The resultant voltage will be about 110 volts d. c. The automotive series are of a lower plate voltage type than most others, so 110 volts will be satisfactory.

The extra kick needed to make the detector give out loud signals is provided by a third stage of intermediate frequency amplification, the prevailing practice, where there is audio amplification, being to employ only two such stages. With a stage

of t.r.f., a sensitive modulator hookup, a good oscillator and high gain in the three intermediate stages, with one of the most sensitive output tubes in existence, the loudness ought to be pretty good.

### Report on the Result

Short waves do not give the volume obtained on the longer waves, therefore something must be done to compensate for this. Ample audio amplification is one way. It should not be difficult to attain enough loudness of output to satisfy most users, although the circuit may suffer a little from the plate voltage being about 25 volts less than what specifications usually call for. A mere 25 volts means little, but when that amount of voltage is missing from all stages, including the output stage, it may make a sizeable difference. Nevertheless, this is theoretical. The thing may be all right.

The circuit is being built and a report will be made about it by the author to any who will write to him in care of RADIO WORLD, 145 West 45th Street, New York, N. Y. Also, the answer will be published in these columns, although that will be a few weeks later than could be accomplished by mail.

It is obvious to all that the method used in Fig. 2 dispenses entirely with a power transformer. Something to think about is the fact that the receiver works on all frequencies. Also, if an additional resistor of 200 ohms is included, with switch to cut it out if not needed, the circuit can be used at 220 volts. Therefore the receiver would be almost universal, that is, would be all right for 110 volts, 25, 40 or 60 cycles, the commercial voltage and frequencies prevailing in the United States, and also for 220 volts, 25, 40 or 60 cycles, which takes care of conditions in some foreign countries. The author designed the method with universality of use in mind.

### Safety Lamp for D.C.

The other point is that the circuit can be used on a.c. or d.c. of 110 or 220 volts, it being possible to obtain 220 volts d.c. in many locations, especially near factories, as the third wire can be brought into the home or factory by the lighting company, instead of only ground and one high side.

A pilot lamp of the line type would safeguard a d.c. line against shorting and also serve as an indicator that the grounded side is picked up for a.c.

The pilot lamp for the dial may be in series with the heaters, as .3 ampere is right for a 2.5 volt pilot lamp.



# A Versatile Chassis

## May Be Used for Variety of Circuits

By Herbert E. Hayden

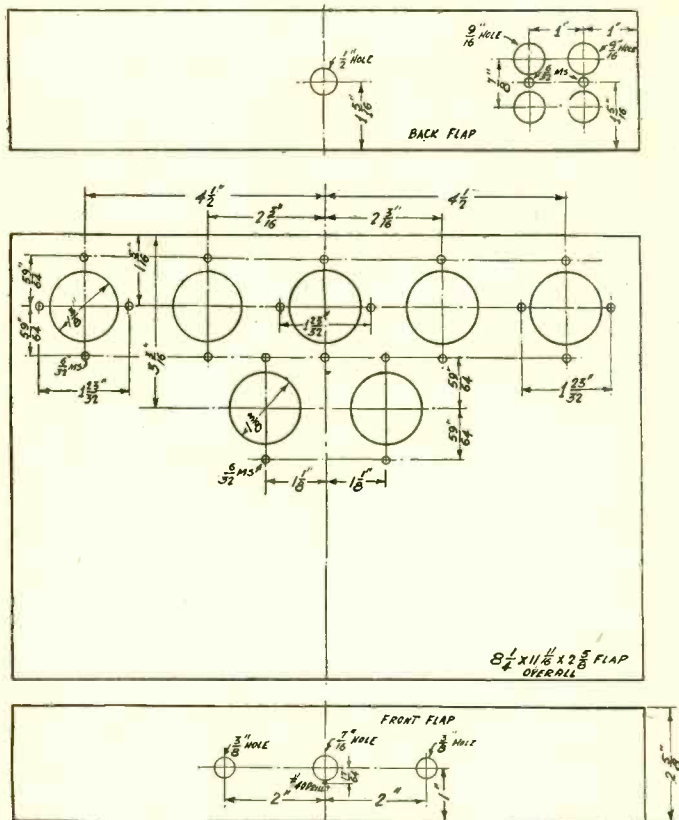

FIG. 1

Layout for an aluminum chassis on which a variety of circuits, both A-C and battery-operated, may be built.

SOMETIMES a man desires to build a circuit of his own design and would like some assistance as to the chassis layout. It is quite easy for any constructor these days to get an aluminum panel made to order. To use one created for some other circuit the only requirement is that the layout be flexible enough to serve the needs. Fig. 1 shows the dimensions,

with drilling data, for a chassis layout that can be used for a variety of circuits.

Suppose you want to build a five-tube set, consisting of four tubes and rectifier. It is just the thing for that. Two 8 mfd. electrolytic condensers may be placed in the holes at extreme left and right rear, the radio frequency tubes in the forward holes (in which wafer sockets are put), and the rest of the tubes in the remaining sockets. The condenser would be mounted with shaft at right angles to the front panel, requiring a disc type dial. There would be room for the power transformer and choke coil to left and right of the two-gang tuning condenser.

### Option of Drum Dial

Suppose you desire to build a five-tube battery operated set, using plug-in coils of the tube base type, or of any type that has a plug with the tube base geometry. The plug-in coils could be placed either at extreme left and right rear, or second from left and second from right, the rest of the sockets accommodating the tubes. A small three-gang condenser would fit in the condenser space, so that there would be two t-r-f stages, detector and two audio stages. A small three-gang condenser would permit use of a drum dial.

A six-tube set does not lend itself so well to symmetry with this layout, but of course barring that, the plan may be used. For a seven-tube battery-operated set, using two stages of t-r-f, detector, first resistance stage of audio and push-pull output, the arrangement is symmetrical and roomy enough. The condenser, a three-gang, may be placed with shaft at right angles, or, if preferred, as in the previous case, a drum dial may be used, providing the gang condenser is not more than 6 inches long, shaft length extra. Some are only 4 1/2 inches long, plus 1 1/2 inch long shaft.

### Electrolytic Condensers

A six-tube A-C set, with rectifier, making in all seven tubes, likewise could be accommodated, only electrolytic condensers, if wet, could not be of 8 mfd., as there is no room to stand them up. However, dry 8 mfd. could be used, as these may be placed in any position, or 4 mfd. may be mounted upside down, underneath the chassis top, as the 2 3/8 inches allows room for most of the diminutive sized 4 mfd. Some 4 mfd. electrolytics, particularly of the wet type, are in the same large size can as the 8 mfd., so won't do for this purpose.

There are three holes at front for conventional controls, and a hole at back for emergence of a cable, for A-C or batteries, preferably with a rubber grommet in the hole for protection against scraping off insulation from the outleads. The four holes at right for the rear flaps are for twin jack assemblies, to accommodate tips connecting to aerial, ground and the two speaker output posts. It is assumed the output transformers, if a dynamic speaker is used, is in the speaker, as no special place is provided for it on the chassis.

## Standard Frequency Schedule

Once a week the Bureau of Standards sends out highly accurate signals on 5,000 kc from WWV. The frequency is piezo controlled and is accurate to much better than one part in a million. The power of the station is 1,000 watts and the standard signals should be receivable in most parts of the country provided a suitable short wave receiver is used for their interception.

### 5,000-Kilocycle Transmissions

2 to 4 p.m. and 10 p.m. to 12 midnight, Eastern Standard Time			
July	August	September	
..	11	8	
..	18	15	
28	25	22	
..	..	29	

### Multifrequency Transmissions

Eastern Standard Time		Frequencies in Kilocycles	
p.m.	p.m.	August 4	September 1
2.00	10.00	3,600	6,400
2.18	10.18	4,000	7,000
2.36	10.36	4,400	7,600
2.54	10.54	4,800	8,200
3.12	11.12	5,200	8,800
3.30	11.30	5,800	9,400
3.48	11.48	6,400	10,000

## List Prices of Tubes

The following table gives the prevailing price lists of the various tubes

Tube	Price	Tube	Price	Tube	Price
227	@ \$1.25	551*	@ \$2.20	WD-11	@ \$3.00
201A	@ \$1.10	171A	@ \$1.40	WX-12	@ \$3.00
245	@ \$1.40	112A	@ \$1.50	200A	@ \$4.00
280	@ \$1.40	232	@ \$2.30	222	@ \$4.50
230	@ \$1.60	199	@ \$2.50	BH	@ \$4.50
231	@ \$1.60	199	@ \$2.75	281	@ \$5.00
226	@ \$1.25	233	@ \$2.75	250	@ \$6.00
237	@ \$1.75	236	@ \$2.75	210	@ \$7.00
247	@ \$1.90	238	@ \$2.75	BA	@ \$7.50
223	@ \$2.00	120	@ \$3.00	Kino	
235	@ \$2.20	240	@ \$3.00	Lamp	@ \$7.50

\*This table comparable to the 235.

### Unbalances Causes Motorboating

WHILE I was servicing a midget push-pull receiver I observed an effect which I had not noticed before although I have serviced hundreds of similar sets. When I took one of the push-pull tubes the set continued to play all right but when I took out the other the circuit motorboated violently. What is the explanation?—W. G. E.

While the circuit is balanced in the last stage there is no audio feed back to cause the motorboating. As one tube is withdrawn the feedback is reversed, causing degeneration. As a the other tube is withdrawn the feed back is positive, causing the oscillation. The effect is quite common.



# Two Tube SW Circuits

## Battery-Operated Models Considered

By J. E. Anderson and Herman Bernard

[Crystal and one-tube receivers for short waves were discussed by the authors in last week's issue, July 18th.—EDITOR.]

A CIRCUIT consisting of a stage of untuned radio frequency amplification and a regenerative detector is shown in Fig. 10, where the regeneration is controlled by a high-resistance rheostat, R5.

In general, this rheostat should have a resistance at least twice the sum of the plate resistance of the tube and the resistance of the earphones.

Assuming the tube has a plate resistance of 10,000 ohms and the phones have a resistance of 1,000 ohms, the rheostat should be at least 21,000 ohms, therefore 25,000 ohms would be suitable. The value is not critical, but it should be large enough to afford control of regeneration. If the resistance is too large, say, several hundred thousand ohms, then the regeneration control may be confined to a relatively small percentage of the total displacement of the knob attached to this control. Naturally, control then will become more critical than it should be, since you have to work in a much narrower margin.

### Potentiometer Used as Rheostat

The rheostat effect may be obtained from a potentiometer by using only two of the terminals, one of the two, however, being the lug that connects to the moving arm. A potentiometer has two extreme external connections, representing the terminals of the resistance, while the third, usually a lug at center, connects to the slider that moves across the resistance element. If a given connection to one extreme causes the rotation of the knob to be from right to left to increase regeneration, and you prefer the movement to be from left to right, simply move the connection from the present extreme terminal to the free terminal.

Such reversal is sometimes highly advisable, not so much to satisfy a whim about direction of turning, as to capitalize the taper of the resistance element, should it have a taper. A resistance is said to be tapered when the variation in resistance is disproportionate to the distance traversed by the slider.

The purpose is to prevent extremely rapid changes in effects produced by rotation of the slider. In a circuit like the one diagrammed in Fig. 10 the reduction in the amount of regeneration is at first very slow, then becomes quite rapid as the plate voltage is reduced below a certain amount. This slowness of effect is due mostly to the fact that it takes a large reduction in plate voltage to reduce the amplification factor of the tube.

Hence if the resistance is so constructed that as the slider moves from maximum to lower values, the actual resistance used changes rapidly, but toward the minimum setting it changes much more slowly, the spread-out may be more suitable for purposes of regeneration control.

### Resistor as Antenna Coupler

The coupler in the antenna circuit of Fig. 10 is a resistor. This may have a value of 20,000 ohms (.02 meg.) but should not be much higher because much higher values develop a capacity effect that is relatively large in respect to the higher bands of frequencies to be tuned in, and this capacity detours some of the signal voltage. It is of the metallized or carbon type, not wire-wound. Moreover, large values may be due to greater surface, and as there is a skin effect it is then larger with greater resistance values. The skin effect is the action whereby radio currents travel principally on the surface of the conductor. The higher the frequency, the greater the skin effect.

A resistor is a satisfactory coupler for the purpose outlined, particularly since, if of not too high a value, it offers little discrimination in respect to frequencies. This condition of uniform action regardless of frequency is called non-reactance. Resistors, in general, thus may be regarded as not having reactance, but coils and condensers do have reactance, because their effects change considerably with frequency.

R2 and R3 are filament resistors to reduce the electromotive force of the A battery, consisting perhaps of two dry cells connected in series, to the voltage required for operation of the tube filaments. This filament voltage is different for different types of tubes. Moreover, the resistance of the filaments of different types of tubes also differs, so that a variety of voltages and currents are required for battery-operated tubes, depending on the types of tubes.

### Values for Phone Bypass Condenser

R4 is the grid leak, while R5 is the regeneration control. C1 is the tuning condenser, C3 is the grid condenser, which has clips to hold the tubular grid leak, while C4 is the usual condenser to bypass the impedance of the phones to the radio frequencies in

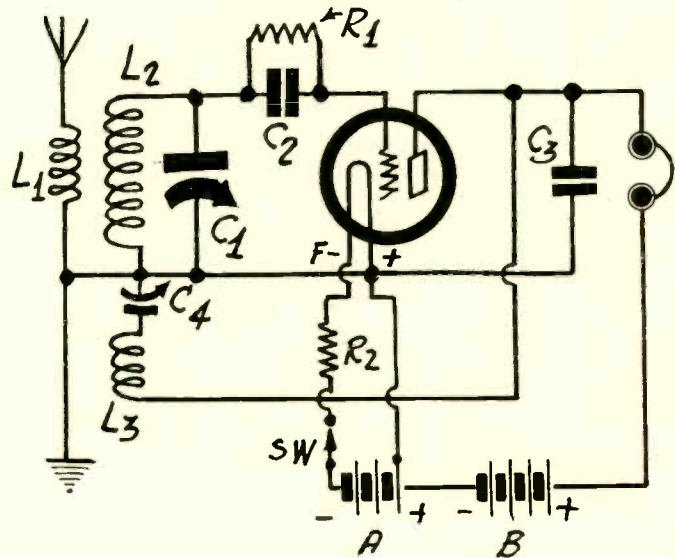

FIG. 7

Circuit with capacity feedback reprinted from last week's issue.

the plate circuit. Such a bypass condenser is nearly always necessary for good detecting efficiency. It is permissible to omit it only when capacity is otherwise present.

In Fig. 10 the phone bypass condenser may be relatively large, up to .001 mfd. If it is made much larger, then some of the high audio frequencies will be reduced considerably in strength. Any value of condenser may be used here, up to .001 mfd., but it should not be smaller than .0001 mfd. The radio frequencies being high, small capacity acts suitably to bypass them.

In Figs. 7 and 8 (last week) were shown circuits that used capacity feedback. One end of the plate winding was connected to plate, the other end to a one side of a condenser, the other side of the condenser to the grid return. If a variable condenser were used for regeneration control the rotor of the condenser went directly to ground. If a fixed condenser were used, then a rheostat connected from one side of the condenser to ground. As a condenser is connected indirectly from plate to ground in the feedback system, this condenser has to be large in respect to any bypass condenser directly from plate to ground.

In fact, since there is a condenser present anyway, it may be regarded as functioning as a variable bypass condenser, so the usual fixed condenser may be omitted in such an instance. If included, this is done only because the minimum setting of the feedback condenser may afford too small capacity for aiding detecting efficiency. Therefore the plate bypass condenser, small compared to the regeneration condenser, may be .0001 mfd., if the

(Continued on next page)

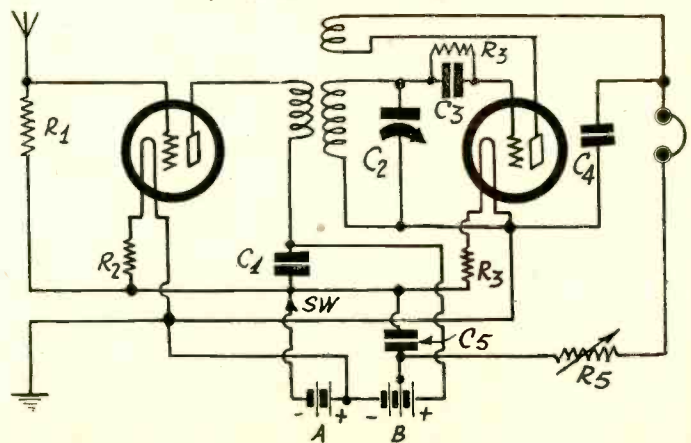

FIG. 10

A stage of untuned radio frequency amplification and a regenerative detector.



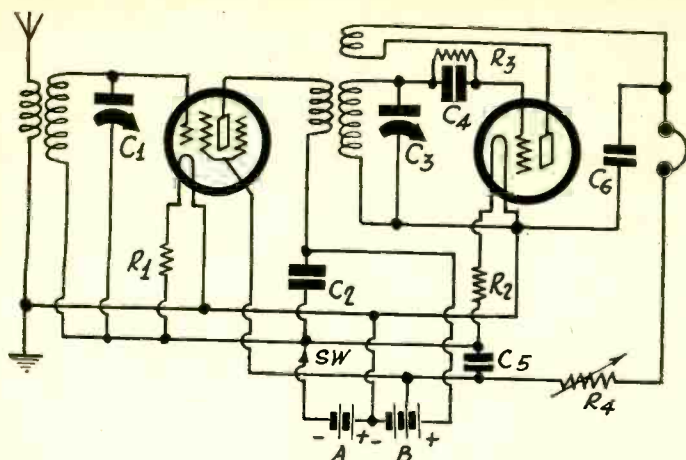

FIG. 11

The radio frequency stage is tuned in this instance. Individual condensers are used for C1 and C3.

(Continued from preceding page)

feedback control has .00025 mfd. or higher capacity. It is customary to omit the fixed bypass condenser entirely, because of the variable bypass condenser present, and to put enough turns on the feedback winding to afford regeneration when some satisfactory amount of capacity is obtained from the variable feedback condenser, avoiding necessity of using the extremely low capacity settings of this device.

It can be seen that the problem does not arise where regeneration is governed by a high resistance rheostat, as by R5 in Fig. 10, so a fixed bypass condenser may be included. It makes little difference if the return of the bypass condenser is made to positive or negative filament or to negative of the A battery.

#### Introducing Tuning in First Stage

Two batteries are used, an A battery and a B battery. The total B battery voltage may be 90 volts, comprised of two 45-volt batteries in series. Thus the detector plate voltage of 45 volts is readily obtainable.

A bypass condenser, of 1 mfd., is advisable across the total B voltage, so that if the B batteries become run down there will not be such a high resistance offered to radio frequency currents as would be true were this condenser omitted. The batteries under run-down conditions develop a relatively high resistance.

Fig. 11 is an improvement over Fig. 10 in a few respects. The principal advantage is that the radio frequency amplifying stage is tuned. There is no better way to develop a large voltage across the input than to tune it, so the sensitivity is greatly increased. So is the selectivity, as there are twice as many tuned stages.

#### Screen Grid R.F. Amplifier Tube

A screen grid tube is used as the radio frequency amplifier. This tube not only affords higher gain, but it has greater stability, because of the extra element or screen that totally surrounds the plate, both inside and out, preventing voltage variations on the plate from affecting the grid. The desire is to have the grid voltage changes affect the plate current, in an amplifier tube, and when there is a reverse action it is a disadvantage. One result is that an unwelcome feedback circuit is established, and instability arises, particularly at the higher radio frequencies that one tunes in with a short-wave set.

The voltage applied to the plate of the radio frequency amplifier A may be 135 volts, obtained from three 45-volt B batteries connected in series, while the screen is connected to the 45-volt tap. The plate voltage for the detector also is 45 volts, but there is a high resistance rheostat, R4, in series with the positive side of the phones and the B plus connection, for regeneration control.

C1 and C3 are the tuning condensers, and it is assumed that they are separate units, not two condensers mounted on one frame and actuated by one shaft. Therefore the two different grid returns, with condensers directly across each secondary, are permissible. The return for the radio frequency amplifier is to A minus and that for the detector is to A plus.

#### Negative Grid Bias From Filament Resistor

It will be noted that no C battery is used for bias. Where there are more than 45 volts applied it is almost universal to use C bias, because in battery-operated circuits the resultant reduction in plate current is a consideration, while it is also true that the amplifier tube will stand a heavier signal load without distortion if a negative bias is present.

The first tube of a receiver that has radio frequency stages has to handle extremely tiny voltage, so that from the distortion viewpoint only little bias is needed. There is some negative bias on the grids of the radio frequency amplifying tubes in Figs. 10 and 11, due to the potential difference between the extremes of the filament resistor. This is known as self-bias or automatic bias.

The datum or reference point for the examination of battery-operated tubes is the negative filament (F-). Normally this is not A minus, because the battery's electromotive force is greater than the voltage required for the filament, and a resistor is inter-

posed to take up the difference. If this resistor is located in the negative filament leg, then the negative filament (F-) is positive in respect to the negative point of the battery system (A-). Nothing can be more negative than A minus in these circuits (Figs. 10 and 11), and therefore if there is any difference in voltage, the point other than A minus is positive.

#### Various Biases Obtainable

Suppose, then, that the radio frequency amplifying tube in Fig. 11 is a 232 screen grid tube. This has four prongs for insertion in and contact with socket springs, and for the fifth connection has a cap at top of the tube. To this cap a grid clip is connected from stator of the condenser C1 and terminal of the secondary coil, L2. What bias, if any, the grid will receive, and whether it will be positive or negative, will depend on where the connection is made from the other terminal of the secondary coil, L2. For bias purposes the coil may be neglected, and may be considered as if it were simply a short, straight piece of wire connected from grid to some other point.

Suppose the grid connection established, and the other end of the coil L2 connected to positive of the filament. This connection is exactly the same as positive of the A battery, since no resistor is interposed between. The reference point is the negative of the filament, so the bias is positive, since F plus is positive, and the amount of positive bias is equal to the voltage across the filament. For the 232 tube this voltage would be 2 volts.

Suppose instead that the end of the secondary that we are moving from place to place were connected to the negative filament. This is the very reference point, so there is no bias. This is called zero bias.

#### Effective Bias 1 Volt Negative

Now, the tube in question requires 2 volts across the filament, and the A battery voltage will be assumed to be 3 volts, obtained from two 1½ volt No. 6 dry cells connected in series. It is plain that the voltage drop in the filament resistor R1 is 1 volt.

Suppose that the secondary coil now is returned to A minus. The negative filament, or reference point, is at a higher direct current potential than A minus by 1 volt, or, negative A (A-) is 1 volt negative in respect to negative filament (F-). So the grid is returned to a point negative in respect to the negative filament, and as the self-bias has resulted from utilizing the voltage drop in the filament resistor R1. Therefore the grid has a negative bias of 1 volt, which is sufficient. For general purposes 1.5 volts are recommended for negative bias for this tube, the other voltages being 135 applied to the plate and 45 applied to the screen, but at least in the first stage of radio frequency amplification 1 volt negative bias is sufficient.

Other differences between Figs. 10 and 11 are that the plate B voltage has been increased on the amplifier tube, a bypass condenser, C5, which may be 1 mfd., has been placed from B plus 45 volts to A minus, and a C battery has been included.

#### Audio Stage Added

We now come to one of the circuits that afford real utility, Fig. 12. There has been no vital improvement over Fig. 11, except that a stage of audio frequency amplification has been added. This makes the response in the telephones very much louder. Radio frequency amplification is necessary for high sensitivity, and should be of the tuned type; regeneration is needed in the detector for sufficient selectivity and enhanced sensitivity, while a stage of audio is virtually necessary to insure good audibility on weak signals.

Some refinements have been introduced. A method of regeneration control has been included that was not treated of previously. This is variation of the voltage on the screen of a screen grid tube. A potentiometer R4 is used for this purpose. Another refinement is the inclusion of a radio frequency filter somewhat more effective than merely a bypass condenser in the plate circuit of the detector. A radio frequency choke coil and two fixed condensers complete the filtration. The condensers are connected to ground from the respective terminals of the choke. Also, single tuning control has been introduced, as a two-gang condenser is used. There is a small variable condenser across the detector's main tuning condenser, to enable justification of the two tuned circuits when frequency discrepancies arise. The tuning might be considered of the double control type, because of the presence of this compensating or trimming condenser, but since it would be practical to set that adjunct at a given capacity and leave it thus, as a fixed condenser, the expression "single tuning control" as applied to such an arrangement including a trimming condenser is justifiable. The reason for using the extra control is that slight alteration of capacity brings the two circuits into resonance, whereas with no such alteration for adjustment they might be tuned to slightly different frequencies, with resultant large loss in sensitivity and selectivity. Since a very wide range of frequencies is to be tuned in, and the normal frequency ratio of one coil and the condenser is 3-to-1, the inductance will have to be changed for a 100-to-1 ratio, and the smaller the inductance the greater the need of the trimmer.

#### "T. R. F., Detector and One Step"

Here we have more than only a tuner, which is a radio frequency amplifier and detector, for there is a stage of audio frequency amplification. In the early days of short-wave experiments a popular circuit consisted of a regenerative detector and a stage of audio, known as "detector and one step." Here we have tuned radio frequency amplification, detector and a stage of audio, known as "t-r-f, detector and one step." Since the detector always is tuned, no special designation is required to evoke this fact.

(Continued on next page)



(Continued from preceding page)

The rheostat R9 is used to reduce the electromotive force of the A battery, while the separate filament resistors complete this reduction for the respective tube circuits in which they are connected. Therefore the rheostat is common to all, while the filament fixed filament resistors are separate. The reason for the common rheostat is to compensate for the so-called voltage change in the battery, assuming 3 volts from dry cells. As these cells become used up, a voltmeter will show a lower reading at the battery terminals. So a voltmeter is included in the circuit as a permanent fixture. This is regarded as advisable particularly if 2-volt tubes are used, 233 and 237. These tubes are critical as to filament voltage. The rheostat may be front-panel mounted.

The potentiometer voltage can be adjusted to suitable extreme values, on account of R3 and R8 being in the circuit. R3 permits raising or lowering the minimum voltage applicable, so the voltage always will be at least more than zero, while R8 governs the maximum voltage. If the potentiometer is 25,000 ohms, than R3 may be 5,000 ohms and R8 10,000 ohms or more. As for other parts, the inductance of the radio frequency choke may be low, around 1 millihenry, while C8 and C9 may be .00025 or .0001 mfd. each, as only short waves are concerned. Small capacities are more effective on short waves in this position than on broadcast waves.

The earphones need no bypass condenser in this circuit, because they are in the output of an audio amplifying tube, and no radio frequencies are in the circuit. Indeed, it was the

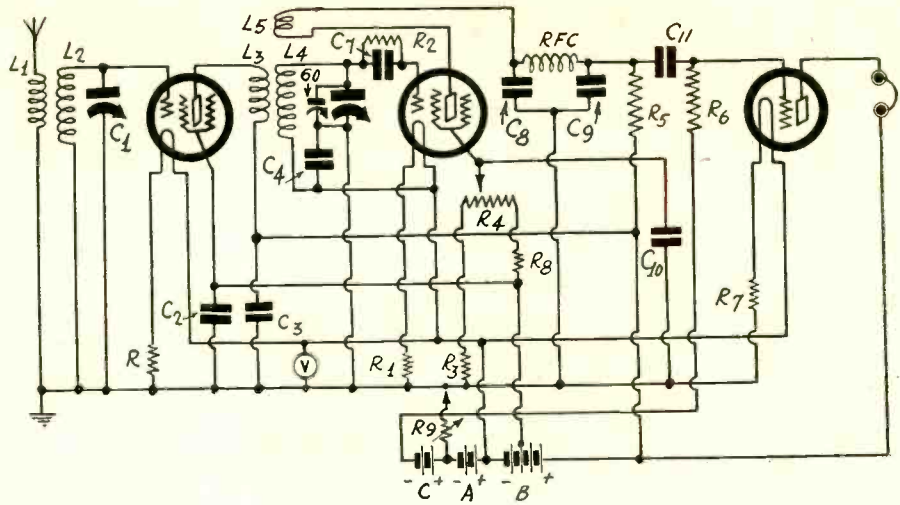

FIG. 12  
A highly practical circuit

purpose of the detector plate filter, C8C9, RFC, to keep these very radio frequencies out of the audio amplifier.

[The foregoing is the second of a series of articles on short-wave receiver circuits. The first was published last week. Another will appear next week and subsequently other instalments will be published.—EDITOR.]

## Short-Wave Club

Here is a list of new members of the Short Wave Club. New names are printed each week:

- Francis Granucci, 174 No. Whittelsey Ave., Wallingford, Conn.
- Clarence C. Andrews, R. R. No. 1, Bath, Penna.
- G. Giasson, 432 St. John St., Quebec, P. Q., Can.
- Ernest H. Newman, 192 Merrick Road, Rockville Center, L. I.
- Henry H. Poynter, 5684 Grand River Ave., Detroit, Mich.
- Louis C. Voight, U. S. Airways Station, Airport, R. R. 4, Evansville, Ind.
- Jack Troulman, 1021 South Burlington Ave., Los Angeles, Calif.
- F. M. Shimidzu, 1441 N. Dearborn Pkway., Chicago, Ill.
- Walter L. Kuss, 67 Woodward Heights Blvd., Pleasant Ridge, Mich.
- Larry Ritter, R. F. D. No. 2, Orland, Ind.
- L. Mansfield, 442 Barker Ave., Peoria, Ill.
- Fred J. Theiler, 1506 11th St., Monroe, Wis.
- Paul Grass, 1085 Annette Ave., Montreal, Que., Canada.

- E. B. Holden, 1933 So. Salina, Syracuse, N. Y.
- John Emerich, 2087 Chesterland Ave., Lakewood, Ohio.
- R. A. Bell, 1957 W. 100th St., Cleveland, Ohio.
- P. B. Kehoe (Radio Shop), 818 W. 2nd St., Fort Myers, Fla.
- M. Rosenau, 3925 George St., Chicago, Ill.
- Clifford Bartin, 810 Orchard St., New Haven, Conn.
- W. E. Hughes, Jr., 745 Grape St., Vineland, N. J.
- R. F. Cadiz, Hunter Ave., Fanwood, N. J.
- James Home, 702 St. Paul St., W., Montreal, P. Q., Canada.
- Wm. B. Polin, 1980 East 7th St., Brooklyn, N. Y.
- Henry Saul, Box 85, San Juan, P. R.
- Maurice Levison, 5637 Oak St., Kansas City, Mo.
- Joseph Maresca, 22 Olive St., New Haven, Conn.
- R. Del Valle Sarraga, P. O. Box 935, San Juan, Porto Rico, W. I.
- Ramon Collazo, Jr., Box 326, Bayamon, Porto Rico.
- Herman Hoelsing, Box 84, Hartington, Nebr.
- T. Van Woody, 1129 East 19th St., Oklahoma City, Okla.
- J. F. Ballitch, R. D. No. 4, Mansfield, Ohio.
- V. O. York, 2247 Adeline Ave., Dearborn, Mich.
- Glenn George Rowe, 144 1/2 American Ave., Long Beach, Calif.
- Nat Wiener, 2357 Davidson Ave., New York, N. Y.
- Calvin G. Ladd, c/o S. W. Bell Tel. Co., Pauls Valley, Okla.
- Joseph H. Samuelson, Jr., 5130 Hoopes St., West Philadelphia, Pa.
- H. R. Earhart, 917 Franklin Ave., Columbus, Ohio.
- S. P. Dolter, 529 Hazel Ave., Ellwood City, Pa.
- C. L. Masser, 5335 Angora Terrace, Philadelphia, Pa.
- Chas. La Belle, 134 Oceola St., Laurium, Mich.
- Gilbert L. White, 40 Spring St., Albany, N. Y.
- Ezra J. Hardesty, Terra Alta, W. Va.
- Richard Sinclair, 10 Greenwich Ave., Stamford, Conn.
- Charles Dutton, 518 East Fisher St., Salisbury, N. C.
- Arthur C. Pforzheimer, 861 Broadway, Woodmere, N. Y.
- O. A. Richter, 1259 Gates Ave., Brooklyn, N. Y.
- Gerald M. Isaac, 1017 Colony St., Saskatoon, Sask., Canada.
- Hamilton D. Hayes, 4700 N. W. Third Ave., Miami, Fla.
- G. F. M. O'Grady, 32 Cavour St., Jefferson Park, Colmo, Calif.
- Harry W. Gally, 34 So. Burnett St., East Orange, N. J.
- Andrew Puel, 1245 High St., Pittsburgh, Pa.
- A. E. Holland, 173 Chattanooga St., San Francisco, Calif.
- Laurence Villar, Jr., 126 Sickles Ave., New Rochelle, N. Y.
- Thomas W. Windmuller, 188-23-120th Ave., St. Albans, N. Y.
- Solomon Cohen, 815 Florida Ave., Tampa, Fla.
- Ralph Quarles, 324 W. 53rd St., New York City.
- Andrew Drotar, 726 Broadway, West New York, N. J.
- Stanley Theodore Jacobson, 2198 Coney Island Ave., Brooklyn, N. Y.
- Otto E. Zieger, 1218 W. 53rd St., Austin, Tex.
- H. M. Rice, 4126 Watterson St., Cincinnati, Ohio.
- Hubert E. Siepmann, 837 Rundell St., Owa City, Iowa.
- J. G. Greger, 6220 LaMirada Ave., Hollywood, Calif.
- Cecil Swatzel, 633 S. 22nd St., Bethany, Mo.
- George Rogers, P. O. Box 143, East San Diego, Calif.
- John Clements, 540 W. 157th St., New York, N. Y.
- Bruce T. Telfer, 2201 West 110th Place, Chicago, Ill.
- Anthony Dusa, 1407 East 51st St., Cleveland, Ohio.
- Nikola Ilijic, 42-16 Boulevard, Edgemere, L. I., N. Y.
- F. M. Wentz, W8EEQ, 211 Larkins St., Findlay, Ohio.
- D. M. Bassett, Operator, Amateur Radio Station W8CDC, 443 Welsted Street, Napoleon, Ohio.
- Lloyd Henderson, Radio Doctor, 703 1st-Ave., Grinnell, Iowa.
- Jesse Udilson, 1491 East New York Ave., Brooklyn, N. Y.
- George G. Symes, Jr., 89 Crofut St., Pittsfield, Mass.
- Gregg Stephenson, Old Wire Mill Road, Stamford, Conn.
- Howard Wenner, 3302 West 110th Street, Cleveland, Ohio.
- A. Watson, R. 1, College Place, Columbia, S. C.
- Vernon D. Cox, 1229 W. 3rd St., Santa Ana, Calif.
- J. H. Lewis, Jr.—W9IN, 634 East 51st St., Chicago, Ill.
- R. W. Rowder, 2952 Shubert Ave., Chicago, Ill.
- Max Stein, 40 Carmel St., Chelsea, Mass.
- R. C. Levea, 2241 Eads St., New Orleans, La.
- Elmer Rowder, 2863 Edgewood Ave., Chicago, Ill.
- Norman F. Fenstermaker, 127 Quincy St., Quincy Adams, Mass.
- Fred C. Jenkins, 200 Elmwood Ave., Irvington, N. J.

ARE you interested in short waves? Receivers, transmitters, converters, station lists, trouble shooting, logging, circuits, calibration, coil winding—what not? If so become a member of Radio World's Short-Wave Club, which you can do simply by filling in and mailing attached coupon. As many names and addresses as practical will be published in this department, so that short-wave fans can correspond with one another. Also letters of general interest on short-wave work will be published. Besides, manufacturers of short wave apparatus will let you know the latest commercial developments. Included under the scope of this department is television, which is spurting forward nicely. Fill out the coupon and mail at once.

If you prefer, send in your enrolment on a separate sheet or postal card.

Short-Wave Editor, Radio World, 145 West 45th Street, New York, N. Y. Please enroll me as a member of Radio World's Short-Wave Club. This does not commit me to any obligation whatever.

Name .....

Address .....

City ..... State .....

- I am a subscriber for Radio World.
- I am not a subscriber, but buy copies at news-stands.



# The Simplest, Smallest, Low

## Five 227 Tubes Used, One of Them as

By Henry

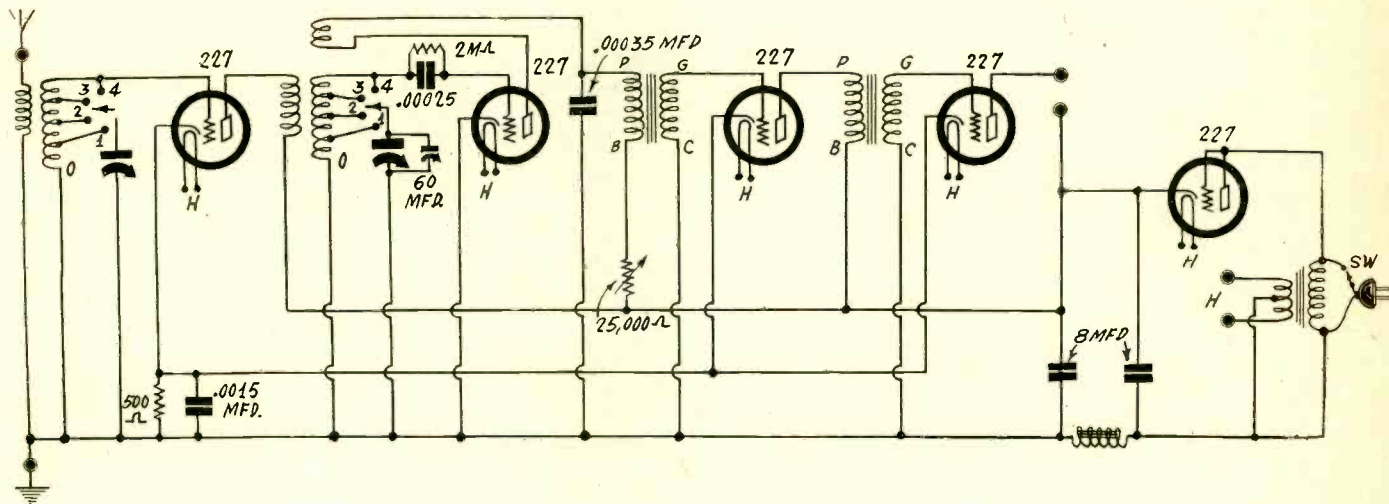

FIG. 1

Simple as can be, this circuit for all-wave reception effectuates extreme economy, consistent with good results.

THE simplest and possibly least expensive all-wave set that can be built for satisfactory speaker operation is the one diagrammed in Fig. 1, and it is also encompassed in the smallest dimensions. The circuit consists of a stage of radio frequency amplification, a regenerative detector and two transformer coupled audio stages, with rectifier. All the tubes, including the rectifier, are 227's. There would be no advantage in using screen grid tubes in a set such as this, nor any other output tube, due to the plate voltage and plate current limitations.

The combination sensitivity and volume control is a 25,000 ohm rheostat, or potentiometer used as rheostat, used for reducing the plate voltage. When the slider is moved to one extreme there is no drop, and the detector works at its normal voltage. When the potentiometer arm is moved the plate voltage decreases and the less it becomes, the less the amplification of the detector, and the less the regenerative effect, so that regeneration may be controlled from its full value to zero value.

### What to Expect

So if the receiver is used for broadcast wavelengths, the volume control is set to fix the signal value at the output tube to a value that does not accumulate overloading. For short waves, where the signal intensity nearly always is much less, the control may be almost at the zero resistance point, so long as not too much regeneration is present, otherwise the arm is moved a little in the right direction to give just the amount of feedback desired. The tube, as ever, is most sensitive just below the oscillation point.

The short-wave reception is very good in this manner, while the only object of including the broadcast band of wavelengths is to enable the reception of local or semi-distant stations. The set is not a marvelous performer on the broadcast band, but its chief advantage is its excellent sensitivity and all-around performance on short waves. In any band, broadcast or otherwise, it affords enough volume for speaker operation. In fact, in the broadcast band the volume on locals nearly always has to be cut down with the volume control, otherwise the signals would be too loud.

### Broadcast Band Without Switching

If .00035 mfd. tuning condensers are used, then it is possible to cover the broadcast band without molesting the switch. After 200 meters is reached, and it is desired to tune to lower wavelengths, the switch is set at the next tap (3), and for still lower waves at tap (2), while finally around 15 meters may be reached at tap (1). However, little reception is enjoyed around 15 meters, as waves in this band seem to travel best in daylight, and do not afford much results at night. Since it is assumed

most persons will listen in at night, naturally not much should be expected from tap (1).

### How to Wind Coils

It is further assumed that a metal chassis is used and that the coils are mounted underneath, as far apart as practical, and at magnetic right angles, which usually means a T-shaped layout

### LIST OF PARTS

#### Coils

- One antenna coupler, 83-turn secondary on 1.75 inch diameter, tapped in three places
- One interstage three-circuit coil, 83-turn secondary on 1.75 inch diameter, tapped in three places
- One 2.5 volt filament transformer, secondary center tapped
- One 15 henry B supply choke coil
- Two audio frequency transformers

#### Condensers

- One two-gang .00035 mfd. straight frequency line tuning condenser
- One .00025 mfd. grid condenser with clips
- One .0015 mfd. fixed condenser
- Two 8 mfd. electrolytic condensers with brackets (insulator for one)
- One compensating condenser, 60 mmfd.; knob

#### Resistors

- One 500 ohm flexible biasing resistor
- One 25,000 ohm potentiometer with switch attached; two 7/16" insulator knobs
- One 2 meg. tubular grid leak (not pigtail)

#### Other Parts

- One front panel
- One subpanel with five UY sockets
- One vernier dial
- One selector switch, double pole, four-point, with knob; shaft insulated from all connections
- Two binding posts (for aerial and ground)
- Two insulators for aerial binding post
- One speaker output twin assembly jack
- One roll of hookup wire
- One dozen 6/32 machine screws and one dozen nuts
- Six 5/8" right-angle brackets for coil mounting



# Lowest-Cost All-Wave Circuit

## Rectifier; Band Selector Switch at Front

B. Herman

for the coils. The top of the metal subpanel will be perhaps one inch or so away, and perhaps a side flap will be near, also. The coils may be mounted, one on the back of the front flap, the other on a side flap.

This proximity to the metal—which should not be iron and preferably should be aluminum—causes a semi-shielding effect. All shielding of radio frequency coils reduces the inductance. Therefore more turns are put on than would be required were the subpanel or chassis of a non-metallic material.

The information on winding the coils now will be given on the basis of the use of an aluminum chassis, with the coils positioned somewhat as outlined.

The diameter is 1.75 inches. The tubing is natural bakelite. The wire is No. 28 enamel. The primary consists of 12 turns. A space of  $\frac{1}{8}$  inch is left. Then the secondary is wound. Where the primary was begun will be the antenna connection, where it ends will be the ground connection. Now, the secondary also is grounded, so the grounded end of the secondary is the beginning thereof, adjoining the end of the primary. Hence like potentials are together—ground. Put on two turns, tap. This is the winding from (0) to (1). Put on 7 more turns and tap. This is from (1) to (2). Put on 19 more turns and tap, to constitute the inductance between (2) and (3). Now finally put on 55 turns. This is from (3) to (4). The total is 83 turns, and will tune in the broadcast band, between (0) and (4), with a .00035 mfd. variable condenser.

### Turns for Other Cases

The interstage coil is wound exactly the same way as the other. However, there is a third winding, the tickler. This consists of 25 turns, begun  $\frac{1}{8}$  inch from the secondary. When time comes to connect it, the terminal nearer the end of the secondary goes to plate, while the outside terminal of the tickler goes to B plus through primary of the first audio transformer.

These directions for polarities depend on the windings being in the same direction.

If a bakelite subpanel is used, that is, there is no metal near the coils as would be true if an aluminum chassis were used, then the number of turns is different. The primaries and tickler may be the same as heretofore, but the total number of secondary turns, instead of being 83, should be 70. The respective turns for tapping are 3, 6, 15 and 46. Since the inductance is proportionate to the square of the number of turns, it can be seen that only about two-thirds as much apparent inductance is necessary when there is no metal near. More properly, the part shielding effected by the metal drops the inductance about one-third. The added turns make up for that in the metal-chassis instance. The inductance is really the same in both cases, if the different conditions prevail.

It is practical, of course, to use .0005 mfd. capacity or .00025 mfd. capacity for tuning. In the case of the larger capacity the suitability for short-wave tuning is reduced, because of the extremely wide range of frequencies crowded between 0 to 100 on the dial. Also, .00025 mfd. does not readily lend itself to coverage of the entire broadcast band of wavelengths without throwing the switch to bring in, say, from 250 meters to the lowest wavelength of the broadcast band, 200 meters. Of course the position now occupied by the switch would result in the minimum capacity of the tuning condenser bringing in about 80 meters.

### Use of Straight Frequency Tuning

The spreadout is best when straight frequency line tuning condensers are used, and it is practical to have the two capacities ganged, using a 60 mmfd. trimming condenser. The antenna-ground circuit will introduce some capacity, and the trimmer therefore is in the detector circuit, which otherwise in a capacity aspect would lag behind the other. Tickler adjustment results in detuning, though it is slight, another reason for putting the trimmer where it is. The action of the tickler is that when more tightly coupled it reduces the inductance of the secondary with which it is associated.

The bias for the radio frequency amplifier and the two audio tubes is obtained from the voltage drop in a 500 ohm fixed resistor. This will be about 7.5 volts, which is a satisfactory bias, considering that there will be about 110 volts applied plate voltage.

The 110 volts arise from the fact that the type of rectifier used develops almost as much direct current voltage at the

output of the rectifier filter as the introduced AC line voltage. It can be seen that the line voltage, usually 110 volts, 50-60 cycles AC, is introduced directly to the 227 tube, which is used as a diode or two-element tube, for rectification. There are only two requirements for any rectifier: current must pass in only one direction, and the direct current path must be complete. The two requirements are really one, if you say that the direct current must pass in only one direction, for if the circuit is not complete for direct current, this current will not pass.

Therefore the alternating voltage introduced from the united plate-grid element of the 227 rectifier is broken down to a direct voltage, with direct current flowing, and the path is from anode (grid-plate) to cathode, through the receiver tubes to ground and then around again.

### Filtration Method

The direct current is of the pulsating type, as there is a large ripple voltage, so a most adequate filter is introduced, consisting of a 15 henry choke, which affords sufficient inductance although any larger inductance may be used, and two 8 mfd. electrolytic condensers. The case of these condensers must go to negative, so if an insulating subpanel is used, you should solder the ground lead to a lug on one case or to a lug held by a bracket nut, and the other case to the opposite side of the choke. If a metal chassis is used, the chassis itself is negative (B minus and ground) for all purposes, and simply mounting one condenser constitutes grounding the case to B minus, while the other 8 mfd. must have an insulator, so its case can go to the other side of the B choke.

The rectifier and the coil switching arrangement are the only novelties in the circuit, aside from all-wave coverage, which perhaps has passed the novelty stage and come into the generally accepted class.

The three questions most frequently asked concerning this type of rectifier are: How can you set up a power supply without a power transformer? Will the 227 tube stand the strain on it? Is there danger of short-circuiting the a. c. lines?

The answers are as follows:

The diagram itself, with the explanation of rectification, reveal how the filament transformer alone serves as a power transformer for heaters and for rectifier plate. The rectification is single-wave. The absence of a high voltage secondary winding, which so many associate with a power transformer as an imperative inclusion, is explained by the statement that the a.-c. voltage is simply taken right off the line. It is the same as if there had been a one-to-one ratio transformer, and the secondary were connected to the rectifier, instead of the primary.

### 2/10 Cent Per Hour for Rectifier

The 227 will stand the drain of this receiver, which is about 20 milliamperes. There is a common saying that tubes have an average life of 1,000 hours. But actually the heater type tubes now have an average life of about twice that. The only effect of drawing 20 milliamperes is that tube life is shortened. Suppose the rectifier lasts 500 hours. Probably you did not pay more than \$1.00 for the tube, so the cost of the tube was two-tenths of a cent per hour, which you must agree is not bad.

There is no danger of short-circuiting the a.-c. line, because of the position of the B supply choke. Suppose that one side of the line is grounded, as is usual. Suppose you put in the plug so that when you pick up the grounded side you connect it to the right hand side of the B supply choke coil in Fig. 1. Then surely there is no danger, for one side of the choke is at ground potential, because of the receiver's grounded connection, and the other side of the choke also is at grounded potential, so there is no a.-c. voltage drop across the choke coil due to the line voltage. The direct current from the rectifier flows through the choke, that's all.

### Impossible to Short Line With Plug-in

Now, suppose that when you plug into the convenience outlet you pick up the high side of the a.-c. line, thus establishing connection to one side of the choke. The other side of the choke is connected to ground because the receiver is grounded. Now you have the two extreme potentials across the choke, or the choke across the line. What of it? The choke has an impedance of about 400 ohms, and that is no short-circuit. Indeed, is not the primary of the transformer itself across the line all the while the transformer is in use? The primary usually has an impedance lower than 400 ohms.



# A Shorting Inductance

## Turns Outside. Tuned Circuit Are

By Capt. Peter

FIG. 1

Switch arranged to short out turns beyond the tuned winding, consistent with the theory of a desirable low impedance for the external circuit. This is a short-wave converter with B supply.

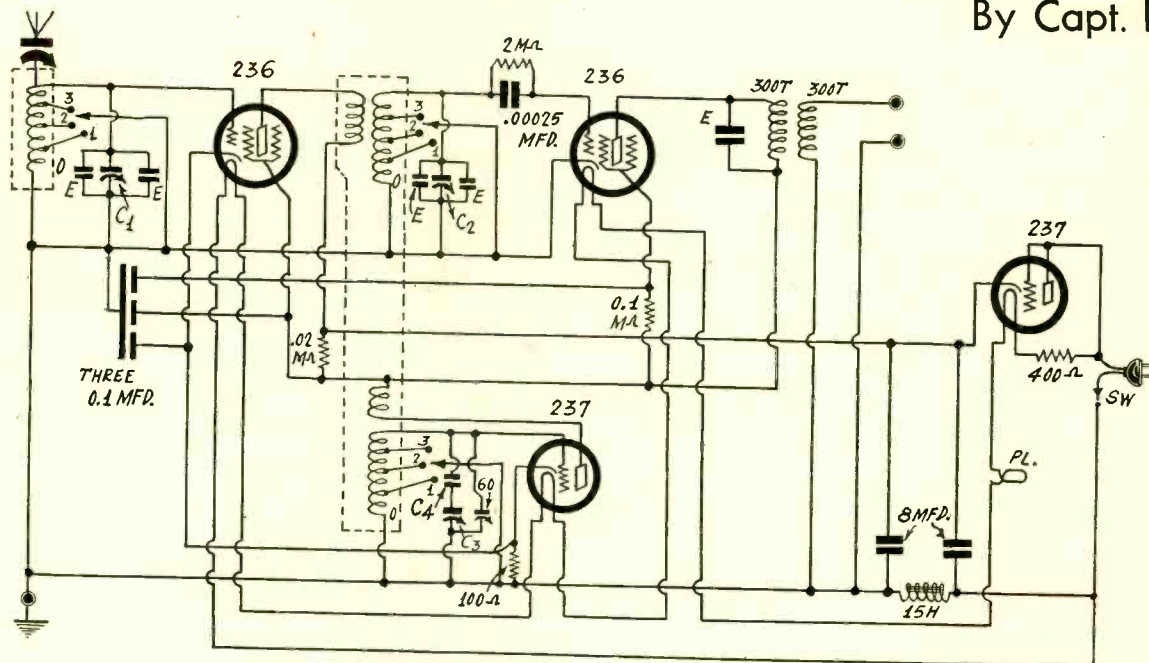

THERE are two debated theories regarding the better method of using an inductance switch for wide-range coverage of frequencies with a given tuning condenser to avoid plug-in coils, and use single windings. The coil is tapped and by either method all or part of the total inductance is in the tuned circuit. The problem is whether to short out the unused turns, or to include them as a continuation to grid thereby establishing an auto-transformer effect. By one method (Fig. 2) the stator of the tuning condenser is connected to the switch arm, so that turns not included in the tuned circuit continue on to grid. By the other method, as in Fig. 1, the switch arm is grounded and the unused part of the secondary is short-circuited.

Those favoring the grid-continuation method, Fig. 2, argue that since the untuned portion of the secondary, where less than the full inductance is tuned, is always a large part of the total inductance, this unused section acts as a radio frequency choke coil. It may have a high resistance, and the higher the better, since it is part of a secondary, outside of a tuned circuit.

### Relatively Large Cut-Out

The ratio of the number of turns is approximately proportionate to the frequency. The ratio of the frequency, with a .00035 mfd. condenser for example, is about 3 to 1. Therefore if the total secondary consists of 66 turns, the first tap (1 in Fig. 1) would be 44 turns removed from the ground end (0). So the number of untuned turns, (1) to (0), is about twice as great as the used number in the tuned circuit. It is true that this is a large difference, and maybe a choking effect is produced. Many experiments confirm the fact that the grid-continuation method works, all right. But so does the other one (Fig. 1), and something should be said in favor of the short-circuiting method.

Bear in mind that the numerical order of taps in Fig. 1 relates to the order of frequencies, that is, the higher numbers on the taps represent less inductance in the tuned circuit, hence higher frequencies in the band covered, while the opposite is true in Fig. 2.

Suppose the switch in the first circuit (at left in Fig. 1) is set at (3). Suppose the total turns equals 45, meaning that only short waves are to be covered by this converter. One-third of 45 is 15, so there will be only 15 turns between (1) and grid, or 30 turns between (1) and (0). The switch is of the short-circuiting types, because the arm is connected to ground. We have shorted out 30 turns of a total of 45 turns. Why?

### Effect of Few Open Turns

It has been found that where relatively few turns are "open"—meaning they are out of the tuned circuit—the impedance of the open turns is low. In the grid-continuation method the part of the winding between tap and grid is considered open, because not in the tuned circuit. It might be better to close it, which could be done by short-circuiting, as in Fig. 1, because theory calls for an "open" condition only when the number of turns outside the tuned winding is relatively small, and here it is large in both instances.

If the impedance of the open section is large, as it might be with the grid-continuation method, the voltage developed in the

untuned part will be large. It may be many times greater than the voltage across the tuned circuit. This would show up as a loss, because the larger voltage would not be at resonance, or indeed may be at some other definite frequency. Perhaps double response would result at a single setting.

Let us follow the result in Fig. 1. With the switch at point (1) one-third the number of turns is left in the tuned circuit, two-thirds is out, and a large part being out, it is short-circuited so that there will be very low impedance, virtually zero. At point (2) the 15 turns are reduced in the same proportion as was the total 45 turns, so that only 5 turns then will remain in the tuned circuit, 40 turns being out of it. Obviously the number of turns outside the tuned winding gets larger, and the advisability of short-circuiting these turns increases.

### Different Proportion Required

When tap (2) is to be located, 2 turns may be left between (3) and grid. This is not the same proportion as formerly, as the proportion does not hold for the very high frequencies now involved. The reduction in the number of turns must be less. The 45 turns are tapped at the 30th, 40th and 43rd turns. The diameter is 1.75 inches, the wire No. 18 enamel.

So at least we act completely in conformity with the theory, the short-circuiting being all the more requisite the more turns cut out by tapping. The tuned circuit is always between grid and ground, and since the switch arm is grounded there is no need for insulation even if a metal chassis is used.

The circuit shown in Fig. 1 is quite intricate as to wiring the leads to the switch, not difficult, however. There are three tuned circuits. A triple-pole three-point switch is shown.

The assumption made in the foregoing was that the tuning condenser was .00035 mfd., and that inferred that the capacity change was from some orthodox minimum, say 20 mmfd., to maximum, 350 mmfd., or a ratio of 1-17.5. The effect of such a ratio would be all right with a midline or straight frequency line condenser for use of the full winding, grid to (0). This might tune from 1,500 kc to 4,500 kc. But for the higher frequencies the rapidity of capacity change over the dial spread or any part of it would be too great. It would be easier to skip over a weak station than actually to bring in the signal. Greater spreadout is desired.

### Large Condenser With Big Minimum

One way that spreadout is accomplished is by using a smaller condenser. Then the ratio of minimum to maximum capacity is less. Capacities of .0002 mfd., .0015 mfd. and .00014 mfd. are popular.

Another way, which enables the use of the larger capacity condensers more familiar in broadcast receivers, is to put a relatively large fixed capacity across the tuning condenser. Thus the minimum capacity is greatly increased and the ratio of minimum to maximum is decreased. Using two equalizing condensers, adjustable from 20 to 100 mmfd., and assuming both at maximum, let us see what the case would be with a .00046 mfd. condenser.

Assume the minimum of the condenser to be 46 mmfd. Therefore











# Time Constant Fallacy

## Advice on Stopping Condenser Usually Wrong

By Brunsten Brunn

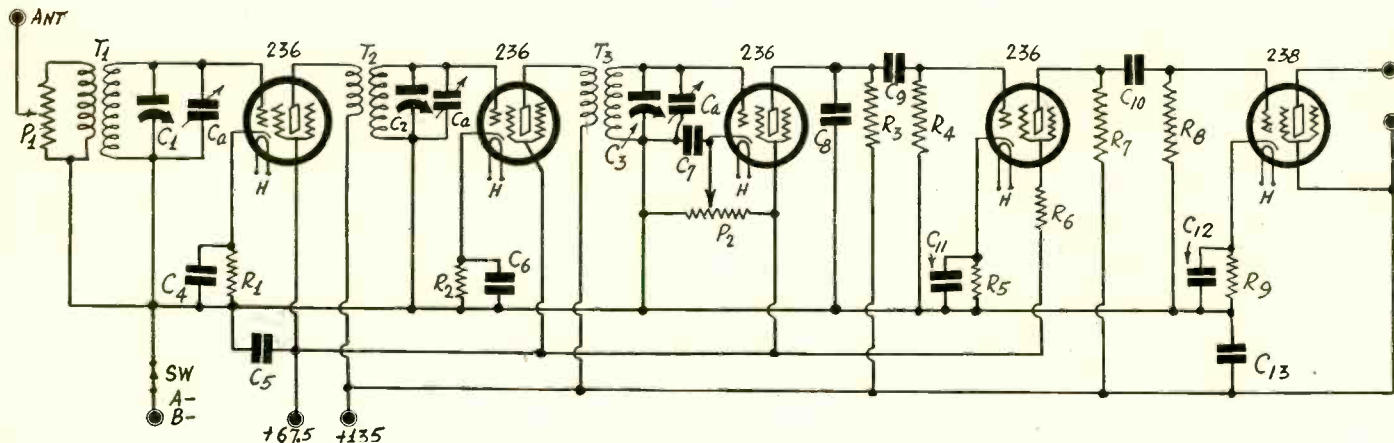

FIG. 1

In this circuit there are two stopping condensers each followed by a grid leak. The time constant of each, as of C9R4, should be as high as possible

ONE of the most persistent fallacies occurring in radio literature is that the time constant of the stopping condenser and the grid leak in a resistance coupled circuit has a limiting effect on the amplification of the high audio frequencies. This fallacy crept into radio when the resistance coupled amplifier was first popularized and since then most writers have repeated it without giving the subject any consideration.

Thought about the matter would convince anyone that the man who first committed the blunder was laboring under a misconception.

The argument is that the stopping condenser, for a given value of grid leak following it, should be as small as possible in order that the time constant of the circuit should be small. If the time constant is not small, the argument goes, the high audio frequencies will not be amplified because it takes a considerable time for the condenser to respond. The response in this case means that the condenser should charge up to a high voltage.

### The Fallacy

It is true that if the time constant of a condenser and resistance is high, the circuit is sluggish. It will not respond quickly to changes in voltage because it does take a considerable time for the condenser to charge up, or to discharge, through the high resistance. But that has nothing to do with the case.

The fallacy is the assumption that the condenser should charge up, or discharge, as the signal passes through. The fact is that it should do nothing of the kind. It is only when it charges up to a considerable voltage that the amplification is reduced. The voltage across the condenser should not change at all as the signal passes through it. At very low frequencies the time constant enters to reduce the amplification, but at high frequencies it does not. And in order that the amplification on the low notes should be as high as possible the time constant should be as high as possible. That is, exactly the reverse is true to what is generally being said about it.

### How Good Designers Work

Designers of amplifiers who really understand the problem make the stopping condenser as large as practical. They do not worry about the suppression of the high audio frequencies but about the amplification of the very low. The unfortunate part is that these fellows rarely write about it. They regard it as obvious, which it is.

The correct statement is that the time constant of the stopping condenser and the grid leak should be as large as possible in order to amplify the very low notes without attenuation. The high notes will take care of themselves when the low notes have been provided for.

The reason why the stopping condenser does not suppress the high notes is that the condenser and the grid leak are in series and in order to have a high amplification the entire voltage drop should be across the grid leak. There should be no drop across the stopping condenser, except the d-c drop, in which we are not interested. The lower the drop across the stopping condenser at any frequency, compared with the drop across the grid leak, the higher is the amplification on that frequency. The

condenser should be so large that it does not charge up at all, that is, so that it does not develop a voltage drop across itself.

### Where Time Constant Enters

However, there is another circuit having a time constant which enters into the suppression of the high notes. Suppose there is a high effective capacity across the grid leak. It is not really necessary to suppose there is, for it is there in all cases, internally. The circuit formed by this shunt condenser and the grid leak has a time constant, and this should be as small as possible if the amplification on the high notes is to be retained. Thus shunt capacity, which is the capacity between the grid and the cathode, must charge up and discharge if a high voltage is to be built up across the resistance of the grid leak. If the stopping condenser were small, the amplification on the high notes would be still less. So there are several reasons why the stopping condenser should be large in all cases, when regarding the amplification alone.

There are many conditions which call for a modification of the proper design. For example, there may be motorboating on a very low frequency. One way of stopping this is to make the time constant of the grid leak and the stopping condenser smaller. The object of this is to reduce the amplification on the lower frequency at which the motorboating occurs, not to affect the high frequency amplification. This remedy is not detrimental, as over-amplification in the low-frequency region is avoided. It will not change that appreciably.

### Makes Little Difference Here

Whether the time constant is large or small, within reasonable values, does not make much difference on the very high frequencies. But it does make a difference what the time constant of the grid leak and the capacity across it is.

Let us summarize. The stopping condenser should be as large as practicable in order to amplify the low notes. The grid leak should have as high resistance value as practicable in order to amplify all frequencies. The time constant of the grid leak resistance and the capacity across the leak should be as small as possible in order to amplify the high notes.

### Case of Fig. 1

In Fig. 1 there are two circuits the time constants of which should be high. These are C9, R4 and C10, R8. In each case there is a distributed capacity across the grid leak which causes a loss at the high audio frequencies, but the stopping condensers, however large, do not suppress the high notes.

The inter-electrode conductances and capacities also affect the transmission of voltage from one tube to the next, as does the load resistance on each tube, but the grid leak and stopping condensers are the main factors. A mathematical expression giving the effect of all the elements is very complex and does not show clearly what the effect of each element is. But it must be emphasized that the stopping condenser does not suppress the high audio frequencies because it requires a long time to respond. It responds instantaneously the way it should and if it is large enough it does not charge up at all at any frequency.



## A THOUGHT FOR THE WEEK

**H**AVE you heard Alice Remsen on WOR's "Footlight Echoes" program? Miss Remsen has a rich voice especially suited to radio and, having had stage experience, she knows how to interest an audience and hold its attention. She has been radio editor, dramatist, columnist, librarian and fictionist and her verse is graceful and will stand the test of the severest scanning. Her middle name is Versatile, but what is much more important, she accomplishes with skill and artistry the many things she attempts.

# RADIO WORLD

The First and Only National Radio Weekly  
Tenth Year

Owned and published by Hennessy Radio Publications Corporation, 145 West 45th Street, New York, N. Y. Roland Burke Hennessy, president and treasurer, 145 West 45th Street, New York, N. Y.; M. B. Hennessy, vice-president, 145 West 45th Street, New York, N. Y.; Herman Bernard, secretary, 145 West 45th Street, New York, N. Y.

Roland Burke Hennessy, editor; Herman Bernard, managing editor and business manager; J. E. Anderson, technical editor; L. C. Tobin, advertising manager.

## Books

### "The Radio Handbook"

**T**HERE are not many authors who produce excellent radio technical books of the so-called "popular" type. It is fortunate, however, that those who have the knowledge and the knack are industrious producers. James A. Moyer and John F. Wostrel, who are in the anointed class, are positively prolific, for they are out with a big new volume, "The Radio Handbook" (McGraw-Hill Book Company, Inc., \$5.00), that contains no less than 886 pages, and even includes something about television and sound pictures.

This is the most practical handbook that has come to our attention, and it has the high advantage of being from the pen of a pair of collaborators who are well versed in their subject. Both are connected with the Massachusetts Department of Education, in fact, Moyer is director of university extension of that institution. Knowing their subject, they can write about it simply and plainly, introducing only so much mathematics as is necessary for accuracy. This is quite different from some of the volumes of lesser consequence on various radio topics that come from other pens, where it is obvious the author himself didn't know any too much about his subject, and found refuge perhaps in the assumption that the reader knew less, so there was small risk.

Not only is this new handbook as complete as one would desire, it is perhaps not stretching the point to say it is complete beyond one's expectation. Tables, hard to find in radio literature, but seriously important when needed, are printed, so you can find the allowable carrying capacities of copper wires, standardized stranding of wires, relation of wavelength and frequency and the product of capacity and inductance in oscillatory circuits, weight of bare and insulated copper wire, properties of copper wire, diameters of bare copper wire and outside diameters of insulated wire, fuse-selection, common logarithms, trigonometric functions, and the like.

Definitions are plentiful and concise. Fundamental units in radio are set forth in a clear way, the electron theory is ex-

## Portable Transmitters

**O**NE can imagine a sympathetic old lady recoiling with proxy fright on being told about an announcer who has to carry a transmitting station on his back. Figures have been strewn before the public gaze that relate the expense of maintaining a transmitter, and photographs show the large dimensions as compared to the human form, but there are transmitters and transmitters, and the totable type isn't half so severe a strain as might be imagined.

A service man, who has a small seashore bungalow, desired to do some radio construction work at his Summer place, so went to his town home for tools and parts. He put them in a satchel. At a subway station he curiously weighed the filled satchel at a slot machine. The weight was just 30 pounds. The day was hot, yet he could believe the scales were not conspiring against him.

Well, the portable transmitter is less of a burden than that, by five pounds. One used by announcers of the National Broadcasting Company weighs 25 pounds, total equipment, including the extension microphone, power amplifier, voltage sources, antenna, tuned circuits and the like.

Of course this type of transmitter is for short waves. The one in mind works on 5 meters and is used by announcers for spot broadcasts, as in such news events and stunts as golf championship matches, airplane broadcasts, subsea descriptions, zoo realism and even for parachute jumping. The jumper is principally a jumper, only incidentally an announcer, in such instances.

The short-wave transmission is picked up at the main plant and broadcast on regular wavelength from that point.

pounded, and the various parts used in radio receivers, power amplifiers and in sending stations are explained. Phenomena of transmission are cited, with an interesting section on short waves. Nor is the laboratory forgotten, for equipment and method are set forth for measuring, while the subject of tubes is treated in the authors' familiar style, along the line of their book on tubes.

The industrial applications of vacuum tubes is one topic on which the authors dwell, while television and sound motion pictures are developed instructionally, television probably because it is supposedly about to break in a big way, and sound pictures because so many service men and others in this field are from the ranks of radio, and there is a close association between the two fields.

"The Radio Handbook" is a real handbook, genuine to the point of exultation, and constituting a benefaction to workers in the radio field, be they instructors, designers, service men or students. This is a radio compilation with a vengeance, a flexible-bound blessing to the science.

### "Experimental Radio Engineering"

**P**ROF. JOHN H. MORECROFT, perhaps the outstanding author of radio text books, is prodigious in his output, also, and has a new book, "Experimental Radio Engineering" (John Wiley & Sons, Inc.; \$3.50), intended for the serious worker, the man with a mathematical background.

The professor has never cared to amble along with a non-mathematical treatment, since so little of real value can be presented without mathematics in regard to the subjects he discusses. However, the thought may have come to many that since so much in radio requires mathematical treatment, if their eagerness for accurate knowledge runs high, they had better study mathematics as perhaps the first preparation for an understanding of

radio. With some knowledge of mathematics they can quickly annex the professor bodily, and be all the more joyous and well informed for the intellectual invasion.

Fifty-one experiments are described in the book, and full acknowledgement is made of difficulties where they arise, as for instance the common and unavoidable errors in measuring distributed capacities. The professor says the errors run to about 50 per cent.; however, it is a case where relative values may suffice, so the absolute errors need not cause loss of sleep.

The workmanlike manner of treatment and the deep understanding that the author brings to his work make the book even a Summer delight. More books like this and the study of radio technique may oust the reading of light Summer fiction for the radio-minded.

The volume is in text book form, and is intended as a companion to the author's very substantial volume, "Principles of Radio Communication," a 1,000-page book.

### "Foundations of Radio"

**T**HE third new book of consequence, just published, is "Foundations of Radio," by Rudolph L. Duncan (John Wiley & Sons, Inc.; \$2.50), containing an exposition of electrical phenomena, particularly as applying to that branch of electricity involving radio.

The book is earnestly written for the veriest beginner, and nothing is taken for granted. Lest the reader know nothing about arithmetic, there is something in the book to set him straight on that. If square root is a new quantity, this will be found explained, with actual working examples of finding the square root. The author gets around the simplicity of the book by suggesting that these very elementary considerations will refresh the recollection. The reader therefore is assumed, from this viewpoint, to have known but perhaps forgotten, a diplomatic motive, yet one revealing the depth to which the author has conscientiously spaded his field.

Even in reading about the most familiar subjects there is always the opportunity to run across something that seems new, or that presents a new viewpoint, or that recalls a forgotten fact. For instance, the magnetic compass is discussed, and the author points out that the popular conception is that the north pole needle point is attracted to magnetic north, but reminds the reader that like poles repel. So it must be the magnetic south pole that is attracting the tail of the needle to make the pointer indicate magnetic north.

Duncan, like Morecroft, Moyer and Wostrel, is a teacher, and he takes obvious delight in leading the beginner by the hand, emphasizing that it is exceedingly important to be well grounded in the fundamentals, as advance students sometimes find new problems difficult only because they have not fully understood simpler and fundamental ones.

The whole science of radio is built around phenomena of effect, and correlated cause, concerning operations we do not see, and it is harder from a purely inhibited consideration for a beginner to feel at home with the invisible properties than those he can see. In fact, many beginners, in getting their first explanation of radio phenomena, doubt the statements made, and believe the author is romancing, the whole dissection seeming too fantastic. But Duncan has struck a sincere course along which he carries the reader on a most enjoyable journey, where every scene pointed out at once appears real and credible. He has broken down the element of radio exposition to the veriest electron thereof and is entitled to wide appreciation from a class of radioists for whom not very much is being written in book form these days.

Herman Bernard.



## TWO TYPES OF CELLS BLENDED FOR TELEVISION

Boston.

The Shortwave and Television Corporation is experimenting with two different types of photo-electric cells to obtain better shading of televised pictures.

Simultaneous use of two different types of photo-electric cells is controlled in a mixing panel. Potassium cells have been used for pickup work in television for several years. More recently the caesium cell has been introduced into the television studio. The caesium cell has been replacing the older potassium cell because it is about five times as sensitive.

These two cells were studied. While the caesium cell was very sensitive, pictures reproduced from its pick-up seemed to lack some of the qualities of the earlier potassium cell pictures.

### Color Sensitivity Varies

Colors are located in a scale or spectrum. At one end of the color scale we have ultra-violet and at the other end infra-red. The eye cannot pick up the extreme ends of the scale, infra-red or ultra-violet, but it can red and blue, the first colors visible at either end, and therefore of interest to television workers.

Caesium is particularly sensitive to red but is also quite sensitive to blue. Potassium is sensitive only to the blue end of the scale and does not respond at all to red. The result of this characteristic of the potassium cell has been dark splotches and a tendency to fasten a beard on the subjects being televised, noticed in early television work.

### Mixture Proportioned

Caesium, used alone, however, seems to give rather a flat picture. Thus it became apparent that if the qualities of the potassium cell could be added to those of the caesium cell a finer type of picture would result. The potassium would make up for the weakness of caesium to red colors and the caesium fill in the lack of response to blue, characteristic of the potassium cell.

Due to the much greater sensitivity of the caesium cell, this mixing had to be such that the potassium would have an equal value with the caesium.

This has been accomplished in the studio of the Shortwave and Television Corporation's station, WIXAV, by having a group of several potassium cells for each caesium cell used. The impulses of these cells are then fed into a mixing panel and thence into the amplifier.

### TELEVISION DISCS

WE all understand that the television scanning disc is not the ultimate device that will be used, but so that the radio experimenter and fan may avail himself of radio movies now being broadcast it is possible to use a cardboard type of disc. I have used one of the three-flexible-cardboard type that I developed for mounting on a small electric fan motor with  $\frac{1}{4}$  inch shaft.

The 12 inch, 45 hole three spiral has a picture proportion of 1-to-1, giving a picture 13/16 inch high by 13/16 inch wide. The 48 hole single spiral has a picture proportion of 5 to 6, giving a picture  $\frac{5}{8}$  inch high by  $\frac{3}{4}$  inch wide. The 16 inch disc, with 60 holes, single spiral, has a ratio of 5-to-6, giving a picture 43/64 inch high by 51/64 inch wide.

ARTHUR M. POHL,  
3541 Michigan Ave., Detroit, Mich.

## Literature Wanted

Readers desiring radio literature from manufacturers and jobbers concerning standard parts and accessories, new products and new circuits, should send a request for publication of their name and address. Send request to Literature Editor, RADIO WORLD, 145 West 45th Street, New York, N. Y.

W. R. Everett, 312 No. 12th St., Allentown, Pa.  
George Eckhardt, Station Dispensary, Fort Wood, Bedloe's Island, New York Harbor, N. Y.  
E. M. Lively, Box 415, Fort Lyon, Colo.  
Hubert E. Siepmann, 837 Rundell St., Iowa City, Iowa.  
Marion A. Burns, Box 182, Florien, Louisiana.  
John R. Holloway, Jr., 18 Lee Ave., Haddonfield, N. J.  
O. E. Anderson, 122 N. Root St., Aurora, Ill.  
Zairo Malavolti, care Delfiore, 2503 Tratman Ave., Bronx, N. Y. City.  
Andrew Miller, 1934 - 44th St., Brooklyn, N. Y.  
W. L. Cook, 412 East 23rd St., Erie, Pa.  
Harry I. Torch, 418 Poplar St., Macon, Ga.  
Miguel Fuentes, 13 Zaragoza St., Stop 24, Santurce, Porto Rico.  
Harry Perkins, 456 Herzl St., Brooklyn, N. Y.  
Robert D. Allen, P. O. Box 204, Mingus, Texas.  
H. P. Congdon, 2092 Juliet St., St. Paul, Minn.  
Elmer A. Noble, P. O. Box 642, Borger, Tex.  
B. A. Shannahan, 1029 E. McLeod Ave., Sapulpa, Okla.  
Isa William Jacobs, Infanta Luisa No. 2, San Juan, P. R.  
Schober's Radio Service, 17 S. Van Brunt St., Englewood, N. J.  
J. B. Huslake, care Jacobs-Mazur Co., 226 E. Houston St., San Antonio, Tex.  
John Crentz, care Mr. Steuer, Loon Lake House, Loon Lake, N. Y.  
Harold Scott, Utility Shop, P. O. Box 482, Marmarth, N. D.  
George Mitchell, 960 E. Grand St., Elizabeth, N. J.  
E. H. Lambert, 604 Bankers Trust Bldg., Norfolk, Va.  
C. H. Poland, Poland Photographers, 319 Union Ave., Memphis, Tenn.

## HIGHEST VISION AERIAL PLANNED

Television signals will soon be broadcast from the top of the Empire State Building in New York city. Sight and sound studios will be established on the eighty-fifth floor of the building as soon as licenses have been granted by the Federal Radio Commission.

Arrangements for the installation of the equipment were made between former Governor Alfred E. Smith, president of Empire State, Inc., and M. H. Aylesworth, president of the National Broadcasting Company.

The new television station will occupy the east half of the eighty-fifth floor, about 1,000 feet above the street, and the transmitting antenna will be installed at the top of the mooring mast on the building, about 1,250 feet above the street. Work on the station will be begun as soon as the license has been granted, according to Mr. Aylesworth. It is not expected that this will be until the Fall because the members of the Federal Radio Commission are now on vacation and will not meet for several months.

The high spot was selected because the engineers of the broadcasting company believe that operation at this altitude will not be accompanied by the difficulties that have been met in the transmission of television signals in the past. Mr. Aylesworth said that the reason for establishing the station was to bring television out of the laboratory and to begin experimental sight and sound broadcasting.

The Empire State Building is the highest building in the world.

### SCHULLINGER APPOINTED

Karl W. Schullinger, formerly of the RCA Victor Company in Hollywood, has been appointed assistant to Don E. Gilman, National Broadcasting Company vice president in charge of the Pacific Division. The office is in San Francisco.

## AEROVOX SUED BY ELKON ON ELECTROLYTIC

P. R. Mallory Co., maker of the Elkon electrolytic condensers, has started suit against Aerovox Wireless Corporation, Brooklyn, N. Y., for injunction and damages, alleging infringement by manufacture and sale of the Aerovox dry electrolytic condensers.

Thereupon Aerovox sent the following letter, so it announced, "to all radio manufacturers throughout the country":

"P. R. Mallory Company has been spreading rumors since last December that they are about to sue us for infringement of their Ruben patents Nos. 1710073 and 1714191. This threat relates to our Aerovox dry electrolytic condenser, and only a few days ago they actually served us with papers.

### Guarantees Protection

"With regard thereto, please be advised that in the manufacture of our electrolytic condensers we follow the teachings of our own patent No. 1789949 and of other patents still pending on various valuable and characteristic features of our condenser.

"So radically different are our condensers as compared with the Mallory product, Elkon condensers, that we challenge the motive of this suit.

"We guarantee you full protection!

### Says Good Faith is Evidenced

"All we ask of you is if any action is brought against you, based on these Ruben patents, or either of them, charging infringement by your use or sale of our condensers, that you promptly refer all papers to us and permit us to assume full charge of the defense at our own expense. In any case, should such suit terminate adversely, we agree to hold you harmless and to pay any judgment or decree for profits, damages or costs resulting from such litigation.

"We offer this guarantee of our own initiative as an evidence of our good faith and confidence of our position."

The letter was signed by Samuel I. Cole, treasurer.

### AN ENCOURAGING SUPPOSITION

YOUR weekly, I suppose, is still going. I have before me a copy dated September 17th, 1927. I wonder if it is possible to get a copy for September 24th, 1927. I am interested in the article about "The Unified Diamond," and as I have some parts for that set and have lost the directions I had for putting them together, I thought that if I had the other number containing the continuation of the description perhaps I could do something with the set.

JOSEPH S. HUNT,  
Charlestown, N. H.

### MIXED FEELINGS

I HAVE been buying RADIO WORLD quite regularly for the past two years and find lots of interesting matter and good information in it.

There is, however, one criticism I wish to make, and that is in the publication of some of your hookups sufficient detail is not given to enable one successfully to build the set described, and in some articles further information is promised in a future issue, but the information never appears. This is misleading and disappointing.

C. A. COOLIDGE,  
Kentfield, Calif.



# GREAT GROWTH IN "FAN" MAIL; A NEW RECORD

More letters from radio listeners already have reached the National Broadcasting Company's mail box, and stations associated with its networks, in the first half of this year than were received in all twelve months of last year. More significant still is that hot weather mail, in previous years light, bids fair to be heavier than that in the earlier months of 1931. There is substantial increase in the June mail over that of May.

Last year 2,178,574 members of the radio audience wrote how much they had enjoyed (or disliked) its programs. All but a small percentage enjoyed. The figures for the first six months of 1931 are 2,196,684.

## Number Grows Weekly

Tabulations of letters received during May and June show that the avalanche of mail is growing week by week. The May total for this year was 255,100, as compared with 124,476 last May. The June total in 1931 was 292,897, as compared with the 97,314 total for June, 1930.

In one six-day week last month—from June 8 through June 13—fan letters numbered 78,420, only 8,894 fewer than the total for all of June in 1930.

That the stream of fan mail is flowing ever stronger is further illustrated by the fact that the number of letters received in June is 37,797 larger than the number received in May of this year.

## Tabulation Since 1927

The totals are made up only of letters actually received by the company. The records quoted do not include the vast numbers of letters sent directly to the sponsors of programs, nor to their advertising agents. The majority of sponsors on the air arrange to receive directly mail relating to their broadcasts.

The tabulation since 1927 follows:

1927 .....	540,263
1928 .....	772,483
1929 .....	1,279,796
1930 .....	2,178,574
1931 (six months).....	2,196,684

## Super-Power

### Action in Fall

Washington.

The Federal Radio Commission has postponed action on super-power licenses until October 1st. Commissioners Saltzman, Sykes, Robinson and Starbuck voted for and Commissioner Lafount against the postponement.

Twenty stations, or four in each of the five radio zones, are to use 50,000 watts, under a general order issued by the Commission. Twelve stations now use 50,000 watts on an experimental basis but these and eight others will be assigned the maximum power as a regular assignment. There are twenty-four applicants for the twenty high power assignments.

## PORTABLE'S USE EXTENDED

When outstanding sporting events are taking place and the action covers a large territory, the reporters of the radio chains employ portable radio transmitters which are strapped to their backs.

The signals transmitted by these sets are picked up by receivers located nearby, are then amplified and transmitted to the broadcasting stations over land wires. In addition to the transmitters the chains also have portable receivers, carried by other men than those carrying the transmitters. The object of the portable receivers is to enable the men in the field to maintain two-way communication with the operators at headquarters.

The National Broadcasting Company employs a transmitter operating on five meters and 7.5 watts, a power several times greater than that of any transmitter of the type previously employed. It has a tested range of seventy-five miles.

When Billy Burke and George von Elm battled through 144 holes on the Inverness course, Toledo, Ohio, for the National Open Golf Championship, they were followed by two of these one-man transmitting stations, one for the Columbia System and the other of the National Broadcasting Company. Ted Husing announced for the Columbia and Thomas Manning for NBC.

## RCA STATION LICENSES AGAIN BEFORE COURT

Washington

The Radio Corporation of America license issue is in the courts again. WTMJ, of Milwaukee, has filed an appeal with the Court of Appeals of the District of Columbia, challenging the action of the Federal Radio Commission in deciding that it was not compelled by law to revoke the licenses held by RCA and its subsidiaries, 1,409 licenses in all. The appellant alleges that the decision of the Commission was "erroneous, contrary to law and in violation of the duty imposed upon said Commission by the provisions of the law which created it."

### WTMJ Was Intervenor

The decision of the Commission in question was taken on June 24 and was concurred in by Commissioners Robinson, Lafount and Starbuck, Commissioners Saltzman and Sykes dissenting.

WTMJ, the appeals petition brought out, was one of four intervenors in the litigation before the Commission. It was explained at the Commission that while the appeal is directed only against the single channel of 870 kilocycles for which the Milwaukee station is an applicant, with the maximum power of 50,000 watts, the entire issue of possible cancellation of the 1,409 licenses is automatically raised.

### Action in Fall

No action is expected on the petition until Fall, for the court is in recess. But it is expected that the Commission will file an answer to the petition within thirty days, following its customary procedure, giving a statement of the facts and grounds for the decision. Because the Milwaukee "Journal," the station owner, is not seeking a restraining order of any nature, the licenses of the RCA stations will be continued on regular basis, but licenses for new projects probably will be conditionally.

### Not Tubes Alone

The Radio Corporation of America welcomes the new litigation because it is firmly convinced that the outcome can only be favorable, according to statements by RCA counsel. John W. Davis, former presidential candidate on the Democratic ticket, expressed the opinion when the case first came up that there was no question of monopoly of communication but only of sales of receiving tubes. Tubes of a particular company are not essential to radio communication, was his contention, and in this he was supported by the majority of the Radio Commission.

Radio communication was conducted successfully for many years long before any tubes were invented and even now both code and voice communication are conducted without transmitting or receiving tubes.

## Lindberghs Licensed

Washington.

Commercial radio operating licenses have been issued to Col. and Mrs. Charles A. Lindbergh, who had passed the regular government tests, it was announced by the Radio Division of the Department of Commerce. The licenses were issued in connection with the projected flight to the Orient. Both are licensed airplane pilots.

## IN PREPARATION! Special SHORT WAVE Number of RADIO WORLD

Dated August 8—Last Form Closes July 28

Nobody has to be told that the Short Wave angle of radio is a mighty important factor at the present time. It has gone so far ahead of the merely experimental stage that there no longer is the slightest doubt as to its fixed and ever-increasing importance and value.

Radio World has done its share in informing the public of the important developments in Short Wave theory and practice. Its columns have reflected from week to week the knowledge of our experts who have written on the subject. Many interesting and informative diagrams and other illustrations have been used with the text matter, and the trade aspects have been given careful attention. An army of Short Wave enthusiasts has flocked to our banner as subscribers and purchasers at the news-stands.

Now Radio World announces a special Short Wave number. This issue will reflect the latest word in Short Wave developments.

If you have anything to sell in the Short Wave field, be sure to use this number and reach the many thousands who will buy it and eagerly read it.

Radio World's rates of \$150.00 a page and \$5.00 an inch are exceedingly low for the service it gives.

**RADIO WORLD, 145 West 45th St., New York City**



## 1/4 OF NATION'S BUSINESS DONE IN TWO CITIES

The management of the Radio-Electrical World's Fair, Madison Square Garden, New York, and the similar show at the Coliseum, Chicago, points out that 25% of the nation's radio and electric appliance business is done in these two cities.

The Fair's business office in New York is at 1904 Times Building (West 43d street), while the Chicago office is at 127 North Dearborn street.

The statistical comparison follows:

"The outstanding economic importance of the New York and Chicago markets for radio and electric appliances is emphasized by the results of a survey by the management of the Eighth Annual Radio-Electrical World's Fair and the Tenth Annual Chicago Radio-Electrical Show.

"The survey reveals that the total radio sales in the metropolitan areas of New York and Chicago in 1929 was \$141,000,000, or more than 27 per cent of the total \$510,000,000 for the entire nation. The total sales of electrical appliances in the two largest American cities, the same year, was \$178,000,000, or more than 23 per cent of the national total of \$750,000,000. Thus New York and Chicago did an average of 25 per cent of the nation's \$1,260,000,000 radio and electric business in 1929.

### Foundation for National Acceptance

"Not only are the largest total sales concentrated in the New York and Chicago trading areas, but the acceptance of a product in the New York and Chicago retail markets is found to lead to national acceptance. These markets are located in the nation's most fertile territory where people have the money to buy what they want.

"The radio and electrical trades are particularly favored in these two cities, which jointly have 2,000,000 registered electric meters. Besides the fact that this meter total is the largest of any two American cities, there are numerous users of radios and electrical appliances in hotels, apartment houses and office buildings where there are 'community' meters for entire structures rather than separate meters for individual tenants.

### "Biggest Events"

"With the augmented features of exhibiting and demonstrating electrical appliances, in addition to the elaborate displays of the latest trends in radio, the Eighth Annual Radio-Electrical World's Fair at Madison Square Garden, New York, September 21st to 26th, inclusive, and the Tenth Annual Chicago Radio-Electrical Show at the Coliseum, October 19th to 25th, inclusive, will be the biggest events of their type ever held."

Substantial reductions in admission prices will prevail at the Eighth Annual Radio World's Fair and the Tenth Annual Chicago Radio-Electrical Show.

The admission to the New York show at Madison Square Garden, September 21st to 26th, inclusive, will be 50 cents afternoons and 75 cents evenings. For the Chicago show at the Coliseum, October 19th to 25th, inclusive, the charge will be 50 cents for afternoon or evening. Last year's admission prices were 75 cents afternoons and one dollar evenings, in New York, and 50 cents afternoons, 75 cents evenings, in Chicago.

## Staffs Enlarged for Public Show

Sales staffs of the Eighth Annual Radio-Electrical World's Fair, which will be held at Madison Square Garden, New York, September 21st to 26th inclusive, and the Tenth Annual Chicago-Radio-Electrical Show, at the Coliseum, October 19th to 25th, inclusive, have been enlarged, G. Clayton Irwin, Jr., general manager, announced.

New appointments on the New York sales staff are George E. Martin and Paul A. Singleton. Mr. Martin previously was with Atwater Kent as a sales promotion specialist among jobbers and dealers. Mr. Singleton served on the national advertising staff of the New York "Times."

James Hickey, former Chicago advertising manager of the National Carbon Company, is a new addition to the Chicago staff.

Three assistant general managers are Charles W. Glaser, Chicago office; J. Chester Johnson, New York office, and Arthur Stringer, sales promotion, exposition features and publicity.

## CONTRASTS U.S. WITH BRITAIN

London

The differences between the British and American systems of broadcasting were discussed recently by W. S. Paley, president of the Columbia Broadcasting System. He said that the two different systems were developed because each country "is bound to have the broadcasting that is adapted to its needs."

In the United States radio broadcasting is privately operated but under government regulation. In England, on the other hand, broadcasting is a monopoly completely under government control.

"America is traditionally antagonistic to monopoly," said Mr. Paley, "especially to government monopoly, so we decided on government regulation rather than government control and on orderly competition rather than monopoly."

"It is difficult, yet quite possible, for a wise British Broadcasting Corporation to feel and follow the pulse of the public's taste, to strike a fair balance between praise and blame, but in America success or failure is made evident only as the result of competition. It is the only real measuring stick we can employ. We take as our guide the free vote of the people, expressed by the simple device of turning the button."

## Pointed Quotations

**WILLIAM S. PALEY, president, Columbia Broadcasting System:** "If listeners do not like a given program they quickly turn that most influential of all knobs and are listening to a rival program that may serve them better."

\* \* \*

**MERLIN HALL AYLESWORTH, president, National Broadcasting Company:** "Television should be ready for public use after about a year of intensive development in experimental tests under actual working conditions. This does not mean that it will be perfect, but television at least will have reached the stage where only refinements of technique will be required, rather than development of new basic principles."

## STATION CHAIN DISPATCHES BIG PLANE FLEETS

Washington

A vast network of radio stations, covering the entire nation and extending into South America, now controls the operation of airplanes over the American airways, according to Federal Radio Commissioner William D. L. Starbuck, who is in charge of engineering work for the commission. This system is entirely apart from the radio aids to navigation, such as range-beacons and the dispatch of general weather information, conducted by the Airways Division of the Department of Commerce.

The facilities of the radio system are available to all companies operating airplanes, which are charged on a pro rata basis to maintain it.

### Continuous Distress Watch

They are also open to itinerant or taxi airplanes making use of the airways. Twenty-four hour service is maintained and the watch on the calling and distress frequencies is continuous. The name of the company operating the system is Aeronautical Radio, Inc., which was organized to take over the radio facilities of the various commercial air lines, and which now serves as a radio-aviation public utility.

Practically all the radio stations devoted to this service are operating in the high frequency band set aside by international agreement for such services.

### Success Complete

Since the beginning of the system eighteen months ago it has been entirely successful and the channels allocated to the service carry more traffic than any other commercial channels with the exception of some broadcast stations. Airplanes are now dispatched with the accuracy of trains.

## New Record-Changer Plays Whole Opera

A radio-phonograph combination with a new record-changing mechanism which makes possible the complete playing of whole operas or symphonies and albums of records in correct sequence irrespective of the size of the records was demonstrated recently by the Aeolian Company.

The new device was perfected after two years' work by the Capehart Corporation, of Fort Wayne, Ind. It is the first instrument of its type that can play both sides of a record automatically and can handle from three to twenty-four records of standard manufacture.

The instrument has a wider range of tonal reproduction than any other instrument, reproducing from 16 to 4,600 cycles. Besides the phonograph it has a thirteenth-tube superheterodyne.

### NORMAN F. DAW DIES

Norman F. Daw of the DeForest Radio Company, veteran of many World War battles, died after two months illness caused by complications of a wound received at Belleau Wood.

### COLUMBIA TRIES VISION

The Columbia Broadcasting System has started experimental television transmission in New York City.



The inductor dynamic offers high sensitivity and true tonal response. It requires no exciting field current, unlike other dynamics. Order model R for 112A or pentode, and Model G for all other output tubes.

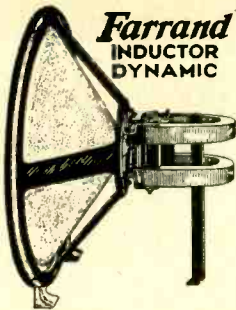

- Cat. 9-G (9" extreme outside diameter) \$8.49
- Cat. 9-B .....\$8.49
- Cat. 12-G (12" extreme outside diameter) .....\$10.03
- Cat. 12-B .....\$10.03

**GUARANTY RADIO GOODS CO.**  
143 W. 45th St., New York, N. Y.

## NEW BOOKS

**"EXPERIMENTAL RADIO ENGINEERING,"** by Prof. John H. Morecroft, of the Department of Electrical Engineering, Columbia University. A companion book to the author's "Principles of Radio Communication," but in itself a text on practical radio measurements. Cloth bound, 345 pages, 6 x 9, 250 figures.....\$3.50

**"THE RADIO HANDBOOK,"** by James A. Moyer and John F. Wostrel, both of the Massachusetts Department of Education. Meets the need for a complete digest of authoritative radio data, both theoretical and practical. Flexible binding, 886 pages, 650 illustrations.....\$5.00

**"RADIO FREQUENCY MEASUREMENTS,"** by E. B. Moulin, M.A., A.M., E.E., M. I. Rad. Eng. Reader of Engineering Science in the University of Oxford. Second Edition, entirely reset and greatly enlarged. For advanced students with mathematical foundations. Cloth, 487 pages and 289 illustrations .....\$12.50

**"FUNDAMENTALS OF RADIO,"** by Rudolph L. Duncan. A treatise for the beginner, setting forth clearly and carefully the electrical phenomena associated with radio. Just the book to give you a firm grip on the subject.....\$2.50  
Remit with order. We pay transportation. Ten-day money-back guaranty on all books.  
Radio World, 145 45th St., New York, N. Y.

### Full Text of the Langmuir Opinion

in RADIO WORLD of June 13  
The United States Supreme Court unanimously decided that Dr. Irving Langmuir's high vacuum for radio tubes did not constitute invention. The final court's 10,000-word opinion contains an exposition of the structure, function and operation of the vacuum tube, as well as a review of the tube's development, all scientifically treated. Be sure to read the opinion in full.

Copy mailed to you for 15c in stamps or coin.  
**RADIO WORLD**  
145 W. 45th St., NEW YORK CITY

## The New 2-Volt Tubes at \$1.00

### List of Tubes and Prices

230 .....	\$1.00	224 .....	\$1.00
231 .....	1.00	227 .....	1.00
232 .....	1.00	245 .....	1.00
222 .....	2.10	210 .....	2.95
171A .....	1.00	250 .....	2.95
171 (for AC) .....	1.00	228 .....	1.00
112A .....	1.00	280 .....	1.00
112 (for AC) .....	1.00	281 .....	2.95
201A .....	1.00		
240 .....	1.00		
UX-199 .....	1.00		
UV-199 .....	1.00		
120 .....	1.00		
200A .....	1.00		
WD-12 .....	1.00		

**SPECIAL TUBES**  
Tellon, neon gas tube, for television .. \$3.85  
Photo-electric cell, 2-Inch coil height \$4.50

### RELIABLE RADIO CO.

143 West 45th Street, New York, N. Y.

Enclosed please find \$..... for which ship at once, on 10-day money-back guar-antee, the following tubes:

- |                               |                                 |                                     |   |
|-------------------------------|---------------------------------|-------------------------------------|---|
| <input type="checkbox"/> 230  | <input type="checkbox"/> 240    | <input type="checkbox"/> 228        | If C.O.D. is desired <input type="checkbox"/> please put a cross in square at left. |
| <input type="checkbox"/> 231  | <input type="checkbox"/> UX-199 | <input type="checkbox"/> 250        |   |
| <input type="checkbox"/> 232  | <input type="checkbox"/> UV-199 | <input type="checkbox"/> 222        |   |
| <input type="checkbox"/> 171A | <input type="checkbox"/> 120    | <input type="checkbox"/> 210        |   |
| <input type="checkbox"/> 171  | <input type="checkbox"/> WD-12  | <input type="checkbox"/> 250        |   |
| <input type="checkbox"/> 112A | <input type="checkbox"/> 200A   | <input type="checkbox"/> 281        |   |
| <input type="checkbox"/> 112  | <input type="checkbox"/> 224    | <input type="checkbox"/> Tellon     |   |
| <input type="checkbox"/> 201A | <input type="checkbox"/> 245    | <input type="checkbox"/> Photo sell |   |

Name .....

Address .....

City ..... State .....

### HAMMARLUND SFL

Hammarlund's precision .0005 mfd. condenser, with removable shaft; single hole panel mount. Lowest loss construction; rigidity; Hammarlund's perfection throughout. Order Cat. HAM-SFL @ \$3.00 net price. Guaranty Radio Goods Co., 143 W. 45th St., New York.

## RADIO WORLD and "RADIO NEWS"

BOTH FOR ONE YEAR **\$7.00**

You can obtain the two leading radio technical magazines that cater to experimenters, service men and students, the first and only national radio weekly and the leading monthly, for one year each, at a saving of \$1.50. The regular mail subscription rate for Radio World for one year, 3 new and fascinating copy each week for 52 weeks is \$8.00. Send in \$1.00 extra, get "Radio News" also for a year—a new issue each month for twelve months Total, 64 issues for \$7.00.  
RADIO WORLD, 145 West 45th Street, New York, N. Y.

## RF CHOKES

### HONEY COMB TYPE

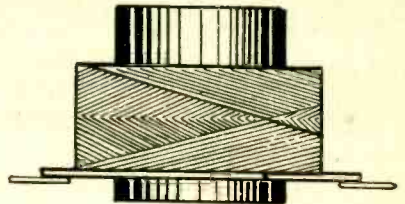

800-turn duolateral wound radio frequency choke. Inductance 60 millhenrys, DC resistance 75 ohms. The distributed capacity is so low as to be negligible. The choke, therefore, may be used as plate circuit or grid circuit load, even in short-wave sets and converters, and will provide extremely high sensitivity with a low order of noise level, due to filtration by the choke. Suitable for antenna input (grid of first tube to ground) or for filtration of plate and screen grid circuits with condenser of 0.1 mfd. to ground (extra).

The choke is wound of green silk covered No. 38 wire on a pierced dowel, with bakelite base accommodating two riveted lugs. Contact is perfect. The dowel diameter is 1/2 inch, the hole through it (which may be used for mounting device) passes 10/32 screw. The extreme coil diameter is only 3/4 inch. The distance between lug tips is 1 1/4 inches. The dowel protrudes 1/2 inch beyond the bottom to prevent shorting where mounting is done on a metal sub-panel. No particular polarity of connections need be observed.

Two of these chokes may be used with an isolating condenser of .00025 mfd. or higher capacity for radio frequency coupling in broadcast sets for amplification peaked broadly around 600 meters to make the total RF amplification more uniform and obviate the "rising characteristic" of tuned radio frequency amplification. 12 ma maximum current rating. Order Cat. CH-800 @.. 50c

### DETECTOR TYPE

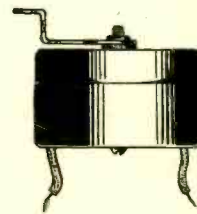

For detector circuit filtration, to choke the radio frequency, so it will not go through the audio channel, use a 50 millihenry copper-shielded RF choke. This is supplied with mounting bracket and two insulated wire leads. No particular polarity need be observed. This choke is wound of extra heavy wire, and its DC resistance will not show up on the usual type ohmmeters. Order Cat. SH-RFC (25 ma maximum current rating) @ .....

### VOLUME CONTROL TYPE

Where a receiver is to be built to incorporate automatic volume control, the shielded choke, consisting of two closely coupled separate windings, may be used. Connect one winding (yellow leads) from detector plate, to the audio input. Connect the two other leads (red and black) as follows: Black to the slider of a potentiometer (400 ohms up, without limit), red to the joined grid and plate leads of a 227 tube used as automatic volume control. Connect cathode of that tube to ground (B minus), and the grid returns of coils in controlled tube or tubes to arm of the potentiometer. Put 1 mfd. from arm to ground. Order Cat. DW-SHCH (maximum current rating, 25 ma) @ Hammarlund 5 mfd. band pass filter coupling condenser, Cat. H6T, @ .....

### DIRECT RADIO COMPANY

143 West 45th Street New York City

# Quick Action Classified Ads

## Radio World's Speedy Medium for Enterprise and Sales

7 cents a word—\$1.00 minimum—Cash with Order

**ROTARY SELECTOR SWITCHES**, double pole—4 points, \$1.25. Radio, 111 W. 28th St., Indianapolis, Ind.

**PHONOGRAPH PICK-UP** — Made by Allen-Hough. \$3.32. Guaranty Radio Goods Co., 143 W. 45th St., N. Y. C.

**"HANDBOOK OF REFRIGERATING ENGINEERING,"** by Woolrich—Of great use to everybody dealing in refrigerators. \$4. Book Dept., Radio World, 145 W. 45th St., N. Y. City.

**EXPERT RADIO SERVICEMEN**, send for tube prices. Great Kills Electric Shop, 15 Nelson Ave., Great Kills, S. I., N. Y.

**"RADIO FREQUENCY MEASUREMENTS,"** by E. B. Moulin, M.A., A.M.I.E., M.I.Rad. Eng. Second Edition entirely reset and greatly enlarged illustrated. 487 pages, plus 12-page index. Indispensable for radio experts and engineers. \$12.50 Radio World, 145 W. 45th St., N. Y. City.

**SUMMER BARGAIN IN .00035 MFD.** Here is your opportunity to get a 4-gang .00035 condenser, with trimmers built-in, at only 92 cents, on basis of remittance with order. Shipping weight, 3 lbs. Include postage or condenser will be sent express collect. Direct Radio Co., 143 West 45th Street, New York, N. Y.

**FOR SALE**—1931 Hi-Q. F. L. Hanson, Iilon, N. Y.

**RADIO WORLD AND RADIO NEWS.** Both for one year, \$7.00. Radio World, 145 W. 45th St., N. Y. City.

**U. S. BROADCASTING STATIONS BY FREQUENCY.**—The April 11th issue contained a complete and carefully corrected list of all the broadcasting stations in the United States. This list was complete as to all details, including frequency, call, owner, location, power and time sharers. No such list was ever published more completely. It occupied nine full pages. Two extra pages in the April 11th issue were devoted to a conversion table, frequency to meters, or meters to frequency, 10 to 30,000, entirely reversible. 15c a copy. RADIO WORLD, 145 West 45th Street, New York, N. Y.

**SHORT-WAVE NUMBERS OF RADIO WORLD** Copies of Radio World from Nov. 8, 1930 to Jan. 3, 1931, covering the various short-wave angles sent on receipt of \$1.00. Radio World, 145 W. 45th St., N. Y. City

**HAMMARLUND SFL** — Hammarlund's precision .0005 mfd. condenser, with removable shaft; single hole panel mount. Lowest loss construction; rigidity; Hammarlund's perfection throughout. Order Cat. HAM-SFL @ \$3.00 net price. Guaranty Radio Goods Co., 143 W. 45th St., New York.

**WANTED**—Addresses of Manufacturers of Radio sets to be sold through mail orders. G. E. Ralstin, 1049 Hosbrook St., Indianapolis, Indiana.

**MOUNTED STEER HORNS:** For sale, over six feet spread, mounted on panel. Rare opportunity. Texas longhorn cattle now extinct. Lee Bertillion, Mineola, Texas.

**WRIGHT DeCOSTER DYNAMIC**, 12 inch new. List 75.00, sell for 39.50. Also expert wiring on all type sets. Regent Radio Shop, 205 E. 58th St., New York City.

### SITUATIONS WANTED

**YOUNG MAN**, 19, desires position in broadcast station as remote point operator and announcer, or in radio laboratory. Experience in broadcasting, sound systems and short wave work. Working for commercial operator's ticket at present time. Speak, read and write German perfectly. One year of college. Free to travel. Excellent references as to character and ability on request. Salary of secondary consideration. G. C. Willecke, Box 24, Unity, Wisc.

**YOUNG MAN**, 20, desires position in radio laboratory. Very much interested in radio transmission and television. Willing to start at low pay. D. Reynolds, 1029 Garden St., Hoboken, N. J.



## ALL ABOUT TUBES

The following illustrated articles on Tubes have appeared in back numbers of Radio World:

Published in 1930

- PHASE SHIFT TUBE IN NON-REACTIVE PUSH-PULL CIRCUIT DESIGNS. By J. E. Anderson—Feb. 8.
- THE PENTODE. Six Full Pages Discussing the Five-Element Tube. By J. E. A.—Feb. 22.
- A PENTODE CIRCUIT. By Spencer Watson Pierce—March 1.
- HOW TO ADAPT SCREEN GRID RECEIVERS TO PENTODES. By J. W. L. Bradford—March 1.
- VACUUM TUBE VOLTMETER FOR LOFTIN-WHITE CIRCUITS. By J. E. A.—March 1.
- RESOLVED, THAT THE PENTODE IS DESIRABLE. Affirmative. By Adam J. Broder. Negative. By Quinlas Ross. March 15.
- NEW TUBES IN A CONVERTER. By William J. Woods—August 2.
- NEW TUBES IN BATTERY OPERATED AF CIRCUITS. By J. E. A.—August 2.
- MODERN RADIO TUBES. By J. E. Anderson—August 9.
- THE THYRATRON TUBE. By William T. Meenam. August 9.
- 120, 201A and 240 TUBES. By J. E. A.—August 16.
- TWO OF THE LATEST TUBES: The 230 and 231. By J. E. A.—Sept. 6.
- HOW TO MEASURE THE MU OF A TUBE. By Brunsten Brunn. Sept. 13.
- THE LATEST SCREEN GRID TUBE, the 232. By J. E. A.—Sept. 13.
- NEW FACTS ON THE 232. By J. E. A.—Sept. 20.
- USES OF THE 224 TUBE. By J. E. A.—Sept. 27.
- THE 227 TUBE ANALYZED. By J. E. A.—Oct. 4.
- THE MOST SENSITIVE TUBE. By E. L. Manning—Oct. 11.
- ADAPTATION TO NEW TUBES. By Neal Fitzalan—Oct. 25.
- THE 245 and the 250. By J. E. A.—Oct. 25.
- THE EARLY HISTORY OF THE VACUUM TUBE. By John C. Williams—Nov. 8.
- THE BIRTH OF THE TUBE. By John C. Williams—November 15.
- DATA ON THE 280 TUBE. By J. E. A.—Nov. 15.
- 280 CHARACTERISTICS. By J. E. A.—Nov. 22.
- CONVERTER USING 230's. By Herman Bernard—November 29.
- 2-V TUBES IN NEUTRODYNE. By Stewart McMillin—November 29.
- MODERN USES OF EFFECTS OF RADIATION TUBES. By John C. Williams—November 29.
- THE RAYTHEON BH AND BA. By J. E. A.—November 29.
- SELECT RIGHT POWER TUBE. Dec. 27.
- TRANSMITTING TUBES. By J. E. A.—Dec. 27.

Published in 1931

- THE SCREEN GRID TUBES. By Brainard Foote—January 3.
  - A CONVERTER FOR NEW 2-VOLT TUBES. By Einar Andrews—Jan. 10.
  - MATCHING LOUDSPEAKERS TO POWER TUBES. J. E. A.—Feb. 7.
  - THE VARIABLE MU TUBE. By E. J. A.—Feb. 28.
  - NEW SCREEN GRID TUBE REDUCES CROSS MODULATION—Feb. 28.
  - THE 227 TUBE AS RECTIFIER—Feb. 28.
  - A 6-TUBE BATTERY SET USING NEW 2-VOLT TUBES—March 7.
  - VARIABLE MU TUBE OPERATION. By Sidney E. Finkelstein—March 7.
  - TWO-VOLT TUBES ON 110 v. DC. By Herbert E. Hayden—March 14.
  - SERVICE FROM ONE-TUBER. By H. B.—April 11.
  - A TUBE GALVANOMETER. By Brunsten Brunn—April 11.
  - OUTPUT PENTODE ENTERS AMERICAN ARENA. By J. E. A.—April 11.
  - HOOK-UPS FOR AC PENTODE: BUILDING A ONE-TUBER. April 18.
  - A PENTODE POWER AMPLIFIER. April 25.
  - ENTODE OUTPUT TUBE SOLVES BATTERY RECEIVER—May 2.
  - CHARACTERISTIC CURVES OF A SAMPLE 236 TUBE—May 2.
  - THE PENTODE DIAMOND: HOW TO CONNECT AND USE THE NEW POWER PENTODE. CHARACTERISTIC CURVES OF THE AUTOMOTIVE PENTODE. May 9.
  - NEW TUBES IN SUPER: CURVE FOR AUTO PENTODE. By J. E. A. May 18.
  - THE PENTODE DIAMOND FOR BATTERY OPERATION; TUBES AT A GLANCE. COMPLETE LIST. May 16.
  - CHOOSE THE RIGHT TUBES. By Brainard Foote—May 16.
  - THE VARI-MU AND PENTODE. By Allen B. Dumont; ANSWERS TO QUESTIONS ABOUT PENTODE TUBES—May 23.
  - LANGMUIR TUBE PATENT VOIDED BY FINAL COURT—Full text of U. S. Supreme Court Decision. June 13.
- 15c per one copy; \$1.00 for any 7 copies. Radio World, 145 W. 45th St., New York City.

## 115 DIAGRAMS FREE!

115 Circuit Diagrams of Commercial Receivers and Power Supplies supplementing the diagrams in John F. Bider's "Trouble Shooter's Manual." These schematic diagrams of factory-made receivers, giving the manufacturer's name and model number on each diagram, include the MOST IMPORTANT SCREEN GRID RECEIVERS.

The 115 diagrams, each in black and white, on sheets 8 1/2 x 11 inches, punched with three standard holes for loose-leaf binding, constitute a supplement that must be obtained by all possessors of "Trouble Shooter's Manual" to make the manual complete. We guarantee no duplication of the diagrams that appear in the "Manual." Circuits include: Bosch 54 D. C. screen grid; Balkitt Model B; Crosley 20, 21, 22 screen grid; Eveready series 50 screen grid; Eria 224 A. C. screen grid; Peerless Electrostatic series; Philco 78 screen grid.

Subscribe for Radio World for 3 months at the regular subscription rate of \$1.50, and have these diagrams delivered to you FREE!

Present subscribers may take advantage of this offer. Please put a cross here  to expedite extending your expiration date.  
Radio World, 145 West 45th St., N. Y. C.

## Send \$8.26! Get This Tester!

HERE is your opportunity to get immediate delivery of the Jiffy Tester at \$8.26 remittance with order, balance of \$3.50 payable in one year. Your credit is good with us. This Tester will read plate current, plate voltage and filament voltage simultaneously, when plug is put into any set socket and tube in the Tester.

Jiffy Tester, Model JT-N, consists of three double-reading meters, with cable plug, 4-prong adapter test cords and screen grid cable. The ranges are filament, heater or other AC or DC 0-10 v, 0-140 v; plate current: 0-20, 0-100 ma; plate voltage: 0-60 v, 0-300 v. It makes all tests former models made. Each meter is also independently accessible for each range. The entire device is built in a chromium-plated case with chromium-plated slip-cover. Instruction sheet will be found inside. Order Cat. JT-N.

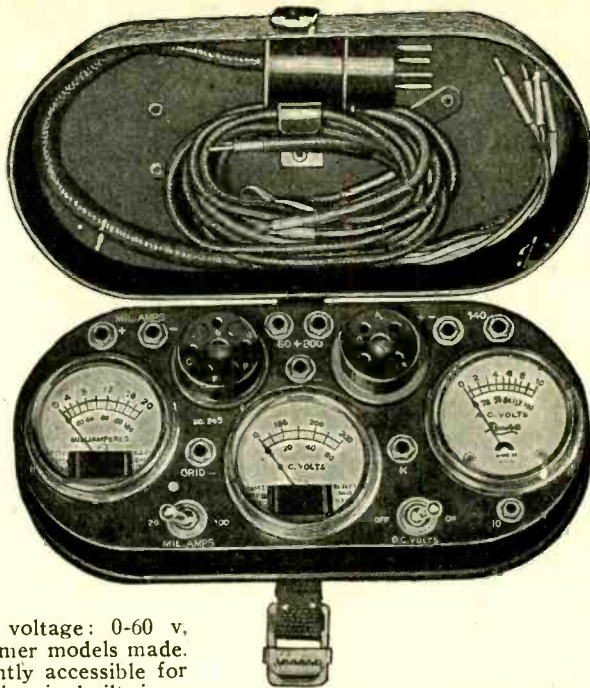

DIRECT RADIO CO.  
143 W. 45th St., N. Y. C.

## RESISTORS and Mountings

### Plate Circuit

0.25 meg. (250,000 ohms) Brach resistor, for all screen grid tubes. Order Cat. BRA-25, at...12c  
0.1 meg. (100,000 ohms) Brach resistor for all except screen grid tubes. Order Cat. BRA-10, at .....12c

### Grid Circuit

1.0 meg. Brach resistor for grid leak. Order Cat. BRA-100 at.....12c  
2.0 meg. Brach resistor for grid leak. Order Cat. BRA-100, at.....12c  
Carborundum grid leak for highest detector sensitivity. The leaks are marked "5 to 7 meg," because values in this range are present. Order Cat. CAR-57, at.....12c

### Biasing Resistors

.005 meg. (5,000 ohms) Brach resistor. Order Cat. BRA-005, at.....13c  
.015 meg. (15,000 ohms) Amsco resistor. Order Cat. AMS-15, at.....14c  
.025 meg. (25,000 ohms) Amsco resistor. Order Cat. AMS-25, at.....14c  
[The above resistors are of the tubular type and require a mounting. Lynch moulded bakelite mountings, Cat. LYM, at.....15c]

### Filament Circuits

1-ohm Brach resistor, to afford 5 volts for four 1/4 amp. tube when source is 6 volts. Supplied with mounting capacity 2 amps. Order Cat. BRA-1, at .....22c  
2-ohm Brach resistor, to afford 5 volts when two 1/4 amp. tubes are supplied from a 6-volt source. Furnished with mounting; capacity 1 amp. Order Cat. BRA-2, at.....20c  
4-ohm Brach resistor, to drop 6 volts to 5 for one 1/4 amp. tube. Mounting supplied at this price. Order Cat. BRA-4, at.....18c  
30-ohm Brach resistor. To drop 3 volts to 2 volts on 232 and 230 tubes; use two of these resistors in parallel. Order Cat. BRA-30 (mounting supplied); price is for TWO sets at.....22c

DIRECT RADIO CO.  
143 West 45th Street,  
New York, N. Y.

## RECEIVE RADIO WORLD DURING YOUR VACATION

Are you going away on vacation for a week, a fortnight, or a month? You will, of course, want to read RADIO WORLD during that period. Send \$1.00 for 8 weeks' subscription, and when you return home we will change your address if you will let us hear from you. RADIO WORLD, 145 W. 45th St., N. Y. City.



## Your Choice of NINE Meters!

To do your radio work properly you need meters. Here is your opportunity to get them at no extra cost. See the list of nine meters below. Heretofore we have offered the choice of any one of these meters free with an 8-weeks subscription for RADIO WORLD, at \$1, the regular price for such subscription. Now we extend this offer. For the first time you are permitted to obtain any one or more or all of these meters free, by sending in \$1 for 8-weeks' subscription, entitling you to one meter; \$2 for 16 weeks, entitling you to two meters; \$3 for 26 weeks, \$6 for 52 weeks, entitling you to six meters. Return coupon with remittance, and check off desired meters in squares below.

RADIO WORLD, 145 West 45th Street, New York, N. Y. (Just East of Broadway)

Enclosed please find \$..... for.....weeks subscription for RADIO WORLD and please send as free premium the meters checked off below.

I am a subscriber. Extend my subscription. (Check off if true.)

- |                          |                           |       |         |
|--------------------------|---------------------------|-------|---------|
| <input type="checkbox"/> | 0-6 Voltmeter D.C.        | ..... | No. 326 |
| <input type="checkbox"/> | 0-50 Voltmeter D.C.       | ..... | No. 337 |
| <input type="checkbox"/> | 6-Volt Charge Tester D.C. | ..... | No. 23  |
| <input type="checkbox"/> | 0-10 Amperes D.C.         | ..... | No. 338 |
| <input type="checkbox"/> | 0-25 Milliamperes D.C.    | ..... | No. 325 |
| <input type="checkbox"/> | 0-50 Milliamperes D.C.    | ..... | No. 350 |
| <input type="checkbox"/> | 0-100 Milliamperes D.C.   | ..... | No. 350 |
| <input type="checkbox"/> | 0-300 Milliamperes D.C.   | ..... | No. 399 |
| <input type="checkbox"/> | 0-400 Milliamperes D.C.   | ..... | No. 394 |

NAME .....

ADDRESS .....

CITY .....

STATE .....



## Coils for Screen Grid RF and Sensitive Detector



The Diamond of the Air is a popular circuit using an antenna coil and a three-circuit tuner. For this circuit the standard Diamond pair of coils consists of two, wound on 2½-inch diameters, except for rotor on smaller form. The standard pair may be obtained for .0005 or .00035 mfd. tuning. Tickler coil has single hole panel mount. For .0005 mfd. order PR-SDP-5, with blueprint, free with a six-months subscription (26 weeks) at \$3.00. For .00035 mfd. order PR-SDP-35, free with a six-month subscription at \$3.00.

These coils will give extreme satisfaction and are excellent for the Diamond of the Air, being specified by Herman Bernard, the designer of the circuit. Shipping weight, 2 lbs.

## High Impedance TRF Coils for Screen Grid Circuits

These shielded coils are especially suitable for screen grid circuits, but are adaptable also to other circuits.

They consist of a secondary wound on a 1¼" diameter bakelite tubing, a layer of moisture-proof insulating fabric, and primary wound over the secondary. The bakelite tubing is firmly embedded in a veneered base, to which an aluminum plate is attached at bottom, punctured to pass outleads and to coincide with mounting holes of the aluminum shield. The shield size is 2-11/16" x 2-11/16" x 3/4". The mounting method keeps the walls of the shield equi-distant from the coil. The outleads are: shielded wire lead to plate, red lead to B plus, dark blue lead to grid and yellow to ground. When the coil is used as antenna coupler a fixed condenser of .00025 mfd. should be in series with the aerial. The connections should be: shielded wire to fixed condenser, red and yellow both to ground and dark blue to grid.

The coils are packed in matched sets of four. Thus they are of precision type, necessary for full effectiveness from gang tuning.

The primaries are of high impedance and the coupling to the secondary is very tight. The primary was made so high (40 turns) so that turns could be removed as desired, for proper proportion of stability and amplification, plus full-wave coverage.

For circuits using other tubes, the primary turns may be easily reduced by the user even to 10 turns, by cutting the primary wire near where it enters the insulating cloth, and unwinding all but 10 turns, cutting and then soldering the two wires together. Primary is on outside.

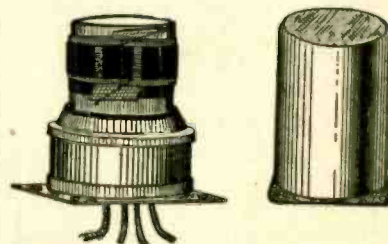

Small primaries are necessary for general purpose tubes, somewhat larger ones for screen grid tube plate circuits. Coil and shield sent free with \$2 subscription for 16 weeks. Order PR-40-70 for .0005 mfd. or PR-40-80 for .00035 mfd. Matched fours, order PR-40-70 MF or PR-40-80 MF, free with \$8 subscription, 68 weeks.

## DYNAMIC TUNER ASSEMBLY—OTHER COILS

A tuning condenser with a dynamic coil to match, mounted on an aluminum base that has socket built in. The condenser shaft goes in a dial (not furnished). The tuned circuit includes a fixed and a movable winding (rotor coil) in series. The moving coil is used as a trimmer, set once and left thus, so two separate tuning dials are made to read alike, or gang tuning is made practical. No equalizing condensers needed. Do not couple the adjoining shafts.

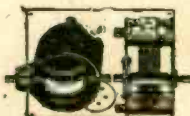

For antenna circuit input to any tube fitting four-prong UX socket, or for interstage coupling for 226, 201A, 199, 240 or 230, but NOT interstage for 232 or 222, order PR-BT-L-DC.

For interstage coupling for 232 and 222, order PR-BT-R-DC. For antenna circuit, as RF input to any five-prong tube, order PR-BT-L-AC.

For interstage coupling for 224, order PR-BT-R-AC.

The assembly will be sent free with a \$4 subscription, 35 weeks (7 mos., 1 week). Shipping weight, 2 lbs.

The dynamic coil alone, for either .0005 mfd. or .00035 mfd. tuning. The same coil serves either capacity, as the series rotor may be set in position to increase or reduce the total secondary inductance.

For antenna coil, all circuits, and interstage coupling for all tubes except screen grid, order PR-BT-3A, free with \$2.00 subscription, 16 weeks.

For interstage coupling from plate circuit of screen grid tube, order PR-BT-3B, free with \$2.00 subscription, 16 weeks.

### ANY ONE OF THESE FREE WITH \$2 SUBSCRIPTION

(PR-5-HT)—Special three-circuit tuner for .0005 mfd. tuned primary in plate circuit of a screen grid tube; untuned secondary.

(PR-3-HT)—Same as Cat. 5-HT, except that it is for .00035 mfd. tuning.

(PR-T-5)—Standard 3-circuit tuner for .0005 mfd. where primary is for any type of tube other than plate circuit of screen grid tube.

(PR-T-3)—Same as T-5, except for .00035 mfd. condenser instead of .0005.

(PR-2-R5)—Radio frequency transformer for .0005 mfd. condenser where high impedance untuned primary is in plate circuit of a screen grid tube, and secondary is tuned by .0005 mfd.

(PR-2-R3)—Same as 2-R5, except that it is for .00035 mfd. tuning.

(PR-5-TP)—Radio frequency transformer for use where primary is tuned and placed in plate circuit of screen grid tube, while secondary is not tuned. For .0005 mfd.

(PR-3-TP)—Same as Cat. 5-TP, except that it is for .00035 mfd. tuning.

(PR-RF-5)—Radio frequency transformer for .0005 mfd. tuning, where untuned primary is in plate circuit of any type tube except screen grid. Useful also as antenna coupler.

(PR-RF-3)—Same as Cat. RF-5, except that it is for .00035 mfd. tuning.

Send \$2 for 16 weeks' subscription and select any ONE of above ten coils as premium. Shipping weight, 1 lb.

# DOLLAR SPECIALS!

RADIO WORLD, 145 West 45th Street, New York, N. Y.

Enclosed please find \$..... for subscription for Radio

World for..... weeks. Please send me the premium as indicated below:

- PR-40-80 \$2 for 16 weeks; shipping weight, 1 lb.
- PR-40-80 MF \$8 for 68 weeks (1 yr., 16 wks.); shipping weight, 2 lbs.
- PR-40-70 \$2 for 16 weeks; shipping weight, 1 lb.
- PR-40-70 MF \$8 for 68 weeks (1 yr., 16 wks.); shipping weight, 2 lbs.
- PR-BT-L-DC \$4 for 35 weeks (8 mos. and 1 week); shipping weight, 1 lb.
- PR-BT-3A \$2 for 16 weeks; shipping weight, 1 lb.
- PR-BT-3B \$2 for 16 weeks; shipping weight, 1 lb.
- PR-5-HT \$2 for 16 weeks; shipping weight, 1 lb.
- PR-3-HT \$2 for 16 weeks; shipping weight, 1 lb.
- PR-T-5 \$2 for 16 weeks; shipping weight, 1 lb.
- PR-T-3 \$2 for 16 weeks; shipping weight, 1 lb.
- PR-2-R5 \$2 for 16 weeks; shipping weight, 1 lb.
- PR-2-R3 \$2 for 16 weeks; shipping weight, 1 lb.
- PR-5-TP \$2 for 16 weeks; shipping weight, 1 lb.
- PR-3-TP \$2 for 16 weeks; shipping weight, 1 lb.
- PR-RF-5 \$2 for 16 weeks; shipping weight, 1 lb.
- PR-RF-3 \$2 for 16 weeks; shipping weight, 1 lb.
- PR-KLT \$1 for 8 weeks; shipping weight, 1 lb.
- PR-MCD \$1 for 8 weeks; shipping weight, 1 lb.
- PR-POY-1 \$1 for 8 weeks; shipping weight, 1 lb.
- PR-20-VT \$1 for 8 weeks; shipping weight, 4 lbs.
- PR-30-SR \$1 for 8 weeks; shipping weight, ¼ lb.

Name .....

Address .....

City ..... State .....

If renewing an existing subscription for Radio World, please put a cross in square.

Send \$1 for 8 weeks' trial subscription and get any one of the following premiums free:

\$1

Klear Tuner, interference reducer, for minimizing or preventing cross-talk and cross-modulation. Makes a set more selective. Works with any receiver. Order PR-KLT. Shipping weight, 1 lb.

\$1

Marco Vernier Dial, flat type, with scale suitable for either direction of rotation; auxiliary scale reads finer than main one; both work together. Order PR-MCD. Shipping weight, 1 lb.

\$1

1 mfd. Polymet bypass condenser, 250 volts DC continuous duty rating. Lug connects to positive, case to negative. A sturdy and dependable product. Order PR-POY-1. Shipping weight, 1 lb.

\$1

20-volt transformer; primary, 110 v., 50-60 cycles; secondary will serve as dynamic speaker rectifier transformer or A eliminator transformer, or for six heater tubes with series heaters. Order PR-20-VT. Shipping weight, 4 lbs.

\$1

30-ohm rheostat with switch attached. Useful in battery-operated receivers. One motion actuates both switch and rheostat. Eliminates one panel control. Order PR-30-SR. Shipping weight, ¼ lb.