

JUNE 7th
1930

THREE NEW TUBES

15 Cents
PER COPY

RADIO

REG. U.S. PAT. OFF.

WORLD

The First and Only National Radio Weekly

428th Consecutive Issue—NINTH YEAR

All-Wave Battery Set

Inductances for Short Waves

Converter Picture Diagram

Auto Sets Debated

Filters for Multi-Tube Sets

Portable for Car, Boat, Camp or Home Use

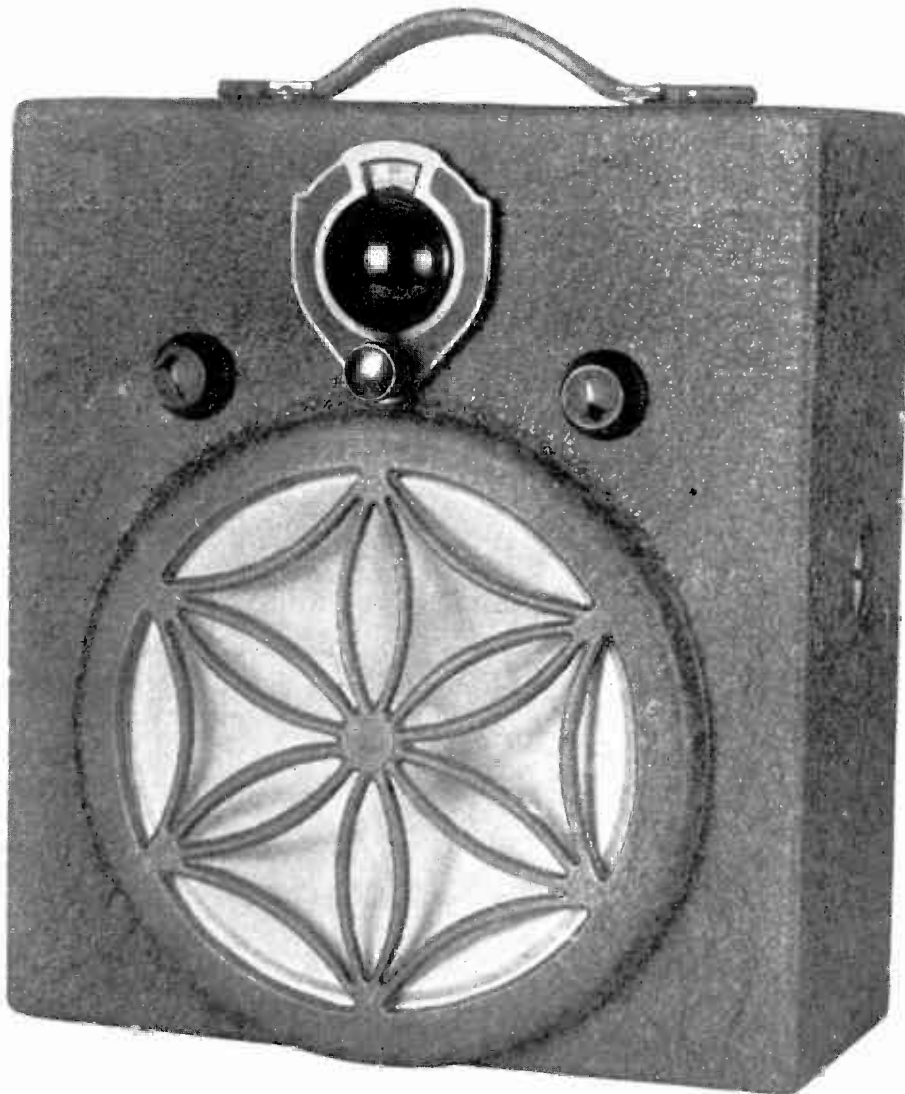

A compact and light 4-tube screen grid portable for auto, camp, boat or home. See page 10.

RADIO WORLD, Published by Hennessy Radio Publications Corporation. Roland Burke Hennessy, editor; Herman Bernard, managing editor and business manager, all of 145 West 45th Street, New York, N. Y.

New Polo Power Transformers and Chokes

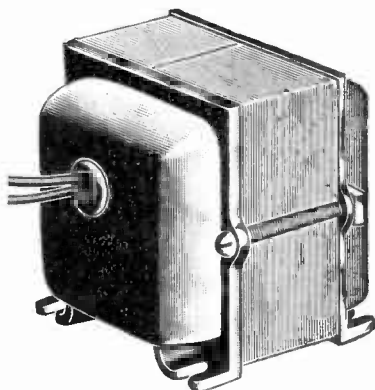

Shielded single choke, 200 ohms D.C. resistance non-saturable at 100 milliamperes, with two black outleads, each 8 inches long. For filtration of B supplies. Inductance, 30 henrys. Cat. SH-S-CH, price\$5.00

The shielded single choke will pass 100 ma. One will suffice if the current is 300 ma. or less, for filtration of B supplies, provided the capacity at the filter output is 8 mfd. or more. Use two such shielded chokes if less than 8 mfd. is used at the filter output. Also, the shielded single choke may be used as in the power tube circuit for an output filter. In this connection use at least 2 mfd. for the capacity section of the filtered speaker output. Order Cat. SH-S-CH @\$5.00

The shielded double choke may be used for filtration where the B current is 60 ma. or less, with relatively small filter capacities, no less than 4 mfd. at the output, however. This choke consists of one winding, center-tapped. Its use is especially recommended for 171, 171A, 245 or 210 push-pull output. Connect the black leads (extremes of windings) to plates of the push-pull tubes, red center tap to B plus, and the speaker may be connected directly to plates without any direct current, but only signal current, flowing through the speaker. This system is applicable only to push-pull. Order Cat. SH-D-CH @\$6.00

In the same type of case a 20-volt secondary filament transformer, for 110 volts, 50-133 cycle, may be obtained for use in conjunction with dry rectifiers, such as Kuprox, Westinghouse, Benwood-Linze and Elkco, in dynamic speakers or A battery eliminators. Not made for 25 or 40 cycles. Order Cat. SH-F-20 @\$2.50



245 Power Transformer for use with 280 rectifier, to deliver 300 volts D.C. at 100 milliamperes. Slightly higher voltage at lower drain, and supply filament voltages. Cat. 245-PT price\$8.50

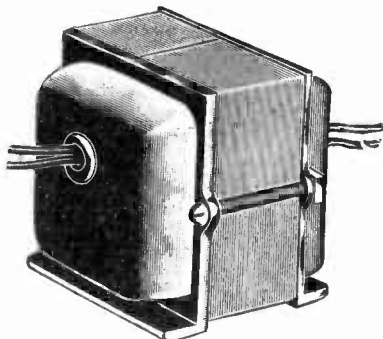

Twenty-volt filament transformer, 110 v. 50-133 cycle input, for use in conjunction with dry rectifiers. It will pass 2.25 amperes.

In a different type case, square, of cadmium plated steel with four mounting screws built in, size 4 1/2 inches wide by 8 3/4 inches high by 4 inches front to back, a 50-60 cycle filament transformer is obtainable with the same windings as the 245 power transformer, except that the high voltage secondary is omitted. Order Cat. 245-FIL @\$4.50

For 40 cycles order Cat. 245-FIL-40 @7.00

For 25 cycles order Cat. 245-FIL-25 @8.50

[Any of the above three in the same case as the 245 power transformer, @ \$1.00 extra. Add 17C after the Cat. number.]

A single choke, unshielded, 65 ma rating, 30 henrys inductance, for B filtration or single output filter of speaker, is our Cat. US-S-CH @\$1.25

The Polo 245 power transformer is expertly designed and constructed, wire, silicon grade A steel core and air gap large enough to stand the full rated load. The primary is for 110v. A.C., 50-60 cycles, tapped for 82.5 volts in case a voltage regulator, such as a Clarostat or Amperite, is used. The black primary lead is common. If no voltage regulator is used, connect black lead to one side of the A.C. line, green lead to the other side of the line, and ignore red lead, except to tape the end. For use with a voltage regulator (82.5-volt primary) use red lead and ignore the green except to tap the end. The secondaries are: high voltage for 280 plates, with red center tap to ground; 2.5 volts, 3 amperes, red center tap to C plus, for 245 output, single or push-pull; 5 volts, 2 amperes, red center tap, as positive B lead, for filament of 280 tube; 2.5 volts, 16 amperes, red center tap to ground, for 224, 227 and pentode tubes, up to nine heater type tubes. Hence there are five windings.

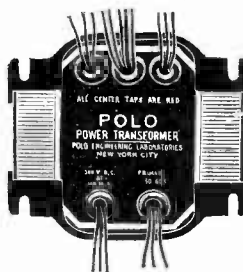

Bottom view of the 245 power transformer. All leads are plainly marked on the nameplate, including the top row.

A special filament transformer, 110 v., 50-60 cycles, with two secondaries, one of 2.5 v. 3 amp. for 245s, single or push-pull, other 2.5 v. 12 amperes for 224, 227, etc., both secondaries center-tapped. Shielded case, 6 ft. AC cable, with plug. Order Cat. F-2.5-D @\$3.75

The conservative rating of the Polo 245 power transformer insures superb results even at maximum rated draw, working up to twelve tubes, including rectifier, without saturation, or overheating due to any other cause. This ability to stand the gaff requires adequate size wire, core and air gap, all of which are carefully provided. At less than maximum draw the voltages will be slightly greater, including the filament voltages, hence the 16 ampere winding will give 2.25 volts at maximum draw, which is an entirely satisfactory operating voltage, increasing to 2.5 volts maximum as fewer than a total of nine RF, detector and preliminary audio tubes are used.

The avoidance of excessive heat aids in the efficient operation of the transformer and in the maintenance of good regulation. An excessive heat increases the resistance of the windings.

The transformer is equipped with four slotted mounting feet and a nameplate with all leads identified. It is one of the very finest instruments on the radio market.

Highest Capacity of Filament Secondary

SPECIAL pains were taken in the design and manufacture of the Polo 245 power transformer to meet the needs of experimenters. For instance, excellent regulation was provided, to effect minimum change of voltage with given change in current used. Also, the 2.5 volt winding for RF, detector and preliminary audio tubes, was specially designed for high current, to stand 16 amperes, the highest capacity of any 245 power transformer on the market. Hence you have the option of using nine heater type tubes. The shielded case is crinkle brown finished steel, and the assembly is perfectly tight, preventing mechanical vibration.

The power transformer weighs 11 1/2 lbs., is 7 inches high, 4 1/2 inches wide, and 4 1/4" front to back, overall. Elevating washers may be used at the mounting feet to clear the outleads, or holes may be drilled in a chassis to pass these leads, and the transformer mounted flush.

Advice in Use of Chokes and Condensers in Filter

With the 245 power transformer either one or two single chokes should be used, or a shielded double choke, depending on the current drain and the capacity of filter condenser used. Where the capacity at the output is 8 mfd. or more for a drain of 65 to 100 ma., a single choke will suffice (Cat. SH-S-CH), but where smaller output capacity than 8 mfd. is used on such drain, two such chokes should be used in series. Next to the rectifier, in either instance, use a 1 or 2 mfd., 350 A.C. working voltage rated condenser (D.C. rating, 1,000 volts). You may use your choice of capacity at the midsection.

If the drain is to be 65 milliamperes or less, the double choke, Cat. SH-D-CH, may be used for filtration, instead of two single shielded chokes.

The Polo 245 power transformer may be obtained for 25 cycles or 40 cycles on special order, as these are not stocked regularly, and remittance must accompany order. The same guaranty attaches to them as to all other Polo apparatus—money back if not satisfied after trial of five days. In these the primary and secondary voltages and taps are the same, only the case is deeper (front to back) because of larger core and wire for lower frequency.

For 40 cycles order Cat. 245-PT-40 @\$9.50

For 25 cycles order Cat. 245-PT-25 @\$12.50

[Note: The filter for 40 cycles should consist of two shielded single chokes, Cat. SH-S-CH, with 2 mfd. next to the rectifier and 4 mfd. minimum at the joint of the two chokes and at the end of the filter. For 25 cycles the same holds true, except that the output capacity at end of chokes should be 8 mfd. minimum.]

We Make Special Transformers to Order

Polo Engineering Laboratories, 143 West 45th St., New York, N. Y.

Enclosed please find \$_____ for which ship at once:

- | | |
|---|---|
| <input type="checkbox"/> Cat. 245-PT @ \$8.50 | <input type="checkbox"/> Cat. 245-FIL @ \$4.50 |
| <input type="checkbox"/> Cat. 245-PT-40 @ 9.50 | <input type="checkbox"/> Cat. 245-FIL-40 @ 7.00 |
| <input type="checkbox"/> Cat. 245-PT-25 @ 12.00 | <input type="checkbox"/> Cat. 245-FIL-25 @ 8.50 |
| <input type="checkbox"/> Cat. SH-S-CH @ 5.00 | <input type="checkbox"/> Cat. SH-F-20 @ 2.50 |
| <input type="checkbox"/> Cat. SH-D-CH @ 6.00 | <input type="checkbox"/> Cat. UN-S-CH @ 1.25 |
| <input type="checkbox"/> F-2.5-D @ | <input type="checkbox"/> |

Note: Canadian remittance must be by post office or express money order.

If C.O.D. shipment is desired, put cross here. No C.O.D. on 25 and 40 cycle apparatus. For these full remittance must accompany order. The 25 and 40 cycle apparatus bears the 50-60-cycle label, but you will get actually what you order.

Name

Address

City..... State.....



Vol. XVII. No. 12 Whole No. 428
June 7th, 1930
15c per Copy. \$6.00 per Year
[Entered as second-class matter, March 1922 at the Post Office at New York, N. Y., under act of March, 1879.]

Latest Circuits and News
Technical Accuracy Second to None
NINTH YEAR

A Weekly Paper published by Hennessy Radio Publications Corporation, from Publication Office, 145 West 45th Street, New York, N. Y.
(Just East of Broadway)
Telephone, BRY ant 0558 and 0559

RADIO WORLD, owned and published by Hennessy Radio Publications Corporation, 145 West 45th Street, New York, N. Y. Roland Burke Hennessy, president and treasurer, 145 West 45th Street, New York, N. Y.; M. B. Hennessy, vice-president, 145 West 45th Street, New York, N. Y.; Herman Bernard, secretary, 145 West 45th street, New York, N. Y.; Roland Burke Hennessy, editor; Herman Bernard, business manager and managing editor; J. E. Anderson, technical editor.

Now for ALL Waves

By Herman Bernard

[Letters to the editor disclose a great interest in all-wave receivers. Here is a good one for battery operation, as a starter. It will be shown in subsequent issues in AC form as well. Next week's issue, June 14th, will contain further data on the battery model. Coil construction will be included. Readers desiring to substitute for prescribed parts should not do so without expert advice, unless they themselves are experts. All questions regarding the All-Wave Receiver, battery model, should be addressed to Herman Bernard, c/o RADIO WORLD, 145 West 45th Street, New York, N. Y. Tabulate your questions and leave room so answers may be written next to them. Also enclose stamped and personally addressed envelope.—Editor.]

SINCE there is great interest in short waves just now, and an ever-heightening interest in broadcast wavelength reception as well, the desirability of having a receiver that brings in well both the short waves and the broadcast waves is at the highest peak in history. Such a combination of results can be well attained if certain precautions are taken in the design, so that the receiver will stand up on the broadcast waves.

The first consideration is the number of tuning controls. There must be two. It is practical to use single control by ganging, but, no matter how accurate the condensers used for tuning, or the inductances across which they are connected, sensitivity will suffer, on the short waves as well as on the broadcast waves, if two tuned circuits are made single mechanical control.

Also, on broadcast waves, where selectivity demands are greater, inadequate separation may result unless two controls are used. So the popular compromise of simplification by single control, at the expense of sensitivity and selectivity, can not be made in the present instance.

Tuned RF Adapted to Short Waves

There have been excellent short-wave receivers that permit of broadcast wave reception as well, but the excellence was confined to short-wave reception, and the broadcast reception was badly lacking in selectivity. To avoid this, two tuned circuits are used, and, as stated, each must be independently tuned.

Tuned radio frequency amplification can be applied to short-wave work as well as to broadcasts, the only drawback being the tendency of the first tube to oscillate. If a 222 screen grid tube is used in a battery-model All-Wave Receiver, any tendency toward unwanted oscillation in the first tube at the lower end of the short-wave spectrum can be corrected by suitable reduction of the voltage on plate or screen grid. The lower the voltage the lower the sensitivity and the volume, but since 45 SG volts are maximum, and 22½ volts will correct any squealing tendency, the compensation may be made equitably without loss of sensitivity, and the voltage need not be changed thereafter. Or, the screen grid voltage may be held at 45 and the 135 plate voltage reduced to correct squealing. Indeed, a high degree of sensitivity is attainable, provided coils are used that do not introduce large losses. Hence coils wound on ribs, affording 93 per cent. air dielectric, are recommended.

How Regeneration Is Obtained

For improvement of sensitivity and selectivity on the broadcast band particularly, although also incidentally on the short-wave bands as well, regeneration is used in the detector circuit. A 30,000-ohm wire-wound potentiometer is placed across the tickler, and the amount of resistance effective in the wind-

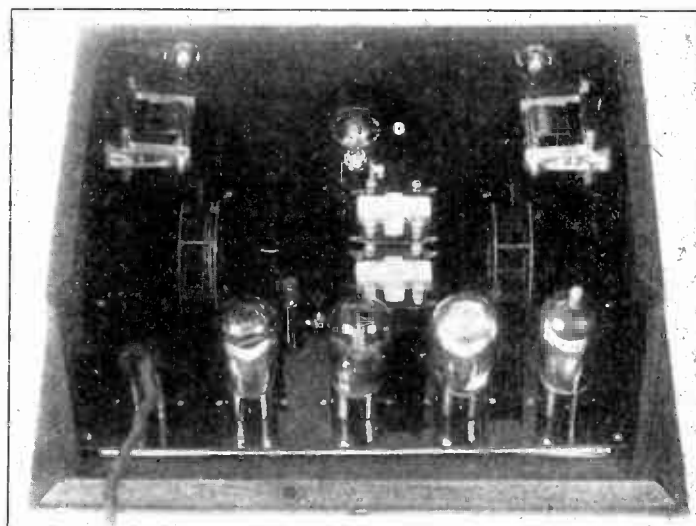

FIG. 1
THE ALL-WAVE RECEIVER, THAT COVERS 15 TO 500 METERS WITH THREE DIFFERENT SIZE INDUCTANCES, AND DOES IT EXTREMELY WELL.

ing is governed by the adjustable arm from the front panel. This device also works as a volume control for broadcast waves.
(Continued on next page)

LIST OF PARTS

- Two sets of precision, de luxe coils, wound on ribs, 93 per cent air dielectric, three coils to a set, total, six coils to cover 15 to 560 meters.
- One plate coil with mounting bushings.
- Two Hammarlund .0005 mfd. straight frequency line condensers.
- One 20-ohm filament resistor.
- One 1½-ohm filament resistor.
- One 14¼x9½ inch bakelite subpanel, with four UX (four-prong) sockets and one built in UY (five-prong) socket; two coil receptacles, also built in.
- One 5-lead battery cable, 36 inches long, with five-prong plug attached.
- One steel cabinet with crinkle brown finish, 7x15½x10½.
- One steel bottom shield for cabinet.
- One 1-to-3 audio transformer.
- One 1-to-5 audio transformer.
- Two insulating washers, for volume control.
- Four subpanel brackets.
- One antenna-ground binding post unit.
- One speaker binding post unit.
- One .00025 mfd. grid condenser with clips.
- One Lynch 5 meg. metallized grid leak.
- Two National type VB-D variable ratio dials, maximum reduction 20-to-1, with two 2.5 volt pilot lights and illumination brackets.
- Two Polymet 1 mfd. bypass condensers, single lug type (case goes to ground).
- One 30,000 ohm Clarostat wire-wound potentiometer, with switch attached.

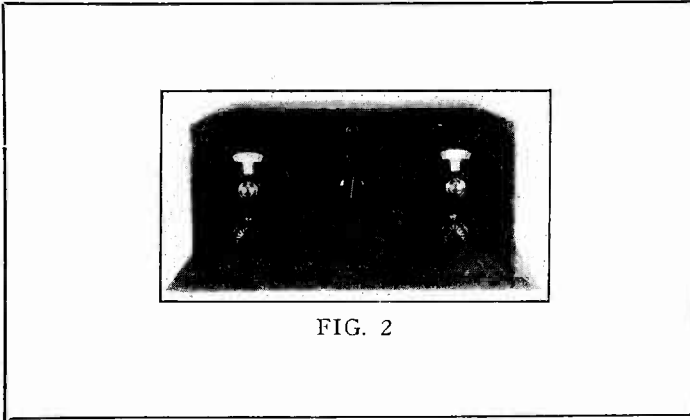

FIG. 2

FRONT VIEW OF THE ALL-WAVE RECEIVER.

It is hardly necessary to use it for a strict volume control on short waves.

The switch for turning on and off the A battery, hence the effect of the B voltage as well, is built into the potentiometer. Due to the wide range of wavelengths to be covered, from 15 to 560 meters, and you will please note that the highest broadcast wave is tuned in for a certainty, not only should regeneration be controllable from the front panel, but the position of the tickler, which is in inductive relationship to the secondary, should be adjustable. This position will need little attention, but once in a while if regeneration fails, it may be restored by making the coupling tighter, simply by moving the tickler coil closer to the secondary.

Broadcast Waves With One Combination

Also, occasionally, on the lowest band of short waves, regeneration may fail due to a choke-coil effect, and would be restored by moving the tickler farther away from the secondary. These seemingly conflicting cures for the same trouble are part of the solution of phenomena experienced on short waves, and the solution utterly avoids any skip-tuning, whereby portions of the dial would be dead. The circuit is sensitive throughout the entire range, from lowest to highest wave. One of the methods used to accomplish in excellent manner the combination results of fine reception on short waves and broadcast waves is the inclusion of .0005 mfd. tuning condensers of straight frequency line characteristic. The condenser is the new Hammarlund model and it serves the purpose of covering the broadcast band with one coil and one condenser, for each circuit, without change of coil or any switch attached to the condenser to cut in more capacity and alter the dial settings for given waves.

When mention is made of use of a .0005 mfd. condenser for tuning in short waves, since the same condenser is used for that purpose, some experimenters will throw up their hands, saying it can't be done without crowding the dial hopelessly. Their reason is that they have been used to .00014 mfd. condensers. But they forget one important point. The .00014 mfd. condensers they have been using have been of the straight capacity or midline type, or affording some rate of capacity variation other than straight frequency line.

Why .0005 mfd. SFL Excels

Let us take as an example the straight frequency line condenser as compared to the straight capacity line. Here we find that the .0005 mfd. straight frequency line condenser, starting from zero on the dial scale, .00014 mfd. is 60 on the dial, whereas the .00014 mfd. reaches this capacity at 100.

Now, if the straight frequency line condenser has a dial that affords a 20-to-1 reduction ratio, the vernier action is four times as great as that of ordinary vernier dials such as are used with .00014 mfd. condensers, including drum dials. So the mechanical ease of tuning with a high-ratio vernier dial, like the National type VB-D, using a .0005 mfd. straight frequency line condenser, as compared with a 1-to-5 ratio, using .00014 mfd., is represented by the proportion 60:100 :: 6:1, and the .0005 capacity gives 2.4 times as great mechanical tuning ease. Where a midline .00014 mfd. is used the difference is not so great, yet it is a difference in favor of the .0005 mfd. with high-ratio vernier dial.

First Tube Tuned Twice

Besides, the .0005 mfd. permits the use of its extra capacity, hence the same band of short waves can be covered with two coils that the other covers with three coils. In the present instance three coils are used, but the third one alone covers the broadcast spectrum completely.

As for the circuit itself, the input to the screen grid tube is tuned in the usual manner, and the plate circuit of the same tube is tuned likewise, the input to the grid circuit of the detector tube being untuned.

Since the condenser tuning the plate circuit has nothing at a high potential (B plus 135 volts), this need not be insulated from the front of the steel cabinet used. But the volume control should be insulated. Two fibre insulators are required.

The cabinet has a front of 7x15½ inches, while the bakelite subpanel used is 14¼ inches wide and 9½ inches front to back. This subpanel is elevated from the inside flange of the steel cabinet by washers, and the subpanel is bracketed underneath. to provide rigidity when tubes or coils are plugged in or removed. The elevation of the subpanel also protects against any possibility of the socket springs touching anything below them.

It will occur to many that since a steel cabinet is used the receiver is shielded against outside interference, except for the bottom, since the subpanel is bakelite. However, those desiring to capitalize on this shielding possibility, after completing the receiver, may attach a sheet of aluminum, steel or iron, 15¼ inches wide by 10 inches front to back, and fasten it to the extreme bottom of the steel cabinet, using the same machine screws that hold the bakelite subpanel in place.

Designed for Highest Sensitivity

The detector, to resume the circuit discussion, uses grid leak and condenser, and returns the grid to positive filament, the reason for these choices being that highest sensitivity is thereby attained. The grid condenser may have a value of .00025 mfd. and have clips attached for holding the leak, which may be from 2 to 5 meg. The higher values of leaks afford greater sensitivity.

The detector is a 201A, and so is the first audio tube. The output tube is a 112A. Therefore this circuit may be operated with 135 volts of B battery (consisting of three 45-volt blocks) and a storage A battery.

Instead of the B batteries a B eliminator may be used, as the circuit will not motorboat, and moreover, will give good performance in other respects on a B eliminator. Instead of the A battery an A eliminator may be used, but the trouble with A eliminators is that factory-made products of this kind are usually made to meet price, instead of performance, and as a rule are poor, especially regarding regulation and filtration. A good A eliminator can not be bought for less than \$30, and the cheap ones are not only not recommended but are hereby most respectfully denounced!

Draws Little Current

The entire circuit draws only 21 milliamperes of B current, and .882 ampere of A current, so it is very light on both A and B batteries. The B's should last from six to nine months of average use, the A battery, if of 60 ampere hours or more, requiring recharging only every six weeks, under the same average conditions.

However, it should be borne in mind that the attractiveness of the receiver, because of its dual purpose, renders quite likely a strong excess over what would be termed average use. When the family as a whole has decided that it has had enough of broadcast listening for the night, some one member, or a group of members, may decide that the time is ripe for trying to get England or Holland on the short-wave end, so it may not be rash to assume that double the average use will be given to the receiver because of the double purpose.

The two stages of transformer-coupled audio will give you plenty of volume on all signals. The transformers may be of different ratios, for instance 1-to-3, which would go in the first stage, and 1-to-5, which would go in the second stage. You may use audio transformers you have, and if they are of the same ratio and make they are interchangeable. But if the ratios differ, likely the primary of the lower-ratio type has more turns on it than the other, and a high impedance primary is to be preferred in the plate of the detector circuit.

Mechanical Details

The tubes are arranged at rear of the subpanel. The screen grid tube is at extreme left, as you look at the receiver from the front, the detector tube second from right. The first audio tube is third from right and the last audio tube second from left. This row of four tubes has a five-prong socket at extreme right for plug-in cable. Remembering that the heater prongs and grid prong form a triangle, grid is the apex. Looking at the socket from top, cathode is at left, plate at right. If you turn the subpanel upside down, front to back, not disturbing the left and right directions, apex or grid is toward you, heater away from you, cathode still at left, plate at right. These prongs do not connect to a tube but to the cable, as follows: blue with white marker is G post, used as 135 volts plus; red is plate, used as B plus detector; green as one heater side, used as A plus; black with yellow marker is other heater side, used as A minus and the remaining one is B minus.

No provision has been made for cabling the C batteries, as only one is used, and it fits inside the cabinet. Connect positive of the C battery, a small 7½ volt type, to A plus, an extra lead soldered to the heater side used as A minus, while 7½ volts negative goes to the 112A grid return (giving an effective negative bias of 8½ volts), while 3 volts negative of battery (effectively 4½ volts) go to the first audio grid return.

Converter Construction

By H. B. Herman

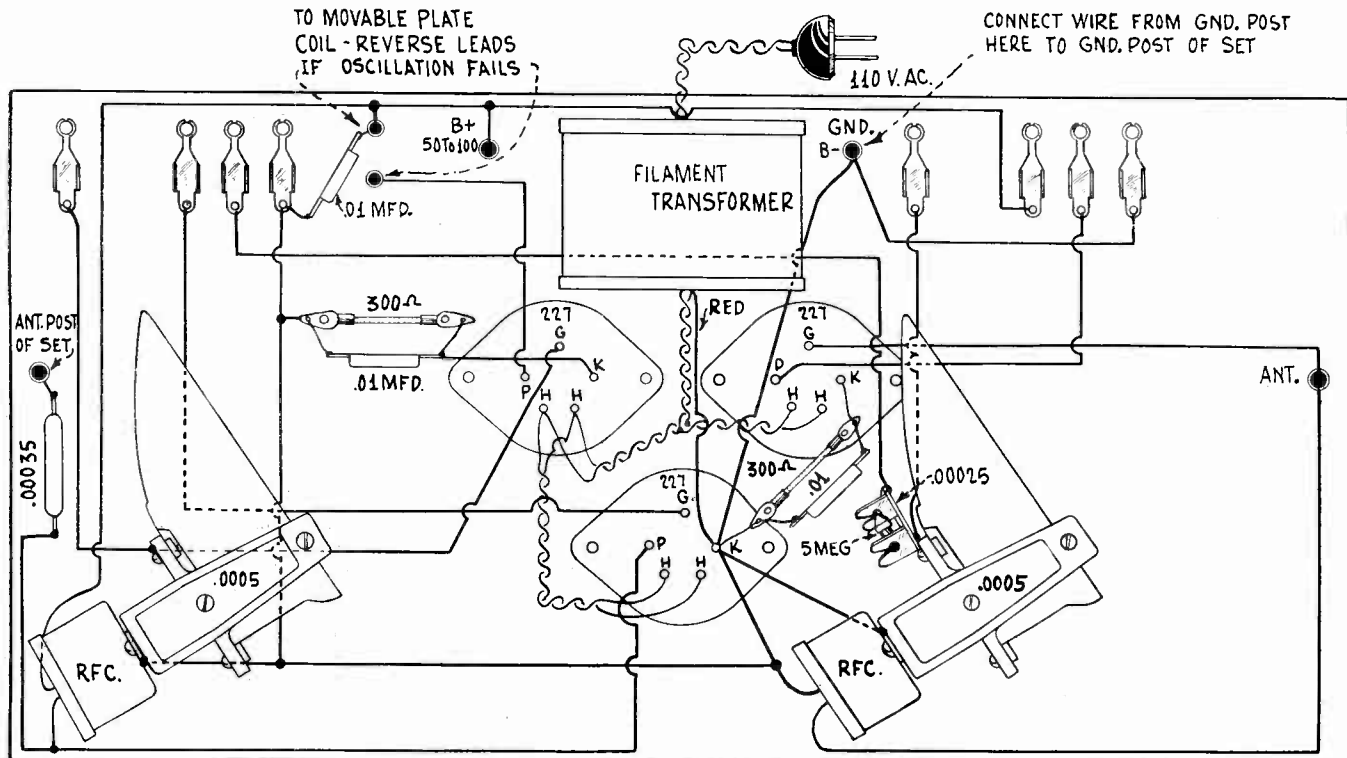

PICTURE DIAGRAM OF THE UNIVERSAL SHORT-WAVE CONVERTER, WITH ACCOMPANYING SCHEMATIC DIAGRAM. THE PICTURE DIAGRAM IS A TRIFLE LESS THAN ONE-HALF ACTUAL SIZE.

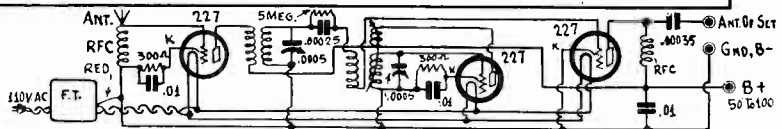

THE picture diagram of the Universal Short-Wave Converter, with accompanying small schematic diagram, is shown herewith. By following the picture diagram as to location of parts and wiring, the construction is greatly simplified.

A few pointers a diagram can not well reveal will be discussed, however, and these are additional to data published in the May 10th, 17th, 24th and 31st issues on this converter that uses two tuned circuits.

The RF choke coils are shown mounted on the frames of the tuning condensers. This mounting is accomplished by widening the hole on either side of the base strip of the RF choke, using either a drill or a penknife, so as to pass a 10/32 screw. As only one mounting hole is needed for each choke, two such screws are required. The tapped holes are in the condensers already, to receive these 10/32 screws, which should be no more than 1/2 inch long.

Testing RF Chokes

Sometimes shielded RF chokes are so constructed that one terminal of the winding is connected to the shield inside. If this is true, no special precaution need be taken as to the choke used in the antenna-ground circuit, except to have the shield-connected terminal represent ground.

The test for this is to use a small dry cell or battery and a suitable indicating device, for instance a 1.5-volt dry cell and a 0-6 voltmeter. Connect one terminal of the meter to one side of the battery, and have two free leads, one running from the other side of the battery and the other from the other side of the meter. To test for correct meter polarity, see that the deflection is positive, that is, gives the desired reading of 1.5 volts without regard to the coil. Now connect one side of the battery to the frame of the shielded choke, the other free lead, from the meter, to one side of the coil. Then remove this connection from the coil and put it to the other terminal of the coil.

If the deflection is 1.5 volts from one side of the choke to the coil frame, that side is the grounded one and should go to ground, the other choke lead going to antenna. Under these circumstances the other side of the choke, because of the resistance of the winding included in the tested circuit, will give only a small deflection, instead of full 1.5 volts.

It is well to test both chokes, one after the other, and put markers on the terminals. If both terminals show only a slight deflection, instead of full 1.5 volts, then the coil is not connected inside to the shield at either terminal, and should be selected for

use in the plate circuit of the modulator, as this carries a high direct potential. The object is to avoid shorting due to the coil shield being connected to the condenser frame, or ground, and again to B plus through internal conduction. If both RF chokes are grounded, insulate the one used in the modulator plate circuit. If both coil terminals, connected one after another in series with the test circuit to the coil shield, show full 1.5 volts, the entire choke is shorted.

One Moving Coil Used

As for the tuning circuit, there is only one movable coil, and this is in the oscillator plate circuit. Follow the connections as diagrammed.

The converter receives short waves and changes them to the frequency to which the receiver is tuned, for intermediate amplification. This frequency should be as high as practical, say a little higher than the highest broadcast frequency, i. e., a little above 1,500 kc or below 200 meters.

LIST OF PARTS

- Two sets of short-wave coils, wound on air dielectric, three coils to a set, total of six coils, with two plug-in receptacles, with one adjustable coil.
- Two .0005 mfd. Hammarlund de luxe straight frequency line tuning condensers.
- Two radio frequency choke coils, 50 mh shielded type.
- One .00035 mfd. fixed condenser.
- One .00025 mfd. fixed grid condenser with clips.
- One 5 meg. Lynch metallized grid leak.
- Two Electrad wire-wound flexible type biasing resistors, 300 ohms each.
- Three .01 mfd. fixed condensers.
- One 7 x 14-inch drilled bakelite panel, with three UY sockets (5 spring) and coil receptacles built in.
- One cabinet to fit.
- Four binding posts.
- One 2.5-volt center-tapped filament transformer, 6 ampere rating.
- Two National Velvet Vernier dials, type VB-D, with 2.5 pilot lights and lamp brackets.

How to Wind Short-Wave

By Brunsten

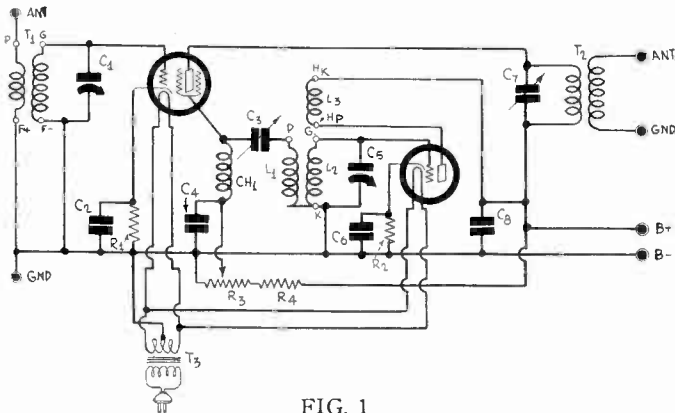

FIG. 1

THE DIAGRAM OF A SELECTIVE AND SENSITIVE SHORT-WAVE CONVERTER IN WHICH SMALL-TYPE PLUG-IN COILS ARE USED. THE INTERMEDIATE FREQUENCY IS SUPPOSED TO BE 1,500 KC.

MOST fans who are building short-wave converters notice that broadcast stations come in as well as the short-wave stations, and for some reason they feel cheated when they get more than they expected. Exclusion of the undesired stations seems to be generally desirable even though these stations in no way interfere with the reception of short-wave signals.

In the May 31st issue of Radio World we described a simple two-tube converter that was both sensitive and selective although practically all the broadcast stations could be brought in with it. Of course, it was not as selective as it could have been, but it was simple. Any increase in selectivity must be secured by sacrificing simplicity, and we shall now proceed with the sacrifice.

The exclusion of the broadcast stations is not so much a matter of increasing the selectivity of the circuit as it is of designing properly the oscillator and the RF coils and of shielding the circuit from strong local broadcast stations.

Design of Oscillator

We shall first consider the necessary design for the oscillator so that the converter will not bring in broadcast stations. The first thing we have to do is to fix the intermediate frequency for the design of the oscillator depends on the choice. Since most broadcast receivers are supposed to tune up to 1,500 kc we shall select this frequency. If the broadcast receiver tunes higher, say to 1,700 kc, some of the broadcast stations may be receivable if the broadcast receiver is set at 1,700 kc instead of 1,500 kc. If this should happen and the operator objects to the broadcast stations all he has to do is to reset the broadcast receiver tuner a little. If, on the other hand, the broadcast receiver does not tune to 1,500 kc some of the short-wave stations may be missed but not many important ones.

Well, then, we have an intermediate frequency of 1,500 kc and we want to receive stations of higher frequency only. Then if we tune the oscillator to 3,000 kc, the beat frequency between a short-wave station operating on 1,500 kc

LIST OF PARTS

for Fig 1

- C1, C5—Two Hammarlund straight frequency line .0005 mfd. condensers.
- C2, C4, C6, C8—Four .01 mfd fixed condensers.
- C3—One Hammarlund 100 mmfd. trimmer condenser.
- C7—One variable condenser made up of a fixed condenser and a trimmer, the total capacity depending on the inductance of the primary. Or use a .00025 mfd. variable condenser.
- CH1—One 50 mh. radio frequency choke coil.
- T1—One radio frequency transformer as described.
- T2—One radio frequency transformer as described.
- T3—One shielded filament transformer with one center-tapped 2.5 volt secondary.
- L1-L2-L3—One oscillator coil as described.
- R1, R2—Two 800 ohm resistances.
- R3, R4—One 30,000 ohm potentiometer.
- One UX socket (four prong).
- Three UY sockets (five prong).
- Six binding posts.
- Two vernier dials.
- One sub-panel about 7 x 10 inches.
- One panel about 7 x 12 inches.

will be 1,500 kc. Thus we must choose our oscillator inductance and capacity so that we can tune no lower than 3,000 kc.

Next we have to choose the maximum capacity of the tuning condenser. Now it is customary to use condensers having a maximum capacity of 140 mmfd. for short-wave sets, but there is little reason for choosing such a small condenser provided we have a dial with which we can tune accurately. Splendid results both as to sensitivity and ease of tuning have been obtained with condensers having a maximum capacity of 500 mmfd., that is, .0005 mfd. Since this is a size that is available everywhere and since it works just as well as a smaller condenser we may choose it.

Now we have the maximum capacity in the oscillator circuit and the minimum frequency at which the circuit is to oscillate, and therefore we have enough data to calculate the inductance of the coil across which the condenser is to be connected. If we apply the usual formula and use 3,000 kc and .0005 mfd. we obtain 5.64 microhenries for the inductance. This is a very small inductance but as long as it will make the circuit oscillate it is just as good as a larger value.

Design of Coil

Let us wind the coil on standard tube base the diameter of which is 1½ inches. It may be taken from an old tube or a new base may be obtained for the purpose. If the base is from an old tube remove the sealing wax and don't put any wax in when the coil has been wound.

First let us determine the number of turns necessary to give the required inductance, using No. 24 double cotton covered wire. Since only a few turns will be required we have to make allowance for the diameter of the wire, because the effective diameter of the coil is measured from center to center of the wire on the opposite sides of the coil. No. 24 DCC wire winds 41 turns to the inch. This means that the diameter of the wire is 1.41 of an inch, measured over the insulation. This will make the effective diameter of our coil 1.36814 inches. This will be decreased a little by the fact that the insulation will be squeezed a bit when the wire is wound tightly. Hence let us use 1.368 inches. From here on the computation is a matter of cut and try until we get the right combination of turns, and this process leads to the conclusion that the turns should be a small fraction less than 10 turns. If ten turns are used the coil will be too large. If nine are used it will be too small. So take your choice. If the G prong on the tube base been used for the grid end of the coil and the K prong for the other end, the number of turns would be about 9.75, which should be all right.

Mechanical Work

Drill a small hole in the side of the base directly above the G prong and near the upper rim of the base. Likewise drill a like hole directly over the K prong ten turns vertically below the grid hole. Run the terminals of the coil down through the G and K prongs and solder. We now have the tuned winding complete, and it is placed high up on the base.

Next put on the tickler winding directly below the tuned winding. Use the same kind of wire and wind it in the same direction as the tuned winding. Six turns, or a fraction less as imposed by the locations of the prongs, will do. For this winding use the two heater prongs on the five-prong tube base. Run the terminal of the tickler which is nearer the K terminal of the other winding to that heater prong which is nearer the K prong, and run the extreme terminal of the tickler prong which is nearer the plate prong. The socket into which the five-prong coil is to be plugged must be wired correspondingly. The circuit diagram in Fig. 1 shows how. Here Hk represents the heater prong nearer the cathode or K, and Hp represents the heater prong nearer the plate prong on the socket. When this wiring is followed exactly the circuit will be correctly wired for oscillation.

The Pick-up Winding

We have left the plate prong on the five-tube base open so far. It is to be used for one terminal of the pick-up winding, which is placed below the tickler winding. It matters little just how many turns are put on this winding, or how far it is placed for the other winding. There is ample room for several turns below the tickler winding. It is not necessary to use more turns on the pick-up winding than are used on the tickler. Connect either end of the pick-up winding to the plate prong and the other to the K prong.

If there were six prongs on the tube base, and six corresponding springs on the socket, the circuit could be simplified a good deal, for both the choke coil CH1 and the condenser C3 could be dispensed with. Since there is no six-prong tube base available we have to do the best we can with a five-prong base,

Coils of Tube-Base Size

Brumm

and the arrangement in Fig. 1 is a very good one. However, if we are willing to leave a loose, flexible wire dangling from the coil base, we can still dispense with Ch1 and C3, for P on the socket could be connected directly to the screen grid and the loose lead to a convenient binding post connected where the lower terminal of Ch1 is connected.

When there are two or more coils in a short-wave set the arrangement shown in Fig. 1 is more convenient than the use of a loose, flexible lead.

Input Tuner

We have excluded the broadcast stations by the design of the oscillator circuit. However, we have not necessarily shut out the harmonics of the strong local broadcast stations, especially the second harmonics of the stations operating on frequencies higher than 750 kc. This exclusion is accomplished in a large measure by the radio frequency tuner between the antenna-ground circuit and the first tube. This transformer is also wound on a tube base of the same size as the oscillator coil. In this case, however, a four-prong base is used, since there are only four terminals involved. The connections of the coil terminals to the base and the connections of the other circuit elements to the sockets are indicated by appropriate lettering.

The design of the secondary of this transformer is different from the design of the oscillator coil because the lowest frequency to which the input tuner must tune is 1,500 kc. whereas the lowest frequency to which the oscillator must tune is twice as high. If C1, the tuning condenser, has the same maximum capacity as C5, namely .0005 mfd., the inductance of the coil across C1 should be 22.5 microhenries. Twenty-four turns of No. 24 double cotton covered wire on the standard tube base will give the necessary inductance.

This winding should be placed as near the top of the tube base as possible in order that loose coupling may be obtained between this winding and the primary.

Loose coupling between the antenna coil and the secondary is an essential condition for selectivity. For that reason the primary should be placed as near the bottom of the tube base on which the coil is wound as possible. The hole that is drilled for the antenna terminal should be placed so that the drill will just clear the bottom of the recess, or so that the drill just breaks through in the corner. Then for the twenty-four turn coil it is best to use not more than two turns. This loose coupling will insure that only the signals to which the secondary is tuned will get through to the grid of the modulator tube.

Another essential for selectivity, and especially for excluding the broadcast stations is that the output be tuned, not to any of the broadcast frequencies or to any of the short-wave signal frequencies, but to the intermediate frequency.

The tuned circuit is put in the plate lead to the modulator for several reasons. First, it puts a high impedance load on the screen grid tube at the intermediate frequency. Second, it practically shorts out the output for all other frequencies. Third, this short-circuiting effect prevents the plate lead from acting as an antenna for the broadcast receiver used after the converter. Fourth, it makes the detecting or modulating efficiency of the screen grid tube greater, which means greater sensitivity.

The primary of the output transformer T2 which is tuned with C7 may be the primary of a radio frequency transformer intended for use between screen grid tubes. Since the inductance of such primaries varies greatly it is not possible to give the capacity of the condenser C7, even approximately. But if C7 is an ordinary tuning condenser it is almost certain to cover the 1,500 kc frequency with all practical screen grid coils. If the primary contains 40 turns of No. 28 enameled wire, closely wound on a 2-inch diameter the inductance is such that the required value of C7 is almost exactly 100 mmfd.

Secondary Turns Important

The number of turns on the secondary may be whatever it happens to be in the coil, but if it is wound especially for a given broadcast receiver due attention should be given to the type of input circuit. If the antenna and ground binding posts on the set are connected by a small winding the secondary of T2 should be a similar winding.

If the two input terminals to the broadcast receiver are joined by a choke coil or a high resistance the secondary of T2 should contain many turns, say twice the number used on the primary. In the case the first tube in the broadcast receiver is a screen grid tube then the best connection is to connect the output ANT. on the converter to the cap of the tube and the output GND to the ground in the set.

Screen grid bias was provided in this circuit both by means of a three-volt dry-cell battery and by the potentiometer arrangement shown in Fig. 1. There was little difference in the results and for that reason the simpler and more convenient arrangement illustrated was retained. R3 should be a 2,000 ohm potentiometer or resistor provided with a slider and R4 should be a

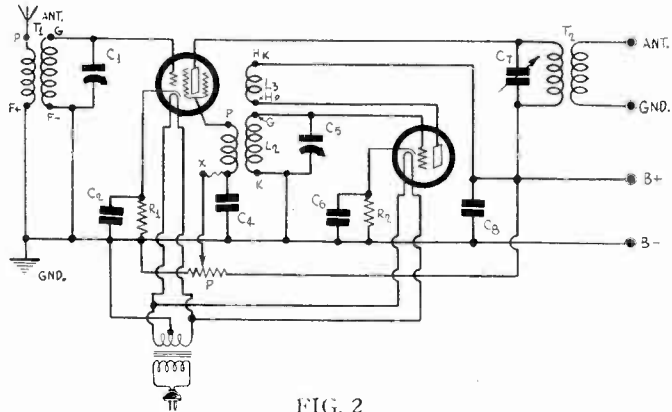

FIG. 2

THE DIAGRAM OF THE SAME CIRCUIT AS IN FIG. 1 EXCEPT THAT THE PICK-UP COIL HAS BEEN CONNECTED DIRECTLY INTO THE SCREEN CIRCUIT, THUS PERMITTING THE ELIMINATION OF Ch1 AND C3.

resistor of 25,000 ohms. Since these two are in series and connected across the plate supply, the current through the resistors will be $E/27,000$, where E is the plate voltage. A good value for E is 90 volts, and if this is used the current will be 3.3 milliamperes. This is so small that it does not add an appreciable drain on the B supply. If the total resistance is 27,000 ohms the return of the choke Ch1 should be made to a point 900 ohms from the B minus end of the resistor.

If a single potentiometer of resistance between 20,000 and 50,000 ohms is available this can be used in place of the two resistors shown in Fig. 1. This has to be adjusted for greatest modulating efficiency. The best point is not difficult to find for the volume responds to the potentiometer in much the same manner as it does to a moderately sharp tuner.

By-Pass Condensers

The bias resistors R1 and R2 used in this circuit were of 500 ohms each. Bias values other than those provided by these two resistors were tried in steps of 1.5 volts, but there was no apparent advantage gained by changing the bias, especially in view of the fact that the bias required on the first tube can be changed by changing the screen grid voltage.

There are four by-pass condensers in the circuit, namely, C2, C4, C6 and C8. Each one of these might be a .01 mfd unit. This value, however, should be regarded as the minimum, for the larger the condensers the better.

Ch1 was a 50 millihenry radio frequency choke coil and C3 was a trimmer condenser having a maximum capacity of 100 mmfd.

Knack to Tuning In The Short Waves

There are many who are interested in a four-tube circuit, because of low current drain, and their interest is principally in broadcast listening. They want selectivity and distance, too. They can get them on broadcast waves with this receiver, while of course plenty of distance is to be expected on the short-wave side, including foreign reception.

However, there is a knack of tuning in short-wave stations, and tuning experience must be acquired. It need not follow any given rote. You may invent your own way of tuning closely for bringing in the short waves from distant places. Yet it is only fair to state that the free-and-easy method of tuning that works out well enough on local broadcast waves will bring in precious little distance on short waves.

Some short-wave converter constructors will perhaps wonder whether the type and length of the receiving antenna bears any relation to the effectiveness of short wave reception. The writer was recently asked why a short wave receiving set, whether receiving short waves directly or via the converter, would not operate better with a short antenna, implying that he thought there was likely some reasonable connection between long waves and long antennas and short waves and short antennas.

If the received energy of the two independent systems be compared it will be found that the antenna in the higher frequency field will apparently be receiving a weaker signal, and in order to raise the received signal strength (correct tuning being assumed) it will be found necessary to lengthen the antenna conductor.

Three New Battery Tubes

By J. E.

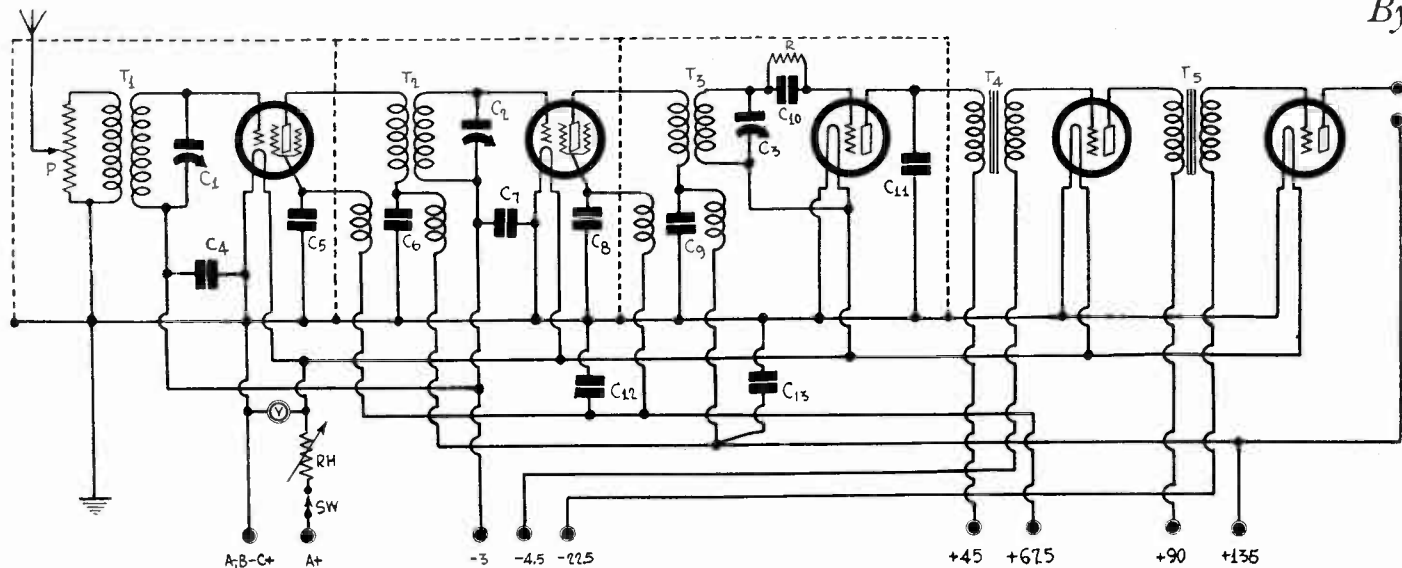

FIG. 1
A FIVE-TUBE SHIELDED RECEIVER DIAGRAM EMPLOYING THE NEW, LOW FILAMENT VOLTAGE TUBES OF THE SCREEN GRID, GENERAL PURPOSE, AND POWER TYPES.

THREE new tubes have been added to the RCA Radiotron line of receiving tubes. These tubes are for battery operation on low filament voltage and include 230, a general purpose tube; 231, a power tube, and 232, a screen grid tube. All three are of the high vacuum type and employ a strong metallic filament coated with alkaline earth compound. The filament of each is designed to take as little power as possible, consistent with satisfactory operating performance. These new tubes, therefore, are particularly suited for use in radio receivers operating from dry cells or from a storage battery where economy of filament current drain is important, for example, portable and semi-portable receivers.

The general purpose tube is useful either as a detector or as an amplifier, and in external appearance is like the UX-199. The new power tube is intended for the last audio stage only and has been designed to give good output volume from battery operated receivers where economy of plate current is important. The new screen grid tube is particularly recommended for operation as a radio-frequency amplifier in circuit designed especially for it.

Characteristics of New Tubes

The tentative ratings and average characteristics of these tubes Nos. 230, 231 and 232 are as follows:

	230	231	232
Filament voltage—	2.0 volts	2.0 volts	2.0 volts
Filament current—	0.06 amperes	0.150 amperes	0.06 amperes
Plate voltage (maximum)—	90 volts	135 volts	135 volts
Grid voltage (C-bias)—	-4.5 volts	-22.5 volts	-3 volts
Plate current—	2 ma.	8 ma.	1.5 ma.
Plate resistance—	12,500 ohms	4,000 ohms	.8 megohm
Amplification factor—	8.8	3.5	440
Mutual conductance—	700 micromhos	875 micromhos	550 micromhos
Grid to plate capacity—	6 mmfd.	6 mmfd.	0.02 mmfd.
Grid to filament capacity—	3.5 mmfd.	3.5 mmfd.
Plate to filament capacity—	2 mmfd.	2 mmfd.
Screen voltage (max.)—	67.5 volts
Screen current—	0.5 ma.
Overall length—	4½ inches	4½ inches	5¼ inches
Overall diameter—	1.125 inches	1.125 inches	1 13/16 inches
Base—	Small UX	Small UX	Large UX

It is recommended that these tubes be mounted in a vertical position and that the sockets be cushioned so as to minimize microphonic effects. However, the filaments and the struc-

tures of these tubes are sturdy so that microphonic effects are very small.

The filaments of these tubes should be operated at the rated voltage of 2 volts. The voltage may be supplied either by a dry cell battery or a storage battery, but in either case it is recommended that an adjustable rheostat be put in the filament circuit so that the voltage across the filaments may be held at 2 volts. Either a voltmeter or a milliammeter should be permanently installed in the circuit as an aid in holding the voltage or current constant at the rated values. Operating with fixed filament resistors will not give sufficient regulation to permit satisfactory performance throughout the discharge cycle of the battery.

It is further suggested that the rheostat be used as a switch in the filament circuit so that when the switch is turned on the maximum resistance of the rheostat is always cut in. This is a protection against over-voltage being applied when the circuit is first closed. This is of especial importance when dry cells are used, for after such cells have been used for some time the voltage is considerably higher after a period of rest than after it has been used again for a few moments.

Use in Conventional Design

The general purpose tube can be used in circuits of conventional design, as a radio frequency amplifier, intermediate frequency amplifier, or as a detector, except that the specified voltages should be used on the elements. The grid and plate returns should be made to the negative side of the filament circuit, as is usual, except that when the tube is used as a grid condenser-leak detector, the return should be made to the positive side, as is also customary in other tubes.

When the general purpose tube is used as a grid leak-condenser detector, the plate voltage should be 45 volts and the grid condenser should be .00025 mfd. The grid leak should be between 2 and 5 megohms. The higher value of grid leak will give a greater sensitivity on weak signals but not quite so good fidelity as the lower value.

When the general purpose tube is used as an amplifier the negative bias should be 3.0 volts when the plate voltage is 67.5 volts and 4.5 volts when the plate voltage is 90 volts.

About the same recommendations are made of the power tube as for the general purpose tube. It fits the same kind of socket and the connections are made in the same way, which is the same way as in the UX-120 or UX-199.

The recommended and maximum plate voltage for the power tube is 135 volts and the proper grid bias for this plate voltage is 22.5 volts. This bias should not be reduced for a lower bias will greatly increase the plate current in the tube, thus shortening the life of both the tube and the plate battery without gaining anything in volume or quality. A small reduction in the plate voltage does not affect the output materially except that it will be slightly less.

The plate current of the power tube is not so great that an output transformer is necessary. Practically all loudspeakers will stand 8 milliamperes indefinitely without undue heating of the windings. This assumes that the output tube is operated under the recommended conditions.

The new screen grid tube is designed primarily for use as a screen grid radio-frequency amplifier tube and can be used in circuits designed for the 222 screen grid tube, provided that

of Low Filament Current

Anderson

the filament voltage is adjusted to meet the requirements of the new tube.

The control grid is electrostatically shielded from the plate by means of an extra grid placed between the plate and the control grid and operated at a suitable positive potential. The resultant reduction in the plate to control-grid capacity makes high voltage amplification per stage practical without any external capacity neutralization circuits. This isolation of the plate and the control grid results in a small change of plate current with change of plate potential. The resistance, therefore, of the plate circuit is high, averaging about 800,000 ohms. This is the same as the plate resistance of the UX-222. With such a high plate resistance and with a mutual conductance of 550 micromhos, or microamperes per volt, an amplification factor of 440 is obtained. As a result, unusually high voltage amplification per stage is obtainable when special high impedance circuits are used.

Special Circuits Needed

The new screen grid tube will not work successfully in the circuits designed for three-electrode tubes and cannot ordinarily be substituted for a three-electrode vacuum tube. This tube requires the same socket as the other new tubes, or as the UX-222, and the socket connections are the same as for the older screen grid tube. The control grid is the cap of the tube.

The filament is of the coated type and should be operated in the same manner as that of the general purpose tube.

The positive voltage for the screen grid should be obtained from a tap on the plate battery. It should never be attempted to obtain it by connecting a high resistance between the high voltage tap and the screen because this will not give the proper screen voltage due to the uncertain voltage drop in the resistance. Not only would the screen voltage vary with the signal impressed on the control grid but it would vary with different tubes.

Stable operation of this screen grid tube in circuits designed to give maximum gain per stage requires separation of the input and output circuit elements. Internal shielding by the screen makes neutralization of the plate to grid capacity unnecessary, but it does not reduce any of the coupling externally to the tube. The high gain per stage makes it essential to prevent external coupling between circuit elements on the control grid and the plate sides of the tube if the full capabilities of the tube are to be realized. In general, with multi-tube amplifier circuits, it is necessary to use complete stage shielding, including all the components of each stage.

The use of filters in all the leads entering the stage shields is advisable to reduce the coupling in the external parts of the circuit. In the construction of filters for the screen circuit, a by-pass condenser must be provided to keep the impedance from the screen to ground as low as possible.

A Typical Circuit

In Fig. 1 is shown a typical circuit suitable for the new tubes. The radio-frequency amplifiers are new screen grid tubes, the detector and the first audio are new general purpose tubes and the last tube is the new output tube. As far as most of the connections are concerned the diagram is standard. However, the filament circuit has been simplified considerably. There is a single rheostat, Rh, controlling the filament current and filament terminal voltage. This has a built-in filament switch, Sw, which may be either of the type that is attached to the rheostat knob or it may simply be the usual open in the rheostat. A voltmeter, V, is connected across the filaments to indicate the actual voltage across the filaments.

The positions of the stage shields relative to the tubes and the parts are shown by the dotted lines. Since there are three tuned circuits there are three shield compartments. These dotted lines stop at the grounded bar, which is to be taken that the shields completely surround the parts within the dotted lines and the ground bar. Note particularly how the shields are placed after a tube, that is, as near the plate as possible. This is to indicate that as many of the parts as possible in the plate circuit should be shielded from the parts in the grid circuit.

This shielding is subject to some common sense interpretation. For example, the leads from the plate to the following primary must necessarily be an inch long or more. This lead may be shielded inside a compartment and should be if it is long. This may be done by using wire with a metal braid over it, and grounding this metal cover.

There are certain by-pass condensers associated with each state. These should always be inside a shield, for example, C4 and C5 should be inside the first compartment. Likewise C6, C7 and C8 should be in the second, and C9 and C11 should be in the third. The choke coils in the screen and plate leads,

on the other hand, though placed inside the shields, may be placed outside. In fact, it may be better to put them outside than inside. If they are placed inside they certainly should be arranged as indicated in the figure.

Condensers like C5, C8 and C11, which are either in the screen or the plate circuits, expose other parts in the grid circuits of the same tube, or it should be said that the leads of these condensers do. Hence these leads should be made short and preferably shielded.

Word of Warning

It is very important that the filament terminal voltage be not increased beyond the 2 volt limit. For that reason the rheostat, Rh, should not be used as a volume control, especially not to increase the sensitivity of the circuit that that afforded by the normal setting of the rheostat. The potentiometer, P, in the antenna circuit, should be used for high volume control. If the circuit is not sensitive enough when the potentiometer slider is set at the top, and when the filament voltage is set at 2 volts, the set as a whole is not sensitive enough. Increasing the sensitivity of the circuit by advancing the rheostat beyond 2 volts simply endangers the tubes. If a squawk from the distant station is worth more than a set of new tubes, then of course the rheostat might be advanced.

But remember that a much louder squawk from the same distant station can be obtained by adding another new screen grid tube and another tuner.

It is not sufficient to depend on the shielding and the filtering in each stage, or at least it may not be, for eliminating all feed-back among the tubes. For that reason it is well to use condenser C12 and C13 across the voltage supply sections, and to make these condensers large. This added precaution is especially important when the B battery has been used for some time, or when it is old, even if it has not been used. It is surprising how little feed-back sometimes will cause oscillation in a receiver. There is even a strong possibility that the fact all the tubes are on one filament battery and on one rheostat will cause regeneration sufficient to start sustained oscillations. If it does, the remedy is a condenser across the filament circuit, say across the voltmeter.

Since the plate characteristics of the general purpose tube are about the same as those of older tubes of this general type, standard audio frequency transformers may be used after these new general purpose tubes. Therefore T4 and T5 in Fig. 1 need not be special. Just good audio transformers will do.

The principles of shielding and filtering that apply to the UX-222 tube apply to the new screen grid tube and the radio frequency transformers designed for the old tubes apply to the new. Hence the main changes when the new tubes are used concern the filament, plate, and grid voltages.

As soon as the new tubes become generally available detailed circuit diagrams and constructional articles will be published.

Favors Single Amplifiers

The advantages of singlesided amplifiers are manifold. First, we have the choice of using resistance coupling which is not possible when push-pull is used. Thus we can select the best known method of amplification as far as quality is concerned. Second, we get plenty of volume with greater economy. We need less plate voltage, less plate current, less filament power, and less expensive filters and rectifier circuits. Third, the quality is not appreciably poorer since a harmonic distortion as high as 15 per cent can be tolerated. Fourth, we save our nerves from undergoing the torture excessive volume inflicts. Fifth, we get a more pleasing reproduction because we restrict the volume to reasonable values. Then if we use resistance coupling in addition to moderate volume we get something which is very nearly equal to the original.

The strongest argument for push-pull, namely, that people want it, is very weak since it rests purely on human fickleness. One day the demand may be for push-pull—nothing else will do at all. The next day something else is the vogue and a push-pull receiver could not be given away, unless the emphasis were placed on some other feature which happened to be in style that day. An illustration of this is afforded by the popularity of the Loftin-White non-reaction amplifier. Thousands of fans were satisfied with their push-pull amplifiers and swore by them. Then one day the Loftin-White amplifier is announced and half of those satisfied fans crowd into radio stores to get parts for the new amplifier. The other half could not get into the stores. And these fans are now using Loftin-White amplifiers, which are singlesided. Are they satisfied with the quality and the volume? Most assuredly they are. H. J. Smith.

A Screen Grid Portable

By Worcester Warren

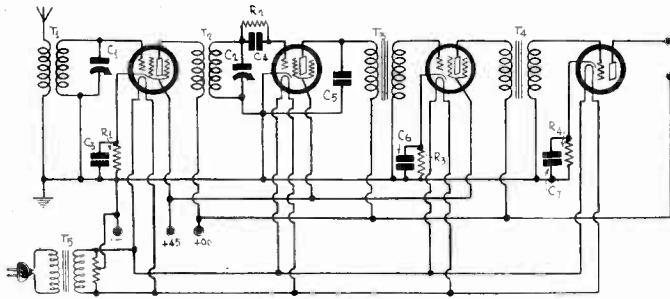

FIG. 1

THE CIRCUIT DIAGRAM OF THE FOUR-TUBE RECEIVER ESPECIALLY DESIGNED FOR USE IN AN AUTOMOBILE OR OTHER PORTABLE USE.

THERE have been so many complex radio receivers that one gets the impression that no others will work. Yet it is true that the simpler the circuit the more efficient it is. Of course, there is a world of difference between the efficiency of a circuit and its sensitivity. It is this difference that reconciles the two apparently divergent statements. A complex receiver, when the complexity is due to a large number of tubes, is more sensitive than a simple receiver having only few tubes. The unfortunate part is that when a receiver has many tubes each stage must be made more complex than it would have to be if there were only a few tubes in the set.

At least the consensus is that each stage must be made more complex to have a stable, sensitive, multi-stage receiver. Now, this idea of complexity is not at all consistent with compactness and lightness of weight, and therefore it is not consistent with the demands of portable and automobile receivers, which must be compact and light in weight, and moreover must be sensitive.

Wired With About a Foot of Wire

It would seem that a compromise must be made in respect to the number of tubes used in the portable or automobile receiver if we are to get the optimum combination of sensitivity and compactness.

Our attention has just been called to an automobile receiver, built in portable form, that represents simplicity. Yet it has four tubes in it, three of which are AC screen grid tubes.

When one first looks into this receiver one wonders whether it possibly could be a completely wired set or only an assembly of miniature parts. Closer scrutiny, however, will reveal that every connection has been made. One cannot help admiring the designer of that set, for he certainly has complied with all the dicta of good design. And he has succeeded in laying out a receiver in which the wiring is scarcely discoverable. Imagine starting out with a foot of wire and making all the necessary connections in a four-tube set with it. The designer of this set almost limited himself to this amount of wire for connecting the various parts.

The Four-Tube Circuit

A special feature of this four-tube receiver is that it can be operated either from a six-volt battery of the type common in automobiles, or from a 110-volt AC line. Thus it may be used in an automobile or in a hotel room. And, of course, it can be used in any home where the current supply is AC, or where there's an A battery.

We cannot discuss a receiver without giving the diagram, so we reproduce it in Fig. 1. We note that there are two radio frequency transformers T1 and T2. These are wound with fine silk insulated wire on tube bases and they are designed to work with screen grid tubes and .00035 mfd. tuning condensers. Then we also note that there are two audio frequency transformers T3 and T4. These also are designed so as to work efficiently with screen grid tubes. Grid condenser-leak method of detection is used.

Thus for sensitivity we have AC screen grid tubes, specially wound transformers, condenser-leak detection, and the absence of unnecessary "lossers."

The receiver, including the loudspeaker, is inclosed in a cast white metal case, measuring 12 inches wide, 13 $\frac{3}{4}$ inches high, and 5 $\frac{1}{2}$ inches deep. It is sprayed on the outside in imitation brown leather and is provided with a leather carrying strap.

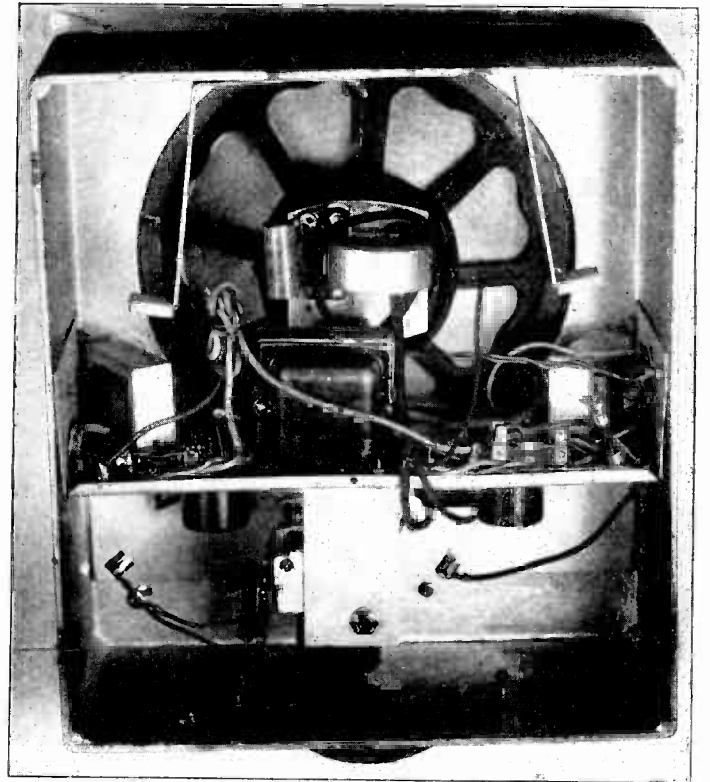

FIG. 2

REAR VIEW OF THE AUTOMOBILE RECEIVER, SHOWING THE LAYOUT OF THE VARIOUS PARTS. FOR THE FRONT VIEW OF THE SAME RECEIVER SEE THE FRONT COVER.

The back cover is a sheet of Masonite in natural color, which is almost exactly of the same shade as the metal finish.

Interior Arrangement of Parts

All the parts with the exception of the loudspeaker are mounted on a metal shelf formed out of one piece so that it forms the sub-panel, the "front" panel, and supporting flanges. The "front" panel is mounted back of the front side of the containing case, in which holes are drilled to admit the shafts of the tuning condenser, the volume control, and the filament switch. The panel arrangement may be seen from the illustration on the front cover, and the interior arrangement from Fig. 2.

In Fig. 2 may be seen four tube sockets of the flush type, two on each side of the double tuning condenser, which is in the middle. There are also two raised type sockets, one on each side of the condensers, and these hold the two tuning coils. The audio frequency transformers and the filament transformer are below the sub-panel. The two audio transformers are placed in the corners on either side of the speaker cone and the filament transformer is placed in front of the cone, looking from the rear of the set.

On the right side of the set, looking from the front, is a UY type socket, which is in lieu of binding posts. Two cables are provided with plugs fitting into this socket. One of these cables is for use when the set is to be operated with a 6-volt storage battery and other when it is to be operated from a 110-volt AC line. Leads are provided for connection to the B battery, and these leads emerge through holes in the back plate. A black lead is provided for B minus, a green for plus 45, and a red lead for plus 90 volts.

Installation In Automobile

Installation in an automobile is quite simple and can be done by almost anyone. Connect the two free ends of the battery cable to the storage battery at the ammeter or at the dash light socket or with battery clips direct to the battery terminals. Since all the tubes in the receiver are cathode type tubes, no polarity need be observed. Either lead may be connected to plus or minus.

There are several ways in which to provide an antenna in the automobile. The most common practice is to tack a piece of copper screen up inside the top. Another is to zigzag a wire back and forth across the top in place of the screen. In some

(Concluded on next page)

Multi-Tube Filtration

By Edward J. Hobart

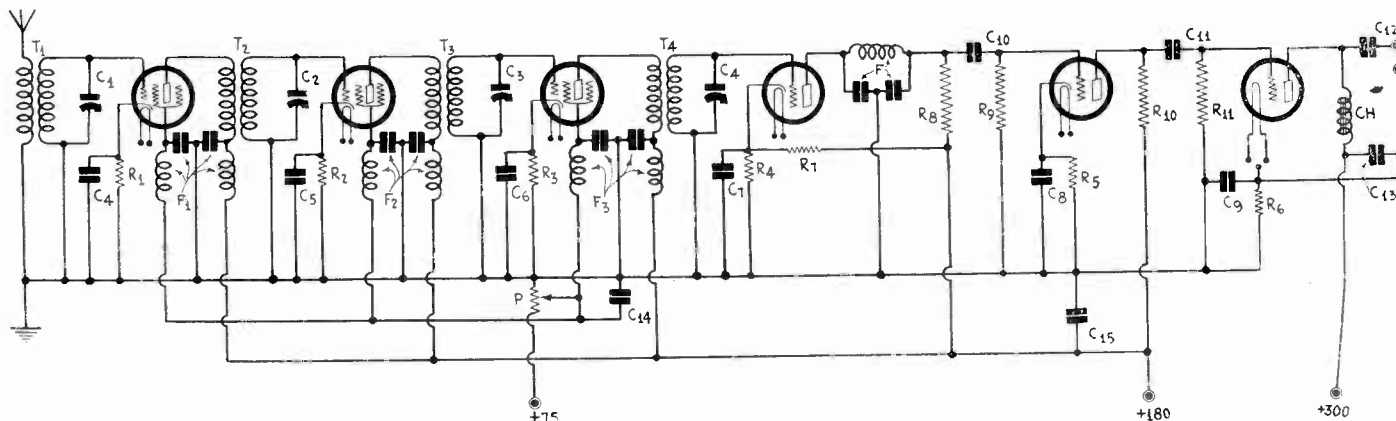

MULTI-TUBE SETS USUALLY REQUIRE A HIGH DEGREE OF FILTRATION FOR STABILITY AND UNIFORMITY.

THERE is a strong temptation in building receivers to leave out every part that does not seem to be essential. For example, it may be recommended that a certain radio frequency choke be put in a plate lead. The builder may find that it makes no apparent difference in the results whether this choke is there or not. Again, it may be recommended that a by-pass condenser be used in conjunction with this choke, and the builder may find that it makes little, if any, difference whether this is put in or left out. Naturally, the temptation is to leave out both the choke and the condenser. It really seems at first thought that the choke makes the use of the condenser desirable, so why use either?

There is something in this argument when we are dealing with a single tube but not when we are dealing with multi-tube receivers, such as that shown in Fig. 1. Every condenser, every choke, every resistance in that circuit has a definite function.

While the circuit may work without one of the condensers, one of the chokes, or one of the resistors, it will not work as well as with it. And when considering how well a receiver works we must take into account stability as well as sensitivity. It may be that if one of the chokes is taken out the circuit will be more sensitive at some frequency. Indeed, it may be extremely sensitive. But on another frequency it may be oscillatory and unmanageable. So the advantages of the filter devices are stability and uniformity of results.

Function of Plate Chokes

The circuit in Fig. 1 is well filtered. Let us see what each component of a filter does to justify its presence in the circuit. Take first the radio frequency choke coils in the plate circuits of the first three tubes. They serve a two-fold purpose, first, to prevent signal currents in the tube from entering the power supply, and second, to prevent any signal currents that may be in the power supply from entering the tube. Thus each of these chokes is an obstruction preventing the signal current both from coming and going. But this two-way obstruction would also be an impediment to the signal current that should flow in the plate winding of the coupling coil. It is for this reason that a condenser is connected from the junction of the choke and the primary to ground. This condenser not only furnishes an easy path for the signal current, but it also makes the choke coil much more efficient than it otherwise would be.

There is also a similar radio frequency choke in series with the screen of each of these tubes, and each of these chokes is also by-passed by a condenser to ground. The action of this condenser and this choke is about the same as that of those placed in the plate circuit. The potential on the screen should remain constant if the screen is to work properly. If the plate voltage fluctuated by reason of the presence of signal currents in the B supply the voltage would not be constant. Hence the choke is put in the screen grid lead to stop any variations that

may exist. But since the screen normally takes current and this current flowing through the choke coil would cause a voltage fluctuation, the condenser is connected from the screen to ground to provide an easy path for the signal current in the screen circuit.

Keeping Voltage Constant

Sometimes a resistance is put in the screen grid lead to cut down the applied steady voltage, but this resistance does not keep the voltage constant. Indeed, it causes it to vary. A condenser would tend to keep it constant but not so constant as a choke coil and a condenser. Hence it is better to provide the correct steady screen grid voltage in some other manner than by means of a resistance and then use the condenser and the choke to maintain the voltage constant with respect to signal variations.

The above explains how the filters act but the real object of the filters in both the screen and the plate circuits is to prevent feedback, which they do by keeping the signal currents where they belong without causing any changes in the DC potentials applied to the elements of the tubes.

Frequency Determines Values

It should be remembered that the larger the inductances of the radio frequency chokes and the higher the capacities of the condensers associated with them, the more complete is the prevention of the feedback. If a 5 millihenry choke does some good a choke of 85 millihenries is seventeen times as effective. If a condenser of .01 mfd. does a little good a condenser of 1 mfd. is just one hundred times as effective.

The values that should be used, however, depend on the frequency that is involved. In a radio frequency stage where the lowest frequency that must be provided for 550 kc values of 85 millihenries for the chokes and .01mfd. for the condensers should be sufficient in all cases, even when there are many radio frequency stages with screen grid tubes in all. For an intermediate frequency amplifier the values should be multiplied by the ratio of the frequency. For example, suppose the intermediate frequency is 100 kc. The ratio is 5.5. Hence for equal filtering both the condensers and the inductances should be multiplied by 5.5, which would make the condensers .05 mfd. and the inductances about half a henry each. Of course, it is not necessary to have exactly equal filtering, so that in practice one would choose the nearest commercial values.

Product Should Be Same

For audio frequency stages we have to provide for the lowest audio frequency, which might be placed arbitrarily at 30 cycles. It should also be remembered that the same filtering is obtained for different combinations of inductances and capacities so long as the product of the inductance and the capacity remains the same.

Antenna and Ground Connections for Portable

(Concluded from preceding page)

cars, however, an inside antenna will not produce results on account of the shielding effect of the steel body. In such cases an insulated wire strung underneath the car from the front to the rear bumper will give fairly good response. Another method is to tack metal plates or string insulated wire beneath the wooden running boards. The best antenna that can be secured in an automobile is never as good as a short wire strung up in the air, but this type of antenna can only be used when the car is standing still.

When the set is operated in a home or a hotel room, good reception can generally be obtained by connecting the antenna wire to a radiator or other ground or by stringing a short wire across the room. Do not use a long antenna on the set, as this will destroy its selectivity, especially on a strong local station.

A ground is automatically provided through the battery, which is grounded to the frame of the car.

(Other Illustration On Front Cover)

Resolved, That a S

HERE and there throughout the United States opposition to the installation of radio sets in automobiles has arisen, and some States and local communities have enacted laws prohibiting use of such installations within the jurisdiction.

The Radio Manufacturers Association is fighting this opposition to auto radios. It has issued a digest, "Radio In the Motor Car," covering the objections raised by opponents, and the answers to these objections.

Arguments Summarized

Under the heading, "Summary of the Points For and Against Radio in Motor Cars," the following is published in the digest:

"(1)—That radio would be distracting to the driver and cause accidents.

"Radio is not distracting, because it demands no attention from the driver and requires no answer, as does conversation between driver and passengers.

"(2)—That the act of tuning would take attention from driving.

"Motor car radio is tuned by ear. Single knob selector enables operator to tune without taking his eyes off the road. Requires no more attention than the other instruments on the car, namely: choke, lights, horn, as well as various dash gauges and road signs which must be watched. Motor car radio is less disconcerting than the rear view mirror.

"(3)—That music would lull the driver to sleep.

"Constant purring motor over extended trip is monotonous and often causes sleep and resultant accident. Radio brings companionship and entertainment, promoting alertness.

"(4)—That radio will distract drivers of other vehicles by contributing distracting street noises.

"Motor car radio is designed for use within the narrow limits of the car itself, and its volume is limited to such an extent that it cannot be heard as far as the sidewalk. In most cities there is no restriction against radio speakers playing in front of radio dealers' stores. The ordinary household radio set has more than 25 times the volume of the motor car radio set."

To the allegation radio in a car is unsafe, the reply is:

"Insurance companies, always quick to sense a risk or liability, see nothing unsafe in motor car radio. Cars which are radio equipped pay no additional premium. Insurance companies say, "Safe!"

Regarding speeding and traffic wiggling, the following is said:

"Many highway and city accidents are due to speeding. Motor car radio tends to reduce speeding, eliminating this hazard. Cutting in and out of traffic lines has caused innumerable accidents. Radio in the car promotes steadier and easier driving, eliminating the impatience over traffic delays. By providing amusement, one-way traffic delays pass unnoticed."

Colby Opposes Ban

Clarence C. Colby, chairman of the legislative committee, before the Public Works Commissioner of Massachusetts, opposed a bill prohibiting the operation of motor vehicles equipped with radio receiving sets while the sets are in operation. For the RMA Mr. Colby said:

"It is not the intention of the Radio Manufacturers' Association to handicap or embarrass the Registrar of Motor Vehicles or this Commission in the important work of supervising and regulating the use of motor vehicles in this State, but rather to bring to your attention at this time for your consideration facts and thoughts with relation to this problem, which comes to us by reason of our intimate knowledge and experience with radio.

"The basis of the regulation is the claim that by disconcerting the driver radio in the car will tend to increase accidents.

"There can be no facts or evidence to bear this out as there are in operation in this State, to the best of our knowledge and belief, less than one hundred radio sets installed in cars out of the more than seven hundred thousand motor vehicles registered. The regulation, therefore, cannot be urged on the basis of experience.

"There are several sound reasons on the other hand why radio may be a factor in reducing accidents.

Radio is 80% Music

"It will tend to reduce speed. I do not need to argue that the reduction of speed will tend to reduce accidents. Fast driving grows out of the desire to get from somewhere to somewhere else in a hurry. The hurry is the nature of American life. With the mind set on getting to that other place, the

pace is only qualified by traffic conditions, and the average driver plays his traffic to a fairly close margin. He presses on with the uppermost thought of getting to his destination.

"This condition of mind is entirely changed with radio in the car. The press of that single thought of getting to that other place gives way and the driver slows up to enjoy the music while he is on his way, or to pick up a quotation from some stock in which he is interested, or to hear the news, or whatever it is that comes from the air, to lessen that pressing driving mental complex to get on to that other place he is headed for.

"The music industry has compiled figures to show that radio is 80% music, thereby claiming it as their foster child. Whatever the figure (and they are probably right) those who know the mental attitude of the average driver when operating a car will agree that music will tend to soften speed.

"It will tend to prevent loss in direction by inattention with consequent saving of accidents.

"The monotony of a long drive is well recognized as one of the causes of accident. There are many recorded cases of drivers being lulled to sleep by this monotony, with resulting accidents or death. But while this type of trouble may be small in proportion to the whole, there are thousands of cases where the driver fills in the monotonous driving spaces, thinking of some problem, some happening, of someone, and thinking so deeply, that his mind passes from his driving. If he is lucky, he comes up with a start. If not, well—the ambulance and the rest.

Keeps All Entertained

Here the radio is in value as, with its changing program, it keeps the occupants of the car, including the driver, entertained so that his face does not slip into that fixed stare which means his thoughts and mind are elsewhere.

As to multi-tube sets, if you want a pretty array of glass bottles by all means use plenty of tubes, but why stop at ten? Why not go on up by easy stages to 25, 40 or even 50? This follows the line of reasoning that if ten are good, fifty ought to be nearly perfect. If we use enough of the critters they should gradually come down in price to the level of our Mazda lamps.

Back a few years the old regenerative and two-step made many records, and to my knowledge never equalled, and with the present trend of receivers, never will be. The writer recalls a few such instances, for example: Nightly reception of old KOB, State College, New Mexico; WSB reliable reception when using transmitter tubes no larger than some of the present-day receiving tubes. The first transmitter at KDKA and KFI with reliable reception all over the Central states. None of them was super-power in those days.

In 1923 I heard the dedication program of a transmitter opened in Buenos Aires. In 1924 I and many others heard station 2LO, London, broadcast, a test program for which all American stations closed down, and again the following year. At present most of us are enjoying the same conditions on the short waves with three-tube sets and small power transmission from London. Any old timer has had such reception for several years. Well, what does this tell us? Merely that the old regenerative was a distance getter, and with a stage of tuned RF it was a wow.

What was lacking? Principally selectivity, volume and quality. All right, where would the present-day multistage be for volume and quality without the recently developed power tubes and dynamic speakers? Just try the detector output through one of the old type audio channels and old type speaker, then couple the output of a regenerative detector to a good power amplifier and dynamic speaker and watch the volume and quality bloom! It seems, then, that

For

the improvement in isn't so much a prop as perhaps the impr sign and reproduc greater potentials a now.

I wonder if multi-tube amplification possible with 224 tube, or ever use hook-up? Do they obtaining only abo possible amplification three used in such a waste of perfect tubes to utilize th Ten years ago there and twelve-tube sets idly died out, leavin our heads that the reception, but i the idea that was sei ago by some enterpr capitalized. They sta tube sets on the purely as a sales ta result that it was nee facturers all to mee a matter of performe ber of tubes used. each stage of RF th necessarily reduced overall gain was no this overall gain bet tions that are not re addition or eliminati

A few years ago to 4 inches in diam ate in length. Now close to 1 inch in di 1½ inches long and v At the time of this peared in various tr effect that such a cl

et in a Car is Safe

Radio is not so disconcerting as conversation.

There are several kinds of this. There may be back seat direction, there may be argument, you may have a friendly person pointing out points of interest, or the querulous person with his eternal questions, or the dialogues of children; your chum may be repeating the story of the night before, or he may be pointing out this or that attraction, a girl, another car, or something of interest as you go.

Nothing that ever comes over the air can be held as disconcerting as such conversation to the driver as such conversation tends to draw the driver's eye from the road—the fatal thing—where radio does not.

The tuning of a radio set does not take the driver's attention from the road.

It must be made clear here that we refer to the modern radio, the set which is tuned from one dial and whose volume is controlled from one additional knob. If it were the two-dial set with which we were familiar a few years ago, or even the three-dial set, the statement which I have made would be incorrect, for the tuning of such a set does require the person tuning it to watch the dials to see that the setting is correct.

The two-dial set and the three-dial set, however, have long since passed away and all modern radio is tuned from a single dial.

How Set Is Tuned

In tuning a set the operation is to throw up the volume with one hand, and then passing that hand to the tuning dial and turn this until the ear hears the program coming in and then to pass the same hand back to the volume control and tune this up or down to the required volume. The thing is done entirely with one hand and with the aid of the ear and does not in any way involve the use of the eyes. No more effort is needed for this than to operate a choke or to start or stop windshield wipers, or other slight manual adjustments with which the driver

in manufacture for developing of multi-stage channels and gang condensers. No mention was made of the increased resistance of these coils, and the fact that the old type coil tuned very sharp and actually peaked, making it practically impossible, even with the most precise manufacturing methods, to match such coils and condensers in gangs, while the small coil with its increased resistance, small size and crowded shielding gave practically no peak, but a broad, flat hump that was sure to hit even with the most haphazard assembly. In short, there was but little difference in the new coil than the old aperiodic transformers of five years before.

It takes at least two and sometimes more stages of the present-day RF amplifiers to equal in selectivity the old type regenerative with an efficient tuner, and with a stage of tuned RF before the detector.

As for the single dial control, I have yet to see one. I believe I have serviced nearly every make set on the market but I have never found a truly single control set to the present time.

They all have one main tuning control, and one or two other knobs, where in the old days we would have used a dial, but as a matter of fact we do find the knobs serve as well. If it is desired to have a single dial outfit, by all means omit the dial from the regeneration control and use a knob. As for appearances, I know of no reason why the simple four or five tube could not be worked up in just as neat a design as a multi-tube set, because here again the number of tubes plays no part.

It is my forecast that just as soon as the public is acquainted with the fallacy of the multi-tube bunk that there will be a rapid change back to the four and five tube outfits, and then, and not until then, will the best talent assert itself.

V. H. BROYLES,
525 West Olive St.,
Decatur, Ill.

of a car is familiar. It should be clearly understood that there is no need to take the eyes from the road and no benefit if you do.

You can now see that it is entirely possible that the use of radio in the car will tend to reduce speed as high speed is entirely incompatible with the enjoyment of a program either of music or of an informative nature. We have also seen that radio may be very useful to prevent the loss of direction caused by inattention through the deep pondering of a subject or happening, or by the sleepiness of the driver due to long driving, which is particularly true in the case of over-worked chauffeurs.

We have also seen that it will help to eliminate disturbing conversation in many cases and keep the mind entertained, fresh and alert, and with eyes on the job of driving and not directed elsewhere.

Case of Disturbance

One other claim has been made by some against the use of radio in the car and that is—that it will tend to cause disturbance by adding to the street noise. We think that this claim is easily refuted and is made largely in ignorance of conditions by judging from the amount of volume which is available in the ordinary radio set used in the home. The radio set and the speaker in the car are so constructed that the volume available is only suitable for the close contact of a closed or partly open car. I have tested this matter out for the express purpose of satisfying myself as to the facts and have driven a car through the streets of Boston in the early evening with the streets thronged with people and in other places where there were but a few on the sidewalk and, having driven the car close to the sidewalk with volume at the highest peak, have passed for miles without having a single pedestrian notice the fact of the radio operation.

I do not mean if a passerby were standing on the sidewalk as whether or not he could hear the radio in the car, that he might not catch some portion of it, but from my experience I contend that unless the passerby is making it a point to see if he could hear the reproduction, he would not notice, and I believe these to be the facts. I do not, therefore, believe that the contention that a radio set in a car or in all of the cars would tend to create a bad condition in traffic to be sustained by the facts.

Other Points Covered

There are a few other points to which I desire to call your attention. The effectiveness of radio in the car has been well demonstrated by the police systems which have been instituted in many of our large cities. In many of such communities the Chiefs of Police have not only approved its use, but have been highly enthused with its operation. It is a well known engineering fact that for the transmission of music and information at short distances (and by short distances I mean several hundred miles) the use of the broadcasting frequencies are very much more effective than those at short waves at which the police signals have operated. It is quite obvious, therefore, that so far as the effectiveness of a radio system in an automobile for the transmission of programs from broadcasting stations, it is entirely suitable and applicable. It should be borne in mind, also, that millions of dollars have already been invested by the automobile companies in the equipping of cars since last October to make the cars ready for the installation of a radio set and that many millions of dollars have already been invested in material and equipment for car installation. These investments have not been made without a careful investigation of the considerations involved.

The insurance companies who undertake the responsibility of paying the loss in accidents have gone into this matter thoroughly and in detail and the large insurance companies have advised the automobile manufacturers that, in their judgment, the use of radio in the car will not increase the risk on their policies and that they will issue policies at no increase of premium where radio sets are installed. In other words, "radio in the car" has been given a "clean bill of health" by the insurance companies.

Affected Only 5%

In a recent report the Registrar of Motor Vehicles of Massachusetts made the statement, in substance, that the regulation of traffic involved only a question of 5% of those driving. I ask you whether it is fair to take away from the 95% who drive automobiles upon the road, the right to have a radio in the car, whereas the Registrar of Motor Vehicles states that regulatory provisions are needed for only 5%.

In closing, let me point out that I cannot feel that this commission will take a position of condemning the radio in the car without a trial. Such a course would be un-American and contrary to the history of Massachusetts.

um

volume and quality position of multi-tubes movement in tube design, together with the applied to the tubes

tube advocate realize possibilities of the type used one in a four-tube realize that they are not one-fiftieth of the gain from each of the tubes in a set? And that it is only good screen grid tubes in this manner?

was a boom for ten years in Supers that raising only the idea in more tubes the better it wasn't so. This is based upon a few years of advertising, and started fostering multi-tube unsuspecting public, with the ultimate necessary for the manufacture competition, not as a matter of fact, but in the number. With the addition of the gain per stage was to a point where the gain greater than before, being limited by condenser merely by the number of so many tubes. tuning coils were 3 tubes and proportionately they are averaging a meter and perhaps found with fine wire. change articles appeared in journals to the change was necessary

TELEVISION PUT ON AT THEATRE IN TALKIE FORM

Schenectady, N. Y.

Dr. E. W. F. Alexanderson, chief consulting engineer of the General Electric Company, made television history here when he demonstrated talking television pictures six feet square to an audience in the RKO-Proctor Theatre here, for the first time in history.

About a year ago Dr. Alexanderson showed television images 14 inches square large enough to enable a number of persons to see the images at the same time, but this time the pictures were large enough for the entire audience to see them clearly.

In the previous demonstration the Moore crater neon lamp was the luminous source which enabled sufficient light to be thrown on the 14-inch screen to be seen by the spectators. In the present demonstration a powerful arc lamp was the source of the illumination and the Karolus light valve the means of modulating the light beam projected.

Used Karolus Light

The greater intensity of the arc permitted a greater magnification of the image and the practically instantaneous action of the Karolus light valve permitted faithful modulation of the day of light. The well-known Nipkow scanning disc was used in both instances.

The scanning disc used in projecting the 6-foot square image contained 48 holes which divided the field into 48 lines. The speed of the disc was 20 repetitions per second. This number of holes in the disc allows considerable detail and the 20 repetitions per second eliminates the flicker.

The basis of the Karolus cell is rotation of polarized light when it passes a cell of nitrobenzol subjected to an electric field, the rotation being approximately proportional to the intensity of the electric field.

Vibrates in One Plane

The polarized light, which is light that vibrates only in one plane, passes through a prism when the plane of vibration is in a certain direction and is cut off when it vibrates at right angles to this plane.

The signal received from the television transmitter is transformed into an electric field of varying intensity and this is made to turn the plane of polarization, thus permitting more or less light to pass through. The light that passes through the cell is first polarized by passing through a prism, then it passes through the cell and into a second prism of the same kind as the first. The action of this shutter is practically instantaneous, and it is also faithful to the electric force, that is, to the signal.

Dr. Lee De Forest, pioneer radio inventor and president of the Institute of Radio Engineers, called the recent demonstration a "startling achievement and a definite step in television progress."

Startling, Says DeForest

"I venture to predict," Dr. Alexanderson said, "that we will soon see a wave of activity in amateur television. There are more than 100,000 experimenters in America, young and old, who go in for radio, not to be entertained, but who like to build their own sets and get a thrill from exploring the unknown."

Radios in Prison As Revolt Cure

Chicago.

Radio reception, which is provided for prisoners in the prisons of many states, was introduced in Joliet penitentiary recently. A small speaker was installed in each of 1,000 cells, fed from a master receiver, which the warden tuned in.

The prisoners welcomed the innovation. Correct time, received at 6 a. m., evoked groans, as this feature, the prisoners said, was of no value to them. Humorous sketches brought laughs from all. Jazz music from a cabaret filled some with sadness, because of recollection of other days.

One man, a prisoner for thirty-five years, for murdering a woman, couldn't understand much that the announcers spoke about. Allusions were to many things that didn't exist when this man "went in." He is soon to be paroled. Baseball scores were gladly heard.

Major Henry C. Hill, the warden, said radio installation had a beneficial effect on prisoners and helps to safeguard against any prison revolt.

COURT REVIEW POWER CURBED

Washington.

The administrative acts of the Federal Radio Commission, instead of being subject to review, would be final, except where insufficiency of evidence, or constitutional questions, are involved, under an amendment to the radio law proposed by the House Committee on Marine and Fisheries.

The section would limit the power of the court in reviewing Commission decisions, according to Representative Brand (Rep.) of Urbana, Ohio, a member of the Committee. The amendments, he said, rectifies a condition which permits the court of appeals to reconsider completely any decision of the Commission and act as a "second radio commission."

Restriction of decisions of the court to questions of law would result from the amendment, with findings of fact by the Commission to be conclusive if supported by substantial evidence.

"These amateurs have been rather starved of real interest in the last years, due to the commercialization of broadcasting. They will be the ones that will popularize long distance television, just as they were the ones that created the interest in broadcasting."

"In this interest the amateurs and the professional experimenters are on common ground. We got a real thrill out of sending a television wave to Australia and have it come back and tell its tale, even though it was a simple one."

Still Had Four Corners

"We observed that after traveling 20,000 miles a rectangle still had four corners, which was more than we had expected. As a matter of fact it was broken up into pieces most of the time. But there were glimpses of encouragement and a fertile field for the imagination. These are the incentive of the explorer, whether he is an amateur or a professional."

FAMILIES THAT LISTEN IN ARE 43% OF TOTAL

Washington.

A survey made by Dr. Daniel Starch, of Cambridge, Mass., shows that 43 per cent of the families of the United States have radio receiving sets, and that 81 per cent of all the families in the United States possessing sets listen in two hours a day, or more.

The survey covered the entire United States and was obtained by individual canvassers. More than 18,000 families were visited. From this group, scientifically located by cross-sections of the country, were obtained for the first time basic facts and figures of the radio industry.

The survey showed that 12,824,800 families in the country own receiving sets.

Mostly More Than Five Tubes

More than three-quarters of the sets in use employ more than five tubes (including rectifier for AC sets.) More than 52 per cent of the sets were bought in the last two years, and more than 30 per cent in the last year.

The maximum listening takes place between 8 and 10 p. m., while the noon hour and the dinner hour bring about an equal number of responses.

Nearly three-quarters, or 73.41 per cent of the families owning receiving sets told the Starch interviewers that they listened about equally all evenings of the week, while an additional 24 per cent reported listening more on Saturday and Sunday. On this basis, it was calculated, says "The United States Daily," that there is a certain audience every evening of the week or more than 7,000,000 people.

The popularity of sponsored programs was shown, the survey states, in view of the fact that 81 per cent of those interviewed preferred "light musical features."

Summer Listening Runs High

The commonly accepted belief that the radio audience dwindles materially in the summer, when long-range reception is supposed to deteriorate, is disputed in the Starch survey. The survey revealed conclusively that the radio receiving sets is in use nearly as much in the summer as in any other season of the year.

Of the families interviewed, 78.8 per cent said they used the radio in the summer—either taking their own sets and installing them whenever the summer sojourn made this possible, or obtaining access to radio programs through use of a portable set or the radio in the hotel where they were spending their vacation.

The question: "Do you enjoy talks on agricultural subjects?" brought affirmative responses from 72 per cent of the farm families interviewed; 31 per cent of the town families; 23 per cent of the medium sized city families, and 18 per cent of the families in the large metropolitan centers.

A THOUGHT FOR THE WEEK

RECIPE for Radio cocktail: take twelve of soprano, three of contralto, one of basso, four of tenor and six of good, bad, indifferent and awful crooner; mix with band and orchestra, mostly jazzy, and whining ukulele and crying sax; add a little lecture on "Famous Feet I Have Stepped on," two dramalets of doubtful parentage, and a pinch of science and travel. Shake well and take at one sitting. Then to bed and sleep—we dare you!

HIGHEST COURT TO FIX HOTEL'S TUNING RIGHTS

Washington.

The question of a hotel's liability for affording to its guests reception of a copyrighted song broadcast by a station that had no authority from the copyright owner to use that song, is before the Supreme Court of the United States for determination.

The plaintiff is Gene Buck, representing the American Society of Composers, Authors and Publishers, to which the firm that published the song assigned all but the dramatic rights. The defendant is the Jewel-LaSalle Realty Company, operating the LaSalle Hotel, at Kansas City, Mo. The hotel won in the Federal District Court in Kansas City, and the society appealed to the Circuit Court of Appeals for the Eighth District. On an agreed state of facts the legal question involved was cited to the United States Supreme Court by the Appeals Court.

Question Put to Highest Court

The question certified follows:

"Do the acts of a hotel proprietor, in making available to his guests, through the instrumentality of a radio receiving set and loudspeaker installed in his hotel and under his control and for the entertainment of his guests, enabling the hearing of a copyrighted musical composition which has been broadcast from a radio transmitting studio station, constitute a performance of such musical composition within the meaning of the law?"

The song, "Just Imagine," was broadcast in August, 1927, from KWKC, owned by William Duncan, who was also made defendant, but who defaulted in the first court, whereupon an injunction was issued against him and damages assessed.

Hotel's Defense

The hotel makes two main contentions: (1), that the hotel was not a performer, and (2), that the alleged performance was not for profit.

The District Court sustained the hotel, stating that no copyright infringement had been committed by the hotel, because the exclusive right obtained under a copyright does not carry with it a proprietary interest in the waves that go out in the ether when such composition is broadcast, since such waves are the common property of all.

Also, reception of a musical composition on a radio set is not a performance at all, the lower court held, even though the received music was furnished to guests in private and public rooms of a hotel.

Vallee Donates Profits From Maine Stein Song

All profits accruing to Rudy Vallee from the "Maine Stein Song," will be given to the University of Maine to be used in erecting a new gymnasium on the campus, the NBC artist has announced.

The promise was made by Vallee during a recent testimonial dinner to him by the alumni club of the university. During his speech at the dinner the artist related in detail how the "Stein Song" had been lifted from the musical morgue to become a leading musical number of America almost overnight.

Board Finds SOS Rule Broken

Washington.

A warning to all licensed coastal and ship radio stations to observe the international radiotelegraph regulations requiring that watches be maintained twice hourly on the international distress wave, and that the requisite "silent periods" be observed in the interest of safety of life at sea, was issued by the Federal Radio Commission.

The attention of the Commission has been called to the fact that ship and coastal stations "have not been observing" this provision of the international convention, the Commission stated in a circular to all holders of licenses for this mode of radio communication.

CONSOLIDATION BILL ADOPTED

Washington.

The Senate passed the Dill bill for the transfer of the radio work of the radio division of the Department of Commerce to the Federal Radio Commission, effective July 1st. The measure was sent to the House.

The Dill measure, introduced by Senator Dill (Dem.) of the State of Washington, provides that the entire personnel of the radio division be taken over by the Commission without change in salary or status.

Consolidation of the two agencies, according to Senator Dill, is planned as a forerunner to the proposed Federal commission on communications, with full authority over telephones, telegraph and cables as well as radio. The communications commission is projected in the Couzens bill now pending before the Senate Committee on Interstate Commerce.

The radio division, as at present constituted, is the radio "police agency," charged with checking the operations of all licensed users of the ether, inspections of apparatus, and ascertaining that the Federal laws governing radio and the regulations of the Commission are enforced.

William D. Terrell is chief of the division, which has a force of approximately 50 radio supervisors and inspectors, distributed among the nine radio supervisors' districts. In each of these districts, says the "United States Daily," frequency-checking apparatus is maintained for the purpose of checking station operations. A fleet of "radio patrol" cars, equipped with measuring apparatus, also operates from each of these offices.

Besides these functions, the division is charged with the licensing of apparatus and operators for radio communication, both ashore and afloat.

LITERATURE WANTED

G. A. Ernst, 14705 Kercheval Ave., Detroit, Mich.
Louis Puzio, 100 Wood St., Garfield, N. J.
Floyd Tillman, Box 484, Post, Tex.
Otto T. Hagen, 117 S. Page St., Stoughton, Wis.
P. Provost, 4676 St. André St., Montreal, Canada
Wm. Clark, Jr., 817 S. Washington St., Circleville, Ohio.
J. M. Everitt, Sharp St., Hackettstown, N. J.
Harry D. Dudichurn, Jr., 125 East Ave., Pitman, N. J.
Edward J. McNamara, 2217 - 39th St., Camden, N. J.
Robert Andrews, 211 N. Edgefield, Dallas, Tex.
E. J. Barnett, South Boston, Virginia.
O. L. Wright, Cranberry, No. Car.
H. J. Myers, 6401 University, Chicago, Ills.
John W. Welstead, 98 Cushing St., Portsmouth, Va.
John E. Romer, 3401 Grove Ave., Richmond, Va.

PROGRAM GOES ON, BUT STATION OFF, DURING SOS

Every listener knows what SOS means. Somewhere a ship is in distress. Somewhere lives are in danger. And until the SOS has been answered and the distressed ship located, the biggest show in the world—the theatre of the air—stops its performance.

But what actually happens when an SOS is pounded out? How do the radio stations know when to stop broadcasting and when to go back on the air?

O. B. Hanson, Manager of Plant Operations and Engineering of the National Broadcasting Company and himself a veteran sea-going wireless operator, gives the answer. Hanson tapped out an SOS from a sinking ship years ago. He was wireless operator aboard the S.S. Stephano when that vessel was torpedoed by a German submarine in October, 1916.

Order to Operator

"When a ship is in danger and needs help the wireless operator receives an order to send out the SOS," Hanson said. "This call, best known of all International code signals, is merely three dots, three dashes and three dots. It is one of the most easily recognized signals and the combination of letters was selected for that reason and not because the letters stand for Send Out Ships or Save Our Ship or Send Out Succor or Save Our Souls, as many people believe.

"The ship operator tunes his set to 600 meters and with all the power available pounds out the distress signal. The first ship or land station to pick up the SOS attempts to establish radio connections with the distressed ship and at the same time sends out the QRT signal, which might mean Quiet Radio Transmission. All stations must stop transmitting when this signal goes on the air.

Program Goes Right On

"Often stations broadcasting entertainment are the first to hear an SOS, for all broadcasters are required to keep an SOS watch. All stations operated by the National Broadcasting Company keep a man on the SOS watch continually.

"He is a licensed operator and has his receiving set constantly tuned to 600 meters. As soon as he hears the SOS, he throws a switch and, at a special microphone, announces that the program is off the air. Then he notifies the studios.

"The nearest naval radio station is immediately notified when an SOS is received and that station takes charge of traffic on the air and sends out the QRT signal. All stations not actually communicating with the distressed ship are shut down until the situation is cleared.

Artists Last to be Told

"Radio artists at the microphone usually are the last to hear of an SOS. It is a studio custom that the programs continue regardless of whether the station is on the air or not. This is necessary in order not to upset the carefully worked out schedule.

"When the air finally is cleared and broadcasting may be resumed, the clearance is flashed from station NAH, naval transmitter in Brooklyn."

90% REGIONAL STATIONS CITE INTERFERENCE

By HAROLD A. LAFOUNT
Federal Radio Commissioner

Because of the ever-increasing demand from all sections of this country for added radio facilities, including change of wavelength, increased power, new stations, etc., and because most of the applications are for regional facilities, the Federal Radio Commission decided to make a survey of stations occupying regional channels, or using 250 to 1,000 watts power, to ascertain as nearly as possible the service area of each, and the amount of interference, if any.

Questionnaires were sent to all such stations, and replies indicate the average night service area of a 1,000-watt station to extend about 50 miles in each direction from the transmitter.

Ninety per cent of these stations report interference either from stations on the same or adjoining channels. The service area increases and interference decreases where stations on the same frequency are 1,000 miles or more apart. A less separation reduces the effectiveness and increases the interference.

Separation Must Exceed 1,000 Miles

These data supplied by the stations themselves coincide to a remarkable degree with reports of the radio supervisors based upon thousands of monitoring checks and also with reports made by many listeners. With this information before them the Commission's engineers are studying the problem of duplicating stations on the same frequency and methods of reducing interference.

It is very evident that most applicants are being misled by the Commission's present allocation of regional stations. They base their applications and urge grants on the basis of those already made, little realizing the present overcrowded conditions, which is a result of the Commission's desire to accommodate all existing stations.

To improve reception and reduce interference regional stations on the same frequency must be more than 1,000 miles apart; consequently, applicants should not feel they are being discriminated against when their applications are denied, although their requests may be for assignments similar to many already in existence.

Wants Fewer Stations

The aim and object of the Commission are to improve conditions, consequently existing allocations should not be considered as a basis for new applications. Many applicants are further deceived by the fact that they, not hearing a station on some particular frequency or at some point on the dial, believe that frequency to be available in their locality.

They completely lose sight of the fact that the nuisance area of a station is many times greater than its service area, and that the so-called carrier wave extends far beyond the modulated wave, thus heterodyne interference results. This carrier wave is not usually detected by the average receiving set.

The only way materially to improve radio reception in the United States is to eliminate a number of stations and to apply strictly sound engineering principles in making any future assignments.

Committee Scans Pentode Needs

Constructive steps in the development and application of pentodes and other new radio tubes are being taken by the Radio Manufacturers Association.

Roger M. Wise of Emporium, Pa., has accepted the chairmanship of the recently appointed R. M. A. Joint Committee on New Tubes.

At the first meeting of this Committee, recently held in New York, a number of questionable points in connection with the proposed pentode or five-element tube were discussed and tentative characteristics for pentode detectors and audio output tubes for experimental use were determined. Several of the tube manufacturers will make up experimental pentodes for the engineers of the receiver manufacturers to work with in the laboratory with a view to exchange results in a later meeting and deciding which tubes, if any, may be desirable for production and incorporation in radio receivers.

RADIO EXPANDS SPEECH APPEAL

By RAY LYMAN WILBUR
Secretary of the Interior

Throughout the whole history of the human race, until the last decade, the old phrase "within the sound of my voice" meant that the limits were very narrow for the orator. The printed word carried much farther. But today, with the radio, it is possible for the voice to have a national, if not a world-wide, scope. This makes it more incumbent upon us than ever to see that those who are to speak to us have a sound fundamental training; that they organize what they have to say, so that it will be orderly and effective, and that they feel the responsibility which must apply to those who speak to an unseen audience.

There is something about the relationship of the audience to a speaker which vitalizes and intensifies the capacities of the speaker. This is one of those extraordinary human relationships which we know exist but which we find it impossible fully to understand. It is the element that gives us often what we call leadership, though unfortunately it is often misleadership.

Now with the radio, the carefully balanced diaphragm and wire contraption provided for the speaker provide no such stimulation as comes from a visible audience. Because of this, the preparation of the speaker at present must be more extensive and thorough, since the appeal he makes is more to the intellect than to the emotions.

I consider this one of the most fortunate advances made possible through the radio. Buncombe over the radio sounds like buncombe. Sometimes audiences feel that it may be the truth.

Because of these changes that are going on in the relationship to the use of the spoken word, I am particularly interested in national oratorical contests, since they have stimulated the boys and girls of our country to express themselves well, to gain confidence before an audience, and to learn to use their minds freely while controlling their tongues.

WISE JOINS MARTWELL

Martin Zatulove, president of the Martwell Corporation, 1501 Broadway, New York City, announced the addition of Harry Wise as vice-president.

NEED IS CITED FOR UNIVERSAL RADIO TONGUE

International communication, especially by radio, has created an immediate need for an international language, Dr. Alfred N. Goldsmith, vice president of the Radio Corporation of America, declared recently before the International Auxiliary Language Association in New York City.

"The exchange of Christmas greetings between nations and continents last Winter, and more recently the broadcasting of reports of the disarmament conference in London showed that we are up against a fact, not just a theory," Dr. Goldsmith declared.

Six International Tongues

There are now six rival international languages—esperanto, ido, nov. esperanto, occidental novial, and Latin without inflections. Co-operation among the exponents of these languages is needed to make much progress toward an international language.

Mrs. Dave Hennan Morris, honorary secretary of the association and one of the most active workers, told of the work done toward co-operation at the international meeting of linguistic research at Geneva a year ago.

Needed At Conferences, Too

The need for a universal language in international conferences was pointed out by Dr. Herbert N. Shenton, Professor of Sociology at Syracuse University. There are 300 such conferences a year, he said, and organizations conducting them range from free thinkers to bicyclists.

Other speakers at the meeting were Dr. Samuel W. Stratton, president of the Massachusetts Institute of Technology, Dr. Edward L. Thorndyke and Dr. Robert H. Fife of Columbia University, and Dr. Henry Grattan Doyle of George Washington University.

Phone to be Used on N. Y. City Fireboats

Radio telephone will be used to direct the New York city fireboats as soon as the two-way communication set has been installed on the fireboat John Purroy Mitchel, it has been announced by Chief Valentine Fendrich of the Bureau of Fire Alarm Telegraph. The Federal Radio Commission has authorized the John Purroy Mitchel to operate on 1,596 kilocycles and has assigned the call letters WRBC to the vessel.

The equipment will be installed through the courtesy of the Western Electric Company, since no appropriations have been made by the city for the experiment. The receiving equipment on land will be in the office of Deputy Chief John J. McElligott of the marine division of the fire department.

According to Chief McElligott, thousands of dollars will be saved by the prevention of useless trips responding to false alarms. With the radio telephone on board the vessel can be informed en route whether the alarm is false or whether it is necessary to proceed.

New Incorporations

Texas Radio Corporation, Wilmington, Del., operate broadcasting stations—Corporation Service Co.
Recorded Radio Corporation, broadcasting—Atty. S. J. Schwartzman, 220 West 42nd St., New York, N. Y.

TRUST SUIT IS FOR CONSPIRING AND "POOLING"

Washington.

The radio anti-trust suit started by the Federal Government is directed against the following defendants:

Radio Corporation of America, a Delaware corporation.

General Electric Co., a New York corporation.

American Telephone and Telegraph Co. a New York corporation.

Western Electric, a New York corporation.

RCA Photophone, Inc., a Delaware corporation.

RCA Radiotron, Inc., a Delaware corporation.

RCA Victor Co., Inc., a Delaware corporation.

General Motors Radio Corporation, a Delaware corporation.

General Motors Corporation, a Delaware corporation.

Sherman Act Called Violated

Conspiracy and a combination in restraint of trade, in violation of the Sherman Act, are alleged. Sections 19 and 20 of the complaint follow:

19. The defendants in the manner and by the means hereinafter alleged have been and are engaged in a combination and conspiracy in restraint of trade and commerce among the several States and with foreign nations in radio communication and radio apparatus, and the defendants are parties to contracts, agreements and understandings in restraint of said commerce, in violation of section 1 of the act of Congress of July 2, 1890 (26 Stat. 209), known as the Sherman Anti-Trust Act, and the defendants have in like manner monopolized and are attempting to monopolize, and are combining and conspiring with one another to monopolize, said commerce among the several States and with foreign nations in violation of section 2 of said act, and this suit is instituted to prevent and restrain the defendants from further violating said act.

Pool Outlined

20. As a part of said unlawful combination, conspiracy and monopoly, the defendants by contracts, agreements and understandings made between themselves at various times, beginning in the year 1919, have granted to each other rights to make, use and sell radio apparatus under all existing and future patents and patent rights on radio apparatus held or acquired by them; and the defendants thereby have had and enjoyed a community of interest in each and all of said patents and patent rights and in the control thereof; and the defendants have continuously used and dealt with said patents and patent rights as being jointly owned for their common, mutual and exclusive benefit; and have assigned and allocated among themselves the exclusive use, enjoyment and benefits of said patents and patent rights, including the right to make, use and sell all radio apparatus covered by said patents and patent rights; and the defendants have thereby divided among themselves the business of interstate commerce in radio communication and radio apparatus, to the end that they should not compete with each other in said commerce and

Bathtub Singing Flatters Voice

Singing in the bathtub is just a form of conceit, according to Reinald Werrenrath, vocal counsel of the National Broadcasting Company.

"Bathrooms are generally small," he said. "Their walls, particularly if they are of tile, make splendid sound reflectors. When the occupant of the bathtub bursts into song his voice literally bounces back and forth from the four walls, creating a pleasing resonance.

"The bathtub singer's voice, with the aid of the sound-reflecting walls, seems from 50 to 100 per cent better than it really is. If you don't believe it, try singing in the bathtub and later sing the same song in a sound-deadened room such as, for example, your bedroom."

TONE CONTROLS FEATURE SETS

Tone quality will be the dominant factor of appeal in the radio receivers of 1930-31. Heretofore, the appeal has been to appearance of the cabinet, the kind of tubes used in the circuit, the selectivity and the sensitivity, or distance getting ability.

This season the manufacturers emphasized tone realism at the sixth annual trade show held recently in the Atlantic City Auditorium.

Manufacturers have come to realize that the customers have become tone conscious, that they recognize realistic reproduction as the main function of the receiver, and because of this realization the manufacturers have designed sets which stress tone quality. True, they have not neglected the other features heretofore regarded as essential, but they are stressing tone.

One of the features in the new sets is tone control, a device which enables the listeners to choose the kind of reproduction they wish. Owners of the new models no longer will have to be satisfied with the tone quality that is predetermined in the set but they can select their own combinations. If they prefer the emphasis on the treble and thus get richness in the high notes, which affords particularly distinct speech, they can have it by turning a knob or switch. If they want the emphasis on the bass, which means rich voluminousness on the low tones of the piano, the orchestra, the organ, they can have that, too, by turning the same knob to another position. Or if they prefer a more even distribution of the volume the same knob is the means for procuring it.

to the end that each primary defendant should unlawfully restrain and monopolize said commerce in the fields allocated to it and the remaining primary defendants should refrain from competing in said fields. Pursuant to said combination, conspiracy and monopoly the defendants have continuously refused, except on terms prescribed by them, to grant licenses under said patents and the patent rights to any individuals, firms or corporations for the purpose of enabling the latter to engage in radio communication, radio broadcasting or interstate commerce in radio apparatus, independently of, or in competition with, the defendants.

JONES & HARE, FUNSTERS, ALSO BUSINESS FIRM

Billy Jones and Ernie Hare, formerly known as the Happiness Boys, but who for an enhanced consideration have become the Interwoven Pair, may seem like a couple of casual funsters to listeners, but, besides the entertainment side, they are a business organization. They have a suite of offices on Broadway, in New York City, equipped like any other up-to-date business organization, and the payroll includes an office boy, a music arranger, a secretary and a manager.

In the office are a piano, a time chart and a stop watch, but otherwise the equipment is as elsewhere.

Thus have Jones and Hare made a business out of the profession of entertainment. These business methods, they claim, form another reason for the \$1,800 income tax payment each made to the Federal Government last March 15th.

Met Twelve Years Ago

Jones and Hare met twelve years ago in a phonograph recording studio. Jones, the tenor, and Hare, the baritone, were there to make records as individuals. A director, after listening to them work, suggested a duet. A duet it was from then on.

Their first radio broadcast came some five years later.

In those days neither was married and the two were partners in every sense of the word. They stayed at the same hotels, ate at the same places and enjoyed the same amusements. If they were apart for three consecutive hours both began to worry about the safety of the partnership.

Hare Is Married

Hare has since married and Mrs. Hare now demands some of his attention. The team of Jones and Hare is seen around almost as often as the team of Hare and Mrs. Hare. Jones is not married.

The first Jones and Hare broadcast occurred in October, 1921. The scene was the original WJZ studio atop the Westinghouse Electric and Manufacturing Company's plant in Newark, N. J. They went on the air at a moment's notice with the same type of program they are playing today, a song and chatter act, the chatter having been written by themselves and the songs especially arranged by them. The program ran for an hour and a half, or until the performers had exhausted their repertory.

Only 12 Original Jokes

Jones said the other day: "Remember, there are only twelve original jokes, and we have been doing at least nine a week for radio over a seven-year period. We keep a complete file of our 'gags' and avoid repetition."

Dress Shirt's Squeak Annoys Listeners

Ray Perkins of the National Broadcasting Company forces complained that the crackling of a dress shirt is enormously amplified in listeners' receiving sets.

Edwin Whitney and other NBC performers and announcers have been irritated by the squeaking of stiff shirts.

RADIO WORLD and "RADIO NEWS"

BOTH FOR ONE YEAR @ **\$7.00**

You can obtain the two leading radio technical magazines that cater to experimenters, service men and students the first and only national radio weekly and the leading monthly, for one year each, at a saving of \$1.50. The regular mail subscription rate for Radio World for one year, a new and fascinating copy each week for 52 weeks is \$6.00. Send in \$1.00 extra, get "Radio News" also for a year—a new issue each month for twelve months. Total, 64 issues for \$7.00.

If renewing Radio World subscription, put cross in square.
RADIO WORLD, 145 West 45th Street, New York, N. Y.

Subscribers! Important!

Note subscription expiration date on wrapper containing your copy of RADIO WORLD. If nearing expiration date, please send in renewal so that you will not miss any copies. Subscription Dept., RADIO WORLD, 145 W. 45th St., New York City.

Hi-Q 30

GET OUR PRICE ON AC OR BATTERY MODEL

Write or wire!

Guaranty Radio Goods Co.

143 West 45th St.,
New York City

NEW DRAKE'S ENCYCLOPEDIA

1,680 Alphabetical Headings from A-battery to Zero Beat; 1,025 Illustrations, 920 Pages, 240 Combinations for Receiver Layouts. Price, \$6.00. Radio World, 145 W. 45th St., N. Y. C.

ARISTOCRAT FLOOR SPEAKER

With Molded Wood Horn and Horn Motor built in. Good value. \$12.00. Acoustical Engineering Associates, 143 W. 45th St., N. Y. C.

SOCKET WRENCH SET FREE

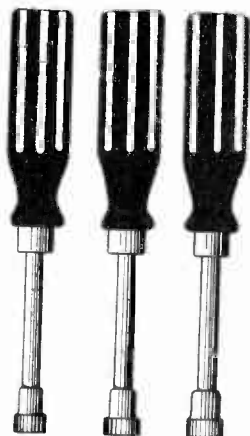

FOR turning down nuts there is nothing as efficient and handy as a socket wrench. Here is a set of three wrenches for hexagonal nuts, enabling use with 5/32, 6/32, 8/32 and 10/32 nuts. Fit the nut into the proper socket and turn down. The three different size sockets, one size on each wrench, enables use of three different outside diameters of nuts, but at least four different sizes of threads. Send 50 cents for four weeks subscription for RADIO WORLD and get this set of three wrenches free!

RADIO WORLD,
145 West 45th Street, New York, N. Y.

Enclosed please find 50 cents for four weeks subscription for RADIO WORLD. Send set of three socket wrenches free!

Name

Address

City State

Cross here if renewing.

FILL OUT AND MAIL NOW

SUBSCRIPTION BLANK

RADIO WORLD

RADIO WORLD

145 West 45th Street, New York City

Please send me RADIO WORLD for months, for which

SUBSCRIPTION RATES:

Single Copy.....\$.13
Three Months..... 1.50
Six Months..... 3.00
One Year, 52 Issues..... 6.00
Add \$1.00 a Year for Foreign Postage; 50c for Canadian Postage.

If this is a renewal, put cross in square at left.

..... please find enclosed

Highest Grade Key Tubes at Defiant Prices!

Screen Grid Tubes

224	at	\$1.43
222	at	1.88

Power Tubes

250	at	4.95
210	at	3.25
245	at	1.28
112A	at	.78
171A	at	.78

Other Tubes

227	at	.90
226	at	.68
280	at	1.13
281	at	2.95
201A	at	.53
240	at	1.60

The above constitute the nine most popular tubes used in radio today. Despite the severely low prices the Key tubes are firsts of the very first quality. Besides, there is a generous replacement guaranty! The above tubes are manufactured under licenses granted by the RCA and its affiliated companies.

All prices are net and represent extreme discount already deducted.

GUARANTY RADIO GOODS CO., 145 West 45th St., N. Y. City. (Just East of Broadway).

Enclosed please find \$..... for which ship at once tubes marked below:

<input type="checkbox"/> 224 AC screen grid\$1.43
<input type="checkbox"/> 245 AC power tube\$1.28
<input type="checkbox"/> 228 AC amplifier65
<input type="checkbox"/> 227 AC det.-amp.90
<input type="checkbox"/> 280 AC restifier\$1.13
<input type="checkbox"/> 222 battery screen grid\$1.88
<input type="checkbox"/> 112A power tube78
<input type="checkbox"/> 171A power tube78
<input type="checkbox"/> 201A battery tube53
<input type="checkbox"/> 240 hi mu tube\$1.60
<input type="checkbox"/> 250 power tube4.95
<input type="checkbox"/> 210 power tube3.25

Name

Address

City State

Put cross here if C. O. D. shipment is desired. Canadian remittance must be by postal or express money order.

Quick Action Classified Ads

Radio World's Speedy Medium for Enterprise and Sales

10 cents a word — 10 words minimum — Cash with Order

EDUCATIONAL

BOOKKEEPING OR ACCOUNTING LEARNED IN 60 hours. New method. Easy. Thorough. Personal instruction. Reasonable tuition. Diploma. Accounting Institute, Duluth, Minn.

HANDY 4 FT. FLEXIBLE TEST-CORDS WITH UNIVERSAL CLIPS—42c—POSTPAID. THREE FOR \$1.00.

TELE-DYNE ELECTRICAL LABORATORY, 2935 WALNUT STREET, CHICAGO.

A REVELATION! Acid-free soldering paste 20c can. Liquid flux 30c bottle. Guaranteed. Furnhold Co. 109-24 - 208th Street, Bellaire, N. Y.

HELP WANTED MALE ONLY

AMAZING SCREW HOLDING SCREW DRIVERS! Remove, insert screws inaccessible places! Factories, garages, electricians, mechanics, auto, radio owners buy on sight! Exclusive territory. Free trial! President, 3742 Spring Lane, Boston.

BARGAINS in first-class, highest grade merchandise. B-B-L phonograph pick-up, theatre type, suitable for home, with vol. control, \$6.57; phono-link pick-up with vol. control and adapter, \$3.50; steel cabinet for HB Compact, \$3.00; four-gang .00035 mfd. with trimmers built in, \$1.95; .00025 mfd. Dubilier grid condenser with clips, 18c. P. Cohen, Room 1214, at 143 West 45th Street, N. Y. City.

THE ELECTRIC WORD, by Paul Schubert.

A narrative of the rise of radio from the discovery of Hertzian waves and the first practical use of them by Marconi, in 1900, to its present-day position of eminence. This book will be of great interest, not only to the great army of persons concerned in one way or another with radio work, but also to the layman whose immediate interest in radio is confined to his own set, and who will be fascinated by this story of an interplay of science, business, politics, and diplomacy that is without parallel in history. Price \$2.50.

RADIO WORLD, 145 W. 45th St., New York City

Erla Dynamic Chassis, Westinghouse Rectifier

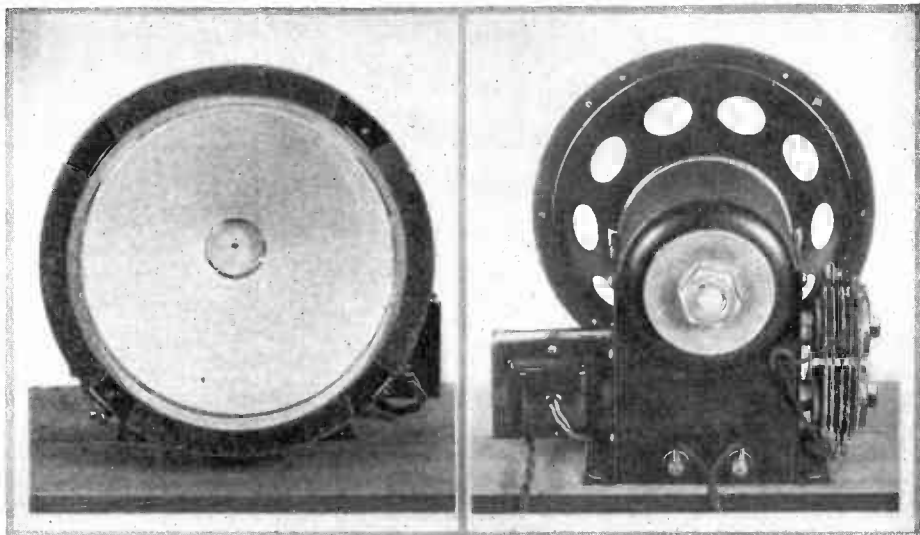

One of the most sensitive and most faithful dynamic speaker chassis, the Erla, has a 9-inch outside diameter cone, with built-in Westinghouse Rectox dry metallic rectifier, output transformer and mounting board. Equipped with 10-ft. A.C. cable and plug, to go into house socket, 110 v. 50-60 cycle, and two 10-ft. tipped leads for connection to set. Will stand up to output of 250 tubes in push-pull, but will work well on any set, battery-operated or A.C. Order Cat. ER-D-AC. List price \$25.00; net price \$22.50. Besides the AC Erla we also have the DC type, for use on 90-125 volts. It may be connected direct to 110 v. DC house line or to 90 v. of B supply. Order Cat. ER-D-DC. List price \$20.00; net price \$18.00. 6v. DC model, to be energized by your 6-volt storage battery. Order Cat. ER-6-v. @ \$12.50

Ansonia Speaker



Ansonia magnetic speaker, in genuine walnut cabinet. A loudspeaker that gives you real performance, that stands up to a 171 or 171A tube without requiring an output filter, and that works splendidly from output filters in sets using tube 171A in push-pull. And the magnetic unit in this Ansonia Speaker is of the very best Ansonia type. The cabinet is a beauty indeed. Order Cat. AN-G. List price \$35, net price \$31.50. **\$4.89**

Velvetone Power Amplifier

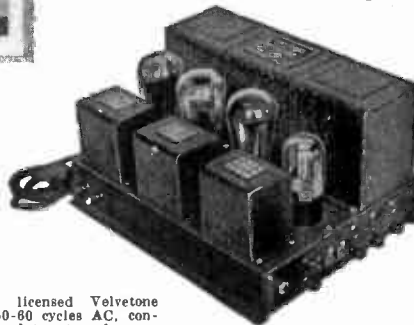

The National Company's wired and licensed Velvetone push-pull power amplifier, for 110 v. 50-60 cycles AC, consisting of B supply for 280 rectifier, and two transformer-coupled audio stages, the first 227, the second 245s in push-pull, with output transformer built in. Supplies all B voltages for an AC or any other tuner, also 2.5 v. heater voltage for 227 and screen grid KF, detector and preliminary audio tubes, and is especially suitable for the MB-29 tuner. Order Cat. P.P.P.A. List price \$97.50; net price \$87.75. **\$56.52**
 MB-29 AC screen grid tuner parts, assembled complete in chassis. Uses four 224 and one 227 detector. Equipped with new tuning condensers, built-in trimmers, volume control and AC front panel switch (not illustrated). Order Cat. MB-29-K. List price \$69.50; net price \$62.55. **\$39.61**

MB-29 Screen Grid Tuner

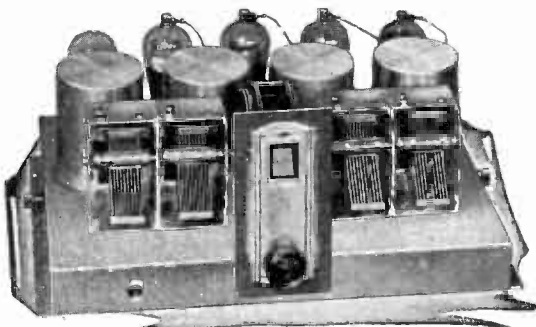

220-v Kodel "B" Supply



Kuprox B eliminator, Model 316, 220 volts DC, utilizing 280 tube, for 110 v. AC, 50-60 cycles, to deliver positive voltages of 45, 90, 135 and 180 and negative voltage of 40 for biasing 171 or 171A, also delivers 4 volts negative for other receiver tubes. One knob on the terminal panel controls the actual voltage on the 45-volt tap and another knob controls the voltage on the 180-volt tap. The terminal panel contains in addition to the two knobs seven binding posts for B minus, which is connected to the case, for the four positive and the two negative voltages. It is provided with a standard plug and an 80-inch connecting cord. The overall dimensions are width 5 1/4 inches; length, 13 inches; height, 8 1/4 inches. Order Cat. KO-B. List price \$25, net price **\$13.16**
280 TUBE FREE WITH EACH KO-B

Mike Lighter

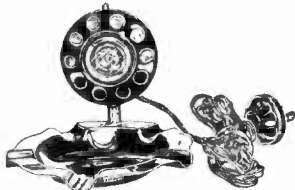

Clear-cigarette stand, with imitation microphone pedestal, into which is built a lighter. Press button at top and light up. 10-ft. AC cable and plug. Works on AC or DC, 110 v. Order Cat. MIK-L-S. List price \$2.75; net price **\$1.49**

Spring Action Nipper



Handiest radio tool. Cuts even 8/32 machine screws. All wire, of course. Order Cat. NIP. List price \$2.75; net price **\$1.49**

Reference Book



Biggest bargain price of this famous encyclopedia, containing definitions of 1930 different terms. Classified alphabetically and defines the terms used in radio. Pages 9x12 inches, 540 illustrations. Cross-indexed. Order Cat. GER-EN. List price \$2.50, net price **\$1.49**

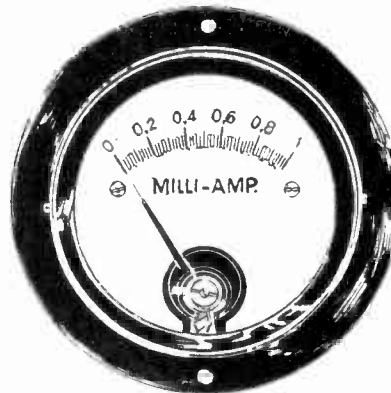

0-1 milliammeter, 99% accurate; panel mount type; internal resistance, 88 ohms; used as voltmeter, with 1,000 series ohms for each volt to be read, has resistance of 1,000 ohms per volt. Order Cat. F-0-1. List price \$12; net price **\$5.95**

Turntable Motor



Synchronous motor, for phonograph records, 80 revolutions per minute. Works on 60-cycle 110 v. AC. Smooth-running and lasts a lifetime. Fine for console installation. Turntable free with each synchronous motor order. Order Cat. SY-M. List price \$20, net price **\$10.00**

"Radio Trouble Shooting"

By E. R. Haan

The outstanding exposition of the solution of radio troubles. Just the thing for service men and experimenters. 328 pages 6x9 inches; 300 illustrations. Order Cat. HA-TS @ **\$3.00**

Write for circular on Haan's book.

Guaranty Radio Goods Co., 143 W. 45th Street, New York, N. Y. (Just east of Broadway)

- Enclosed please find \$..... for which send me the following:
- Cat. ER-D-AC @ \$12.50
 - Cat. ER-D-DC @ \$10.00
 - Cat. AN-G @ \$4.89
 - Cat. PPPA @ \$56.52
 - Cat. MB-29-K @ \$39.61
 - Cat. MIK-L-S @ \$1.49
 - ER-6-V @ \$9.25
 - Cat. NIP. \$1.49
 - Cat. GER-EN. \$1.49
 - Cat. SY-M, \$10.00
 - Cat. HA-T-S, \$3.00
 - Cat. F-0-1, \$5.95
 - Cat. KO-B, \$16.13

Canadian remittance must be by express or P. O. Money Order. If ordering C. O. D. put cross here.

Name

Address

City..... State.....

"Seconds"

But Serviceable Tubes Nevertheless at Prices That Seem Incredible

A tube factory that maintains the highest possible standards for a large laboratory customer has tubes for sale that fall just a trifle below the most exacting specifications, but which are excellent tubes nevertheless. They are called "seconds" and they are "seconds," but they are not "thirds." You can get 300 hours excellent use out of them. Note the prices. Remit with order. Generous replacement policy.

112A	50c	227	50c
UV or UX-199	50c	245	50c
201A	45c	250	75c
210	60c	171A	50c
224	65c	280	50c
226	50c	281	60c

DIRECT RADIO CO.
Room 504, at
1562 Broadway, N. Y. City.

RECENT NUMBERS

for the current year are procurable at the rate of 15c a copy, or 7 copies for \$1.00. RADIO WORLD, 145 West 45th St., N. Y. City.

Horn Unit \$2.25



Fidelity Unit, Cat., FDU, price \$2.25

or otherwise. The casing is full nickel finish, highest polish.

This unit can be used in a portable without any horn attached and will give loud reproduction. Standard size nozzle and thread. Works great from AC set, battery set or any other set, push-pull.

GUARANTY RADIO GOODS CO.
143 West 45th Street, New York City

RADIO WORLD'S BOOK SERVICE

has been found of great value not only by radio fans, constructors, etc., but also by radio and other technical schools throughout the country. See the radio books advertisement in this issue.

The Fidelity unit is prominent for horn-type speakers such as exponential horns. The faintest word from a "whispering tenor" or the tumultuous shout of the crowd or highest crescendo of the band is brought out clearly, distinctly. Stands up to 450 volts without filtering. Works right out of your set's power tube, or tubes, requiring no extra voltage source. Standard size nozzle and thread. Works great from AC set, battery set or any other set, push-pull.

Parts for All-Wave Set

[Order what individual parts you desire. You don't have to order all.]

- Two sets of precision, de luxe coils, wound on ribs, 93 per cent. air dielectric, three coils to a set; one detector plate coil with mounting bushings total, seven coils to cover 15 to 560 meters (Cat. AW-CK) @ \$12.00
- Two Hammarlund .0005 mfd. straight frequency line condensers (Cat. II-SP-5 @ \$3.20) @ 6.60
- One 20-ohm filament resistor (Cat. FIL-20) @ .20
- One 1 1/3 ohm filament resistor (Cat. FIL-13) @ .20
- One 1 1/4 x 9/16 inch bakelite subpanel, with four UX and one UY sockets built in, also two coil receptacles built in (Cat. AW-SUB @ 3.50
- One 5-lead battery cable with 5-prong plug attached (Cat. 5-L-CP) @ 1.50
- One steel cabinet with crinkle brown finish 7x15 1/2 x 10 1/2 (Cat. AW-CAB) @ 4.50
- One bottom shield for cabinet (Cat. SH-BOT) @ 1.50
- One 1-to-3 audio transformer (Cat. GB-1-3) @ 1.50
- One 1-to-5 audio transformer (Cat. GB-1-5) @ 1.50
- Two insulating washers for volume control (Cat. IN-W) @ .05
- Four subpanel brackets (Cat. BRA) @ .05
- One antenna-ground binding post unit (Cat. A-G-BPU) @ .35
- One speaker binding post unit (Cat. SP-BPI) @ .35
- One .00025 mfd. grid condenser with clips (MICON-00025-CL) @ .18
- One Lynch 5 meg. metallized grid leak (Cat. LYN-5) @ .20
- Two National type VB-D variable ratio dials, maximum reduction to 20-to-1 with 2.5 volt pilot lights and illumination brackets (Cat. VI-D-PB) @ \$1.80
- Two Polymet 1 mfd. bypass condensers, single line type, (case goes to ground), (Cat. POLY-1) @ 50c
- One 30,000 ohm Chromat wire-wound potentiometer with switch attached (Cat. CLA-30,000-S) @ 1.50
- All parts (Cat. AP-AWR) @ \$40.78

PORTABLE

as described on page 10 of this issue, \$35.00 assembled.

Guaranty Radio Goods Co.
145 W. 45th St., N. Y. C., Just E. of B'way

Official Parts for Popular Circuits

- 1,500 to 200,000 ohmmeter, 0-10, 0-200, 0-1,000 voltmeter, at 1,000 ohms per volt; includes 0-1 ma. resistors, knob, calibrated panel, switches, cabinet, etc., as described by Herman Bernard. Cat. OM-VM @ \$13.70
- Universal Short-Wave Converter, using three 227 tubes; six de luxe precision short-wave air dielectric coils, condensers, chokes, 7"x14" panel, etc. Cat. UN-SVC @ \$22.37

GUARANTY RADIO GOODS CO.
143 West 45th Street
New York City

BROADWAY-HOLLYWOOD

World's most intriguing places. Where famous stage, screen, radio stars live their lives. Intimate stories of their stage and personal doings in

NEW YORK STAR National Illustrated Amusement Weekly

Edited by Roland Burke Hennessy. Clever writers: cover comedy, tragedy, fascination of professional life. Portraits and unusual pictures of favorites. 10c copy, \$5 year (52 issues). SPECIAL: 12 issues \$1. STAR, 1562 Broadway, New York.

MICROPHONE LIGHTERS

For cigars or cigarettes, with button switch at top. Press switch, and lighter acts instantaneously. New. Model B lighter on tray, \$1.50. Radio World, 145 W. 45th St., N. Y. C.

RADIO WORLD'S QUICK-ACTION CLASSIFIED ADS

10 CENTS A WORD
10 WORDS MINIMUM
CASH WITH ORDER



Your Choice of These Nine Meters FREE!

0-8 Voltmeter D.C.	No. 328
0-50 Voltmeter D.C.	No. 337
0-Volt Charge Tester D.C.	No. 23
0-10 Amperes D.C.	No. 338
0-25 Milliamperes D.C.	No. 325
0-50 Milliamperes D.C.	No. 330
0-100 Milliamperes D.C.	No. 339
0-300 Milliamperes D.C.	No. 339
0-400 Milliamperes D.C.	No. 334

Equip Yourself Now With Necessary Meters!

To do your radio work properly you need meters. Here is your opportunity to get them at no extra cost. See the list of nine meters at left. Heretofore we have offered the choice of any one of these meters free with an 8-weeks subscription for RADIO WORLD at \$1. the regular price for such subscription. Now we extend this offer. For the first time you are permitted to obtain any one or more or all of these meters free, by sending in \$1 for 8-weeks subscription, entitling you to one meter; \$2 for 16 weeks, entitling you to two meters; \$3 for 24 weeks, entitling you to three meters; \$4 for 32 weeks, entitling you to four meters; \$5 for 44 weeks, entitling you to 5 meters; \$6 for 52 weeks, entitling you to six meters. Return this offer with remittance and check off desired meters in squares at left.

RADIO WORLD will help you in your radio work, as you will be able to use the meters most valuably. Keep abreast of all the new circuits, intimate details on perfecting existing sets, and get inside track on sensitivity, distance, reception, tonal quality, and news of radio, technical and non-technical. Enjoy the writings of Dr. Lee De Forest, McMurde Silver, J. E. Anderson, Herman Bernard and a host of other radio engineers who contribute their knowledge to you through the medium of RADIO WORLD, the first and only illustrated national radio weekly. You can find no magazine that better caters to your needs than RADIO WORLD. Short waves? RADIO WORLD will tell you all about them. Extremely sensitive broadcast receivers? Their construction and operation are fully discussed with confident regularity. Power supplies --push-pull or otherwise? AC receivers? Screen grid tubes? Large receivers that give a super-abundance of performance--small, economical receivers that give performance out of all comparison to their size? Are you interested in these? Then you're interested in RADIO WORLD.

Present mail subscribers may renew their subscription under this remarkably generous offer. Put a cross in square under

RADIO WORLD
145 W. 45th St., N. Y. City--Published Weekly.
All Newsstands, 15c per copy--\$5, six months--\$8 a year

Two for the price of One

Get a FREE one-year subscription for any ONE of these magazines:

- CITIZENS RADIO CALL BOOK AND SCIENTIFIC DIGEST (quarterly, four issues).
- RADIO (monthly, 12 issues; exclusively trade magazine).
- RADIO ENGINEERING (monthly, 12 issues; technical and trade magazine).
- RADIO INDEX (monthly, 12 issues) Stations, programs, etc.
- SCIENCE & INVENTION (monthly, 12 issues; scientific magazine, with some radio technical articles).
- AMERICAN BOY--YOUTH'S COMPANION (monthly, 12 issues; popular magazine).
- BOYS' LIFE (monthly, 12 issues; popular magazine).

Select any one of these magazines and get it FREE for an entire year by sending in a year's subscription for RADIO WORLD at the regular price, \$6.00. Cash in now on this opportunity to get RADIO WORLD WEEKLY, 52 weeks, at the standard price for such subscription, plus a full year's subscription for any ONE of the other enumerated magazines FREE! Put a cross in the square next to the magazine of your choice, in the above list, fill out the coupon below, and mail \$6 check, money order or stamps to RADIO WORLD, 145 West 45th Street, New York, N. Y. (Just East of Broadway).

Your Name

Your Street Address

City State

- If renewing an existing or expiring subscription for RADIO WORLD, please put a cross in square at beginning of this sentence.
- If renewing an existing or expiring subscription for other magazine, please put a cross in square at the beginning of this sentence.

RADIO WORLD, 145 West 45th Street, New York, N. Y. (Just East of Broadway)

DOUBLE

VALUE!

Accurate Tuning Condensers and Accessories

EQUALIZER

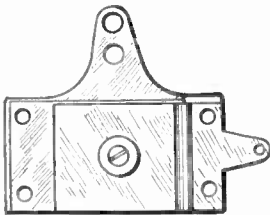

CAT. EQ-100 AT 35c

The most precise and rugged equalizing condenser made, with 20 mmfd. minimum and 100 mmfd. maximum, for equalizing the capacity where gang condensers are used that are not provided with built-in trimmers. Turning the screw alters the position of the moving plate, hence the capacity. Cross-section reveals special threaded brass bushing into which screw turns, hence you can not strip the thread. Useful in all circuits where trimming capacity of 100 mmfd. or less is specified. Maximum capacity stamped on

SINGLE .00035

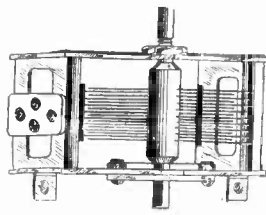

CAT. KH-3 AT 85c

A single .00035 mfd. condenser with nonremovable shaft, having shaft extension front and back, hence useful for ganging with drum dial or any other dial. Shaft is 1/4 inch diameter, and its length may be extended 3/8 inch by use of Cat. XS-4. Brackets built in enable direct sub-panel mounting, or may be piled off easily. Front panel mounting is practical by removing two small screws and replacing with two 3/34 screws 3/4 inch long. Condenser made by Scovill Mfg Co.

THREE-GANG SCOVILL .0005 MFD.

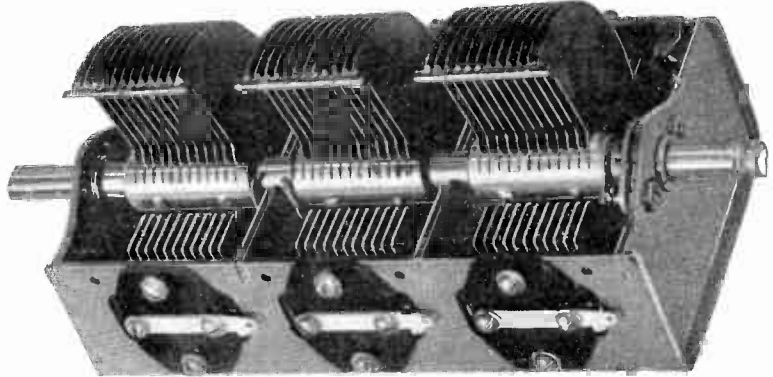

One of the finest, strongest and best gang condensers ever made is this three-gang unit, each section of full .0005 mfd. capacity, with a modified straight frequency line characteristic. The net weight of this condenser is 3 3/4 lbs. Cat. SC-3G-5 at \$4.80.

HERE is a three-gang condenser of most superior design and workmanship, with an accuracy of at least 99% per cent. at any setting — rugged beyond anything you've ever seen. Solid brass plates perfectly aligned and protected to the fullest extent against any displacement except the rotation for tuning. It has both side and bottom mounting facilities. Shaft is 3/8 inch diameter and extends at front and back, so two of these three-gangs may be used with a single drum dial for single tuning control. For use of this condenser with any dial of 1/4 inch diameter bore, use Cat. XS-8, one for each three-gang. Tension adjusters shown at right, other side of shaft.

SALIENT FEATURES OF THE CONDENSER

- (1)—Three equal sections of .0005 mfd. capacity each.
- (2)—Modified straight line frequency shape of plates, so-called midline.
- (3)—Sturdy steel frame with rigid steel shields between adjacent sections. These shields minimize electric coupling between sections.
- (4)—The frame and the rotor are electrically connected at the two bearings and again with two sturdy springs, thus insuring positive, low resistance contact at all times.
- (5)—Both the rotor and the stator plates are accurately spaced and the rotor plates are accurately centered between stator plates.
- (6)—Two spring stoppers prevent jarring when the plates are brought into full mesh.
- (7)—The rotor turns as desired, the tension being adjustable by set-screw at end.
- (8)—The shaft is of steel and is 3/8 inch in diameter.
- (9)—Each set of stator plates is mounted with two screws at each side of insulators, which in turn are mounted with two screws to the frame. Thus the stator plates cannot turn sideways with respect to the rotor plates. This insures permanence of capacity and prevents any possible short circuit.
- (10)—Each stator section is provided with two soldering lugs so that connection can be made to either side.
- (11)—The thick brass plates and the generous proportions of the frame insure low resistance.
- (12)—Provision made for independent attachment of a trimmer to each section.
- (13)—The steel frame is sprayed to match the brass plates.
- (14)—The condenser, made by America's largest condenser manufacturer, is one of the best and sturdiest ever made, assuredly a precise instrument.

RIGID AND FLEXIBLE LINKS

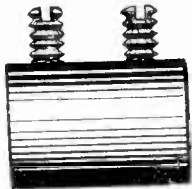

CAT. RL-3 AT 12c

The rigid link, Cat. RL-3, has two set-screws, one to engage each shaft, and is particularly serviceable where a grounded metal chassis is used, as the returns then need no insulation.



CAT. FL-4 AT 30c

Flexible insulated coupler for uniting coil or condenser shafts of 1/4 inch diameter. Provides option of insulated circuits.

For coupling two 1/4 inch diameter shafts, either coil shaft and condenser shaft, or two condenser shafts, a coupling link is used. This may be of the rigid type, all metal, where the link-ed units are not to be insulated.

EXTENSION SHAFTS, TWO SIZES

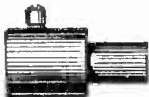

CAT. XS-4 AT 10c

Here is a handy aid to salvaging condensers and coils that have 1/4 inch diameter shafts not long enough for your purpose. Fits on 1/4 inch shaft and provides 3/8 inch extension, still at 1/4 inch. Hence both the extension shaft and the bore or opening are 1/4 inch diameter. Order Cat. XS-4.

For condensers with 3/8 inch diameter shaft, to accommodate to dials that take 1/4 inch shaft, order Cat. XS-8 at 15c.

.00035 TWO-GANG

A two-gang condenser, like the single type, KHS-3, but consisting of two sections on one frame, is Cat. KHD-3, also made by Scovill. The same mounting facilities are provided. There is a shield between the respective sections. The tuning characteristic is modified straight frequency line. Order Cat. KHD-3 at \$1.70.

DRUM DIAL

CAT DD-0-100 @ \$1.50

A suitable drum dial of direct drive type is obtainable for 1/4 inch shafts or 3/8 inch shafts, and with 0-100 scales. An escutcheon, is furnished with each dial.

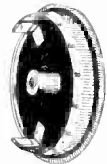

FOUR-GANG .00035 MFD. WITH TRIMMERS BUILT IN

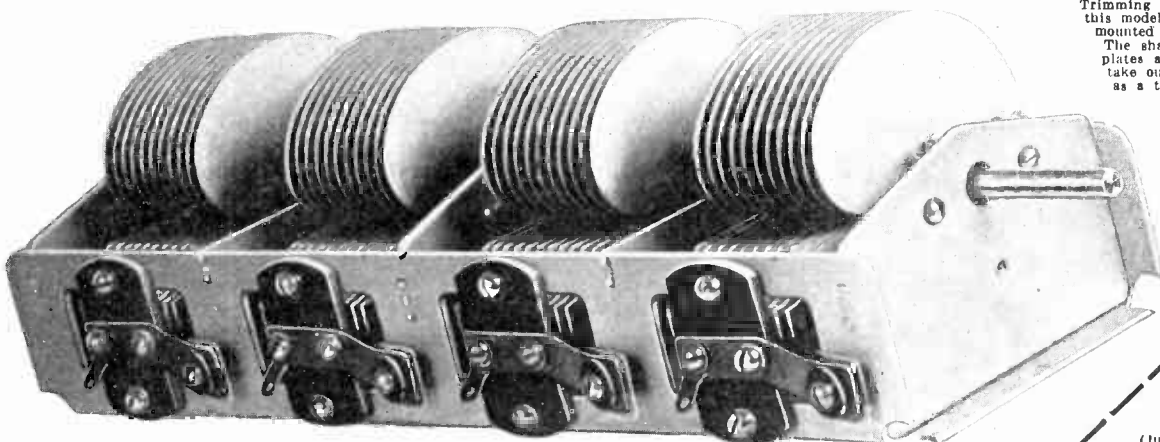

Trimming condensers are built into this model. The condenser may be mounted on bottom or on side. The shaft is removable, also the plates are removable, so you can take out one section and operate as a three-gang.

Four-gang .00035 mfd. with trimmers built in. Shaft and rotor blades removable. Steel frame and shaft aluminum plates. Adjustable tension at rear. Overall length, 11 inches. Weight, 3 1/2 lbs. Cat. SPL-4G-3 @ \$3.95.

SHORT WAVES

Tuning condensers for short waves, especially suitable for mixer circuits and short-wave adapters. These condensers are .00015 mfd. (150 micro-microfarads) in capacity. They are suitable for use with any plug-in coils. Order Cat. SW-S-150 @ \$1.50. To provide regeneration from plate to grid return, for circuits calling for this, use .00025 mfd. Order Cat. SW-S-250 @ \$1.50.

A four-gang condenser of good, sturdy construction and reliable performance fits into the most popular tuning requirement of the day. It serves its purpose well with the most popular screen grid designs, which call for four tuned stages, including the detector input.

Ordinarily a good condenser of this type costs, at the best discount you can contrive to get, about twice as much as is charged for the one illustrated, and even then the trimming condensers are not included. The question then arises, has quality been sacrificed to meet a price? As a reply, read the twenty-six points of advantage. The first consideration was to build quality into the condenser. The accuracy is 99%.

GUARANTY
RADIO GOODS CO.,
143 West 45th St.,
N. Y. C. City
(Just East of Broadway.)

Enclosed find \$.....for
which ship designated parts:

Street Address.....
City..... State.....

the following merchandise as advertised:

- Cat. XS-4 @ 10c
- Cat. KH-3 @ 85c
- Cat. XS-8 @ 15c
- Cat. KHD-3 @ \$1.70
- Cat. RL-3 @ 12c
- Cat. DD-0-100 @ \$1.50
- Cat. EQ-100 @ 35c
- Cat. SC-3 G-5 @ \$4.80
- Cat. SPL-4 G-3 @ \$3.95
- Cat. FL-4 @ 30c
- Cat. SW-S-150
- Cat. SW-S-250

ALL PRICES ARE NET

Headquarters for Outstanding Books—FREE!

"AUDIO POWER AMPLIFIERS"—Anderson and Bernard



"Audio Power Amplifiers" is the first and only book on this important subject. The authors are:
 J. E. Anderson, M.A., former instructor in physics, University of Wisconsin, former Western Electric engineer, and for the last three years technical editor of "Radio World."
 Herman Bernard, I.L.B., managing editor of "Radio World."

The book begins with an elementary exposition of the historical development and circuit constitution of audio amplifiers and sources of powering them. From this simple start it quickly proceeds to a well-considered exposition of circuit laws, including Ohm's laws and Kirchhoff's laws. The determination of resistance values to produce required voltages is carefully expounded. All types of power amplifiers are used as examples: AC, DC, battery operated and composite. But the book treats of AC power amplifiers most generously, due to the superior importance of such power amplifiers commercially.

CHAPTER I. (page 1) General Principles, analyzes the four types of power amplifiers, AC, DC, battery-operated and composite, illustrates them in functional blocks and schematic diagrams.—CHAPTER II. (page 20) Circuit Laws, expounds and applies Ohm's laws and those known as Kirchhoff's laws.—CHAPTER III. (page 35) Principles of Rectification, expounds the vacuum tube, both filament and gaseous types, electrolytic and contact rectifiers, full-wave and half-wave rectification, current flow and voltage derivation. Regulation curves for the 280 tube are given.—CHAPTER IV. (page 62) Practical Voltage Adjustments, gives the experimental use of the theoretical knowledge previously imparted. Determination of resistance values is carefully revealed.—CHAPTER V. (page 72) Methods of Obtaining Grid Bias.—CHAPTER VI. (page 90) Principles of Push-Pull Amplifier.—CHAPTER VII. (page 98) Oscillation in Audio Amplifiers, motorboating and oscillation at higher audio frequencies.—CHAPTER VIII. (page 118) Characteristics of Tubes, tells how to run curves on tubes, how to build and how to use a vacuum tube voltmeter, discusses hum in tubes with AC on the filament and presents families of curves, plate voltage-plate current, for 240, 220, 201A, 112A, 171A, 227, 245, with load lines. Also, plate voltage-plate current characteristics of 220, 200A, 201A, 112A, 171A, 222, 240, 226, 227, 224, 245, 210, 230, full data on everything. There is a composite table (11) of characteristics of Rectifier and Voltage Regulator Tubes, and individual tables, giving grid voltage, plate current characteristics over full useful voltage ranges for the 220, 201A, 112A, 171A, 222, 240, 227, 245 and 224.—CHAPTER IX. (page 131) Reproduction of Recordings, states coupling methods and shows circuits for best connections.—CHAPTER X. (page 161) Power Detection.—CHAPTER XI. (page 121) Practical Power Amplifier, give AC circuits and shows the design of a sound reproduction system for theatres. A page is devoted to power amplifier symbols.—CHAPTER XII. (page 183) Measurements and Testing, discloses methods of qualitative and quantitative analysis of power amplifier performance. Order Cat. APAM.

"Radio Manual"—Sterling



The new edition of "The Radio Manual" answers questions about the principles, methods, or apparatus of radio transmitting and receiving. A complete course in radio operation in a single volume.

20 big chapters cover: Elementary Electricity and Magnetism; Motors and Generators; Storage Batteries and Charging Circuits; The Vacuum Tube; Circuits Employed in Vacuum Tube Transmitters; Modulating Systems and 100% Modulation; Wave-meters; Piezo-Electric Oscillators; Wave Traps; Marine Vacuum Tube Transmitters; Radio Broadcasting Equipment; Arc Transmitters; Spark Transmitters; Commercial Radio Receivers; Marconi Auto-Alarm; Radio Beacons; Practical Television and Radiomovies; Eliminating Radio Interference; Radio Laws and Regulations; Handling and Abstracting Traffic.

The author, G. E. Sterling, is Radio Inspector and Examining Officer, Radio Division, U. S. Dept. of Commerce. Edited by Robert S. Krusa. Nearly 900 pages, 269 illustrations; flexible fabrioid cover. Order Cat. MAN.

"FOOTHOLD ON RADIO"

In simple English that any one can understand, the technical side of radio is presented by Anderson and Bernard in their book, "Foothold on Radio." Any one who can read English can understand this book. It is intended for the sheer novice. The treatment is non-mathematical. The origin of the broadcast wave, its radiation, reception, amplification and rectification are set forth in clear language. Side bands are explained simply. The types of receiving circuits are illustrated, described and contrasted. A chapter is devoted to loudspeakers, explaining the different kinds and the principles of their operation. Performance is compared. Audio coupling is fully explained, also the action of the vacuum tube, with a special analysis of plate current and its behavior. Those who have been thirsting for a book that readily reveals the marvels of the radio science will appreciate this little volume. Paper cover 60 pages, fully illustrated. Published May, 1930. Order Cat. FOR.

"Principles"—Morecroft

The outstanding book by Prof. John H. Morecroft is "Principles of Radio Communication," of which the new second edition is now ready. Prof. Morecroft, of the Electrical Engineering Department of Columbia University and past president of the Institute of Radio Engineers, is a noted authority. Set builders, experimenters, distributors, dealers, salesmen and teachers, students and operators, all find Morecroft their standby, and now the new second edition awaits you, 1,001 pages and 831 illustrations in this cloth-bound volume. Order Cat. M-PRIN.

"THE SUPERHETERODYNE"

This is a new volume by Anderson and Bernard dealing with the principles and practice of the superheterodyne method of receiving. It explains the function of the oscillator, the modulator, the pre-modulator selector, and the intermediate frequency amplifier. It explains the cause of repeat points and gives methods for avoiding them or minimizing their effect. It expounds the relative advantages and disadvantages of high and low intermediate frequencies, and shows the effect of selectivity on the quality.

It illustrates various forms of oscillators and tells of the advantages of each. Different types of modulators and pick-up systems are explained and their advantages stated. Different methods of coupling in the intermediate frequency amplifier are shown.

Image interference is discussed in detail and methods given by which it may be reduced. A special method of ganging the oscillator to the radio frequency condensers is explained, a method which allows either the high or the low oscillator setting to be selected by means of a variometer in the oscillator circuit. One section is given over to coil design for the radio frequency tuners, the oscillator, and the intermediate frequency filter.

Audio amplifiers suitable for superheterodynes are also described. These include transformer, resistance, and push-pull amplifiers both for AC and DC.

While the book is primarily intended to expound the principles of the Superheterodyne, the practical phase has not been neglected. Detailed descriptions of AC and DC superheterodynes, designed in conformity with best practice and sound applications of the principles, have been included in the book. These descriptions are well illustrated. Order Cat. ABSH.

"Elements"—Morecroft

A good book for beginners is Prof. Morecroft's "Elements of Radio Communication," to inform you authoritatively on the technical phases of radio in plain language, provided you have some foundation knowledge of radio. The book is a complete course on the elements of radio, containing much material never before published. It has 226 pages, 170 illustrations and a complete index. Cloth bound. Order Cat. M-ELEM.

115 LATEST COMMERCIAL SET DIAGRAMS—Rider

Schematic diagrams of 115 latest commercial receivers, including screen grid, collated by John F. Rider, into Supplement No. 1, each diagram on a separate sheet 8 1/2 x 11 inches. Needed by every service man. "Trouble Shooter's Manual," by Rider, contains 200 diagrams, but the present 115 are additional and up to date. No duplication.

Audiola 3011 and 7430; Bakrite F; Crosley 31A, 42 A.C., 609, 600 A.C., 29, 21, 22, 31S, 30S, 33S, 801 A.C., 40S, 41S, 42S, 82S, 60S, 81S, 82S; Sonora 7P, A32, A31, A36, A10, A14; Kennedy 80, 10, 20; Stewart-Warner 900 A.C., 950 battery, 950 A.C., 950 D.C., Model B; Radiola 44, 47, 60; Majestic 90, 91 1/2 power unit, 91 3/4 power unit; Stromberg-Carlson 611, 612, 816; Edison R1, R2, C2 (50 and 25 cycles); R5 and C4, C1; American Bosch 51 D.C.; Victor R32 and R45; Grebe SK4 A.C. (early model), SK4 A.C. (late model), SK4 D.C., 428; Traveler A.C. power pack; Eria 224 A.C. screen grid; Silver-Marshall 30B, 30C, 30D, 30E; Eveready 1, 2 and 3; Series 30, Series 40, Series 50; Stelrite 40, 50 and 102, 50 power unit; All American Mohawk 90 (60 cycle), 90 (25 cycle), 90 (60 cycle), 70, 73 and 75; Gilbranson Model C (early model), Model C (late model); Bremer-Tully 7-70 and 7-71, 81, 82; Earl 21, 22, 31, 32, 41, 42; Philco 65, 76, 87, 93 screen grid; Peerless Electrostatic series, screen grid; Pada 20, 20Z, 22 battery, 25, 25Z, 25, 25Z, M250, M250Z, Electric units, 35, 35Z, 75, 77; Brunswick 5 NCR Radio Chassis Schematic, NCR Audio Chassis Schematic, NCR and 3 NCR, Audio Chassis Schematic, 5 NCR cabinet wiring, 3 NCR Radio Chassis Schematic, 3 NCR cabinet wiring, S14, S21, S31, S81, S82 screen grid Radio Chassis Schematic, S14, S21, S31, S81, S82 screen grid Radio Chassis Schematic, S14, S21, S31, S81, S82 Audio Chassis Schematic (25 cycle), S14, S21, S31, S81, S82 Audio Chassis Schematic (60 cycle), S14, S21, S31, S81, S82 Audio Chassis Schematic (60 cycle), S31, Audio Chassis Actual (60 cycle), 3 KR8 cabinet wiring, 3 KR8 Radio Chassis, 3 KR8 Audio Chassis Schematic, 3 KR8 Audio Chassis Actual, 5 NO Radio Chassis Schematic, 5 NO Socket Power Schematic, 5 NO Socket Power Actual, 3 KRO and 3 KR6 Radio Chassis, 3 KRO and 3 KR6 Socket Power, 5KR, 5KRO, 2KRO Socket Power, 5KR, 5KRO, 2KRO, 5KR6 Radio Chassis; Amrad Hel-Canto series; Spartan 89, 89A, 49, ensemble, 931, 301 D.C., 931 A.C., 110 A.C., 301 A.C. Order Cat. SUPP. No. 1.

"Trouble Shooter's Manual"

The first comprehensive volume devoted exclusively to the topic uppermost in every service man's mind is "Trouble Shooter's Manual," by John F. Rider. It is not only a treatise for service men, telling them how to overcome their most serious problems, and fully diagramming the solutions, but it is a course in how to become a service man. It gives all the details of servicing as they have never been given before. Finding the right mode of attack, applying the remedy promptly and obtaining the actual factory-drawn diagrams of receivers always have been a big load on the service man's chest. But no more.

This book is worth hundreds of dollars to any one who shoots trouble in receivers—whether they be factory-made, custom-built or home-made receivers.

THESE THIRTY-TWO DRAWING DIAGRAMS OF RECEIVERS MADE BY MORE THAN FORTY DIFFERENT SET MANUFACTURERS ARE PUBLISHED IN THIS BOOK, INCLUDING OLD MODELS AND LATEST MODELS. RCA, ATWATER KENT, CROSLY MAJESTIC, ZENITH, STROMBERG CARLSON, KOLSTER, FEDERAL, PADA, ETC. 240 pages, size 8 1/2 x 11", 200 illustrations. Imitation leather cover. Order Cat. TSM.

"Mathematics of Radio"

"Mathematics of Radio," by Rider, 128 pages, 8 1/2 x 11", 119 illustrations, bridges the gap between the novice and the college professor. It gives a theoretical background so necessary for a proper understanding of radio and audio circuits and their servicing. Formulas for capacity, inductance, impedance, resistance, etc., are explained. Flexible cover. Order Cat. MOR.

"Treatise on Testing Units"

"Treatise on Testing Units for Service Men," by Rider, is a 48-page, illustrated book on testing units and circuits. Tells what equipment a service man should have and how to use it most effectively and quickly. Order Cat. TTU.

Radio World, 145 West 45th Street, New York, N. Y. (Just East of Broadway—Phone BRyant 0558.)

Enclosed please find \$... for which please enter my subscription for RADIO WORLD for specified period and send free (postpaid) the one premium book designated by my cross in square.

- ABSH \$2.00 for 16 weeks (16 issues) TTU
- FOR \$3.00 for 6 months (26 issues) Supp. No. 1
- MOR \$4.00 for 34 weeks (34 issues)
- MWP \$5.00 for 42 weeks (42 issues)
- MWT MWPR
- \$6.00 for 1 year (52 issues)
- APAM TSM M-ELEM
- TEL REX PRK
- RFM \$7.00 for 60 weeks (60 issues)
- MAN \$10.00 for 86 weeks (86 issues)
- DRA \$12 for 2 years (104 issues)
- RTT M-PRIN

Name

Address

City State

If extending existing subscription put cross here.

OTHER BOOKS

- "ABC of Television," by Raymond Francis Yates, tells the whole story and gives data on construction of a television receiver, 214 pages, 100 illustrations. Cloth bound. Order Cat. TEL.
- "Drake's Encyclopedia," new edition, 2 1/4" thick, weighs 3 1/2 lbs., 920 pages, 1,025 illustrations. Order Cat. DRA.
- "Experimental Radio," by R. R. Ramsey, Ph.D., Prof. Physics, Indiana University, 255 pages, 168 illustrations. Cloth cover. Order Cat. REX.
- "Fundamentals of Radio," by Ramsey, 372 pages, 402 illustrations. Order Cat. RFM.
- "Principles of Radio," by Keith Henney, M.A., former director, laboratory, Radio Broadcast, 477 pages, 305 illustrations. Order Cat. PRK.
- "Radio Telegraphy and Telephony," by Rudolph L. Duncon and Charles F. Drew, of Radio Institute of America. Order Cat. RTT.

High-Gain Shielded Coils

A SHIELDED radio frequency transformer for use as antenna coupler or as interstage coupler, for screen grid circuits. The coil is wound on a 1 3/4-inch diameter bakelite form with No. 28 enamel wire, primary on the outside, separated from the secondary by an insulating wrapper 42/10,000-inch thick. This moisture-proof insulation is so shaped that it completely insulates the primary from the secondary, preventing short-circuit. The coil form is mounted on a wooden base, which base has the removable shield bottom fastened to it. The drawn aluminum shield fits snugly over the wooden base, and coils remain always erect and amply spaced from the shield wall in all directions. The shielded coils are suitable for baseboard or metal chassis mounting. The four leads emerge through an insulated hole in the shield bottom.

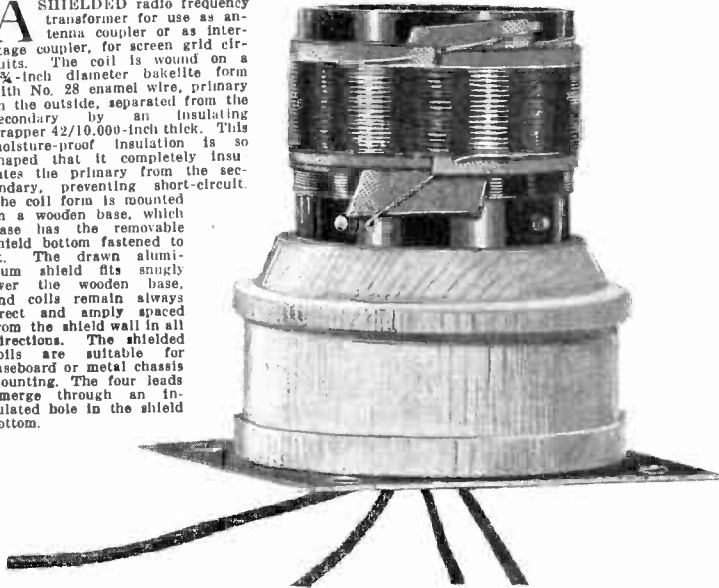

The coil comes already mounted on a shellacked wooden base, which is fastened at the factory to the shield bottom. Series A coil is illustrated.



The external appearance of the shield, with four 6/32 machine screws and nuts, which are supplied with each coil assembly.

Precisely Matched for Gang Tuning

ONE primary lead-out wire from the coil, for antenna or plate connection, has a braided lined alloy covering over the insulation. This alloy braid shields the lead against stray pick-up when the braid alone is soldered to a ground connection. The outleads are 6 inches long and are color identified. The wire terminals of the windings themselves, and the outleads, are soldered to copper rivets. Each coil comes completely assembled inside the shield, which is 2 3/4 inches square at bottom (size of shield bottom) and 3 3/4 inches high. High impedance primaries of 40 turns are used. Secondaries have 80 turns for .00035 mfd. and 70 turns for .0005 mfd.

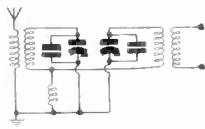

BP-6 is the coil at bottom.

EXTREME accuracy in winding and spacing is essential for coils used in gang tuning. These coils are specially suited for gang condensers, because the inductances of all are identical for the stated size condenser. The coils are matched by a radio frequency oscillator. The color scheme is as follows: shielded wire outlead is for antenna or plate; red is for ground or B plus. (These options are due to use of the same coil for antenna coupling or interstage coupling.) Blue is for grid and yellow is for grid return. For .00035 mfd. the Cat. No. is A-40-80-S. For .0005 mfd. the Cat. No. is A-40-70-S. Where a band pass filter circuit is used the small coupling coil to unite circuits is Cat. BP-6. The connection is illustrated herewith.

Junior Model Inductances

The Series B coils have the same inductance and the same shields as the series A coils, but the primary, instead of being wound over the secondary, with special insulation between, is wound adjoining the secondary, on the form, with 3/4-inch separation, resulting in looser coupling. No wooden base is provided, as the bakelite coil form is longer, and is fastened to the shield bottom piece by means of two brackets. No outleads. Wire terminals are not soldered. Order Cat. B-SH-3 for .00035 mfd. and Cat. B-SH-5 for .0005 mfd.

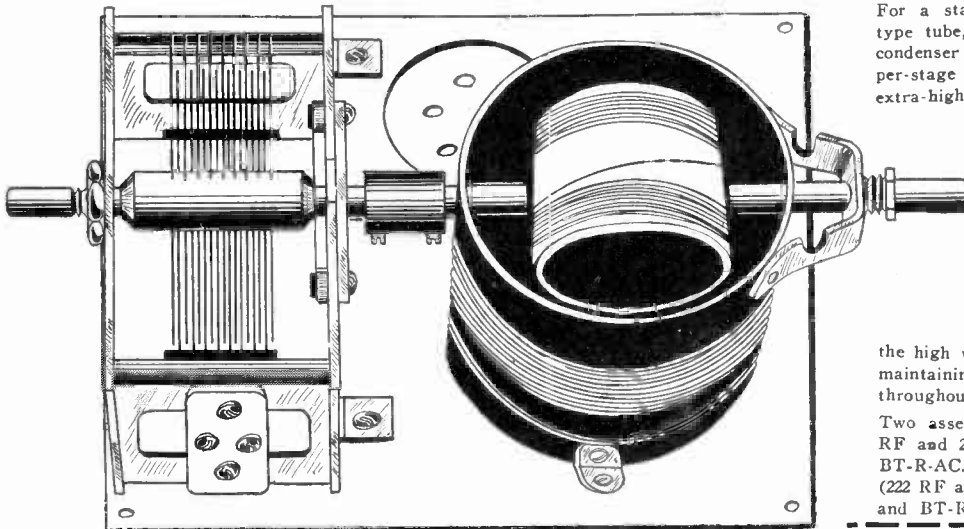

Coils for Six-Circuit Tuner

Series C coils for use with six tuned circuits, as in Herman Bernard's six-circuit tuner, are wound the same as type A shielded coils, but the shields are a little larger (3 1/16-inch diameter, 3 3/4 inches high), and there are no shield bottoms, as a metal chassis must be used with such highly sensitive circuits. Fasten the brackets to the shield and then, from underneath the chassis, fasten the other arm of the two brackets to the chassis. Order Cat. C-6-CT-5 for .0005 mfd. and Cat. C-6-CT-3 for .00035 mfd. Five needed for Bernard's circuit. If band pass filter coupling coil is desired order Cat. BP-6 extra.

For a stage of screen grid RF, either for battery type tube, 222, or AC, 224, followed by a grid-leak-condenser detector, no shielding is needed, and higher per-stage amplification is attainable and useful. This extra-high per-stage gain, not practical where more than one RF stage is used, is easily obtained by using dynamic tuners. Two assemblies are needed. These are furnished with condensers erected on a socketed aluminum base. Each coil has its tuned winding divided into a fixed and a moving segment. The moving coil, actuated by the condenser shaft itself, acts as a variometer, which bucks the fixed winding at the low wavelengths and aids it at the high wavelengths, thus being self-neutralizing and maintaining an even degree of extra-high amplification throughout the broadcast scale.

Two assemblies are needed. For AC operation (224 RF and 224 or 227 detector), use Cat. BT-L-AC and BT-R-AC. For battery or A eliminator operation (222 RF and any tube as detector), use Cat. BT-L-DC and BT-R-DC.

BT-L for the antenna stage and BT-R for the detector input. BT-L consists of a small primary, with suitable secondary for the .00035 mfd. condenser supplied. BT-R has two effective coils: the tuned combination winding in the RF plate circuit, the inside fixed winding in the detector grid circuit. The moving coils must be "matched." This is done as follows: Turn the condensers until plates are fully emmeshed, and have the moving coils parallel with the fixed winding. Tune in the highest wavelength station receivable—above 450 meters surely. Now turn the moving coils half way round and retune to bring in the station. The setting that represents the use of lesser capacity of the condenser to bring in that station is the correct one. If gang tuning is used, put a 20-100 mmfd. equalizing condenser across the secondary in the antenna circuit and adjust the equalizer for a low wavelength (300 meters or less).

Screen Grid Coil Co., 143 West 45th Street, New York (Just East of Broadway):

- Enclosed please find \$..... (Canadian must be express or P. O. Money Order), for which send me prepaid the following:
- A-40-80-S, each \$2.25
 - A-40-70-S, each 2.25
 - Matched set of four A-40-80-S 10.00
 - Matched set of four A-40-70-S 10.00
 - BT-L-AC and BT-R-AC, assembled, with condenser, link, socket and base, per pair 6.00
 - BT-L-DC and BT-R-DC, assembled, with condenser, link, socket, base, per pair 6.00
 - C-6-CT-5, .0005 mfd. shielded coil for six-circuit tuner each \$2.25
 - C-6-CT-3, .00035 mfd. shielded coil for six-circuit tuner each \$2.25
 - BP-625
 - EQ-100, equalizer of 20-100 mfd. capacity, made by Hammariund35
 - B-SH-3, each \$1.00
 - Matched set of four B-SH-3 4.00
 - B-SH-5, each 4.00
 - Matched set of four B-SH-5 16.00
- (Note: All coils come with shields, except BP-6 and BT-L.)

NAME..... ADDRESS.....
 CITY..... STATE.....
 If ordering C.O.D. put cross here. Post office fee will be added to prices quoted.

Balkite Push-Pull Receiver

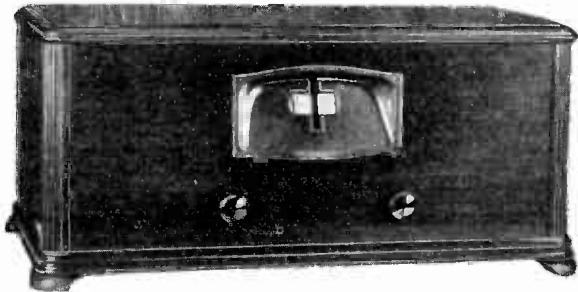

The Balkite A-5 Neutrodyne, one of the most sensitive commercial receivers ever developed; 8 tubes, including 280 rectifier. Wholly AC operated, 105-120 v. 50-60 cycles; in a table model cabinet, genuine walnut, made by Berkeley & Gay.

Three stages of tuned RF, neutralized, so there's no squealing; easy tuning; operation on short piece of wire indoors perfectly satisfactory; no repeat tuning points; no hum; phonograph pickup jack built in; excellent tone quality; good selectivity. Two posts are accessible for connecting the field coil of a DC dynamic speaker.

The parts of which this receiver is made are all ace-high and the wiring is done with extreme expertness, by Gilfillan. The power supply is exceptionally fine, the set being worked at 50% less than the rated capacity of the power transformer and chokes, assuring long life. There is no hum, as filtration is remarkably good.

The illuminated drum dial, at center, reads 0-100 at left, and at right has a blank space in which to write call letters. The little knob at left is the volume control, and the one at right is the AC switch. Each RF stage is filtered and bypassed individually, and the RF coils, tuning condenser and power transformer are separately and totally shielded. The lead from antenna binding post to antenna winding of the first coil is of shielded wire that is grounded. Also, the receiver as a whole is totally shielded, with metal chassis and metal under-cover, so there is no stray pickup. Cat. BAL-A5, list price \$135; net price.....

\$44.00

Silver-Plated Coils



Wound with non-insulated wire plated with genuine silver, on grooved forms, these coils afford high efficiency because of the low resistance that silver has to radio frequencies. The grooves in the moulded bakelite forms insure accurate space winding, thus reducing the distributed capacity, and keep the number of turns and separation constant. Hence the secondary reactances are identical and ideal for gang tuning.

The radio frequency transformer may be perpendicularly or horizontally mounted, and has brazed holes for that purpose. It has a center-tapped primary, so that it may be used as antenna coil with half or all the primary in circuit, or as interstage coupler, with all the primary on a screen grid plate circuit, or half the primary for any other type tubes, including pentodes. The three-circuit tuner has a center-tapped primary, also. This tuner is of the single hole panel mount, but may be mounted on a chassis, if preferred, by using the brazed holes. Pair consists of RF transformer and three-circuit tuner, both for .0005 mfd. only. Order Cat., G-RF-3CT. \$2.48 list price \$5.00; net price.....

Shielded Lead-in Wire

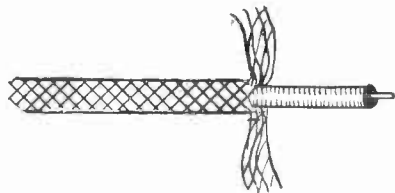

No 18 solid wire, surrounded by a solid rubber insulation covering, and above that a covering of braided copper mesh wire, which braid is to be grounded, to prevent stray pick-up. This wire is exceptionally good for antenna lead-in, to avoid pick-up of man-made static, such as from electrical machines. Also used to advantage in the wiring of receivers, as from antenna post of set to antenna coil, or for plate leads, or any leads, if long. This method of wiring a set improves selectivity and reduces hum. This wire is now appearing on the general market for the first time although long used in the best grade of commercial receivers. Order Cat. SH-LW. List price 9c per ft., net price per foot

New Multi-Tap Voltage Divider

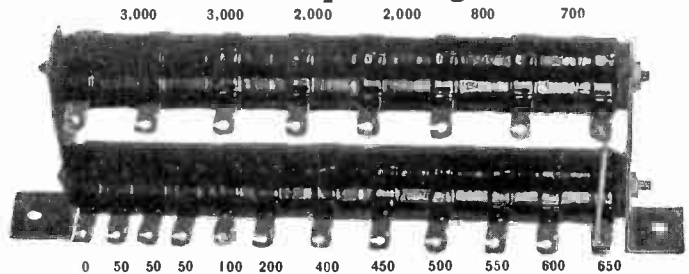

The resistance values between the twenty taps of the new Multi-Tap Voltage Divider are given above. The total is 17,100 ohms and affords nineteen different voltages.

The Multi-Tap Voltage Divider is useful in all circuits, including push-pull and single-sided ones, in which the current rating of 100 milliamperes is not seriously exceeded and the maximum voltage is not more than 400 volts. Higher voltages may be used at lesser drain.

The expertness of design and construction will be appreciated by those whose knowledge teaches them to appreciate parts finely made.

When the Multi-Tap Voltage Divider is placed across the filtered output of a B supply which serves a receiver, the voltages are in proportion to the current flowing through the various resistances. By making connection of grid returns to ground, the lower voltages may be used for negative bias by connecting filament center, or, in 227 and 224 tubes, cathode to a higher voltage.

If push-pull is used, the current in the biasing section is almost doubled, so the midtap of the power tubes' filament winding would go to a lug about half way down on the lower bank.

Order Cat., MTPVD, list price \$8.50, net price.....

\$3.90

R-245 Set and Tube Tester

With the R-245 Tube and Set Tester you plug the cable into a vacated socket of a receiver, pulling the removed tube in the tester and using the receiver's power for making these tests: Plate current, on 0-20 or 0-100 ma. scale, changed by throwing a built-in switch; 0-60, 0-300 v. DC, changed by moving one of the tipped cables to another jack; filament or heater voltage (AC or DC), up to 10 volts, or any other AC voltage source, measured independently, up to 130 volts, including AC line voltage. Also screen grid voltage and screen grid current may be read by following connections specified in the new 8-page instruction sheet.

Each meter may be used independently. The two test leads, one red, the other black, with tip jack terminals, enable quick connection to meters for independent use.

With this outfit you can shoot trouble in receivers and test circuits using the following tubes: 201A, 200A, UX199, UX120, 210, 171, 171A, 112, 12A, 215, 231, 222, 235, 227, and pentodes.

When the R-245 is plugged into the vacated socket of a set and the removed tube is placed in the proper socket of the Tester, the receiver's power supplies all the voltages and currents. You see the vital tests made right before your eyes, all three meters registering immediately, all three reading at the same time.

Here are some of the questions answered by the Tester when plugged into the receiver:

What is the filament or heater voltage (no matter if DC or AC)? What is the plate voltage at the plate itself? What is the plate current drawn by the tube? Is the tube in good condition or does it require replacement? What is the grid bias voltage? What is the cathode voltage? What is the screen grid voltage? Besides, when meters are used independently, you can answer these questions: What is the screen grid current? What is the line voltage (no matter if AC or DC)? Is the circuit continuous or is it open? What is the total plate current drawn in the receiver? What are the respective B voltages at the B batteries or voltage divider?

Order Cat. R-245. List price, \$20; net price.....

\$11.40

Fixed Condensers



Dubilier Micon fixed condensers, type 642, are available at following capacities and prices:

.0001 mfd.	10c	.006	20c
.00025 mfd.	10c	.00025 with clips.	20c
.0003 mfd.	10c	All are guaranteed electrically perfect and money back if not satisfied within five days.	
.00035 mfd.	15c		
.001	17c		
.0015	17c		
.002	18c		

Order Cat. MICON .0001 etc. at prices stated.

High-Voltage Meters

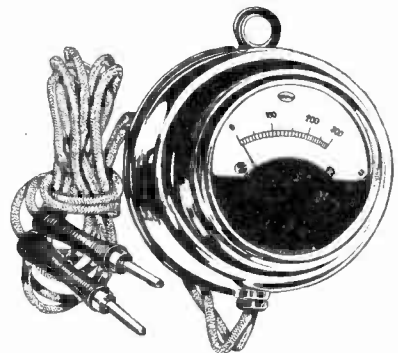

0-300 v., 200 ohms per volt. Cat. F-300 @ \$2.59
 0-500 v., 233 o.p.v. Cat. F-500 @ 3.73
 0-600 v., AC and DC (same meter reads both); 100 ohms p.v. Order Cat. M-600 @ 4.95

Double Drum Dial

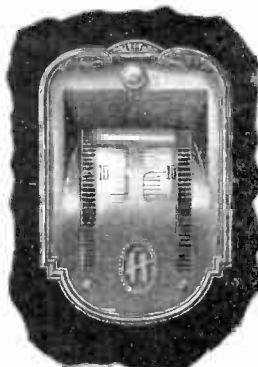

Hammarlund double drum dial, each section individually tunable. Order Cat. H-DDD. List price \$6.00; net price \$3.00

Shielded RF Choke

Excellent in detector plate circuit or in B-plus RF leads of radio frequency tubes to purify signals.

An efficient radio frequency choke in a shielded case. Inductance, 50 millihenries. Useful for all RF choking.

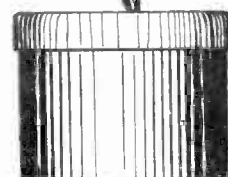

In some instances one outlead is connected to case, so use this lead for B-plus or for ground, otherwise ground the case additionally. Order Cat. SH-RFC. List price, \$1.00; net price

50c

Guaranty Radio Goods Co., 143 West 45th St., New York, N. Y. (Just East of Broadway)

Enclosed please find \$..... (Canadian must be express or post office money order, for which please ship:
 BAL-AS @ \$44.00 Ft. of SH-LW M-600 @ \$4.95
 MTPVD @ 3.90 @ 5c p. f. F-300 @ \$2.59
 G-RF-3CT @ 2.48 H-DDD @ \$3.00 F-500 @ 3.73
 R-245 @ 11.40 SH-RFC @ 50c MICON @
 If C.O.D. shipment is desired put cross here.

Your Name
 Address
 City State