

#309 Vol-17 No-22  
**FEB. 18**

1928

15c

Vol-17 No-22 308  
**THE AC VICTOREEN**

# RADIO WORLD

REG. U.S. PAT. OFF.

The First and Only National Radio Weekly

**FASCINATING FACTS  
ON SUPER-HETERODYNES**

**HARMONICS DISCUSSED  
FOR NOVICES**

**THE AC EQUAMATIC**

**THE TYRMAN "70"**

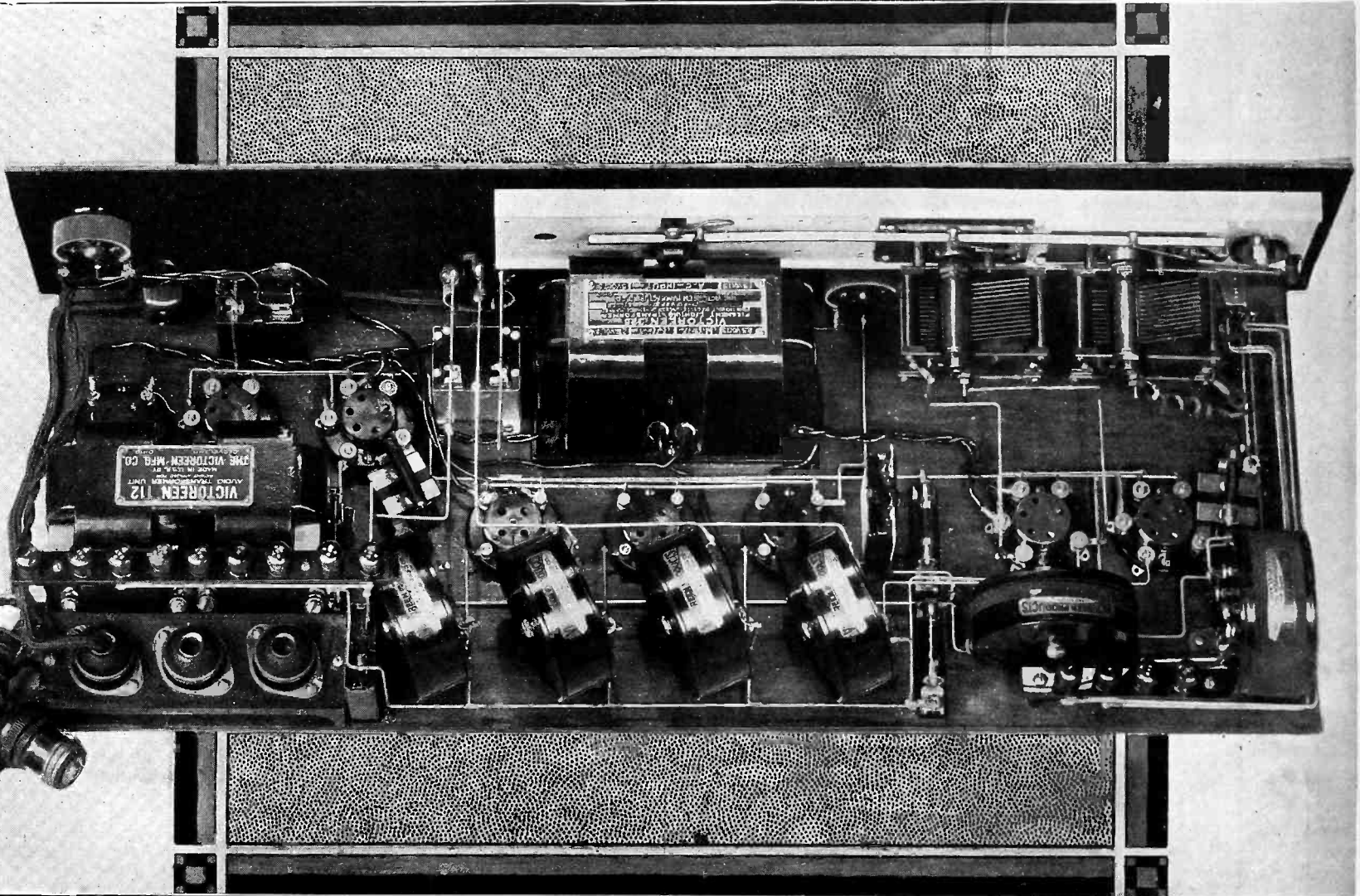

Rear View of the Latest Development in Electric Receiver Kits—  
the AC Victoreen. See page 3

## FIRST SPACE CHARGE DETECTOR

See pages 6 and 7

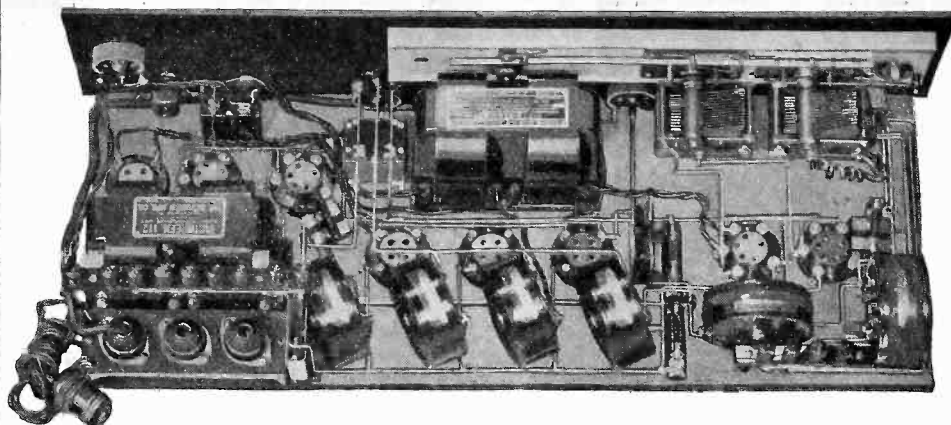

You Can Now Build the "Last Word" in  
Radio Receivers, the  
**Victoreen A. C. Circuit**

Using A. C. Tubes, and Victoreen parts, marvelous tone quality, sensitivity and selectivity have been achieved. This marvelous new circuit is the result of many months development in the Victoreen Laboratory, and is presented as the most highly perfected receiver of the day.

You can easily build this new A. C. Set, as described in this issue of Radio World, Blue print of complete assembly instructions sent free.

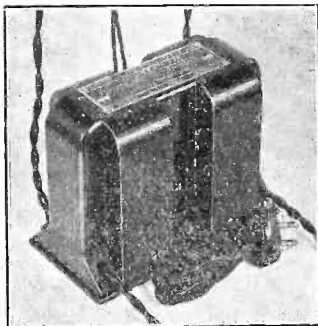

**Victoreen "326" Filament Transformer**

Supplies current to the A. C. tubes at their rated voltages. Capacity 8 UY 327 or UX 326 and 2 half ampere 5 volt power tubes. Price \$22.00.

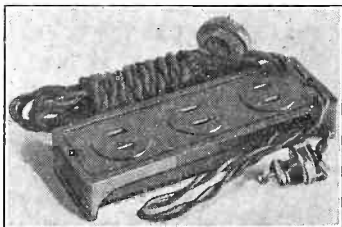

**Victoreen "333" Switch and Plug Unit**

Eliminate the necessity for any A. C. wiring connections by providing 3 receptacles into which the power leads for the A, B and C connections may be plugged. This unit is placed in the set and all A. C. devices are controlled by the panel switch furnished with it. Price \$4.50.

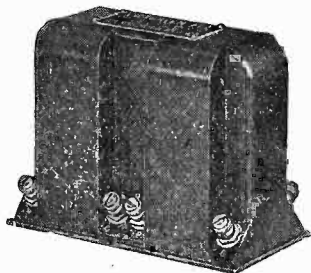

**Victoreen "112" Audio Unit**

Produces a tone quality and faithfulness of reproduction little short of marvelous. Two stages in the one case. When used in the A. C. Set it is designed to handle up to 475 volts of "B" supply in the last stage, using a UX 210 tube, and 180 volts in the first stage using a UY 327 tube. Price \$22.00.

Blue Prints of the Victoreen Universal Circuit and the "B" Power Supply also sent free upon request.

**THE GEORGE W. WALKER CO.**

Merchandisers of Victoreen Radio Products

2825 Chester Avenue

Cleveland, Ohio

**BENJAMIN**  
TRADE MARK

**Cle-Ra-Tone Sockets**



Spring Supported  
Shock Absorbing

Specified for  
"Victoreen A. C."

The choice for practically every prominent circuit for several years. Stop tube noises. Tube holding element "floats" on five finely tempered springs.

At All Radio Dealers and Jobbers

**BENJAMIN ELEC. MFG. CO.**  
New York Chicago San Francisco

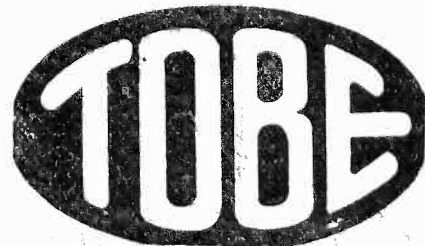

Condensers specified for the AC Victoreen described in this issue.

"It's got to be Tobe" - Send for Price Catalogue  
**TOBE DEUTSCHMANN COMPANY**  
Engineers and Manufacturers of Technical Apparatus  
CAMBRIDGE, MASS.

**Lignole Radio Panels**

are SPECIFIED for  
**THE AC VICTOREEN**

Write for Price List

**THE LIGNOLE CORPORATION**  
508 So. Dearborn St. Chicago, Ill.

**Subscribers: Look at the  
Expiration Date on  
Your Wrapper**

We do not like to take your name from our subscription list without specific instruction to do so, because many of our readers wish to keep a complete file of the paper.

Please therefore, look at the subscription date stamped on your last wrapper, and if that date is earlier than the issue contained in the wrapper, please send check to cover your renewal.

In this way you will get your copies without interruption.

Subscription Dept, RADIO WORLD, 145 W. 45th Street, New York City.

**THE WINNER**, a superb 4-tube receiver, was full described in the October 1, 8, 15, 22 and 29 issues of RADIO WORLD. Send 75c for the complete series or begin your subscription with any of the issues. RADIO WORLD, 145 West 45th Street, New York City.

**EVERY FRIDAY** evening, beginning at 5:40 P. M., a ten-minute talk on radio topics is delivered by Herman Bernard, managing editor of Radio World, from WGBS, the Gimbel Bros. station, New York Listen in.

RADIO WORLD

145 West 45th Street, New York City  
(Just East of Broadway)

Please send me RADIO WORLD for ..... months, for which  
please find enclosed .....

**SUBSCRIPTION RATES:**

Single Copy .....\$ .15  
Three Months ..... 1.50  
Six Months ..... 3.00  
One Year, 52 Issues..... 6.00  
Add \$1.00 a Year for Foreign  
Postage; 50c for Canadian Post-  
age.

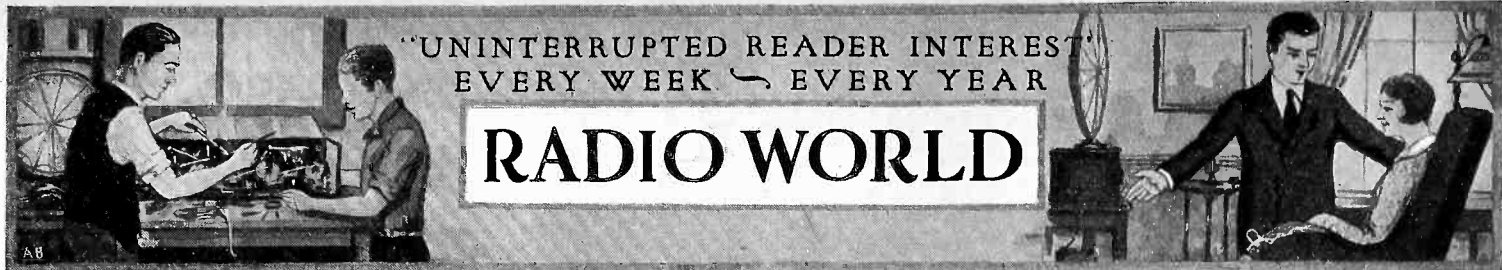

Vol. XII, No. 22, Whole No. 308  
 FEBRUARY 18, 1928  
 15c per Copy. \$6.00 per Year  
 [Entered as second-class matter, March, 1922, at the post office at New York, N. Y., under Act of March, 1879]

Technical Accuracy Second to None

A Weekly Paper Published by Hennessy Radio Publications Corporation, from Publication Office, 145 West 45th Street, New York, N. Y.  
 Phones: BRyant 0558 and 0559

# The AC Victoreen

*Special Arrangement of Standard Tubes Combined With Short Leads and Three Months of Laboratory Development Make This Popular Super-Heterodyne a Remarkable Electric Set*

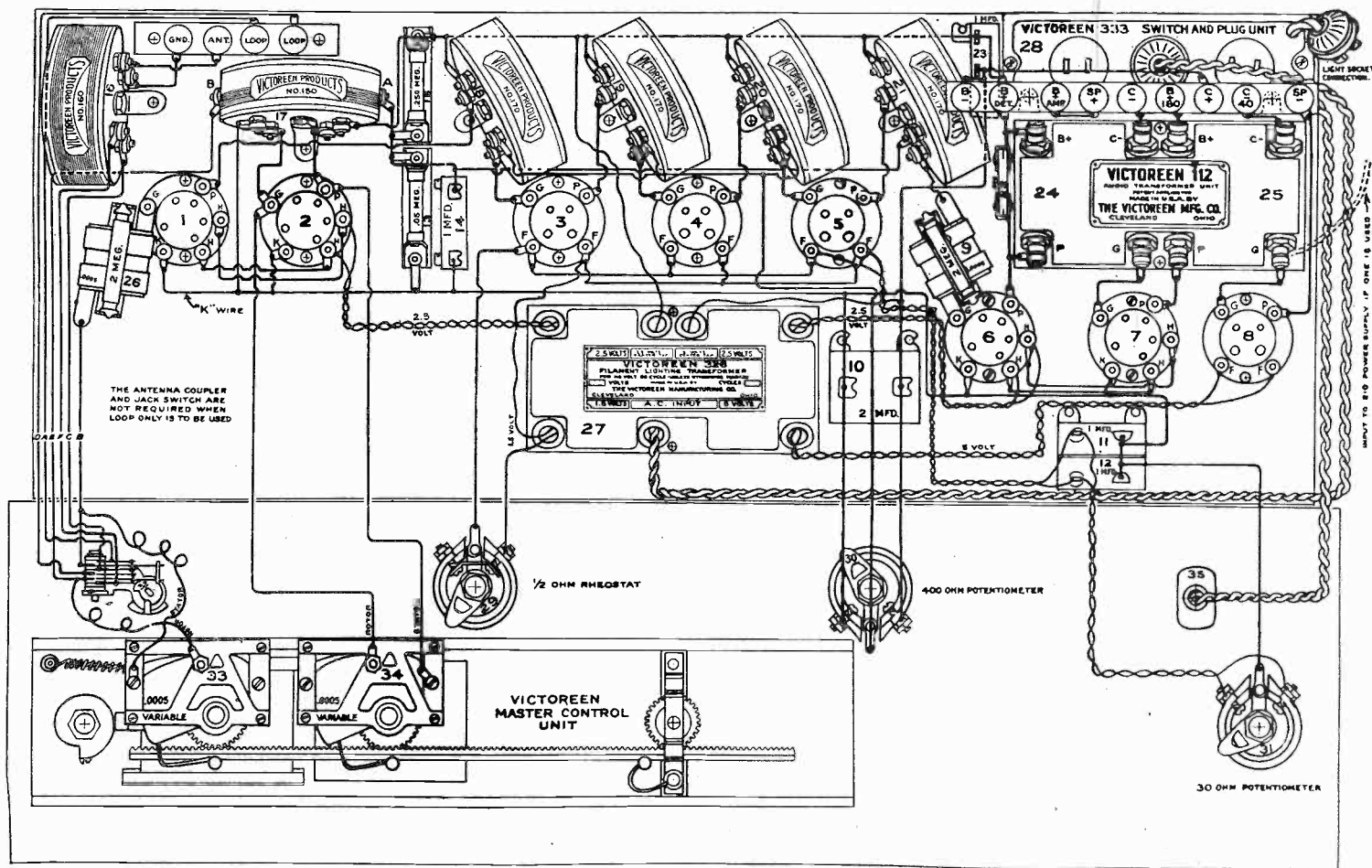

FIG. 1  
 THE PICTURE DIAGRAM OF THE VICTOREEN AC RECEIVER.

*By Capt. Peter V. O'Rourke*

**D**URING the last few months thousands of fans have asked the question:

"When will the Victoreen AC circuit be ready?"

Our answer has been:

"As soon as it has been perfected."

And now we present the final answer:

"The Victoreen AC Circuit has been perfected."

Hence we present it to our waiting readers.

The Victoreen Super-Heterodyne is so

well known in every city, town and hamlet in the United States and Canada that it would be useless to go into the enthusiastic praise that is due it. It speaks for itself, and sings and plays its own praises. And everybody likes to hear self-praise as long as it does not proceed from a human being. Hence Victoreen owners are not only satisfied with their sets but they are inordinately proud of them.

They are satisfied with their sets in all respects but one. And that one has given

rise to an avalanche of such questions as: "When will the Victoreen AC circuit be out?"

The fans are about to be 100% satisfied, for not only does the Victoreen AC model better than the old model in those respects which already were satisfactory but it adds most successfully AC filament operation.

### The AC Model

The Super-Heterodyne circuit, through its endorsement by leading technical and

radio engineers as the peer of all radio receivers, plus the unqualified reception which it offers, places it in the light of the ultimate circuit for quality radio reception.

The new Victoreen AC circuit has been designed for those fans who will never be satisfied with anything except the best in radio reception, combining as it does those features which the radio fan demands—namely, faithful reproduction of quality programs, careful consideration of selectivity and the ability to get distant stations through local interference.

The Victoreen 1928 AC circuit was developed, as the name implies, to fill the need for a completely AC operated set.

Although this circuit was developed by the Victoreen Research Laboratory some time ago, it was not offered to the public until its practicability was established beyond doubt.

The many details which have made it so difficult to construct and operate other types of AC operated sets have been so thoroughly worked out in this circuit that the construction of the Victoreen 1928 AC receiver is no more difficult than that of any similar battery operated circuit.

#### Avoids Twisted Wires

Unlike other AC sets there are no heavy twisted filament leads to be wired in, this eliminating a difficult task and at best an unsightly one. The filament transformer is placed conveniently in the set, making long heavy leads unnecessary.

There is no 110 volt wiring to be done by the constructor and the switch for the entire set is placed conveniently on the panel, the same as on the battery type of set. The Victoreen switch and plug unit is therefore responsible for eliminating one of the difficulties of the AC set.

Contrary to popular opinion, the elimination of hum is not the main difficulty in this kind of set and has been completely mastered in the Victoreen receiver. The problem of efficient, convenient volume control is far more difficult.

#### Double Advantage

This problem has been uniquely met and conquered by one of the noteworthy characteristics of all Victoreen circuits and for which they are all singularly famous. Due to the design of the Victoreen No. 170 RF transformer, the tubes in the intermediate amplifier always operate far below their rated filament voltage.

A filament rheostat is provided so that a twofold advantage may be taken of this feature in the AC set. This rheostat acts as the volume control and obviates the use of impracticable, variable high resistances for volume control, and at the same time lengthens the life of the —26 tubes so that they will outlast the useful life of the normal —01A tubes.

One of the outstanding departures from usual practice is the use of a positive potential on the grid return of the —27 type detectors. It has been found that a positive potential of from five to ten volts increases the efficiency of detection considerably. A pair of tubular resistors has been added for this purpose.

When used with the Victoreen power supply, the AC operated set is not merely equal to the battery operated set, but far surpasses it in every respect as the sensitivity is higher and the selectivity much greater.

#### RF Transformers Closely Matched

The Victoreen RF transformers have a sharp resonance curve, which means high selectivity in each stage. Internal adjustments made at the factory prevent interstage oscillation, make the set more stable and permit the potentiometer to be used solely as a volume control and not as a loss.

All the coils are matched to a precision of better than 1/3 of 1%, and the values

### LIST OF PARTS

| Quantity   | Reference Number |
|--|------------------|
| One Cabinet for 7"x26" panel 10" deep  |                  |
| One Lignole front panel 7"x26"x 3/16"  |                  |
| One Binding post strip 7 1/4"x 5/8"  |                  |
| One Binding post strip 4"x 5/8"  |                  |
| One Wood baseboard 9 1/2"x25"x 1/2"  |                  |
| Four Victoreen No. 170 R. F. transformers  | 18, 19, 20, 21   |
| One Victoreen No. 150 coupling unit  | 17               |
| One Victoreen No. 160 Antenna coupler  | 16               |
| One Victoreen 112 Audio transformer unit   | 24, 25           |
| One Victoreen 326 Filament Transformer   | 27               |
| One Victoreen 333 Switch and plug unit   | 28-35            |
| One Victoreen Master Control Type VU   | 33-34            |
| One Victoreen 1/2 ohm rheostat   | 29               |
| One Victoreen 400 ohm potentiometer  | 30               |
| One Victoreen 30 ohm potentiometer   | 31               |
| Four Benjamin UY type base mounting tube sockets   | 1, 2, 6, 7       |
| Four Benjamin UX type base mounting tube sockets   | 3, 4, 5, 8       |
| One Yaxley No. 760 double pole double throw jack switch  | 32               |
| Two Electrad .0005 grid condensers with grid leak clips  | 9-26             |
| Two Daven 2 megohm grid leaks  |                  |
| One Electrad .005 condenser  | 22               |
| Four Tobe 1 mfd. bypass condensers   | 11, 12, 14, 23   |
| Two Daven No. 50 Grid leak mountings   | 13, 15           |
| One Daven .05 Meg. Grid leak   |                  |
| One Daven .25 Meg. Grid leak   |                  |
| One Marco No. 192, 0-100 Vernier dial. Left to right.  |                  |
| Thirteen Eby Ensign engraved binding posts marked respectively, SP—, SP+, C-40, C+, B+ 180, C—, B+ Amp, B+ Det, B—, Loop, Loop, Antenna, Ground. |                  |
| Three CeCo N 26 tubes  |                  |
| Four CeCo N 27 tubes   |                  |
| One CeCo F tube, 112 or 210 tube   |                  |
| Thirty-six feet No. 12 square tinned Acme bus bar  |                  |
| Nine 1/4" No. 4 round head Brass wood screws   |                  |
| Six 1/4" No. 6 round head Brass wood screws  |                  |
| Twenty-two 3/4" No. 6 head Brass wood screws   |                  |
| Two 1 1/2" No. 6 round head Brass wood screws.   |                  |
| Two 1/2" No. 6 Brass machine screws with nuts.   |                  |
| Two Lengths 3/16" Brass tubing (or 4 angle irons) 1" long for mounting binding post strip  |                  |
| Fifty Solder lugs  |                  |
| Rosin-Core solder  |                  |
| Eight Inches spaghetti tubing for plate lead back of last audio.   |                  |

of inductance and capacity are such that small differences in the tube and circuit stray capacities do not materially affect the adjustment when the coils are put in the circuit as directed.

Hence the individual selectivity of the coils is not nullified by chance unmatching, but the selectivity of the entire amplifier is enhanced by the close matching. Hence there are no matching and tuning adjustments to be made after the coils have been installed in the circuit.

#### The Master Control Unit

A remarkable feature of the Victoreen AC circuit is the simplicity of tuning. There is only one dial on the panel, and this controls both the oscillator condenser and the tuning condenser. Thus there is only one dial to read and only one set of numbers to enter in the log. The design of the circuit is such that the tuning and oscillator circuits are always in close resonance so that when a station is tuned in for maximum it is at an absolute maximum and could not be increased by manipulating either of the condensers separately.

The use of a single tuning control permits a simple and attractive panel layout, which is one of the reasons why the circuit is a favorite with the members of the fair sex.

Body capacity has been reduced to the vanishing point in the receiver by placing the tuned circuits at a considerable distance from the dial. Thus the annoying detuning effects caused by body capacity are absent from this circuit.

#### The Audio Amplifier

The Victoreen 112 audio unit, comprising two high grade audio transformers in one case, is universally known for its electrical and acoustical excellence. Compactness and economy of space in the receiver are gained by the combination of the two in one case, and yet this permits the use of exceptionally large cores, one of the necessary conditions for fidelity.

The first and second stage transformers have been combined in one case not only in order that space be conserved but also to insure the proper location and combination of these transformers. Their design is such that the tendency to "microphone" or set up a sustained howl through mechanical vibration has been almost entirely overcome.

This transformer answers the two most important requisites for an audio amplifier; it has wide tonal limits—that is, it amplifies the highest note and the lowest note played as well as the main harmonics of these notes and it amplifies from the highest to the lowest with equal volume covering the musical scale ranging from approximately 16 to 5,000 cycles.

#### Distortion Absent

Furthermore it shows an absence of distortion; that is, the actual absence of distortion of the wave form of a note in passing through it. Neither transformer in this unit is intended to be used individually in an amplifier and, therefore, should not be used in circuits where the loud speaker is made to operate on either one or two stages. Two stages should be used at all times and the volume controlled by the RF rheostat.

The 112 Audio Transformer Unit is used in the AC hookup with a —27 type tube in the first stage and a power tube in the last audio stage. It was originally designed to operate with high plate voltage and at 475 volts will yield a most realistic and natural reproduction of the program.

#### 326 Filament Transformer

To supply the high plate voltage, necessary for quality production, the Victoreen Laboratories designed the new Victoreen power supply circuit which consists of the new Victoreen 116 Power Transformer, 216 Choke, 115 Output Unit and 316 Resistor. This power supply provides full wave rectification and is designed for use with 2—81 or —16B rectifier tubes and a —10 power tube. The output of this supply is approximately 475 volts on the last

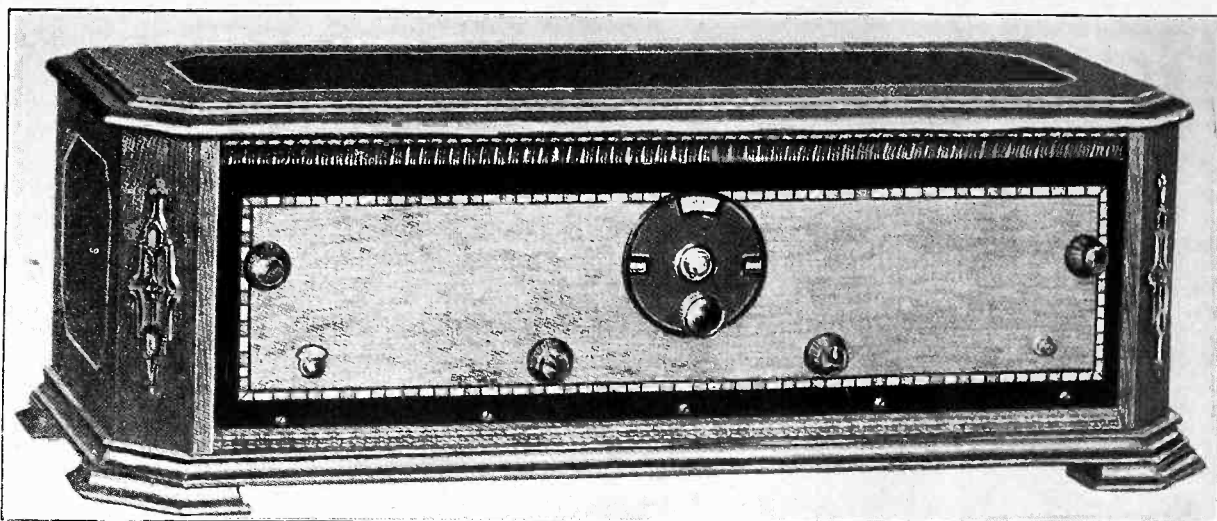

FIG. 2  
PANEL VIEW OF THE VICTOREEN AC RECEIVER.

stage, 180 volts on the first stage and 45 volts for the detectors.

The new Victoreen 326 filament Transformer is designed to supply the standard AC tubes at their rated voltages and is capable of supplying current for 8 —27 type or 8 —26 type and 2 half ampere 5 volt power tubes at the same time when desired. Its maximum load should not be greater than ten tubes in all.

This transformer is standard for fifty to sixty cycle use only and is normally furnished for 108 to 112 volts, but may be secured on special order for special voltages, varying from fifty to sixty cycles only.

#### 333 Switch and Plug Unit

This unit is designed to obviate the necessity of any AC wiring connections, by providing three receptacles in which the power leads for the A, B and C connections may be plugged. This unit comes equipped with a 110 volt switch permanently connected and with leads of proper length to facilitate correct placement. An extension is also furnished with 6 feet of cord permanently connected to the plug unit. This unit is to be placed in the set and permits all the AC devices to be turned off by the panel switch.

#### Tube Requirements

Only genuine CeCo, R.C.A. or Cunningham tubes are recommended. Four —27 and three —26 and one —10 are required and are placed as indicated on the blueprint.

Inasmuch as high voltage is recommended on the last audio tube a Victoreen power supply is recommended, which contains a power amplifier for this purpose. In the event that this is not used, a 112 or 112A may be used in the last socket in the set. If high voltage is used without the power supply, a —10 tube is recommended in the last audio socket, and its filament will be supplied with but five or six volts, with no rheostat.

This reduces the output slightly but will be found to surpass the 112-A in practice the A-71 tube should never be used with the Victoreen 112 audio. When high voltage and a power tube are used in the last stage without the Victoreen power supply a Victoreen 115 Output Unit should be used to prevent damage to the speaker.

The Type —27 tubes should be operated at the C and B voltage recommended by the tube manufacturers. The output as well as the quality may be increased by using the same B and C voltage on the first and second audio; although if this is done it is necessary to pick a Type —27 tube which has a good vacuum, as 475 volts have a tendency to cause ionization in these tubes and it may be necessary to try several tubes until one is found that

does not turn blue. The increased quality should offset the risk involved to the tubes.

#### Phonograph Pickup

The Victoreen 112 unit and power supply is admirably adapted to reproducing phonograph records and will give a fidelity of tone truly remarkable. (See RADIO WORLD Dec. 3, 1927.) It must be noted here, however, that due to the unusual characteristics of the 112 unit the phonograph pickup cannot be plugged in the detector socket as is the usual practice, but the detector tube must be used, making three tubes in use.

A .02 condenser must be connected permanently across the phonograph pickup, which is then connected directly across the grid leak and grid condenser of the second detector. The grid leak may then be removed if desired.

The RF rheostat is then turned off. Any switching device which is installed must be inserted so that when the pickup is not in use, the .02 condenser will not appreciably affect the resonant frequency of the last RF transformer.

#### Dial Lights

In the event that a dial is used that contains a dial light, this light may be connected across either of the windings of the 326 Filament Transformer, depending on the voltage desired. In most cases this will be the five volt winding which connects to the last audio socket in the set.

The 516 C supply may be added by those who desire to eliminate the C battery. This supply consists of a Victoreen 516 Power transformer, a 316 resistor, with the necessary condensers and uses a UX 112A tube for a rectifier. This unit is entirely optional as the long life of a 45 Volt C Battery makes the use of a "C" eliminator really unnecessary.

It may seem an extravagance to build a C battery eliminator for a circuit when the grid bias can be obtained very easily from either a drop in a resistor suitably placed in the B battery eliminator or from a small dry cell battery. But there are other considerations which enter. For example, the battery becomes exhausted in time and must be replaced. When it goes dead it may be the cause of distortion which will be attributed to everything but the true cause. One service call may cost more than the C battery eliminator would have cost.

But there is a greater reason for using a C battery eliminator in preference to a drop in a resistor in the B battery eliminator circuit. A C battery eliminator does not introduce distortion to the same extent as a grid bias resistor. The distortion introduced by the grid bias resistor

is often of first magnitude while that introduced by a C battery eliminator is negligible.

#### Construction of Set

The assembly of the set itself is a very simple proposition. Only a few holes need be drilled in the front panel. A full sized template and blueprint may be obtained by writing to me. Address: Capt. Peter V. O'Rourke, care RADIO WORLD, 145 West 45th St., N. Y. City. This template, which also contains detailed wiring instructions, will help greatly in the building of the set.

Many of the more experienced radio set builders will find sufficient guidance in the panel layout and the simplified wiring diagram published in this issue and numbered respectively 2 and 3. As will be noted Fig. 3 (see front cover) represents the interior of the receiver with the baseboard plan on top and the back view of the panel, tipped forward, on the bottom. Every part, every lead, every connection is shown in that diagram.

#### A Test in Time Saves Grief

It is not customary for the builder to test each individual part before putting it into a unified receiver. He takes for granted that all the parts are perfect just because the manufacturer states that they were tested and found perfect before leaving the factory.

But that assurance does not include the railroad, the express company, the mailman. There are so many chances of damage to a radio part in transit, although it may be packed perfectly, that every component that goes into a set should be tested before it is put into its allotted niche. Much subsequent grief may be saved by doing so.

"I built the set just as you described it," is a common complaint, "yet I cannot get any signals through it." When the fault with that particular job cannot be located by a careful visual inspection of connections it usually lies inside one of the parts and could have located if the parts had been tested at the beginning.

Test condensers for short circuits, that is, see that the plates do not touch at any place for any setting of the dials. Test all transformer windings for continuity, that is, see that current can be passed through all of them. This includes RF, IF and AF. It can be done with a voltmeter and a single dry cell.

#### Check Connections Carefully

In wiring follow the simplified wiring diagram as shown pictorially in Fig. 1, or else the blueprint of that is obtained.

# The First Presentation of

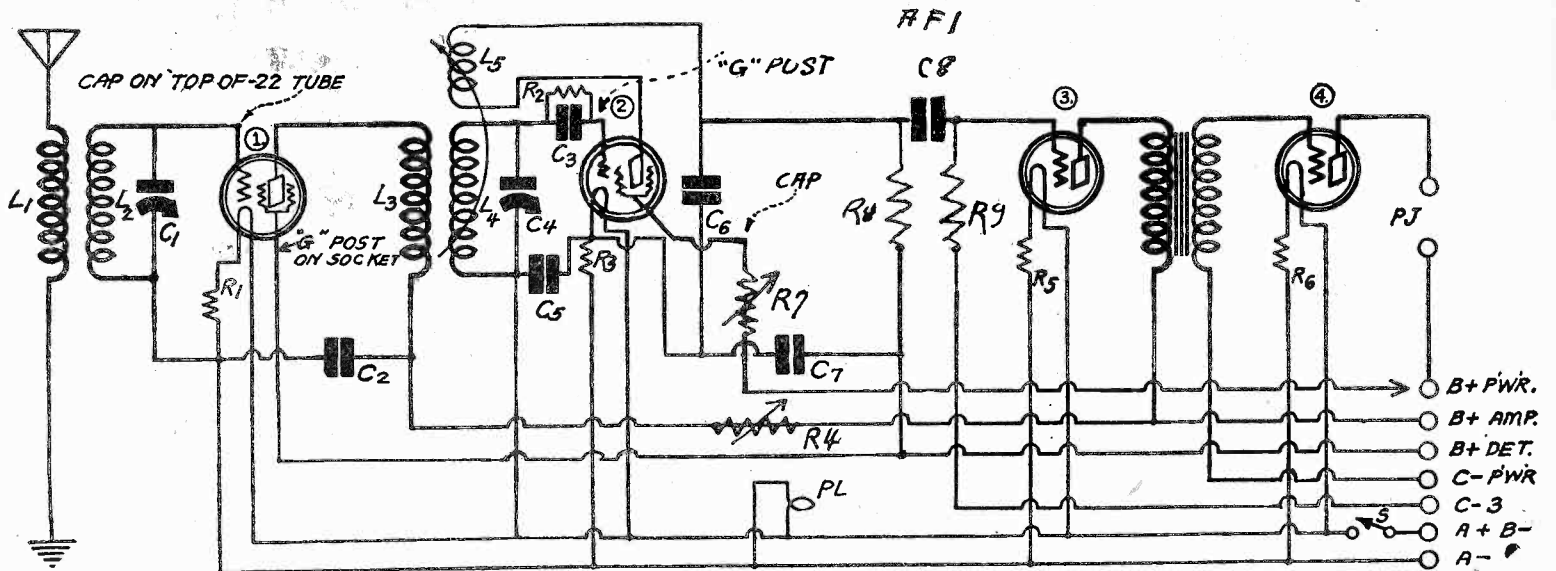

THE FIRST DIAGRAM EVER TO BE PUBLISHED SHOWING THE USE OF A SPACE CHARGE DETECTOR (SOCKET 2.)

## New Principles Embodied in Shielded Grid Diamond of the Air

By H. B. Herman

ONE of the uses of the new screen grid tube, mentioned only in theoretical articles, is that of a space charge tube.

When the tube is used as a screen grid tube the cap on top, connecting to the old or inner grid, simply becomes the conventional grid connection, while the shield grid, or more strictly, the shield plate (G post of socket), is connected to some positive B potential.

This makes the tube a splendid radio frequency amplifier. In this manner the tube is embodied in the Four Tube Shielded Grid Diamond of the air (described in the February 4 and 11 issues), the Silver-Marshall Shielded Grid Six (January 7, 14 and 21), the Tyrman 70 Amplimax (see page 8), the Shielded Grid Laboratory Super, soon to be published, and other circuits.

But nobody has showed the use of the tube as a space charge quadrode, whereby the cap is connected to positive B and the input is made to the new or shield grid (to G post of socket via the grid condenser).

### Difference Explained

The difference between the two uses is shown by the following:

When the tube is used as a shielded grid tube, shield grid tube or shield plate tube (they're the same), the conventional or control grid has an extra grid, connected to B plus, interposed between it and the conventional plate, to prevent plate voltage fluctuations from affecting the conventional grid.

When the tube is used as a space charge tube the connections to the two grids are reversed. The inner or old familiar grid is given a positive B potential, while the outer or extra grid becomes the control grid. The effect is material reduction in

the plate to filament impedance and great acceleration of electrons from filament to plate.

It is obvious that the shielded grid tube is a four-element tube or quadrode, also that when it is used as a space charge tube that existing detector wiring may be retained, except that the plate load should be a resistor. Assuming a detector socket, the filament voltage is made 3.3 volts, the filament itself fixes the .132 ampere current at that voltage, the shielded grid tube is inserted in the socket, a metal shield is placed over the tube, and a clip connection is made to the cap on top of the tube from a wire going to positive B. It is well to connect to one side of the filament the enclosing metal shield, which has a binding post for that purpose.

### Needs Resistance Coupled Audio

Do not confuse this metal shield with any part of the tube structure. The shield is simply a metal envelope reaching from the top of the tube down to the base, and may be the commercial Vac-Shield. It is purchased additionally.

It is surely simple enough to use the tube as a space charge agency, but its use in that direction is definitely limited by practical conditions. The reduced plate-to-filament impedance may be all too easily reflected back upon the input, hence the grid-to-filament impedance is lowered, which reduces selectivity.

It works out that way every time the shielded grid tube is used as a space charged detector, except if the first audio stage is resistance coupled.

Then the low plate impedance not only improves low note reproduction but also increases the amplification abundantly. In any instance the amplification is increased over what it would be even if a special detector tube were used. In fact, except

in resistance coupling, it is likely to be increased altogether too much.

### Greatest Selectivity

When the tube is used as a space charge detector the selectivity of the circuit is increased over what it would be if any other tube were used as detector, provided resistance coupled audio follows. With other forms of plate load the selectivity is reduced but volume increased enormously.

When used as a space charge detector the tube will oscillate nicely, hence it is excellent for circuits using a regenerative detector. Combine the shielded grid tube as a radio amplifier with a space charge detector, as diagrammed, and you have a truly wonderful combination.

Anybody having any Diamond or similar circuit can make the change in fifteen minutes or less—that is, can substitute a screen grid tube in screen grid fashion in the RF stage and quickly substitute a screen grid space charge hookup for the present detector.

The two tubes are exactly alike, but are used in different ways.

### Critical Conditions

The space charge detector is at least as sensitive as the best special detector tubes, and is more selective, in that the grid-to-filament impedance is higher.

Granting that the rated filament voltages are used, the positive voltage on the extra grid in the RF amplifier is rather critical, but the positive voltage on the old or inner grid of the space charge detector is extremely critical.

If no positive voltage is applied no signals will be heard. If this voltage is too low the volume will be too low, the quality poor. If the voltage is too high the tube blocks or motorboats. Hence a variable

# a Space-Charge Detector

resistor, preferably one up to a few million ohms maximum, is advisable.

The current to the cap of the tube is low, usually less than 2 milliamperes, so wide resistance range is necessary for wide voltage range.

Also, the determination of correct positive voltage for the cap depends on a variety of factors, including positive voltage to the conventional plate, filament voltage (assuming that is controllable, which it need not be), grid bias and nature of load on the conventional plate.

## Removes Critical Aspect

The critical aspect fully disappears as soon as the right setting is found. Thereafter the circuit is as easy to control and operate as any other of its kind using general tubes.

My experience to date convinces me that as a space charge detector the new tube is limited to resistance coupled audio resistive plate load, at least in a radio circuit design such as the Diamond.

The detector plate voltage may be much higher than under other conditions. For instance, 135 to 150 volts may be tried. While this voltage is not critical, the greater it is, the greater the amplification, and one's object is to have the amplification as high as practical. Limiting factors are self-oscillation and acoustic coupling. The tube becomes microphonic. But reduction of the ordinary plate voltage (to P post of socket) and reduction or increase of the B potential applied to the inner grid (cap of tube) will cure this. The shield put over the tube also not only acts as a radio frequency shield, but also as a preventive of microphonic effects.

## Newly Acquired Efficiency

Whatever troubles the space charge detector developed were easily soluble, including stopping microphonism and motorboating, both completely, by the turn of the resistor knob. It is one of the few big improvements recently come upon the domestic radio horizon that did not carry with it "grief" of a perplexing nature.

In the service of detection the space charge method comes to the rescue of a hampered radio situation. While self-oscillation at radio frequencies, and less so at audio frequencies, required attention for several years before stable circuits became predominant, detection trailed along at unchanged pace. Then the special detector tubes appeared. Some of them carried a powerful kick. All of them that were of the high gas content variety, that is, were purposely not fully evacuated, operated with a hissing sound. Other special detector tubes, not always quite so loud, were quieter, had no hiss and were preferred by many. At best, choice was made on the basis of preference, and a man got what he wanted. A little hiss, a lot of extra volume. No hiss, somewhat less volume, greater selectivity.

## First Appearance

But with the space charge grid tube with a purely resistive plate load one has more amplification than from the loudest special detector and with a degree of selectivity not equalled by any other tube of comparable volume. Special detectors, gaseous ones, at least, have a fairly low input impedance, and selectivity suffers. The space charge detector has the highest input impedance of all, and yet a low plate impedance, a combination alluring enough to excite anybody.

The appearance of the screen grid tube

## LIST OF PARTS

### Vital Kit

- L1L2, L3L4L5—Hammarlund HR 23, consisting of one antenna coupler and one three-circuit coil, both for .0005 mfd. tuning.
- C1, C4—Two Karas .0005 mfd. SFL condensers, type 23.
- AF1—One Lynch 50,000-ohm resistor (R8); one .01 mfd. Aerovox condenser (C8); one Lynch 2 meg. leak; one Lynch double mounting.
- AF2—One Karas Harmonik audio frequency transformer.
- R1, R3—Two No. 622 Amperites with mountings.
- R5, R6—Two No. 1A Amperites with two mountings.
- R2—One Lynch 5 meg. grid leak.
- R4—One Volume Control Clarostat.
- R7—One Universal Range Clarostat.
- C2, C5, C7—Three Aerovox .006 mfd. fixed mica condensers. (Type 1450.)
- C3—One Aerovox .00025 mfd. mica grid condenser, with clips. (Type 1475.)
- C6—One .001 mfd. Aerovox mica fixed condenser. (Type 1450.)
- S—One Yaxley No. 10 battery switch.
- PL—One Yaxley No. 310 pilot light bracket (with lamp extra).
- PJ—Two Frost phone tip jacks, No. 253.
- Four Frost Bakelite sockets, No. 530.
- Two Eby binding posts (Ant., Gnd.).
- One 7 x 21 inch Bakelite front panel. (Cortlandt Panel Co.)
- One 10 x 20 inch sub-panel or baseboard.
- Two Mar-co dials. No. 210.
- Two Pee-Wee clips (No. 45 Universal clips.)
- Set of three Karas sub-panel brackets.
- Two Vac-Shields for shielded grid tubes.

## ACCESSORIES

- Two shielded grid tubes (Shieldplate 122, CX 322, UX 222) for sockets No. 1 and 2.
- One CeCo type A for socket No. 3.
- One CeCo type F (112A) for socket No. 4.
- One roll flexible Acme Celatsite.
- One 7-lead battery cable.
- One set of cable markers.
- A, B and C supplies.

on the market gave interest in home-constructed receivers a strong push forward. The tube was revealed for set construction purposes as an amplifier only, and as a screen grid amplifier at that. Now it is shown for the first time as a detector, and, besides, is used in a novel but highly efficient fashion as a space charge detector. It does more than produce an output proportionate to the square of the input, and its out-performance in this respect, as well as its generous favoring of low note reproduction, entitles it to the key to any radio experimenter's heart.

While stations may limit themselves to the square law, the space charge tube goes the stations one better. There is a saying that a station's quality in broadcasting presupposes detection at the receiving end according to the square law, so if the space charge detector is a little too far ahead of the times that is all the more reason why radio enthusiasts will want to try it.

## Has to Be Tamed

It is gratifying indeed that the shielded grid tube has capabilities even beyond those which modern receivers can readi-

ly utilize. Limitations must be put upon the operation of the tube.

While self-oscillation has been a barrier to greater performance from general purpose tubes at radio frequency levels, the shielded grid tube will go a great stretch farther without producing this trouble. Originally heralded as a tube that did not oscillate, it turned out to be one that will oscillate if it is pressed too hard for amplification. So at radio frequencies we do not essay anything like 250 as an amplification factor, but content ourselves with one-fifth of that, and are startled by the results even then.

When audio frequencies are considered, although the circuit choice is limited, we find again that a stage of resistance of AF amplification that commonly produces a gain of 8 is brought up to five times that much, without engendering audio howls, uncontrollable motorboating or other serious ills.

## Other Forms of Plate Load

As fine advantage is afforded by the space charge detector as by the strictly shielded grid RF hookup. Ways of utilizing this form of detector with other than purely resistive plate loads may be devised, but from such facts as are now at hand it seems that the RF part of the circuit would have to be made incredibly more selective to permit of an impedance coil or the primary of an audio transformer as the load on the space charge detector.

When either of these two was tried in the present circuit the result was ruin of selectivity. The volume increased to an obnoxious degree.

## How Selectivity Is Observed

In selectivity, as much as in anything else, the space charge detector does its duty with generosity. The circuit as diagrammed brings in KDKA from New York City any night at all, without interference from WABC and WPCB, strong locals in channels close by. Even while locals are on, Middle West stations are easily receivable, also stations in the South. Texas was brought in time and time again. One night, after the locals were silent, intelligible discourse and somewhat blurred music were received from Pasadena, Calif.

While the shielded grid tube as the RF amplifier gives that extra kick which makes an otherwise weak distant station strong, the detector tuning proves so effective in rejecting interference that one gets real enjoyment from listening to distance.

Another angle from which to view the selectivity is this: If the local station that is received with greatest volume is tuned in at full strength, the RF dial may be left at that setting, and the detector dial alone tuned to bring in other strong locals without crosstalk or other interference.

## Detector Selectivity Remarkable

In the particular home in which this receiver was tested for several weeks WOR comes in loudest. Leaving the RF dial tuned to WOR's wave, WEA, WJZ, WMCA and several other strong locals could be tuned in by turning the detector dial without interference.

This shows that the RF stage, while contributing its share to selectivity, functions with much greater effect as a voltage amplifier, while the detector, still doing at least as much, and often more than any other detector, contributes what may be regarded as more than its share of selectivity.

# The Tyrman "70" Amplimax

[Parts I and II of this article were published in the February 4 and 11 issues. Part IV, conclusion, will be published in the February 25 issue.]

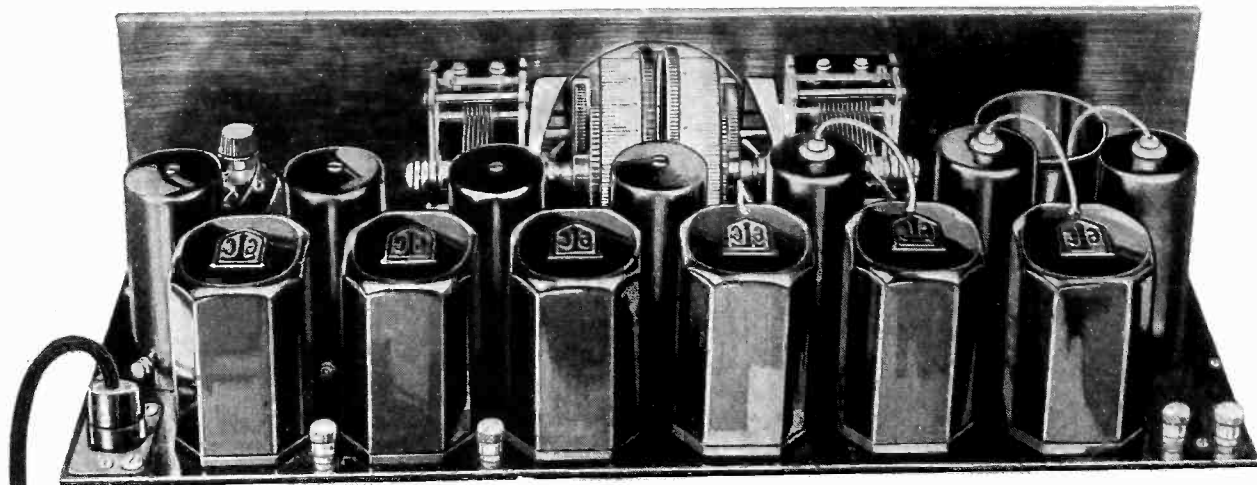

THE RECEIVER  
USED WITH A  
B ELIMINATOR



## PART III

THE great army of full-fledged radio fans stampeded as soon as the details of the Tyrman 70 Amplimax were made public, to the great satisfaction of the manufacturers of the various parts, the radio dealers, and those fans who succeeded in getting the parts. That this receiver is a radical change in circuit design in the right direction was recognized instantly, and the practical operation of the circuit bears this out. Sensitivity of a transcendent magnitude is a characteristic of any receiver containing properly used shield grid tubes, and the same can be said truthfully of the Super-Heterodyne receiver when that has been properly designed. Then when the shielded grid tube is combined with the Super-Heterodyne principle we obtain a receiver having a sensitivity of a transcendancy of a higher order than has ever before been approached in practice.

### Numerical Values

Perhaps it is puerile to set down the amplification when that can only be expressed in figures which transcend human comprehension. But a certain degree of satisfaction is felt looking at numbers inconceivably large when it is realized that they represent the performance index or figure of merit of a receiver which can be purchased for a price which is easily within the average purse, or the receiver one already has. So here we set the figures down in round numbers. The shielded grid tube has an amplification constant of about 300. A circuit can be designed in which an actual voltage amplification of 50 can be secured with such a tube. There are three such tubes in the Tyrman 70 Amplimax, giving an actual amplification of 125,000.

We neglect the amplification, if any, of the second detector, but as the detector output is proportional to the square of the input voltage, the net amplification is the square of 125,000, or it is nearly 16 billion. We are not through yet. There are two stages of audio amplification, which together step up the signal voltage 150 times, a conservative estimate. Hence the total effective voltage amplification is about  $2\frac{1}{2}$  million million, an incomprehensible figure.

This can be stated in a somewhat different way. Suppose that the maximum input voltage on the last grid is 40 volts and that the last tube amplifies 2 times. Then full volume will be received if the signal voltage on the first grid is 30 billionths of a volt.

### Practical Results Understood

While such figures are beyond the grasp of the human mind the practical results following such extreme sensitivity are easily perceived. For example, when a receiver endowed with such sensitivity is used for DX hunting it is as easy to tune in transcontinental, and even trans-oceanic stations, as it is to receive locals. The only way to differentiate the signals from the far-away station from those of the local is by noting the stray noise associated with the signals. There is more of with the DX signal. But as to the volume of the two the limit is the same, namely the power handling capacity of the last tube in the circuit.

The sensitivity of the Tyrman 70 Amplimax searches out the infinitesimal and raises it to the level easily appreciated by the senses and by our comprehension.

### Selectivity No Less

But sensitivity is not the only attribute of the circuit. If it were, it would be of no practical use. Its sensitivity is of equal importance. The circuit steps out and brings

in the whole signal and nothing but the signal. By the whole signal is meant that the circuit brings in the side frequencies as well as the carrier frequency, and it does this without dragging in wide swaths outside the essential frequency band. The signal comes in clean cut and crisp, with the articulation and intelligence carrying higher harmonics as well as the low and booming body notes of the speech or music. The loudspeaker mumbles not, neither does it screech when it is served with the output of the Tyrman 70 Amplimax. It speaks in a natural voice from far or near.

### The Loop Model Tyrman

The Tyrman circuit shown in Feb. 4 number of RADIO WORLD is for the antenna model. For local and medium distance reception it is not at all necessary to employ an open circuit antenna. Entirely satisfactory results can be obtained with a loop of ordinary dimensions. To change from the antenna to the loop model all that is necessary is to remove C3 and the antenna and to substitute the loop for coil Lo. Just imagine that this coil is the loop, and then it is only necessary to remove the antenna and the series condenser C3. A loop should be chosen which has about the same inductance as Lo. The antenna and loop connections can be manipulated very easily by making use of small binding posts in the extreme right hand corner in Fig. 1.

\* \* \*

[This is the third of a series of articles on a circuit using the new screen grid tube. Nothing so fascinating as this tube has appeared in two years or more. Keep abreast of developments made around this tube by reading RADIO WORLD each week. For several months, at least, data on this tube and circuits built around it will be published.]

## Interference In Austria Draws Reprisal Threat

The radio public is becoming increasingly cognizant of the interference caused by electrical vibratory apparatus, according to KFI, Los Angeles.

The station reports several recent instances of newspaper requests that users of such apparatus suspend operations during the broadcast of a given important event or program.

KFI notes that the agitation has

cropped up in Europe, with a report that the people of Carinthia, an Austrian province, have notified the Austrian Broadcasting Company that they will relinquish their licenses unless something is done to relieve the interference havoc being wrought by electro-medical apparatus. European radio receptionists pay a yearly fee which gives them the privilege of receiving radio broadcasts.



# Why the AC Equamatic is as Sturdy as an Oak

By J. E. Anderson

Technical Editor

[The AC Equamatic, a remarkable five tube receiver, was described in last week's issue, February 11. This week the author sets forth reasons for the striking success of the circuit.]

THE AC Equamatic receiver has made many converts to 100% AC operation, and as a result the Equamatic family is growing at a tremendous rate.

But this rapidity of growth is justified by many facts, one being that its operating characteristics are such that the life of the receiver will be as permanent as that of the oak.

It is that freedom from worry associated with a 100% AC set which attracts and holds the radio devotee to the AC Equamatic. In that set the confidence inspiring qualities of unflinching performance, realistic reproduction and absence from service annoyances are combined in the optimum degree in a single attractive unit. "I would not think of having any other receiver," commented one housewife who for years had suffered the numerous radio receivers which her husband had brought home, some of which needed more attention than a sick baby and occupied the whole apartment. "I have tried so many receivers," she added, "that I know a good one when I see and hear it."

## General Enthusiasm

Her enthusiasm is shared by others who have had the privilege to hear and to operate one of these new receivers. A general wave of satisfaction seems to have swept over the owners of AC Equamatics, because there has been a total absence of complaints but many laudatory letters. Defects in a receiver like this show up from the first turning of the switch, and hence there has been plenty of time for complaints if there had been any grounds for them.

When the receiver begins to show weakness on quality and lack of sensitivity, which it will in the course of time, do not suspect that the tuning condensers have lost their efficacy, that the RF coils have lost their inductances, that the tube sockets have developed high loss symptoms, that the audio transformers need rejuvenation, that volume controls need oiling, that the antenna is a foot too short or too long, or any one of a thousand innocent things which are suspected when the receiver loses vitality.

## Voltage High, Electrons Few

The tubes in the circuit are most likely the cause of the sluggishness of the receiver. All the circuit needs is a new set of tubes, or perhaps only one tube. Just how soon after the set is first put into operation the tubes will give out depends on how many plate current ampere-hours each tube has delivered. And that in turn depends on the filament current, the plate voltage, the grid voltage, the type of load

on the tube and on the type of tube. The very first tube to give out is most likely the power tube in the last socket. The last is probably the detector. The last tube in the set takes about 40 times as much plate current as the detector, and therefore for equal filaments the detector should last 40 times as long.

When the tube has come to the end of its useful life the plate current ceases to flow, because the supply of electrons in the filament is exhausted, and therefore the tube cannot deliver any signal to the tube succeeding or to the loudspeaker. When in doubt as to the cause of any lack of sensitivity in the set, try a new tube before suspecting parts of the circuit which never are at fault.

## Another Suspect

Next to the exhaustion of tubes the most likely cause of trouble is the mechanical wear on the controls and the tuning gear. In the Equamatic the condensers are so constructed that they will hardly ever wear out, or give any trouble at all. Likewise the coils. But the flexible leads connecting the primaries to the outside connections may in time wear out. But these are in plain view so that a casual inspection will determine whether or not one or more have wiggled loose. And this trouble will never show up in a gradual decrease in the sensitivity, but will show up as an abrupt cessation of the signal, perhaps accompanied by a few preliminary scratches.

Next as a possible source of trouble are the two volume controls R1 and P. When either of these is at fault through excessive use the source of the trouble is immediately known because the volume will not respond properly to adjustments of the control. The controls recommended were chosen for their sturdiness and long life.

The other variables in the receiver should never be touched after their first adjustment and therefore they will not give trouble.

## Optional Connection

In the diagram of the AC Equamatic, which appeared in the Feb. 11 issue of RADIO WORLD, the loudspeaker and condenser C11 are shown as connected across the choke coil Ch3 only. This connection is the simplest and allows the use of a large condenser of low voltage rating in series with the loudspeaker. But sometimes it is preferable to connect the loudspeaker between the midtap of the five volt winding on the heating transformer and on one side of C11. Hum is thereby reduced sometimes and better low note reproduction is usually gained.

In making this new connection the loudspeaker should be connected to one of the terminals on the output unit ChC311 and the other should be left unconnected. If the wrong terminal is selected the loud-

speaker is thus connected across the high voltage source, which will most likely result in damage to the speaker. To prevent making a wrong connection identify the terminals with a voltmeter. Connect the negative terminal of this meter to the midtap of the five volt winding and the other to both of the loudspeaker binding posts, one at a time. The one which gives no reading is the correct one. The one which shows a high voltage reading would lead to catastrophe.

If there is no hum and if the low note reproduction is satisfactory, it is not necessary to move the speaker leads, and that will be the case in most receivers.

Properly adjusted, this circuit does not oscillate at any setting of the tuning controls. But if it is not properly adjusted the circuit may squeal and oscillate at the lower dial settings. If it does, there may be some hum in the output besides the squeal. The cure for the hum is the same as that for the squeals. Stop the squeals. Two small variable condensers C5 and C8 have been expressly provided for adjusting or neutralizing the receiver.

## Constructional Features

The assembly of the receiver is very simple, particularly when the drilled and engraved panel and sub-panel are procured. In that case it is a case of straight assembly where one part is placed after another as fast as the builder can pick them up.

If the builder chooses to do his own drilling and laying out, he can take the photographs in Feb. 11 issue of RADIO WORLD as models. The panel is easily disposed of as only a few holes need be drilled in it, as is evident from the top photo in the article referred to.

The baseboard requires a little more work since there are many more holes to be drilled in it. But most of the holes are small so that the drilling is easy. The general layout of the sub-panel is shown in the middle photograph of the first installment of this article.

The wiring of the Equamatic should be done with the aid of the circuit diagram, but most of the sub-panel wiring can be done by following the bottom photograph in the group already referred to. The leads which carry alternating current to the filaments should be twisted by pairs. That is, any two wires twisted together should carry the same alternating current.

When the wiring has been completed, including the soldering of every joint, the builder should go over all the binding posts and screw contacts. Screws and nuts often work loose, and when they do the contact depending on them is impaired.

With that detail attended to there is nothing left but to turn on the power and to tune in. And how it will work!

I will send a complimentary blueprint of the AC Equamatic to any reader so requesting.

# The Stamping Ground of

## An Expert Analysis of the Mixing

By Herman

Managing Editor; Associate,

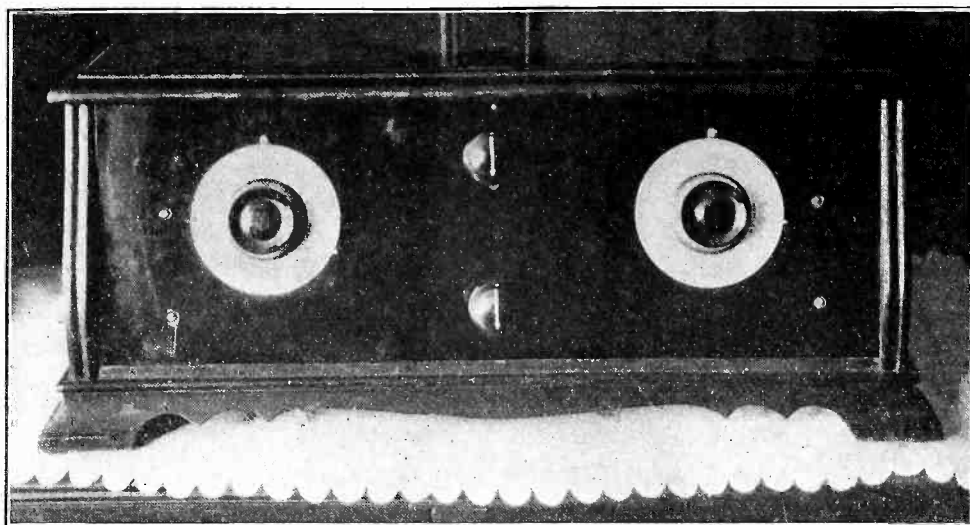

**A SUPER-HETERODYNE USUALLY HAS TWO TUNING CONTROLS, A VOLUME CONTROL AND A SENSITIVITY CONTROL. THE DIALS ARE MODULATOR OR FIRST DETECTOR (AT LEFT) AND OSCILLATOR.**

A COMPLEX circuit is introduced in the construction of any Super-Heterodyne. The performance is necessarily complex, although the construction itself may be simple. Electrical phenomena abound. Many of them are used to fine advantage and constitute the assets of the receiver. Other phenomena may be classed as troubles, and these are circumvented or nullified in Super-Heterodynes of best design.

While the Super-Heterodyne is regarded as the outstanding circuit, and is surely one of the most popular, it is also the most misunderstood. Around it has been developed terminology popular but fallacious, and constituting best evidence of the worst misguidance.

One of the phenomena is that of repeat tuning. Anybody who has operated a Super-Heterodyne knows that a given station comes in at one point on the first detector dial and at two points on the oscillator dial. The second regular oscillator setting is commonly referred to as the "harmonic," but it has nothing to do with any harmonic. You do not have a harmonic unless you have a multiple of some fundamental frequency.

### Remarkable Alternative

The repeat tuning of the oscillator is not a multiple, but arises from the fact that the frequency of the station tuned in by the first detector, or modulator, is mixed with the frequency of the oscillator in an alternative way.

Assume that the broadcast station desired to be received has a frequency of 1,000,000 cycles, and that the fixed frequency of the intermediate amplifier of this particular receiver is 70,000 cycles. Then the oscillator is tuned to 930,000 cycles. As the oscillator is coupled to the modulator, the two frequencies mix, producing a beat or intermediate frequency. Physics takes care of the automatic subtraction of 930,000 oscillator frequency from 1,000,000 modulator frequency. The difference is 70,000 cycles, and the new wave of this frequency is passed along by the intermediate amplifier, with a gain for each stage, until the second detector is reached, when the 70,000 cycle radio frequency is rectified to an audio frequency and is stepped up to speaker volume by the AF amplifier.

As frequency on the one hand and wavelength and capacity on the other vary inversely, the lower oscillator frequency in the assumed instance is represented by a dial setting higher than the setting for the modulator. If the modulator is tuned to 1,000,000 cycles at 40 on the dial, the lower oscillator frequency will be represented by a higher dial setting, say, 45.

### The Second Way

The repeat tuning arises from the possibility of combining the same modulator or broadcast station frequency of 1,000,000 cycles with a higher oscillator frequency to produce the same beat frequency. If the oscillator is tuned to 1,070,000 cycles, a combination of the two still will produce a beat of 70,000 cycles. In this instance the modulator frequency is subtracted from the oscillator frequency, whereas in the previous instance the reverse was true. When two frequencies are mixed a resultant frequency is the difference between the two. In theory it makes no difference which is the higher, but in practice the difference is acute.

The higher oscillator frequency (lower capacity setting of the tuning condenser, and usually also the lower dial setting) works out to better advantage for tuning a Super-Heterodyne.

Some may ask, "If one is better than the other, why permit the option? Why not stick to one?"

Several attempts have been made, some of them successfully, to have only one possible setting of the oscillator. This type of Super-Heterodyne is known as "One Spot."

### Advantage of Option

It is sometimes an advantage to have the option. While it is true that weak and distant stations come in usually on only one of the two oscillator frequency settings—the higher frequency—in freak instances the opposite is true.

Also, even strong locals sometimes come in better on one setting than on the other, and you can not always predict which will prove the better.

Sometimes one oscillator setting for a given station is more effective, and an hour later the other oscillator setting

may prove preferable. This changing condition is not fickleness or erraticism but is due largely to the changed aspect of interference. Between 10 and 12 p. m. the seemingly baffling difference most usually asserts itself, due to stations signing off. Hence heterodyne whistles are fewer and the "natural" oscillator frequency may be used to advantage, whereas previously the "unnatural" oscillator frequency was really more desirable, since it reduced interference.

The complexity of the Super-Heterodyne is due to the phenomena of the beat more than to anything else.

While we have discussed only such beat as arises from subtracting one frequency from another, it is also true that other beats exist, including those arising from the addition of the modulator and the oscillator frequencies. Besides, there is a beat produced by the mixing of the first harmonic of the oscillator with the fundamental of the modulator. Working it out, the 1,000,000 fundamental of the first detector (the station frequency) mixes with the second harmonic, let us say, of the lower frequency oscillator. Add the two. A frequency of 1,940,000 cycles is produced. But this is not utilized in the stated receiver, since the intermediate frequency at which amplification is obtained is 70,000 cycles, and the intermediate channel rejects all frequencies save its own.

### 10,000,000 Waves in One Tube

Again, since the 1,940,000 cycle beat is present in the modulator, it beats again with the intermediate frequency introduced by normal tuning, and we have 2,010,000 cycles, the additive result, as well as the difference frequency, 1,870,000.

Likewise, these stray frequencies of 1,870,000 and 2,010,000 cycles mix by adding together and by striking a difference. So it goes on, almost infinitely, comprising third, fourth, fifth harmonics, etc., all mixing with the station frequency, the oscillator frequency and offspring frequencies of the two.

More than 10,000,000 frequencies are in the mixer tube—and the intermediate channel is called upon to accept one to the exclusion of all others. This it may do. Sometimes it may fail. Sometimes when it succeeds it fails, that is, the acceptance is orthodox, legitimate, perfect, but interference from a direct wave of 70,000 cycles, for instance code, may mix with the modulated frequency without going through the tuners.

The foregoing gives some idea of the complexity arising from the phenomenon of mixing. It should be clear now that repeat tuning is not related to harmonics, since harmonics present are not amplified by the intermediate channel, not rectified, not heard. And the double tuning of the oscillator produces reception—music, speech—and reflects merely the alternative oscillator frequencies that will mix with the station frequency to produce the intermediate frequency.

Forgetting for a moment the Super-Heterodyne, let us assume two coupled tuned circuits, one of which is oscillatory. If the two circuits are tuned close enough in frequency the difference between their frequencies will be audible. Tune one circuit to 1,000,000 cycles, the

# Fascinating Phenomena

## Process in a Super Heterodyne

Bernard

Institute of Radio Engineers

other to 1,000,500. The result is a 500 cycle note. You can hear it. It is a beat and it is a note—that is, you can hear it directly—hence the term “beat note.”

The device that produces beat notes is an audio oscillator.

Now, returning to the Super-Heterodyne, we observe that the modulator and oscillator both operate at radio frequencies and produce an intermediate frequency that also is a radio frequency. Another way of looking at it is that the oscillator is a small broadcasting station sending out a radio frequency which the first detector modulates while combining with the oscillator to change the original carrier to a new carrier frequency—the intermediate frequency. Every Super-Heterodyne is a small broadcasting station sending its freshly modulated new wave through to the second detector, usually on the lower frequency resulting from mixing.

While lower than the broadcast or the oscillator frequency, the intermediate frequency is still not nearly low enough to be heard, without rectification. Therefore it is wrong to refer to the intermediate frequency as a “beat note,” since there is no note. We do not call a thing a note that is 60,000 cycles above our hearing limit. In an audio oscillator “beat note” is the correct term.

### More Than Two Tuning Points

While repeat tuning well may be an asset, because enabling better reception, sometimes a Super-Heterodyne will bring in a given station at more than two places on both dials. These conditions are nuisances. Correct design usually will obviate them.

One of the difficulties arises from genuine harmonics. These usually should not be generously present in the oscillator circuit, where the tube operates on the straight portion of its characteristic curve. But the modulator or first detector is usually of the leak-condenser variety, since that affords maximum volume and sensitivity. A positive bias usually is requisite. This is a ripe condition for the fruition of the harmonics.

Let us take the case of a genuine harmonic in the modulator.

Suppose a broadcasting station has a frequency of 500,000 cycles (600 meters). If the first detector is a harmonic generator, the station can be tuned in at 100 on the modulator dial (500,000 cycles) and again at 40 on the same dial (1,000,000 cycles). Now if the oscillator is tuned to 570,000 cycles (about 95 on the dial) a difference frequency of 70,000 will be produced and this the intermediate channel will amplify. Hence not only does the station come in at two points on the modulator but at four on the oscillator: (1), the difference between the station frequency and the lower oscillator frequency; (2), the difference between the station frequency and the higher oscillator frequency; (3), the difference between the second harmonic modulator frequency and the higher modulator frequency; and (4), the difference between the second harmonic modulator frequency and the lower oscillator frequency.

Suppose a fundamental station fre-

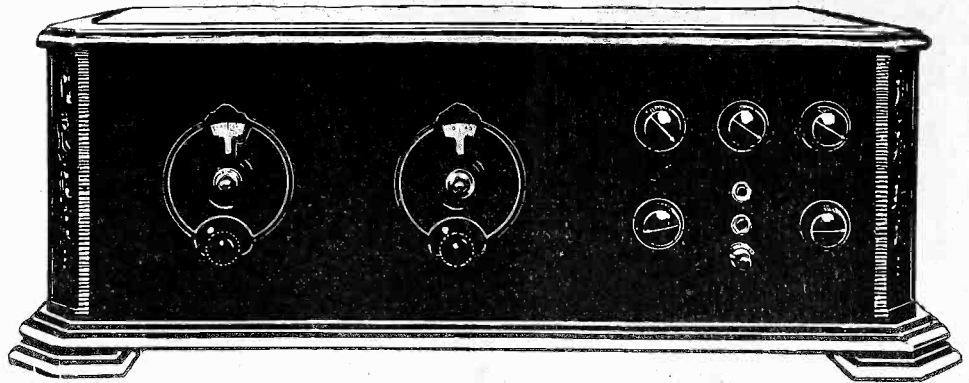

**SOME PERSONS DON'T OBJECT TO NUMEROUS MINOR CONTROLS. STILL, TWO TUNING DIALS CONSTITUTE THE LIMIT IN WAVELENGTH SELECTION, AS DETERMINED BY POPULAR TASTE. WITH A LARGE SET THE LEFT-HAND PLACEMENT OF TUNING DIALS WORKS OUT WELL.**

quency of 1,000,000 cycles is receivable, and that it also represents the second harmonic of another station frequency, as outlined. The likely result is interference.

All such forms of interference—not due to lack of normal separation of stations—are called secondary interference. Those forms of interference in this category that arise from phenomena reflecting some normally expected frequency are called image interference.

It might be assumed that secondary interference is independent of selectivity, since it seemingly arises through no lack of selectivity, but from complex and phenomenal conditions inherent in the circuit. Much of the secondary interference arises from insufficient selectivity in the first detector circuit.

### Selectivity

You remember how broadly the old crystal sets tuned. A single non-regenerative tube circuit is only a little more selective, and then only at the higher frequencies, due to the help of inter-electrode feedback. The non-regenerative first detector in a Super-Heterodyne well deserves construction of parts of low-loss design, or a stage of RF may precede the first detector to exclude undesired frequencies.

Such is not necessary, however, if the intermediate channel is designed to work with a non-regenerative single stage, for the selectivity may be sharpened to such a point in that channel as to make inadvisable the introduction of other rejection.

Whenever you see a One Spot Super-Heterodyne you see tuned radio frequency amplification ahead of the first detector, and perhaps a regenerative first detector to boot. This is because the intermediate frequency of the receiver is usually very high. In one popular instance it is more than 3,000,000 cycles.

At any such intermediate frequency the amplification is low, hence the signal must be built up considerably ahead of the first detector.

The lower the frequency the greater the amplification.

But there are limiting factors. The intermediate frequency must not be so low (such a high wavelength) that an enormous coil would have to be constructed, with high distributed capacity and high resistance, or a large condenser be placed across a small coil. The coil capacity easily could be high enough to eliminate from the carrier all the higher audio fre-

quencies, while the resistance easily could be so high as to make twice as high an intermediate wavelength amplify only half as much per stage.

The One Spot feature may be derived from utilizing the sum of the two frequencies. Hence the first detector circuit is conventional, but the oscillator coil and condenser are so proportioned on smaller inductance and capacity lines that full sweep of the oscillator dial does not produce more than one frequency that mixes with the modulator frequency to constitute the intermediate frequency.

Another way of making a circuit One Spot, or nearly so, is to have the intermediate frequency much lower than usual, not very much less than the lowest broadcast. This is likely to be a modified One Spot, in that at the higher dial settings of the oscillator a few stations will come in at two settings. Thus from 450 to 600 meters you may get repeat tuning, but at no lower wavelengths.

### Effects of the System

While the word “harmonic” is greatly abused in connection with Super-Heterodyne, there is one form of this receiver that actually operates exclusively on the second harmonic. That is one of the designs of the Radio Corporation of America. The Second Harmonic Super-Heterodyne gets its name from the exclusive utilization of the second harmonic of the oscillator to mix with the modulator frequency so as to produce the beat by the difference between the two. Roughly speaking, the oscillator coil and condenser are of twice the inductance and twice the capacity commonly employed.

Specifically, the oscillator range of frequencies is divided by two. Instead of 1,500,000 cycles to 500,000 cycles the range is 750,000 cycles to 250,000 cycles.

By using the second harmonic of the frequencies within this range a suitable frequency for mixing is obtained. Repeat tuning, however, is not avoided, although secondary interference may be reduced, oscillation more readily assured and production of interference by radiation to neighboring receivers very materially reduced. The oscillator power, on the other hand, is less than it would be were the fundamental used.

In the past year or so the Super-Heterodynes for home construction have progressed to a most remarkable point of efficiency and all the constructor need do is follow the advice of those in whom he has confidence, and reap fine reward.

## THIS IS THE LIFE



LAUGH FOLLOWS SMILE AS HOMECASTER IS USED TO BRING ONE'S VOICE OUT OF SET IN NEXT ROOM, WHILE GUESTS THINK IT'S A STATION BROADCASTING.

## FLEMING GETS ANOTHER MEDAL

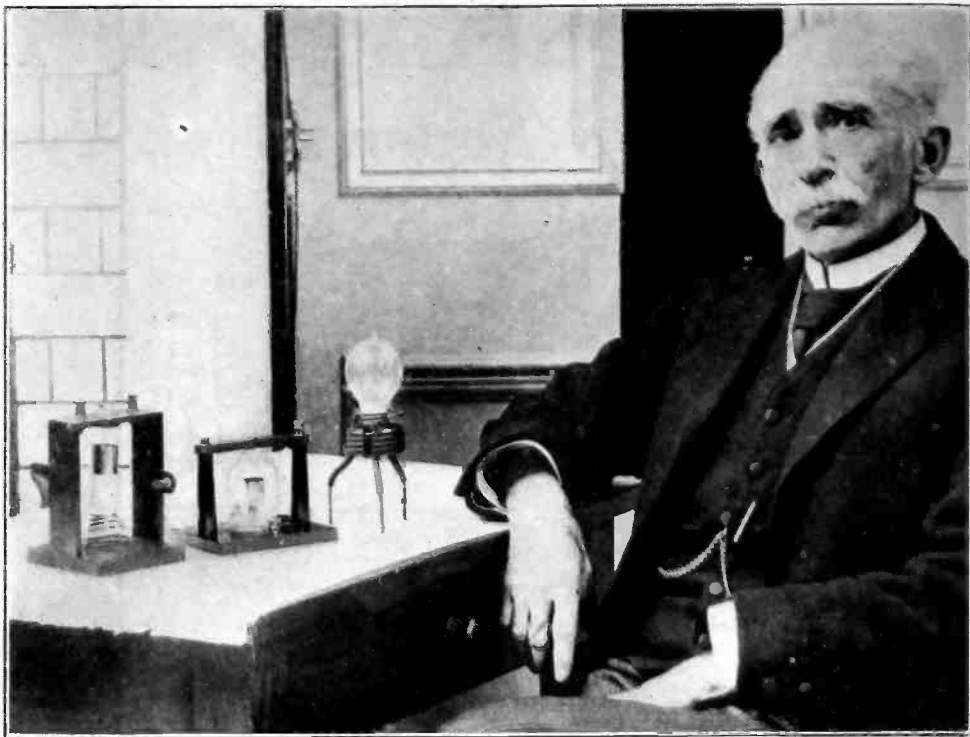

J. A. FLEMING, INVENTOR OF THE FLEMING VALVE, THE TWO-ELEMENT TUBE, HAS BEEN AWARDED THE FARADAY MEDAL BY THE COUNCIL OF THE BRITISH INSTITUTION OF ELECTRICAL ENGINEERS. HE WAS PHOTOGRAPHED IN LONDON, WHERE HE LIVES

### Caldwell States Goal: Clear Programs for All

In reply to criticism of the Commission, O. H. Caldwell, of New York, one of the commissioners whose nominations are pending, told the committee that the goal of the Commission "is to deliver to every home in America clear and satisfactory radio programs."

"Also," he continued, "as time goes on we want to see those programs increasingly diversified. We can not create ideal stations just as we would like to have them, but we must take the actual stations where they are and so arrange their operation and wave lengths that clear radio programs shall reach every farm, ranch and cross roads."

ing recommendations with respect to the use of patented devices. There is sufficient power in the present law to enforce the rule against straying from an assigned wavelength, Mr. Caldwell's opinion.

### No Apologies for Allocations

Replying to the charge that chain stations are predominant on the cleared channels, so that the same program is often tuned in on numerous wave lengths to the exclusion of a varied program, Commissioner Caldwell made the following statement:

"I believe there is a place for relatively high-powered stations on these waves and also for local stations rendering purely local service. We took the situation as we found it, and endeavored to fit stations together, classifying them by functions as to the service rendered, and making allocations on the basis of the audiences served.

The Commission has no apology to make for the stations placed on the cleared channels. Those stations had the best individual records when we made the assignments. If afterward they elected to belong to networks, we could not restrict that.

### Views on Chain Stations

"The present arrangement with regard to chain stations is perhaps unsatisfactory in the public interest. The next step by the Commission will be to substitute independent programs on the cleared channels, because the chain programs should be local. But I think there ought to be four or five high-powered chain stations in this band, properly distributed geographically so as to provide long distance reception of chain programs.

"This would serve 50,000,000 people who live more than 100 miles from radio stations.

"If we can stagger these stations, it will be desirable to give 50 kilowatts of power, or possibly even 100 kilowatts, to these four or five stations. The difficulty with this high power is that the side channels are often interfered with, despite the 10 kilocycle separation between the op-

# Board Plans to Curtail Broadcasts by Chains

Washington.

Seventy per cent of the task confronting the Federal Radio Commission with regard to clarifying the broadcasting situation has been completed, Commissioner O. H. Caldwell testified before the House Committee on Marine and Fisheries. Aside from technical improvements, such as requiring closer adherence to assigned wavelengths, the remainder of the task involves these problems, in Mr. Caldwell's opinion:

1. Limiting the number of chain broadcasting stations on the 25 cleared channels and on the others to be cleared.
2. Freeing more stations from heterodynes occurring within a range of 100 miles.
3. Encouraging individual stations to apply for clear channels now in the possession of stations duplicating programs, such as chain stations.
4. Equalizing the utility of all portions of the broadcasting spectrum, particularly the waves at the lower end.

These points were enumerated by Commissioner Caldwell in the course of his testimony as to the plans and policies of the Commission during the House Committee's consideration of the White radio bill (H. R. 8825) which would extend the life of the Federal Radio Commission for another year beyond March 15. Mr. Caldwell's testimony was devoted entirely to the broadcasting phase of the radio situation.

### Technical Aid Needed

The Commission, he declared, needs technical aid and apparatus, and he recommended expansion of the facilities of the Department of Commerce supervisory force to this end. In connection with the requirement that stations adhere to their assigned frequencies, Mr. Caldwell asserted that regulations can be set up but that it would be unwise to designate the kind of apparatus to be installed in stations.

This apparatus, he said, would involve the Commission in the principle of mak-

## ON JOB AGAIN



(Wide World)

**ALL RADIO AND NO STUDY LOST ERIC PALMER, JR., HIS LICENSE FOR STATION 2ATZ, BUT HE IS BACK ON THE AIR AFTER REINSTATEMENT. HE LIVES IN BROOKLYN, N. Y. HIS FATHER IS A WELL-KNOWN RADIO PROMOTER.**

erated channels. We need to go slowly in granting the use of high power."

Individual merit of the stations will serve as the basis for any reallocations decided upon by the Commission, Mr. Caldwell stated.

### Criticized by Mr. Davis

Representative Davis (Dem.), of Tullahoma, Tenn., said he was glad to hear that chain predominance on the cleared channels would be obviated, but he charged the Commission with having "done nothing but clear 25 channels" since its inception nearly a year ago. When Commissioner Caldwell made the assertion that local listeners throughout the country can now receive local programs, Mr. Davis asserted this was not true to his knowledge.

Representative McKeown (Dem.) of Ada, Okla., said that from his experience as a listener, he would say that reception conditions are the worst they have been in three years.

Representative Davis reiterated his previous charge of discrimination against stations in the South in the matter of wavelength assignments, a charge which Mr. Caldwell denied with the assertion that "there is no more ardent advocate of the rights of the South than Judge Sykes," the acting chairman of the Radio Commission, who represents the Southern zone.

As to the use of the lower end of the broadcast spectrum, Commissioner Caldwell declared that in his opinion, the voluntary selection of lower broadcast waves by some stations indicates the new conception of their utility. At least six stations have volunteered to use these channels if given high power on them, he said. Manufacturers have informed him, he said, that reception on the low waves is quite dependable on the sets now being built.

### Extension of Board's Life Favored by Senate Committee

A bill to extend the life of the Federal Radio Commission for another year after March 15 has been ordered favorably reported to the Senate by its Interstate Commerce committee. A provision proposed by Senator Dill, Democrat, of Washington, to limit broadcasting licenses to six months was included in the report. Under the present law the Commission has the right to grant licenses for 2 years, although its policy has been to grant them for only sixty days.

## BROKENSHERE SAILS



(Metropolitan)

**NORMAN BROKENSHERE, FORMERLY OF WJZ, NOW OF WPG, ATLANTIC CITY (left), SAILS FOR EUROPE, AND GRAHAM MCNAMEE SEES HIM OFF.**

## Move to Strengthen Board's Licenses

Washington.

At a hearing of the House Merchant Marine Committee Representative Davis of Tennessee suggested a change in the Radio Act of 1927 that would remove any doubt that may now exist as to the power of the Federal Radio Commission to revoke or withhold broadcasting or communication licenses. Chairman White of the committee and Judge E. O. Sykes, acting chairman of the Radio Commission, expressed the opinion that under the law no vested right attaches to any radio license.

Mr. Davis pointed out that many licensees take the position that they have a legal right to dispose of their permits together with their equipment. In view of this uncertainty Mr. Davis recommended a change in the law empowering the commission to revoke or withhold a license, and to prohibit the transfer of a license, the amendment being so framed as to withstand all attacks that would be made on it in courts on constitutional grounds.

## HE IS THE ONE

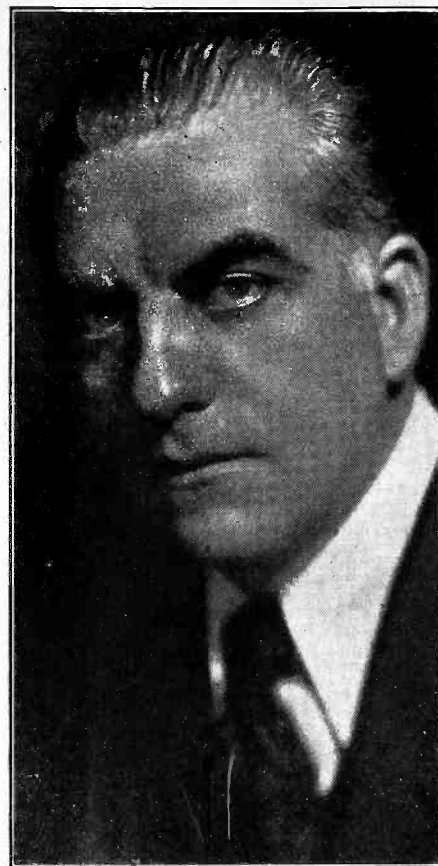

**THE CULTURED ACCENTS OF BEST SPEECH FALL DEFTLY FROM THE LIPS OF ONLY ONE ANNOUNCER IN A HUNDRED ARE SECOND NATURE TO FLOYD NEALE, CHIEF ANNOUNCER, WGBS, GIMBEL BROS. STATION, NEW YORK CITY.**

### COOLEY PHOTOS SENT

Newark, N. J.

The first test of the Cooley system of broadcasting photographs by radio was made over station WOR on Jan. 31 in the morning. Twenty-five receiving apparatus had been distributed among experimenters in New York and adjacent territory.

# Sun Dance Celebration Broadcast to Eskimos

Pittsburgh.

Through the magic agency or radio, modern civilization will be joined in celebrating the centuries-old rite of the Sun Dance of the Eskimos, observed every year when the sun first appears over the Arctic horizon after an absence of 135 days during which the region has been shrouded in continuous darkness.

At 10 p. m. Eastern Standard time KDKA started transmitting the fourth of its special broadcasts to the Far North. This broadcast preceded by only a few hours the sunrise which had been awaited for more than four months, and was the signal for the start of the ancient, primitive festival.

### White Men Join In

The white men at civilization's northernmost outposts, who include Royal Canadian Mounted Police and trappers of the big fur companies, joined with the natives in

their pagan fete and enjoyed it immensely. The program started off with musical selections designed to fit the mood of the isolated people as the most joyous moment of the year creeps on. Officials of KDKA declared that whatever else they might broadcast, there would be no "hog-calling" on the program.

A report has been received from the far north that during a previous broadcast when "hog-calling" was featured, the Eskimos who had gathered at one of the trading posts to "listen in" interpreted the shrieks to be the voice of the Arctic region's counterpart of Satan, and set out en masse post haste in the direction of the North Pole.

### Personal Messages Sent

Following the musical program, personal messages from friends and relatives of those located in the far north were broadcast in quantity.

# How Stability is Capital

By Sidney J.

ONE of the most popular receivers in the congested Chicago territory is the Ellis five-tube receiver. To those fans who have consistently used Ellis D coils for the last few years little need be said of the efficiency of these compact units. For the benefit of the fans who have never used them, however, a few remarks about the coils will be in order.

The latest Ellis D coil, besides using the D-shaped winding, also utilizes a new method of reducing distributed capacity—namely, by group space winding. In preference to spacing every turn on the coil, as is often done, it was found more efficient to wind four turns closely together, then leaving a space about equal to two turns, continuing on again with four more turns and so on for both the primary and secondary.

Theoretically the effect of this method is first to reduce distributed capacity to a minimum, reduce the radio-frequency, and, of course, to provide complete freedom from interference and external pick-up. Not only will this be found quite true if the coils are measured on instruments but it is also proved out in the actual operation of a five or six tube radio-frequency receiver.

In a Super-Heterodyne receiver, where a band pass filter is provided, operating on a wavelength well above the broadcast band, it is, of course, impossible for the set to pick up interference through the intermediates, and the only external pick-up possible is in the oscillator coupling coil. The substitution of an Ellis D coil oscillator coupler in any Super will readily prove the advantages to be gained with the D coil group space winding.

In a tuned radio-frequency circuit the filter circuits provided by the tuned radio-frequency coils are operating on the broadcast wavelengths, therefore it is essential that no external pickup or interstage coupling be allowed in the coils.

It should be impossible to tune in a

station even weakly when the antenna and ground are disconnected.

The reason so many tube radio-frequency sets fail in their ability to cut through and get distance is due solely to the fact that the coils in themselves pick up a certain amount of energy and feed it through the balance of the circuit by intercoupling between coils, thus practically eliminating any possibility of getting out-of-town stations without some background of a local station which is very close to wavelength.

This does not hold true on all stations, of course, but it does hold true where a local station is ten kilocycles away. It may be seen, then, that the solenoid type of coil is far from being the ideal coil for cutting through the barrage of local stations, no matter how efficient the coil may be in electrical measurements and tests.

Since the Ellis five-tube receiver was designed a great many reports have been received by the manufacturers telling of the results obtained using Ellis D coils.

I am reproducing here a list of stations received on the first night's operation of his Ellis receiver through local stations by G. B. McMillen, 1451 Marquette road, Chicago.

Of course, there will be fans who will say they are able to do much better than this with their so-and-so dynes. Be that as it may, every one of these stations was tuned in on the loudspeaker and many of them were far too loud. The log:

WLWL, WWJ, KOA, KOIL, KDKA, WABC, WGR, KMOX, WFBM, WPG, WOC, WGY, KMA, WTAM, WCCO, WLW, WJR, WCX, WJZ, WLW, WRR, WEA, WOW, WHO, KSD, KMAK.

Mr. McMillen's own note follows: "The above stations were logged between 5 and 10 o'clock p. m., all on the loudspeaker."

A number of improvements have been

made in the original receiver, and they are incorporated in Mr. McMillen's set. These improvements are shown on the schematic diagram with this article.

## Resistance Used to Stabilize

It will be noticed that 1,000-ohm resistances have been placed in the grid circuits of the radio-frequency tubes, in addition to the high resistance in the plate circuit to control oscillation. The purpose of these resistances is to stabilize the receiver over the entire wavelength range.

The result is a set which will go smoothly into oscillation at any point between 200 and 550 meters without squealing or howling. This is especially desirable on very weak signals, as it is possible to gradually increase the volume by turning up the high resistance in the plate circuit without the spilling over action found in the usual tuned radio frequency set.

A careful study of the schematic diagram will show that the remainder of the circuit is similar to any of the standard radio-frequency receivers which were previously described.

## Can Be Inserted

Because many fans already have sets built up and will only need to substitute the Ellis D coils for the transformers they are using and make the minor wiring changes called for in this new circuit, a complete layout baseboard plan will not be given. For those who wish to build the receiver from the ground up the following details should suffice:

The baseboard should be about 9 by 21 inches in order to allow 4 to 5 inches separation between centers of the D coils. It is quite important that the coils be placed as shown in the diagram with their slots all in a line. If this is not done there will be no external pick-up, but there may be a tendency to interstage coupling which will be totally absent if the coils are correctly placed.

The parts should be laid out on the baseboard so as to allow an even spacing between each part. Do not try to crowd the instruments together to save space, and likewise it is poor practice to use a 26-inch baseboard when 21 inches is plenty.

## Two-Gang Condenser Used

Three separate condensers may be used if the fan has no objection to using three dials for tuning. The best plan, however, is to use a two-gang condenser for the radio-frequency stages and a single condenser for the antenna tuning coil. This will give efficient two dial operation and allows the use of drum type dials if desired. A Camfield double drum dial and three Camfield .00035 condensers make an ideal tuning element for the receiver.

It is truly surprising how many fans will go to any extent to obtain distance reception and yet will give no thought to the quality of reproduction. Listen to the average receiver that has the ability to get out of town stations and notice the quality of the music. It is invariably hard and usually with a background of local noise. Most set builders will instantly claim that it is not possible to get out of town stations without some noise. It isn't if you don't give the audio end any thought. It is possible to get your distant stations with every bit as good tonal quality as local if the proper at-

## Beam Better, Cheaper on Messages, Says Marconi

Radio telephony across the Atlantic over a beam system which would not only be more free from disturbances than the present service but which could also be furnished for about one-fifth the cost, was the prediction by Senator Marconi in a recent interview.

"We are devoting a good deal of attention to the super-position of telephony on the telegraphic signals now being sent over the beam system," he stated. "The results have been so satisfactory as to warrant the hope that in a period of months we shall be able to take advantage commercially of

this important development.

"Telephony under these conditions would be very much more economical than under existing conditions. The financial return from the telephony would pay largely for the operating expenses of the telegraphic service and make it possible for us to give wireless telephone service certainly at a much cheaper rate than the present \$75 for three minutes.

"The greater the success of our experiments, the greater reduction we may be able to make in the charge. It might be less than \$15 for three minutes."

## Law Is Asked to End Direct Selling Talks

A campaign against direct selling by radio has been started with the circulation in Iowa of 450 petitions asking that the radio law be amended as to make the practice illegal. The petitions charge that direct selling is unfair competition and a menace to the retail business structure of the coun-

Francis St. Austell, president of the Iowa Radio Listeners League, said that plans are under way to extend the movement to fifteen other States, and that Iowa newspapers would be asked to publish ballots in an effort to get a thorough poll of listeners on direct selling.

# ized in Ellis "D" Five

Thompson

### LIST OF PARTS

- One 7 by 21-inch panel.
- One 9 by 20-inch baseboard.
- Camfield .00035 single condensers.
- One double drum dial.
- Two 1/2 mfd. Flechtheim by-pass condensers.
- One .002 mfd. Flechtheim by-pass condenser.
- One Electrad 2 meg. grid leak.
- One Electrad .00025 grid condenser.
- One Frost 6 ohm rheostat.
- One Frost 25 ohm rheostat.
- Set of three matched Ellis D coils for .00035 condensers.
- Five Frost tube sockets.
- One Frost 200,000 ohm volume control.
- Two Halldorson Overtone audio-transformers.
- One Halldorson Overtone output transformer (optional).
- Two No. 1 A Amperites.
- One 7-contact Hagel Power plug and cable with bracket mounting socket.
- Two Frost 1000 ohm grid resistances.
- Frost filament switch.
- Four X. L. binding posts.

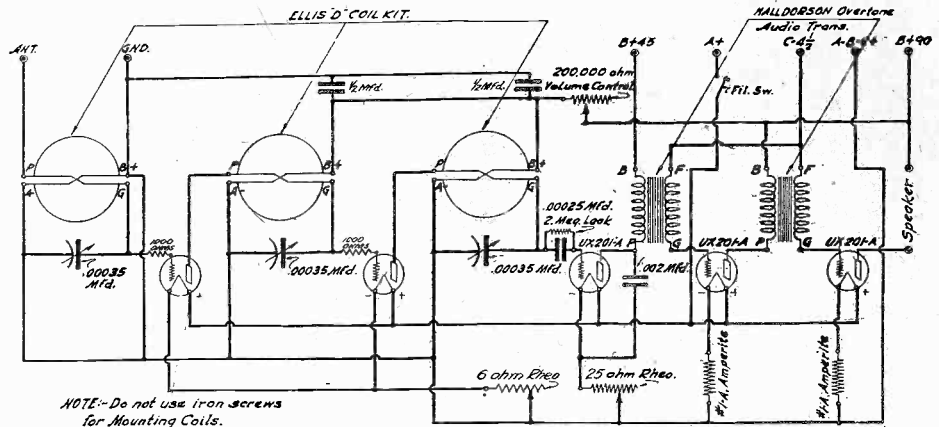

CIRCUIT DIAGRAM OF THE ELLIS "D" FIVE

attention is given to the audio end of the receiver.

### What Is Tonal Quality?

Let us consider what is required to produce true rendition of the selection of a DX station. Audio-amplification systems may be developed to accentuate either high or low tones. The average audio-transformer available today is designed to accentuate the low notes below 100 cycles.

On the old horn type speakers this was a very desirable feature, for the horn would seldom if ever reproduce below 100 cycles.

With the advent of long column air speakers and the better types of cones the speaker in itself is usually very good on the low notes. I we then further accentuate these low notes and ignore the higher tones we obtain a low pitched, monotonous tone from the set with practical elimination of the higher notes entirely.

On distant stations our low pitched tone develops itself into a rumble by blending with the external noise. Listen to a distant station on your receiver closely and see if this is not so.

### Free of Tube Noises

What we really require is an audio system that will amplify evenly over the entire audio range and theoretically with a slight accentuation of the upper register.

In practice, however, it is better to retain the correct amplification of the upper register rather than to accentuate it, for the reason that most of the tube noises are above 5,000 cycles, consequently the ratio between tube noise and signal gain is held at a minimum. This is especially noticeable on distant stations.

### Assembling the Set

Halldorson Overtone audio transformers when used with their special output filter fill the above requirements, hence they have been chosen for the Ellis receiver described. When the set is operated there should be no noise on the low-

er scale on distance other than the music being received and the upper register will be completely free from the usual tube noise of the ordinary receiver.

After the parts have been purchased they should be carefully checked to determine if everything appears O. K. You may now proceed with the assembling.

Mount the parts on the baseboard, putting the Ellis D coils on last of all. The Ellis D coil, by virtue of its low resistance and air dielectric, is rather fragile, so if the coils are mounted last there will be no chance of damaging them.

A study of the schematic diagram will show the position of each part with respect to its terminal markings. The transformer markings will be found down on the small ledge near the eyelet at the base of the transformer.

The coils are plainly marked in gold letters.

When the assembling is completed the baseboard should be wired before the

front panel and baseboard are fastened together.

### Oscillation

In wiring the condensers care should be taken to see that the stator plates go to the grid side of the coil and the rotor plates to the filament side. This will prevent any chance of body capacity.

It is important that the radio-frequency tubes have a full ninety volts or the set will not oscillate when the volume control is turned to maximum. Should this difficulty be encountered there will be a decided lack of volume.

This may be remedied in two simple ways—first, increasing the radio-frequency voltage, or, second, by reducing the two grid resistors to 750 ohms instead of the 1,000 ohms called for. If good tubes and batteries are used this difficulty will not be encountered. In any event the correction will not in any way affect the efficiency of the receiver.

## If One of Mixed Waves Is Pure, Beat is Pure

When two different frequencies are mixed to produce another frequency, as in the Super-Heterodyne, the purity of the wave does not depend on the purity of each of the two components, but if one is pure the beat is pure. This is another mysterious feature of the Super-Heterodyne.

It used to be assumed that the distinction of the beat was proportional to the sum of the distortion in the two components, but oscillograph tests, later supported by theorem, exploded that idea.

When building a set for framing in a sloping cabinet one often has sub-panel

brackets that produce a strictly upright effect. While everybody favors the up-and-up, nevertheless all want to have the panel slope for the sloping front of a cabinet. An easy way out is to cut a small piece of wood of triangular shape, and as thick as the thickness of the bracket, drilling holes in the wood to meet the holes in the bracket.

When the front panel is to be affixed the screws pass through the panel, then through the block and into the straight brackets, yet the sloping effect is there.

Be careful to cut the triangular pieces to the correct angle.

## Brace Subpanel Well; Use Extra Brackets

One of the jobs that not all home constructors of radio sets perform too well is the bracing of the subpanel.

All of us obtained our first experience from baseboard type of construction, but when eye appeal came to the fore and hard rubber or Bakelite subpanels became popular, somehow we forgot the new need or rigid bracing.

It is good practice to use, besides the two brackets for attaching the subpanel and front panel alike, extra supporting brackets that will prevent the subpanel from sagging. In that way not only will you be proud of your "battleship" type of construction but you will prevent breaking of connections due to tension applied to the leads.

# Why Even Harmonics

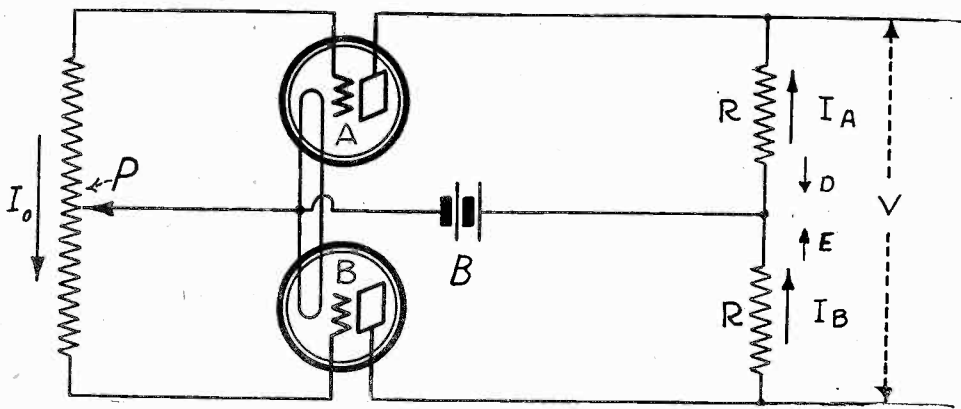

FIG. 1

"Is there a simple way of explaining why the even harmonics are balanced out in a stage of push-pull and why the odd harmonics are reinforced?" So asked a fan who wishes his radio in less abstract terms than mathematical symbols.

The functioning of a push-pull stage in this respect can be shown very simply in terms of mathematics to those who read and interpret mathematical formulas more easily than they read ordinary language, but it is not so easy to show it to those who do not read mathematical signs. But let us try to explain it without recourse to symbols and theorems.

In Fig. 1 is given a typical push-pull stage. In the input is shown a potentiometer P, through the resistance of which a pure alternating current  $I_o$  is supposed to flow. The slider of this potentiometer is returned to the filament of the tubes and is adjusted so that the voltage drop in the total resistance is equally divided between the two tubes.

### Resistive Load Assumed

In the plate circuit of each tube is a resistance of value R ohms. At the junction of the two equal resistors R the positive terminal of the plate battery is connected. The two tubes used are supposed identical in every respect.

Now consider an instant when the current  $I_o$  flows in the direction of the arrow. The grid voltage of tube A thus increases. The plate current in that tube responds in phase and thus increases also. This is indicated by the arrow  $I_a$ . At the same instant the grid voltage of tube B decreases, when the current  $I_o$  flows as indicated by the long arrow. The plate current in B responds in phase with the grid voltage and thus the current decreases. This is indicated by arrow  $I_b$ .

That the grid voltage of one tube increases at the same time that the grid voltage of the other decreases is obvious from the fact that the input current  $I_o$  flows in opposite directions with respect to the two grids. In one case it flows from the grid to the filament and in the other from the filament to the grid.

### Plate Currents Not Equal

In view of the fact that the absolute and instantaneous values of the grid voltages on the two tubes are equal, differing 180 degrees in phase, one might think that the plate currents  $I_a$  and  $I_b$  are also equal at every instant. But that is not so. It would be if the tubes did not distort, and they always introduce some distortion. The form of the plate current wave is not the same as the voltage wave put in. The distortion of the wave form can be accounted for by the introduction of harmonics of the fundamental frequency. For example, if the input is a sixty cycle pure wave, the output is a complex wave

containing not only the sixty cycle wave but also the harmonics of it. It has component frequencies of 120, 180, 240, 300 cycles and so on.

Since the two tubes are exactly the same and the circuit perfectly symmetrical, the instantaneous value of  $I_a$  will be the same as the instantaneous value of  $I_b$  was half a cycle earlier or will be half a cycle later. This comes from the fact that the input voltages are 180 degrees out of phase, or one is half a cycle ahead of the other. This is illustrated in Fig. 2.

Now let us repeat the question, "How are the even harmonics balanced out?"

### The Curves Show How

Refer to the curves in Fig. 2. Curve A shows one cycle of the voltage as put into tube A and Curve B shows one

cycle of the voltage as put into tube B. The total voltage put into the push-pull stage is the sum of these two curves at any given instant. This can also be stated by saying that the total input voltage is the algebraic difference, remembering that the two are in exactly opposite phase. It should be observed carefully that Curve A rises or increases when Curve B falls or decreases, and vice versa.

Curves A and B can also be regarded as representing the fundamental of the plate currents  $I_a$  and  $I_b$ , not the total plate currents. The second harmonic introduced by tube A is represented by Curve D and the second harmonic introduced by tube B is represented by Curve E. The second harmonic has twice the frequency of the fundamental and therefore there is a complete second harmonic wave in each half of the fundamental. Of course the second harmonic is much weaker than the fundamental. If it is 15% as great as the fundamental the distortion is considered very severe.

Note in Fig. 2 that although the fundamental curves A and B are always in opposite phase, the second harmonic curves are always in phase. That is, the second harmonic waves are negative at the same times and positive at the same times, and they are equal in magnitude. If they are equal in magnitude all the time their difference is zero.

Now let us consider the effective or useful output voltage V. Our object is to show why the even harmonics are absent from it while the odd ones are not.

### Second Harmonic Drops

Now assume that  $I_a$  and  $I_b$  are the effective values of the fundamental vibra-

## The Loftin-White Principle

[The following is the conclusion of an article begun last week, issue of February 18.]

The new Model 25 Series Arborphone, is shown in Fig. 11.

The new design has four full tuned stages—three stages of radio frequency ahead of the detector, controlled by a single dial. It is positively single dial control, once a knob on the panel adjusts the antenna secondary circuit to the particular antenna with which the receiver is to be used, except possibly for a now-and-then refined adjustment of this knob in extremely long distance reception.

Complete double shielding is employed, each of the three radio frequency stages and the detector (four tuned stages) being inclosed in its own fully shielded compartment, (see Fig. 12), but each compartment is no larger than physically needed to house the necessary parts for a stage. As a result, the four compartments form the interior of a metal box condensed to 12 inches long by 6 inches wide. Yet, by reason of the Loftin-White circuit, this close shielding is accomplished without loss of efficiency from absorption.

### Solidly Constructed

In the Model 25 Arborphone a distinct step forward has been made in the mechanical construction of radio receivers. Each compartment for a radio frequency stage is so dimensioned and the apparatus in it so located that it is the exact mechanical equivalent of every other compartment, and each rotor of the 4-gang condenser moves identically the same in relation to the apparatus in its own compartment. In effect, by thus

making the compartments exact mechanical equivalents and maintaining them so at every point on the broadcast band, a decided engineering step has been taken toward the necessary maintained electrical equivalency for successful single dial control.

Mechanically, nothing has been spared to make the 4-gang condenser electrically permanent. Thin, springy plates have been discarded for massive stay-put plates, rigidly mounted on a shaft so heavy as to leave no possibility of bending.

As a further precaution the shaft is "full-floating," the drive mechanism producing no strain and no wear on the shaft. Yet the whole condenser unit is so compact that it is a perfect fit for the absurdly small shield box, a further step in holding the necessary rigidity for maintained electrical uniformity.

### One Wire Unit to Unit

The inductance and coupling coils, coupling condensers, and phasing condensers peculiar to the Loftin-White circuit for each stage are built into compact units around a tube socket. Most of the electrical connections between these elements are permanent structures, eliminating the usual maze of interconnected wires soldered to clips. Figs. 12, 13 and 14 are two views of the Model 25 Arborphone chassis base, showing the compactness, clean-cut appearance, simplicity, and beautifully balanced layout of these units.

Each unit is the exact counterpart of every other one, so that they can all be assembled and tested before inserting into the complete receiver. Greater accuracy of assembly results, and freedom from



# Cancel

## Is Explained for the Novice

By Brewster Lee

tions.  $V$  is equal to  $R(I_a + I_b)$ , which is the algebraic difference between the voltage drops in the two equal resistors  $R$  due to the fundamental currents only.

Now assume that  $I_d$  and  $I_e$  are the effective values of the second harmonic currents in the resistors. The difference between the harmonic currents, as we saw above, is zero. Hence  $R(I_d + I_e)$  is zero. The second harmonic has no effect in altering the shape of the voltage wave across the two resistors  $R$ . That is,  $V$  is unaffected by the second harmonic currents.

### The Higher Harmonics

If we had considered any other even harmonic we should have reached the same conclusion. That is, although the even harmonic currents are present in the resistors  $R$ , there are no corresponding harmonics in the total voltage  $V$  across the two resistors.

The steady plate current is mathematically an even harmonic. It is obvious that steady current flows in both the resistors  $R$ , but in opposite directions, that is, as the small arrows  $D$  and  $E$  representing the second harmonics point. It is obvious that both the plates are at the same steady potential. The voltage  $V$  is not affected by the steady current flowing in the two resistances.

### Same Conclusion

Now if we had considered one of the odd harmonics, say the third, we should have reached the same conclusion regarding that as we did regarding the fundamental, which is the first harmonic and odd. Thus not only does  $V$  contain the

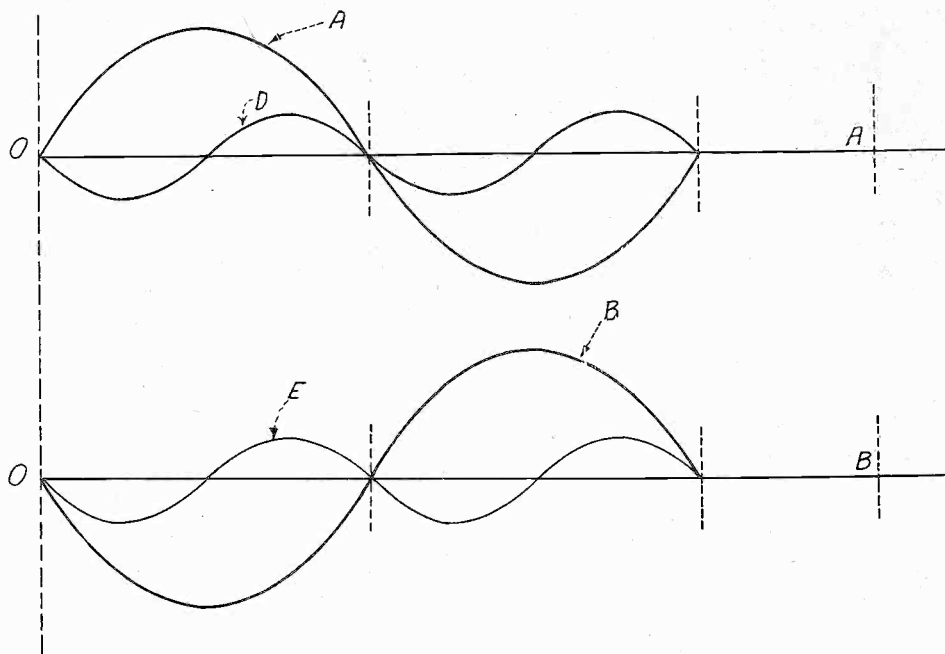

FIG. 2

fundamental of the input but also the odd harmonics.

Hence if a pure alternating current is flowing in the input potentiometer and if the circuit is perfectly symmetrical, none of the even harmonics introduced by the two tubes will appear across the two output resistors  $R$ , but all the odd harmonics will appear. These odd har-

monics will all be the first harmonic as far as the second stage is concerned. Therefore it is of utmost importance not only to eliminate the even harmonics but also to keep the odd harmonics at the lowest possible value in relation to the first harmonic or signal.

In the B battery the odd harmonics are absent but all the even are present. Of course that includes the steady current from the two tubes.

# of Reception Explained

imperfect connections caused by soldering in inaccessible places after the parts are all located in the cabinet or shielding compartment. This, too, is an interesting departure in mechanical practice and seems to be distinctly better.

Four of these perfectly assembled and tested units are mounted on a chassis that forms the base of the shield box. There is but one wire connection between each unit and the succeeding one, and one wire connection between each unit and its own gang-condenser unit. In brief, the unsightly and difficult wiring common to some radio receivers has been eliminated in this design, freeing it from loose connection difficulties.

Fig. 15 is the under side of the chassis base, showing the highly simplified and permanent character of the wiring. Except for the two connections referred to above, this is all there is to the wiring.

### High Efficiency Maintained

In spite of the extremely close shielding of this design, the Loftin-White coupling makes it sufficiently tight between stages to make up for any absorption losses, a feature peculiar to this design alone. Further, by virtue of "constant-coupling," this high efficiency is maintained at a constant level throughout the full broadcast band, 200 to 550 meters.

Without the Loftin-White circuit the degree of coupling is limited by the tendency to oscillate on the short waves. The Loftin-White method of stabilizing by control of plate circuit reactance permits the use of any degree of coupling desired with absolute stability.

It would be impossible without the Loftin-White circuit to include the four tuned stages in such compact and closely spaced compartments, due to feedbacks along the wires interconnecting the compartments and feed backs due to eddy currents set up in the metallic elements of the shields.

With high amplification and close spacing these would produce oscillation. With the Loftin-White circuit, it is possible to introduce a slight reverse feed back through the internal capacity of the tube by proper control of the plate circuit reactance, with the result that a receiver with an extremely high amplification ratio and close spacing can be fully stabilized against oscillation without difficulty.

### Easily Matched to Location

Another unique feature of this design is the fact that it can be better matched to location by a simple adjustment, this being possible only with the Loftin-White method of controlling plate circuit reactance.

This design is extremely selective, and is ideally adapted for present broadcast conditions. The Loftin-White principle of control of plate circuit reactance introduces a selectivity characteristic heretofore impossible, which is a most valuable virtue in a closely shielded receiver in which absorption losses would otherwise tend to reduce selectivity.

### Both at High Speed

In addition the constant-coupling feature, as stated before, makes the selectivity and volume uniform throughout the broadcast band.

## Harmonics Are Multiples of Particular Frequency

Harmonic vibrations are such that their frequencies are exact multiples of some vibrations. For example, 50, 100, 150, and 200 are harmonics of 50. The vibration having a frequency of 50 is called the fundamental and the others in turn are called the second, third and fourth harmonics of the fundamental.

Any vibration however complex can be built up out of simple harmonic vibrations by suitably combining them. When a simple harmonic wave or vibration is distorted harmonics are introduced, making the wave more complex.

## Some of Many Uses of Still Photo Reception

Some of the applications of the home radio telephoto systems are: the complete daily program of a broadcasting station or of a group of stations; the daily weather map with the prediction deduced from it; new cooking recipes; excerpts from musical scores; fingerprints of criminals; photographs of criminals wanted; photographs of important events; photographs of important persons; photographs of groups such as quartets, bands, orchestras and opera scenes; interesting musical instruments; photographs of the performing artists and the composers; laboratory set-ups for scientific demonstration; text book or lecture room illustrations, including blackboards to aid radio teaching; astronomical photographs; photographs of missing persons.

## A THOUGHT FOR THE WEEK

WHERE is the statistician with the ready pencil to figure out how many additional million cubic feet of gas and K. W. H. of electricity are used each current year as against the dark and distant time before radio made Uncle John and Cousin Yetta sit up until the early morning? The public utility concerns would howl raucously if nature or science should turn a somersault and refuse to function as a carrier of waves.

## SIXTH YEAR

# RADIO WORLD

The First and Only National Radio Weekly

Radio World's Slogan: "A radio set for every home."

TELEPHONES: BRYANT 0558, 0559

PUBLISHED EVERY WEDNESDAY

(Dated Saturday of same week)

FROM PUBLICATION OFFICE

HENNESSY RADIO PUBLICATIONS CORPORATION  
145 WEST 45TH STREET, NEW YORK, N. Y.

(Just east of Broadway)

ROLAND BURKE HENNESSY, President

M. B. HENNESSY, Vice-President

HERMAN BERNARD, Secretary

Chicago: 55 West Jackson Blvd.

Kansas City, Mo.; E. A. Samuelson, 300 Coca Cola Bldg.

Los Angeles: Lloyd Chappel, 611 S. Coronado St.

European Representatives: The International News Co.

Breams Bldgs., Chancery Lane, London, Eng.

Paris, France: Brentano's, 8 Avenue de l'Opera

EDITOR, Roland Burke Hennessy

MANAGING EDITOR, Herman Bernard

TECHNICAL EDITOR, J. E. Anderson

RADIO VISION EDITOR, Neal Fitzalan

ART EDITOR, Anthony Sodaro

CONTRIBUTING EDITORS:

James H. Carroll, John Murray Barron and

Capt. Peter V. O'Rourke

## SUBSCRIPTION RATES

Fifteen cents a copy. \$6.00 a year. \$3.00 for six months. \$1.50 for three months. Add \$1.00 a year extra for foreign postage. Canada, 50 cents.

Receipt by new subscribers of the first copy of RADIO WORLD mailed to them after sending in their order is automatic acknowledgment of their subscription order. Changes of address should be received at this office two weeks before date of publication. Always give old address; also state whether subscription is new or a renewal.

## ADVERTISING RATES

## General Advertising

|                           |                |          |
|---------------------------|----------------|----------|
| 1 Page, 7 1/2" x 11"      | 462 lines..... | \$300.00 |
| 1/2 Page, 7 1/2" x 5 1/2" | 231 lines..... | 150.00   |
| 1/4 Page, 8 1/2" D. C.    | 231 lines..... | 150.00   |
| 1/4 Page, 4 1/2" D. C.    | 115 lines..... | 75.00    |
| 1/4 Page, 4 1/2" S. C.    | 57 lines.....  | 37.50    |
| 1 Column, 2 1/4" x 11"    | 154 lines..... | 100.00   |
| 1 Inch.....               |                | 10.00    |
| Per Agate Line.....       |                | .75      |

## Time Discount

|  |         |
|--|---------|
| 52 consecutive issues.....                       | 20%     |
| 26 times consecutively or E. O. W. one year..... | 15%     |
| 13 times consecutively or E. O. W.....           | 12 1/2% |
| 4 consecutive issues.....                        | 10%     |

WEEKLY, dated each Saturday, published Wednesday. Advertising forms close Tuesday, eleven days in advance of date of issue.

## CLASSIFIED ADVERTISEMENTS

Ten cents per word. Minimum 10 words. Cash with order. Business Opportunities, ten cents per word. \$1.00 minimum.

Entered as second-class matter March 23, 1922, at the Post Office at New York, N. Y., under the Act of March 3, 1879.

## A Stimulant in a Vacuum

NOTHING in two years has so taken the set builder by storm as the shielded grid tube. Several kits already are on the market embodying this powerful amplifier. Not only is the tube remarkable but it has possibilities not yet fathomed, and in due time one may expect the experts to show special hookups devised by them from laboratory experience.

The appearance of the tube was accompanied by much theory about its operation, but quickly followed by conventional and highly commendable practical advice. But there is a chance for the pioneers and you will hear from them. Meanwhile the tube should be utilized as the experts recommend, for it outperforms its elder brethren, without introducing puzzling troubles.

The home constructor and the custom set builder have been waiting for something to break, and here it is. An indefinable feeling was dormant in their eager breasts. Now that strange void finds itself occupied. Hands are busy with soldering iron and bus bar, with new and intense vigor. Greater enjoyment, greater activity, greater business follow the introduction of this enticing tube.

After the publication of shielded grid circuits RADIO WORLD received enthusiastic telegrams from constructors. This smacks of the old and glorious days. But we must not forget that still greater glories are right within our reach, because of this tube and the circuits built around it, so let us make it a quick harvest. Let us not only build the recommended circuits but let us do some experimenting and exploring on our own account, as H. B. Herman has done. He now presents constructionally for the first time anywhere the embodiment of the shielded grid tube as a space charge detector.

While the new tube may be wrapped in a heavy blanket of technique, actual inclusion of the tube in any circuit is simple. One need know only that the tube is exceptional when properly connected, and leave the full technical understanding of functions and operation for a later date. That knowledge gradually will build itself up to mountainous proportions, for every radioist will want to fathom this remarkable tube, since the depths of its performance have not yet been sounded.

## A New Plume for Education

THE transmission by WEAf of a still photograph of Mayor Walker of New York City, accompanied by the promise that soon cheap receivers will be available and regular service rendered, is full of educational promise.

It is expected that as broadcasting grows its educational influence will attain a higher effective percentage. Today the air is overburdened with music, but tomorrow a better balance may be struck. The spread of education, even its compulsory nature, has done as much to create the present gigantic commonwealth of the United States as has that other great asset, cheap power.

Once it was assumed that the favorite program of the listening public was that poured forth by a jazz orchestra. While such organizations still predominate, nevertheless canvasses of listeners have disclosed an improved taste in music, and that in itself is some indication of the educational trend.

It was considered quite the thing in other days to tune out talks, but now they are listened to with eagerness, possibly because they are more interesting. Once the air was plugged with whatever happened to be handy, and that usually was some form of abject mediocrity. Now a talk is scrutinized and analyzed by a studio director long before it is delivered before the microphone.

The day of lessons by radio is here, since music lessons, language lessons and scientific discourses prepared for lay consumption are receivable any day or night. One professor tells you how to pronounce the words of the English language, another gives finger exercises for piano playing, another recounts some phase of American history.

The still picture, be it diagram or photograph, will expedite the growth of instruction by radio. It will serve also as something introductory to television, the reception of visualized motion.

It is the moving object that fascinates.

While the still photograph represents the creeping age, the walking and running pace will soon follow.

Within two years we will be building televisions, and technical editors of radio publications will be answering questions like: "Why can't I get DX on my 4-tube Super-Television?" and "How can I achieve synchronization by using the 60-cycle frequency of the supply line for my driving motor?"

## Second Wind for DX Chasers

AIDED by good weather, those sportsmen who love the chase for distant stations, but somehow lost their keenness for it in the bonfire of disgust kindled by an overcrowded ether, have gained their second wind and are hot after the quarry. And why not? The thrill of receiving distant stations is a healthy one. Like all wholesome pastimes, DX hunting, although it may suffer temporary abatement, always comes back. The pace is fast right now, with highly sensitive receivers so abundant, reception conditions remarkably good, and the old flame of enthusiasm whirling upward to skirt the Heavyside layer.

When broadcasting started, in 1921, every tube set got distance, and even some crystal sets. There were few stations. Almost anywhere in the United States KDKA "came in like a ton of bricks." The phrase was apt. Bricks, when delivered in coal chute fashion, make a conglomerate swishing sound, easily a bad case of distortion. Nowadays we have receivers capable of great volume without distortion, and when distance comes in it is likely to be loud and clear. You can understand what is being said. Music as well as speech has meaning.

## Sets Feeble After 6 Months Need New Tubes or Batteries

If your set grows feeble and noisy after six months' use, make sure that the B battery is in good condition, that the tubes are not played out, that the stopping condensers are intact, that the grid leaks still leak, that the grids are otherwise well insulated.

The tubes and the battery are the first which are likely to go, unless the last tube is consistently overloaded and has a resistance audio input, when the grid leak in that tube may go first.

# The Radio Trade

## Yearly Model Question Vexes Manufacturers

Present owners and prospective buyers of radio sets are interested in the question:

"When will the present models be obsolete?"

In the opinion of George Scoville, chairman of the Merchandizing Council, Radio Division, National Electrical Manufacturers Association, the factor of obsolescence in radio sets is being greatly reduced, and while the problem of yearly models is still a worrisome one, the responsible manufacturers are not dodging it.

"A shift in the art which appeals to the public often gives rise to new models," he said, "but the better manufacturers, anticipating refinements and developments, have designed their sets with provisions for keeping the audio-frequency part of the equipment as modern as the art itself.

### Keeping Up Appearances

"Then the only factors which are likely to become obsolete are the appearance of the set and its controls.

"By good engineering judgment and sound manufacturing experience it is possible and has been so demonstrated by a number of companies to keep the appearance of the older sets on a par with the newer ones.

"We frankly admit that as an industry we are not sure of the answer to the question: 'Shall there be yearly models?' In the reproductive part of the apparatus we are constantly making refinements and improvements, but in such a manner that present set owners are able, at a slight expense, to modernize their equipment every year or so.

### Better Than in Auto Industry

"This represents an achievement for the radio manufacturers and a genuine public saving.

"It is considerably better than the automobile companies have been able to do in this problem of obsolescence, because a study of the situation would show, I feel sure, that automotive obsolescence is greater than radio receiver obsolescence."

## Bootlegging in Bakelite Described by Witnesses

Washington.

Charges that laminated sheets produced from synthetic phenolic resins are being "bootlegged" from abroad were made by witnesses appearing before the United States Tariff Commission.

The Commission is holding hearings upon an application by the Bakelite Corporation of New York City and a group of laminators and fabricators of materials made from synthetic phenolic resins.

Albert McC. Barnes, Jr., of counsel for the Bakelite Corporation, called a number of witnesses to the stand to testify that the American industry of laminated sheets was being crippled through unfair competition from abroad. Mr. Barnes also charged that foreign manufacturers, located principally in Germany, have violated American patent rights, and that the importers had erased the mark of origin on articles and sold them in this country as genuine domestic Bakelite.

## Metcalf Quits Magnavox To Enter Sign Business

Herbert E. Metcalf, chief engineer of the Magnavox Company of Oakland, California, manufacturers of electro-dynamic loudspeakers, has resigned to become president and chief engineer of the Wonderlite Company of America, Inc., makers of luminous tube signs in a wide variety of colors.

He will continue teaching radio in the University of California Extension Division, and also engage in consulting work in the fields of radio and television, in which fields he has forty patents granted or pending.

### KHJ ON NEW FREQUENCY

Los Angeles.

KHJ, Los Angeles, owned and operated by Don Lee, is now operating on a frequency of 750 kilocycles or 399.8 meters.

## Daven A C Ballasts Kept Voltage Steady

Daven Radio Corporation, Newark, N. J., are now making ballasts for the AC 26 and AC 27 and similar alternating current tubes, for the purpose of prolonging the life of the AC tubes, which are rather critical as to filament voltage. The object of the ballasts is not to cause a fixed drop in the supply voltage to insure that the tubes get the correct filament voltage while the supply voltage is steady, but to cause a variable voltage drop so that the filament voltage will remain sensibly constant while the line voltage varies by as much as 20%.

The short life of the alternating current tubes is not due to any defect in the rating or in the tubes themselves but rather to the unsteadiness of the line voltage. There are frequent surges in the line which will cause the voltage across the filaments to rise to such values as to materially shorten the life of the tube or to ruin it instantly. The Daven ballasts are designed to overcome this difficulty by keeping the voltage across the filaments at an almost constant value for all ordinary fluctuations in the supply line.

## Hartzell Co.'s Headquarters Changed from N. Y. to Chicago

The Hartzell Sales Co., of which C. C. Hartzell is president, has removed its principal office from 50 Church Street, New York City, to 508 South Dearborn Street, Chicago.

Sales representatives of the organization are maintained in twenty-one principal cities.

### NEW CORPORATIONS

Liberty Service and Radio Supply Co., Queens, N. Y., \$10,000 (Atty., I. L. Merlin, 225 West 34th St., N. Y. City.)  
 Imperial Alliance Corp., N. Y. City; \$25,000. (Atty., C. I. Holland, 420 Lexington Ave., N. Y.)  
 Martin Automotive Corporation, (New York charter) radio apparatus, 49 West 71st St., New York; \$75,000.

## Literature Wanted

THE names and addresses of readers of RADIO WORLD who desire literature on parts and sets from radio manufacturers, jobbers, dealers and mail order houses are published in RADIO WORLD on request of the reader. The blank below may be used, or a post card or letter will do instead.

RADIO WORLD,  
 145 West 45th St., N. Y. City.

I desire to receive radio literature.

Name .....

Address .....

City or town .....

State .....

- Stanley E. Fowler, 77 Kings Highway, Bridgeport, Conn.
- J. A. Osborn, 2414 Como Ave., Minneapolis, Minn.
- Harcourt Radio, 2507 20th Ave., San Francisco, Calif.
- J. L. Wilson, Box 681, Wacogdoches, Texas.
- H. F. Cummins, 930 W. Grammercy, San Antonio, Texas.
- Chas. E. Hartman, Box 256, Little Rock, Arkansas.
- L. R. Guerard, 1402 So. 27th St., Kansas City, Kansas.
- Earl P. Strickler, Station "A," Trenton, N. J.
- William F. Wells, 1831 W. 5th St., Dayton, O.
- John E. Merritt, Wenatchee, Glen Dale, Wash.
- W. W. Grove, 3235 Lafayette St., Denver, Colo.
- Jerome McCarthy, Texon, Tex.
- W. A. Becker, 482 St. Johns Ave., Winnipeg, Manitoba, Canada.
- Henry B. Fairman, 656 West Marquette Rd., Chicago, Ill.
- William Gertler, 76 Putnam Ave., Brooklyn, N. Y.
- W. N. Eley, 110 North 2nd St., Wormleysburg, Pa.
- Eugene A. Lewis, Kittery, Me.
- G. H. Gruber, R. D. 2, Harrisburg, Pa.
- Peter Grzywna, 145 Romeyn St., Schenectady, N. Y.
- Thomas P. White, 5240 Market St., Philadelphia, Pa.
- Lloyd Senborn, Lawton, North Dakota.
- G. C. Gavin, P. O. Box 331, Ortega, Florida.
- Carl H. Edwards, 220 S. Riblet, Galion, Ohio.
- C. S. Gridley, 10 Cedar St., Nutley, N. J.
- Sueji Ito, 1119 E. Jefferson St., Seattle, Wash.
- Walter Triplett, Box 409, Elkins, W. Va.
- Dan Pizzica, 3948 W. Thomas, Chicago, Ill.
- Geo. Neumann, 754 McDonough St., Brooklyn, N. Y.
- G. J. Goodell, 236 Mass. Ave. N. E., Washington, D. C.
- F. B. Wheeler, 4430 Walker Ave., Houston, Texas.
- J. S. Eagler, 159 Pennebaker Ave., Lewistown, Pa.
- Raymond Scott, 108 New Broadway, Brooklawn, N. J.
- L. Stille, 131 Vienna St., San Francisco, Calif.
- Alvin Hall, 15435 Inverness Ave., Detroit, Mich.
- Arthur E. Lowe, 729 Admirals Road, Victoria, B. C., Canada
- John Lawler, 111 Butman St., Akron, Ohio
- N. A. Hollenbeck, 25 West 45th St., New York, N. Y.
- George D. Gordan, 238 Broadway, Cambridge, Mass.
- Otto Neuhaus, Attleboro Falls, Clifton, St., Mass.
- E. Masak, 134 St. Marks Place, Brooklyn, N. Y.
- A. I. Sadick, 1090 Simpson St., Bronx, New York
- Paul W. Steimle, 626 S.W. 4th St., Miami, Florida
- Louis Fristachi, 1781-80 St., Brooklyn, N. Y.
- W. J. Hayes, 870 3rd Ave., Troy, N. Y.
- Theo. W. Hippi, 261 Jackson St., Bristol, Penna.
- Louis B. Hall, 826 9-2 St., Port Huron, Mich.
- E. W. Bingham, 2545 E. Clearfield St., Philadelphia, Penna.
- S. R. Brooks, 4114 Calhoun St., Fordson, Mich.
- Russell G. Hanna, Beardsley, Minn.
- Delphis Monty, 18 Ferry St., Williamsett, Mass.
- E. J. Genereux, 12 Leroy St., Lowell, Mass.
- Harry S. Kunz, 604 East 51st St., Brooklyn, New York
- W. C. Robinson, 119 W. 1st St., Duluth, Minn.
- J. C. Ashcraft, 504 Sanford St., Monroe, North Carolina
- John Kolville, 2032 Haucoch Ave., Detroit, Mich.
- L. C. Holt, 1002 Seco St., Henderson, Ky.
- E. G. Norton, 112 Park Ave., Collingswood, N. J.
- Frank Schiedeck, Sr., Box 176, San Bruno, California
- Chas. Vocasek, Sawyer Road, Stop 25 Kinsman, Warrenville, Ohio
- Eugene Coderre, 16 Ferry St., Williamsett, Mass.

# FORTY TIMES as Much Amplification! The New Shielded Grid 4-TUBE DIAMOND OF THE AIR

Designed by H. B. HERMAN and described by him in the February 4 and 11 issues of RADIO WORLD.

The favorite four-tube design, simple as can be, takes a great step forward, so that home constructors of radio receivers, and custom set builders, can build a distance-getting and voluminous set, the parts for which list remarkably low.

The new shielded grid tube is used as the radio frequency amplifier. That is why the amplification is boosted forty times over and above what it would be if an -01A tube were used instead.

Such simplicity of construction marks the receiver that it can be completely wired, skillfully and painstakingly, in two and a half hours.

All you have to do is to follow the official blueprint, and lo! a new world of radio achievement is before you! Distant stations that four-tube sets otherwise miss come in, and come in strong. No tuning difficulty is occasioned by the introduction of this new, extra powerful, startling tube, but, in fact, the tuning is simplified, because the signal strength is so much greater.

When you work from the official wiring diagram you find everything so delightfully simple that you marvel at the speed at which you get the entire receiver masterfully finished. And then when you tune in—more marvels! 'Way, 'way up, somewhere around the clouds, instead of only roof high, will you find the amplification!

You'll be overjoyed. But you should place every part in exactly the right position. Stick to the constants given, and, above all, wire according to the blueprint!

## Front Panel, Subpanel and Wiring Clearly Shown

When you work from this blueprint you find that every part is shown in correct position and every wire is shown going to its correct destination by the ACTUAL ROUTE taken in the practical wiring itself. Mr. Herman's personal set was used as the model. This is a matter-of-fact blueprint, with solid black lines showing wiring that is above the subpanel, and dotted lines that show how some of the wiring is done underneath.

Everything is actual size.

Not only is the actual size of the panel holes and instruments given, but the dimensions are given numerically. Besides, it is one of those delightful blueprints that novice and professional admire so much—one of those oh-so-clear and can't-go-wrong blueprints.

Be one of the first to send for this new blueprint, by all means, and build yourself this outstanding four-tube receiver, with its easy control, fine volume, tone quality, selectivity and utter economy. It gives more than you ever expected you could get on four tubes—and the parts are well within the range of anybody's purse.

The Four-Tube Shielded Grid Diamond uses two of the shielded grid tubes, the other tubes being one 01A and one 112, or equivalent, or a special detector tube may be used, one -01A for first audio and the power tube in the last stage.

The circuit consists of a stage of tuned RF shielded grid tube amplification, a regenerative detector, and two transformer coupled audio stages.

What a receiver!

**\$1.00 for 27" x 27" Blueprint,  
15c extra for Feb. 4 issue.**

**Send your order today!**

RADIO WORLD,  
145 West 45th St., N. Y. City.

Enclosed please find:

\$1.00, for which send me at once one official blueprint of the Four-Tube Shielded Grid Diamond of the Air, as designed by H. B. Herman, and described by him in the February 4 and 11 issues of Radio World.

30 cents extra for February 4 and 11 issues.

NAME .....  
ADDRESS .....  
CITY ..... STATE .....

# Field of Eye Appeal Wide, Says Sarnoff

By David Sarnoff

Vice-President and General Manager, Radio Corporation of America

We have been working consistently toward the ideal of adding sight to sound in radio transmission. The broadcasting of stationary images or pictures is more limited in scope than television, which is the transmission of motion pictures by radio; but it nevertheless is an important step forward. By such a system there can be produced in the home, in a brief space

of time, a photograph or facsimile of any type of illustration or drawing and with good fidelity.

It is significant that the equipment required for this purpose is simple; that the reception of the picture in the home is a speedy process; and that radio photograph transmission gives the broadcasting station as well as the listeners an agency of contact supplementary to the present sound transmission. It is in no sense a substitute for the broadcasting of sound but purely an auxiliary service. It permits the station to deliver a message to the eye as well as to the ear.

A wide field of application of such still picture transmission appears in the field of educational broadcasting. In relation to music study, portions of a musical score, the arrangement of the orchestra, the types of instruments used, a picture of the composer, and a multitude of other instructional features can be carried with the musical program.

In other educational applications textbook diagrams, laboratory set-ups for scientific demonstrations, maps, charts, drawings, and the like can be carried to the listener. In other words, it will enable the lecturer to add to his power of exposition, as at present, the capability of visual demonstration.

While the broadcasting of pictures by the National Broadcasting Company is experimental at this time, it is planned to carry this work forward, and it is hoped that it will lead to the production of a simple, commercially available adjunct to present-day broadcast receivers.

## Tyrman "70" Shielded Grid Amplimax

OFFICIAL SERVICE STATION  
We Supply Tested Parts. Sets Custom Built to Your Order. Shipped Anywhere. Also MAGNAFORMER 9-8, New Shielded Grid DIAMOND OF THE AIR.  
H. & F. RADIO LABORATORIES, Inc.  
168 Washington Street New York City



Fixed Condensers

specified in

TYRMAN 70

for their well-known permanent accuracy.

Any dealer can supply



# Tyrman "70"

Shielded Grid Amplimax

FOR A.C. or BATTERY OPERATION

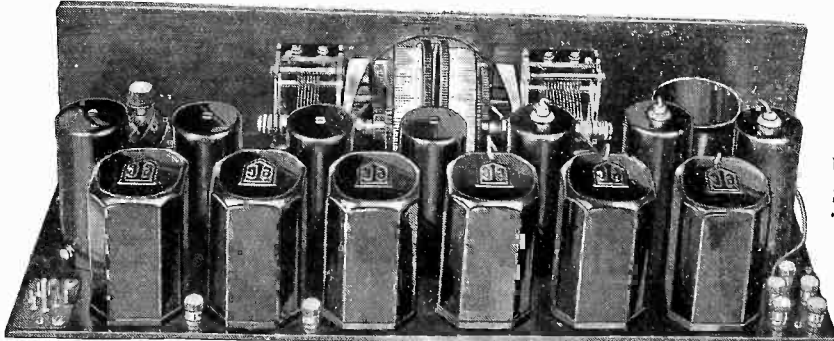

USING  
SP-122  
TUBES

Brings in AUSTRALIA and JAPAN with VOLUME and QUALITY

POSTAL TELEGRAPH - COMMERCIAL CABLES

TELEGRAMS TO ALL AMERICA

CABLEGRAMS TO ALL THE WORLD

35A574 41 4 EXTRA NL

1927 DEC 21 PM 11 33

GS LOSANGELES CALIF 21

TYRMAN ELEC CORP 1806

141 WEST AUSTIN AVE CHICAGO ILLS

CONGRATULATIONS TYRMAN SEVENTY RECEIVED BRISBANE AUSTRALIA SYDNEY AUSTRALIA WITH VOLUME AND QUALITY OF LOCAL STATIONS ALSO ALL THREE JAPANESE STATIONS VERY CLEAR STOP SIMPLICITY OF TUNING REMARKABLE STOP STATIONS WERE TUNED IN AS EASILY AS AMERICAN BROADCASTERS

H G WILLIAMS WILLIAMS AND KLENTZ CO.

BUILD

this new receiver and benefit by this revolutionary improvement.

UNEQUALLED for DX reception and tone quality.

ASK YOUR JOBBER OR WRITE

TYRMAN ELECTRIC CORP.

141 W. AUSTIN AVE. CHICAGO, ILLINOIS

# Goldsmith Tells Thrill of Picture Reception

By Alfred N. Goldsmith

Chairman, Board of Consulting Engineers of the National Broadcasting Company; Chief Broadcasting Engineer Radio Corporation of America; Consulting Engineer General Electric Company.

One of the most fascinating developments in the art of radio communication is the transmission of visual images as well as sound. The broadcasting of sound has reached a highly evolved state, and it is a service of permanent value. Much remains to be done before radio still-picture and motion-picture transmissions reach the same perfection. But the transmission of still pictures from station WEAJ is technically interesting as a step toward the ultimate goal in respect to the simplicity of the methods utilized.

At the transmitter it has been necessary only to substitute for the microphone the compact picture transmitter which operates from a paper or film positive. Ordinary wire line or "remote control" of the transmitter is employed as usual. The time of transmission is brief, so that the listener (or should we say observer?) receives the picture within a minute or two.

### Development Simple, Too

At the receiving set there has been added only a small amplifier and a simple recorder. These are actuated from the receiver without any constructional changes and with only a slight wiring modification.

The present form of the picture adjunct consists merely of a small amplifier, a Moore tube of special construction, and a sheet of photographic paper mounted to be driven by a small motor. The development of the picture and its fixation are as simple as ordinary "tank development" of films.

Seated comfortably in one's own home, it is a unique experience to watch a simple radio apparatus produce photographs or drawings which come speedily through the air from a distant station; and all this without effort or strain. Most of us are accustomed to the telephone, but nearly everyone will get a thrill from clear pictures drawn in the home in a minute or two by an invisible hand.

### No Big Problem Left

Using so simple a system, pictures can readily be transmitted by a broadcasting station and it is also possible to carry forward the ease of operation, continuity of program, and other technical features by methods which have not yet been demonstrated to the public. Even im-

mediate future of this visual broadcasting system no longer presents major engineering problems. From this time on we may expect the development of specialized radio picture transmission methods, each adapted to its particular field, whether it be for transoceanic service or for broadcast operations. The public will be the gainer through the evolution of this new branch of communication engineering.

## ELLIS "D" COILS

No Coupling

No Pickup

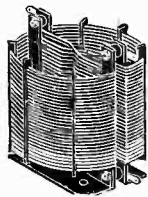

Price per Set of 3 Matched Coils,

\$7.50

The New Ellis "D" Coil Winding produces the most sensitive, selective and powerful R.F. Coil known.

Ask your dealer about Ellis "D" Coils or mail your order direct.

**Ellis Electrical Laboratory**  
223 W. Jackson Boulevard  
CHICAGO, ILLINOIS

EVERY FRIDAY at 5.40 P. M. (Eastern Standard Time) Herman Bernard, managing editor of Radio World, broadcasts from WGBS, the Gimbel Bros. station in New York, discussing radio topics.

RECENT ISSUES of Radio World, 15c each. Be sure to give date of issue when writing. Radio World, 145 West 45th Street, New York City.

Chosen for the Ellis "D" Coil Five Tube Set

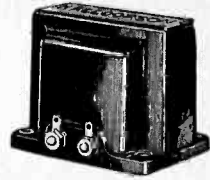

**Halldorson**  
Audio Transformer  
*Overtone*

THE HALLDORSON COMPANY  
Factory: 4745 N. Western Ave. CHICAGO, ILL.  
Office: 223 W. Jackson Blvd.

## Camfield Condensers

CAMFIELD EQUALTUNE

condensers provide means for securing EFFICIENT ONE-DIAL CONTROL. The units in the gang condenser can be adjusted to put all the circuits in balance at all wave lengths.

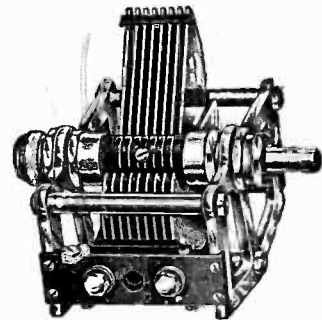

Selected and Specified for Use in

**TYRMAN "70"**

SHIELDED GRID AMPLIMAX

For sale by all jobbers and dealers.

Also the New Ellis Five-Tube Receiver.

**Columbia Metal Products Co.**

Precision Manufacturer

360 E. Grand Avenue CHICAGO

## FROST-RADIO

Exclusively Specified for  
**ELLIS "D" 5 RECEIVER**

AND FOR THE  
**Shielded Grid Diamond**  
Both Described in This Issue

**HERBERT H. FROST, Inc.**  
Main Offices and Factory:  
ELKHART, IND.

New York Chicago

HERBERT H. FROST, Inc.,  
160 N. LaSalle St., Chicago.

Mail me a copy of your free book, "What Set Shall I Build?"

Name.....

Address.....

City..... State.....

# End Radio Bothers

DO YOU KNOW what's wrong when your radio set isn't working right? Ten to one, you don't. Twenty to one, you would if you had a copy of

### Hoff's Radio Trouble Finder



Ever hear of M. M. Hoff, radiotrician, of Philadelphia? He was one of the very first "radio bugs" and has been building and studying sets ever since. And now, out of his broad experience, this man has written a book to tell radio owners how to keep their sets working right.

He tells in plain words and illustrations how a set is made, what the parts are called, what are the few usual troubles and how to fix them. Then he lists 103 troubles that sometimes happen and

tells how to detect and fix each one.

The book is a regular cyclopedia of radio information—only it's in a language anyone can understand. Read it five minutes and you'll know more about radio than you ever dreamed of.

It will save you many a repair man. It will save you hours of guessing and fussing and fuming. It will help you to keep the tone of your set always sweet and strong. It will keep you from losing many programs. And, best of all—

**IT WILL MAKE YOU STOP SWEARING—MUCH TO THE SURPRISE OF YOUR FAMILY—because radio repairs are expensive. Why hire them done when you can easily learn how to keep your set from needing them?**

**All It Costs Is \$1**

Send cash with your order and you get also a Dictionary of Radio Terms and the latest list of Radio Broadcasting Stations with call letters and the new Federal Radio Commission wave lengths. Send your dollar today while the copies last. Six copies for \$4.00.

**CHICAGO BARGAIN HOUSE**

224 QUINCY BUILDING

CHICAGO, ILLINOIS

# POWERFUL UNIT

Drives Any Cone Speaker and Produces Delightful Tone at Great Volume

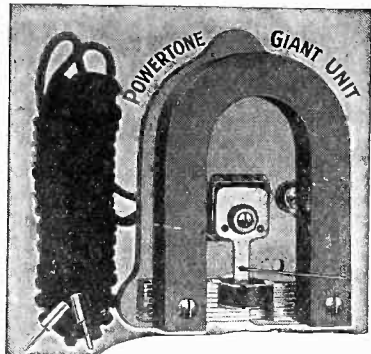

Try It for Five Days!

If not delighted with it, return it and your money will be refunded.

A Superb Creation At a Price That Fits All Purses **\$3.75**

GUARANTY RADIO GOODS CO., 145 West 45th St., New York City. Please send me one cone speaker unit as advertised. I will pay postman \$3.75, plus few cents extra for postage. Your 5-day money-back guaranty is accepted. Name..... Address..... City..... State.....

# Freight Train of 111 Cars Conducted by Radiophone

A practical demonstration of radiophone to conduct moving trains was recently made when a freight train of 111 cars was moved from Selkirk yards near Albany to Utica, (N. Y.), a distance of 95 miles, on the New York Central Railroad. Throughout the trip the conductor in the caboose and the engineer in the cab were in constant radio communication with each other.

A feature of the trip was an exchange of greetings between E. W. Rice, Jr., E. P. Edwards and W. B. Potter of the General Electric Co., in a railway signal tower at South Schenectady, and D. B. Fleming, assistant general manager of the New York Central Railroad, aboard the train.

The communication system, which is a development of the engineers of the General Electric Co., operates on waves from 109 to 130 meters and has a range of five miles. The power for the equipment on

the engine is obtained from the generator that supplies power to the locomotive headlight and the power for the equipment is obtained from a generator installed in the caboose and coupled to the axle of the car by means of a belt.

## Why Faulty Connections Cause Scratchy Sounds

When the sound from the speaker is scratchy and interrupted at irregular intervals the trouble is invariably in a faulty connection. If the scratchiness occurs only when the volume is turned up, the trouble should be looked for in the last stage or in the speaker.

In one case trouble of this kind was traced to a defective —71 type power tube, in another to a loose connection on the loudspeaker, and in still another to a defective output filter.

### NEXT WEEK

The Laboratory Super, Using Screen Grid Tubes

SEND FOR FREE CATALOG From Chicago's Oldest Radio Jobbers The Most Valuable Radio Catalog. Write for your copy today—IT'S FREE TELEPHONE MAINTENANCE CO. 123-5 S. Wells St., Dept. 63 Chicago, Ill.

## Radio World's CLASSIFIED ADS for Quick Action 10 Cents a Word—10 Words Minimum—Cash With Order

WANTED: MEN to work with National Radio Service Organization. No selling scheme. Co-Operative Radio Doctors, Dept. W, 131 Essex St., Salem, Mass.

RADIO FURNITURE, direct from factory to you. Receiving set cabinets, any size. Consoles and tables. Free catalogue on request. Fulbright Cabinet Co., Hickory, North Carolina. W-2-18

EVERY FRIDAY at 5.40 P. M. (Eastern Standard Time) Herman Bernard, managing editor of Radio World, broadcasts from WGBS, the Gimbel Bros. station in New York, discussing radio topics.

SEND \$1 for 8 weeks' subscription to Radio World, 145 W. 45th St., N. Y. C.

COMPLETE DETAILS on the Laboratory-Super appeared in the Nov. 19, 26 and Dec. 3 issues of RADIO WORLD. Send 45c for these issues.

RECENT ISSUES of Radio World, 15c each. Be sure to give date of issue when writing. Radio World, 145 West 45th Street, New York City.

# Take Your Choice of 7 Other Publications

For NEW RADIO WORLD Subscribers Ordering NOW

Radio World has made arrangements

—To offer a year's subscription for any one of the following publications with one year's subscription for RADIO WORLD—

RADIO NEWS or POULAR RADIO or SCIENCE AND INVENTION or BOYS' LIFE or RADIO DEALER or RADIO (San Francisco) or RADIO AGE.

This is the way to get two publications

- for the price of one; —Send \$6.00 today for RADIO WORLD —for one year (regular price —for 52 numbers) —and select any one of the other —nine publications for twelve months.

- Add \$1.00 a year extra for —Canadian or Foreign Postage —Present RADIO WORLD subscribers —can take advantage of this offer by —extending subscriptions one year —if they send renewals NOW!

### Radio World's Special Two-for-Price-of-One Subscription Blank

RADIO WORLD, 145 West 45th Street, New York City. Enclosed find \$6.00 for which send me RADIO WORLD for twelve months (52 numbers), beginning ..... and also without additional cost, Popular Radio, or Radio News, or Science and Invention, or Radio Dealer, or Radio (San Francisco), or Radio Age, or Boys' Life (or \$10.00 for a two-year subscription to one address). No other premium with this offer.

Indicate if renewal. Name ..... Offer Good Until March 15, 1928 Street Address ..... City and State .....

## The New Morecroft Opens Wide Field To You

The great Morecroft has a new message for you. The second edition of his masterpiece, "Principles of Radio Communication," just off the press, is offered to you by Professor John H. Morecroft of the Electrical Engineering Department of Columbia University and past president of the Institute of Electrical Engineers.

The outstanding book on radio principles and practice is something that you must not be without. Every set builder, every designer, every engineer, every service man, simply must have this book. Ready reference to all intricate problems makes this volume invaluable. Distributors and dealers, salesmen and teachers, students and operators, all find Morecroft their standby, and now the new second edition awaits you. 1,001 pages and 831 illustrations in this cloth-bound volume.

### SEND NO MONEY

Fill out and mail in the attached coupon:

GUARANTY RADIO GOODS CO., 145 West 45th St., New York City. Gentlemen: Please send me at once and without cost to me full analytical exposition of brand-new edition of Professor Morecroft's famous "Principles of Radio Communication," consisting of 1,001 pages and 831 illustrations, constituting the second edition, which is brought right up to date, and constituting the most complete and authoritative book. NAME ..... ADDRESS ..... CITY ..... STATE .....

# FEATURES TO FASCINATE and Inform You

Up-to-date Topics Masterfully Treated—See Which Ones You Must Become Fully Acquainted With to Round Out Your Radio Knowledge and Experience

The following issues of Radio World, 15c each:

OCT. 29—The Victoreen Power Supply with Audio Channel, by J. E. Anderson; Beauty of Sound and Appearance in Reproducers, by H. B. Herman.

NOV. 5—Part I of a two-part article on The Fenway Electric Concertrola; The Lynch Five, by Arthur H. Lynch; The How and Why of 3-Ft. Cone, by James H. Carroll.

NOV. 12—The New Nine-in-Line Receiver, by John Murray Barron; Part II on how to construct the Electric Concertrola; Unbiased Facts About Underbiased Grids, by Roger C. Brooks; Data on Meters, by Frank De Rose.

NOV. 19—Part I on how to build the Improved Laboratory Model Super-Heterodyne (Silver-Marshall Jewelers Time Signal Amplifier), by E. R. Pfaff; Part III of a four-part article on the Electric Concertrola; New Model DC Set, by James H. Carroll.

NOV. 26—The Four Tube DX Fountain, by Herbert E. Hayden; concluding installment on the Fenway Concertrola; A Squealless 5-Tuber, by Joseph Bernsley; Secrets of DX in a Creative Receiver, by J. E. Anderson.

DEC. 3—How to Modernize the Phonograph, by H. B. Herman; Part I of two-part article on the Everyman 4, by E. Bunting Moore; Efficiency Data on 4 and 5-Tube Diamond (not Screen Grid Diamond), by Campbell Hearn.

DEC. 10—Seven-page article on the Magnaformer 9-8, the best presentation in the history of radio literature, by J. E. Anderson (this article complete in one issue); The Object of a Power Amplifier, by C. T. Burke, engineer, General Radio Co.; Constructional Data on the Everyman 4 (Part II); The 2-Tube Phonograph Amplifier, by James E. Carroll.

DEC. 17—Complete Official Call Book and Log; How I Tuned In 98 Stations in Six Nights with Magnaformer 9-8, by Thomas F. Meagher; Starting Facts About Harmonics, by H. B. Herman; The G.R. Amplifier and B Supply, by Stuart S. Bruno.

DEC. 24—The AC 300 (four tubes); How Service Men Cheat Radio Builders; Part I of two-part article on the Victoreen Power Supply with one audio stage.

DEC. 31—How DC Sets Are Converted to AC Operation, by W. G. Masson-Burbridge; Cures for Uncanny Noises, by J. E. Anderson; Part II of two-part article on the Victoreen with a Stage of Audio; Complete Driver for an AC Set, by Robert Frank Goodwin.

JAN. 7, 1928—The Shielded Grid Six, first national presentation of loop and antenna models of the new Silver-Marshall circuit, utilizing the new tubes of strong amplification, Part I, by McMurdo Silver; How to Build a Power Amplifier and 210 Push-Pull Unit, by A. R. Wilson, of General Radio Co.

JAN. 14—Assembly and Wiring of Shielded Grid Six, Part II, by McMurdo Silver; Meter Range Extensions, by Bramhall Torrence; Uses of B Batteries and Power Devices, by E. E. Horine, National Carbon Co.; A 5-Tube Set Costing but 2 Cents an Hour to Run, by Capt. Peter V. O'Rourke.

JAN. 21—Bias Resistor Fallacy Exposed, by J. E. Anderson; The Shielded Grid Six, Part III (conclusion); How the "Victory Hour," Reaching 30,000,000, Was Broadcast, by Herman Bernard.

JAN. 28—How to Build the AC Five, a Battery-less Receiver, by H. H. Chisholm; Technique of Home Television Machine, by Dr. E. F. W. Alexander; A Quality Analysis of Resistance Coupling, with Trouble Shooting, by Herman Bernard.

FEB. 4—Tyrman "70" with Shielded Grid Tubes (Part I of four-part article), by Brunsten Brunn; The Four Tube Shielded Grid Diamond, by H. B. Herman; Television's Stride, by Neal Fitzalan, Radio Vision Editor.

Any copy, 15c. Any 7 copies, \$1.00.

All these 15 copies for \$2.00, or start subscription with any issue. Any 8 of these numbers sent as premium with NEW yearly subscription. No other premiums allowed.

**RADIO WORLD**

145 West 45th Street New York City

## "Double-R" Meters With Resistance of 1,000 Ohms Per Volt to Measure Voltages of B Eliminators, Bias Resistors, Batteries

0-300 volts, handsome full nickel finish, convenient portable type meter, accurate to within 2 1/2% plus or minus, with a resistance per volt of a little more than 1,000 ohms, hence more than 300,000 ohms total resistance. Fully guaranteed. To manufacture this meter requires 85 different eyes. No voltmeter but a high resistance one will enable you to tell the voltages of B eliminators and across C biasing resistors. This meter is excellent for general D.C. use. It is furnished with long connecting cords. Catalogue No. 346 (illustrated). **\$4.50**

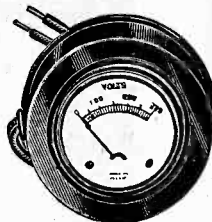

0-500 volts, this meter; of same external appearance and general construction as the 0-300 voltmeter; particularly appeals to the custom set builder, service man, experimenter, etc., who deal with power packs, B supplies, etc., that feed 210 or 310 tubes and otherwise require measurements up to 500 volts. A meter with resistance of more than 1,000 ohms per volt; excellent for all D.C. measurements. Nickel finish; long connector cords. Catalogue No. 347. **\$5.50**

It is absolutely necessary to use a high resistance voltmeter in measuring the voltage of B eliminators, either across the total output or at any intermediate voltage. A low resistance meter at least partly short-circuits the eliminator and causes the voltage reading to be away off. Sometimes the reading is as little as 25 per cent of the total actual voltage. The Double R meters 346 and 347 are accurate to 2 1/2 per cent plus or minus and have the highest resistance per volt of all popular priced meters for this work—more than 1,000 ohms per volt!

### HERE'S OUR COMPLETE CATALOGUE

| Cat. No.  | Type  | Price  | Cat. No. | Type | Price |
|---|---|--------|----------|------|-------|
| <b>POCKET AMMETER</b>                                 |   |        |          |      |       |
| No. 1   | For testing dry cells, 0-40 ampere DC scale pocket meter.....   | \$1.50 |          |      |       |
| <b>POCKET AND PORTABLE VOLTMETERS</b>                 |   |        |          |      |       |
| No. 8   | For testing A batteries, dry or storage, 0-8 volts DC scale.....  | \$1.65 |          |      |       |
| No. 10  | For testing A batteries, dry or storage, 0-10 volts DC scale.....   | 1.65   |          |      |       |
| No. 13  | For testing A batteries, dry or storage, 0-16 volts DC scale.....   | 1.65   |          |      |       |
| No. 50  | For testing B batteries, dry or storage, but not for B eliminators, 0-50 volts DC scale.....  | 1.65   |          |      |       |
| No. 39  | For testing B batteries, dry or storage, but not for B eliminators, 0-100 volts DC scale.....   | 1.85   |          |      |       |
| No. 40  | For testing A and B batteries, dry or storage, but not for B eliminators; double reading, 0-8 volts and 0-100 volts DC scale.....   | 2.25   |          |      |       |
| No. 42  | For testing B batteries, dry or storage, but not for B eliminators; 0-150 volts DC scale.....   | 2.00   |          |      |       |
| No. 346   | For testing B battery eliminators, grid bias voltage across resistors, batteries, etc.; 0-300 DC scale.....   | 4.50   |          |      |       |
| No. 347   | For same as No. 346, except scale is 0-500.....   | 5.50   |          |      |       |
| No. 348   | For testing AC current supply line, portable, 0-150 volts.....  | 4.50   |          |      |       |
| <b>VOLTAMMETERS</b>                                   |   |        |          |      |       |
| No. 18  | For testing amperage of dry cell A batteries and voltage of dry or storage A batteries, double reading, 0-8 volts, and 0-40 amperes DC.....   | \$1.85 |          |      |       |
| No. 35  | For testing amperage of dry cell A batteries and voltage of B batteries (not B eliminators); double reading, 0-50 volts, 0-40 amperes DC.....   | 2.00   |          |      |       |
| <b>6-VOLT A BATTERY CHARGE TESTER</b>                 |   |        |          |      |       |
| No. 23  | For showing when 6-volt A battery needs charging and when to stop charging; shows condition of battery at all times.....  | \$1.85 |          |      |       |
| <b>PANEL AMMETER</b>                                  |   |        |          |      |       |
| No. 338   | For reading amperage, 0-10 amperes DC.....  | \$1.65 |          |      |       |
| <b>PANEL VOLTMETERS</b>                               |   |        |          |      |       |
| No. 326   | For reading DC voltages, 0-6 volts....  | \$1.65 |          |      |       |
| No. 335   | For reading DC voltages, 0-8 volts....  | 1.65   |          |      |       |
| No. 310   | For reading DC voltages, 0-10 volts....   | 1.65   |          |      |       |
| No. 316   | For reading DC voltages, 0-16 volts....   | 1.65   |          |      |       |
| No. 337   | For reading DC voltages, 0-50 volts....   | 1.65   |          |      |       |
| No. 339   | For reading DC voltages, 0-100 volts....  | 1.75   |          |      |       |
| No. 342   | For reading DC voltages, 0-150 volts....  | 1.75   |          |      |       |
| No. 340   | For reading DC voltages, double reading, 0-8 volts, 0-100 volts.....  | 2.25   |          |      |       |
| <b>PANEL AC VOLTMETERS</b>                            |   |        |          |      |       |
| No. 351   | For reading 0-15 volts AC.....  | \$2.25 |          |      |       |
| No. 352   | For reading 0-10 volts AC.....  | 2.25   |          |      |       |
| No. 353   | For reading 0-6 volts AC.....   | 2.25   |          |      |       |
| (See No. 348 under "Pocket and Portable Voltmeters.") |   |        |          |      |       |
| <b>PANEL MILLIAMMETERS</b>                            |   |        |          |      |       |
| No. 311   | For reading 0-10 milliamperes DC.....   | \$1.95 |          |      |       |
| No. 325   | For reading 0-25 milliamperes DC.....   | 1.85   |          |      |       |
| No. 350   | For reading 0-50 milliamperes DC.....   | 1.65   |          |      |       |
| No. 390   | For reading 0-100 milliamperes DC.....  | 1.65   |          |      |       |
| No. 399   | For reading 0-300 milliamperes DC.....  | 1.65   |          |      |       |
| No. 394   | For reading 0-400 milliamperes DC.....  | 1.65   |          |      |       |
| <b>DC PIN JACK VOLTMETERS</b>                         |   |        |          |      |       |
| No. 306   | For No. 25 and No. 28 Radiolas, 0-6 volts DC.....   | \$2.50 |          |      |       |
| No. 308   | For No. 20 Radiola, 0-6 volts DC.....   | 2.50   |          |      |       |
| No. 307   | Desk type voltmeter with cord, 0-6 volts DC.....  | 2.50   |          |      |       |
| <b>TUBE CHECKER</b>                                   |   |        |          |      |       |
| No. 210   | For experimenter, professional set builder, dealer and service man. Consists of 0-6 DC voltmeter, 0-10 DC milliammeter, grid bias switch, rheostat, socket and binding post, instruction sheet..... | \$6.50 |          |      |       |
| <b>CORD AND PLUG</b>                                  |   |        |          |      |       |
| No. 21  | For connecting meters in A and B leads of a receiver without any disconnections. Terminals correspond with posts on No. 210 tube checker.....   | \$1.85 |          |      |       |

A pocket type meter will fit easily in a man's vest pocket. A portable type meter will fit in his sack-coat outside pocket. The other meters—panel type—are intended for panel mounting, 2 5/64-inch hole.

**GUARANTY RADIO GOODS CO.,**  
145 West 45th Street, New York City.

Please send at once your meters, catalogue numbers:

.....  
for which I will pay the postman the price as advertised in Radio World, plus a few cents extra for postage.

Name.....  
Address.....  
City..... State.....  
RW-28

ALL METERS SOLD ON FIVE-DAY MONEY-BACK GUARANTY.