

1926
MAY 8.

THE FIRST AND ONLY RADIO WEEKLY

15c

RADIO WORLD

Title Reg. U.S. Pat. Off.

Vol. 9 No. 7 ILLUSTRATED Every Week

155-215

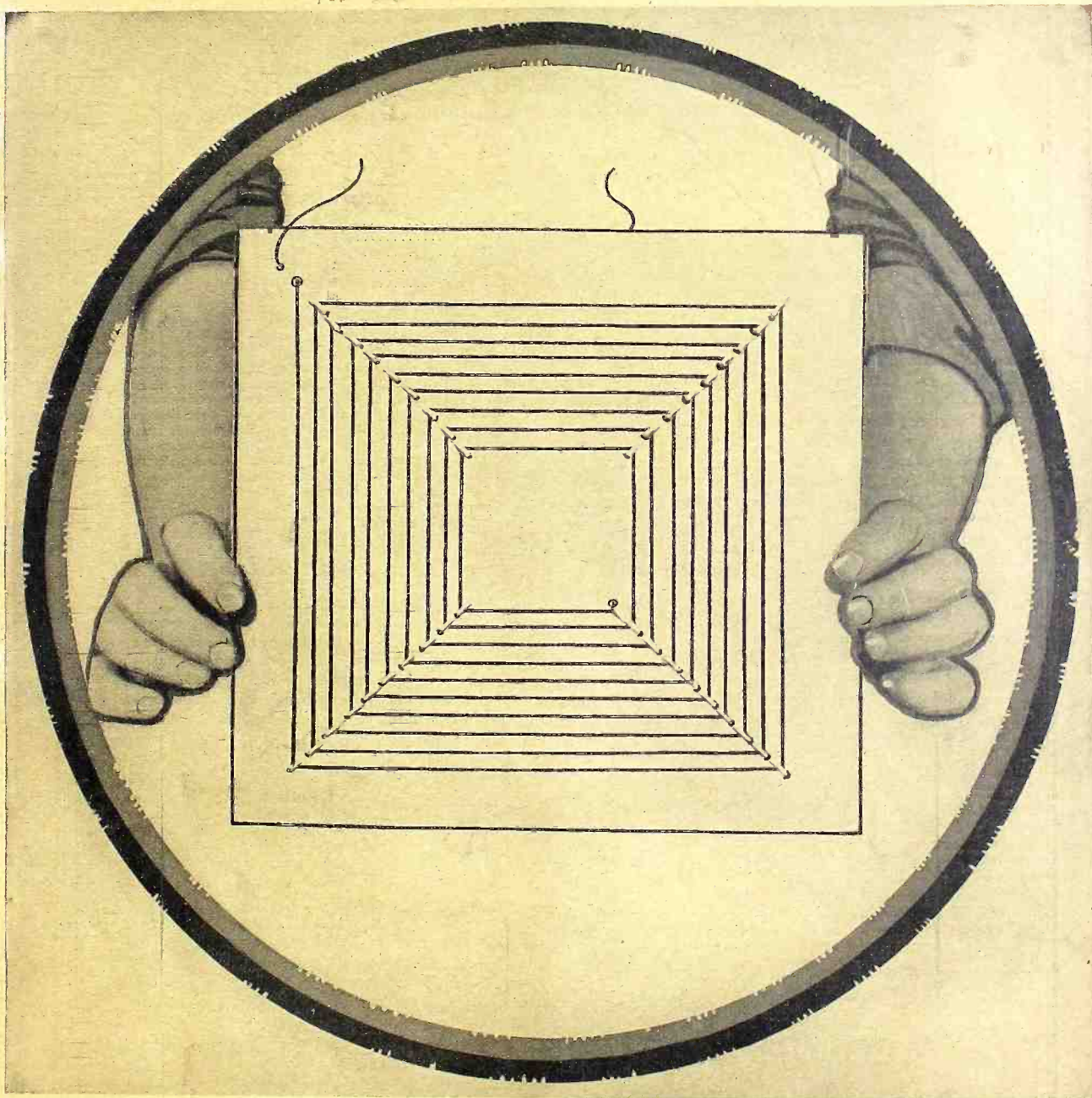

A LOOP may be wound on a stiff piece of square cardboard, as shown, and utilized for a portable. See article on page 27.

The Newest Up-to-the-Minute Radio Set—It has Never Been on a Dealer's Shelf—Most Selective.
A Wonderful DX Getter. Sold on a Guarantee of Satisfaction or Money Back.

Volume Control—Perfect Calibration—Range 180-550

BST-6

B-for Beauty
S-for Selectivity
T-for Tone purity
6-its 6 tubes for distance

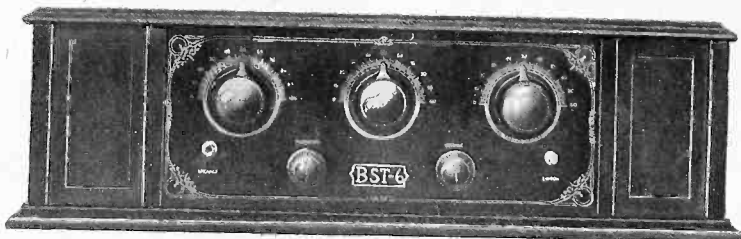

The BST-6. 2 Feet 4 Inches Long. 9 Inches Inside Depth. 8¾ Inches High.

THIS marvelous six-tube tuned radio frequency receiver is Self-Equalized and built of low-loss materials throughout. Its clear, rich tone of astonishing volume is a revelation. The circuit consists of two stages of tuned radio frequency, tube detector and three stages of balanced audio amplification. Air cooled rheostats and universal sockets are used.

Modified straight line frequency variable condensers are employed, insuring separation of the low wave length stations. **PERFECT CALIBRATION—STATIONS ONCE TUNED IN CAN ALWAYS BE LOGGED AT THE SAME DIAL POINT.**

The balanced amplifier gives absolutely natural reproduction of all overtones. The universal sockets permit the use of all the popular tubes, either dry cell or storage. The set does not oscillate, thereby preventing the radiation of signals and reducing interference to a minimum.

Specifications

Bakelite Panel, Walnut Finish—
With Etch-O-Gravure and Gold Decorations—
Bakelite Sub-Base—
Kurz-Kasch Bakelite-Walnut Pointers; Gold-filled, to Match—
Kurz-Kasch Bakelite Gold-filled Rheostat Knobs—
Lubree Straight Line Frequency Condensers—
Special Coils; Double Silk Solenoids—
Shore Audio Transformers—
Caswell-Runyan Two-tone Walnut-Finished Cabinet.

LOG OF BST-6

Taken on a Fifteen Foot Aerial in One-half Hour by
Al. Kraus, 996 Aldus Street, New York City.

WSBC	10	WCY	50
WBBR	16	WMAK	51
WEBH	49	WMSG	11
WHT	55	WOC	85
WCCO	61	WFAA	78
WSB	66		

SELECTIVITY

I live within four blocks of WLWL, and since the opening of this station have had great difficulty in choking them off my old set. Even after employing a wave trap I could still hear WLWL around the entire dial and was told by several friends that living so near this powerful station it would be impossible to entirely cut them out with anything less than a super-het. It was a very agreeable surprise, therefore, when I installed my new BST-6, to find that while WLWL came in on 25 I could tune in WRNY on 21 and entirely cut out WLWL. *This is certainly real selectivity.*—F. S. Clark, 350 West 55th Street, New York City.

Guarantee

Satisfaction or Money Back

Each receiver is tested and retested, boxed and inspected before leaving factory, and guaranteed to reach you direct in perfect condition. Workmanship throughout guaranteed the best. Assembled by experts.

Immediate Delivery

Direct from factory to you
No dealers' or middlemen's profits

\$40.00

SAFETY FIRST!—Why buy obsolete models, or radio failures at department store "bargain sales" when a BST-6, the latest achievement in radio, can be bought direct from the factory with no department store profit added? Here is a real bargain, sold you with a guarantee of satisfaction or money back.

Send Check or P. O. Money Order to

COLUMBIA PRINT,

Radio Division, 143 West
45th St., New York City

RADIO WORLD Guarantees the Responsibility of This Advertiser

RADIO WORLD

[Entered as second-class matter, March, 1922, at the post office at New York, N. Y., under Act of March 3, 1879]

A Weekly Paper Published by Hennessy Radio Publications Corporation from Publication Office, 145 West 45th St., New York, N. Y. Just East of Broadway. Phones: BRyant 0558 and 0559

Vol. IX. No. 7. Whole No. 215.

May 8, 1926

15c per copy, \$6.00 a year

The Great Aid of a By-Pass

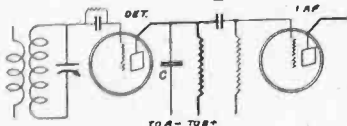

FIG. 1.

Example of a by-pass condenser at the detector output. Note the connection to A minus, instead of to B plus

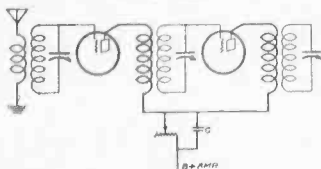

FIG. 2.

WHERE a series resistance is used for oscillation control the resistance in the circuit should be by-passed as shown at C.

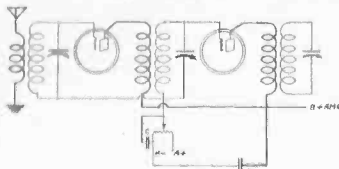

FIG. 3.

A potentiometer should be by-passed as shown at C. The other condenser, C1, by-passes all batteries.

By John F. Rider

Member, Institute of Radio Engineers

ARE you using bypass condensers in your receiver? If not, you are not getting the most out of your receiver, for bypass condensers are essential. And if you are utilizing these capacity units, are they correctly wired into your receiver? If not, you are not getting the most from your receiver.

The bypass condenser is usually overlooked as an unnecessary addition, for the receiver works and brings in distance without it. But this method of reasoning is far from sound, for distance reception with a radio receiver is not the criterion of its efficiency or its correct operation. Are you troubled with lack of the desired degree of regeneration on the upper wavelengths with a regenerative receiver? A bypass condenser correctly connected across the plate circuit of the detector tube will usually result in satisfactory regeneration over the entire wavelength band.

The Method of Connection

This condenser is not difficult to connect. It is so arranged that it is in shunt to the primary of the audio frequency transformer and across that portion of the B battery which supplies plate voltage to

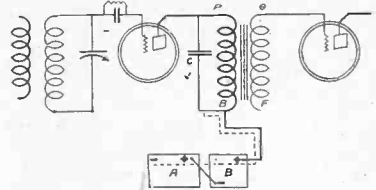
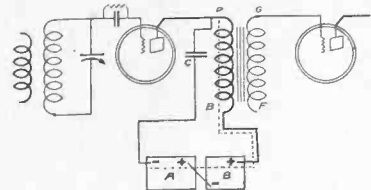

FIGS. 4 and 5.

At left (Fig. 4) the by-pass condenser C keeps the radio current out of both the transformer primary, PB, and out of the batteries. Note that the output is from a detector tube. The dotted line shows the circuit that is by-passed. In Fig. 5 (at right), the wrong way is shown, as the batteries are left in the radio circuit, as shown by dotted line.

the detector tube. Very frequently, fans insert one of these bypass condensers but connect it directly across the primary of the audio frequency transformer. This arrangement is not correct, for while the radio frequency currents have been by-passed across the transformer primary, they must however flow through the battery cells supplying the plate voltage to the detector tube, and if these cells are partially discharged, regeneration will be impaired.

When a resistance coupled audio amplifier is used in conjunction with a separate detector, it will be found best to bypass the first coupling resistor, that is, the coupling resistor connected into the plate circuit of the detector tube. The bypass condenser in this instance, too, should also bypass that portion of the B battery which supplies plate potential to the detector tube. This bypass condenser when connected as mentioned is not only an aid in obtaining better regeneration, but is of distinct aid in obtaining greater volume.

Now, as it is important to bypass that small part of the complete B battery source which supplies the detector plate voltage, it is logical that it would be advantageous to bypass the complete B battery as an aid to audio frequency amplification. The reason for this is very simple. While the resistance of the A and B batteries is fairly low when the cells are fully charged, it increases very rapidly as the cells discharge. So that the effects of this unnecessary resistance be removed, especially from the plate cir-

cuits, it is necessary that bypass condensers be utilized. In connection with these battery bypass condensers, it is highly important that they be of high quality, with a high value of insulation resistance. Otherwise a high resistance leak in the form of the leaky bypass condenser will be in shunt with the B battery, and the battery's operating life will be materially shortened.

Values to Use

Another important position for the bypass condenser has arisen of late. This is in shunt to the series resistance in the plate circuit of radio frequency amplifiers, as a control of the applied plate voltage and consequently volume. If omitted at this point, control of the receiver will be very difficult, and there will always be present a high pitched whistle.

Other points at which bypass condensers are necessary are across the negative leg of the potentiometer in a potentiometer controlled radio frequency receiver, and in shunt with resistance used in reflex receivers, where the resistance is one of the reflexed units.

The exact value of bypass condenser differs for the different positions. When used to bypass the high resistance of a transformer primary or a coupling resistance, values between .002 and .005 mfd. will be found satisfactory. For all other purposes as bypass condensers values greater than 1 mfd. are unnecessary. In fact, across series resistances and potentiometer .5 mfd. units are very satisfactory.

Radio Starts at 10,000, Goes to Light Frequency

Radio currents are nothing more than very high frequency alternating currents. Ordinary alternating current power circuits use frequencies from 25 to 60 cycles per second. The lowest radio frequencies, however, lie above some 10,000 cycles per second. The upper limit scarcely can be gauged. Ultra violet rays are way up in the trillionths of cycles. The great differences in the frequencies naturally give rise to differences in the behavior of radio

circuits, as distinguished from low frequency alternating current circuits.

In low frequency alternating current circuits, the principal opposition to the flow of currents through the wires connecting the various pieces of apparatus, is the actual resistance of the wires. Only in the most unusual cases do inductance and capacity of the wires have anything to do with the opposition. Inductance in generators windings is important, though

Reflexed Resistance AF

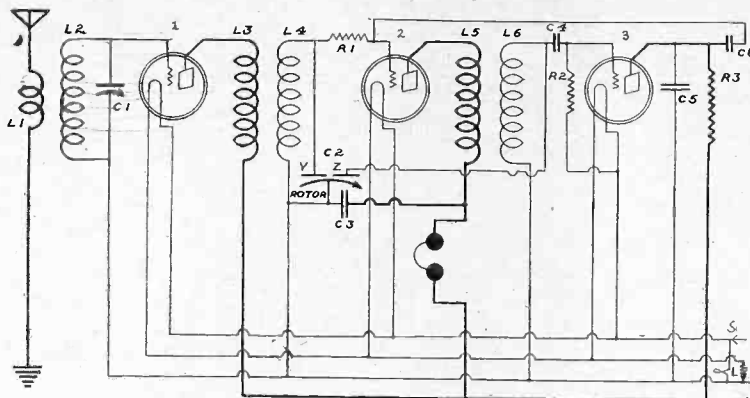

FIG. 1

A practical way of reflexing a resistance-coupled audio stage. The detector output (3), with radio currents by passed by C5, develops a voltage across R3, which is carried by C6 back to the second RF stage (2), in which R1 is the grid leak. Hence, tube (2) is reflexed, the audio output being into a pair of phones.

Precautions Needed With Choke Audio

Technical information is very easily misinterpreted. And when this is the case the results are invariably unsatisfactory. Consider as an example choke coils designed for impedance coupled audio amplifiers. The fact that the choke coil is classed differently than the audio frequency transformer leads many to believe that they can ignore all customary practices and place the chokes in any position with respect to each other, and use whatever plate voltages are desired.

Neither of the two can be effected. In the first place, the choke is a reactive unit, and while its electrical design is such as to concentrate the field to a very small area, the fact remains that it has a field. Therefore it is necessary to exercise precautions to preclude even slight reaction due to coupling between the units. One method is to separate the units about 3" to 4" between edges. Another is to ground each shell. One must not overlook that reaction between two such amplifying stages is not always due to reaction between the coupling media only, but also to the various wires connected to these units. Strong reaction can take place between one coupling unit and a set of wires connected to another.

Another item of interest with respect to choke coils for impedance coupled audio amplifiers is the B current that can be passed through the choke-tube combination. Unfortunately the plate voltage is not unlimited, and is not governed by the tube used but by the electrical design of the choke, that is, the size of its core, the wire used and the DC saturation of the core. Overloading chokes not designed for the purpose, by applying two or three times the rated voltage, even though a more powerful tube is used, will not prove satisfactory. The quality of the output will be very poor, and a unit consisting of three such chokes, all overloaded, will oscillate at an audio frequency, completely impairing the audio amplification of the desired signal.

To preclude this action never apply more than 150 volts to the average choke designed for standard audio amplification.

By Theodore Kerr

Many attempts have been made to return a detector output to a preceding radio frequency stage for a step of resistance coupled audio. This is a resistance coupled reflex. As yet no circuit has been popularized that embodies this plan. Occasionally an article describing such a circuit is published by some enthusiast. The circuit works, but the difficulty lies in the fact the general public, trying to build the set, cannot get it to work well, that is, not a sufficient percentage to entitle the set to popularity.

The chief difficulty lies in proceeding from the first reflexed stage (first audio) to the next audio stage. Everything is all right—or nearly so—when you go as far as shown in Fig 1. Tube (1) is an unmolested stage of tuned RF. Tube (2) is the second tuned R F stage, about which more later, while tube (3) is the detector, with tuned input. Now, the output of the detector (rectified component) is connected to B+ through the usual plate resistor, R3, say 100,000 ohms. C6 is the isolating condenser that keeps the B positive off the succeeding grid. This ensuing grid, however, is that of the second RF stage. Instead of going on to the next grid you go back to the preceding one. Be careful this connection is made to the G post and that the grid leak R1, say .5 meg., is not in the tuned part of the circuit. In other words, follow Fig. 1 closely.

A pair of phones completes the B plus connection for the reflexed stage. As said before, the circuit so far is not trouble-

some, granting the primaries L3 and L5 are small enough not to develop over oscillation.

Don't let C2, with Y and Z and rotor, confuse you, as a double condenser was used instead of two separate ones for these stages. The only difference is the control reduction.

Imagine a plate resistor replacing the phones. This diminishes the effective B voltage on the plate, due to the high resistance (100,000 ohms, as compared with about 2,000 for the phones, hence 102,000 v. 2,000, or a 51-fold resistance increase, external to the plate itself). This of course raises havoc with the plate impedance, important indeed in a reflexed stage particularly.

So the stunt of replacing the phones with a transformer coupled audio stage. This was a sheer makeshift. The resistance replacing the phones, for further AF, worked very poorly. The audio howl wasn't so bad, but the volume disappeared. The transformer hookup (Fig. 2) howled very successfully.

Hence, resistance in the second AF stage having been defeated in this encounter, and the transformer having met the same fate, the matter is left in the hands of the experimenters, while other laboratory tests along this line go on.

Anyway, the Fig. 1 circuit worked very well. No howl, no trouble, no problems.

Here are some suggestions:

Put R1 on the low side, instead of on the high side, as shown. That would necessitate its connection between the rotor and A minus.

Use a fixed resistance for R1, even a variable one, under 100,000 ohms. Thus it will tend to subdue oscillations at radio frequencies, as in the method Atwater Kent uses.

Put a fixed condenser, say .00025, across R1, following grid condenser leak style.

WARSAW ON AIR SOON

WASHINGTON.

A new broadcasting station, which has been under construction in Warsaw, will begin operating soon, according to a statement of the Polish Radio Company which owns the station. The wavelength will be between 470 and 500 meters, power about 6 kilowatts.

KISSES BY RADIO

Kisses were broadcast by a group of Children of the American Revolution as a demonstration of American children's love for the children of the world.

WIOD CLOSES FOR SEASON

Station WIOD, Miami Beach, Fla., has closed after a successful first year. It will reopen November 1.

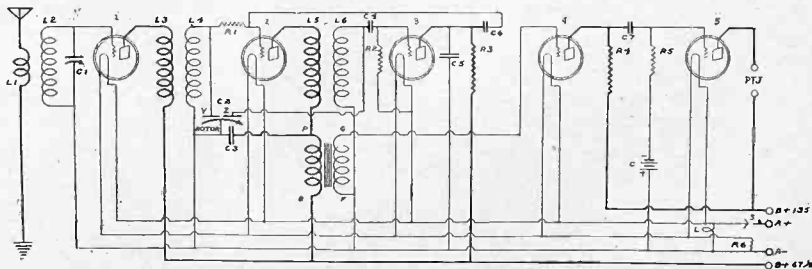

FIG. 2

Here is where the difficulty begins. While the phones handle the situation well in Fig 1, the substituted primary of the audio transformer causes audio oscillations that require expertness to balance out. The problem is one of great fascination for experimenters.

The Key to Selectivity

By K. B. Humphrey

THESE are three things which the listener can try if he wishes to make his set more selective. First, shortening the aerial; second, different grounds; third, bunching and shortening battery leads. It is assumed that the reader has a receiver of good make which has selectivity possibilities, but still does not give the expected results. If the receiver has inherent faults due to poor materials or design various accessories to selectivity will be of little avail.

The greatest trouble is usually experienced in the aerial. A manufacturer in his instructions has to suit the average user of his receiver, which may or may not apply to a particular installation. Consequently, if instructions are given that the aerial should be 100 feet long, it does not mean that your location is surely suited for that length. Therefore if you are troubled with interference, try shortening the aerial. Sometimes a .00025 mfd. fixed condenser in series with the lead-in aids, as it lowers the aerial capacity, but in my opinion is not always so effective as the physical shortening. It is surprising how much the average aerial may be cut down without materially reducing the volume. This is due in a great measure to the almost universal use of radio-frequency amplification. A long antenna is not necessary with this type. Of course a long aerial is better for distance and it is sometimes advisable for the listener to provide a short aerial and a long aerial, with a switch. The short one would be used for receiving the locals and the long one for DX when the locals are shut down.

The effective height of the aerial is seldom found to be exactly that of the distance to the ground, except possibly in open country. If, for instance, the aerial is supported above a metal roof, the height is actually the distance between the wire and the roof, though the roof itself may be 100 feet in the air. If you have a high aerial you will be able to make it shorter and get the desired results than if a comparatively low aerial is to be used. When the antenna is run close to the wall or any metallic structure the average height of the aerial is reduced. This is not the only undesirable result, however. It also forms a small short-circuiting condenser which cuts down the signal strength and makes the receiver less selective.

If the aerial is in good condition and still the selectivity of the set is not what it should be, try shortening up your ground lead. A long ground lead will have the same effect as a long aerial. A ground wire often is run to the front of the house to the water pipe, which leads to the street subsurface. When the set is located some distance away from the pipe, ground the wire additionally at some point near the set, such as the radiator. This would prevent the ground wire picking up energy and feeding it into the set and would reduce the resistance of the ground. A high resistance in the ground, such as is sometimes found when the steam or gas pipe is used, will cause a lack of selectivity. An extra wire supplementing the regular ground can then be used with good results. A ground clamp should always be used on the pipe and the pipe should be cleaned thoroughly before the clamp is attached. It may sound a little extreme to harp on a good ground connection, but just take a look at the average installation and see the ground wire nearly wound around a soiled

pipe or connected in some slipshod manner.

If the aerial and ground are in good condition, take a look at the battery leads. The batteries, both A and B, should be located as close to the set as practical. The leads should be bunched together and taped. A good battery cable is to be recommended. If the wires are long and separated they form a loop aerial which will have a tendency to pick up the powerful locals and cause interference. If it

is impossible to locate the storage battery close to the receiver, a duplex cable of not less than No. 14 gauge should be used, and a bypass condenser attached to the receiver binding posts (A- and B+). This condenser should be of at least 0.5 mfd. The purpose of this condenser is to short circuit any radio frequency currents picked up by the leads and prevent them from interfering with the operation of the set.

Northern Lights Reduce Reception by 50 Per Cent.

WASHINGTON.

Reviving the much discussed theory of the effect of northern lights on broadcasting, the radio supervisor of the Department of Commerce stationed at Seattle, Washington, says that reception in northwestern stations was cut almost in half while the lights were playing.

According to the report, tests were made with an extremely sensitive set, in order to ascertain as nearly as possible the extent of the interference, if any, caused by this natural phenomenon. It was found that various California stations, which under ordinary conditions are received with strong volume with one stage of audio amplification were received with about one-half this former volume, even though a second stage of audio amplification was used.

Whenever the display of Northern Lights became brighter or shifted their position the signal strength of these stations was materially reduced, it was noted. In listening to stations transmitting on wave lengths below 350 meters, the same blanketing effect was noted and in addition a pronounced swishing noise was caused in the radio receiver. At times this interference became more intense, causing a distinct sputtering.

From the observations made, it was

noticed that while this display of Northern Lights produced the blanketing effect on all wave lengths no atmospheric disturbances could be noted in the receiver, except on wave lengths below 350 meters.

Polarity Matters Not At the Input of AC

Many fans are confused as to which terminal of an AC power line, the input terminals of an A or B eliminator or charger, are connected, thinking one is positive and one is negative. There is no positive or negative post on such a line, the potentials varying periodically, depending upon the frequency of the line. That is, if the line is of the 60 cycle type, there will be negative and positive alterations during each second. One terminal will then be positive 1/60 of a second and then negative 1/60 of a second. It does not matter therefore to which terminal the input is connected. The rectifier tube or cell changes this alternating current to pulsating DC. It is then, that a specific positive and a specific negative terminal exists and care should be taken as to the connections on the output or to the filter system.

How a Tuned RF Set Looked in Days of '22

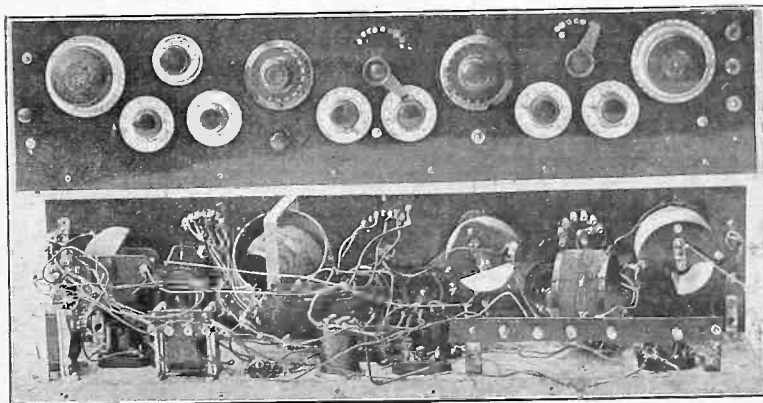

MULTI-CONTROL was the password in 1922, when the above tuned radio frequency set was made. Variable interstage coupling was provided by the vario-coupler. Note the tap switches, four tuning controls and seven variable resistances. As for neatness of panel and assembly, there is no sign of it. Compare this model with the TRF sets of today.

A Study of Detection

[Part I of this article was published last week, issue of May 1. Part II is printed herewith. Part III, the conclusion, will be published next week.]

By J. E. Anderson

Consulting Engineer

If the plate DC flowed through the headset windings, this would cause an additional flux, and this either would increase or decrease the flux produced by the magnet. If the connections were made such that the current increased the permanent flux the sensitivity of the telephone would be increased in proportion to the current. When a transformer primary or some other coupling device is connected in the plate circuit of the detector, the heavy plate current is of no advantage.

The methods for adjusting the grid bias discussed for negative values are also applicable for positive. In most cases the battery E_g would be omitted, or it would be reversed. Fig. 3 is especially applicable when a filament battery is employed which has a voltage higher than that required on the grid.

The position of the two efficiency curves with respect to the characteristic curve of the tube does not change very much with changes in the plate battery voltage, but the position of all the curves changes greatly with respect to the grid voltage axis when the plate voltage moves the curves to the left. For instance, an increase of about 16 volts in the plate voltage might move the curves two volts to the left, so that the peak of the positive efficiency curve might fall on the zero grid voltage axis. In that case it would not be required to use any positive bias, but the return lead from the grid could be connected to the negative terminal of the filament, or to a point on the potentiometer very close to it. The peak on the negative efficiency curve would move over to -5 volts, and of course would be necessary to increase the grid bias battery accordingly.

Where Silence Exists

When the negative or positive grid bias method of detection is employed, the application of an alternating signal voltage changes the plate current of the tube as this would be read on a DC ammeter, as has been explained. If the amplitude of the signal voltage remains unchanged while it is being applied, the reading on the meter also remains unchanged after the first sudden change has taken place. Therefore there would be no sound heard in a headset connected in the plate circuit, and there would be no energy transferred to the secondary of a transformer

which might be connected in the plate circuit. However, the sudden change in the current occurring at the instant of application of the signal voltage, or at the instant of removal of the signal, would be heard as a click or as a dull thud in the phones. Thus when no sound reaches the transmitting microphone the amplitude of the carrier wave remains unchanged and then no sound is heard in the receiver headset or speaker, although the steady current in the plate circuit is different when the pure carrier wave is impinging on the grid circuit. Stopping or starting the carrier wave would produce the click. If the amplitude of the carrier wave changes periodically, as it does when sound reaches the microphone, then there is a periodic change in what has been called above the amplitude of the net increase or decrease in the plate current. This change will be heard in the headset, or it will be transferred to the secondary of the transformer, provided, of course, that the periodic change occurs at an audible frequency.

The Leaky Condenser

The third method of detection is by means of the leaky condenser. In this case detection does not depend on the curvature of the grid voltage, plate current characteristic. The action is rather complex. In the first place the tube operates as an amplifier, both of radio frequency and audio-frequency voltages. For this reason the tube must be operated on that part of the characteristic curve where the curvature is least, or where the amplifying action is greatest; and this point coincides with the point where the detecting efficiency by the two previous methods is least, which in Fig. 1 is the point of zero grid bias. In the second place the tube must be so operated that the grid goes positive for part of the signal voltage wave, because detection depends mainly on the grid current.

When the grid goes positive it becomes a miniature plate and attracts a certain number of electrons from the filament; and the flow of these electrons constitutes the grid current. The more the grid is positive the greater is the grid current; and since the grid may be considered a miniature plate, the grid voltage, grid current characteristic will be very much like the grid voltage, plate current characteristic, except that it will be very much smaller. It starts with zero current at zero grid voltage, increases at first very slowly, then more rapidly. The dotted curve represents this current, though this is not drawn to scale. In order that the tube be the most sensitive as a detector by this method, a given signal voltage must produce the greatest change in the grid current; that is, the tube must be operated on that part of the grid voltage, grid cur-

rent characteristic where the curvature is greatest, for exactly the same reason that the tube must be operated at the point of greatest curvature on the grid voltage, plate current characteristic when the grid bias method of detection is employed.

Coincidence Required

Since the tube must be operated at the steepest part of the grid voltage, plate current characteristic and at the point of greatest curvature of the grid voltage, grid current characteristic, it will be necessary so to adjust the various voltages that these two points coincide. Referring to Fig. 1, suppose that the tube having this curve be operated at zero grid voltage. The zero voltage axis crosses the curve .325 milliamperes. This point is slightly to the right of the point where the curve is steepest, this point being at about -4 volt and .29 milliamperes. There is very little difference, however, between the slope at this point and at the point where the zero voltage axis crosses, so that the amplification will be good. The grid will also become positive during half of the cycle of the input wave, and consequently the effective detection will be fair. But it will not be maximum because the operating point does not coincide with the point of greatest curvature on the grid voltage, grid current characteristic. This point is at about 1.25 volt positive bias (as this particular grid current curve is drawn). Hence the grid bias should be increased to this value. This, however, moves the operating point up on curve A to a point where slope is noticeably less than at the steepest point. Hence to make the two points coincide curve A must be moved to the right 1.65 volts. This is accomplished by decreasing the plate voltage on the tube, and the decrease required is approximately 1.65 times the amplification constant of the tube. In case of a UV201A tube it would be about $1.65 \times 8 = 13.2$ volts. The correct plate voltage for this tube is usually between 40 and 45 volts. Sometimes the two points may be brought together, in effect at least, by changes in the filament current.

The Grid Condenser

So far nothing has been said about the grid condenser from which this method of detection gets its name. Let us now consider that. Referring to Fig. 6, which is a typical circuit employing the leaky condenser method of detection, let C represent the condenser. Let us first assume that the insulation of this condenser is perfect so that no current whatsoever can leak across it. Also let us assume that the grid is otherwise thoroughly insulated, that is, that there is no leakage from the grid to the filament or plate either inside the tube or on the socket.

Now let an alternating voltage of amplitude V be impressed on the grid circuit. As soon as the grid goes positive electrons begin to flow to the grid and they continue to flow as long as the grid is positive. The electrons, being negative, charge the grid and grid condenser negatively by a certain amount. This negative charge remains on the grid on account of the high insulation.

The Choking Effect

When this condition has been reached the input wave produces no effect on the plate current whatsoever. The grid is choked or blocked, a condition which is often met with in practice, particularly when the grid circuit has been accidentally left open. This blocked condition, of course, is not to be desired.

Let the switch S, Fig. 6, now be closed, thus connecting a high resistance leak across the grid condenser. The charge

Sausage Coils Can Be Cut Up

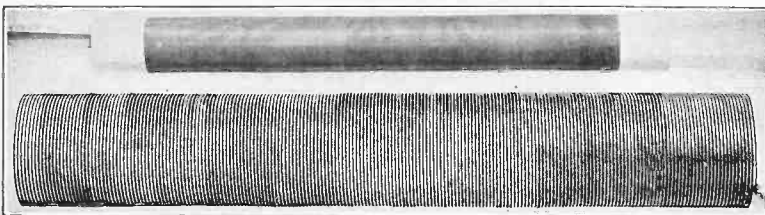

(Hammarlund Mfg. Co., Inc.)

A SPACE-WOUND COIL, supplied to the trade in 20" lengths, may be cut into proper length with a pen knife. The larger coil is of No. 16 green silk over cotton, wound 10 turns per inch, and when cut to proper inductive value is for use in short wave receiving sets. The smaller coil is No. 36 S.S.C., wound 100 turns per inch, to be used for a radio frequency choke coil.

Rectification Is Explained

on C will now gradually leak off, thus restoring the tube to its operative condition; that is, it will move the operating point to the right again. The input wave of amplitude V will tend to charge the condenser continually and the grid leak will relieve this charge. A point of balance between these two effects will be established, and this point will be the effective operating point of the tube. Its position will depend on the amplitude of the input wave, on the grid leak resistance, and on the capacity of the condenser in the grid circuit. Hence the point may be moved by changing any one of these quantities. The fact that the operating point will move with changes in the amplitude of the input wave is of prime importance in connection with detection by this method.

When the amplitude V of the input wave is increased the charging of the condenser due to the grid current gains on the discharging through the leak, consequently the operating point moves to the left, decreasing the plate current; and when the amplitude V is decreased, the charging of the condenser is less on the discharging through the leak, and the operating point moves to the right, thereby increasing the plate current. In any modulated signal wave which is to be detected the amplitude V changes periodically, rising and falling in accordance with the audio frequency or frequencies which are modulated. Hence the operating point of the tube will oscillate back and forth along the grid voltage axis in accordance with the audio frequency, and the plate current will vary in sympathy. This variation occurs over the steepest part of the grid voltage, plate current characteristic, since the voltages had so been adjusted, and therefore the tube acts as an amplifier of the audio frequencies as well as a detector of modulated radio frequencies.

The Hydraulic Analogy

As an aid in understanding the action of the leaky condenser method of detection let us construct a hydraulic analogy. A man has a tank by a well. He hires a boy to bail water from the well, by means of a bucket, and pour it into the tank at a constant rate. There is a small leakage pipe near the bottom of the tank which keeps the tank from overflowing. The rate of dipping the water and the amount in each pailful are so adjusted with respect to the rate of leakage through the pipe that the average height of the water above the bottom is h feet. In this analogy the tank T , Fig. 7, represents the condenser; the size of the tank is the capacity of the condenser; the height of the water in the tank is the voltage of the condenser or grid; the amount of water in the tank is the charge or quantity of electricity on the condenser, and the leakage pipe is the grid leak across the condenser. The water in the pail for each dipping represents the quantity of electricity put on the grid condenser every time the grid goes positive; the rate of dipping corresponds to the radio frequency of the current. Each time a pailful of water is poured into the tank the level of the water rises a little, but this is lowered by leakage through the pipe each time the boy stoops for a new pailful. The second pailful raises the level again. This process is continued and the average level in the tank remains the same. That is, there is a point of balance established between leakage and replenishment.

Just as the water level in the tank rises and falls with the same frequency as the

Briton's Invention Assures Privacy

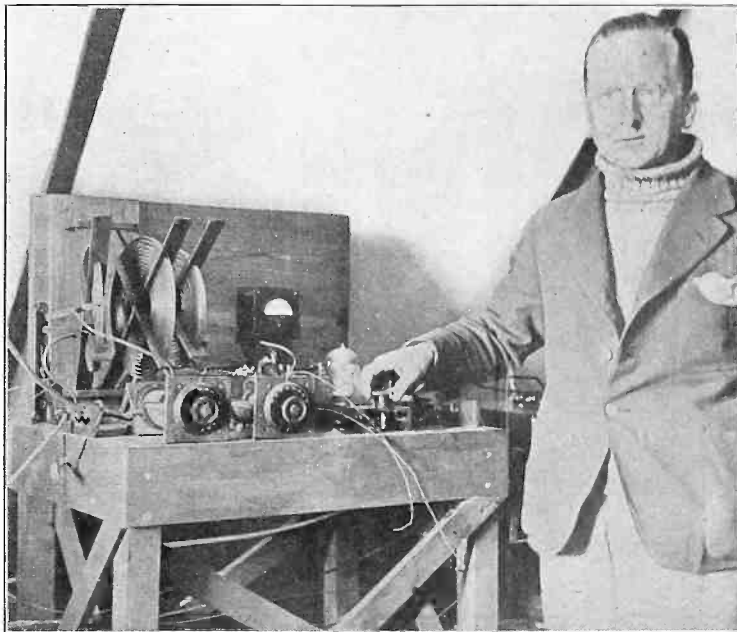

(Wide World)

J. D. CHISHOLM (above) of Birchington, Kent, England, has invented a secret wireless transmitter which works on a combination of wavelengths. Only a person possessing a special set can receive and then only when the message is intended exclusively for him, all other receivers being deaf and dumb to impulse. Chisholm says the secret wireless has unlimited possibilities. He is shown with one of the special transmitters.

boy is dipping, so the potential of the grid, or the voltage level in the grid condenser, rises and falls at radio frequency potential. This radio frequency ripple in the grid potential is communicated to the plate current. It is the function of the plate circuit by-pass condenser to let this by the headset or primary of the transformer. This ripple is also utilized in many detectors for producing regeneration.

Let us continue with the analogy. Above it was assumed that the boy dipped a full pail each time. But the boy is lazy. When the boss is away the boy merely goes through the motion of dipping. Hence the boss makes periodic trips of inspection to see that the boy does his work, say once in every five minutes. When the boy sees the boss approaching he begins to take more water in the pail, and when the boss is present every pail is full. As soon as the boss leaves the boy begins to decrease the amount again. Thus the water poured into the tank is modulated with the frequency of inspection by the boss and to a degree depending on his proximity to the boy. The water level in the tank then not only rises and falls with the dipping frequency but also with the inspection frequency; because when only small amounts of water are poured into the tank at each dipping, the leakage gains on the boy and the level lowers considerably, but when the pails are full, the dipping gains on the leakage, and the water level rises. This slow periodic rise and fall of the water level would be the changes most easily perceived, and they correspond to the audio frequency variations in the voltage level of the grid or grid condenser.

To complete the analogy we may com-

pare the plate current in the tube with the vertical motion of a large float in the tank. To get an analogy of the amplification we would have to connect the float to a suitable lever.

In selecting a grid condenser and grid leak it must be borne in mind that the leakage must be slow in comparison with the radio frequency of the signal to be detected and that it must be fast in comparison with the audio or other frequency with which it is modulated, otherwise the potential of the grid condenser will not follow faithfully the modulating frequency. For weak signals it is best to use a small grid condenser and a high resistance leak. On strong signals this combination is likely to give rise to blocking, and hence either the condenser or the leakage should be increased. The greater the difference between the RF and the AF frequencies, the more effective is this method of detection. In the first detector of a Super-Heterodyne where the two frequencies, that is, the RF and IF, are more nearly equal, this method is not so effective as the grid bias method. If used for this purpose, however, the leakage should be increased so that the grid charge may have time to discharge during the short period allowed for it by the intermediate frequency.

The question has arisen as to whether the action of the frequency changer in a Super-Heterodyne is in reality detection. It is modulation, and modulation and detection are identical both in theory and practice, although not in purpose. The radio frequency generated by the local oscillator is the carrier current and the signal radio frequency is the modulating frequency.

A Study of Detection

[Part I of this article was published last week, issue of May 1. Part II is printed herewith. Part III, the conclusion, will be published next week.]

By J. E. Anderson
Consulting Engineer

IF the plate DC flowed through the headset windings, this would cause an additional flux, and this either would increase or decrease the flux produced by the magnet. If the connections were made such that the current increased the permanent flux the sensitivity of the telephone would be increased in proportion to the current. When a transformer primary or some other coupling device is connected in the plate circuit of the detector, the heavy plate current is of no advantage.

The methods for adjusting the grid bias discussed for negative values are also applicable for positive. In most cases the battery E_g would be omitted, or it would be reversed. Fig. 3 is especially applicable when a filament battery is employed which has a voltage higher than that required on the grid.

The position of the two efficiency curves with respect to the characteristic curve of the tube does not change very much with changes in the plate battery voltage, but the position of all the curves changes greatly with respect to the grid voltage axis when the plate voltage moves the curves to the left. For instance, an increase of about 16 volts in the plate voltage might move the curves two volts to the left, so that the peak of the positive efficiency curve might fall on the zero grid voltage axis. In that case it would not be required to use any positive bias, but the return lead from the grid could be connected to the negative terminal of the filament, or to a point on the potentiometer very close to it. The peak on the negative efficiency curve would move over to -5 volts, and of course would be necessary to increase the grid bias battery accordingly.

Where Silence Exists

When the negative or positive grid bias method of detection is employed, the application of an alternating signal voltage changes the plate current of the tube as this would be read on a DC ammeter, as has been explained. If the amplitude of the signal voltage remains unchanged while it is being applied, the reading on the meter also remains unchanged after the first sudden change has taken place. Therefore there would be no sound heard in a headset connected in the plate circuit, and there would be no energy transferred to the secondary of a transformer

which might be connected in the plate circuit. However, the sudden change in the current occurring at the instant of application of the signal voltage, or at the instant of removal of the signal, would be heard as a click or as a dull thud in the phones. Thus when no sound reaches the transmitting microphone the amplitude of the carrier wave remains unchanged and then no sound is heard in the receiver headset or speaker, although the steady current in the plate circuit is different when the pure carrier wave is impinging on the grid circuit. Stopping or starting the carrier wave would produce the click. If the amplitude of the carrier wave changes periodically, as it does when sound reaches the microphone, then there is a periodic change in what has been called above the amplitude of the net increase or decrease in the plate current. This change will be heard in the headset, or it will be transferred to the secondary of the transformer, provided, of course, that the periodic change occurs at an audible frequency.

The Leaky Condenser

The third method of detection is by means of the leaky condenser. In this case detection does not depend on the curvature of the grid voltage, plate current characteristic. The action is rather complex. In the first place the tube operates as an amplifier, both of radio frequency and audio-frequency voltages. For this reason the tube must be operated on that part of the characteristic curve where the curvature is least, or where the amplifying action is greatest; and this point coincides with the point where the detecting efficiency by the two previous methods is least, which in Fig. 1 is the point of zero grid bias. In the second place the tube must be so operated that the grid goes positive for part of the signal voltage wave, because detection depends mainly on the grid current.

When the grid goes positive it becomes a miniature plate and attracts a certain number of electrons from the filament; and the flow of these electrons constitutes the grid current. The more the grid is positive the greater is the grid current; and since the grid may be considered a miniature plate, the grid voltage, grid current characteristic will be very much like the grid voltage, plate current characteristic, except that it will be very much smaller. It starts with zero current at zero grid voltage, increases at first very slowly, then more rapidly. The dotted curve represents this current, though this is not drawn to scale. In order that the tube be the most sensitive as a detector by this method, a given signal voltage must produce the greatest change in the grid current; that is, the tube must be operated on that part of the grid voltage, grid cur-

rent characteristic where the curvature is greatest, for exactly the same reason that the tube must be operated at the point of greatest curvature on the grid voltage, plate current characteristic when the grid bias method of detection is employed.

Coincidence Required

Since the tube must be operated at the steepest part of the grid voltage, plate current characteristic and at the point of greatest curvature of the grid voltage, grid current characteristic, it will be necessary so to adjust the various voltages that these two points coincide. Referring to Fig. 1, suppose that the tube having this curve be operated at zero grid voltage. The zero voltage axis crosses the curve .325 milliamperes. This point is slightly to the right of the point where the curve is steepest, this point being at about -4 volt and .29 milliamperes. There is very little difference, however, between the slope at this point and at the point where the zero voltage axis crosses, so that the amplification will be good. The grid will also become positive during half of the cycle of the input wave, and consequently the effective detection will be fair. But it will not be maximum because the operating point does not coincide with the point of greatest curvature on the grid voltage, grid current characteristic. This point is at about 1.25 volt positive bias (as this particular grid current curve is drawn). Hence the grid bias should be increased to this value. This, however, moves the operating point up on curve A to a point where slope is noticeably less than at the steepest point. Hence to make the two points coincide curve A must be moved to the right 1.65 volts. This is accomplished by decreasing the plate voltage on the tube, and the decrease required is approximately 1.65 times the amplification constant of the tube. In case of a UV201A tube it would be about $1.65 \times 8 = 13.2$ volts. The correct plate voltage for this tube is usually between 40 and 45 volts. Sometimes the two points may be brought together, in effect at least, by changes in the filament current.

The Grid Condenser

So far nothing has been said about the grid condenser from which this method of detection gets its name. Let us now consider that. Referring to Fig. 6, which is a typical circuit employing the leaky condenser method of detection, let C represent the condenser. Let us first assume that the insulation of this condenser is perfect so that no current whatsoever can leak across it. Also let us assume that the grid is otherwise thoroughly insulated, that is, that there is no leakage from the grid to the filament or plate either inside the tube or on the socket.

Now let an alternating voltage of amplitude V be impressed on the grid circuit. As soon as the grid goes positive electrons begin to flow to the grid and they continue to flow as long as the grid is positive. The electrons, being negative, charge the grid and grid condenser negatively by a certain amount. This negative charge remains on the grid on account of the high insulation.

The Choking Effect

When this condition has been reached the input wave produces no effect on the plate current whatsoever. The grid is choked or blocked, a condition which is often met with in practice, particularly when the grid circuit has been accidentally left open. This blocked condition, of course, is not to be desired.

Let the switch S, Fig. 6, now be closed, thus connecting a high resistance leak across the grid condenser. The charge

Sausage Coils Can Be Cut Up

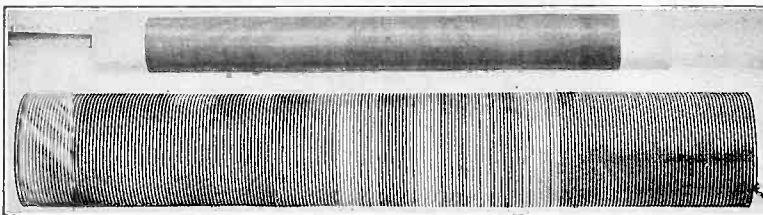

(Hammarlund Mfg. Co., Inc.)

A SPACE-WOUND COIL, supplied to the trade in 20" lengths, may be cut into proper length with a pen knife. The larger coil is of No. 16 green silk over cotton, wound 10 turns per inch, and when cut to proper inductive value is for use in short wave receiving sets. The smaller coil is No. 36 S.S.C., wound 100 turns per inch, to be used for a radio frequency choke coil.

Rectification Is Explained

on C will now gradually leak off, thus restoring the tube to its operative condition; that is, it will move the operating point to the right again. The input wave of amplitude V will tend to charge the condenser continually and the grid leak will relieve this charge. A point of balance between these two effects will be established, and this point will be the effective operating point of the tube. Its position will depend on the amplitude of the input wave, on the grid leak resistance, and on the capacity of the condenser in the grid circuit. Hence the point may be moved by changing any one of these quantities. The fact that the operating point will move with changes in the amplitude of the input wave is of prime importance in connection with detection by this method.

When the amplitude V of the input wave is increased the charging of the condenser due to the grid current gains on the discharging through the leak, consequently the operating point moves to the left, decreasing the plate current; and when the amplitude V is decreased, the charging of the condenser is less on the discharging through the leak, and the operating point moves to the right, thereby increasing the plate current. In any modulated signal wave which is to be detected the amplitude V changes periodically, rising and falling in accordance with the audio frequency or frequencies which are modulated. Hence the operating point of the tube will oscillate back and forth along the grid voltage axis in accordance with the audio frequency, and the plate current will vary in sympathy. This variation occurs over the steepest part of the grid voltage, plate current characteristic, since the voltages had so been adjusted, and therefore the tube acts as an amplifier of the audio frequencies as well as a detector of modulated radio frequencies.

The Hydraulic Analogy

As an aid in understanding the action of the leaky condenser method of detection let us construct a hydraulic analogy. A man has a tank by a well. He hires a boy to bail water from the well, by means of a bucket, and pour it into the tank at a constant rate. There is a small leakage pipe near the bottom of the tank which keeps the tank from overflowing. The rate of dipping the water and the amount in each pailful are so adjusted with respect to the rate of leakage through the pipe that the average height of the water above the bottom is h feet. In this analogy the tank T, Fig. 7, represents the condenser; the size of the tank is the capacity of the condenser; the height of the water in the tank is the voltage of the condenser or grid; the amount of water in the tank is the charge or quantity of electricity on the condenser, and the leakage pipe is the grid leak across the condenser. The water in the pail for each dipping represents the quantity of electricity put on the grid condenser every time the grid goes positive; the rate of dipping corresponds to the radio frequency of the current. Each time a pailful of water is poured into the tank the level of the water rises a little, but this is lowered by leakage through the pipe each time the boy stoops for a new pailful. The second pailful raises the level again. This process is continued and the average level in the tank remains the same. That is, there is a point of balance established between leakage and replenishment.

Just as the water level in the tank rises and falls with the same frequency as the

Briton's Invention Assures Privacy

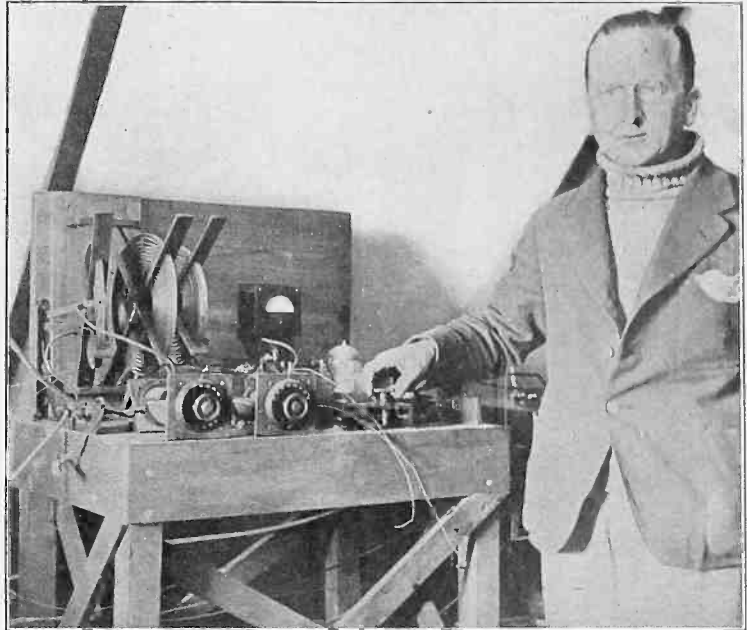

(Wide World)

J. D. CHISHOLM (above) of Birchington, Kent, England, has invented a secret wireless transmitter which works on a combination of wavelengths. Only a person possessing a special set can receive and then only when the message is intended exclusively for him, all other receivers being deaf and dumb to impulse. Chisholm says the secret wireless has unlimited possibilities. He is shown with one of the special transmitters.

boy is dipping, so the potential of the grid, or the voltage level in the grid condenser, rises and falls at radio frequency potential. This radio frequency ripple in the grid potential is communicated to the plate current. It is the function of the plate circuit by-pass condenser to let this by the headset or primary of the transformer. This ripple is also utilized in many detectors for producing regeneration.

Let us continue with the analogy. Above it was assumed that the boy dipped a full pail each time. But the boy is lazy. When the boss is away the boy merely goes through the motion of dipping. Hence the boss makes periodic trips of inspection to see that the boy does his work, say once in every five minutes. When the boy sees the boss approaching he begins to take more water in the pail, and when the boss is present every pail is full. As soon as the boss leaves the boy begins to decrease the amount again. Thus the water poured into the tank is modulated by the boss and to a degree depending on his proximity to the boy. The water level in the tank then not only rises and falls with the dipping frequency but also with the inspection frequency; because when only small amounts of water are poured into the tank at each dipping, the leakage gains on the boy and the level lowers considerably, but when the pails are full, the dipping gains on the leakage, and the water level rises. This slow periodic rise and fall of the water level would be the changes most easily perceived, and they correspond to the audio frequency variations in the voltage level of the grid or grid condenser.

To complete the analogy we may com-

pare the plate current in the tube with the vertical motion of a large float in the tank. To get an analogy of the amplification we would have to connect the float to a suitable lever.

In selecting a grid condenser and grid leak it must be borne in mind that the leakage must be slow in comparison with the radio frequency of the signal to be detected and that it must be fast in comparison with the audio or other frequency with which it is modulated, otherwise the potential of the grid condenser will not follow faithfully the modulating frequency. For weak signals it is best to use a small grid condenser and a high resistance leak. On strong signals this combination is likely to give rise to blocking, and hence either the condenser or the leakage should be increased. The greater the difference between the RF and the AF frequencies, the more effective is this method of detection. In the first detector of a Super-Heterodyne where the two frequencies, that is, the RF and IF, are more nearly equal, this method is not so effective as the grid bias method. If used for this purpose, however, the leakage should be increased so that the grid charge may have time to discharge during the short period allowed for it by the intermediate frequency.

The question has arisen as to whether the action of the frequency changer in a Super-Heterodyne is in reality detection. It is modulation, and modulation and detection are identical both in theory and practice, although not in purpose. The radio frequency generated by the local oscillator is the carrier current and the signal radio frequency is the modulating frequency.

Radio University

A FREE Question and Answer Department conducted by RADIO WORLD for its yearly subscribers only, by its staff of Experts. Address: Radio University, RADIO WORLD, 145 West 45th St., N. Y. City.

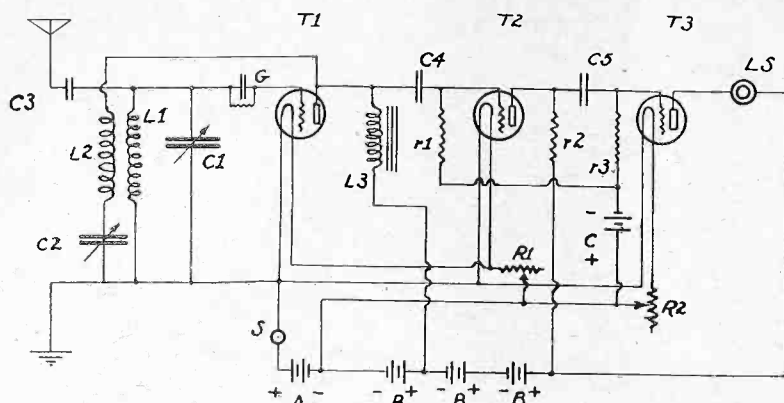

FIG. 314

The diagram of the receiver requested by Buddy Fewster.

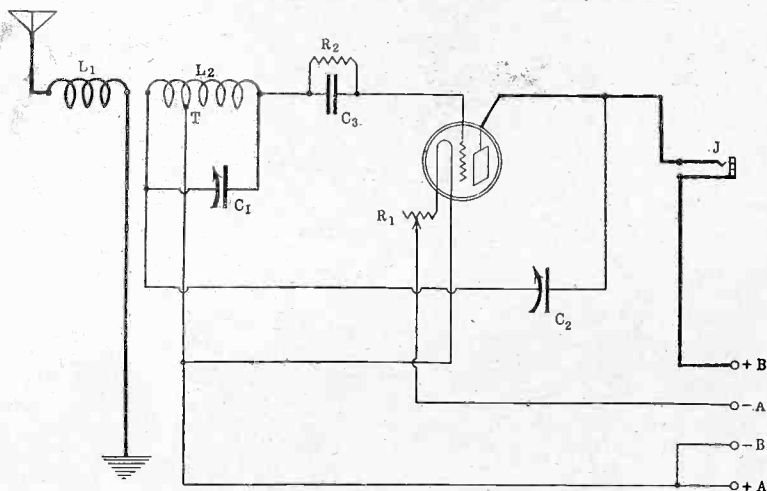

FIG. 315

The circuit diagram of the 1 tube set with a condenser feedback.

I SAW the picture diagram of the 3-tube receiver described by Brainard Foote in the Feb. 20 issue of RADIO WORLD, in the April 24 issue. I cannot follow very clearly this diagram and therefore request that a electrical diagram with all the constants be published.—Buddy Fewster, Allenton, Mo.

Fig. 314, shows the diagram you request. Here are the constants. L1 is a 50 turn honey comb coil. C1 is a .0005 mfd. variable condenser. L2 is another 50 turn honeycomb coil, while C2 is also a .0005 mfd. variable condenser. G forms the combination grid leak and condenser, a .00025 mfd. fixed condenser and a 2 megohm leak, making up the combination. T1 and T2 are two -01A type tubes, whereas T3 is a power tube of the 112 type. L3 is the coupling impedance for the first stage. The secondary of an AFT may be used for this purpose. C4 is the coupling condenser for the first stage. A condenser as small as .002 mfd. may be used. A grid leak resistance, r1, of 1 megohm or 1/2 megohm is required to properly bias the grid of tube T2. Resistance, R2, should be approximately 100,000 ohms. The grid leak, R3, should have a resistance of about 1/4 megohm, to properly bias the last tube and prevent overloading and choking. The detector and the first amplifier tubes are

controlled by one rheostat, R1, having a resistance of 10 ohms. The filament of the last tube, is controlled by a single rheostat, R2, having a resistance of 10

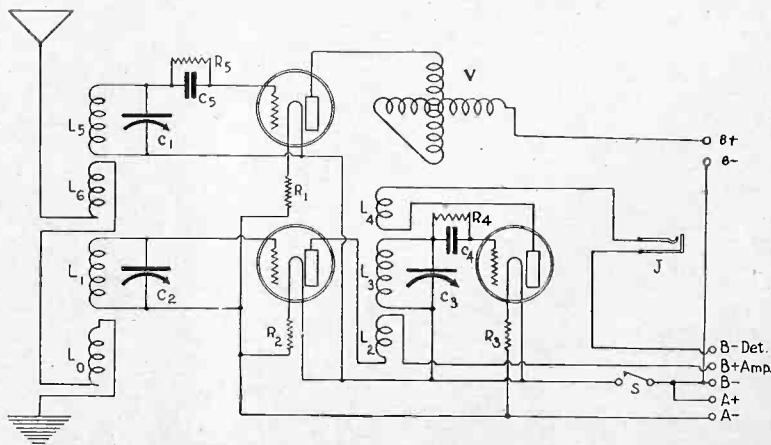

FIG. 316

The Rider Wavetrap inserted in a receiver.

ohms also. S is a filament switch. LS, represents the points at which the tips of the loud speaker are to be inserted. The plates of the amplifier tubes receive a separate voltage from that of the detector tube, viz., plate of detector tube receives about 45 volts, while the plate of the amplifier tubes receive about 90 volts. C3 is a .0005 mfd. fixed condenser. This may be a midget variable condenser also.

* * *

I WISH to have a circuit diagram of a simple 1-tube receiver, in which the plate current is capacitatively fed back. Please state the constants.—Harold Jantes, Lynwood, Cal.

Fig. 315, shows the diagram, which will suit your needs. L1, the primary, consists of 10 turns, wound on a tubing 3/4" in diameter. L2 consists of 60 turns, tapped at the 8th turn. C1 is a .00035 mfd. variable condenser. C2 is a .00025 mfd. variable condenser. No. 20 double cotton covered wire is used to wind the coils. There is a 1/2" separation between the primary and the secondary windings. C3 is a .00025 mfd. grid condenser. R2 is a 2 megohm grid leak. The -01A type of tube is used. The plate of this tube should receive 45 volts. The filament is controlled by a 10 ohm rheostat. The tap on L2, is made from the filament end of the winding.

* * *

I WOULD like to make a Rider Wavetrap, with a variometer in the plate circuit. I have a receiver which consists of a stage of tuned radio-frequency amplification and a regenerative detector. The primaries of the RFT and the tuner consists of 10 turns. The secondaries of these coils consist of 45 turns. They are each wound on a tubing 3/4" in diameter, with a 1/8" separation between the windings. The secondaries are shunted by .0005 mfd. variable condensers. The filaments of both tubes are controlled by ballast resistors. Now this set works very well, but I live so close to WGBS, that I have great difficulty in tuning him out. I believe that with this trap the trick can be done. Therefore, I would like to have the diagram of this wavetrap, with the constants, as it would appear when in the set.—James McDonald, Astoria, N. Y.

Fig. 316, shows the method of installing the wavetrap as well as the method of wiring up the trap. The primary winding of the RFT consists of 5 turns. The other five are placed on the form which will hold the secondary winding, used in the trap circuit, and indicated in this circuit as L5. The secondary winding of the trap circuit, L5, consists of 45 turns. This is wound on a tubing 3/4" in diameter.

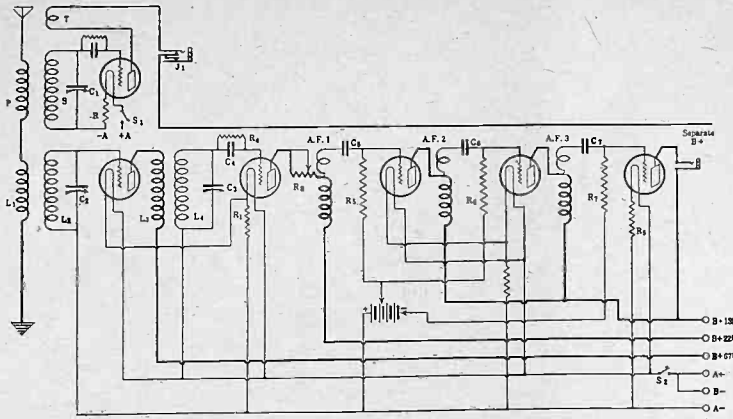

FIG. 317
The special receiver requested by Theodore Kastors.

A .0005 mfd. variable condenser, C1, shunts this secondary winding. No. 22 double cotton covered wire is used to wind this coil. A common grid condenser, C5, having a capacity of .00025 mfd. and a grid leak, R5, having a resistance of 2 megohms are used. A ballast resistor, of the 1/2 ampere type, is placed in series with the negative leg of the filament of this tube. The variometer is indicated by V and is placed in series with the plate of the tube and a B plus post.

I HAVE three autotransformers which I wish to place into a 5-tube receiver, wherein the RF tube is non-regenerative and the detector is regenerative, the regeneration being controlled by a resistance in series with the plate. I live very near to WMCA and with a single tube 3-circuit tuner receiver, I can not tune them out. I was wondering if this receiver, couldn't be employed as a wave-trap as was described by John F. Rider in the Dec. 26 issue of RADIO WORLD. The primary of the tuner consists of 10 turns. The secondary consist of 45 turns. These are wound on a tubing 3/4" in diameter. There is a 1/4" separation between the two windings. The tickler is wound on a tubing 2 3/4" in diameter and consists of 36 turns. No. 22 double cotton covered wire is used for the primary and the secondary windings. The tickler winding uses No. 26 single silk covered wire. The secondary of this tuner is shunted by a .0005 mfd. variable condenser. A -01A type tubes is used. Now then, I would like to have a circuit diagram of the 5-tube receiver mentioned before, with this wavetrap incorporated, which means that I will really have 6-tubes. Please state the data on the coils, condensers, etc.—Theodore Kastors, Hoboken, N. J.

The diagram of the receiver you are desirous of building is shown in Fig. 317. The primary of the first RFT consists of 5 turns. The primary of the tuner will also have to consist of 5 turns, instead of 10. The secondaries of both RFT consist of 45 turns. The primary of the second RFT consists of the conventional 10 turns. The primaries and secondaries of these RFT are each wound on a tubing 3/4" in diameter and 4" high. Condensers having a capacity of .0005 mfd. shunt the secondaries of these RFT. The regular grid leak and condenser combination are employed, e. g., .00025 mfd. condenser and 2 megohm grid leak. The resistance in series with the plate is one, having a variable range of from zero to about 10 megohms. The resistors in shunt to the grid filament circuits of the three amplifier tubes are all 5 megohm type. The filaments of the RF and the detector tubes

are controlled by a 1/2 ampere ballast resistor. The filaments of the first two audio amplifier tubes are also controlled by a 1/2 ampere ballast resistor. The filament of the last tube is, however, controlled by a separate ballast resistor. A power tube, such as the -112 type should be employed here. This necessitates the use of a 1/2 ampere ballast. Condensers having a capacity of .25 or even 1 mfd. can be employed as stopping condensers. These are in shunt to the plate-grid circuits of the three amplifier tubes. In all the other stages, use the -01A type of tube, as in the trap. The trap circuit is at the top of the diagram and is so arranged so that it may be employed as a separate receiver, as well as the trap, if it need be used. A switch is employed, whereby the use of this circuit can be dispensed with, there being no rheostat to cut the filament power off.

I HAVE a 3-circuit tuner with which I wish to build a reflex consisting of two tubes and a crystal detector. The first tube should be regenerative and a RF amplifier. The reflexed crystal stage should follow. A stage of audio frequency amplification using a transformer should follow the crystal. The tuner I have is wound on a basket weave form 3" in diameter. There are 15 loop holes, indicating that 15 dowel sticks were used to wind the coil. It seems as if the standard under two and over two method was employed. The tickler was also wound on a basket weave form in the same style as the other windings. The primary consists of 6 turns.

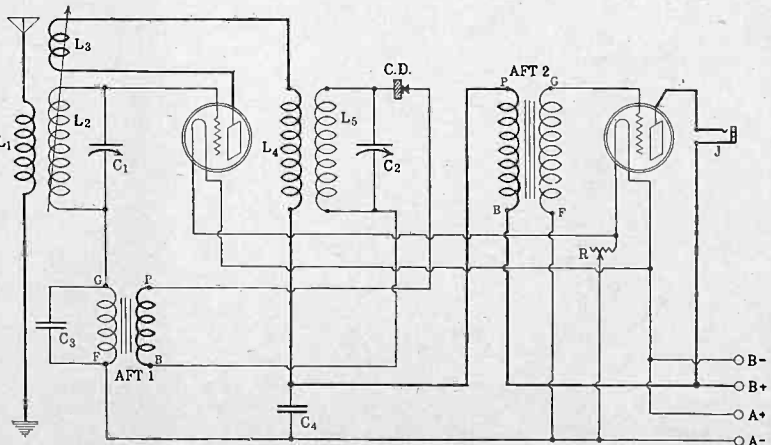

FIG. 318
The diagram of the special reflex, requested by Sinclair Stoneham.

The secondary consists of 53 turns. No. 20 single cotton covered wire is used. The tickler consists of 38 turns, wound with No. 26 single silk covered wire. I have not however a RFT, the constants of which, with the circuit diagram of the receiver employing this material, will be appreciated.—Sinclair Stoneham, Akron, N. Y.

Fig 318 shows the diagram you wish. The primary and the secondary of the RFT, consists of the same number of turns as the primary and secondary of the tuner. They should be wound on the same kind of form with the same dimensions as for the primary and secondary of the tuner. Use the same wire also. All the three tubes are controlled by one rheostat, R, which is a 6 ohm type. C3 and C4 are both .0005 mfd. fixed condensers. CD is the crystal detector. The first AFT as usual is of the high ratio type, while the AFT used in the first stage of AF coupling is of a low ratio type.

IN REGARD to the Victoreen Super-Heterodyne, described in the Feb. 20, 27, March 6 and 13 issues of RADIO WORLD: (1)—I would like to know if it is possible to use WD12 tubes throughout (2)—Will the values of the rheostats have to be changed?—Fred Krell, 527 15th St., College Point, N. Y.

(1)—Yes. (2)—No.

IN THE April 10 issue of RADIO WORLD there appeared an article by Caesar King, describing how to make a 6-tube Super-Heterodyne from an old 5-tube TRFT set. I am greatly interested in this. I am led to believe that any type of intermediate frequency transformer, as used in the standard Super-Heterodyne, may be employed. Please let me know if this is correct.—Louis Staser, care Louisville Title Co., 223 South 5th St., Louisville, Ky.

Yes.

I AM going to build a 4-tube Diamond of the Air. The receiver I now have resembles the Diamond, but the volume obtained from this set is very poor. The detector output is great. Now in this set, an extra inductance coil is placed in series with the antenna. This coil is shunted by a variable condenser. Could this same system be used in the Diamond? This coil consists of 35 turns wound on a tubing 3/4" in diameter, with No. 22 double cotton covered wire. A .0005 mfd. variable condenser shunts the coil.—Harold Barnes, Houston, Texas.

Yes.

I AM going to build the Power Booster Set, which was described in the April 17

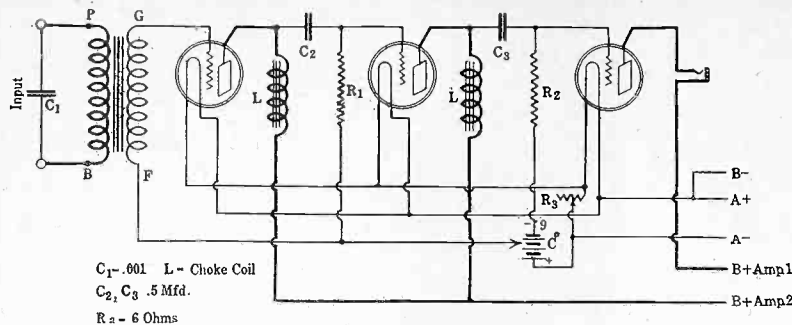

FIG. 319

Above we have the electrical diagram of a quality amplifier.

issue of RADIO WORLD. I have three .00043 mfd. variable condensers, instead of the .0005 mfd. variable condensers specified. Is it possible to use these condensers? If so, state the number of turns that would have to be added to the coils.—E. V. Bohnel, N. Y. City.

Yes. Turns need be added only to L₃, L₄ and L₆. L₄, the Power Booster coil, consists of 60 turns, instead of 55. L₃ and L₆ consist of 55 turns instead of 47.

I AM informed that a stage of transformer coupled AF followed by two stages of impedance or choke coil AF coupling, when hooked up after a regenerative detector, is much more satisfactory as to quality reproduction, than just two stages of transformer coupled AF amplification. If this is so, I would like to have a diagram, showing me how to hook this up. (2)—Can a power tube be used in the last stage of coupling? (3)—If this is done is it advisable to have a separate B voltage?—Hugh Stoneham, Akron, N. Y.

(1)—Fig. 319 shows the stage of transformer coupled AF amplification, followed by the two stages of impedance coupled AF coupling. The constants are all stated. With this method, the quality reproduction is very good. It is however only equal in volume to the 2 stage transformer coupled AF amplifier. The quality is much superior and worth the extra tube. (2)—If the power tube is to be used, a separate rheostat will have to be used to control the filament of this tube. This means that two rheostats instead of one as in the diagram will be needed. It should be a 6 ohm type, being able to pass at least 1 ampere. It should be connected in series with the negative leg of the filament of this tube. (3)—Yes.

REFERRING TO the article on loud speakers, which appeared in the April 3 issue of RADIO WORLD, does the Accusticone loud speaker, fulfill the important requirements set down in this article?—F. P. Andrus, Almont, Mich.

Yes.

I AM going to build a 1-tube regenerative receiver, employing a 3-circuit tuner, with a rheostat to control the filament action of the tube and a single circuit jack in the output. The condenser and tickler have one hole mounts. I would like to have the panel layout, using a 7x14" panel, 4" dials on the condenser and tickler shafts and a knob on the rheostat shaft.—Rodney St. Clair, Hartsdale, N. Y.

Fig. 320 shows the panel layout you request. The shaft for the variable condenser is 3" from the left hand side and 3½" from the top and the bottom of the panel. The shaft for the tickler, is 8" from the left-hand side and 3½" from the top and the bottom of the panel. The shaft for the rheostat is 2" from the right-hand side and 3½" from the top and bottom or in the same line as the holes for the shafts of the condensers and tickler. The hole for the jack is 2" from the right-

hand side of the panel and 1" from the bottom of the panel.

IN THE JAN. 16 issue of RADIO WORLD there appeared an article on how to make a loop, written by Herbert E. Hayden. The instructions and illustrations were very clear. I have built the loop, without any difficulty. However, there are several questions that I would like to ask regarding the loop. (1)—Why is a tap taken after the seventh turn? (2)—How may this loop be connected to a standard 5-tube tuned RFT receiver?—P. J. Rennhack, 49 Chicago Ave., Oak Park, Ill.

(1)—So that you may receive lower wavelength stations than possible when all the turns of the loop are being utilized, this being a concession to a too large capacity condenser. Also the tap may be used for feedback. If you own a Pressley Super-Heterodyne, the middle tap may be connected to the compensating condenser. (2)—Disconnect the beginning and the end of the secondary windings of the first RFT from the grid and filament of the first socket terminals respectively. Connect these terminals to a pair of binding posts. Connect the grid and filament terminals to a pair of binding posts, also. Don't disconnect the variable condenser, though. Now, across the latter pair of binding posts connect the terminals of the loop. It will be noted that the variable condenser is shunted across this loop. Now, if you wish to use the antenna and the ground, place a piece of bus bar across the binding post terminals, so that the end of the secondary winding is connected to the grid post on the socket, while the beginning of the winding goes to the F minus terminals. The loop terminals should, of course, be disconnected.

HOW MANY turns should be placed on a tubing 2¾" in diameter, 3" long, using No. 26 single silk covered wire, to constitute the primary and secondary, so that when the secondary is shunted by a

.00025 mfd. variable condenser, from 80 to 100 meters will be covered?—T. Yuidrock, 421 4th Ave., Dayton, Ky.

The primary should consist of 6 turns. The secondary should consist of 27 turns. This coil will tune from 30 to 95 meters. It is not possible to have a coil, shunted by a .00025 mfd. variable condenser that will only cover a 20 meter band, unless several of the plates of the condenser are shorted, so as to reduce the capacity, etc. Heavy wire should be employed at these high frequencies, as the higher the frequency, the more the conducting space required. No. 16 bare copper wire is better suited than No. 26 SSC. Using this wire, only 20 turns are required.

RECENTLY I put up a new antenna, the length, type of wire and placing of wire being exactly the same as that of the old one. However, I find that with this antenna, the high wavelength stations come in at a higher point. The set has become very sharp and critical also. Nothing was changed in the set, in the battery leads, in the ground lead or in the lead-in of the antenna. The batteries are all fully charged. The tubes are O.K. What could be the trouble and how could it be remedied?—Francis Johns, San Francisco, Cal.

The high wavelength stations come in at a higher setting due to the lower inductance value of the wire, even though it is the same type as used in the old antenna. The tuning was broader on the old antenna, due to the added resistance caused by the dust which had accumulated thereon and ionization which caused high resistance coating. Add a few turns to the aerial primary or shunt the primary with a small fixed condenser, say .0001.

HOW many turns of No. 22 DCC wire should I put on a 3½" form to tune a secondary with a .0005 mfd. condenser?—J. W. Work, Atlanta, Ga.

Use 47 turns.

I HAVE built a B battery eliminator. It uses audio frequency transformers, choke coils and, for stepping down the voltage from the AC lines to the filament, a bell-ringing transformer. It is a double wave rectifying circuit. Two -01A type tubes are employed. Now the results are very good, but the current and the voltage passed are very low. This, of course, causes the signal strength to be very weak on a 5-tube receiver. Could the Magnatron Rex tubes be used as rectifiers with better results?—James Carlson, Jersey City, N. J.

No. To obtain complete success from these Rex tubes it is necessary to place at least 220 volts on the plates. The plates of the -01A type tubes will stand only 110 volts. This is the reason for the low voltage obtained on the output, as

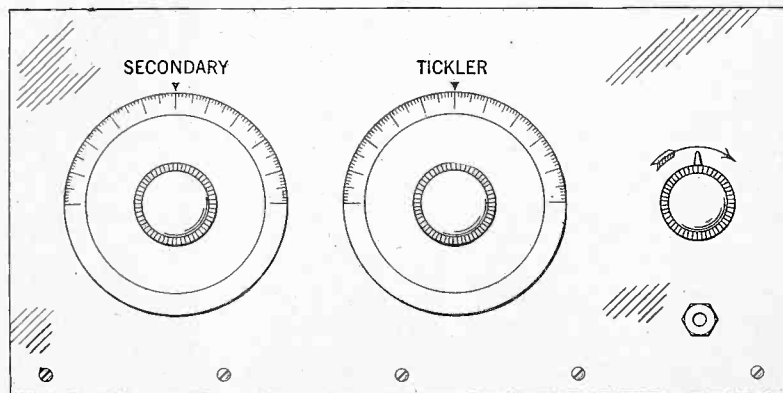

FIG. 320

The panel layout desired by Rodney St. Clair.

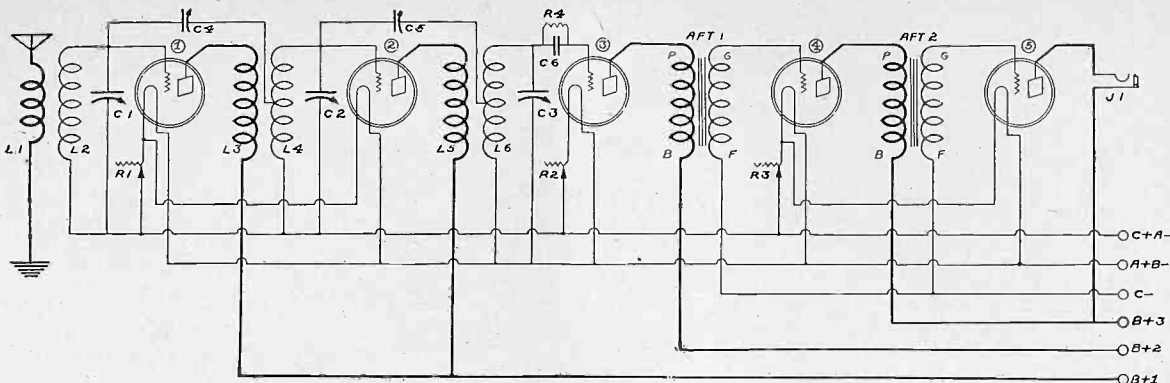

FIG. 321
The electrical diagram of the standard 5-tube Neutrodyne.

well as the low amount of milliamperes. Should you apply 220 volts to the plates of the -01A type tubes, they will become paralyzed and pass only a quarter of the total current and voltage, known as the wattage.

I AM going to rewire my standard neutrodyne receiver, as per diagram, but before doing so I would like to know if it will tune sharply and be easy to neutralize. These were the difficulties encountered in the old receiver that I had. The following changes are to be made in the set as per diagram: Instead of bringing the end of the primary winding, L1, to the A minus post and to the beginning of the secondary winding, L2, which went to the ground, I will break the lead, leaving the A minus run only to the secondary winding; instead of bringing the plate of the detector tube to one terminal of a .002 mfd. fixed condenser and the other terminal to the A plus post, I will leave the condenser out; instead of bringing the grid return of the detector tube to the minus A (-01A type used), I will bring it to the positive A; instead of shunting the A minus, B minus and B plus 90 posts with a .006 mfd. fixed condenser, I will take it out. The constants of the coils, condensers, etc., are the same as used in the old set, thus: L1, L3 and L5, the primaries, consist of 8 turns. L2, L4 and L6, the secondaries, consist of 55 turns. These are wound on tubings 2 7/8" in diameter. No. 22 double cotton covered wire is used. The primary winding is wound opposite to that of the secondary winding. There is a 1/8" separation between the windings. L4 and L6 are tapped at the 15th turn, from the filament end. The secondaries of these coils are shunted by .0005 mfd. variable condensers. The coils are mounted at a 58° angle. R1 and R3 is a 6 ohm rheostat. R2 is a 10 ohm rheostat. R4 is a 2 megohm grid leak. C6 is a .00025 mfd. condenser. Both the audio frequency transformers are of the low ratio type. A 4.5 volt C battery is used. The plates of the RF tubes receive 45 to 67 1/2 volts B+1 point. The plate of the detector tube receives 45 volts, B+2 point. The plates of the AF amplifier tubes receive 90 volts, B+3 point. The coils are 6" apart, center to center. Midget condensers C4 and C5 are going to be used for neutralizing. Are the diagram and the specifications O.K.? —Dr. Albert R. Curtis, 528 First Wisconsin National Bank Building, Milwaukee, Wis.

Fig. 321 shows the revised diagram. The wiring as well as the specification are O. K. Instead of placing the coils at a 58° angle, however, they should be placed at about a 53.7° angle, to be determined by experiment. This set will be very sharp and easy to neutralize.

Keep Up Plate Voltage When Using High Mus

The fact that high mu tubes are used on a resistance coupled audio amplifier does not signify that a lower plate voltage can be used and the output signal be equivalent to that obtained with standard tubes and a higher plate potential. This is demonstrated by a comparison of output values with a resistance coupled amplifier utilizing high mu tubes and regular tubes with the standard mu value of 8.5. The tests were carried out with two values of plate potential and the determinations are given herewith:

High mu tubes, 150 volts on plate; output 400.

Regular tubes, 150 volts on plate; output 300.

High mu tubes, 100 volts on plate; output 240.

Regular tubes, 100 volts on plate; output 180.

The output with high mu tubes is greater than that obtainable with regular tubes when the plate voltage is the same in both cases. A reduction of the plate voltage applied to both types of tubes results in lowering the comparative output of the high mu tubes. At 150 volts, a 1/3 gain; at 100 volts, a 1/4 gain. The proportional gain with the high mu tubes is greater as the applied plate voltage is increased.

Loop Plug Increases Capacity of Circuit

Although a loop jack and plug form a very convenient mechanical switching arrangement, where it is desired to use either the loop or outdoor antenna, they form an electrical imperfection. In the

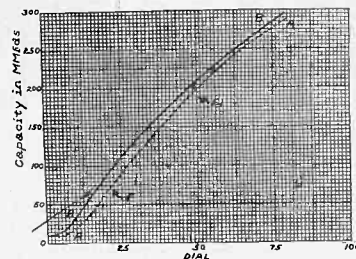

THE CURVE showing capacity effect of loop jack.

graph, it will be seen that when the plug of the loop is placed into the jack, when a station is tuned in at 50 (F1), the capacity is about 200 mmfds., while with antenna connected, the capacity is 206 mmfds., or an increase of 6 mmfds. This shows that the loop plug causes extra capacity. It is also true the resistance goes up.

Join RADIO WORLD'S University Club

And Get Free Question and Answer Service for the Coming 52 Weeks.
This Service for Yearly Subscribers ONLY

Have your name entered on our subscription and University lists by special number. Put this number on the outside of the forwarding envelope (not the enclosed return envelope) and also put at the head of your queries. If already a subscriber, send \$6 for renewal from close of present subscription and your name will be entered in Radio University.

[In sending in your queries to the University Department please paragraph them so that the reply can be written under or alongside of each query. Write on one side of sheet only.]

RADIO WORLD, 145 West 45th Street, New York City.

Enclosed find \$6.00 for RADIO WORLD for one year (52 Nos.) and also enter my name on the list of members of RADIO WORLD'S University Club, which gives me free information in your Radio University Department for 52 ensuing weeks, and send me my number indicating membership.

Name

Street

City and State

Hoover's Talk of "Chaos" Ridiculed by McDonald

The decision of the Federal Court in Chicago upholding the Zenith Radio Corporation (WJAZ, Mt. Prospect, Ill.) in the suit brought against it by the Federal Government for "air piracy," evoked a statement from Secretary Hoover that chaos would result from the court decision. He said the decision, conflicting with another one in another case and district, stripped the Department of Commerce of authority over regulation of stations, wavelengths and time on the air.

Commander E. F. McDonald, of the Zenith Corporation, bitterly attacked Secretary Hoover for sensationalism and misstatement. The Commander emphasized that the Zenith station took a wavelength not assigned to it because, as a manufacturer's experimental and communication station, and so licensed, it had a legal right to do so. Only 5 per cent. of the broadcasting stations have such a license, he said, hence the talk about chaos roused his ire. His own counsel advises prospective broadcasters they cannot usurp a wavelength.

Hoover's Statement in Full

Secretary Hoover's statement follows: "I have now (upon my return to Washington) had an opportunity to discuss the situation created in radio by the decision of Judge Wilkerson in the Zenith radio case.

"The court has refused to impose a penalty upon a concern which admittedly was operating at a time and upon a wavelength not authorized under its license. While the holding is in conflict with an earlier ruling in the District of Columbia, it is apparent that under the present law of 1912, as now construed, no one has authority to protect the listening public against utter chaos in the service upon which it has come to rely. The Chicago decision denies the authority of the Secretary of Commerce to assign either wavelengths or time of operation. It does not affect broadcasting alone, but is equally applicable to the amateurs and any of these services are open to incursion by the others, and any station may be attacked by its neighbor. If stations proceed to select their own wavelengths and choose their own time, considering only their own selfish advantage, effective public service will be at an end.

"Congress has full power to confer the needed authority. The White bill, now before the Senate, which has passed the House, gives the power. There have been suggestions that this authority should be administered entirely outside of the Department of Commerce by a special commission set up for the purpose.

The Three Functions

"There are three separate functions which must be performed by some government agency. The first is the determination of who may broadcast. This is a discretionary or semi-judicial authority. I have continually advocated that the use of wavelengths is the use of public property, and that the determination of who should have use should not be in the hands of any one person, but should be placed in the hands of Commission, representative of the different sections of the United States, wholly independent of the Department. Such a Commission, to be appointed by the President with the approval of the Senate, is provided for in the White bill. This board will not need to be in continuous session and will imply but little expense.

"The second important function lies in the administration of the decisions of

Sir Thomas As Critic



(Wide World)

SIR THOMAS LIPTON, internationally known sportsman, watching **Ann Pennington**, noted dancer, do her stuff at WOR, from where both broadcast.

this commission and the minimizing of interference from many causes outside wave conflict.

"The third is the furthering of development of the art in the interest of the listeners and of the industry. These last two functions are essentially administrative, and in my view should rest in one of the executive departments rather than by creating a new and additional government agency, which would imply considerable additional expense. Moreover, boards and commissions, by their divided authority have always been a failure in administration; they are desirable for discretionary or judicial determinations. The tendency to create in the government independent agencies whose administrative functions are outside the control of the President, is I believe, thoroughly bad. I believe the staff of the Department has performed a great service in development of the radio art and developing the method of control and regulation in a new field. So far as the Department of Commerce is concerned the extraordinary difficulties and conflicts in the situation are such that we will be well satisfied to see radio administered by any other department which can properly undertake its regulation."

McDonald's Statement

Commander McDonald's statement follows in full:

"I have read the most recent statement by the Department of Commerce in which the decision of the court in the Zenith Radio Corporation test case is commented upon. I am very much surprised at this, as I have been at many at the previous statements issued by the Department. The acting Secretary of Commerce is quoted as saying that the decision finding Zenith Radio Corporation not guilty of so-called 'air piracy' completely deprives the Federal Government of control over radio and that the question now presented to Congress is whether or not Federal control of radio shall continue.

"Apparently the Department's analysis

License of WJAZ Now Imperilled

WASHINGTON.

Federal government officials are considering the advisability of revoking the license under which WJAZ operates. Not being able to appeal the Zenith decision, because it was a criminal action, Federal counsel assert the matter can be kept legally alive only by revocation. The license is of a special nature, not like the one possessed by most broadcasting stations.

of the court's decision is not more accurate than was their analysis of the radio communication act of 1912. The Department's misinterpretation of the present statute before the decision of the court might possibly be excused on the ground that they were merely mistaken in their opinion, but since the decision of the court in which the statute is very clearly interpreted there would seem to be no excuse whatever for any representative of the Department being in doubt as to the present status of radio regulation.

Denies Stripping Authority

"The decision in question has not deprived the Federal Government of the right to regulate radio. It is still unlawful for any person to operate a radio station without a license, and the decision of the court so holds, and except in the case of stations engaged in bona fide commercial communication or experimentation in connection with the development and manufacture of radio apparatus for commercial purposes, the Secretary of Commerce has full and complete power to refuse to license any station to operate on a wavelength above 200 meters. The Secretary of Commerce under the present law may, if he sees fit, by special authority authorize any station regardless of the nature of its business, to operate on a wavelength in excess of 200 meters, and if the station is guilty of violating any of the conditions contained in any such special license, the Secretary has full and complete power to meet the situation by revoking the license. Since over 95% of the broadcasting stations in the United States are enjoying these special permits by special authority, if there is any general disregard of the regulations of the Department of Commerce with resulting chaos it will be due to the fact that the Secretary of Commerce has failed to enforce the regulations by exercising the power which he unquestionably has under the present law.

What Counsel Advises

"Since the decision in the Zenith test case our general counsel, Irving Herriott, who prepared and presented our case in Federal Court, has received numerous telegrams from both present and prospective broadcasters asking his opinion whether or not it would be advisable for them to select wavelength and time and begin broadcasting and hope to enjoy immunity. His advice in each case that has been presented to him up to the present time has been that no person may operate a broadcasting station in the United States without a license issued to him by the Secretary of Commerce, and that no person with a license may operate on a wavelength in excess of 200 meters without special authority from the Secretary of Commerce, unless such person is included in one of the two limited

(Concluded on page 13)

Hoover Can't Fool Congress, Says Britten

Representative Fred A. Britten, of Chicago, taking the Hoover "chaos" statement as his text, advocated that control of radio be taken from the secretary and be placed in the hands of a commission.

Britten said:

"Secretary Hoover's statement that the adverse decision in the Government's case against the Zenith Radio Corporation in Chicago for so-called 'air piracy,' will create chaos on the air and will result in the scrapping of \$600,000,000 worth of radio apparatus, is incorrect and ridiculous. I do not believe that Congress will become unduly excited, nor that the U. S. Senate will hastily pass legislation which will perpetuate Hoover as the czar of the air, notwithstanding his repeated assertions that chaos, destruction, waste, and uncertainty, are about to prevail because of his failure in the Federal courts to be adjudged sole proprietor of everything between the earth and the high heavens. I believe it has been clearly demonstrated that regulation of radio by one individual (Hoover) is not only undesirable, but un-American in principle, and the quicker Congress enacts legislation providing for a distinct and separate commission for the regulation of radio in all its ramifications, the better it will be for the industry and the millions of listeners.

"It will be an easy matter for Congress to provide an inexpensive commission of not less than three men to perform the same functions for radio control as are exercised by the Interstate Commerce Commission over the railroads of the country.

"Any future radio legislation which will vest in an individual the power to regulate the spoken word (radio) would be just as unwise and as dangerous as legislation which would seek to place in the hands of any one individual similar control over the printed word (the newspaper).

"The Secretary of Commerce has seen fit to license certain corporations to use the air 24 hours a day for seven days a week, and this I believe to be the most serious aspect of the entire radio situation from the public's standpoint, and this unfair division of time was the cause of Mr. Hoover's recent disastrous experience in court.

"The creation of an independent com-

(Concluded from page 12)

mission would be received with joy by the public and the radio industry. I cannot understand Mr. Hoover's objection to this."

classes described in Section 15 of the present radio law.
 "It would be more to the public's interest if the attorneys for the Department of Commerce would so correctly advise the public and Congress, than to make the statements regarding the power of the Secretary of Commerce under the present law, which they have recently made through the press. The continued cry of chaos coming from the Department of Commerce is intended as a means of forcing Congress to rush through ill-advised and inadequate legislation which will perpetuate the Secretary of Commerce as the dictator of the air.

Is Suspicious of Hoover

"There is no need for any emergency legislation, but we would enact in a proper and orderly manner adequate legislation which will provide for the creation of an independent radio commission vested with full and complete power to regulate radio in all its ramifications.

Modern Barge Office

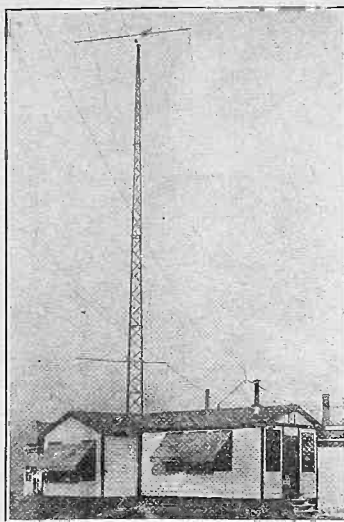

HERE WE have the radio station at Memphis, Tenn. Messages relating to barge traffic on the lower Mississippi are received and sent. This station is kept busy receiving reports from the barges in the 1,154-mile stretch which lies between New Orleans and St. Louis. Regular night and day shifts are kept by the operators on these barges. (Fotograms).

mission would be received with joy by the public and the radio industry. I cannot understand Mr. Hoover's objection to this."

Army Names Board To Reduce Interference

WASHINGTON.

Secretary of War Davis has announced the appointment of a Board of Officers, to meet here not later than April 25, to consider the development of suitable and non-interfering type of radio apparatus for Army air and ground stations, and the question of coordinating Army radio activities with those of other interested departments of the Government.

The work is being done, it is pointed out, for the benefit of the listening-in public, as the question of interference does not present a problem in radio communications in time of war.

"The Secretary of Commerce when questioned as to whether or not he was in favor of a radio commission has said that he was in favor of a commission as provided in the White Bill, which is now pending. The commission provided in the White Bill, however, falls far short of being an independent commission. It is subject to the domination and control of the Secretary of Commerce, and is only called into session and action intermittently at no set time. Any such commission will be the mere mouthpiece of the Secretary of Commerce.

"There never has been, nor is there now, any question in the minds of thinking people as to whether or not Federal control of radio shall continue. It is merely a question of what department or Commission of the Government that control should be vested in.

"When asked recently whether or not he favored an independent commission. Mr. Hoover's Solicitor General replied that the Department did not favor such a commission. My question is, why?"

Dill Turns Against Hoover with Bill Favoring a Board

WASHINGTON.

Introducing the fourth principal bill for radio control this session, and the second of which he is the author, Senator Dill, of the State of Washington, advocates the control of radio by a commission rather than by Secretary Hoover. Mr. Dill's first bill was substantially the same as his second, excepting that he then provided for Hoover control with the aid of an advisory commission. In the meantime, Senator Borah, an Independent Republican, has introduced a bill endorsing a commission and now Senator Dill, a Democrat, follows suit.

Thus the Senate Interstate Commerce Committee, of which Senator James E. Watson is chairman, to which all the bills are referred, has the proposition put up to it more forcibly than ever of taking the first step toward indicating whether Hoover or a Commission shall hereafter direct the fortunes of radio. The decision of the Chicago federal judge in the Zenith-McDonald so called "air piracy" case has forced Mr. Hoover's hand and may prove a factor in an earlier consideration of the legislation.

Dill Explains the Bill

Discussing his latest measure, Senator Dill said:

"The bill is intended to be an amendment to the White Bill which passed the House, by removing the Department of Commerce from any control over radio and giving the entire control to a commission of three members at salaries of \$10,000 per year, to be appointed by the President for a period of five years. In a general way it follows the terms of the White bill, except that there are certain additional provisions I think desirable in whatever legislation is enacted to meet the present situation resulting from the decision of the Zenith radio case in Chicago.

"The general purposes of the Commission as stated by the bill are to prohibit and prevent the monopolizing of the use of the ether within the limits of the United States."

The Leading Provisions

The most important additional provisions are as follows:

The control of chain broadcasting; limitation on the number of stations in any community that any person or corporation may own; and a penal provision against slander by radio.

Also limitation of the selling price of station apparatus, together with the license to the actual value of apparatus sold. In no case shall the selling price exceed the original cost of the apparatus; requirement that applicants for license shall set out all contracts and agreements with any person or firm engaged in broadcasting or radio business; and empowers the Commission to refuse or revoke licenses in cases of monopoly or attempted monopoly.

Authorizes Government stations to send commercial messages where there are no other radio stations available; gives right of aggrieved party to appeal to the district court where the aggrieved party resides, as well as in the District of Columbia.

400 kc. Wave In Water Used In Treating Sick

BALTIMORE.

A method of stimulating circulation without danger of any ill effects has been achieved in experiments conducted by Dr. R. W. Wood, Professor of Experimental Physics, Johns Hopkins University. The experiments were conducted at the country home of Alfred L. Loomis, New York banker, at Tuxedo, N. Y. Mr. Loomis aided Dr. Wood.

The method was originated during the war by Prof. Langevin of Paris for projecting a narrow beam of waves under water for the detection of submarines by reflected sound. The instrument resembles a radio set but is more powerful.

Four hundred thousand vibrations a second at 60,000 volts are applied to a quartz plate, which is thrown into a powerful vibration, emitting its own waves of the same frequency as the electrical vibration.

Increased Circulation

The possibility of applying the discovery to medicine is described as being found in the fact that circulation is greatly stimulated in any part of the body which is thrust into water in which the waves have been introduced. The stimulation is said to be powerful enough to go to the bone without injuring any part of the body immersed.

Dr. Wood said that while the experiments had not gone far enough for him to claim that cures might be accomplished, it had been found that circulation could be tremendously stimulated and that any method for stimulating circulation without injury was valuable to medicine.

Aids in Arthritis

The special use in medicine to which the discovery may be put, it is said, is in treatment of arthritis. That disease has been baffling physicians for years.

It is maintained by some physicians that it is caused by organisms which leave chalky deposits in the joints. The sound waves might be used to stimulate circulation to carry off these deposits. Mineral water baths now are used by physicians in the treatment of the disease.

Dr. Wood was asked about this application of the discovery. While he admitted that it might be found useful he was unwilling to make any definite claims until the work has progressed farther. Fur-

Clothes Line Aerial

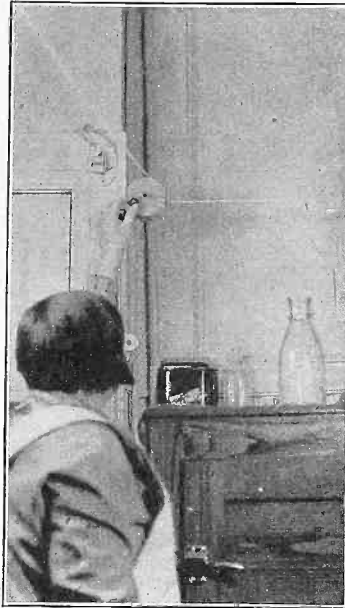

WHERE a pulley type indoor clothes line is used, the line may be of wire, so that in emergency this may be used as an indoor aerial. (Hayden).

thermore, it is said the possibilities for the science of biology and physiology are considerable. The late Dr. Jacques Loeb of New York altered the shapes of low forms of animal life by changing their environment. This discovery by Dr. Wood and Mr. Loomis may be used along similar lines.

Experiments are to be made on fish eggs and other organisms to learn what effect on their development is produced by subjecting them to the sound waves.

Germany Adopts Federal Control Of All Broadcasts

BERLIN.

In the future the programs of all German broadcasting stations will be under the joint control of the National Ministry of the Interior and the government of the district in which the station is located. A program control commission composed of two members, one representing the Federal government and the other representing the Government of the State or district in which the broadcasting station is located, will be assigned to each station to control the dispatching of news service, lectures and political matters.

A consolidation of radio interests, under the name of the National Broadcasting Association, has been effected in the meeting with the participation of all German States except Bavaria. The Federal Postal and Telegraph Departments appointed six members from its department as officers of the association, while five additional officers were elected by the Reichs-Rundfunk-Gesellschaft. The functions of the officers elected are said in Germany to be more of an advisory nature since all administrative matters are decided by the representatives of the Postal Department.

Under the regulations of the Union Internationale de Radiophonie, located at Geneva, Switzerland, Germany operates 20 sending stations. Germany has today 18 stations, the largest of which is the central broadcasting station at Koenigs-Wusterhausen, close to Berlin, with a 1,300 meter wave length. It is reported in Germany that two new stations are to be erected during the current year. The number of registered receivers in Germany totaled 1,108,845 on February 1, according to figures made public in Germany.

U. S. Is Getting Ready for World Radio Parley

WASHINGTON.

A special subcommittee of the State Department's Inter-departmental Committee on Electrical Communications is now preparing the proposals to be submitted by the United States for the international radio conference to be held in Washington.

The subcommittee consists of representatives of the State, War, Navy, Commerce and Treasury Departments and U. S. Shipping Board. It has before it the work of previous international conferences and national committees. In order to facilitate handling the proposals, the subcommittee will follow the methods suggested by the International Office at Berne. It is anticipated, however, that the specific content of the United States proposals will follow the trend of more recent American work and that they will resemble those put forward by the American delegates at Mexico City in 1924, rather than the earlier drafts.

STATION PLANNED IN STAMBOUL WASHINGTON.

A French company is negotiating for a plot of land at Yeni-Baghtche, below Stamboul, Turkey, on which to erect a broadcasting station, according to a cable to the Department of Commerce from Trade Commissioner Julian Gillespie, Constantinople.

15-Hour Day Marks Radio Inspector's Work

A Government radio supervisor in a Pacific Coast territory gives the following report of a typical day's work:

"I left my hotel at 9:30 a. m. in company with a radio club secretary, located trouble caused by a high frequency machine being operated by a local doctor. The doctor was instructed how interference could be eliminated by shielding and grounding his apparatus, an readily agreed not to use his equipment until the recommendations had been accomplished. At 2 p. m. inspected radio broadcast station.

"At 3:30 p. m. visited main power plant of the street railway system; found 20-year-old equipment badly worn and causing a great deal of interference. Arrangements were made to disconnect DC generator after midnight. After broadcasting started at 7 p. m. called on many authors

of complaints. Noticed steady commutator hum carried over entire city by the street car system.

"Because of hard rain was able to locate a number of trees causing swinging tree ground. Called on wire chief of the telephone exchange to investigate trouble caused by a 'busy-back signal.' Wire chief made requisition for a filter system when told that lack of it was causing radio interference.

"At 12:19 a. m. the generator of the street car feeder system was disconnected and very excellent reception was experienced in all sections of the city. Expected that car officials will repair commutator and system within near future."

Finishing his report for the day, the radio supervisor remarked that he did not return to the hotel until 1:35 a. m.

\$25,000 From WEAF, Goal Of Composers

WASHINGTON

The vaulting ambition of the American Society of Authors, Composers and Publishers, in the realm of fees for broadcast music of which it has copyright control, was described by E. C. Mills, of the Society's administrative committee. While during the first year WEAJ was charged \$500, the Society's proposal for next year is \$25,000. The rate went up to \$2,500 for the second year.

Alternative proposals made to WEAJ included one concession that it pay at the rate of \$2,500 so long as it broadcast its own material, but if paid advertising is included, the fee would be \$1,000 for each 52 hours for every advertiser on WEAJ and the same rate, proportionate to power, for every advertiser on allied stations. The alternative proposition was that WEAJ pay the composers \$25,000 a year, entitling it and its allied stations to use any copyrighted musical compositions it may desire.

Testifying before the Congressional Committee Mr. Mills ejaculated:

"You are going to monkey with us until you put us into the American Federation of Labor."

He said the annual income to the composers from the movies was \$300,000 a year and from radio, in the best year, \$113,000.

Shuberts Chime In

One theatrical producer believes that should the author and composer be given the right to make an arrangement for the radio broadcasting for profit of a work used in his musical comedy, that right should be conditioned upon the author or composer first obtaining the consent of the producer, according to Otto A. Schlobohm, Washington attorney for the Shubert theatrical interests.

Mr. Schlobohm said the producers of musical comedy were unalterably opposed to the broadcasting of any music or any play produced by them, as it "hurt box office receipts."

Sousa's \$29,000

Characterizing composing as the finest profession in the world, because it never brings sorrow, John Philip Sousa, vice-president of the Society, said his publishing royalties had dropped from \$60,000 to \$29,000 a year since the advent of the phonograph and the radio and that he was required to sell seven and one-half times as many phonograph records to get the same amount as he would get from sheet music. He characterizes the people today as rather a listening than a buying public.

"However, we want to be fair," Mr. Sousa added, "whether we are dealing with the talking machine people or the radio people. I think when we furnish the brains we should receive an adequate reward."

Talk of Police Work

Declaring that the Society came into existence "as a policeman to catch the thieves and has been catching them," Mills remarked that although the phonograph people had made a revolutionary improvement in sound reproduction and record making, their efforts would be futile to stem the tide of the radio popularity, which in the end would overwhelm them.

Adding Machine Counts Electrons

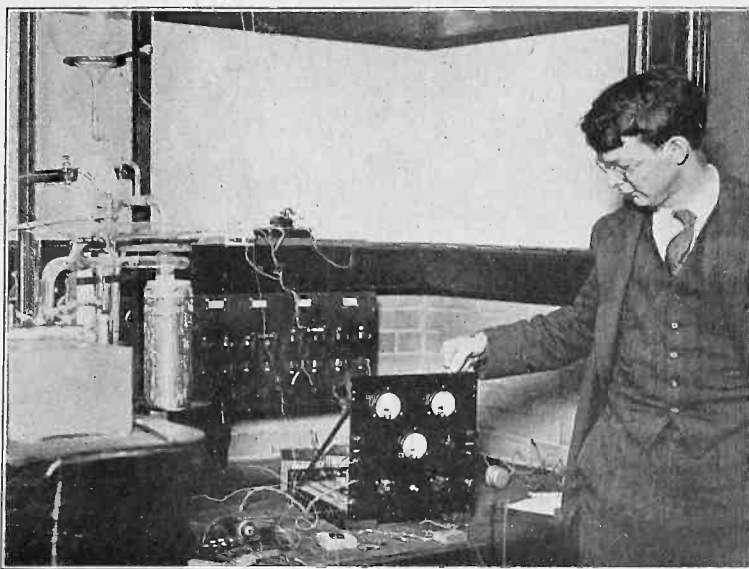

(Harris & Ewing)

L. F. CURTISS, of the Bureau of Standards, with new apparatus designed for counting tiny particles of matter, by means of a radio receiver. This method is automatic, from the time the tiny electron races across a wire, until it is counted by an adding machine.

Police System Maintained By Music Society

The American Society of Composers, Authors and Publishers operates an organized "police department" to discover stations that broadcast copyright music without "coming across" to the society. In 36 cities the society has representatives doing this important work. There are 54 stations not licensed by the society.

The society has 500 members in the metropolitan district—New York City and environs—there is no special police force, the resident membership being relied on. Every infringement brings from 10 to 50 reports from members who were casually listening in.

Report of violation is promptly followed by a visit by the society's agent and talk of money and compromise. Here is an excerpt from the society's notice:

"Notice is hereby given to all persons,

firms or corporations operating hotels, restaurants, cabarets, dance halls, theatres, radio broadcasting stations and all classes of establishments in which music is publicly performed for profit, that the copyrights of musical compositions belonging to the members of the American Society of Composers, Authors and Publishers may not lawfully be performed publicly for purposes of profit without license issued by us, and that any such performance without license constitutes a violation of the copyright law of 1909 and subjects the infringer to a penalty of not less than \$250 and not more than \$5,000 for each infringement.

"Please take further notice that no agent, employe or representative of any member of the society is vested with authority or power under any circumstances to grant to any firm or individual the right to publicly perform for profit the musical compositions owned by our members, and that the possession of a printed copy or orchestration of any such composition does not imply or convey to the holder thereof any right to public performance thereof for profit, irrespective of whether such printed copy is received as a gift, obtained by purchase, or otherwise."

Radio Introduces Farmer To People, Says Jardine

The importance of a sympathetic understanding of the problems of the farmer was brought out by William M. Jardine, secretary of the United States Department of Agriculture in a short address prepared for delivery from WGY on the occasion of broadcasting a special program on 35 meters wavelength for the annual Agricultural Show of the Union of South Africa. Mr. Jardine said:

"Radio, the newest of inventions, is proving of great and increasing usefulness to agriculture, the oldest of the occupations of civilized man. Not only is it

supplying accurate information in time for the farmer to use it, but it is giving the rest of the population an understanding of the problems and needs of farming. Everywhere farming and the farmer need clear-headed sympathetic understanding on the part of the population as a whole. Nowhere in the world can we have a permanently prosperous civilization if agriculture is unsuccessful and rural life unsatisfactory.

"In our complex modern life, all groups in the population must in the last analysis stand or fall together. Cooperation, not conflict, is essential to steady progress."

Radio Doing Bit For Veterans

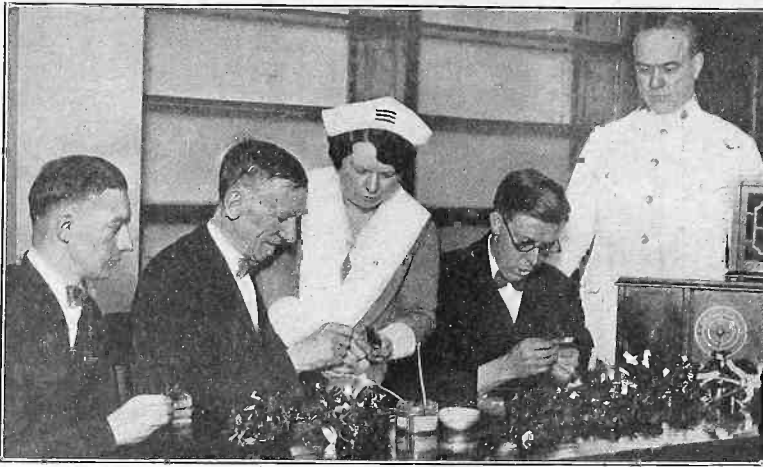

Harold Stein

RADIO, in the U. S. Base Hospital No. 81 at Kingsbridge Road, Bronx, N. Y. City, supplies music, talks, etc., to the entire ward of disabled veterans, who make artificial poppies and other articles.

Television Next Year, Is Inventor's Promise

Baird, Scottish Inventor of Receiver of Broadcast Motion Pictures, Says Set Will Cost Less Than \$200 — Explains How His System Works — Series of Images, 10 or More Per Second, Modulated On a Carrier Wave at Station — Receiver Eliminates Carrier, So That One Sees Motion Pictures.

GLASGOW

ONLY 36 years old, John L. Baird, of Scotland, has invented what he calls a televisor, which makes possible the visualization of motion, so that scenes are reproduced on somewhat the same plan as programs now are broadcast. While **RADIO WORLD** previously recorded the fact of the invention, Mr. Baird's discussion of it is now made public, wherein interesting new details are revealed. It is expected the invention will be ready for general use in England early next year.

The system enables practically simultaneous visualization of motion broadcast from a studio, a receiver in the home accomplishing the final conversion equivalent to rectification. The light rays, representing photography at the studio, are impressed on a radio carrier wave, and the carrier is eliminated at the receiving end.

The British Broadcasting Co. now has control of radio in Great Britain, but its contract with the general post office expires at the end of this year, when it is expected a special government commission, as recommended in a recent Parliamentary committee report, will assume charge. This has held up the introduction of the Baird system, but negotiations with the

government are under way, and Mr. Baird predicts receivers designed by him for moving picture reception will be on the market for less than £40. These receivers will be compact.

Baird's Statement

After giving a demonstration of his system, Baird, son of a Helensburgh Presbyterian minister, said:

"My televisor is nothing like telephotography. The transmission of photographs or still pictures onto a plate is no longer a novelty. What my televisor does is to transmit to the human eye living and moving pictures at the instant of their occurrence.

"The problem which I have had to solve is not only that of converting light into electric waves at the transmitting end and reconverting waves into light at the receiving end, but also of synchronizing the converting and reconverting processes and of speeding them up so as to give the eye the impression that it is seeing a whole picture instead of a succession of parts. Once the synchronizing and speeding up problems have been solved, we can transmit moving pictures to any distance that wires or wireless will carry. We can focus the lens of our transmitter just as you focus a kodak, so that we can send a close-up of a face or a distant view of a battle in progress. It is all a matter of speed and synchronization in transmitting.

Speed the Only Problem

"There is only one thing which makes the problem of television an extremely difficult one. That is the speed of signaling which is necessary if you are going to see an event at the actual moment at which it is occurring. The transmitting and receiving mechanisms must not only be so sensitive as to respond to extremely small quantities of light, but they must respond practically instantaneously. This is the great obstacle in all attempts to develop practical television.

"My invention is not yet perfect, but it is much better than a couple of months ago. Its perfection is now only a matter of time and money, and, for the first time

Professor Uses A



(Underwood & Underwood)

MEASURING SOCIABILITY is the receiver is placed close to the subject terminated. He or she is then placed lean back in an easy chair, look at he can hear is again determined. times are the most sociable, the pr the machine

since I began work on it in 1912, I have all the money at my disposal which I need.

"Aside from the speed and synchronization and signaling, the problem of television is simple. The general theory of it is to project a picture onto a light-sensitive cell in a piecemeal fashion. Each of the small areas into which the picture is divided causes the light-sensitive cell to send out an electric current which is proportional to the amount of light in its area. Thus the dim parts of the picture send out a weak current and the bright parts send out a stronger current. At the receiving station these currents control a source of light which is projected onto a screen in exact synchronism with the projection of the picture at the transmitting station, and the process is performed so rapidly that, due to the eye's retention of images, the whole picture appears simultaneously.

"The light-sensitive cell is nothing very novel among inventors. I use only one cell at the transmitting end, and I break up my picture into areas by means of the lenses in a whirling disk. The lenses in the disk focus the areas of the picture, one by one, onto the cell, and when the disk has been whirled once around every area of the picture has been focused consecutively onto the cell.

"The cell is connected by vacuum tubes and electric gear to the transmitting apparatus and the wave, when we are transmitting, is continually modulated so as to convey the strength of the light from successive areas of the picture. At the re-

Ability Test to Determine Subject's Socialblity



test undertaking at the Northwestern University by Prof. J. B. Morgan. A telephone ear. Then, with an audiometer the faintest sound that the subject can hear is de- a dark room, where only a weakly illuminated crystal ball is visible and is told to ball and lose himself in day dreams. During the reverie, the faintest sound that e hear as well, when day dreaming, as when alert. Those who hear well at both or says. At right is Miss Madessa Wolfe undergoing the test. In the lower left own. At top Prof. Morgan is seen operating the machine.

ceiving end we have a source of light whose strength is controlled by the transmitted wave. We bring this light to a spot and move it so as to follow exactly the beam which comes through the whirling disk onto the cell at the transmitting end.

"We then have the picture traced out in light and shade at the receiving end with sufficient quickness so that the whole of it is complete before the eye has had time to lose any of it. To the eye, therefore, the whole picture appears to be projected simultaneously, although, in reality, it is projected piecemeal in successive areas.

"When we transmit a still picture the disk is whirled only once, but when we transmit the picture of a moving object the disk is kept whirling and the successive pictures are traced out at the receiving end. All of this is comparatively simple, except the matter of speed and synchronization. Take the case of transmitting a still picture.

"If the picture is to appear as a whole at the receiving end, its last area must be transmitted before its first area has faded from the eye, and this in actual practice means that all of it, every area of it, must be completed in less than a tenth of a second. Unless we can complete the picture in this almost instantaneous time, television by my method or, as far as I know, by any known method, is of no use, for the eye will have lost the first areas by the time the last areas are coming through.

"It is simple enough merely to transmit

the areas, but you must remember that we have to transmit them ultimately to the human eye.

"For instance, let us say that we take as much as half a second to send a picture of my face. By the time the light-sensitive cell is transmitting the light values

Atwater-Kent Concerts to Continue All Summer

A. Atwater Kent, of Philadelphia, who has provided a season's series of Sunday evening radio concerts by illustrious musical artists, announced that he has signed an agreement with the management of the Metropolitan Opera Company, of New York, under which, next season, he will present an even greater number of the famous artists of the world through his Sunday evening radio concerts.

He will put on a series of half-hour Sunday evening radio concerts, beginning May 9, and continuing during the summer, to be broadcast through eight separate stations.

While Mr. Kent has presented some of the most noted artists of the world he has been prevented from broadcasting others because of rigid contracts the Metropolitan Opera Company had with them for their exclusive services. The completion of the new arrangement, then not yet announced, was signalized by the ap-

A Simple Tip Jack

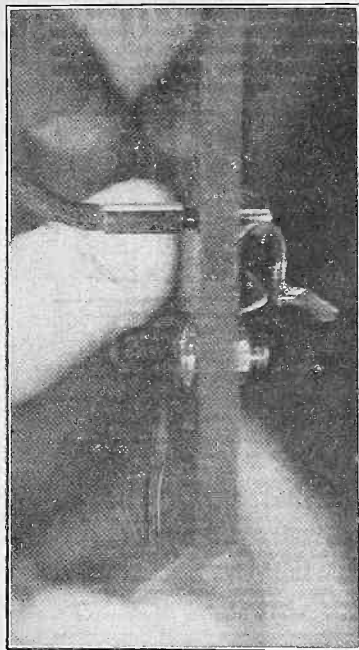

HOW to "tip jack" a clip, for front and rear panel connections.

of my chin the eyes which are watching the screen at the receiving end will have lost values of my hair, and the result will be that, although our transmitting method in itself may be perfect, the eyes at the receiving end will retain no image at all. We must be able to transmit all the areas of my face within a tenth of a second if the eyes at the receiving end are to retain an image of my face as a whole. That is the great obstacle in practical television. Once we have succeeded in overcoming that obstacle, we can transmit moving pictures as easily as the cinema does. Having given the eye at the receiving end one complete picture in a tenth of a second, we can give it another complete picture in the next tenth of a second by merely keeping the disk whirling at the transmitting end. This is the ordinary motion picture or cinema principle."

pearance of Madame Frances Alda, in the Atwater-Kent concert, April 18. This internationally known soprano is the wife of Giulio Gatti-Casazza, general director of the Metropolitan and America's foremost operatic impresario.

In the thirty radio concerts previously given, thirty-eight famous opera and concert stars took part. The concert series proved so popular from the start that the network of broadcasting stations was increased to fifteen stations.

The summer series will be under the direction of Allen McQuhae, famous tenor, who will be assisted by a full orchestra. The series will begin at 9:15 P. M., East-ery Daylight Time, and will continue for a half hour. The concerts will be broadcast from Station WEAJ, New York; WEEL, Boston; WSAI, Cincinnati; WCAP, Washington; WCCO, Minneapolis-St. Paul; WGN, Chicago; WGR, Buffalo, and WWJ, Detroit.

A THOUGHT FOR THE WEEK

WHY not the slogan: "A radio set for his birthday"? This idea, if carried out, would mean that millions of devices that nobody wants and stocks of freak, worthless gifts that nobody appreciates, will not be sold, but radio will take their place, to the delight of everybody concerned.

RADIO WORLD

REG. U.S. PAT. OFF.



Radio World's Slogan: "A radio set for every home."

TELEPHONE BRYANT 0558, 0559
PUBLISHED EVERY WEDNESDAY
(Dated Saturday of same week)
FROM PUBLICATION OFFICE
HENNESSY RADIO PUBLICATION CORPORATION
145 WEST 45th STREET, NEW YORK, N. Y.
(Just East of Broadway)
ROLAND BURKE HENNESSY, President
M. B. HENNESSY, Vice-President
FRED S. CLARK, Secretary and Manager
European Representatives: The International News Co.,
Brema Bldg., Chancery Lane, London, Eng.
Paris, France: Brentano's, 8 Avenue de l'Opera
San Francisco: Lloyd B. Chappell, 656 O'Farrell St.

EDITOR, Roland Burke Hennessy
MANAGING EDITOR, Herman Bernard
TECHNICAL EDITOR, Lewis Winner
CONTRIBUTING EDITORS, John F. Ridor, J. E. Anderson

SUBSCRIPTION RATES

Fifteen cents a copy, \$6.00 a year, \$3.00 for six months, \$1.50 for three months. Add \$1.00 a year extra for foreign postage. Canada, 50 cents.
Receipt by new subscribers of the first copy of RADIO WORLD mailed to them after sending in their order is acknowledgment of their subscription order. Changes of address should be received at this office two weeks before date of publication. Always give old address; also state whether subscription is new or a renewal.

ADVERTISING RATES

General Advertising		
1 Page, 7 1/4" x 11"	462 lines	\$300.00
1/2 Page, 7 1/4" x 5 1/2"	231 lines	150.00
1/4 Page, 8 1/2" D. O.	231 lines	150.00
1/4 Page, 4 1/2" D. O.	115 lines	75.00
1 Column, 7 1/4" x 11"	184 lines	100.00
1 Inch		10.00
Per-agate Line		.75
Time Discount		
53 consecutive issues		20%
26 times consecutively or E. O. W. one year		15%
4 consecutive issues		10%

WEEKLY, dated each Saturday, published Wednesday.
Advertising forms close Tuesday, eleven days in advance of date of issue.

CLASSIFIED ADVERTISEMENTS

Ten cents per word. Minimum 10 words. Cash with order. Business Opportunities ten cents per word, \$1.00 minimum.

Entered as second-class matter March 23, 1923, at the Post Office at New York, N. Y., under the Act of March 3, 1879.

MAY 8, 1926

Burglar Uses Tips In Announced Requests CHICAGO.

An odd way of utilizing the radio is charged to William Schoch, a former lawyer, accused of burglary. He admitted, say the police, that during the early evening he would listen to radio announcers as they gave names and addresses, over the ether, of persons requesting certain selections be played.
Later in the night Schoch would visit the homes mentioned by radio and rob the victims.
In the 125 homes visited by the radio prowler, police estimate \$500,000 was taken. Much of the loot has been recovered.
Schoch is a graduate of the University of Wisconsin and practiced law in Indiana and Illinois before coming to Chicago.

Check Facsimile Hearst Applies Radioed Over Sea for Stations In And Cashed Here Eleven Big Cities

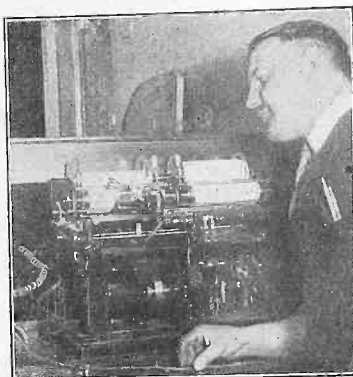

(International Newsreel) D. B. TIMBERLAND, at the apparatus employed to receive the check.

In the presence of Ambassador Houghton, General James G. Harbord, president of the Radio Corporation of America, and Mrs. Harbord; Owen D. Young, Chairman of the board of the Radio Corporation and Mrs. Young; Colonel H. L. Roosevelt, European representative of the Radio Corporation; Judge Woodward, counsel of the General Electric Co., and others, experiments with the new radio picturegram transmission apparatus, invented by Capt. R. H. Ranger, one of the engineers of the Radio Corporation, were carried out at the Marconi Building, London. One of the picturegrams sent was of a \$1,000 check, payable to the Radio Corporation of America, signed by General Harbord and drawn on the Bankers Trust Company of N. Y. The check was handed to Capt. Ranger, who applied it to a glass cylinder on the transmitting apparatus. In twenty minutes the reproduction of the original was in the hands of Colonel Samuel Reber, director of traffic production for the R. C. A., New York. Colonel Reber handed the check to Marion Payne, Assistant Treasurer of the R. C. A., who indorsed it and presented it for payment at the offices of the Bankers Trust Company. It was accepted.

It is expected by General Harbord that extensive use of this new device on a commercial basis will follow these experiments. Such use would increase the speed of international business. It is possible that facsimiles of important documents will be transmitted from one side to the other.

Mr. Young sent the reproduction of part of an autograph manuscript of Robert Browning to the St. Lawrence University, Canton, N. Y., for its library.

Lutheran Church Seeks Station License in N. Y.

The American Lutheran Church has applied to the Department of Commerce for a license to operate a broadcasting station in New York, according to a statement issued by the American Lutheran Publicity Bureau, 69 Fifth Avenue.

J. F. E. Nickelsburg, business manager of the bureau, said its attorneys had advised that a change in radio legislation was soon to be made which would enable the Lutherans to get a license, despite the fact that the Department of Commerce has more than 525 applications on file. In the

WASHINGTON.

Among the new applicants for broadcasting licenses this week were the Hearst newspapers, who applied for the privilege of broadcasting in the following cities: New York, Baltimore, Washington, San Francisco, Seattle, Detroit, Boston, Albany, Rochester, Syracuse and Chicago.

William Randolph Hearst has one or more newspapers in each of these cities. His papers constitute the most influential chain of its kind in this country.

Mr. Hearst always has been friendly and co-operative toward broadcasting. Some of his newspapers had a station or used some one else's station. The N. Y. American broadcasts news items through WJZ, for instance.

As Mr. Hearst's enterprises included the globe-encircling Universal Service and International News Service, he is free to have news, from the world over, broadcast from his own or any other station, since his units themselves collect it.

Mr. Hearst, as a station owner, would dedicate the stations to public service.

Other applicants were: Mariners Savings Bank, New London, Conn.; Lutheran Radio Committee, Bronxville, N. Y.; Twentieth Assembly District, Regular Republican Club, Brooklyn, N. Y.; Harry Weinberg, Brooklyn, N. Y.; W. S. McCachren, Mack's Battery Co., Harrisburg, Pa.; Ort Realty Co., Key Largo, Fla., and Boggs Electric Co., Birmingham, Ala.

H. L. Trefl, Cleveland, Miss.; Dallas Radio Labs, Inc., Dallas, Texas; Chamber of Commerce, Lafayette, La.; First Presbyterian Church, Pine Bluff, Ark.; R. C. Denny, Fresno, Calif., Hollywood American Legion, Post No. 43, San Francisco; Franklin Electric Shop, Roseville, Calif., and Daily Post, Idaho Falls, Idaho.

C. C. Garber, Ney, Ohio; Meadville Buick Co., Meadville, Pa.; Virgil E. Fowler, Portsmouth, Ohio; Carleton Kinch, Walton, N. Y.; Saginaw Board of Commerce, Saginaw, Mich.; Black Bros. Flour Mills, Beatrice, Nebr.; Liberty Radio Research Lab., Cedar Rapids, Iowa; Mayer's Special Service, near Chicago; J. E. Bute, Jr., Hastings, Nebr.

Chamber of Commerce, Deborah, Ia.; Hafer Supply Co., Joplin, Mo.; Southern Baptist Theological Seminary, Louisville, Ky.; James B. Sedwick, Jr., Monrovia, Ind.; D. A. Burton, Muncie, Ind.; Reliance Radio Co., Osborne, Kansas, Central College, Pella, Ia.; West Bend Pilot, West Bend, Wis., and Gates Electric Co., Winona, Minn.

event that a license was not granted he said that arrangements would be made to divide time on the air with an existing station but he declined to give the station's name.

If the license is granted it is understood that the aerial masts will be erected on the grounds of Concordia Lutheran College, Bronxville, but the studio will be located in Manhattan.

There are four stations owned and operated by religious organizations in New York: WBBR, People's Pulpit Association, Staten Island; WQAO, Calvary Baptist Church; WLWL, Missionary Society of St. Paul, and WSDA, Seventh Day Adventists.

Super-Power Advocated As An Economical Move

By Sidney Z. Mitchell

President, Electric Bond and Share Co.

When the average man hears the word "superpower," he conjures up an idea of something new and gigantic, when, as a matter of fact, a superpower system is so called merely because it makes a super—meaning a better—use of the generating facilities of an interconnected electric system.

When utility men speak of an interconnected system they do not necessarily mean a system which produces some vast amount of electricity. They merely mean that modern methods of interconnection have been applied to that particular system.

Discussion of Terms

So, instead of confusing you by using the word "superpower," I shall follow the lead of Secretary Hoover and talk in more understandable terms.

Mr. Hoover referred to electric interconnection and interchange of power as an evolution and it will clarify the atmosphere if I quote to you a paragraph from Mr. Hoover's speech at San Francisco last summer.

"I do not propose," he said, "to refer to this evolution as either 'superpower' or 'giant power.' Both these terms are blamed with connoting something that is not existent in power production. 'Superpower' has been envisaged as some overwhelming sinister encroachment into public rights. 'Giant power' has been interpreted by extremists to be like any giant hitherto known, as having its only realism as a bogey or as entertainment for children or as a side show for the political circus. The practical everyday fact is that all this development is simply a centralization of power houses and interconnection of distribution systems. We had better stick to our engineering terms to describe what the thing really is—central generation and interconnection of distribution systems. If anybody can find evil or humor or poetry in these terms, he will need to be ingenious."

The Earlier Days

In the days before interconnection, each separate electric plant was compelled to maintain equipment within its own walls sufficient to carry its peak load and to take care of inevitable emergencies.

Thus if every electric lamp in the community were lighted at the same instant, and if at that same time the local industries, using electric power, were still going at full blast, the local electric plant was required to have sufficient generating capacity to meet this maximum demand. It might happen, and in many instances it did happen, that this peak load lasted for only one or two hours of the day, the local plant used only a small fraction of its full capacity.

Furthermore, since electricity must be available at the instant the consumer desires it, the local plant was forced to maintain spare equipment—generally equal to its largest unit—in addition to that essential for its peak load, as emergency insurance against breakdowns.

An Uneven Burden

Now another plant, perhaps only twenty miles away, might be in precisely the same situation, except that its peak load, because of different local conditions, came at a different time that the peak load of the first plant.

One plant, for instance, might be in a community where electricity was used only for

lighting the streets and the houses at night; the second plant might be in an industrial community, where the peak demand for electrical power was to turn the wheels of industry during the day.

One plant might need maximum power at six o'clock in the evening when homes were being lighted and transportation systems were carrying their rush-hour loads. The other plant might be in a coal district where the mines closed at four o'clock in the afternoon releasing practically all the power used in the mines.

A Move for Economy

Common sense and thrift dictated that the transmission lines of these separate plants should be connected, so that surplus power could flow from one transmission system into the other. By this interconnection the generating capacity of the first plant—otherwise idle during the day—could be used to supplement the capacity of the second plant which needed additional daytime power. Similarly the generating capacity of the second plant which was busiest during the day could be used after four o'clock to supplement the first plant, which supplied its peak load at night.

Furthermore, since power could be transmitted from one plant to the other, the need of spare capacity would be reduced in both, inasmuch as the interconnected lines would make any idle capacity in one plant available to make up a shortage of capacity in the other.

What Interconnection Means

If you will take the simple illustration I have just given, and, instead of thinking of two interconnected plants, think of five or ten or twenty plants so tied together, you will obtain a picture of what modern electrical interconnection really means.

Two definite and extensive economies are made possible by interconnection. The most obvious, as I have indicated, is the reduction in the investment needed for spare equipment.

Let us suppose that there are ten electric stations within reasonable reach of each other and that in each of these stations the largest single generating unit is of 20,000 kilowatts capacity. Without any interconnection each of these ten stations would need a spare generator equal to its largest unit, so that, operating independently, these ten stations would require for emergency purposes ten 20,000 kilowatt generators which would represent 200,000 kilowatts of idle capacity and a total plant investment for emergency purposes of approximately \$26,000,000.

A Large Reduction

If these ten stations, however, are tied together with adequate transmission lines, instead of requiring a total of ten spare generators, the whole ten stations can be adequately protected against breakdowns with plant equipment of one, or at the most two, emergency generators.

In actual practice the diversity or difference in time of peak loads of the ten interconnected systems would probably result in a saving of at least 40,000 kilowatts as compared with the sum of the separate peaks when the stations were operated independently.

Consequently, instead of needing two of their original spare units for emergency purposes, the interconnected system would create a saving which would provide the equivalent spare capacity of two 20,000 kilowatt units, without using

Machine Turns Pages of Music; Boon to Studio

Broadcasting studios are interested in a novel device to enable a musician to turn the pages of his music without removing his hands from his instrument. This device has been invented by a German. The apparatus is called a leaf turner. It consists of a mechanism of shafts, levers, springs, and electromagnets contained in a steel casing about 6 inches square by 3 inches wide.

From the axis within the casing protrude six to twelve steel rods terminating in springs and adjustable clips. The back of the device is shaped so that it can be hung on a music rack or be clamped on a piano. It has been patented in Germany and a patent has been applied for in the United States.

a single one of the original spares.

In other words, by spending perhaps \$5,000,000 for interconnection, these ten stations would make freely available to meet the normal demands of their natural growth generating equipment which would otherwise cost them about \$26,000,000.

Second Economy

The second economy made possible by interconnection is the marked saving in the costs of operation. The aggregate peak load of this interconnected system will probably be at least 40,000 kilowatts smaller than the sum of the individual peak loads of the plants operated independently and yet the total kilowatt hour output is the same in both cases. It necessarily follows that in the interconnected system the average load is a higher percentage of the maximum load than would be the case if the systems were operated independently. This higher average use of facilities means a great saving in power generating cost. Furthermore, it is usually the case that some of the units or perhaps entire plants of the interconnected systems are of more modern design and normally operate at lower cost than others.

It also frequently happens that some of the plants in the interconnected system are better situated as to coal and water. By contractual arrangement between the various interconnected companies it is the custom to carry the continuous or long hour loads as much as practicable upon the plants with the lowest operating cost. In most instances these operating savings alone more than offset the operating cost and the fixed charges on the entire investment in transmission lines used to interconnect the separate stations.

Act of Common Sense

Interconnection is as different from the Giant Power "bogey" as day is from night.

Interconnection is the application of American engineering and common sense to the practical economies of the publicly regulated and publicly controlled electric industry.

Giant Power is merely the application of a catch-phrase to a theory which never worked and never can work.

There is nothing new about the broad principle which underlies the development of interconnected electric systems. It is the principle of making the widest and most efficient use of existing equipment. The most outstanding example, the one which most nearly parallels electrical interconnection, is that of the American railways.

THE RADIO TRADE

The Radio Show To Be On Non-Profit Basis

Joseph D. R. Freed, president of the Freed-Eisemann Radio Corp., told the radio press at the dinner given at the Roosevelt Hotel, New York City, that the majority of the substantial radio manufacturers had joined together in the organization known as the Radio Exhibition Corporation for the sole purpose of giving the public the best possible radio show in New York. Each manufacturer has one vote and subscribes time and money with no thought of profit, he added. The show will be held at the Grand Central Palace, New York, Sept. 10 to 17. Harold Bolster, who has been so successful in promoting radio shows in the past, has consented to act as managing director of the show.

George A. Scoville, Vice-President of the Stromberg Carlson Tel. Mfg. Co., spoke on radio industrial problems.

A subject of great interest at the dinner was the recent court decision on the Zenith case. One or two of the speakers seemed to feel that this might throw all radio broadcasting into chaos, that the different stations would be at liberty to steal each other's wavelengths, time, etc., and that Senators and Congressmen should be urged to enact remedial legislation. Others said that this decision would probably make no difference whatever and that any broadcasting station attempting to pirate another's wavelength and time would only gain the ill will of the public and do themselves injury. Another view was that very few stations could do as Zenith did, as Zenith has an experimental and communication license and there are few such.

Scoville's Remarks

Mr. Scoville said:

"The radio industry is the latest commercial wonder that has appeared on the horizon and it is running true to form, yet I doubt if any one here has any idea of the number of manufacturers that have jumped into this business and have already passed out of the picture. If tabulated, the results would amaze you.

"It was my privilege, a few years ago, to be connected with the automotive industry and I watched that industry, almost over night, become a leading factor in the commerce of our country. That industry had its growing pains, just as the radio industry has today. As we all know that experience is a good teacher, it would seem that the radio industry could well study the problems that confronted the automotive industry, as well as their eventual solution. However, although actively engaged in that business, the manufacturers who ventured into the business and passed out of the picture did not leave a marked impression on me or on any of my colleagues.

Deserves Prominence

"The important problem confronting the radio industry today is the Radio Show.

"The Radio Show should, in the first place, be an exhibit sponsored and operated by the entire industry, as only in this way can it tell the complete story of radio progress. Furthermore, by being controlled by the industry, it will be possible to maintain the position of prominence which radio is fast assuming. By means of a unified control, exerted in be-

half of the industry as a whole, it will be impossible for promoters to run wild, thus bringing untold grief on all manufacturers.

"A Radio Show should not be run for profit, but for the interest of the public and the exhibitors; however, if any money is made it should be returned to the exhibitors. By the establishment of this rule, the promoter, whose sole thought is monetary return, is necessarily eliminated.

For Public's Benefit

"Personally, I have my own ideas as to the whys of an exhibition, and I believe that while radio is going through the formative stage that it now is, the radio show should be run more for the benefit of the public than for any other reason. We are not to the stage of catering to dealers and jobbers alone. The public is interested, and this interest on their part should be heartily encouraged. One of the best ways of doing this is to maintain one show where they may see at one time any and all models that they may be interested in. Furthermore, our publicity should appeal to the public so that they may come out in ever increasing numbers.

"The Radio Show also provides a big opportunity for visiting dealers and jobbers, but I still feel that at this time, its main appeal should be to the consumer, and the exhibitors, distributors and dealers should carry complete advertising tie-ups during the show.

"In my opinion, the Show should never be made the deciding time when new models are exhibited. After the industry is stabilized, that might be a consideration, but I believe that the manufacturer who continually changes his design is working out an injustice to the dealer and the public, and cannot long exist, and I sincerely trust that manufacturers will take this thought seriously to heart, and do everything they can to stabilize their product. Of course, there will be more changing during this period than later on, because it is right and just that we give the public the benefit of developments.

Must Watch Step

"However, I predict that the manufacturer who does not carefully study each constructive factor, such as I have suggested above, and apply it in his business, is likely to find himself eliminated from the industry sooner than he has any idea of.

"We are endeavoring to accomplish these things by the Radio Industry operating its own show, just as the automotive industry does, the conveyance being the Radio Exhibition Corporation.

"It would take considerable time to tell you of the heartaches and difficulties that beset our path in the organization of the Radio Exhibition Corporation. Suffice it to say that about 30 leading manufacturers have formed this corporation. Each stockholder has but one vote, so that it cannot be controlled by any interest, but must be run for the greatest good for the greatest number. An organization still open for more reputable manufacturers.

Economic Waste Eliminated

"By the maintenance of one Radio Show operated by the industry, as promoted by the Radio Exhibition Corporation, the eco-

Radio World's Fair Pledged for 1927, Too

U. J. Herrmann, managing director of the Radio World's Fair, which will be held in New Madison Square Garden, New York City, Sept. 13-18, in response to reports that there will be no radio exposition under his management in New York City next year, said:

"There is no truth in the statement that this is our last New York show. We will run a show in 1927 and give our radio friends of the past, present, and future the best that money can buy."

This answered the statement made on behalf of the newly formed Radio Exhibition Corporation, handling the radio show which will be held in New York simultaneously this year with the Radio World's Fair, that only one exhibition would be held in New York City next fall, and indicating that their show would be that one.

nomie waste will be eliminated which manufacturers have incurred in the past in being forced to exhibit in two or more shows. In addition to the saving in floor space expense and the duplication of exhibit materials, the most important saving of all will be in man power required to run the exhibits. Irrespective of its commercial channels, the Radio industry outside of the retail outlets, from the standpoint of its engineering and manufacturing side, is primarily an electrical business. Our Radio Exhibition Corporation is built so as to secure the approval of the Show requirements of the Electrical Manufacturers Council. Their rules and regulations have been formulated after some years of observation, so that they know just what are good ones and what are bad ones.

"The stockholders of the Radio Exhibition Corporation are made up of representatives of companies that have made good, companies that have had comprehensive experience and are composed of mature executives.

"To succeed, manufacturers must build a worthy product—the best that they can build; produce a sound merchandising policy and vigorously administer it; and advertise reasonably. It is for that type of manufacturer that our Radio Exhibition Corporation has sprung into existence. That type of manufacturer is interested in a real Radio Show. He is not crazy about it making money for him, but he is desperately interested in a successful exhibit.

"We may sum this up briefly in the slogan: 'By the Industry, for the Public and the Industry.'"

This is "radio's critical year," said Mr. Freed. He added:

"Radio, as an industry, is on trial. Its strength must be demonstrated this year, in order that it may be worthy of the leading position in our industrial life it should naturally assume.

"Its leaders are becoming recognized. Names count, just as in other fields of activity. The products bearing these names must warrant continuous and increasing public confidence. Competition will become keener as the weaker interests are forced out of the race. The public will be bewildered no longer by extravagant claims and what to them is meaningless controversy respecting the merits of hundreds of products by hundreds of companies, as we saw in the past.

"But the industry must also manifest other signs of stability and strength, in the public interest and for its own salvation.

"One of the things that must be done is for the industry to make known its will and determination in the important show situation, particularly in New York City."

TOO MANY TUBES

By Dan Napoli



Mayor at 23, He Conducts Profitable Radio Store

Paul Ungrodt, the 23 years old radio and hardware dealer, who, as mayor of the village of Washburn, Wisconsin, has succeeded in pulling the town out of a slough of indebtedness by the application of business methods in the handling of the village's funds, is a Crosley dealer. In spite

of the strenuous duties in connection with the office he holds, he has been able to build a profitable business, helping his father to succeed when other merchants in the village failed with the slump that followed the close of the World War. All in the village are radio fans, now

paid for broadcasting a play a single time and that it would prove a profitable thing for both the broadcaster and the producer.

Radio Called Theatrical Not Electrical Business

That nobody could foresee how much ought to be charged by composers and authors for broadcasting their works was asserted by Arthur Hopkins, producer of "What Price Glory."

"Only a few years ago we thought we were getting a good price when we got \$5,000 for movie rights; now we are getting \$200,000 in some cases," he said. "Ben Hur" brought the Wallace estate \$1,000,000 last year."

Mr. Hopkins remarked that the radio people would soon realize "they were in the show business rather than the electrical business." He believed the time was coming when as much as \$25,000 would be

Parts Business Grows

The tail end of the season shows a healthy condition of the parts business, with indications that, beginning in late August, it will resume a position of prime importance.

New Diaphragm So Thin One Can Look Through It

A new process for the manufacture of super-thin metal diaphragms is said to have been developed by Dr. Carl Mueller, in Berlin. By the process the inventor claims to be able to manufacture them in thicknesses down to one one hundred thousandth of a millimeter.

It is claimed by the manufacturer that these diaphragms are so thin that it is possible to read and even to take photographs through them. It is said that the largest field of practical application will be found for microphones, telephones, loudspeakers, and phonographs.

The Trade's Best Opportunity to Build a Big Sales Demand

RADIO WORLD is now the only illustrated national radio fan weekly. RADIO WORLD is the only publication having 100,000 weekly readers, most of whom are experimenters in radio. RADIO WORLD's readers build sets for the fun of it, the thrill of the successful experiment, and when something new comes along they start all over again with a new set, and they not only build sets but buy sets as well.

"Drops of water wear away the hardest granite." Even a small advertisement in RADIO WORLD brought to our readers' attention week by week, fifty-two times a year, wears away trade resistance and brings a brand or trade-mark to the buyers' attention so persistently it creates real demand. RADIO WORLD gives you a service that no other publication can, because it is a radio service publication.

Fiction magazines of general circulation supply the best fiction; newspapers, even small-town papers, give good radio programs, but only RADIO WORLD gives real weekly radio service information—the newest things in radio, the latest and best hook-ups, the last word in battery service and elimination, etc. In other words, RADIO WORLD is the only national radio weekly, with 100,000 weekly fan readers who are constant buyers of radio and can give you the biggest result for your advertising dollar.

RADIO WORLD is dated each Saturday, is on the news-stands the previous Wednesday, and closes each Wednesday noon, ten days in advance of date of issue. Results are

quicker from RADIO WORLD than any other radio publication. A single inch message can be delivered in RADIO WORLD to the 100,000 people most interested in radio throughout the United States in ten days for ten dollars.

RADIO WORLD gives its advertisers every possible editorial co-operation. The set builder as a rule follows as closely as possible the laboratory models of radio tuned circuits in which the manufacturer's article is specified, and in this way it is constantly creating a demand, and new users for radio parts and accessories.

In regard to factory-made sets, we take various leading sets from week to week, giving full and detailed information regarding each particular set, creating not only a demand for the goods but showing the buyer in advance how to get the best possible results from the set, making the buyer a pleased and satisfied customer that will recommend your set to his friends. To get any real joy out of radio, one should know something about radio. RADIO WORLD fifty-two times a year is putting joy into radio reception by giving useful radio information—nothing else—no programs, no fiction—just all radio.

To sell the retailer is important, but not the most important thing. The big idea is to move your goods off the dealers' shelves. It has been proven over and over again that RADIO WORLD, with its week-by-week advertising urge, can best do this at the lowest cost. May we send you the proof? RADIO WORLD, 145 W. 45th St., New York.

NEW CORPORATIONS

Paramount Broadcasting and Artists Device, N. J., 1,000 shares, no par; James L. Shearer, Elizabeth, N. J.; Earl C. Fuller, Newark, N. J.; Harry Didge, Belleville, N. J. (Atty., Alfred G. Nowakowski, Newark, N. J.).
Radio Research Laboratories of Asbury Park, N. J., 250 shares, no par; Andrew C. Dam, Louis Shepper, William Schiff, Victor Sanford, Asbury Park, N. J. (Atty., Geran & Matlack, Asbury Park, N. J.).

Broadcast Listeners' Association of New Castle Co., Wilmington, Del. promote radio reception; F. H. Frazer, J. C. Pennewill, J. P. Prentiss. (Atty., K. K. V. Casey, Wilmington, Del.).

Business Opportunities Radio and Electrical

Rates: 10c per word; Minimum, \$1.00; Cash with order

VICTROLA-RADIO STORE FOR SALE IN city of 40,000, 30 miles from New York; established 10 years; capable of netting \$10,000 per year; cash required \$18,000; valuable franchise; reason, other interests. Box 3, RADIO WORLD.

OUTSTANDING ACCOUNTS FINANCED: liberal terms, lowest rates; confidential; quick service assured. Mercantile Factors Corporation, 230 5th Ave., N. Y. C. Phone Ashland 9506

BATTERY - IGNITION - RADIO SERVICE: moneymaker for right party; established 5 years; sacrificing for \$1,500 to quick buyer; stock and fixtures worth double. Phone Raymond 0422, Brooklyn, N. Y.

METAL ARTICLES, STAMPING, ASSEMBLING, finishing, dies and tools for economical quantity manufacturing. n Metal Craft Co., 306 East 40th, N. Y. C.

Design Copyright Bill Attacked As a Menace

By John D. Myers

Of the Philadelphia Bar

Every manufacturer and dealer whose products involve industrial designs, no matter how simple they may be, has a vital interest in legislation now pending in Congress which not only threatens the development of industrial art, but may seriously embarrass industry generally.

The substitution of copyright for patent protection for designs and the repeal of the design patent laws is the basic change embodied in this legislation, which is officially known as House Bill 6249. The change sounds simple enough, but owing to the fundamental difference between copyrights and patents, its effects are far-reaching.

The degree of protection afforded against infringement, for instance, will be less than under the present patent laws. On the other hand, manufacturers, dealers, and the public generally will be confronted with the prospect of endless litigation under copyrights indiscriminately registered for designs which are not now entitled to protection at all, such as those lacking novelty or having merely a trivial character.

Reduces the Protection

Taking a specific example, if a manufacturer developed at much expense a distinctive and very valuable industrial design and obtained a copyright registration for it, he would be unable to protect his design against anyone else who later, independently and without copying, produced a design identical with his work. Such a manufacturer would have to share his market with the producers of the later design. Under these circumstances, there will naturally be little inducement to manufacturers to spend large sums developing distinctive articles only to have their designs duplicated later by competitors who would share in their commercial possibilities.

Should such a manufacturer seek protection in the courts, he could not obtain relief under his copyright unless his competitor's design was in fact copied from his, and this would present an obviously difficult point for proof. This difficulty is not raised at all as the test of infringement under the design patent laws is based solely on substantial resemblance. If one design resembles another which is patented, it may not be manufactured, used or sold without infringing, regardless of whether it is a copy or is independent work.

Fear of Copyright Monopoly

Another far-reaching effect of this proposed change will be that it will enable copyright monopolies to be created in designs which are now the property of any manufacturer who desires to use them. These indiscriminate copyright registrations will present a wide opportunity for harassing tactics and will breed much litigation.

A concern marketing an article of a particular design which had been common property for many years would be open to attack at any time under a copyright registration which could be readily obtained by another for an identical, or substantially identical, design. Under these circumstances, there would be no infringement if the design so marketed had not been copied from the copyrighted work. But even if this satisfactorily appeared from the evidence and the concern should win, the trouble and expense of the litigation might make it an actual loser. Confusion of rights and conse-

quent suits will also grow out of the fact that the proposed change will make it possible for different persons to obtain separate copyright registrations on identical designs. This would manifestly be a great hardship upon the one first producing such a design and copyrighting it. He and his trade might be confronted at any time with wide spread competition developing under a later copyright.

Opens Door to Unscrupulous

The situation would be menacing enough in instances where the design of the latter registration was produced by independent work and without copying, but how much worse it would be if this was not true. Yet as copyrights are registered as a matter of routine and without examination, the door will be open for the unscrupulous readily to cloak themselves with copyright registration, and the way of the pirate will be made easier.

"The bars will be let down" in other ways and permit the copyrighting of designs of a trivial character, and many others which do not meet the requirements for a patent. This is because of the different standard determining the right to a copyright, as distinguished from a patent, and the different method by which it is secured.

One of the principal objects of the proposed change is to avoid the delay involved by examination in securing design patents. It is claimed that design, if promptly marketed, may be copied by competitors, cheapened, and their value destroyed before patent rights can be obtained under which suit can be brought.

Difficulty Not General

The need, if any, does not justify the radical departure proposed. The difficulty, if it exists, is not general, but applies only to particular cases. Doubtless relief could be obtained by appropriate changes in the present laws or their administration, but even now patents are promptly granted on designs which are not open to objection.

Creators of designs which meet the requirements of the patent laws will scarcely be willing to accept a monopoly of less value, in order to avoid the short delay involved in examination. Of course, those whose designs do not meet these requirements may be in favor of the proposed change; not, however, because of merely avoiding short delay, but because now they are not entitled to any kind of monopoly at all. This, after all, is the real purpose back of this proposed change in the law.

The sum and substance of the matter lies in the fact that copyright is not an appropriate form of protection for industrial designs, because it has been developed to deal with literature and the fine arts. Industrial designs, on account of their relation to the useful arts, involve conditions of a different kind and which are more analogous to those under patents than under copyrights.

Short-Wave Show In N. Y. Next Week

Short-wave reception for broadcast listeners and short-wave reception and transmission for amateur radio operators will be featured at the Hudson Division American Radio Relay League Convention and Exhibition, May 13 to 15, inclusive, in the United Engineering Societies Building, 29 West Thirty-ninth street, New York City.

Literature Wanted

THE names of readers of RADIO WORLD who desire literature from radio jobbers and dealers are published in RADIO WORLD on request of the reader. The blank below may be used, or a post card or letter will do instead.

Trade Service Editor,

RADIO WORLD,

145 West 45th St., N. Y. City.

I desire to receive radio literature.

Name

City or town

State

Are you a dealer?

If not, who is your dealer?

His Name

His Address

Dr. High, 76 East 86th St., N. Y. City.
D. W. Husted, Sapulpa, Okla.
W. C. Rogers, 2018 McKinney Ave., Dallas, Tex. (Dealer).
Ottawa Radio Service, Port Clinton, O. (Dealer).
W. H. Powell, 350 Hanover St., Bridgeport, Conn.
E. Jean, Box 469, New London, Conn.
D. A. Johnston, New Britain, Conn.
H. D. Dieterich, 887 Herkimer St., B'klyn., N. Y.
Henry Kelley, Devils Lake, N. D.
C. Duane Smith, Dayton, Tenn.
James Murphy, 5139 Third Ave., Detroit, Mich.
C. B. Rutherford, 3656 Bryant St., Denver, Col.
Ralph Happekotte, 620 North 18th St., Quincy, Ill.
C. C. Williams, Box 823, Atoka, Okla.
Alfred De Gregory, 84 Grove St., B'klyn., N. Y.

Inclusion of Receivers Saved the Phonograph

Much confusion has existed in the public mind as to what effect the advent of radio had upon the phonograph business. John G. Payne, counsel for the Victor Company, said:

"With the coming of radio the sales of our instruments dropped tremendously. 'However, we didn't go to Congress with our troubles but instead we called in the radio people and said, 'How are you going to help us?' As a result of their assistance and devices, we were able to put on the market an entirely new type of machine.

"Our business began to pick up immediately and we are now working overtime and nights in an effort to fill all the orders."

Industry to Meet May 10 for Rally at Atlantic City

The radio industry will foregather the week of May 10 at the Ambassador Hotel, Atlantic City. Represented will be the following: Radio Manufacturers' Association, National Radio Trade Association, Radio Writers' Association, National Association of Broadcasters, National Farm Radio Council, Broadcast Listeners' Association of America, Radio Magazine Publishers' Association, International Radio Week Committee.

FEBRUARY EXPORTS

Domestic exports of radio apparatus from the United States by some of the leading purchasers, for February, the last month reported by countries, follow:

Transmitting sets and parts: Chile, \$661; and Japan, \$500. Receiving Sets: Canada, \$56,040; Argentina, \$37,342; and Japan, \$17,801. Tubes: Japan, \$56,227; Australia, \$12,520; and Canada, \$7,659.

Receiving Set components: Canada, \$27,487; United Kingdom, \$16,876; Australia, \$14,130; and The Netherlands, \$13,918. Receiving set accessories: Canada, \$51,698; Australia, \$26,655; and Japan, \$25,368.

The month's total exports of transmitting sets and parts amounted to \$2,271.

Lead-in Connector Makes Aerial Always Efficient

Little do radio fans realize the importance of the lead-in connection. Scratchy, interrupted and fading signals, also poor distance and volume, are often the result of poor lead-in connection. The most common method of making this connection is by wrapping the antenna wire with that of the lead-in wire, covering it with tin foil and tape. Soldering of the lead-in to the antenna wire is more efficient, but is difficult. In both methods the two wires are interwound. In the first method there are small gaps between the intervening turns of wire. This allows dust and dirt to accumulate, causing resistance and a leakage path with a consequent loss of signal strength in the receiver.

Although in the soldering method the

entire surface is covered, the solder breaks in places, when the wire is pulled by a strong wind or dampened by heavy rains, causing small gaps. Beside the gaps being present, the wire starts to slacken up. Then the fun begins, resulting in scratchy noises. The batteries, tubes and all the parts in the set are tested time and time again. The cause cannot be found. A service man is called in. He cannot find the trouble. The set or circuit, even though it has worked for a long while, is condemned. As a last resort, the antenna is thought of. Ah, the lead-in wire has become loose! It is tightened. Again the same delightful results are obtained. But think of all the trouble encountered, also the money and time spent.

The James F. Doolan Mfg. Co., of 62 West 45th St., N. Y. City, have solved this problem with their Tip Top Connector. It consists of two triangular brass pieces which cannot corrode. One of these pieces fits into the other. The metal is mottled so as to permit the lead-in wire to be attached to a screw. This bolts the metal pieces together, permitting the antenna wire to be run through at the same time. The lead-in wire is individual of the antenna, contact being made through the brass. No jarring can break the contact, once the bolt is tightened. And summer is the time to repair your antenna. One of these little connectors installed now, will save you

BEAUTY-QUALITY-LOW PRICE

TYPE 5SS 5-Tube Toned Radio Frequency. \$45
TYPE 5RR 6-Tube Resistance Coupled Audio Tuned Radio Frequency \$50

If your dealer cannot make immediate delivery we will ship direct from factory
American Interstate Radio Service
133 Greenwich Street, New York City
Distributors, Jobbers, Dealers, write for special trade terms.

JAYNXON TONE BRIDGE

Gets the Real Tone Value From Loud Speaker

Direct Battery Current Spoils a Speaker—A JAYNXON TONE BRIDGE Saves It! Perfect volume control without change of quality. Reduces static interference.



\$10.00

Post-Paid
A Jaynxon Product
"Gets the Tone—From Horn or Cone"

Matches Tube Impedance to All Speakers
JAYNXON LABORATORIES
57 DEY STREET NEW YORK CITY
Approved by RADIO WORLD Laboratories

Sent Prepaid in the U.S.
SPACES PERFECTLY \$7.50

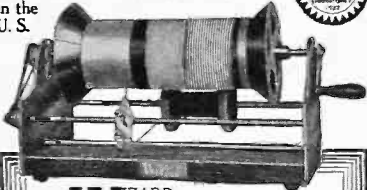

WIZARD WINDER

eliminates the most trying and difficult job in building sets. Saves hours in time and waste! Winds automatically and uniformly any thickness of silk, cotton and enamelled wire into practically any style coil from 3/8 in. to 3/4 in. diam. and up to 10 1/2" long. Full instructions with each machine. Ready for instant use. Nickel plated throughout, strongly built.

SEND NO MONEY We'll send your WIZARD C.O.D., or enclose \$7.50 with your order—either way we pay the postage.

Wizard Wire Winder Co.
3812K Central Ave.
Los Angeles, Calif.
Dealers! Investigate!

Sold on an Absolute Money Back Guarantee

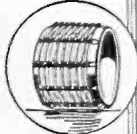

PHONOGRAPH OWNERS!

Convert your phonograph into the latest amazing electrical machine. Startling in its life-like reproduction of the new electrically recorded records. For a few dollars and several hours' time you may have the world's greatest talking machine. Operates on dry cells or lamp socket. Building plans by Hartman and Jenkins, formerly with Westinghouse Electric & Mfg. Co. and Western Electric Co. \$1.00 cash or C.O.D. Absolute satisfaction guaranteed. E. E. Hartman, 738 Garfield Ave., Kansas City, Kansas.



D-X OWL



EUREKA

Right to the Point!
Eureka Dial Pointers
Polished Nickel or Gilt
10c Each
DX Owl Nickel...18c
DX Owl Goldplated...15c
At your dealers or sent direct for stamps.
C. W. BUTTS, INC.
42 Hedden Place
East Orange, N. J.

"LOOK UP DOWN"

For SERVICE

A Complete Radio Testing Laboratory for the Corrections of Radio Troubles!

CHAS. W. DOWN
SUPER-HETERODYNE SPECIALIST
711 - 8th Ave., New York, N. Y.

TECTRON "B" ELMINATOR

Superior to Any Other
Smaller than one B Battery.
Delivers as high as 150 Volts and up to 60 Milliampere of Humless Rectified Power.

TECTRON RADIO CO., 1270 Broadway, N. Y.

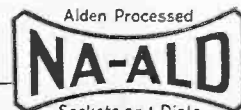

Sockets and Dials
ALDEN MANUFACTURING CO.
Dept. S-4 Springfield, Mass.

a lot of trouble, by preventing scratchy noises breaking up the program.

Thermiodyne Petitioned in Bankruptcy, as is the DeForest Company

Petitions in bankruptcy were filed against two radio companies. The two concerns are the De Forest Radio Company and the Thermiodyne Radio Corporation.

Application for a receiver for the De Forest Radio Company was filed in the United States District Court at Wilmington, Del., by an attorney representing Lee De Forest and William S. Preis, both of this city, who alleged mismanagement and asked for an accounting. Federal Judge H. H. Morris set May 17 as the date for the hearing on the application. The receivership proceedings will be contested by the company, according to H. L. Lanphear, an official of the company, who issued the following statement:

"The De Forest Radio Company is entirely solvent and has never defaulted in payments of its obligations. The suit for a receiver was not instituted by a creditor, but by two stockholders who were formerly connected with the management of the company and who object to some of the policies of the present management. The suit will be contested and we have no doubt as to the outcome."

The involuntary action against the Thermiodyne Radio Corporation was filed in the United States District Court by the Presto Machine Product Company, Inc.; the Interstate Corrugated Box Company and the Advertising Art & Printing Company, Inc. The largest claim of the more than twelve creditors amounted to approximately \$2,000.

Bruno's Latest Design a Ruby Light Switch

A unique battery switch incorporating a red pilot light which indicates whether the set is turned on or off has been brought out by the Bruno Radio Corporation, 40 Pyntar Avenue, Long Island City.

The device consists of a pear-shaped fiber strip whose narrow end is fitted with a small bracket holding a miniature lamp socket. The wide upper end holds the switch unit proper, the exposed knob of which is a knurled and nickel-plated ring filled by a bright red piece of glass cut to resemble a diamond. The entire switch mounts on the panel in one hole by means of a threaded bushing.

To turn the set on, the glass knob is turned to the right; to turn it off, the glass is simply pushed with the tip of the finger, and a coiled spring pulls the contact lever back around to the left. The small flashlight bulb that fits in the miniature receptacle is in the filament circuit of the radio tubes, and illuminates the red pilot lights when the latter are turned on. The bright iridescent glow of the glass serves as an unforgettable indication that the set is working, and makes such an impression on the owner that he cannot inadvertently leave the tubes burning over night, as many people frequently do.

The new Bruno light switch is adaptable to all types of radio sets and current carrying accessories.

Coast to Coast Easy For Him, Fan Reports

RESULTS EDITOR:

The Diamond of the Air sure can pull 'em in from coast to coast from this point.
GEO. J. ELLIS,
Copeland Lake Lodge,
Allens Park, Colorado.

Farm Service by Radio Takes Big Step Forward

By Sam Pickard

Chief of Radio Service,
U. S. Department of Agriculture
WASHINGTON.

For a long time Uncle Sam has conducted an elaborate farm information cafeteria at Washington. The food has always been good, substantial, plentiful, and free. The canned facts, press sandwiches and other culinary accomplishments of the big kitchens have proved helpful in sustaining agricultural life. Special orders from farmers for this government ration served a la carte or table d'hote were received last year at the rate of about 4,000 a week.

Secretary Jardine, who runs this establishment, recently put into effect a resolution to make the service par excellence. He introduced the long arm of radio, hundreds of miles longer than the best boarding house reach, and started serving direct to a million farm homes hot attractive morsels of a wholesome, well-balanced diet of wealth-building food.

May Double Crops

Hitherto a great deal has been said about radio on the farms but not very much has been done about it. A spot news market and weather service have been the only radio contributions from the Department.

Only about one-half of the agricultural colleges to date have broadcast more than a few feeble flickers of their goldmine of information. And this situation in the face of the statement from leading agricultural authorities that farm profits in the United States may be doubled by application of better methods of production and marketing-ammunition with which farm specialists are heavily belted.

Chance to Improve

Suppose that 50 per cent. more farmers

did plant the best yielding local varieties of crops, avoided insects and disease losses, exercised correct farm management and marketing principles, and in other ways doubled their profits. The inevitable result would be a much greater prosperity for the entire country.

The profits from this great basic industry would bring greater sales of clothing, furniture, and machinery in the smaller towns, a subsequent increased factory production in the cities, and most important of all—greater happiness and contentment on the farm. This is just what radio is going to do. Therefore with

this situation clearly in mind the Department of Agriculture has planned a comprehensive radio service—one which necessitates, not only the united effort of every investigator in the Department itself, but also the cooperation of all agricultural college authorities.

An attempt to correlate the individual radio activities of all the colleges in the preparation of fewer but more adequate and better distributed programs has been made. The cooperation of farm schools has been enlisted in sponsoring a daily Fifty Farm Flash program. Many of the institutions furnish answers to questions put by farmers of the state through the local broadcasting station.

Each Flash is fifty or less words in length and includes the statement of a timely, practical question, asked by one or more farmers with the answer to it concisely, clearly, and completely stated.

CLAROSTAT



prescribed by LEWIS WINNER for the TECTRON "B" ELIMINATOR, and the 2 D.C. "B" Eliminators
The success of these and many other RADIO WORLD Circuits depends on CLAROSTAT.

Also O.K.'d by RAYTHEON and a host of other nationally known eliminator manufacturers. \$2.25.

AMERICAN MECHANICAL LABORATORIES, INC.

285 N. 6th St., Dept. R.W., Brooklyn, N. Y.
A book of valuable radio diagrams and information covering the above subjects will be mailed to you upon receipt of four cents in stamps.

FANS! All Parts for The NEW S-C 4 TUBE

SINGLE CONTROL RECEIVER as designed by McMurdo Silver and L. M. Cockaday; Described in March Issue of Popular Radio. Wave Lengths Range from 50 to 1800 Meters.

RADIO MAIL ORDER HOUSE
P. O. BOX 129, Times Square Station, N.Y.C.

The world's greatest variable grid leak, distributed by the North American Bretwood Co., is selling enormously, and is giving universal satisfaction. Get more out of your set by using the Bretwood Grid Leak. Mailed for \$1.50. Radio Division, The Columbia Print, 145 W. 45th St., N. Y. C.



Tip-Top

LEAD-IN CONNECTOR

Goes On in a Jiffy

Makes Perfect Contact

About the TIP-TOP CONNECTOR—

Makes Perfect Contact—Holds the wires securely in place and provides a large contact surface. Cannot come loose as hand connections do.

Eliminates Loose Lead-wire connections with their resulting noises and other objectionable features.

Goes On in a Jiffy—Only a screw driver needed. Bend the antenna wire, and form an eye in end of lead-in wire.

Helps Volume and Distance—Through reducing resistance in the path from antenna to set.

Will Last for Years—Made of brass. Cannot corrode or rust.

At your dealers or mailed prepaid for 25c.

J. F. Doolan Manufacturing Corporation, 62 W. 45th St., New York City

FREE!

12-Cell—24-Volt Storage'B'Battery

Positively given free with each purchase of a WORLD "A" Storage Battery. You must send this ad with your order. WORLD Batteries are famous for their guaranteed quality and service. Backed by years of successful manufacture and thousands of satisfied users. Equipped with Solid Rubber Case, an insurance against acid leakage. You save 50 per cent and get a

2-Year Guarantee

Bond in Writing

WORLD Battery owners—tell their friends. That's our best proof of performance. Send your order in today.

6-Volt, 100-Ampere	\$11.25
6-Volt, 120-Ampere	\$12.25
6-Volt, 130-Ampere	\$13.00

Solid Rubber Case Auto Batteries

6-Volt, 11-Plate	\$11.25
6-Volt, 18-Plate	\$12.25
12-Volt, 7-Plate	\$16.00

Send No Money

Just state battery wanted and we will ship per order as received, by Express C. O. D. subject to your examination on arrival. FREE "B" battery included. Extra offer: 5 per cent discount for cash in full with order. Buy now and get a guaranteed battery at 50 per cent saving to you.

WORLD BATTERY COMPANY
1219 So. Wabash Ave., Dept. 17 CHICAGO, ILL.

World
STORAGE BATTERIES

Get your Radio Deals at 210 meters for the new 1000 watt World Storage Battery Station, WBB, Chicago. Watch for announcements.

CHANGES OF ADDRESS

should be sent to Subscription Department at least two weeks in advance of publication in order to insure early and proper attention. RADIO WORLD'S subscription list is so large that it is necessary that changes be sent in as requested. Address, Subscription Department, RADIO WORLD, 145 W. 45th St., New York.

Farm Service by Radio Takes Big Step Forward

By Sam Pickard

Chief of Radio Service,
U. S. Department of Agriculture
WASHINGTON.

For a long time Uncle Sam has conducted an elaborate farm information cafeteria at Washington. The food has always been good, substantial, plentiful, and free. The canned facts, press sandwiches and other culinary accomplishments of the big kitchens have proved helpful in sustaining agricultural life. Special orders from farmers for this government ration served a la carte or table d'hote were received last year at the rate of about 4,000 a week.

Secretary Jardine, who runs this establishment, recently put into effect a resolution to make the service par excellence. He introduced the long arm of radio, hundreds of miles longer than the best boarding house reach, and started serving direct to a million farm homes hot attractive morsels of a wholesome, well-balanced diet of wealth-building food.

May Double Crops

Hitherto a great deal has been said about radio on the farms but not very much has been done about it. A spot news market and weather service have been the only radio contributions from the Department.

Only about one-half of the agricultural colleges to date have broadcast more than a few feeble flickers of their goldmine of information. And this situation in the face of the statement from leading agricultural authorities that farm profits in the United States may be doubled by application of better methods of production and marketing-ammunition with which farm specialists are heavily belted.

Chance to Improve

Suppose that 50 per cent. more farmers

did plant the best yielding local varieties of crops, avoided insects and disease losses, exercised correct farm management and marketing principles, and in other ways doubled their profits. The inevitable result would be a much greater prosperity for the entire country.

The profits from this great basic industry would bring greater sales of clothing, furniture, and machinery in the smaller towns, a subsequent increased factory production in the cities, and most important of all—greater happiness and contentment on the farm. This is just what radio is going to do. Therefore with

this situation clearly in mind the Department of Agriculture has planned a comprehensive radio service—one which necessitates, not only the united effort of every investigator in the Department itself, but also the cooperation of all agricultural college authorities.

An attempt to correlate the individual radio activities of all the colleges in the preparation of fewer but more adequate and better distributed programs has been made. The cooperation of farm schools has been enlisted in sponsoring a daily Fifty Farm Flash program. Many of the institutions furnish answers to questions put by farmers of the state through the local broadcasting station.

Each Flash is fifty or less words in length and includes the statement of a timely, practical question, asked by one or more farmers with the answer to it concisely, clearly, and completely stated.

CLAROSTAT



prescribed by LEWIS WINNER for the TECTRON "B" ELIMINATOR, and the 2 D.C. "B" Eliminators

The success of these and many other RADIO WORLD Circuits depends on CLAROSTAT.

Also O.K.'d by RAYTHEON and a host of other nationally known eliminator manufacturers.

AMERICAN MECHANICAL LABORATORIES, INC.
285 N. 6th St., Dept. R.W., Brooklyn, N. Y.
A book of valuable radio diagrams and information covering the above subjects will be mailed to you upon receipt of four cents in stamps.

FANS! All Parts for The NEW S-C 4 TUBE

SINGLE CONTROL RECEIVER as designed by McMurdo Silver and L. M. Cockaday; Described in March Issue of Popular Radio. Wave Lengths Range from 50 to 1800 Meters.

RADIO MAIL ORDER HOUSE
P. O. BOX 129, Times Square Station, N.Y.C.

The world's greatest variable grid leak, distributed by the North American Bretwood Co., is selling enormously, and is giving universal satisfaction. Get more out of your set by using the Bretwood Grid Leak. Mailed for \$1.50. Radio Division, The Columbia Print, 145 W. 45th St., N. Y. C.



Tip-Top

LEAD-IN CONNECTOR

Goes On in a Jiffy

Makes Perfect Contact

About the TIP-TOP CONNECTOR—

Makes Perfect Contact—Holds the wires securely in place and provides a large contact surface. Cannot come loose as hand connections do.

Eliminates Loose Lead-wire connections with their resulting noises and other objectionable features.

Goes On in a Jiffy—Only a screw driver needed. Bend the antenna wire, and form an eye in end of lead-in wire.

Helps Volume and Distance—Through reducing resistance in the path from antenna to set. Will Last for Years—Made of brass. Cannot corrode or rust.

At your dealers or mailed prepaid for 25c.

J. F. Doolan Manufacturing Corporation, 62 W. 45th St., New York City

FREE

12-Cell — 24-Volt Storage'B'Battery

Positively given free with each purchase of a WORLD Storage Battery. You must send this ad with your order. WORLD Batteries are famous for their guaranteed quality and service. Backed by years of successful manufacture and thousands of satisfied users. Equipped with Solid Rubber Case, an insurance against acid and leakage. You save 50 per cent. and get a

2-Year Guarantee

Bond in Writing

WORLD Battery owners "tell their friends." That's our best proof of performance. Send your order in today.

Solid Rubber Case Radio Batteries	12.25
6 Volt, 120-Amperes	14.00
6 Volt, 100-Amperes	12.25
6 Volt, 125-Amperes	14.00
6 Volt, 140-Amperes	14.00

Solid Rubber Case Auto Batteries

6 Volt, 11-Plate	11.25
6 Volt, 18-Plate	11.25
6 Volt, 15-Plate	11.25
12 Volt, 7-Plate	16.00

Send No Money

Just state list-
tary wanted and
we will ship, day
press C. O. D. subject to your examination
on arrival. FREE "B" Battery included.
Extra Offer: 5 per cent. discount for cash
in full with order. Buy now and get a guar-
anteed battery at 50 per cent. saving to you.

WORLD BATTERY COMPANY
1219 So. Wabash Ave., Dept. 17 CHICAGO, ILL.

World
STORAGE BATTERIES

Set your Radio Dials at 210 meters for the new 1000 watt World Storage Battery Radio, W.B.C. Chicago. Watch for announcements.

CHANGES OF ADDRESS

should be sent to Subscription Department at least two weeks in advance of publication in order to insure early and proper attention. RADIO WORLD'S subscription list is so large that it is necessary that changes be sent in as requested. Address, Subscription Department, RADIO WORLD, 145 W. 45th St., New York.

Approximately 20 minutes are required for broadcasting the questions and answers, which in most instances follow a 10-minute entertainment program of special interest to farmers. Several thousand letters received each week by the Department serve as a barometer to indicate the farmers' immediate problems. Stations are furnished only such material as is of particular interest to the agricultural section within positive reception distance. The program is scheduled as follows: Monday, livestock; Tuesday, crops and soils; Wednesday, poultry; Thursday, fruits and vegetables; and Friday, dairying. The Housekeepers' Half Hour, a bi-weekly service, is an information chatty program, attractively presenting the great

fund of facts available from the Bureau of Home Economics in the Department.

Getting the Youngsters

The Radio Order of Junior Gardeners was started by the Department in March. Stations using this service introduce the character "Uncle Bert—the Garden Expert." Uncle Bert gathers the young folks around their receiving sets at a certain period each week and starts his meeting with appropriate music or a few applicable readings. Timely gardening subjects are discussed in dialogue fashion, one or more boys or girls at the microphone asking questions.

The garden club will be followed later in the year by similar organizations covering other nature studies.

No longer is it necessary for the agri-

cultural colleges to restrict their number of students to the 150,000 now taking resident training, nor for extension services to be content with their additional contacts.

The most visionary futurist would doubtless underestimate radio's educational possibilities if he were to prophesy the next decade of progress in this new field. Previously educators have concerned themselves with training a few. Today the masses are clamoring for attention.

CALLS HEARD

By G-6QB, L. H. Thomas, 33, Harpenden Road, West Norwood, London, England, S.E. 27.—laao, laap, ladi, lahv, laou, lapv, lasu, latg, lawg, laxa, layg, layi, lbeb, lbf, lbie, lbke, lbqd, lbvb, lbzp, lcaa, lcal, lcaw, lcax, lci, lcjc, lcxm, lcoe, lds, ldy, lej, lgr, ljr, ln1, lor, lon, lsw, lvc, lvy, lxae, lzk, zaan, zacp, zaef, zaes, zaev, zag, zagb, zagq, zajw, zaky, zamj, zamp, zann, zann, zaov, zatp, zbbb, zbm, zbn, zbui, zbwa, zbxj, zbyg, zcaz, zccl, zcgj, zcig, zcpq, zcyl, zcvu, zcx1, zcxn, zczr, zczy, zds, zfc, zfo, zfk, zgp, zhp, zhu, zih, zkp, zmk, znj, znz, zvb, zxo, zzb, zacm, zagf, zah1, zahp, zbhw, zbms, zbvt, zdh, zev, zhg, zio, zjo, zkm, zld, zxav, zav, znx, zur, zaty, zatx, zew, zfc, zib, zyd, zcto, zadm, zbig, zbig, zba, zakk, zaks, zal1, zbau, zbdc, zbg, zcau, zcbi, zccr, zcpa, zddp, zdrj, zdrs, zed, zji, zks, zok, zpl, zrh, zsy, zxe, zzu, zxae, zao, zai, zao, zec, zee, zek, zhp, zne, zxe; Canadian: zax, zbg, zkp, zml. Z: zaq, zac, zas. A: zbk, zyl, zxo. BZ: lac, laf, lai, lin, zab, zaf, zab. O: a4z, a6n. Y: hbk, crp. Miscellaneous: E-1bh, 99x, nal, nism, naw, sgc, si, sdx. PSE QRK G-6QB on 43-45 metres? Cards waiting for all the above.

FREE BOOKLET FOR INVENTORS
 IF YOUR INVENTION is new and useful is patentable. Send me your sketch.
 Z. H. POLACHEK, 70 Wall St., New York
 Reg. Patent Attorney-Engineer

How to Build THE FENWAY
 The famous DX set that, by the turn of a switch, is a 4-tube tuned RF set with regeneration, or a 9-tube Super-Heterodyne! Remarkably sensitive!
 Described by Leo Fenway himself in the February 6, 13, 20 and 27 issues, including trouble shooting. Send 60c for all four issues, or send \$3 for year's subscription and get these four copies FREE!
 RADIO WORLD, 145 W. 45th St., N. Y. C.

SEE JAY POWER UNIT
 Here at Last!

 A combination alkaline element battery and trickle charger all in one. Can be charged while set is operating. Price complete shipped dry with solution, \$16.00. 100-Volt with Chemical Charger, \$12.00. 140-Volt, \$17.00.
 Write for our illustrated 24 page booklet and Sample Cell 20c.
 Send No Money. Pay Expressman.
SEE JAY BATTERY COMPANY
 915 Brook Avenue New York City

B-C-L RADIO SERVICE CO., 223 Fulton Street, N. Y. City

Something New!
A Versatile Tube!
 First time offered to the public! The new Switch Tube is a Power Tube or a regular O1A Tube, at your option. Just turn the tiny switch in the base to convert it from one to the other. Also, if you burn out the O1A filament, the tube is still just as good as before, because you simply switch over to the Auxiliary Filament! Works from 6-volt source. Draws .25 amp. as O1A and .5 amp. as power tube. **\$3.00**
 Inquiries Invited from the Trade

STREAMLINE
 Tuned Radio Frequency Kit. Three Streamline .00035 straight frequency condensers; three coils; three Bruno Vernier Dials; one Bruno Light Switch. **\$9.50**

STREAMLINE SF CONDENSERS
 .0005, \$2.50; .00035, \$2.25; .00025, \$2.00

Bruno Slo-Moshen Vernier Dials **\$2.00** Bruno Magic Dial for SLC Condensers **\$2.50**

BRUNO LOW-LOSS COILS

 Bruno "99" or "55" RF Transformer. **\$3.00**

 Bruno "99" Tuning Coil **\$5.50**

 The Bruno Ruby Light Switch is a combination A battery switch and pilot light. When the knob is turned to the right, the bulb lights up, the set is on. When the knob is pressed, the set is turned off. Single hole panel mount. Price, less bulb **75c**

B-C-L RADIO SERVICE CO., 223 Fulton Street, N. Y. City

TEN MILLION POUNDS OF COPPER!
 The radio industry has more than doubled its consumption of copper during the last two years and is now approximating 10,000,000 pounds a year.

WORLD'S FINEST LOUD-SPEAKER
 A three-foot cone speaker—unit developed by the inventor of the Tropadyne. Can be assembled in fifteen minutes, saving 80% of the cost. Complete Kone Kit with blue prints sold on rigid money-back guarantee—shipped prepaid—\$10.
Engineers' Service Company
 Suite 203 15 Park Row, New York

AEROVOX
 "Built Better"
RESISTOFORMERS
 Tested and approved by M.I.T., Yale, Radio News, Popular Radio, and Popular Science. Used by over 200 of America's leading set manufacturers.
AEROVOX WIRELESS CORP.
 489-491-493 Broome St., New York
 Branch Offices:
 St. Louis, Mo., Syndicate Trust Building
 Cincinnati, O., 201 Federal Theatre Bldg.
 Chicago, Ill., 53 W. Jackson Boulevard
 Boston, Mass., 94 Portland Street
 Los Angeles, Calif., 324 N. San Pedro St.

FILL OUT AND MAIL NOW
SUBSCRIPTION BLANK
RADIO WORLD
 RADIO WORLD 145 West 45th Street, New York City (Just East of Broadway)
 Please send me RADIO WORLD for months, for which please find enclosed \$.....
SUBSCRIPTION RATES:
 Single Copy \$.15
 Three Months 1.50
 Six Months 3.00
 One Year, 52 Issues 6.00
 Add \$1.00 a Year for Foreign Postage; 50c for Canadian Postage.

RADIO NEWS

Regular Subscription Rate \$3 the Year

Your Choice of Either of These Valuable Premiums.

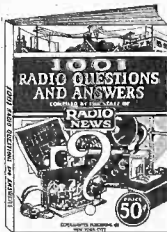

1001 Radio Questions and Answers

A brand new book filled to the brim with a priceless array of selected Questions and Answers that are necessary to every one in the construction, care and maintenance of modern sets, including information on hundreds of simple and complex circuits in common use today.

Contains 116 pages, 300 illustrations, size 9x12 inches—a big book for every radio man.

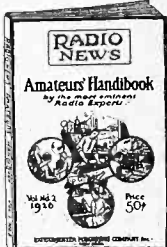

Amateurs Handbook

The "RADIO NEWS" Amateur Handbook is a large 116-page magazine size book containing a wide, varied and carefully selected array of the finest and most helpful radio articles that have appeared in the pages of Radio's Greatest Magazine, R A D I O NEWS. The cream of practical, up-to-the minute circuits and miscellaneous information and data is culled from RADIO NEWS and presented in compact form in this book. It embraces every phase of radio, but particularly the new and more practical receivers and circuits developed for modern reception.

BIG SPECIAL OFFER

\$3.00 Value for \$1.00

Radio News has been radio's greatest and biggest magazine since the very beginning of radio broadcasting. It is the outstanding authority in the radio industry, carrying more new developments, more detailed drawings and more news than any other radio periodical. Some of the regular features are liberal prize offers, an attractive rotogravure section, articles by Hugo Gernsback and other foremost writers, departments giving Standard Hook-ups, Radio Patents, etc. In short, Radio News covers everything worth while in the radio field.

SEND ONLY \$1.00 FOR SIX MONTHS' TRIAL SUBSCRIPTION TO "RADIO NEWS"—and take your choice of either of the two valuable premiums shown in this advertisement.

If you desire both premiums send \$2.00 for a full year's subscription.

EXPERIMENTER PUBLISHING CO., Inc.

53 Park Place (Dept. W.)

New York, N. Y.

DON'T MISS THIS BOOK—Fresh from the Press!

"500 RADIO WRINKLES"

A big book full of short cuts, hints and practical ideas

The 500 RADIO WRINKLES BOOK is a very comprehensive compilation of the best time and money saving hints that can be effected. Under fifteen separate and distinct headings, the entire field of radio apparatus and instruments has been covered in simple, understandable language. It is divided into sections covering Antennae, Batteries, Coil Mountings, Condensers, Crystal Detectors, Inductances, Lightning Protectors, Loop Antennae, Loud Speakers, Resistances, Sockets, Switches, Transformers, Vernier Dials. There are no ifs nor buts to complicate directions. The Beginner as well as the more advanced radio man will soon find that this book contains a veritable storehouse of practical, inexpensive hints toward improving his radio apparatus.

Large Size 9x12 Inches, 100 Pages, Illustrated

If your dealer cannot supply you, write direct to

EXPERIMENTER PUBLISHING CO., Inc.

53 Park Place

(Dept. W)

New York, N. Y.



PRICE 50c.

ON ALL NEWSSTANDS

100 PAGES

SIZE 9x12 INCHES

How to Wind a Loop On a Cardboard Frame

A large piece of heavy cardboard may be used as a loop form for a portable receiver, where the loop is enclosed on the inside of a hinged door. The size of the cardboard depends upon the size of the door. In this case a 1 foot square was used. The number of turns, also depends upon the capacity of the condenser. A .001 mfd. variable is used here, with a .0005 or a .00025, more turns and closer spacing will be necessary. For .001 use about 75 feet of wire, e.g., No. 20 DCC. For .0005 use 90 feet, for .00035, 100 feet. A ruler is laid diagonally across and a line is drawn. The ruler is then placed diagonally

ally across, so that the center point of the line just drawn hits the center point of the ruler. Draw a line across the ruler at this position. Draw a 3" square box in the center. Now 3" from the edges on all the four corners, make dots. Draw a box around these dots. Now at 1/4" points on the diagonal lines, within the two boxes, make dots. Take a compass needle or scribe and punch holes on both sides of each of these dots, e.g., 1/8" on each side of dot. There will be 11 loop holes on each diagonal. Thread these holes with wire or heavy cotton, leaving a little slack over each hole, so that the wire may be passed through. This is also done on each diagonal. Now obtain some No. 18 wire (bare or insulated), and beginning

VEBY HIGH-MU TUBES

Made especially for Resistance Coupled Amplifiers. Now you can get more volume with greater clarity.
A.F. 20 for 1st and 2nd Stage.....\$3.00
A.F. 6 Power Tube for 3rd Stage.....\$4.50

VEBY RADIO CO.

47-51 Morris Avenue Newark, N. J.

New and Improved FRESHMAN MASTERPIECE

AT AUTHORIZED
FRESHMAN DEALERS ONLY

We Specialize in Complete Kits
The M. & H. Engineering Service Will Supply Parts
or Complete Sets of Any Hook-Up

DESCRIBED IN THIS OR ANY
OTHER RADIO MAGAZINE

M & H SPORTING GOODS CO.
512 Market St. Philadelphia, Pa.

NEW FREE RADIO GUIDE 1926

Newest Edition Ready

Shows the latest circuits, the newest developments in radio at startlingly low prices. Get the parts you want here and save money. The best in parts, kits, sets and supplies. Orders filled same day received. Write for free copy NOW; also please send names of one or more radio fans.

BARAWIK COMPANY, 102-140 So. Canal St., Chicago.



Blueprints and Service \$3.00

LEO FENWAY

Consulting Radio Engineer
29 WEST 64th ST. NEW YORK, N. Y.

Microphone is Guarded



WHEN an announcer is broadcasting a narrative of a ball game he gets excited once in a while, like the rest of the crowd. So a guard is put in front of the microphone to prevent him, in the midst of forgetful excitement, from getting closer than 6' from the microphone. The photo shows Graham McNamee, WEAF announcer, at the Polo Grounds. His voice is carried from the microphone by land wire to 195 Broadway, whence it is sent by wire again to the WEAF transmitter at 463 West Street.

(Foto Topics)

in the center (punch small 1/8" starting hole here) start threading the wire. There will be 11 turns.

Now, using this loop, the door will consist of two pieces of wood, 1/4" thick and 1 1/2 feet square. The loop is placed between the two pieces. The leads are brought through the gaps between the boards, onto a pair of small binding posts on the board to be placed on the inside of the cabinet. Four bolts are then placed at the four ends of the boards, for holding. The door is then hinged onto the cabinet.

[Picture on front cover]

DC Voltmeter Designed By General Electric Co.

A direct-current voltmeter, a portable instrument designed especially for use with receiving sets and known as type DO-3, has been introduced by the General Electric Company. The instrument has a double scale, 0-7.5 and 0-150 volts, which combinations are most suited for measuring filament and plate voltages (A and B batteries).

The DO-3 instrument may be mounted on a panel, if desired, but probably will be more useful as a portable instrument. It operates on the D'Arsonval principle, is of unusually rugged construction, and is accurate to a high degree.

The resistance of the 7.5-volt circuit is approximately 500 ohms, and of the 150-volt circuit, 10,000 ohms, or 66 ohms per volt. Consequently the drain on either "A" or "B" batteries is negligible. Each instrument is supplied with a set of 18-inch leads with terminals.

The voltmeter is of use in several ways. It permits a close check on filament voltage and, since any increase above rated voltage materially reduces the life of a tube, it will prolong the usefulness of tubes. Similarly, it serves as a quick test on B batteries.

THE DIAMOND A BADGE OF MERIT

Join the Happy Thousands Who Triumphantly Built This 5-Tube Set!

Real
Know
Quality!



Easy to
Tune, Easy
to Build!

Herman Bernard, designer of this wonder circuit, has written an illustrated booklet on "How to Build RADIO WORLD'S 1926 Model Diamond of the Air." Send 50c and get this booklet, including a full-sized wiring blueprint and free nameplate.

Outstanding Features of Set: (1) Fans, charmed by tone quality, sensitivity and selectivity, report speaker reception of far-distant stations with great volume. (2) A 2-tube earphone set, a 5-tube speaker set, and a separate 3-stage audio-amplifier for immediate use with any tuner, are combined in one. (3) No rheostats are used. (4) The set is inexpensive to construct and maintain.

Send \$6 for year's subscription and get booklet, blueprint and nameplate FREE.

[Newsdealers or radio dealers, order the booklets with blueprints included, in quantity, direct from American News Co. or Branches.]

Radio World, 145 West 45th St., New York City
Nameplates Free to All

Radio Is Indispensable; Advisable in All Rooms

By E. E. Bucher

General Sales Manager, R.C.A.

One by one the many comforts of modern civilization and inventive genius have become integral features of the present-day American home. The central heating plant, sanitary plumbing, electrical appliances, the telephone and a host of other devices have entered the home to enlighten the burden of household routine and irksome duties and make life more enjoyable. And now the radio receiver has found entrance to the American home, taking its place side-by-side with the other products of industrial and scientific enterprise.

In fact, it is remarkable that, after five short but eventful years of development, radio broadcasting is a firmly established and indispensable element in the home-life of the American family. Having thus established itself as an institution in the homes of millions, radio service is showing a tendency to outgrow the confines of a single room just as electrical service, once limited to a number of locations in the home, is instantaneously and universally available, an ever-willing servant.

Radio, not so long ago, held forth in the attic or cellar of the home, there to be heard but not seen. Today, the art is face to face with the necessity of providing greater utilization of the various radio programs. It

must provide ample facilities for enjoying them, more fully and conveniently, in the home. For example, radio has something to say to the housekeeper while she is about her daily work in various parts of the house; radio has music for the family and friends during the summer's evening spent on the porch; radio has dinner music to make the meals all the more enjoyable; radio has setting-up exercises for the more ambitious members of the family in the privacy of their bedroom; radio has bedtime stories and lullabies for the kiddies; radio has plenty to do in whiling away the long hours of the sick member of the family in the seclusion of the bedroom. So radio is no longer a living-room variety of entertainment. Its place in the household is everywhere, rendering services from morning till night, to be heard by anyone at will and with the utmost convenience.

FREE RADIO CATALOG



Just off the press! Our second catalog for 1926. 100 pages of parts, accessories, kits and sets—all the best and the latest. A copy is yours for the asking. Just drop us a line—do it today!

DEPT. PM

CHICAGO SALVAGE STOCK STORE

509 S. State Street CHICAGO, U. S. A.

Bring in Europe on a
Victoreen "Super"

Write for Layout and Parts List
THE GEORGE W. WALKER CO.
6515 Carnegie Avenue Cleveland, Ohio

HARD RUBBER

SHEET—ROD—TUBING
Special Hard Rubber Parts Made to Order
**RADION HARD RUBBER
PANELS ANY SIZE**
Send for price list.
WHOLESALE. RETAIL.
NEW YORK HARD RUBBER TURNING CO
212 Centre Street New York

QUICK ACTION CLASSIFIED ADS

10 CENTS A WORD. 10 WORDS MINIMUM. CASH WITH ORDER

LONG DISTANCE CRYSTAL SET PLANS. \$1.00. Loudspeaker volume. Patent pending. Write Burgess, 618 3d St., S. W. Washington, D. C.

SET BUILDERS SEND FOR price lists and discounts. Martien Radio Shop, Galion, Ohio.

PATENTS—Write for free Guide Books and "Record of Invention Blank" before disclosing inventions. Send model or sketch of your invention for our inspection and instructions free. Terms reasonable. Radio, Chemical, Mechanical, Electrical and Trademark experts. Victor J. Evans Co., 924 Ninth, Washington, D. C.

THE NEW 1-DIAL POWERTONE SET, by Capt. P. V. O'Rourke, appeared in RADIO WORLD dated April 17, sent on receipt of 15c, or start sub. with that number. RADIO WORLD, 145 W. 45th St., N. Y. C.

THE 5-TUBE SUPER HETERODYNE SET, by Jasper Jellicoe, appeared in RADIO WORLD dated April 17, sent on receipt of 15c. RADIO WORLD, 145 W. 45th St., N. Y. C.

CASH PAID FOR Dental Gold, False Teeth, Discarded Jewelry, Diamonds, Platinum. Mail, Florida Gold Refining Co., 21 Adams, Jacksonville, Fla.

BULLDOGS

BEAUTIFUL REGISTERED BULL PUPS. \$15. Bulldogs, 501 Rockwood, Dallas, Texas.

600 MILE RADIO. \$2.95. NO BATTERY nor tubes needed. Always ready. Fully guaranteed. 200,000 sold. No screening nor grinding. Real radio, no toy. Sent postpaid. Order one today. Crystal Radio Company, Wichita, Kansas.

THE CONTROL OF FEEDBACK, by Barney Feete, appeared in RADIO WORLD dated April 24. Sent on receipt of 15c, or start sub. with that issue. RADIO WORLD, 145 W. 45th St., N. Y. C.

THE AERO ALL-WAVE SET, by Capt. P. V. O'Rourke, appeared in RADIO WORLD dated April 24 and May 1. Sent on receipt of 30c. RADIO WORLD, 145 W. 45th St., N. Y. C.

Good Back Numbers of RADIO WORLD

The following illustrated articles have appeared in recent issues of RADIO WORLD:

1925:

Aug. 29—A Set a Baby Can Build, by Herbert E. Hayden. A Fine Meter Switchboard, by Lewis Winner.

Sept. 12—The 1926 Model Diamond of the Air, (Part 1), by Herman Bernard. A 25-to-110 Meter Receiver, by Sidney R. Finkelstein.

Sept. 19—Diamond of the Air (Part 2), by Herman Bernard. A Tube B Battery Eliminator, by Louis Winner.

Oct. 24—A Phonograph Cabinet Set, by Lewis Winner. The Thoroughbred, by Herbert Hayden (Part 2).

Oct. 31—The 4-Tube Pathfinder, by S. E. Finkelstein. How to Make a Simple Loop, by Herbert E. Hayden.

Nov. 7—A 3-Tube Dry-Cell Circuit, by Capt. P. V. O'Rourke. One of the Best Crystal Sets, by Herbert E. Hayden. 1-Tube DX Set, Herman Bernard.

Dec. 5—A Toroid RF Set, using Crystal, by Lewis Winner. The Diamond of the Air (In Text and Diagram), by Herman Bernard.

Dec. 12—A Self-Contained Receiver, by H. E. Hayden (Part 1). B Battery Eliminator, by Lewis Winner (Holiday Gifts No.).

Dec. 26—The Regenerative Wave Trap, by John E. Bider. The 5-Tube Tuned RF Set, by Capt. P. V. O'Rourke.

1926:

Jan. 2—The 2-C Set for Simplicity, by Capt. P. V. O'Rourke.

Jan. 9—The 4-Tube DX Symphony Set, by A. Irving Witz. A Skillfully Made 1-Dial Set, by Herman Bernard.

Jan. 16—Anderson's 5-Tube Quality Receiver. The Haytheon B. Eliminator, by Lewis Winner.

Jan. 23—The 4-Tube Diamond of the Air, by Herman Bernard. The Diamond of the Air, by Herbert E. Hayden (Part 1). B Batteries Last Six Months, by S. E. Finkelstein.

Jan. 30—An Individual AF Amplifier, by H. E. Hayden. The Antennatrol, by Herbert E. Hayden (Part 2). Trapping Out Super-Power in New Jersey, by Capt. P. V. O'Rourke.

Feb. 6—The Fenway (4 or 9 tubes), by Leo Fenway (Part 1). The Great 1-Tube DX Set, by Herman Bernard.

Feb. 13—Anderson's 5-Tube Economical Receiver. Trouble Shooting for Novices, by M. B. Strock. The Fenway, by Leo Fenway (Part 2).

Feb. 20—The 8-Tube Victoreen, by Herbert E. Hayden. The Fenway, by Leo Fenway (Part 3). Quality Stressed in 9-Tube Set, by Brainerd Foote.

Feb. 27—The 4-tube DX Dandy, by Herbert E. Hayden. Umbrella Aerial for DX, by Hugo Gernsback. Part 2 of the Victoreen.

Mar. 6—The 1 tube Set, by Capt. O'Rourke. The Chemistry of Batteries, by A. R. Beld. The Victoreen Set (Part 3), by Herbert E. Hayden.

Mar. 13—The Non-Regenerative Browning-Drake Set, by M. B. Sleeper. The Tectron Eliminator (Part 1), by Lewis Winner. Curious Victoreen Trouble, by Herbert E. Hayden.

Mar. 20—The Super-Heterodyne, by J. E. Anderson. A 2-Tube Speaker Set, by Percy Warren. The Browning-Drake Set (Part 2), by M. B. Sleeper. A 2-tube Eliminator, by Lewis Winner.

Mar. 27—An Economical 4-Tube Set, by Edgar T. Collins. A Practical B Battery, by Capt. P. V. O'Rourke. Tectron Trouble Shooting, by Lewis Winner.

April 3—The Bernard Portable, by Herman Bernard (Part 1). How to Get Dx, by Capt. P. O'Rourke. A Compact B Supply, by Lewis Winner.

April 10—The Bernard Portables, by Herman Bernard (Part 2). Two Eliminators for DC, by Lewis Winner. A Super From An Old Set, by C. King.

April 17—The New 1-Dial Powertone, by Capt. P. V. O'Rourke. The Bern rd Portable (Part 3), by Herman Bernard. The Action of Transformers, by Lewis Winner.

April 24—All Waves on One Set, by Capt. P. O'Rourke. Bernard's Portable (Conclusion). Control of Feedback, by Barney Feete.

May 1—New Multiple Tube, by Herman Bernard. The Aero All-Wave Set, by Capt. O'Rourke. Kilocycle-Meter Chart. Official List of Stations.

Any copy, 15c. Any 7 copies, \$1.00. All these 27 copies for \$3.85, or start subscription with any issue. RADIO WORLD, 145 W. 45th St., N. Y. C.

1925 BACK NUMBERS OF RADIO WORLD WANTED

Mail us copies of any of the following 1925 issues of RADIO WORLD, and we will send you a copy of a current issue for every copy sent us: February 21, April 4, 11; May 16, 23; June 6, 13, 20; July 4, 11, 18, 25; Sept. 5, 26, 1925.

Police Reserve Adopts The Diamond of the Air

Among the activities of the Police Reserve of the City of New York is the class in radio. Believing that radio communication will be one of the most important factors in police work, the officers decided that a knowledge of this form of communication should be part of the equipment of the members of the Reserve.

The radio class, established in 1924, was organized to give the members a comprehensive knowledge in lessons easily understood by the average person and at no expense to the student.

The course was planned by Major

Edward B. Craft. Associated with him in an advisory capacity are Capt. Joseph D. R. Freed, Capt. Peter V. O'Rourke, Lieut. Claude Golden, Lieut. Paul Hoernel, Lieut. Charles R. Leutz and others.

The corps of instructors includes Capt. George F. Morrison, Lieut. Joseph E. Engstrom, Sergt. Claude Boyles and Pvt. Howard Ragsdale, all experts. Lieut. Engstrom, a commercial operator, is responsible for the instruction in code and preparation for examinations for licenses. The class is under the supervision and direction of Col. Oscar H. Williams, commanding Headquarters Division.

During the life of the class a number of students have been enabled to obtain their amateur licenses through the instruction received and in one case a student has started and worked up a lucrative business in parts and receivers.

Lager and O'Rourke Thanked

It was felt that the instruction in set

building should be, for the present, confined to one particular circuit, thus simplifying matters for both students and instructors. The question of what circuit to concentrate on then arose. This was settled by adopting a circuit with one stage of radio amplification, regenerative detector, one stage of transformer audio and two of resistance audio amplification. This arrangement would give the students a working knowledge of what goes into one of the best present day types of receivers. Next arose the question of what material would best serve the purpose of instruction for this particular circuit. A survey of the market of kits and knock-down receivers was then made. The survey resulted in an unanimous decision that the Diamond of the Air, originated by Herman Bernard, was ideal for the purpose. Through the interest and kindness of Louis Lager, of the B. C. L. Radio Service Co., and Capt. P. V. O'Rourke, the class was presented with one of the complete kits.

An Ideal Circuit

The circuit being simple to make and easy to tune, the students rapidly grasped what the instructors were teaching. Each part, before being placed in the set, was explained as to its construction and function. When the set was finally completed and put to work it demonstrated to the full every claim made for it. Plentiful DX was obtained, with rich, clear tone.

In addition to instructing the class, the instructors have informally made themselves into a service unit which will trouble hunt and repair the set of any member of the Reserve or of the regular department who will bring his instrument to the class room.

SANGAMO CONDENSERS WESTON INSTRUMENTS MAGNATRON TUBES

All types and sizes carried regularly in stock for immediate delivery.

ROSSITER & CO., Inc.

Wholesale Distributors

136 Liberty Street

New York

The AIRGAP SOCKET

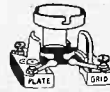

The gap prevents closed circuit, inter-coupling, feedback and undesirable capacity (which causes the squeaks and howls), resulting in more stable circuit, sharper tuning, clearer and louder reception.

Electrically and Mechanically It's Perfect
Sent direct if your dealer cannot supply you, 75c each.

AIRGAP PRODUCTS CO., Mfr.
9 Campbell Street Newark, N. J.
IT GETS THAT LAST MILE

CRAM'S INTERNATIONAL RADIO ATLAS

This latest and greatest Radio Atlas has four big maps, a list of all the Radio Stations in the United States, Canada and the entire world, alphabetically arranged by states and cities, latest wave lengths, kilocycles and names of operators. Liberal space for your private log. Postpaid on receipt of 50c or one sent free with new yearly subscription for Radio World (\$6.00 for 52 nos.), but with no other premium.

THE COLUMBIA PRINT

145 W. 45th St.

New York City

FENWAY —for DX

Winter or Summer the Fenway is a consistent DX-getter. Naturally, you want to own one of these super-sensitive receivers. Fenway Blueprints show you how to build a laboratory set.

PRICE OF COMPLETE SET OF BLUEPRINTS—\$3.00 Postpaid

Others Give Their Radio Prints Away FREE!—Fenway Prints Cost

You \$3.00—WHY?

Radio Division, The Columbia Print
147 West 45th Street New York City

ACCUSTI-CONE SPEAKER

FROM FACTORY TO YOU

19-inch Full Size \$7.50
full floating cone

Would cost \$30 in a retail store. You save by buying direct. It is superior to any speaker made. Try it in your home; if not satisfied, return and get money back.

Accusti-Cone Laboratories
96 Church St. New York

RADIO WORLD'S PREMIUM SUBSCRIPTION OFFER For NEW RADIO WORLD Subscribers Ordering NOW

Radio World has made arrangements

- To offer a year's subscription FREE for any one of the following publications with one year's subscription for RADIO WORLD
- RADIO NEWS or -BOYS' LIFE or
- POPULAR RADIO or -RADIO DEALER or
- RADIO BROADCAST or -RADIO (San Francisco) or
- SCIENCE AND INVENTION or -RADIO AGE or -COLLIER'S

This is the way to get two publications

- for the price of one:
- Send \$6.00 today for RADIO WORLD
- for one year (regular price
- for 52 numbers)
- and select any one of the other
- nine publications for twelve months.
- Add \$1.00 a year extra for
- Canadian or Foreign Postage.
- Present RADIO WORLD subscribers
- can take advantage of this offer by
- extending subscriptions one year
- if they send renewals NOW.

RADIO WORLD'S SPECIAL TWO-FOR-PRICE-OF-ONE SUBSCRIPTION BLANK

RADIO WORLD, 145 West 45th Street, New York City.

Enclosed find \$6.00 for which send me RADIO WORLD for twelve months (52 numbers), beginning..... and also without additional cost, Radio Broadcast, or Popular Radio, or Radio News, or Science and Invention, or Radio Dealer, or Radio (San Francisco), or Radio Age, or Boys' Life, or Collier's (or \$10.00 for two yearly subscriptions).

Indicate if renewal.

Offer Good Until

June 2, 1926

Name

Street Address.....

City and State.....

Balloon Race Safety Increased by Broadcast

Radio broadcasting has taken a hand to prevent the loss of life which occurs annually in connection with balloon racing. The first experiment along this line was conducted in connection with the National Balloon Elimination Race that started from Little Rock, Arkansas.

"The use of radio broadcasting to give

the balloonists ample information regarding weather conditions, winds, barometric pressures and other data so necessary to aerial navigation should result in fewer casualties in this exciting sport," says J. E. Van Orman, the pilot of the Goodyear entry in the coming contest. "Once the balloons have left the ground, the pilots

Station Seeks Trade Mark Of Its "Invisible Phrase"

CHICAGO.

For the first time in the history of radio, so far as is known, an attempt will be made to register an invisible phrase as a trade mark. The main point involved is the question of whether spoken words can be "stamped" on the other waves that transmit them in broadcasting. This interesting legal problem is to be submitted to the Commissioner of Patents at Washington for adjudication.

The phrase in question is the one that has been officially adopted by the Stewart-Warner Speedometer Corporation in connection with broadcasting Station WBBM. It is as follows: "WBBM—the Stewart-Warner Air Theater—Chicago."

Attorneys for the corporation have already set the legal wheels in motion to have this phrase registered as a trademark. It is their contention that a trademark is a mark that is identified with a commodity; that in this case the commodity is one that is subject to interstate jurisdiction; and that it is in fact the commodity of entertainment for broadcasting listeners.

In presenting the case the attorneys will offer unusual exhibits. One will be a phonograph record of the phrase as it is announced every night over the air by Charlie Garland, Broadcasting Director, and Nate Caldwell, Chief Announcer. In addition a copy of the program together with the designated phrase interlined just as it is spoken over the microphone, will be exhibited.

When the question first arose it brought up the point that there is a difference between a trademark and a slogan. The

Builder is Appreciative Of His High-Class Set

RESULTS EDITOR:

May I express my hearty thanks and sincere appreciation? I am a subscriber for RADIO WORLD and expect to be as long as I live. I have built over 75 different circuits, 10 from RADIO WORLD. I have been pleased with them all, but am tickled most with the Diamond of the Air. It produced such remarkably good results that I feel duty-bound to let you know about it. When any one reads my log of stations picked up on loud speaker, without the use of head phones, in the heart of N. Y. City I have no doubt he will agree that I have just cause to be proud and thankful. The locals were gotten on a loop, the rest on outside antenna. I have no interference or cross talk, no oscillation trouble, no regrets whatever. I can get all voice and instrument reproduced, both high and low, to the queen's taste.

ALONZO BERNARD COLES,
141 W. 98th Street, N. Y. City.

trademark is a mark which is used to identify a commodity. A slogan is a phrase which serves to describe the commodity.

In this case the commodity is in the form of music, songs and other entertainment and it is the belief of the attorneys that as a commodity the corporation has a right to stamp on it a specified trade mark even if that mark is invisible.

FREE RADIO BOOK

Science has invented a new kind of coil. Now have it on your present set. Gives 4 great advantages otherwise impossible. Write for new book just published showing many new ideas. Also 8 new circluid circuits. Address Electrical Research Laboratories, R.W., 2548 Cottage Grove Avenue, Chicago.

Vacuum Tubes Rebuilt \$1.00 each

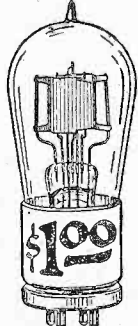

POSITIVELY GUARANTEED equal to new tubes in every respect. Money will be refunded if tubes prove unsatisfactory for any reason other than burn-outs.

Send us your broken and burned out tubes by parcel post. (Not necessary to insure or guard against breakage.) We make return shipments by parcel post C.O.D. and try to maintain 24-hour service.

HARVARD RADIO LABORATORIES
200 Old Colony Avenue
South Boston, Mass.



FIXED RESISTORS

Micamold

REG. U.S. PAT. OFF.

FIXED CONDENSERS

Specified for the Fenway. Superior in all circuits. Accurate, Constant in Value, Indestructible. "Made of Mica and Moulded in Bakelite."
At Good Radio Stores.

MICAMOLD RADIO CORP.,
Flushing and Porter Aves.,
Brooklyn, N. Y.



ACCURACY GUARANTEED
-VALUES REMAIN CONSTANT



HOLED UNDER PRESSURE OF 50 TONS

are thrown upon their own limited resources to determine the future weather conditions and an error often means the loss of two lives.

"With radio to advise them with certainty about storm areas, the pilots can avoid them to a certain extent, and if no other means of getting around a storm can be found, the balloon can be brought to land. It will also be helpful to know the whereabouts of the other contestants and it will no longer be necessary for a pilot to drift on for hours and possibly run into perils which will cost him his life when he has already won the race."

Station WJZ was selected to supply this information to the contestants, primarily on account of the great power which this station uses, making it practically impossible for the balloons to drift beyond the range of the station. The balloons were equipped with sensitive receivers, specially constructed with lightness as the prime factor.

Join the Happy Diamond Family!

Build This Famous 5-Tube Set and Know Real Quality Reception!

Easy to Build, Easy to Tune!

Herman Bernard, designer of this wonder circuit, has written an illustrated booklet on "How to Build RADIO WORLD's 1926 Model Diamond of the Air." Send 50c and get this booklet, including a full-sized wiring blueprint. Also name plate, FREE.

Outstanding Features of Set:

- (1) Fans, charmed by tone quality, sensitivity and selectivity, report speaker reception of far-distant stations with great volume.
- (2) A 2-tube earphone set, a 5-tube speaker set, and a separate 3-stage audio-amplifier for immediate use with any tuner, are combined in one.
- (3) No rheostats are used.
- (4) The set is inexpensive to construct and maintain.

What the Circuit Is

The 1926 Diamond consists of one stage of tuned radio-frequency amplification, regenerative detector, one transformer-coupled audio stage, and two resistance audio stages—the utmost from five tubes!

Follow Bernard

You can't go wrong if you follow the directions as written by the designer himself, as contained in the booklet. The diagrams, including blueprint, are guaranteed 100% accurate. Play safe!

Send \$6 for year's subscription and get booklet blueprint and nameplate FREE.

[Newsdealers or radio dealers, order the booklets with blueprints included, in quantity, direct from American News Co. or branches.]

RADIO WORLD
145 West 45th St., New York City

IT DOES THE TRICK!

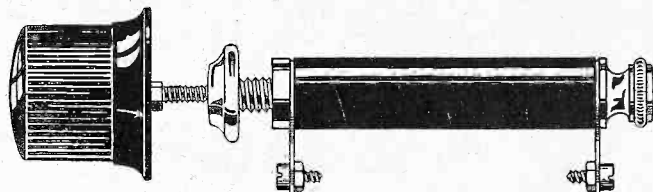

The Bretwood Variable Grid Leak

(Bretwood, Ltd., Sole Patentees and Owners)

Guaranteed Precision Range 1/4 to 10 Megohms

Brings in More Distant Stations — Affords Greater Volume — Improves Tone Quality! Fits Any Set, Panel or Baseboard. Price, \$1.50

“Nothing Better”

The North American Bretwood Co.

For some time I have seen in the Radio World your advertisement of the Bretwood Grid Leak, as well as some of your testimonials, and I decided to try one of them at the first opportunity which presented itself last night.

I own a 5-tube factory built set. During the last three days I could not get a sound out of it due to what I thought was a terrific spell of static, but which was caused by a defective grid leak. The noise was indeed so terrible that rather than hear such a racket I turned off the set and went to bed.

To-day, as luck would want it, I happened into a store and saw a Bretwood Variable Grid Leak on display. I decided to try it immediately. The results were absolutely gratifying. Other sets in the neighborhood are not getting anything at all, while I have brought in a great number of stations with speaker volume, with a socket aerial. I must say for the benefit of those who have not tried your grid leak that there is nothing better in this line.

ALFONSO FABRIS ARCE,
4116 Ave. R, Galveston, Tex.

The North American Bretwood Co.

Telephone, BRyant 0559

145 West 45th Street, N. Y. City

Sole Distributors for United States

North American Bretwood Co., 145 West 45th St., N. Y. City.

Gentlemen: Enclosed find \$1.50. Send me at once one Bretwood Variable Grid Leak on 5-day money-back guarantee.

NAME

ADDRESS

CITY STATE

Inquiries Solicited from the Trade



“The little wrinkle that makes my ‘B’ batteries last longer is using the right size Evereadys with a ‘C’ battery”

“I USED to think that because the Eveready ‘B’ Battery No. 772 cost less than either of the larger Heavy Duty Evereadys that I was saving money. As a matter of fact, on four or five tube sets, that was false economy.

“The right size Eveready ‘B’ Batteries to use depends on the number of tubes in your set. The life of the batteries depends on how much you listen in and on whether a ‘C’ battery is employed.”

To get the maximum of “B” battery life and satisfaction, follow these simple rules:

- On 1 to 3 tubes—Use Eveready No. 772.
- On 4 or more tubes—Use the Heavy Duty “B” Batteries, either No. 770, or the even longer-lived Eveready Layerbilt No. 486.
- On all but single tube sets—Use a “C” battery*.

Follow these rules, and No. 772, on 1 to 3 tube sets, will last a year or more; Heavy Duties, on sets of 4 or more tubes, eight months or longer.

The average year-round use of a set is two hours a day. If you listen longer,

your “B” batteries will have a somewhat shorter life. If you listen less, they will last longer.

Our new booklet, “Choosing and Using the Right Radio Batteries,” is free for the asking. It also tells about the proper battery equipment for the new power tubes.

*NOTE: A “C” battery greatly increases the life of your “B” batteries and gives a quality of reception unobtainable without it. Radio sets may easily be changed by any competent radio service man to permit the use of a “C” Battery.

Manufactured and guaranteed by
NATIONAL CARBON CO., INC.
 New York San Francisco
 Canadian National Carbon Co., Limited
 Toronto, Ontario

Tuesday night means Eveready Hour—8 P. M., Eastern Standard Time, through the following stations:

- WEAF—New York
- WJAR—Providence
- WEEL—Boston
- WTAG—Worcester
- WFI—Philadelphia
- WGR—Buffalo
- WCAE—Pittsburgh
- WSAI—Cincinnati
- WTAM—Cleveland
- WWJ—Detroit
- WGN—Chicago
- WOC—Davenport
- WCCO—Minneapolis
- WCCO—St. Paul
- KSD—St. Louis

LEFT — No. 486, for 4, 5 or more tubes. \$5.50.

RIGHT — Eveready Dry Cell Radio “A” battery, 1½ volts.

EVEREADY
 Radio Batteries
 —they last longer

May 15 1936

RADIO

Reg. U. S. Pat Off.

WORLD

Vol. 9. No. 8. ILLUSTRATED Every Week

165-26

**GAINING EFFICIENCY IN
SUPER-HETERODYNES**

*How to Arrange Aerial
For the Utmost DX*

THE TRUTH ABOUT COILS

Sunset Effect on Signals



G.SHEEDY.

THE CHARLESTON—OF COURSE

IT DOES THE TRICK!

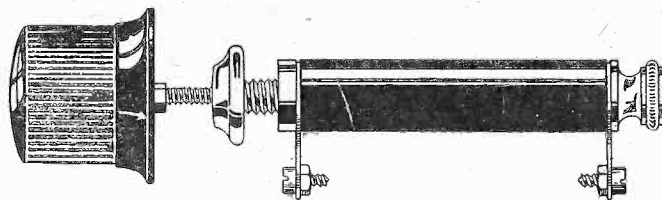

The Bretwood Variable Grid Leak

(Bretwood, Ltd., Sole Patentees and Owners)

Guaranteed Precision Range $\frac{1}{4}$ to 10 Megohms

**Brings in More Distant Stations — Affords
Greater Volume — Improves Tone Quality!
Fits Any Set, Panel or Baseboard. Price, \$1.50**

"Nothing Better"

The North American Bretwood Co.

For some time I have seen in the Radio World your advertisement of the Bretwood Grid Leak, as well as some of your testimonials, and I decided to try one of them at the first opportunity which presented itself last night.

I own a 5-tube factory built set. During the last three days I could not get a sound out of it due to what I thought was a terrific spell of static, but which was caused by a defective grid leak. The noise was indeed so terrible that rather than hear such a racket I turned off the set and went to bed.

To-day, as luck would want it, I happened into a store and saw a Bretwood Variable Grid Leak on display. I decided to try it immediately. The results were absolutely gratifying. Other sets in the neighborhood are not getting anything at all, while I have brought in a great number of stations with speaker volume, with a socket aerial. I must say for the benefit of those who have not tried your grid leak that there is nothing better in this line.

ALFONSO FABRIS ARCE,
4116 Ave. R, Galveston, Tex.

The North American Bretwood Co.

Telephone, BRYant 0559

145 West 45th Street, N. Y. City

Sole Distributors for United States

North American Bretwood Co., 145 West 45th St., N. Y. City.

Gentlemen: Enclosed find \$1.50. Send me at once one Bretwood Variable Grid Leak on 5-day money-back guarantee.

NAME

ADDRESS

CITY STATE

Inquiries Solicited from the Trade

RADIO WORLD

[Entered as second-class matter, March, 1922, at the post office at New York, N. Y., under Act of March 3, 1879]

A Weekly Paper Published by Hennessy Radio Publications Corporation from Publication Office, 145 West 45th St., New York, N. Y. Just East of Broadway Phones: BRYant 0558 and 0559

Vol. IX. No. 8. Whole No. 216.

May 15, 1926

15c per copy, \$6.00 a year

Super-Heterodyne Results Brought Up to Maximum

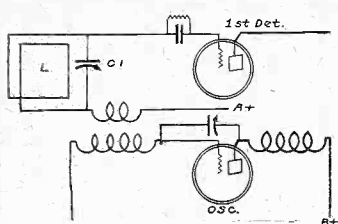

FIG. 1

The Hartley oscillator for a Super-Heterodyne. The coupling coil is the one connected to loop.

By Herman Bernard

Associate, Institute of Radio Engineers
MANY users of Super-Heterodynes must have noticed that the loop circuit tunes broadly and that the selectivity burden falls upon the oscillator. This tuning condition is due to the Super-Heterodyne action taking place after the loop tuning is accomplished. First the signal frequency is tuned in, and if we stop there we have a tuned impedance input, which is always broad, whether it be a loop or a single-winding coil connected to aerial and ground. The next tuning operation concerns the oscillator, which is tuned to a frequency not far removed from that of the broadcasting station's wave, but the difference between the two, subtracting either one from the other, gives the much higher wavelength, known as the intermediate or medium frequency. It is between the audible and the signal frequencies.

The assumption that a loop is more selective than an outdoor antenna is not well founded. It may be but usually is not. Whenever you use an external loop, meaning thereby one which is not wound around the inside of the cabinet and fixed there, you have a tuning control, because the loop should be turned in the direction of the station desired to be heard. This is known as the directional quality of the loop. Also, the tuning condenser across the loop must be varied for different wavelengths. Hence each loop entails two controls.

Fixed Loop Inefficient

It may happen that, with many local stations, all-sufficient volume is obtained without rotating the loop. The same position may be maintained not only for locals but for some distant stations. This led to the enclosed type of loop being introduced, but the efficiency factor naturally declined, because the directional effect is noticeable indeed on weak signals, and to be denied the advantage is about the same as being shielded from weak stations. They don't come in.

Just as much selectivity may be ob-

tained from an outdoor aerial as from a loop, if the coupling between antenna coil and secondary of the tuned input circuit is sufficiently loose. It is incredible to some how far distant from the secondary this primary coil may be. In one receiver, for instance, the distance is nearly three inches, but that is rather a wide space.

Reduction of Noise Pickup

The reason for large separation, of course, was the reduction of the static level, as compared with the signal level, since the Super-Heterodyne is so sensitive that in many instances an outdoor aerial results in a noisy receiver. With wide separation between primary and secondary, the Super-Heterodyne, operated on an outdoor antenna, of course has no directional effect, unless some slight effect is obtained due to the direction in which the aerial runs and the point where the lead-in is taken. This is never more than meagre with a receiving aerial.

You have one less thing to move than if you were using a loop, and you have as much selectivity, probably more, unless you are using a long antenna. For a Super-Heterodyne a 30-foot aerial is long enough, usually, and if it is outdoors greater pickup may be accomplished, if desired, by increasing the height of the aerial. But an indoor wire of that length is ample.

The objection to using an outdoor aerial with a Super-Heterodyne is radiation. To prevent radiation, which means sending out squeals that are received in others' sets, a stage of tuned radio-frequency amplification, properly neutralized, may be placed ahead of the first detector. This greatly increases selectivity, but inaugurating that quality in a part of the circuit independent of the oscillator circuit. Indeed, if one builds a Super-Heterodyne for the sole object of receiving far-distant stations with speaker volume, he may be disappointed unless he makes the circuit, prior to the oscillator action, fairly selective. This may be done by the addition of the stage of tuned radio-frequency or, without adding an extra tube, by introducing regeneration in the first detector stage. The regeneration sharpens the selectivity peak very considerably and adds likewise to the sensitivity.

Limits of Super-Heterodyne

Without regeneration or tuned RF the Super-Heterodyne, operated on a loop, need not be expected to exceed in distance and other performance, the good models of five 5- and 6-tube TRF receivers. Indeed, one very strong point in favor of the Super-Heterodyne is its ability to perform, when operated on a loop, as well as the good TRF receivers, of fewer tubes, operating on a suitable

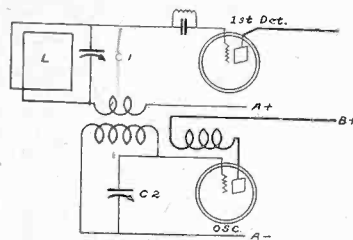

FIG. 2

The Meissner system of oscillation.

outdoor antenna. Hence the Super-Heterodyne is admirably adapted to use in an apartment house in a large city or under similar conditions of air congestion and obstacles to outdoor antenna erection.

In searching out the far-distant stations, however, on either loop or outdoor antenna, the Super-Heterodyne needs the regenerative action in the first detector, or the stage of tuned RF. When regeneration is introduced it need not be of the variable sort, since critical regeneration is not necessary. All that is required is sufficient feedback whereby the input tuning is sharpened.

Regeneration Method

If a loop is used, and this advantage is sought, a small fixed condenser may be connected from the plate of the first detector to one terminal of the loop, while the grid return connection, instead of being made from a terminal of the loop winding, is made to a tap on the loop. If a 14-turn loop is used the tap may be at the fourth turn. Thus four turns of the loop are in the plate circuit and 10 turns in the grid circuit, although the tuning condenser is across the entire loop winding. The fixed condenser may be .0001 or .00025 mfd., or something on that order. Its capacity depends somewhat on the location of the tap, so a little experimenting here will prove of value. The connection results in the establishment of a shunt capacity feed or Hartley oscillator system in the first detector.

The Squeal Means DX

From the foregoing it may be supposed that the seekers after extreme DX must have a Super-Heterodyne that is of the squealing variety, and this indeed seems to be the case. If all one desires is a set that will operate well from a loop, and equal or exceed in performance a 5-tube set operated from an outdoor aerial, then this regenerative feature is unnecessary.

As all the pickup one should require may be derived from a loop, and regeneration will diminish the broadness in the input circuit, the DX hunter will confer

Weak Spots Strengthened

a favor upon his neighbors, and indeed upon persons perhaps miles away, by using only a loop, if he intends to incorporate regeneration. While a loop radiates, it does not do so to any great extent, the radiation being confined very often to a matter of yards. Theoretically it is infinite, as are all radio waves.

The mere inclusion of regeneration will not prove a panacea, however, because of all the circuits wherein impediments to the desired goal may arise, the Super-Heterodyne seems to lead. This applies particularly to such receivers as are home-constructed. No specific exception is made of factory-made Super-Heterodynes, however, because persons who buy them, of their own volition expect more than they should, due to price of set and the number of tubes used. Besides, if they do not know how to tune the set properly their results may be very poor. The use of the double effect of the oscillator, for instance, is something that needs to be understood and mastered.

A station may be brought in at a given setting of the first detector input, C1 in Fig. 2, and at either of two settings of the oscillator condenser, C2, because in one instance the oscillator frequency is subtracted from the modulator frequency, while in the other instance the modulator frequency is subtracted from the oscillator frequency. In either instance, sum or difference, the answer is the same intermediate frequency.

Options Valuable

Often station beat notes and other interference may be eliminated by changing over to the other oscillator setting, or, apart from interference, volume may be better one way than another. As a general rule one setting or the other—upper or lower oscillator dial reading—will give generally superior results over the tuning scale, hence if one properly rotates C1 and C2 in unison, the return to a previous station, though one is seemingly on another band, will be avoided. An exception is that if the set tunes to sufficiently low wavelengths, harmonics of broadcast frequencies may be picked up. An harmonic is a multiple of the fundamental or broadcast frequency, or a fraction of the wavelength. A station transmitting at 500 meters, for instance, which is the fundamental wavelength, has its second harmonic at 250 meters.

Violation of Rules

Stations should not send out anything except the fundamental, which is the first harmonic, and it is against the rules of

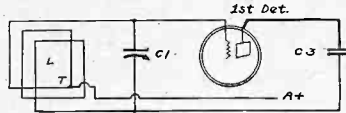

FIG. 3
The regenerated loop circuit.

the Department of Commerce to do otherwise, but some infract the rules, and second harmonics are on the air frequently. This becomes a nuisance indeed when the second harmonic of some powerful local drowns out other stations whose fundamental is at or near the same wavelength as the other's harmonic. Then cutting through the local's harmonic is the barrier to distance reception in addition to other obstacles.

When this condition exists to the point of nuisance it is all the more necessary to have an ultra-selective receiver, for then the opportunity is best for tuning out interfering harmonics, as well as overlapping fundamentals.

Every one knows the behavior of his receiver when tuning in locals, especially powerful ones, for the words and music come in with a fine boom, delightful to hear. One hopes for such volume and clarity from distant stations, but the hope is in vain, for it can not be done, and there is no present indication that it ever will be done. The locals therefore take more than their share of the air, in a practical sense. Stations the country over are separated, as to frequency, by 10,000 cycles, and as each emits probably a total sideband of 5,000 cycles, there are, in theory, 5,000 cycles to spare. This is the silent area on the dial between stations.

The Safety Margin

Local stations that come in strong occupy more than the allotted share of the dial. Putting it differently, in practice these stations use more than the theoretical channel. The drowning effect of their power, if there were two stations, one 10,000 cycles from the other, would result in one hearing both stations at the same time, no matter if the receiver were manually tuned to only one of them. Fortunately, the minimum separation (10,000 cycles) prevails only with stations separated by considerable distance, and the power question does not arise as to channel neighbors. But it does arise on another score—the operation of the receiver so as to produce excellent quality for local reception, while the quality on distant reception is merely the best that

one may obtain under the circumstances, though it be none too good.

It must be conceded that quality and distance do not go hand in hand and that anyone with a penchant for hearing the far-off stations is willing to forego quality, as to them. But how about locals? Is he willing to have a receiver so selective as to bring in distance with great consistency, at the expense of injuring the quality of reception from local stations? Extreme selectivity, of course, makes the resonance curve—frequency plotted against dial setting—so sharp that a slice is taken off the 5,000 cycle margin. When that happens quality begins to fly away.

The answer is that the power of the locals, the spreading effect whereby their waves occupy more space than conventionally supposed, takes care of the quality aspect, and there is no reason, on the quality score, for having any change-over system for making the set utilize fewer tubes and tune less sharply. Economy of tubes and watts would be some reason for such a switching arrangement, but the quality argument is not a good reason.

Two Excellent Oscillators

Feeling that selectivity is safe, therefore, one need inquire only as to the further means of making the set suitably selective. The oscillator's important part in this performance has been mentioned. The tube used as the oscillator should be the best one you have for the purpose. Also the oscillator system should be a good one. Two of the best ones are shown in Figs. 1 and 2. One is the Meissner and the other is the Hartley. Each has advantages over the other. Each has disadvantages. The Hartley is prone to be over-rich in harmonics of its own fundamental oscillator frequency. It may diminish in comparative efficiency somewhat on lower wavelengths. On the other hand the Meissner method may give you all too bountiful oscillation at these higher frequencies. On the question of body capacity effects, the Hartley may develop some, but the Meissner is relatively free from these, if the stator plates of the condenser are connected to grid. Tendency toward self-harmonics may be reduced in the Hartley hookup by diminishing the plate voltage. One should use about the same voltage as would be employed if this were a detector circuit. The same holds true of the other method.

Use Small Coupling

With the oscillator functioning well, indeed with virtually everything tip-top, a frequent source of failure to achieve much is due to the coupling coil. Reverse the connections thereto and see if results improve. There is usually a marked difference between the right way and the wrong way. Also, if this coil has many turns of wire the set's efficiency is reduced. Always couple with a very few turns. Usually about 5 will be plenty. Many turns mean much capacity coupling, besides the inductive coupling, and consequent tendency toward absorption by the modulator circuit. This absorption obtains when the modulator and oscillator are tuned to the same frequency. It is common for the modulator to stifle all the oscillatory power of the oscillator, hence prevent reception when the dials are thus set. Under these conditions you are not supposed to get reception, anyway, because there should be no beat note, but in practice the loop circuit, unless regenerated, will tune so broadly that strong signals will pass right into the grid of the first detector.

20 Billions of Electrons Occupy 1/100,000 of an Inch

The name electron tube is derived from the fact that the action of the tube is due to very small particles of matter called electrons. An electron is much smaller than an atom and is the building block of which atoms are constructed. An idea of the extremely small size of the electron may be obtained from the estimate that in a spherical globule of copper having a diameter of one one hundred-thousandth of an inch there are about 20 billion electrons. The atom was formerly regarded as the smallest particle of matter which could exist. Something like 25,000 hydrogen atoms would have to be placed in contact in a row to make up a length of one ten-thousandth of an inch. The

weight of an electron is only about one two-thousandth of the weight of a hydrogen atom. The fact that the electron carries a charge of negative electricity makes possible the use of vacuum tube in radio communication.

A tube containing a filament and an additional metal (plate) is commonly called a two-element tube, with the filament as one electrode and the plate as the other. The plate is positively charged while the filament is negatively charged. Thus the electrons are attracted from the filament to the plate and a flow of current takes place. The grid is the third element in the tube commonly used today. This controls the flow of electrons

Set Needs Matched Aerial

By John F. Rider

Member, Institute of Radio Engineers

THE acceptance by the radio fraternity in general of a standard aerial, a certain length of aerial wire, insulators and ground clamp, has led many radio fans to believe that there exists a standard aerial of a certain length which could be used with all types of receivers, irrespective of the number of tubes. That conclusion is wrong. In many instances great dissatisfaction results.

The selective powers of the majority of receivers are definitely limited. That condition exists with all radio receivers. And since the selectivity factor is governed to a very great extent by the amount of power received from the broadcasting station and passed into the receiver, it stands to reason that to obtain the desired degree of selectivity it is imperative that the amount of power passed into the receiver be limited.

Must Limit Pickup

And as the aerial comprises the pickup system by means of which the energy is obtained from the ether and passed into the receiver, one can see very readily that the pick-up with the aerial must be within definite limits, which in turn means that the aerial must possess definite physical dimensions, since the amount of energy pick-up is dependent upon the length and height of the aerial. The location of the pick-up system at this time is neglected.

The next important factor is the signal to static ratio. A weak signal free of strays and extraneous noises may be more readily amplified than a loud signal with which are simultaneously received various loud interfering noises. The reason for this lies in the effective amplifying powers of a radio receiving system.

Foreign Noises Present

In every receiver and amplifier there are present various noises, due to slight leakage between units carrying potentials, voltage fluctuations of potential sources, tube noises, slight regeneration even in the audio frequency stages, microphonic contacts between connecting units, and other causes, and all of these are amplified to their fullest extent when the receiving system is "pushed" so as to afford the greatest output. Now, if the original signal received is made up of the desired signal and other noises, the amplification of the inherent noises and those received with the signal would tend to offset any advantage by having a large pick-up system and loud signals. If the amplifying powers of the receiver are reduced so as to diminish internal noises, the incoming signal current made up of the desired signal and the interfering noise will still be amplified uniformly. But if the pick-up system is reduced so that only a small fraction of the original signal intensity is picked up, but free of interfering noises, the amplifying system may be "pushed" slightly, since the signal is free of interference, and the ratio of amplification of the inherent noises and that of the signal is such that the signal will be amplified sufficiently to afford satisfactory reception, and the noise level will be low.

"Custom Tailoring" Needed

As to the use of a standard aerial with all receivers, it is out of the question. Each type of receiver requires an aerial of certain physical dimensions if the utmost is to be obtained from the receiver. Of course similar receivers, with identical degrees of sensitivity, require similar aeri-als, but dissimilar receivers require different aeri-als. Take for example

His Aerial 'Way Up

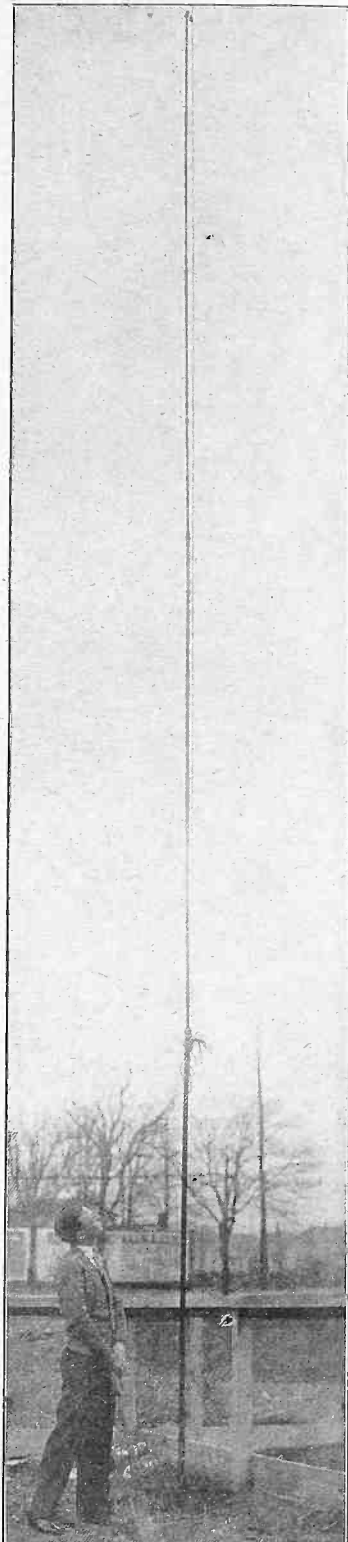

(Hayden)

A BROOKLYN (N. Y.) fan made sure his aerial would be high enough. He installed a 45-foot iron pipe mast.

any 6-tube radio receiver, utilizing three stages of tuned radio frequency amplification non-regenerative detector and two stages of transformer-coupled audio frequency. Would the standard aerial required for a 3-tube receiver, made up of a regenerative detector and two stages of audio frequency amplification, be suitable for the 6-tube receiver specified? No. While it is true that the use of the long aerial would result in a large amount of volume, this volume would result in other actions that would discount the advantages gained through the use of such a sensitive receiver. For instance, many distant stations would not be heard while locals were on the air, because the excessive pick occasioned by the long aerial and the sensitiveness of the receiving system would drown out the distant station.

How DX Is Drowned Out

The energy due to the local station would be so great in the various tuning circuits that the resonance curve would be broad enough to overlap that of the distant station. In this way the advantage of the great sensitivity of the receiver, so far as the reception of distant station is concerned, would be lost entirely. Some fans may not be in accord with me on this subject, contending that a receiver utilizing three stages of tuned radio frequency amplification should possess sufficient selective powers to cut through the locals.

The contention is entirely correct, since the average receiver which contains three stages of tuned radio frequency amplification is sufficiently selective to cut through the locals, providing that the local's received energy is not excessive. It should be realized that during the time the local broadcasters are in operation, the receiver also is responsive to the distant station, when tuned to its wavelength, but the reason for the lack of reception is that locals overlap. Many fans hear distant stations only when the locals are off.

A reduction in the energy input into the receiver by pruning the aerial almost invariably solves this trouble, although the volume of the distant station is slightly reduced, but the fact remains that the distant station is satisfactorily received free of local interference.

Reason for Poor Selectivity

The so-called selectivity trouble with many 5 and 6-tubed tuned radio frequency receivers is, in my opinion, attributable directly to excessive energy input. And the reason for this excessive input is an aerial of more than the required length. And in turn, the reason for the excessively long aerial is the failure to consider the sensitivity factor of the receiver and adherence to the idea that it is necessary to utilize every inch of the aerial wire available.

This subject has another angle, pertaining to the selection of aeri-als for receivers of medium selectivity powers when located in highly congested areas, such as large cities wherein are numerous powerful broadcasting stations. Were one to render final decision upon this question from the data given in the preceding paragraphs, selectivity would be very poor with receivers such as the regenerative receiver, since the longest aerial is prescribed for this type of receiving system.

The Author's Rule

Adherence to the following rule will at all times prove beneficial:

"The more sensitive the receiver, the smaller the aerial should be."

The Truth About Coil Fields

By J. E. Anderson
Consulting Engineer

THERE has been considerable talk about fieldless inductances. It has crept into advertising copy, into headlines, into popular articles, and even into the more serious technical articles. Fieldless inductances! These oddities fall into the same category as dry water, non-alcoholic alcohol, brilliant darkness, weightless weight, and other similar absurdities.

Inductance is, by definition, the total magnetic field, or the total number of lines of magnetic induction, that is associated with an electric circuit when unit current is owing in that circuit. Hence if an electric circuit is fieldless it is also non-inductive. But no circuit can be non-inductive, for if it is a complete circuit, current will flow, or would flow with the proper emf, and the lines of magnetic induction cannot be dissociated from the current.

May Minimize Field

Circuits, or rather the conductors whereof circuits are made, can be so arranged as to minimize or intensify the inductance. Certain portions of a circuit may be so constructed as to contain nearly all the inductance in the entire circuit, or they may be so constructed that their inductance is negligible in comparison with the inductance in the rest of the circuit. If a conductor is so arranged that it contains nearly all the inductance it is called a lumped or concentrated inductance. If it is so constructed as to have a negligible inductance it is called non-inductive.

A coil having many turns is a concentrated inductance. If the coil has an iron core the inductance is still more concentrated. If the conductor is wound back over itself in the manner of wire-wound standards of resistance, the device becomes non-inductive, or very nearly so. The latter is as fieldless as it is possible to get it in practice. But a concentrated inductance, no matter what particular shape of the coil, is not fieldless, otherwise it would not be an inductance.

Another idea about coils is that the field is limited to a very small space about the coil. In any practical coil the field extends to infinity no matter what the inductance value or shape of the coil may be. It is true that the intensity of the field is very much greater close to the coil than it is far away; but the intensity does not become zero at any finite distance away from the coil. The intensity of the magnetic field about a long straight conductor, such as a stretched wire which is carrying a current, is proportional to the current and inversely proportional to the distance away from the wire. This distribution of intensity of magnetic flux is different, of course, for lumped inductances, but the intensity is never zero.

It is therefore idle to talk about certain distances beyond which the magnetic intensity is zero, a favorite exercise in which many indulge when discussing the proper placement of coils relative to condensers and other metal objects in a radio receiver.

Placement of Coils

The coils should be placed with respect to metal bodies in such a manner that the metal is in a weak portion of the field of the coil, or in such a manner that the most extensive sectional planes of such metal bodies are parallel with the direction of the magnetic field. The first is usually attained by keeping the metal bodies away from the coil a few inches;

More Heat for the Iron



SOMETIMES a soldering iron reaches that stage of exasperating malperformance where it does not heat up sufficiently. Turns of bare No. 16 wire, wound as shown, often cures this defect.

the second by turning the coil in a suitable manner.

Some time ago there appeared an article in a journal devoted to radio which explained and illustrated the effect of shape of coils on the magnetic field. Two coils of equal inductances were taken, one of which was long and narrow and the other short and wide. The magnetic fields about the coils were represented in the usual manner by means of lines. The long coil had two lines of induction, and they clung closely to the winding. The short coil had four lines of induction, and they were spread out wide. The conclusions were that the long and narrow coil had a small field and would therefore be preferable for use in crowded places, and that the short coil was not suitable for this purpose, since it had a much more extended field. Whatever the value of the conclusions, they were reached by taking two coils of equal inductance and then stating that one had twice the number of lines of induction. Just another way of proving that one equals two!

Three Types of Coils

Consider the fields of three typical inductance coils, the single layer solenoid, the astatic pair, and the toroidal coil, all of the same inductance value. Since they all have the same inductance, they all have the same fields as regards to quantity but not as regards shape of field, or as regards the distribution of the magnetic lines of induction. The field of the single layer solenoid has circular symmetry about its axis, that is, the coil may be rotated about its axis without changing the intensity of magnetization at any point around it. The intensity of its field externally is quite high, and for this reason this coil is never spoken of as a fieldless coil.

The astatic pair is made up of two equal single layer solenoids placed side by side and connected in series aiding. A similar coil is made by winding the turns into loops like a figure eight. The intensity of the external field for this case is not so great as that for the solenoid but it is not zero, except along the perpendicular bisector of the line which joins the centers of the two separate coils or loops. The magnetic field extends to infinity.

Some Legerdemain

Illustrations have appeared to show how the magnetic field is confined in this type of coil. First two separate solenoids have been given with lines of force threading through the coils in every direction. In one coil the direction of the lines of force is up and in the other it is down, a necessary condition for the series aiding connection. Then the two coils are placed side by side and connected up for series aiding. Presto, and all the lines of force of each coil, except those threading through the other, disappear. That leaves the coil combination without an

external field, naturally. All astatic coils leave a considerable external field. If they did not, they would be almost useless for radio purposes, for they would not be much better for tuning purposes than non-inductive resistances.

Now we come to the toroidal coil. This is the coil that is usually referred to as fieldless. Nearly all of the external part of the field is neutralized by doubling the wire back over itself, in effect at least. Enough wire has to be used to make the internal, or saved, part of the field equal to the inductance required.

Fieldless Coil a Fallacy

The major portion of the magnetic field is confined to the space inside the annulus. But it is not fieldless. There is even a weak external field associated with a toroid. This comes from the fact that each turn on the annulus is not a perfect circle whose plane is at right angles to the ring. The wire is wound diagonally like a screw. This fact makes the annulus itself in effect a circular loop of wire whose diameter is the mean diameter of the annulus. This loop will have an inductance, or a field, which is essentially of the same form as that given by a circular loop of plain wire.

There seems to be a general belief that capacity depends on voltage. Here is a typical manner in which this belief manifests itself. " . . . Anything besides air between the wires, especially along where the voltage is high, changes the capacitance between the wires . . ." Such statements are often made in connection with the discussions of the distributed capacity of coils.

Capacity Wrongly Judged

The idea seemingly is that as long as the two conductors are at the same or nearly the same potential the capacity between the conductors is unaffected by the dielectric that is placed between them: but if the two conductors are at widely different potentials the capacity is greatly increased by the dielectric constant of the material placed between them. If there is any variation of capacity with voltage it is a second or higher order effect. Aside from this possibility, capacity is a property of a condenser which depends on the dimensions of the conductors and on the distance apart of the conductors. It also depends on the dielectric constant, that is, on the specific electric inductivity of the material of the insulator. The dimensions involved do not change with voltage; not in a good condenser, at least, in which the conductors are clamped. Neither does the property of the insulator change with voltage.

High Losses the Reason

It is true that potential is used in deriving the formulas for the capacity of various condensers or conductors. But the quantity, or the electric charge, is used simultaneously. When the derivation is complete nothing but a dimension, a length, and the dielectric constant, remains. What has led to the fallacy is probably that more current will pass through a given capacity if the voltage is high, and hence that the losses in the dielectric will be greater when the voltage is high. Thus in the case quoted above, nothing should be placed between the two wires where the voltage is high because the losses in any dielectric placed there would be greater than if the same body of dielectric were placed between the wires when the voltage is low. The effect on the capacity between the wires would be the same no matter where the thing is inserted between them.

Rubber Bands As Support Keep Tube Free of Microphonic Effects

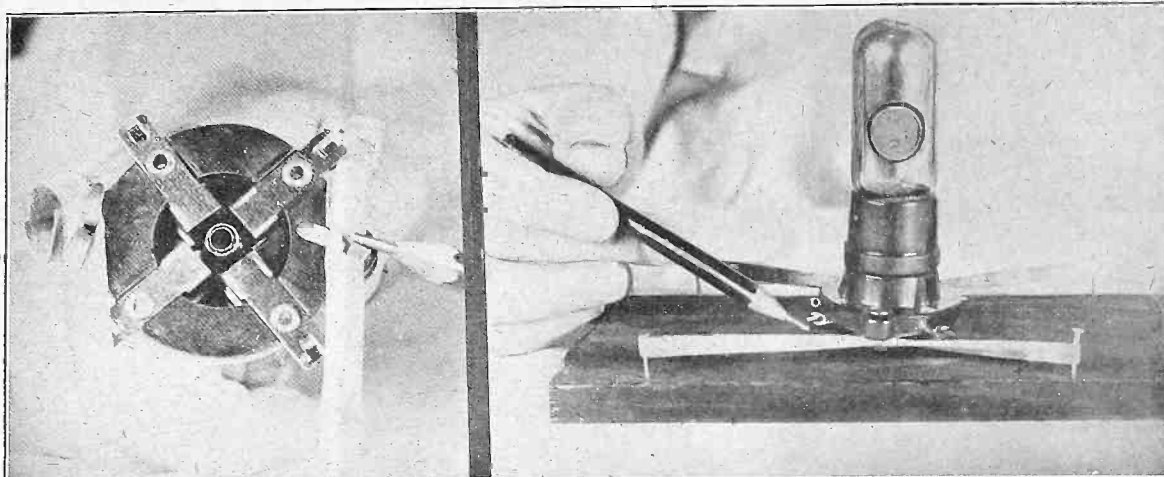

(Hayden) PERSONS troubled with microphonic noises may use a pair of strong rubber bands to apply a remedy. The bands, tacks and paper clips are all that are required. The clips are placed through the holes where the screws are to be inserted. Four thumb or carpet tacks are placed about 1" from socket in a square. The rubber bands are slipped over the heads of the tacks. The points of the tacks are then pushed through the center of the rubber band loops. The rubber bands should be of sufficient tightness to keep the socket in a springy position.

Keep 1" Margin in Shield



(Hayden) WHEN PLACING coils in a shield, keep them at least 1" from the sides of the shield. In a complete shield the coil is enclosed by two more walls, the 1" separation still being kept. Tin-foil may be successfully employed as shield material, but copper, either solid sheet or insect netting type, may be utilized. This prevents the coils acting as loops and minimizes stray coupling effects. It is getting to be very popular.

Increases Selectivity

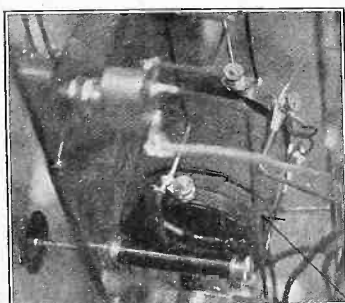

BY taking turns off the primary of an interstage coupler, as shown above, the selectivity of the set may be increased. Arrow points to primary.

Spring Clip Holds Solder and Prevents Smearing

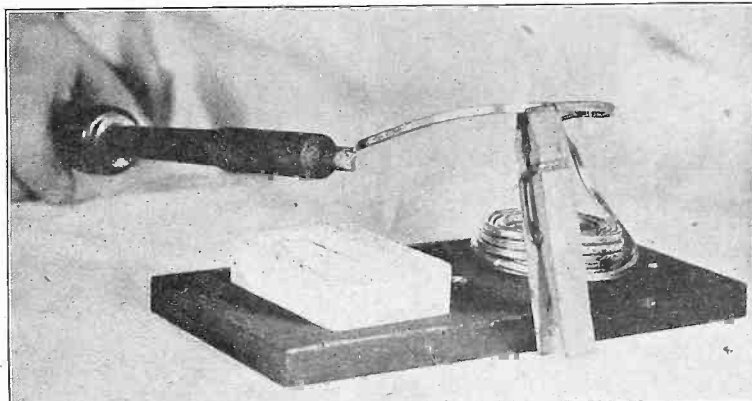

PROBLEM: How to get some one else to hold the self-fluxing solder when you're all alone. Solution: See photograph. The method prevents smearing by the flux.

UX Socket Precaution

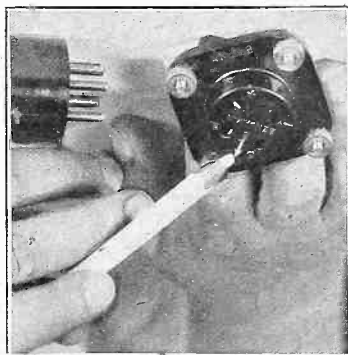

(Hayden) WHEN using the U. V. type of tube in the new U. X. socket be sure to place tube with its pin over the white arrow in the socket before plunging the tube in. Otherwise blown out tubes may result, due to putting B battery across the filament. This arrow innovation is employed on a majority on the sockets on the market today.

Station Is Floated



(International News Reel) THE NEW marine broadcast ship Mu-1 on blocks at the shipyards at Wilmington, Del. just before it took to the water where it will operate as a regular broadcast station (WRMU). The ship is owned by Douglas Rigney.

Signal Intensity Goes Down With Sun, Returning Soon

The following report from the Bureau of Standards, was prepared by Dr. J. H. Dellinger, C. B. Joffe and T. Parkinson.

The work here described is the third extensive program of cooperative radio observations conducted by the Bureau of Standards on radio signal fading and on the conditions affecting distance range of broadcasting.

At the beginning of the 1925 season, the Bureau of Standards invited a number of qualified laboratories to participate in the beginning of a cooperative program of measurements. The general program contemplates measurements of the several quantities: field intensity, fading, direction variations, polarization and atmospheric.

Fading a Fruitful Field

In 1925 the work was largely confined to fading measurements. This quantity was selected both because the apparatus required is relatively simple and because fading phenomena promise to shed the most light on wave characteristics.

The work was mainly at the broadcast frequencies because transmissions with uninterrupted carrier are not so readily available in other parts of the frequency spectrum. Results at other than broadcast frequencies, and field intensity and direction observations, where mentioned herein, are therefore considered as incidental to the principal aim of the 1925 work, which was the study of fading phenomena in the broadcast range.

Graphic Records Taken

The general plan of the work was the arrangement of special transmissions in each of which a certain station transmitted continuously during a specified period, and the taking of graphic records simultaneously by the observing laboratories.

Twenty laboratories were engaged in this work. About 20 others expressed interest in the work and made some effort to begin observations. The results of some of the tests have been described in previous special reports by the Bureau or in articles that some of the cooperating observers have published.

The method of measurement used a receiving set, of any type, plus a sensitive direct-current galvanometer used with a detector in such a way as to measure variations in the received carrier wave current.

Records were in some cases made by visual observation of galvanometer deflections, taking readings several times a minute and plotting these afterward on coordinate paper. Very good records showing the major variations have been obtained in this way. Automatic continuous records were obtained in most of the work, however. These were easier for the observer, and showed up the smaller fluctuations which sometimes proved significant. A number of records made during some of the sunset fading tests, for instance, showed a rapid periodic swing starting about fifteen minutes after the local sunsets at the observing points and lasted approximately a half hour.

All of the laboratories sent their graphical records to the Bureau of Standards where they were analyzed. The analyses consisted of the taking of averages from the records and preparation of condensed graphs from these of both intensity and fluctuation.

Eclipse Results

The observations during the eclipse showed, as expected, a condition inter-

mediate between daytime and nighttime transmission. The perceptible variation due to the eclipse lasted for about an hour and consisted of a decrease in the field intensity to a minimum followed by an increase to a maximum and then a subsidence to normal.

The several sunset tests showed a similar decrease followed by an increase superposed, however, on a marked general increase of signal intensity in the transition from daytime to nighttime conditions. The time required for transition from normal daytime field intensity to normal nighttime field intensity at the particular frequencies used is about 2 to 3 hours beginning about 1 to 1½ hours before sunset and ending 1 to 1½ hours after sunset.

General Conclusions

All of the records showed short-period and long-period fading fluctuations. A large number of detailed results for different times, directions and places were obtained. The small amount of direction observations and places were obtained. The small amount of direction fluctuation arious sunset fading tests lead to the following general conclusions:

1. Short period fading (periods of a few seconds to 8 or 10 minutes) is not the same on record made simultaneously even at distances of a few kilometers.

2. The same is true of long period changes (10 minutes to several hours).

3. Records of the same transmission made on successive days at the same receiving point bear little resemblance.

4. There is no correlation between intensity and fluctuation changes.

5. There is no consistent correlation between good reception and the relation of the transmission path to the direction of isobars or isotherms as shown on weather maps covering the test periods.

6. Averaging a number of sunset records made over a period of two weeks shows a rise of intensity starting over an hour previous to sunset, a drop or lessen-

Clean Up Soldered Joint



(Hayden)

IT is always a good plan to clean newly soldered joints, to remove flux. Denatured alcohol serves the purpose.

ing of the rate of increase before or during sunset at the receiving point, and a rise during or after sunset to a nighttime value reached an hour to two hours after sunset. This value is not necessarily the night maximum which may occur much later. In the case of north-south transmission the increase of intensity during the sunset period is continuous.

7. Averaging fluctuation changes shows in general greater fluctuation at night than during daytime, the daylight value often being close to zero while the night value in rare instances, mounts to 3.5 times the mean intensity.

8. On the KDKA average records there is a consistent correlation between the ratio of day-to-night intensity and distance from the transmitting station.

9. A correlation also between the ratio of day-to-night fluctuation and distance appears on the average records for KDKA.

10. On a single set of 24-hour tests the maximum intensity appears at about the same time, the four hours preceding sunrise, for observers within 1,000 km. of the transmitting station.

11. Measurement of direction shifts during some of the tests indicate in general direction shifts are accompanied by fading of the short period type.

(Copyright, 1926, by Stevenson Radio Syndicate)

CONSTRUCTION OF THE 4-TUBE A-A RECEIVER, by Herbert E. Hayden, appeared in RADIO WORLD dated Nov. 21, 1925, 15c per copy, or start your subscription with that number.

Half-Dozen Celebrities Heard at Same Presentation



ALL HEARD on same night, these artists gave the audience a great treat during the Atwater Kent Radio Hour. At left is Phillips Carlin, announcer of WEAF. The operatic and concert performers (left to right) are: Allen McQuahae, tenor; Katherine Meisle, contralto; Maria Kurenko, soprano; Louise Homer, contralto; Frances Alda, soprano, and John Powell, pianist.

Radio University

A FREE Question and Answer Department conducted by RADIO WORLD for its yearly subscribers only, by its staff of Experts. Address: Radio University, RADIO WORLD, 145 West 45th St., N. Y. City.

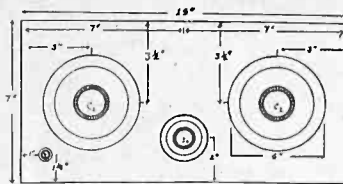

FIG. 323
The panel layout for the Harkness.

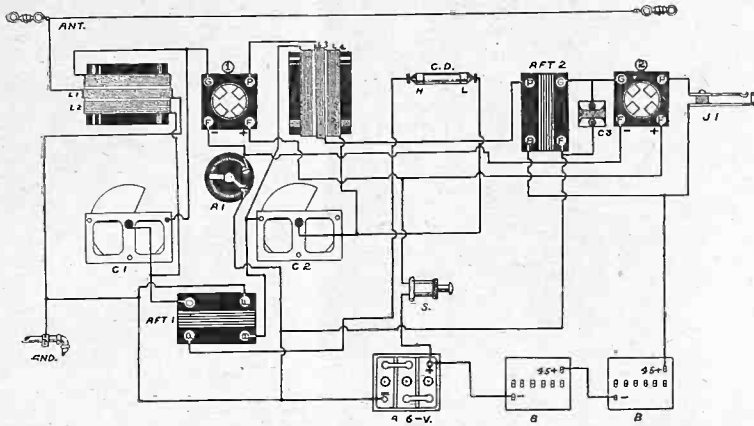

FIG. 322

The picture diagram of the old type Harkness reflex, requested by J. P. Savarese. Note that the coils are placed at right angles to each other. They should also be placed directly on the end plates of the condenser, with about a 2" separation, between the coil and the condenser.

I HAVE obtained the wiring directions of the old type Harkness reflex from the April 17 issue of RADIO WORLD (Radio University). Although the description is O. K., I, having little radio knowledge, would like to have a picture diagram of this receiver, with the constants of the apparatus, all mentioned. A panel layout would also be appreciated.—J. P. Savarese, 152 East 123rd St., N. Y. C.

Fig. 322 shows the picture diagram of this receiver. Fig. 323 shows the panel layout. L1 and L3, the primaries, consists of 10 turns. L2 and L4 consists of 62 turns. No. 22 double cotton covered wire is used. Tubings 3" in diameter and approximately 2½" in height, are used. First the secondary winding is put on a tubing. A piece of empire cloth or heavy manila paper is then placed over the center of the secondary winding. Over this insulation, the primary is wound. The windings should be very tightly wound. The number of turns on these secondaries are such, that when shunted by .00035 mfd. variable condensers, having a minimum capacity of .0001 mfd., the entire waveband from 200 to 550 meters, will be covered. AFT1 is a high ratio type, about 6 to 1. AFT2 is a low ratio type, about 3 to 1. If another stage of transformer coupled audio frequency amplification is added, a low ratio transformer should be used. R1 is a 6 ohm rheostat. S is the filament switch. CD is the fixed crystal detector. H indicates the high potential point, while the low potential point is indicated by L. C3 is a .001 mfd. fixed condenser. It will be found that this condenser, with some type of transformers, distortion is prevented, while with others, it has no effect, except to cut the volume down.

WHERE CAN I get commercial information about the B battery eliminator described in the March 27 issue of RADIO WORLD by Capt. P. V. O'Rourke?—A. J. Stubler, 113 East Franklin St., Baltimore, Md.

Write to C. E. Jacobs, 2803 North Kedzie Ave., Chicago, Ill.

MY FRIEND informed me that it is injurious to hook up a fresh B battery

with an old one. Is this true? Why?—F. Han, 341 West 45th St., N. Y. City.

Your friend is correct. The high internal resistance of a run-down battery, when connected in the same circuit as that of the new battery, which has a low internal resistance, will resist the flow of current through the circuit, heating up the cells in the new battery, causing them to deteriorate, shortening the life.

* * *

PLEASE GIVE a description of a 5-tube receiver, employing a stage of untuned radio frequency amplification, two stages of tuned radio frequency amplification, a non-regenerative detector followed by two stages of transformer coupled audio-frequency amplification. The secondaries of the RFT for the detector and the RF stages should be shunted by a double condenser, each section having a capacity of .0005. Please give the constants of the coils and condensers.—P. Kramer, 939 Longwood Ave., N. Y. C.

The untuned RFT may be of any standard type, which will cover the waveband of from 200 to 550 meters. Consider the primaries as L1 and L3; the secondaries as L2 and L4; the double condenser as C1; a ballast controlling the filament of the first tube as R1; a rheostat controlling the filament of the second tube as R2; another rheostat controlling the filament of the detector tube, as R3; a ballast controlling the filaments of both audio tubes, as R5; the grid condenser as C2; the grid leak as R4; the first audio-frequency transformer as AFT1; the second audio-frequency transformer as AFT2. Now the primaries, L1 and L3, consist of 10 turns wound on a basket weave form with fifteen ¼" diameter spokes in a ¾" diameter. L2 and L4, the secondaries, consist of 50 turns. These are wound on the under two and over two method, e.g., a wire is brought under two spokes and then over two spokes, etc. No space is left between the primary and the secondary windings. R2 and R3 are both 6 ohm rheostats. R5 is a ½ ampere ballast resistor. R4 is a 4 megohm grid leak.

C2 is a .00025 mfd. fixed grid condenser. Both AFT1 and 2 are of a low ratio, with large primary windings. Now as to the wiring. It is suggested that you take a pencil and paper and make a schematic diagram from the wiring directions, before attempting to wire the set. It will be less confusing and will speed the work up to a considerable degree. The P post of the untuned RFT goes to the antenna post. The B post goes to the ground post. The G post goes to the G post on the first socket. The F minus post goes to the A minus post on a terminal strip. The F minus post on this socket goes to a terminal of R1. The other terminal goes to the A minus post, or to the same place the F minus post on the untuned RFT was connected. The F plus post is connected to the F plus terminals of all the other sockets. This common terminal goes to a terminal filament switch. The other terminal of this switch goes to the A plus B minus post on a terminal strip.

The beginning of the primary winding, L1, goes to the P post on the first socket. The end of this winding goes to a B plus post on a terminal strip, labelled 67½ volts. The beginning of the secondary winding, L2, goes to the common rotor terminal of the double condenser, C1 and to the arm of the rheostat R2. This arm also goes to the arm of rheostat, R3. This common terminal goes to the A minus C plus post. The resistance wire terminals of both these rheostats, respectively, go to the F minus posts on both sockets. The end of the secondary winding, L2, goes to one set of the stationary plates of C1 and to the G post on the second socket. The other terminal connecting with the stationary plates of C1 goes to one terminal of C2 and to the end of the secondary winding, L4. The beginning of the primary winding, L3, goes to the P post on the second socket. The end of labelled 67½ volts. The other terminal of the fixed grid condenser, C2, goes to the G post on the third socket (detector) and also to one terminal of the grid leak, R4. The other terminal of the leak, goes to the F plus post on the same socket. You will note here, that although there is a common negative return for both the RF and the detector tubes, the actual grid return of the detector tube is positive. This is done by bringing the leak in shunt to the grid and the positive side of the filament, instead of in shunt to the grid condenser as is usually done. This method is used because a -01A type tube requires a positive grid return. If a soft tube, such as the -00 type is used, then the grid leak can be shunted across the condenser. The P post on AFT1 goes to the P post on the detector socket. The B plus post goes to the B plus post on the strip, labelled 22½ to 45 volts. The G post on this same AFT goes to the G post on the fourth socket, which holds the first audio tube. The F minus posts of AFT1 and 2 are connected to C minus. The P post on AFT2 goes to the P post on the fourth socket. The B plus post goes to the bottom terminal of a single circuit jack, which goes to the B plus post on the strip, labelled 90 to 112 volts. The G post on AFT2 goes to the G post on the last socket. The P post on this socket goes to the top terminal of a single circuit

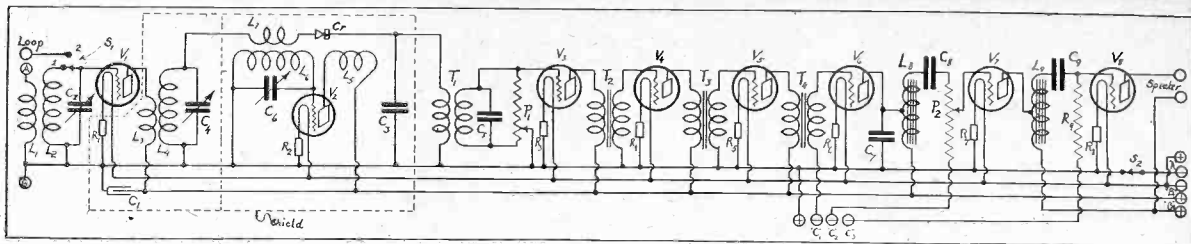

FIG. 324

The circuit diagram of the DX Super-Heterodyne, requested by Karl Gray.

jack. The F minus posts of both these sockets are connected together. They go to a terminal of a ballast resistor, R5, which is of the 1/2 ampere type. The other terminal of this resistor, goes to the A minus C plus post. This completes the actual wiring. Now, there are several hints as to successful operation that may help. If the signals are weak, a condenser of .001 mfd. capacity may be connected from the plate of the detector tube to the A minus post. A 20 turn coil, shunted by a .0005 mfd. variable condenser in series with the antenna may also build up the signal strength. Of course, changing the position of the tubes and also the varying of the voltages may increase the volume of the signals. Rheostats, R2 and R3, have a great deal to do with the controlling of the volume. The C minus battery, should be, if 90 volts are to be used, of the 4.5 volt type. If about 112 volts are used, then it should be of the 6 volt type. The two RF coils, are mounted at right angles to each other, while the untuned RFT is mounted in any convenient position. A comparative short antenna can be used. This set is very selective and is a bit difficult to tune, if great care is not taken.

KINDLY GIVE a list of parts required to build the 6-tube Neutrodyne receiver, printed in the April 24 issue of RADIO WORLD on page 22.—Otto J. Havel, 7802 21st Ave., Brooklyn, N. Y.

One antenna coupler, L1L2, (10 turn primary, 45 turn secondary, 3/4" tubing, No. 22 DCC wire), two neutroformers, L3L4; L5L6, (same primary and secondary winding as L1L2. Secondary winding tapped at 10th turn from filament end). Three .0005 mfd. variable condensers, C1, C2, C3; two 3/4 ampere ballast resistors, R1, R2; two midge neutralizing condensers, N; three .25 mfd. fixed condensers, C5, C6, C7; three .1 megohm resistors, R4, R6, R8; one 1 megohm resistor, R5; one .5 megohm resistor, R7; one 25 megohm resistor, R9; one .00025 mfd. grid condenser, C4; one 2 megohm grid leak, R3; one filament switch, S; three 4" dials; one 7x26" panel; six sockets; one base-board, 6x24x3/4", or one sub-panel, 2 1/2x23" and connecting wire, A, B and C bat-

teries, angle brackets, screws, nuts, terminal strip, etc.

* * *

CAN A loop be used with the 5-tube Super-Heterodyne described in the April 17 issue of RADIO WORLD by Jasper Jellicoe? If so, please describe the method of insertion, so that it may be cut in or out.—Arthur Strawhacker, 3719 Cypress Ave., Cleveland, O.

A loop can be used, but the results will not be very good. That is, only the local and stations about 75 miles distant will be heard with loud speaker volume. The beginning and the end of the secondary of the antenna coupler are detached from their respective positions. This means that the variable condenser, C1, is connected in series with the low potential point of the crystal and the beginning of the grid coupling coil, L3. Across these terminals, the loop is connected. The condenser will be shunted across these terminals. Binding posts may be connected at these points, so that a bus bar may be strapped across, if the antenna and the ground are to be used, instead of the loop. Small single pole single throw knife switches can be connected in series with these straps, for cutting in or out.

* * *

I AM going to build the 1925 Diamond of the Air, but before doing so, would like to know if a low ratio AFT can be used in the first and second stages, or if a high ratio should be used in the first stage and a low ratio in the second stage?—Andrew Tokar, 9702 Aetna Road, Cleveland, O.

You will get louder signals, when a high ratio AFT is used in the first stage and a low ratio AFT in the second stage, but you will get much better quality reception when two low ratio AFT are used.

* * *

I WOULD like to have the circuit diagram of a Super-Heterodyne, employing a stage of radio-frequency amplification, the regulation oscillator, a crystal as the first detector, three stages of intermediate frequency amplification, a second tube detector, with a grid bias battery, instead of a leak and condenser and two stages

of auto-transformer coupling.—Karl Gray, Cheyenne, Wis.

Fig. 324 shows the circuit diagram of a receiver which you desire. L1L2 and L3L4 are tuned radio-frequency transformers. The primaries, L1L3, consist of 11 turns. The secondaries, L2L4, consist of 68 turns. Forms 2" in diameter and 4" high are used. L5L6L7 constitutes an oscillating coil. Any commercial type may be used. The plate and the grid windings are made on a form 2 1/4" in diameter. L5, the plate coil, consists of 35 turns. L6, the grid coil, consists of 39 turns. The tickler coil, L7, is wound on a form 1 1/4" in diameter. This consists of 10 turns. No. 24 silk over cotton covered wire is used for all windings. T1 is the filter transformer. T2, T3 and T4 are the intermediate transformers. L8 and L9 are the auto-transformers. P1, P2 and R9 500,000 ohm potentiometers. C2 and C4 are a double condenser. Each section has a capacity of .0005 mfd. C6 is a .0005 mfd. variable condenser. C3 is a .001 mfd. fixed condenser. C8 and C9 are 1 mfd. fixed condensers. C1 is a .0001 mfd. fixed condenser. A carborundum fixed crystal detector is used. The first five tubes should be of -99 type. The 6V -199 Amperites should then be used here. The last three tubes should be the -01A type.

* * *

I AM enclosing the circuit diagram of a reflex receiver, which I have built. L1 and L3, the primaries, consist of 10 turns, wound on a form 3 1/2" in diameter. L2 and L4, the secondaries consist of 46 turns. There is no space left between the primary and the secondary windings. C1 and C2 are .0005 mfd. variable condensers. C3 is a .001 mfd. fixed condenser. CD is the crystal detector. Now, although in most reflexes it is recommended that a high ratio AFT be used in the reflexed stage and a low ratio AFT in the regular AF coupling stage, I have reversed these positions. Is it possible that this placement would cause the receiver to give poor volume? What else beside this change might increase the volume of this receiver?—F. L. Keats, 353 Union Ave., Elizabeth, N. J.

Reverse the AF transformers. Reverse the secondary winding of the first or reflexed AFT. Reverse the leads of the crystal detector. Increase the plate voltage. Take the fixed condenser C3 out of the circuit.

* * *

I WOULD like to have the circuit diagram, with constants, of a selective and voluminous crystal detector receiver, using carborundum as the crystal and a potentiometer in series with a battery to control the voltage applied to the crystal, for volume and sensitivity control.—Craig Drainston, Great Neck, L. I., N. Y.

Fig 326 shows the electrical diagram of such a receiver. L1, is a loading coil, consisting of 50 turns wound on a tubing 3/4" in diameter, using No. 22 double cotton covered wire as the conductor. It is tapped at every fifth turn, bringing the taps to a total of 10. Five of these are placed so that they can be cut in or out of the antenna, while the other five are connected, so that they may be cut in or

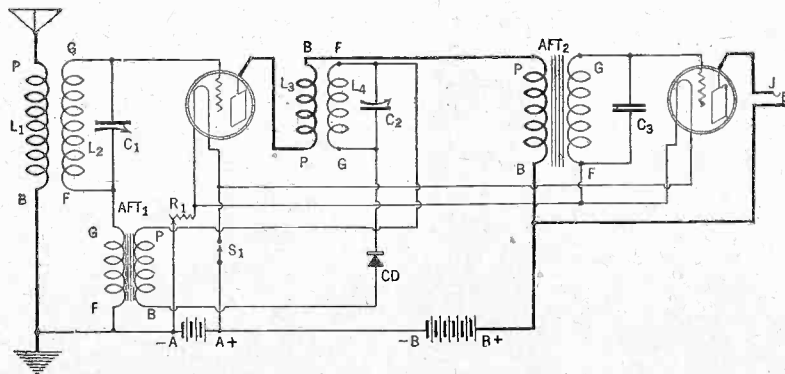

FIG. 325

The circuit diagram of the receiver Mr. F. L. Keats enclosed.

out of the variable condenser circuit, C1. L2 is a 15-turn primary, wound on a tubing $3\frac{1}{4}$ " in diameter, but tapped at every second turn, three of which are placed in the condenser circuit and two in the ground circuit. C1, the antenna tuning condenser is of the .0005 mfd. type. L3, is a 45-turn coil wound on the same tubing as L2, the primary. There is a $\frac{1}{4}$ " separation between the two windings. This coil is tapped at every fifth turn for the last 20 turns. This means that there will be 4 taps. C2 is also a .0005 mfd. variable condenser. The potentiometer which is in shunt to the battery is of the 400 ohm type. The battery consists of six $1\frac{1}{2}$ -volt dry cells connected in series, giving a total of nine volts. CD, represents the crystal detector. A .001 mfd. fixed condenser shunts the phones, which have a total resistance of about 3,000 ohms.

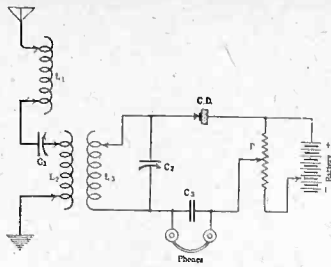

FIG. 326
The electrical diagram of the crystal receiver.

the secondaries, L2 and L4. When connecting up the loop jack, be careful to connect the frame to the negative side of the filament. R3 is a $\frac{3}{4}$ ampere ballast resistor. R5, R6 and R7 are all .1 megohm resistors, while R8 is a .5 megohm resistor. C5 and C6 are both .25 mfd. fixed condensers. FCJ is the filament control jack, so wired, that when the plug is inserted in the jack, the amplifier tubes light up. The plates of the radio frequency amplifier and the last audio amplifier tubes receiver one voltage, e.g., 90 volts (B plus No. 2). The

plate of the detector tube receives 45 volts (B plus No. 1). The plates of the first and second audio tubes receiver 135 volts (B plus No. 3).

* * *

SOMEHOW OR other I misplaced my Jan. 30 issue of RADIO WORLD, in which a discussion of Litz wire was given by Sidney E. Finkelstein. Now I would like to have a photograph of the six types of coils tested by the Bureau of Standards, with the data as to which one of these coils is the best to use. A small discussion of what wire was found to be best in the tests will also be appreciated. —Roy Carroll, Tannersville, N. Y.

Fig. 328, shows the photograph of the six coils tested and compared by the Bureau of Standards. The loose basket weave and the single layer coils were found to be approximately equal and also the best of the six coils, the loose basket weave having a small edge. The 32 strand of No. 38 enameled wire, litz wire, was found to be best for broadcast use, with No. 24 double cotton covered wire running a close second, the actual digerence between the two being in price. The litz wire is about 7 times as expensive as the double cotton covered. The honeycomb coil was found to be the worst of the six, with the bank wound or two layer solenoid, next. The spider

I HAVE a double condenser, having a capacity of .001 mfd., that is, each section has a capacity of .0005 mfd. I also have a transformer which has a 3-to-1 ratio, three .1 megohm and one .5 megohm resistors. A circuit diagram of a 5-tube receiver, using this double condenser to shunt the secondary of a radio-frequency transformer, in a stage of tuned RF amplification and the secondary of a second RFT in the detector circuit, which is non-regenerative, followed by a stage of transformer and two stages of resistance coupled AF amplification, is requested. Now I would like to have a switching arrangement, whereby a loop can be switched in and the antenna ground switched out. I have a filament control jack, which I would like to use also. It is a single circuit type. The coil data, etc., would be appreciated. — Henry Seivers, Providence, R. I.

Fig. 327, shows the diagram of a receiver, based around the principles you have stated. The primaries, L1 and L3, consist of 10 turns, wound on a form $3\frac{1}{4}$ " in diameter. L2 and L4, the secondaries consist of 45 turns. Each primary and secondary is wound on a separate tubing. About a $\frac{1}{4}$ " separation should be left between the primary and the secondary windings. No. 22 double cotton covered wire should be used. LJ is the loop jack, it being an ordinary double circuit type. R1 and R2 are both 6 ohm rheostats, the resistance wire being of the type, that will pass at least $\frac{1}{4}$ ampere without any heating up. C2 and C4 are .001 mfd. fixed condensers. C3 is a .00025 mfd. grid condenser. R4 is a 2 or 3 megohm grid leak. The stators of the variable condenser are connected to the end of the secondary windings of both RFT, e.g., one stator to the end of the secondary winding, L2, through the loop jack, and the other stator to the end of the secondary winding, L4. The common rotor is connected to the beginnings of

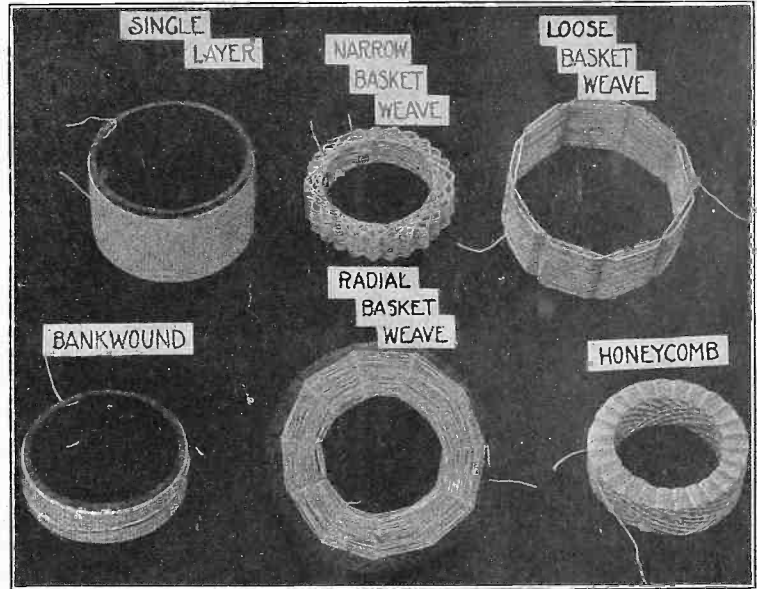

FIG. 328. The photograph showing the six coils tested and compared by the Bureau of Standards.

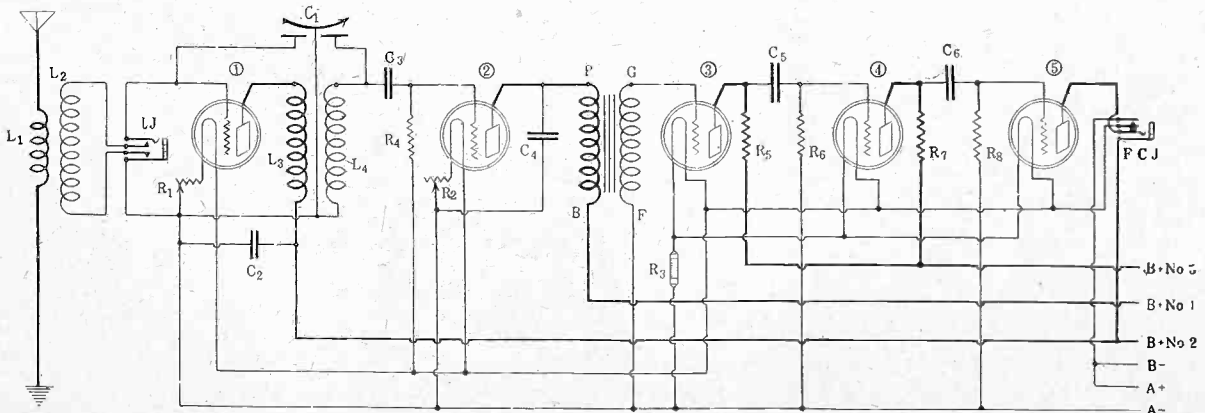

FIG. 327. The schematic diagram of the 1-control receiver, requested by Mr. Henry Seivers.

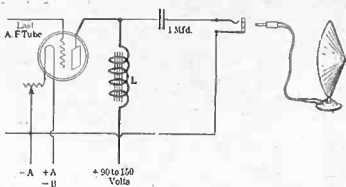

FIG. 329. The electrical diagram demonstrating how to hookup a cone speaker, so as to keep the direct current off the speaker windings.

weave or radiall basket weave and the narrow basket run in between the four coils first mentioned.

I HAVE a cone speaker and am informed that by connecting the B battery directly to the speaker magnets as is commonly done, they will become demagnetized very shortly. Is this right? (2) If so, a diagram showing how to hook the speaker up, so as to prevent the magnets from becoming demagnetized would be very much appreciated.—Ruth Jacobson, 2003 Walton Ave., Bx., N. Y. City.

(1)—Yes, this is true. The direct current is placed on the magnets, which is injurious. (2)—Fig. 329, shows the electrical diagram of such a hookup. L is a 200 henry choke coil. The top prong which formally went to the plate of the last tube, now goes to one terminal of a fixed condenser. The bottom terminal of the jack goes to the A minus post, instead of the B plus post. In this manner D. C. is fed to the magnets only.

I WOULD like to have the circuit diagram of a 3-tube receiver, employing a 3-circuit tuner and two stages of transformer coupled AF amplification. The AF tubes should be so arranged that a simple switching device can shut the filament power of the last tube off and connect the plate of the first AF tube to the B plus. This eliminates the jack, which I find to be troublesome. A high resistance should be shunted across the secondary of the first AGFT, so that the volume can be controlled. The coil, data, etc., with a panel layout, would also be appreciated.—Robert Klugh, Jamestown, N. Y.

Fig. 330 shows the circuit diagram of this receiver, while Fig. 331 shows the panel layout. L1, the primary is wound on a tubing 3 1/4" in diameter and consists of 10 turns. No. 22 double cotton covered wire is used. A 1/4" space is then left and the secondary, L2, is wound. This consists of 45 turns. The tickler is wound on a tubing 2 3/4" in diameter and consists of 36 turns, using No. 26 single silk covered wire as the conductor. This

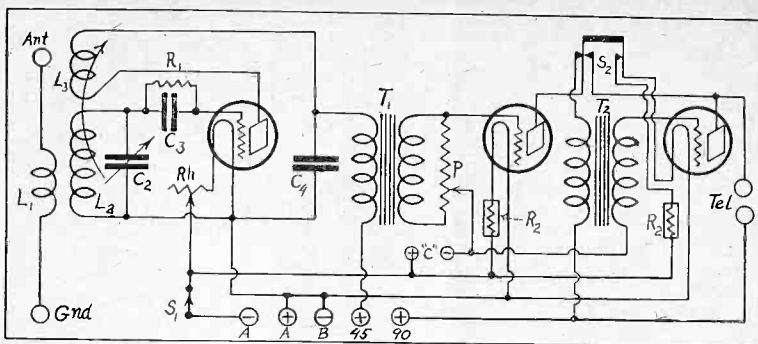

FIG. 330. The electrical diagram of the 3-tube set, requested by Mr. Robert Klugh.

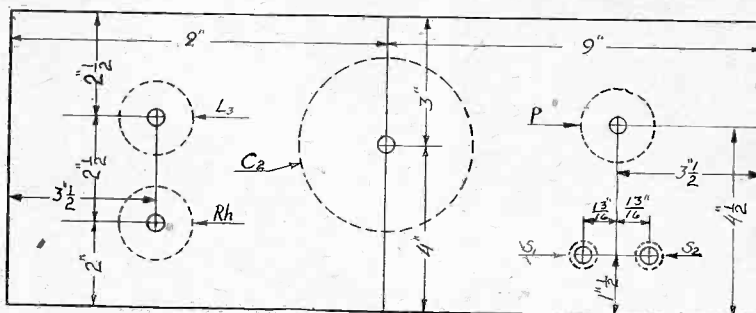

FIG. 331. The panel layout.

is wound in two 18-turn sections, a 1/4" space being left between the windings. This is for the tickler shaft. C2 is a .0005 mfd. variable condenser. C3 is a .00025 mfd. grid condenser, while R1 is a 2 megohm grid leak. Rh is a 10 ohm rheo-

stat. C4 is a .001 mfd. fixed condenser. T1 and T2 are both low ratio AFT. P is a 500,000 ohm potentiometer. R2 are 1/4 ampere ballast resistors. S2 is the special switching arrangement. A 4.5 volt C battery should be used.

Stations Let Licenses Lapse and Meet Trouble

Stations which permit their licenses to expire without attempting to renew them immediately are having a hard time of it with the Department of Commerce. Through carelessness a number of stations failed to renew their licenses and they were automatically cancelled. In attempting to set aside the cancellation, the stations are compelled to show that they are rendering a definite public service.

CALL LETTERS CHANGED

WCBQ, Nashville, Tennessee, to WBAW. The station is owned by the First Baptist Church.

WHAV, Wilmington, Delaware, to WDEL. The station is owned by the Wilmington Electric Specialty Company.

Magnetic Field of a Coil



FIGS. 1, 2, 3 shown in Fig. 2.

Notice the greatest field is at the tips of the magnet (pole ends) and the strength diminishes as we approach the top or bend in the magnet. "Can the electrons in a tube be yanked out faster?"

When the tube is surrounded by a small coil as shown, the terminals of the coil being connected to a suitable battery, a field is produced which causes greater filament emission (Fig. 3). The same effect can be produced by holding a horseshoe magnet against the side of the bulb.

1926 DIAMOND OF THE AIR BOOKLET with full instructions to make the Diamond, with blue print, 30c. Newsdealers and radio dealers can get supply from American News Co. and its branches. RADIO WORLD, 145 W. 45th St.

Join RADIO WORLD'S University Club

And Get Free Question and Answer Service for the Coming 52 Weeks.

This Service for Yearly Subscribers ONLY

Have your name entered on our subscription and University lists by special number. Put this number on the outside of the forwarding envelope (not the enclosed return envelope) and also put at the head of your queries. If already a subscriber, send \$6 for renewal from close of present subscription and your name will be entered in Radio University.

[In sending in your queries to the University Department please paragraph them so that the reply can be written under or alongside of each query. Write on one side of sheet only.]

RADIO WORLD, 145 West 45th Street, New York City.

Enclosed find \$6.00 for RADIO WORLD for one year (52 Nos.) and also enter my name on the list of members of RADIO WORLD'S University Club, which gives me free information in your Radio University Department for 52 ensuing weeks, and send me my number indicating membership.

Name

Street

City and State

WHAT VALUE OF RHEOSTAT TO EMPLOY

A 2-ohm rheostat should be used for two UV200 tubes, four UX112 tubes, seven or eight UV201A tubes or six, seven or eight WD12 tubes.

A 3-ohm rheostat should be used for three UX112 tubes, five or six UV201A tubes or four or five WD12 tubes.

A 6-ohm rheostat should be used for one UV200 tube, two UX112 tubes, three or four UV201A tubes and two or three WD12 tubes.

A 10-ohm rheostat should be used for one UX112 tube, two UV201A tubes, eight UV199 tubes or one WD12 tube.

A 15-ohm rheostat should be used for seven UV199 tubes.

A 20-ohm rheostat should be used for one UV201A tube or six UV199 tubes.

A 25-ohm rheostat should be used for five UV199 tubes, a 30-ohm rheostat for four UV199 tubes, 40-ohms for three UV199 tubes, 60-ohms for two UV199 tubes and 100 ohms for one UV199 tube.

—Yaxley Mfg. Co.

What About Shielding? Fan Questions Answered

The consensus of Super-Heterodyne fans who have written me concerning this subject is that removing the shielding improves the set. One said that removing a strip of shielding between the IF and the RF parts of the circuit improved the set 300 per cent. Another said that by removing a shield between the oscillator and the RF amplifier and modulator coils improved it greatly. By doing so, however, one million and one squeals were introduced for every ten divisions of the dials. In the first case it was possible to isolate thousand-mile stations from among the squeals; in the second case it was possible to squeeze in a local station now and then between the squeals. It all depends on what is meant by improvement. I am planning a Super-Heterodyne for myself now and I contemplate thorough shielding, inside and out. If I don't get enough squeals to satisfy me, I'll rip the shielding out until a satisfactory balance has been effected. Shielding improves selectivity; shielding doesn't improve selectivity; shielding increases sensitivity; shielding doesn't increase sensitivity. That is my honest opinion about shielding. Shielding does kill the squeals, that I know.

—J. E. Anderson.

High Plate Voltage Improves RF Circuit

By-pass condensers across batteries aid in neutralizing the set, they help to conserve energy by keeping the radio frequency currents out of the batteries and other high-resistance devices, and they also help to obtain regeneration.

If radio frequency amplifiers are employed they should be used as such; not merely to make the receiver a 5-tube set. To use a tube as an amplifier the filament current should be normal, the plate voltage should be fairly high, and the grid voltage must be adjusted to fit the plate and filament voltages used as well as the purpose of the tube.

Exact tuning of the various circuits to the frequency of the desired signal is of paramount importance in getting DX.

Get Rid of Distortion; Watch the AF Channel

Is your set distorting? If so, a poor audio amplifier or too much regeneration, or both, are the likely causes. Audio-transformers more than a year old are likely to be distorters, because transformer design has made great progress since then. Resistance coupled audio amplification gives the purest tones. Three stages are needed. Two good, large transformers make a splendid AF amplifier.



The bass viol, the soprano and the piano reproduce wretchedly on a poor audio amplifier, but a barytone, a saxophone or a banjo behaves passably.

Pound of Salt to Gallon of Water Aids Ground

"The salt of the earth" added to water in proper portions, makes an exceptionally good improvement in conductivity for "grounds" where rods and pipes have been driven into the earth for use with radio receivers.

An experiment conducted by engineers in the Crosley radio laboratory showed that a strong solution of common table salt, about one pound to a gallon of water, poured in the immediate vicinity of the pipe or rod driven into earth, will give added conductivity. The conducting powers of the soil which surrounds the rods and pipes makes radio "ground" connections good or bad. A dry ground is not as good as a wet one and the salt solution forms an electrolyte when mixed with the natural mineral salts of the earth.

Salt Solution Ideal

Dry earth is not a good conductor of electricity while a wet ground is the ideal way to make a connection when no other form, such as a water pipe in the home, is available. This salt solution will be found ideal for use on farms where there

is no modern plumbing or while on camping trips in dry country.

When using the radio receiver in summer and the earth is dry, use the solution to a greater extent than would be the case when the earth is moist from rains. The solution should be used when the receiver is to be used in dry weather, while an occasional bucket of water will give additional moisture when the receiver is about to be used.

Radio Helps Church, Preacher Tells Flock

The Rev. Dr. Minot Simons, preaching at All Souls' Unitarian Church, New York City, said:

"The radio will cooperate and not compete with the church. The people who stay away from the inspirations of a church service in order to get it comfortably and lazily at home are the people who spend most of their Sundays at home anyway. The radio is helpful and satisfactory up to a certain point, but there are qualities in a religious service which cannot be sent over the air."

R. C. A. Has New Detector; Tube Called Best Yet

A new detector tube, the UX200A, is about to be marketed by the Radio Corporation of America, Elmer E. Bucher, general sales manager, announced. It is understood Cunningham will have a tube just like it, the CX200A.

In size the new tube resembles the 01A type. The bulb is smoke colored, instead of silvery, due to the special gas inside. The filament voltage is 5 and the filament, drain .25 ampere. The filament is XL (thoriated tungsten). The plate voltage should be 45 or less.

"The UX200A tube has a greater sensitivity than any existing special detector tube," said Mr. Bucher.

It may be used in any receiver of the storage battery type without change or special adjustment.

Nearly Equals Extra RF

Actual tests with typical receivers indicate that UX200A provides an increase in volume nearly equal to an additional radio frequency amplifier stage, without distortion or loss of tone quality. The sensitivity is likewise increased.

Mr. Bucher pointed out that a detector having the efficiency of the new radiotron was not essential to the operation of the Super-Heterodyne where the sensitivity with the ordinary form of detector tube goes to the limit of that which is practically usable; for it is well known that the Super-Heterodyne provides a high sensitivity level through its intermediate frequency stages which amplify at a single frequency wavelength. As there is, therefore, no necessity for this new type of tube in this class of receivers, it will not be marketed in the dry battery form.

Great Demand in Sight

The recommended grid leak and condenser are 2 megohms and .00025 mfd. The rheostat should be 10 ohms. The plate drain at 45 volts is 2 milliamperes. The plate impedance is 28,800 ohms.

The new tube meets a demand started on a big scale when the Sodian D21 was marketed more than a year ago. The Connecticut Telephone & Electric Co. made that tube, but Westinghouse bought the patent and took the tube off the market.

Mr. Bucher said: "The UX200A radiotron is the result

of long and extensive study and development with the detection aid rectification of radio frequency energy by the research engineers of the R. C. A.'s manufacturing associates, the General Electric Company and the Westinghouse Company."

The 200A overcomes the objections laid against the formerly popular—200 soft detector—critical filament and plate voltages and large A current consumption (1 ampere at 5 volts).

Recently H. P. Donle, inventor of the Sodian tube, brought out a new tube that develops even greater detecting efficiency than the Sodian D21. It is manufactured by the Donle-Bristol Corporation, Meriden, Conn.

New Heavy Duty Power Tube Brought Out

To provide still greater power from the storage-battery receiver, yet without the need for alternating-current-supply, a new tube, UX171, has been put on the market. This tube, although no larger than the UX112, is capable of supplying large volume of undistorted output to the loud-speaker. It is intended for use only in the last stage of an audio-frequency amplifier. The announcement of the new tube was made by Mr. Bucher.

The 171 tube may be operated from a 6-volt storage battery through a 5 or 6 ohm rheostat, or, if preferred, may be operated from a 5-volt source of alternating current supply.

The maximum plate potential of this new tube is 180 volts. The negative grid bias or C battery should be 40.5 volts for the full 180 volt plate potential, with correspondingly less grid potential for lower plate potentials. The following table gives the recommended values and also shows the approximate DC plate current (in milliamperes) for each value of plate and grid voltages:

Plate Voltage	Grid Bias	Plate Current
180	40.5	20
157.5	33.0	18
135	27.0	16
90	16.5	10

It will be noted that the plate current drain, even under the large bias, is heavy.

So powerful is the output from the new 171 when operating at its full capacity that it is imperative that a transformer or choke and by-pass be placed between the tube and the loud-speaker. Accordingly, it is recommended that the plate current, or output from this power tube, be delivered to an audio-frequency choke of from 10 to 30 henries, shunted across the output, together with a 2 to 6 microfarad by-pass condenser in one lead to the loud-speaker and a direct connection for the other lead, an arrangement already in extensive use.

May Use Transformer

If preferred, the output may be delivered to the primary of a 1-to-1 output transformer, the secondary of which is connected with the loud-speaker. In either event, the direct current from the tube will not flow through the loud-speaker. The purpose of the transformer is to insulate the loud-speaker from the high voltage used on the plate of the tube and thus keep the high potential within the cabinet which houses the set. Only the desirable AC component will be passed. This operates the loud-speaker.

The new power tube is provided with the UX base which fits all standard Navy bayonet type sockets (the old type sockets), as well as the new push type or universal sockets (the UX sockets).

The characteristics of the 171 follow:
Appearance..... Same as 112 Base..... Large Standard UX type
Filament Voltage 5
Filament Current 0.5 ampere
Plate Voltage 90-180
Negative Grid Bias..... 16½ to 40½ volts
Plate Current..... 10-20 milliamperes

[For method of connecting choke coil and condenser see Fig. 329 on page 12 of this issue.]

Listening-in Called Real Meter of Taste

By RT. REV. JAMES E. FREEMAN, Bishop of Washington

God's greatest gift is the gift of utterance wisely used. Listening-in has become one of the most popular occupations of the day. The whole world through radio has been resolved into a vast whispering gallery. The time is coming when a voice speaking in Washington will be heard in the remotest corners of the remotest parts of the world.

It is my taste and my choice that determine what I shall hear. Tastes are more disclosed today in listening-in than in any other occupation. We are living in an age where discrimination is enormously demanded that we may grow mentally and physically.

Dr. Loewe New Claimant for First Broadcast

Although Frank Conrad, of the Westinghouse Electric and Manufacturing Co., East Pittsburgh, Pa., is known as the "father of broadcasting, KDKA being the call letters of the first station of its type, a letter written in 1920 in New York by Dr. Siegmund Loewe, famous German scientist, has been brought forth to show that this title should go to the doctor. David L. Loewe, brother of the doctor, has given a statement that Dr. Loewe was the first man to demonstrate broadcasting, this being in New York City. The brothers own a tube factory in Germany.

Amateur Station Heard World Over

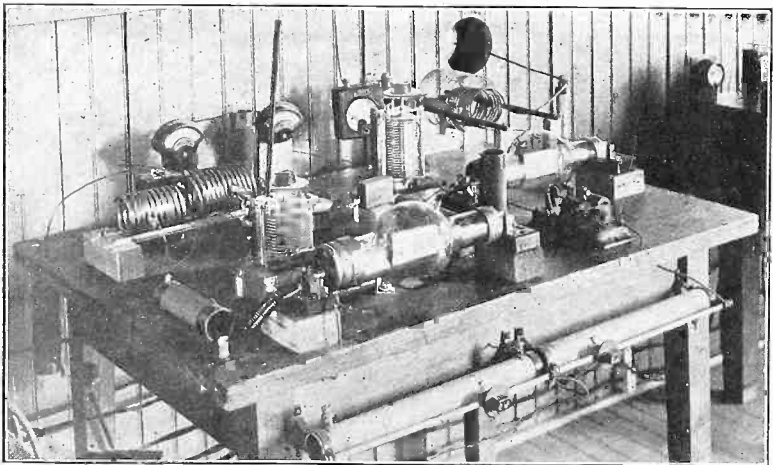

THE 40-meter transmitter of station 2CXL which has been heard all over the world. (Kadel & Herbert).

Five Interesting Hookups

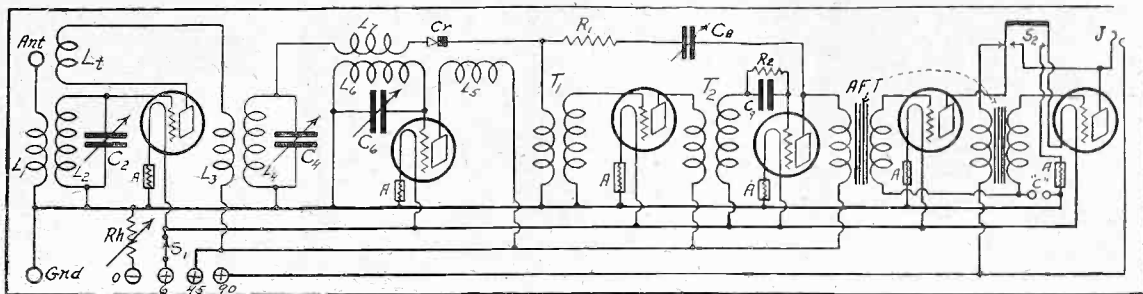

THE CIRCUIT diagram of the 6-tube set described by J. E. Anderson in the July 18 issue of RADIO WORLD. The first tuning unit, comprising the primary winding, L1, the secondary winding, L2 and the plate coil, L3, may be any 3-circuit tuner having the secondary shunted by a .0005 mfd. variable condenser, C2. C2 and C4 are a double condenser, each section having a capacity of .0005 mfd. C6 is also a .0005 mfd. variable condenser. R1 is a 100,000 ohm resistance, while C8 is a midjet variable condenser. A crystal is used as the first detector, this being indicated by the letters, Cr. It will be noted that the stage of RF ahead of the oscillator and detector is regenerative. This gives the set its wonderful sensitivity.

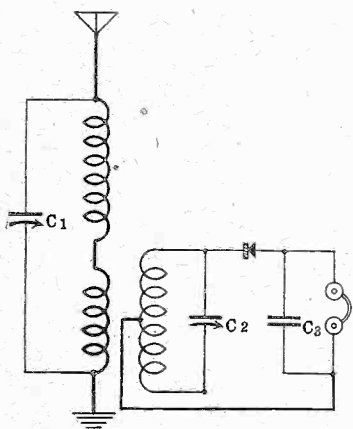

THE ELECTRICAL diagram of a crystal receiver that can be logged. With this set it is possible to receive signals from local stations with good volume. Complete data on how to build this marvelous little receiver were given in the Feb. 13 issue of RADIO WORLD.

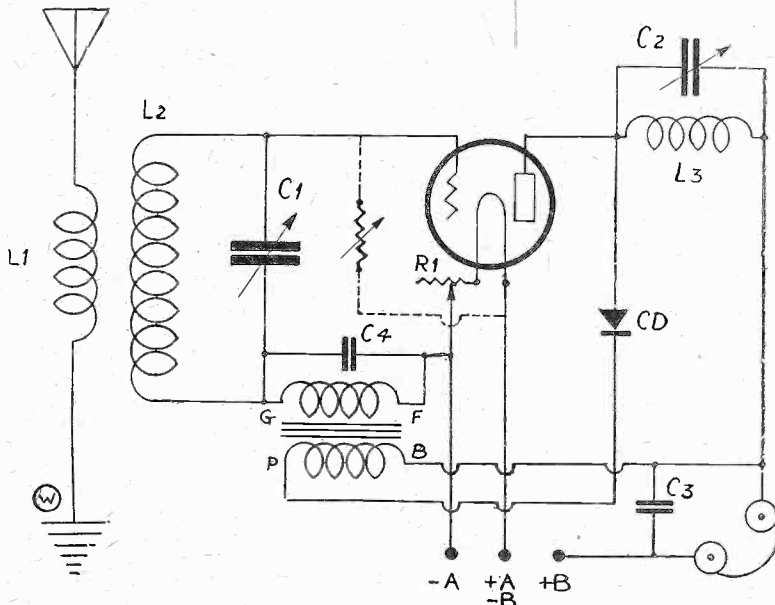

HERE WE have the circuit diagram of one of the most popular of reflexes printed in RADIO WORLD. This was described by Feodor Rospatkin in the Feb. 21, 1925 issue. L1L2 constitute the primary and secondary windings of a tuned RFT, whose secondary is shunted by a .0005 mfd. variable condenser. L3 is a special plate coil, shunted by a condenser suited for the constant of this coil.

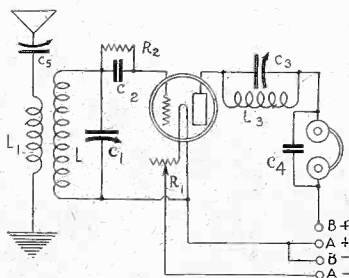

THE ELECTRICAL diagram of a 1-tube receiver. The plate of this tube in this circuit is tuned by a .0005 mfd. variable condenser, C3. This condenser is in shunt to a fixed inductance, L3, which consists of 35 turns of No. 22 double cotton covered wire wound on a tubing 3" in diameter. C5 is also a .0005 mfd. variable condenser. This condenser improves the DX ability of this receiver. The rheostat, R1, is a 6-ohm type.

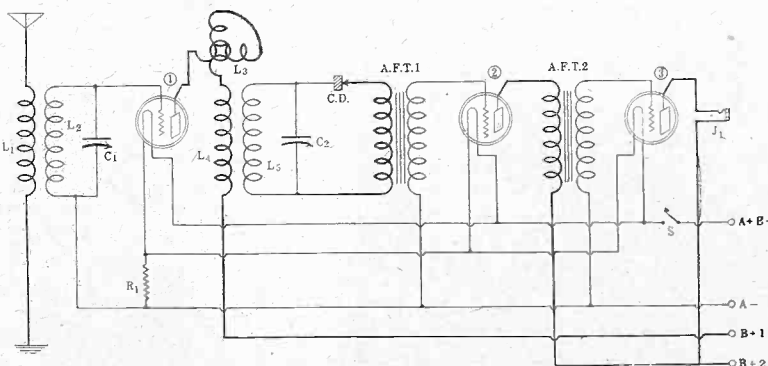

THE CIRCUIT diagram of a 3-tube receiver, using a plate variometer. A crystal is the detector, followed by two stages of transformer coupled audio frequency amplification. This set was described by Lewis Winner in the Dec. 5 issue of RADIO WORLD.

Acoustician Secret Hero of Many Artistic Feats

PITTSBURGH

Considering the many channels that contribute to a typical KDKA program, the station is not unlike a great river and its tributaries.

The tributaries of a radio station, however, do not take care of themselves. They require manifold and expert attention. And that's where the radio acoustician and the radio operator enter the scene.

When the listener turns his dial and gets the announcement, "This is Westinghouse Station KDKA at Pittsburgh" the subsequent number may come to him from any one of 45 pick-ups maintained by the station in Pittsburgh and its boroughs.

Process of Equipment

These pick-ups in concert halls, clubs, hotels, schools and churches are sources that present more than a few difficulties to J. Frazier, manager of KDKA, and his operating staff.

The operator and acoustical expert coming to the location of the new pick-ups are confronted with the initial task of determining what will be the most advantageous spot for the microphone.

The process of equipping the new place means not alone the technical work of setting up the machinery, checking up on characteristics of the room, etc., but it also necessitates a kind of dress rehearsal.

On the Job Early

If it happens to be a Sunday morning church service the radio operator and acoustician are at work while the choir is still asleep. Hours before the song or sermon can go on the air there is a try-out to be staged. When the test program reaches the central station satisfactorily that pick-up is labeled O. K. and he operators drive on to the next.

In the case of most of KDKA'S studio tributaries this operation must be repeated for each program as it is impracticable to keep permanent equipment at 45 different points.

After the program has reached the pick-up microphone it is first amplified and then relayed by telephone line (it may be 15 or 30 miles) to the main studio

in East Pittsburgh. Here is the station's filtering room where the song, sermon, address, or orchestra selection is, so to speak, placed under the "microscope."

Many Questions

"Is the number coming in too softly or too loudly? Does the speaker's voice sound natural? Would his listening friends recognize the speaker? Are the basses overwhelming the soprano or are the sopranos singing rings around the baritone?"

These, and many more, are the questions behind the activity in the filtering room.

The filtering room is the diagnosing room of radio broadcasting. The acoustician is the diagnostician; the radio operator is the surgeon.

The person who directs this business of tone analyses and doctoring must be an individual who understands radio apparatus as well as music.

Popcke Is the Man

At KDKA the position is held by A. Popcke.

Some months ago a Pittsburgh musician was the recipient of letters from radio auditors complimenting him on the excellencies of his new organ.

"It just can't be compared with the old one," they wrote.

These people were very kind about writing but nevertheless they had to be disappointed; they were told there was no new organ. Just new draperies in the room that contained the organ. That was all. The unsung radio acoustician had been on the job.

Unwept, Unhonored and Unsung

The work of engineers is lauded. Artists are showered with letters of praise and tenderness; announcers are worshipped and glorified but alas, for the unsung radio acoustician. He is a faithful and important contributor to the success of the program and yet—

Nobody writes to him.

He is not praised by listeners.

He is almost unknown; he works behind the scenes.

Good Time Had By All But Remote Control Men

Did you ever stop to think when you hear WRNY broadcasting just how much difficulty there is, how much complexity there is, in sending any program from a remote point to the control room of the station?

Two men, an operator and an announcer, start from the station an hour before the program is to be broadcast, carrying with them two black fibre suit cases in which are contained all the essential apparatus necessary to broadcast. In the suit cases are microphones, batteries, extensions, phones, spare tubes, and last but not least is the amplifier which multiplies the volume of the program thousands of times in order that it may overcome the resistance of the telephone lines.

With this apparatus they proceed to the point of broadcasting, and then comes the hardest part of the job. This is the

setting up of the apparatus in the right place for the best results, and arranging the microphones so that they will pick up the voices or instruments of the artists in the best possible manner.

In some cases, take for instance a banquet, there is a crowd of hectic diners, all out for a good time, and the little matter of broadcasting doesn't worry them in the least. They may be very much in the way, but it is the job of the remote control operator to arrange the microphone without disturbing any of them.

This having been done, and the amplifier having been set up and tested, the remote control operator calls up the station and informs the operator there that he is ready for a complete test through the station amplifier. There are two telephone lines to every point where remote broadcasting is to be done, and if one of the lines should fail, the other can be used to broadcast over.

For Fishing For Waves

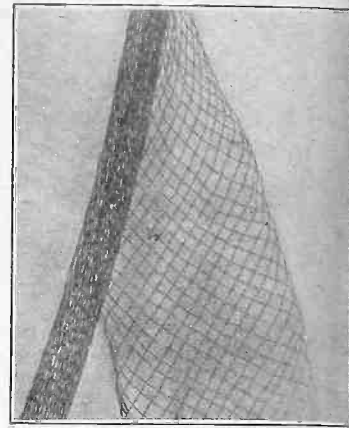

"LET'S go fishing," said the young man, pointing to the net on the sand. But that had nothing to do with this picture, which shows No. 25 stranded enamelled aerial wire as it is strung and as it looks when spread out.

Nobel Winner a Fan



(Kadel & Herbert)

SELMA LAGERLOF, Sweden's famous woman writer, in the study in her country home, near Stockholm. Miss Lagerlof is the only woman who received the Nobel award for literature.

A Loop on a Door

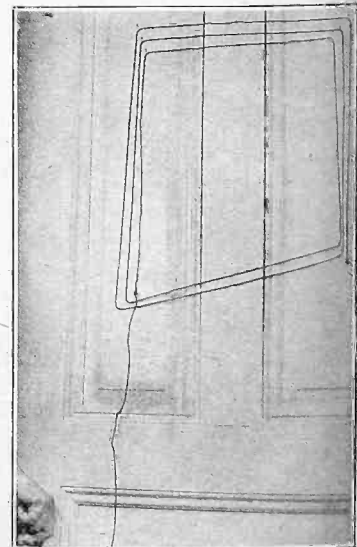

(Hayden)

AN improvised loop may be made by putting a few turns on a door, to bring in locals.

Invalid Composer Broadcasts Thanks



(Kadel & Herbert)

JANET BULLOCK WILLIAMS, well known teacher and composer of music who for the last several years has been confined to bed, due to paralysis, sends her own message of appreciation through station WOR, after she had heard the premiere of her operetta "Niebelungen Ring, Jr.," a travesty on Wagnerian music. She composed the piece while in bed.

DeForest Enlightened



DAVID L. LOEWE, of the Loewe Audion Co. of Berlin, explains to **Dr. Lee De Forest** (at right) the functioning of the Loewe Multiple Tube. Dr. De Forest invented the three-element vacuum tube; Siegmund Loewe, David's brother, invented the tube that has a detector and two audio stages inside, including all parts and wiring, except the tuner.

His Ear to the Ground



(Wide World)

DR. J. HARRIS ROGERS, who discovered the possibilities of radio reception via the earth, rather than through space, is shown above tuning in with an antenna loop.

WEAF Pays Orchestras Up to \$400-an-Hour Rate

There has been considerable discrepancy in amounts reported to have been paid to orchestras and others for radio appearances. It is quite true that many stations do not pay their talent but it is also equally true that others pay them well.

For instance, it has been learned upon reliable authority that one orchestra appearing for WEAf in New York City and allied stations receives \$265 for an hour. Such an appearance sometimes requires as many as three rehearsals, inas-

much as the day has passed when a first-class orchestra simply plumps down into a station and begins to play.

Another orchestra at WEAf receives \$300 an hour, two others, \$325 an hour each, another \$350 an hour; and still another \$400 an hour, usually depending upon the number of men in the orchestra. A popular string trio receives \$75 an hour and a quartet \$100. A well-known male singer gets \$40 an appearance. If he is accompanied by an orchestra, this, of course means an extra charge.

International Broadcast Chain Started in Europe

Europe is to enjoy superlative DX programs by international telephonic relays. Experiments to that end by the Comité Consultatif International des Communications Téléphoniques a Grand Distance, headquarters in Paris have proven successful.

In a letter to Eric H. Palmer of the Reed-Eisemann Radio Corporation, who visited Europe as official observer during the international broadcast tests, Arthur R. Burrows, Secretary General of the Union Internationale de Radiophonie,

Geneva, writes enthusiastically of the results obtained in the broadcasting of the speeches at the last meeting of the League of Nations council.

"I am told that the effect was really impressive for those at a distance," reports Mr. Burrows. "Five countries took part. The Swiss had a specially prepared line to serve Geneva, Lausanne, Berne, and Zurich. The French had two lines, one for the Assembly current and a second for control purposes, which was split at the French frontier to feed two circuits."

Old Home Changeth

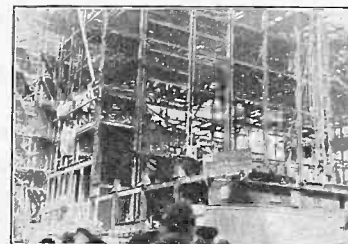

THE new Paramount Theatre Building, now erecting on Broadway, Forty-third to Forty-fourth Streets, New York City, is on the site formerly shared by **RADIO WORLD**, whose new address is 145 West Forty-fifth Street.

RADIO WORLD

REG. U.S. PAT. OFF.



Radio World's Slogan: "A radio set for every home."

TELEPHONE BRYANT 0558, 0559
 PUBLISHED EVERY WEDNESDAY
 (Dated Saturday of same week)
 FROM PUBLICATION OFFICE
 HENNESSY RADIO PUBLICATION CORPORATION
 145 WEST 45th STREET, NEW YORK, N. Y.
 (Just East of Broadway)
 ROLAND BURKE HENNESSY, President
 M. B. HENNESSY, Vice-President
 FRED S. CLARK, Secretary and Manager
 European Representatives: The International News Co.
 Breems Bldgs., Chancery Lane, London, Eng.
 Paris, France: Brentano's, 8 Avenue de l'Opera
 San Francisco: Lloyd B. Chappell, 656 O'Farrell St.

EDITOR, Roland Burke Hennessy
 MANAGING EDITOR, Herman Bernard
 TECHNICAL EDITOR, Lewis Winner
 CONTRIBUTING EDITORS, John F. Rider, J. E. Anderson

SUBSCRIPTION RATES

Fifteen cents a copy. \$6.00 a year. \$3.00 for six months. \$1.50 for three months. Add \$1.00 a year extra for foreign postage. Canada, 50 cents.
 Receipt by new subscribers of the first copy of RADIO WORLD mailed to them after sending in their order is automatic acknowledgment of their subscription order. Changes of address should be received at this office two weeks before date of publication. Always give old address; also state whether subscription is new or a renewal.

ADVERTISING RATES

General Advertising

1 Page, 7 1/4" x 11"	462 lines	\$300.00
1/2 Page, 7 1/4" x 5 1/2"	231 lines	150.00
1/2 Page, 8 1/2" x 5 1/2"	231 lines	150.00
1/4 Page, 4 1/2" x 5 1/2"	116 lines	75.00
1 Column, 2 1/4" x 11"	154 lines	100.00
1 Inch		10.00
Per Agate Line		.75

Time Discount

52 consecutive issues	20%
26 times consecutively or E. O. W. one year	15%
4 consecutive issues	10%

WEEKLY, dated each Saturday, published Wednesday. Advertising forms close Tuesday, eleven days in advance of date of issue.

CLASSIFIED ADVERTISEMENTS

Ten cents per word. Minimum 10 words. Cash with order. Business Opportunities ten cents per word, \$1.00 minimum.

Entered as second-class matter March 23, 1922, at the Post Office at New York, N. Y., under the Act of March 3, 1879.

MAY 15, 1926

THE REBUS

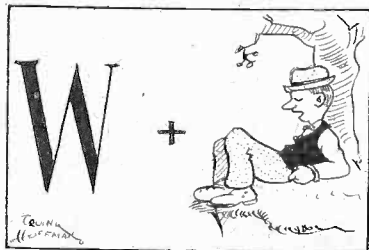

CAN you decipher what station this rebus stands for?

Prisoners in Atlanta Use 50 Radio Receivers

To make life a little less onerous to prisoners in the Federal penitentiary at Atlanta, Ga., Warden John W. Snook permits the operation of some fifty radio receiving sets. Only during music hour between 6 and 7 p. m. are loud speakers permitted, but practically all of the sets have wires attached with earphones in digerent cells, at which convicts can listen in.

Publisher As a Broadcaster

THE dissemination of news by broadcasting is an important function much neglected. While several stations do broadcast news bulletins, the extent of this service is limited. The stations that render it are few and often far apart. Nothing has such a general interest as news, so radio is missing one of its biggest opportunities. Your jazz orchestra may play "A Cup of Coffee, a Sandwich and You," and the anti-jazz element will feel perturbed. Or a fancy soprano and gusty tenor may unite on "Laissez-moi Contempler Ton Visage," from "Faust," and the jazzites will feel offended. Hymns may bore the free-and-easy, yet negro spirituals, not much different, delight them. Broadcast plays tantalize some. There is no possibility of doing anything that will delight everybody, where the audience may run into the hundreds of thousands. The nearest thing to pleasing everybody is in broadcasting news, for on that, one interest combines. What was the verdict in the great criminal trial of the moment? What did the President say about the League of Nations resolution? Well, what do you know about that—a philanthropist gives \$10,000,000 to charity! The doings of the whole world will filter through the microphone. This internationalizes broadcasting to a new and marked extent.

The fact that William Randolph Hearst is pressing his application for station licenses in eleven cities naturally means that he hopes to get more news into the microphone. Mr. Hearst, as a news analyst and indeed missionary, is one of the keenest in the United States, and he has imparted an education along this line to his editors. Thus, with a Hearst paper in each of the eleven cities, he seeks to supplement each of these with a microphone.

These cities are New York, Chicago, Baltimore, Washington, San Francisco, Seattle, Detroit, Boston, Albany, Rochester and Syracuse. Each Hearst paper in these cities has the service of one or more of Mr. Hearst's own news syndicates that cover the world with searching thoroughness. Thus Mr. Hearst as a broadcaster would enable his stations to do what no other chain of stations can do, for there is a property interest in news, and stations are unable to buy the privilege of broadcasting an adequate amount. Some who appropriated news were stopped by a still greater public interest in news. Far from being competitive, the microphone will be the blood brother of the printing press. While the sale of "extras" may not go up, for the microphone will be a prompter and less expensive "extra" by itself, general newspaper circulation is bound to be stimulated, on a firmer basis than a mere bash ever established and that is what counts.

The radio public will welcome the Hearst genius for news, as well as the editorial comment on the doings of the world.

The Hearst chain of stations, of course, would present a well-balanced program, with entertainment and education aplenty, merely giving news its proper place, which it has not yet enjoyed in broadcasting.

Mr. Hearst is a skilled producer, so the combination of theatrical and news talents is a happy one indeed.

Let us hope that a way will be found promptly to grant the licenses and wavelengths that will enable an unstintingly conducted chain of stations to render public service through the microphone.

PICTURES RADIOED REGULARLY

Regular commercial transmission of pictures by radio has been inaugurated by the Marconi Wireless Company of London and RCA of N. Y. City.

Jovial Announcer



AUSTIN RAHE, humorous announcer of station WMCA, at the "mike." His jovial manner of announcing the various artists has earned him, the well deserved title, of "The Announcer With the Smiling Voice." Mr. Rahe claims the distinction of knowing every orchestra leader in N. Y., which accounts for the many witty ditties, he springs, when they appear at the station.

Coughing Sounds Like Samson Rocking Temple

A listener recently remarked that the thoughtless coughing and clearing of throats of speakers into the microphone was as bad as static. He spoke of a well-known clergyman who had a habit of doing this and remarked that he was sure that this divine was doing it unconsciously. This was intended as a reminder to speakers when they are coughing or clearing their throats at least to turn away from the microphone.

The use of increased power, which greatly amplifies every sound, makes it more and more necessary for radio speakers to give thought to such details.

Bureau Has 3 Vacancies, Pay Ranges Up to \$3,800

To fill vacancies at the Bureau of Standards, where some of the most important radio research work in the country is being carried on, the Civil Service Commission announces open competitive examination for a physicist at a salary of \$3,800; an associate physicist, \$3,000; and an assistant physicist, \$2,400.

Competitors will be rated in optional subjects of radio, electricity, mechanics, and others. Receipt of applications will close June 8 and full information and application blanks will be given from the Civil Service Commission, Washington, D. C.

Strauss Prefers "Mike" to Concert or Opera

According to reports filtering from Vienna, Richard Strauss, the composer, prefers appearing on the air to personal appearance in concert halls or opera conducting.

At any rate, it is said his only Vienna appearance this season will be to accompany Franz Steiner, radio artist, when Steiner broadcasts.

De Mott Outlines Path For Big Sale of Receivers

[The following address was delivered before the Radio Manufacturers Association at their convention in Atlantic City.]

By R. W. De Mott

President Radio Magazine Publishers' Association, Inc.

At the inception of the Radio Magazine Publishers Association there were any number of good radio magazines in the field covering practically every phase of the radio industry. There were some published exclusively for the radio amateur, others for the broadcast listener who built his own sets and those of his friends, others for the broadcast listener who knew a little of the theory of radio, but who would never attempt to build a set, relying upon a manufactured model and using his knowledge of radio to improve or get the utmost efficiency out of his set. There were other magazines devoted exclusively to the radio trade, the dealer and jobber, and still others which covered all of these markets simultaneously, reaching both the consumer and the trade.

One of these publications had been in existence since 1913, another since 1915, another since 1917, still another since 1919, and new ones were starting up every week—all striving to do their bit toward the fostering and furtherance of the radio industry, and each independently and honestly working toward the one goal, that of increasing the market for radio products, parts, accessories and complete sets, and the education of the public to the semi-technical side of radio so that the man or woman who had just purchased a set would know how to properly operate that set and it would stay sold.

Every Little Bit Helps

Every radio publication that has ever been published, every piece of radio literature that has ever been put out, has created and helped to build up the radio market, which today has assumed such tremendous importance as to be one of this country's leading industries.

I need not remind you that radio could not have accomplished in four short years what it has if it had not been for the nucleus of radio fans around which the whole structure of the radio industry is built. This nucleus was created and enlarged by the radio magazines, some of which have been at it since the old days of wireless—the days of the spark gap and the coherer. It would be ridiculous to suppose that any group of publications which had been in the radio business long

before there were such things as complete factory-built receiving sets for broadcast reception could fail to know something about the radio market.

List of Members

The leading radio magazines of the country realizing the importance of their work, and the vast benefits which they could accomplish by concerted instead of haphazard methods, united in the formation of the Radio Magazine Publishers Association as it exists today. Our members stretch from the Atlantic Ocean to the Pacific and include the following magazines: "Amateur Radio," "Citizens Radio Call Book," "Q. S. T.," "Radio," "Radio Age," "Radio Broadcast," "Radio Dealer," "Radio Digest," "The Radio Home," "Radio International," "Radio News," "Radio Review," RADIO WORLD, "Radio Weekly," "Retail Radio," "Radio Dealer Year Book," and "Science and Invention." These magazines represent a combined circulation of more than 2,052,000 copies monthly. Think of it—more than two million copies monthly. And yet there are those who say that the radio magazines go only to the radio fan who wouldn't buy a complete manufactured set. Why, there aren't more than 50,000 radio amateurs in the country. Allowing another 300,000 for broadcast fans, who buys the remaining 1,702,000 copies of our circulation? Yet set manufacturers, if you had cultivated this market and sold last year only one set to each of our readers, could have cleaned out practically the entire output of sets manufactured during this year.

Furthermore, and in addition to this, don't forget that our readers buy or build an average of two sets every year—the life of a radio set with our readers is only six months.

Passing over routine matters, let me state that the purposes and aims of the association fall into three classifications and we have accomplished much along all three lines.

First, we have aimed by co-operative work to standardize our individual Laboratory Services so that these laboratories will not only perform a genuine service to our readers in giving them the results of tests made on new and improved apparatus, but will give to each and every manufacturer, whether of parts or complete sets, the means of obtaining outside independent tests of his merchandise that would cost him hundreds of dollars if he were to go to a commercial laboratory. Today a manufacturer, let's say he makes

transformers, can receive from any one of the laboratories of our members an unbiased report and a chart or curve on the performance of his transformers, absolutely free. Not only does this laboratory work of our members save manufacturers who take advantage of it many hundreds of dollars a year, but it makes the marketing of his goods easier, because it strengthens public confidence in his merchandise among our readers, and with the radio trade.

Co-operation, Second Point

The second branch of our activities embraces the co-operative efforts of all of our members toward educating the public to the intricacies of radio. Our aim is not only to arouse public interest in radio reception, but to so educate them through our editorial columns that they will know how to handle a set after they have bought it. When goods are sold to people who know nothing about radio, the goods are often condemned and do not remain sold, while sales made to readers of radio magazines are assured of staying sold.

Through our mutual co-operation we have devised ways and means for increasing our circulations and getting new blood into the radio industry. As a result the great majority of the members of the Radio Magazine Publishers Association are finding right at this time such an increased demand for radio magazines that they have had to very materially increase their distribution of copies *this summer*. This means the creation of a bigger market for you.

The present structure of the radio market is based upon interest aroused by the radio magazines, and we are continually striving to stimulate further public interest in radio, not merely to make one sale, but continually to create demand for improved radio apparatus—both complete sets and standard parts and accessories.

Third Stage is Statistical

The third phase of our activities consists in the preparation of statistics covering the radio market and the education of manufacturers and their advertising agencies as to the definite place the radio magazines have in their distribution scheme, whether the manufacturer be a maker of parts, accessories or complete, factory-built sets. In many cases we have been successful. It is a strange fact, and one worthy of careful consideration by every set manufacturer that every make of set that has been successful this year has been advertised in radio magazines, while on the other hand the big failures this year are among the group who ignored the radio magazines in their sales campaigns.

The presentation of such facts to manufacturers and advertising agencies in par-

(Concluded on page 20)

WHY PARTS BUSINESS IMPROVES

By Dan Napoli

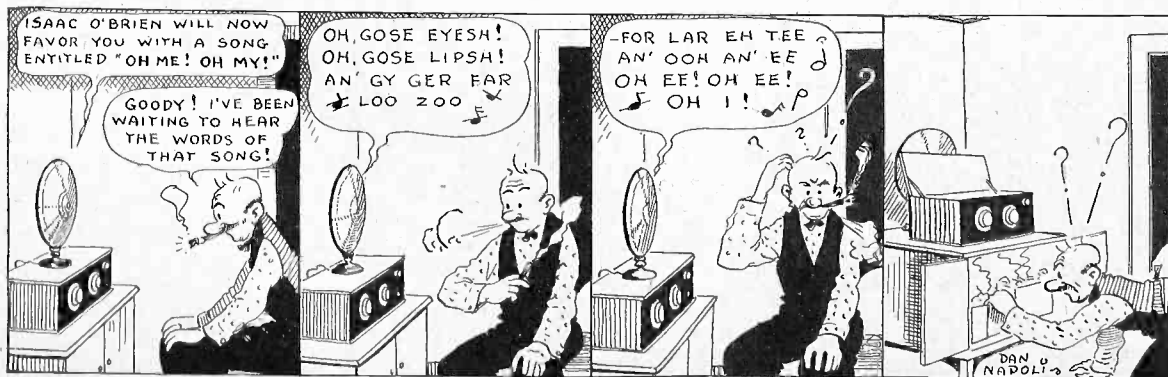

Acoustician Secret Hero of Many Artistic Feats

PITTSBURGH

Considering the many channels that contribute to a typical KDKA program, the station is not unlike a great river and its tributaries.

The tributaries of a radio station, however, do not take care of themselves. They require manifold and expert attention. And that's where the radio acoustician and the radio operator enter the scene.

When the listener turns his dial and gets the announcement, "This is Westinghouse Station KDKA at Pittsburgh" the subsequent number may come to him from any one of 45 pick-ups maintained by the station in Pittsburgh and its boroughs.

Process of Equipment

These pick-ups in concert halls, clubs, hotels, schools and churches are sources that present more than a few difficulties to J. Frazier, manager of KDKA, and his operating staff.

The operator and acoustical expert coming to the location of the new pick-ups are confronted with the initial task of determining what will be the most advantageous spot for the microphone.

The process of equipping the new place means not alone the technical work of setting up the machinery, checking up on characteristics of the room, etc., but it also necessitates a kind of dress rehearsal.

On the Job Early

If it happens to be a Sunday morning church service the radio operator and acoustician are at work while the choir is still asleep. Hours before the song or sermon can go on the air there is a try-out to be staged. When the test program reaches the central station satisfactorily that pick-up is labeled O. K. and he operators drive on to the next.

In the case of most of KDKA'S studio tributaries this operation must be repeated for each program as it is impracticable to keep permanent equipment at 45 different points.

After the program has reached the pick-up microphone it is first amplified and then relayed by telephone line (it may be 15 or 30 miles) to the main studio

in East Pittsburgh. Here is the station's filtering room where the song, sermon, address, or orchestra selection is, so to speak, placed under the "microscope."

Many Questions

"Is the number coming in too softly or too loudly? Does the speaker's voice sound natural? Would his listening friends recognize the speaker? Are the basses overwhelming the soprano or are the sopranos singing rings around the baritone?"

These, and many more, are the questions behind the activity in the filtering room.

The filtering room is the diagnosing room of radio broadcasting. The acoustician is the diagnostician; the radio operator is the surgeon.

The person who directs this business of tone analyses and doctoring must be an individual who understands radio apparatus as well as music.

Popcke Is the Man

At KDKA the position is held by A. Popcke.

Some months ago a Pittsburgh musician was the recipient of letters from radio auditors complimenting him on the excellencies of his new organ.

"It just can't be compared with the old one," they wrote.

These people were very kind about writing but nevertheless they had to be disappointed; they were told there was no new organ. Just new draperies in the room that contained the organ. That was all. The unsung radio acoustician had been on the job.

Unwept, Unhonored and Unsung

The work of engineers is lauded. Artists are showered with letters of praise and tenderness; announcers are worshipped and glorified but alas, for the unsung radio acoustician. He is a faithful and important contributor to the success of the program and yet—

Nobody writes to him

He is not praised by listeners

He is almost unknown; he works

behind the scenes.

Good Time Had By All But Remote Control Men

Did you ever stop to think when you hear WRNY broadcasting just how much difficulty there is, how much complexity there is, in sending any program from a remote point to the control room of the station?

Two men, an operator and an announcer, start from the station an hour before the program is to be broadcast, carrying with them two black fibre suit cases in which are contained all the essential apparatus necessary to broadcast. In the suit cases are microphones, batteries, extensions, phones, spare tubes, and last but not least is the amplifier which multiplies the volume of the program thousands of times in order that it may overcome the resistance of the telephone lines.

With this apparatus they proceed to the point of broadcasting, and then comes the hardest part of the job. This is the

setting up of the apparatus in the right place for the best results, and arranging the microphones so that they will pick up the voices or instruments of the artists in the best possible manner.

In some cases, take for instance a banquet, there is a crowd of hectic diners, all out for a good time, and the little matter of broadcasting doesn't worry them in the least. They may be very much in the way, but it is the job of the remote control operator to arrange the microphone without disturbing any of them.

This having been done, and the amplifier having been set up and tested, the remote control operator calls up the station and informs the operator there that he is ready for a complete test through the station amplifier. There are two telephone lines to every point where remote broadcasting is to be done, and if one of the lines should fail, the other can be used to broadcast over.

For Fishing For Waves

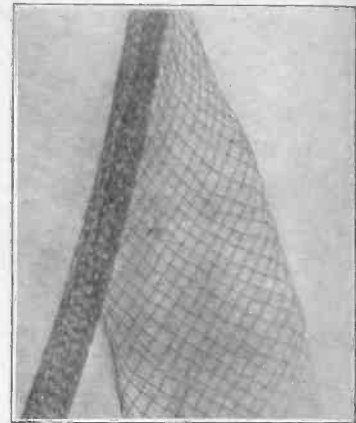

"LET'S go fishing," said the young man, pointing to the net on the sand. But that had nothing to do with this picture, which shows No. 25 stranded enamelled aerial wire as it is strung and as it looks when spread out.

Nobel Winner a Fan



(Kadel & Herbert)

SELMA LAGERLOF, Sweden's famous woman writer, in the study in her country home, near Stockholm. Miss Lagerlof is the only woman who received the Nobel award for literature.

A Loop on a Door

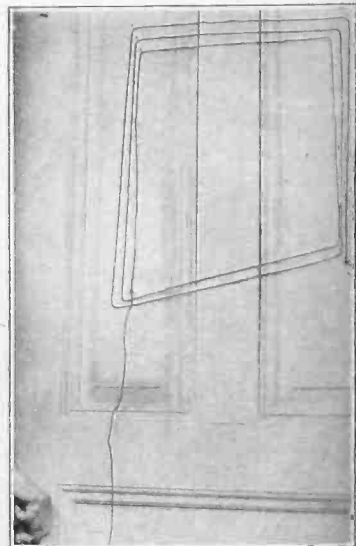

(Hayden)

AN improvised loop may be made by putting a few turns on a door, to bring in locals.

Invalid Composer Broadcasts Thanks



(Kadel & Herbert)

JANET BULLOCK WILLIAMS, well known teacher and composer of music who for the last several years has been confined to bed, due to paralysis, sends her own message of appreciation through station WOR, after she had heard the premiere of her operetta "Nibelungen Ring, Jr.," a travesty on Wagnerian music. She composed the piece while in bed.

DeForest Enlightened



DAVID L. LOEWE, of the Loewe Audion Co. of Berlin, explains to Dr. Lee De Forest (at right) the functioning of the Loewe Multiple Tube. Dr. De Forest invented the three-element vacuum tube; Siegmund Loewe, David's brother, invented the tube that has a detector and two audio stages inside, including all parts and wiring, except the tuner.

His Ear to the Ground

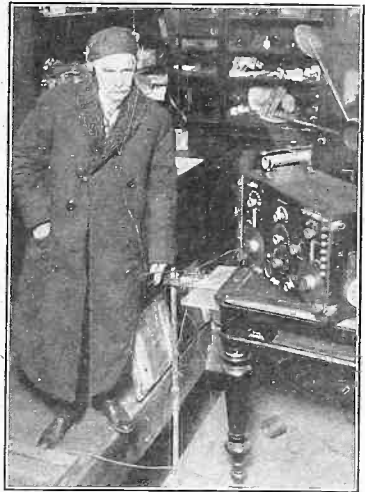

(Wide World)

DR. J. HARRIS ROGERS, who discovered the possibilities of radio reception via the earth, rather than through space, is shown above tuning in with an antenna loop.

WEAF Pays Orchestras Up to \$400-an-Hour Rate

There has been considerable discrepancy in amounts reported to have been paid to orchestras and others for radio appearances. It is quite true that many stations do not pay their talent but it is also equally true that others pay them well.

For instance, it has been learned upon reliable authority that one orchestra appearing for WEAf in New York City and allied stations receives \$265 for an hour. Such an appearance sometimes requires as many as three rehearsals, inas-

much as the day has passed when a first-class orchestra simply plumps down into a station and begins to play.

Another orchestra at WEAf receives \$300 an hour, two others, \$325 an hour each, another \$350 an hour; and still another \$400 an hour, usually depending upon the number of men in the orchestra. A popular string trio receives \$75 an hour and a quartet \$100. A well-known male singer gets \$40 an appearance. If he is accompanied by an orchestra, this, of course means an extra charge.

International Broadcast Chain Started in Europe

Europe is to enjoy superlative DX programs by international telephonic relays. Experiments to that end by the Comité Consultatif International des Communications Téléphonique a Grand Distance, headquarters in Paris have proven successful.

In a letter to Eric H. Palmer of the Freed-Eisemann Radio Corporation, who visited Europe as official observer during the international broadcast tests, Arthur R. Burrows, Secretary General of the Union Internationale de Radiophonie,

Geneva, writes enthusiastically of the results obtained in the broadcasting of the speeches at the last meeting of the League of Nations council.

"I am told that the effect was really impressive for those at a distance," reports Mr. Burrows. "Five countries took part. The Swiss had a specially prepared line to serve Geneva, Lausanne, Berne, and Zurich. The French had two lines, one for the Assembly current and a second for control purposes, which was split at the French frontier to feed two circuits."

Old Home Changeth

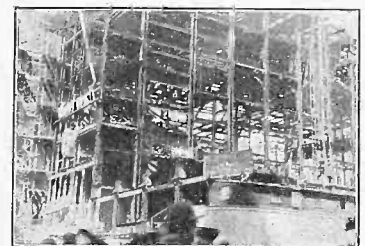

THE new Paramount Theatre Building, now erecting on Broadway, Forty-third to Forty-fourth Streets, New York City, is on the site formerly shared by RADIO WORLD, whose new address is 145 West Forty-fifth Street.

RADIO WORLD

REG. U.S. PAT. OFF.



Radio World's Slogan: "A radio set for every home."

TELEPHONE BRYANT 0568, 0559
 PUBLISHED EVERY WEDNESDAY
 (Dated Saturday of same week)
 FROM PUBLICATION OFFICE
 HENNESSY RADIO PUBLICATION CORPORATION
 145 WEST 45th STREET, NEW YORK, N. Y.
 (Just East of Broadway)
 ROLAND BURKE HENNESSY, President
 M. B. HENNESSY, Vice-President
 FRED S. CLARK, Secretary and Manager
 European Representatives: The International News Co.
 Brema's Bldgs., Chancery Lane, London, Eng.
 Paris, France: Brentano's, 8 Avenue de l'Opera
 San Francisco: Lloyd B. Chappell, 656 O'Farrell St.

EDITOR, Roland Burke Hennessy
 MANAGING EDITOR, Herman Bernard
 TECHNICAL EDITOR, Lewis Winner
 CONTRIBUTING EDITORS, John F. Rider, J. E. Anderson

SUBSCRIPTION RATES

Fifteen cents a copy, \$6.00 a year, \$3.00 for six months, \$1.50 for three months. Add \$1.00 a year extra for foreign postage. Canada, 50 cents.

Receipt by new subscribers of the first copy of RADIO WORLD mailed to them after sending in their order is automatic acknowledgment of their subscription order. Changes of address should be received at this office two weeks before date of publication. Always give old address; also state whether subscription is new or a renewal.

ADVERTISING RATES

General Advertising

1 Page, 7 1/4"x11"	462 lines	\$300.00
1/2 Page, 7 1/4"x5 1/2"	231 lines	150.00
1/2 Page, 8 1/2"x D. C.	231 lines	150.00
1/4 Page, 4 1/2"x D. C.	115 lines	75.00
1 Column, 2 1/4"x11"	154 lines	100.00
1 Inch		10.00
Per Agate Line		.75

Time Discount

52 consecutive issues	20%
26 times consecutively or E. O. W. one year	15%
4 consecutive issues	10%

WEEKLY, dated each Saturday, published Wednesday. Advertising forms close Tuesday, eleven days in advance of date of issue.

CLASSIFIED ADVERTISEMENTS

Ten cents per word. Minimum 10 words. Cash with order. Business Opportunities ten cents per word, \$1.00 minimum.

Entered as second-class matter March 23, 1922, at the Post Office at New York, N. Y., under the Act of March 3, 1879.

MAY 15, 1926

THE REBUS

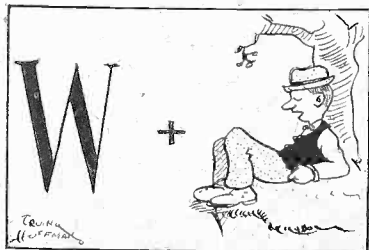

CAN you decipher what station this rebus stands for?

Prisoners in Atlanta Use 50 Radio Receivers

To make life a little less onerous to prisoners in the Federal penitentiary at Atlanta, Ga., Warden John W. Snook permits the operation of some fifty radio receiving sets. Only during music hour between 6 and 7 p. m. are loud speakers permitted, but practically all of the sets have wires attached with earphones in digerent cells, at which convicts can listen in.

Publisher As a Broadcaster

THE dissemination of news by broadcasting is an important function much neglected. While several stations do broadcast news bulletins, the extent of this service is limited. The stations that render it are few and often far apart. Nothing has such a general interest as news, so radio is missing one of its biggest opportunities. Your jazz orchestra may play "A Cup of Coffee, a Sandwich and You," and the anti-jazz element will feel perturbed. Or a fancy soprano and gusty tenor may unite on "Laissez-moi Contempler Ton Visage," from "Faust," and the jazzites will feel offended. Hymns may bore the free-and-easy, yet negro spirituals, not much different, delight them. Broadcast plays tantalize some. There is no possibility of doing anything that will delight everybody, where the audience may run into the hundreds of thousands. The nearest thing to pleasing everybody is in broadcasting news, for on that, one interest combines. What was the verdict in the great criminal trial of the moment? What did the President say about the League of Nations resolution? Well, what do you know about that—a philanthropist gives \$10,000,000 to charity! The doings of the whole world will filter through the microphone. This internationalizes broadcasting to a new and marked extent.

The fact that William Randolph Hearst is pressing his application for station licenses in eleven cities naturally means that he hopes to get more news into the microphone. Mr. Hearst, as a news analyst and indeed missionary, is one of the keenest in the United States, and he has imparted an education along this line to his editors. Thus, with a Hearst paper in each of the eleven cities, he seeks to supplement each of these with a microphone.

These cities are New York, Chicago, Baltimore, Washington, San Francisco, Seattle, Detroit, Boston, Albany, Rochester and Syracuse. Each Hearst paper in these cities has the service of one or more of Mr. Hearst's own news syndicates that cover the world with searching thoroughness. Thus Mr. Hearst as a broadcaster would enable his stations to do what no other chain of stations can do, for there is a property interest in news, and stations are unable to buy the privilege of broadcasting an adequate amount. Some who appropriated news were stopped by a still greater public interest in news. Far from being competitive, the microphone will be the blood brother of the printing press. While the sale of "extras" may not go up, for the microphone will be a prompter and less expensive "extra" by itself, general newspaper circulation is bound to be stimulated, on a firmer basis than a mere bash ever established, and that is what counts.

The radio public will welcome the Hearst genius for news, as well as the editorial comment on the doings of the world.

The Hearst chain of stations, of course, would present a well-balanced program, with entertainment and education aplenty, merely giving news its proper place, which it has not yet enjoyed in broadcasting.

Mr. Hearst is a skilled producer, so the combination of theatrical and news talents is a happy one indeed.

Let us hope that a way will be found promptly to grant the licenses and wavelengths that will enable an unstintingly conducted chain of stations to render public service through the microphone.

PICTURES RADIOED REGULARLY

Regular commercial transmission of pictures by radio has been inaugurated by the Marconi Wireless Company of London and RCA of N. Y. City.

Jovial Announcer



AUSTIN RAHE, humorous announcer of station WMCA, at the "mike." His jovial manner of announcing the various artists has earned him, the well deserved title, of "The Announcer With the Smiling Voice." Mr. Rahe claims the distinction of knowing every orchestra leader in N. Y., which accounts for the many witty ditties, he springs, when they appear at the station.

Coughing Sounds Like Samson Rocking Temple

A listener recently remarked that the thoughtless coughing and clearing of throats of speakers into the microphone was as bad as static. He spoke of a well-known clergyman who had a habit of doing this and remarked that he was sure that this divine was doing it unconsciously. This was intended as a reminder to speakers when they are coughing or clearing their throats at least to turn away from the microphone.

The use of increased power, which greatly amplifies every sound, makes it more and more necessary for radio speakers to give thought to such details.

Bureau Has 3 Vacancies, Pay Ranges Up to \$3,800

To fill vacancies at the Bureau of Standards, where some of the most important radio research work in the country is being carried on, the Civil Service Commission announces open competitive examination for a physicist at a salary of \$3,800; an associate physicist, \$3,000; and an assistant physicist, \$2,400.

Competitors will be rated in optional subjects of radio, electricity, mechanics, and others. Receipt of applications will close June 8 and full information and application blanks will be given from the Civil Service Commission, Washington, D. C.

Strauss Prefers "Mike" to Concert or Opera

According to reports filtering from Vienna, Richard Strauss, the composer, prefers appearing on the air to personal appearance in concert halls or opera conducting.

At any rate, it is said his only Vienna appearance this season will be to accompany Franz Steiner, radio artist, when Steiner broadcasts.

De Mott Outlines Path For Big Sale of Receivers

[The following address was delivered before the Radio Manufacturers Association at their convention in Atlantic City.]

By R. W. De Mott

President Radio Magazine Publishers' Association, Inc.

At the inception of the Radio Magazine Publishers Association there were any number of good radio magazines in the field covering practically every phase of the radio industry. There were some published exclusively for the radio amateur, others for the broadcast listener who built his own sets and those of his friends, others for the broadcast listener who knew a little of the theory of radio, but who would never attempt to build a set, relying upon a manufactured model and using his knowledge of radio to improve or get the utmost efficiency out of his set. There were other magazines devoted exclusively to the radio trade, the dealer and jobber, and still others which covered all of these markets simultaneously, reaching both the consumer and the trade.

One of these publications had been in existence since 1913, another since 1915, another since 1917, still another since 1919, and new ones were starting up every week—all striving to do their bit toward the fostering and furtherance of the radio industry, and each independently and honestly working toward the one goal, that of increasing the market for radio products, parts, accessories and complete sets, and the education of the public to the semi-technical side of radio so that the man or woman who had just purchased a set would know how to properly operate that set and it would stay sold.

Every Little Bit Helps

Every radio publication that has ever been published, every piece of radio literature that has ever been put out, has created and helped to build up the radio market, which, today has assumed such tremendous importance as to be one of this country's leading industries.

I need not remind you that radio could not have accomplished in four short years what it has if it had not been for the nucleus of radio fans around which the whole structure of the radio industry is built. This nucleus was created and enlarged by the radio magazines, some of which have been at it since the old days of wireless—the days of the spark gap and the coherer. It would be ridiculous to suppose that any group of publications which had been in the radio business long

before there were such things as complete factory-built receiving sets for broadcast reception could fail to know something about the radio market.

List of Members

The leading radio magazines of the country realizing the importance of their work, and the vast benefits which they could accomplish by concerted instead of haphazard methods, united in the formation of the Radio Magazine Publishers Association as it exists today. Our members stretch from the Atlantic Ocean to the Pacific and include the following magazines: "Amateur Radio," "Citizens Radio Call Book," "Q. S. T.," "Radio," "Radio Age," "Radio Broadcast," "Radio Dealer," "Radio Digest," "The Radio Home," "Radio International," "Radio News," "Radio Review," RADIO WORLD, "Radiocast Weekly," "Retail Radio," "Radio Dealer Year Book," and "Science and Invention." These magazines represent a combined circulation of more than 2,052,000 copies monthly. Think of it—more than two million copies monthly. And yet there are those who say that the radio magazines go only to the radio fan who wouldn't buy a complete manufactured set. Why, there aren't more than 50,000 radio amateurs in the country. Allowing another 300,000 for broadcast fans, who buys the remaining 1,702,000 copies of our circulation? Yet set manufacturers, if you had cultivated this market and sold last year only one set to each of our readers, could have cleaned out practically the entire output of sets manufactured during this year.

Furthermore, and in addition to this, don't forget that our readers buy or build an average of two sets every year—the life of a radio set with our readers is only six months.

Passing over routine matters, let me state that the purposes and aims of the association fall into three classifications and we have accomplished much along all three lines.

First, we have aimed by co-operative work to standardize our individual Laboratory Services so that these laboratories will not only perform a genuine service to our readers in giving them the results of tests made on new and improved apparatus, but will give to each and every manufacturer, whether of parts or complete sets, the means of obtaining outside independent tests of his merchandise that would cost him hundreds of dollars if he were to go to a commercial laboratory. Today a manufacturer, let's say he makes

transformers, can receive from any one of the laboratories of our members an unbiased report and a chart or curve on the performance of his transformers, absolutely free. Not only does this laboratory work of our members save manufacturers who take advantage of it many hundreds of dollars a year, but it makes the marketing of his goods easier, because it strengthens public confidence in his merchandise among our readers, and with the radio trade.

Co-operation, Second Point

The second branch of our activities embraces the co-operative efforts of all of our members toward educating the public to the intricacies of radio. Our aim is not only to arouse public interest in radio reception, but to so educate them through our editorial columns that they will know how to handle a set after they have bought it. When goods are sold to people who know nothing about radio, the goods are often condemned and do not remain sold, while sales made to readers of radio magazines are assured of staying sold.

Through our mutual co-operation we have devised ways and means for increasing our circulations and getting new blood into the radio industry. As a result the great majority of the members of the Radio Magazine Publishers Association are finding right at this time such an increased demand for radio magazines that they have had to very materially increase their distribution of copies *this summer*. This means the creation of a bigger market for you.

The present structure of the radio market is based upon interest aroused by the radio magazines, and we are continually striving to stimulate further public interest in radio, not merely to make one sale, but continually to create demand for improved radio apparatus—both complete sets and standard parts and accessories.

Third Stage is Statistical

The third phase of our activities consists in the preparation of statistics covering the radio market and the education of manufacturers and their advertising agencies as to the definite place the radio magazines have in their distribution scheme, whether the manufacturer be a maker of parts, accessories or complete, factory-built sets. In many cases we have been successful. It is a strange fact, and one worthy of careful consideration by every set manufacturer that every make of set that has been successful this year has been advertised in radio magazines, while on the other hand the big failures this year are among the group who ignored the radio magazines in their sales campaigns.

The presentation of such facts to manufacturers and advertising agencies in par-

(Concluded on page 20)

WHY PARTS BUSINESS IMPROVES

By Dan Napoli

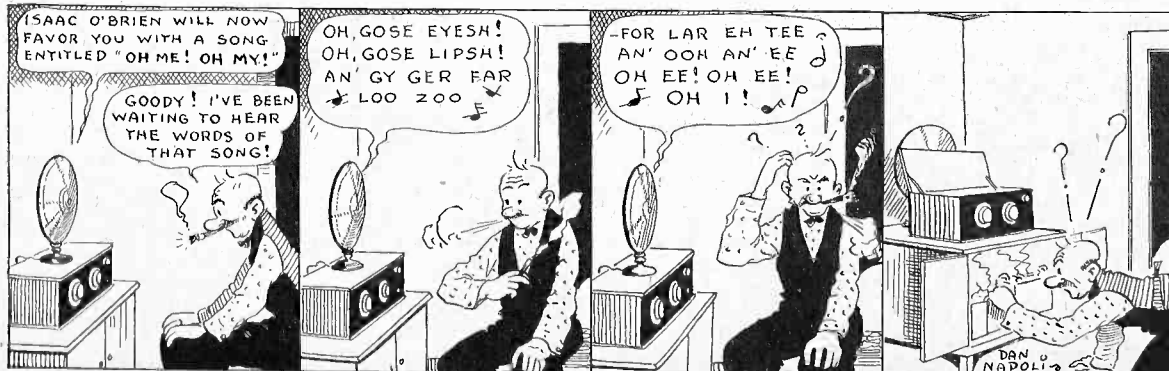

RADIO WORLD

REG. U.S. PAT. OFF.



Radio World's Slogan: "A radio set for every home."

TELEPHONE BRYANT 0558, 0559
 PUBLISHED EVERY WEDNESDAY
 (Dated Saturday of same week)
 FROM PUBLICATION OFFICE
 HENNESSY RADIO PUBLICATION CORPORATION
 145 WEST 45th STREET, NEW YORK, N. Y.
 (Just East of Broadway)
 ROLAND BURKE HENNESSY, President
 M. B. HENNESSY, Vice-President
 FRED S. CLARK, Secretary and Manager
 European Representatives: The International News Co.
 Breains Bldg., Chancery Lane, London, Eng.
 Paris, France: Brentano's, 3 Avenue de l'Opera
 San Francisco: Lloyd B. Chappell, 656 O'Farrell St.

EDITOR, Roland Burke Hennessy
 MANAGING EDITOR, Herman Bernard
 TECHNICAL EDITOR, Lewis Winner
 CONTRIBUTING EDITORS, John F. Rider, J. E. Anderson

SUBSCRIPTION RATES

Fifteen cents a copy. \$6.00 a year. \$3.00 for six months. \$1.50 for three months. Add \$1.00 a year extra for foreign postage. Canada, 50 cents.

Receipt by new subscribers of the first copy of RADIO WORLD mailed to them after sending in their order is automatic acknowledgment of their subscription order. Changes of address should be received at this office two weeks before date of publication. Always give old address; also state whether subscription is new or a renewal.

ADVERTISING RATES

General Advertising		
1 Page, 7 1/4 "x11"	462 lines	\$300.00
1/2 Page, 7 1/4 "x5 1/2"	231 lines	150.00
1/2 Page, 8 1/2 " D. C.	231 lines	150.00
3/4 Page, 4 1/2 " D. C.	116 lines	75.00
1 Column, 2 1/4 "x11"	154 lines	100.00
1 Inch		10.00
Per Azate Line		.75

Time Discount

32 consecutive issues	20%
28 times consecutively or E. O. W. one year	15%
4 consecutive issues	10%

WEEKLY, dated each Saturday, published Wednesday. Advertising forms close Tuesday, eleven days in advance of date of issue.

CLASSIFIED ADVERTISEMENTS

Ten cents per word. Minimum 10 words. Cash with order. Business Opportunities ten cents per word, \$1.00 minimum.

Entered as second-class matter March 23, 1922, at the Post Office at New York, N. Y., under the Act of March 3, 1879.

MAY 15, 1926

THE REBUS

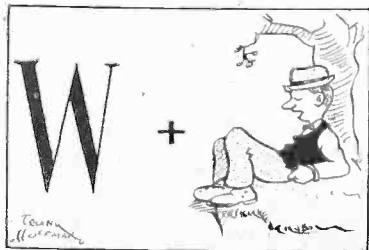

CAN you decipher what station this rebus stands for?

Prisoners in Atlanta Use 50 Radio Receivers

To make life a little less onerous to prisoners in the Federal penitentiary at Atlanta, Ga., Warden John W. Snook permits the operation of some fifty radio receiving sets. Only during music hour between 6 and 7 p. m. are loud speakers permitted, but practically all of the sets have wires attached with earphones in divergent cells, at which convicts can listen in.

Publisher As a Broadcaster

THE dissemination of news by broadcasting is an important function much neglected. While several stations do broadcast news bulletins, the extent of this service is limited. The stations that render it are few and often far apart. Nothing has such a general interest as news, so radio is missing one of its biggest opportunities. Your jazz orchestra may play, "A Cup of Coffee, a Sandwich and You," and the anti-jazz element will feel perturbed. Or a fancy soprano and gusty tenor may unite on "Laissez-moi Contempler Ton Visage," from "Faust," and the jazzites will feel offended. Hymns may bore the free-and-easy, yet negro spirituals, not much different, delight them. Broadcast plays tantalize some. There is no possibility of doing anything that will delight everybody, where the audience may run into the hundreds of thousands. The nearest thing to pleasing everybody is in broadcasting news, for on that, one interest combines. What was the verdict in the great criminal trial of the moment? What did the President say about the League of Nations resolution? Well, what do you know about that—a philanthropist gives \$10,000,000 to charity! The doings of the whole world will filter through the microphone. This internationalizes broadcasting to a new and marked extent.

The fact that William Randolph Hearst is pressing his application for station licenses in eleven cities naturally means that he hopes to get more news into the microphone. Mr. Hearst, as a news analyst and indeed missionary, is one of the keenest in the United States, and he has imparted an education along this line to his editors. Thus, with a Hearst paper in each of the eleven cities, he seeks to supplement each of these with a microphone.

These cities are New York, Chicago, Baltimore, Washington, San Francisco, Seattle, Detroit, Boston, Albany, Rochester and Syracuse. Each Hearst paper in these cities has the service of one or more of Mr. Hearst's own news syndicates that cover the world with searching thoroughness. Thus Mr. Hearst as a broadcaster would enable his stations to do what no other chain of stations can do, for there is a property interest in news, and stations are unable to buy the privilege of broadcasting an adequate amount. Some who appropriated news were stopped by a still greater public interest in news. Far from being competitive, the microphone will be the blood brother of the printing press. While the sale of "extras" may not go up, for the microphone will be a prompter and less expensive "extra" by itself, general newspaper circulation is bound to be stimulated, on a firmer basis than a mere bash ever established, and that is what counts.

The radio public will welcome the Hearst genius for news, as well as the editorial comment on the doings of the world.

The Hearst chain of stations, of course, would present a well-balanced program, with entertainment and education aplenty, merely giving news its proper place, which it has not yet enjoyed in broadcasting.

Mr. Hearst is a skilled producer, so the combination of theatrical and news talents is a happy one indeed.

Let us hope that a way will be found promptly to grant the licenses and wavelengths that will enable an unstintingly conducted chain of stations to render public service through the microphone.

PICTURES RADIOED REGULARLY

Regular commercial transmission of pictures by radio has been inaugurated by the Marconi Wireless Company of London and RCA of N. Y. City.

Jovial Announcer



AUSTIN RAHE, humorous announcer of station WMCA, at the "mike." His jovial manner of announcing the various artists has earned him, the well deserved title, of "The Announcer With the Smiling Voice." Mr. Rahe claims the distinction of knowing every orchestra leader in N. Y., which accounts for the many witty ditties, he springs, when they appear at the station.

Coughing Sounds Like Samson Rocking Temple

A listener recently remarked that the thoughtless coughing and clearing of throats of speakers into the microphone was as bad as static. He spoke of a well-known clergyman who had a habit of doing this and remarked that he was sure that this divine was doing it unconsciously. This was intended as a reminder to speakers when they are coughing or clearing their throats at least to turn away from the microphone.

The use of increased power, which greatly amplifies every sound, makes it more and more necessary for radio speakers to give thought to such details.

Bureau Has 3 Vacancies, Pay Ranges Up to \$3,800

To fill vacancies at the Bureau of Standards, where some of the most important radio research work in the country is being carried on, the Civil Service Commission announces open competitive examination for a physicist at a salary of \$3,800; an associate physicist, \$3,000; and an assistant physicist, \$2,400.

Competitors will be rated in optional subjects of radio, electricity, mechanics, and others. Receipt of applications will close June 8 and full information and application blanks will be given from the Civil Service Commission, Washington, D. C.

Strauss Prefers "Mike" to Concert or Opera

According to reports filtering from Vienna, Richard Strauss, the composer, prefers appearing on the air to personal appearance in concert halls or opera conducting.

At any rate, it is said his only Vienna appearance this season will be to accompany Franz Steiner, radio artist, when Steiner broadcasts.

De Mott Outlines Path For Big Sale of Receivers

[The following address was delivered before the Radio Manufacturers Association at their convention in Atlantic City.]

By R. W. De Mott

President Radio Magazine Publishers' Association, Inc.

At the inception of the Radio Magazine Publishers Association there were any number of good radio magazines in the field covering practically every phase of the radio industry. There were some published exclusively for the radio amateur, others for the broadcast listener who built his own sets and those of his friends, others for the broadcast listener who knew a little of the theory of radio, but who would never attempt to build a set, relying upon a manufactured model and using his knowledge of radio to improve or get the utmost efficiency out of his set. There were other magazines devoted exclusively to the radio trade, the dealer and jobber, and still others which covered all of these markets simultaneously, reaching both the consumer and the trade.

One of these publications had been in existence since 1913, another since 1915, another since 1917, still another since 1919, and new ones were starting up every week—all striving to do their bit toward the fostering and furtherance of the radio industry, and each independently and honestly working toward the one goal, that of increasing the market for radio products, parts, accessories and complete sets, and the education of the public to the semi-technical side of radio so that the man or woman who had just purchased a set would know how to properly operate that set and it would stay sold.

Every Little Bit Helps

Every radio publication that has ever been published, every piece of radio literature that has ever been put out, has created and helped to build up the radio market, which today has assumed such tremendous importance as to be one of this country's leading industries.

I need not remind you that radio could not have accomplished in four short years what it has if it had not been for the nucleus of radio fans around which the whole structure of the radio industry is built. This nucleus was created and enlarged by the radio magazines, some of which have been at it since the old days of wireless—the days of the spark gap and the coherer. It would be ridiculous to suppose that any group of publications which had been in the radio business long

before there were such things as complete factory-built receiving sets for broadcast reception could fail to know something about the radio market.

List of Members

The leading radio magazines of the country realizing the importance of their work, and the vast benefits which they could accomplish by concerted instead of haphazard methods, united in the formation of the Radio Magazine Publishers Association as it exists today. Our members stretch from the Atlantic Ocean to the Pacific and include the following magazines: "Amateur Radio," "Citizens Radio Call Book," "Q. S. T.," "Radio," "Radio Age," "Radio Broadcast," "Radio Dealer," "Radio Digest," "The Radio Home," "Radio International," "Radio News," "Radio Review," RADIO WORLD, "Radiocast Weekly," "Retail Radio," "Radio Dealer Year Book," and "Science and Invention." These magazines represent a combined circulation of more than 2,052,000 copies monthly. Think of it—more than two million copies monthly. And yet there are those who say that the radio magazines go only to the radio fan who wouldn't buy a complete manufactured set. Why, there aren't more than 50,000 radio amateurs in the country. Allowing another 300,000 for broadcast fans, who buys the remaining 1,702,000 copies of our circulation? Yet set manufacturers, if you had cultivated this market and sold last year only one set to each of our readers, could have cleaned out practically the entire output of sets manufactured during this year.

Furthermore, and in addition to this, don't forget that our readers buy or build an average of two sets every year—the life of a radio set with our readers is only six months.

Passing over routine matters, let me state that the purposes and aims of the association fall into three classifications and we have accomplished much along all three lines.

First, we have aimed by co-operative work to standardize our individual Laboratory Services so that these laboratories will not only perform a genuine service to our readers in giving them the results of tests made on new and improved apparatus, but will give to each and every manufacturer, whether of parts or complete sets, the means of obtaining outside independent tests of his merchandise that would cost him hundreds of dollars if he were to go to a commercial laboratory. Today a manufacturer, let's say he makes

transformers, can receive from any one of the laboratories of our members an unbiased report and a chart or curve on the performance of his transformers, absolutely free. Not only does this laboratory work of our members save manufacturers who take advantage of it many hundreds of dollars a year, but it makes the marketing of his goods easier, because it strengthens public confidence in his merchandise among our readers, and with the radio trade.

Co-operation, Second Point

The second branch of our activities embraces the co-operative efforts of all of our members toward educating the public to the intricacies of radio. Our aim is not only to arouse public interest in radio reception, but to so educate them through our editorial columns that they will know how to handle a set after they have bought it. When goods are sold to people who know nothing about radio, the goods are often condemned and do not remain sold, while sales made to readers of radio magazines are assured of staying sold.

Through our mutual co-operation we have devised ways and means for increasing our circulations and getting new blood into the radio industry. As a result the great majority of the members of the Radio Magazine Publishers Association are finding right at this time such an increased demand for radio magazines that they have had to very materially increase their distribution of copies *this summer*. This means the creation of a bigger market for you.

The present structure of the radio market is based upon interest aroused by the radio magazines, and we are continually striving to stimulate further public interest in radio, not merely to make one sale, but continually to create demand for improved radio apparatus—both complete sets and standard parts and accessories.

Third Stage is Statistical

The third phase of our activities consists in the preparation of statistics covering the radio market and the education of manufacturers and their advertising agencies as to the definite place the radio magazines have in their distribution scheme, whether the manufacturer be a maker of parts, accessories or complete, factory-built sets. In many cases we have been successful. It is a strange fact, and one worthy of careful consideration by every set manufacturer that every make of set that has been successful this year has been advertised in radio magazines, while on the other hand the big failures this year are among the group who ignored the radio magazines in their sales campaigns.

The presentation of such facts to manufacturers and advertising agencies in par-

(Concluded on page 20)

WHY PARTS BUSINESS IMPROVES

By Dan Napoli

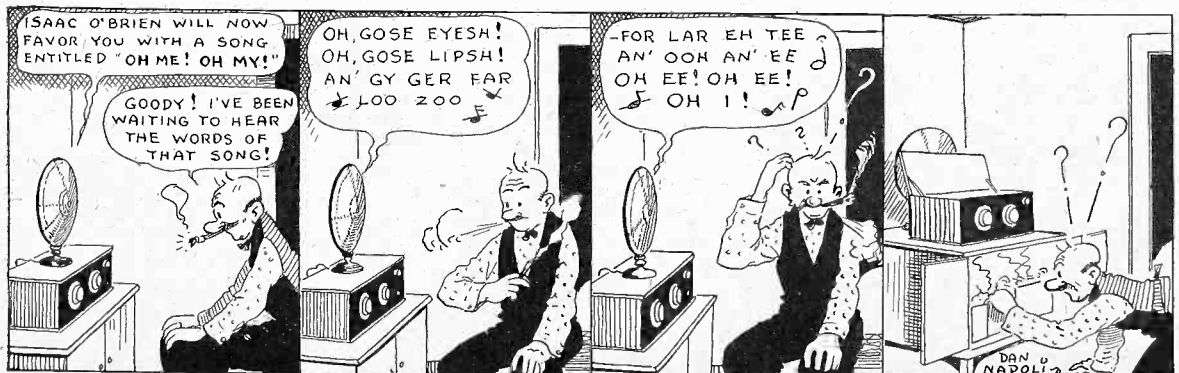

Big Season For Leaders, Is Freshman's Prophecy

Net profits of \$343,147.11 before taxes, for the first quarter of 1926 are reported by the Chas. Freshman Co., Inc. A statement by the President, Chas. Freshman, accompanies this report. He says:

"In reviewing the first quarter's business of 1926, we wish to point out that the net profits, \$343,147.11, before taxes, are after the company's absorption of adjustment on price concessions of retail dealers' stocks when our list prices were reduced on February 8, 1926.

"Our net earnings for this quarter show a substantial increase over the first quarter of 1925, which were \$304,915.82, based

on sales of radio sets retailing at much higher prices. As an example, the popular set which retailed at \$60 in the first quarter of 1925, is now being sold at \$38.50.

"The general outlook for the radio industry for the coming season is highly satisfactory for well financed companies on a solid foundation. General conditions in our industry have been greatly improved by the reduction of the number of manufacturers through the elimination of some of the less firmly established producers. Competition will tend to be on a more healthy basis in the future."

COMING EVENTS

JUNE 1 to DEC. 1—Sesqui-Centennial, Industrial Arts Bldg., Philadelphia, Pa., with concurrent radio exposition. J. C. Johnson, manager, 1560 B'way, N. Y. City.

SEPT. 10 to 17—National Radio Exposition, Grand Central Palace, New York City. American Radio Exposition Co., 1560 Broadway, New York City.

SEPT. 13 to 18—Third Radio World's Fair, Madison Square Garden, New York City. G. Clayton Irwin, manager, Times Bldg., N. Y. City.

OCT. 11 to 17—Fifth Annual Chicago Radio Show, Coliseum, Chicago, Ill. G. Clayton Irwin, manager, Times Bldg., N. Y. City.

Crosley Gets New Home for His Label Plant

Powel Crosley, Jr., owner of The National Label Company, has just purchased a new site for the erection of a modern printing plant, at the northwest corner of Colerain avenue and Brashears street, Cincinnati.

The National Label Company not only prints labels for some of the largest industrial concerns in the country, but prints the literature and labels for The Crosley Radio Corporation, which is also owned by Mr. Crosley.

Business Opportunities Radio and Electrical

Rates: 10c per word; Minimum, \$1.00; Cash with order

WOODWORKING AND RADIO CABINET plant, fully equipped with practically brand new machinery; individual motors, Blowers spraying outfit, plenty of lumber, over 1,000 finished and unfinished cabinets, hardware, finishing materials; very cheap rent; bargain to quick purchaser. 20 Mill Road, Jersey City, N. J.

ELECTRICAL ENGINEER, MANUFACTURING experience, developing electrical mechanical devices, inventions, seeks part or full time connection; have suitable laboratory. Box 1000, Radio World.

WILL FINANCE, BATTERYLESS RADIO; write full particulars. Box 2000, Radio World.

VICTROLA-RADIO STORE FOR SALE IN city of 40,000, 30 miles from New York; established 10 years; capable of netting \$10,000 per year; cash required \$18,000; valuable franchise; reason, other interests. Box 3, RADIO WORLD.

OUTSTANDING ACCOUNTS FINANCED; liberal terms, lowest rates; confidential; quick service assured. Mercantile Factors Corporation, 230 5th Av., N. Y. C. Phone Ashland 9506

BATTERY - IGNITION - RADIO SERVICE; money-maker for right party; established 5 years; sacrificing for \$1,500 to quick buyer; stock and fixtures worth double. Phone Raymond 0422, Brooklyn, N. Y.

METAL ARTICLES, STAMPING, ASSEMBLING, finishing, dies and tools for economical quality manufacturing. n Metal Craft Co., 306 East 40th, N. Y. C.

DE MOTT'S SPEECH

(Concluded from page 19)

ticular, has been one of our chief aims. It is a shame how little most advertising agencies in the past, and right today, have known about radio magazines. It isn't all personal interest in our own publications that induces our members to strive to keep these facts before you. It is a blow to the whole radio industry every time a large advertiser of radio sets fails, after having wasted his own and very often the public's money in a campaign founded upon ignorance.

An Economical Method

And I want to state right now, that there is no known method today for the sale of radio apparatus, including complete sets, that is as economical as a campaign that is first based upon selling the fan through his own magazine. Every fan influences, as you all know, the radio purchases of his friends' apparatus. Every one of you probably has been asked dozens of times during the past year, "What's a good set to buy?" We have constantly striven to keep these salient facts regarding the radio market before you manufacturers, as much for your own good as ours.

The radio business as it exists today is unlike any other business in this country, and don't let anyone tell you differently. You can't market radio sets or parts as you would Uneda Biscuits or automobiles. It is a ticklish market, as everyone in the radio industry knows. And it is going to remain so for the next ten years.

The days of experimenting, the days of new circuits, the wild, hectic changes that have been a feature of the past are far from over. What has gone before is only a very small part of what is to come. Radio sets will be vastly simplified, made more compact and more stable. The day of "you press the button and we'll do the rest" is nowhere in sight.

Television on Way

Radio television is coming—in fact, it is here. Already the transmission of photos taken by land wire and by radio is an accomplished commercial fact. You can take a photo today to the American Telephone & Telegraph Co. and they will transmit it for you to Chicago. You can take a picture to the Radio Corporation of America and they will radio it to London. So it is only a few steps to the transmission of moving scenes. Radio television, as I have already said, is here, but it is in the laboratory stage, and it remains only to put it upon a commercial plane to give the radio industry an impetus such as it has never before known.

The engineers know that there are no unsurmountable obstacles to commercial television—they know, as you and I know, that before long we will be able to sit down at our receiving sets and see, as well as hear, the World's Series being played in Pittsburgh or Washington. Today radio is sightless, even as the movies are dumb. Television will give to radio the missing sense, and it takes no imagination to predict what that will mean to the industry. Those with present day sets must either change or add to them, or scrap the old and buy new.

Those who are tired of radio programs or are so fed up on the sameness of radio-reception will find their appetites whetted anew. Suppose you do hear the same song sung twice. If a reproduction of the artist actually accompanies the rendition of the song it will be different. What keeps the interest of the public alive in the theatre? The actual sight of the actors themselves as well as the spoken or sung word.

New B Battery Unit Marketed by See Jay

After months of experimentation the See Jay Battery Company has perfected and placed on the market a new B Battery Power Unit. This is a combination alkaline element B battery, of the well-known See Jay quality, and trickle charger, all in one. The charger is connected to batteries and light socket, making a permanent battery supply with all charging troubles eliminated. Due to the special transformer having separate independent coils and therefore needing no electrical connections with outside mains it is not necessary to remove the battery from the set while charging. This is a valuable feature. The battery unit is shipped dry with solution and can be safely sent to any part of the world. All See Jay batteries and units are constructed from genuine alkaline elements and connected with their own non-corrosive connective. Literature on this unit may be had on application from See Jay Battery Company, 915 Brook Avenue, New York City. Mention RADIO WORLD.

Rix Radio Expands

Due to the growth of their business, the Rix Radio Supply House, of 5505 Fourth Avenue, Brooklyn, N. Y., has opened another store and warehouse at 72, 74 and 76 Cortlandt Street, New York City. Here a complete stock is carried, especially the new and hard-to-get parts. Anything and everything used in radio, including complete kits and sets of parts for every known circuit, is carried. Special lists will be sent to those interested. Mention RADIO WORLD.

Aerovox Brings Out Wire Wound Resistance

In modern practice when resistances are used it has been found desirable to use metallic wire on account of its permanence, uniformity and current carrying qualities. The Aerovox Wireless Corporation have placed on the market a compact wire-wound resistance, of their usual high quality, which meets every requirement for use in all kinds of battery eliminators. This unit is of 10,000 ohms, is 4" long, having a resistance of 2,500 ohms per inch of length, and is so constructed that several lengths can be taken off as required. These units are also made to carry current up to 250 milliamperes, the size depending upon the resistance and the amount of current it is required to carry. Further details can be had from Aerovox Wireless Corporation, 493 Broome Stret, New York City. Mention RADIO WORLD.

Resale Price Bill Aimed at Deceivers

By F. A. D. Andrea

As manufacturers of one of the leading brands of radio receiving sets, it has been our pleasure to have enjoyed a substantial growth during the last four years and our success we attribute in a large measure to the extended advertising we have done on our trade marked merchandise.

In the retail radio industry there have been a large number of opportunists who have taken fullest possible advantage of the heavy demand which at times has existed for radio receivers, and which in the face of the rapid growth of the industry has often run far ahead of the available supply.

Trade on Trade-Mark

Obviously under these conditions a shrewd retail merchant could resort to many tactics not strictly sanctioned by legitimate business procedure, and could even establish conditions to his own temporary benefit which are not of benefit to the manufacturer nor to the industry at large.

Lack of sophistication on the part of the purchasing public leaves the shrewd merchant broad latitude as regards the scope of his activities.

Not only our trade marked brand, but several other prominent manufacturers have suffered considerably through unethical retailers featuring this trade-marked merchandise in their advertising and at prices often considerably less than those which will permit the retailer to show a living profit, the object being not to sell the trade-marked merchandise

which is advertised, but rather to attract trade to the store by the seeming bargain in his trade-marked merchandise, and then switching the customer into the purchase of some other and inferior brand on which the retailer makes perhaps an exorbitant profit.

Distrust is the Result

Obviously the trade-marked merchandise when subjected to advertising at seemingly bargain figures by several dealers in the same city, and perhaps at a different price by each one of these dealers, establishes distrust in the minds of the purchasing public as to the actual value of the trade-marked merchandise, and in consequence the manufacturer and legitimate dealer are bound to suffer.

Again, it is manifest that if a well-advertised trade-marked article is used merely as bait to entice a customer into the store, and an endeavor is then made to sell other merchandise, it is decidedly unfair treatment.

The Capper-Kelly resale price bill, now before Congress, is drawn along lines which with reasonable certainty would prevent the undesirable procedures above outlined and in consequence the bill has our hearty indorsement.

By the terms of the bill, articles may be sold by the retailer or jobber at lower prices than prescribed by the vendors if the manufacturer discontinue dealing in such articles or cease to do business or shall become bankrupt. Under a reasonable system of resale price maintenance it is claimed that producer, wholesaler and consumer benefit. The consumer is protected in the purchase of identified merchandise.

Power Problems Likened To Railroads' Car Snarl

By Sidney Z. Mitchell

President, Electric Bond and Share Co.

The use of super power is economical for the same reason that joint efforts on car use are economical for railroads.

Car Borrowings

The fluctuating requirements of industry and the seasonal movements of commodities mean that each railroad at certain times requires many more cars than it ordinarily uses. Instead of spending huge sums to purchase additional rolling stock which would lie idle most of the time, each road, through interconnection and interchange, is today able to borrow from other roads (which do not at the time have a similar peak demand) sufficient cars to promptly and adequately meet its emergency requirements.

We have all had the experience of watching freight trains made up of cars carrying the names of a dozen different railways, but few of us ever stop to inquire by what system and through what methods the rolling stock of these diversely owned and diversely operated systems are all brought together on a single track.

The answer, as I have indicated, is that long ago the railroads of the United States adopted the principle of interconnection and interchange as a means of

eliminating waste and of improving their service to the public.

A Big Saving

Recently one of the leading railroad authorities was asked to estimate what annual saving to the railroads and to the public had been brought about through the system of interconnection and car exchange and his answer will give you some conception of the importance to any industry of the intelligent use of its equipment.

According to this authority, the saving secured through the interchange of freight cars on the railroads amounts, at an extremely conservative estimate, to not less than \$1,500,000,000 a year.

According to this same authority, if there were no interconnections between the various railroads, and if the cars of one railroad were not used on the tracks of another, it would mean that the aggregate rolling stock of all the railroads would need to be doubled. This alone would represent an additional investment of at least \$3,600,000,000 and the interest on this vast sum at 5 per cent. would amount to \$180,000,000 a year.

STATIC LEVEL RISES

WASHINGTON.

According to experts of the Navy Department, there was a great increase in atmospheric interference to radio reception during March.

Literature Wanted

THE names of readers of RADIO WORLD who desire literature from radio jobbers and dealers are published in RADIO WORLD on request of the reader. The blank below may be used, or a post card or letter will do instead.

Trade Service Editor.

RADIO WORLD,
145 West 45th St., N. Y. City.

I desire to receive radio literature.

Name

City or town.....

State

Are you a dealer?.....

If not, who is your dealer?

His Name

His Address

- O'Brian & Mohr, Brockton, Mass. (Dealers).
- J. R. Williams, Monrovia, Cal.
- Schlumann Motor Co., Waukesha, Wis. (Dealers).
- Reginald A. Vornham, 32 Lincoln Road, Walkerville, Ont., Canada.
- Joe V. Olst, 312 Foote Ave., Bellevue, Ky.
- Waynesburg Radio Shop, Waynesburg, Ky.
- W. J. Stevens, 1017 Peneston St., New Orleans, La.
- M. Orvey Jeglum, Grand Forks, N. D.
- C. R. Angel, Grand Rapids, Michigan (Dealer).
- Beane & Rogers, 404 Baltimore, Jackson, Tenn.
- H. W. Aeyer, 126 Valentine St., Glendale, L. I., N. Y.
- Dale Johnson, Box 312, Cambridge, Ill.

Freed Calls Two Shows

At Once "A Spectacle"

"The spectacle of two radio shows going on simultaneously must not be repeated.

"The position of the industry on this point is sound. By united action the industry can eliminate this undesirable situation, and that from next year on there will be only one radio show in New York, representative of the entire industry.

"To attain that end, the Radio Exhibition Corporation has been formed.

"Not a single officer will profit by a successful exhibition. The show will be conducted for the public and the industry alone—with no other object. No pecuniary interest will be the underlying factor, as quite naturally is the case with shows privately conducted.

"We are going ahead in a constructive, energetic manner, and we believe that behind us is the force of public opinion."

—Joseph D. R. Freed.

New Corporations

West End Supply Co., N. Y. City, radios and autos, \$10,000; D. Halpern, E. Stempel, C. Rabinowitz (Atty., A. J. O. Hoscckel, 1,540 Bway, N. Y. City).

Mayolan Radio Corp., N. Y. City, 10 common, no par; R. R. Mayo, C. B. Deming, L. H. Mingen (Atty., U. S. Corp., 150 Bway, N. Y. City).

M. Rabinowitz & Sons, N. Y. City, \$10,000; M. and M. and D. Rabinowitz (Atty., P. Pokor, 1,457 Bway, N. Y. City).

General Radio & Talking, Wilmington, Del., radios, talking machines, \$100,000 (John H. Short, Wilmington, Del.).

Roth Radio, N. Y. City, 200 shares, \$100 each, 200 common, no par; A. S. Bursky, I. Wertz (Atty., C. Benowitz, 15 West 44th St., N. Y. City).

Albin Radio Co., N. Y. City, \$4,000; A. Eisenstat, M. Stoller, C. Ollstein. (Atty., D. L. Spring, 7 East 42d St., N. Y. City).

STORAGE BATTERY CAPITAL REQUIRED to market new storage battery construction which has valuable features doing away with defects of present batteries; fully covered by patents, has had satisfactory test for over two years; one of largest battery jar manufacturers has reported favorably after testing thoroughly at their own plant; especially suitable for radio use, an ideal proposition for radio manufacturer who wishes to include the battery with the set. Box 234, Radio World.

COMPLETE LIST OF BROADCASTING STATIONS appeared in RADIO WORLD dated May 1. Sent on receipt of 15c, or start sub. with that number. RADIO WORLD, 145 West 45th St., N. Y. C.

Guesswork is Painlessly Extracted by Laboratory

By James H. Carroll

Radio has taken its place among the arts and sciences with the establishment of the fully equipped radio laboratory. Fans have awakened to the necessity of tested radio apparatus. The pioneers among set builders can readily remember the days when, full of enthusiasm, the new super circuit diagram before them, they rushed out to gather armfuls of parts and equipment and went to it, with no idea of calibrating the various parts and synchronizing them all through the circuit. Calibrating a loop and fitting the loudspeaker to the needs of the output was unheard of. Standards of voltage, current, inductance, capacity, etc., were unknown quantities to them.

Numerous private laboratories have been established to minister to the needs of the individual, also proving invaluable to the radio manufacturer whose requirements extend beyond the limits of his own laboratory equipment.

Where Theories Are Tested

There is a good baker's dozen of real, honest-to-goodness laboratories, conducted by highly-trained men wherein the working quarters are marvels of modern efficiency, equipped with the finest obtainable instruments that perform miracles of measurement. Here the weaver of loops may test out his theories of inductance and capacity; the finder of frequencies may obtain the exact values of his revolutionary coil; the Harum of harmonies may find out the use or mayhap the uselessness of his wonderful audio transformers or resistance complication, while plain John Smith can find out why his super will not "supe," and have it pepped up so it will do tricks.

There is a fee, but it is generally low, and is commensurate with the worth of the work performed. And with it comes the knowledge that the work is done right and will not have to be done over again. This is a highly technical branch and as in all radio practice the axiom obtains: "It pays to buy the best." This applies to service as well as to parts.

The giant strides made by radio advancement are exemplified by the feats performed in these laboratories. Their experiments, aside from the regular work of the day, are responsible for many of the short cuts to better radio. One well-known laboratory head recently in photographing audio waves made valuable discoveries regarding comparative efficiency of audio coupling. The researches of these laboratories come under many heads and the activities are varied.

R F Research Important

One of the most important is radio frequency research. There are two standard means of deriving radio frequencies; one by means of a 1,000 cycle tuning fork, the other by standing waves on wires. In the former, a tuning fork is kept vibrating by means of a vacuum tube and a series of tubes is made to oscillate in synchronism with harmonics of the tuning fork. In this way, radio frequency power is generated at frequencies which are exact multiples of 1,000 cycles. In the other method, standing waves of about 60,000-000 cycles, approximately five meters wavelength, are produced on a pair of parallel wires and the wavelength is measured directly by a tape. By means of oscillators whose harmonics are kept in synchronism with the 5-meter wave, lower

frequencies are produced. Therefore, radio frequency power is generated at frequencies which are exact fractions of 60,000,000 cycles. The two methods overlap and serve to check each other. Wave meters are by this means calibrated by tuning to these known frequencies.

The Whole Gamut Run

Here we have an example of the exacting procedure of laboratory practice and of the brains and skill that go into it. Voltage in all its ramifications is traced; current and its effects are analyzed; inductance and capacity are studied and measured. Through an exact series of tests results can be mathematically plotted on paper and the exact performance of a radio apparatus or receiver be precisely shown before its operation. And these tests are uniformly accurate.

Voltage standards, in another example of research, cover the range from a millionth of a volt to 50,000 volts at radio frequency. These standards are used to measure the voltage in a loop caused by a radio signal from across the seas or from the coast, to measure the voltage in loud speakers, or to measure the antenna voltage of a high power transmitter from the infinitesimal to the Niagara of radio power. Imagine the delicacy, the accuracy and the price of the infallible instruments used in laboratory practice. Therefore, the laboratory comes as another boon to the sincere seeker after radio truth and progress. There are many standard laboratories of this kind and among the best equipped for all classes of radio research are those of Rossiter, Tyler and McDonnell, Inc., H. and F. Radio Laboratories, The Superadio Co., Radio Construction Laboratories, and John F. Rider.

SPECIALTY CO. MOVES

The Specialty Service Company have moved to larger offices at 575 Atlantic Avenue at Fourth Avenue, Brooklyn. This firm, of which Julian Loeb is president, covers the Brooklyn and Long Island territory for some of the best known manufacturers in the country.

PIONEER ENLARGES LINE

The Pioneer Radio Sales Company, Tribune Building, New York City, have been appointed the factory representatives of the Metropolitan area for the Webster Super B Eliminators, manufactured by the Webster Company, of Chicago. They are also representatives for the Super Ball Antenna Company, of Green Bay, Wis., in this territory.

PLEASED WITH 3 TUBER

RESULTS EDITOR:

I have completed the 3-tube 3-circuit set as described by Capt. P. V. O'Rourke in Oct. 10 RADIO WORLD and wish to thank him for the wonderful receiver.

I have had splendid results with it and am including a list of several distant stations I have received in the week I have operated it:

KOA, Denver; WOAI, San Antonio; WOAW, Omaha; WRR, Dallas; KWWG, Brownsville.

KDKA comes in with as much volume as our local WOWO, of Ft. Wayne.

Am using two 199 tubes and one 120 tube and on nearly all of the sixty-two stations I have logged I could use a loud speaker.

HAROLD BABB,
Warren, Indiana.

STATION ON WORLD TOUR FOR TESTING

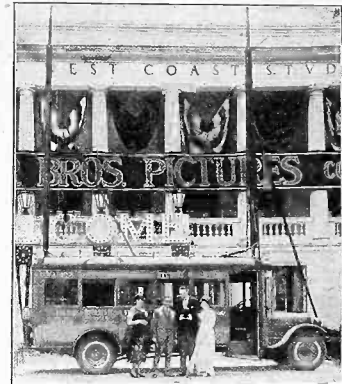

(James Englander)

WARNER BROTHERS' portable broadcasting station, 6XBR, started on a tour around the world from the Warner Station, KFVB. From left to right in front of the truck are Louise Fazenda, Ernst Lubitsch, director; Monte Blue, with the microphone, and Patsy Ruth Miller.

From Los Angeles to New York and across the Atlantic to London and back to Los Angeles again by way of Kobe. That, in part, is the territory which will be covered by the only portable radio broadcasting station of its kind in the world, 6XBR.

The huge truck was given the starting word by Betty Warner, 6-year-old daughter of Harry M. Warner, president of Warner Brothers Pictures, Inc. The station was christened The Betty Warner.

Amateur and commercial radio operators will have an opportunity to obtain awards for the most accurate report sent to Warner Brothers at Hollywood on code conversations between the portable station and its mother plant, KFVB, the movie city.

Portable station 6XBR has been assigned the official call letters 6KY to be used when the station broadcasts in code. For musical programs which the portable station will broadcast during its tour the plant will use 6XBR.

During the tour 6XBR will broadcast on a wavelength of 105 meters and will use 40 meters for code. The power will be 250 watts.

6KY will communicate with KFVB in Hollywood every night from 11 until 12 o'clock P. M. (standard time of whatever section of the country 6XBR may happen to be in).

The trip in the United States is with the sanction and cooperation of the Department of Commerce. The present itinerary includes the following cities: Santa Barbara, San Francisco, Oakland, Portland, Seattle, Spokane, Walla Walla, Boise, Salt Lake, Denver, Hastings, Lincoln, Omaha, Kansas City, Decatur, Chicago, Indianapolis, Columbus, Cleveland, Youngstown, Pittsburgh, Washington, Philadelphia and New York.

At the conclusion of the American tour the station will be shipped overseas, and if suitable arrangements can be made with the radio governing bodies of England, France, Germany, Spain and Italy, 6XBR will make tests in those countries, thence to the Orient, Australia, the Philippines, Hawaiian Islands and back to Hollywood.

"LOOK UP DOWN"

For
SERVICE

A Complete Radio Testing Laboratory for the Corrections of Radio Troubles!
CHAS. W. DOWN
SUPER-HETERODYNE SPECIALIST
711 - 8th Ave., New York, N. Y.

**MICA FIXED
AND
BY - PASS CONDENSERS**

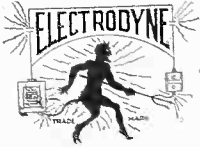

**ELECTRODYNE CO.,
INC.**
2378 THIRD AVENUE, N. Y. C.



Why Postpone Building It?

FENWAY BLUEPRINTS and FENWAY RADIO SERVICE render it simple—easy—for you to build one of these receivers. And they cost so little, \$3.00 postpaid, for full sized drawings—25x40 in.—showing the complete layout, wiring diagrams, drilling dimensions, data for making your own coils and copper cans, list of parts, etc.

FENWAY FREE SERVICE SAVES YOU from \$5.00 to \$50.00 on trouble-shooting. For example: From the time you start building your laboratory set, and until it is finished and working properly, you have the advice and help of the designer himself. You simply can't go wrong.

So, send today for your DX blueprints—Fenway means DX, Winter or Summer!

**Fenway Radio & Research
Laboratory**

890 Eighth Ave., New York, N. Y.

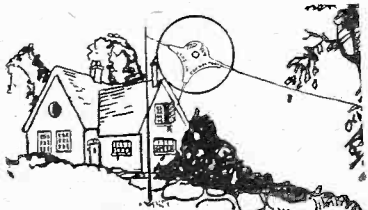

Tip-Top LEAD-IN CONNECTOR

**GOES ON IN A JIFFY
MAKES PERFECT CONTACT**

About the TIP-TOP CONNECTOR

Makes Perfect Contact—Holds the wires securely in place and provides a large contact surface. Cannot come loose as hand connections do.

Goes On in a Jiffy—Only a screw driver needed. Bend the antenna wire, and form an eye in end of lead-in wire.

Eliminates Loose Lead-wire connections with their resulting noises and other objectionable features.

Helps Volume and Distance—Through reducing resistance in the path from antenna to set.

Will Last for Years—Made of brass. Cannot corrode or rust.

At your dealers or mailed prepaid for 25c.

J. F. Doolan Manufacturing Corporation
62 W. 45th St., New York City

Index to Radio World

Issues of November 21, 1925, to May 8, 1926

The DX Super-Heterodyne, an 8-tube receiver, with diagrams by J. E. Anderson.
A Set That Stresses Quality, a 4-tube quality receiver, by Lewis Winner.
A 3-Tube Regenerative Set, using a resistance to control the regeneration, by Percy Warren.
An Exposition of Earphones, by Sidney E. Finkelstein.
The 4-Tube A-A Receiver, Part II, by Herbert E. Hayden.
Full Text of Hoover's Address to the Fourth National Radio Conference.
Laboratory Tests on the 1926 Diamond, by Herman Bernard.

NOVEMBER 23

The Zero Potential Loop, by Frank Freer.
A 1-Tube Regenerative Receiver, by J. E. Anderson.
A Study of AF Amplification, by William H. Fortington.
A Discussion of the AF Circuit used in the 1926 Model Diamond, by Herman Bernard.
A Summing Up of The Results of The Fourth Radio Conference, by Herbert C. Hoover.
The Reinartz Plug-in SW Set, by Lewis Winner.

DECEMBER 5

Table for Conversion of Frequencies and Meters.
A Toroid RF Set, Using a Crystal as a Detector, by Lewis Winner.
Pointers on Batteryless Sets, by William H. Fortington.
A 70-to-1208 Meter, 5-Tube Receiver, by Robert Force.
A Study of Ohms Law, As Applied to Tube Circuits, by J. E. Anderson.
1926 Diamond Wiring Kioks Solved, by Herman Bernard.

DECEMBER 12

The See-Saw, a Model 3-Tube Circuit, by P. E. Edelman.
Housing the Pressley Super-Heterodyne, Part I, by Herbert E. Hayden.
A Simple B Battery Eliminator, Part I, by Lewis Winner.
Getting Results With The Powertone; Matching of Dials, by Herman Bernard.
An Analyses of the 1926 Diamond, by John F. Rider.

DECEMBER 19

The Lennis Entertainer, A 6-Tube Receiver, by Edward Spiegler.
A Discussion of Trouble Shooting, by Brainard Foote.
A 5-Tube Quality Receiver, by Lewis W. Feldman.
Some Pointers on Dials, by Sidney E. Finkelstein.
A Continuation of the Analyses of the Diamond, by John F. Rider.
Transformers and Chokes for B Eliminator, Part II, by Lewis Winner.
Housing the Pressley Super-Heterodyne, Part II, by Herbert E. Hayden.

DECEMBER 26

The Regenerative Wave Trap, by John F. Rider.
The 5-Tube Tuned RF Set, by Capt. P. V. O'Rourke.
A Cabinet B Eliminator, Part III, by Lewis Winner.
A Study of Types of Receivers, by J. E. Anderson.
Housing the Pressley Super-Heterodyne, Part III, by Herbert E. Hayden.

JANUARY 2, 1926

The 2-C Set For Simplicity, a 5-Tube Receiver, by Capt. P. V. O'Rourke, by Lewis Winner.
A Chemical B Eliminator, by Lewis Winner.
A Study of Multiple Condensers, by Herman Bernard.
A Discussion of The Proper Voltage Required For The Tubes in The 1926 Diamond, by John F. Rider.

JANUARY 9

The 4-Tube DX Symphony Set, by Irving Witz.

Single Control Compensation, by Herman Bernard.
Tuned Antenna Used In a Special 1-Tube Receiver, by Lewis Winner.
Taking Care of Batteries, by Capt. P. V. O'Rourke.
A 4-Tube Toroid Receiver, by Chester Charlton.

JANUARY 16

A Clinical Study of Low-Loss Coils: A Discussion of the Bureau of Standards Report, by Herman Bernard.
A 5-Tube Quality Receiver, by J. E. Anderson.
The Raytheon Power Unit, by Lewis Winner.
Making a Box Loop, by Herbert E. Hayden.

JANUARY 23

The 4-Tube Diamond Set, by Herman Bernard.
The Antennatrol, Part I, by Herbert E. Hayden.
A Study of The Life of B Batteries, by Sidney E. Finkelstein.
An Extensive Study of Battery Types, by Lewis Winner.
Eliminating Noises in Receivers, by E. P. Peck.
Testing Your Set on a Loop.

JANUARY 30

An Individual AF Amplifier, by Herbert E. Hayden.
A Discussion of Hi-Mu and Power Tubes, by F. R. Jolin.
A Study of Litz, 32-38, No. 24 and 28 DCC Wires, When Used on Coils in Broadcast Receivers, by Sidney E. Finkelstein.
Trapping Out Super-Power, by Capt. P. V. O'Rourke.
Completing the Antennatrol, Part II.
Discussion of The AF Amplifier Used in the Diamond, by John F. Rider.
The Diamond University (3 pages).

FEBRUARY 6

The Fenway, a 9-Tube Super-Heterodyne or 4-Tube Regenerator, Part I, by Leo Fenway.
The Loud Boy, a 1-Tube Regenerative Receiver, by Herman Bernard.
The Diamond University.

FEBRUARY 13

An Economical 5-Tube Receiver, by J. E. Anderson.
A Selective Crystal Set, by Herman Bernard.
Trouble Shooting For Novices, by M. B. Stock.
The 2d Step in the Fenway, Part II, by Leo Fenway.
A Discussion of AF Amplification, by Dr. A. N. Goldsmith.

FEBRUARY 20

The Victoreen, an 8-Tube Super, Part I.
A Real 3-Tube Quality Set, by Brainard Foote.
Definitions for Novices.
The Completion of the Fenway, Part III, by Leo Fenway.

FEBRUARY 27

The 4-Tube DX Dandy, Part I, by Herbert E. Hayden.
Curing Noises in the Set, by J. E. Anderson.
Definitions For the Novices.
Distortion Elimination in AF Amplification, by Dr. A. N. Goldsmith.
Fenway Trouble Shooting, Part IV, by Leo Fenway.
The Victoreen, Part II.
A Coupler for a Loop in a Super, by Herbert E. Hayden.
Tubes For the Diamond, by Herman Bernard.

MARCH 6

The Old Salt, a 1-Tube, 1-Dial Set, by Capt. P. V. O'Rourke.
The Chemistry of Batteries, by A. R. Reid.
An Astatic Crystal Set, by Frank Freer.
Wiring the Victoreen, Part III.
The 4-Tube DX Dandy, Part II, by Herbert E. Hayden.
Diamond Efficiency Data, by Herman Bernard.
The KB-8, a 5-Tube Receiver, Part I, by M. B. Sleeper.

MARCH 13

A Comparative Study of the Crystal and the Tube as Detectors, by John F. Rider.
The Tectron B Eliminator, Part I, by Lewis Winner.
My Experiences with Super-Heterodyne Sets, Part I, by J. E. Anderson.
Curing Victoreen Trouble, Part IV.

MARCH 20

A Super-Heterodyne De Luxe, by J. E. Anderson.
My Experiences with Super-Heterodyne Sets, Part II.
A 2-Tube Speaker Set, by Percy Warren.
Testing AF Quality, by John F. Rider.
Making a Pickle-Bottle Coil, by Herbert E. Hayden.
The KB-8, Part II, by M. B. Sleeper.
The Choke Coils for the Tectron B Eliminator, Part II, by Lewis Winner.
The Goat at the Mike, a humorous discussion of broadcasters, by Herman Bernard.

MARCH 27

An Economical 4-Tube Set, by Edgar T. Collins.
A 1-Hour 3-Tube Set, by Chester Charlton.
An All-Wave 4-Tube Regenerator, by McMurdo Silver.

(Concluded on page 26)

FIXED RESISTORS
Micamold
FIXED CONDENSERS

Specified for the Fenway. Superb in all circuits. Accurate, Constant in Value, Indestructible, "Made of Mica and Moulded in Bakelite."
At Good Radio Stores.

MICAMOLD RADIO CORP.,
Flushing and Porter Aves.,
Brooklyn, N. Y.

ACCURACY GUARANTEED
VALUES REMAIN CONSTANT

MILLED UNDER PRESSURE OF 50 TONS

Guesswork is Painlessly Extracted by Laboratory

By James H. Carroll

Radio has taken its place among the arts and sciences with the establishment of the fully equipped radio laboratory. Fans have awakened to the necessity of tested radio apparatus. The pioneers among set builders can readily remember the days when, full of enthusiasm, the new super circuit diagram before them, they rushed out to gather armful of parts and equipment and went to it, with no idea of calibrating the various parts and synchronizing them all through the circuit. Calibrating a loop and fitting the loudspeaker to the needs of the output was unheard of. Standards of voltage, current, inductance, capacity, etc., were unknown quantities to them.

Numerous private laboratories have been established to minister to the needs of the individual, also proving invaluable to the radio manufacturer whose requirements extend beyond the limits of his own laboratory equipment.

Where Theories Are Tested

There is a good baker's dozen of real, honest-to-goodness laboratories, conducted by highly-trained men wherein the working quarters are marvels of modern efficiency, equipped with the finest obtainable instruments that perform miracles of measurement. Here the weaver of loops may test out his theories of inductance and capacity; the finder of frequencies may obtain the exact values of his revolutionary coil; the Harum of harmonies may find out the use or mayhap the uselessness of his wonderful audio transformers or resistance complication, while plain John Smith can find out why his super will not "supe," and have it pepped up so it will do tricks.

There is a fee, but it is generally low, and is commensurate with the worth of the work performed. And with it comes the knowledge that the work is done right and will not have to be done over again. This is a highly technical branch and as in all radio practice the axiom obtains: "It pays to buy the best." This applies to service as well as to parts.

The giant strides made by radio advancement are exemplified by the feats performed in these laboratories. Their experiments, aside from the regular work of the day, are responsible for many of the short cuts to better radio. One well-known laboratory head recently in photographing audio waves made valuable discoveries regarding comparative efficiency of audio coupling. The researches of these laboratories come under many heads and the activities are varied.

R F Research Important

One of the most important is radio frequency research. There are two standard means of deriving radio frequencies; one by means of a 1,000 cycle tuning fork, the other by standing waves on wires. In the former, a tuning fork is kept vibrating by means of a vacuum tube and a series of tubes is made to oscillate in synchronism with harmonics of the tuning fork. In this way, radio frequency power is generated at frequencies which are exact multiples of 1,000 cycles. In the other method, standing waves of about 60,000-100,000 cycles, approximately five meters wavelength, are produced on a pair of parallel wires and the wavelength is measured directly by a tape. By means of oscillators whose harmonics are kept in synchronism with the 5-meter wave, lower

frequencies are produced. Therefore, radio frequency power is generated at frequencies which are exact fractions of 60,000,000 cycles. The two methods overlap and serve to check each other. Wave meters are by this means calibrated by tuning to these known frequencies.

The Whole Gamut Run

Here we have an example of the exacting procedure of laboratory practice and of the brains and skill that go into it. Voltage in all its ramifications is traced; current and its effects are analyzed; inductance and capacity are studied and measured. Through an exact series of tests results can be mathematically plotted on paper and the exact performance of a radio apparatus or receiver be precisely shown before its operation. And these tests are uniformly accurate.

Voltage standards, in another example of research, cover the range from a millionth of a volt to 50,000 volts at radio frequency. These standards are used to measure the voltage in a loop caused by a radio signal from across the seas or from the coast, to measure the voltage in loud speakers, or to measure the antenna voltage of a high power transmitter from the infinitesimal to the Niagara of radio power. Imagine the delicacy, the accuracy and the price of the infallible instruments used in laboratory practice. Therefore, the laboratory comes as another boon to the sincere seeker after radio truth and progress. There are many standard laboratories of this kind and among the best equipped for all classes of radio research are those of Rossier, Tyler and McDonnell, Inc., H. and F. Radio Laboratories, The Superadio Co., Radio Construction Laboratories, and John F. Rider.

SPECIALTY CO. MOVES

The Specialty Service Company have moved to larger offices at 575 Atlantic Avenue at Fourth Avenue, Brooklyn. This firm, of which Julian Loeb is president, covers the Brooklyn and Long Island territory for some of the best known manufacturers in the country.

PIONEER ENLARGES LINE

The Pioneer Radio Sales Company, Tribune Building, New York City, have been appointed the factory representatives of the Metropolitan area for the Webster Super B Eliminators, manufactured by the Webster Company, of Chicago. They are also representatives for the Super Ball Antenna Company, of Green Bay, Wis., in this territory.

PLEASED WITH 3 TUBER

RESULTS EDITOR:

I have completed the 3-tube 3-circuit set as described by Capt. P. V. O'Rourke in Oct. 10 RADIO WORLD and wish to thank him for the wonderful receiver.

I have had splendid results with it and am including a list of several distant stations I have received in the week I have operated it:

KOA, Denver; WOAI, San Antonio; WOAW, Omaha; WRR, Dallas; KWWG, Brownsville.

KDKA comes in with as much volume as our local WOWO, of Ft. Wayne.

Am using two 199 tubes and one 120 tube and on nearly all of the sixty-two stations I have logged I could use a loud speaker.

HAROLD BARR,
Warren, Indiana.

STATION ON WORLD TOUR FOR TESTING

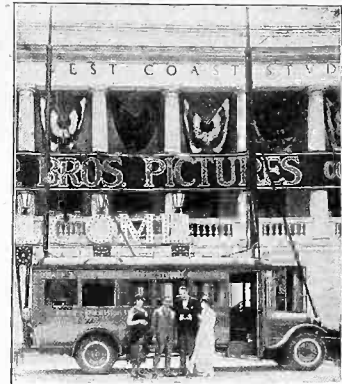

(James Englander)

WARNER BROTHERS' portable broadcasting station, 6XBR, started on a tour around the world from the Warner Station, KFVB. From left to right in front of the truck are Louise Fazenda, Ernst Lubitsch, director; Monte Blue, with the microphone, and Patsy Ruth Miller.

From Los Angeles to New York and across the Atlantic to London and back to Los Angeles again by way of Kobe. That, in part, is the territory which will be covered by the only portable radio broadcasting station of its kind in the world, 6XBR.

The huge truck was given the starting word by Betty Warner, 6-year-old daughter of Harry M. Warner, president of Warner Brothers Pictures, Inc. The station was christened The Betty Warner.

Amateur and commercial radio operators will have an opportunity to obtain awards for the most accurate report sent to Warner Brothers at Hollywood on code conversations between the portable station and its mother plant, KFVB, the movie city.

Portable station 6XBR has been assigned the official call letters 6KY to be used when the station broadcasts in code. For musical programs which the portable station will broadcast during its tour the plant will use 6XBR.

During the tour 6XBR will broadcast on a wavelength of 105 meters and will use 40 meters for code. The power will be 250 watts.

6KY will communicate with KFVB in Hollywood every night from 11 until 12 o'clock P. M. (standard time of whatever section of the country 6XBR may happen to be in).

The trip in the United States is with the sanction and cooperation of the Department of Commerce. The present itinerary includes the following cities: Santa Barbara, San Francisco, Oakland, Portland, Seattle, Spokane, Walla Walla, Boise, Salt Lake, Denver, Hastings, Lincoln, Omaha, Kansas City, Decatur, Chicago, Indianapolis, Columbus, Cleveland, Youngstown, Pittsburgh, Washington, Philadelphia and New York.

At the conclusion of the American tour the station will be shipped overseas, and if suitable arrangements can be made with the radio governing bodies of England, France, Germany, Spain and Italy, 6XBR will make tests in those countries, thence to the Orient, Australia, the Philippines, Hawaiian Islands and back to Hollywood.

"LOOK UP DOWN"

For SERVICE

A Complete Radio Testing Laboratory for the Corrections of Radio Troubles!
CHAS. W. DOWN
 SUPER-HETERODYNE SPECIALIST
 711 - 8th Ave., New York, N. Y.

MICA FIXED AND BY-PASS CONDENSERS



ELECTRODYNE CO., INC.
 2378 THIRD AVENUE, N. Y. C.

FENWAY for DX!

Why Postpone Building It?

FENWAY BLUEPRINTS and FENWAY RADIO SERVICE render it simple—easy—for you to build one of these receivers. And they cost so little, \$3.00 postpaid, for full sized drawings—25x40 in.—showing the complete layout, wiring diagrams, drilling dimensions, data for making your own coils and copper cans, list of parts, etc.

FENWAY FREE SERVICE SAVES YOU from \$5.00 to \$50.00 on trouble-shooting. For example: From the time you start building your laboratory set, and until it is finished and working properly, you have the advice and help of the designer himself. You simply can't go wrong.

So, send today for your DX blueprints—Fenway means DX, Winter or Summer!

Fenway Radio & Research Laboratory

890 Eighth Ave., New York, N. Y.



Tip-Top LEAD-IN CONNECTOR

GOES ON IN A JIFFY
 MAKES PERFECT CONTACT
 About the TIP-TOP CONNECTOR

Makes Perfect Contact—Holds the wires securely in place and provides a large contact surface. Cannot come loose as hand connections do.

Go on in a jiffy—Only a screw driver needed. Bend the antenna wire, and form an eye in end of lead-in wire.

Eliminates Loose Lead-Wire connections with their resulting noises and other objectionable features.

Helps Volume and Distance—Through reducing resistance in the path from antenna to set.

Will Last for Years—Made of brass. Cannot corrode or rust.

At your dealers or mailed prepaid for 25c.
J. F. Doolan Manufacturing Corporation
 62 W. 45th St., New York City

Index to Radio World

Issues of November 21, 1925, to May 8, 1926

The DX Super-Heterodyne, an 8-tube receiver, with diagrams by J. E. Anderson.

A Set That Stresses Quality, a 4-tube quality receiver, by Lewis Winner.

A 3-Tube Regenerative Set, using a resistance to control the regeneration, by Percy Warren.

An Exposition of Earphones, by Sidney E. Finkelstein.

The 4-Tube A-A Receiver, Part II, by Herbert E. Hayden.

Full Text of Hoover's Address to the Fourth National Radio Conference.

Laboratory Tests on the 1926 Diamond, by Herman Bernard.

NOVEMBER 23

The Zero Potential Loop, by Frank Freer.

A 1-Tube Regenerative Receiver, by J. E. Anderson.

A Study of AF Amplification, by William H. Fortington.

A Discussion of the AF Circuit used in the 1926 Model Diamond, by Herman Bernard.

A Summing Up of The Results of The Fourth Radio Conference, by Herbert C. Hoover.

The Reinartz Plug-in SW Set, by Lewis Winner.

Table for Conversion of Frequencies and Meters.

DECEMBER 5

A Toroid RF Set, Using a Crystal as a Detector, by Lewis Winner.

Pointers on Batteryless Sets, by William H. Fortington.

A 70-to-1200 Meter, 5-Tube Receiver, by Robert Force.

A Study of Ohms Law, As Applied to Tube Circuits, by J. E. Anderson.

1926 Diamond Wiring Kinks Solved, by Herman Bernard.

DECEMBER 12

The See-Saw, a Model 3-Tube Circuit, by P. E. Edelman.

Housing the Pressley Super-Heterodyne, Part I, by Herbert E. Hayden.

A Simple B Battery Eliminator, Part I, by Lewis Winner.

Getting Results With The Powertone; Matching of Dials, by Herman Bernard.

An Analyses of the 1926 Diamond, by John F. Rider.

DECEMBER 19

The Lemnis Entertainer, A 6-Tube Receiver, by Edward Spiegler.

A Discussion of Trouble Shooting, by Brainard Foote.

A 5-Tube Quality Receiver, by Lewis W. Feldman.

Some Pointers on Dials, by Sidney E. Finkelstein.

A Continuation of the Analyses of the Diamond, by John F. Rider.

Transformers and Chokes for B Eliminator, Part II, by Lewis Winner.

Housing the Pressley Super-Heterodyne, Part II, by Herbert E. Hayden.

DECEMBER 26

The Regenerative Wave Trap, by John F. Rider.

The 5-Tube Tuned RF Set, by Capt. P. V. O'Rourke.

A Cabinet B Eliminator, Part III, by Lewis Winner.

A Study of Types of Receivers, by J. E. Anderson.

Housing the Pressley Super-Heterodyne, Part III, by Herbert E. Hayden.

JANUARY 2, 1926

The 2-C Set For Simplicity, a 5-Tube Receiver, by Capt. P. V. O'Rourke.

A Chemical B Eliminator, by Lewis Winner.

A Study of Multiple Condensers, by Herman Bernard.

A Discussion of The Proper Voltage Required For The Tubes in The 1926 Diamond, by John F. Rider.

JANUARY 9

The 4-Tube DX Symphony Set, by Irving Witz.

Single Control Compensation, by Herman Bernard.

Tuned Antenna Used in a Special 1-Tube Receiver, by Lewis Winner.

Taking Care of Batteries, by Capt. P. V. O'Rourke.

A 4-Tube Toroid Receiver, by Chester Charlton.

JANUARY 16

A Clinical Study of Low-Loss Coils; A Discussion of the Bureau of Standards Report, by Herman Bernard.

A 5-Tube Quality Receiver, by J. E. Anderson.

The Raytheon Power Unit, by Lewis Winner.

Making a Box Loop, by Herbert E. Hayden.

JANUARY 23

The 4-Tube Diamond Set, by Herman Bernard.

The Antennatrol, Part I, by Herbert E. Hayden.

A Study of The Life of B Batteries, by Sidney E. Finkelstein.

An Extensive Study of Battery Types, by Lewis Winner.

Eliminating Noises in Receivers, by E. P. Peck.

Testing Your Set on a Loop.

JANUARY 30

An Individual AF Amplifier, by Herbert E. Hayden.

A Discussion of Hi-Mu and Power Tubes, by F. R. Jolin.

A Study of Litz, 32-38, No. 24 and 28 DCC Wires, When Used on Coils in Broadcast Receivers, by Sidney E. Finkelstein.

Trapping Out Super-Power, by Capt. P. V. O'Rourke.

Completing the Antennatrol, Part II.

Discussion of The AF Amplifier Used in the Diamond, by John F. Rider.

The Diamond University (3 pages).

FEBRUARY 6

The Fenway, a 9-Tube Super-Heterodyne or 4-Tube Regenerator, Part I, by Leo Fenway.

The Loud Boy, a 1-Tube Regenerative Receiver, by Herman Bernard.

The Diamond University.

FEBRUARY 13

An Economical 5-Tube Receiver, by J. E. Anderson.

A Selective Crystal Set, by Herman Bernard.

Trouble Shooting For Novices, by M. B. Strook.

The 2d Step in the Fenway, Part II, by Leo Fenway.

A Discussion of AF Amplification, by Dr. A. N. Goldsmith.

FEBRUARY 20

The Victoreen, an 8-Tube Super, Part I.

A Real 3-Tube Quality Set, by Brainard Foote.

Definitions for Novices.

The Completion of the Fenway, Part III, by Leo Fenway.

FEBRUARY 27

The 4-Tube DX Dandy, Part I, by Herbert E. Hayden.

Curing Noises in the Set, by J. E. Anderson.

Definitions For the Novices.

Distortion: Elimination in AF Amplification, by Dr. A. N. Goldsmith.

Fenway Trouble Shooting, Part IV, by Leo Fenway.

The Victoreen, Part II.

A Coupler for a Loop in a Super, by Herbert E. Hayden.

Tubes For the Diamond, by Herman Bernard.

MARCH 6

The Old Salt, a 1-Tube, 1-Dial Set, by Capt. P. V. O'Rourke.

The Chemistry of Batteries, by A. R. Reid.

An Astatic Crystal Set, by Frank Freer.

Wiring the Victoreen, Part III.

The 4-Tube DX Dandy, Part II, by Herbert E. Hayden.

Diamond Efficiency Data, by Herman Bernard.

The KB-8, a 5-Tube Receiver, Part I, by M. B. Sleeper.

A Comparative Study of the Crystal and the Tube as Detectors, by John F. Rider.

The Tectron B Eliminator, Part I, by Lewis Winner.

My Experiences with Super-Heterodyne Sets, Part I, by J. E. Anderson.

Curing Victoreen Trouble, Part IV.

MARCH 20

A Super-Heterodyne De Luxe, by J. E. Anderson.

My Experiences with Super-Heterodyne Sets, Part II.

A 2-Tube Speaker Set, by Percy Warren.

Testing AF Quality, by John F. Rider.

Making a Pickle-Bottle Coil, by Herbert E. Hayden.

The KB-8, Part II, by M. B. Sleeper.

The Choke Coils for the Tectron B Eliminator, Part II, by Lewis Winner.

The Goat at the Mike, a humorous discussion of broadcasters, by Herman Bernard.

MARCH 27

An Economical 4-Tube Set, by Edgar T. Collins.

A 1-Hour 3-Tube Set, by Chester Charlton.

An All-Wave 4-Tube Regenerator, by McMurdo Silver.

(Concluded on page 26)

FIXED RESISTORS
Micamold
FIXED CONDENSERS

Specified for the Fenway. Superb in all circuits. Accurate, Constant in Value, Indestructible, "Made of Mica and Moulded in Bakelite."

At Good Radio Stores.

MICAMOLD RADIO CORP.,
 Flushing and Porter Aves.,
 Brooklyn, N. Y.

ACCURACY GUARANTEED
 VALUES REMAIN CONSTANT

MADE UNDER PRESSURE OF 50 TONS

Many Turns, Low Capacity, Problem in AF Transformer

While the average fan is fairly well posted on the subject of determining what represents efficiency in radio frequency work, when he comes to the audio frequency amplifier he is often in the dark. Only a short while ago the fan concerned himself mostly with the turns ratio, getting a high ratio transformer for the first stage and a lower ratio transformer for the second stage. And when he wanted more volume, he was generally at a loss to know just how to get it without introducing distortion.

As to the transformer choice, one should be guided less by the ratio than by the inductance, which should be large, the distributed capacity, which should be small, and the amplification, which should be even. The ratio is a consideration, but it is not the most important.

Ear Will Tell

Naturally, a transformer that has the fundamental merits which result in a practically even amplification over the audible range will make its superiority obvious to the ear. A test made with earphones will give different results than one made with a speaker.

When judging a transformer, one must consider also the speaker.

Normally the speaker will handle the low notes very well, and likewise the transformer will amplify them evenly.

Once Stopped, Lost Forever

As much inductance is desirable in the transformer, both primary and secondary, unless some special design is used, the distributed capacity will be rather large, and this condenser effect, especially in the secondary, will bypass some of the higher frequencies, particularly the harmonics, that give the voice its individuality and naturalness. What the transformer stops will never get to the speaker, hence even the best of speakers will scarcely have a chance to prove their superiority. If anything, they seem worse than poorer ones, because the better ones emphasize by the fidelity of their reproduction the shortcomings of the transformer, which a poorer speaker would smother to some extent.

The object is to have a transformer that

not only will do justice to an orchestra piece but also to a coloratura soprano, and with sufficient volume, even great volume, where it is desired.

One method is to employ push-pull amplification, whereby two tubes equally share the load. A secondary tapped at the middle, while enabling push-pull connection, often provides disappointing results, because the voltage and the amperage of the output are not apace. The secondary windings should be separate, that is, inductive instead of conductive

coupling should be employed. Then both outside terminals do not have to go to grid connections, which is the vice of the midtap method, and brings on distortion.

Loud, Clear Signals

The push-pull stage may be placed wherever desired, although it is most commonly used in the final stage. If it is preceded by one transformer stage it will be of advantage only if the preceding transformer was not a good one. Where two straight transformer stages are used the quality result should be excellent, and if it is not so, look to the transformers.

The push-pull method is most desirable as the third stage, where the volume will be very great. And yet the signals will be clear and pure.

Long Distance Radio

Only \$2.95



200,000 SATISFIED OWNERS

—Getting stations 600 miles away on Lambert Radios. No batteries or tubes required. A real Radio—not a toy or attachment. One to four can listen at once. If your dealer doesn't carry Lambert Radios, write us for literature.

LEON LAMBERT RADIO CO.
Kaufman Building Wichita, Kansas
Liberal Offer to Dealers—Write Us Today

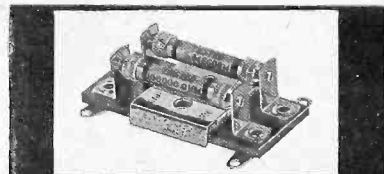

AEROVOX "Built Better" RESISTOFORMERS

Tested and approved by M.I.T., Yale, Radio News, Popular Radio, and Popular Science. Used by over 200 of America's leading set manufacturers.

AEROVOX WIRELESS CORP.
489-491-493 Broome St., New York

Branch Offices:
St. Louis, Mo., Sandstone Trust Building
Cincinnati, O., 304 Palace Theatre Bldg.
Chicago, Ill., 53 W. Jackson Boulevard
Boston, Mass., 24 Fortland Street
Los Angeles, Cal., 324 N. San Pedro St.

HARD RUBBER
SHEET-ROD-TUBING
Special Hard Rubber Parts Made to Order
RADION HARD RUBBER
PANELS ANY SIZE
Send for price list.
WHOLESALE RETAIL
NEW YORK HARD RUBBER TURNING CO.
212 Centre Street New York

GET THE OFFICIAL BOOKLET ON HOW TO BUILD Radio World's 1926 Model DIAMOND OF THE AIR

The text of the official Diamond booklet was written by HERMAN BERNARD, designer of the 5-tube circuit which offers the most in selectivity, volume, tone, quality and DX. Price, per copy **50c**

CERTIFIED BLUEPRINT FREE with every copy of THE OFFICIAL Booklet. Bernard's signature is on every booklet and every blueprint. Both sent FREE to new yearly subscribers. Also name plate FREE.

News and Radio Dealers: Send to publication office for Wholesale Prices. Or order direct from American News Co., Inc., 131 Varick St., N. Y. C., or American News Co. Branches in other cities.

RADIO WORLD, 145 W. 45th St., N. Y. C.
Enclosed find 50c. Send me copy official Diamond Booklet, with FREE blueprint. Or both free with \$6.00 for yearly subscription.

NAME
ADDRESS
CITY..... STATE.....

FREE BOOKLET FOR INVENTORS

IF YOUR INVENTION is new and useful is patentable. Send me your sketch.
Z. H. POLACHEK, 70 Wall St., New York
Reg. Patent Attorney-Engineer

RADIO WORLD'S PREMIUM SUBSCRIPTION OFFER

For NEW RADIO WORLD Subscribers Ordering NOW

Radio World has made arrangements

- To offer a year's subscription FREE for any one of the following publications with one year's subscription for RADIO WORLD
- RADIO NEWS or —BOYS' LIFE or
- POPULAR RADIO or —RADIO DEALER or
- RADIO BROADCAST or —RADIO (San Francisco) or
- SCIENCE AND INVENTION or —RADIO AGE or
- COLLIER'S

This is the way to get two publications

- Add \$1.00 a year extra for
- Canadian or Foreign Postage.
- Present RADIO WORLD subscribers
- can take advantage of this offer by
- extending subscriptions one year
- if they send renewals NOW.

—for the price of one:
—Send \$6.00 today for RADIO WORLD
—for one year (regular price
—for 52 numbers)
—and select any one of the other
—nine publications for twelve months.

RADIO WORLD'S SPECIAL TWO-FOR-PRICE-OF-ONE SUBSCRIPTION BLANK
RADIO WORLD, 145 West 45th Street, New York City.

Enclosed find \$6.00 for which send me RADIO WORLD for twelve months (52 numbers), beginning..... and also without additional cost, Radio Broadcast, or Popular Radio, or Radio News, or Science and Invention, or Radio Dealer, or Radio (San Francisco), or Radio Age, or Boys' Life, or Collier's (or \$10.00 for two yearly subscriptions).

Indicate if renewal. Name
Offer Good Until Street Address.....
June 9, 1926 City and State.....

An Antenna Coupler for the Super-Heterodyne

To make an inductive antenna coupler for Super-Heterodyne, get the following material:

Two 10 x 1 7/8" spindle sink drains purchased in novelty store; fifteen feet of stranded bare copper antenna wire; brown stain or varnish.

Take one of the sink drains and saw

off two sections containing four spindles for the sides. Take the other and make three ten inch sections of three spindles each. These form the top, bottom and middle braces by dovetailing the three spindles into the three spaces made by the four outside spindles. Drive 1/4-inch fine brad nails at the points of intersection of the three braces with the uprights. This makes a rigid frame for the wire.

Cut the wire off at the ends so that the end clipped will be tightly wrapped, solder lightly and wipe off smooth for about one



Right to the Point.
Eureka Dial Pointers
Polished Nickel or Gilt
10c Each
DX Owl Nickel.....10c
DX Owl Goldplated..15c
At your dealers or sent
direct for stamps.
C. W. BUTTS, INC.
42 Hedden Place
East Orange, N. J.

DX OWL

EUREKA

EUREKA

How to Build THE FENWAY

The famous DX set that, by the turn of a switch, is a 4-tube tuned RF set, with regeneration, or a 9-tube Super-Heterodyne! Remarkably sensitive!

Described by Leo Fenway himself in the February 6, 13, 20 and 27 issues, including trouble shooting. Send 60c for all four issues, or send \$4 for year's subscription and get these four copies FREE!

RADIO WORLD, 145 W. 45th St., N. Y. C.

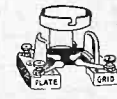

The AIRGAP SOCKET

The gap prevents closed circuit, inter-coupling, feedback and undesirable capacity (which causes the squeaks and howls), resulting in more stable circuit, sharper tuning, clearer and louder reception.

Electrically and Mechanically It's Perfect
Sent direct if your dealer cannot supply you, 75c each.

AIRGAP PRODUCTS CO., Mfr.
9 Campbell Street Newark, N. J.
IT GETS THAT LAST MILE

A Home-Made Leak



(Hayden)

AN EMERGENCY grid leak may be made by drawing a pencil line on the scratchpiece of a book of paper matches and putting the strip on a fixed condenser. The heavier the line the greater the resistance.

BRUNO DEVELOPS A NEW CONDENSER

Extremely high efficiency and compactness mark Bruno's newest product—a straightline frequency condenser that is of full rated capacity. This condenser successfully "uncrowds the air" by maintaining equal dial separation for equal frequency difference. Price of .0005...

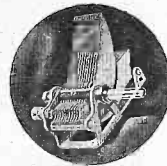

\$4.00

Something New! A Versatile Tube!

First time offered to the public! The new Switch Tube is a Power Tube or a regular Tube, at your option. Just turn the tiny switch in the base to convert it from one to the other. Also, if you burn out the OIA filament, the tube is still just as good as before, because you simply switch over to the Auxiliary Filament! Works from 6-volt source. Draws .25 amp. as OIA and .5 amp. as power tube. **\$3.00**



The New Switch Tube

Inquiries Invited from the Trade

POWERTONE KIT

Complete Parts for the 5-tube 1-dial set described in Radio World, April 17. Bruno 99 RF, Bruno 99 Tuning Coil, Bruno Light Switch, Bruno Dial, Double Condenser, panel, sub-panel, sockets, Bruno brackets, etc. Price **\$24.50**

Bruno Slo-Moshen Vernier Dials **\$2.00** Bruno Magic Dial for SLC Condensers **\$2.50**

BRUNO LOW-LOSS COILS

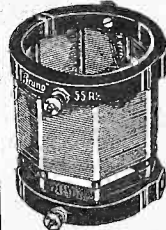

Bruno "99" or "55" RF Transformer. \$3.00



Bruno "99" Tuning Coil\$5.50

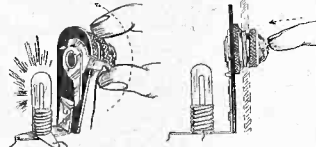

The Bruno Ruby Light Switch is a combination A battery switch and pilot light. When the knob is turned to the right, the bulb lights up, the set is on. When the knob is pressed, the set is turned off. Single hole panel 75c mount. Price, less bulb.....

Send for Our New Bulletin No. 702. It will Amaze You!

STREAMLINE SLF CONDENSERS **\$1.95**

10,000 of Them! We Bought Out Streamline's Stock. Any Capacity—Same Price

B-C-L RADIO SERVICE CO., 223 Fulton Street, N. Y. City

inch of each end of the wire to facilitate clipping on to antenna and ground leads.

Bore two holes in first spindle at bottom about an inch apart, pass end of wire through both and tighten with match pegs to hold. Pass wire from you over top of spindles which have been notched with saw to hold wire, bring wire over top and bottom each spindle ending on opposite side of loop where two holes are bored for passing ground end of wire through spindle. Leave about 3 to 4 inches free ends to clip to antenna and ground leads.

The effect of this coupler, is when reception is good, to bring stations in that were never received before; to increase signal volume on all stations and thus reduce filament voltage or A battery current. The effect is controlled by moving the antenna loop to or from the loop connected with the receiver. Not necessary to turn receiver loop in direction of station.

FOR CLEAR, QUIET "B" POWER



RADIO Storage "B" Battery

12 Cells 24 Volts Lasts Indefinitely—Pays for Itself Economy and performance unheard of before. Recharged at a negligible cost. Delivers unfailing power that is clear, pure and quiet. Approved and listed as Standard by leading Radio Authorities, including Pop. Radio Laboratories, Pop. Sci. Inst., Standard, Radio News Lab., Letfax, Inc., and other important institutions. Equipped with Solid Rubber Case, an insurance against acid and leakage. Extra heavy glass jars. Heavy rugged plates. Order yours today!

SEND NO MONEY Just state number of batteries wanted and we will ship day order is received. Extra offer: 4 batteries in series (96 volts), \$14.50. Free express after examining batteries. 5 per cent discount for cash with order. Mail your order now!

WORLD BATTERY COMPANY
1219 So. Wabash Ave., Dept. 82 Chicago, Ill.
Makers of the Famous World Radio "A" Storage Battery
Prices: 6-cell, 105 Amp. \$11.00; 120 Amp. \$12.50; 140 Amp. \$14.00.
All equipped with Solid Rubber Case.

World STORAGE BATTERIES
Set your Radio Dials at 210 meters for the new 1000 watt World Storage Battery Station, WSSC, Chicago. Watch for announcements.

Warsaw Opens Its Official Station



(Underwood & Underwood)

COUNT SKRZYŃSKI, Polish Premier, opening the ceremony, initiating the inauguration of the Polish broadcasting station at Warsaw. To the right of the Count is the Minister for Education, St. Grabski, and to the left is the Minister of Interior, Raczkiwicz.

INDEX (from page 23)

A Practical Chemical B Supply, by Capt. P. V. O'Rourke.
The Frequency Dials, by Herman Bernard.
Neutralization of the KB-8, Part III, by M. B. Sleeper.
Tectron B Eliminator Trouble Shooting, by Lewis Winner.

APRIL 3—ANNIVERSARY NUMBER

The Bernard Portable, an 8-Tube Super-Heterodyne portable, Part I, by Herman Bernard.
How to Get DX, by Capt. P. V. O'Rourke.
Adjustment of Grid Bias, by J. E. Anderson.
A Compact B Supply, by Lewis Winner.
Loudspeaker Requisites, by Dr. A. N. Goldsmith.

APRIL 10

A Super-Heterodyne from an Old Set, by Caesar King.
A Stabilized TRF Receiver, by Roger Ferris.
The T-A 4-Tube Receiver, by Raymond C. Wells.
DC B Eliminators, Part I, by Lewis Winner.
Bait That Coaxes in DX, by J. E. Anderson.
The Bernard Portable, Part II, by Herman Bernard.

APRIL 17

The New I-Dial Powertone, by Capt. P. V. O'Rourke.
The Power Booster Set, by Mary C. Drew.
A 5-Tube Super-Heterodyne, by Jasper Jellicoe.
Smoothing Out the Tickler, by Jackson Lee.
The Action of Transformers, by Lewis Winner.
A Neutralized TRF Set, by Ben Aplin.

Wiring the Bernard Portable, Part III, by Herman Bernard.

Etiquette of Listening-In, by Dr. A. N. Goldsmith.
A Discussion of the RCA Receivers.

APRIL 24

A 4-Tube All Wave Set, Part I, by Capt. P. V. O'Rourke.
The Novice's Nook by the Beginner's Friend. Controlling Feedback, by Barney Feete.
Curing Bernard Portable Trouble, Part IV, by Herman Bernard.
Discussion of the Arguments on the Dill-Vestal Copyright Bill.
Details of Wiring the DC B Eliminator, Part II, by Lewis Winner.

MAY 1

Discussion of The New 3-in-1 Loewe Audion, by Herman Bernard.
An Analyses of Detection, Part I, by J. E. Anderson.
The Aero All-Wave Set, Part II, by Capt. P. V. O'Rourke.
The Coils for the Fenway, by Leo Fenway.
News About Zenith Victory As To "Piracy" of Wavelength, Dill-Vestal Bills, etc.

MAY 8

The Aid of By-Pass Condensers, by John F. Rider.
Reflexed Resistance AF, by Theodore Kerr.
The Key to Selectivity, by K. B. Humphrey.
A Study of Detection, by J. E. Anderson.
Four Pages of Q. and A.
Seven Pages of Up-to-Date Radio News.
Winding a Loop on a Cardboard Frame.

BAR MITZVAHE BROADCAST

Said to be the first time in radio history, the Jewish confirmation ceremony, known as the "Bar Mitzvahe," was broadcast through station WRNY, New York City.

BEAUTY-QUALITY-LOW PRICE

TYPE 5SS + 5-Tube Toned Radio Frequency. \$45

TYPE 6RR 6-Tube Resistance Coupled Audio Tuned Radio Frequency \$50

If your dealer cannot make immediate delivery we will ship direct from factory

American Interstate Radio Service

183 Greenwich Street, New York City

Distributors, Jobbers, Dealers, write for special trade forms.

VEBY HIGH-MU TUBES

Made especially for Resistance Coupled Amplifiers. Now you can get more volume with greater clarity.

A. F. 20 for the 1st and 2nd Stage.....\$3.00

A. F. 6 Power Tube for 3rd Stage.....4.50

VEBY RADIO CO.

47-51 Morris Avenue Newark, N. J.

New and Improved FRESHMAN MASTERPIECE

AT AUTHORIZED
FRESHMAN DEALERS ONLY



19-inch Full Size \$7.50
full floating cone

Would cost \$30 in a retail store. You save by buying direct. It is superior to any speaker made. Try it in your home; if not satisfied, return and get money back.

Accusti - Cone Laboratories
96 Church St. New York

RADIO WORLD'S QUICK-ACTION CLASSIFIED ADS.

10 CENTS A WORD. 10 WORDS MINIMUM. CASH WITH ORDER

LONG DISTANCE CRYSTAL SET PLANS, \$1.00. Loudspeaker volume. Patent pending. Write Burgess, 618 3d St., S. W. Washington, D. C.

SELL AND INSTALL RADIO SETS. With a \$25 capital we can put you in the radio business and show you how to earn a hundred or two a week. For full details write Columbia Print. Radio Division, 143 West 45th St., New York City.

THE CONTROL OF FEEDBACK, by Barney Feete, appeared in RADIO WORLD dated April 24. Sent on receipt of 15c, or start sub. with that issue. RADIO WORLD, 145 W. 45th St., N. Y. C.

THE AERO ALL-WAVE SET, by Capt. P. V. O'Rourke, appeared in RADIO WORLD dated April 24 and May 1. Sent on receipt of 30c. RADIO WORLD, 145 W. 45th St., N. Y. C.

600 MILE RADIO, \$2.95. NO BATTERY nor tubes needed. Always ready. Fully guaranteed. 200,000 sold. No screeching nor grinding. Real radio, no toy. Sent postpaid. Order one today. Crystal Radio Company, Wichita, Kansas.

BULLDOGS

BEAUTIFUL REGISTERED BULL PUPS, \$15. Bulldogs, 501 Rockwood, Dallas, Texas.

"ME WANTS MORE DX"—worth framing. This is the front page of RADIO WORLD dated March 6. If you haven't a copy, get this number and you will find that this youngster with the earphones is one of the cutest little kids you ever saw, except your own, of course, 15c per copy, or start sub. with that number. RADIO WORLD, 145 W. 45th St., N. Y. C.

THE BERNARD PORTABLE SUPER-HETERODYNE appeared in RADIO WORLD dated April 3, 10, 17 and 24. Sent on receipt of 60c, or start your subscription with April 3 issue.

WIRELESS IN THE HOME by Lee deForest, sent on receipt of 15c. The Columbia Print 145 W. 45th St., N. Y. C.

KILOCYCLE-METER CHART, appeared in RADIO WORLD dated May 1. Sent on receipt of 15c, or start sub. with that number, RADIO WORLD, 145 W. 45th St., N. Y. C.

A PAYING POSITION OPEN to representative of character. Take orders shoe, hosiery direct to wearer. Good income. Permanent. Write now. Tanners Shoe Mfg. Co., 5-710 C St., Boston, Mass.

SPECIAL DISCOUNTS ON SETS AND parts. Send for price lists. Martien Radio Shop, Galion, Ohio.

THE 5-TUBE SUPER HETERODYNE SET, by Jasper Jellicoe, appeared in RADIO WORLD dated April 17. Sent on receipt of 15c. RADIO WORLD, 145 W. 45th St., N. Y. C.

CONSTRUCTION OF RADIO PHONE AND TELEGRAPH RECEIVERS by M. B. Sleeper, sent on receipt of 75c. The Columbia Print, 145 W. 45th St., N. Y. C.

DESIGN DATA FOR RADIO TRANSMITTERS AND RECEIVERS by M. B. Sleeper, sent on receipt of 75c. The Columbia Print, 145 W. 45th St., N. Y. C.

TEAR OFF AND MAIL TODAY

8 Week's Trial Subscription, \$1.00

KEEP ABREAST OF THE LATEST
RADIO DEVELOPMENTS

RADIO WORLD
145 WEST 45TH ST. NEW YORK CITY

Good Back Numbers of RADIO WORLD

The following illustrated articles have appeared in recent issues of RADIO WORLD:

- Aug. 29—A Set a Baby Can Build, by Herbert E. Hayden. A Pilot Meter Switchboard, by Lewis Winner.
 - Sept. 12—The 1926 Model Diamond of the Air (Part 1), by Herman Bernard. A 25-to-110 Meter Receiver, by Sidney E. Finkelstein.
 - Sept. 19—Diamond of the Air (Part 2), by Herman Bernard. A Tube B Battery Eliminator, by Louis Winner.
 - Oct. 24—A Phonograph Cabinet Set, by Lewis Winner. The Thoroughbred, by Herbert Hayden (Part 2).
 - Oct. 31—The 4-Tube Pathfinder, by S. E. Finkelstein. How to Make a Simple Loop, by Herbert E. Hayden.
 - Nov. 7—A 3-Tube Dry-Cell Circuit, by Capt. P. V. O'Rourke. One of the Best Crystal Sets, by Herbert E. Hayden. 1-Tube DX Set, Herman Bernard.
 - Nov. 28—The Zero Potential Loop, by Frank Freer. The 1-Tube Headset Receiver, by J. E. Anderson. A Discussion of AF Amplification, by Wm. Fortington.
 - Dec. 5—A Toroid RF Set, Using Crystal, by Lewis Winner. The Diamond of the Air (In Text and Diagram), by Herman Bernard.
 - Dec. 12—A Self-Contained Receiver, by H. E. Hayden (Part 1). B Battery Eliminator, by Lewis Winner (Holiday Gifts No.).
 - Dec. 26—The Regenerative Wave Trap, by John F. Ryder. The 5-Tube Tuned RF Set, by Capt. P. V. O'Rourke.
- 1926:
- Jan. 2—The 2-C Set for Simplicity, by Capt. P. V. O'Rourke.
 - Jan. 9—The 4-Tube DX Symphony Set, by A. Irving Witz. A Skillfully Made 1-Dial Set, by Herman Bernard.
 - Jan. 16—Anderson's 5-Tube Quality Receiver, The Raytheon B. Eliminator, by Lewis Winner.
 - Jan. 23—The 4-Tube Diamond of the Air, by Herman Bernard. B Batteries Last Six Months, by S. E. Finkelstein.
 - Jan. 30—An Individual AF Amplifier, by H. E. Hayden. The Antennator, by Herbert Hayden (Part 2). Trapping Out Super-Power in New Jersey, by Capt. P. V. O'Rourke.
 - Feb. 6—The Fenway (4 or 9 tubes), by Leo Fenway (Part 1). The Great 1-Tube DX Set, by Herman Bernard.
 - Feb. 13—Anderson's 5-Tube Economical Receiver, Trouble Shooting for Novices, by M. B. Strock. The Fenway, by Leo Fenway (Part 2).
 - Feb. 20—The 8-Tube Victoreen, by Herbert E. Hayden. The Fenway, by Leo Fenway (Part 3). Quality Stressed in 3-Tube Set, by Brainard Foot.
 - Feb. 27—The 4-tube DX Dandy, by Herbert E. Hayden. Umbrella Aerial for DX, by Hugo Gemback. Part 2 of The Victoreen.
 - Mar. 6—The 1 tube Set, by Capt. O'Rourke. The Chemistry of Batteries, by A. R. Reid. The Victoreen Set (Part 3), by Herbert E. Hayden.
 - Mar. 13—The Non-Regenerative Browning-Drake Set, by M. B. Sleeper. The Teetron Eliminator (Part 1), by Lewis Winner. Curing Victoreen Trouble, by Herbert E. Hayden.
 - Mar. 20—The Super-Heterodyne, by J. E. Anderson. A 2-Tube Speaker Set, by Percy Warren. The Browning-Drake Set (Part 2), by M. B. Sleeper. A 2-tube Eliminator, by Lewis Winner.
 - Mar. 27—An Economical 4-Tube Set, by Edgar T. Collins. A Practical B Battery, by Capt. P. V. O'Rourke. Teetron Trouble Shooting, by Lewis Winner.
 - April 3—The Bernard Portable, by Herman Bernard (Part 1). How to Get DX, by Capt. P. O'Rourke. A Compact B Supply, by Lewis Winner.
 - April 10—The Bernard Portable, by Herman Bernard (Part 2). Two Eliminators for DC, by Lewis Winner. A Super From An Old Set, by C. King.
 - April 17—The New 1-Dial Powerstone, by Capt. P. V. O'Rourke. The Bernard Portable (Part 3), by Herman Bernard. The Action of Transformers, by Lewis Winner.
 - April 24—All Waves on One Set, by Capt. P. O'Rourke. Bernard's Portable (Conclusion). Control of Feedback, by Barney Foote.
 - May 1—New Multiple Tube, by Herman Bernard. The Aero All-Wave Set, by Capt. O'Rourke. Kilocycle-Meter Chart. Official List of Stations. An Analysis of Detection, by J. E. Anderson.
 - May 8—A Study of Detection, by J. E. Anderson, Part 2. To Wind a Loop on a Card-board Frame. How to Reflex Resistance AF, by Theo. Kerr.

Any copy, 15c. Any 7 copies, \$1.00. All these 29 copies for \$4.00, or start subscription with any issue. RADIO WORLD, 145 W. 45th St., N. Y. C.

Talks on Topics Weekly

Odd Set



MICHAEL L. SIMMONS, motion picture critic and author, broadcasts on picture topics from WFBH each Friday at 5:45 p. m. WFBH is the Warners Theatre Studio, New York City. Mr. Simmons is associate editor of the "Exhibitors Daily Review."

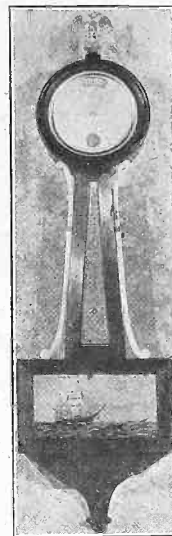

(Hayden)

A N enterprising fan made a radio set to fit in a banjo clock. The single dial is at top, where the clock face was. The set is below, behind the pendulum ornament.

GEM TUBE

A Guaranteed Radio Tube Within Reach of All. Every tube guaranteed. A tube for a dollar of \$2 value. A trial order will convince you as it has thousands of others. Send your orders at once. Orders sent C.O.D. parcel post.

Type 200
Type 201-A
Type 199
Type 199-A with 1.00 Standard Base
Eac'

Dealers, Write for Discounts

GEM TUBE CO.
Dept. W, 200 E'way, N. Y. C.
220 So. State St., Chicago, Ill.
Lafayette Bldg., Detroit, Mich.



"DIAMOND of the Air" PANELS



All Drilled and Engraved Worth \$4.00

\$1.60 ea. C.O.D.

Cortlandt Panel Engraving Co.
79 Cortlandt Street New York City

THE VICTOREEN

How to build this 8-tube Super-Heterodyne described in February 20, 27, March 6 and 13 issues of RADIO WORLD. Send 60c for all four copies. Send \$6 for year's subscription and get these four copies FREE!

RADIO WORLD
145 W. 45th St. New York City

TABLE FOR CONVERSION OF FREQUENCIES AND METERS appeared in RADIO WORLD dated May 1, 1925. Sent on receipt of 15c, or start your sub. with that number. RADIO WORLD, 145 W. 45th St., N. Y. C.

KILL STATIC

GET TONE QUALITY All summer control volume instantly — from a whisper to maximum! Smooth out powerful locals. Dampen annoying noises with a

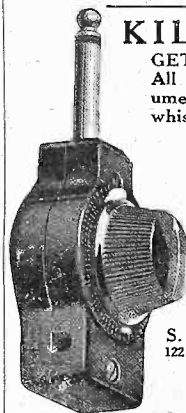

Centralab Modulator Plug Instantly attached to any set. Improves any Loud Speaker Sent Postpaid on receipt of **\$2.50**

S. & H. INC., Sales Div.
122 Greenwich St., N. Y. C.
Approved by **RADIO WORLD** Laboratories

1926 DIAMOND OF THE AIR BOOKLET with full instructions to make the Diamond, with blue print, 50c. Newsdealers and radio dealers can get supply from American News Co. and its branches. RADIO WORLD, 145 W. 45th St.,

RADIO WORLD'S
Fifth Annual Vacation Number
June 12th

The Detection Principle In Super Heterodynes

[Parts I and II of this article by J. E. Anderson on detection were published in the May 1 and 8 issues. Part III, the conclusion follows.]

There are three main products of a modulator of any of these types; first, the carrier frequency; second, the summation frequency; third, the difference frequency. The summation frequency is the sum of the carrier and the modulating frequency; the difference frequency is simply the difference between them. In broadcasting, all of these frequencies are transmitted, and the summation and difference frequencies are so nearly equal to the carrier that no differentiation between them is made in ordinary broadcast receivers. In the Super-Heterodyne they are widely different. The modulating frequency is of the same order of magnitude as the carrier frequency; the summation frequency is approximately twice as great as either of the components. The difference frequency is comparatively very small. In ordinary broadcast reception one tuned circuit, or filter, can pick out all the three parts; in the Super-Heterodyne one filter can pick out only one component. The filter may be tuned to any one of the three main components. If it is tuned to the carrier, that is, to the frequency of the local oscillator, nothing is received because this does not carry any audio frequencies. It may be tuned to the summation frequency. This does carry audio frequencies, and the original broadcast matter may be received on this summation frequency. But nothing would be gained especially by doing that, and a great deal would be lost because an amplifier tuned to this high frequency would be less efficient and more troublesome than an amplifier tuned to the original modulated carrier. The filter is usually tuned to the difference frequency, which also carries the original broadcast matter. Since this frequency is very low, comparatively, an amplifier tuned to this is very efficient and not very troublesome. While the difference frequency is only one of the two side frequencies locally generated, it carries both of the side bands of the original carrier frequency broadcast.

Where Mixing Fails

Just one more statement regarding whether the Super-Heterodyne modulator or first detector is, or should be, oper-

ated as a detector. The alternative is to operate the tube as an amplifier. If it were, and if its characteristic were perfectly straight over the region involved, the two waves, the signal wave and the locally generated wave, would pass through it independently of each other, both being amplified. There would be no more modulation or mixing of the two than there is modulation in the ether of light waves or radio waves of different frequencies, or of two distinct sound waves in air, or of two independent waves in water. They pass through the same medium, cross each other with a simple how do you do, and go on their way unaffected by the meeting. The modulation of two sound waves of different frequencies often

heard in music takes place in the ear of the observer.

Which is the better detector method, the grid bias or the leaky condenser? The consensus is almost unanimous for the leaky condenser. But it depends somewhat on purpose and conditions. For weak signals the leaky condenser method is unquestionably far superior, provided that the plate potential, the grid potential, the capacity of the grid battery and the resistance of the grid leak have been properly coordinated. For very strong signals the method is not so good on account of the tendency for the grid to block. For such signals the high grid bias method is more stable in operation, and it is just about as sensitive provided that the grid bias has been carefully adjusted. In cases where the difference between the carrier frequency and the modulating frequency is not great the grid bias method is, in my opinion, superior for reasons already pointed out.

Bring in Europe on a
Victoreen "Super"
Write for Layout and Parts List
THE GEORGE W. WALKER CO.
6515 Carnegie Avenue Cleveland, Ohio

FREE RADIO CATALOG



Just off the press! Our second catalog for 1926. 100 pages of parts, accessories, kits and sets—the best and the latest. A copy is yours for the asking. Just drop us a line—do it today!

DEPT. PM

CHICAGO SALVAGE STOCK STORE

509 S. State Street CHICAGO, U. S. A.

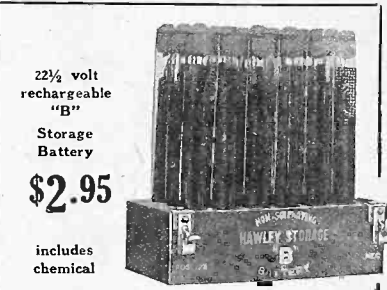

22½ volt rechargeable "B"

Storage Battery

\$2.95

includes chemical

45 volts, \$5.25; 90 volts, \$10.00; 112½ volts, \$12.50; 133 volts, \$14.75; 157½ volts, \$16.80. Truly, the biggest buy today. Easily charged on any current, including 32-volt systems. Any special detector plate voltage had. Tested and approved by leading authorities such as Popular Radio Laboratories. Over 3 years sold on a non-red tape, 30-day trial offer with complete refund if not thoroughly satisfied. Further guaranteed 2 years. Knock-down kits at great savings. Complete "Hawley" "B" battery charger, \$2.75. Sample cell, 35¢. Order direct—send no money—simply pay the expressman's cost on delivery. Or write for my free literature, testimonials and guarantee. Same day shipments. B. Hawley Smith, 318 Washington Ave., Danbury, Conn.

FENWAY —for DX

Winter or Summer the Fenway is a consistent DX-getter. Naturally, you want to own one of these super-sensitive receivers. Fenway Blueprints show you how to build a laboratory set.

PRICE OF COMPLETE SET OF BLUEPRINTS—\$3.00 Postpaid

Others Give Their Radio Prints Away FREE!—Fenway Prints Cost

You \$3.00—WHY?

Radio Division, The Columbia Print
147 West 45th Street New York City

JAYNXON TONE BRIDGE

GETS THE REAL TONE VALUE FROM LOUD SPEAKER

Direct Battery Current Spoils a Speaker—A JAYNXON TONE BRIDGE Saves It! Perfect volume control without change of quality. Reduces static interference.



\$10.00

Post-Paid A Jaynxon Product "Gets the Tone—From Horn or Cone"

Matches Tube Impedance to All Speakers
JAYNXON LABORATORIES
57 DEY STREET NEW YORK CITY
Approved by RADIO WORLD Laboratories

1925 BACK NUMBERS OF RADIO WORLD WANTED

Mail us copies of any of the following 1925 issues of RADIO WORLD, and we will send you a copy of a current issue for every copy sent us: January 10, February 21, March 21, 28, April 4, 11, 25; May 16, 23, 30; June 6, 13, 20; July 4, 11, 18, 25; Aug. 8, 15, 29; Sept. 5, 26; also Jan. 23, 1926.

FILL OUT AND MAIL NOW SUBSCRIPTION BLANK RADIO WORLD

RADIO WORLD

145 West 45th Street, New York City
(Just East of Broadway)

Please send me RADIO WORLD for months, for which

please find enclosed \$.....

SUBSCRIPTION RATES:
Single Copy \$.15
Three Months 1.50
Six Months 3.00
One Year, 52 Issues 6.00
Add \$1.00 a Year for Foreign Postage; 50c for Canadian Postage.

S. HAMMER RADIO CO.

303 Atkins Avenue, Brooklyn, N. Y.
Please send me FREE Your NEW
RADIO CATALOG

Name
Address
City State

FILL OUT AND MAIL

The Oscillator as Used in W. E. Super-Heterodyne

The circuit diagram shown is a form of the Hartley oscillator. With this system, a great oscillatory action of the tube is obtainable. A fixed condenser of about .006 mfd. may be shunted between the opposite ends of the plate and grid coils which are connected to the rotary and stationary plates of the variable condenser. This will cause the tube to oscillate more readily, giving the variable condenser a greater controlling range. The coil in series with the grid of the detector tube is for coupling with the grid of the oscillator coil, so that energy may be transferred.

This oscillator and first detector arrangement are similar to that employed in

the Super-Heterodyne used by the American Telephone and Telegraph Co. for measuring field strengths at broadcast frequencies. The receiver was designed by Western Electric.

This oscillator detector arrangement may be hooked in to take the place of other oscillator detector circuits, in Supers. The grid coil may consist of 36 turns wound on a tubing 3" in diameter, while the plate coil may consist of 34 turns wound on the same tubing with a 1/8" separation between the two. About No. 26 single silk covered should be used. The oscillator condenser should have a capacity of .0005 mfd.

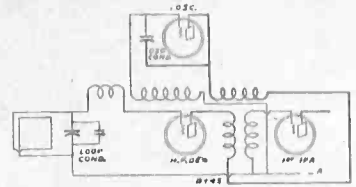

FREQUENCY CHANGING system used in Western Electric Super-Heterodyne. The extra condenser on the loop is a parallel vernier and one like it (not shown) is used on the oscillator condenser.

Special \$25,000 Organ In Remodelled WBBM

CHICAGO

A new \$25,000 specially designed broadcasting Barton Pipe Organ; a completely remodeled and enlarged studio; important additions and changes in the musical staff.

These are some of the developments announced by Charlie Garland, broadcasting director, in connection with the recent change in policy of Station WBBM, the Stewart-Warner Air Theater, Chicago.

The new organ was built by the Bartola Musical Instrument Company of Chicago, who for a number of years have specialized in pipe organs used in broadcasting. In the new instrument are incorporated changes dictated by past experience in broadcasting stations. It has been specially designed by Dan Barton, originator of this type of organ.

The installation of this instrument together with additions to the staff has made necessary the remodeling of the studio. The new arrangement is designed to give the Air Theater the most up-to-date studio possible. There will be a large waiting room for artists and listeners separated from the studio itself by plate glass windows. In addition there will be a specially designed sound proof announcer's booth that will enable announcers to concentrate on their work and will eliminate studio noises and interruptions.

Reading is First Road To Seek Radio Goodwill

The Reading Company, the first railroad in the country to enter the broadcasting field, gave its first concert over Station WJZ, where the Reading Seashore Band was on the air from 9 to 10 p. m. It is planned to give a program every Monday night at the same hour.

Join the Happy Diamond Family!

Build This Famous 5-Tube Set and Know Real Quality Reception!

Easy to Build, Easy to Tune!

Herman Bernard, designer of this wonder circuit, has written an illustrated booklet on "How to Build RADIO WORLD's 1926 Model Diamond of the Air." Send 50c and get this booklet, including a full-sized wiring blueprint. Also name plate, FREE.

Outstanding Features of Set:

- (1) Fans, charmed by tone quality, sensitivity and selectivity, report speaker reception of far-distant stations with great volume.
- (2) A 2-tube earphone set, a 5-tube speaker set, and a separate 3-stage audio-amplifier for immediate use with any tuner, are combined in one.
- (3) No rheostats are used.
- (4) The set is inexpensive to construct and maintain.

What the Circuit Is

The 1926 Diamond consists of one stage of tuned radio-frequency amplification, regenerative detector, one transformer-coupled audio stage, and two resistance audio stages—the utmost from five tubes!

Follow Bernard

You can't go wrong if you follow the directions as written by the designer himself, as contained in the booklet. The diagrams, including blueprint, are guaranteed 100% accurate. Play safe!

Send \$6 for year's subscription and get booklet blueprint and nameplate FREE.

[Newsdealers or radio dealers, order the booklets with blueprints included, in quantity, direct from American News Co. or branches.]

RADIO WORLD
145 West 45th St., New York City

NEW 1926 FREE RADIO GUIDE
Newest Edition Ready
Shows the latest circuits, the newest developments in radio at startlingly low prices. Get the parts you want here and save money. The best in parts, kits, sets and supplies. Orders filled same day received. Write for free copy NOW; also please send names of one or more radio fans.
BARAWIK COMPANY, 102-140 So. Canal St., Chicago.

We Specialize in Complete Kits
The M. & H. Engineering Service Will Supply Parts or Complete Sets of This Hook-Up
DESCRIBED IN ANY OR ANY OTHER RADIO MAGAZINE
M & H SPORTING GOODS CO.
512 Market St. Philadelphia, Pa.

Alden Processed
NA-ALD
Sockets and Dials
ALDEN MANUFACTURING CO.
Dept. S-5 Springfield, Mass.

PHONOGRAPH OWNERS!
Convert your phonograph into the latest amazing electrical machine. Startling in its life-like reproduction of the new electrically recorded records. For a few dollars and several hour's time you may have the world's greatest talking machine. Operates on dry cells or lamp socket. Building plans by Hartman and Jenkins, formerly with Westinghouse Electric & Mfg. Co. and Western Electric Co. \$1.00 cash or C.O.D. Absolute satisfaction guaranteed. E. E. Hartman, 738 Garfield Ave., Kansas City, Kansas.

Vacuum Tubes Rebuilt \$1.00 each
POSITIVELY GUARANTEED equal to new tubes in every respect. Money will be refunded if tubes prove unsatisfactory for any reason other than burn-outs.
Send us your broken and burned out tubes by parcel post. (Not necessary to insure or guard against breakage.) We make return shipments by parcel post C.O.D. and try to maintain 24-hour service.
HARVARD RADIO LABORATORIES
200 Old Colony Avenue South Boston, Mass.

The world's greatest variable grid leak, distributed by the North American Bretwood Co., is selling enormously, and is giving universal satisfaction. Get more out of your set by using the Bretwood Grid Leak. Mailed for \$1.50. Radio Division, The Columbia Print, 145 W. 45th St., N. Y. C.

No Noises!
Tones clearer, voices more distinct, and volume greater with—AMPERITE. No moving parts. It brings the utmost out of each individual tube. Specified in all popular construction sets. Price \$1.10.
Radiall Company
Dept. R.W.-5, 50 Franklin Street, New York City
Write for FREE Hook-ups
AMPERITE
The "SELF-ADJUSTING" Rheostat

RADIO NEWS

Regular Subscription Rate \$3 the Year

BIG SPECIAL OFFER

\$2.00 Value for \$1.00

Your Choice of Either of These Valuable Premiums.

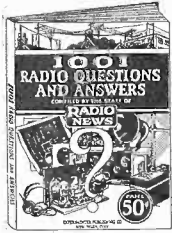

1001 Radio Questions and Answers

A brand new book filled to the brim with a priceless array of selected Questions and Answers that are necessary to every one in the construction, care and maintenance of modern sets, including information on hundreds of simple and complex circuits in common use today.

Contains 116 pages, 300 illustrations, size 9x12 inches—a big book for every radio man.



Amateurs Handbook

The "RADIO NEWS" Amateur Handbook is a large 116-page magazine size book containing a wide, varied and carefully selected array of the finest and most helpful radio articles that have appeared in the pages of Radio's Greatest Magazine. **RADIO NEWS.** The cream of practical, up-to-the minute circuits and miscellaneous information and data is culled from RADIO NEWS and presented in compact form in this book. It embraces every phase of radio, but particularly the new and more practical receivers and circuits developed for modern reception.

Radio News has been radio's greatest and biggest magazine since the very beginning of radio broadcasting. It is the outstanding authority in the radio industry, carrying more new developments, more detailed drawings and more news than any other radio periodical. Some of the regular features are liberal prize offers, an attractive rotogravure section, articles by Hugo Gernsback and other foremost writers, departments giving Standard Hook-ups, Radio Patents, etc. In short, Radio News covers everything worth while in the radio field.

SEND ONLY \$1.00 FOR SIX MONTHS' TRIAL SUBSCRIPTION TO "RADIO NEWS"—and take your choice of either of the two valuable premiums shown in this advertisement.

If you desire both premiums send \$2.00 for a full year's subscription.

EXPERIMENTER PUBLISHING CO., Inc.

53 Park Place (Dept. W.)

New York, N. Y.

DON'T MISS THIS BOOK—Fresh from the Press!

"500 RADIO WRINKLES"

A big book full of short cuts, hints and practical ideas

The 500 RADIO WRINKLES BOOK is a very comprehensive compilation of the best time and money saving hints that can be effected. Under fifteen separate and distinct headings, the entire field of radio apparatus and instruments has been covered in simple, understandable language. It is divided into sections covering Antennae, Batteries, Coil Mountings, Condensers, Crystal Detectors, Inductances, Lightning Protectors, Loop Antennae, Loud Speakers, Resistances, Sockets, Switches, Transformers, Vernier Dials. There are no ifs nor buts to complicate directions. The Beginner as well as the more advanced radio man will soon find that this book contains a veritable storehouse of practical, inexpensive hints toward improving his radio apparatus.

Large Size 9x12 Inches, 100 Pages, Illustrated

If your dealer cannot supply you, write direct to

EXPERIMENTER PUBLISHING CO., Inc.

53 Park Place

(Dept. W)

New York, N. Y.



PRICE 50c.

ON ALL NEWSSTANDS

100 PAGES
SIZE 9x12 INCHES

RADIO WORLD'S

Fifth Annual Vacation Number

JUNE 12th

A radio doubles vacation joys, gives baseball and all sports results, play by play; there are no dull, rainy days at seashore or mountains with a radio.

Thousands of RADIO WORLD'S readers are now most interested in installing radio in their bungalows, summer cottages, pleasure boats, camps and hotel rooms. This Vacation Issue of June 12th will give the latest and best information on portables, battery eliminators, DX getters, new sets and hookups.

Advertisers
read this



RADIO WORLD is
the only national
WEEKLY.

The one radio publi-
cation giving quick,
immediate results.

RADIO WORLD'S
readers are buying
NOW.

Offer to send them
your goods direct
from factory—many
of them live miles
from a radio dealer.

You will be surprised
and amazed at the big
direct returns that
RADIO WORLD'S
advertisements give.

The Trade's Best Opportunity to Build a Big Sales Demand

RADIO WORLD is now the only illustrated national radio fan weekly. RADIO WORLD is the only publication having 100,000 weekly readers, most of whom are *experimenters* in radio. RADIO WORLD's readers build sets for the fun of it, the thrill of the successful experiment, and when something new comes along they start all over again with a new set, and they not only build sets but buy sets as well.

"Drops of water wear away the hardest granite." Even a small advertisement in RADIO WORLD brought to our readers' attention week by week, fifty-two times a year, wears away trade resistance and brings a brand or trade-mark to the buyers' attention so persistently it creates real demand. RADIO WORLD gives you a service that no other publication can, because it is a radio *service* publication.

Fiction magazines of general circulation supply the best fiction; newspapers, even small-town papers, give good radio programs, but only RADIO WORLD gives real weekly radio service information—the newest things in radio, the latest and best hookups, the last word in battery service and elimination, etc. In other words, RADIO WORLD is the only national radio weekly, and its 100,000 weekly fan readers who are constant buyers of radio can give you the biggest result for your advertising dollar.

RADIO WORLD is dated each Saturday, is on the news-stands the previous Wednesday, and closes each Wednesday noon, ten days in advance of date of issue. Results are

quicker from RADIO WORLD than any other radio publication. A single inch message can be delivered in RADIO WORLD to the 100,000 people most interested in radio throughout the United States in ten days for ten dollars.

RADIO WORLD gives its advertisers every possible editorial co-operation. The set builder as a rule follows as closely as possible the laboratory models of radio tuned circuits in which the manufacturer's article is specified, and in this way it is constantly creating a demand, and new users for radio parts and accessories.

In regard to factory-made sets, we take various leading sets from week to week, giving full and detailed information regarding each particular set, creating not only a demand for the goods but showing the buyer in advance how to get the best possible results from the set, making the buyer a pleased and satisfied customer that will recommend your set to his friends. To get any real joy out of radio, one should know something about radio. RADIO WORLD fifty-two times a year is putting joy into radio reception by giving useful radio information—nothing else—no programs, no fiction—*just all radio*.

To sell the retailer is important, but not the most important thing. The big idea is to move your goods off the dealers' shelves. It has been proven over and over again that RADIO WORLD, with its week-by-week advertising urge, can best do this at the lowest cost. May we send you the proof? RADIO WORLD, 145 W. 45th St., New York.

Summer schools, camps, hotels throughout the country receive and preserve RADIO WORLD'S Vacation Issues.

Thousands of extra circulation—no increase in advertising rates: Page \$300, Column \$100, Inch \$10.

Extra color red FREE on full page advertisements if copy is received by Tuesday morning, June 1st.

LAST ADVERTISING FORMS CLOSE JUNE 2nd

FRED S. CLARK, Advertising Manager

Radio World, 145 W. 45th St., New York

The Newest Up-to-the-Minute Radio Set—It has Never Been on a Dealer's Shelf—Most Selective. A Wonderful DX Getter. Sold on a Guarantee of Satisfaction or Money Back.

Volume Control—Perfect Calibration—Range 180-550

BST-6

B-for Beauty
S-for Selectivity
T-for Tone purity
6-its 6 tubes for distance

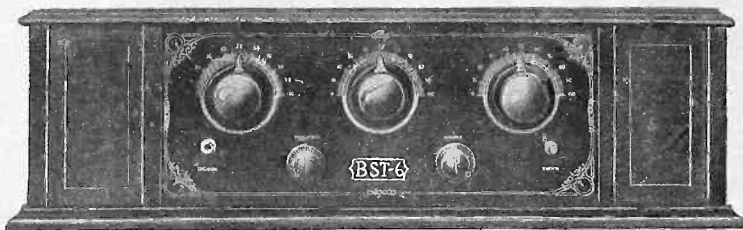

The BST-6. 2 Feet 4 Inches Long. 9 Inches Inside Depth. 8 3/4 Inches High.

THIS marvelous six-tube tuned radio frequency receiver is Self-Equalized and built of low-loss materials throughout. Its clear, rich tone of astonishing volume is a revelation. The circuit consists of two stages of tuned radio frequency, tube detector and three stages of balanced audio amplification. Air cooled rheostats and universal sockets are used.

Modified straight line frequency-variable condensers are employed, insuring separation of the low wave length stations. **PERFECT CALIBRATION—STATIONS ONCE TUNED IN CAN ALWAYS BE LOGGED AT THE SAME DIAL POINT.**

The BST-6 works best with a 75 to 100 foot aerial, 6 volt "A" storage battery, two 45 volt "B" batteries, 4 1/2 volt "C" battery, six 201-A tubes and any good loudspeaker.

Specifications

- Bakelite Panel, Walnut Finish—
- With Etch-O-Gravure and Gold Decorations—
- Bakelite Sub-Base—
- Kurz-Kasch Bakelite-Walnut Pointers; Gold-filled, to Match—
- Kurz-Kasch Bakelite Gold-filled Rheostat Knobs—
- Lubree Straight Line Frequency Condensers—
- Special Coils; Double Silk Solenoids—
- Shore Audio Transformers—
- Caswell-Runyan Two-tone Walnut-Finished Cabinet.

LOG OF BST-6

Taken on a Fifteen-Foot Aerial in One-Half Hour by Al. Kraus, 996 Aldus Street, New York City.

WSBC	10	WGY	50
WBBR	16	WMAK	51
WEBH	49	WMSG	11
WHT	55	WOC	85
WCCO	61	WFAA	78
WSB	66		

SELECTIVITY

I live within four blocks of WLWL, and since the opening of this station have had great difficulty in choking them off my old set. Even after employing a wave trap I could still hear WLWL around the entire dial and was told by several friends that living so near this powerful station it would be impossible to entirely cut them out with anything less than a super-het. It was a very agreeable surprise, therefore, when I installed my new BST-6, to find that while WLWL came in on 25 I could tune in WRNY on 21 and entirely cut out WLWL. **This is certainly real selectivity.**—F. S. Clark, 350 West 55th Street, New York City.

Guarantee

Satisfaction or Money Back

Each receiver is tested and retested, boxed and inspected before leaving factory, and guaranteed to reach you direct in perfect condition. Workmanship throughout guaranteed the best. Assembled by experts.

Immediate Delivery

Direct from factory to you
No dealers' or middlemen's profits

\$40.00

SAFETY FIRST!—Why buy obsolete models, or radio failures at department store "bargain sales" when a BST-6, the latest achievement in radio, can be bought direct from the factory with no department store profit added? Here is a real bargain, sold you with a guarantee of satisfaction or money back.

Send Check or P. O. Money Order to

COLUMBIA PRINT,

Radio Division, 143 West
45th St., New York City

RADIO WORLD Guarantees the Responsibility of This Advertiser