

RADIO WORLD

Trade Reg. U.S. Pat. Off.

Vol. 8 No. 25 ILLUSTRATED Every Week

IS CRYSTAL PURER RECTIFIER THAN TUBE?

By John F. Rider

THE KB-8 *BY M. B. Sleeper*

THE TECTRON ELIMINATOR

nearly all of the radio magazines each month. I now dropped them ALL in favor of RADIO WORLD. I am convinced I am missing something very important if I do not get RADIO WORLD every week.

John Metcalf, 510 Ridge Road, Rochester, N. Y. I formerly

bought nearly

all of the

magazines

each month.

I have now

dropped them

ALL in favor

of RADIO WORLD.

I am convinced

I am missing

something very

important if

I do not get

RADIO WORLD

every week.

John Metcalf,

510 Ridge Road,



THE KB-8, being tested by the designer and author, M. B. Sleeper. See article on page 3 of this issue. (Radio Eng.)

Rochester, N. Y. I formerly bought nearly all of the

magazines each month. I have now dropped them

in favor of RADIO WORLD. I am convinced I

am missing something very important if I do not get R

ADIO WORLD every week. John Metcalf, 510 Ridge

Rochester, N. Y. I formerly bought nearly all

s each mo

nor of RA

ssing som

WORLD

chester, N.

adio maga

ALL in fa

t I am mis

ot get RA

10 Ridge R

y all of the

SPECIALISTS WHO CATER TO VICTOREEN BUILDERS

Kit Complete Parts Victoreen Super Heterodyne Set Special at \$69.50

Including the Same Parts as Described in This Issue of Radio World

We have sold more than 300 of these 8-tube Kits all over the country to enthusiastic owners who write us most glowingly of results. A wizard for Distance, Selectivity, Volume. Tune out any local station and get real DX on two-or-three meter wave difference. One of the few super-heterodynes with air-core transformers. No self-oscillations, whistles or squeals. Easier tuning because air-core transformers operate at higher frequencies. A demonstration will convince you. Tubes, batteries and aerial, of course, not included. Packed, ready for you anywhere.

LIST OF THE PARTS INCLUDED IN THIS VICTOREEN SUPER-HETERODYNE

- Four Victoreen RF Transformers, No. 170
- One Victoreen Antenna Coupler, No. 160
- One Victoreen Oscillator Coil, No. 150
- Eight Kurz-Kasch Standard Bakelite Sockets
- Two .0005 mfd. Hammarlund SLF Condensers
- Two Kurz-Kasch E-Z-Toon Vernier Dials
- Two .00025 mfd. Grid Condensers with Mountings
- Two 2-megohm Grid Leaks
- One .001 mfd. Fixed Condenser
- One 1.0 mfd. By-Pass Condenser
- One 400 ohm Victoreen Potentiometer
- Two Victoreen 30 ohm Rheostats
- Two Meloformers
- One 7"x24" Drilled and Engraved Panel
- One 8 3/4"x23" Baseboard
- Two No. 104 Carter Double-Circuit Jacks
- One No. 103 Carter Single Automatic Filament Control Jack
- One Imp Battery Switch
- Seven Binding Posts
- Two 6 ohm Victoreen Rheostats

We Specialize in Complete Kits DESCRIBED IN THIS OR ANY OTHER RADIO MAGAZINE

Hammarlund-Roberts, Silver-Marshall, Bremer-Tully, Harkness, Etc.

Only One Kind of Quality—the Best



30 Years' Experience Back of Each Sale

VICTOREEN SUPER!

Coast to Coast on a Loop! Verified Reception from Paris by Cadiz, Ohio, Radio Fan on a Victoreen. Built with "Tuned" R. F. Transformers of Air Core Construction. No Oscillations, Howls or Squeals—No Matching of Tubes. Range—Clarity—Volume—Selectivity—Ease of Operation.

COMPLETE KIT, \$54.95

CONSISTING OF THE FOLLOWING LIST OF HIGH-CLASS PARTS:

- 1 Victoreen Antenna Coupler No. 160.
- 4 Victoreen R. F. Transformers No. 170.
- 1 Victoreen Oscillator Coil No. 150.
- 8 Bell Bakelite Standard Sockets.
- 2 .0005 Mfd. Montrose SLF Condensers.
- 2 Apex Vernier Dials.
- 2 .00025 Mfd. Grid Condensers with Mountings
- 2 2-Megohm Grid Leaks
- 1 .001 Mfd. Fixed Condenser.
- 1 1.01 Mfd. Tobe By-Pass Condenser.
- 1 400 Ohm DeJur Potentiometer.
- 2 30 Ohm DeJur Rheostats.
- 1 Victoreen Kit alone (4 R. F. Transformers, No. 170; 1 Oscillator Coil, No. 150, and 1 Antenna Coupler, No. 160), \$37.00.
- 24 Hour Service on Shipments.
- Dealers! Write for Discounts on the Victoreen Super; Silver Six and Silver-Cockaday Parts.

MAURICE SCHWARTZ & SON
710-712 BROADWAY, SCHENECTADY, N. Y.

VICTOREEN

OFFICIAL SERVICE

Authorized by Geo. H. Walker Co. Endorsed by Radio World

- Victoreen Kits (4 Transformers and Oscillator Coil).....\$33.50
- Antenna Coupler..... 3.50
- Meloformer Audio Transformers..... 4.00
- Victoreen Rheostats... 1.20
- Victoreen Potentiometers 1.50
- Special Baseboard..... 1.00
- Special Bakelite Panel.. 6.00
- With Subpanel and Radiation Brackets..... 15.00
- Complete Kits.....\$70 Up

WRITE FOR PRICES ON KITS TO YOUR OWN SPECIFICATIONS, ASSEMBLY, ETC.

H. & F. Radio Laboratories

PAUL R. FERNALD

168 Washington St., New York City

WE DISTRIBUTE

VICTOREEN S. H. KITS VICTOREEN RHEOSTATS POTENTIOMETERS MELOFORMER AUDIO TRANSFORMERS

And all other necessary parts. Also Browning-Drake, National Dials, Impedafomers, Choqe Coils, etc.

Other lines as well.

Paramount Electrical Supply Co., Inc.

132 Church Street New York City

Tone Purity

with

Meloformer



Eliminate distortion and transformer noises by installing MELOFORMER, the new audio simplification instrument, in your set. Unequalled in volume, tone and range. Send for Free Booklet A-3, showing Meloformer Hookups.

Robertson Davis Co.

420 Orleans St., Chicago

CARTER Jacks and Switches



The new Carter "IMP" Battery Switch is a quarter turn switch with an "off and on" name plate clearly indicating when "A" Battery is "off or on." See one at your dealers.

65c

Carter Radio Co.
300 S. Racine Ave. Chicago

Join the Leaders At

RADIO CENTER!

Radio Center is *the* big move of the year in radio—"The one thing the industry needs most, we're strong for it—" that's the comment of radio leaders all over the country who are reserving space at Radio Center for the permanent display of their complete lines.

Occupying two floors of more than twenty thousand square feet in the famous Bush Building, New York City—in the heart of the world's greatest radio market—Radio Center enjoys the great advantage of a location where remarkable clarity of reception can be had from any of the well-known broadcasting stations.

It is directed by men of wide experience in cooperative merchandising—it is backed by large financial resources—it provides sound-proof offices and demonstration rooms of special construction where radio manufacturers and distributors can enjoy year-round sales facilities of unusual attractiveness.

Progressive radio men everywhere have been quick to grasp this chance—space at Radio Center is being reserved by telegram, by telephone, by letter and in person.

This real opportunity calls for action *now*—don't delay—there is less space available every day—call in person if possible—or wire for space reservations.

RADIO CENTER, Inc.

S. HERBERT MAPES, President

Bush Building

130 West Forty-Second Street

New York City

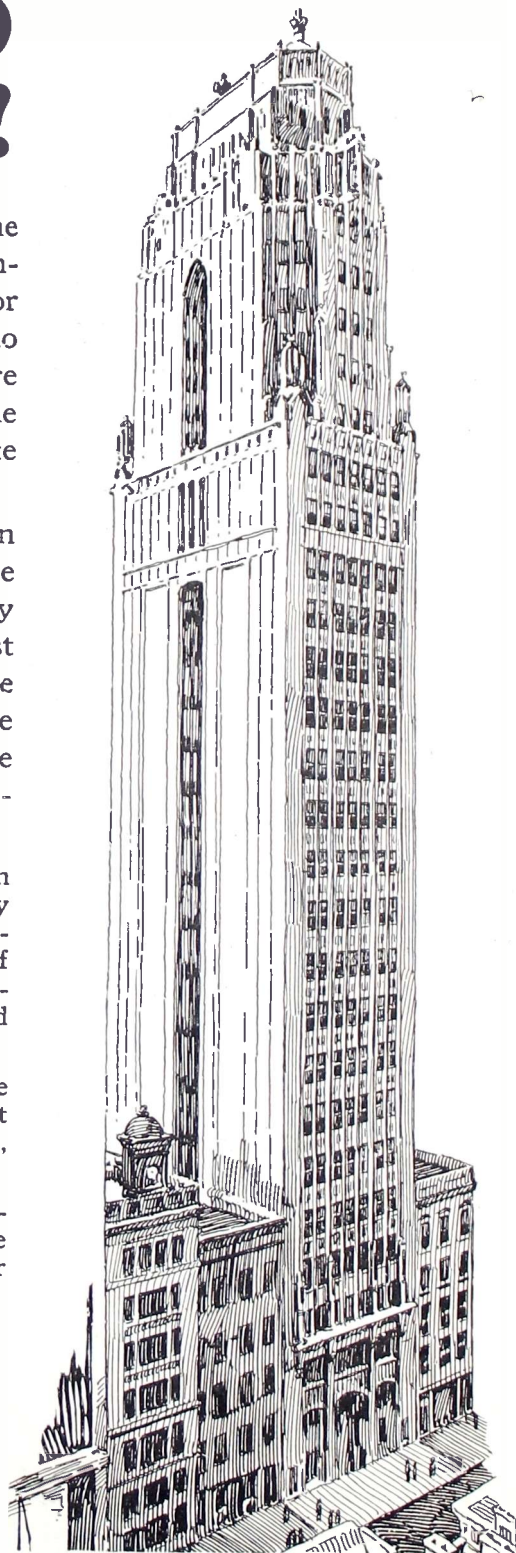

RADIO WORLD

[Entered as second-class matter, March, 1922, at the post office at New York, N. Y., under Act of March 3, 1879]

A Weekly Paper Published by Hennessy Radio Publications Corporation from Publication Office, 145 West 45th St., New York, N. Y. Just East of Broadway Phones: BRYant 0558 and 0559

Vol. VIII. No. 25. Whole No. 207

March 13, 1926

15c per copy, \$6.00 a year

The KB-8

A Non-Regenerative Browning-Drake Set

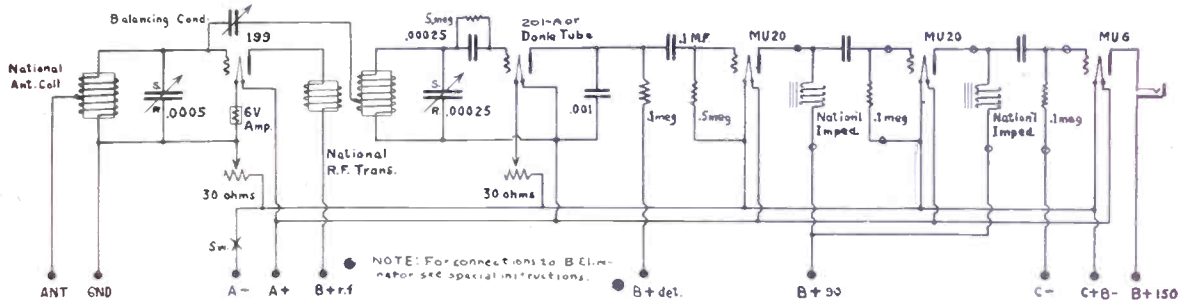

THE CIRCUIT NETWORK of the KB-8, designed by M. B. Sleeper, of "Radio Engineering." The hookup consists of one stage of tuned radio frequency amplification, non-regenerative detector, a first stage of resistance-coupled audio frequency amplification, followed by two impedance stages.

By M. B. Sleeper

PART I

WHEN a B. C. L. asks a dealer or set builder to construct a receiving set for him, he generally has uppermost in his mind one specification—the set must be satisfactory in operation and results. An experimenter, on the other hand, buying parts to make an outfit, generally wants something unusual in the way of operation or design.

The non-regenerative Browning-Drake receiver, type KB-8, was designed to meet the requirements of both the B. C. L. and the experimenter.

For the B. C. L. the KB-8 has been made irrefragable in operation; that is, there are two adjustments for tuning and that is all, once the rheostats and neutralizing condenser have been regulated. The set can be tuned quickly, for it requires only two hands, and there are no auxiliary controls to play with and which will cause the set to howl by throwing it into oscillation. Therefore, the set is not open to criticism for bad manners, either by the operator or his next-door neighbor, who resents so strongly the presence of sets which are tuned by putting the set into oscillation in order to pick up squeals. The system of audio frequency amplification is equal to any other, and made doubly satisfactory because distortion cannot be introduced by putting the circuit into the unstable condition which is encountered just under the point of oscillation. The current consumption is extremely low, so that good B batteries will give such long life that no one can complain of expense or dissatisfaction from that source. The construction is rugged and permanent, precluding the development of loose parts and broken connections. The range is sufficient to bring in, at full volume, any broadcasting that can be received without distortion on a super-sensitive receiver.

Innovations Introduced

The experimenters will quickly recognize a number of innovations. The non-regenerative circuit, developed by "Radio Engineering," is a conclusive demonstra-

tion of the fact that sensitiveness, sharpness, and quality are not confined to sets using regeneration control in one form or another. The National S. L. F. condensers, running over a compass of 270 degrees, are brand new, as are the National impedaformers which contain the chokes and stopping condensers, and mountings for the grid leaks. The Eiectrad rheostats, switch, and phone jack are just being put on the market, the Walbert neutralizing condenser is an innovation, and such mechanical features as the arrangement of the amplifying units and the pin-jack panel for voltage readings are shown for the first time.

Of special importance is the introduction of the new Donle detector tube. Harold P. Donle, formerly chief engineer of the Connecticut Telephone and Electric Company and inventor of the Sodian detector, the most sensitive type which has ever been made, is now producing the Donle detector tube. This tube operates on a principle recently discovered by Mr. Donle, and in a recent series of tests demonstrated a degree of sensitiveness which has not been approached previously by any other tube. The electrical characteristics are somewhat similar to the D-21 Sodian. It does not require a potentiometer; it can be operated without grid-leak or grid condenser, and the plate impedance is very high. With $2\frac{1}{2}$ volts,

the plate current is only 0.1 milliamperes. The filament takes 0.25 ampere at 5 volts.

The sensitiveness of the detector is not only important in DX reception, but it has a marked effect upon the quality. When a fairly high minimum voltage must be applied to the detector to make it function, it is obvious that a part of the received speech must be lost. Increasing the sensitiveness of the detector reduces the amount of modulation which does not go into the AF amplifier.

Description of Set

In the description of the KB-8 receiver, the various units and features have been subdivided so as to make them as understandable as possible. This is a most satisfactory way, since the unusual features of this set can be best explained by discussing them individually. This set is entirely unlike any other that has been shown and the features are well worth careful consideration.

As to the actual construction details, blue prints are available which give the panel patterns and picture wiring diagram in full size, step-by-step assembly instructions with explanatory notes, terminal checking list by which the possibility of wrong or omitted connections is obviated, and a complete list of the parts used in

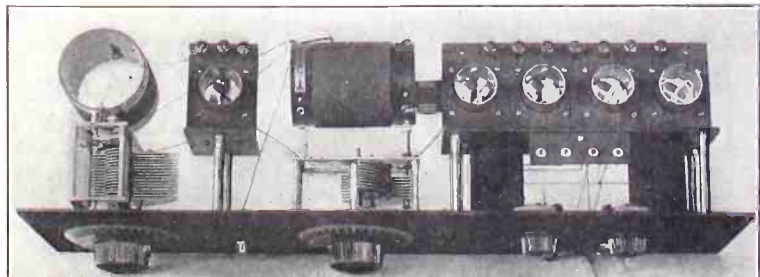

Looking down at the completed receiver. Note the neat outlay of parts. The two National Impedaformers may be seen at the right between the panel and sockets.

High-Class Audio Used

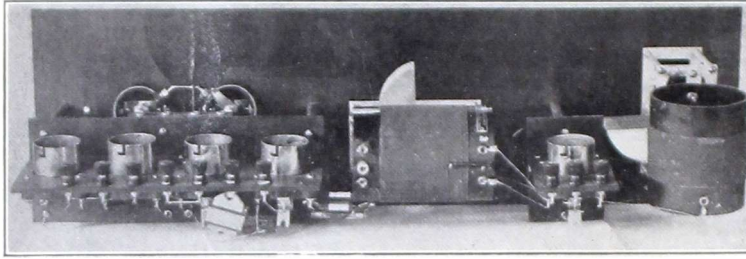

REAR VIEW of the completed receiver.

the original set, as well as the electrical constants.

In the circuit of the RF amplifier there is the left-hand tuning unit, looking at the set from the front, RF tube panel, and neutralizing condenser.

The coil is identical in dimensions to that which has been furnished in the standard Browning-Drake units of the National Company, but the .0005 mfd. variable condenser is of SLF design, turning through 270 degrees. A Velvet vernier is employed, with a dial having 150 graduations. This gives an effective reduction ratio of 4 to 1.

Two panel support pillars, $3\frac{3}{8}$ " long by $\frac{3}{8}$ " in diameter, carry a vertical panel $2\frac{1}{2} \times 3\frac{1}{2}$ ", $3/16$ " thick, to which another panel, of the same size, is secured with 1" angle brackets. An AmSCO socket is mounted under the horizontal panel. Instead of fastening the socket with two screws, as was originally intended, the socket is held to the panel by $\frac{5}{8}$ " 6-32 round head screws running through the panel, socket base, and into Lastites. The clips were taken from a single grid leak mounting, and fastened to the socket through the regular mounting holes. The clips are held by $\frac{1}{2}$ " 6-32 round head screws threaded into Lastites. This provides a convenient mounting for the 6V-199 Amperite.

If a UX199 tube is used for the RF amplifier, the Amperite, which is in series with the 30-ohm rheostat, makes it impossible to burn out the tube by turning the rheostat too far. The UX tube can be fitted into the socket with a Pacent Isolantite adapter. On the other hand, some persons prefer the UV201A for an RF tube. In that case, the Amperite terminals must be short circuited. Then the rheostat gives the usual filament control.

High Amplification

A Walbert neutralizing condenser is mounted between the pillars which hold

the RF tube panel. This is a very convenient type of neutralizing condenser, for it can be adjusted from the front of the panel. However, since the adjusting screw is covered by a cap nut, there is no tendency to play with it, as is the case with types having a regulating knob. No change has been made in the inductance for the detector circuit. The standard regenerative coil is employed, but the tickler is omitted, and a .00025 SLF condenser substituted for the SLC or SLW types previously used.

It has been observed by some engineers that it is difficult to build a non-regenerative RF transformer which, without regeneration, gives a high degree of amplification over the entire broadcast range. Tests on the Browning-Drake transformer



THE PANEL VIEW of the KB-8.

show that the loss at high wavelengths is practically negligible. This is due to the design of the coils and the method of winding and placing the primary.

In other words, regeneration increases the signal strength over the whole wavelength range. However, the design of this set is such that, even with a 201A tube for a detector, a very high degree of sensitivity is obtained. Using the Donle detector tube, the set showed a response equal to that of the Browning-Drake re-

ceiver equipped with a tickler. Instead of using transformer or impedance coupling after the detector, the coupling for the first stage is resistance. Results shown by hundreds of reports from RX-1 owners confirmed my judgment in deciding upon resistance for the first stage. Moreover, because of the high impedance of the Donle tube, greater amplification may be obtained in the first stage with resistance than with either transformer or impedance coupling.

The 0.1 mfd. stopping condenser is fastened between the resistances on to the vertical panel. The clips were taken from two single resistor mountings, and fastened to the regular mounting holes of the sockets just as the clips for the Amperite were put in place.

The Audio Amplifier

The two stages of impedance amplification are connected in the conventional manner, although the combination of impedance or transformer amplification following a first stage of resistance coupling, first shown in the RX-1 receiver, was originated by "Radio Engineering." (The RX-1 was described in the October 17 issue of RADIO WORLD.)

The impedafomers are fastened to the vertical panel. The outer mounting screws at the top, looking at the set from the front, also hold the angle brackets which fasten the horizontal panel to the vertical panel. This detail is explained in the blue prints. The amplifier unit can be entirely assembled and almost completely wired before it is put on the front panel.

(Continued next week)

500-Mile Day Range Claimed for Super-Power

The report of the Radio Corporation of America for 1925, just issued, says on the subject of super-power:

"To render an improved service to the public and to transmit the entertainment and educational influences developed in the great centers of population, particularly to homes distant from local broadcasting stations, an experimental high-power broadcasting station (WJZ) was established at Bound Brook, New Jersey, which is about twenty-five miles from New York City. It has a maximum power one hundred times greater than that heretofore used by stations WJZ, WJY and WRC. Experimental tests have shown that this high-power station will give im-

proved service to New York and its suburbs and good service during daylight hours to points within a radius of 500 miles. During the hours of darkness it has been heard in all parts of the United States and at many outside points. It is expected to furnish a reliable night broadcasting service to all points in the United States east of the Mississippi River."

With regard to the comments concerning the operation of this station the report says: "The experimental operation of the new high-power broadcasting station at Bound Brook resulted in favorable comments from radio listeners in many places in the United States and other parts of the world."

LIST OF PARTS

- One B-D SLF antenna unit (National).
- One B-D SLF RF unit (National).
- Two Impedafomers (National).
- One 5-megohm resistor (Daven).
- One 1-megohm resistor (Daven).
- Three 1-megohm resistors (Daven).
- One .00025 mfd. fixed condenser (Dubilier 648-G).
- One .001 mfd. fixed condenser (Dubilier 648).
- One .1 mfd. fixed condenser (Dubilier 656).
- One balancing condenser (Walbert).
- One ballast resistor (Radiall Amperite, 6V-199).
- Two 30-ohm rheostats (Electrad).
- One filament switch (Electrad).
- One open circuit jack (Electrad).
- Five sockets (AmSCO No. 100).
- Three resistor mountings (Daven, No. 50).
- One $7 \times 2 \times 3/16$ " panel (Celoron-Bakelite).
- Two $3\frac{1}{2} \times 2\frac{1}{2} \times 3/16$ " panels (Celoron-Bakelite).
- Two $3\frac{1}{2} \times 2\frac{1}{2} \times 3/16$ " panels (Celoron-Bakelite).
- Ten engraved binding posts (Eby).

Accessories: Three feet, 4-21-40-RF copper cable; one length No. 7 varnished tubing; forty feet Writ (2 coils); fifty 6-32 Lastites; six Durant terminal pillar supports; ten $\frac{1}{2}$ " 6-32 FH lacquered screws; thirty $\frac{3}{8}$ " 6-32 RH nickelled screws; six $\frac{1}{2}$ " 6-32 RH nickelled screws; twenty $\frac{5}{8}$ " 6-32 RH nickelled screws; twenty $\frac{3}{4}$ " 6-32 .041 nickelled nuts; ten Durant soldering lugs.

The Tube vs. the Crystal

Author Makes Comparative Tests of Rectification and Announces Decision Whether the Mineral Affords Greater Purity Than the Bulb

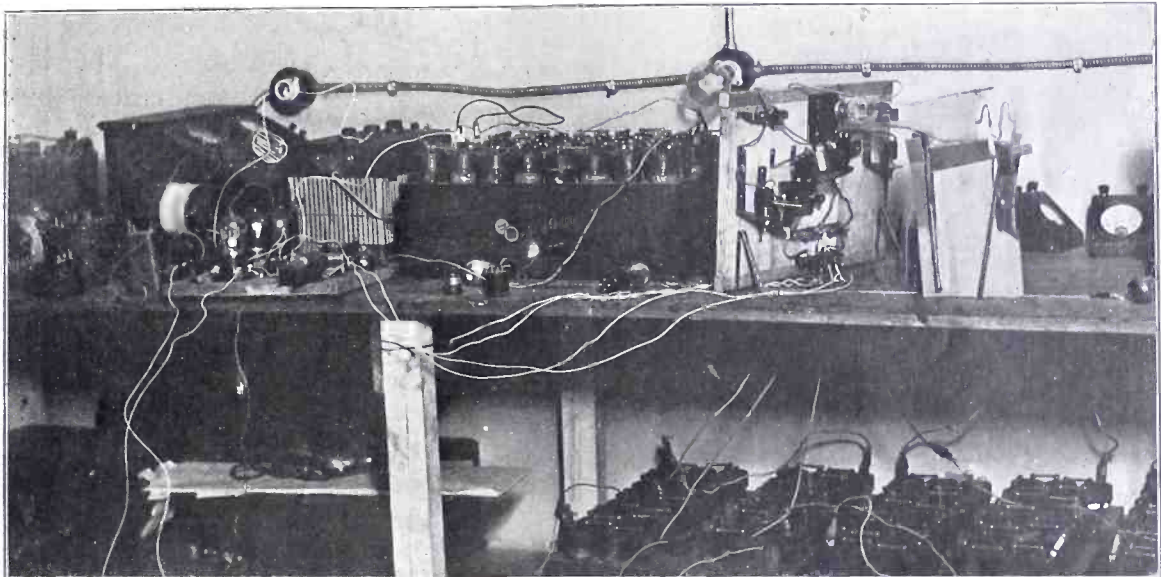

FIG. 2.

The complete layout of the test apparatus. The modulated radio frequency oscillator is at left, with the coil in view at the side nearer you. The test circuit is located by the three tubes in a row. To the right of the shelf batteries is the oscillograph, with a wave form showing on the screen. (Foto Topics.)

[The purity of crystal rectification as compared with tube rectification, considering only the wave form, has been taken for granted by many fans. The author, however, decided to make an investigation on his own account. He used a cathode ray oscillograph tube, whereby it is possible to see the audio wave, indeed even represent it at a standstill. The results of his interesting work are set forth in the following article.]

of the consideration that whenever the tube is replaced with a crystal, the rectifying unit is usually preceded by one or two stages of radio frequency amplification, thus being without selectivity jurisdiction.

Comparison of Wave Forms

The comparison of quality output can best be carried out by one method only,

and this method is the comparison of the wave forms of the input at the broadcasting station and the output of the rectifier as it would be passed into the phones of the loud speaker, the output of course taking place at the receiving end. This system no doubt appears far-fetched, in that it would seem impossible to obtain the wave form curves of the input signal at the broadcasting station. In test work,

By John F. Rider

Member, Institute of Radio Engineers

IS crystal rectification better than tube rectification?

So that the comparison between the two be properly comprehended, it is imperative to arrive at a fundamental basis relative to the prime requisite of the rectifying element. To be exact there are several requirements which must be fulfilled. First, the rectifying element must be sensitive and responsive to weak impulses. Second, the rectified signal must be a faithful reproduction of the original signal generated at the broadcasting station, assuming that our concern is solely with transmission and reception of broadcast speech and music. Third, extraneous noises other than those due to the desired signal must be as little as possible.

Of the above three, faithful reproduction is the major item, as perfect quality is one of the two essentials of every radio receiver. The other, selectivity, is beyond the discussion at this time, although a crystal rectifier manifests an effect upon selectivity. However, the discussion of the selectivity factor is omitted because

First Super-Heterodyne Is Still Doing Its Bit

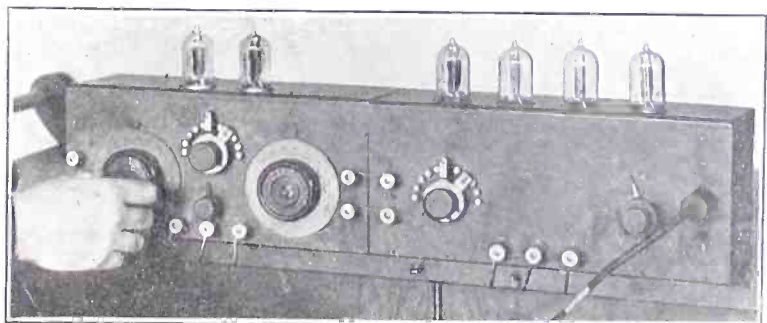

THE original Super-Heterodyne, invented and built by Major E. H. Armstrong, U. S. Signal Corps, in the Signal Corps Research Laboratory at Paris, during the World War, is still being used in Washington. The set is the forerunner of the present Super-Heterodyne receiver and is now in the historical collection in the office of the Chief Signal Officer, U. S. Army. (Harris & Ewing).

Audio Waves Made Visible

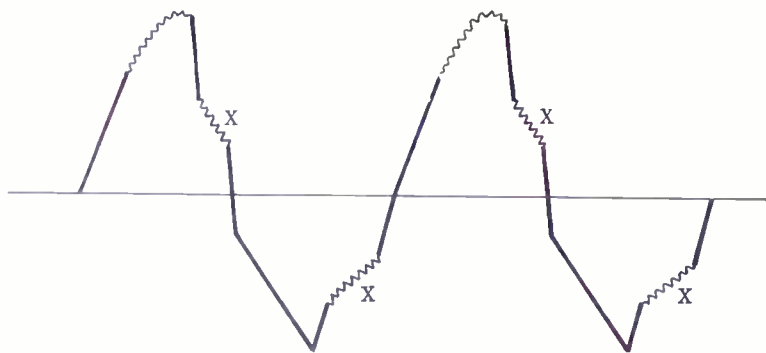

FIG. 1.

Wave form of a note produced by an audio frequency amplifier. The peaks and depressions at X are those that will vary if the same note, say middle C, is played on a piano or banjo, and must be watched to determine the tonal characteristics. Of course the frequency is not altered by any tone characteristic change.

however, it is possible to utilize a unit known as a modulated oscillator, to replace the outside broadcasting station, and the wave forms of the modulated signal can be ascertained easily. The system of comparing wave forms is therefore entirely feasible; in fact its application to the regular tests conducted upon the various types of audio-frequency amplifiers would show up defects entirely lost in methods more frequently employed.

If we look into this matter a little deeper we will find that the loud speaker must set the air into corresponding periods of vibration, as does the voice of the speaker or the singer at the transmitter. Hence it is essential that during the progress of transmission, reception, rectification and amplification, the original voice wave form with all its little complexities or variations be retained. Otherwise the voice becomes unrecognizable, since through the loss of the small variations the distinguishing characteristics are lost. Not that the words become incoherent or the voice unintelligible, but rather that the features which permit one to distinguish between the voices of two different persons are lost. In substance, these minor but important variations comprise the characteristics of the voice, even as the dimples, ridges and depressions upon a person's face constitutes the distinguishing features between different faces.

The Author's Answer

Therefore, will a crystal rectifier, used in place of a tube in a non-regenerative circuit, with the associated equipment identical in both instances, retain these small variations of the voice wave form

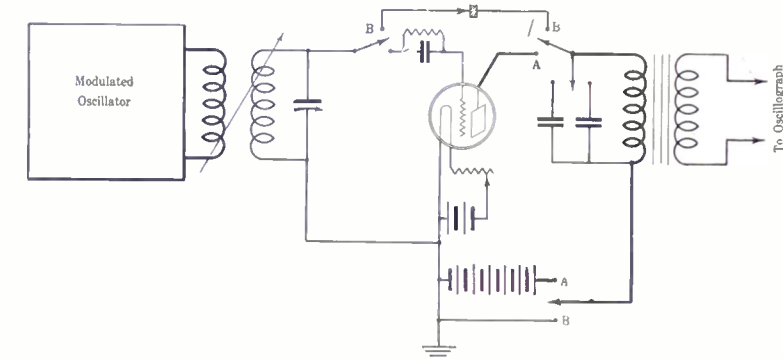

FIG. 3.

Wiring diagram of the test circuit. Note how the tube rectifier is replaced by a crystal by throwing a switch.

to a greater degree than the vacuum tube? The regenerative detector is deliberately omitted because a crystal is very seldom, if ever, used to replace a regenerative detector.

The crystal detector does not afford better quality output than the tube detector, utilized in a non-regenerative circuit and in the normal manner. Insofar as the small distinguishing variations in the wave form are concerned, the non-regenerative detector retains them as well as the crystal detector. A distinction is necessary between the accuracy of the wave form and extraneous noises. Very erroneously fans have considered the superiority of the crystal as general, simply because it was quieter in opera-

tion. The reason for this action will be dealt with later. At this time the quieter operation of the crystal is beyond the point.

Ear a Poor Guide

Because of the deficiency of the ear with respect to very slight variations in tone, the comparison of the crystal and middle C on a piano and the middle C on a banjo. Remove these peaks, and, while the frequency has not been altered, the tonal characteristics have changed.

Since the test by ear is unsatisfactory,

why not utilize equipment whereby it is possible to observe visually the actual electrical wave form of the audio signal prior to its being transformed into sound waves via the loud speaker? The equipment suitable for this work is the Cathode Ray Oscillograph tube, operated in conjunction with other associated equipment. A photograph of the complete layout is shown in Fig. 2. By the action of the cathode ray tube there is cast upon its fluorescent screen an image of the electrical potential constituting what later develops to be the sound wave emitted from the loud speaker. The speed at which this image traverses the screen is entirely within the operator's control, and by means of certain adjustments the moving image can be stopped and a close study of the wave form made. Consequently a close study of all forms of electrical potentials can be effected, including the outputs of tube or crystal rectifiers. This is the equipment utilized in making the various determinations mentioned in the text.

Switches Facilitate

The complete circuit layout is shown in Fig. 3. By means of the various switches in the test circuit, the tube rectifier can be instantly removed and replaced with the crystal. The input and output circuits remain constant, the same units being utilized in both tests. The coupling between the oscillator and the pick-up coil of the test circuit is variable, thus permitting of the signal pick-up and voltage output variation, facilitating the observation of the wave forms upon the screen.

Keep the Aerial's Period Below Broadcast Range

Quite a few instances have been found where fans utilize very long aerials, a decrease in signal intensity is noticed on some stations and an increase on others, after the insertion of a series condenser. This is due to the extremely high fundamental prior to the insertion of the series condenser and the reduction to a value approximating the wavelengths of the stations received with increased intensity. It should be remembered that the resonance phenomenon is equal on

both sides of the resonance point. With a unit input, practically the same decrease is noted when the incoming signal is on a wavelength and equal distance above or below the fundamental. Thus with a long aerial increased selectivity may be obtained on certain wavelengths and decreased selectivity on others. To safeguard against this, the fundamental of the aerial should always be less than the lowest wavelength covered by the tuning circuits of the receiver.

The Effect of Grid Leaks

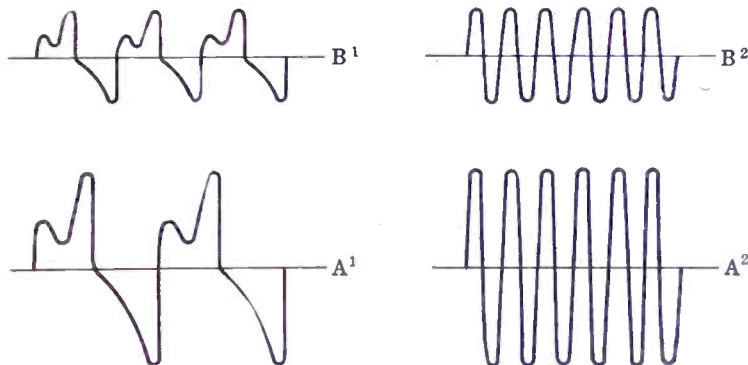

FIG. 4.

Two different frequencies (pair at left and pair at right). A1 and A2 represent tube output, compared with crystal output, B1 and B2. While the amplitude differs considerably—that is, the height of the wave form—the wave form itself undergoes no change, the author found.

Reading from left to right, we have the modulated radio frequency oscillator, the tests circuit and the oscillograph. (Fig. 2).

No doubt some will claim that the operating characteristics of the audio-frequency transformer will show an effect upon the wave form; also that its effect will vary when used with the tube and then with the crystal. Granted. What of it? Its effects cannot be different under these conditions than they would be if the oscillograph were replaced by another amplifying tube and the complete test circuit contained within a receiver operating in the normal manner. Whatever effect the transformer will show upon the wave form when the tube is used will be shown when the crystal is used. At least such is the operating condition in actual practice, therefore we must make our determinations under the same conditions. And the remark that the crystal affords better quality than the tube assumes perfect operation of the transformer. Hence the choice of the transformer need not be special, since the comparison between the two outputs can be considered as indicative of the operating characteristics of the two types of rectifiers.

Amplitudes Differ

Assuming the same wave form input and perfect rectification, the same output wave form will be seen. That the amplitudes will differ is logical, but the change in amplitude bears no relation to the change in wave form. The amplitude may vary in any proportion, but an analysis of the wave forms will show them to be identical in shape.

Accordingly, various signals generated by a local audio oscillator were used to modulate a radio frequency oscillator and the modulated radio frequency wave was fed into the input circuit of the rectifier combination, and observations of the output voltage wave form made upon the oscillograph screen. The modulated waves varied from practically a sine wave of 1,000 cycles to complex waves of as low as 60 cycles. The images as depicted upon the oscillograph screen are shown in Fig. 4 and designated by the letter A for the tube output and letter B for the crystal output. The amplitude proportions are not directly in proportion to the relative degrees of rectifying efficiency of the tube and crystal, the tube amplitude being normally much greater than the crystal's. There is very little difference in the actual wave form. Due to the variance in amplitude an optical illusion of variance in shape is unavoidable.

able. However, a plot of each of the curves of similar cross sectional paper will show them to be uniform and identical.

Source of Confusion

A test of the two outputs by means of the ear shows up the variance in amplitude, but there is ever present the possibility of confusing tone with volume. A weaker signal will sound different than a stronger signal. The truth in this statement was illustrated during the test. Three separate individuals were certain that the tone of the signal emitted when the crystal rectifier was used differed from that when the tube was used. Only one person thought the two alike and he was borne out by the oscillograph. Hence from the angle of quality output, or faithful reproduction, the superiority of the crystal over the tube fails; it is not present.

We have not considered the effect of the decrement of the circuit upon the resonance curve of the input circuit to the rectifier, an item of great importance in regenerative detector circuits, since in these circuits by virtue of the regeneration the decrement of the circuit is lowered to the point where the resonance curve becomes so narrow at the base that some of the side bands of the transmitted modulated carrier are cut off. With a portion of the side bands missing, the rectified reproduction cannot be perfect. But this regenerative condition is not existent in either of the circuits under discussion, and while no doubt the decrement of the tube combination is less than that of the crystal combination, and would tend to cause a resonance curve with a narrower base, the curve of the non-regenerative system is at all times sufficiently broad to cover the full side bands. And since nothing is gained by having the base any broader than is

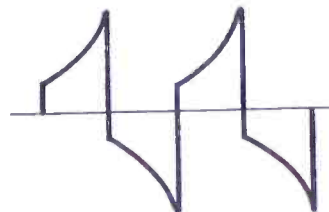

FIG. 5.

The same frequency as plotted in Fig. 4A1 is shown in the above graph, which was made with the grid leak omitted. This denotes decided distortion.

necessary to cover all side bands, the additional breadth of the crystal combination is of no material advantage.

Low-Frequency Discrepancy

Relative to the comparison of the original audio wave used to modulate the radio frequency oscillator, and the output of the rectifier system, similarity was noticeable only on the 1,000-cycle note. The original wave form and that of the rectified signal were practically identical. On the lower frequencies, however, there existed a marked discrepancy, due no doubt to two causes far removed from the rectifier. These were first, incorrect modulation of the radio frequency wave, and second, the amplifying characteristics of the modulation transformer used. This transformer was not of the modern type, being designed primarily for speech transmission, hence its peak operation was at 1,000 cycles. But the divergence from the original wave form is not of great consequence in respect to the rectifying actions of the two types of rectifiers. The similarity between the two output signals is the important factor, since the distorted radio frequency wave arrived at the receiver in the same form for both types of rectifiers. And if the output curves are similar, the rectification must surely be similar.

As to the adjustment of the tube rectifying system to its best point of operation it was found that during the tests, that is for the signal intensities encountered, no radical change in wave form was noticed with grid leaks varying in resistance from 1 to 5 megohms. But the omission of the leak did cause quite a change, resulting in the loss of one of the distinguishing characteristics, as shown by a comparison of the form in Fig. 5 with that shown as A1 in Fig. 4.

Tube Superior

Concerning the relative amplitudes of the crystal rectifier output and the tube rectifier output, much need not be said. The superiority of the tube is far beyond dispute. If there are any radio fans who have been convinced by word of mouth that a crystal rectifier will afford an

(Concluded on page 21)

Resistance Is Like Friction In Piping

A pipe, through which water flows, always has some friction which hinders to some extent, the flow of the water. Were it not for this friction the water would increase in speed beyond means of control. The same thing takes place in an electrical circuit. This is known as the

resistance of the circuit. The greater the resistance the smaller the current which can be produced in the circuit by a battery. In other words, an external resistance at any point in the circuit is equal to a partly closed valve in a pipe at any stated point.

The Tectron Eliminator

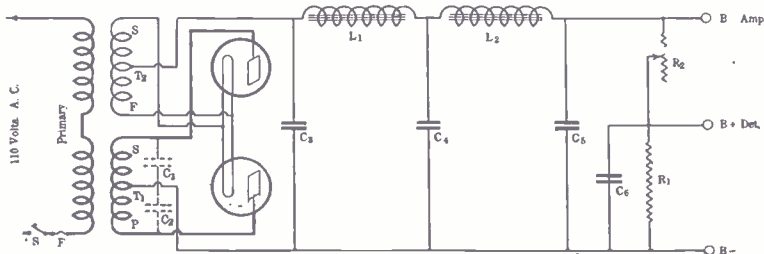

FIG. 1, showing the schematic diagram of the eliminator. T1 is the plate tap, while T2 is the filament tap.

By Lewis Winner

Associate, Institute of Radio Engineers

PART I

UP to the present three specific types of B battery eliminators have been discussed by me in RADIO WORLD. (1)—The Rex B Battery Eliminator, employing a single tube, rectifying one side of the AC line. (2)—The Chemical B Eliminator, employing chemical cells for rectifying both sides of the AC line. (3)—The Raytheon Power Unit, employing a gaseous tube, rectifying both sides of the AC line (Dec. 12, 19, 26, Jan. 2 and 16 issues). An eliminator employing two tubes, rectifying both sides of the AC line, will be discussed in this issue. This is the Tectron, named after the rectifier tube employed. The electrical schematic diagram of this eliminator is shown in Fig. 1. It will be noted by a glance at the photos and diagrams that there is no difficulty attached to the construction.

In the Rex Eliminator the filtering system employed was quite bulky, although efficient. In the present eliminator, due to the rectification of both sides of the line, the filtering system becomes quite simple and therefore less bulky. In the Rex Eliminator the hum could be done away with, but it required careful tuning by the operator of the receiver as well as careful adjustment of the variable resistances, in both the filament and plate circuits. Although in the present eliminator careful adjustment is required, the action is very simple and requires very little time. No adjustment is used in the filament circuit, the tube being so made that its greatest point of operating efficiency is when 5 volts are applied to heat the filament, at which voltage one ampere is drawn. In other words, if you install a variable resistor in series with the filaments of both tubes, in series and shunt with which are a voltmeter and an ammeter, you will note that by adjusting the resistances until you come to the stated wattage, the efficiency of tube will be nil. There is very little heat produced by the tube, which accounts for the common shape of the glass surrounding the elements. A word about these elements. The filament is quite heavy and will stand up under knocking around as well as surges. That is, a sudden increase in the line voltage, increasing the filament voltage to 6 or 6.5, will not blow out the tube. Of course, the efficiency of the tube at this point will be decreased. The plate is very large, accounting for the great amount of current that may be passed. The maximum output current rating of this tube, according to laboratory tests, was 30 milliamperes at no load. This means that if two tubes are used here, as much as 60 milliamperes can be obtained. At 125 volts on full load from a 6-tube set the tube passed 50 milliamperes. At no load,

that is when it is not being used in a receiver, as much as 150 volts at the first stated current rate was obtained. The high voltage secondary supplies 220 volts to the plate of the tubes. However, the plate is so constructed that it will stand as much as 290 volts without a breakdown. This, therefore, takes care of a possible surge.

Now as to the choke coils and the step-up transformer. Instead of there being 60 henries, as in the Rex, only choke coils of 30 henries are employed. The shell type core was used in the construction of the chokes in the laboratory model. However, the laminated closed type core can be used. With the shell type core, the choke consists of 5,800 turns of No. 32 enameled wire. There are 80 laminations necessary to make up the core. Using the closed type core, the choke consists of 6,850 turns, employing No. 32 enameled wire. Here 120 laminations are employed. In the shell type core there is a normal gap of .005". In the closed type core, a gap of .005" is made by inserting a piece of paper between the laminations. Now as to the transformer. The primary consists of 920 turns of No. 26 enameled wire. The secondary, PS, consists of 3,680 turns, tapped at the 1,840th turn, using No. 31 enameled wire. This, of course, is the high tension or the plate voltage secondary. The secondary, FS, consists of 50 turns, tapped at the 25th turn, using No. 18 enameled wire. This is the secondary, which applies the voltage to the filaments. The primary is first wound, the plate voltage secondary over this and the filament secondary over this winding.

The condensers C3, C4 and C5 are obtained in one unit. C3 is a 3 mfd. fixed condenser. C4 is a 2 mfd. fixed condenser and C5 is a 6 mfd. fixed condenser. If the unit is not used, then C3 should be a 4 mfd. fixed condenser and C5 a 8 mfd.

LIST OF PARTS

- One AC 220-volt step-up transformer (Shore).
- Two 30-henry choke coils, L1L2 (Shore).
- Two .5 mfd. fixed condensers, C1 C2 (Aerovox).
- One .5 or 1 mfd. fixed condenser, C6 (Aerovox).
- One condenser unit; one 3 mfd. fixed condenser, C3; one 2 mfd. fixed condenser, C4; one 6 mfd. fixed condenser, C5 (Aerovox).
- One variable resistor, R2 (American Mechanical Laboratories).
- One 10,000 ohm fixed resistor, R1 (Aerovox).
- Two rectifying tubes (Tectron).
- Two sockets, standard base.
- One socket for input voltage.
- One switch, S.
- One panel.
- One 25.0 ampere, 110 volt AC fuse, F.
- One socket for holding fuse.
- Accessories: Lamp cord, aluminum brackets, screws, nuts, cabinet, flexible wire, binding posts, insulating strips, etc.

fixed condenser. C6 is a 1 or a .5 mfd. fixed condenser. C1 and C2, both of which are optional, are of the .5 mfd. variety. In both these optional cases it is well to purchase the condensers to try them in the circuit as different lines require a slight increase or decrease in the capacity of the filter to obtain the correct filtering action.

R2 is a variable resistor, zero to five megohms, and is used to control the voltage flowing in the plate circuit of the detector tube. R1 is a 10,000-ohm fixed resistor, used for bypassing action.

Placing the Parts

The parts, as in the Raytheon Power Unit, are laid out on a metal baseboard. You will note by looking at Fig. 2 that a special cut baseboard was used, so that it could be placed in a cabinet, the photo of which will be shown next week. That is also the reason for bending over of the variable resistor, which is to be mounted on a panel. The design for mounting these parts, with the various positions designated, is shown in Fig. 3. The condensers are enclosed in one metal box, with the terminals coming from one end. This is placed in the center. Over this is placed a strip of aluminum, on which the sockets are mounted. The step-up transformer is placed to the right of the condenser bank. The socket for the input

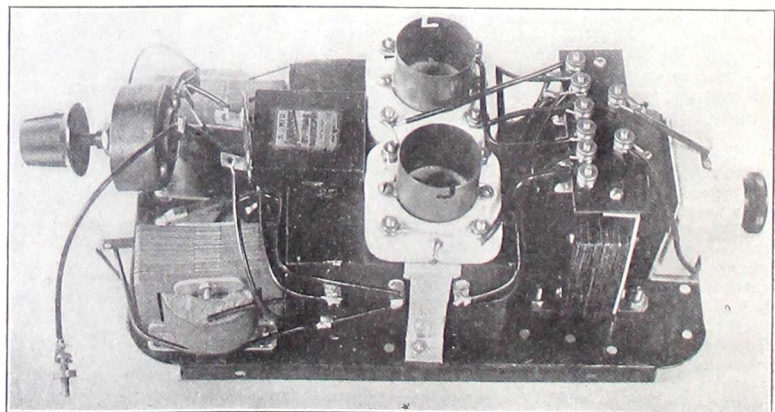

FIG. 2, looking down on the eliminator. Here a clear view of the layout of parts is seen.

Wiring the Power Unit

voltage is also mounted on an aluminum bracket and at the furthest right-hand point. The choke coils are at the extreme left-hand sides, with the variable resistor in the center. The fixed resistor (Fig. 4) is underneath the variable resistor and is first mounted on a piece of insulating material, to prevent any possible shorting. Now you will note that there is still room for a switch or fuse socket. Move the input voltage socket over to the right or near the right-hand edge, placing the fuse socket near the left-hand edge. The switch can be mounted on an angle bracket made of aluminum right over or in between the two sockets. These extra insertions will be shown next week in picture diagram form. When mounting the sockets over the condenser bank, make sure that there is at least $\frac{1}{4}$ " space between the condenser bank and the bottom of the socket. This is to prevent any possible softening up of the paraffin holding the condenser together, occurring from the small heat delivered by the tube.

Wiring the Eliminator

The wiring or hooking up is done with the aid of flexible wire of either the No. 18 annunciator or Celatsite type. Be sure that the wire is well insulated. If you are using bare wire, place spaghetti over it. Solder all connections, where lugs are present, as on the condenser bank, choke coils, etc.

Bring one terminal of the primary winding of the step-up transformer to a post on the input voltage socket. Bring the other terminal of this winding to one terminal of a fuse. The other terminal of this fuse goes direct to a switch and from the switch to the input voltage socket. The fuse and the switch may be left out, thereby connecting this terminal of the primary winding direct to the post on the input voltage socket. Now bring one end of the secondary winding, P S to the plate post of one of the sockets, while the other end of this same winding goes to the plate post of the other socket. The tapped terminal of this winding goes to the B minus post. The filament secondary is now wired, this being on the top of all the windings. Connect the F plus posts of both sockets together. Connect the F minus posts of both sockets together also. Now connect one end of the winding to the F minus posts, while the other end of this winding goes to the F plus posts of both sockets. The tapped portion of this winding goes to one terminal of L1 the choke coil and C3, which is the 3 mfd. condenser. The wiring of the transformer is now concluded.

Now bring a lead from the B minus post to the other terminal of C3, to one terminal of C4, to one terminal of C5, to one terminal of C6 and to one terminal of R1. The other terminal of C4 goes to the other terminal of L1 and to one terminal of L2. The other terminal of L2 goes to one terminal of C5, to the B plus Amp. terminal and to the resistance portion of the variable resistor. The controlling arm of the resistance goes to the B plus Det. post, to one terminal of C6 and to the left off terminal of R1. This completes the wiring.

The following suggestions should be followed, before the insertion of eliminator in a cabinet, as after the insertion it is a pretty difficult thing to get at the connections if any errors have been made.

First place the tube in the socket, at the same time taking the fuse out, if such be in. Get some lamp cord which is about 10 or 11 feet long.

(Continued next week)

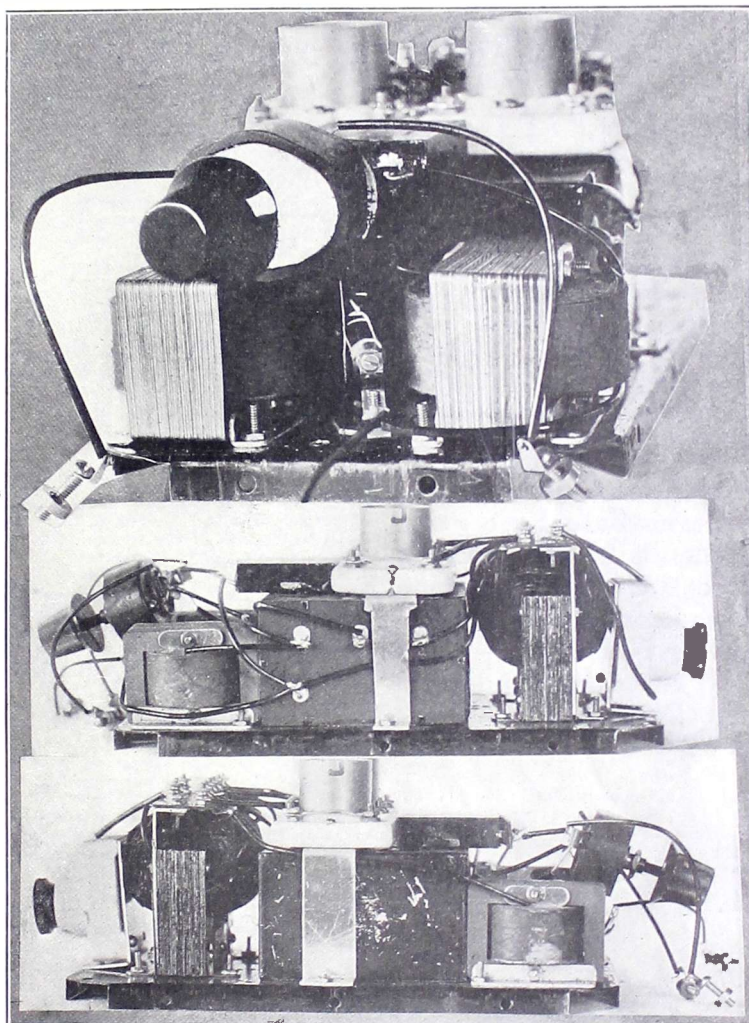

FIG. 4, (top), showing the placement of the fixed resistor, R1, in between the two chokes, L1 and L2. Note the two holes in the angle bend. This may be used for the mounting of the panel. Fig. 5 (center), a side view of the eliminator. Note the terminals of the condenser bank, which is in the center. Fig. 6 (bottom), showing the other side of the eliminator. Note the aluminum bracket, holding the socket.

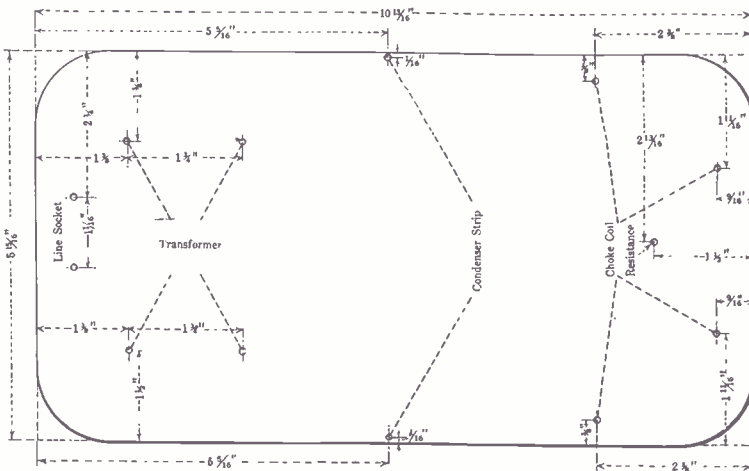
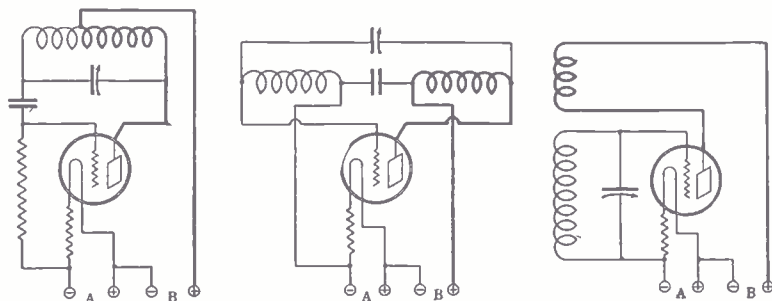

FIG. 3, showing the design for the placing of the parts.

My Experiences with Super-Heterodyne Sets



THE THREE most popular types of oscillators. Figs. 2 and 3 (left to right) may give much body capacity trouble. Fig. 4 is the hookup J. E. Anderson prefers.

$$f = \frac{CF\Delta C}{4C_1C_2} \dots (1)$$

$$f = \frac{F\Delta C}{4\sqrt{C_1C_2}} \dots (2)$$

$$f = \frac{F\Delta D}{4\sqrt{(D_0+D_1)(D_0+D_2)}} \dots (3)$$

THE THREE EXPRESSIONS for determining the intermediate frequency.

Problem of Choosing Best Intermediate Frequency Depends Much on One's Location—The Solution Lies in Abating the Harmonic Nuisance — Ways of Preventing Radiation Are Discussed.

[J. E. Anderson, noted radio engineer, is one of the recognized authorities on the Super-Heterodyne. For several years he has specialized on this type of receiver. The following is Part I of a two-part article in which he points the way to the solution of many Super-Heterodyne problems. Part II will be published next week.]

By J. E. Anderson
Consulting Engineer

THE Super-Heterodyne receiver is a fickle affair. Normal experience with it, I believe, is a preponderance of disappointments over successes. In theory the circuit is the paragon of sensitivity, selectivity, and "ritziness"; in practice it is altogether too often a conglomeration of squeals, howls, mush, interference, silence, and in general, all things which it is supposed not to be. Despite the fickleness of various circuits of the type it is decidedly worth while to woo the prin-

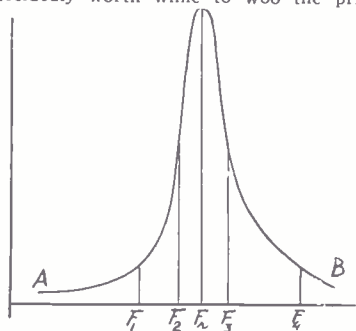

FIG. 1, conditions for overloading and explaining the silent space on dial where signal should come in loudest.

ciple of the Super-Heterodyne because of its inherent possibilities. A good Super which has been carefully designed and built, stabilized, and cured of its many ills is worthy of all the superlatives with which it is usually associated. But a Super-Heterodyne cannot be built merely by assembling all the ingredients as given in some list of parts, dumping all of them into a box, and shaking it thoroughly. The chances that they will arrange themselves into a Super-Heterodyne are against success.

Abundance of Reports

Ever since I published my first description of a Super-Heterodyne a few years ago, fans have bombarded me with questions regarding the fickleness of this type of receiver. In one letter a fan gives an imposing list of remote stations picked up and is enthusiastic over his "best ever" set. The next letter from the same fan is an S O S. Some other fan sends in his distress call first and then follows it up with one indicative of hope. One fan says he can get European and trans-continental stations "any time he wants them," while another fan, working with supposedly the same hook-up, condemns the super-heterodyne as no good because he can't get anything but squeals. Fans are prolific questioners, and some of their questions are real problems. In the following I shall endeavor to include and answer, in my way, some of the more frequent questions asked.

Let us start with the question: Which is the best intermediate frequency?

The available frequencies for the intermediate amplifier may be arbitrarily taken as between 30 and 75 kilocycles. Points in favor of low intermediate frequencies are greater amplification per stage, greater stability of amplifier, higher selectivity. Points against them are: the set will be critical to tune; it may be too selective for good quality, a serious fault; it will be difficult to make the oscillator and the other radio frequency tuned circuits independent, and if they are not independent the set will not work at all. Points favoring the higher frequencies are that smaller coils will be required and that regeneration may be employed to better advantage. Against the higher frequencies are lower selectivity and less stability. Another point is that the two points at which a given station comes in on the oscillator dial are so far apart as to crowd one of them off the dial for most of the stations it is desired to tune in.

The choice of intermediate frequency

depends some what on local conditions. It is a question of minimizing cross talk of secondary order. This calls for an explanation. Suppose that the intermediate frequency of the super amplifier is 45 kc. Further suppose that there are two broadcasting stations operating within range of the receiver on the frequencies of 570 and 660 kc. Now if the oscillator is set at 615 kc, the 570 kc station is brought in, because 570 plus 45 equals 615. But this setting of the oscillator will also bring in the 660 kc station, because 660 minus 45 is also 615. Both of the stations will then be heard when the oscillator is set at 615 kc. This type of interference may be called secondary cross talk, and that trouble is one of the most serious defects of the super-heterodyne. It is the cause of a lot of the squealing with which the super is cursed. If it were pure cross talk the case would not be so bad, but that is rarely so. Usually the intermediate frequency is such that the local oscillator is not half way between the two station oscillators, but slightly to one side. Squealing results.

A Tough Problem

It is obvious that it is practically impossible so to choose an intermediate frequency as to eliminate secondary cross talk. Stations are located every 10 kilocycles between 550 kc and 1,500 kc. Hence no matter what frequency is chosen there will be some squealing, and not only will this occur at one of the points on the oscillator dial, but at both, except for those stations which operate near the limits 550 and 1,500 kc. These will only have interference on one. The common 45 kc frequency was chosen with the idea that one which was an odd multiple of 5 would not cause as much interference as on which was an even multiple of 5. The example above was cited to disprove that idea, and it is the actual case of WJZ and WYNC. There are several other pairs of stations in the New York area which will interfere in the same manner on intermediate frequencies around 50 kc.

What to Avoid

A method of finding out what frequencies to avoid in selecting the intermediate frequency is the following. Write down all the stations that may be considered as local and set down their operating frequencies. Take all the possible differences and divide each by two. The resulting numbers are the frequencies not to choose. In congested districts like New York and Chicago practically all fre-

How to Cure Squealing

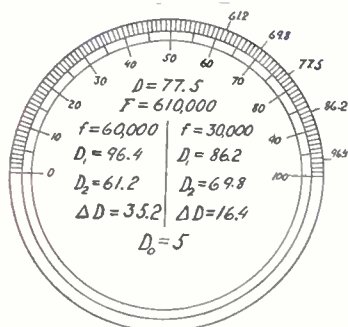

FIG. 5, the determination of the intermediate frequency in a Super-Heterodyne. Signal frequency used was 610 k.c., which comes in at 77.5. For the 30 k.c. IF the side frequencies come in at 86.2 and 69.8. For the 60 k.c. IF the side frequencies come in at 96.4 and 61.2. The delta Ds for these cases are respectively 16.4 and 35.2 divisions. Zero capacity is represented by $D_0 = 5$ divisions. One disadvantage of high IF is illustrated by the wide separation between the two side frequencies, that is, by large value of delta D.

Oscillator Hookups Found to Possess Too Much Body Capacity Effects—Author Shows His Favorite Oscillator Diagram and Votes for Grid Bias Method of Detection.

quencies in the 30-75 kc range are ruled out. And that accounts for the fact that all Super-Heterodynes in congested districts are notorious squealers, because nearly all Supers built for broadcast reception have intermediate frequencies in this range. In regions where there are no local stations, or at most only a few, it may be possible to select a frequency which would avoid this trouble, but then comes the problem of getting the filter for this frequency. Most fans buy their filters, and they have a choice of 30 kc, of 45 kc or of catch-as-catch-can kc. The majority are of the latter type.

Since it is very difficult to eliminate squealing by choosing an appropriate intermediate frequency, some other means must be found whereby the secondary cross talk nuisance may be abated. This will be discussed later in this article.

It is sometimes desirable to know the intermediate frequency of a Super-Heterodyne filter, or of a part of the filter, since this information may be used in adjusting all of the filter transformers to the same frequency. This information is easily obtained either in the completed Super-Heterodyne or in a test circuit set up for that purpose. A formula may easily be developed for finding the frequency in terms of the impressed radio frequency and the capacities in the oscillator circuit when this is set for the impressed frequency and the two side frequencies. The process of development will not be given here, but the formula together with a number of modifications,

is given in the accompanying table of formulas.

Data in Formulas

In this table formula No. 1 gives the intermediate frequency F , in terms of the received radio frequency f , the total capacity C in the oscillator circuit when this is tuned to F , the total capacity C_1 in the oscillator circuit when this is tuned to Ff , the total capacity C_2 in the oscillator circuit when this is tuned to F plus f , and the difference ΔC between C_1 and C_2 . This formula is exact, and the accuracy of a determination of f depends largely upon the accuracy with which ΔC can be determined. Formula No. 1 may be modified slightly for more practical application. The capacity C is not often easy to determine directly in a well filtered super-heterodyne. However, it does not differ very much from the geometric mean between C_1 and C_2 , that is, from the square root of the product of these two. On this assumption formula No. 2 takes the form of formula No. 2. This formula is only approximate but if f/F is less than $1/10$ the error is less than one per cent. Hence it is sufficiently accurate for all practical purposes.

Of course, these two formulas require that a calibrated condenser be used in the oscillating circuit. But such a condenser is rarely available to the Super-Heterodyne owner. Most fans either have a straight line capacity condenser in the circuit or somewhere around. If such condenser be used in the oscillating circuit the dial readings may be substituted for the capacities. Formula No. 3 is a modification of No. 2, using dial readings D instead of capacities. ΔD is the numerical difference between D_1 and D_2 ; D_0 is the zero setting capacity of the circuit expressed in divisions of the dial, and D_1 and D_2 are the dial readings at the two places at which a given signal of frequency F comes in. It must be remembered that No. 3 holds only if the condenser is straight line capacity in fact, if the dial is linearly coupled to the shaft of the condenser, and if the divisions on the dial are all equal. If a condenser having semicircular plates be used with an ordinary dial coupled directly to the shaft, the formula applies well enough. D_0 must be found by trial, and it usually is about five divisions on a 100 division scale.

Directions for No. 3

In applying formula No. 3 no reading should be taken within five divisions of 100, and no short wave stations should be worked with. ΔD cannot be accurately obtained for them and hence the results will not be reliable. It is best to operate between 300 and 550 meters. In this range a determination of f should be made for every available station. The two points should be found accurately and the dial readings should be estimated to a tenth of one division. D_0 may be obtained empirically. It will be noticed that if D_0 be omitted all the values obtained will be too great, and the error will be greater the shorter the wave of the received station. Hence the value obtained for a 300-meter wave will be greater than that obtained from the 550-meter wave. Also if the value of D_0 selected be too small the values of f will be too large, but the difference between the values of the 550 and 300 meter waves will not be so great as if D_0 had been omitted. If the selected value of D_0 be too large, the values of f obtained will be too small, and that obtained for the 300-meter wave will be smaller than that obtained for the 550-meter wave, barring

Difference in Volume of Signals Explained

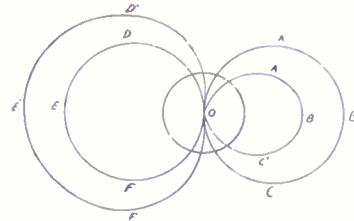

FIG. 6

The drawing shows reason why the signal on one side frequency is louder than that on the other. Circles ABCO and DEFO represent the emf introduced into the modulator circuit from the oscillator by means of the pick-up coil. The small circle in the center represents the emf introduced by capacity coupling between oscillator and modulator. The small loop ABCO represents the effective emf introduced on the side where the inductive and the capacitive couplings oppose, and this loop is the difference between the radii vectors of ABCO and the central circle. The large loop DEFO represents the effective emf introduced into the modulator on that side where the inductive and the capacitive couplings aid, and this loop is the sum of the radii vectors of DEFO and the central circle. When there is no resistance coupling the two values to be taken are OB and OE. If the radius of the central circle is negligible or zero, these two radii vectors are equal, and there is no difference between the signal strengths on the two side frequencies. If the radius of the central circle is equal to the diameter of ABCO, one of the side frequencies will give no signal whatsoever.

errors of determination. A few values of D_0 should be tried until there is neither a tendency for the observed f to increase nor to decrease, that is, until all the observed values of f group themselves about a mean which might occur either at 550 or at 300. Only a few trials need be made, and they may well be 4, 5 and 6 divisions if a 100 degree dial is used. The chief error of this method is that a so-called straight line capacity condenser is not really straight, but is a little wavy. The determination, however, is accurate enough to give a fairly close approximation to the intermediate frequency.

There is only one practical way of minimizing squealing arising from secondary cross talk, and that is by reducing the interfering wave at radio frequency until its effect is negligible. Unfortunately, it does not require very much of the interfering wave to give rise to intolerable squealing. The elimination of it must be thorough. A single radio frequency tuner in the modulator, even if this is a selective loop circuit, is not sufficient. Regeneration in the loop or modulator circuit, if this is independent from the oscillator, will help a good deal, but it is not enough. A radio frequency amplifier with a selective tuned circuit usually is sufficient. This complicates the tuning, and the Super-Heterodyne immediately loses one of its main advantages, simplicity of tuning. But even so it only becomes a three control affair and it is certainly better to put up with that than to have the majority of the stations made unavailable on account of cross talk.

(Concluded next week)

Curing Victoreen Trouble

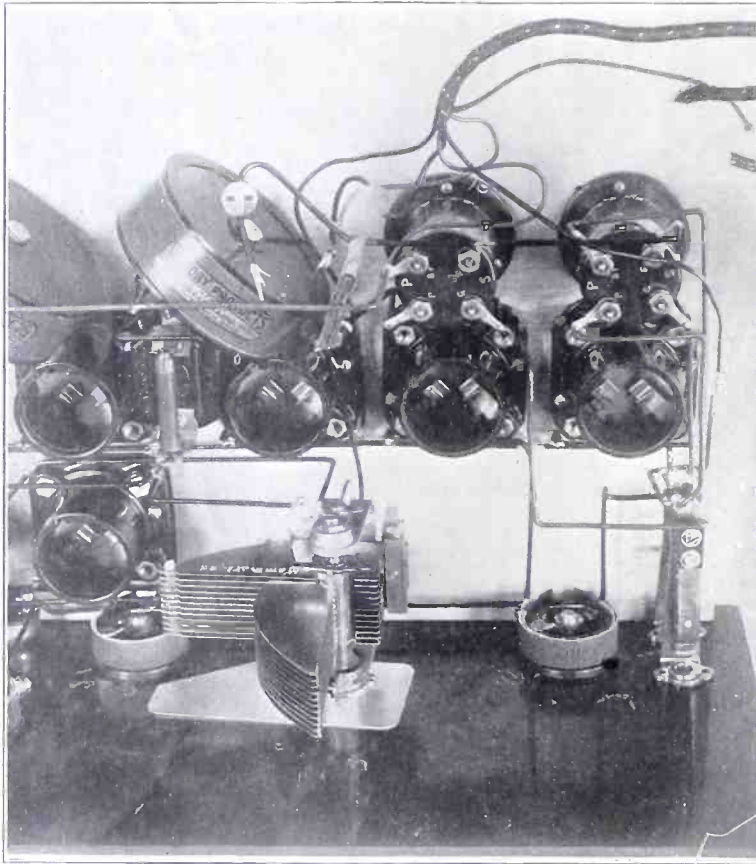

THE OSCILLATOR CONDENSER C1 (foreground) must tune sharply. If it does not, apply the remedies suggested in the text.

[The construction of the Victoreen, an efficient 8-tube Super-Heterodyne, was described in the February 20, 27 and March 6 issues of RADIO WORLD.]

PERSONS who have built their first Super-Heterodyne or who are tuning one for the first time often complain of harmonic trouble, as they call it, being rather peeved because a station may be heard at a given setting of the modulator condenser (C1 in the Victoreen) and either of two settings of the oscillator condenser (C2). It may even happen that two settings of the modulator condenser possibly bring in the same station, although this is a rarity and is due mainly to the second harmonic.

As for the double effect in the oscillator tuning, it is erroneous to ascribe this to harmonics. Where the fundamental of the oscillator is used to establish the beat note or intermediate frequency by combination with the signal frequency, it will be possible to get many stations at the same modulator setting but at two different oscillator settings. This is characteristic of the circuit itself, not of a particular set. It is not to be rated as "trouble," since it is a normal condition. It arises from the phenomenon of the beat note, which is a new frequency set up by mixing the signal frequency with that of the oscillator frequency. The oscillator frequency, to establish the desired beat note, must differ from the frequency of the tuned input. The beat note is obtained by subtracting the signal frequency from the oscillator frequency or by subtracting the oscillator frequency from the signal frequency. Hence the

double setting phenomenon is based on an equal difference, the only distinction being that in one case the difference is up and in the other it is down. As greater volume often accompanies one setting of the oscillator condenser, as compared with the other setting of that same condenser, the double reading frequency becomes an advantage.

Harmonics are multiples of the fundamental frequency (fractions of the wavelength), and of course it is possible on such a sensitive set as the Victoreen Super-Heterodyne to tune in harmonics of stations, as well as fundamentals, but this is true of all sensitive receivers. For instance a station operating on a wavelength of 416.4 meters may be tuned in also, in some cases, at 208.2 meters, since the Victoreen tunes that low, the 208.2 meter wave being the second harmonic.

It would be impossible to tune in the third harmonic of that station, as the set does not tune that low. Theoretically the second harmonic of all stations above 416.8 meters might be heard.

Of course it is not taken for granted that any station is generating harmonics, but no doubt some stations do so.

As for sources of real trouble, lack of sufficient selectivity, failure to get distance and shortcomings in volume and control will be discussed.

The selectivity of the set is governed largely by the oscillator. If the loop or aerial circuit tunes seemingly broadly for local stations, do not mistake that for poor selectivity. The selectivity test is: Does the set tune in a station without program interference from other stations? This it is bound to do, if properly made of specified parts.

The oscillator variation, by turning C2, takes care of that. In addition selectivity is gained to an important extent by the efficiency of the intermediate amplifying system. Absence of selectivity should not be ascribed to the frequency changing part of the circuit until the intermediate amplifiers have been tested.

Look at the potentiometer. Take extreme care to note which side of it represents the negative A battery lead. The set should operate best with the potentiometer on the negative side, sometimes nearly all the way over at the negative post. If you must use the positive half then you may make up your mind that you are suffering from interstage coupling in the intermediate amplifier or over-amplification. Take the first intermediate transformer, the one at left in the chain of four as you face the panel. Move it slightly out of the angle it occupies at present. Experiment with changing the position of this transformer until it is possible to get just as much volume as before, without having the potentiometer arm on the positive side. If this is impossible, shift the transformer second from the left. As a last resort try mounting the second transformer nearly at right angles to the first and third transformers, leaving the four others just as they were originally.

Otherwise lack of selectivity may be due to too high B battery voltage on the lead that usually takes 45 volts, improper value of grid leaks or defective leaks, poor tubes, particularly a bad one in the oscillator socket, and stray coupling between the input coil and the oscillator coil. The input coil is L1L2, otherwise a loop.

Failure to get distance may be due to poor selectivity occasioned by wrong placement of parts, low sensitivity, due to defective tubes, incorrect B battery voltages, and mounting of the oscillator coil.

(Continued on page 28)

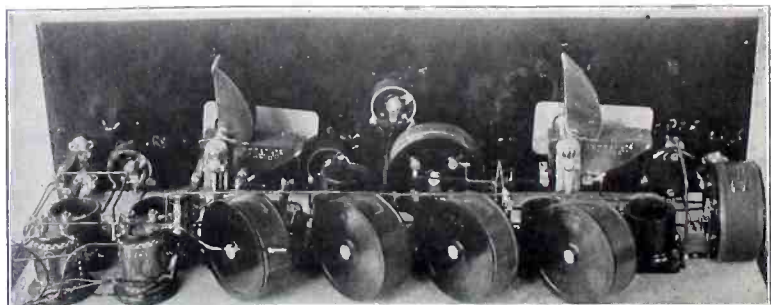

THE FOUR intermediate transformers are in the front row. Vary the angle of the one at right if selectivity is poor.

Radio University

A QUESTION and Answer Department conducted by RADIO WORLD for its Readers by its staff of Experts. Address Radio University, RADIO WORLD, 145 West 45th St., N. Y. C.

I AM contemplating building the 4-tube Diamond of the Air, but before doing so, I would like to have a panel layout as well as a baseboard layout of the parts. Only one rheostat is to be used. This is to control the filament of the detector tube. No radio-frequency coil is to be employed, which means that only the loop is to be used.—Theodore Cohen, Briggs Ave., and 199 St., Bx., N. Y. City.

Figs. 273 and 274 show the panel and baseboard layout respectively. The photos representing these layouts, are those of the set constructed by Harry Finger, of 215 West 51st St., N. Y. City. These layouts are very good and should be followed carefully.

AS TO the 3-tube regenerative receiver which appeared in the Jan. 9 issue of RADIO WORLD, on page 19. (1)—How many turns are placed on a tubing $3\frac{3}{4}$ " in diameter and 4" high, to constitute the primary, L1, and the secondary, L2? (2)—How many turns are placed on a form 3" in diameter to constitute the plate coil, L3? (3)—What is the value of C3 and the grid leak, which shunts the same? (4)—What is the capacity of C1 and C4. (5)—What are the ratios of both the audio-frequency transformers? (6)—What type of jacks are J1 and J2? (7)—What kind of tubes are used?—Frank Graders, Morristown, N. J.

(1)—The primary consists of 10 turns. The secondary consists of 45 turns. Use No. 24 double cotton covered wire when winding the coil. Leave a $\frac{1}{4}$ " space between the two windings. (2)—This coil consists of 35 turns. Use No. 24 single silk covered wire. (3)—C3 is a .00025 mfd. fixed condenser. The grid leak has a value of 2 megohms resistance. (4)—C1 has a capacity of .0005 mfd. and is variable. C4 is a .001 mfd. fixed condenser. (5)—They are both of the low ratio type, about 3 to 1. (6)—J1 is a double circuit jack. J2 is a single circuit jack. (7)—Use 201A tubes throughout. The plate of the detector tube receives 45 volts, while the plate of the amplifier tubes receive $67\frac{1}{2}$ to 90 volts.

WHAT IS the plate resistance, amplification factor, plate current at maximum and the number of watts output that can be expected at maximum point of the V. T. 2 vacuum tube?—Benjamin Kirschner, 976 Legget Ave., Bx., N. Y. C.

The plate resistance of this tube is 5,000 ohms. The amplification constant is about 7 maximum. The plate current at maximum is .04 amperes. The maximum voltage that the plate of this tube can stand is 350. The greatest number of watts that can be expected is 5.

WHAT IS the law according to the National Electrical Code for receiving stations only, regarding the ground wire?—Lou Straus, 526 West 151st, N. Y. City.

"The ground wire may be bare or insulated and shall be of copper or approved copper-clad steel. If of copper, the ground wire shall be not smaller than No. 14 Brown & Sharpe gauge, and if approved copper-clad steel it shall be not smaller than No. 17 Brown & Sharpe gauge. The ground wire shall be run in as straight a line as possible to a good permanent ground. Preference shall be given to water piping. Gas piping shall not be used for grounding protective devices. Other permissible grounds are grounded steel frames of buildings or other metallic work in the building and artificial grounds such as driven pipes,

plates, cones, etc. The ground wire shall be protected against mechanical injury. An approved ground clamp shall be used wherever the ground wire is connected to pipes or piping."

COULD I expect satisfactory service from the loop described by Herbert E. Hayden in the Jan. 16 issue of RADIO WORLD, when used in conjunction with the 1926 Model Diamond of the Air? (2) Does it matter to which terminals of the variable condenser the terminals from the loop go? (3) What tubes are recommended for the 1926 Model Diamond?—W. Washburn, 20 West Palm Ave., Redlands, Cal.

(1) Yes. (2) Yes. The terminal on the side facing the station goes to stator.

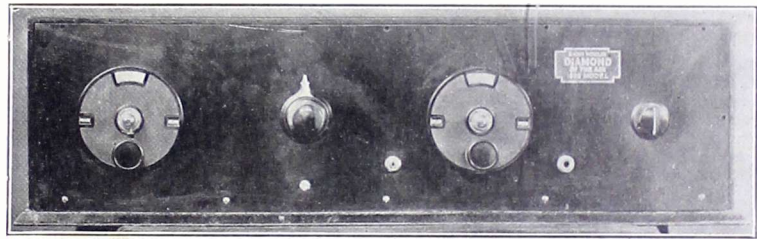

FIG. 273, showing the panel view of the 4-tube Diamond. The knob between the two Marco dials controls the tickler coil.

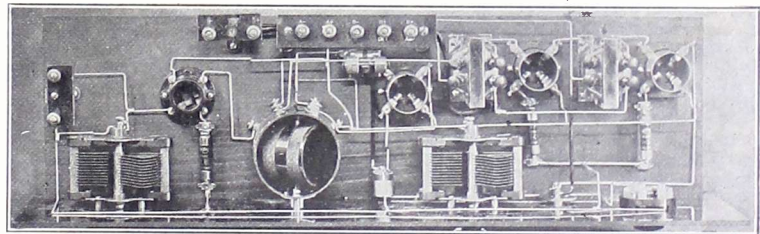

FIG. 274, showing the internal wiring as well as the layout of the parts of the 4-tube Diamond.

Reverse to determine the better position. (3) See the Feb. 27 issue of RADIO WORLD.

I HAVE built the 2-tube reflex receiver, which appeared in the Oct. 31 issue of RADIO WORLD, on page 14 in the Radio University Columns, Fig. 244. I have built the set according to the data given. The parts are all O. K. The volume, however, is very low. How could the trouble be cured?—Miss Georgia E. Connolly, 12 Everett St., Malden, Mass.

Try a new crystal detector. Reverse the crystal detector leads. Reverse the leads of the tickler coil L3. Place a .001 mfd. fixed condenser across the primary of the first audio-frequency transformer. Use a separate rheostat for controlling the filament of the of the regenerative RF tube. This should have a resistance of 10 ohms, with a carrying capacity of $\frac{1}{4}$ amperes. Be sure that the primaries and the secondaries of the AFT are not shorted.

WHAT CHANGE would have to be made in a 5-tube Neutrodyne, so that it could be made to operate with a loop?—F. Fitzgerald, Customs Bureau, General P. O., N. Y. City.

See the Radio University columns in the March 6 issue of RADIO WORLD. An extra tube will have to be added.

I HAVE a .000375 mfd. variable condenser, which I would like to use in conjunction with a wavetrap. Could I obtain

a description of how to use this condenser in either the Rider wavetrap, which appeared in the December 26 issue of RADIO WORLD or in a simple coil-condenser trap?—Charles Turner, 118 High St., Elyria, O.

The simple wavetrap will consist of a coil consisting of 50 turns wound on a tubing $3\frac{3}{4}$ in. in diameter, using No. 22 double cotton covered wire, with the variable condenser shunting the beginning and the end of the coil. This is inserted in series with the antenna. The Rider wavetrap, which uses a 3-circuit tuner, will have to have its secondary winding rewound to fit the condenser. That is if the secondary consists of 50 turns wound on a 3 in. diameter, then increase the number of turns to 60.

I AM building the 4-Tube Symphony set, described by Irving Witz in the January 9 issue of RADIO WORLD. Is the hook-up as published all right? That is, does the plate of the detector tube receive the same B battery voltage as the plate of the

RF tube?—E. C. Zimmerman, 1215 Tinton Ave., Bx., N. Y. City.

Yes, 45 volts.

I AM building the Victoreen Super-Heterodyne receiver which was described in the February 20, 27, March 6 issues. I would like to insert a voltmeter and milliammeter in this set, placing them so that only when the entire batch of tubes is used will the meters give readings. How can these be inserted?—H. W. Schoeff, 3433 Butler St., Pittsburgh, Pa.

You will have to have two milliammeters instead of one. One of these is inserted in series with the B+ Det. post. The other is inserted in series with the B+ Amp. post. The voltmeter is shunted across the positive A and the negative A.

HOW MANY turns of No. 22 double cotton covered wire should be placed on a form $3\frac{3}{4}$ " in diameter, to constitute the primary and secondary windings of a tuner. The tickler is to be wound on a form $2\frac{1}{2}$ " in diameter, using No. 22 double cotton covered wire. The secondary is to be shunted by a .0005 mfd. variable condenser of the SLF type.—S. Kimeals, 190 Sturvestant Ave., Brooklyn, N. Y.

The primary will consist of 10 turns. The secondary will consist of 42 turns. The tickler will consist of 35 turns.

I HAVE constructed the 1-tube set described by Herbert E. Hayden in the

417
2
1

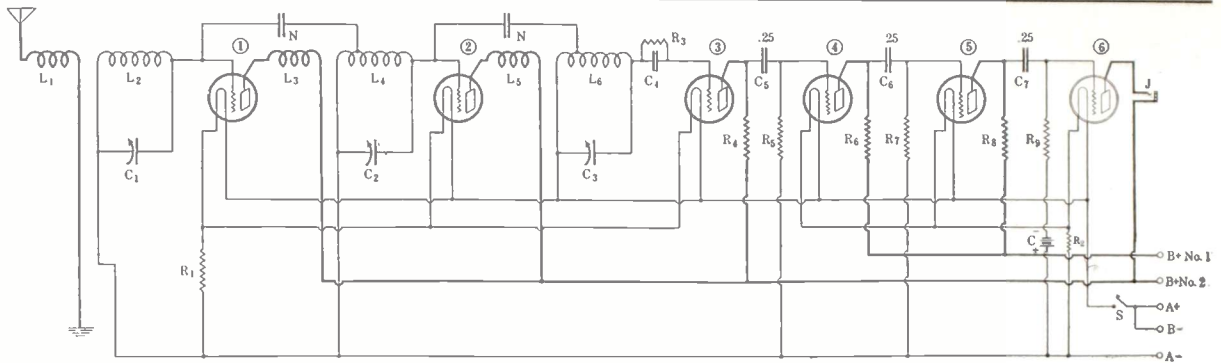

FIG. 275, showing the wiring diagram of the Neurodyne, with the resistance-coupled audio stages.

August 29 issue of RADIO WORLD and am obtaining wonderful results. However, I find that I cannot receive well stations above 500 meters. I am at present using a tuner, the primary consisting of 10 turns and the secondary of 35 turns. These are wound on a tubing 4" diameter. A .0005 mfd. SLF variable condenser shunts the same. The tickler consists of 20 turns wound on a tubing 3" in diameter. No. 22 double cotton covered wire is used for winding the primary, secondary and the tickler coils. I am using a 60-foot antenna.—F. E. Richter, 3631 Virginia Ave., St. Louis, Mo.

You should be able to receive as high as 560 meters with this coil. Your antenna is too short. Either add 7 turns to the secondary or 40 feet to the antenna.

I WOULD be pleased to have the wiring diagram of a 6-tube Neurodyne receiver, in which three stages of resistance coupled amplification are used. The filaments of the radio-frequency tubes should be controlled by a ballast resistor. The filaments of the 3-audio tubes should also be controlled by one ballast resistor. This means that there will be no variable resistance in the set. A C battery should be inserted in series with the grid of the last tube. The constants of the coils, condensers would be appreciated.—Graham Rocker, Hoover, Ind.

Fig. 275, shows the schematic diagram of the Neurodyne receiver you request. Tubings 3" in diameter and 4" high are used to place the windings to constitute the radio-frequency transformers, L1L2, L3L4 and L5L6. No. 22 double cotton covered wire is used. The primaries, L1, L3 and L5 consists of 10 turns. The secondaries, L2, L4 and L6 consists of 60 turns. C1, C2 and C3, each have capacities of .000375 mfd. N, the neutralizing condensers, have variable capacities of from .00004 to .0001 mfd. C4 is a .00025 mfd. condenser. R3 is a 2 megohm grid leak. R1 and R2 are 3/4 ampere ballast resistors. R4, R6 and R8 are .1 megohm resistances.

R5 is a .5 megohm resistance. R7 and R9 are .1 megohm resistors. J is a single circuit jack. The tubes used should be of the .01A type. Therefore a 6 volt source is required for the filaments. The plates of the first and second audio tubes receive 135 volts. The plates of the two RF tubes, detector and the last audio-tube receive 90 volts. It is a good idea to place 135 volts on the plate of the last tube, instead of the 90 which is going to the other RF and Det. tubes. If you are going to place 90 volts on the plate of the last tube, then a 4.5 volt C battery will be necessary. If you are going to place 135 volts on the plate of this tube, then 9 volts C battery should be used. S is a filament switch.

I HAVE a Fada variocoupler of the 180° type. The stationary form contains 56 turns. The rotary form contains 48 turns. I would like to use this form to make a 3-circuit tuner so that it could be used in the Loud-Boy, which was described by Herman Bernard in the February 6 issue of RADIO WORLD. The diameter of the stationary form is 3 1/2", while the diameter of the rotary form is 2 1/4". Please state the number of turns to place on the stationary form to constitute the primary and secondary and on the rotary form to make the tickler. I wish to use No. 22 double cotton covered wire.—J. J. Sunn, 37 Lincoln Ave., Albany, N. Y.

The primary consists of 10 turns. The secondary consists of 42 turns. The tickler consists of 36 turns. No. 26 single silk covered wire is used here.

I DESIRE to build the set described by William Mercer in the February 20 issue of RADIO WORLD. However, instead of using tubing 3 1/2" in diameter I wish to use tubing 3" in diameter. Please give the number of turns to place on such a tubing.—Arthur Soderstrum, Orpheum Building, Topeka, Kan.

First wind 18 turns, then make a small loop. Continue the winding for 50 more

turns. This makes a total of 68 turns. No. 20 double cotton covered wire is used

I WOULD like to get some information regarding a 5-tube standard Neurodyne receiver. (1)—Is the 57.3 angle the correct one for mounting the neuroformers? (2)—I have two rheostats, one controlling the filaments of the RF tubes, while the other controls the filaments of the detector tube. Both these rheostats are placed in the negative lead of the A battery. Would the reception of signals be improved any if the rheostats were placed in the positive leg of the A battery? (3)—The neuroformers contain 63 turns on the secondaries. A 3" form is used to hold these windings. The secondaries are shunted by .000375 mfd. variable condensers. Now I use 180° dials, KSD, which operates on a wavelength of 545 meters is tuned in at 145 on the dial. This I think is too low a reading. Should not the station be received at about 170? If it should, how many turns are to be taken off the coils? (4)—Will the strength of the signals decrease when the turns are taken off the secondary? (5)—I have read many articles about keeping like potentials together. Now my neuroformers are wound with the primary winding inside of the secondary winding. The beginning of the primary winding (top) goes to the aerial. The bottom of this winding goes to the ground. The beginning of the secondary winding (near the antenna post), goes to the A minus post. The end of this winding goes to the G post. Is the above the correct manner to keep the potentials? (6)—I also have a 1-tube set, which is wired up thus: One variometer in the grid circuit and shunted by the antenna and the ground. A variable condenser of .0005 mfd. capacity is also shunted across the same. Another variometer is in series with the plate. A rheostat is in series with the A+B— post. There is a great deal of body capacity in this set. The entire wavelength is covered on 30° of the dial. How can these troubles be cured?—Phil Thompson, Walnut Grove, Minn.

(1)—Yes. (2)—The rheostats should be in the negative side. (3)—Take 5 turns off the secondaries. (4)—No. (5)—The beginning of the secondary winding, which is near the antenna post, should go to A minus and not to grid. The ending of the secondary winding, which now goes to the A minus post should go to the grid. This supposes the windings are in the same direction. If they are not, the reverse is true. (6)—By placing a .0001 condenser in series with the variometer in the grid circuit this body capacity may be reduced. To spread the stations out when using variometer take off turns. Try taking off five at first.

KINDLY TELL me the gauge of wire used in winding the coils to be used in the Reflex Set described by Burton Lindheim in the May 30 issue of RADIO WORLD.—Fred Dieter, 2788 Fulton St., Brooklyn, N. Y. No. 22 double cotton covered wire.

Join RADIO WORLD'S University Club

And Get Free Question and Answer Service for the Coming 52 Weeks.

Have your name entered on our subscription and University lists by special number. Put this number on the outside of the forwarding envelope (not the enclosed return envelope) and also put it in your queries and the questions will be answered the same day as received. If already a subscriber, send \$6 for renewal from close of present subscription and your name will be entered in the Radio University.

[In sending in your queries to the University Department please paragraph them so that the reply can be written under or alongside of each query. Write on one side of sheet only.]

RADIO WORLD, 145 West 45th Street, New York City.

Enclosed find \$6.00 for RADIO WORLD for one year (52 Nos.) and also enter my name on the list of members of RADIO WORLD'S University Club, which gives me free information in your Radio University Department for 52 ensuing weeks, and send me my number indicating membership.

Name

Street

City and State

THE RADIO TRADE

R. C. A. 1925 Report Shows Profit of \$5,737,206

THE Annual Report of the Radio Corporation of America for 1925 shows that the Corporation maintained its position of leadership in international radio communication, in the field of marine radio communication and in the radio broadcast industry. Although the year 1925 was a period of liquidation and readjustment affecting the entire industry, the Radio Corporation of America solidified its position in the radio broadcasting sales field. The report shows a gross income of \$50,405,144 for 1925 and after deducting general operating and administrative expenses, depreciation and cost of sales, a net profit of \$5,737,206 as compared with a loss in 1924.

In 1924 the preferred shares were reduced from 5,000,000 to 500,000 of "A" preferred, and the common stock reduced from 7,500,000 shares to 1,500,000, without changing the capitalization.

The report continues: "The following dividends have been paid on the 'A' preferred and on the original preferred stock:

No.	Dividend
1—(3½%)	July 1, 1924—1st and 2nd quarters of 1924.
2—(1¼%)	October 1, 1924—3rd quarter of 1924.
3—(1¼%)	January 1, 1925—4th quarter of 1924.
4—(1¼%)	April 1, 1925—1st quarter of 1925.
5—(1¼%)	July 1, 1925—2nd quarter of 1925.
6—(1¼%)	October 1, 1925—3rd quarter of 1925.
7—(1¼%)	January 1, 1926—4th quarter of 1925.

"No dividends have been declared on the common stock.

Balance Sheet

"Your Corporation's capital stock consists of 395,597 and four-tenths shares of seven per cent. 'A' preferred stock, with a par value of \$50 per share and 1,155,400 shares of 'A' common stock of no par value.

"The Corporation's financial position has been further strengthened during 1925. Current assets have increased \$1,646,277 and exceed the current liabilities by \$17,564,047. The Corporation has no bonded debt or notes outstanding.

"The total of plant and equipment stands at \$13,779,510 and the reserve for depreciation and obsolescence of plant amounts to \$2,631,930. The amortization of patents reserve after charging

patents expired, new stands at \$4,849,497 and represents the depreciation to December 31, 1925, indicated by the schedule founded on the life of such patents.

Operations

"After providing for depreciation of plant and inventory, the operations for the year resulted in a net profit of \$5,737,206. Of this \$1,660,145 has been allocated to reserves for patents and Federal Income Tax, and \$2,852,993 has been credited to surplus account. The balance of \$1,224,068 has been applied to reserve against foreign investments and writing down contracts, good-will, etc.

"Surplus account at January 1, 1925, amounted to \$5,000,570. To this amount \$2,852,993 was transferred from 1925 earnings making a total of \$7,853,563. From this amount \$1,500,000 has been deducted as a further write-off against the good-will account, leaving a balance of \$6,353,563 to the credit of surplus account."

Sales

The report says: "Notwithstanding heavy liquidation of competitive radio sets, your Corporation maintained its policy of contributing towards the stabilization of the radio industry by reducing its prices to the consumer without destroying the investments made by distributors and dealers in Radiolas and Radiotrons." On February 2, 1925, the price of Radiotron vacuum tubes was reduced from \$4 to \$3 and a further reduction from \$3 to \$2.50 was made on August 1, 1925 according to the report. Trade adjustments which resulted in lower prices to the consumer cost your Corporation \$4,000,000, but it was an investment in good faith and square dealing which has placed the Radio Corporation of America in a strong commercial position."

Commenting upon the development of new types of Radiolas, Radiola Loudspeakers and Radiotrons, the report says, "With the cooperation of the General Electric Company and the Westinghouse Electric and Manufacturing Company, your Corporation developed new types of Radiolas, Loudspeakers, Radiotron Power Amplifiers and Battery Eliminators. For the first time, radio sets which operate satisfactorily by using electric light current instead of batteries, were made available to the public.

"The commercial position of your Corporation at the close of the year and public approval of its new radio equipment fully justified this policy of development."

The report states that manufacturing adjustments, made necessary by the new features of the Corporation's 1925-26 line, did not permit substantial deliveries of the new apparatus to the trade until well into the last quarter of 1925."

The report states that a contract was made with the Victor Talking Machine Company for the sales of Radiolas and Radiotrons for combination radio phonograph sets.

Tradiograms

Rodgers Radio Company, 3737 Belmont Avenue, Chicago, Ill., have designed a most singular single control set in a Renaissance Design finished in American Walnut cabinet that has many unique features. If one is interested in an exceptionally beautiful yet very simply operated set it might be well to write this company mentioning RADIO WORLD.

A most complete list of Read-Easy Hydrometers that are made by the Ala Manufacturing Company, 401 S. Sangamon St., Chicago, Ill., may be obtained by just writing to this company mentioning RADIO WORLD.

Lynn Radio Specialty, Inc., 1355 East 53rd St., Chicago, Ill., are putting out a reflex crystal called the Lynn ultra-reflex Crystal. The claim of superiority being that it does not break down in subjecting to high voltages. Further information on this crystal can be obtained by writing to this company direct, mentioning RADIO WORLD.

Business Opportunities Radio and Electrical

Rates: 10c per word; Minimum, \$1.00; Cash with order

MANUFACTURERS AND INVENTORS—Experimental work, models, dies, tools, instruments, light machinery, general manufacturing; inventions developed; customer's supervision in machine shop permitted; over twenty-five years' specialized experience. Manufacturers' & Inventors' Electric Co., 228 West Broadway, New York.

WE DESIGN AND BUILD special machinery, tools, dies, jigs and fixtures. Experimental work. Light stamping, quantity production. Reliable Machine Co., 151 West 18th St., New York City.

DIES, TOOLS, manufacturing, stamping, automatic machinery models contract work every description. Eureka Tool Co., 42 Walnut St., Newark, N. J.

\$1,000 BUYS GOING RADIO mail order cash business. Box 101, RADIO WORLD.

MANUFACTURING MACHINE SHOP located in Brooklyn, having large machine, tool and assembly equipment, is available for immediate production on contracts covering large and small quantities; plant consists of 25,000 square feet of floor space. Duplex Condenser & Radio Corp., 36 Flatbush Ave., Extension, Brooklyn, N. Y. Phone Cumberland 0900.

ELECTRICAL CONTRACTING AND SUPPLY business, established; \$4,700; going South. Box E. F. G. Radio World.

\$100 WEEKLY UP. We want experienced radio men to operate branch assembly plants. Part or whole time. Barfield Radio Co. 13 Tillary St., Dept. W. R., Brooklyn, N. Y.

Literature Wanted

THE names of readers of RADIO WORLD who desire literature from radio jobbers and dealers are published in RADIO WORLD on request of the reader. The blank below may be used, or a post card or letter will do instead.

Trade Service Editor,

RADIO WORLD,
145 West 45th St., N. Y. City.

I desire to receive radio literature.

Name

City or town

State

Are you a dealer?

If not, who is your dealer?

His Name

His Address

- S. Davis, 282 Avondale Road, Cleveland, O.
- E. A. Wagne, 627 Main St., Toledo, O.
- W. J. Tindlwisser, c/o Strayers, 11th and Iowa Sts., Dubuque, Ia.
- L. Mandel, 2732 Washington Boulevard, Chicago, Ill.
- Harry G. Adams, 44 Hennepin Park, Buffalo, N. Y.
- R. E. Clark, Chopin, Ill.
- West Dirks, 4 Coso Ave., San Francisco, Cal.
- C. B. Wanemacker, Ottoville, O. (Dealer).
- R. E. James, City Division, P. O. Dept., Des Moines, Ia.
- Wilbert E. Scheer, 1329 Campbell Ave., Des Plaines, Ill.
- F. G. Tilson, c/o P. & G. Radio Mart, Post Office Box 727, Asheville, N. C. (Dealer).
- Henry Tinsley, Marion, Ky.
- Richard Schultz, 154 Jackson St., Hempstead, L. Is., N. Y.
- R. Bank, 2615 Pillsbury Ave. South, Minneapolis, Minn.
- Arthur Biebe, 83 Ersworth Circle, Niagara Falls, Ont.
- Ottumwa Optical Co., Ottumwa, Ia. (Dealer).
- Ando Radio Co., 13 Kitaigacho, Yotuya, Tokyo, Japan. (Dealers).
- Fred W. Ruisscau, Harbor Knoll, Great Neck, L. Is., N. Y.
- A. P. McCormick, 313 Wenger St., South Bend, Ind.
- Post Radio Co., 843 F St., N. W., Washington, D. C. (Dealer).
- Henry S. Morris, 937 Tea St., N. W., Washington, D. C.
- Russell Letford, Two Harbors, Minn.
- Louis A. Baxter, c/o Elite Lamp Shop, 211 N. Sixth St., Cambridge, O. (Dealer).
- Frederick, R. D. No. 2, P. O. Ulster, Pa. (Dealer).
- C. H. Bradbrook, Kansas City, Mo.
- Laurence Scheffahd, Marquis, Saskatchewan, Canada. (Dealer).
- John M. Decker, R. F. D. 1, Middletown, N. Y.
- R. A. Reddick, 1204 West 10th St., Port Angeles, Wash.
- E. F. Manis, Box 369, Camden, Ark.
- Floyd McElroy c/o Columbus Garage, Columbus, Pa. (Dealers).
- W. F. Kuhn, Security Radio Electric Co., 1506 Pine St., St. Louis, Mo. (Dealers).
- H. C. McCorkle, 802 West 18th St., Huntington, W. Va. (Dealer).
- D. B. Truitt, 5719 Malcolm St., Philadelphia, Pa. (Dealer).
- W. Mayes, Box 15, Marietta, O. (Dealer).
- F. C. Whitney, 3207 Whitney Ave., Detroit, Mich.
- H. D. Johnson, 915 N. 31st St., Camden, N. J. (Dealer).
- Albert C. Adams, Port Clinton, O.
- W. W. Stanton, Box 689, Miami, Fla. (Dealer).
- T. F. Barnby, Palo Alto, Cal.
- E. R. Watts, 2116 10th Ave., South, Birmingham, Ala.
- Chas. A. Sepic, 842 East Ohio St., N. S., Pittsburgh, Pa.
- W. D. Stanton, 111 W. Plume St., Norfolk, Va.
- C. H. Peery, Box 218, Colorado Springs, Colo.
- William Hawkes, 281 8th St., Jersey City, N. J.
- Anthony J. Goetz, 380 N. Main St., Liberty, N. Y.
- C. P. Wilbur, 3073 Restorruel St., Duluth, Minn. (Dealer).
- Albert Brown, 1708 Gibson St., Scranton, Pa.
- Albert Walker, 2832 N. Swanson St., Philadelphia, Pa.
- James Primm, Wynnewood, Okla. (Dealer).
- Harry L. Goldblum, 6144 Pine St., Philadelphia, Pa.
- F. L. Wilson, 2158 Lincoln Ave., Chicago, Ill. (Dealer).

NEW CORPORATIONS

- Warren Radio Corp., N. Y. City, \$10,000; P. Heteny, L. Cresap. (Atty., A. I. Warren, 52 Vanderbilt Ave., N. Y. City).
- Keeler Radio Corp., N. Y. City, 250 shares, \$100 each; 150 common, no par; O. J. Mendel, M. E. Mackey. (Atty., H. Sammet, 165 B'way, N. Y. City).
- Mastertone Radio Corp., Newark, N. J., manufacture. \$125,000; George H. Porell, Walter R. Porell, Raymond Adams, Newark, N. J. (Atty., A. V. Sneider, Newark, N. J.)

Girls Study Radio Engineering



STUDENTS at O'Keefe Junior High School, Atlanta, Ga., learning how to repair a Super-Heterodyne, under the instruction of Prof. C. H. Kreuger. This is the only girls' class in mechanical engineering in the South. (Wide World).

Rickard Prophesies Bout



"TEX" RICKARD, world-known promoter of professional championship boxing bouts, who recently returned from a trip to Miami, Fla., where Gene Tunney is training, broadcast through the Madison Square Garden station, WMSG, the news that Jack Dempsey, world's heavyweight champion, would defend his laurels this year and that in all probability his opponent would be Tunney. Sartorial experts will note Tex's way of holding a cigar, also the crease in his trousers. (Wide World).

Reversed Speaker Cord Frequent Trouble Cause

Sometimes a speaker will give a mushy, rumbling sound although there is nothing wrong with the set. This is particularly true in regenerative receivers. The cause may be found in the wrongly polarized connection of the speaker cords. Simply reverse them. In many instances speaker cords are wrongly connected. At least reduced volume results. Some units are not so critical on the direction of current flow, but the unit will last longer if the

right connection is made. Speaker cords usually have a marker on one of the leads, like a red stripe, to identify the positive connection, and often plugs have a red-tipped designator for the corresponding lead. Unfortunately this scheme will not be of much help, because it operates on the assumption that the jack itself, at the rear of the panel, is wired to the set so as to make the red designate the sleeve lead, as it should.

Light Socket Aerial Suits In Many Homes

A connection made to a light socket through a condenser connection, as in the socket aerial plugs, may give excellent or poor or no results. Usually in large cities, unless the user lives on the second floor or higher up, the device does not work so well, because the lighting mains are laid underground. In outlying districts, where overhead wiring prevails,

results usually are good. The elevation of the actual point of reception is important in cities because it represents so much unburied wire. A fan living on the third floor of a large New York City apartment house received WOC, Davenport, Ia., on a 1-tube set, using a socket aerial. Therefore the try-out method is the only one for this device.

Power Tubes Improve Quality, Not Volume

The power tubes, usually installed in the final audio stage, make for better quality, as these tubes stand a heavier load, but they do not increase volume as such. The signals may seem louder,

due to their greater clearness. On the other hand, the high nu tubes, used in resistance or impedance coupled stages, do increase volume, in that they afford greater voltage amplification.

New Location of WGBS Eliminates Dead Spots

Since moving its transmitter from the congested downtown district at Broadway and 33rd Street, WGBS has practically been deluged with letters from listeners-in reporting that the new location in Astoria has greatly increased the receptivity of the Gimbel Brothers' Station.

Before this step was taken WGBS was heard with excellent quality in many parts of the country, but a great many fans in Greater New York, principally parts of Brooklyn, found it difficult to tune in the station. This was due entirely to the mass of steel and other air obstructions about the midtown district. So, for many months WGBS engineers conducted tests in all parts of Greater New York and New Jersey, with the result that the location in Astoria, opposite 90th Street, Manhattan, was selected. Now the listeners give evidence that the former dead spots have all been obliterated.

All Quiet on Potomac

Major Bowes Sails For Lovely Miami



SYMBOLISM—When Major Edward Bowes (left) director of the Capitol Theatre, whose family of artists broadcasts every Sunday night from WEAF and its chain, sailed for Miami he turned the microphone over to Tommy Dowd, Dr. Billy Axt, and David Mendoza. (Foto Topics).

Radio Bills Face Defeat; Macdonald Case Is Pivot

By Thomas Stevenson

WASHINGTON.

The most optimistic supporters of radio legislation have almost abandoned hope that a law giving the Secretary of Commerce authority to regulate broadcasting will be enacted at this session of Congress.

This is the consensus of the supporters of the White and Dill radio bills in the House and Senate. The opinion is that the White bill will pass the House but that it will be buried in the archives of the Senate when the closing day of the session arrives.

According to Senator Dill, the failure of radio legislation to pass the Senate will not be due to lack of interest in the subject. Senator Dill believes that most of his colleagues are perfectly satisfied with the present regulation of radio by the Department of Commerce and that considerable more time will be required for a study of its broad aspects.

Wave Problem Acute

According to the committee members the chief element of doubt seems to lie in the allocation of wavelengths. At the present time there are only 89 wavelengths available upon which are operating around 530 broadcasting stations. At the same time there are on file at the Department of Commerce more than 300 applications for new stations.

"I hope a way can be found to enlarge the present broadcasting band so that more stations may be allowed to broadcast," said Senator Dill. "I believe this will solve one of our greatest problems. I favor announcing that within one year we will open up to broadcasting a much larger band of wavelengths. This will give sufficient time for manufacturers to produce sets capable of tuning them in. At the same time it will permit

present owners of sets to change their apparatus to meet new conditions."

Senator Dill was reluctant to express his opinion as to the chances for enactment of radio law this session.

Satisfied With Hoover

"Most of the members of the Senate," said he, "do not know very much about radio. They could hardly be expected to have much knowledge on such a technical subject. Most of them are fairly well satisfied with the way Secretary Hoover is handling the situation. They do not want to make a step until they are absolutely sure of what they are doing. As they are not convinced of the immediate necessity for legislation it is possible that they may want the radio bill to go over until the next session of Congress."

Officials of the Department of Commerce, while none too optimistic as to the chances of radio bills, are hopeful that a way can be found to put them through. To their minds the crux of the situation depends on the outcome of the Macdonald case in Chicago. They believe if the government wins its case against Macdonald for the use of a wavelength in violation of a law, the Secretary of Commerce may be able to keep the situation in hand.

Chaos if U. S. Loses

If the Government loses the case, complete chaos will result unless legislation is enacted immediately. At the same time it is recognized that the Department of Commerce at present has not the authority to refuse a license to any applicant for a broadcasting station. This condition is being met at present with the very simple explanation that a wavelength cannot be furnished when it is not available.

(Copyright, 1926, by Stevenson Radio Syndicate)

An Evaporated Leak Spoils Set Operation

If a set that gave good reception gradually becomes less sensitive and selective, see if there is a variable grid leak in it that has a visible fluid inside. If so, note whether this fluid has dried up. If it has, the set is operating without any leakage path at all for the excess negative electrons on the grid. This introduces, at

least, distortion of a severe order, and often cuts the volume in half. Install a new leak and note the difference.

The correct leakage should be used in all cases, though the value is not critical with most tubes. A variable leak serves the purpose well.

K. P. ROYCE of the Scientific Division of the Graybar Electric Company, making a test with the audiometer, at the East Gate of the White House. The noise measurement here was 25 units, showing that President Coolidge works comparatively free from interference. (Fotograms.)

Amid March Snow



WHEN stuck with some wiring problem it is always consoling to gaze upon inspiring faces that are charmed by reception amid adverse conditions! The "Cocoanut" Company girls are Bonnie Murray, Irene Pedrick, Irene Joyce and Mrs. Chicco Marx. (Foto Topics).

Extra Funds to Be Used to Fight Interference

WASHINGTON.

An increased appropriation of \$125,000 is recommended for the Radio Service of the Department of Commerce in the Appropriation bill for that department, reported to the House by the Appropriations Committee.

Plans have already been made by the Radio Service as to the utilization of the money to decrease interference. Deputy Commissioner Arthur J. Tyrer, of the Bureau of Navigation, gives the following account of how the money will be spent:

"We believe we should locate offices in the present centers of sending stations, at strategic points. In each of these sub-offices we should have an assistant inspector and one clerk. The new offices that we propose are at Dallas, Memphis, Los Angeles, Portland, Ore., Pittsburgh, Buffalo, Denver, St. Louis, Minneapolis and Omaha."

The Official List of Stations

Corrected and Revised Up to March 3

Station	Owner and Location	Meters	Station	Owner and Location	Meters	Station	Owner and Location	Meters
KDKA	Westinghouse E. & M. Co., Pitts- burgh, Pa.	309	KFUR	H. W. Peery and R. Redfield, Ogden, Utah	224	KTBR	Brown's Radio Shop, Portland, Ore.	263
KDLR	Radio Eloc. Co., Devils Lake, N. D.	231	KFUS	Louis L. Sherman, Oakland, Cal.	256	KTCL	American Radio Tel. Co., Inc., Seattle, Wash.	306
KDYL	Newhouse Hotel, Salt Lake City, Utah	246	KFUT	University of Utah, Salt Lake City, Utah	261	KTHS	New Arlington Hotel, Hot Springs, Ark.	375
KDZB	F. A. Seifert, Bakersfield, Cal.	210	KFUU	Coburn Radio Laboratories, San Leandro, Cal.	220	KTNT	N. Baker, Muscatine, Ia.	256
KFAB	Nebraska Buick Auto Co., Lincoln Neb.	340	KFUV	G. P. Ward, Springfield, Mo.	252	KUT	1st Presbyterian Church, Seattle, Wash.	454
KFAD	Electrical Equipment Co., Phoenix Ariz.	273	KFVD	Chas. & W. J. McWhinnie, San Pedro, Cal.	205	KUO	Examiner Printing Co., San Francisco, Cal.	250
KFAE	State College, Pullman, Wash.	349	KFVE	Film Corp., St. Louis, Mo.	240	KUOM	State University of Montana, Mis- soula, Mont.	245
KFAF	A. E. Fowler, San Jose, Calif.	217	KFVF	Clarence B. Juneau, Hollywood, Cal.	208	KUSD	University of S. D. Vermillion, S. D.	278
KFAJ	University of Colorado, Boulder, Colo.	261	KFVG	1st Methodist Church, Independence, Kan.	236	KUTV	Voice of Texas, Austin, Tex.	231
KFAU	Boise High School, Boise, Idaho.	283	KFVH	Herbert Whan, Manhattan, Kans.	219	KVCR	H. F. Paar, Cedar Rapids, Ia.	278
KFBB	F. A. Buttry Co., Havre, Mont.	275	KFVI	56th Cav. Brigade, Houston, Tex.	240	KWC	Portable Wireless Tel. Co., Stockton, Cal.	248
KFBG	1st Presbyterian Church, Tacoma, Wash.	250	KFVN	C. E. Bagley, Welcome, Minn.	227	KWKC	Wilson Duncan Studios, Kansas City, Mo.	236
KFBK	Kimball Upson Co., Sacramento, Cal.	248	KFVW	Francis Cal. Girardeau, Battery Station, Cape Girardeau, Mo.	224	KWKH	W. K. Henderson I. W. & S. Co., Kennewick, Wa.	273
KFBL	Leese Bros., Everett, Wash.	224	KFVX	Radio Supply Co., Albuquerque, N. M.	250	KWSS	State College, Pullman, Wash.	349
KFBS	School District No. 1, Trinidad, Col.	238	KFWA	Browning Bros. Co., Ogden, Utah.	261	KWVG	City of Brownsville, Brownsville, Tex.	278
KFBU	Bishop N. S. Thomas, Laramie, Wyo.	270	KFWB	Warner Bros. Pictures, Inc., Holly- wood, Cal.	252	KYW	Westinghouse E. & M. Co., Chicago, Ill.	535
KFCB	Nielson Radio Co., Phoenix, Ariz.	238	KFWC	E. Wall & C. S. Myers, Upland, Cal.	211	KZZ	Electric Supply Co., Manila, P. I.	270
KFCF	F. A. Moore, Walla Walla, Wash.	256	KFWF	St. Louis Truth Center, St. Louis, Mo.	214	KZRO	Far Eastern Radio Inc., Manila, P. I.	270
KFDD	St. Michael's Cathedral, Boise, Idaho.	278	KFWH	F. Wellington Morse, Jr., Chico, Cal.	254	NAA	U. S. Navy, Arlington, Va.	435
KFDM	Magnolia Petroleum Co., Beaumont, Texas	316	KFWI	Radio Entertainers, Inc., South San Francisco, Cal.	230	WAAB	V. Jensen, New Orleans, La.	288
KFDX	1st Baptist Church, Shreveport, La.	250	KFWM	Oakland Educational Soc., Oakland, Cal.	207	WAAD	Ohio Mech. Institute, Cincinnati, O.	258
KFDY	State College of Agriculture, Brook- ings, S. D.	273	KFWU	Louisiana College, Pineville, La.	238	WAAP	Drovers Journal, Chicago, Ill.	278
KFDZ	H. O. Iberson, Minneapolis, Minn.	231	KFWV	Wilbur Jerman, Portland, Ore.	213	WAAM	I. R. Nelson Co., Newark, N. J.	263
KFE	Meier & Frank Co., Portland, Ore.	248	KFY	Carl's Radio Den, Oxnard, Cal.	205	WAAW	Omaha Grain Exchange, Omaha, Neb.	273
KFEL	Winnier Radio Corp., Denver, Colo.	254	KFXB	B. O. Heller, Big Bear Lake, Cal.	203	WABC	Asheville Battery Co., Inc., Asheville, N. C.	254
KFEM	J. L. Seibert, New York, N. Y.	268	KFXC	Santa Maria Valley R. R. Co., Santa Maria, Cal.	210	WABI	Bangor Ry. & Elec. Co., Bangor, Me.	240
KFEY	Bunker Hill & Sullivan, Kellogg, Idaho	233	KFXD	L. H. Strong, Logan, Utah	205	WABO	Lake Avenue Baptist Church, Roch- ester, N. Y.	278
KFFP	1st Baptist Church, Moberly, Mo.	242	KFXH	Bledsoe Radio Co., El Paso, Texas.	242	WABQ	Haverford College Radio Club, Haver- ford, Pa.	261
KFGQ	Crary Co., Boone, Iowa	226	KFXJ	Mt. States Radio District, Inc., (Port- able), Col.	216	WABR	Scott High School, Toledo, O.	263
KFHA	Western State College, Gunnison, Colo.	252	KFXK	Pikes Peak Broadcasting Station Co., Colorado Springs, Colo.	250	WABW	College of Wooster, Wooster, O.	207
KFHL	Penn College, Oskaloosa, Iowa	240	KFXM	Neches Electric Co., Beaumont, Tex.	227	WABX	H. B. Joy, Mt. Clemens, Mich.	246
KFII	C. S. Anthony, Inc., Los Angeles, Cal.	469	KFXR	Classier Film Finishing Co., Okla. City, Okla.	214	WABY	John Magaldi, Philadelphia, Pa.	242
KFIP	Penson Theatrical, Portland, Ore.	248	KFYJ	Mary M. Costigan, Flagstaff, Ariz.	205	WABZ	Coliseum Place Baptist Church, New Orleans, La.	275
KFIQ	1st Methodist Church, Yakima, Wash.	243	KFYK	Houston Chronicle, Houston, Tex., (Portable)	238	WADC	Allen Theatre, Akron, Ohio.	258
KFIU	Alaska Elec. Co., Juneau, Alaska.	226	KFYR	Hoskins Meyers, Inc., Bismarck, N. D.	248	WADF	A. B. Paries Co., Fort Huron, Mich.	275
KFIZ	Daily Commonwealth, Fond du Lac, Wis.	273	KGO	General Electric Company, Oakland, Cal.	361	WAHG	A. H. Grebe Co., Richmond Hill, N. Y.	316
KFJB	Marshall Elec Co., Marshalltown, Ia.	248	KGTT	Glad Tidings Tabernacle, San Fran- cisco, Cal.	207	WAGM	R. L. Miller, Royal Oak, Mich.	225
KFJC	R. B. Fegan, Junction City, Kan.	219	KGU	M. A. Mulrony, Honolulu, Hawaii.	270	WAIT	A. H. Waite & Co., Taunton, Mass.	229
KFJD	National Radio Co., Oklahoma City, Okla.	261	KGW	The Oregonian, Portland, Ore.	492	WAU	American Ins. Union, Columbus, O.	294
KFJJ	Liberty Theatre, Astoria, Ore.	246	KGY	St. Martin's College, Lacey, Wash.	246	WAMD	Hubbard & Co., Minneapolis, Minn.	244
KFJM	University of N. D., Grand Forks, N. D.	278	KH	The Times, Los Angeles, Cal.	405	WAPI	Alabama Polytechnic Inst., Auburn, Ala.	248
KFJR	Ashley C. Dixon & Son, Portland, Ore.	263	KHQ	Louis Wasmser, Sewa, Wash.	273	WARC	American Radio Res. Corp., Medford Hillside, Mass.	261
KFJY	Tunwall Radio Co., Ft. Dodge, Iowa.	246	KJBS	J. Brunton & Sons Co., San Fran- cisco, Cal.	220	WBAA	Purdue University, West Lafayette, Ind.	273
KFJZ	Southwestern Baptist Theo. Seminary, Ft. Worth, Texas	254	KJR	Northwest Radio Co., Seattle, Wash.	384	WBAL	State Police, Harrisburg, Pa.	276
KFKA	State Teachers College, Greeley, Colo.	273	KLDS	Reorganized Church of Jesus Christ of Latter Day Saints, Independence, Mo.	441	WBAP	James Millikin University, Decatur, Ill.	270
KFKU	University of Kansas, Lawrence, Kans.	275	KLS	Warner Bros. Radio Co., Oakland, Cal.	252	WBAX	J. H. Stenger, Jr., Wilkes-Barre, Pa.	256
KFKX	Westinghouse E. & M. Co., Hastings, Neb.	288	KLX	Tribune, Oakland, Cal.	208	WBBL	Grace Covenant Presbyterian Church, Richmond, Va.	229
KFKZ	F. M. Henry, Kirksville, Mo.	226	KLZ	Reynolds Radio Co., Denver, Colo.	266	WBEM	H. L. Atlas, Chicago, Ill.	226
KFLP	Everett M. Foster, Cedar Rapids, Ia.	256	KMA	May Seed & Nursery Co., Shenan- doah, Ia.	252	WBFB	Petoskey High School, Petoskey, Mich.	238
KFLR	University of N. M., Albuquerque, N. M.	254	KMJ	San Joaquin Corp., Fresno, Cal.	234	WBFR	Peoples Pulpit Ass'n., Rossville, N. Y.	273
KFLU	San Benito Radio Club, San Benito, Tex.	236	KMO	Love Elec. Co., Tacoma, Wash.	250	WBBS	1st Baptist Church, New Orleans, La.	252
KFLV	Swedish Evangelist Church, Rockford, Ill.	229	KMOX	St. Louis Globe-Democrat, Louis- ville, Mo.	280	WBW	Ruffner City High School, Norfolk, Va.	222
KFLX	George R. Clough, Galveston, Texas.	220	KMMJ	M. M. Johnson Co., Clay Center, Neb.	229	WBYY	W. L. Young Light Infantry, Charles- ton, S. C.	268
KFLZ	Atlantic Auto Co., Atlantic, Iowa.	273	KNRC	J. B. Juneau, Hollywood, Cal.	208	WBZZ	(C. L. Carrell, (Portable), Chicago, Ill.	216
KFM	University of Arkansas, Fayetteville, Ark.	230	KNTR	D. S. Garretson & R. M. Turner, Los Angeles, Cal.	238	WBBC	Southtown Economist, Chicago, Ill.	266
KFMR	Morningside College, Sioux City, Iowa	261	KNX	Express Holywood, Hollywood, Cal.	337	WBDC	Baxter Laundry Co., Grand Rapids, Mich.	256
KFMW	M. G. Sataren, Houghton, Mich.	263	KOA	General Electric Co., Denver, Col.	322	WBES	Bliss Electrical School, Takoma Park, D. C.	222
KFMX	Carleton College, Northfield, Minn.	337	KOAC	Oregon Agricultural College, Cor- vallis, Ore.	283	WBOQ	A. H. Grebe & Co., Richmond Hill, N. Y.	236
KFNF	Henry Field Seed Co., Shenandoah, Iowa	266	KOB	College of Agri., State College, N. M.	349	WBNY	Miss S. Katz, New York City	210
KFOA	Rhodes Company, Seattle, Wash.	454	KOCH	Omaha Central High School, Omaha, Neb.	258	WBR	State Police, Butler, Pa.	203
KFOB	Chamber of Commerce, Burlingame, Cal.	226	KOCW	Okla. College for Women, Chickasha, Okla.	252	WBRC	Bell Radio Corp., Birmingham, Ala.	248
KOFJ	KFOS—Moberly High School, Moberly, Mo.	242	KOIL	Monarch Manufacturing Co., Council Bluffs, Ia.	278	WBRE	Baltimore Radio Ex., Wilkes-Barre, Pa.	231
KFON	Nichols and Warriner Co., Long Beach, Cal.	233	KPO	Hale Brothers, San Francisco, Cal.	429	WBT	Charlton Chamber of Commerce, Charlotte, N. C.	275
KFOO	Latter Day Saints University, Salt Lake City, Utah	236	KPPC	Pasadena Presbyterian Church, Pasa- dena, Cal.	220	WBZ	Westinghouse E. & M. Co., Spring- field, Mass.	333
KFOR	David City Tire & Elec. Co., David City, Neb.	226	KPRC	Houston, Houston, Tex.	277	WBZA	Westinghouse Electric and Mfg. Co., Boston, Mass.	242
KFOT	College Hill Radio Club, Wichita, Kan.	231	KPSN	Pasadena Star-News, Pasadena, Cal.	316	WCAC	Agricultural College, Mansfield, Conn.	275
KFOX	Technical High School, Omaha, Neb.	248	KQP	H. B. Read, Portland, Ore.	213	WCAD	State University, Lawrence, Kansas, N. Y.	263
KFOY	Beacon Radio Service, St. Paul, Minn.	252	KQV	Doubleday Hill Elec Co., Pittsburgh, Pa.	275	WCAE	Kaufman & Baer, Pittsburgh, Pa.	461
KFPI	C. C. Baxter, Dublin, Texas.	252	KQW	First Baptist Church, San Jose, Cal.	227	WCAJ	Nebraska Wesleyan University, Uni- versity Place, Neb.	254
KFPM	New Bureau Co., Greenville, Texas.	242	KRE	Gazette, Berkeley, Cal.	258	WCAL	St. Olaf College, Northfield, Minn.	337
KFPR	Forestry Department, Los Angeles, Cal.	231	KSAC	Kansas State Agricultural College, Manhattan, Kans.	341	WCAP	C. & F. Tel. Co., Washington, D. C.	469
KFPW	St. John's Church, Cartersville, Mo.	258	KSD	Post Dispatch, St. Louis, Mo.	545	WCAR	Southern Radio Corp., San Antonio, Texas	263
KFPY	Symonds Investment Co., Spokane, Wash.	266	KSL	Radio Service Corp., Salt Lake City, Utah	300	WCAT	School of Mines, Rapids City, S. D.	240
KFQA	The Principia, St. Louis, Mo.	261	KSO	A. A. Berry Seed Co., Clarinda, Ia.	242	WCAU	Universal Broadcasting Co., Philad- elphia, Pa.	278
KFQB	Searchlight Publishing Co., Ft. Worth, Texas	263	KTAB	Tenth Ave. Baptist Church, Oakland, Cal.	240	WCAX	University of Vermont, Burlington, Vt.	250
KFQC	Kidd Bros., Toledo, Ohio	231	KTBI	Bible Inst., Los Angeles, Cal.	294			

Station	Owner and Location	Meters	Station	Owner and Location	Meters	Station	Owner and Location	Meters
WCBA	C. W. Heinbach, Allentown, Pa.	254	WGBX	University of Maine, Orono, Maine	252	WLB	University of Minneapolis, Minneapolis, Minn.	278
WCBD	W. G. Voliva, Zion, Ill.	345	WGES	Oak Leaves Broadcasting Station, Oak Park, Ill.	250	WLBL	Wisconsin Department of Markets, Stevens Point, Wis.	278
WCBE	Uhalt Radio Co., New Orleans, La.	263	WGH	G. H. Boules, Developments, Clearwater, Fla.	266	WLIB	Liberty-Weekly Inc., Elgin, Ill.	303
WCBH	University of Mississippi, Oxford, Miss.	242	WGN	The Tribune, Chicago, Ill.	303	WLIT	Lit Brothers, Philadelphia, Pa.	395
WCBM	Hotel Chateau, Baltimore, Md.	229	WGMU	A. H. Grebe & Co., Inc., Richmond Hill, N. Y.	236	WLS	Sears Roebuck Co., Chicago, Ill.	345
WCBQ	1st Baptist Church, Nashville, Tenn.	236	WGCP	Grand Central Palace, N. Y. City	252	WLTS	Lane Technical High School, Chicago, Ill.	258
WCBR	C. H. Messter (Portable), Providence, R. I.	205	WGHF	G. H. Phelps, Inc., Detroit, Mich.	270	WLW	Crosley Radio Corp., Cincinnati, O.	422
WCCO	Gold Medal Station, Minneapolis, St. Paul, Minn.	416	WGR	Federal Telephone Mfg. Co., Buffalo, N. Y.	319	WLW	Missionary Society of St. Paul the Apostle, N. Y. City	288
WCK	Stix Baer & Fuller Co., St. Louis, Mo.	273	WGST	Georgia School of Tech., Atlanta, Ga.	270	WMA	C. B. Meredith, Cazenovia, N. Y.	275
WCLC	C. E. Whitmore, Camp Lake, Wis.	231	WGY	General Elec. Co., Schenectady, N. Y.	380	WMAF	Round Hills Radio Corp., Dartmouth, Mass.	441
WCLS	H. M. Church, Joliet, Ill.	214	WHA	University of Wisconsin, Madison, Wis.	535	WMAK	Norton Laboratory, Lockport, N. Y.	266
WCM	Texas Market Department, Austin, Texas	268	WHAD	Wisconsin University, Milwaukee, Wis.	275	WMAL	Leese Optical Co., Washington, D. C.	213
WCSH	Henry P. Rines, Portland, Me.	256	WHAM	University of Rochester, Rochester, N. Y.	278	WMAN	1st Baptist Church, Columbus, O.	278
WCSO	Wittenberg College, Springfield, Ohio	248	WHAP	Taylor Finance Corp., 426 West 31st St., New York City	241	WMAQ	Chicago Daily News, Chicago, Ill.	448
WCUC	Clark University, Worcester, Mass.	238	WHAR	F. P. Cook's Sons, Atlantic City, N. J.	275	WMAY	Kings Highway Presbyterian Church, St. Louis, Mo.	248
WCWS	C. W. Selen, Providence, R. I.	210	WHAS	The Courier Journal-Times, Louisville, Ky.	400	WMAZ	Mercury University, Macon, Ga.	261
WCCX	Detroit Free Press & Jewett Radio and Phonograph Co., Pontiac, Mich.	517	WHAT	Dr. G. W. Young, Minneapolis, Minn.	263	WMBB	American Bond and Mortgage Co., Chicago, Ill.	250
WDND	Dod's Auto Accessories, Inc., 160-164 8th Ave., N., Nashville, Tenn.	226	WHAV	Wilmington Elec. Spec. Co., Wilmington, Del.	266	WMBF	Fleetwood Hotel, Miami Beach, Fla.	384
WDZ	J. L. Bush, Tuscola, Ill.	278	WHAZ	Rensselaer Polytechnic Institute, Troy, N. Y.	280	WMC	The Commercial Appeal, Memphis, Tenn.	500
WDAD	Dad's Auto Accessories, Inc., Nashville, Tenn.	226	WHB	Sweeney School Co., Kansas City, Mo.	366	WMA	Hotel McAlpin, N. Y. C.	341
WDAE	Tampa Daily News, Tampa, Fla.	273	WHBA	Shaffer Music House, Oil City, Pa.	250	WNAB	Shepard Stores, Boston, Mass.	250
WDAF	Kansas City Star, Kansas City, Mo.	366	WHBC	Rev. E. P. Graham, Canton, Ohio	254	WNAC	Shepard Stores, Boston, Mass.	280
WDAG	J. L. Martin, Amarillo, Tex.	263	WHBD	Charles W. Howard, Bellefontaine, Ohio	222	WNAD	University of Okla., Norman, Okla.	254
WDAA	Trinity Metr. Church, El Paso, Tex.	268	WHBF	Beardsley Specialty Co., Rock Island, Ill.	222	WNAL	Omaha Central High School, Omaha, Nebr.	258
WDAY	Radio Equipment Corp., Fargo, N. D.	261	WHBG	John S. Skane, Harrisburg, Pa.	231	WNAT	Lenning Bros. Co., Philadelphia, Pa.	250
WDBE	Gilham-Schoen Elec. Co., Atlanta, Ga.	278	WHBH	Culver Military Academy, Culver, Ind.	222	WNAX	Dakota Radio App. Co., Yankton, S. D.	244
WDBJ	Richardson Wayland Elec. Co., Roanoke, Va.	229	WHBI	Laver Auto Co., Ft. Wayne, Ind.	234	WNBH	New Bedford Hotel, New Bedford, Mass.	248
WDBK	M. F. Broz, Furr, Cleveland, O.	227	WHBK	Franklin St. Garage, Ellsworth, Me.	231	WNJ	Radio Shop, Newark, N. J.	252
WDBO	Rollins College, Winter Park, Fla.	240	WHBL	J. H. Slusser, Logansport, Ind.	216	WNOX	Peoples Tel. & Tel. Co. Knoxville, Tenn.	268
WDBR	Tremont Temple Baptist Church, Boston, Mass.	261	WHBM	C. L. Carroll (Portable), Chicago, Ill.	233	WNYC	Municipal Station, New York, N. Y.	526
WDBZ	Boy Scouts of America, Kingston, N. Y.	233	WHBN	1st Ave. Methodist Church, St. Petersburg, Fla.	238	WOAI	South East Equipment Co., San Antonio, Texas	395
WDCH	Dartmouth College, Hanover, N. H.	250	WHBP	Johnstown Auto Co., Johnstown, Pa.	256	WOAN	Vaughan Con. of Music, Lawrenceburg, Tenn.	283
WDOO	Chattanooga Radio Co., Chattanooga, Tenn.	256	WHBR	Scientific E. & M. Co., Cincinnati, O.	216	WOAW	Woodmen of the World, Omaha, Neb.	526
WDZ	J. L. Bush, Tuscola, Ill.	278	WHBU	B. L. Bing's Sons, Anderson, Ind.	219	WOAX	F. J. Wolf, Trenton, N. J.	404
WDR	Doolittle Radio Corp., New Haven, Conn.	268	WHBW	D. R. Kienzel, Philadelphia, Pa.	216	WOC	Palmer School of Chiro., Jay'sport, Ia.	484
WDWF	Dutec Wilcox Flint, Inc., Cranston, R. I.	441	WHDI	Wm. Hood Dunwoody Ind. Inst., Minneapolis, Minn.	278	WOCL	Hotel Jamestown, Jamestown, N. Y.	275
WEAF	A. T. & T. Co., N. Y. City, N. Y.	492	WHEC	Hickson Elec. Co., Rochester, N. Y.	258	WOI	Iowa State College, Ames, Iowa	270
WEAH	Hotel Lassen, Wichita, Kans.	268	WHN	George Schubel, New York, N. Y.	361	WOK	Neutrowound Radio Mfg. Co., Homewood, Ill.	217
WEAI	Cornell University, Ithaca, N. Y.	254	WHK	Radio Air Service Corp., Cleveland, Ohio	273	WOKO	Otto Baur, N. Y. City	233
WEAM	Borough of North Plainfield, N. J.	261	WHO	Bankers Life Co., Des Moines, Ia.	526	WOO	John Wanamaker, Philadelphia, Pa.	508
WEAN	Shepard Co., Providence, R. I.	261	WHT	Radiohone Corp., Deerfield, Ill.	238	WOQ	Unity School of Christianity, Kansas City, Mo.	278
WEAO	Ohio State University, Columbus, O.	294	WIAD	H. R. Miller, Philadelphia, Pa.	250	WOR	L. Bamberger & Co., Newark, N. J.	405
WEAR	Goodyear T. and R. Co., Cleveland, O.	390	WIAS	Homer Electric Co., Burlington, Ia.	254	WORD	Peoples Pulpit Assn., Batavia, Ill.	275
WEAU	Davidson Bros. Co., Sioux City, Ia.	275	WIBA	Capita Times, Madison, Wis.	236	WOS	Mo. State Marketing Bureau, Jefferson City, Mo.	441
WEBC	W. C. Bridges, Superior, Wisc.	242	WIBG	St. Paul's E. P. Church, Elkins Park, Pa.	222	WOWL	Owl Battery Co., New Orleans, La.	270
WEBD	Elec. Equipment & Service Co., Anderson, Ind.	246	WIBH	Elite Radio, New Bedford, Mass.	210	WOWO	Main Auto Supply Co., Ft. Wayne, Ind.	227
WEBE	Roy W. Waller, Cambridge, Ohio	246	WIBI	Fredk. B. Zittel, Flushing, N. Y.	219	WPAK	N. D. Agricultural College, Agricultural College, N. D.	275
WEBH	Edgewood Hotel, Chicago, Ill.	370	WIBC	C. L. Carrell, Chicago (portable)	216	WPCC	N. D. Agri. College, N. D.	275
WEBJ	Third Avenue R. R. Co., New York, N. Y.	273	WIBO	Elite Radio Stores, New Bedford, Mass.	210	WPDP	Hiram L. Turner, Buffalo, N. Y.	205
WEBK	Grand Rapids Radio Co., Grand Rapids, Mich.	242	WIBR	Billy Maine, Chicago, Ill.	226	WPG	Municipality, Atlantic City, N. J.	300
WEBL	Radio Corp. of Ama. (Portable)	226	WIBS	Thurman A. Owings, Weirton, W. Va.	246	WPRC	Wilson Printing & Radio Co., Harrisburg, Pa.	216
WEBM	Radio Corp. of Ama. Portable Mobile Station	226	WIBT	The Electric Farm, Fayette, Wisc.	222	WPS	Fenn State College, State College, Pa.	261
WEBQ	Tate Radio Co., Harrisburg, Ill.	226	WIBU	Dr. L. L. Dill, Logansport, Ind.	220	WQAA	H. A. Beale, Jr., Parkersburg, Pa.	220
WEBR	H. H. Howell, Buffalo, N. Y.	244	WIBX	Grid-Lex, Leona, Ala.	205	WQAE	Moore Radio News Station, Springfield, Vermont	246
WEBW	Beloit College, Beloit, Wisc.	268	WIBZ	Powell Electric Co., St. Louis, Mo.	273	WQAM	Electric Equipment Co., Miami, Fla.	263
WEBZ	Savannah Radio Corp., Savannah, Ga.	263	WIC	Gimbel Brothers, Philadelphia, Pa.	508	WQAW	Scranton Times, Scranton, Pa.	250
WEEL	Edison Electric Illuminating Co., Boston, Mass.	476-349	WJAD	Jackson's Radio Elec. Co., Waco, Tex.	353	WQAO	Calvary Baptist Church, New York, N. Y.	360
WEHS	Robert E. Hughes, Evanson, Ill.	203	WJAG	Norfolk Daily News, Norfolk, Nebr.	270	WQJ	Calumet Rainbo Broadcasting Co., Chicago, Ill.	448
WEMC	Empire Military College, Merrien Springs, Mich.	286	WJAK	Rev. C. L. White, Greentown, Ind.	254	WRAP	Radio Club, Inc., Laporte, Ind.	224
WENR	All-Amer. Radio Corp., Chicago, Ill.	266	WJAM	D. L. Perham, Cedar Rapids, Ia.	268	WRAM	Lombard College, Galesburg, Ill.	244
WEW	St. Louis University, St. Louis, Mo.	248	WJAR	The Outlet Radio Club, New York, N. Y.	306	WRAY	Antioch College, Yellow Springs, O.	263
WFAM	Dallas News & Journal, Dallas, Tex.	476	WJAS	Pittsburgh Radio Supply House, Pittsburgh, Pa.	275	WRAY	Avenue Radio Shop, Reading, Pa.	238
WFAN	The Times, St. Cloud, Minn.	273	WJAX	Voice of Jacksonville, Fla.	337	WRAX	Flexon's Garage, Gloucester City, N. J.	268
WFAY	University of Nebr., Lincoln, Nebr.	275	WJAZ	Zenith Radio Corp., Chicago, Ill.	322	WRBC	Immanuel Lutheran Church, Valparaiso, Ind.	278
WFBC	1st Baptist Church, Knoxville, Tenn.	250	WJBA	J. V. De Walle, Seymour, Ind.	226	WRB	Radio Corp. of America, Washington, D. C.	469
WFBD	Gethsemane Baptist Church, Philadelphia, Pa.	234	WJBB	L. W. McCullung, St. Petersburg, Fla.	254	WRCO	Wynna Radio Co., Raleigh, N. C.	252
WFBE	J. V. De Walle, Seymour, Ind.	226	WJBC	Hummel Furniture Co., 2nd and Joilet Sts., La Salle, Ill.	234	WRO	Reo Motor Co., Lansing, Mich.	286
WFBG	W. F. Gable Co., Altoona, Pa.	278	WJBG	Interstate Radio, Inc., Charlotte, N.C.	224	WRHM	Rosedale Hospital, Minneapolis, Minn.	252
WFBH	Concourse Radio Corp., New York, N. Y.	273	WJBI	R. S. Johnson, Red Bank, N. J.	219	WRNK	Doron Bros., Elec. Co., Hamilton, O.	270
WFBI	Calvary Radio Supply Co., Camden, N. J.	236	WJBK	Ernest F. Goodwin, Ypsilanti, Mich.	233	WRNY	News N. Y. City	258
WFBJ	St. Johns University, Collegeville, Minn.	236	WJBL	Wm. Gushard Dry Goods Co., Decatur, Ill.	270	WRM	University of Illinois, Urbana, Ill.	273
WFBL	Onondaga Hotel, Syracuse, N. Y.	252	WJBP	Seneca Vocational School, Buffalo, N. Y.	219	WRMU	A. H. Grebe & Co., Inc., Motor Yacht Mu-1, N. Y. City	236
WFBM	Merchants Lighting Co., Indianapolis, Ind.	268	WJBQ	Bucknell University, Lewisburg, Pa.	211	WRST	Radiotel Mfg. Co., Inc., 5 First Ave. Bay Shore, N. Y.	216
WFBR	Maryland National Guard, Baltimore, Md.	254	WJBD	Loyal Order of Moose, Moosehead, Ill.	370	WRVA	Laurus & Bros., Co., Richmond, Va.	256
WFBS	Knox College, Galesburg, Ill.	254	WJBR	Detroit Free Press and Jewett Radio and Phonograph Co., Pontiac, Mich.	517	WRW	Tarrytown Research Laboratory, Tarrytown, N. Y.	273
WFDF	F. D. Fallain, Flint, Mich.	234	WJBY	Radio Corp. of Ama., New York, N. Y.	405	WSAI	U. S. Playing Card Co., Cincinnati, O.	326
WFI	Strawbridge & Clothier, Philadelphia, Pa.	395	WJW	Radio Club of York, N. Y.	450	WSAJ	Grove City College, Grove City, Pa.	229
WFKB	F. K. Bridgman, Chicago, Ill.	205	WKAA	H. F. Paar, Cedar Rapids, Iowa	278	WSAN	Allentown Call, Allentown, Pa.	229
WFLR	R. M. Sacey, Brooklyn, N. Y.	205	WKAF	WKAF Broadcasting Co., Milwaukee, Wis.	261	WSAR	Doughty & Welch Elec. Co., Fall River, Mass.	254
WGAL	Lancaster Elec. Supply Co., Lancaster, Pa.	248	WKAG	Radio Corp. of Porto Rico, San Juan, P. R.	341	WSAX	Zenith Radio Corp., Chicago, Ill.	248
WGBB	H. H. Carman, Freeport, N. Y.	244	WKAR	Mich. Agricultural College, Lansing 285	285	WSAZ	Chase Electric Shop, Pomroy, Ohio	244
WGB	1st Baptist Church, Memphis, Tenn.	266	WKAV	Lacoma Radio Club, Lacoma, N. H.	210	WSB	The Atlanta Journal, Atlanta, Ga.	428
WGBF	The Finke Furniture Co., Evansville, Ind.	236	WKBB	Sanders Bros., Joliet, Ill.	214	WSBC	Port Battery Co., Chicago, Ill.	210
WGBI	S. Megaw, Scranton, Pa.	240	WKBE	K. & B. Electric Co., Webster, Mass.	231	WSBF	Stix Baer and Fuller, St. Louis, Mo.	273
WGBM	T. N. Saaty, Providence, R. I.	234	WKBG	C. L. Carrell, (Portable) Chicago, Ill.	216	WSBT	South Bend Tribune, South Bend, Ind.	275
WGBU	Florida Cities Finance Co., Fulford By-the-Sea, Fla.	278	WKBC	Kodol Radio Corp., Cincinnati, O.	326-422			
WGCR	Marshfield Broadcasting Association, Marshfield, Wis.	229	WKY	C. E. Hill and H. S. Richards, Oklahoma City, Okla.	275			
WGBS	Gimbel Brothers, New York, N. Y.	316	WLAL	1st Presbyterian Church, Tulsa, Okla.	250			

A THOUGHT FOR THE WEEK
REFORMS in radio, as in other departments of human activities, are important and sometimes necessary—but do not forget the bromide about the operation having been successful even though the patient died.

RADIO WORLD

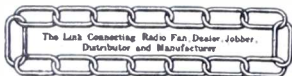

Radio World's Slogan: "A radio set for every home."

TELEPHONES BRYANT 0558, 0559
 PUBLISHED EVERY WEDNESDAY
 (Day Saturday of same week)
 FROM PUBLICATION OFFICE
HENNESSY RADIO PUBLICATION CORPORATION
 145 WEST 45th STREET, NEW YORK, N. Y.
 (Just East of Broadway)
BOLAND BURKE HENNESSY, President
M. B. HENNESSY, Vice-President
FRED S. CLARK, Secretary and Manager
 European Representatives: The International News Co.
 Breams Bldg., Chancery Lane, London, Eng.
 Paris, France: Breutano's, 88 Avenue de l'Opera
 San Francisco: Lloyd B. Chappell, 656 O'Farrell St.
 EDITOR, Roland Burke Hennessy
 MANAGING EDITOR, Herman Bernard
 TECHNICAL EDITOR, Lewis Winner
 CONTRIBUTING EDITOR, John F. Rider

SUBSCRIPTION RATES

Fifteen cents a copy, \$6.00 a year, \$3.00 for six months, \$1.50 for three months. Add \$1.00 a year extra for foreign postage. Canada, 50 cents.
 Receipts by new subscribers of the first copy of RADIO WORLD mailed to them after sending in their order is automatic acknowledgment of their subscription order. Changes of address should be received at this office two weeks before date of publication. Always give old address

ADVERTISING RATES

General Advertising		
1 Page, 7 1/2 "x11"	462 lines.....	\$300.00
1/2 Page, 7 1/2 "x5 1/2"	231 lines.....	150.00
1/2 Page, 8 1/2 "x D. C.	231 lines.....	150.00
1/4 Page, 4 1/2 "x D. C.	115 lines.....	75.00
1 Column, 2 1/2 "x11"	154 lines.....	100.00
1 Inch.....		10.00
Per Agate Line.....		.75

Times Discount

53 consecutive issues..... 30%
 26 times consecutively or B. O. W. one year... 15%
 4 consecutive issues..... 10%
WEEKLY, dated each Saturday, published Wednesday.
 Advertising forms close Tuesday, seven days in advance of date of issue.

CLASSIFIED ADVERTISEMENTS

Ten cents per word. Minimum 10 words. Cash with order. Business Opportunities ten cents per word, \$1.00 minimum.

Entered as second-class matter, March 23, 1922, at the Post Office at New York, N. Y., under the act of March 3, 1879.

MARCH 13, 1926

Swamped With Telegrams



THE ANNIVERSARY program at KFNF, Shenandoah, Ia., brought in 216,764 telegrams and thousands of letters, containing congratulations and requests.

WGY Plans to Forecast Transmission Quality

Because of the activity of the radio engineering research departments of the General Electric Company in the development of the as yet little known science, Schenectady has become the center of radio investigation and WGY the proving station. At South Schenectady the home of the 54-acre transmitter developmental station, special transmitters operating on 41, 76, 1,560 and 379.5 meters have been erected and almost nightly are on the air with programs of WGY while at nearby and remote stations, on land and on sea, in the tropics and in the far north, observers are obtaining transmission data on the various wavelengths. The engineer hopes to reach the point where transmission of quality may be accurately forecast under all conditions. WGY is not only a source of entertainment and information for many thousands of people but is the instrument by means of which pioneer work in radio is being carried out.

Fought Shy of Mechanical Music

From the time of its formal opening four years ago, WGY avoided the inclusion of "mechanical" numbers, that is selections produced by phonograph or player piano. The Department of Commerce recognized the studio-produced program by creating a special class known as Class B in which were included only those stations which did not depend upon mechanical music.

From the very first, Martin P. Rice, manager of broadcasting for the General Electric Company, saw that progress in program development would be seriously handicapped if the station were dependent upon programs originating in the studio. Within a year WGY'S engineers began the development of remote control stations wire-connected to the studio. Now the Schenectady station has one of the most elaborate systems of remote control of any station in the country.

Public halls, churches and theatres in Schenectady were first brought into the studio by wires; then Albany was covered in a similar way and a short time later a pair of wires spanned the 150 miles to New York.

Has a Wide Scope

Through its affiliations with WJZ, WGY has the advantages of tapping into the remote control system of the New York station which includes wires to Washington and to station WRC. During the past year, WGY extended its lines westward and is now connected to Station WFBL in Syracuse, WHAM in Rochester and WMAK in Buffalo. Wire connection gives great elasticity to program. Practically the whole state becomes the studio of WGY and anything originating in any city in the system is made available for broadcasting. Further any broadcasting in the system, is technically equipped to broadcast anything originating in any other station.

Simultaneously with the development of the wire system, engineers have been engaged in the development of radio relay. Two years ago, the portable broadcasting station of 50 watts was tried out. The station, fitted up on a truck, was transported to church or theatre and direct connected to the amplifiers and microphone. The output of the microphone was then broadcast on 100 meters, picked up by WGY and rebroadcast on the station's wavelength. Later work has resulted in the development of 1560 meters as the ideal wavelength for rebroadcast relay service within a distance of 250 miles, WCAD, the station of St. Lawrence University at Canton, N. Y., rebroadcasts WGY, by means of the 1560 meter wave, every Thursday night. Residents of northern New York thus receive programs which originate in New York, Washington, Buffalo, Syracuse, Rochester, Schenectady and Albany.

Some Locations Make Quality Hard to Obtain

In order to obtain the proper control of the tubes which amplify the signals at audio frequency, the grid biasing or C battery is placed in the grid circuit. The absence of this battery, or the choice of an unsuitable voltage for this battery, will cause tone distortion and will also limit the output of the amplifier so that rattling sounds will be produced at volumes less than those desired for natural reproduction.

Connecting the successive stages of audio frequency amplification are transformers. It is not a simple matter to produce such transformers which will transfer from each tube to the next, and in an equal way, all tone frequencies from the lowest to the highest which may be desired. Many transformers now in use drop out the lower frequencies and give a peculiarly mechanical or tinny quality to the reproduced music. Only by careful design and the use of special transformer materials can this defect be avoided.

In its broadcast sense, acoustic synchronizing can hardly be obtained in certain poor locations. If the listener lives in a neighborhood where others are tuning their sets on antennas closely adjacent to his own and thereby disturbing his settings, or where static or other dis-

turbances are heavy on the signals from the nearest stations, or where beat-notes, or "birdies" intrude with their whistling notes from neighboring radiating receivers, he is indeed unfortunate because he can hardly hope for a natural and satisfactory effect of the received program under such conditions. Only by moving his antenna away from other nearby antennas, by listening to local stations which ride above the disturbances, and by educating his neighbors to avoid the production of beat-note interference, can he improve his receiving conditions.



WHEN a fan's alarm went bad on his clock, though the timepiece worked, he used the minute hand as a switch to contact with an insulated clip. Hence at 10:50 a. m. (he's a night worker) he heard the speaker and arose! (Hayden)

Symphonies Favored 5 to 1 Over Jazz Music

THE newest batch of votes cast in RADIO WORLD's canvass of preferences on type of programs, representing two weeks of balloting and by far the greatest number tallied so far, shows the symphony concert far in the lead. Jazz is second, instrumental renderings in solos, duets and trios are grouped for third place, while classical vocal solos are fifth. Kind words have been spoken, too, for opera, old-time music, band concerts and waltzes.

So far the canvass indicates that the preference for symphony concerts over jazz is 5-to-1, but it must be remembered that thousands of more ballots will be cast, and if the experience of other tallying sources is to be reckoned, symphonic music may not continue its strong lead. It seems certain, however, that it will finish first. A recent canvass by WJZ showed that the preference for symphony over jazz was about 30 per cent.

Hard Lines for the Saw

On the negative side, many fans emphatically voted against the musical saw, indeed this seems to be the pet aversion. Almost as greatly abhorred are banquet speeches. A few voted against jazz, but it was the musical saw that provoked the greatest amount of underscoring and capitalizing of the word "no."

A year ago jazz may have been considered the favorite, but today its popularity is on the decline with the radio audience, except of course for dancing. Investigation shows that comparatively little dancing is done to broadcast music, listening occupying 88 per cent. of the response to such offerings.

It is important to cast a ballot in RADIO WORLD's canvass because co-operation is being effected with several leading stations who may be guided in the selection of their programs by what the tally shows. Thus you will be making a good bid for actually getting what you want, when you cast the ballot.

Additions Welcome

If you think any item should be added to the list on the attached coupon, write a letter to the Program Editor, embodying the suggestion. For instance, this week we are adding the band concert because there is a substantial demand for this type of entertainment.

Talks are not so boring as some station managers or announcers may imagine. Travel is one of the leading topics to receive favor, while that particular branch of travel devoted to explorative work is most decidedly popular. Also talks on the construction, care and operation of radio receivers are well-liked, judging by the ballots. But musical saws—no!

Cast Ballot Now

It is imperative that ballots be cast NOW, as the test is drawing to a close. Radio listeners should write on the proper line of the attached coupon the numerical preference, at least up to sixth preference, so that the canvass will be made the more valuable. There is no need of writing the word "yes" anywhere, but if any offering is particularly objectionable, write the word "no" after that listing.

The names and addresses of some more who cast ballots follow:

- W. S. Schultz, 540 Pacific St., Brooklyn, N. Y.
- George A. Holly, Station E, Box 2067, Cleveland, O.
- A. J. Opperman, Box 933, Ft. Meyers, Fla.
- Mrs. J. N. Sayre, R. F. D., Orangeburg, N. Y.
- William J. Dreusiki, Box 616, Huntington Station, N. Y.
- Victor Kane, 3041 Grand Central, N. Y. City, N. Y.
- K. C. Tregens, 222 Stanley Boulevard, Ardmore, Okla.

- Dennis Ryll, Jr., 3915 N. Kilbourne Ave., Chicago, Ill.
- Fred J. Fisher, 537 Grier Ave., Elizabeth, N.J.
- A. A. Holydt, Gulfport, Miss.
- W. D. Woodford, 267 Yale Station, New Haven, Conn.
- L. F. Dorn, Rowayton, Conn.
- E. D. Meriwether, 421 Dayton Ave., St. Paul, Minn.
- Clifford Collins, 803 Main St., Highland, Ill.
- H. H. Savage, 139 Virginia Ave., Audubon, N.Y.
- H. Hodgson, 709 First St., Wansan, Wis.
- R. W. Davenport, 1583 Hurlbut Ave., Detroit, Mich.
- L. H. Moore, Burnet Hotel, Cincinnati, O.
- M. K. VanDuzor, 22 Wall St., Orlando, Fla.
- Lambert Thommer, Colton, Wash.
- Scott Nixon, 104 Masonic Bldg., Augusta, Ga.
- E. A. Fordyce, Court House, Cedar Rapids, Ia.
- George I. Scovill, 1218 Marlborough, Detroit, Mich.
- W. Gilbert, 233 Broadway, N. Y. City, N. Y.
- E. B. Lund, 74 Broadway, N. Y. City, N. Y.
- M. P. Brogan, 4220 Wakeley St., Omaha, Neb.
- J. W. Millard, 17 State St., N. Y. City, N. Y.
- Grady Romine, Box 1041, Corpus Christi, Tex.
- Leon Bemederfer, 642 Astor St., Norristown, Pa.
- L. K. Doane, 515 Burke St., Jersey Shore, Pa.
- R. A. Yentic, 3711 Fifth Ave., Pittsburgh, Pa.
- Chas. E. Kimmel, Windber, Pa.
- Wm. Neighbors, Smithville, Mo.
- Emlen P. Pitfield, 5032 Newhall St., Philadelphia, Pa.
- S. J. T. Lowe, Auburn, Ky.
- Mrs. J. E. Hathaway, 2115 Broadway, Fort Wayne, Ind.
- W. H. March, 1115 American Trust Bldg., Birmingham, Ala.
- W. W. Rissingner, 15 Franklin St., N. E., Washington, D. C.
- F. N. Pierce, Taylor, Tex.

Tube vs. Crystal

(Concluded from page 7)

quantitative output of the two it is dependent upon the sensitivity of the crystal and of the tube. Both being of normal sensitivity, the response of the tube is approximately 10 times that of the crystal.

The quieter operation of the crystal rectifier is attributable directly to two causes: first being the lower degree of sensitivity of the crystal. It can be easily understood that the many weak disturbances which are barely audible with a

tube rectifier would not register at all with a crystal. And if these weak interfering signals were the only detrimental obstacles encountered during the period of operation, reception with the tube rectifier would certainly be noisier than that with the crystal. Calculating along the same lines, disturbing signals, such as static signals which may weakly modulate the carrier wave of a distant station, would be more audible with the tube rectifier due to its greater sensitivity and also to its inherent amplifying power. Noises encountered with tube rectifiers, we must admit, are due also to residual gases left in the tube itself in order that its degree of sensitivity be increased. Another source are leaky units associated with tube rectifiers and carrying DC potentials, and it is quite difficult to segregate these various sources of disturbances. The deficiencies of tube rectification as outlined above constitute the second reason for the apparent quieter operation of the crystal. Hence the quieter operation of the crystal rectifier is not due to any salient feature possessed by the crystal, but rather to its deficiencies in sensitivity and the faults of the other unit.

Station Distribution Plan of White Bill

In providing that each state shall have at least one broadcasting station, the White bill says:

"The Secretary of Commerce shall . . . determine the location of classes of stations or individual stations with due consideration of the right of each state to have allocated to it, or to some person, firm, company or corporation within it, the use of a wavelength for at least one broadcasting station located or to be located in such state, whenever application may be made therefor . . ."

The bill as amended also provides: "In considering applications for licenses and renewals for licenses, when and in so far as there is a demand for same, the Secretary of Commerce shall make an equitable distribution of licenses, bands of frequency or wavelengths and power among the different zones."

Program Editor, RADIO WORLD, 145 West 45th Street, New York City:
My preference for entertainment and instruction on the radio is as follows, the numbers next to the listed items representing the order of preference:

- | | | |
|---------------------------------|----------------------------------|------------------------------|
| Grand opera..... | Ringside..... | Football game..... |
| Jazz Orchestra..... | boxing report..... | Hockey match..... |
| Talk..... | Classical instrumental solo..... | Recitation..... |
| State subject of talk here..... | State kind here..... | Musical comedy (stage)..... |
| Classical vocal solo..... | Jazz songs vocal..... | Short play (drama)..... |
| State kind here..... | Waltz (orchestral)..... | Short play (comedy)..... |
| Musical saw..... | Symphony concert..... | Banquets, with speeches..... |
| Vocal duet..... | Instrumental duet..... | Sermons..... |
| Vocal trio..... | Instrumental trio..... | Market reports..... |
| Vocal quartet..... | Instrumental quartet..... | Weather report..... |
| Old-time music..... | Brass quartet..... | Organ recital..... |
| Band concerts..... | Bedtime story..... | |
| World Topics..... | Baseball game..... | |

If you particularly dislike any of the above listed offerings, write "No" on the dotted line.

Other offerings (not listed above).....

Remarks (if any).....

Fill out and mail this coupon today!
Name.....
Address.....
City..... State.....

Snodgrass Making Good



HARRY SNODGRASS, "King of the Ivories," is gaining popularity daily as a broadcast artist. He is making good morally, after having been in jail last year. He won **RADIO WORLD'S** popularity contest in 1924 when he was in trouble.

COMING EVENTS

MARCH 8 TO 13—Annual Convention and Show, Executive Council, Second District, at Hotel Pennsylvania, N. Y. City.
MARCH 26 AND 27—Fourth Annual Michigan State Convention, Central Division, American Radio Relay League, Park American Hotel, Kalamazoo, Mich.

FENWAY BLUE PRINTS

ACTUAL SIZE LAYOUTS
 "PICTURE" DRAWINGS, COIL DATA
 EVERYTHING YOU SHOULD KNOW
 Price, Postpaid—\$3.00
 You Can't Go Wrong with Fenway Blueprints!
LEO FENWAY
 29 WEST 64th STREET NEW YORK, N. Y.

The New NATIONAL Variable Velvet Vernier Dial

Positive Control
 Easily Mounted
 Gearless

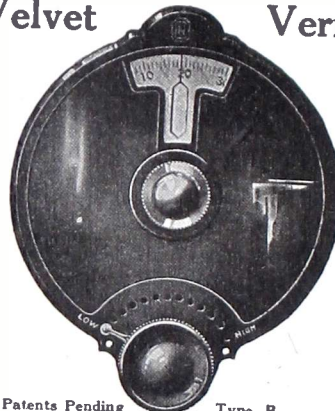

Variable Ratio
 Velvet Smoothness
 Ornamental

Patents Pending Type B
 This dial embodies a modified application of our "Velvet Vernier" mechanism designed to facilitate mounting on the 1/4" shaft of any standard type of variable condenser, without the use of tools other than a screw driver. It will replace plain dials on any receiver where sharper tuning is desired.
 Of special importance is a new and novel device which enables the user to adjust at will the reduction to any ratio from 6:1 to 20:1. This feature aids greatly in the separation of stations operating on the lower wave lengths. This new dial is moulded from black bakelite in a highly ornamental design.

Specifications	Price	Gold Finish
Counter-Clockwise 200-0 (360°)	\$2.50	\$3.00
Clockwise 0-200 (360°)	2.50	3.00

Send for Bulletin 109 RW
NATIONAL CO., INC., 110 Brookline Street, Cambridge, Mass.
 W. A. READY, President

List of Parts for the "Fenway"

- 1 Special Drilled and Engraved Panel as specified.....\$10.00
- 1 Special Hardwood Baseboard..... 1.00
- 1 Set of Four Special Copper Cans, Black Satin Finish, per set..... 11.00
- 1 Sub Panel, Drilled and Engraved..... 1.25
- 3 General Radio Variable Condensers, 00035, each \$3.75 11.25
- 1 General Radio Medium Frequency Input Transformer No. 331..... 5.00
- 3 General Radio Medium Frequency Input Transformers, No. 271, each \$5.00..... 15.00
- 2 General Radio 6-ohm Rheostats, No. 301, each \$1.25.. 2.50
- 1 General Radio 400-ohm Potentiometer, No. 214..... 3.00
- 2 General Radio Audio Transformers I, No. 285 and 1 No. 285-L, each \$6.00..... 12.00
- 1 Silver-Marshall Changeable Coils, No. 110-A and 1 No. 111-A, each \$2.50..... 5.00
- 2 Silver-Marshall Coil Sockets for No. 110-A and No. 111-A, each \$1.00..... 2.00
- 1 Special R. F. Variable Coupler mounted on sub panel with switch and taps, all wound ready for use.... 6.00
- 3 Gem Fuses and Base..... 1.00
- 1 Royalty Type B Resistance..... 1.50
- 1 Yaxley Filament Switch..... .50
- 1 Yaxley Filament Control Jack......70
- 1 Yaxley 2 Circuit Jack......80

SUPER-HETERODYNE SPECIALIST

A Complete Radio Testing and Research Laboratory for the Correction of Radio Troubles.

WIRING AND REPAIRS WITH RESULTS GUARANTEED

CHAS. W. DOWN,
 711 Eighth Avenue New York, N. Y.

Bet. 44th and 45th Sts. Penn. 4779

New Type National Dials Now in Stock

CONQUERS

DEAD SPOTS ANNIHILATES DISTANCE

THE **FENWAY**

RADIO'S MOST REMARKABLE RECEIVER
 IT GETS RESULTS! IT SATISFIES!

I HAVE **LOOK UP DOWN** I SHIP
 THE PARTS SUPER-HETERODYNE SPECIALIST SAME DAY

- 1 Yaxley D. P. D. T. Switch No. 60..... \$1.25
- 9 Air-Gap Sockets, each 75c..... 6.75
- 3 National Vernier Dials (new type), each \$2.50..... 7.50
- Eby Binding Posts, each 15c..... 1.20
- 50-Foot Celatsite Wire, per foot, 4c..... 2.00
- 1 Jewell Combination Volt Meter 0 to 8-80-160..... 12.50
- 1 Jewell Meter 0 to 50 Milli-Amps..... 7.50
- 1 Micamold Condenser Gfid.00025..... .35
- 1 Micamold Condenser Grid .0005..... .45
- 1 Micamold Condenser By-Pass .001..... .40
- 1 Micamold Condenser By-Pass .01..... .90
- 3 Micamold Condenser By-Pass .5, each 90c..... 2.70
- 1 Micamold Grid Leak 2 Megs..... .30
- 1 Micamold Grid Leak 5 Megs..... .30
- 1 Micamold Grid Leak Mount..... .30

Total\$133.90
 NOTE—Silver-Marshall Transformers can be supplied at an additional cost of \$4.00 per set.

NOTE—For those desiring to wind their own coils, coupler and other special parts, the proper parts may be had on receipt of order for same. A Micamold .04 fixed condenser will make any cone speaker work better. Try one. Fenway recommends a cone speaker for the Fenway.

Cabinets for the Fenway now in stock... \$22.50
 All types of meters and special parts. A full stock of nickel, wood and machine screws. .04 Micamold condensers in stock. A special mail order department for prompt service. All orders shipped same day received.

(Wholesale Prices Quoted to Bonafide Dealers Only)

Parts for "B" Eliminators, A.C. and D.C.
TELL ME YOUR TROUBLES

KB-8

Browning-Drake Non-Regenerative

DATAPRINTS for SET BUILDERS..... **\$1.00**

THE KB-8 Dataprints, bearing the O. K. and signature of G. H. Browning, give the full size panel patterns and picture wiring diagrams, parts list, assembly instructions, and all information necessary. If your dealer cannot supply them order by mail from M. B. Sleeper, Inc., and they will be sent postpaid.

DETAILED description and 12 photographs are given in Radio Engineering Magazine, March issue. Send 20c in stamps, or \$2.00 for a year's subscription. Radio Engineering is not sold on newsstands.

RADIO DEALERS

The KB-8 is the very latest thing in Browning-Drake development. Dataprints can be bought at full discount. Sell them to move parts. It is non-regenerative.

Dataprints Sold in Individual Tubes

M. B. Sleeper, Inc.
TECHNICAL PUBLISHER
V-52 Vanderbilt Ave.
Vanderbilt-4996.

1926 DIAMOND OF THE AIR BOOKLET, containing complete constructional data and diagrams, with blue print. 50c. Columbia Print, 145 W. 45th St., N. Y. C.

STATIONS

(Continued from page 19)

WSDA—Seventh Day Adventist Church, N. Y. City	263
WSKC—World's State Knitting Co., Bay City, Mich.	261

HARD RUBBER PANELS

Size.	Black
7 x 10.....	.32
7 x 12.....	.39
7 x 14.....	.42
7 x 18.....	.56
7 x 21.....	.64
7 x 25.....	.85
7 x 30.....	.96

RIX RADIO SUPPLY HOUSE, Inc.

5505—4th Ave.
Brooklyn, N. Y., U. S. A.

FIXED RESISTORS

Micamold

FIXED CONDENSERS

Accurate, Constant in Value
Indestructible.
"Made of Mica and Moulded
in Bakelite"
At good Radio Stores
MICAMOLD RADIO CORP.,
Flushing and Porter Aves.,
Brooklyn, N. Y.

ACCURACY GUARANTEED
VALUES REMAIN CONSTANT

MOURDED UNDER PRESSURE OF 50 TONS

Station	Owner and Location	Meters
WSM	National Life and Accident Ins., Nashville, Tenn.	283
WSMB	Saenger Amusement Co., New Orleans, La.	319
WSMH	Shablik Music House, Owosso, Mich.	240
WSMK	G. M. K. Radio Corp., Dayton, O.	275
WSOE	School of Engineering, Milwaukee, Wisc.	246
WSRO	H. W. Fahlander, Hamilton, Ohio.	251
WSUI	State University of Iowa, Iowa City, Ia.	489
WSWS	S. W. Strauss Co., Batavia, Ill.	275
WTAB	Fall River Daily Herald, Fall River, Mass.	266
WTAD	R. E. Compton, Carthage, Ill.	236
WTAG	Worcester Telegram Publishing Co., Worcester, Mass.	268
WTAL	Toledo Radio & Elec. Co., Toledo, O.	252
WTAM	Willard Storage Battery Co., Cleveland, Ohio	389
WTAP	Cambridge Radio Elec. Co., Cambridge, Ill.	242
WTAQ	S. Van Gordon & Son, Osseo, Wis.	254
WTAR	Reliance Radio & Elec. Co., Norfolk, Va.	261
WTAS	Charles E. Erbstein, Elgin, Ill.	303
WTAW	Agricultural & Mech. College, College Station, Tex.	270
WTAX	Williams Hardware Mfg. Co., Streator, Ill.	231
WTAZ	T. J. McGuire, Lambertville, N. J.	261
WTIC	Travelers Insurance Co., Hartford Conn.	349-476
WWAD	Wright & Wright, Inc., Philadelphia, Pa.	250
WWAE	Electric Park, Plainfield, Ill.	242
WWAO	Michigan College of Mines, Houghton, Mich.	263
WWGL	Radio Engineering Corp., Richmond Hill, N. Y.	213
WWI	Ford Motor Co., Dearborn, Mich.	266
WWJ	Detroit News, Detroit, Mich.	353
WWL	Loyola University, New Orleans, La.	275

RESULTS EDITOR:

I have tried over fifty hookups within the last two years and find that the Diamond rivals them all, including a 9-tube Super-Heterodyne tried out here recently. Once again let me thank you and the Messrs. Bernard, Anderson and O'Rourke for their hookups as published in RADIO WORLD.

HARRY FINGER,
215 West 51st Street,
New York City.

Victoreen SUPER-HETERODYNE

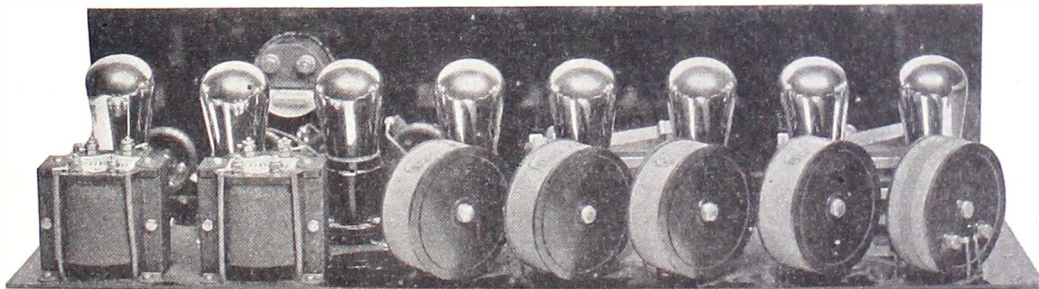

In building this great receiving set, bear in mind that your results will be in direct ratio to the kind of parts you put in it. It is folly to expect the wonderful tone quality, sharp tuning, and long distance reception of which the Victoreen is so capable by using cheap and unmatched parts in its construction. You can buy our laboratory tested and matched parts at no greater cost than the ordinary hit or miss kind, and you will get real Victoreen results. Let us supply your radio requirements direct from Radio Headquarters. We can furnish from stock matched parts for any set.

Wire us today. All letters answered same day as received.

WALDEN ELECTRIC COMPANY

Radio Headquarters
25 North Dearborn Street, Chicago

Action of Electrons Explained for Novices

Radio fans frequently hear that electrons flowing from the filament bombard



THE Antennaphone
 IMPROVES RECEPTION
 Gives wonderful results with any radio set. Not attached to, but merely placed under the telephone. Price One Dollar. Complete with insulated wire and simple instructions. At Your Dealer or Mailed C.O.D. on 3 days approval.
ANTENNAPHONE CO.
 90 West St. New York City

BUY A BUSINESS OF YOUR OWN

You can build a carpet and rug cleaning business with a Hamilton Beach Electric Carpet Washer. Our machine has revolutionized rug cleaning. Finishes rugs like new. Washers in use by United States Government and hotels like the Statler. Low down payment with easy terms. Our booklet "How to have a big paying business of your own" on request.

Hamilton Beach Mfg. Co.
 Racine, Wis.



COUPON BRINGS FREE BOOK

Name
 Address
 State

the plate, but are at sea as to exactly what these electrons are. The Bureau of Standards' circular 40 gives an excellent description of these mysterious particles. "When electric current flows in a conductor, there is a flow of extremely small particles of electricity, called electrons. The study of these particles is important, not only in connection with current flow, but also in light and heat in chemistry. The reason for this is that all matter contains them. Matter of all kind is made up of atoms, which are extremely small portions of matter. A drop of water contains millions of atoms. The atoms contain electrons, which consist of negative electricity. The electrons are all alike and are in turn much smaller than the atoms. Besides containing electrons, each atom also contains a certain amount of positive electricity. Normally the positive and negative electricity are just equal. However, some of the electrons are not held so firmly to the atom, escaping when the atom is violently jarred. When an electron leaves an atom, there is then less negative electricity than positive in the atom. In this condition, the atom is said to be positively charged. When, on the other hand, an atom takes one or more extra electrons, it is said to be negatively charged.

"The atoms in matter are constantly in motion and when they strike against one another, an electron is sometimes removed from an atom. This electron then moves about freely between the atoms. Heat has an effect upon this process. The higher the temperature, the faster the

atoms move and the more electrons given off. If a hot body is placed in a vacuum, the electrons thus given off travel from the hot body out into the surrounding space. This sort of a motion is made use of in the electron tube."



FREE!

To Each Purchaser of a **WORLD 6 V. Auto or Radio BATTERY**

12-Cell — 24-Volt Storage 'B' Battery

Positively given free with each purchase of a WORLD "A" Storage Battery. You must send this ad with your order. WORLD Batteries are famous for their guaranteed quality and service. Backed by years of successful manufacture and of thousands of satisfied users. Equipped with Solid Rubber Case, an insurance against acid and leakage. You save 50 per cent and get a

2-Year Guarantee

Bond in Writing "tell their friends." That's our best proof of performance. Send your order in today.

Solid Rubber Case Radio Batteries	6-Volt, 100-Amperes \$11.25
	6-Volt, 120-Amperes 13.00
	6-Volt, 140-Amperes 13.00
Solid Rubber Case Auto Batteries	6-Volt, 11-Plate \$11.25
	6-Volt, 13-Plate 13.00
	6-Volt, 7-Plate 16.00

Send No Money Just state battery wanted and we will ship day order is received, by Express C. O. D. subject to your examination on arrival. **FREE 'B' battery included.** Extra Offer: 5 per cent discount for cash in the home, auto battery at 50 per cent saving to you.

WORLD BATTERY COMPANY
 1219 So. Wabash Ave., Dept. 17 CHICAGO, ILL.

World STORAGE BATTERIES

Set your Radio Dial at 210 meters for the new 1000 watt World Storage Battery Station, W5BC, Chicago. Watch for announcements.

WKA WFAF WGN WJS KHJ KGO KFAP WIV WKD

KITS—KITS—KITS AND STILL MORE KITS!

The Demand for the 1926 Model, Boxed and Sealed

DIAMOND OF THE AIR KIT.....\$35.00

Is Exceeding Our Wildest Expectations. The Country Is Going DIAMOND Crazy! Recognition Like This Must Be Deserved! No Kit Is Genuine Unless It Bears the Seal and signature of HERMAN BERNARD

Here are a few of RADIO WORLD'S most famous kits, which were presented to its readers in the past few months. The parts included in each are exactly as specified by the authors in the articles. Full instructions for construction will be included in each kit for the convenience of the builders. Our kit department carries nearly every kit ever described, and if not included in these columns, we would be glad to advise you as to its price, etc.

Bruno Powertone Kit—
 A 5-tube single control receiver. Described Aug. 29, Sept. 5 and Dec. 12. **22.50**

The Bernard DX 1-Tube Receiver. Distance on 1 tube. Described Oct. 24. **7.75**

The 3-Tube, 3-Circuit Receiver. An efficient DX getter. Described Oct. 10. **18.50**

Sidney E. Finkelstein's 25-110 Meter Short Wave 2-Tube Set. Described Sept. 12. **12.95**

Herbert E. Hayden's A-A Receiver. An efficient, all-around set. Described Nov. 14 and 21. **22.50**

The Pathfinder—A 4-tube receiver of exceptional merit. Described Oct. 31 and Nov. 7. **31.25**

Bernard's Audio Amplifier—3 stages of amplification with volume. Described Oct. 3. **10.50**

The Famous RXI Receiver. Described in issues of Oct. 17 and 24. **21.50**

Thordarson Wade Kit—Clarity, Volume and Selectivity. Described Oct. 3, 10, 17. **41.50**

The 4-Tube DX Dandy—Herbert E. Hayden's Receiver. Described Feb. 27. **15.95**

Bernard's Loudboy—Distance and Volume on 1 Tube. Described Feb. 21. **9.65**

Bruno 3-Tube DX Set—All Low Loss Parts Used for DX and Volume... **18.50**

Current In a Circuit Same at All Points

The current which flows in a circuit is no stronger at any one point of the circuit than at another. This statement can

easily be proven by connecting up a simple circuit with battery in series with a lamp and a switch and connecting an ammeter at different points. The reading will be the same at all the points. Another way of proving it is by taking a pipe, which is closed, filling it up with water and placing pumps at two points whereby the water can be made to circulate. It will be noted that the amount of water which leaves a specific point in each second is exactly the same as the amount which arrives in the same length of time. In other words, the fluid always flows at the same rate (provided the external rate is not increased), at any point with the same amount of fluid. Electricity acts in the same way that the water does in the pipe. Therefore it can be thought that the electric current is a stream of electricity flowing around the circuit.

RESULTS EDITOR:

I have constructed the Diamond of the Air and have had wonderful success. All the distant stations that are obtained are heard on the speaker. Most of these DX stations are over 1,000 miles distant. The clarity and the volume of the signals of this set are great. I certainly want to thank Herman Bernard for this hookup.

A. W. LEEK,
60 Burling Street,
Flushing, L. I., N. Y.
* * *

RESULTS EDITOR:

I have built the Diamond of the Air and it is the best set that I have ever

built. The very first night that I had the set on test I received more than 15 distant stations. All of these stations were heard on the speaker. These and many more distant stations are heard nearly every night.

EDWARD LAYHURST,
2214 German Street,
Eric, Pa.

RIGHT TO THE POINT!

Extreme accuracy of dial reading is assured when you use EUREKA DIAL POINTERS! Tuning in distance is simplified.

Polished Nickel or Gilt, 1/4 or 3/8" 10¢

C. W. BUTTS, Inc.
40 Hedden Place East Orange, N. J.

Dealer Inquiries Solicited.



FREE RADIO CATALOG

WRITE for a copy of our NEW 100-Page Radio Catalog—Parts, Accessories — Kits — Sets — Everything for the Fan.

DEPT. R. W.

CHICAGO SALVAGE STOCK STORES
509 S. State Street, CHICAGO, U. S. A.

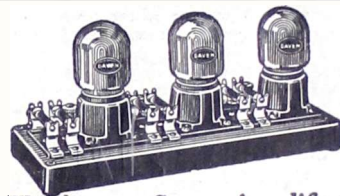

The Daven Super-Amplifier

for volume and tone quality
3 STAGES RESISTANCE COUPLED
ECONOMICAL DISTORTIONLESS

Easily added to any set
Saves Several Hours' Assembly
For Sale by All Good Dealers

SHORE

Transformers
Choke Coils
Condensers
Will

Enable You to
Build Your Own

TECTRON "B" BATTERY ELIMINATOR

As described by
Lewis Winner in this issue

Full Instructions
Sent on Request

for
RAYTHEON
REX, and
CHEMICAL
RECTIFIERS

Prices on request

SHORE ELECTRIC CO., Inc.
64 University Place
New York City

All types of special
transformers built to
specifications

TECTRON TUBES

For Sure Results with the
TECTRON "B" ELIMINATOR

Described in this issue



Selected by Lewis Winner as the most suitable tube for this wonderful Eliminator.

TECTRON RECTIFIER tubes have a long life and will pass a maximum of rectified current.

Price \$2.50

If your dealer cannot supply you order direct.

Special Prices to Manufacturers

TECTRON RADIO CO.

1270 Broadway New York

For real reception, clarity and volume use:
Tectron 201A.....\$2.00
Power Tube.....\$5.00

Special Compact Model Tectron "B" Eliminator, 4x7x7 inches, small enough to be built into the cabinet of your set. Price, complete, ready to operate..... \$35.00

THE RESULT OF EXPERIMENTING IS A SUPER-HET astounding the world. Non-regenerative, no oscillations. Send stamp for free print. Box 32, Station C, Toledo, Ohio.

\$150,000 Premium Asked for Station, Says Lawyer

WASHINGTON.

Morris L. Ernst, New York attorney, representing the American Civil Liberties Union, believes preference should be given to colleges, schools, churches and non-profit organizations in the allocation of licenses and wavelengths for broadcasting stations.

Testifying before the Senate Interstate Commerce Committee, Mr. Ernst charged that there was a considerable traffic going on in the sale of broadcasting stations and wavelengths.

"Of the total licenses now issued," said Mr. Ernst, "ninety-four are held by colleges and forty-three by churches, while 250 are used by commercial enterprises. The price for the sale of broadcasting stations should be regulated by the actual cost of the plant. Premiums as high as \$150,000 are now being asked for the signature of the Secretary of Commerce, exclusive of the value of the plant."

"Radio is a public utility," he added, "and everything concerning its operation and its cost should be open to the public."

16 Stations Indorsed For Steady Frequency

WASHINGTON.

Sixteen broadcasting stations have been found by the Bureau of Standards to maintain sufficiently constant frequencies to justify their use in the calibration of radio sets.

VICTOREEN Super Heterodyne

Build the Right Set

COAST TO COAST-ON-A-LOOP

No Oscillations, Howls or Squeals
No Matching of Tubes

Range-Clarity-Selectivity-
Ease of Operation

KIT—
COMPLETE PARTS—
SPECIAL \$64.00

Including the Same Parts as Described in
This and Other Issues of Radio World.

A demonstration will convince you. Tubes, batteries, cabinet and aerial, of course, not included. Packed, ready for you anywhere, with blue print instructions for connecting up.

Orders shipped same day as received.

JOHN C. RAU

522-524 12th St., N. W., WASH., D. C.

These stations, the average deviation of which was less than two-tenths of one-per cent, follow:

WQL, frequency kilocycles 17.13; NSS,

17.50; WCI, 17.95; WGG, 18.86; WII, 21.80; WRT, 22.60; WVA, 100; NAA, 113; WJR, 580; WEA, 610; WCAP, 640; WRC, 640; WSB, 700; WGY, 790; WBZ, 900.

Meloformer



Set builders are turning to MELOFORMER for perfection in a audio amplification. Pure tones—no distortion—no inter stage coupling—perfectly stabilized impedance. For sale at all dealers for \$4.00 each.

Send for Free Booklet A-4
of MELOFORMER Hookups.

ROBERTSON DAVIS CO.
420 ORLEANS ST. CHICAGO, ILL.

CARTER

Jacks and Switches



"HOLD-TITE"

Jacks

Made in ten different spring combinations.

One for every circuit.

No spacer washers required. Sturdy construction. Skilled workmanship. Highest quality materials. Original patented Carter design.

See them at your dealer's

Carter Radio Co.

300 S. Racine Ave Chicago

Cadiz, O.



Verified Reception
from Paris by Cadiz,
Ohio, Radio Fan

Coast to Coast on a Loop
is easy with a

Victoreen "Super"

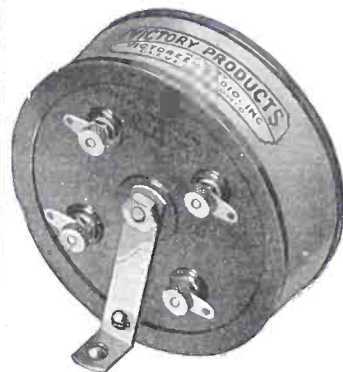

No. 170 R. F. Transformer

The Heart of the Circuit

4—No. 170 R. F. TRANSFORMERS
at \$7.00 each and

1—No. 150 Coupling Unit at \$5.50

No oscillations, howls or squeals—no matching of tubes.

Complete parts to build the "Victoreen" can be purchased of your dealers at moderate cost.

Ask your dealer for free "Victoreen" folder which contains hook-up and complete information, or write us direct.

THE GEORGE W. WALKER CO.

6515 CARNEGIE AVE.

CLEVELAND, OHIO

Branch Offices in Principal Cities

EXTRA SPECIAL—NOW IN PREPARATION

The Greatest Issue of the Year

RADIO WORLD'S FOURTH ANNIVERSARY NUMBER

DATED APRIL 3rd

Last Advertising Forms Close March 24, A. M.
Last Red Form March 22, A. M.

Radio World's weekly subscribers have doubled since our Third Anniversary Number. Still advertising rates remain the same—\$240 a page, or \$8 an inch, on yearly contract. With Radio World's 100,000 weekly circulation this advertising rate is only \$2.40 per page per thousand—a lower rate than any other 100% radio interest publication.

On page copy received by Monday A. M., March 22, an extra color, red (two printings), will be given in this great anniversary issue without extra charge.

For space reservation write or phone F. S. Clark, Advertising Manager.

RADIO WORLD, 145 WEST 45TH STREET, NEW YORK

Telephone: Bryant 0558-0559

Wrong Grid Return Is Frequently Used

Nobody has had the fortunate experience of being able to examine thousands of home-made sets to see in just what wiring condition they are at the moment

HARD RUBBER SHEET—ROD—TUBING
In various sizes
Special Hard Rubber Parts Made to Order
Send Sample or Sketch for Quotation

PANELS ANY SIZE

RADION AND HARD RUBBER
PRICE LIST FOR ALL RADION PRODUCTS
MAILED ON REQUEST

WHOLESALE RETAIL
NEW YORK HARD RUBBER TURNING COMPANY
212 CENTRE STREET NEW YORK



Make Your Set Deliver its Best with

The WOUND WIRE AERIAL
Improved Reception and Greater DX Guaranteed!
Approved by Popular Radio and Radio World.

For indoor or outside aeri-als
Send postal for descriptive booklet
"Something New in Radio"

THE WOUND WIRE AERIAL CO.,
Reedville, Virginia

of completion. It is safe to assume, however, that in a large percentage of cases there is at least one wiring mistake, and this may be enough to prevent best reception results. In a set that requires say a hundred connections even an expert may make a mistake, but in this instance it is not likely to be a vital one. Leads that would cause tube blowout, if mixed up, are watched carefully, as a rule, but one common mistake is to make the wrong grid return connection. In the detector tube hookup the grid return should be to A plus. If the rheostat or ballast is in negative lead, as is the better practice, F plus, which represents a socket post, and A plus, are the same lead, and the connection may be made at the socket post. But when a negative grid return is required, as in all amplifier circuits, do not connect to F minus, a socket post, but to A minus, which is the other side of the rheostat and represents the battery lead. If the mistake is made the rheostat may be found to affect the setting of the tuned circuit, due to the inductance of the wire with which the rheostat is wound, and the rotation of the rheostat arm to represent, accidentally of course, different values of inductance. Keep the rheostat out of the tuned circuit.

Kit Complete Parts Victoreen Super Heterodyne Set Special at \$69.50

Including the Same Parts as Described in
This Issue of Radio World

We have sold more than 300 of these 8-tube Kits all over the country to enthusiastic owners who write us most glowingly of results. A wizard for Distance, Selectivity, Volume. Tune out any local station and get real DX on two-or-three meter wave difference. One of the few super-heterodynes with air-core transformers. No self-oscillations, whistles or squeals. Easier tuning because air-core transformers operate at higher frequencies. A demonstration will convince you. Tubes, batteries and aerial, of course, not included. Packed, ready for you anywhere.

LIST OF THE PARTS INCLUDED IN THIS VICTOREEN SUPER-HETERODYNE

- Four Victoreen RF Transformers, No. 170
- One Victoreen Antenna Coupler, No. 160
- One Victoreen Oscillator Coil, No. 150
- Eight Kurz-Kasch Standard Bakelite Sockets
- Two .0005 mfd. Hammarlund SLF Condensers
- Two Kurz-Kasch E.Z-Toon Vernier Dials
- Two .00025 mfd. Grid Condensers with Mountings
- Two 2-megohm Grid Leaks
- One .001 mfd. Fixed Condenser
- One 1.0 mfd. By-Pass Condenser
- One 400 ohm Victoreen Potentiometer
- Two Victoreen 30 ohm Rheostats
- Two Melofomers
- One 7"x24" Drilled and Engraved Panel
- One 8 1/2"x23" Baseboard
- Two No. 104 Carter Double-Circuit Jacks
- One No. 103 Carter Single Automatic Filament Control Jack
- One Imp Battery Switch
- Seven Binding Posts
- Two 6 ohm Victoreen Rheostats

We Specialize in Complete Kits

The M. & H. Engineering Service Will Supply Parts or Complete Sets of Any Hook-up

DESCRIBED IN THIS OR ANY OTHER RADIO MAGAZINE

Only One Kind of Quality—the Best



30 Years' Experience Back of Each Sale

SANGAMO CONDENSERS and WESTON INSTRUMENTS

all types and sizes carried regularly in stock for immediate delivery.

ROSSITER & CO., Inc.
Wholesale Distributors
136 Liberty Street, New York

VICTOREEN

OFFICIAL SERVICE

Authorized by Geo. H. Walker Co.
Endorsed by Radio World

- Victoreen Kits (4 Transformers and Oscillator Coil) \$33.50
- Antenna Coupler 3.50
- Meloformer Audio Transformers 4.00
- Victoreen Rheostats 1.20
- Victoreen Potentiometers 1.50
- Special Baseboard 1.00
- Special Bakelite Panel.. 6.00
- With Subpanel and Radion Brackets 15.00
- Complete Kits \$70 Up

WRITE FOR PRICES ON KITS TO YOUR OWN SPECIFICATIONS, ASSEMBLY, ETC.

H. & F. Radio Laboratories

PAUL R. FERNALD
168 Washington St., New York City

How to Remedy Poor Control in Victoreen

(Continued from page 12)

If the oscillator picks up energy on its own account, in loop fashion, then selec-

FREE RADIO BOOK

Science has invented a new kind of coil. Now have it on your present set. Gives 4 great advantages otherwise impossible. Write for new book just published, showing many new ideas. Also 8 new circlotron circuits. Address Electrical Research Laboratories, R.W., 2548 Cottage Grove Avenue, Chicago.



100% Value From Each Tube

What's the use of buying good tubes if you don't get their full value? Individual, automatic tube control is the answer. Amperite alone gives it. That's why it is specified in every popular construction set. Offers precision regulation—automatically. No hand rheostats to regulate. Eliminates all errors of human judgment. A special type for every style and strength of tube. Price \$1.10.

Write for free hook-ups

Radiall Company

Dept. RW3 50 Franklin St., N. Y. City

AMPERITE

The "SELF-ADJUSTING" Rheostat

Tonic for sick tubes

from any lamp socket, A.C. or D.C., 110 volts



SOCKET Tube Reviver

\$4.50 and this coupon

BRINGS QUICK RELIEF

International Resistance Co.,

Perry Bldg., Philadelphia,

Please send me by prepaid Parcel Post, C.O.D., one SOCKET Tube Reviver, type as noted. I will pay postman \$4.50—with the understanding that money will be returned if I am not entirely satisfied.

Name Cross out
Address one
City State 201-A
199

tivity and sensitivity of the set as a whole will drop. Therefore try turning the oscillator coil to a slightly different position, and finally at right angles to where it was originally. If the set picks up signals of local stations with the modulator tube out, even with L1L2 or loop disconnected, then the oscillator coil is functioning as a loop.

A shielded location may prevent distance reception on any set, hence if you never got DX on any set in a given location, maybe no set can be built that will bring in DX there. Anyway, give the set at least a two-weeks trial, preferably a month's trial, before rendering the verdict of "guilty of no DX." In that time you will learn how to tune the set, and this is the major part of the DX problem.

The tuning trick is best learned by experience. It will be found that on distance reception even the modulator condenser C1 will tune sharply, hence expect this different condition. The oscillator condenser in particular must be set just right, and this is a very fine adjustment for DX. Remember, too, if using a loop, that you may be tuned to the desired DX station, but your loop may be pointing the wrong way. The directional quality of the loop does not always abide by the rule that you should point the coil antenna toward the station, because the incoming wave may be refracted, and the pointing should be done to the direction of wave entry, determined only by experiment. And remember, too, that the loop is more sensitive and voluminous when the side of the winding that connects to grid is pointed toward the incoming wave. If

you do not know which is which, tune in a local station, reverse the loop leads, reverse them back again, and note the volume difference.

If control is difficult and the set squawks readily, see that the potentiometer

(Concluded on next page)

A GUARANTEED BATTERY FOR YOUR RADIO OR AUTOMOBILE

Thousands of satisfied users are the best recommendation that can be given for these high grade low priced batteries. Made with SOLID RUBBER CASE which prevents leakage.

GUARANTEE
These batteries are guaranteed, which means the quality and service are unsurpassed.

RUBBER CASE RADIO BATTERIES
6 volt—100 Amp. \$10.50
6 volt—150 Amp. 12.50
RUBBER CASE AUTO BATTERIES
6 v., 11 pl. \$10.50; 6 v., 13 pl. \$12.50; 12 v., 7 pl. \$15.35.
SEND NO MONEY—Just mention battery wanted and we will ship by Express C.O.D., subject to your examination on arrival.
Remington Mfg. Co. 4243 Armitage Avenue Chicago, Ill.

MAIL YOUR ORDER TODAY Agents Wanted Remington Mfg. Co.

LISTEN TO YOUR LOCAL STATIONS with

THE TALKING BOOK

Reg. U. S. Pat. Off.
A complete radio set in the form of a book, bound in fine cloth with gold stamping. Equipped with Towers head phones and antenna.

Guaranteed range fifteen miles. An ideal auxiliary to a tube set. Costs nothing to operate and lasts forever.

Just the set for the children and fine for the traveling man.

PRICE FIVE DOLLARS, sent prepaid. Approved by the Popular Radio Laboratory Mfd. by

LISTEN-IN PUBLISHING CO. 110 Main St. Cambridge, Mass. Publishers of the Listen-In Radio Record. If you live within ten miles of a broadcasting station write for exclusive agency.

5 Tube Radio Set



\$29.50

AMERICAN RADYNOLA

The Biggest 5 Tube Value

on the Market

5 TUBE SET
Fostively the world's greatest 5-tube radio bargain. Regular \$75.00 value, fully built and wired in beautiful mahogany cabinet of latest design, sloping Bakelite panel, Satin finish, handsomely etched and engraved. Constructed of the finest low-loss condensers, coils and sockets. Bakelite baseboard panel and dials. \$29.50 for set only. Transportation charges extra, shipping weight 25 lbs.

This set with all accessories, including the famous American Bell loud speaker with adjustable unit, 2-45 volt "B" batteries, one guaranteed 100 Ampere Hour, storage "A" battery, cable for battery connection, 6-201A tubes, aerial and ground equipment, and everything complete ready to set up and operate. Nothing else to buy. Price \$59.75. Transportation charges extra. Shipping weight 100 lbs.

Send For This Radio Book FREE

Contains thousands of bargains in radio sets, semi-finished sets and radio kits of all styles, sizes and approved circuits. Beautiful models of latest designs and types. Elaborate console models with loud speakers built right in cabinets of genuine mahogany and walnut. All sets guaranteed. Coast to coast receiving range. Also contains everything in radio supplies, including batteries, chargers, loud speakers, transformers, condensers, rheostats and any other parts you may want for improving your set or building a new one. Guaranteed saving to you of 15 to 17. We are the world's largest exclusive radio mail order house.

RANDOLPH RADIO CORPORATION
159 North Union Ave., Dept. 268 CHICAGO



1926

Catalog

Containing

64

illustrated

pages of

Radio

Bargains

Write for

It

Today

CHANGES OF ADDRESS

should be sent to Subscription Department at least two weeks in advance of publication in order to insure early and proper attention. RADIO WORLD'S subscription list is so large that it is necessary that changes be sent in as requested. Address, Subscription Department, RADIO WORLD, 145 W. 45th St., New York.

Tuning Fork Parallel Shows Beat Note Action

If a tuning fork, which is vibrating at 270 times per second, is mounted near a

tuning fork vibrating 265 times per second and sounded, a person listening a short distance away will hear a sound alternately swelling out and dying away five times per second. These tone vibrations are known as beats. Now suppose that two sources of undamped or continuous electrical oscillations of steady amplitude act at the same time upon one circuit, one of frequency of 39,500 cycles and the other at a frequency of 38,000 cycles, the height of the oscillations which result will rise to a maximum and then fall to a minimum at the rapid rate of 1,500 cycles a second. This is obtained by subtracting 38,000 from 39,500 cycles. If this is rectified by a vacuum tube detector or a mineral (crystal) detector, the variations of the oscillations that result, will make a note of audible character at the frequency of 1,500 cycles in the loud speaker or headphones. Now if one of these two oscillations is the signal being received and the other is manufactured by the circuit, we have what is known as beat or heterodyne reception.

FREE BOOKLET FOR INVENTORS
 IF YOUR INVENTION is new and useful it is patentable. Send me your sketch.
 Z. H. POLACHEK, 70 Wall St., New York
 Reg. Patent Attorney-Engineer

New and Improved FRESHMAN MASTERPIECE
 AT AUTHORIZED FRESHMAN DEALERS ONLY

Long Distance Radio

Only \$295



200,000 SATISFIED OWNERS
 —Getting stations 600 miles away on Lambert Radios. No batteries or tubes required. A real Radio—not a toy or attachment. One to four can listen at once. No howling or screeching noises. Hear local stations on bed-springs, light sockets or telephons. Fully guaranteed. Set, \$2.95—Phones, \$2.95—Aerial, \$1.00. Mail orders filled same day. We pay postage.
LEON LAMBERT RADIO CO.
 212 So. Market St. Wichita, Kansas

VICTOREEN—(From page 28)
 meter leads are securely made—that is, well soldered—and that the contact of the lead from the potentiometer arm, or midpoint, to the F posts of the three transformers is a good one. Be sure that the oscillator grid return is to A minus, not to negative filament on any socket, for otherwise the potentiometer is placed in the tuned circuit, and squealing may be-

come inevitable, although curable by potentiometer readjustment.
 As a final resort against squeals or broad tuning, copper mesh in screen form may surround the oscillator condenser. This would constitute one box-like compartment in which these parts are housed. Only faulty construction or unwise choice of parts would require you to resort to such shielding in this set.

DON'T TRY TO TUNE BY GUESS
 KNOW where to place your dials for each station in America.
 KNOW what station you receive without waiting announcement.
 You can do both with **RADEX**
 Send 25c Coin or Stamps
RADEX, Box 143-M, Cleveland, O.

LOUD SPEAKER RECEPTION
 from either coast on three tubes
 Blueprint and instructions..... \$1.00
 Necessary low loss coll..... 2.50
 Beautiful finished instrument.....\$35.00
S. A. TWITCHELL CO.
 1930 Western Avenue Minneapolis, Minn.

Vacuum Tubes Rebuilt \$1.00 each
POSITIVELY GUARANTEED equal to new tubes in every respect. Money will be refunded if tubes prove unsatisfactory for any reason other than burn-outs.
 Send us your broken and burned out tubes by parcel post. (Not necessary to insure or guard against breakage.) We make return shipments by parcel post C.O.D. and try to maintain 24-hour service.
HARVARD RADIO LABORATORIES
 200 Old Colony Avenue South Boston, Mass.



The Miracle OF THE Magic Dial!

How This **Bruno** Precision Instrument Contributes to the Ease and Comfort of Life

MANY sets—home-constructed or factory-built—render excellent service, except that tuning in low wave-length stations is an ordeal, they are so frightfully crowded on the dials. This is due to the semi-circular plates of the tuning condensers in conjunction with any ordinary dial. The only way to cure this nuisance would be to rip the set apart and put in straight-line frequency condensers, were it not for the Bruno Magic Dial.

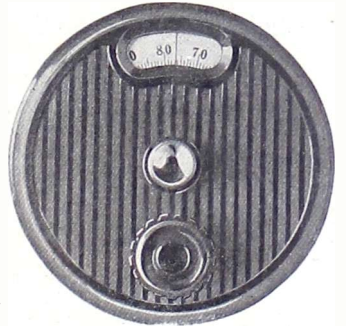

The Magic Dial

All you need to do to uncrowd the air is to slip Bruno Magic Dials on your present set, *without putting a screw or bolt on your panel!* The Magic Dial makes any condenser that is not SLF tune as if it were! Moulded Bakelite, \$2.50.

For straight-line frequency condensers use the "BRUNO" SLO MOSHEN VERNIER DIAL (same face as the Magic Dial).....\$2.00

Complete Kit for 5-Tube, 1-Dial POWERTONE \$22.50
 Build this set and enjoy acoustical synchronizing—real tone quality. SLF condenser and Bruno Slo-Moshen Vernier dial. Blueprint FREE with each kit.

POWERTONE CONE SPEAKER
 18" Diaphragm. 5-Day, Money-Back Guarantee. Charming Tone.
 \$14.49.

BRUNO RADIO CORP.
 221 FULTON STREET
 NEW YORK CITY

KB-8
 Browning-Drake Non-Regenerative
PARTS for SET BUILDERS
SET OF 6 PANELS
 Genuine Celoron, drilled and decorated..... \$8.35
ALL HARDWARE
 Lastites, screws, pillars, angle brackets, etc..... \$3.80
DONLE DETECTOR
 The most sensitive tube for KB-8 and RX-1 Sets.. \$5.00
WIRIT,
 neatest and easiest for wiring radio sets 20 ft.. 25c

RX-1 Construction Kit
 Complete RX-1 Kit, and Donle Tube, latest improved design.....\$37.50

DEALERS
IMMEDIATE DELIVERY ON DONLE DETECTOR TUBES—FULL DISCOUNT—

DURRANT RADIO, Ltd.
 R-52 Vanderbilt Ave.
 Vanderbilt—2274.

1925 BACK NUMBERS OF RADIO WORLD WANTED
 Mail us copies of any of the following 1925 issues of RADIO WORLD, and we will send you a copy of a current issue for every copy sent us: January 10, March 23, April 4, 11, 18, 25; May 2, 9, 16, 23, 30; June 6, 13, 20; July 4, 11, 18, 25; August 1, 8, 15, 22; September 5.

Dah-Dit-Dah-Dit-Dah!

By IRVING PHILIP WOLFE
ZAPJ

The Sixth Annual Convention of the Executive Council, Second District, is in full swing in the Hotel Pennsylvania, New York City. A large group of third district hams is augmented by hams from many other parts of the country. The club members are starting their annual festivities in the Grand Ball Room where the convention is being held and are all out for the booth honor. A talk on transformer types by Lewis Winner, Technical Editor of RADIO WORLD, was fully enjoyed Tuesday evening. Friday, Herman Bernard, Managing Editor of RADIO WORLD, talks on "Trouble Shooting in Broadcast Receivers."

1 AOA of Newport, R. I., the RADIO WORLD representative in lower New England, sends me the following dope: "1 CH worked Portugese 3 GB a couple of nights ago and AOA says that the Portugese is sure fb up in Newport. 1 AOA, one of the star stations of the first district, works every foreigner he calls and some whom he doesn't. AOA was reported in New Zealand at 2:30 in the afternoon and worked a new ham BB2. If anyone knows BB2's QRA please send it to me, care of RADIO WORLD."

Our weekly new QRA—2 NJ—is at 9537 Tyndal St., Jamaica, L. I., N. Y. His name is Charles Sanders, and he is on the air at present.

1 AFN is pounding away as usual and

DISTANCE AND VOLUME AT YOUR COMMAND

Build a 5-Tube Tuned Radio-Frequency Set, Using the Streamline Kit.....**\$7.50**



Boxed Kit consists of 3 Streamline .00035 mfd. straight-line frequency condensers, 3 basketweave coils, 3 mountings. Above, with 3 Bruno Slo-Moshen Vernier Bakelite Dials.....**\$12.50**

Streamline SLF Condensers

- .00025 mfd.....\$2.00
- .00035 mfd..... 2.25
- .0005 mfd..... 2.50

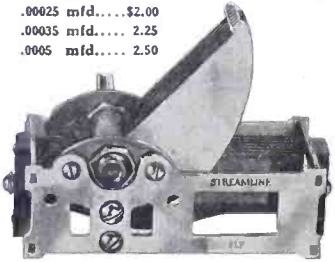

Enclosed find \$..... for which send me at once.....Streamline SLF tuned radio frequency kit,.....Streamline SLF tuned KF kit, with Bruno Slo-Moshen Dials,.....Streamline SLF condensers; capacity.....

Name
Address
City..... State.....

STREAMLINE RADIO CO.
223 FULTON STREET
New York City

is having some remarkable luck with mercury cam switches. He has the best luck with remote control in the first district. 1 AAP's set is for sale. He intends to put in some new UX 210s. The circuit is undecided as yet but he may turn out a master oscillator affair.



The Edison Element "B" Battery has long been the marvel of battery users, thereby surpassing all others. The See-Jay Battery is constructed from genuine alkaline elements and connected with a non-corrosive connector. 100-volt Alkaline Rechargeable "B" Battery and factory made charger for \$12.00; 140-volt, \$17.00. Write for literature or send 20c for sample cell. Send no money—pay on delivery. SEE-JAY BATTERY CO., 915 Brook Ave., N. Y. City

2 CV, Irving Korenman, has returned from a trip to the gulf ports and will soon open up on 40 meters with some sort of low power set. Incidentally, he is with the City Radio Co. of N. Y. C.

Italian 1 AS says that 1 AOA is one (Concluded on page 31)

Save 20 to 50% FREE RADIO CATALOG

LATEST IN HOOP-UPS AND RADIO
Get the lowest rock-bottom prices on radio parts, sets, kits. New free Radio Catalog and Guide brimful of standard, reliable, guaranteed goods. Over 100 latest hoop-ups and illustrations. Be sure to get this thrifty book before you buy. It puts money in your pocket. Saves you as much as half on a set. Also please include name of radio fan. Send letter or postal NOW.

THE BARAWIK COMPANY
103-140 S. Canal St., Chicago, U. S. A.

AEROVOX

Is Specified By LEWIS WINNER for the TECTRON

AND ALL OTHER RADIO WORLD'S "B" ELIMINATORS

Why? Because they are "BUILT TO BE BETTER." Also FIXED MICA CONDENSERS, RESISTORS and RESISTANCE-COUPLED UNITS.

AEROVOX WIRELESS CORP.

489-491-493 Broome Street

New York City



QUICK-ACTION CLASSIFIED ADS.

10 Cents a Word. 10 Words Minimum. Cash with Order.

FOR SALE—NEW FIVE-TUBE AERODYNE RADIO RECEIVER without accessories, \$34.80. 10% off on Radio Sets and parts. Agents for Kennedy, A. C. Dayton, Burgess, Cunningham Tubes, etc. 10% of the amount must accompany your order. Amateur Radio Supply Shop, 525 Park Ave., Kent, Ohio.

LONG DISTANCE ONE-TUBE RADIO—BLUE PRINTS 50 cents. Volume, distance, selectivity. Built very reasonably. J. M. Hobbs, Jr., R. No. 1, Box 483, Houston, Texas.

PATENTS—Write for free Guide Books and "Record of Invention Blank" before disclosing inventions. Send model or sketch of your invention for our Inspection and Instructions Free. Terms reasonable. Radio, Chemical, Mechanical, Electrical and Trademark experts. Victor J. Evans Co., 924 Ninth, Washington, D. C.

FOR SALE—Quick—25 standard Victoreen Kits, all six coils, \$28.00 per kit. First come, first served. Box 32, Station C, Toledo, Ohio.

BARGAINS—S-TUBE RECEIVERS—Crosley, Atwater-Kent, Grimes, Freshman. Speakers, eliminators. G. Simmis, Lake, New York

SILVER-GILT, THE NEW SILVER-PLATED bus wire. Price 4c foot, postpaid. Also silver-plated antenna wire. Send for circular, J. A. Armstrong, 124 Pleasant St., Attleboro, Mass.

BULLDOGS BEAUTIFUL REGISTERED BULL PUPS, \$15. Bulldogs, 501 Rockwood, Dallas, Texas.

HELP WANTED MALE
EARN \$110 to \$250 monthly, expenses paid as Railway Traffic Inspector. We secure position for you after completion of 3 months' home study course, or money refunded. Excellent opportunities. Write for Free Booklet, G-161 Stand. Business Training Inst., Buffalo, N. Y.

FILL OUT AND MAIL NOW SUBSCRIPTION BLANK

RADIO WORLD

RADIO WORLD

145 West 45th Street, New York City (Just East of Broadway)

Please send me RADIO WORLD for months, for which please find enclosed \$.....

SUBSCRIPTION RATES:
Single Copy \$ 15
Three Months 1.50
Six Months 3.00
One Year, 52 Issues 6.00
Add \$1.00 a Year for Foreign Postage; 50c for Canadian Post age.

6th Annual
RADIO SHOW
and
CONVENTION
Executive Radio Council, 2nd District, Inc.
Mar. 8 to 13—Hotel Pennsylvania
Admission 50c. NEW YORK CITY

GET THE OFFICIAL
BOOKLET ON HOW TO BUILD
Radio World's 1926 Model
DIAMOND
OF THE AIR

The text of the official Diamond booklet was written by HERMAN BERNARD, designer of the 5-tube circuit which offers the most in selectivity, volume, tone, quality and DX. Price, per copy **50c**

CERTIFIED BLUEPRINT
FREE with every copy of THE OFFICIAL Booklet. Bernard's signature is on every booklet and every blueprint. Both sent FREE to new yearly subscribers. News and Radio Dealers: Send to publication office for Wholesale Prices. Or order direct from American News Co., Inc., 131 Varick St., N. Y. C., or American News Co. Branches in other cities.

RADIO WORLD, 145 W. 45th St., N. Y. C. Enclosed find 50c. Send me copy official Diamond Booklet, with FREE blueprint. Or both free with \$6.00 for yearly subscription.

NAME
ADDRESS
CITY STATE

(Concluded from page 30)
of the loudest U. S. stations heard and promises to start sending me Calls Heard.
* * *

VEBY HIGH-MU TUBES

Made especially for Resistance Coupled Amplifiers. Now you can get more volume with greater clarity.
A. F. 20 for the 1st and 2nd Stage..... \$3.00
A. F. 6 Power Tube for the 3rd Stage..... 4.50

VEBY RADIO CO.
47-51 Morris Avenue Newark, N. J.

BEAUTY-QUALITY-LOW PRICE

TYPE 5SS \$45
5-Tube Tuned Radio Frequency.
TYPE 6RR \$50
6-Tube Resistance Coupled Audio Tuned Radio Frequency.

If your dealer cannot make immediate delivery we will ship direct from factory
American Interstate Radio Service
183 Greenwich Street, New York City
Distributors, Jobbers, Dealers, write for special trade terms

Gets Everything but Noise!

Amazing new Aerial guaranteed to eliminate all power noises such as leaky transformers, generators, motor hums, D.C. Flute, etc. Ques static, regeneration low and squeals.
L. E. Dr. Gehrig, Oakland, Cal. says Improves reception 60%.
Hundreds other testimonials. Wonderful results. Mr. Beech, Grand Haven, Mich. heard 3 foreign stations during tests with Kane Antenna. Easy to install.
\$1.00 Bronze **BLUE PRINT**—Working Drawings—
Complete Instructions for Erecting.
I will send dealer bill for credit. Limited quantity. Send TODAY.
KANE ANTENNAE CO., Dept 833 3343 W. Monroe, Chicago

ULTRA-LOWLOSS
CONDENSER

SPECIAL CUTLASS PLATES DISTRIBUTE THE STATIONS EVENLY OVER THE DIAL SIMPLIFIES TUNING. CAPACITY 0005 MFD
\$5.00
PHENIX RADIO CORP., 116 F East 25 St., N.Y.C.

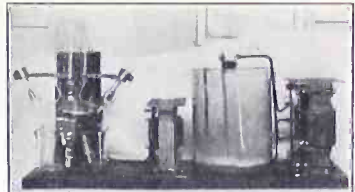

THE NEW MERCURY arc rectifier of 3 CDQ, which is started by tipping the tube. Note that the bottom of the rectifier tube is placed in a jar of oil.

All stations hearing 2 ERC are asked to report to the Executive Radio Council, 74 Cortlandt St., N. Y. City.
QST-QST-QST-de-2 APJ-2 APJ-2 APJ.
Don't forget to send those Calls Heard, new QRAs, bits of news and queries to 2 APJ, Irving P. Wolfe, Amateur Editor, RADIO WORLD, 145 West 45th Street, New York City, or call 2 APJ on the air, 40, 80, or 150 meters.]

CLAROSTAT
prescribed by LEWIS WINNER for the TECTRON "B" ELIMINATOR. Also O.K.'d by RAYTHEON and a host of other Nationally Known Eliminator manufacturers. \$2.25.
American Mechanical Laboratories, Inc. 285 N. 6th St. Brooklyn, N. Y. Dist. R. W.

Lastite
terminals look all circuit connections permanently; save time and labor; they are neater. ISN'T THAT GOOD?
Write to
William Stewart Co.
27 Hammett Road Roslindale, Mass.

"Send Me Another BRETWOOD Variable Grid Leak"

Thank you for introducing me to the Bretwood Variable Grid Leak! I have installed one in my Three Circuit Tuner according to your instruction and find that it does all you said it would and more.
S. R. HUBBS,
180 Quincy St.,
Brooklyn, N. Y.

The grid leak I sent for arrived and has been installed in a 4-tube regenerative set. I have tried them all, but have never had the pleasure of a real grid leak before. It is just a wonderful little instrument.
F. K. WEISER,
Haskell, Oklahoma.

Gridleak received and tested out, and find it is the only variable leak I ever used that is really variable.
Enclosed find \$1.50 for which please send me another one.
F. E. STALTON,
Box 240, Ardmore, Okla.

I think it is about the best grid leak I have ever used. Have made quite a few sets and this beats them all. Get DX very plainly and clearly.
WM. HEBERSON,
2510 N. Franklin St.,
Philadelphia, Pa.

This leak is used in King George's Palace and by the U. S. Shipping Board; over 270,000 sold in last four months

Specified for the Diamond of the Air

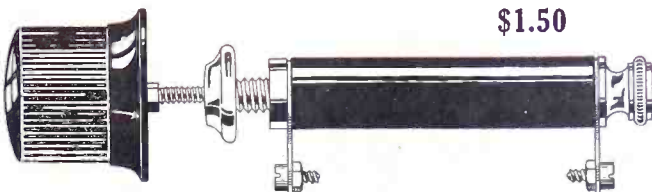

\$1.50

1/4 to 10 Megohms

Bretwood, Ltd., London, Eng., Sole Patentees and Owners

More DX, Clearer Reception, Smoother Control in Regenerative Sets Assured

The Bretwood Variable Grid Leak may be installed in any set in five minutes by single hole panel mounting.

The North American Bretwood Co., 145 W. 45th St., N. Y. City

Sole Distributors for United States
Canadian Distributor, Radio, Ltd., Phillips Square, Montreal

NOTE TO RADIO MANUFACTURERS

Write for Wholesale Rates

A set with a FIXED Grid Leak may work perfectly where tested, while it needs a VARIABLE Grid Leak so that set may be adjusted to the locality where used.

THE NORTH AMERICAN BRETWOOD CO., 145 West 45th Street, New York City.

Gentlemen: Enclosed find \$1.50 for which you will please send me one Bretwood Variable Grid Leak prepaid. Satisfaction guaranteed or my money back after trial within ten days of receipt by me.

NAME
STREET CITY
STATE

Perhaps you, too, can cut your "B" battery costs in half. Just follow the chart. It gives you the secret of "B" battery economy.

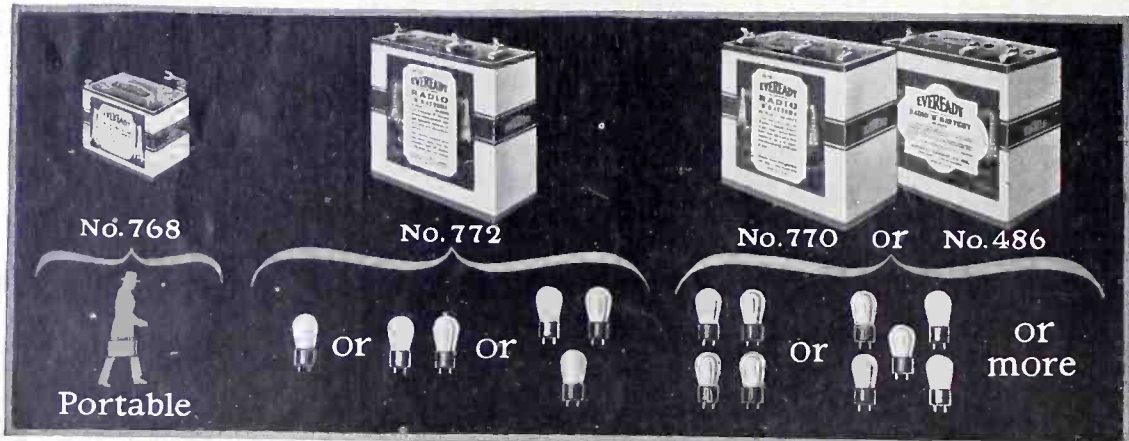

THOUSANDS of people have made the discovery that Eveready "B" Batteries, when used in the proper size and with a "C" battery*, are the most economical, reliable and satisfactory source of radio current.

On sets of one to three tubes, Eveready "B" Battery No. 772, used with a "C" battery, will last a year or longer, usually longer. On sets of four and five tubes either of the larger Heavy Duty Eveready Batteries No. 770 or No. 486, used with a "C" battery*, will last eight months or more.

These figures are based on the average use of receivers, which a country-wide survey has shown to be two hours daily throughout the year. If you listen longer, of course, your batteries will have a somewhat

*NOTE: In addition to the increased life which an Eveready "C" Battery gives to your "B" batteries, it will add a quality of reception unobtainable without it.

shorter life, and if you listen less, they will last just that much longer.

Here is the secret of "B" battery satisfaction and economy:

With sets of from 1 to 3 tubes, use Eveready No. 772.

With sets of 4 or more tubes, use either of the Heavy Duty Batteries, No. 770, or the even longer-lived Eveready Layerbilt No. 486.

Use a "C" battery on all but single tube sets.

Evereadys give you their remarkable service to the full when they are correctly matched in capacity to the demands made upon them by your receiver. It is wasteful to buy batteries that are too small. Follow the chart.

In addition to the batteries

illustrated, which fit practically all of the receivers in use, we also make a number of other types for special purposes. There is an Eveready Radio Battery for every radio use. To learn more about the entire Eveready line, write for the booklet, "Choosing and Using the Right Radio Batteries," which we will be glad to send you on request. This booklet also tells about the proper battery equipment for use with the new power tubes. There is an Eveready dealer nearby.

Manufactured and guaranteed by
NATIONAL CARBON CO., INC.
 New York San Francisco
 Canadian National Carbon Co., Limited
 Toronto, Ontario

Tuesday night means Eveready Hour
 —9 P. M., Eastern Standard Time,
 through the following stations:

- | | |
|------------------|--------------------------------|
| WEAF—New York | WSAI—Cincinnati |
| WJAR—Providence | WEAR—Cleveland |
| WEEI—Boston | WWJ—Detroit |
| WTAG—Worcester | WCN—Chicago |
| WFI—Philadelphia | WOC—Davenport |
| WGR—Buffalo | WCCO—Minneapolis |
| WCAB—Pittsburgh | WCCO—St. Paul |
| | KSD—St. Louis |
| | Pacific Coast Eveready Period |
| | KGO—San Francisco—8 to 9 P. M. |

EVEREADY
Radio Batteries
—they last longer