

The Improved BROWNING-DRAKE

AUGUST 14

15 CENTS

1926.

RADIO WORLD

Reg. U. S. Pat. Off.

Vol. 9. No. 21 ILLUSTRATED Every Week

STORAGE BATTERY
LIFE 4 TO 6 YEARS
STEINMETZ'S FIRST
GREAT DISCOVERY
REAL QUALITY FROM
SET IS COMPROMISE

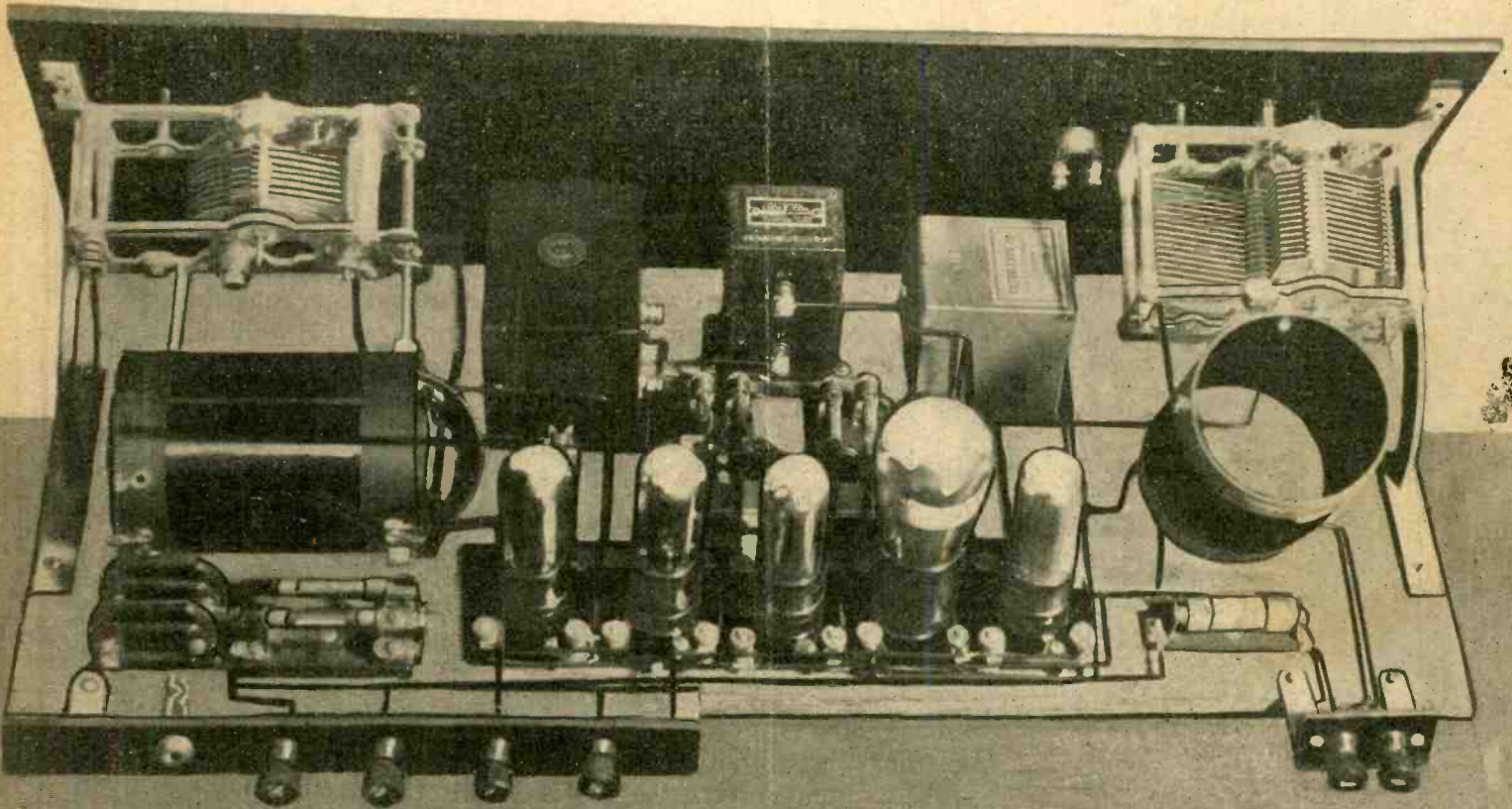

(Foto Topics)

REAR VIEW of the Improved Browning-Drake See article on page 3.

DE FOREST SEEKS R. C. A. MILLIONS

How the Vacuum Tube Was Invented

BROADCAST THUNDER AMAZES FANS

FREE!!

This handsome VALET Auto-Strop Razor FREE—with every five months' subscription to "Radio News" or "Science and Invention" or "Amazing Stories"



In order to acquaint the readers of this magazine with these great publications, we are making, for a limited time, a special reduced rate and are also giving FREE one complete VALET Auto-Strop Razor outfit.



For only \$1 (Regular Newsstand price \$1.25) you can obtain any one of these magazines for five months and also, one FREE Razor—

RADIO NEWS is the largest radio magazine published. It is the outstanding authority in the radio field, carrying more new developments, more hook-ups and more news than any other radio magazine.

RADIO NEWS has been radio's greatest magazine since the very beginning of radio broadcasting.

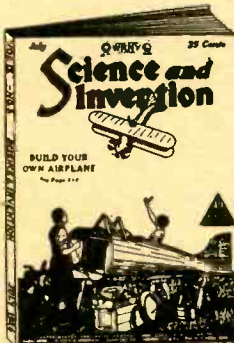

Every day, in all corners of our busy world, Scientists are at work on new Inventions, developing marvelous machines for the progress of the world or compounding strange chemicals for many uses. All these things are shown in the novel magazine "SCIENCE AND INVENTION."

There is also a big Radio Section to "SCIENCE AND INVENTION" for beginners.



Marvelous, Amazing Stories by great men such as Jules Verne, H. G. Wells, etc., appear in this new magazine AMAZING STORIES every issue.

Stories of flying into space at dazzling speed on a comet; Mesmerizing the dead, remarkable situations of all kinds. Tremendously interesting—yet instructive.

Keeps you in touch with the writings of the men with the greatest imaginations in the world.

EXPERIMENTER PUBLISHING CO., Inc.
53 Park Place, New York, N. Y.

Gentlemen: Enclosed find \$1 for 5 Months' subscription to RADIO NEWS or SCIENCE and INVENTION, AMAZING STORIES and 1 Free Auto-Strop Razor advertised above.

NAME

ADDRESS

CITY, STATE

CHECK MAGAZINE DESIRED AND MAIL COUPON TODAY.

The coupon on this page is for your convenience, clip it today and pin a \$1 bill, money order, or check to it. Fill out the Coupon with your complete name and address NOW.

EXPERIMENTER PUBLISHING CO., Inc.
53 Park Place New York, N. Y.

[Entered as second-class matter, March, 1922, at the post office at New York, N. Y., under Act of March 3, 1879]

The Improved BROWNING-DRAKE

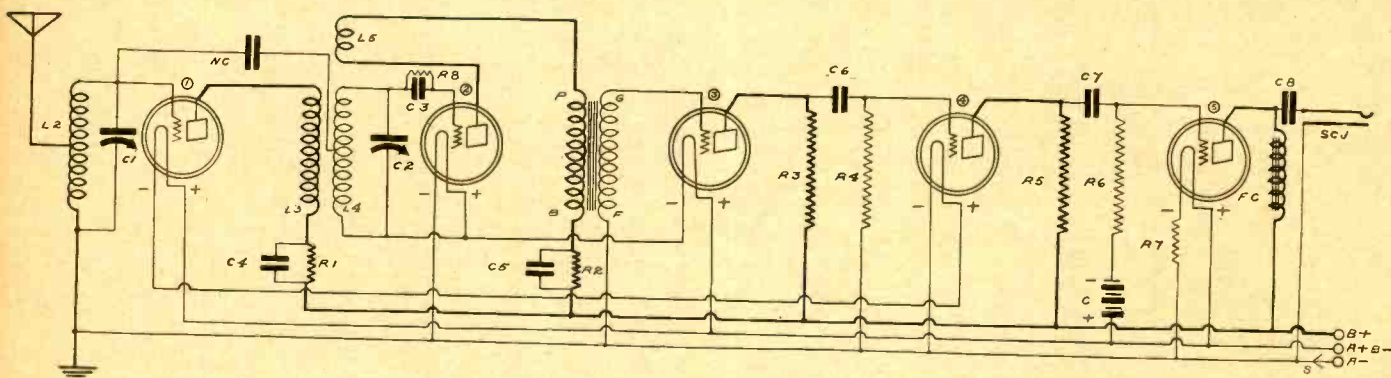

FIG. 1

THE IMPROVED Browning-Drake, shown in electrical diagram, and representing the combined talents of Glenn H. Browning, Frederick H. Drake, Arthur H. Lynch and Laurence M. Cockaday. Coils of almost incredibly low loss are used. The first four tubes are of the 99 type, while the last tube is a 171 power tube. Only one B+ lead is used, thus simplifying the wiring. The plate voltage is suitably dropped for the radio frequency and detector tubes by fixed metallized resistors. Tubes 1 and 4 are series connected, as are tubes 2 and 3.

Gain in Selectivity, Sensitivity and Tone

Scientifically Designed Coils Reduce Radio Frequency Resistance 40%—High-Grade Transformer and Metallized Resistors Give Superb 3-Stage Audio Channel—Four 99 Tubes and One 171 Power Bulb Used in Set—Neutralization Simplified

By Herman Bernard

Associate, Institute of Radio Engineers

PART I.

FOR the radioist who wants a 5-tube receiver of the tried and true variety, made of the best parts that the market affords for the particular design incorporated, the Browning-Drake is highly attractive, especially in its new dress. The circuit itself is three years old, which is something decidedly in its favor, for no circuit is re-elected to popular favor year after year without fully justifying the distinction.

It was developed by Glenn H. Browning and Frederick H. Drake in the Cruft Laboratory at Harvard and first was published in "The Christian Science Monitor." Since then it has been published by every American radio magazine or supplement of any standing and by periodicals the world over. You will find the receivers in the missionary huts in Alaska, in the tea houses and pagodas of Japan, on the Bund in Shanghai, in the Raffles Hotel at Singapore, no less than in thousands of American, Cana-

A Compelling Circuit

TO those who build their own sets the Improved Browning-Drake's appeal is compelling. Every angle of efficiency has been expertly considered and the result is the present circuit—a model of efficiency. Selectivity, sensitivity, tone quality and volume are obtainable to a thrilling degree. The circuit is presented with suggestions to experimenters, some of whom perhaps will discover new means of refinement. Built as described, the set will prove extraordinarily efficient. Whatever improvements time will produce will be duly recorded in these columns. Meanwhile, however, all may accept the united findings of four noted experts as compelling.

—EDITOR.

dian, Mexican, South American, British and European igloes, homes and haciendas.

The new model will have an even farther flung fame and will be the electrical and aesthetic pride of many more thousands of abodes, because it represents refinements that, while not changing the original design of the radio part of the receiver, make for better tone and greater efficiency and economy.

Outstanding Features

The outstanding features of the Improved Browning-Drake (Fig. 1) are:

(1) Coil design. This is the contribution of Messrs. Browning and

How Experts Improved The Browning-Drake



(Foto Topics)

PANEL VIEW of the set. The National dial actuating C1 is at left. Next to it is the filament switch. At right are the dial for C2 and the knob for L5. The name engraving and "Designed by Arthur H. Lynch" also appear on the panel.

Drake to the improved receiver. The coil construction is such that the radio frequency resistance has been decreased to 7 ohms at 300 meters, an improvement of about 40 per cent. over conventional coil design.

(2) The inclusion of a superb audio channel, consisting of a first stage of high-grade transformer coupling, followed by two metallized resistance-coupled stages. The output from the last tube is obtained through a filter choke and fixed condenser hookup that keeps the B battery current out of the speaker windings, which might be injured or ruined by long use with a high plate voltage power tube were not this tone-smoothing method used. The audio channel, as devised, is highly suitable even if a B battery eliminator is employed.

(3) A single lead is used for the B plus, the voltages for the radio frequency and detector tubes being suitably reduced by fixed metallized resistors, bypassed for radio frequency efficiency. The common lead considerably reduces the wiring for the B voltages and makes for greater effectiveness, due to shortened or omitted leads. This is the contribution of Arthur H. Lynch to the new design, which he worked upon in its entirety as modeller and collator.

(4) Economized filament wiring, in conjunction with the use of low filament consumption tubes. All tubes, except the last bulb, are of the 99 variety. The first (radio frequency) and the fourth (second audio) tubes have their filaments in series with a 6-volt source, while the filaments of the second (detector) and third (first audio) tubes likewise are in series. The last tube is a power tube, connected in the usual way, in parallel with the A battery, and has a fixed resistor to drop the 6 volts at the source to 5 volts at the filament. The method of filament wiring is the contribution of Laurence M. Cockaday, technical editor of "Popular Radio," the enterprising periodical that has done much to give the Improved Browning-Drake the place it properly deserves in the hearts of the home constructors this season.

Thus it can be observed that no paucity of expertness has accompanied the design of the refined receiver.

Analysis of Circuit

These four men were responsible for selection of most suitable parts for the

hookup, electrical and space requirements being taken into full account.

The circuit consists of a neutralized stage of tuned radio frequency amplification, a regenerated detector and the 3-stage audio amplifier, with filter choke and condenser hookup for the output. The antenna connection is made to a mid-tap on the single winding which comprises the radio frequency transformer. This is in fact an auto-transformer, where L1 is the primary, connected to aerial at midtap, and to ground and minus A at one terminal. The secondary consists of the entire winding, L1L2, which is tuned by the variable condenser C1.

This method of antenna coupling affords a very strong input, the energy being many times greater than by the inductively coupled untuned primary type of transfer. Owing to the effect of the antenna-ground capacity upon the tuned circuit, being like a parallel capacity across L1, the condenser C1 is .0005 mfd. This affords absolute safety in covering the wavelength or frequency band.

A higher inductance to capacity ratio prevails in the interstage circuit, the secondary L4 being wound for tuning with a .00025 mfd. variable condenser (C2). The L3L4 inductance ratio therefore permits a greater voltage stepup, on account of the correspondingly larger number of turns on the secondary in respect to the primary L3.

Moreover, the primary L3 is generously wound, the inherent coil efficiency and the neutralization of the radio frequency tube making it unnecessary to resort to the skinny primary device to avoid uncontrollable oscillations. The Browning-Drake is completely in check at all times and the over-oscillation nuisance can be created only by clumsy mistuning of the tickler coil L5.

The neutralization is made very effective and simple by the use of a wide range, easily adjusted compensating condenser, known as the X-L Vario Denser, Model N.

The Tuning Units

The tuning units, about which the whole circuit pivots, include the famous BD-1B, for L1L2C1, and BD-2B, for L3L4L5C2. The tuning condensers are of necessarily high electrical efficiency and mechanical strength. Suitable dials are included in the BD-1B and BD-2B units. The National Company manufactures these units consistent with the designs specially prepared by Messrs. Browning and Drake. While the coils are just as efficient, as

LIST OF PARTS

One National antenna unit, type BD-1B (one single tapped coil, one Equeicycle variable condenser and one dial); L1L2, C1.

One National detector tuning unit, type BD-2B (one triple coil, one Equeicycle variable condenser and one dial); L3L4, L5, C2.

One Jefferson Concertone sealed audio frequency transformer; PBGF.

One Thordarson 30-henry filter choke, R 196; FC.

One Tobe paper filter condenser, 4.0 mfd.; C8.

One Sangamo, Aerovox or Dubilier mica fixed condenser, .002 mfd.; C4.

One Sangamo, Aerovox or Dubilier mica fixed condenser, .006 mfd.; C5.

One X-L Vario Denser, model N; NC.

Three Lynch double mountings for the resistors R1, R2, R3, R4, R5, R6.

Two Tobe paper filter condensers, 0.1 mfd. each; C6, C7.

Three Lynch metallized resistors, 0.1 meg. each; R3, R5, R6.

One Lynch metallized resistor, 0.5 meg.; R4.

Five Benjamin push type Cle-Ra-Tone sockets; 1, 2, 3, 4, 5.

One Lynch metallized resistor, 6.0 meg.; R8.

One Lynch metallized resistor, .025 meg. (25,000 ohms); R1.

One Lynch metallized resistor, .09 meg. (90,000 ohms); R2.

One Brach-stat, code 2B, with mounting; R7.

One Carter battery switch; S.

One Sangamo, Aerovox or Dubilier mica fixed grid condenser, .0005 mfd., with clips; C3.

One Bakelite decorated panel, 8x22" (Cortlandt Panel Co., Insulating Co. of America or Pausin).

One pair of Tait brackets.

One Corbett sloping panel cabinet for 8x22" panel.

One bracketed antenna connection block (Ant. Gnd. Eby binding posts thereon).

One bracketed battery connection block (A-, A+, B-, B+, C- Eby binding posts and one Frost Gem-Jac No. 954 thereon).

One 9 1/2 x 2 1/4" hardwood baseboard (furnished with Corbett cabinet).

Four Ce-Co type C tubes.

One 171 power tube.

[Note: The National Velvet Vernier type A dials are furnished with the BD-1B and BD-2B units, unless the variable ratio type is specially requested.]

coils, no matter what circuit is used, and are suitable for wave traps, crystal sets, absorption circuits, inductively compensated or volume-controlled hookups and the like, the home constructor, in the interest of scientific experimentation, will be glad to judge their high efficiency in the Browning-Drake circuit, and if he is so minded it is up to him to adopt the coils to the circuit.

Without constant experimenting with factory-made and other apparatus there would be little or no advance in radio, and the Improved Browning-Drake is offered

Filaments Economized By Series Connections

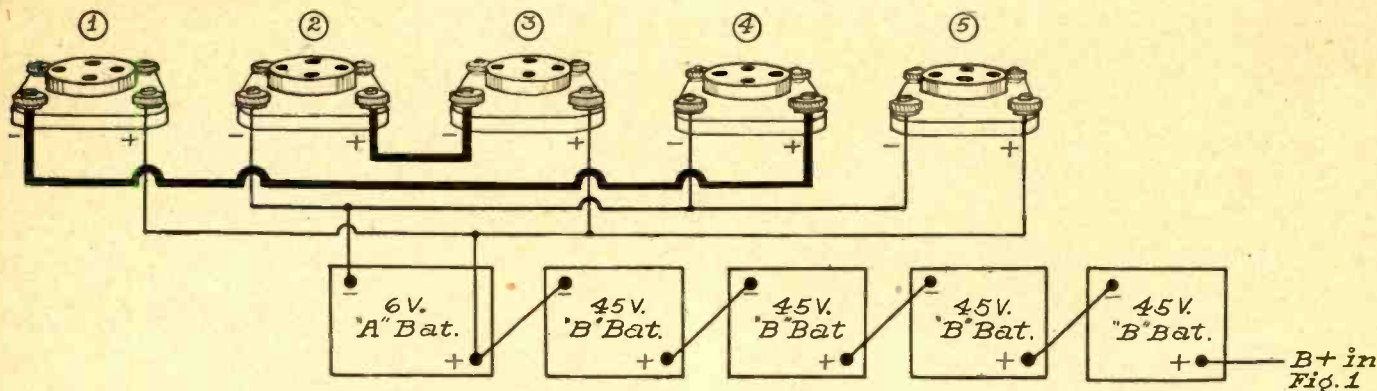

FIG. 2

DETAIL OF the filament wiring, showing the first and fourth tubes series connected, and the second and third tubes similarly joined (accented by heavy lines). The final or power tube is filament wired in the conventional way. With a 171 tube in socket 5 suitable B batteries for the receiver would be Eveready Layerbuilt No. 486. A 45-volt battery (not shown) may be used for grid biasing, as explained in the text.

Ohm's Law Applied To Get Tube Voltages

to all, and especially to those who have a laboratory comprising precision instruments, so that the voltage development in successive stages may be measured, as well as the sensitivity and selectivity. All these are inordinately high, but it is not to be expected that every one scientifically inclined will take another's word for it. Some, like Charles P. Steinmetz, may doubt everything until they prove it to their own personal satisfaction, and as to them, the laboratory experimental method, with precise measurements at every step, will prove doubly attractive, and, incidentally, corroborative of the findings of other engineers. Besides the research may lead to further improvement in the art.

Attractive to Eye

In keeping with the excellent design of the radio and audio features—that is, the set itself—a panel and cabinet arrangement has been selected that will make the receiver very attractive. The sloping panel type cabinet used is a Corbett 8x22", with which a baseboard is supplied. The panel is suitably drilled and engraved. Many will find it convenient to use this decorated type of panel, but for those otherwise inclined, the drilling dimensions will be given.

The filament drain is .06 ampere for a 99 tube, with a filament voltage of 3. The filament resistance equals the voltage divided by amperage, usually expressed as

$$R = \frac{E}{I}$$

Numerically this is

$$R = \frac{3}{.06} \text{ or } \frac{300}{6} = 50 \text{ ohms.}$$

Thus by connecting the positive leg of the filament of a 99 tube to A battery plus, and the negative leg of the filament

of that tube to the positive leg of the filament of another 99 tube, the negative leg of which second tube is joined to A battery minus, we have effected series connection, have added the resistance of one filament to that of the other, but have not increased the drain. It is still .06 ampere, though two tubes are used, for the series connection reduces the voltage while allowing the amperage to remain unchanged.

Potential Difference

Another way of looking at it is to regard the filament of one of the tubes as being used as a fixed resistance to drop the voltage. Thus in Fig. 1 or Fig 2, with a 6-volt source, be it storage battery or an A battery eliminator, the voltage at the negative filament leg of tube 2, connected to A minus, is zero. At the plus post of this tube it is 3 volts positive, at the minus leg of the filament of tube 3 it is 3 volts positive and at the positive post of tube 3 it is 6 volts positive. As positive and negative are purely relative designations, used for convenience, and as direct current flows only one way, from low to high potential, the minus post of tube 3 is really zero and the plus post is 3 volts positive, on account of there being only a 3-volt potential difference between these two posts. Graphically, the minus leg in tube 2 and the positive leg in tube 3 are connected across the A source, the filament of tube 2 dropping 3 volts and the filament of tube 3 dropping 3 volts.

The same series system of connection is used in respect to tubes 1 and 4.

Hence the filament drain in amperes is a total of .06 for tubes 1 and 4, a total of .06 for tubes 2 and 3, and for the power tube is .5, a grand total of only .62 ampere.

The Power Tube

The constructor has a choice of power tubes for the last socket, 5. He may use the recommended 171, which has a maxi-

mum undistorted output of 700 milliwatts at a positive plate potential of 180, with the grid negatively biased 40½ volts. Under these conditions the B battery drain of the tube is 20 milliamperes. The negative bias is readily obtainable if a 45-volt B battery is used as the C battery, and the C plus (45) is connected to A plus, instead of to A minus. This starts off the C battery with 5 volts positive (A plus as compared with filament minus of tube 5), so that the minus post of the C battery is really + 5 - 45 = minus 40 volts.

The plate current drain of the receiver will be about 28.5 milliamperes from a 180-volt source. This is not extraordinarily high, but unless one uses heavy duty or layer built B batteries he will find that his choice of B batteries has not been tintured with economic wisdom. I used Eveready Layerbuilt No. 486 with four 99 tubes and one 171. With two hours average daily use of the receiver these batteries last about eight months.

Use of 112 Tube

An alternative is to use a 112 tube for the fifth socket, and if 180 volts are applied to FC, then the grid bias should be about 12 volts negative, and the plate drain will be about 11 milliamperes. Another possibility is to use only 157½ volts for B plus, still retaining the 112, but using 10½ volts negative bias, the plate drain being 8 milliamperes, or a total drain of 16½ milliamperes for the set, which drain is comparatively low, and well within the economy range of the run of B batteries used in the home. (Eveready 770).

But if less than 180 volts are used for the B plus lead, then R1 and R2 may have to be of smaller resistance than prescribed in the list of parts, so the drop will not be so great across them, and the effective voltages on the RF and detector plates consequently will be higher than if the R1 and R2 values were retained as specified.

[This concludes Part I of the article. Part II, dealing with layouts and wiring, will be published next week, issue of August 21.]

Heat Causes Drop In Wave Efficiency

Effect Noted by Standards Bureau on Sky Component
Although Ground Wave Seems Immune From
Effects of Temperature

That temperature influences the strength of radio signals is the conclusion reached by L. W. Austin and Miss Wyomore of the Bureau of Standards, Department of Commerce. This work is a part of the program of the International Union of Scientific Radio Telegraphy, which was adopted at Brussels in 1922 and is now being carried on in the various countries belonging to the Union.

Two years ago Dr. Austin described a decided increase in the signals received at Washington from the Radio Corporation trans-Atlantic stations at Tuckerton and New Brunswick, N. J., during the passage of severe cold waves over the Eastern States. Further study now indicates that whenever the temperature rises along the signal path there is a tendency for the signal to drop, and conversely, a falling temperature tends to produce a stronger signal, though these temperature effects are often masked by other unknown influences.

Experiments on the relations existing between meteorological phenomena and radio transmission require preferably at least fairly uniform meteorological conditions between the sending and receiving stations. For this reason, stations between 125 and 190 miles distant were chosen for the experiments, rather than stations at great distances. On the other hand, stations much less than 125 miles distant would probably not have shown the influence of weather changes to so marked an extent.

There seems to be no doubt that the temperature changes influence the waves which are reflected or refracted from the Kennelly-Heaviside layer, 60 miles or more above the earth's surface, rather than the waves which glide along the ground, since no marked change is observed in signal intensity due to long continued rain or drought, the presence of snow, or the presence or absence of frost in the ground.

Neutralization Used In An Audio Hookup

Hazeltine Method Is Employed in Conjunction With
Push-Pull Transformers

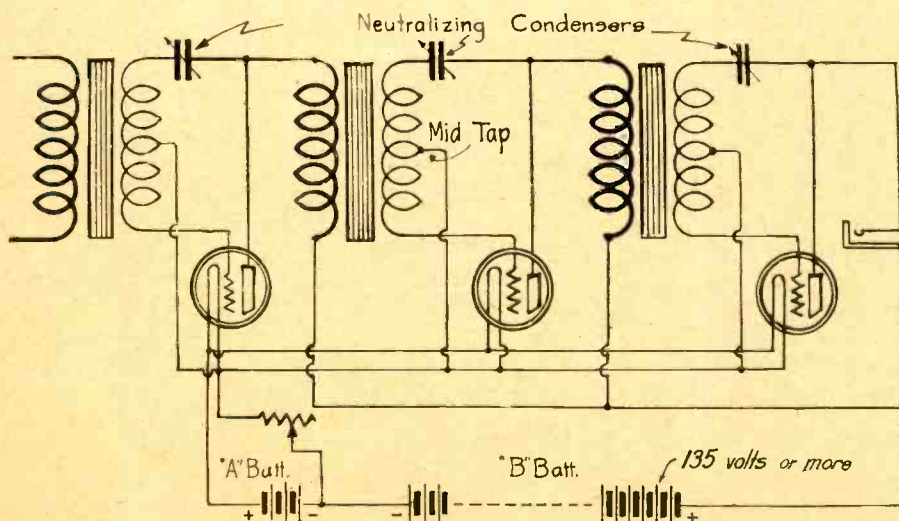

FIG. 1.

The circuit diagram of a neutralized audio-frequency amplifier.

The use of push-pull transformers, in conjunction with the regulation neutralizing condensers employed for radio circuits, enables one to experiment enjoyably with a neutralized audio hookup. Even three stages may be tried. The push-pull trans-

former lends itself to this system because of the midtap. This goes to F minus in the diagram. Note that the neutralizer connects from plate to grid of the same tube, through the secondary winding of each transformer.

CELL USED AS SIMPLE RECTIFIER



(Hayden)

PHOTO ILLUSTRATING the hooking up of a trickle A charger.

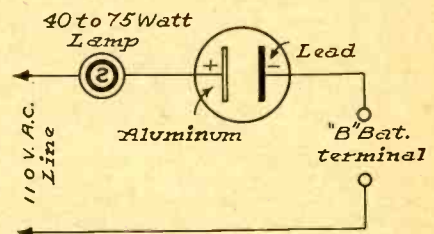

DIAGRAM ILLUSTRATING the hooking up of the same parts in a B eliminator (without filter).

Chemical cells are very useful when used as rectifiers in conjunction with eliminators and trickler chargers. They are compact, will pass much current at a high or low voltage and are quiet in operation. They can be used in single or double wave rectification systems. If pure aluminum and lead plates (before their forming) are employed, pure DC can be obtained, thus obviating the use of a filter, when used in a B eliminator circuit. In a trickle charger circuit the filter is unnecessary.

In the diagram and photo, a B eliminator hookup shown, a lamp being used in series, with no filter at the output. It must be remembered that unless the elements are very pure, the rectification will be poor. To get chemically pure plates is a difficult task. It is therefore suggested that the above hookup be used to supply plate voltage for the amplifiers, a regulation B battery being used for detector plate voltage. The secondary of a Ford spark coil shunted by 2 mfd. fixed condensers can be used as a filter, if the detector plate is to be supplied. For A trickle charger the above circuit, with a resistance in series with the AC lead, may be used with great success. The plates, already formed, may be purchased, while the borax solution may be made at home. An ordinary fruit jar may be employed as the container. The number of milliamperes that the plates will pass, depends upon the number of square inches of the plates beneath the solution, allowing about 41 mills to the sq. in.

One WJZ Generator Would Light All Tubes In New York City Sets

Huge motor generator units are used to supply the current to light the filaments of the transmitting tubes of Station WJZ in Bound Brook, N. J. The current output of one of these generators alone is sufficient to light the tubes of all the receiving sets in New York City simultaneously.

Storage Batteries Live 4 to 6 Years

How to Gain This Result—Comparison of Dry and Rechargeable Sources Made by Expert

By John A. White

Vice-President U. S. Light & Heat Corp.

The storage battery and the dry battery are alike in one important particular. The two devices have a common characteristic, unique and peculiar to the supply of electrical energy by chemical means, that this supply is true direct current. There is no ripple or fluctuation in voltage corresponding to commutator hum or due to incomplete rectification or to fluctuation of voltage of supply mains.

Over intervals relatively long as compared with the frequencies used in radio, that is to say from second to second and from minute to minute, under a maintained condition of constant current, the voltage of the storage battery or dry battery remains absolutely constant.

This point is important in amateur radio transmission. It is not going too far to say that any amateur can identify a storage battery operated station, as soon as he hears the note. Interference from stations on adjacent wavelengths using bad alternating current supply is more or less eliminated, as the signal is sharper and more confined to its operating wavelength. It is easy to copy the direct-current note through interference and at remarkable distances.

This has been many times demonstrated during the past winter in the records made by low power direct current operated transmitters.

Four Differences

Between the storage battery and the dry battery, however, are four outstanding differences in operating characteristics:

First, the storage cell is rechargeable. Following the change of lead peroxide and sponge lead to lead sulphate in the normal discharge of the cell, this lead sulphate may be converted again to the original condition of peroxide on the positives and sponge lead on the negatives by connection to a suitable source of charging current, the cell then being again ready for another period of service discharge.

In other words, the discharging process is reversible, and the succeeding operations of discharge as a source of electric power supply and charge to bring back the conditions under which the storage cell may again furnish electric current may be repeated indefinitely until the cell wears out in service.

The primary or dry cell, however, may act but once, continuously or intermittently, as a source of electrical current. When discharged it is useless.

Second, the difference in voltage of the storage cell between the state of full charge and that of nearly complete discharge is relatively slight. The voltage is well maintained under given conditions of discharge rate for the larger portion of the discharge period, dropping down less rapidly at the start and holding well up until nearly at the end. With the dry cell the voltage drops in more or less of a straight line from beginning to end of discharge and over a considerable range.

Third, the virtual internal resistance, that is, the resistance factor which pro-

duces variation in voltage with change in current rate, is extremely low in the storage cell. Both storage and dry cells increase in internal resistance as discharge progresses. Not only is this increase in resistance less marked in the storage cell but the initial value of resistance is so low that this effect is practically nil. The dry cell, however, gives a voltage somewhere near its initial voltage for only a small portion of its rated capacity in terms of rate and time and exhibits more and more as discharge progresses variation of this voltage with current change.

Fourth, the storage cell has to a marked extent the property of recovery. In intermittent operation, as usual in radio service, it gives at the beginning of any short discharge period a voltage higher than that given at the end of the previous discharge, and until the intermittent discharges have integrated nearly to the rated capacity, the storage cell gives under these conditions of intermittent use the voltage of a nearly charged condition.

Why Life Is Shortened

Reverting for a moment to the first outstanding characteristic of the storage cell, the type of plate used in both A and B radio batteries will give in laboratory practice from 400 to 600 cycles of charge and discharge before disintegration. This would indicate a service life in radio of many years. Actually, this service life is greatly shortened, due to abuse, overcharging and overdischarging, idle periods in a discharged condition, lack of attention to the necessity of refilling to replenish evaporation and other causes. In farm lighting plants, where the same type of plate is used and the battery is given a more or less complete charge, usually weekly or twice a week, a service life of ten years is not unusual and six to eight years something like the average. A good radio A battery should give dependable service over a period of at least four to six years.

In our second consideration, the open circuit voltage of the storage cell of the pasted plate type may be taken as 2.15 volts at full charge and initial operating voltage at low rates as 2.1. Radio batteries are usually of sufficient capacity for several weeks' intermittent operation. The final discharge voltage may be as low as 1.80.

Greatest Discharge

By far the greater portion of the discharge at radio rates, whether continuous or intermittent, is between 2.05 and 1.95 volts. The final voltage is approached only as the cell nears complete discharge. This variation from 2.05 to 1.95 represents only 5 per cent. lowering in voltage over most of the discharge period. In comparison, the initial voltage of the dry cell, 1.5, drops down from the start, going to about 1.13 at the practical end of its useful service life, a variation of 25 per cent.

Now, again if partially charged at more frequent intervals than would be represented by the full discharge period, or installed with a so-called trickle charger, the available voltage of the storage cell

A Charging Precaution

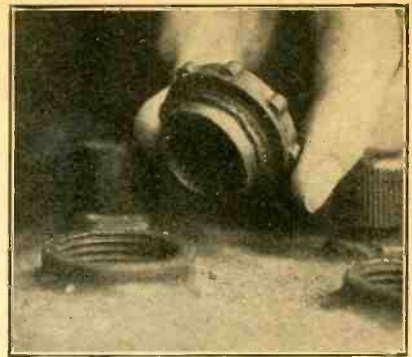

(Radio World Staff Photo)

ALWAYS TAKE 'off the caps on your storage battery during the charging process. Hydrogen gas is formed and when held within the walls of the battery will tend to expand. Matches lighted near it would be dangerous. Take off the caps for absolute safety.

may be considered as constant at or near the 2.1 voltage or full charge, whereas the continual loss in voltage of the dry cell is unavoidable.

Storage batteries for radio service are almost universally in the lead-acid type of the so-called Faure plates. These are made with grids or lattice frameworks of lead antimony alloy, on which by special machine processes are pasted mixes of lead oxides, constituting the active material.

After pasting, the plates are converted respectively into positives and negatives in the forming process, that is, by continued charging. They are then in A battery manufacture, assembled into groups by lead burning the plate lugs to so-called post straps, then assembled with the separators, usually of wood, Port Oxford cedar, in compartment type rubber or glass containers.

Cells are joined together by lead links, integrally lead burned to the posts of the positive and negative groups, and to gas and acid tight lead bushings moulded in the rubber covers. When finished, the batteries are shipped either with the acid, charged and ready for use, or more often in what is called the Add-Acid type. In this form the batteries are without acid, but completely charged and ready for service upon the addition of the necessary acid electrolyte.

Sizes of Batteries

Radio A batteries range in size from 18 ampere hours capacity at four volts for Super-Heterodyne receiving sets, and 35 ampere hours at six volts for so-called trickle charge batteries, up to the larger A sizes of 75, 93½, 105 and higher ampere hour capacities. B batteries are usually in two plate types, in glass jars, of capacities 2500 to 4500 milliampere hours and in assemblies of 12, 24 and 40 cells, giving nominally 24, 48 and 80 volts, and covering the voltage range of standard 22½, 45 and multiples of these figures in dry batteries. Both the A and B types find application in broadcasting stations as well as for home receiving sets and amateur transmission.

A set is just now being installed for the new Palisades Station of WHN, New York. In this thirty 6-volt A batteries of 105 ampere hours capacity will be used for the filament circuits, in two duplicate sets of 15 batteries each, arranged in series parallel to give up to 60 amperes at various voltages up to 14. The B batteries are of special design, 1280 cells of 34 ampere hours capacity, to give plate currents up to 2½ amperes at nominal 2500 volts. Standard 4500 milliampere hour B batteries are provided for grid bias.

Science Requires Reasonable Aims

Tone Quality Preserved Only When Selectivity Is Not Pressed Too Far—To Fill a Hall Use Power Amplifier

By Arthur H. Lynch

Remember, the last time you attended a symphony concert, how you watched the fellow with the bull fiddle saw the ropes all evening and how the bosom of his dress shirt had a habit of sneaking up to meet his chin? There was something pungent and mellow about the cavernous cadences his energetic bow drew out, wasn't there? Remember how, at the end of a very lively martial phrase, his deep voiced rhythm blended with the booming of the heavy drums while the shrill tones of many violins made your pulse quicken and little shivers run up and down your spine?

The rest of the music was there, but it was pleasing because it was blended masterfully. Without the deeper tones it would have lacked that peculiar something which gives the symphony orchestra its roundness of tone color, so pleasing to the cultured musical ear.

Well, it is the effort to reproduce the lower registers as well as the very high registers which is a problem being fought by both engineers in charge of broadcasting and those who design radio receivers. If you are to have great symphonies reproduced faithfully in your homes the broadcast engineer must see to it that the waves leaving his antenna for their journey to your home are truly replicas of the waves produced by the orchestra in the auditorium.

This does not sound like a very complicated problem, but it is. In order to solve it, the engineer must provide himself with some means of picking up the faint call of the violins, flutes and other wood winds as well as the extremely powerful sounds produced by the French horns and your friend the bull fiddle.

Limitations at Every Hand

The first thought of the broadcaster, then, centered upon a diaphragm which

UNIT ADJUSTMENT

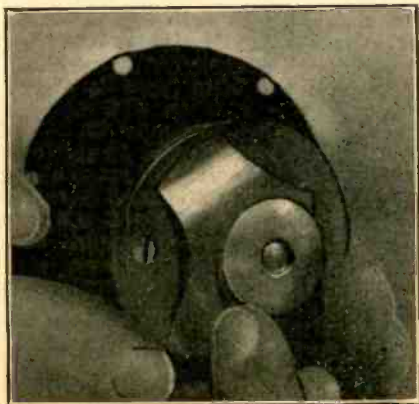

(Radio World Staff Photo)

YOU CAN make your phone or loudspeaker unit adjustable, by soldering a 2" screw on the internal casing and placing a bent piece of hard copper over it. A nut can vary the pressure, causing the magnets to go nearer or further from the diaphragm.

would be placed in a position when it would be struck and made vibrate by the sound waves leaving the instruments in the orchestra. To do this work properly the single diaphragm or disc would have to be sensitive enough to pick up the faint harmonics of all the notes produced by all the instruments and transmit these tone shadings to a point at its center where the sound vibrations on it would cause similar vibrations in an electrical contact which would control the remainder of the transmitting apparatus.

Various types of pick-up devices have been used for this purpose and not a single one can actually encompass the entire musical register, but they are approaching this goal all the time. The most common fault of the microphone, as such a pick-up is called, is its susceptibility to sounds in the upper register and its failure to properly pass sounds in the lower registers.

In order to overcome this difficulty there are two general methods of attack. By placing the deep voiced instruments near the pick-up device their pressure on it is increased to a point where it is forced to carry or pass the vibrations. There is a physical limit to which this scheme may be carried because the sensitive microphone may be so heavily shocked at to cause blocking or rattling. The other means of accentuating the lower tones is to reduce the energy in the high and middle registers by designing the amplifier portion of the transmitter to pass the low tones more readily than the higher ones. This system means, therefore, that the over-all amplification, if it is to include the bass notes, must be much greater than would be necessary if the bass notes were not important.

Microphone's Limit

Most present-day microphones have what in radio parlance is called a rising characteristic. That merely means they will respond most easily to notes in the upper register. Many amplifier systems share this characteristic and the result, if proper precautions were not taken, would be the sending out from the broadcasting station a series of waves in which the higher notes were not only reproduced, but their volume, with relation to the remainder of the music, would be all out of proportion and what is commonly called distortion would be introduced. The result would be anything but pleasing.

The broadcast engineer, then, has a very difficult job on his hands and the high quality now radiated by an increasing number of stations bears witness to the excellence with which he has done it. These are only a few of his many and complicated problems, but, for the time we may as well let him rest with his worries and strive for a few minutes to learn some of the problems we will have in attempting to reproduce what he has been able to satisfactorily provide.

Most of us demand of radio receivers more than is physically possible. For instance, we want tone quality first, last and all the time. Sometimes we want to be able to reach out for distant stations

and even on such reception we continue to demand tone fidelity. Where we live in sections provided with many broadcasting stations we sometimes demand that our receivers be capable of cutting through the local stations with knife-like precision and bring in the distant stations and still deliver a true tone picture of what is taking place at the distant station.

To accomplish all these things is, with our present knowledge of radio and acoustic fundamentals, a practical impossibility. It would still be impossible even though we were able to cut out all interfering electrical disturbances produced by other systems than radio, but which do affect radio receivers when they are operated in the sensitive condition necessary for extreme distance and sharpness of tuning.

Limit of Selectivity

In order to have our receivers capable of cutting in the desired stations and cutting out all the undesired ones, it must be designed so as to cover a very narrow band for any given setting of the dial or dials. There is a definite limit to which we may go in this direction and just as soon as we pass this limit we must sacrifice some of the tone quality. Radio men call a procedure of that kind "cutting side bands." It amounts to cutting off some of the speech or music tones and results in producing a sort of rhythmic discord at the loud speaker and this reproduction is commonly referred to as being "tinny." The tones are sharp and nasal and lack that full roundness which characterizes good music and a cultured voice. Listening to music (if it may be called music) of this sort, for any length of time, becomes monotonous and bore-some.

Therefore we must compromise, and many manufacturers are now appreciating the necessity of this compromise. A few years ago almost anything of a rhythmic nature coming from a distant station was considered wonderful. It was indeed wonderful, but hardly wonderful music. Its musical properties were so poor that many true music lovers would have nothing to do with radio and would not permit a receiver in their homes.

Rich Tone Today

This is not true today, because there are now available any number of radio receivers capable of rich tone quality on stations where extreme selection power is not necessary. Most of them are capable of getting distant stations when they are desired, but they must not be expected to deliver the same high class music from a station several hundred miles away when that station is found directly between two local stations on the dials and the separation between the three is very slight. There are some limitations even to radio.

Within the past two years more attention has been paid to reproducing true tone quality than ever before, and more engineers have come to realize that much of their work would be in vain, if they attempt to produce tone with finesse from receivers which would, because of their very sharpness, prevent some of the tones from passing through.

Even the public is coming to realize that radio, as wonderful and as satisfactory as it is, cannot yet be considered as a perpetual motion device. In order to get something out of the loud speaker we must have some energy to operate it.

More Volume, More Current

Most of this energy comes from the batteries we use at the receiving end. If we require great volume we must expect to use more current from the batteries than is necessary for little volume. It should be remembered, however, that

receiving engineers have gone to great lengths in saving this current by improving the vacuum tube and methods of using it, just as illuminating engineers have been able to give us the same amount of light from much less current by improving our lamps. However, for a given producing system we will require more current for more volume.

And the question of volume in radio is a very important one, because about nine tenths of us operate our receivers at a point where the volume produced is beyond the limit of the units employed in our receivers.

There are physical limits to the capacity of our tubes just as there are to our appetites or the speed our car will develop without also developing trouble. Very few machines of any kind are efficient when overloaded. If we eat beyond our normal requirements we suffer all manner of disagreeable conditions—indigestion, fatigue, sleeplessness, et al; if we drive our motor beyond its normal capacity we lose traction, are bounced about and are as likely as not to burn out a bearing or two. If, in our radio receiver, we are using small tubes and we turn out enough volume to fill a dance hall we cannot expect music, because we are sure to get noise instead. Overloading our tubes—and such operation is surely doing just that—results in a heavy drain on our batteries and produces distortion which almost any ear will detect.

Do Not Overload Tubes

Where small tubes are employed we may well be satisfied if our load supplies volume enough for a medium sized room. Where semi-power tubes are properly used we may expect enough volume from our speaker to fill a large room without sacrificing tone quality, but where music loud enough for dancing in a fair-sized ball room is required ordinary tubes will not do. We must use a power amplifier, equipped with power tubes.

The idea that an ordinary receiver may be used in a club or hotel dining room without such a power amplifier is doing much more to hurt radio than to make it popular. In almost every cast of this nature the receiver is cranked up to the last notch in order to have it heard above the rattle of dishes and buzz of conversation. The result is bedlam. Radio receivers, when properly designed and properly operated, are capable of tremendous volume accompanied by beautiful tone color. They may be called upon to serve where every other means for providing entertainment would fail and they will produce music in a most satisfactory manner if we employed them with some regard for their limitations and do not look for Cadillac performance from a flivver.

Better Chance to Hear Seven Foreign Stations

WASHINGTON.

A number of foreign stations have increased their power sufficiently to enable them to be heard in the United States under favorable conditions, according to reports to the Department of Commerce. Here is a list of foreign stations of high power:

| Call Meters | Watts | Location |
|------------------|-------|----------------------------|
| ORV—488—10,000— | | Austria, Vienna. |
| OKP—513—5,000— | | Prague, Czechoslovakia. |
| 5XX—1600—16,000— | | Daventry, England. |
| 2FC—1100—10,000— | | Sydney, Australia. |
| 3LO—371—5,000— | | Melbourne, Australia. |
| 4QG—385—5,000— | | Brisbane, Australia. |
| 5CL—395—5,000— | | Adelaide, South Australia. |

Broadcast Thunder Outpaces Original

**Picked Up by Outdoor Microphone, It Arrives Through
Speaker Earlier Than Through Window,
Proving Radio is Speedier**

The broadcast listeners who doubted the statement of engineers that radio waves travel more rapidly than sound waves had a splendid opportunity to prove themselves wrong when Station WJZ was broadcasting the Carillon of the Park Avenue Baptist Church one Sunday evening recently.

The broadcast was unusual in that it was one of the first times that thunder had been broadcast, it usually being the case that when a thunder shower comes up, any outdoor broadcasting is discontinued, and furthermore, it proved conclusively to thousands of listeners that radio waves actually do move faster than sound waves.

Shortly after the broadcasting began, a severe thunder storm arose in the Southeast, moving rapidly toward the church where the microphones were in an exposed position picking up the sounds of the bells. As the storm approached, the crashes of thunder became louder and louder, finally drowning out the bells in their intensity.

Change of Conditions

Broadcast listeners at points to the north, northwest, and west of the church were able to look out of their windows, see a flash of lightning, which they heard simultaneously as a crash of static in their loudspeakers, and shortly afterwards would hear the roll of the thunder, which accompanied the flash of lighting, come through the loudspeaker as transmitted by the microphones at the church. Several seconds later, the same crash of thunder was again heard, but this time it was heard coming through the window, having reached the listener direct from the clouds by the sound wave route.

Broadcast listeners who were situated between the storm center and the microphones at the church had the same opportunity of hearing the thunder twice, but they heard it in the reverse order, hearing the direct crash first, and a few seconds later hearing the same crash after it had "travelled on" to the church microphones and then been transmitted back to them.

As the storm moved away to the northwest, conditions reversed themselves, those living in that section hearing the direct crash first and the radio transmitted crash later, whereas the listeners living in the southeast, where the storm originated, were hearing the crash from the loudspeaker first and a few seconds later, the direct crash. There was a point of balance for each listener, which lasted only a few seconds, at which time the direct crash and the radio transmitted rumble arrived simultaneously.

Did a Little Good

They say that "it is an ill wind that blows nobody good," and while the storm that caused this phenomenon took the toll of several lives and thousands of dollars in property damage, and finally tore down the power lines which supplied WJZ with electrical current for transmission and thereby forced the super-station to shut down for several hours, it did

several good turns. Outside of offering the listeners the opportunity of hearing such an unusual broadcasting event, it also demonstrated to the owners of sets whether their receivers were capable of reproducing the low frequencies.

Thunder is one of the lowest frequency sounds which can be heard, and some of the receivers in the metropolitan district were not able to participate in the fun of the broadcast because their reproduction qualities were such that only the high frequencies were reproduced and the sound of thunder did not percolate through.

Attention to Set Brings Summer DX

"Summer radio is like charity—both begin at home," says Earle C. Anthony, owner of KFI. "Except in the rarest of instances, Summer heat does not interfere with the transmission and reception of programs between stations and their legitimate local audiences.

"It is said by some," he continues, "that the effective range of Summer broadcasting is slightly less than half of the Winter range. Since KFI was and still is a nightly visitor to thousands of Atlantic Coast receiving sets, by accepting this ratio between cold and warm weather, we may naturally expect this Summer to cover the Western states quite thoroughly in spite of atmospheric disturbances.

"There are three or four things, however, that no listener can afford to overlook if he wishes to get the maximum reception during the Summer. He should tighten all loose connections, replace any broken wires in his antenna system; replace any batteries that are below full voltage; test all tubes and replace those below normal strength, and put his receiving set in the best possible condition."

EQUALIZATION

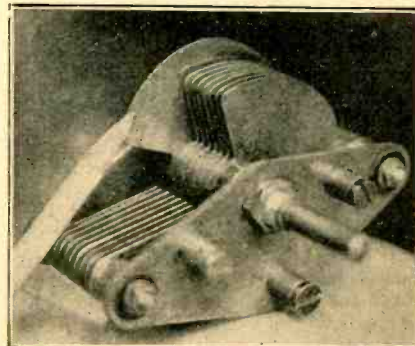

(RADIO WORLD Staff Photo)

IF YOU are the owner of a receiver (wherein the dials are supposed to read alike, but do not) having coils which cannot well be tampered with, you may use the extra plate type of condenser to balance tuning. This end plate, once set, can not be moved independently.

Radio University

A FREE Question and Answer Department conducted by RADIO WORLD for its yearly subscribers only, by its staff of Experts. Address Radio University, RADIO WORLD, 145 West 45th St., N. Y. City.

When writing for information give your Radio University subscription number.

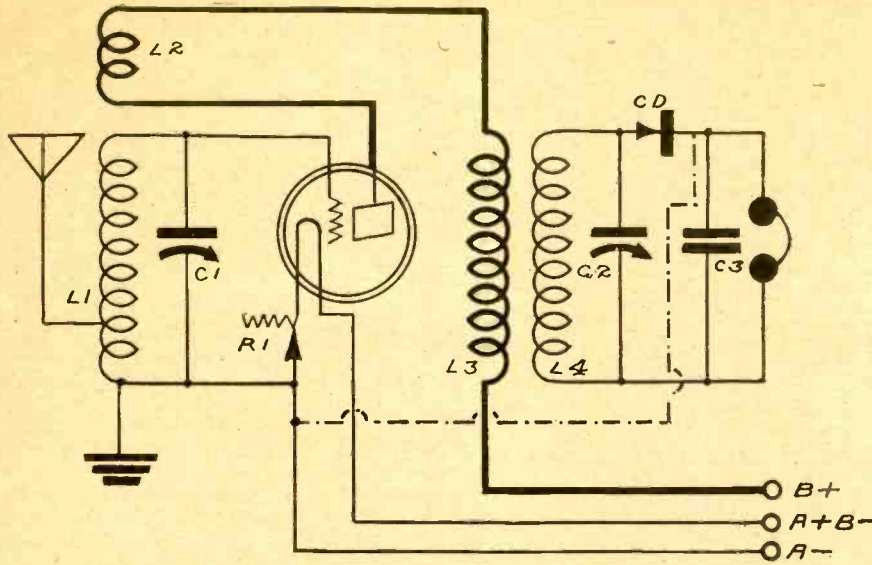

FIG. 407

THE ELECTRICAL diagram of the 1-tube receiver, employing a regenerative RF tube and a crystal detector.

PLEASE GIVE the circuit diagram of a 1-tube receiver employing a regenerative RF tube and a crystal as a detector. The antenna coil should be of the impedance type. The wiring directions with the constants of the parts, would be appreciated.—Henry Strand, Hurleyville, N. Y.

Fig. 407 shows the circuit diagram of this receiver. A 3-circuit tuner may be employed in the RF stage. L1 consists of 50 turns tapped at the 8th turn from the beginning of the coil. This is wound on a tubing 3 1/4" in diameter, using No. 22 double cotton covered wire. L2, the tickler, consists of 36 turns, wound on a tubing 1 3/4" in diameter, using No. 26 single silk covered wire. The tickler coil is placed near the 42 turn portion of the antenna winding, so as to obtain feedback of plate to grid. C1 is a .0005 mfd. variable condenser. L3 consists of 10 turns. L4 consists of 45 turns. These windings are made on one tubing, which is 3 1/4" in diameter, with a 1/4" separation between them. No. 22 double cotton covered wire should be used. A variable condenser (C2) having a capacity of .0005 mfd. shunts the secondary of this latter RFT. C2 is a .0005 mfd. fixed condenser. CD is the crystal detector, which may be fixed or variable. R1 is a 10-ohm rheostat. The -01A type tube is used. This set should be used when listening to local stations only. The antenna is connected to the 8th turn from the beginning of the coil L1. The beginning of the coil is brought to the ground. The end of this coil is brought to the stationary plate post of C1 and to the grid post of the socket. The rotary plate post of C1 is brought to the beginning of L1 and to the minus post of the A battery. The movable arm of the rheostat is now connected to this same joint. The terminal carrying the resistance wire of the rheostat is brought to the F minus post on the socket. The F plus post is brought to the A plus post. The B minus post is also connected to the A plus post. The beginning of the tickler winding is brought to the plate post on the socket. The end of this winding is brought to the beginning of the primary winding L3. The end of this winding is brought to the

B plus post. The beginning of the secondary winding L4 is brought to the rotary plate post of C2, to one terminal of the fixed condenser C3 and to one phone tip post. The end of this winding is connected to the high potential point of the crystal. The low potential point is brought to the other terminal of the fixed condenser C3 and to the other phone terminal. The high potential terminal of the crystal is also connected to the stationary plate post of C2. The low potential point is connected to the A minus post. This connection is experimental and will work best with fixed detectors. About 67 1/2 volts may be supplied to the plate of the tube. Any form of AF amplification may be added to the output of the crystal detector, transformer coupling being advised.

I RECENTLY built a 5-tube Neutrodyne for use with 5-volt tubes. However I found that I did not wish to use these tubes. Instead I tried the 99 type. I found that the volume decreased to a great extent, also the neutrodons had no effect. The tubes will not oscillate even when the neutrodons are taken out of the circuit. What can I do to rectify this fault?—Jonas Grant, Pawtucket, R. I.

The RFT you are now using were designed for use with 5-volt tubes only. The internal capacity of the 99 tubes is low in comparison to the 5-volt tubes. Therefore, to get equal results, add about 5 turns to the primaries. Be sure to have the bypass condenser in the detector circuit connected properly. This is connected from the plate to the A plus.

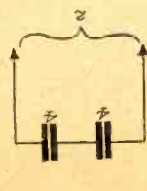

FIG. 405

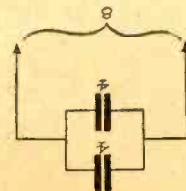

FIG. 406

THE PARALLEL and series methods of connecting condensers.

HOW CAN I find out the mutual conductance of a tube in micromhos, when the amplification constant and the plate resistance are known?—Carlos DeKohnes, Tannersville, N. Y.

To obtain the mutual conductance, divide the amplification constant by the plate resistance, e.g., 6.25 divided by 16,500 equals 380. This 380 is the mutual conductance in micromhos. Either the plate resistance or the amplification factor may be found out with this formula, also, if these are the unknown quantities to be obtained.

I HAVE two 4.0 mfd. fixed condensers. How will I connect them so as to obtain a capacity of 8.0 mfd.?—George Cram, Roscoe, N. Y.

Connect them in parallel. That is, connect one lead of one condenser to a lead of the other condenser and then connect together the other two leads. You have two leads, each lead coming from joined terminals. Fig. 405 illustrates the parallel method, which you should use, while Fig. 406 shows the series method (decreasing capacities), which you should not use for your purpose.

PLEASE GIVE a description of the internal wiring of the Carborundum Stabilizing Detector Unit and characteristics.—William Varks, Larchmont, N. Y.

The unit consists of a high resistance center-tapped potentiometer. A 400 ohm type may be used for tests in the laboratory. Also the Carborundum detector and bypass condenser are employed. The bypass condenser is used to kill the inductive reactance of the portion of the potentiometer, included in the detector circuit. By tapping the potentiometer at the center tap, a so-called biasing voltage of a negative 3/4 and a positive 3/4 volts is obtained. The battery which supplies the original voltage is of the 1 1/2 type. It is possible, with the great number of turns in the high resistance to obtain minute voltages impressed upon the crystal. In this way, the resistance of the detector may be made so high, that the detector will have very little damping effect on the tuning circuit. This gives more selectivity. Also the sensitivity point of the crystal may be obtained with greater ease. One side of potentiometer is connected to the plus post of the 1 1/2 volt battery. The minus post is connected to the other terminal of the potentiometer. The center tap is connected to one terminal of the bypass condenser. The slider of the potentiometer is brought to the other terminal of the condenser, making contact with the resistance wire. The center tap is also brought to the low potential point of the crystal detector, with the high potential point going to the detector input (from secondary). The slider contact goes to the return of the secondary. This wiring description of the external connections, serves for example only. That is, there are many circuits, where it may be connected otherwise.

WILL THE set described in the Radio University columns of the July 17 issue of RADIO WORLD, and shown diagrammatically in Fig. 375, work satisfactorily with dry cell tubes? If so, please state the best tubes to use. Please state the exact ratio of the audio frequency transformers employed.—J. H. Mallery, Farmerville, La.

Yes, using the 99 type tubes. The B voltages remain the same. The AFT used in the reflex stage should have a 6-to-1 ratio, while the AFT used in the regular AF circuit, should have a 3-to-1 ratio.

HOW MANY feet of wire (No. 20 dcc wire) are used to wind the honeycomb coils having 1,250 and 1,550 turns respect-

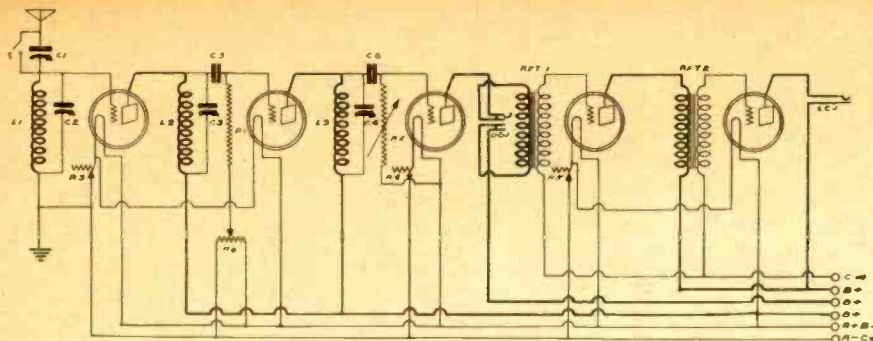

FIG. 408

The circuit diagram of the 5-tube impedance set.

ively? — Samseon Freighton, Catskill, N. Y.

The 1,250 turn coil consists of about 800 feet, while the 1,500 turn coil consists of about 950 feet.

PLEASE DESCRIBE the different methods of the use of the loop in conjunction with a Neutrodyne.—Charles Clauson, Pelham, N. Y.

The loop may be used in the same fashion as an antenna or a regular loop. The following methods are illustrative of the antenna methods. (1)—One end of the loop may be connected to the antenna post and the other terminal left open. The regular ground is left on. (2)—Both terminals of the loop may be connected together and thence to the antenna post. The ground is still left connected. (3)—One terminal of the loop may be connected to the antenna post. The other terminal of the loop may be connected to the stationary plate post of a known variable condenser. The rotary plate post of this condenser is then connected to the ground post. The ground may or may not be connected. The last method when using the loop as an antenna, is to connect both terminals of the loop to the antenna and the ground posts, shunting the terminals with a known variable condenser. Again the connection of the ground is optional. Now as to the connections which to employ when using the loop as a regular loop. Either four binding posts or a double circuit jack will be needed. When using the posts, connect the beginning and the end of the secondary winding to two posts. Connect the stationary and the rotary plate posts of the condenser that originally shunted this secondary, to another pair of posts opposite to those, just installed and connected. When desiring to use the loop, connect the loop terminals to the posts connected to the condenser posts. When desiring to use the antenna and ground, short these posts with strips of bus bar. When using the jack, the inner terminals are connected to the beginning and the end of the secondary winding. The top terminal (should be near the end of the secondary winding), is connected to the grid post. The bottom terminal (near the end of secondary winding) is brought to the A minus post.

WHEN SIX volts are impressed upon the primary windings of a Ford coil, what is the approximate secondary voltage obtainable? (2)—Please give a list of the various sizes of copper wire from No. 14 up to No. 40 accompanied with the resistance of each in ohms per thousand feet.—Thomas Crader, Lakeview, N. J.

(1)—It is possible to obtain as much as 8,500 volts at about 1/2 milliampere, when that voltage is impressed upon the primary. This, of course, could be stepped down through a resistance or transformer, if you contemplate using it as a B battery supply in a transmitter. (2)—No. 14 equals 1.580 ohms; No. 15 equals 2.504; No. 16 equals 3.172; No. 17 equals

5.04; No. 18 equals 6.36; No. 19 equals 8.25; No. 20 equals 10.12; No. 21 equals 12.76; No. 22 equals 16.76; No. 23 equals 20.30; No. 24 equals 24.60; No. 25 equals 32.2; No. 26 equals 40.7; No. 27 equals 51.3; No. 28 equals 64.8; No. 29 equals 81.6; No. 30 equals 103; No. 31 equals 130; No. 32 equals 164; No. 33 equals 206; No. 34 equals 260; No. 35 equals 328; No. 36 equals 414; No. 37 equals 523; No. 38 equals 660; No. 39 equals 832; No. 40 equals 1049.

I HAVE three 50-turn honeycomb coils, which I would like to use in a 5-tube tuned impedance receiver, wherein two stages of RF amplification, a non-regenerative detector and two stages of transformer coupled AF amplification are employed. The circuit diagram, constants and wiring of the RF stages, of this set is desired.—Quentin Humbult, Mineola, L. I., N. Y.

Fig. 408 shows the electrical diagram of this receiver. L1, L2 and L3 are the three honeycomb coils. C2, C3 and C4 are .0005 mfd. variable condensers, tuning these coils. C1 is another .0005 mfd. variable condenser. This is used to tune the antenna. It may also be used to obtain lower wavelength stations, that it is possible to receive if a long antenna is used. A switch is provided to cut this condenser out. One rheostat R3 is used to control the filament of the two RF tubes. A single rheostat R4 controls the filament temperature of the detector tube. Both these rheostats are of the 10 ohm type. R5 is a 10-ohm rheostat which controls the filament temperature of the AF tubes. R1 is a 1 megohm fixed resistor. R2 is a variable grid resistance. C5 is a .0005 mfd. fixed condenser. C6 is the regular .00025 mfd. grid condenser. DCJ is the double circuit jack, which may be used for listening in on earphones from the detector output. SCJ is a single circuit jack used for connecting the output of the AF circuit to the speaker. AFT1 and AFT2 are low ratio AFT (3 to 1). R6 is a 400 ohm potentiometer used to control the oscillatory action of the second RF tube. The antenna is connected to the stationary plate post of C1 and to one terminal of a switch. The other terminal of the switch is connected to the rotary plate post of the condenser and to the beginning of the primary winding L1. This same connection is also brought to the stationary plate post of C2 and to the grid post of the first socket. The end of this winding is connected to the rotary plate post of C2 and to the ground. It also is connected to the terminal of R3 going to the arm and to the A minus, C plus post. The terminal carrying the resistance wire of R3 is brought to the F minus post of the socket. This same connection is brought to the F minus post of the second socket, carrying the second RF tube. The beginning of L2 is brought to the plate post of the first socket and to the stationary plate post of C3. The end of this coil is connected to the rotary plate post of C3 and to the B plus 67 1/2-volt post. The plate

post of the first socket is connected to one terminal of C5. The other terminal of this condenser is connected to the grid post of the second socket and to one terminal of R1. The other terminal of R1 is connected to the terminal of the potentiometer connected to the arm. One resistance terminal of this potentiometer is connected to the F plus post, while the other is connected to the F minus post. The plate post of the second socket is connected to the beginning of L3, to the stationary plate post of C4 and to one terminal of C6. The end of the plate winding L3 is connected to the rotary plate post of C4 and to the B plus 67 1/2 post. The other terminal of C6 is connected to the grid post of the third socket and to one terminal of the variable resistor R2. The other terminal of the resistor is brought to the F plus post on the socket. The rheostat R4 is connected in series with the negative leg of the filament. The rest of the circuit is hooked up in standard fashion. A C battery is used in the grid circuits of the AF tubes. This should be of the 4.5 volt type if a 90-volt B battery is used to supply the plate voltage to the AF tubes. About 45 volts should be applied to the plate of the detector tube. The honeycomb coils can be mounted on back of the condensers by means of angle irons, or on the baseboard in their original mountings. They should each be placed so that no magnetic field exists between them. The C plus is connected to the A minus post. Bypass condensers, having a capacity of .001 mfd., may be connected from the plate to the A minus posts, in the RF and detector stages, for obtaining louder signals.

RECENTLY I have noticed that I must turn the rheostats controlling the filaments of the RF and Det. tubes in my 5-tube set all the way up in order to get satisfactory volume. These tubes have been in the set for the past year. Is it possible that the filament of these tubes are worn? My A and B batteries are fully charged. I also notice that the A battery discharges much quicker than heretofore. The voltmeter, when connected in the rheostat circuit, shows that 6 volts must be placed on the filament, to get any kind of volume.—Turner Smert, Larchmont, N. Y.

The filament is worn. Suggest that you get new tubes or try reactivation. At 6 volts, the filament is drawing more than 1/4 ampere, therefore causing a quicker discharge of the battery. If you find that it is necessary to burn the filament of the tube above 5 volts, which is the rated voltage given by the manufacturer, then you may be sure that the tube is deficient. The filament of the tube must not be heated with less than 5 volts, either, as this causes it to become brittle. In other words, to get absolute satisfaction from a tube, with correct plate and grid voltages, the filament must be heated with the voltage stated by the manufacturer, no higher or lower.

PLEASE GIVE the circuit diagram, electrical constants and RF wiring directions of the Super-Plidyne, which employs the Ferrand system of controlling the oscillatory action of the RF tubes. This set, I understand, employs 6 stages of tuned RF amplification, a non-regenerative detector and two stages of transformer coupled AF amplification.—Fred Bungster, Monticello, N. Y.

Fig. 409 shows the electrical diagram of this receiver. All the variable condensers, C1, C2, C3, C4, C5, C6 and C7, are .0005 mfd. capacity. These condensers are all geared together, thus giving you one dial for control. The transformers employed allow broad tuning. This is the reason for the use of so many stages tuned simultaneously. The primaries, L1, L3, L5, L7, L9, L11, L13, consist of 25 turns, wound on tubings 1 1/4" in diameter.

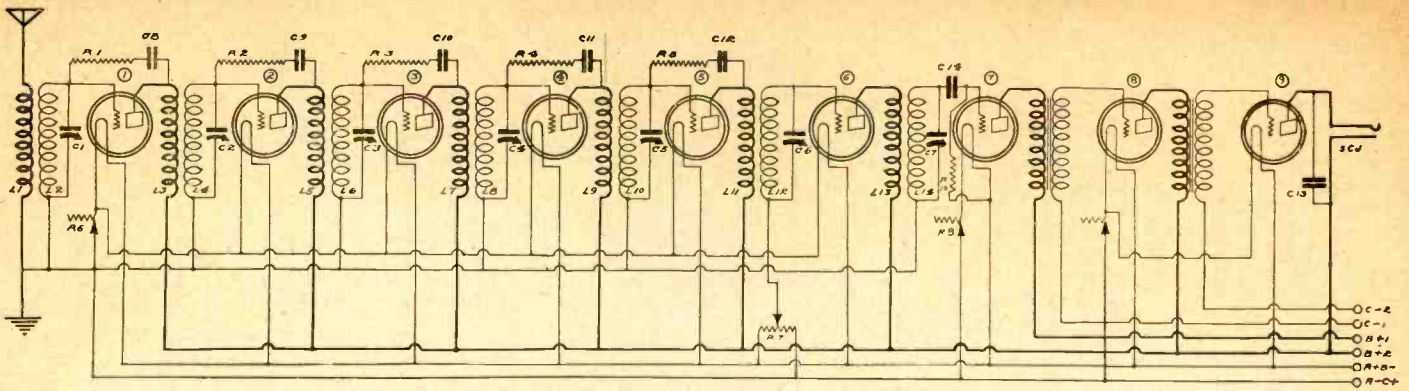

FIG. 409
The circuit diagram of the Super-Plidyne, a 9-tube super-sensitive receiver.

The secondaries, L2, L4, L6, L8, L10, L12, L14, consists of 100 turns wound on tubings 2" in diameter. No. 26 double cotton covered wire is used. The primary winding is placed inside of the secondary tubing. The primary winding is spaced. Between every primary turn, allow a space equal to three turns. This is equal to about 1/8" space between turns. The resistors in the neutralized stages are variable, although not indicated as such. They vary from 20,000 to 120,000 ohms. The condensers in these stages are also variable, they being of the regular midget type. C14 is the grid condenser, having a capacity of .00025 mfd. R10 is the grid leak, having a resistance of from 1 to 3 megohms. The filaments of all the RF tubes are controlled by a single rheostat, R6. The filament of the detector tube is controlled by a rheostat R8 having a resistance of 20 ohms. The RF rheostat has a resistance of 6 ohms. It should pass 1 1/2 amperes. The filaments of the AF tubes are controlled by a single rheostat R9 having a resistance of 10 ohms and being able to pass 1/2 ampere. The -01A type tubes are used throughout, thus a 6-volt A battery for filament supply. C13 is a .003 mfd. fixed condenser. R7 is a 400 ohm potentiometer used to control the oscillatory action of the tube. As to the wiring. The beginning of the primary winding is brought to the antenna post. The end of this winding is brought to the ground post and to the beginning of the secondary winding L2. This same lead is extended to the arm of the rheostat R6 and to the A minus C plus post. The rotary plates of all the variable condensers and the beginnings of the secondary windings of all the coils except L12 are connected to this same lead. This gives all the tubes in these circuits a negative grid return. The beginning of the secondary winding L12 is brought to the arm of the potentiometer. The resistance terminals of this potentiometer are brought to the plus and minus posts of the A battery. Although the grid return through the secondary winding, L14, is to minus, a positive bias is obtained on this detector tube by connecting the grid leak in shunt to the grid and F plus. The beginnings of the secondaries, L2, L4, L6, L8, L10 and L12 are brought to the grid posts of their respective sockets. The beginning of L14 is brought to one terminal of C14. The other terminal of this condenser is brought to the grid post. The beginnings of the secondary windings, L2, L4, L6, L8, L10, are also connected to one terminal of the resistors in their stages. The other terminals of these resistors are connected to one terminal of the condensers. The other terminals of these condensers are brought to the plates of their respective tubes. No such resistor and condenser is included in the 6th tube, the potentiometer taking its place. The rheostats are all connected in the negative legs of their respective filaments which they control. The variable condensers are connected in shunt to the secondaries, the rotary plates going to the filament

side and the stationary plates going to the grid side. The plates of the RF and the AF tubes should receive about 90 volts (B plus 2). The plate of the detector tube should receive about 45 volts (B plus 1). A 4.5 volt C battery (C minus 1) should be used as a grid bias in the first stage of AF coupling. A 9-volt C battery should be used as a grid bias on the second and last stage. The first condenser can be controlled individually of the other 6 condensers, which may be ganged. This may lead to easier synchronization of dials and louder signals. The complete set is placed in a totally shielded cabinet, with the coils placed so that practically no field exists between them. This is to prevent interstage coupling and consequent uncontrollable oscillations of the tubes in these circuits. The signals obtained from this set on locals are so strong, that it is a good plan to place a single circuit jack at the detector output, so that the local stations may be heard with comfortability. This set is a wonder on DX reception. As a matter of fact, many DX stations can be tuned in, using the speaker. A ballast resistor may take the place of the rheostat controlling the filaments of the AF tubes. This may be of the 1/2 ampere type, unless you wish to use a power tube in the last stage.

* * *

PLEASE PUBLISH a wiring description of a 4-tube receiver, employing two steps of tuned radio frequency amplification—a non-regenerative detector and one stage of transformer coupled audio frequency amplification. The first stage of tuned RF amplification should be reflexed. That is, this tube should act both as an RF and AF amplifier. The antenna circuit proper, should be tuned. A single winding should be used as the antenna coupler. The constants of the coils and condensers would be appreciated also.—Oram Marwood, Poughkeepsie, N. Y.

A 35-turn coil wound on a tubing, 3/4" in diameter, using No. 24 double cotton

covered wire and shunted by a .0005 mfd. variable condenser, is connected in series with the antenna and used to tune the antenna. A switch is connected across the two leads, so that it may be shunted out of the circuit. The rotary plate post of this condenser is connected to the 8-turn portion of a 50-turn coil, wound on a tubing 3/4" in diameter, using No. 22 double cotton covered wire. The end of this winding is brought to the ground. This means that the antenna-ground system will be connected in the 8-turn portion of the total winding. The beginning of this coil (42 turn portion) is connected to the grid post and to the stationary post of a .0005 mfd. variable condenser. The rotary plate post of this condenser is connected to the G post of a 6 to 1 ratio AFT and to the ground post. The F post on this AFT is connected to the arm of a 10-ohm rheostat. The resistance post of this rheostat is connected to the F minus post of this socket. The beginning of the primary winding of the first RFT, which consists of 10 turns, wound on a tubing 3/4" in diameter, using No. 22 DCC wire, is connected to the plate post of the first socket (1st RF tube). The end of this winding is brought to the P post on a second AFT, this one having a ratio of 3 to 1. The secondary of the first RFT consists of 45 turns, wound on the same tubing as the primary with a 1/4" separation between the two, using No. 22 DCC wire. The primary and secondary windings of a second RFT consist of the same number of turns, using the same kind of wire and tubing as the one just discussed. The beginning of the secondary winding of the first RFT, is connected to the rotary plates of another .0005 mfd. variable condenser and to one terminal of a 1/4 ampere ballast resistor. This same terminal is brought to the A minus post. The other terminal of the ballast is brought to the F minus post. The end of this secondary winding is brought to the stationary plate post of the variable con-

(Continued on page 27)

Join RADIO WORLD'S University Club

And Get Free Question and Answer Service for the Coming 52 Weeks.
This Service for Yearly Subscribers ONLY

Have your name entered on our subscription and University lists by special number. Put this number on the outside of the forwarding envelope (not the enclosed return envelope) and also put at the head of your queries. If already a subscriber, send \$6 for renewal from close of present subscription and your name will be entered in Radio University. No other premium given with this offer.

[In sending in your queries to the University Department please paragraph them so that the reply can be written under or alongside of each query. Write on one side of sheet only. Always give your university number.]

RADIO WORLD, 145 West 45th Street, New York City.

Enclosed find \$6.00 for RADIO WORLD for one year (52 Nos.) and also enter my name on the list of members of RADIO WORLD'S University Club, which gives me free information in your Radio University Department for 52 ensuing weeks, and send me my number indicating membership.

Name

Street

City and State

Eight Alluring Hookups

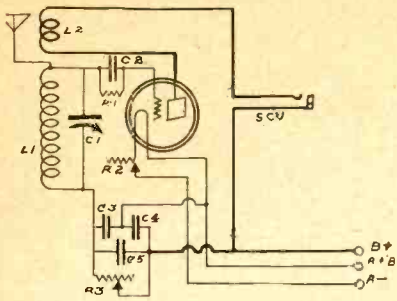

THE ELECTRICAL diagram of the Flewelling circuit, which employs super-regeneration. A 50-turn honeycomb coil is used in the antenna circuit, while a 75-turn honeycomb coil is placed in the plate circuit.

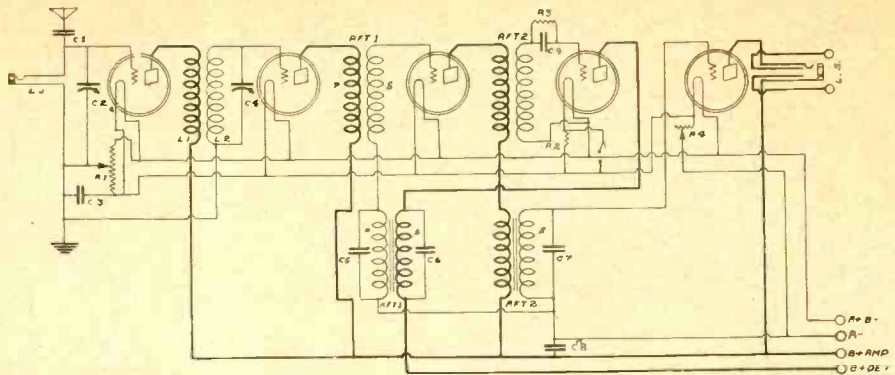

THE SCHEMATIC diagram of the DeForest D17 reflex receiver, using a tube as a detector instead of a crystal. Five tubes do the work of six, the first RF tube acting also as an AF tube.

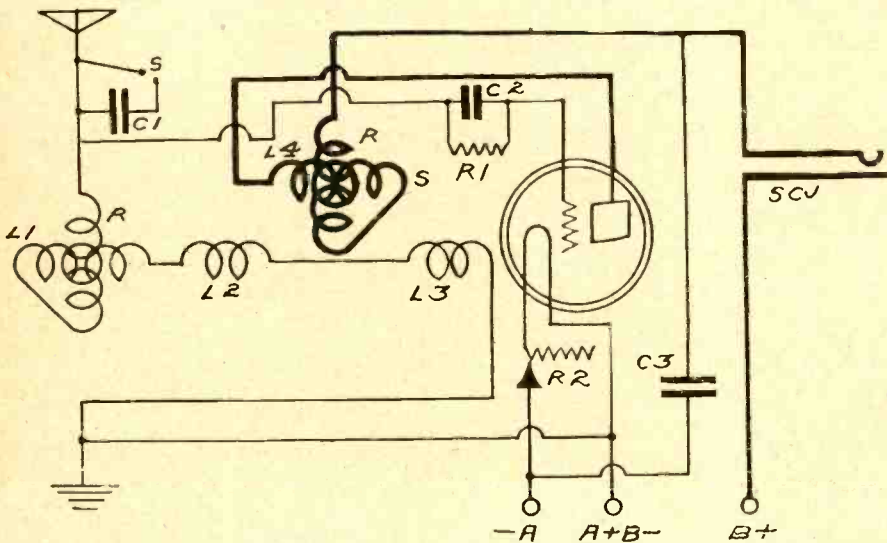

THE AERIOLA, SR., is diagrammed above. Variometers are employed in the antenna grid and plate circuits. A short wave condenser, C1, with switch is employed.

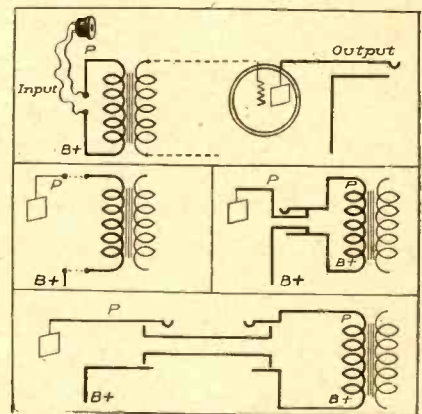

METHODS WHEREBY your voice may be heard through a loud speaker are illustrated above. The top shows a direct connection made as per diagram below to left. Diagram to left shows the jack connection. Bottom diagram shows use of a double jack in input circuit.

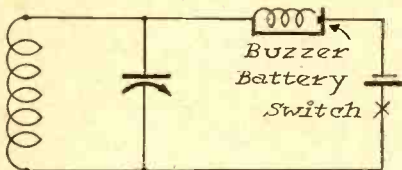

A 50 turn coil wound on a 3" diameter tubing, using No. 22 DCC wire, shunted by a calibrated .0005 mfd. variable condenser and connected with a buzzer and battery as above, can be used both as a damped wave generator or a wavemeter. The coil is placed in inductive relation to input circuit coil.

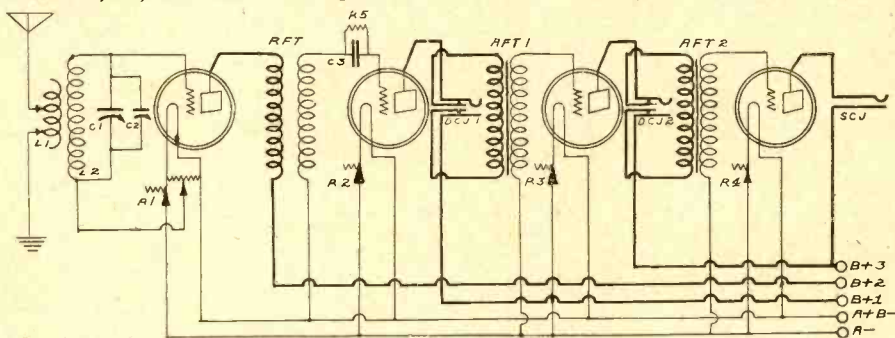

THE ELECTRICAL diagram of the Federal Type 59 receiver. A tuned stage of RF amplification, untuned non-regenerative detector and two transformer AF stages are employed.

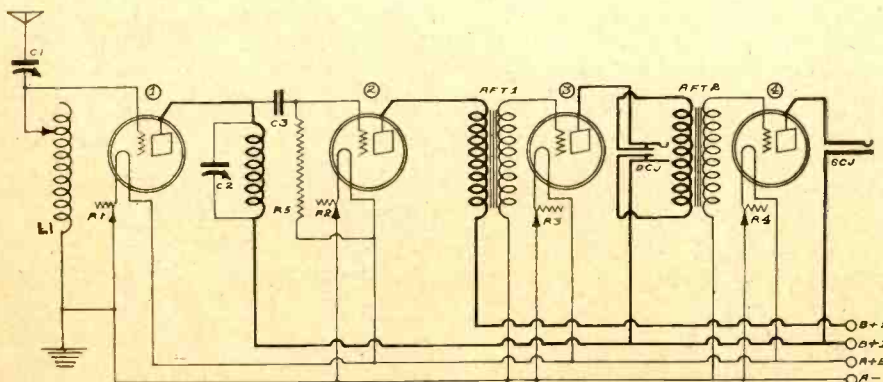

THE CIRCUIT diagram of the Crosley XJ, 4-tube receiver. Impedance tuning is employed.

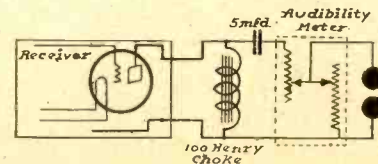

HOW TO calibrate the actual output of a receiver with the aid of an audibility meter is shown above in an electrical diagram. Note that two resistance units are employed. The lower the value of the phone resistance, the greater the original flow in the phones. But the impedance of the circuit must be kept constant, while the other resistance is employed, therefore the other series resistance. The meter is usually calibrated in arbitrary values of audibility of from 1 to 2000.

Hoover Is Accused Of Inviting Chaos

Has Power to Prevent Wave Piracy, Says Head of Broadcast Listeners—Wants Him to Keep on Exercising Authority

"Is Hoover Trying to Create Chaos in Radio?" is the caption of a comprehensive article which appears in the current issue of "The Broadcast Listener," official publication of the Broadcast Listeners' Association of America.

"Failure of Congress to enact any radio legislation during the session ending in July has stirred up much discussion in the radio world as to what the results will be," says Frank H. McDonald, president of the Broadcast Listeners' Association of America, author of the article. Continuing, the article says:

"Secretary of Commerce Hoover admits that Government regulation of radio has broken down. Mr. Hoover's announcement followed expression of an opinion by Attorney General Sargent that the Secretary of Commerce is without power to enforce or deny the use of particular wavelengths or fix the power of individual broadcasting stations.

Quotes Law

"The Broadcast Listeners' Association of America differs with the Attorney General. Quoting the law as enacted in 1912:

"No private or commercial station not engaged in the transaction of bona fide commercial business by radio communication or in experimentation in connection with the development and manufacture of radio apparatus for commercial purposes, shall use a transmitting wavelength exceeding two hundred meters, or a transformer input exceeding one kilowatt, except by special authority of the Secretary of Commerce contained in the license of the station."

"The officers of the Association maintain that any station committing air piracy by appropriating or interfering with existing licenses and wavelengths can be legally punished, even though new legislation was not enacted by Congress. The same act under which the Secretary of Commerce was empowered to regulate issuance and renewal of broadcasting licenses still stands and has lost none of its effectiveness despite the efforts to make out that it was undermined and wiped out by the decision against the government in its air piracy suit against The Zenith Radio Corporation, Radio Station WJAZ. Chaos of radio can be prevented if Mr. Hoover will continue to function under the powers vested in him under the laws of 1912.

Buying a Law Suit

"Any station committing an act of air piracy tending to create chaos would only be buying a law suit. Any station that has been functioning satisfactorily on the wave band and power allotted it would be the injured party—the one who would suffer financial loss and have its property interests damaged.

"Irrespective of the opinion rendered by Attorney General Sargent prompting the stand Mr. Hoover has taken, under common law such injured parties could easily obtain an injunction against offend-

ing stations and recover damages. That Hoover still holds the reins of radio was ruled by Federal Judge A. L. Reeves in the United States District Court, Kansas City, Mo., July 19, when he issued a permanent injunction restraining station WOS, Jefferson City, Mo., from monopolizing time from KLDS of Independence, Mo.

"The listeners, who are the all-important factor in radio, will have considerable to say in preventing any interference in radio that Mr. Hoover's actions might bring about. The listeners are the people of the United States who govern the country. Any station that enters this class of offenders by broadcasting on a wave band other than that originally assigned it by the Department of Commerce or using greater power than given it, or any new stations going on the air on a wave band of their own selection, will lose the support of the listeners, whose good will and support are absolutely necessary to the existence of broadcasting stations.

Intends to Fight

"That the listeners' rights will and must be respected and that they are the dominant factor in radio was proven last year in the strike for silent night in the Chicago area, in which they were successful. Radio listeners in twenty-three states and a part of Canada cooperated with listeners in the Chicago area who struck against unfair stations by refusing to listen to them under any circumstances. The Broadcast Listeners' Association of America was powerful enough at that time to protect the rights of the listeners and today is even more powerful, as its membership extends from coast to coast. The same means can be employed against pirating stations that were used to win the fight for the Chicago area silent night. The listener has a right to decide what station he will or will not listen to.

"The ruination of radio reception by piracy will be a vital injury to the interest of the industry. If the Department of Commerce will not function under the authority vested in them under the laws of 1912, the Broadcast Listeners' Association of America will fight for the protection of the industry, the science, and the fair broadcasting stations."

STATIONS WARN OF BIG RISKS

The National Association of Broadcasters issued the following statement:

One of the greatest romances of American industry is being written by the broadcasters of the country. In response to the appeal which we made to all broadcasting stations on July 19 to sign a Certificate of Promise assuring this Association that the station would continue to operate under the assignments made by the Department of Commerce prior to the Attorney General's opinion, more than 150 stations have returned the signed agreement already, and each mail brings more. Many of them are doing so at the sacrifice of their individual interests, which are born of deep convictions.

Great Response

So fine has been the immediate response to this call, that so far as existing broadcasters are concerned, we feel assured that the situation is well in hand, and no one needs to fear any kind of chaos due to the operations of those now in the field. However, attention should be directed to the long list of applicants who desire to get into the broadcasting business.

It costs from \$50,000 to \$250,000 to build, equip and place a broadcasting station in operation. There are already 536 stations operating on the 89 available wavelengths. Simple arithmetic shows how these stations must be dividing time to avoid interference. Obviously, it is impossible to put 600 more stations on the available wavelengths and justify even the minimum investment. It becomes necessary for someone to say who may and who may not broadcast, and there is no doubt that as soon as Congress convenes in December adequate legislation will be provided, placing this power in the hands of either the Secretary of Commerce or a separate radio commission. When this takes place, many will certainly be shut out, and it is logical to believe that those who have pioneered in the art, and who have maintained adequate and improving service, should be given prior consideration.

Wild Risk

Some may say that they will take their chances and go ahead with the erection of a station, gambling entirely on what their position may be after the passage of the new law. This would prove to be the wildest kind of speculation, and it is believed that very few, if any, will take the risk.

STATIONS STATE THEIR POSITION

KFWI, San Francisco, Calif., by Tom Catton: "Col. Dillon, former supervisor of this district, has the pledge of broadcasters of this vicinity that they will abide by his future decisions as when he was in control. Tom Catton KFWI is member of committee of five stations represented to act with Dillon."

WJJD, Mooseheart, Ill.: "WJJD is contemplating no change in wavelength, power or operating schedule.

KFWM, Oakland, Calif.: "With approval of Radio Commissioner's Office we

have accepted change from 207 to 325 and from 250 to original wattage of 500. Broadcasting on this change now. Change is not result of present condition, which is regrettable, but transfer of established wave."

WBAL, Baltimore, Md., by Fred R. Huber: "My plan is to go along with the Government in an orderly way and cooperate with it in every way possible. The station is now broadcasting at its full capacity 3,000 watts. Intend to stay on present wavelength until change is made by Washington."

12 Out of 600 Seek Station Licenses

**Requirement That Actual Erection Must Precede Grant
of Permit Causes 588 to Become Disinterested**

By Thomas Stevenson

WASHINGTON.

Chief Radio Supervisor W. D. Terrell finds a bit of grim humor in the new radio situation developed through the breakdown of radio regulation.

Prior to the adjournment of Congress, more than 600 applicants were clamoring for licenses for stations. Most of them claimed they had their stations ready for operation. The refusal of the Department of Commerce to grant the license sometimes resulted in denunciations and protests of a heated character.

About a month ago the Department of Commerce announced it would no longer attempt to withhold licenses from applicants for stations. The only proviso was that the station must be ready for operation before the license would be granted.

A neat announcement was made to all of the 600 applicants that just so soon as their stations were ready for operation a license would be granted them. To date, only around a dozen have taken advantage of the situation. In a given week not one station applied for a license.

Mr. Terrell does not expect that the public will suffer from interference to any considerable extent this summer.

Different In Winter

When cool weather starts and distance reception is easier, Mr. Terrell expects a prolonged "howl" from fans in several cities and communities. With a number of stations changing to new wavelengths, giving regard only to the problem of local interference, and with a number of new stations coming in, it is not believed that many of the DX stations which ordinarily come in quite strong would be picked up with sufficient clarity to enjoy their programs.

It is believed that the situation will demonstrate the absolute necessity for some directing head who can assign wavelengths with due regard to the entire country rather than to the needs of any particular community.

The general opinion is that distance reception has received a blow from which it can recover only through the administration of iron-bound regulations. Until Congress enacts such regulations and grants the authority for their enforcement, local programs will probably constitute the major part of broadcast reception.

Aside from regulations, Congress is expected to have a new problem which did not enter into consideration of radio legislation at the last session. Some provision must be made for the disposition of new stations which were licensed after the adjournment of Congress.

Crowded Prospects

Mr. Terrell will not attempt to predict how many new stations will be licensed between now and the first of next year, before which time radio legislation cannot be expected. The general guess is that there will be from 50 to 100 new stations, or around 10 per cent. of those who have applications on file.

Sixty new stations would bring the total number of broadcasters up to around 600. With only 89 wavelengths available it can

be seen that most of the stations will be compelled to divide time two or three ways or else several stations must use the same wavelength simultaneously.

Secretary Hoover hopes that good business judgment will prevent the erection of many new stations. He does not think the uncertainty of getting a satisfactory wavelength justifies the large expenditure necessary for the construction and upkeep of a station.

Mr. Hoover also expresses pleasure at steps taken by the broadcasters to pledge themselves to stick to the wavelength assigned them by the Department of Commerce. He thinks such cooperation will be absolutely necessary to prevent the temporary collapse of the broadcasting structure.

(Copyright, 1926, by Stevenson Radio Syndicate)

WHN Reunites Minstrel Team

Wright and Wrong are together again and WHN did it. Wright played the piano and sang at this station while Wrong, who is a real estate man now, was listening. Wrong recognized the voice of his old partner in the George Primrose Minstrels and on the vaudeville stage of 20 years ago. It thrilled him and he made haste to find Wright. Next they sang and played together for radio fans at the station.

CRISIS PAST, IS HOOVER'S VIEW NOW

WASHINGTON.

"There has been a tendency already," said Mr. Hoover, "on the part of those stations which have gone off their regular wavelengths to get back to those which had been assigned to them."

So said Secretary Hoover in an interview. There will be no serious complications, he believes.

WCAP Sold to R. C. A.; United With WRC

WASHINGTON.

The Chesapeake and Potomac Telephone Company at Washington sold WCAP to the Radio Corporation of America and the station was consolidated with station WRC. The reason given for the sale was that it would make possible more economical operation of the stations with the same personnel for both. The last day of operation for WCAP was July 31.

Under the new arrangement, the New York programs which formerly came to Washington through WCAP, are continued through WRC. Other features of WCAP also are continued. WRC under new plan operates 7 days a week.

NEW SWEDISH STATION

The Swedish Government has appropriated \$287,500 for the erection of a large broadcasting station in Motala in Central Sweden, according to advices to the Department of Commerce.

Five New Stations; Seven Wave Changes

**Some Interference Expected as Waves Are Same as or
Near Those of Existing Stations**

WASHINGTON.

Five new stations were licensed by the Department of Commerce while seven stations changed their wavelengths.

NEW STATIONS

WJBV, Union Course Laboratories, Woodhaven, N. Y., 469.9 meters.

KGBS, A. C. Dailey, Seattle, Washington, 209.7 meters.

KRCA, Radio Corporation of America, Portable, San Francisco and Los Angeles, Calif., 305 meters.

WMBI, Moody Bible Institute, Chicago, Ill., 288.3 meters.

WJAF, J. A. Fenberg Radio Co., Ferndale, Mich., 400 meters.

STATION CHANGES

WGBH, Clearwater, Fla., 265.5 meters, is now owned by the Fort Harrison Hotel. The station was formerly owned by the George H. Bowles Developments.

WNAC, Shepard Stores, Boston,

changed from 280.2 meters to 430.1 meters.

WNAB, Shepard Stores, Boston, changed from 250 meters to 280.2 meters.

WRNY, Experimenter Publishing Co., New York, changed from 258 meters to 374.8 meters.

WBNY, Baruchrome Corporation, New York, changed from 209.7 meters to 322.4 meters. This station was formerly licensed in the name of Miss Shirley Katz.

WEW, St. Louis University, St. Louis, changed from 247.8 meters to 360 meters.

KFNF, Henry Field Seed Co., Shenandoah, Iowa, changed from 263 meters to 461 meters.

The stations newly licensed or changed may cause interference to the following stations:

KOA, Denver, Col.; WRC, Washington; KFKX, Hastings; WLWL, New York; WCAE, Pittsburgh; WSB, Atlantic; KTHS, Hot Springs; KVOO, Bristol; WJAZ, Chicago; and WQAO, New York.

Refinement Stage Reached In Radio

No Revolutionary Invention in Sight—Heterodyning Evil Lacks Solution—Eliminator Year Forecast

By Hugo Gernsback

During the course of conversation with many people in all walks of life, the question is frequently asked me if radio has now settled down, in the same degree as the automobile industry, and whether it has become stabilized?

I have answered, a great many times during the past few years, that we need not look for any revolutionary improvements in radio at present. The chances are against any invention that will entirely upset the radio industry. Just as in the automobile industry, we may not look for any revolutionary invention that will upset the entire trend of the automobile—unless it should be a flying attachment, which might be applied to any automobile—and this, while not impossible nevertheless will not appear in the immediate future.

Finer Touches Now

It is the same with radio. Television, to be sure, is in the offing, but several years will elapse before you will be able to sit before your radio at home and witness a baseball game 100 miles distant. On the broadcasting end, no great and epochal improvements need be expected shortly.

While improvements are being made right along, these are now more in the nature of finer touches rather than revolutionary; but we can expect better and better transmission and greater clarity.

One of the great troubles in the United States at the present time is the heterodyning between different stations nearly on the same wavelengths. This is particularly true of the low wavelengths, where there is serious congestion, and there does not seem to be any immediate remedy for this. Technically, there seems to be no possible way to separate two stations less than 1,000 miles apart and operating on the same wavelength. As Congress has adjourned for some six months, and the Department of Commerce is left with little authority, there seems to be little hope that the heterodyning evil can be done away with in the immediate future.

5 and 6 Tubes Popular

On the receiving end it does not seem that sets will be altered radically during the next few years. Five and six tube sets probably will prevail for quite a long time to come; although there is always the possibility that a single-tube super-regenerative set, which in output may equal the present 4 and 5-tube set, can be developed. So far the super-regenerative circuit, while admitted to be one of the great possibilities, has been and remains nothing but an experiment. It is, as yet, too tricky and has never left the laboratory stage.

From these remarks no rash conclusions should be reached that radio is stagnant and does not progress. Quite the contrary. During the entire year of 1925 more than 900 radio patents were

issued by the Patent Office; and during the first six months of 1926 almost 600 radio patents have been issued. As a matter of fact, it will be seen from these figures, our inventors in the various laboratories all over the country are still tremendously busy devising new and better things in radio. It would seem that this activity should keep on increasing rather than decreasing in the immediate future.

Radio in this country goes through various strange cycles. When broadcasting started off with a rush we were in the crystal-set stage. That prevailed during some six months, until the single-tube epidemic set in, which lasted for a year. With one bound we jumped from the single-tube to the 5-tube set which, even today, is more or less standard. At first the sets were built in a box to put on the table. That continued for about a year, when the industry was affected with the console-set fever, which does not yet seem to have abated.

An Eliminator Year

As to the parts, conditions were much the same. Last year we saw a small epidemic of straight-line-frequency condensers, which have practically displaced the old straight-wave type. Then came the vernier-dial tempest, which is still blowing strong.

This year seems to be an A and B eliminator year, because more firms are becoming engaged in the manufacture of eliminators than in possibly any other single radio accessory. There are several million radio sets in use today, and the market for batteries and A and B eliminators is therefore very large. As in all such phenomena, there is sure to be a race for supremacy between the manufacturers of eliminators and those of batteries. And we may be certain that the battery people are not standing by idle.

When radio first came along it seemed that the deathknell of the phonograph had definitely been sounded; but the phonograph people merely rolled up their sleeves and went to work producing such phonographs as they had never before believed it possible to build. The immediate result was that the phonograph today is in far greater demand than it was before the advent of radio; and, whereas in 1922 every phonograph manufacturer had "nerves" every time the word "radio" was mentioned, he sits back today, complacently, and is not worried at all.

So it will probably come about that the battery manufacturers will be spurred on to meet the invasion and give the eliminator people a stiff battle. Already the storage-battery folk have seen the light, and are putting out radio power plants that connect right to the lighting circuit. These miniature power plants give A and B battery current with a minimum of attention from the owner. No longer is he required to lug around heavy A and B storage batteries; now he leaves the

MARCONI IN HIS



(Underwood & Underwood)

THE LATEST PHOTO of Guglielmo Marconi in his lab

Change In Affects t

Many Listeners Mistakenly Is Merely Meetin

Many fans attempt to retune their set when one program number gives way to another. They notice a decline in volume and assume that the set needs adjustment. If the dials are not turned the volume control is adjusted, or perhaps both are tinkered with, on the assumption that this is necessary.

Nearly always there is no occasion for touching the set. The volume change is due entirely to conditions at the broadcasting station. Perhaps a soprano has just given way to a brass band. The operator in the control room of the station takes care of the volume by adjust-

unit in the cellar and it is charged automatically.

As to the radio sets, they are getting better and better as time goes on. More attention is being paid now to reduction of losses, shielding, and mechanical perfection, than at any time during the history of radio. It is safe to say that an up-to-date set bought today will be in service for many, many years to come. In the meanwhile, the sets are becoming more sensitive as well, and will have better and better range, by virtue of the improvement in vacuum tubes, which are

Steinmetz Thrilled World When 26

Stood Up Before American Institute of Electrical Engineers and Disclosed Solution of Hysteresis Loss.

[The first instalment of a short biography of Charles P. Steinmetz, published last week, told of his college career, his arrival in America and his fruitless search for a job. The second chapter follows.]

By John W. Hammond

He did not grow discouraged because he could not find a position right away. He kept on looking.

As soon as he could do so, he started out to find the manufacturing establishment of Rudolf Eickemeyer, to whom his editorial friend in Germany had given him a letter of introduction. Eickemeyer's place was in Yonkers, about fifteen miles north of New York.

His First Job Here

Steinmetz reached Yonkers and after making a number of inquiries found the Eickemeyer factory. He was granted an interview with Mr. Eickemeyer.

Eickemeyer found out at once that this young fellow was no ordinary floater, looking for a chance job. He discovered that Steinmetz possessed a fine technical education. He at once treated Steinmetz almost as an equal. He was much interested in what Steinmetz knew about electrical matters.

Finally, on Monday, June 10, 1889, Steinmetz was put to work in Eickemeyer's factory as a draftsman at \$12 a week.

Almost the first thing that Steinmetz did after obtaining work was to take steps to become an American citizen. He had instinctively decided that he wanted to live in America the rest of his life. So he appeared that very year before a naturalization court and took out his first papers.

Steinmetz Rises

During his first year in America he rapidly began to establish himself as an electrical mathematician.

He joined the New York Mathematical Society, now the American Mathematical Society, and was admitted a little later to membership in the American Institute of Electrical Engineers. His first public appearance was at a meeting of the latter organization, early in 1890, when he took part in a discussion of a mathematical paper presented by Thorburn Reid.

He attracted a good deal of attention, in this discussion, by the surprising skill which he showed in handling the most complicated mathematics.

The other engineers realized that there was unmistakable genius in this keen, friendly, crippled young fellow, who still spoke English with a foreign accent. For Steinmetz was not yet thirty years of age. By this time, he had made a home for himself in Yonkers, and was beginning to enjoy his work. His faithful friend, Assmusen, meanwhile, had returned to Europe.

Steinmetz was now almost ready for the first big achievement of his life—a difficult and brilliant mathematical investigation which resulted in a new law re-

garding the design of electric motors.

As a young draftsman at the factory of Eickemeyer & Osterheld, Steinmetz was put to work making complete drawings of a motor for electric street cars. Such a motor had been designed by Rudolf Eickemeyer and Stephen D. Field, but it was comparatively crude.

First Practical Work

Never before had Steinmetz worked on practical electrical apparatus. Never before had he come so close to the actual use of electricity in commercial affairs.

All through these busy months he was brought into constant contact with both Eickemeyer and Field. These men were skilled inventors, particularly interested in electric street cars. Field had invented a "system" of electric car propulsion, and Eickemeyer had agreed to manufacture the motors.

This was in 1885. By the time that Steinmetz began working for Eickemeyer, Field had given up his experiments on the elevated road and had designed a motor for street cars. With this motor he used an overhead trolley to conduct the current from the wire to the armature. This was the motor on the drawings for which Steinmetz worked. It was an improvement on the Field-Eickemeyer motor of 1885, was wound for only about half the voltage, and was geared to the traction wheels.

Down Crashed the Trolley

Trouble was experienced with the overhead trolley. Contrary to the present arrangement, the trolley wheel ran on top of the wire, not underneath it; and it would keep falling off. Field finally tried magnetizing the wheel, so that the wire would be attracted to it. But the first time an attempt was made to operate a car in this manner the wheel came off and pulled the whole trolley mechanism down upon the roof of the car.

Before long Eickemeyer began to observe how much personal interest Steinmetz was taking in his work. It was about this time, too, that Steinmetz unexpectedly revealed to his employer how much he knew about chemistry.

Eickemeyer, one morning suddenly entered the drafting room, where Steinmetz was working, and said:

"Does anyone know what will take an aniline stain off my fingers?"

"Yes," replied Steinmetz, without hesitation, "sulphuric acid will do it."

Enters a Mansion

Then he told Eickemeyer just how to apply the sulphuric acid; and the two had quite a chat for a few moments.

Eickemeyer, who lived in a stately mansion, with extensive grounds and a number of servants, soon afterward began to invite Steinmetz to call at his home on Sunday afternoons. They would spend the time talking over the work they were doing at the factory. Men who become as much fascinated as that by the work in which they are engaged almost always become unusually successful.

About this time, Eickemeyer felt that he needed an experimental laboratory, so he asked Steinmetz to establish such a laboratory at the factory. This was just the sort of work that Steinmetz enjoyed. A small room on the second floor of the building next to the Eickemeyer factory was turned over to him for his use. He had a man to help him; but only for part of the time. Most of the work consisted of investigations requiring the uses of mathematics. A number of new ideas was worked out; and the friendly teamwork between Steinmetz and Eickemeyer grew more pronounced.

Steinmetz used to recall this laboratory with much vividness, revealing how really barren and crude it was.

"The laboratory," he said, "came about as a matter of course. When I first began to work at Eickemeyer's there was one other draftsman there, Mueller, at whose home I finally boarded.

Growth of Laboratory

"Later the second floor of the next building to Eickemeyer's factory was obtained, a door was cut through, and that became my own room. At first I had a shop man working under me, and later a draftsman. The shop man did the mechanical work of the laboratory. He was not there at all times, as he was an expert machine repairer, and if anything went wrong with any of the machines in the factory, he was sent for immediately. Then he would disappear from my room for a day or two at a stretch.

"This was the room where Stephen D. Field used to sit by the fire. It was a cold room in the winter, so I bought a good-sized stove. It took a big fire to keep the stove going, and that made the room roasting hot. When I tried to check the fire, it would go out."

Late in the summer of 1891, somewhat more than two years after young Carl Steinmetz landed in America, Eickemeyer gave him an important piece of work to do. He asked Steinmetz to make calculations for the design of an electric railway motor of the same type as those now in use on the New York, New Haven & Hartford Railroad, and other railroads.

Different Motor Types

Electric motors, as designed and built today, are wonderfully capable machines. They deliver a high percentage of power, are made in many sizes, and are of many types, each type suited to some particular sort of work.

One kind of motor is especially designed to run electric elevators; another kind is built to drive textile looms; still another, for use in steel mills; another to run an electric sewing machine, or a clothes-washing machine.

Some motors are traction motors—that is, they provide the motive power for electric street cars or electric locomotives on railroads. Still others, and some of the very largest, propel the battleships of Uncle Sam's navy.

These last—marine-type motors—tower thirty or forty feet into the air. They stand as high as the second story of an ordinary dwelling house. And there are little bits of motors, so small that one of them seems almost lost in the palm of the hand, which operate electric clocks.

Hysteresis Law a Problem

The engineers of that day knew, of course, that magnetic flux would produce a current of electricity whenever a conductor of electricity, connected to a closed circuit, cut through the magnetic field. The principle of electro-magnetic induction was being successfully used from 1880 on, both in generators and motors.

Early in the progress of electrical development, inventors had discovered that every electric generator is essentially a source of alternating current. They had also found that they could change this

S LABORATORY

Three Contributed To Birth of Tube

**Edison Discovery of Space Current Was Forerunner,
Fleming Applied It to Radio and DeForest
Added the Vital Grid**

By Leon L. Adelman

The Chas. Freshman Co., Inc.

"What is the greatest radio invention?" Surely not a difficult question, yet some would hesitate to answer it. And not only is it the greatest radio invention, but also the greatest electrical invention. It is the vacuum tube—the three-element tube without which our progress would be greatly handicapped. Our transcontinental telephone, our radio broadcast stations, public address systems, transmission of photos by radio and other very important developments of modern life depend upon it. And to think that at the base of all these wonderful inventions lies the so-called Edison effect, a discovery made many years ago and little thought of for several years later!

Thomas Alva Edison, the electrical wizard, in his pioneer work in investigating the peculiarities and behavior of the incandescent lamp, came upon a phenomenon which was termed the Edison Effect. His work led him into the study of the physical and chemical actions which take place in highly evacuated glass bulbs containing an incandescent filament.

What Effect Is

By the term "effect" physicists have long designated phenomena or groups of phenomena which are new in themselves and which fail to arrange themselves into any given theoretical classification or to admit of an explanation under existing theories. Thus we have in physics a large number of effects to which have been given the names of their discoverers, all of whom have been distinguished in the field of pure science, such as for instance, the Peltier effect, having to do with the absorption and evolution of heat at the junction of two metals carrying a current; the Thomson effect, having to do with thermo-electric currents in a given metal; the Hall effect, having to do with the deviation of currents in a thin film under the influence of a powerful magnetic field; the Purkinje effect, having to do with the variation of sensibility of the eye for the red and blue ends of the spectrum with high and low illumination; the Zeeman effect, having to do with the displacement of spectral lines when a radiating gas is submitted to a powerful magnetic field, etc. Of all these effects, none has been so prolific in practical consequences as the Edison effect. What is the Edison effect? It is best answered in Edison's own words which appear in a patent filed by him in October, 1883:

"I have discovered that if a conducting substance is interposed anywhere in the vacuous space within the globe of an incandescent lamp, and said conducting substance is connected outside of the lamp with one terminal, preferably the positive one of the incandescent conductor, a portion of the current will, when the lamp is in operation, pass through the shunt circuit thus formed."

In other words, Edison was the first to notice that a current flowed through the space in the evacuated tube, but since at that early date electrons were unheard of, no satisfactory explanation was available.

Clearer Idea Now

Today, in the light of Richardson's formulas governing the laws of emission and Langmuir's supplementary work showing the so-called space charge effect, we are able to give an accepted hypothesis showing that the Edison effect is simply this: that negatively charged particles of electricity, called electrons, are shot off from an incandescent conductor, such as a heated filament, and that these electrons are attracted either by the positive leg of the filament or by a second conductor called a plate. The thermionic current which flows is unilateral. We then have the substance of a rectifying valve which will conduct currents in one direction only. And due only to the fact that Edison was too busy with the development of the electric lamp, his discovery was not practically applied until Fleming took advantage of it and applied it to the reception of wireless signals, eleven years afterwards.

Fleming in "Principles of Electric Wave Telegraphy," states: "A third method of utilizing the properties of rarefied gases for the purpose of a cymoscope was discovered by the author in 1904, based upon a fact discovered by him in 1890 in the course of some investigations upon incandescent electrical lamps."

This statement would lead one to believe that Fleming was responsible for the discovery of the fact that electronic emission takes place when a filament is heated and that the electronic stream is conductive in one direction only.

Credit to Edison

Instead, the full credit belongs to Edison, since what Fleming merely did was to apply the known principle to the rectification of wireless waves. The fact that no mention has been made by Fleming on the Edison effect has been erroneously construed by some to indicate that Fleming first came upon the principle.

From the Fleming valve, which was not particularly effective as a wireless detector the next advance made was the 3-electrode tube as conceived by De Forest. This remarkable step forward was the introduction of a third element—the grid—which could regulate the passage of the electrons between filament and plate.

The audio or 3-electrode tube, in its property of operating as a detector or rectifier of signals, as an amplifier, and generator of alternating currents of any frequency, is a most wonderful and versatile piece of apparatus. Since its inception by De Forest it has undergone some remarkable development work and from the unpretentious "oscillation valve" to the 100 kilowatt water-cooled power tube is a tremendous stride.



Marcconi, radio inventor. He is shown in laboratory.

Program the Volume

Readjust Dials, But Station g New Conditions

ing resistances connected with the speech amplifier—an audio channel used for regulating the amplification of everything broadcast. A different adjustment is needed for a band than for a soprano and it may take a few moments before the transmitter is properly settled for the new conditions.

Therefore when a station seems to be suffering from an odd form of fading at the time of program change, keep in mind the probable cause and let your receiver alone. No attempt should be made at readjustment until a few minutes have elapsed.

being made more sensitive every month. Not only are they more sensitive, but they are being made more economical as well. The 5-tube set in 1920 required 5 amperes at 6 volts, which is 30 watts, to light its filaments. It meant, then, recharging your storage battery every few days. The like set today uses only about 1 1/4 amperes at 5 volts, or 6 1/4 watts. It is safe to say that the consumption of current by the average radio set, at the end of the next five years, will not be even half what it is today.

(Broadcast from WRNY)

current, before it passed into the working circuit, from alternating current to direct current by means of a commutator.

The simplicity of the direct current and the lack of suitable devices for using the alternating current in practice caused most of the early electrical supply systems to be planned as direct-current circuits. Hence, up to about 1890, men were somewhat more familiar with direct-current characteristics than with those of the alternating current.

Science Applied to Problem

A year or two later, when the transformer and the multiphase system of generating electrical energy led to more interest in the alternating current, engineers were to find themselves facing several intricate problems which are involved only in the alternating current. And in solving these, also, the mathematical genius of Steinmetz was to prove itself of immense value.

At the earlier period of 1890, however, it was already realized that in the case of motors, whether designed for direct current or alternating current operation, the magnetism of the magnetic circuit alternates; that is, it moves first in one direction, then in the opposite direction. This alternating movement produces a certain loss of magnetic flux, caused, it is supposed, by the friction of molecules. It makes itself apparent by heat in the electromagnets of the motor.

Until the time of Steinmetz no one knew with any certainty what the ratio of this loss of magnetic flux might be to the magnetism produced in the motor. They simply knew that there was a loss; but not being able to determine in what proportion it increased as the capacity of the motor was increased, they could not design motors of high efficiency. Furthermore, they did not know which mineral substance would produce the greatest amount of magnetism.

Steinmetz's Objective

The motor which Steinmetz was trying to design for Eickemeyer was an alternating current single-phase motor with compensated windings. Steinmetz knew very well that the magnetism in the motor would alternate, and therefore would consume power. This consumption of power within the motor itself, caused by loss of magnetic flux, is called the "hysteresis loss."

As it is necessary to keep this loss down to the smallest possible point, Steinmetz began to make calculations to see how he could do this and at the same time have the motor produce the greatest possible volume of power.

Before long he discovered that there was no information in existence which would tell him just how much power loss would occur for a certain amount of magnetism in the iron of the motor. To discover this rule—or law, as electrical engineers call it—he found it necessary to make some profound mathematical calculations. It was a problem that could be solved only by mathematics.

He Solves the Problem

He worked at it for weeks—and finally he found the answer.

When he had finished his calculations, he drew up a table, similar to a multiplication table, which showed, without any further figuring of any kind, the amount of power loss for each particular volume of magnetism.

Dr. Steinmetz once told his own story of how he grappled with and conquered this problem, in the following simple, unboastful language:

"I knew there would be a loss of power in the alternating magnetism of the motor, and I wished to calculate this hysteresis loss, to get the efficiency of the motor. I therefore looked through the literature obtainable and found two tables of hysteresis losses given, one by Ewing, in his

Kent Donates 200 Lighthouse Sets

Manufacturer Acts on Hoover's Appeal That Lonely Keepers Need Receivers in Isolated Places—Speakers Included in the Gift

WASHINGTON.

Secretary Hoover's plan to equip all the more isolated and remote lighthouses with radio receiving sets, although Congress has made no appropriation for such equipment, has succeeded. With the gift by A. Atwater Kent, of Philadelphia, of 200 5-tube sets and speakers, a sufficient number of sets to outfit all major stations at which the men are cut off for long periods from the outside world, is assured.

Secretary Hoover believes that radio can do more to relieve the monotony, the loneliness of the life to which their work subjects lightkeepers and their families than anything else that could be given them. Particularly during the Winter, when heavy weather sets in, these stations are often cut off from any outside contact whatever for months at a time. Radio, which can bring to even the most isolated lighthouses a variety of

entertainment and information—concerts, lectures, sermons, news and weather reports—is expected not only to benefit the men, though relieving the monotony of slowly dragging days, but to be a direct aid to the service through the improved morale that will result.

In offering his contribution of 200 sets, Mr. Kent wrote Secretary Hoover: "I can think of no group of people to whom radio would mean more than to these keepers and their families, cut off as they are for long periods from either contact or communication with the outside world. I consider it a privilege to do my bit toward relieving their isolation and loneliness."

George R. Putnam, Commissioner of Lighthouses, will direct the distribution and installation of sets, giving precedence to those that are most rarely reached by the tenders which carry supplies and mail.

book on magnetism, and one by Kapp, in his little book on alternating currents.

"Unfortunately, the two tables disagreed with each other, and the curves given by the tables differed in shape from each other. I then studied both tables and found that Kapp's table must contain a typographical error. From Ewing's table, however, I derived mathematically a law, the 'law of hysteresis,' showing how the hysteresis loss increases with the increase of magnetization. Roughly, it is that every time the magnetization doubles, the hysteresis loss trebles."

Steinmetz announced the new law before the American Institute of Electrical Engineers in 1892. He immediately became recognized as a "powerful thinker," a profound mathematician—and he had been in the United States only two years and a half, not even long enough to speak English perfectly! He was only twenty-six years of age.

It is quite likely that the year 1892 was one of the most important in the career of Charles P. Steinmetz. There were several events in that year which set it apart from other periods of his life.

One of these was his final decision to make his name an American, instead of a German, name. Until then, his actual name had always remained just as it was given him at his christening—Carl August Rudolf Steinmetz.

But since he had been living in America he had become enthusiastic about being an American. He decided that if he were going to be a real American he must have an American name. He therefore changed the "Carl" into its English equivalent, "Charles."

And he gave up his two German middle names. In their place he decided to have a single initial, like the many American names that he saw almost every day in the newspapers, magazines and letters. The only thing that gave him special thought was what his middle initial should be and what it should stand for.

While he was thinking this over, he re-

ceived a visit one day from a man with whom he had studied at the University of Breslau—one of his old college chums, whom he had not seen for several years. This friend came into Eickemeyer's laboratory quite unexpectedly, and upon catching sight of Steinmetz he stepped up, gave the young mathematician a friendly slap on the back, and cried out: "Well, Proteus! How are you?"

The sound of the familiar college nickname gave Steinmetz a thrill of delight; and almost on the spur of the moment he made up his mind that the middle initial of his American name should be "P," and that it should stand for Proteus. From that moment he always signed himself "Charles P. Steinmetz."

In 1892 the General Electric Company, which had just been organized, heard about the electrical work of Eickemeyer, and also heard, of course, about the remarkable mathematical work of Steinmetz. The General Electric Company was anxious to obtain the patents of Eickemeyer; and at a meeting in New York, satisfactory terms of sale were agreed to.

It was especially stated, however, that the young German engineer Steinmetz, was to become associated with the General Electric Company in connection with the purchase of Eickemeyer's business. To arrange for this, one of the engineers of the General Electric Company, E. Wilbur Rice, Jr., went to Yonkers to talk with Steinmetz.

It is true that Steinmetz agreed immediately to become an employe of the General Electric Company. He did not ask for a large salary, although his pay was as high as that given any one on the staff of engineers which the company had gathered together.

Early in 1893, after he had helped to transfer the records, patents and engineering data of Eickemeyer & Osterheld to the new owners, he left Yonkers for Lynn, Mass., which was then the headquarters of the General Electric Company.

(Broadcast from WGY)

A THOUGHT FOR THE WEEK

THE radio trade is constantly discussing the question of whether or not there are too many concerns in the set and parts business. It should be remembered that the automobile trade has been stabilized only during the past few years. In radio, as in every other line of business activity, it becomes a matter of the survival of the fittest.

RADIO WORLD

REG. U.S. PAT. OFF.

Radio World's Slogan: "A radio set for every home."

TELEPHONE BRYANT 0558, 0559
PUBLISHED EVERY WEDNESDAY

(Dated Saturday of same week)

FROM PUBLICATION OFFICE

HENNESSY RADIO PUBLICATION CORPORATION
145 WEST 45th STREET, NEW YORK, N. Y.

(Just East of Broadway)

ROLAND BURKE HENNESSY, President

M. B. HENNESSY, Vice-President

FRED S. CLARK, Secretary and Manager

European Representatives: The International News Co.

Brema Bldgs., Chancery Lane, London, Eng.

Paris, France: Brantano's, 8 Avenue de l'Opera

Los Angeles: Lloyd B. Chappell, 811 S. Coronado St.

EDITOR, Roland Burke Hennessy
MANAGING EDITOR, Herman Bernard
TECHNICAL EDITOR, Lewis Winner
ART DIRECTOR, J. Gerard Sheedy

SUBSCRIPTION RATES

Fifteen cents a copy, \$6.00 a year, \$3.00 for six months, \$1.50 for three months. Add \$1.00 a year extra for foreign postage. Canada, 50 cents.

Receipt by new subscribers of the first copy of RADIO WORLD mailed to them after sending in their order is automatic acknowledgment of their subscription order. Changes of address should be received at this office two weeks before date of publication. Always give old address; also state whether subscription is new or a renewal.

ADVERTISING RATES

General Advertising

| | | |
|---------------------------|-----------|----------|
| 1 Page, 7 1/4" x 11" | 482 lines | \$300.00 |
| 1/2 Page, 7 1/4" x 5 1/2" | 231 lines | 150.00 |
| 1/4 Page, 8 1/2" D. C. | 231 lines | 150.00 |
| 1/4 Page, 4 1/2" D. C. | 115 lines | 75.00 |
| 1 Column, 2 1/4" x 11" | 154 lines | 100.00 |
| 1 Inch | | 10.00 |
| Per Agate Line | | .75 |

Time Discount

52 consecutive issues..... 20%
26 times consecutively or 2 O. W. one year.... 15%
4 consecutive issues..... 10%WEEKLY, dated each Saturday, published Wednesday.
Advertising forms close Tuesday, eleven days in advance of date of issue.

CLASSIFIED ADVERTISEMENTS

Ten cents per word. Minimum 10 words. Cash with order. Business Opportunities ten cents per word, \$1.00 minimum.

Entered as second-class matter March 23, 1922, at the Post Office at New York, N. Y., under the Act of March 3, 1879.

AUGUST 14, 1926

Distinctive Announcers

THE successful announcer must be proof against censure and praise, for to the best of the announcers come tributes that may easily convert them to the belief that the transmitter is simply the medium by which they, the announcers, charm the human race and lift its burden of suffering. When one is blazing paths in a new profession there is no standard by which values may be calibrated. It is quite natural for one to assume that the ability to address anywhere from 200 to 2,000,000 people exalts one to first rank among the seven wonders. One of the traits that makes an announcer good is the ability to absorb flattery and denunciation and remain serene and unruffled.

Stations are distinguished by the quality of their transmission, their signal strength, the quality of their programs and the sound-personality of their announcers. A good program may be marred by poor announcing and in poor announcing may be included not only ungrammatical phrasing and mispronunciation, but gratuitous and wordy explanations and light comedy by-play that may

My First Adventure With a Radio Receiver

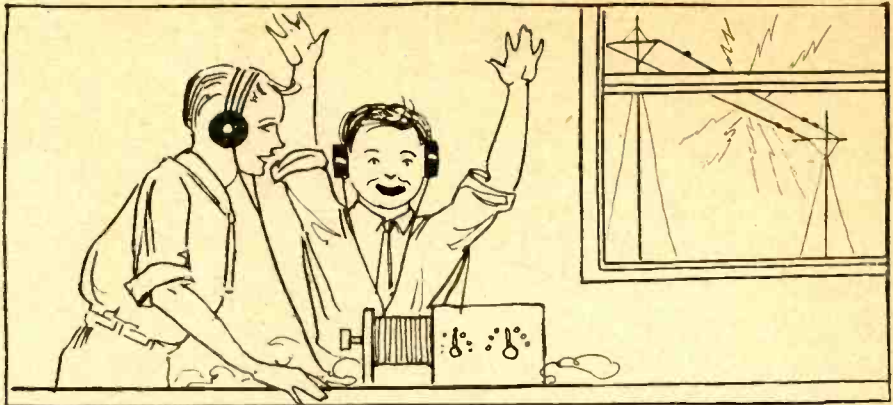

"I WAS REWARDED by hearing just the faintest suggestion of dots and dashes, which I surmised were the signals of some ship far out on the ocean."

"Back in 1913 a Boy Friend Introduced Me to Code Reception," Says Author, Citing Dots and Dashes that Originated Two Blocks Away

By J. Gerard Sheedy

Illustration by the Author

Numerous radio engineers and others affiliated with the radio game have at some time or other felt the urge to write their memoirs so that their records of trial and tribulation will go down in history. With this thought in mind I will write mine in one brief snatch.

It was way back in 1913, the year before the big war, that I received my introduction to a radio set. I call it a radio set out of kindness to my chum at the time, because of his great sacrifice in depriving himself of ice cream sodas, baseball gloves, moving pictures and other essentials of youth, to save enough to purchase a loose coupler, a crystal, phones and three dry batteries.

This elaborate collection of apparatus was stored in the attic, far from the prying eyes of the skeptical and safe from his mother's vigorous dustbrush, as the slightest jar would have thrown the crystal out of adjustment for weeks.

DX Around the Corner

I was led into the attic amid whispering on the part of my friend, for to let me hear the set he was "cutting" his homework, which was considered a grievous offense in those days. After having taken all the necessary precautions against noise, I finally managed to find an old soap box, upon which I sat while he untangled many mysterious wires and put the contraption

on my ears known as a pair of phones.

As many realize, there was no broadcasting at this time, only code.

Even bringing in code, according to my friend, was a feat in itself. If we were lucky, I was informed, we might be able to hear the New York Navy Yard station, in Brooklyn, which was nearly two blocks away.

After a siege of pulling, scraping and breathless waiting on the part of my colleague, I heard a very faint click. Suddenly the face of my youth of mystery lighted up with a superior smile.

Mystery Unfolded

"Did you hear that?" he cried.

"Yes," I replied, "What was it?"

"That," he exclaimed, "was the automatic switch in the car tracks down at the corner.

After another hour of patient waiting I was rewarded by hearing just the faintest suggestion of dots and dashes, which I surmised were the signals of some ship far out on the ocean. These signals lasted for almost thirty seconds. I then asked my friend what ship it might be. He replied that it was no ship, but was the Naval Station two blocks away, the antenna of which was plainly visible through the window.

Glancing at my friend's face I concluded from his expression that the demonstration was at an end. I then thanked him most heartily and bade him good-night, feeling that he was indeed making progress in the world of science.

be understood and appreciated in the studio but is sad and flat to the rest of the world.

The average listener holds that it is the duty of the announcer to convey by word the personality of his station, to let the listener know the call letters of the station, the name of the performer and the title of his selection. After he has done that he is no longer necessary in the picture. The most successful announcers are those who avoid stereotyped phrasing and who, in vocal tone, convey friendliness, good will and a desire to please.

That is the side of the announcer that

the listener gets but the announcer also has his duty to the performer and very often it is a difficult duty. Many performers, even though experienced in public performance, quail before the microphone. The announcer must say and do the right thing to put the nervous performer at ease.

Then there is the temperamental musician, not always in the class described as artists, who because of some fancied slight, appears but refuses to go on at the scheduled time. Such a one must be coddled and convinced that thousands will go to bed unhappy if he is not heard.

De Forest Co. Plans Suits Ending All Sets by R.C.A.

Will Allege Infringement of Regenerative Patent, Newly Awarded to De Forest — Court Cancels Armstrong's Grant — Westinghouse "Licenses" Held Illegal.

MILLIONS IN SIGHT

Damages to Be Sought from All Violators, As 7-Year Feedback Dispute Reaches "Final Stage."

(Special to RADIO WORLD)

PHILADELPHIA.

Having previously obtained patents on the regenerative circuit, through court decision, Dr. Lee De Forest won another victory in his 9-year fight against the Armstrong patent, when Judge J. J. Thompson, in Federal Court, Eastern District, also handed down a decision cancelling the patent granted to Armstrong, and automatically declaring Dr. De Forest the actual inventor.

The suit was against the Westinghouse Electric & Manufacturing Co., to whom Edwin H. Armstrong had assigned his rights, if any, and for which he had been paid a lump sum of several hundred thousand dollars.

Westinghouse has licensed several set manufacturers and others under the Armstrong patent, including the Radio Corporation of America, the General Electric Co., and a score more. Under this so-called license regenerative receivers and kits have been and are being sold, and Westinghouse is collecting royalty thereon, often using the legal department of the R. C. A. to enforce royalty payments, bring injunction suits, etc. In these suits the Westinghouse and R. C. A., as plaintiffs, are using a stock affidavit of John V. L. Hogan, a New York radio experimenter, which attempts to show how defendants infringe the Armstrong patent.

Called "Final Stage"

The decision by Judge Thompson is hailed by Dr. De Forest as marking "the final stage" of the long legal dispute as to whether Armstrong or De Forest actually was first to invent the regenerative circuit.

The De Forest Radio Co., to whom Dr. De Forest assigned his rights, was the plaintiff in the suit just decided. Following the result it immediately began preparations to enforce to the utmost its rights against Westinghouse, et al., not only as a matter of legal right, but because the long hostility between the De Forest Co. and the R. C. A. has become even more acute of late.

The plans of the De Forest Co. include the following:

(1) Suit for money damages against the Westinghouse and all its pretended licenses under the regenerative

patent, including firms "licensed" since the decision in the District of Columbia in 1924, holding that De Forest (and not Armstrong) owned the patent. Set manufacturers and kit assemblers or any others operating under any such pretended license are to be named defendants. The actions would be in the nature of a demand for an injunction and accounting of profits. The actual money involved strictly as profits runs into several millions of dollars.

(2) Attempt by suit to stop the R. C. A. from manufacturing or having manufactured by it (this covers General Electric) or from selling any receivers that infringe the patent, and these are said to include every receiver in the R. C. A. catalogue, for some of its sets are merely regenerative, while others use regeneration in necessary conjunction with Super-Heterodyne circuit operation. Without regeneration there can be no Super-Heterodyne.

The De Forest Co. is said to be determined to do all within its power and legal rights to put R. C. A. out of the set business as an infringer.

Fires Blaze Up

The R. C. A. several months ago roused anew the ire of the De Forest outfit when it "bought" employes of the De Forest tube works, using them as spies and obtaining secret data in an endeavor to put De Forest out of the tube business—De Forest, by the way, being the undisputed inventor of the 3-element vacuum tube, the greatest invention within the memory of any living person.

At the time this expensive spy system was being maintained by the R. C. A. with headquarters at a secret office in lower Manhattan, with skilled operatives coaching the tools and traitorous employes of De Forest, the entire De Forest outfit, set manufacturing and tube making, was in a weak financial condition, as was very well known in the industry. However, resources were commanded at great sacrifice and a suit started to enjoin the R. C. A. from its spy work and demanding that the big filing system, recording data taken from the De Forest works, be returned to the rightful and aggrieved owner. These demands were quickly granted in a temporary injunction issued against the R. C. A., the court attacking the methods employed by the R. C. A.

The De Forest Co. went to great expense in this suit. Finally it found that

it could not maintain itself longer without reorganization, and a bankruptcy petition was filed and a receiver appointed. The company is coming along all right and, especially under the heartening result of the Pennsylvania suit, bids fair to resume "on its own" and enjoy a prosperous season.

Darby's Statement

Samuel E. Darby, 220 Broadway, New York City, chief patent attorney for the De Forest Radio Co., and who personally submitted his client's case to the Pennsylvania court, issued the following statement:

"The feedback regenerative circuit has been aptly termed 'the heart and soul of radio.' Without it broadcasting would be impossible. Dr. De Forest's regenerative transmitter with its novel circuit was held to be the original invention of this essential device when in September, 1924, the District of Columbia Court of Appeals reversed the Commissioner of Patents and granted priority of invention to Dr. De Forest over Major Armstrong. Patents were issued to De Forest. Despite this, the Westinghouse Company through its licensees continued the manufacture of hundreds of thousands of radio sets using the infringing Armstrong circuit.

"The De Forest Radio Company's suit for cancellation was necessitated by the contention of the Westinghouse interests that the United States Court of Appeals in New York had sustained the Armstrong patent, and the licensed manufacturers under it included the Radio Corporation of America, General Electric Company and nearly a score of other radio manufacturers. It has been estimated that this essential circuit is in use in over one-half of all the radio sets or receivers built and sold in the United States since Dr. De Forest's invention of the three-electrode audion.

"The profits accruing to the De Forest Radio Company from the infringing use of this circuit by the Westinghouse Company and its licensees will be enormous as a result of the decision which will bring to a close litigation that has been fought in various United States courts since 1917. In addition, this action of Judge Thompson will automatically release the De Forest Radio Company from any and all liability for infringement which was charged in parallel suits filed to sustain the validity of the Armstrong circuit patent."

Patent All-Inclusive, Says Real Inventor

By Lee De Forest

Priority for this invention was originally awarded to Mr. Armstrong by the Commissioner of Patents, and this award was reversed by the Court of Appeals, District of Columbia, and letters patent were granted to me on September 2, 1924. Due to the fact that the Court of Ap-

peals in their opinion quoted three claims, all of which were directed to the use of such a circuit for the production of oscillations, the public at large has received the impression that the sole matter in controversy was the oscillating audion, or the audion as a generator of alternating currents. Such is far from the case. In the first place, the controversy involved

(Concluded on page 22)

THE RADIO TRADE

1927 Outlook Fine In the Middle West

Business Founded on a Firm Basis, and Not a Passing Affair, Says Crosley

Powel Crosley, Jr., President of The Crosley Radio Corporation, of Cincinnati, recently made a week's tour of the Middle West, where he addressed gatherings of distributors. He spoke to several hundred radio men in St. Louis, Kansas City, Waterloo, Ia.; Omaha and Minneapolis.

"The outlook for the 1927 radio season is particularly bright and gives encouragement for the stability of the industry," Crosley said. "The enthusiasm shown by the radio men from the Middle Western states indicates their firm belief in the big future of the business which has proven itself to be founded upon a firm basis and not some passing affair, as some people seemed to think.

"The bumper wheat and corn crops in

the Mid West indicate a prosperous year, with plenty of money to be spent for radio equipment. Nearly every farm has its receiving set and the people look upon this form of information as to conditions of the market with as much interest as was the case when the rural mail delivery had to be depended upon for the same data."

Crosley, his family and guests, are on a month's vacation cruise aboard his 65-foot motor-yacht *Muroma*, sailing up the Hudson River, through Lake Champlain, to the St. Lawrence River and then to Quebec, Montreal and on to New Brunswick where the party will cast lines for big fish.

They hope to catch plenty.

Kiley Likes Cones for Outdoor Use

The public is rapidly finding out that cone loud speakers are best for outdoor use, according to George H. Kiley, vice-president of the Farrand Manufacturing Company of New York, makers of loud speakers and other radio devices.

"A cone speaker distributes the sound over a wider area and the music reproduced seems to stand up better against the casual noises of the open spaces of porch or summer camp," Mr. Kiley said at a recent gathering of radio dealers where he presented the result of a survey among the trade that has just been completed by his company.

"Cone type speakers are rapidly replacing all other forms of reproduction, our survey shows," Mr. Kiley continued pointing out the large number of port-

able set manufacturers who are using cone speakers in their receivers this season.

Walbert in Canada

Walbert of Canada, Ltd., has been organized by Canadian capital to manufacture and distribute Walbert Penetrolas, Isofarad Receivers and kits in Canada. This concern has been licensed by the Walbert Mfg. Co., of Chicago, to manufacture these items. The new concern is located in London, Ontario, and is under the management of George Young and William Daniel, of that city.

NEW CORPORATIONS

Lake City Sales Corp., N. Y. City, radio instructions, \$20,000; M. Gordon, D. Weisbarth, L. Morris. (Atty., C. J. Holland, 350 Madison Ave., N. Y. City.)

NAME CHANGES

Brooklyn Radio Co., Brooklyn, N. Y., to Brooklyn Radio Service Corp.

Victoreen Master Control Unit On Market

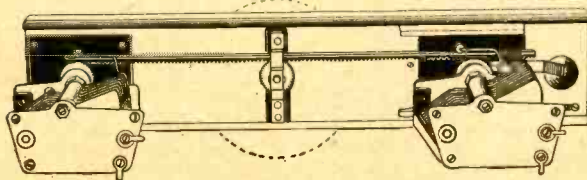

THE Victoreen Single Control Unit

The latest Victoreen product to be placed on the market is a completely assembled single control unit for use on all circuits employing two or three condensers of .0005 capacity.

This control unit simplifies tuning, as there is only one dial to turn in place of two or three dials. The reading of the dial is alike whether loop or antenna is used.

The Victoreen Master Control Unit is

easy to mount. The V. S. type which is intended primarily for the Victoreen hook-up, can be installed without change in wiring.

The T. R. F. type is the same as the V. S. type except that three condensers are used. Both models are completely assembled with condensers ready for use.

The George W. Walker Co., Cleveland, Ohio, is marketing the device, and it is proving popular.

Literature Wanted

THE names of readers of RADIO WORLD who desire literature from radio jobbers and dealers are published in RADIO WORLD on request of the reader. The blank below may be used, or a post card or letter will do instead.

Trade Service Editor,
RADIO WORLD,
145 West 45th St., N. Y. City.

I desire to receive radio literature

Name

Address

City or town.....

State

C. C. Morgan, 850 Arch St., Burlington, Ia.
G. Clifford Wilson, E. Shawmont Ave., Roxborough, Phila., Pa.
J. M. Kerr, 120 S. 4th St., Cuyahoga Falls, O.
Lester Sasser, Fossil, Ore.
Floyd G. Close, Pawnee, Okla. (Dealer.)
Frank E. Coates, 1021 South Ridgeland Ave., Oak Park, Ill.

DE FOREST TELLS SCOPE OF PATENT ON REGENERATION

(Concluded from page 21)

the so-called feedback or regenerative circuit for reception as well as for transmission, and, in fact, for any purpose in which reamplification or regeneration is desired, whether in an oscillatory or a non-oscillatory condition.

The patents issued to me as a result of this decision, after describing eight different circuit arrangements for securing feedback or regeneration, including the so-called ultra audion circuit, the common inductive lead circuit and the straight inductive coupling between the grid-filament or input circuit and the plate-filament or output circuit, contains the following passage:

"I am unable at the present time to give a complete explanation of the theory of action of the apparatus when operating as a generator. I have discovered, however, that a system constructed as shown, described and energized from a suitable current source, becomes the seat of continuous high frequency oscillations.

"Undoubtedly the phenomenon involved depends upon the effect of successively applied charges or surges of potential upon the grid and plate elements, and having the power to affect momentarily the conductivity of the medium between the filament and plate electrodes in such a manner that the current variations in the grid filament circuit produce corresponding variations in the plate-filament circuit which are fed back to the grid-filament circuit to add their effects to the initial variations, which latter, thus reenforced, create and form greater variations in the plate-filament circuit which are, in turn, fed back to the grid-filament circuit to still further amplify the variations in that circuit, and so on.

"The energy of the variations of each circuit reacts upon and increases that of the other circuit until a maximum sustained alternating current is finally produced, whose frequency can be controlled by varying the electrical constants of the associated circuits. In other words, the amplifying action incident to the feeding back of energy from the one circuit to the other increases until oscillations are produced which, once set up, are self-perpetuating."

Radio Compass Aid to Shipping

WASHINGTON.

New perfections in the radio compass have greatly increased its value to shipping, according to letters received by the Lighthouse Service. Following is a letter from Captain S. S. Wilpen, of the S. S. Munroe, which tells of the great accuracy now possible through use of the radio compass:

"On our down trip I had a good chance to try out our radio direction finder as we had a dense fog from Duluth to Lake Huron Lightship. On leaving Duluth we got Devils Island, also Manitou Island. We could locate our position, also the

time we were abreast, and the distance off each light as we passed them just as accurate as if we were running in clear weather. When I was abreast of Copper Harbor I got Whitefish Point, a distance of 148 miles. I shaped our course by radio and found it to be as accurate as if we had been able to see the light at that distance. I shaped a course from Harbor Beach to Lake Huron Lightship by radio. It cleared up before I got to the lightship. When we saw the light we were heading directly on it. In my opinion it is the most wonderful aid to navigation that was ever put aboard a steamboat."

TUBE RESTORER



(Hayden)

BY CONNECTING a number of sockets with filaments in series, and using a B battery as the A voltage source, a number of thoriated tungsten filament tubes may be reactivated together. No plate voltage is used. The 22½-volt post of a standard F battery may be employed in extreme cases for 8 to 10 second flash.

WOWO Keeps Wave, and So Does KFON

WOWO, Ft. Wayne, Ind.: "We are changing station to Class B requirements both in power and equipment. Have applied for high wavelength and will use same if granted by Government. Will not go contrary to governmental regulations and will do nothing to increase chaos in present broadcasting situation."

KFON, Long Beach, Calif., by Hal G. Nichols, president: "Station KFOM will not alter wavelength pending adjustments of chaos caused by failure of Congress to enact regulatory radio legislation. We depreciate attempt of mercenary interests to discredit Secretary of Commerce Hoover, whose policies in supervision of radio we deem eminently fair. We do not believe a high-salaried radio bureau necessary to control situation but consider such a bureau or commission an added burden on taxation. Broadcasters who deliberately trespass on the wavelengths of other stations are guilty of radio piracy."

PICTURE SPEAKER



(International Newsreel)

SIDNEY HEDGELAND, shown with invention, has devised a speaker fashioned ingeniously in the shape of a framed photograph which can be hung on any wall. The framed picture itself contains mechanism for distributing the electrical vibrations as sound waves.

SEE SEPTEMBER, 1926,
"RADIO NEWS"
ON THE NEW
"1927 DIAMOND
OF THE AIR"

Send in for Bulletin 702

B. C. L. Radio Service, Inc.

223 FULTON ST. NEW YORK CITY

Superior to Any Other TECTRON "B" ELIMINATOR

Smaller than one B Battery.
Delivers as high as 150 Volts
and up to 60 Milliamperes
of Humless Rectified Power.

TECTRON RADIO CO., 1270 Broadway, N. Y.



UX POWER TUBES installed in any set without rewiring by Na-Ald Adapters and Connectorals. For full information write Alden Manufacturing Co., Dept. S-18, Springfield, Mass.

New and Improved FRESHMAN MASTERPIECE

AT AUTHORIZED
FRESHMAN DEALERS ONLY

THE AERO ALL-WAVE SET, by Capt. P. V. O'Rourke, appeared in RADIO WORLD dated April 24 and May 1. Sent on receipt of 30c. RADIO WORLD, 145 W. 45th St., N. Y. C.

THE GREAT AID OF BY-PASS CONDENSERS, by John F. Rider, appeared in RADIO WORLD dated May 8. Sent on receipt of 15c, or start sub. with that number, RADIO WORLD, 145 W. 45th St., N. Y. C.

FREE RADIO CATALOG



Just off the press! Our second catalog for 1926. 100 pages of parts, accessories, kits and sets—all the best and the latest. A copy is yours for the asking. Just drop us a line—do it today!

DEPT. PM

CHICAGO SALVAGE STOCK STORE

509 S. State Street, Chicago, U. S. A.



FREE! 12-Cell — 24-Volt Storage 'B' Battery

Positively given free with each purchase of a WORLD "A" Storage Battery. You must send this ad with your order. WORLD Batteries are famous for their guaranteed quality and service. Backed by years of successful manufacture and thousands of satisfied users. Equipped with Solid Rubber Cases, an insurance against acid and leakage. You save 50 per cent and get a

2-Year Guarantee

Bond in Writing. World Battery owners tell their friends. That's our best proof of performance. Send your order in today.
Solid Rubber Case Radio Batteries
6-Volt, 100-Amperes \$11.25
6-Volt, 120-Amperes 13.25
6-Volt, 140-Amperes 14.00
Solid Rubber Case Auto Batteries
6-Volt, 11-Plate \$11.25
6-Volt, 13-Plate 13.25
12-Volt, 7-Plate 16.00

Send No Money. Just state battery wanted and Express C. O. D. subject to your examination on arrival. FREE "B" Battery included. Extra Offer: 5 Per cent discount for cash in full with order. Buy now and get a guaranteed battery at 50 per cent saving to you.

WORLD BATTERY COMPANY
1219 So. Wabash Ave., Dept. 17 CHICAGO, ILL.

World STORAGE BATTERIES

Approved and Listed as Standard by Leading Authorities including Radio News Laboratories, Popular Science Institute of Standards, Popular Radio Laboratories, Radio Broadcast Laboratories, Home and Latex, Inc.
Set your Radio Dials at 210 meters for the new 1000 watt World Storage Battery Station, WSBG, Chicago. Watch for announcements.

OFFICIAL LIST OF STATIONS

(Corrected and Revised Up to August 4)

| Station | Owner and Location | Meters |
|---------|--|--------|
| KDKA | Westinghouse Co., Pittsburgh | 309 |
| KDLR | Radio Elec. Co., Devils Lake, N. D. | 231 |
| KDYI | Newhouse Hotel, Salt Lake City, Utah | 246 |
| KFAB | Nebraska Buick Auto Co., Lincoln | 273 |
| KFAB | Nebraska Auto Co., Lincoln, Neb. | 340 |
| KFAD | Electrical Equip. Co., Phoenix, Ariz. | 273 |
| KFAF | A. E. Fowler, San Jose, Calif. | 217 |
| KFAU | Ind. School Dist., Boise, Idaho | 280 |
| KFBB | F. A. Buttry Co., Havre, Mont. | 275 |
| KFBC | W. K. Azbill, San Diego, Cal. | 216 |
| KFBK | Kimball Upson Co., Sacramento, Cal. | 248 |
| KFBL | Leese Bros., Everett, Wash. | 224 |
| KFBS | School District No. 1, Trinidad, Col. | 238 |
| KFBT | Bishop N. S. Thomas, Laramie, Wyo. | 270 |
| KFCB | Nielson Radio Co., Phoenix, Ariz. | 238 |
| KFCD | St. Michael's Cathedral, Boise, Idaho | 278 |
| KFDM | Magnolia Petroleum Co., Beaumont, Texas | 316 |
| KFDX | 1st Baptist Church, Shreveport, La. | 250 |
| KFDY | State College of Agriculture, Brookings, S. D. | 273 |
| KFDZ | H. O. Iberson, Minneapolis, Minn. | 231 |
| KFEC | Meier & Frank Co., Portland, Ore. | 248 |
| KFEL | Winner Radio Corp., Denver, Colo. | 254 |
| KFEQ | J. L. Scroggin, Oak, Neb. | 268 |
| KFEY | Bunker Hill & Sullivan, Kellogg, Idaho | 233 |
| KFFP | 1st Baptist Church, Moberly, Mo. | 242 |
| KFFQ | Crary Co., Boone, Iowa | 226 |
| KFH | Hotel Laessen, Wichita, Kans. | 268 |
| KFHA | Western State College, Gunnison, Colo. | 252 |
| KFHL | Penn College, Oskaloosa, Iowa | 240 |
| KFI | E. C. Anthony Inc., Los Angeles, Cal. | 469 |
| KFIF | Benson Institute, Portland, Ore. | 248 |
| KFIO | North Central H. S., Spokane, Wash. | 266 |
| KFIQ | 1st Methodist Church, Yakima, Wash. | 256 |
| KFIU | Alaska Elec. Co., Juneau, Alaska | 226 |
| KFIZ | Daily Commonwealth, Fond du Lac, Wis. | 273 |
| KFJB | Marshall Elec. Co., Marshalltown, Ia. | 248 |
| KFJC | R. B. Fegan, Junction City, Kan. | 219 |
| KJFF | National Radio Co., Oklahoma City, Okla. | 261 |
| KFJI | Liberty Theatre, Astoria, Ore. | 246 |
| KFJM | University of N. D., Grand Forks | 278 |
| KFJR | Ashley C. Dixon & Son, Portland, Ore. | 263 |
| KFJJ | Tunwall Radio Co., Ft. Dodge, Iowa | 246 |
| KFJZ | W. E. Branch, Fort Worth, Tex. | 254 |
| KFKA | State Teachers College, Greeley, Colo. | 273 |
| KFKU | University of Kansas, Lawrence, Kans. | 275 |
| KFKX | Westinghouse Co., Hastings, Neb. | 288 |
| KFKZ | Chamber of Commerce, Kirksville, Mo. | 226 |
| KFLR | University of N. M., Albuquerque, N. M. | 254 |

| Station | Owner and Location | Meters |
|---------|---|--------|
| KFLU | San Benito Radio Club, San Benito, Tex. | 236 |
| KFLV | Swedish Evangelist Church, Rockford, Ill. | 229 |
| KFLX | George R. Clough, Galveston, Texas | 240 |
| KFLZ | Atlantic Auto Co., Annetta, Ia. | 273 |
| KFMR | Morningside College, Sioux City, Iowa | 261 |
| KFMW | M. G. Satara, Houghton, Mich. | 263 |
| KFMX | Carleton College, Northfield, Minn. | 337 |
| KFNF | H. Field Seed Co., Shenandoah, Iowa | 461 |
| KFOA | Rhodes Company, Seattle, Wash. | 454 |
| KFOB | KFOB Inc., Burlingame, Cal. | 226 |
| KFON | Echophone Shop, Long Beach, Cal. | 233 |
| KFOO | Latter Day Saints University, Salt Lake City, Utah | 236 |
| KFOR | David City Co., David City, Neb. | 226 |
| KFOT | College Hill Radio Club, Wichita, Kan. | 231 |
| KFOX | Technical High School, Omaha, Neb. | 248 |
| KFOY | Beacon Radio Service, St. Paul, Minn. | 252 |
| KFFL | C. C. Baxter, Dublin, Texas | 252 |
| KFFM | New Furniture Co., Greenville, Texas | 242 |
| KFFR | Forestry Department, Los Angeles, Cal. | 231 |
| KFFW | St. John's Church, Cartersville, Mo. | 258 |
| KFFY | Symonds Invest. Co., Spokane, Wash. | 266 |
| KFOA | The Principia, St. Louis, Mo. | 261 |
| KFOB | Searchlight Pub. Co., Ft. Worth, Tex. | 227 |
| KFOD | Chovin Co., Anchorage, Alaska | 227 |
| KFQP | G. S. Carson, Jr., Iowa City, Ia. | 224 |
| KFQU | W. C. Riker, Holy City, Cal. | 217 |
| KFQW | F. C. Knierim, North Bend, Wash. | 216 |
| KFQZ | Taft Products Co., Hollywood, Cal. | 226 |
| KFRB | Hall Bros., Beville, Texas | 248 |
| KFRD | City of Paris, San Francisco, Cal. | 268 |
| KFRU | Stevens College, Columbia, Mo. | 500 |
| KFRW | G. and G. Radio and Electric Shop, Olympia, Wash. | 219 |
| KFSD | African Radio Corporation, San Diego, Cal. | 246 |
| KFSG | Echo Park Evang. Assn., Los Angeles | 275 |
| KFUL | T. Googan & Bro., Galveston, Tex. | 258 |
| KFUM | W. D. Corley, Colorado Springs, Col. | 240 |
| KFUO | Concordia Theo. Seminary, St. Louis, Mo. | 545 |
| KFUP | Fitzsimmons Gen. Hospital, Denver | 234 |
| KFUR | Peery Building Co., Ogden, Utah | 224 |
| KFUS | Louis L. Sherman, Oakland, Cal. | 256 |
| KFUT | Univ. of Utah, Salt Lake City, Utah | 261 |
| KFUU | Colburn & Mathewson, Oakland, Cal. | 220 |
| KFVD | C. & W. J. McWhinnie, San Pedro, Cal. | 205 |
| KFVE | Film Corp., St. Louis, Mo. | 240 |
| KFVG | 1st Meth-Epis. Church, Independence, Kan. | 236 |
| KFVI | 56th Cav. Brigade, Houston, Tex. | 240 |
| KFVN | C. E. Bagley, Welcome, Minn. | 227 |
| KFVS | Cape Girardeau Battery Station, Cape Girardeau, Mo. | 224 |
| KFVY | Radio Supply Co., Albuquerque, N. M. | 250 |
| KFWA | Browning Bros. Co., Ogden, Utah | 261 |
| KFWB | Warner Bros., Hollywood, Cal. | 252 |
| KFWC | L. E. Wall, San Bernardino, Cal. | 211 |
| KFWF | St. Louis Truth Center, St. Louis | 214 |
| KFWH | F. Wellington Morse, Jr., Chico, Cal. | 254 |
| KFWI | Radio Entertainers, Inc., South San Francisco, Cal. | 220 |
| KFWM | Oakland Educat. Soc., Oakland, Cal. | 207 |
| KFWO | Lawrence Mott, Avalon, Cal. | 211 |
| KFWU | Louisiana College, Pineville, La. | 238 |
| KFWV | Wilbur Jerman, Portland, Ore. | 213 |
| KFXB | B. O. Heller, Big Bear Lake, Cal. | 203 |
| KFXD | Service Radio Co., Logan, Utah | 205 |
| KFXF | Pikes Peak Broadcasting Station Co., Colo. Springs, Colo. | 250 |
| KFXH | Bledsoe Radio Co., El Paso, Texas | 242 |
| KFXJ | Mt. States Radio District, Inc., (Portable), Col. | 216 |
| KFKR | Classen Film Finishing Co., Okla. City, Okla. | 214 |
| KFKY | Mary M. Costigan, Flagstaff, Ariz. | 205 |
| KFYF | Carl's Radio Den, Oxnard, Cal. | 206 |
| KFYJ | Houston Chronicle, Houston, Tex., (Portable) | 238 |
| KFYO | Buchanan Vaughn Co., Texarkana, Tex. | 210 |
| KFYR | Hoskins Meyers, Inc., Bismarck, N. D. | 248 |
| KGAR | Citizen Pub. Co., Tucson, Ariz. | 244 |
| KGBS | A. C. Dailey, Seattle, Wash. | 210 |

| Station | Owner and Location | Meters |
|---------|--|---------|
| KGO | General Electric Company, Oakland, Cal. | 361 |
| KGTT | Glad Tidings Tabernacle, San Francisco, Cal. | 207 |
| KGU | M. A. Mulrony, Honolulu, Hawaii | 270 |
| KGW | The Oregonian, Portland, Ore. | 492 |
| KGY | St. Martin's College, Lacey, Wash. | 246 |
| KHJ | The Times, Los Angeles, Cal. | 405 |
| KHQ | Louis Wasmer, Spokane, Wash. | 273 |
| KJBS | J. Brunton Co., San Francisco | 230 |
| KJR | Northwest Radio Co., Seattle, Wash. | 384 |
| KLDS | Reorganized Church of Jesus Christ of Latter Day Saints, Independence, Mo. | 441 |
| KLS | Warner Radio Co., Oakland, Cal. | 250 |
| KLX | Tribune, Oakland, Cal. | 508 |
| KLZ | Reynolds Radio Co., Denver, Colo. | 266 |
| KMA | May Seed & Nursery Co., Shenandoah, Ia. | 252 |
| KMJ | Fresno Bee, Fresno, Cal. | 234 |
| KMMJ | Johnson Co., Clay Center, Nebr. | 239 |
| KMO | Love Elec. Co., Tacoma, Wash. | 250 |
| KMOX | Globe Democrat, St. Louis, Mo. | 250 |
| KNRC | C. B. Juneau, Hollywood, Cal. | 208 |
| KNTR | Garretson & Turner, Los Angeles | 337 |
| KNX | Express, Los Angeles, Cal. | 238 |
| KOA | General Electric Co., Denver, Col. | 322 |
| KOAC | Oregon Agricultural College, Corvallis, Ore. | 280 |
| KOB | College of Agri., State College, N. M. | 349 |
| KOCH | Omaha Central High School, Omaha, Neb. | 258 |
| KOCW | Okla. College for Women, Chickasha, Okla. | 252 |
| KOIL | Monarch Mfg. Co., Council Bluffs, Ia. | 278 |
| KOWW | Blue Mountain Radio Assn., Walla Walla, Wash. | 256 |
| KPO | Hale Brothers, San Francisco, Cal. | 429 |
| KPPC | Presbyterian Church, Pasadena, Cal. | 229 |
| KPRC | Houston Print Co., Houston, Tex. | 256 |
| KPSN | Pasadena Star-News, Pasadena, Cal. | 297 |
| KQP | H. B. Read, Portland, Ore. | 316 |
| KQV | Doubleday Hill Elec. Co., Pittsburgh | 213 |
| KQW | First Baptist Church, San Jose, Cal. | 275 |
| KRCA | RCA, portable, San Francisco and Los Angeles, Cal. | 305 |
| KRE | Gazette, Berkeley, Cal. | 256 |
| KSAC | Kansas State Agricultural College, Manhattan, Kans. | 341 |
| KSD | Post Dispatch, St. Louis, Mo. | 545 |
| KSL | Radio Service Corp., Salt Lake City, Utah | 300 |
| KSMR | S. M. Valley R. R. Co., Santa Maria, Cal. | 210 |
| KSO | A. A. Berry Seed Co., Clarinda, Ia. | 242 |
| KTAB | Tenth Ave. Bapt. Ch., Oakland, Cal. | 294 |
| KTBI | Bible Inst., Los Angeles, Cal. | 240 |
| KTBR | Brown's Radio Shop, Portland, Ore. | 263 |
| KTCL | American Radio Tel Co., Inc., Seattle, Wash. | 306 |
| KTHS | New Arlington Hotel, Hot Springs, Ark. | 375 |
| KTNT | N. Baker, Muscatine, Ia. | 256 |
| KTW | 1st Presbyterian Church, Seattle, Wash. | 454 |
| KUOA | University of Ark., Fayetteville, Ark. | 300 |
| KUOM | State University of Montana, Missoula, Mont. | 245 |
| KUSD | University of S. D. Vermillion, S. D. | 278 |
| KUT | University of Texas, Austin, Tex. | 231 |
| KVOO | Voice of Oklahoma, Bristow, Okla. | 375 |
| KWCR | H. F. Paar, Cedar Rapids, Ia. | 278 |
| KWG | Portable Wireless Tel. Co., Stockton, Cal. | 248 |
| KWKC | Duncan Studios, Kansas City, Mo. | 236 |
| KWKH | W. K. Henderson I. W. & S. Co., Shreveport, La. | 261 |
| KWSC | State College, Pullman, Wash. | 349 |
| KWUC | Western Union College, Le Mars, Ia. | 252 |
| KWWG | City, Brownsville, Tex. | 278 |
| KYW | Westinghouse Co., Chicago | 535 |
| KZKZ | Electric Supply Co., Manila, P. I. | 270 |
| KZM | P. D. Allen, Oakland, Cal. | 240 |
| KZRQ | Far Eastern Radio, Inc., Manila, P. I. | 222 |
| NAA | U. S. Navy, Arlington, Va. | 435 |
| WAAD | Ohio Mech. Institute, Cincinnati, O. | 258 |
| WAAF | Drovers Journal, Chicago, Ill. | 278 |
| WAAM | I. R. Nelson Co., Newark, N. J. | 263 |
| WAAW | Omaha Grain Ex., Omaha, Neb. | 278-384 |
| WABB | Harrisburg Radio Co., Harrisburg, Pa. | 204 |
| WABC | Asheville Battery Co., Asheville, N. C. | 254 |
| WABI | First Universalists Church, Bangor, Me. | 240 |
| WABO | Lake Ave. Bapt. Ch., Rochester, N.Y. | 278 |
| WABQ | Haverford College Radio Club, Haverford, Pa. | 261 |
| WABR | Scott High School, Toledo, O. | 263 |
| WABW | College of Wooster, Wooster, O. | 207 |

CONFESSIONS OF A SUPER BUG, by James H. Carroll, appeared in RADIO WORLD dated May 22. 15c per copy, or start sub. with that number. RADIO WORLD, 145 W. 45th St. N. Y. C.

FENWAY

—for DX

Winter or Summer the Fenway is a consistent DX-getter. Naturally, you want to own one of these super-sensitive receivers. Fenway Blueprints show you how to build a laboratory set.

PRICE OF COMPLETE SET OF BLUEPRINTS—\$3.00 Postpaid

Others Give their Radio Prints Away FREE!—Fenway Prints Cost

You \$3.00—WHY?

Guaranty Radio Goods Co.

147 West 45th Street New York City

FILL OUT AND MAIL NOW

SUBSCRIPTION BLANK

RADIO WORLD

RADIO WORLD

145 West 45th Street, New York City

(Just East of Broadway)

Please send me RADIO WORLD for months, for which

please find enclosed

SUBSCRIPTION RATES:

Single Copy.....\$ 15

Three Months..... 1.50

Six Months..... 3.00

One Year, 52 Issues..... 6.00

Add \$1.00 a Year for Foreign Postage; 50c for Canadian Postage.

FREE BOOKLET FOR INVENTORS

IF YOUR INVENTION is new and useful it is patentable. Send me your sketch.

Z. H. POLACHEK, 70 Wall St., New York

Reg. Patent Attorney-Engineer

VEBY HIGH-MU TUBES

Made especially for Resistance Coupled Amplifiers. Now you can get more volume with greater clarity.

A.F. 20 for 1st and 2nd Stage.....\$3.00

A.F. 6 Power Tube for 3rd Stage.....\$4.50

VEBY RADIO CO.

47-51 Morris Avenue Newark, N. J.

| Station | Owner and Location | Meters |
|---------|--|--------|
| WABX | H. B. Joy, Mt. Clemens, Mich. | 246 |
| WABY | John Magaldi, Philadelphia, Pa. | 242 |
| WABZ | Coliseum Place Baptist Church, New Orleans, La. | 275 |
| WADC | Allen T. Simmons, Akron, O. | 258 |
| WAFD | A. B. Parfet Co., Port Huron, Mich. | 275 |
| WAHG | Grebe Co., Richmond Hill, N. Y. | 316 |
| WAGM | R. L. Miller, Royal Oak, Mich. | 225 |
| WAIT | A. H. Waite & Co., Taunton, Mass. | 229 |
| WAIU | American Ins. Union, Columbus, O. | 294 |
| WAMD | Radisson Co., Minneapolis, Minn. | 297 |
| WAPI | Alabama Polytechnic, Auburn, Ala. | 248 |
| WARC | American Radio Res. Corp., Medford Hillside, Mass. | 261 |
| WATT | Edison Co. (Portable), Mass. | 244 |
| WBAA | Purdue University, West Lafayette, Ind. | 273 |
| WBAK | State Police, Harrisburg, Pa. | 276 |
| WBAL | Gas and Elec. Co., Baltimore, Md. | 246 |
| WBAO | James Millika University, Decatur, Ill. | 270 |
| WBAP | Star Telegram, Fort Worth, Tex. | 476 |
| WBAA | 1st Baptist Church, Nashville, Tenn. | 236 |
| WBAX | J. H. Stenger, Jr., Wilkes-Barre, Pa. | 256 |
| WBBL | Grace Covenant Presbyterian Church, Richmond, Va. | 229 |
| WBBM | Atlas Investment Co., Chicago, Ill. | 226 |
| WBBP | High School, Petoskey, Mich. | 238 |
| WBBR | Peoples Pulpit Ass., S. Is., N. Y. | 416 |
| WBSB | 1st Baptist Church, New Orleans, La. | 252 |
| WBBW | Ruffner City, Norfolk, Va. | 222 |
| WBBY | Washington Light Infantry, Charleston, S. C. | 268 |
| WBBZ | C. L. Carrell, (Portable), Chicago, Ill. | 216 |
| WBCN | Foster McConnell, Chicago, Ill. | 266 |
| WBDC | Baxter Co., Grand Rapids, Mich. | 256 |
| WBES | Bliss Electrical School, Takoma Park, Mich. | 222 |
| WBOQ | Grebe & Co., Richmond Hill, N. Y. | 236 |
| WBNY | Miss S. Katz, N. Y. C. | 322 |
| WBRC | Bell Radio Corp., Birmingham, Ala. | 248 |
| WBRE | Baltimore Radio Ex., Wilkes-Barre, Pa. | 231 |
| WBT | Westinghouse Chamber, Charlotte, N. C. | 275 |
| WBZ | Westinghouse Co., Springfield, Mass. | 333 |
| WBZA | Westinghouse Electric and Mig. Co., Boston, Mass. | 242 |
| WCAC | Agricultural College, Mansfield, Conn. | 275 |
| WCAD | St. Lawrence University, Canton, N. Y. | 263 |
| WCAE | Kaufman & Baer, Pittsburgh, Pa. | 461 |
| WCAJ | Nebraska Wesleyan University, University Place, Neb. | 254 |
| WCAL | St. Olaf College, Northfield, Minn. | 337 |
| WCAM | Galvin Radio Supply Co., Camden, N. J. | 236 |
| WCAO | Brager of Baltimore, Baltimore, Md. | 275 |
| WCAR | Southern Radio Corp., San Antonio, Texas | 263 |
| WCAT | School of Mines, Rapids City, S. D. | 240 |
| WCAU | Universal Broadcasting Co., Philadelphia, Pa. | 278 |
| WCAX | University of Vermont, Burlington, Vt. | 250 |
| WCBA | C. W. Heinbach, Allentown, Pa. | 254 |
| WCBD | W. G. Voliva, Zion, Ill. | 345 |
| WCBE | Uhalt Radio Co., New Orleans, La. | 263 |
| WCBH | University of Mississippi, Oxford, Miss. | 242 |
| WCMA | Culver Military Academy, Culver, Ind. | 222 |
| WCMB | Hotel Chapeau, Baltimore, Md. | 229 |
| WCBR | C. H. Messter (Portable), R. L. | 210 |
| WCBO | 1st Baptist Church, Nashville, Tenn. | 236 |
| WCCO | Gold Medal Station, Minneapolis, St. Paul, Minn. | 416 |
| WCK | Stix Baer & Fuller Co., St. Louis, Mo. | 273 |
| WCLO | C. E. Whitmore, Camp Lake, Wis. | 231 |
| WCLS | H. M. Church, Joliet, Ill. | 214 |
| WCOA | Municipal Station, Pensacola, Fla. | 222 |
| WCSH | Henry P. Rines, Portland, Me. | 256 |
| WSCO | Wittenberg College, Springfield, Ohio. | 248 |
| WCWS | C. W. Selen, Providence, R. I. | 210 |
| WCX | Detroit Free Press & Jewett Radio and WZJ—J. L. Bush, Tuscola, Ill. | 278 |
| WDAD | Dod's Auto Accessories, Inc., Nashville, Tenn. | 226 |
| WDAE | Tampa Daily News, Tampa, Fla. | 273 |
| WDAF | Kansas City Star, Kansas City, Mo. | 366 |
| WDAG | J. L. Martin, Amarillo, Tex. | 263 |
| WDAH | Trinity Metr. Church, El Paso, Tex. | 268 |
| WDAY | Radio Equipment Corp., Fargo, N. D. | 261 |
| WDBE | Gilham-Schoen Elec., Atlanta, Ga. | 278 |
| WBDJ | Richardson Wayland, Roanoke, Va. | 229 |
| WDBK | M. F. Broz, Furr., Cleveland, O. | 227 |
| WDBO | Rollins College, Winter Park, Fla. | 240 |
| WDBZ | Boy Scouts of Amer., Kingston, N.Y. | 233 |
| WDCH | Dartmouth College, Hanover, N. H. | 250 |
| WDGY | Dr. G. W. Young, Minneapolis, Minn. | 263 |
| WDND | Dod's Auto Accessories, Inc., 160-164 8th Ave., N., Nashville, Tenn. | 226 |
| WDOD | Chatt. Radio Co., Chattanooga, Tenn. | 256 |
| WDZ | J. L. Bush, Tuscola, Ill. | 278 |
| WDR | Doolittle Radio, New Haven, Conn. | 268 |
| WDWF | Dutree Wilcox Flint, Cranston, R. I. | 441 |
| WEAF | Broadcasting Company of America, N. Y. City, N. Y. | 492 |
| WEAI | Cornell University, Ithaca, N. Y. | 254 |
| WEAM | Borough of North Plainfield, N. Plainfield, N. J. | 261 |
| WEAN | Shepard Co., Providence, R. I. | 270 |
| WEAO | Ohio State University, Columbus, O. | 294 |
| WEAR | Willard Storage Battery Co., Cleveland, O. | 390 |

| Station | Owner and Location | Meters |
|---------|---|--------|
| WEAU | Davidson Bros. Co., Sioux City, Ia. | 275 |
| WEBC | W. C. Bridges, Superior, Wis. | 242 |
| WEBD | Elec. Equipment & Service Co., Anderson, Ind. | 246 |
| WEBH | Edgewater Beach Hotel, Chicago, Ill. | 370 |
| WEBJ | Third Avenue R. R. Co., New York, N. Y. | 273 |
| WEBL | Radio Corp. of Ama. (Portable) | 226 |
| WEBO | Tate Radio Co., Harrisburg, Ill. | 226 |
| WEBR | H. H. Howell, Buffalo, N. Y. | 244 |
| WEBW | Beloit College, Beloit, Wisc. | 268 |
| WEBZ | Savannah Radio Corp., Savannah, Ga. | 263 |
| WEEI | Edison Co., Boston, Mass. | 349 |
| WEHS | Robert E. Hughes, Evanston, Ill. | 203 |
| WEMC | Emm. Missionary College, Merrien Springs, Mich. | 286 |
| WENR | All-Amer. Radio Corp., Chicago, Ill. | 266 |
| WEW | St. Louis University, St. Louis, Mo. | 360 |
| WFAD | Dallas News & Journal, Dallas, Tex. | 476 |
| WFAM | The Times, St. Cloud, Minn. | 273 |
| WFAY | University of Nebr., Lincoln, Nebr. | 275 |
| WFBC | 1st Baptist Church, Knoxville, Tenn. | 250 |
| WFBE | J. V. De Walle, Seymour, Ind. | 226 |
| WFBG | W. F. Gable Co., Altoona, Pa. | 278 |
| WFBH | Galvin Radio Supply Co., Camden, N. J. | 236 |
| WFBJ | St. Johns University, Collegeville, Minn. | 236 |
| WFBL | Onondaga Hotel, Syracuse, N. Y. | 252 |
| WFBM | Merchants Lighting Co., Indianapolis, Ind. | 268 |
| WFBZ | Maryland National Guard, Baltimore, Md. | 254 |
| WFCL | Chicago Fed. of Labor, Chicago, Ill. | 492 |
| WFBL | Knox College, Galesburg, Ill. | 254 |
| WFDF | F. D. Fallain, Flint, Mich. | 234 |
| WFFI | Strawbridge & Clothier, Philadelphia, Pa. | 395 |
| WFKB | F. K. Bridgman, Chicago, Ill. | 217 |
| WFLR | R. M. Lacey, Brooklyn, N. Y. | 205 |
| WGAL | Lancaster Elec. Supply Co., Lancaster, Pa. | 248 |
| WGBB | H. H. Carman, Freeport, N. Y. | 244 |
| WGBC | 1st Baptist Church, Memphis, Tenn. | 278 |
| WGBF | The Finke Furniture Co., Evansville, Ind. | 236 |
| WGBH | Fort Harrison Hotel, Clearwater, Fla. | 266 |
| WGBI | Scranton Broadcasters, Inc., Scranton, Pa. | 240 |
| WGBR | Marshfield Broadcasting Association, Marshfield, Wis. | 229 |
| WGBS | Gimbel Brothers, New York, N. Y. | 316 |
| WGBU | Florida Cities Finance Co., Fulford By-the-Sea, Fla. | 278 |
| WGBX | University of Maine, Orono, Maine. | 234 |
| WGES | Oak Leaves Broadcasting Station, Oak Park, Ill. | 250 |
| WGHB | G. H. Boules, Developments, Clearwater, Fla. | 266 |
| WGN | The Tribune, Chicago, Ill. | 303 |
| WGMU | A. H. Grebe & Co., Inc., Richmond Hill, N. Y. | 236 |
| WGCP | Grand Central Palace, N. Y. City. | 252 |
| WGHB | G. H. Boules, Clearwater, Fla. | 266 |
| WGHP | G. H. Phelps, Inc., Detroit, Mich. | 270 |
| WGMU | Grebe & Co., Richmond Hill, N. Y. | 236 |
| WGR | Federal Tel. Mfg. Co., Buffalo, N. Y. | 319 |
| WGST | Ga. School of Tech., Atlanta, Ga. | 270 |
| WGY | General Elec. Co., Schenectady, N. Y. | 380 |
| WHA | University of Wisconsin, Madison, Wis. | 535 |
| WHAD | Marquette Univ., Milwaukee, Wis. | 275 |
| WHAM | Eastman Sch. Music, Rochester, N. Y. | 278 |
| WHAP | Taylor Finance Corp., N. Y. C. | 431 |
| WHAR | Cook's Sons, Atlantic City, N. J. | 275 |
| WHAS | The Courier Journal-Times, Louisville, Ky. | 400 |
| WHAV | Wilmington Elec., Wilmington, Del. | 266 |
| WHAZ | Rensselaer Institute, Troy, N. Y. | 280 |
| WHB | Sweeney School Co., Kansas City, Mo. | 366 |
| WHBA | Shaffer Music House, Oil City, Pa. | 250 |
| WHBC | Rev. E. P. Graham, Canton, Ohio. | 254 |
| WHBD | C. W. Howard, Bellefontaine, Ohio. | 222 |
| WHBF | Beardsley Co., Rock Island, Ill. | 222 |
| WHBG | John S. Skane, Harrisburg, Pa. | 231 |
| WHEC | Hickson Elec. Co., Rochester, N. Y. | 258 |
| WHBJ | I-aver Auto Co., Ft. Wayne, Ind. | 234 |
| WHBL | C. L. Carroll (Portable), Ill. | 216 |
| WHBM | C. L. Carroll (Portable), Chicago. | 233 |
| WHBN | 1st Ave. Methodist Church, St. Petersburg, Fla. | 238 |

| Station | Owner and Location | Meters |
|---------|--|--------|
| WHBP | Johnstown Auto Co., Johnstown, Pa. | 256 |
| WHBR | Scientific E. & M. Co., Cincinnati, O. | 216 |
| WHBQ | St. Johns Meth. Church, Memphis, Tenn. | 233 |
| WHBU | B. L. Bing's Sons, Anderson, Ind. | 219 |
| WHBY | St. Norbert's College, De Pere, Wis. | 250 |
| WHBW | D. R. Kienzle, Philadelphia, Pa. | 216 |
| WHDI | Wm. Hood Dunwoody Ind. Inst., Minneapolis, Minn. | 278 |
| WHEC | Hickson Elec. Co., Rochester, N. Y. | 258 |
| WHN | George Schubel, New York, N. Y. | 361 |
| WHK | Radio Air Service Corp., Cleveland, Ohio | 273 |
| WHO | Bankers Life Co., Des Moines, Ia. | 526 |
| WHT | Radiophone Broadcasting Corp., Derrfield, Ill. | 400 |
| WIAD | H. R. Miller, Philadelphia, Pa. | 250 |
| WIAS | Home Electric Co., Burlington, Ia. | 254 |
| WIBA | Capital Times, Madison, Wis. | 236 |
| WIBC | St. Paul's E. P. Church, Elkins Park, Pa. | 222 |
| WIBH | Elite Radio, New Bedford, Mass. | 210 |
| WIBI | Frederick B. Gittel, Flushing, N. Y. | 219 |
| WIBJ | C. L. Carrell, Chicago, (Portable) | 216 |
| WIBO | Nelson Bros., Chicago, Ill. | 226 |
| WIBM | Billy Maine, Chicago, Ill. | 216 |
| WIBR | Thurman A. Owings, Weirton, W. Va. | 246 |
| WIBS | Lt. T. F. Hunt, Elizabeth, N. J. | 203 |
| WIBU | The Electric Farm, Poynette, Wis. | 222 |
| WIBW | Dr. L. L. Dill, Logansport, Ind. | 220 |
| WIBX | Grid-Leak, Inc., Utica, N. Y. | 205 |
| WIBZ | A. B. Trum, Montgomery, Ala. | 231 |
| WIL | Benson Radio Co., St. Louis, Mo. | 273 |
| WIOD | Carl S. Fisher Co., Miami, Fla. | 248 |
| WIP | Gimbel Brothers, Philadelphia, Pa. | 508 |
| WJAD | Jackson's Radio Elec. Co., Waco, Tex. | 353 |
| WJAF | J. A. Fenberg Radio Co., Ferndale, Mich. | 400 |
| WJAG | Norfolk Daily News, Norfolk, Nebr. | 270 |
| WJAK | Kokomo Tribune Station, Kokomo, Ind. | 254 |
| WJAM | D. M. Perham, Cedar Rapids, Ia. | 268 |
| WJAR | The Outlet Co., Providence, R. I. | 306 |
| WJAS | Pittsburgh Radio Supply House, Pittsburgh, Pa. | 275 |
| WJAX | Voice of Jacksonville, Fla. | 337 |
| WJAZ | Zenith Radio Corp., Mt. Prospect, Ill. | 322 |
| WJBA | D. H. Lentz, Jr., Joliet, Ill. | 207 |
| WJBB | L. W. McClung, St. Petersburg, Fla. | 254 |
| WJBC | Hummer Furn. Co., La Salle, Ill. | 234 |
| WJBE | Financial Journal, St. Petersburg, Fla. | 254 |
| WJBI | R. S. Johnson, Red Bank, N. J. | 219 |
| WJBK | Ernest F. Goodwin, Ypsilanti, Mich. | 233 |
| WJBL | Gushard Dry Goods, Deratur, Ill. | 270 |
| WJBO | V. Jensen, New Orleans, La. | 268 |
| WJBQ | Bucknell University, Lewisburg, Pa. | 211 |
| WJBR | Omro Drug Store, Omro, Wis. | 228 |
| WJBT | J. S. Boyd, Chicago, Ill. | 238 |
| WJBU | Bucknell University, Lewisburg, Pa. | 211 |
| WJBV | Union Course Lab., Woodhaven, N. Y. | 470 |
| WJJD | Order of Moose, Mooseheart, Ill. | 370 |

(Concluded on page 26)

Your Radio Set
 DESERVES
 Good Condensers
 The Trade-Mark

 Insures What It Deserves.
 Tobe Deutschmann Company
 Cambridge Mass.

Get Your Share of DX!

DX Means the Reception of Programs from Distant Stations, and that in Turn Means Pure Joy for Many Thousands of Fans. Better Distant Reception is Being Accomplished Right Now Than Was Possible Last Winter!

THE TRICK LIES IN KNOWING WHAT TO DO TO GET DX!

ALL THE INSIDE FACTS AT YOUR COMMAND FOR 50c!

CAN YOU ANSWER THESE TEN QUESTIONS?

- (1) How does the tuning in of DX stations differ from the tuning in of locals?
- (2) How can you make your antenna pick up more energy without adding any wire to it or making any change in your set?
- (3) If low wavelength stations are too loud and high wavelength stations not loud enough, how can you make them all as loud as desired?
- (4) What is the easiest way to improve selectivity?
- (5) How can you reduce the antenna resistance to get highest voltage?
- (6) How should coils be placed to avoid losses?
- (7) What effect has audio amplification on ability to get DX?
- (8) Where should by-pass condensers be placed to improve DX?
- (9) How should tubes be connected and operated for maximum efficiency?
- (10) Does the grid leak setting affect DX, and if so, how?

These and many other questions affecting DX are answered in articles by Capt. Peter V. O'Rourke, J. E. Anderson and John F. Rider, published in the April 3, 10 and 24 and May 29 issues of RADIO WORLD. All four copies sent on receipt of 50c., or given free with a year's subscription (52 numbers, \$6.00).

RADIO WORLD, 145 West 45th Street, NEW YORK CITY

Bring in Europe on a
Victoreen "Super"
 Write for Layout and Parts List
THE GEORGE W. WALKER CO.
 6515 Carnegie Avenue Cleveland, Ohio

STATIONS

(Concluded from page 25)

| Station | Owner and Location | Meters |
|---------|--|---------|
| WJR | Detroit Free Press and Jewett Radio and Phonograph Co., Pontiac, Mich. | 517 |
| WJY | Radio Corp. of Amer., N. Y. C. | 405 |
| WJZ | Radio Corp. of Amer., N. Y. C., Bound Brook, N. J. | 455 |
| WKAF | WKAF broadcasting Co., Milwaukee, Wis. | 261 |
| WKAQ | Radio Corp. of Porto Rico, San Juan, P. R. | 341 |
| WKAR | Mich. Agric. College, Lansing, Mich. | 286 |
| WKAF | WKAF Co., Milwaukee, Wis. | 261 |
| WKAU | Laconia Radio Club, Laconia, N. H. | 224 |
| WKBA | Arrow Batt. Co., Chicago. | 288 |
| WKBB | Sanders Bros., Joliet, Ill. | 214 |
| WKBE | K. & B. Electric Co., Webster, Mass. | 231 |
| WKBC | C. L. Carrell, (Portable) Chicago, Ill. | 216 |
| WKRC | Kodel Radio Corp., Cincinnati, O. | 326-422 |
| WKY | Hill Richards, Oklahoma City, Ok. | 275 |
| WLAL | 1st Presbyterian Church, Tulsa, Okla. | 250 |

| | | |
|------|---|-----|
| WLAP | W. V. Jordan, Louisville, Ky. | 275 |
| WLB | University of Minn., Minneapolis, Minn. | 278 |
| WLBL | Wisconsin Department of Markets, Stevens Point, Wis. | 278 |
| WLIB | Liberty-Weekly Inc., Elgin, Ill. | 303 |
| WLIT | Lit Brothers, Philadelphia, Pa. | 395 |
| WLS | Sears Roebuck Co., Chicago, Ill. | 345 |
| WLSI | Lincoln Studio Inc., Providence, R. I. | 441 |
| WLTS | Lane Technical H. S., Chicago. | 258 |
| WLW | Crosley Radio Corp., Cincinnati, Ohio | 422 |
| WLWL | Missionary Society of St. Paul the Apostle, N. Y. City | 288 |
| WMAC | C. B. Meredith, Cazenovia, N. Y. | 275 |
| WMAF | Round Hills Radio Corp., Dartmouth, Mass. | 441 |
| WMAK | Norton Laboratory, Lockport, N. Y. | 266 |
| WMAI | Leese Optical Co., Washington, D. C. | 213 |
| WMAN | 1st Baptist Church, Columbus, O. | 278 |
| WMAQ | Chicago Daily News, Chicago, Ill. | 448 |
| WMAY | Kings Highway Presbyterian Church, St. Louis, Mo. | 248 |
| WMAZ | Mercer University, Macon, Ga. | 261 |
| WMBB | Amer. Bond and Mort. Co., Chicago | 250 |
| WMBG | Mich. Broadcasting Co., Detroit. | 256 |
| WMBF | Fleetwood Hotel, Miami Beach, Fla. | 384 |
| WMBI | Mosty Bible Institute, Chicago, Ill. | 288 |
| WMC | Commercial Appeal, Memphis, Tenn. | 500 |
| WMCA | Hotel McAlpin, N. Y. C., Hoboken. | 341 |
| WMRJ | P. J. Prinz, Jamaica, N. Y. | 227 |
| WMSG | Madison Square Garden Bdstg Corp., N. Y. C. | 303 |
| WNAB | Shepard Stores, Boston, Mass. | 280 |
| WNAC | Shepard Stores, Boston, Mass. | 430 |
| WNAD | University of Okla., Norman, Okla. | 254 |
| WNAL | Omaha Central High School, Omaha, Nebr. | 258 |
| WNAT | Lenning Bros. Co., Philadelphia, Pa. | 250 |
| WNAX | Dakota Radio App. Co., Yankton, S. D. | 244 |
| WNBH | New Bedford Hotel, New Bedford, Mass. | 248 |
| WNJ | Radio Shop, Newark, N. J. | 252 |
| WNOX | Peoples Tel. & Tel. Co., Knoxville, Tenn. | 268 |
| WNYC | Municipal Station, New York, N. Y. | 526 |
| WOAI | Southeast Equip. Co., San Antonio, Tex. | 395 |
| WOAN | Vaughan Con. of Music, Lawrenceburg, Tenn. | 283 |
| WOAW | Woodmen of the World, Omaha, Nebr. | 326 |
| WOAX | F. J. Wolff, Trenton, N. J. | 240 |
| WOC | Palmer School of Chiro, Davenport, Ia. | 484 |
| WOCL | Hotel Jamestown, Jamestown, N. Y. | 275 |
| WODA | O'Dea Radio, Paterson, N. J. | 224 |
| WOI | Iowa State College, Ames, Iowa. | 270 |
| WOK | Neutrowound Radio Mfg. Co., Homewood, Ill. | 217 |
| WOKO | Earl B. Smith, Patterson, N. J. | 233 |
| WOO | John Wanamaker, Philadelphia, Pa. | 508 |
| WOOD | Grand Rapids Radio Co., Grand Rapids, Mich. | 242 |
| WOQ | Unity School of Christianity, Kansas City, Mo. | 278 |
| WOR | L. Bamberger & Co., Newark, N. J. | 405 |
| WORD | Peoples Pulpit Assn., Batavia, Ill. | 275 |
| WOS | State Market Bur., Jefferson City, Mo. | 441 |
| WOWO | Main Auto, Ft. Wayne, Ind. | 227 |
| WPAK | N. D. Agricultural College, Agricultural College, N. D. | 275 |
| WPCC | N. Shore Congre. Church, Chicago. | 258 |
| WPDQ | H. L. Turner Buffalo, N. Y. | 205 |
| WPG | Municipality, Atlantic City, N. J. | 300 |
| WPRC | Wilson Radio, Harrisburg, Pa. | 216 |
| WPSC | Penn State College, State College, Pa. | 261 |
| WQAA | H. A. Beale, Jr., Parkersburg, Pa. | 220 |
| WQAC | Gish Radio Service, Amarillo, Tex. | 234 |
| WQAE | Moore Radio News Station, Springfield, Vermont | 246 |
| WQAM | Electric Equipment Co., Miami, Fla. | 263 |
| WQAN | Scranton Times, Scranton, Pa. | 250 |
| WQAO | Calvary Baptist Church, New York, N. Y. | 360 |
| WQJ | Calumet Rainbo Broadcasting Co., Chicago, Ill. | 448 |
| WRAF | Laporte Radio Club, Wash., D. C. | 224 |
| WRAC | Economy Light Co., Escanaba, Mich. | 256 |
| WRAM | Lombard College, Galesburg, Ill. | 244 |
| WRAV | Antioch College, Yellow Springs, O. | 263 |
| WRAW | Avenue Radio Shop, Reading, Pa. | 238 |

| | | |
|------|---|-----|
| WRAX | The Berachah Church of Philadelphia, Gloucester City, N. J. | 280 |
| WRBC | Immanuel Lutheran Church, Valparaiso, Ind. | 278 |
| WRC | Radio Corp. of America, Washington, D. C. | 469 |
| WRCO | Wynna Radio Co., Raleigh, N. C. | 252 |
| WREC | Wooten's Radio Shop, Cold Water, Miss. | 254 |
| WREO | Reo Motor Co., Lansing, Mich. | 286 |
| WRHF | Washington Radio Hospital Fund, Wash., D. C. | 256 |
| WRHM | Rosedale Hospital, Minneapolis, Minn. | 252 |
| WRK | Doron Bros., Elec. Co., Hamilton, O. | 270 |
| WRM | University of Illinois, Urbana, Ill. | 273 |
| WRMU | A. H. Grebe & Co., Inc., Motor Yacht Mu-I, N. Y. City | 236 |
| WRNY | Experimenter Pub. Co., N. Y. C. | 375 |
| WRR | City of Dallas, Tex. | 246 |
| WRST | Radiotol Mfg. Co., Inc., 5 First Ave. Bay Shore, N. Y. | 215 |
| WRVA | Laurus & Bros. Co., Richmond, Va. | 235 |
| WRW | Tarrytown Research Laboratory, Tarrytown, N. Y. | 273 |
| WSAI | U. S. Playing Card Co., Cincinnati, O. | 325 |
| WSAJ | Grove City College, Grove City, Pa. | 229 |
| WSAN | Allentown Call, Allentown, Pa. | 229 |
| WSAR | Doughty & Welch Elec. Co., Fall River, Mass. | 254 |
| WSAX | Zenith Radio Corp., Chicago, Ill. | 263 |
| WSAZ | Chase Electric Shop, Pomeroy, Ohio. | 244 |
| WSB | The Atlanta Journal, Atlanta, Ga. | 425 |
| WSBC | World Battery Co., Chicago, Ill. | 210 |
| WSBF | Stix Baer and Fuller, St. Louis, Mo. | 273 |
| WSBT | South Bend Tribune, South Bend, Ind. | 275 |
| WSDA | 7th Day Adventist Church, N. Y. C. | 265 |
| WSKC | World's Star Knitting Co., Bay City, Mich. | 261 |
| WSM | National Life and Accident Ins., Nashville, Tenn. | 283 |
| WSBM | Saenger Amus. Co., New Orleans | 319 |
| WSMH | Shathick Music House, Owosso, Mich. | 240 |
| WSMK | S. M. K. Radio Corp., Dayton, O. | 275 |
| WSOE | School of Engineering, Milwaukee. | 245 |
| WSRO | H. W. Fahlander, Hamilton, Ohio. | 251 |
| WSSH | Tremont Temple Baptist Church, Ia. | 404 |
| WSVI | State University of Iowa, Iowa City, Ia. | 404 |
| WSVS | Seneca Vocational School, Buffalo, N. Y. | 219 |
| WSWS | S. W. Straus & Co., Woodale, Ill. | 275 |
| WTAB | Daily Herald, Fall River, Mass. | 265 |
| WTAD | R. E. Compton, Carthage, Ill. | 236 |
| WTAG | Telegram, Worcester, Mass. | 545 |
| WTAL | Toledo Radio & Elec. Co., Toledo, O. | 252 |
| WTAM | Wilard Storage Batt. Co., Cleveland | 389 |
| WTAP | Cambridge Radio Elec. Co., Cambridge, Ill. | 242 |
| WTAQ | S. Van Gordon & Son, Osseo, Wis. | 254 |
| WTAR | Reliance Radio Co., Norfolk, Va. | 261 |
| WTAW | Agricultural & Mech. College, College Station, Tex. | 270 |
| WTAX | Williams Hardware, Streator, Ill. | 231 |
| WTAZ | T. J. McGuire, Lambertville, N. J. | 476 |
| WTIC | Travelers Insur. Co., Hartford, Conn. | 261 |
| WUBO | V. Jansen, New Orleans, La. | 268 |
| WWAE | Electric Park, Plainfield, Ill. | 240 |
| WAO | Michigan College of Mines, Houghton, Mich. | 263 |
| WWGL | Radio Engineering Corp., Richmond Hill, N. Y. | 213 |
| WWI | Ford Motor Co., Dearborn, Mich. | 266 |
| WWJ | Detroit News, Detroit, Mich. | 353 |
| WWL | Loyola University, New Orleans, La. | 275 |

VERNIER DIAL \$1.25



The Bruno Vernier Dial, 24-to-1 ratio. Smooth in operation, accurate and dependable. Beautifies any panel. Made of moulded Bakelite.

STREAMLINE FREQUENCY CONDENSERS .0005, .00035 or .00025 mfd.

\$1.95

ELECTRIC SOLDERING IRON

95c

CRESCENT AUDIO TRANS. 3-to-1 or 2-to-1

\$2.00

M. LERNER

Room 1214

143 West 45th Street, New York City

Business Opportunities Radio and Electrical

* Rates 10c per word; Minimum, \$1.00; Cash with order

BROADCASTING STATION, SUPERPOWER, 5,000 watt, licensed A. T. and T., and department includes Western Electric amplifiers and tubes, for sale, lease or hire; offers wanted immediately. Address Box 927, San Antonio, Texas. Business address 101 West Pecan St.

ACTIVE RADIO AND ELECTRICAL MANUFACTURING business, long established, with jobbing accounts throughout United States and Canada; this corporation will sell its entire plant together with patents, machinery, tools, finished and unfinished stock raw materials, outstanding accounts, &c.; \$20,000 required, worth double. Box 111 Radio World.

"RAMBLER-SIX"

THE ONLY REAL PORTABLE \$90

without tubes or batteries

Satisfaction Guaranteed

WRITE FOR KIT PRICES

Approved by Radio World Laboratories

American Interstate Radio Service

183 Greenwich Street, New York City

Distributors, Jobbers, Dealers, write for special trade terms

Radio Planned In Each Office

WASHINGTON.

Studies are being made to determine the feasibility of having radio connection for each office room in the National Press Building, a 14-story home and office building being erected here by the National Press Club. Up to the present time no office structure in the country has offered this facility.

The building will also lead in telephone and telegraph service. Modern telegraph equipment will be installed with private wires to offices if desired. It will also be equipped with intercommunicating private telephone wires to each office.

THE IMPROVED

Browning Drake PANELS

Beautiful de Luxe \$7.50 Brilliantly Engraved

Certified by Herman Bernard

Cortlandt Panel Engraving Co. 79 Cortlandt Street New York City

Attention, Radio World Subscribers!

Subscribers will note that the end of their subscriptions is indicated on the labels on wrappers. If your wrapper shows a date earlier than the current issue, please send payment for renewal. Changes in expiration dates on wrappers appear two weeks after receipt of renewal.

RADIO WORLD, 145 West 45th St., New York City. (Phone: Bryant 0558-0559.)

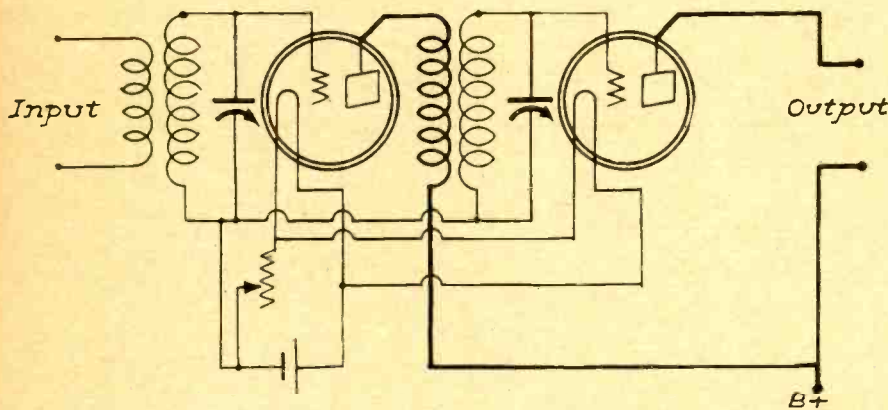
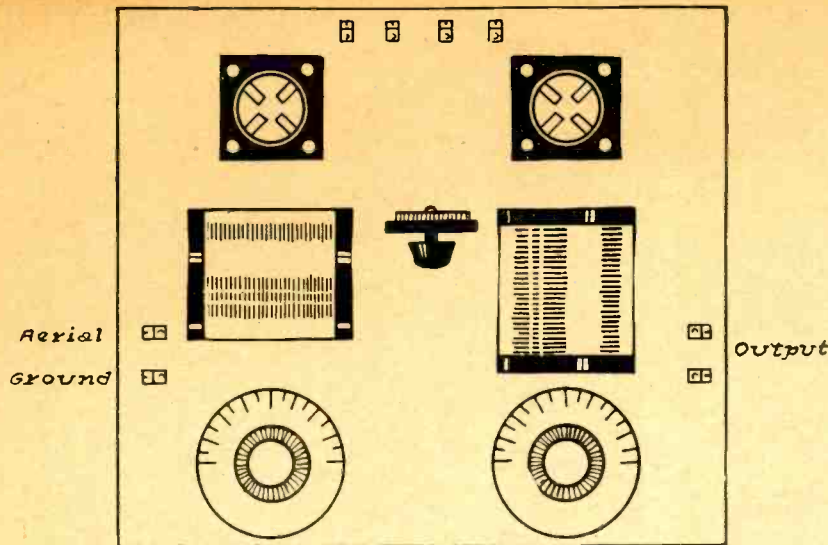

FIG. 410

The circuit diagram and layout of parts used to test coupling values in a tuned RF set.

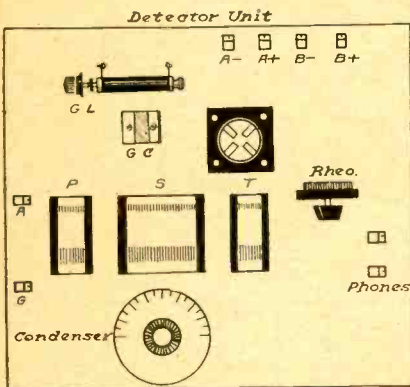

FIG. 411

The circuit diagram and layout of parts used to test the coupling values in a regenerative detector unit.

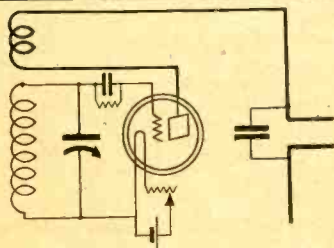

FIG. 411

The circuit diagram and layout of parts used to test the coupling values in a regenerative detector unit.

UNIVERSITY

(Continued from page 12)

denser and to the grid post of the second socket (2nd RF tube). The plate post on this socket is brought to the beginning of the primary winding of the second RFT. The end of this winding is brought to the bottom terminal of a single circuit jack. This common lead is then connected to the B plus 90-volt post. It is also connected to the B post on the second (low ratio) AFT. The beginning of the secondary of the second RFT is connected to the rotary plate post on the last .0005 mfd. variable condenser and to the F plus post on the third socket (detector). The beginning of

SEE JAY POWER UNIT



Here at Last!

A combination alkaline element battery and trickle charger all in one. Can be charged while set is operating. Price complete shipped dry with solution, \$16.00. 100-volt with Chemical Charger, \$12.00. 140-volt, \$17.00.

Write for our illustrated 24-page booklet and Send No Money Pay Expressman.

SEE JAY BATTERY COMPANY
913 Brook Avenue New York City

THE BERNARD PORTABLE SUPER-HETERODYNE appeared in RADIO WORLD dated April 3, 10, 17 and 24. Sent on receipt of 60c. or start your subscription with April 3 issue. RADIO WORLD, 145 West 45th St., N. Y. City.

THE 5-TUBE SUPER HETERODYNE SET by Jasper Jellicoe, appeared in RADIO WORLD dated April 17. Sent on receipt of 15c. RADIO WORLD, 145 W. 45th St., N. Y. C.

this winding is brought to the stationary plate post of this variable condenser and to one terminal of a grid leak-condenser (2 megohm-.00025 mfd.) combination. The other terminal of this combination is brought to the grid post on the third socket. The plate post on this socket is brought to the P post on the 6 to 1 ratio AFT. The B post on this AFT is brought to the B plus 45-volt post. A rheostat (10 ohm) is connected in series with the negative leg of the filament. All the F plus posts are connected together and thence to one terminal of a filament switch. The other terminal of this switch is brought to the A plus, B minus post. The G post on the 3 to 1 ratio AFT is brought to the G post on the last socket (audio). The F post on this AFT is brought to the C minus (4.5 volt) post. The plate post on the socket is brought to the top terminal of the single circuit jack. A ballast resistor, of the ¼ ampere (Continued on page 30)

X-L VARIO-DENSER

Also Used by ARTHUR LYNCH

in the Improved Browning-Drake Hookup

"I was really surprised at the fine adjustment I was able to get."

GLENN H. BROWNING.

also specified by GERALD M. BEST

Endorsed by POPULAR RADIO LABORATORY

Tested and approved by G. M. WILCOX

Prof. of Physics, Armour Institute of Technology

SEE THAT SCREW



A screw-driver adjusts an X-L in crowded places.

X-L VARIO-DENSER

Results in easier tuning, more distance, volume and clarity—greater stability. Model "N" A slight turn obtains correct tube oscillation on all tuned radio frequency circuits. Neutrodyne, Roberts two tube Browning-Drake, McMurdo Silver's Knockout, etc., capacity range ¼ to 20-micro-micro farads. Price \$1.00

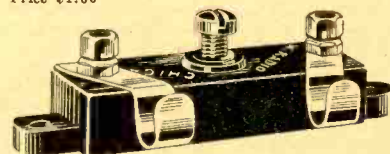

Model "G" with grid clips obtains the proper grid capacity on Cockaday circuits, filter and intermediate frequency tuning in heterodyne and positive grid bias in all sets. Capacity range:

- Model G-1—.00002 to .0001 MFD
- Model G-5—.0001 to .0005 MFD
- Model G-10—.0003 to .001 MFD

Price \$1.50

X-L PUSH POST

Push it down with your thumb, insert wire, remove pressure and wire is firmly held. Releases instantly.

Price 15c.

Push Post Panel permanently marked in white on black insulating strip. In box including soldering lugs, raising bushings and screws for mounting, etc.

Price, \$1.50



X-L Radio Laboratories 2430 Lincoln Ave. CHICAGO, ILL.

MEMBER RMA
LYNCH
METALLIZED
FIXED RESISTORS

WGN Moves Into Its New Studios

Three Separate Ones Created—Facilities for 5-Station Chain Linkup and 100 Remote Controls

In preparation for the unusual program of entertainment and public service it is planning for the winter, WGN, Chicago, moved into its recently completed studios and control room on the twelfth floor of the Drake Hotel.

Products of one of the finest engineering organizations possessed by any radio station, the new studios and control room have been specially designed and constructed to meet the various needs of the swiftly moving day and night schedule of WGN. The present studio facilities have been taxed to the utmost, and when the enormous program developed for the fall and winter months came under consideration, the station officials realized they were inadequate and plans were at once drawn for new studios and a control room that would be the last word in radio engineering.

Work was started in May, and fruition of the months of labor came when the first programs were broadcast from these modern studios.

New studios and control room cover a total area of over 1,700 square feet. Studio

No. 1 is 20 by 40 feet; studio No. 2, 20 by 30 feet, and the control room, 15 by 15 feet. A third studio, ten feet square, has been built particularly for "Sam 'n' Henry," WGN's popular colored boys.

Past experience has played a large part in the design and equipment of these new studios. While mechanically perfect, they are bare of unnecessary tables, chairs and lamps. The customary gaudy magnificence of the radio station has been sacrificed to insure a site where the special programs and productions of the type WGN has featured in the past may be presented under ideal conditions. WGN's new studios are ideal workshops. All lighting is overhead. There is no desk for the announcer, who will do all of his talking into a special microphone fixed to the wall. Only such chairs as are necessary for musicians will be permitted.

The new control room is a marvel of its kind. Four huge panels, designed under the direction of Chief Engineer Carl Meyers, and constructed by Assistant Engineer George Leverett and his staff, have numerous unique features in addition to being modern in every respect. Chief among these is the "mixer panel," permitting simultaneous broadcasting from twelve microphones. This panel will be used for productions and feature programs where unusual blending of music is necessary.

The panel also contains facilities for chain broadcasting to five stations, while WGN can operate 100 "remote controls" (broadcasts that emanate from a point

other than the studio), without overtaxing the panels. A special panel is also maintained for the feature programs brought by leased telephone wire from New York studios.

The operator seated before the panel has the master control of all station mechanical activities. The complicated task of switching from studio to studio, from remote control to remote control, has been reduced to its simplest terms and the work of making changes can transpire in less than a second's time. While a special switch will be placed in the studios so that the announcer can operate the various microphones, a mistake on his part can be instantly rectified by the operator, who has a clear view of all studios through heavy plate glass windows.

The new studios are expected to assist in speeding up programs. When one orchestra is scheduled to follow another, there is often a delay to permit the exit of one group and the entrance of the second. The two studios will eliminate this. The second orchestra can be getting ready in the other studio while the first is completing its program.

In the case of a feature where numerous people are necessary, such as the series of "Old Time Prize Fights," when the first studio "mob" was used, the extra studio will permit the preceding and succeeding feature to move forward without discomfort or interruption from the "extras."

Tighten Up Aerials Now

Good weather is a good time to tighten your aerial wires. Do this now, so they will be in good condition for all Winter. Do not forget that aerial wires should be clear of tree branches. Place your insulators far away from the trees and use a pulley with a weight on the end of the aerial wire if it is used with a swaying tree. High, strong winds cause aerials to tighten and break unless properly fastened.

HARD RUBBER

SHEET—ROD—TUBING
Special Hard Rubber Parts Made to Order
**RADION HARD RUBBER
PANELS** ANY SIZE

Send for Price List
WHOLESALE RETAIL
NEW YORK HARD RUBBER TURNING CO.
212 Centre Street New York

RADIO WORLD'S QUICK-ACTION CLASSIFIED ADS.

10 CENTS A WORD. 10 WORDS MINIMUM. CASH WITH ORDER.

CASH PAID FOR Dental Gold, False Teeth, Discarded Jewelry, Diamonds, Platinum. Mail. Florida Gold Refining Co., 21 Adams, Jacksonville, Fla.

RADIO SUMMER DISCOUNTS. Becker Radio Service, Seventh Street, Martins Ferry, Ohio.

MANAGER: LARGE JOBBER, handling several standard makes of Radio wishes to engage services of Manager of Radio Department. Write giving full details, salary expected, etc. Box 400, Radio World.

HOW TO USE AERIALS IN GROUND AND WATER, by Lewis Winner, appeared in RADIO WORLD, dated May 29. Sent on receipt of 15c, or start subscription with that number. RADIO WORLD, 145 W. 45th St., N. Y. C.

TABLE FOR CONVERSION OF FREQUENCIES AND METERS appeared in RADIO WORLD dated May 1, 1925. Sent on receipt of 15c, or start your sub. with that number. RADIO WORLD, 145 W. 45th St., N. Y. C.

HERMAN BERNARD, managing editor of RADIO WORLD, broadcasts every Friday at 7 p. m., from WGBS, Gimbel Bros., N. Y. City—315.6 meters. He discusses "What's Your Radio Problem?" Listen in!

"LIBERTY AFLAME" and other verses, by Roland Burke Hennessy. Handsomely bound in cloth; sent postpaid for \$1.00. Guaranty Radio Goods Co., 145 West 45th Street, New York City.

BLUE PRINT FOR 1926 DIAMOND OF THE AIR sent on receipt of 50c. Guaranty Radio Goods Co., 145 West 45th Street, New York City.

A BUILT-IN SPEAKER SET, by Herbert E. Hayden, **POWERTONE IN OPERATION,** by Capt. P. V. O'Rourke, **THE NOVICE'S NOOK,** by James B. Scully, appeared in RADIO WORLD dated May 22. Sent on receipt of 15c, or start sub. with that number. RADIO WORLD, 145 W. 45th St., N. Y. C.

THE BRETWOOD GRID LEAK will aid you to get DX even in the summer. Sent on receipt of \$1.50. North American Bretwood Co., 145 W. 45th St., N. Y. C.

A DISCUSSION ON SELECTIVITY, by J. E. Anderson, appeared in RADIO WORLD, dated June 19. Sent on receipt of 15c, or start subscription with that number. RADIO WORLD, 145 W. 45th St., N. Y. C.

GETTING MAXIMUM RESULTS with Super-Heterodynes by Herman Bernard appeared in RADIO WORLD dated May 15th. 15c per copy, or start your subscription with that issue. RADIO WORLD, 145 West 45th St. N. Y. City.

SELL AND INSTALL RADIO SETS. With a \$25 capital we can put you in the radio business and show you how to earn a hundred or two a week. For full details write Guaranty Radio Goods Co., 145 West 45th Street, New York City.

THE VACATION NUMBER OF RADIO WORLD DATED JUNE 12 contained many great features. The light 5-tube Portable, by Herman Bernard, **The Freshman Masterpiece,** by Albert W. Franklin, **The Importance of C Batteries,** by John F. Rider, etc. Sent on receipt of 15c, or start sub. with that number. RADIO WORLD, 145 W. 45th St., N. Y. C.

TO KEEP YOUR FILES COMPLETE, you can order your newsdealer to put a copy aside for you each week while on your vacation. Or, send \$1.00 for RADIO WORLD from now until the end of August, and in this way you will not miss any copies. **SUBSCRIPTION DEPT.,** RADIO WORLD, 145 W. 45th St., N. Y. C.

THE NEW 1-DIAL POWERTONE SET, by Capt. P. V. O'Rourke, appeared in RADIO WORLD dated April 17. Sent on receipt of 15c, or start sub. with that number. RADIO WORLD, 145 W. 45th St., N. Y. C.

MALE HELP WANTED
A PAYING POSITION OPEN TO REPRESENTATIVES of character. Take orders shoes-hosiery, direct to wearer. Good income. Permanent. Write now. Tanners Shoe Mfg. Co., 8-710 C Street, Boston, Mass.

TEAR OFF AND MAIL TODAY

8 Week's Trial Subscription, \$1.00

RADIO DEVELOPMENTS
KEEP ABREAST OF THE LATEST
RADIO WORLD
145 WEST 45th ST. NEW YORK CITY

Television Kills Dual Personality

Artists Famous Under Own and Also Assumed Names May Have to Wear Disguises

The arrival of television will probably do away with a pleasant deception practiced by some of radio's most famous singers—the appearance before the microphone under several different names.

Several of KFI's most popular artists, who under their own names, have built up a reputation for a certain type of singing, but who, following a human impulse, desire fame in other fields instead, have created a great prestige for themselves in two or three varying characters, each of which specializes in absolutely different types of music.

Amazing reactions often follow. For instance, one tenor was informed that he is infinitely better than another tenor, who was in reality himself under his real name. Often receptionists write in and ask for duets by two singers, both of whom are one and the same. One soprano, possessed of an amazing voice and technique, finding that classic renditions brought little reaction from the public, as a test created a name under which she sang popular songs without her previous crisp technique, so as to mask her identity. The fictitious character became so popular that it threatened to overwhelm her true self and so was regretfully discontinued.

ELECTRICAL AND MECHANICAL MANUFACTURING work wanted; complete facilities; also light drilling, assembling. Robertson, 540 West 22d, N. Y. C.

BROADCASTING STATION, MANHATTAN, for sale or lease to national organization; occupies national prominence and affiliations; great earning possibilities, as well as publicity creator; opportunity for national advertiser. Box X, Radio World.

Demagogue Lost Before Microphone

The orator who specializes in "artificial appeal to superficial emotionalism"—in other words the demagogue—will find radio an unwelcome medium for getting his art across.

Vice President Dawes in praising the science of broadcasting called attention to this as one of the blessings of radio in his address at the 300th anniversary of the founding of Salem, Mass.

"The political blatherskite or demagogue," Mr. Dawes said, "appeals to the crowd through its emotions." When the demagogue tries his art before the microphone he is bereft of the power which his emotional claptrap exerts when he appears before an audience in person. In radio he indicated sound logic and intellectual appeal are paramount.

By Able Soldering He Became Somebody

Clarence G. Stoll, general manager of manufacture of the Western Electric Company, has been elected a vice-president, to succeed the late H. F. Albright. Mr. Stoll was formerly manager of the Western Electric Hawthorne Works in Chicago. He began with the company 25 years ago as a student engineer in Chicago.

Mr. Stoll's first job was the modest

task of soldering jacks in the factory cabling department. A few months later he was transferred to New York, where he spent some time in the switchboard wiring, tool inspection and engineering department. His training on these jobs won for him promotion to head of the apparatus design department in New York.

In 1907 he returned to Chicago to take charge of apparatus design work. In October of the same year practically all apparatus designing was concentrated in New York, with Mr. Stoll as head of the enlarged organization.

Fan Listened Months To the Same Singer

The radio audience has a faculty of writing interesting and unusual communications to its favorite radio entertainers. Virginia Flohri, KFI's foremost soprano, once received a letter, each word of which was taken from the titles of the various songs she had sung, proving consistent listening over a period of many months. In her scrap book she has letters in nine different languages, showing that all nationalities meet on a common ground in the love of music.

Paul Roberts, popular KFI tenor, received an envelope recently that contained nothing but an ace of hearts on which was scrawled the message, "Your voice." Whether it came from a love-lorn maiden or a superstitious gambler has not as yet been decided.

NEW 1926 FREE RADIO GUIDE
Newest Edition Ready



Shows the latest circuits, the newest developments in radio at startlingly low prices. Get the parts you want here and save money. The best in parts, kits, sets and supplies. Orders filled same day received. Write for free copy NOW; also please send names of one or more radio fans.

BARAWIK COMPANY, 102-140 So. Canal St., Chicago.

BROADCASTING STATION, SUPERPOWER, 5,000 watt, licensed A. T. and T., and department includes Western Electric amplifiers and tubes, for sale, lease or hire; offers wanted immediately. Address Box 927, San Antonio, Texas. Business address 101 West Pecan St.

SUMMER PREMIUM SUBSCRIPTION OFFER

For NEW RADIO WORLD Subscribers Ordering NOW

Radio World has made arrangements

—To offer a year's subscription FREE for any one of the following publications with one year's subscription for RADIO WORLD

- RADIO NEWS or —BOYS' LIFE or
- POPULAR RADIO or —RADIO DEALER or
- SCIENCE AND INVENTION or —RADIO (San Francisco) or
- RADIO AGE

This is the way to get two publications

- for the price of one:
- Send \$6.00 today for RADIO WORLD
- for one year (regular price)
- for 52 numbers)
- and select any one of the other
- nine publications for twelve months.
- Add \$1.00 a year extra for
- Canadian or Foreign Postage.
- Present RADIO WORLD subscribers
- can take advantage of this offer by
- extending subscriptions one year
- if they send renewals NOW!

RADIO WORLD'S SPECIAL TWO-FOR-PRICE-OF-ONE SUBSCRIPTION BLANK

RADIO WORLD, 145 West 45th Street, New York City.

Enclosed find \$6.00 for which send me RADIO WORLD for twelve months (52 numbers), beginning..... and also without additional cost, Popular Radio, or Radio News, or Science and Invention, or Radio Dealer, or Radio (San Francisco), or Radio Age, or Boys' Life (or \$10.00 for two yearly subscriptions).

Indicate if renewal. Name

Offer Good Until Street Address

August 25, 1926. City and State

IF YOU ARE GOING AWAY ON YOUR VACATION

Tell your newsdealer to save a copy of RADIO WORLD for you each week. In this way, you will have a complete file—as sometimes it is difficult to get back numbers.

Or send us \$1.00 and we will save you a copy of each week's issue until September 15, 1926, and mail them to you at whatever date you specify.

Circulation Manager, RADIO WORLD, 145 West 45th Street, N. Y. City

GETTING DX by Capt. P. V. O'Rourke, appeared in RADIO WORLD dated April 3. 15c per copy or start sub. with that issue. RADIO WORLD, 145 West 45th St., N. Y. C.

THE CONTROL OF FEEDBACK, by Barney Feete, appeared in RADIO WORLD dated April 24. Sent on receipt of 15c, or start sub. with that issue. RADIO WORLD, 145 W. 45th St., N. Y. C.

TABLE FOR CONVERSION OF FREQUENCIES AND METERS appeared in RADIO WORLD dated May 1, 1925. Sent on receipt of 15c, or start your sub. with that number. RADIO WORLD, 145 W. 45th St., N. Y. C.

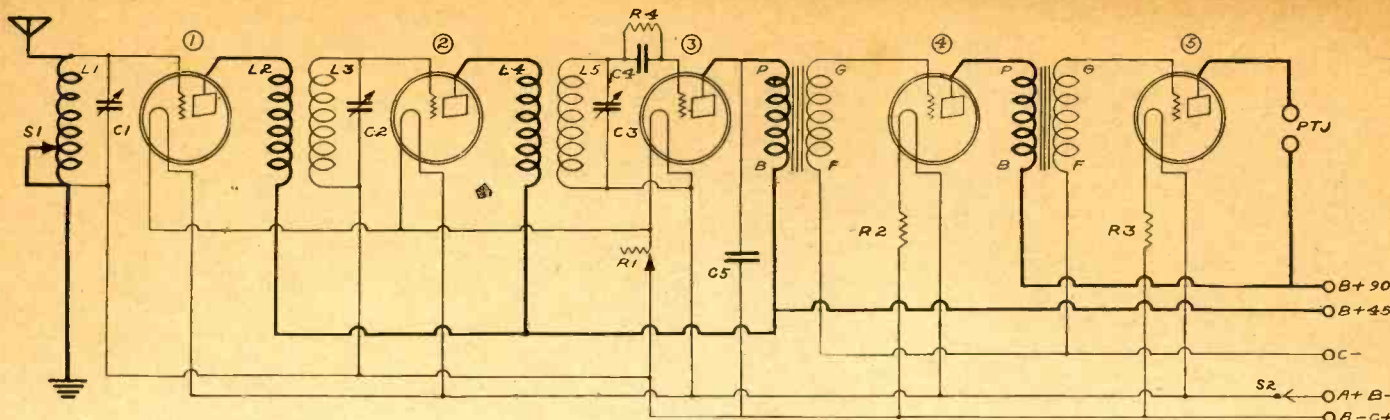

FIG. 411
The circuit diagram of the receiver desired by Trent Harbor.

Good Back Numbers of RADIO WORLD

The following illustrated articles have appeared in recent issues of RADIO WORLD:

- Feb. 27—The 4-Tube DX Dandy, by Herbert E. Hayden. Umbrella Aerial for DX, by Hugo Gernsback. Part 2 of The Victoreen.
- Mar. 6—The 1-Tube Set, by Capt. O'Rourke. The Chemistry of Batteries, by A. R. Reid. The Victoreen Set (Part 3), by Herbert E. Hayden.
- Mar. 13—The Non-Regenerative Browning-Drake Set, by M. B. Sleeper. The Tectron Eliminator (Part 1), by Lewis Winner. Curling Victoreen Trouble, by Herbert E. Hayden.
- Mar. 20—The Super-Heterodyne, by J. E. Anderson. A 2-Tube Speaker Set, by Percy Warren. The Browning-Drake Set (Part 2), by M. B. Sleeper.
- Mar. 27—An Economical 4-Tube Set, by Edgar T. Collins. A Practical B Battery, by Capt. P. V. O'Rourke. Tectron Trouble Shooting, by Lewis Winner.
- April 3—The Bernard Portable, by Herman Bernard (Part 1). How to Get DX, by Capt. P. V. O'Rourke. A Compact B Supply, by Lewis Winner.
- April 10—The Bernard Portable, by Herman Bernard (Part 2). Two Eliminators for DC, by Lewis Winner.
- April 17—The New 1-Dial Powertone, by Capt. P. V. O'Rourke. The Bernard Portable (Part 3), by Herman Bernard. The Action of Transformers, by Lewis Winner.
- April 24—All Waves on One Set, by Capt. P. V. O'Rourke. Bernard's Portable (Conclusion).
- May 1—New Multiple Tube, by Herman Bernard. The Aero All-Wave Set, by Capt. O'Rourke. Kilocycle-Meter Chart. An Analysis of Detection, by J. E. Anderson (Part 1).
- May 8—A Study of Detection, by J. E. Anderson (Part 2). To Wind a Loop on a Card-board Frame. How to Reflex Resistance AF, by Theo. Kerr.
- May 15—Super-Heterodyne Results Brought Up to Maximum, by Herman Bernard. The Truth About Coil Fields, by J. E. Anderson.
- May 22—A Built-in Speaker Set, by Herbert E. Hayden. The Powertone in Operation, by Capt. P. V. O'Rourke.
- May 29—Aerials in Ground and Water, by Lewis Winner. Economized Filaments, by J. E. Anderson. How to Get DX, by John F. Rider.
- June 5—Five-Tube Compact Receiver, by J. E. Anderson. A Tester for Tube Circuits, by Spencer Hood. Problems of Portables, by Hugo Gernsback.
- June 12—The Light 5-Tube Portable, by Herman Bernard (Part 1). The Rogers-Schudt Receiver, by Wm. A. Schudt, Jr. (Part 1). The Freshman Masterpieces, by A. W. Franklin.
- June 19—Selectivity's Amazing Toll, by J. E. Anderson. The Light 5-Tube Portable Set, by Herman Bernard (Part 2). The 4-Tube Rogers-Schudt, by Wm. A. Schudt, Jr. (Part 2).
- June 26—The Victoreen Portable, by Herman Bernard (Part 1). The Manufacture of a Tube, by E. C. Kelley. The Light 5-Tube Portable, by Herman Bernard (Part 3). The Rogers-Schudt Circuit (Part 3 concluded), by Wm. A. Schudt.
- July 3—Set with a 1-Turn Primary, by Herman Bernard. Part 2 of the Victoreen Portable, by H. Bernard. Trouble Shooting Article for The Light 5-Tube Portable.
- July 10—A Rub in Single Control, by Herman Bernard. A DX Double Regenerator, by Capt. P. V. O'Rourke. A 2-Tube Dry Cell Receiver, by Samuel Schmalz.
- July 17—A Double Duty Loop Aerial, by J. E. Anderson. How to Measure Coupling, by John Rider. A 1-Control Crystal Set, by Smedly Lyons.
- July 24—Why the Super-Heterodyne Is the Best Set, by Herman Bernard. A 1-Tube Reflex Receiver, by H. A. Reed.
- July 31—What's Best in an AF Amplifier, by Herman Bernard. A 6-Tube Reversed Feedback Set, by K. B. Humphrey.

Any copy, 15c. Any 7 copies, \$1.00. All these 23 copies for \$3.25, or start subscription with any issue. RADIO WORLD, 145 West 45th Street, New York City.

UNIVERSITY

(Concluded from page 27)

type, is connected in series with F minus post. All the F minus return leads are connected to the A minus post.

* * *

PLEASE GIVE circuit diagrams and suggested layouts, for testing the efficiency of coupling in tuned RF and detector circuits, with an explanation of each.—Frank Idant, San Antonio, Tex.

Figs. 409 and 410 (on page 27) show diagrams and layouts. Fig. 409 illustrates the circuit and layout used in conjunction with tuned RF circuits. At the bottom of this figure, we have the circuit diagram, while above, we have the picture layout. The variable condensers are mounted in the front, with the coils, having their secondaries tuned by these condensers, directly in back. In back of these coils, the sockets are mounted. The rheostat is mounted in the center, with the clips or binding posts to the left, right and rear. The complete outfit can be mounted on a 12x15" baseboard. Fig. 410 shows the testing methods employed in a regenerative detector circuit. The primary coil is connected in the regular fashion to either the antenna-ground or plate B plus input, etc. The layout of the parts employed is shown above the circuit diagram. The coils should be mounted on brass tubings, 1/8" diameter. These tubings should then pass through a single tubing, 3/4" diameter. This allows the coils to be moved about in or out of the fields of each other. They should be mounted so that they can be tilted. This is done with the aid of angle irons, mounted on the brass tubings on the baseboard. As to the RF unit, the rheostat may be taken from its place, allowing the use of the tubings, here also.

* * *

PLEASE GIVE the electrical diagram of a 5-tube receiver, employing two steps

RADIO-5 tube Set \$22.50

DELIVERED

Thing of It! A big handsome five tube Radio receiver only \$22.50 delivered. Tremendous range, clear powerful volume and simple tuning. Literature free.



SEMINOLE CO., Dept. 23
427 East 16th St., New York
Agents and Dealers Wanted

FENWAY for DX!

Perhaps you haven't heard the latest news? Something big is on the air—we'll let you in on it if you will drop us a line. Simply address Fenway for DX, 890 Eighth Avenue, New York City.

of tuned radio frequency amplification, a non-regenerative detector and two stages of transformer coupled audio frequency amplification. I wish to use a single winding antenna inductance and .00035 mfd. variable condensers.—Trent Harbor, St. Paul, Minn.

Fig. 411 shows the circuit diagram of such a receiver. Standard RFT are employed. The primaries consist of 8 turns. The secondaries consist of 65 turns. Tubings 3" in diameter and No. 22 double cotton covered wire is used. The antenna inductance consists of 65 turns, wound on a tubing 3" in diameter, tapped at the 8th turn, so as to be able to cover the entire wavelength. No. 22 dcc wire is used here, also. The .00035 mfd. variable condensers shunt the secondaries of these coils. The filaments of the RF and Det. tubes are controlled by a rheostat, R1, which has a resistance of 10 ohms and able to pass 3/4 of an ampere. C5 is a .001 mfd. fixed condenser. The filaments of the two AF tubes are controlled by ballast resistors, each of which are of the 1/4 ampere type. The -01A tubes must be used throughout. A common grid bias is employed. If the plates of the AF tubes are supplied with 90 volts, then this bias should be 4.5 volts. A 112 1/2 voltage will require the use of a 6-volt C battery. The plates of the detector and the RF tubes receive one B voltage, e.g., 67 1/2. A switch is used to turn the filaments of the tubes off or on. Phone tip jacks are used at the output of the AF tubes, although a single circuit jack may be substituted. The grid returns of the RF tubes are to F minus, while the grid return of the detector tube is to F plus. A .00025 mfd. fixed grid condenser and a 2 megohm grid leak is used.

FRATERNIZING LEADINS

Antenna wires so thickly populate the roofs of some apartment houses in large cities that no rain even touches the tin and no leadin ever fails to make brotherly contact with a fellow leadin. Let's start a Fraternal Order of Leadins.

BROWNING-DRAKE

OFFICIAL BLUEPRINTS
\$1.00 Per Set Postpaid
Write for Our Prices on Parts
THE RADIO SHOP OF
20 WORTH ST. STAMFORD, CONN.

"Look Up Down" FOR SERVICE

A Complete Line of Radio Parts of the better kind for all popular Circuits.
Official Factory Service for
RADIOLA R. C. A. OPERADIO
CHAS. W. DOWN
2050 BROADWAY NEW YORK CITY

THEY ALL
PRAISE THE

BRETWOOD Variable Grid Leak

The Bretwood Grid Leak came with today's mail. It is now exactly 9:00 P.M. and the leak was installed about a half hour ago. This note is not only an expression of appreciation but also an attestation of the truth of your advertising. During the past half hour I have tuned in stations "ALL OVER THE DIALS" at leisure, and can adjust reception with the leak almost equal to a variable condenser.

I feel constrained to add that while waiting for reply and then receipt of leak from you, there has been on the set a fixed leak and condenser of well known and thoroughly reliable make, and fairly good reception has been enjoyed, but during this half-hour-only test thus far the results are inexpressibly beyond expectation.

Have been a radio fan only about four years, but feel I have sufficient knowledge and experience to recognize a good thing upon fair trial. Your promptness and desire to satisfy your trade, in this case has won for you another "BRETWOOD BOOSTER." Thank you.

The Rev. WALTER G. BARLOW,
Bishopville, Md.

Very many thanks for your kind letter of the 21st ult. and for the grid leak, which works perfectly. I have tried four different makes of grid leaks. The Bretwood "has 'em beat."

M. SAWYER,
Box 238, Los Gatos, Calif.

Received your grid leak and wish to say that none can compare with it when it comes to clearing up reception.

JOHN A. BLACKBURN,
5328 Warren Ave., Norwood, Ohio.

Enclosed find P. O. money-order for \$3.00. Please send me two of your Variable Grid Leaks. I am using one and it works fine. Please mail them as soon as possible.

W. H. PERRY,
119 Congress St., Buffalo, N. Y.

Received your grid leak and many thanks. It is the best \$1.50 that I have spent for radio equipment.

ED. JENKINS,
703 E. Main St., Louisville, Ky.

Enclosed herewith find check for \$1.50 for one Bretwood Grid Leak. I am using your leak and find it far superior to any others. This is my third Bretwood.

J. C. WHITE,
422 W. Wooster St., Bowling Green, Ohio.

Will you please send me by return mail two Bretwood Variable Grid Leaks. I enclose herewith check for \$3.25, the 25c. being for a special handling stamp, as these leaks are needed at once. The leaks are the only satisfactory instrument on the market. I find them absolutely essential in the construction and operation of sensitive experimental receivers.

ED. J. WHITTIER,
The American Appraisal Co.,
Milwaukee, Wis.

I want to thank you for your leak, it makes the set 100% better. I was going to have a Diamond of the Air built, but since I have added your leak to my set I am now down in the dining room of the first floor and the set is on the second floor. I can hear the set just as plainly as if I were up there. I can hear every player in any band or music which is on air. The first night I gave the leak a very good test, and I got four stations in Chicago, one in Detroit, one in Canada, one in Atlanta, Ga., and several others without any noise. All were good and clear. It is going to make me spend more money, as I will have to get a good loud speaker. The horn I have now is a Manhattan Jr., and is good and clear, but as soon as your leak is installed the howling present when using three tubes is immediately stopped.

LEON E. COLE,
5816 Tilbert St., Philadelphia, Pa.

Grid Leak received and tested out, and find it is the only variable leak I ever used that is really variable. Enclosed find \$1.50, for which please send me another one.

F. E. STAYTON,
Box 240, Ardmore, Okla.

Thank you for introducing me to the Bretwood Variable Grid Leak! I have installed one in my Three-Circuit Tuner, according to your instructions, and find that it does all you said it would—and more. I am now recommending the Bretwood to all my friends, and those who have used this wonder grid leak have nothing but high praise for it. The fact that it can be adapted for any hookup makes it invaluable to the experimenter.

Although I have only used the Bretwood leak for three weeks I have pulled in several of the weaker stations which were inaudible before, and the microphonic noises which were decidedly pronounced before have entirely disappeared.

Please accept my best wishes for your continued success and also for the Bretwood Grid Leak.

S. R. HUBBS,
180 Quincy St., Brooklyn, N. Y.

Let me say that the Bretwood Grid Leak improves the set 100%.

J. E. MCGINNIS,
27 Lenox Rd., Brooklyn, N. Y.

I wish to take this occasion to thank you for your courtesy in furnishing me with your very excellent Grid Leaks. I have installed one with your Condenser on my own personal radio set, and am delighted with the results.

R. W. DeMOTT,
Experimenter Pub. Co.,
53 Park Place, N. Y. C.

I have received the Grid Leak you sent me and it is perfect. It is surely wonderful the way it works. Please send me another by return mail for a friend.

J. F. COOPER,
1029 Courtlandt St.,
Cincinnati, Ohio.

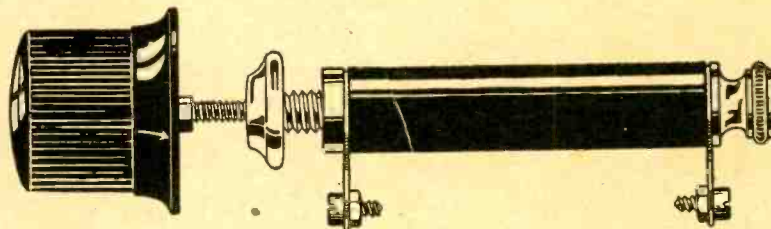

The Bretwood Variable Grid Leak

(Bretwood, Ltd., Sole Patentees and Owners)

Guaranteed Precision Range 1/4 to 10 Megohms

Brings in More Distant Stations—Affords Greater Volume—Improves Tone Quality Fits Any Set, Panel or Baseboard.

Price, \$1.50

"IT DOES THE TRICK"

The North American Bretwood Co.

Telephone, BRyant 0550

145 West 45th Street, N. Y. City

Sole Distributors for United States

North American Bretwood Co., 145 West 45th St., N. Y. City.

Gentlemen: Enclosed find \$1.50. Send me at once one Bretwood Variable Grid Leak on 5-day money-back guarantee.

NAME

ADDRESS

CITY STATE

Inquiries Solicited from the Trade

Buy Safe By Guaranty

We claim that our \$40.00 BST-6 is the equal of any \$75.00 radio set. Here is how we will prove it to you.

Our Offer:—Send us your check or post office money order for \$20.00, one-half its price, try out the BST-6 in your own home for ten days, then either send us the other \$20.00, making \$40.00 in all, or return the set and we will return your \$20.00—no questions, no argument.

Send us only

\$20

and This Marvelous Set Will Be Sent You Immediately!

This marvelous six-tube tuned radio frequency receiver is Self-Equalized and built of low-loss materials throughout. Its clear, rich tone of astonishing volume is a revelation. The circuit consists of two stages of tuned radio frequency, tube detector and three stages of balanced audio amplification. Air cooled rheostats and universal sockets are used.

Lubree modified straight line wave variable condensers are employed, insuring separation of the low wave length stations. **PERFECT CALIBRATION — STATIONS ONCE TUNED IN CAN ALWAYS BE LOGGED AT THE SAME DIAL POINT.**

The BST-6 works best with a 75 to 100 foot aerial, 6-volt "A" storage battery, two 45-volt "B" batteries, 4½-volt "C" battery, six 201-A tubes and any good loudspeaker.

Specifications

- Bakelite Panel, Walnut Finish—With Etch-O-Gravure and Gold Decorations—
- Bakelite Sub-Base—
- Kurz-Kasch Bakelite-Walnut Pointers; Gold-filled to Match—
- Kurz-Kasch Bakelite Gold-filled Rheostat Knobs—
- Lubree Straight Line Wave Variable Condensers—
- Special Corkoid Coils; Highly Concentrated Field—
- Shore Audio Transformers—
- Caswell-Runyan Two-tone Walnut Finished Cabinet.
- New Dubilier Grid Condenser.



The BST-6. 2 Feet 4 Inches Long. 9 Inches Inside Depth. 8¾ Inches High.

Every BST-6, since we started to sell direct from factory to consumer, has been sold on guarantee of satisfaction or money back. Ninety-nine out of a hundred have given absolute satisfaction.

We have yet to hear of any other make of radio giving such a high percentage of satisfaction. It is almost foolproof.

LOG OF BST-6

Taken on a Fifteen-Foot Aerial in One-half Hour by Al. Kraus, 996 Aldus Street, New York City.

| | | | |
|----------------------------|----|-----------------------------|----|
| WSBC, Chicago, Ill..... | 10 | WGY, Schenectady, N. Y..... | 50 |
| WBBR, Rossville, N. Y..... | 16 | WMAK, Lockport, N. Y..... | 14 |
| WEBH, Chicago, Ill..... | 49 | WMSG, New York City..... | 11 |
| WHT, Deerfield, Ill..... | 55 | WOC, Davenport, Ia..... | 85 |
| WCCO, St. Paul, Minn..... | 61 | WFAA, Dallas, Texas..... | 78 |
| WSB, Atlanta, Ga..... | 66 | | |

SELECTIVITY

I live within four blocks of WLWL, and since the opening of this station have had great difficulty in choking them off my old set. Even after employing a wave trap I could still hear WLWL around the entire dial and was told by several friends that living so near this powerful station it would be impossible to entirely cut them out with anything less than a super-het. It was a very agreeable surprise, therefore, when I installed my new BST-6, to find that while WLWL came in on 25 I could tune in WRNY on 21 and entirely cut out WLWL. **This is certainly real selectivity.**—F. S. Clark, 350 West 55th Street, New York City.

GUARANTY RADIO GOODS CO., 145 West 45th Street, New York City.

Gentlemen:—Ship me one BST-6, \$40.00 Radio Set, for which I enclose \$20.00 on account. I am to test it out for ten days in my own home and if satisfactory I will then send you the balance of \$20.00; but if not satisfactory to me, I will return the set at the end of the ten days' trial and you are to return my \$20.00 immediately on receipt of the set without question.

NAME

ADDRESS

DATE