

RADIO WORLD

(Trade Mark)

ILLUSTRATED. WEEKLY

Army Antenna Erected in 90 Seconds!

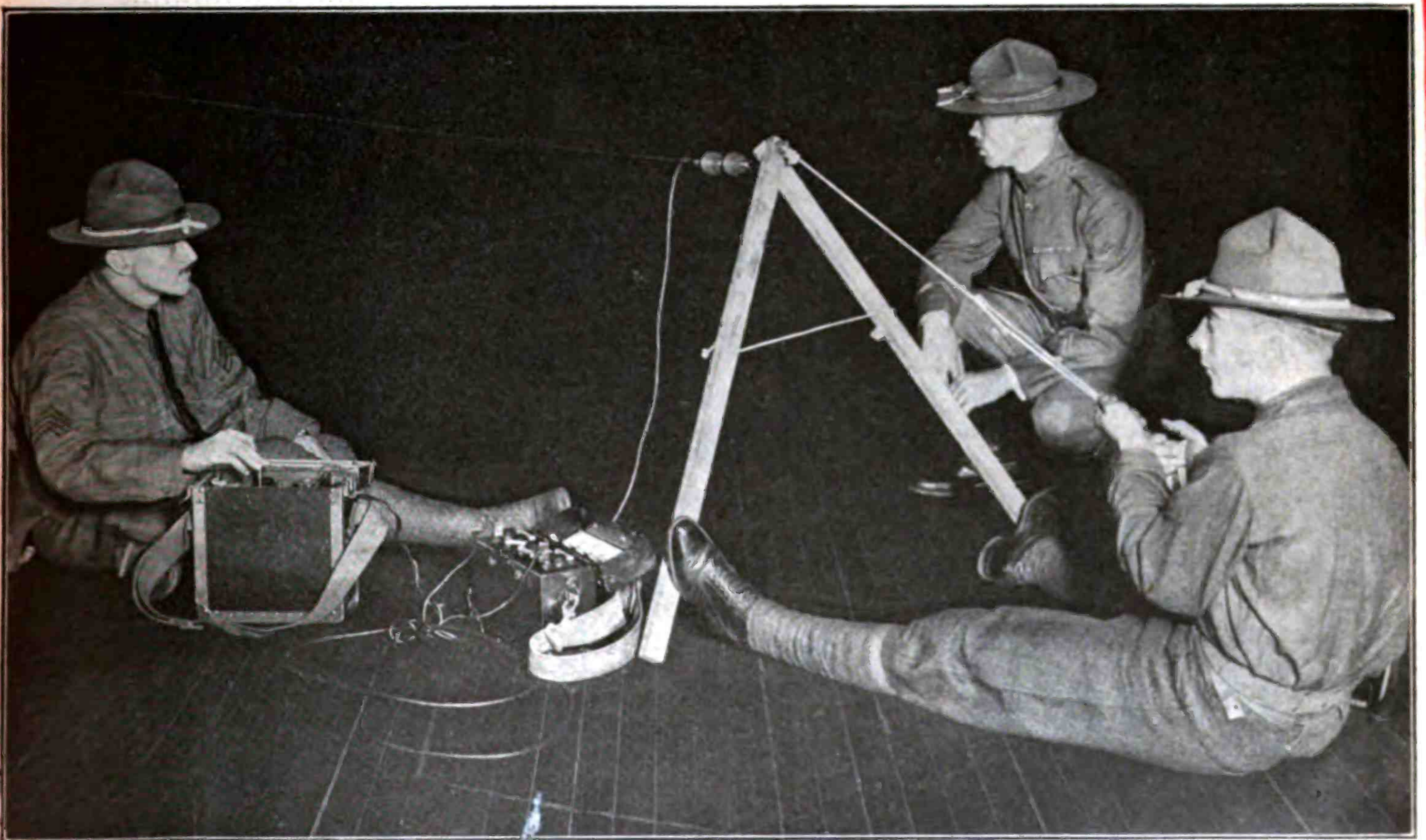

(C. International News-Reel)

The recent reorganization plans of the National Guard of New York provide for the latest in radio equipment. The above is an illustration of the type of low-visibility antenna used by the Signal Corps, Headquarters Company, 71st Infantry. The set is three feet high and can be erected in ninety seconds. This low antenna is specially adapted to the radio work of a battalion in a forward position.

(See story and additional photographs on page 16)

WHAT YOU NEED FOR AN ARMSTRONG

CG

Most Complete—Interesting—Information Book
Ever Compiled on Radio

Textbook on Radio

By JAMES R. CAMERON

Whose textbooks are used and indorsed by the U. S. Army, Navy, and Department of Public Instruction

JUST OFF
THE PRESS

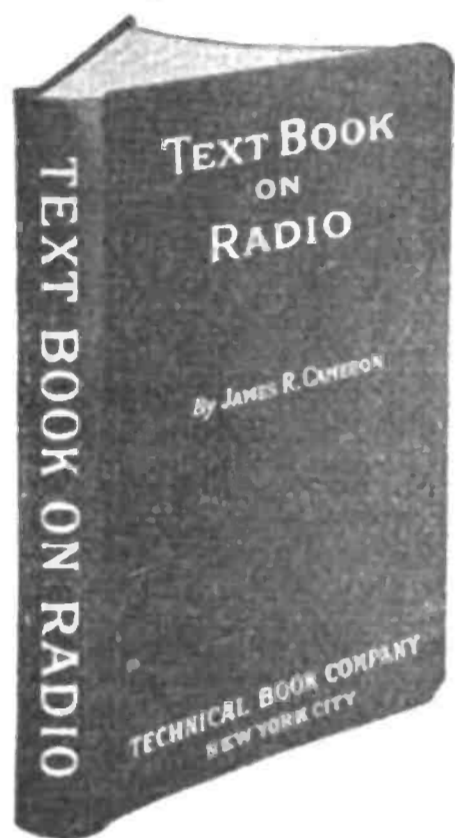

350 PAGES
ILLUSTRATED

Over four thousand mail orders received
before this book was off the press.

BUY FROM YOUR DEALER OR USE THIS ORDER BLANK

—ORDER BLANK—

TECHNICAL BOOK COMPANY,
130 West 42nd Street,
Dept. W., New York.

Please send me by return of post your 350-page, profusely illustrated Textbook
on Radio, for which I am enclosing you

Cloth Bound \$2.50

Flexible Leatho \$3.00

Name

Address

Be a Booster
for

National Radio Week

VOLUME TWO

RADIO WORLD

[Entered as second-class matter, March 28, 1922, at the Post Office at New York, N. Y., under the act of March 3, 1879.]

A Weekly Journal, Published Every Wednesday and Dated Saturday, by Hennessy Radio Publications Corporation from Publication Office, 1493 Broadway, New York, N. Y. Telephone: Bryant 4796.

Vol. II, No. 5. Whole No. 31

October 28, 1922

15c. per copy, \$6.00 a year

New Wonder of Warfare! Tanks Directed by Hidden Radio Operator



(Both photographs C. Pacific & Atlantic Photos, Inc.)

TH**ERE** is no end of romance in the story of the radiophone. It is an invention that came back, so to speak, in a big way after an ignominious career. But such a wonderful thing as speaking and receiving through space, without wires, tubes, cables or other physical connections, was almost certain to fall into the hands of unscrupulous promoters, long before the serious, honest experimenters had an opportunity of evolving something more than a crude, laboratory demonstration. So we find that, a dozen years ago, the radiophone was nothing more than a crude device, making use of a sputtering, uncertain electric arc as a "generator" of the high-frequency machine. The high-frequency, so uncertain as to be almost hopeless, was modulated or varied by means of some form of carbon microphone. This instrument, as anyone familiar with its construction knows, is quite unsuited to the handling of heavy currents.

A series of experiments were being conducted for the United States Signal Corps with a view to proving the practicability of radiotelephony in military communication. After numerous attempts the vacuum tube came into play. It opened a new era in telephone work. The vacuum tube is nothing short of an electrical acrobat. It can do all sorts of tricks—tricks no other electrical device has been able to perform.

Today the vacuum tube is producing most remarkable results, and the latest achievement in the United States Army is the equipment of steel clad "tanks" by radio. With radio it is possible to direct war tanks in the direction they should go! The photograph at the left is the interior of a tank, showing the operator with his radio gear. The lower picture is that of a number of tanks being directed by radio to operate in certain war areas.



A Simple Superregenerative Receiver

By Harold S. Potter

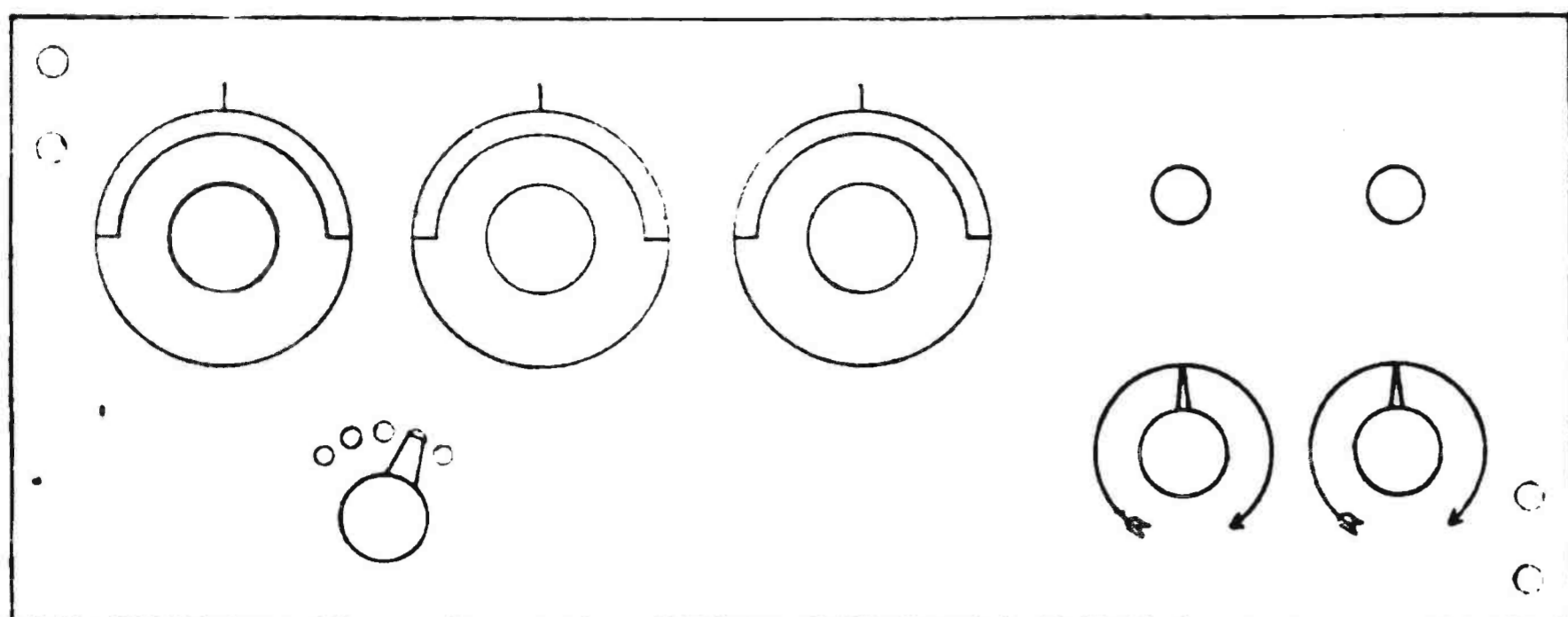

How the front panel will look when completed. The dials should appear on the panel in this manner. The two dials to the right are the rheostats for the tubes; the three large dials are the tuning devices. Drawn by Harold S. Potter,

SUPERREGENERATION is the carrying on of the familiar phenomena of regeneration, beyond the point where it usually must cease, due to the circuit starting to oscillate, making the signals mushy and unintelligible.

When the new system was first placed before the public, great claims were made for it, many of which have since proved unfounded. It was not, as was then claimed, the equal of the seven-tube superheterodyne, for long-distance, short-wave reception. However, for short-wave reception over moderate distances, it is the thing. It is the solution of the apartment-house dweller's troubles, as it makes possible the reception of broadcast entertainments on a small-loop antenna without any outside connections whatever. Formerly this could only be accomplished by the use of a considerable number of tubes, which meant a considerable outlay, but now it may be accomplished with but two tubes.

Superregenerative sets have been built using one, two and three tubes. The one which I am about to describe is of the two-tube type and best for general use.

Many amateurs are under the impression that the superregenerative system is an expensive one to use. This is incorrect, as may be seen by the following list of parts and their cost:

1 bakelite panel 7x18x3/16 inch..	\$3.00
1 wood base 9x18x3/8 inch.....	.50
1 43-plate variable condenser....	4.50
1 23-plate variable condenser....	3.75
2 tube sockets	2.00
2 rheostats	2.00
1 D. L. 1500 coil (unmounted)...	2.75
1 D. L. 1250 coil (unmounted)...	2.25
1 3 1/2 inch rotor.....	.50
1 length cord tubing.....	.10
3 3-inch dials	3.00
1 1-inch radius panel switch....	.50
12 binding posts60
1 phone condenser30
Wire, brass, screws, etc.....	.50

Total \$26.25

The panel may be of bakelite,

formica, celeron or hard rubber; but hard rubber is not to be recommended, as it is apt to warp. It may be purchased cut to size and squared up. The dimensions are 7 x 18 x 3-16 inches.

Figure 2 shows the details of the panel layout. If any other make of instrument is mounted on the panel in the place of those listed, allowance must be made for their different dimensions. The holes should first be located by the use of square and ruler, then spotted with a center punch.

The panel should be given a coarse-grain finish by rubbing lengthwise with a piece of No. 2 emery cloth until all shine is removed. A small quantity of olive oil should then be rubbed into the panel. A rich gloss finish will result.

Closely allied to the panel is the base, which is of 3/8-inch hardwood, 9 x 18 inches. Three screws pass through countersunk holes at the bottom of the panel, into the front edge of this base, holding them firmly together at right angles to one another. This base is used for mounting the duo-lateral coils, the tube bases, the battery-connection strip and the tickler bearing.

Two variable condensers are mounted near the center of the panel.

Referring to Figure 3, C is a .0005 mfd. condenser used across the inductance to tune the input. See Figure 5.

C₂ is a .001 mfd. condenser used across the D-L. 1,500 coil. It should be shunted by a .001 fixed condenser, giving an effective capacity of .002 mfd.

The input tuning inductance and the

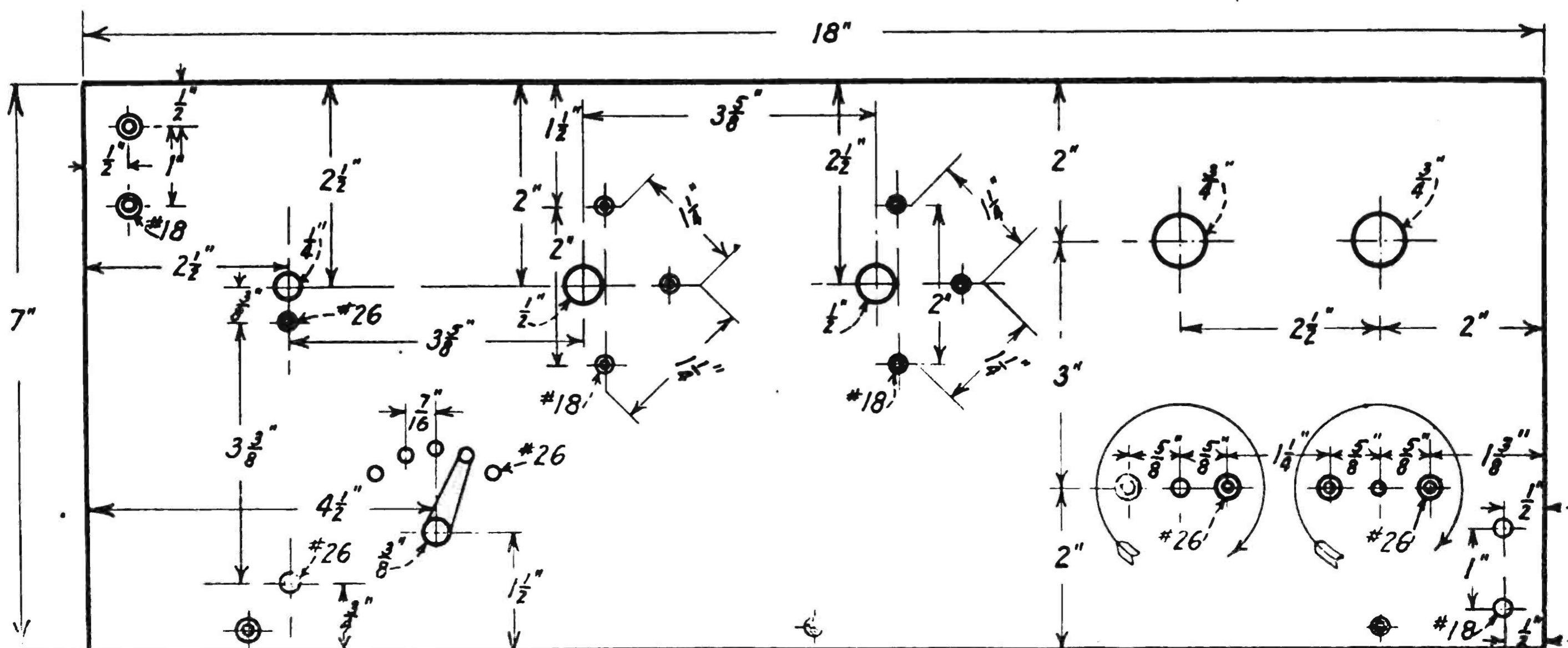

View of the front panel, showing all necessary dimensions for the construction of this superreceiver. Careful attention should be given to each section. Suggested by Harold S. Potter. Drawn by S. Newman.

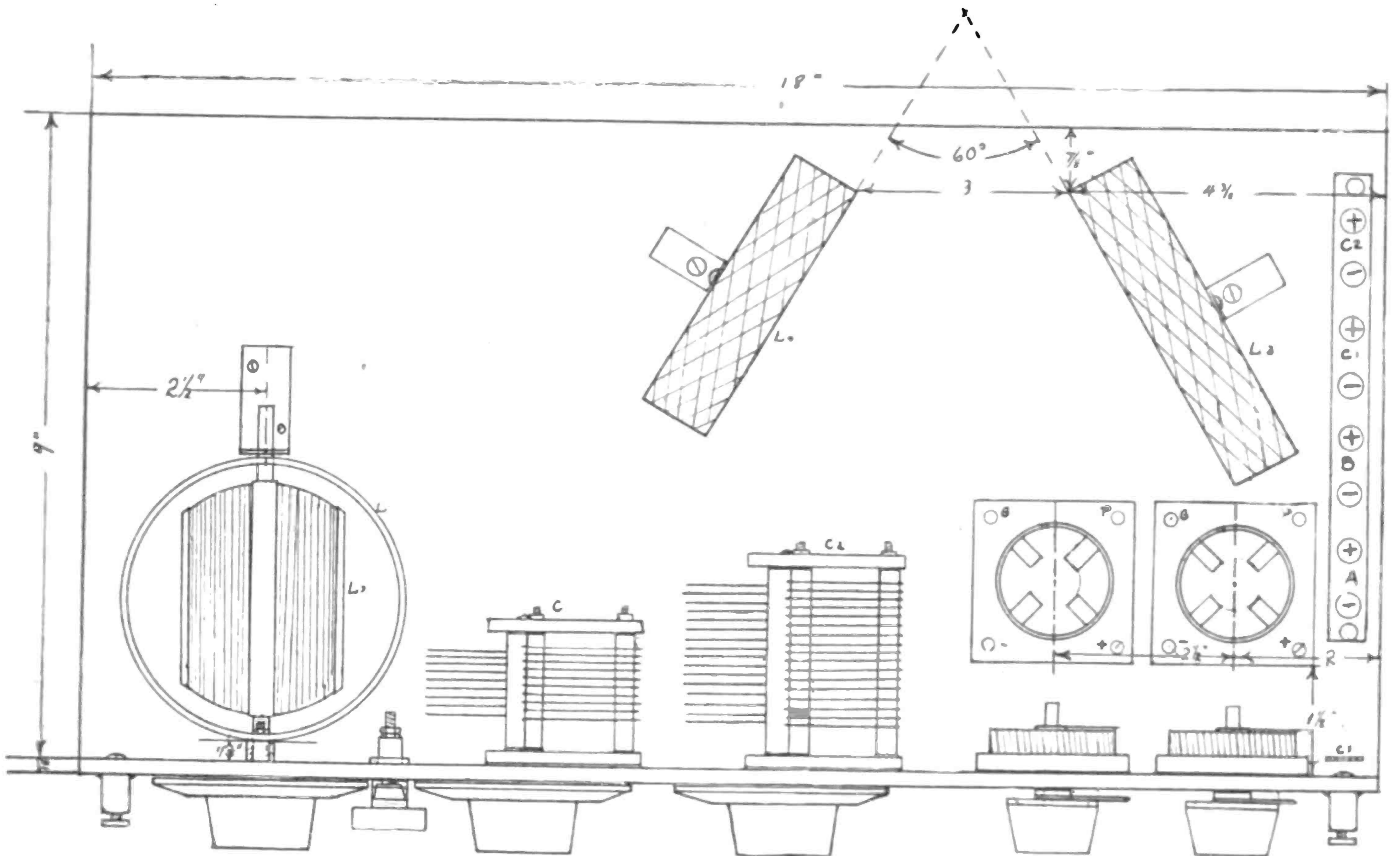

Looking into the receiver. This is the "layout" of the equipment, not the position of the various instruments such as the condensers, rheostats, vario-coupler and honeycomb coils. It carries its complete dimensions. Drawn by Harold S. Potter.

(Continued from preceding page.)
tickler are mounted together in the form of a vario-coupler, the tuning inductance being the fixed member. The form for this inductance is a piece of cardboard tubing 4 inches in diameter and 4 inches long. Starting $\frac{1}{2}$ an inch from the top end, wind for 2 inches with No. 24 D.C.C. magnet-wire, tapping every $\frac{1}{2}$ inch, giving 5 tap leads in all, including the start and finish. These taps are connected to the points of the tap switch, shown in Figure 1, below and between the coupler and condenser dials.

A hole is drilled through one side of this tube, $\frac{1}{4}$ inch down from the top, and another $3\frac{3}{8}$ inches below it, to match the two holes in the panel, and are used for mounting. Two $\frac{3}{4}$ inch $\frac{6}{32}$ flat-head nickel-plated machine screws serve to support the inductance. A couple of battery terminal nuts slipped over the screws serve to keep the inductance $\frac{1}{4}$ of an inch from the panel.

The tickler is made by winding a $3\frac{1}{2}$ inch rotor ball with a single layer of No. 28 S.C.C. magnet wire, giving about 96 turns in all.

A $\frac{1}{4}$ inch brass shaft passes through this ball and is supported by a brass angle bracket at one end, while a $\frac{1}{4}$ inch hole in the panel, shown in Figure 2, serves as the other bearing. Great care should be taken in mounting and making the brass angle support to get the hole to line up properly with the

bearing hole in the panel, as otherwise the dial will not run true.

In making connections to this tickler winding use flexible leads in order to allow the ball to run smoothly.

In the variation frequency-generator circuit 2 large honeycomb coils are used. One is a D.-L. 1500 coil, in the grid circuit. This is shunted by the variable condenser previously mentioned. It is mounted back of the tube bases, as shown at L3, Figure 3.

A D.-L. 1250 coil, L4, is connected in the plate circuit, Figure 5.

In Figure 3 is shown the correct relative positions for these inductances, 3 inches apart at their nearest points, and at an angle of 60 degrees to one another. This I found to be the best position in my set, and slightly different coupling may work best on another set; but once they are placed the inductances need not be moved. Figure 4 shows the details of the coil mountings. The brass support is made of strip brass $\frac{1}{2}$ inch wide and $\frac{1}{16}$ inch thick. The dimensions are shown in the detail drawing. A hardwood plug should be fitted to the center of each coil. But one screw is used to fasten each support to the base, so the angle of the coils may be changed, if need be, by simply loosening this screw.

A most important part of any tube set is the rheostat. The tubes in my set are mounted at the lower right-hand end of the panel, below the peepholes.

Just back of the rheostat are the

tube sockets. These are all bakelite. It is well to remember, when picking a tube socket, to get one which holds the tube snugly and has strong contact-springs, in order that a good contact with the prongs on the tube may be assured.

A mica phone condenser having a capacity of .0025 mfd. is shunted across the phone binding posts at the lower right-hand corner. It may be seen in Figure 3 (C₂). It is supported in place by the wires which connect to it.

At the right-hand end of the base, Figure 3, is a strip of bakelite $\frac{1}{2}$ inch by $6\frac{1}{2}$ inches by $\frac{3}{16}$ inch thick. On this connection panel 8 small binding-posts are mounted, to make connection to the A, B, and C batteries. These posts are placed $\frac{3}{4}$ inch apart. Two $\frac{3}{4}$ -inch roundhead brass wood screws secure the connection panel to the base, while two battery terminal nuts slipped over the screws between the panel and the base keep it raised $\frac{1}{4}$ inch above the base, making room for connecting to the binding posts.

Regarding the dials, any 3-inch 180-degree dial having a $\frac{1}{4}$ -inch shaft-hole may be used. When buying dials be sure to pick ones which are flat and true if even, smooth-running of controls is desired. Also, be sure to get bakelite dials—not those made from molded "mud" composition.

(Continued on following page.)

which have a habit of chipping and splitting.

The handiest binding post to use is the type having a hole drilled through for the wire or phone tip and a set screw. For the sake of appearance, get a small nickel-plated post, not a clumsy brass one.

Only the antenna, ground, and phone posts are on the panel. All battery connections are made to the

well to enclose the set in a cabinet. If you are not handy with tools this should be purchased ready-made.

For those who care to build their own the following particulars are given. The inside dimensions of the cabinet are: 7 inches high, 18 inches long, and $9\frac{3}{16}$ inches deep. Quarter-inch oak, mahogany, or some other hard wood may be used and finished in any manner desired. The top of

cept under almost perfect atmospheric conditions. However, interfering noises may be eliminated by using a loop antenna. I use a loop 3 feet square, wound with 10 turns of No. 18 bare copper wire spaced $\frac{1}{2}$ an inch apart.

Fine results may be obtained on a loop as small as 1 foot square; in fact, little difference in signal strength will be noticed when changing antennae. About 50 feet of annunciator wire may be wound into a loose coil and dumped on the floor, the ends connected to the set. Surprisingly good results will be obtained.

It is almost impossible to give instructions for the operation of this receiver. Adjustment of L2 and of C2 cuts out the howling and whistling which is common to this circuit when out of adjustment. The various stations are tuned in by varying C1 and the tap switch. The final adjustments are then made with the rheostats and with C2.

The above hints will prove helpful, but the builder must learn the meaning of the many indescribable sounds characteristic of this circuit. A little practice will mean more than pages of instructions.

In conclusion, this offers a great field for experiment to the dabbler in superregeneration, as the circuits yet developed have their limitations and there is much improvement to be hoped for in the reception of spark signals over long distances by this system.

And now, you "bugs" who try this set or are experimenting with superregeneration: How about a line or two telling of your results? I would be glad to hear from anyone on this subject.

Claims Receiving Record

If Any Radioist Can Beat Mr. Merklein's or Would Like His Hook-up, Write Him.

Editor, RADIO WORLD: Speaking of receiving broadcasting a la D X, I believe I hold the record. On the night of October 16, at 11:15, I happened to tune out WJZ, and tuned in WDAP. Later I received WSB. Station WDAP is located in Chicago; WSB in Atlanta, Ga.

The concerts came in very clear, and only on one tube. My outfit is of the two-variometer type, and the design of wiring is my own: Two Steps of Audio, frequency—VV 201—detector; VTI—first step; VT2—second step; 110 volts on amplifiers; 4 wire "L" type aerial, 40 feet long and 50 feet high.—Best 73, J. A. Merklein, 7513 Third Ave., Brooklyn, N. Y.

Perfection at Last

Madge: "Do you know anything about this radio fad?"

Marjorie: "It must be just lovely, dear. I understand that you can listen in."

—"The Sun," New York.

Fifty-two issues for \$6.00. Sub. Department, Radio World, 1493 Broadway, N. Y. C.—Advt.

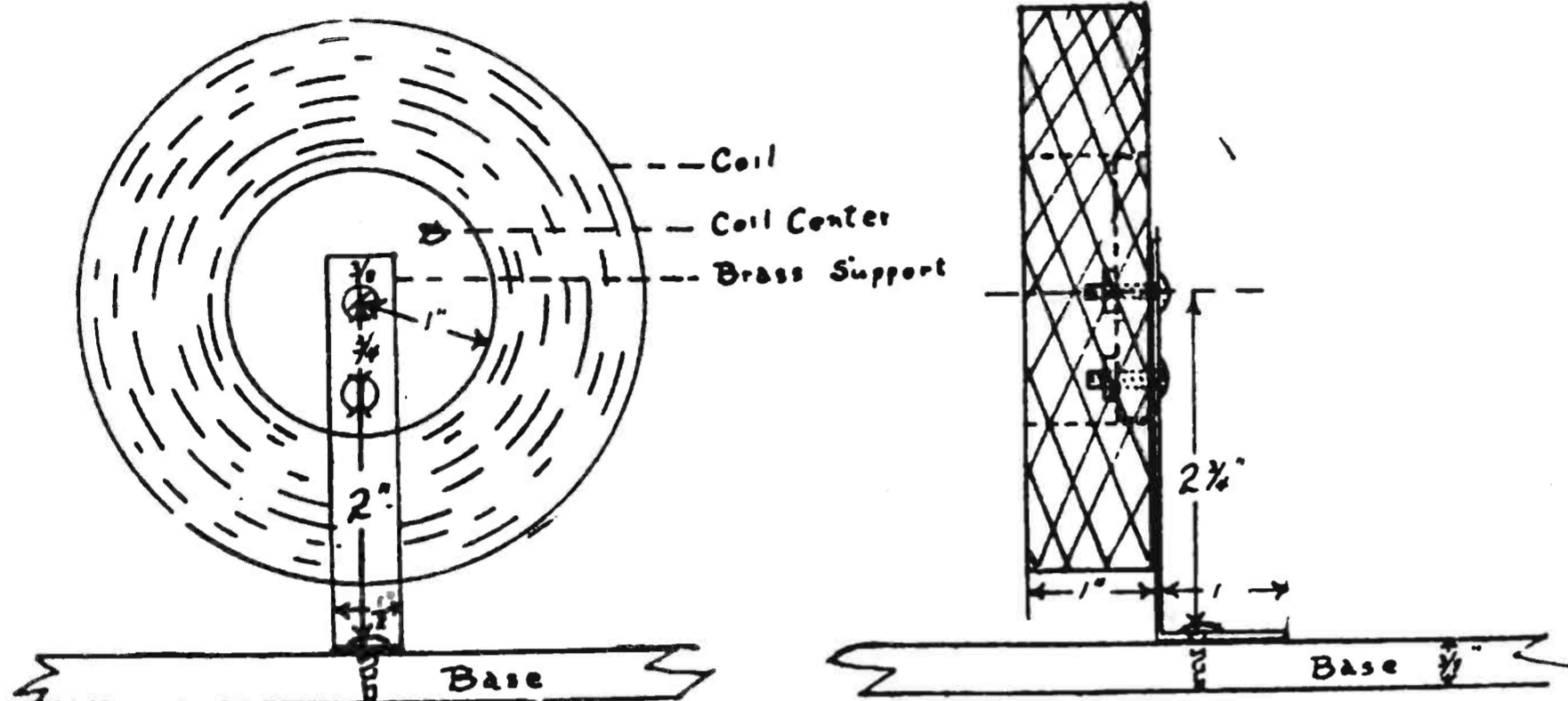

The honeycomb or duo-lateral coils. This diagram shows how they should be mounted. Note the position of their layout. Dimensions are given to assemble them. Drawn by Harold S. Potter.

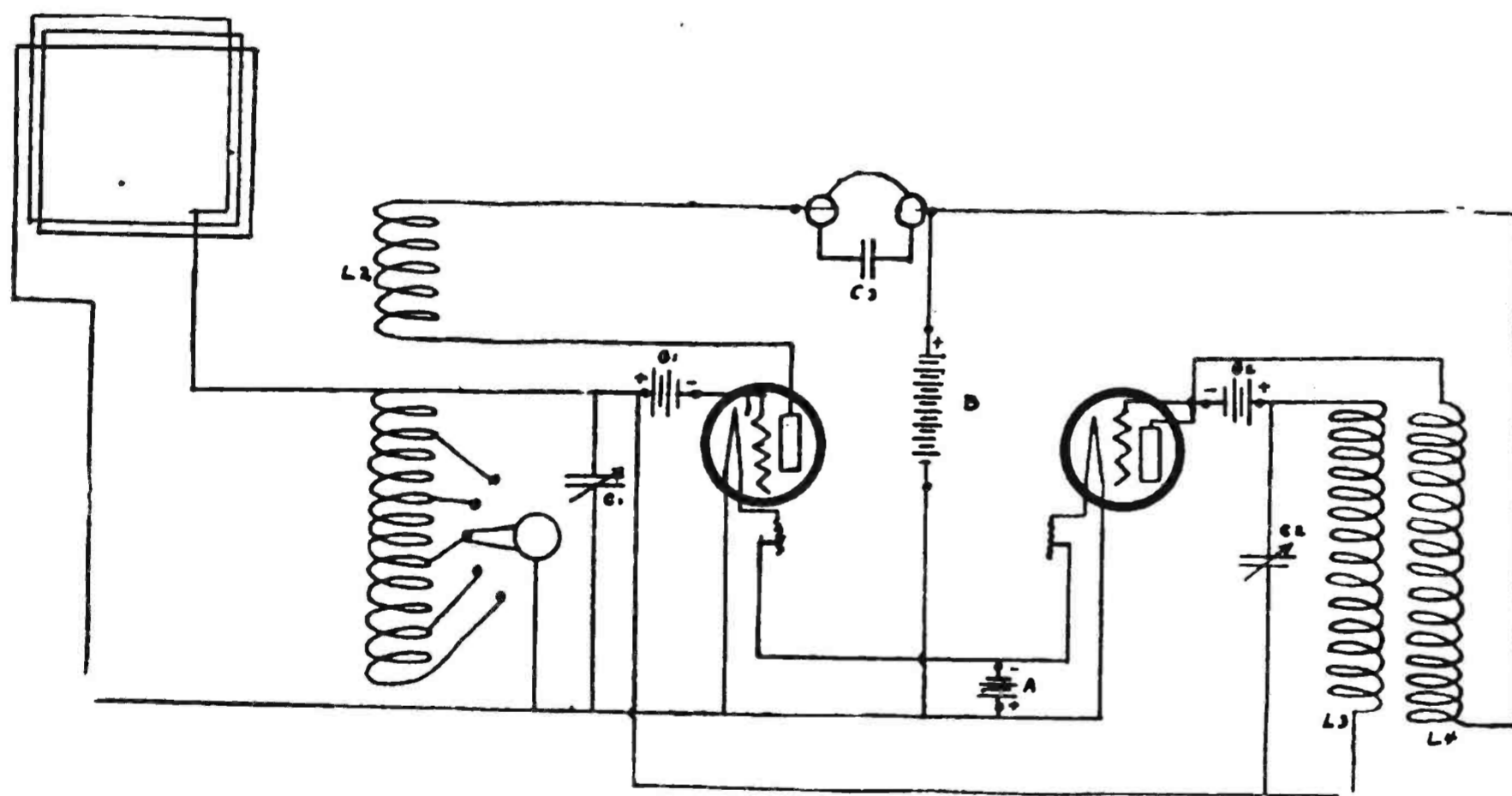

Schematic diagram of the internal wiring of the complete set. When wiring, it is best to solder all connections that can be soldered. Follow each connection closely as you go along. Remember, one wrong connection will make the set inoperative. When finished examine the wiring. Drawn by Harold S. Potter.

connection panel back of the main panel.

Next comes the wiring. The neatest thing for this purpose is square, tinned-copper wire. If this is not available, No. 14 bare copper wire may be used. In order to make a neat job bend and fit each connection before putting it in place. Make all connections short and avoid long parallel wires, as these tend to produce howling and cause energy losses. Solder all connections.

Be sure to follow the wiring diagram in Figure 5 carefully, as all connections must be correct if results are to be obtained. Carelessness may mean a couple of burnt-out tubes, so it is better to be certain than sorry.

In order to protect the instrument from dust, dirt, and injury, it will be

the cabinet should be hinged to allow for easy inserting and removing of the tubes, and for changing connections. The battery wires should be led in through holes in the side of the cabinet.

A 6-volt, 80 to 100 ampere-hour storage battery will be needed to light the filaments.

For the plate battery, several B-battery blocks of $22\frac{1}{2}$ or 45 volts should be connected in series to give the proper voltage.

The grid, or C batteries, consist of several flashlight cells in series. The necessary voltage may vary from 5 to 25 volts, depending on the tube used and on the plate voltage. I found that 10 volts worked best on my set.

A super-regenerative set cannot be used on a regular outdoor antenna ex-

Takes Radio Circles by Storm

National Radio Week Acclaimed by All

Radio World's Proposition, That Seven Days Be Given Up to Boosting Radio, Strikes Ten with the Trade, Fans, and Amateurs

LAST week's issue of RADIO WORLD (No. 39, October 21) had no sooner reached the newsstands and subscribers than the editors realized that it had landed as a bombshell in radio circles. Telephone calls, messages, and letters soon made it apparent that RADIO WORLD'S announcement that November 26 to December 2 be set aside as a National Radio Week—to create greater public interest in radio, to increase the output of manufacturers, to increase sales by distributors and dealers, to create a wider interest among fans—is about the biggest thing that has hit the radio game since it was started.

It so happened that a luncheon in the interests of radio was held at the Bankers Club, New York, the day preceding this announcement. This luncheon was attended by Hon. Frank H. Hitchcock, J. H. Beyers, H. Gernsback, Laurence A. Nixon, and other men interested in radio promotion. When RADIO WORLD'S proposition was announced, it was so generally regarded as a matter of vital importance to every person and firm interested in radio, that the editor of RADIO WORLD immediately agreed to permit his suggestion to become a general plan of the radio world at large and to permit a committee to decide on the best and most advantageous time for the celebration of National Radio Week.

Consequently, a second meeting will be held Tuesday, October 24 (this page is going into type on October 18), when the proposition will be discussed at length and the final date decided on.

The full report of this meeting will be published in the next issue of RADIO WORLD.

The first letter to be received by RADIO WORLD commending its plan was from Edward M. Morgan, postmaster of New York City. His and other letters follow:

Laurence A. Nixon, managing editor, says "The Radio Dealer" says it's "smashing good!"

A smashing good idea! It will create a greater interest in radio, boom business, and bring new enthusiasts into our fold.

Edward M. Morgan, postmaster of New York City, an ardent Co-operator:

As to the proposition that there be a National Radio Week, there is no doubt in my mind but it would be most useful; for it would unquestionably promote the science and industry of radio; and whatever does this will be for the welfare of the nation, since every advance that facilitates the communication of information and intelligence makes for enlightenment and progress. It would have a special utility to the post office at the time suggested, November 26 to December 2, since

it would permit the broadcasting of messages urging early Christmas mailing.

H. Gernsback, editor, "Radio News," one of the first to commend the idea, writes:

Allow the writer to compliment you on the idea of a National Radio Week. This is a splendid idea, and if enough publicity matter can be broadcast so that the public will become aware that there is such a movement, we are certain that it can only help the entire radio industry.

Personally, the writer thinks that the last week in December would, perhaps, be most appropriate, because it has been found, in past years, that there is more interest in Radio displayed just before and after Christmas than during any other time of the year.

Kendall Banning, editor, "Popular Radio," is with us:

I am glad of the opportunity not only of endorsing but of actively participating in any movement that will help to establish the radio industry in the high position which it must eventually attain. Your suggestion for a National Radio Week is a step in that direction, and I shall be glad to do what I can to make it a success.

Paul V. Godley, famous radio engineer of the Adams Morgan Company, New Jersey, says: it will result in good:

I see no reason why such an arrangement as a National Radio Week should not result in some good being done. I must confess at this time, however, that no ideas of value occur to me in connection with your plan, although I shall watch its effect with interest.

What have YOU to say or suggest? What can YOU do to boost National Radio week in your town? What plan can YOU devise for some novel form of radio entertainment or display. Can YOU get up a radio party that will be pleasant and profitable and introduce strangers to radio?

Suggestions forwarded to RADIO WORLD on this important event will be welcome and will be afforded space in our editorial columns.

But—don't miss next week's RADIO WORLD. (Dated November 4, on sale November 1.) It will contain the very latest and most important news regarding National Radio Week.

Be a National Radio Week Booster

Latest Important Radio News of the Week

THE success of a sixteen-hour test of electron tubes in place of large alternators in transmitting wireless telegraph messages across the Atlantic from the Radio Corporation plant at Rocky Point, L. I., has led Dr. E. F. W. Alexanderson, chief engineer of the corporation, and inventor of the alternators which will soon be supplanted by the tubes, to predict that the transmission of power from Niagara to New York through the air by means of tubes was a possibility of the future.

It is reported that the Prince of Wales has become an ardent radiolist and has induced his father, King George V, to install a set in St. James Palace.

Receipt of wireless messages inside a steel car of a fast-moving train with no outside aerial was successfully demonstrated by the Pennsylvania Railroad on the Broadway Limited, from New York to Chicago. The tests were conducted by

Arno Zillger, of Philadelphia. The aerial used was an inside loop device, small and compact, and placed on a table. It was 18 inches square. The radio set was assembled after the train left New York, enroute to Chicago, and immediately was tuned into WOR, Newark. The entire concert was heard during the run to Philadelphia, where a second one was picked up. Broadcasting, even from the Great Lakes, was picked up all the way to Chicago.

A charge that the Radio Corporation of America, the General Electric Company and others have entered a conspiracy to obtain a monopoly of wireless service and prevent individual use of the radio is made in a suit filed in the United States District Court today by John O. Yelzer, Jr., of Omaha, Nebraska, who asks an injunction to restrain the defendants from interfering with his right to broadcast. He alleges that his own radio station was closed recently because he was operating slightly above the 360-meter wave

length, and that the first amendment to the Constitution, which says: "Congress shall make no law abridging the freedom of speech or of the press," is being thereby violated. A jury to determine damages, which he alleges to be \$25,000, is requested, with treble damages under the Sherman anti-trust law and an attorney's fee of \$25,000.

The Knoxville, Tennessee, automobile club, in conjunction with the other clubs of the state, will broadcast nightly the number and description of all stolen automobiles.

Chicago newspapers report that half the audience of the recent Radio Show in that city was composed of boys and young men, and that the most interested attendance was at the booth of the National Radio Chamber of Commerce, where experts gave the youngsters advice as to what was wrong with their instruments.

Radio Legislation Slated for December

By *Washington R. Service*

CONGRESSMAN WHITE, of Maine, "father" of the Radio Bill calculated to improve radio in this country commercially, in broadcasting, and for amateurs, has returned to the Capitol and believes that the bill will be taken up by his committee early in December.

The enactment of this long-looked-for legislation will benefit all branches of radio, but officials of the Department of Commerce say that it will not entirely eliminate interference in broadcasting. There are some features in connection with radio which cannot be corrected by legislation, it is pointed out by experts of the government, such as the mastering of one's own set.

Good Sets Badly Tuned

Even if there were enough waves to give each station an exclusive band—and there are not nearly enough—interference would still be encountered, or at least reported, by fans endeavoring to receive the news and entertainment offered by 522 stations, many of them in one community. This would be so because many receiving sets are not capable of fine adjustment and cannot be properly tuned to a specified wave length.

Though possessing excellent sets, many enthusiasts are not able to tune properly; they do not know how to manipulate their sets and eliminate interference within a prescribed band. Already reports have been received by the Department of Commerce that broadcasting on the new 400-meter wave is interfering with that on the 360-wave, which should not be the case with 40 meters between.

If transmission is good, first-class receiving sets should be capable of tuning within a variation of from 5 to 10 meters, inspectors say, unless one station broadcasting is in the immediate vicinity of the receiver.

Although Secretary Hoover will probably receive authority in the radio bill to limit the number of transmitting stations, it will be difficult to accomplish this in congested areas where several broadcasting stations are already located. Municipal authorities and organizations of listeners-in may have to aid the Secretary, when the time comes, by indicating which stations are the best and what services are most desired. The listeners-in are organized in Washington and such a body might become a censor of the air, so to speak, endorsing satisfactory stations and reporting those which are

unsatisfactory, thus aiding in establishing better service. In any event, it is hoped that both wave lengths and time schedules will aid the broadcasting in congested districts.

Must Learn How to Receive

Distributors of radio equipment capable of fine adjustment should instruct purchasers carefully and, when possible, assist them in setting up their sets and tuning in. It is evident that a large percentage of those interested in radio must be educated in the use of their sets, and this may develop on the broadcasters who are interested in having their programs clearly heard or on radio associations. The Bureau of Standards has been giving information along this line for some time.

It is expected by Department of Commerce experts that the loop receiver, possessing directional qualities, will aid in the selection of broadcasts and help in eliminating the other stations' programs, when used in conjunction with tube receiving sets. The cost is not excessive in comparison to an aerial, and as the indoor coil can be installed in a corner of a room, the disfiguring overhead aerial may eventually disappear from housetops. It is part of the question of experimentation and education in radio.

How Radio Is Supplementing the Ticker in Wall Street

THE amplifier is responsible for many radio achievements. For instance, the recent "spanning" of the Atlantic using 1 kilowatt of power, or less, would have been impossible had it not been for the highly efficient receiving equipment and amplifier employed. An ordinary set would not respond to such signals, and the transmitters, under such circumstances, would be incapable of forcing sound over so great a distance. Yet with the proper receiving set and super amplifier the signals from such a weak station were found to span the intervening space with a marked degree of success. This serves to prove that no matter how weak a transmitter may be, its waves are driven through space and kept going farther and farther—endlessly.

The advantage of employing a radio-frequency amplifier is this: It amplifies only the wave and not the many little irregularities and imperfections which exist in the usual receiver and amplifier equipments. No matter how many steps of radio frequency may be piled up to aid the detector, the signal which has failed to actuate the detector will NOT be heard. With radio-frequency amplification, on the other hand, there is no critical point, and even the weakest signal is built up to the desired degree before it is passed on to the detector, there to be rectified to audio-frequency current, which, if desired, may be passed on through one or more stages of audio-frequency amplification.

The illustration at the right shows a self-contained, six-stage radio-frequency receiver which provided the thousands who flock daily into that short, yet long, thoroughfare known as Wall Street, N. Y., with news of the moment. It was an experiment, but it worked out wonderfully. The radio set is mounted on an automobile, a 16-inch loop aerial providing the necessary completion of the circuit. The broadcast matter was carried to the crowd by means of the loud-speaker mounted on the shed of the car.

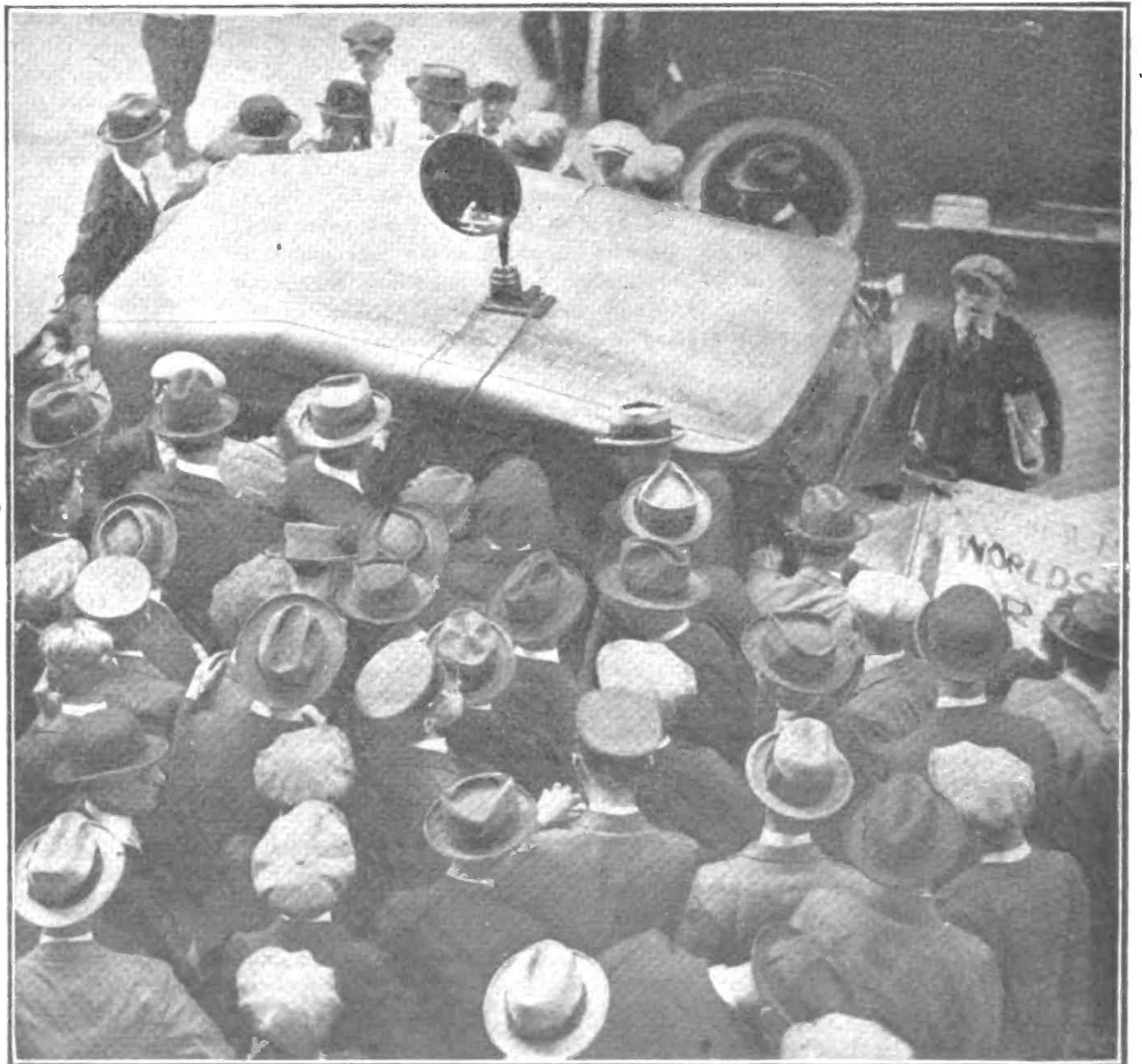

(C. International News-Reel)

Radio Guides Rescuers to Steamer Burning in Mid-Pacific

By Peter Gray

New York Evening Post

FOUNDED 1861

Friday, October 13 1922

governing the application of the Volstead law to American and foreign ships

Radio Saved 217 After Ship Burned

Navy Vessels, Yachts, Liners, Picked Up City of Honolulu's Calls

West Faralon Reached Blazing Ship 4 Hours After Her Company Had Taken to Boats

(By the Associated Press)

SAN FRANCISCO, October 13.—The radio man's bridge on space, and that hardly less potent thing the fellow ship of those who go down to the sea.

be, coupl
trer
on S
slayl
It
thort
upon
they
their
contis
forma
carefu
stated
of the
cover
A
A
A
wit
A
was
Not
Hays
Schru
charg

How the "New York Evening Post" "played up" the heading of its story of the "City of Honolulu" disaster.

WHILE she was 670 miles off San Pedro, California, fire broke out in the second-class cabin of the giant ocean liner of the Los Angeles Steamship Company's new Honolulu service, the "City of Honolulu," once a pride of the North German Lloyd. In some unaccountable way, the flames so advanced on the crew—which did heroic work in battling them—that in two hours it was found necessary to abandon ship. But before that command had been given by Captain R. H. Lester the vessel's radio had sent far and wide the call that means disaster, distress, and the possible loss of human life on the high seas.

Two ships, "Enterprise," of the Matson Line, and "Thomas," a United States Army transport, westbound, from Hawaii, picked up the signal and turned towards the position the operator had given. A pleasure yacht, the "Casiana," cruising to Honolulu, with her owner, E. L. Doheny and party of friends aboard, caught the appeal and turned her bow that way. Los Angeles caught the signals and Navy vessels stood by to race with death to the scene of the fire.

San Francisco caught the signals,

waited awhile until the radio operator on a distant ship had turned that vessel, too, towards the scene. It was that ship, the "West Faralon," M. M. Walk, master, that swept down the sea lanes to the "City of Honolulu" and effected the rescue.

But she did not get there until more than four hours after the flames had forced the captain, his first officer, the chief engineer, and the radio operator, who had stayed behind to serve to the uttermost the passengers confided to their care, to leave the blazing hulk. The officers stayed to advise, suggest, and confer; the radio operator stayed to keep the "West Faralon" advised lest she miss the boatloads of passengers floating near by and the rescue be delayed.

The chief radio operator of the "City of Honolulu" was W. H. Bell, of Oakland, California, who was making his first trip. The assistant operators were H. D. Hancock, Venice, California, and N. C. Kumler, Yakima, Washington. The three men remained at their posts so long as it was humanly possible. Mr. Bell is twenty-four years old.

Commenting editorially on the successful and remarkable part radio played in saving the lives of the passengers and crew in this latest of sea horrors, "The Times," New York, says:

Fortunately there was time to lower the boats and get everybody into them but the chief officers and the radio operators, whose duty it is to leave last and only when they are driven from their posts.

There must have been anxious moments for those in the boats, calm as the sea was. No smoke, no sail in sight. Many women and some children were among the passengers. Those vast waters appalled them. If help did not come soon, all knew the boats would not ride out a heavy sea. The comfort was in the thought that immediate response would be made to the radio signals—the nearest ship would come to the rescue under forced draft. Even so, it might be a race between her and the winds of the Pacific that at this time of the year sometimes rage on the briefest notice. But four ships, including the army transport "Thomas," picked up the call. It was the good luck of the freighter, "West Faralon," to be only fifty miles from the flaming ship and the waiting boats. She was perhaps four hours getting to the scene. Quick work was made in taking the castaways aboard. Sailors never spare themselves when a rescue is to be made.

In the old days of shipwreck without benefit of radio a rescuing vessel would probably have had to continue on her voyage to her first port of destination with the salvaged on board, but now there can be an interchange of messages between shore and ship. So it was arranged to have the "West Faralon" transfer the saved from the "City of Honolulu" to the army transport, permitting the freighter to proceed to the Dutch East Indies. As usual, the officers and radio operators of the abandoned vessel behaved with a gallantry and coolness expected of Americans beset by danger at sea. When the battle with the flames was lost the operator sent out his "Good-by" nonchalantly, and down into the boat he went, with the captain bringing up the rear of the little party.

The story is one to stir human emotions to the utmost—to make mankind thankful that radio is playing so important a part in the affairs of the world.

Vacuum Type of Arrester Safe

THROUGH proper publicity, the fear of danger in connection with radio sets has been greatly alleviated; indeed, to such an extent that some people have become exceedingly careless in rigging up their aerial and ground systems. Some believe that by simply disconnecting the aerial and letting it hang free they are assured of perfect protection. Though it is improbable that any damage would be done, this procedure is the least safe of all. Other people disconnect the aerial wire from their instruments and connect it to the ground lead. This is a safe but inconvenient method. One might forget to disconnect, with the result that some part of the set may be damaged.

The best method to pursue is to permanently connect some sort of lightning arrester—such as a vacuum, or air, gap—in the circuit between the aerial and ground. With such an arrangement, it is not necessary to change any connections during a storm or to think of grounding the aerial. Two metal plates mounted on an insulating base, so that the points are about 1/8 inch apart, will provide ample protection and be easy to make.

There are a number of worth-while types of arresters on the market. Provide yourself with one and be absolutely safe. The lightning arrester forms a positive protection against lightning troubles and will operate indefinitely without attention.

The Radio Primer

For Thousands of Beginners Who
Are Coming into Radio Circles

*Weekly A B C of Radio Facts and Principles
Fully and Tersely Explained*

By Lynn Brooks

WHAT are the essential features of construction of the audio-frequency amplifying transformer?

The audio-frequency amplifying transformer consists of an iron core, around which are wound several thousand turns of fine insulated wires. The windings are in two parts—primary and secondary.

* * *

What is meant by primary and secondary?

The words are used to designate the two windings of the transformers. The primary winding is the winding into which the current is fed. It is generally marked on transformers by the letter P. It may be determined also by looking at the transformer. The smaller winding of the two is generally the primary, while the larger is the secondary. The secondary winding is marked S. It is the winding from which the transformed current is taken.

* * *

What is the iron core made of?

The iron core is made up of a large number of thin sheets of a special iron arranged in a square, or rectangle, thus forming a complete path for the magnetic force which is produced in the iron when the transformer is connected into the circuit of any radio-receiving-set.

* * *

What is the function of these transformers?

To change the audio-frequency variations in the plate circuit of the detector tube into the similar but greater variations in the grid circuit of the first amplifier tube. As a potential on the grid determines the strength of the signals heard by means of the phones in the plate circuit, the transformers make it possible to greatly strengthen these signals by increasing, or boosting, the potential impressed from the plate circuit of one tube onto the grid of the next.

* * *

What is meant by amplification?

Amplification means to magnify or enlarge. In radio it refers to the magnification of the strength, or loudness, of the signals received and detected.

The transformers just described are used in radio as magnifiers.

* * *

How are the radio signals amplified?

By the use of additional vacuum tubes and amplifying transformers. Instead of inserting the head phones in the output, or plate circuit, of the detector tube, the currents in this circuit are passed into a special transformer called the amplifying transformer. After passing through the transformer the signals are conducted to the grid of an amplifying tube. Being of a greater potential when they enter the tube through the grid, these currents liberate a large plate-current. Thus, if the head phones instead of being inserted in the detector plate-circuit are inserted in the amplifier plate-circuit, the signals heard will be many times louder.

* * *

How many times may detected signals be amplified?

Experimentally, without limit; practically, the strengthening of the signals is limited to two amplifying tubes.

* * *

Can amplifiers be used with regenerative sets?

Yes; but it will be found advantageous to insert a small bypass condenser around the primary winding of the first transformer.

* * *

What is the reason for this condenser?

The high-frequency resistance, or impedance, of the transformer winding is so great as to form a barrier against the passage of the retuned currents. A condenser allows the high frequency, or—as they are more often called—radio-frequency currents, to pass around to the grid without encountering this barrier.

Take Care of Your Phones

One thing that is important—dropping phones. This is apt to break the ear-caps and possibly injure the windings. It may injure the phones entirely. Receivers are built like a watch and should be given as careful attention. Take care of your phones and they will last you a long time.

How Crystals Change the Speed of Radio Waves

Thousands of radio beginners have come into the radio field since summer. They will find "The Radio Primer," published weekly in RADIO WORLD, a regular source of instruction and aid. For this reason, RADIO WORLD will republish, from time to time, some of the valuable primer articles that appeared in its early issues. These articles, by experts, contain a vast amount of radio information that cannot be duplicated. Every beginner will find them necessary to the building of sets and cooperative with the new material being printed.

BECAUSE of a peculiar property which they have of letting only part of an electric current pass through them all radio waves, when they pass through the air, are in the form of a wave, one-half of which is traveling in a positive direction while the other half is traveling in a negative direction, said a writer for this department in RADIO WORLD No. 6. This is illustrated in Figure 1. Now a crystal of one of the substances men-

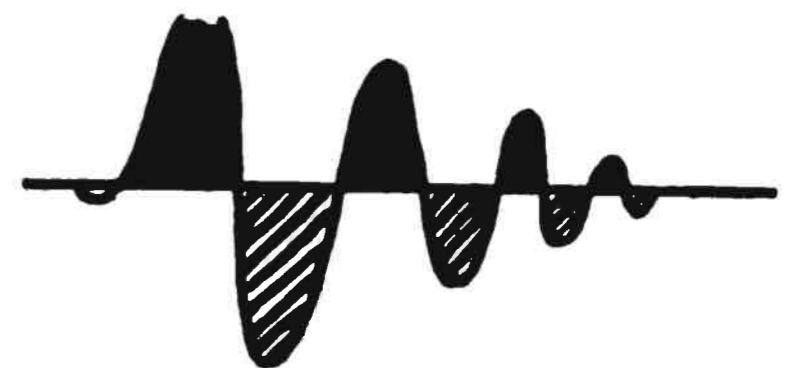

Figure 1. Diagram of radio wave as it passes around through tuning coil and condenser. Solid-black part represents positive wave; cross-sectioned part the negative wave.



Figure 2. After passing through detector, wave of Figure 1 has been reduced to this form. The negative wave has been strained out by the crystal.

tioned above has a fondness for the positive kind of electricity, but won't have anything whatsoever to do with the negative kind. The crystal opens wide its door to the waves that are positive, but the door is slammed in the face of the other waves. This exclusiveness of the crystal is a fortunate thing for us. If the radio waves are trotting around our receiving circuit at a tremendous speed and we insert a detector in their path just one-half of all the waves will be rectified.

"Shielding" the Set

UNTIL the coming of the modern regenerative receiver, the term, "shielding," as applied to radio apparatus, was quite unknown. The regenerative receiver, however, being supersensitive to all electrical influences, has been found to require protection against external electrical disturbances. Shielding accomplishes this. It is the process of surrounding the entire receiver, and, frequently, the individual circuits therein, with a metallic surface. This generally takes the form of a copper lining in the cabinet and on the rear of the panel itself. Shielding takes care of the energy loss from the windings which tend to induce another current in the same manner that radio waves induce electric currents in a receiving antenna.

How to Make Your Aerial Function

By Horace Beers

ALTHOUGH any alternating current will cause a disturbance in the ether regardless of the size or shape of the circuit, in order to create the maximum disturbances possible with the power available, it is necessary to erect an aerial.

An aerial or antenna, as it is sometimes called, is a system of wire or wires stretched above the surrounding objects and connected to the radio set. The aerial is used for both receiving and transmitting, a switch or other transfer method being used to connect it to one or the other, according to the station sending or receiving the messages.

The wire used in aerials is either bare copper, phosphor bronze, or copper-clad steel. The ends of the wires are insulated with special insulators and the wire led into the house through an insulating tube known as a "bulk-head" insulator.

The problem of installing an aerial presents considerable difficulty to the beginner, but as a general rule, by bearing in mind just exactly what function an aerial performs, the problem is simplified. The average receiving set will operate with perfect satisfaction if a single wire—about size No. 14—100 to 150 feet in length is used. It is not absolutely necessary to have a fixed length. The wire may vary between 150 feet and 300 feet, and satisfactory results will be obtained.

The function of an aerial is to collect the electro-magnetic energy sent out from the transmitting station and convey it, through the receiving set, to the ground. As any conductor will perform a similar function, it is desirable that the aerial be suspended above surrounding objects. The electro-magnetic energy then reaches the aerial wire before it reaches any other object with the result that the receiving set receives more energy than would be the case if the wire were below surrounding objects.

In laying out an aerial, always endeavor to keep the wire level. If this is not possible, fasten the end from your receiving set as high up as practical and let the end from which the wire reaching to the receiving set is taken, be the lower end. Do not attempt to stretch the wire too tightly; it is of no particular advantage. It only raises the center of the wire a few feet and puts it under a severe strain which may result in breakage. This is especially true if sleet or snow collects on the wire.

In stretching the wire, try to eliminate as many bends as possible. Bring

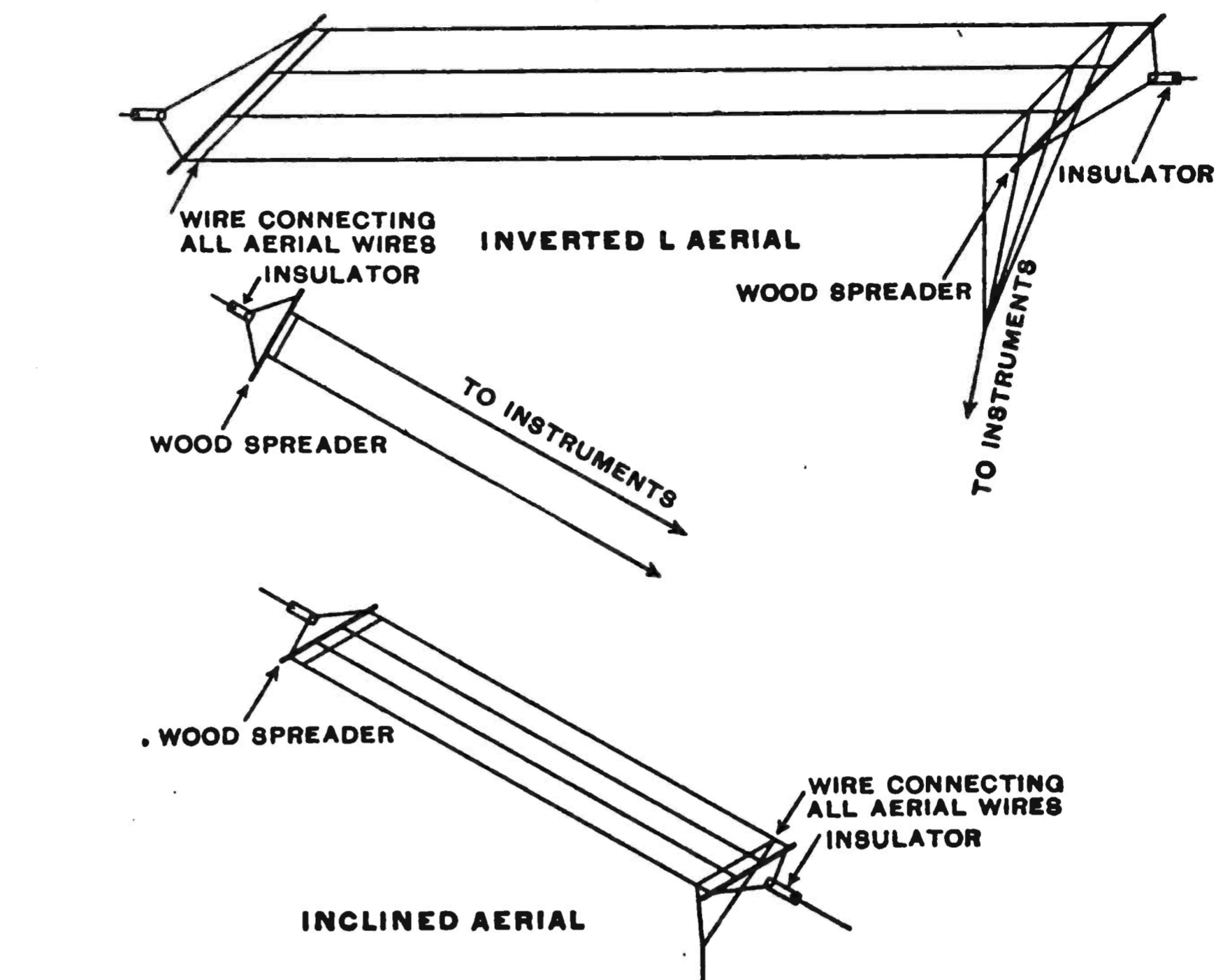

Diagram of various types of aerials. The 4-wire aerial shown at the top is the inverted-L type, which may be used for receiving as well as transmitting. The two lower aerials are the inclined type. They may be used for transmitting messages.

the conductor leading to the set directly to your window without fastening it to the building. It is of great importance to keep this wire away from the surrounding objects, as there is a capacity effect between the wire and surrounding object which robs the aerial of some of its energy.

It is not possible to give specific di-

rections on the erection of aerials. Each particular house presents its own problem. With a little ingenuity an amateur may construct easily an efficient aerial in any place. In connecting aerial wires, be sure that perfect contact are made. When possible, always solder the connections.

This is important.

Accessories May Be Used to Increase Wave Lengths

THE average receiving set is usually capable of operation over only a comparatively narrow band of wave lengths. This should not be considered as a great fault, because sets can be more efficiently designed to operate over a narrow wave-length range than over a wide one. But occasionally it is desirable to hear stations that operate on wave lengths higher or lower than those afforded by the tuning apparatus of a set. Sometimes an aerial may be too long to work with a certain set to hear the shorter waves and some means must be provided to cut down the natural period.

An accessory that may be attached to a set to increase its wave length in order to hear some of the longer wave stations is called a "loading coil." This is connected in aerial and ground.

When a two-circuit receiver is used, another coil must be connected in series with the secondary in order to balance the two circuits. When a loose coupler is used, a moderate amount of loading may be used in the primary circuit without any in the secondary, as the secondaries of these instruments are usually wound with more wire to compensate for the slight loading. If a shorter wave than the natural wave-length of the aerial is wanted, some sort of condenser may be connected in series with the aerial circuit. This condenser is usually of the variable air type, though it can be of the fixed variety. Where a short-wave condenser is used, a single pole switch may be provided so that when it is not needed it can be short circuited without any trouble.

How to Avoid Interference when a 360-Meter and a 400-Meter Station Are Operating Simultaneously

By C. W. Horn,

Superintendent of Radio Operations, Westinghouse Electric & Manufacturing Co.

THE U. S. Department of Commerce, in order to assist radio broadcasting, has specified two wave lengths on which broadcasting may be conducted. These wave lengths are 360, the one in general use up to this time, and 400, just recently allotted. While these wave lengths are 40 meters apart, there will undoubtedly be considerable confusion on the part of those owning radio receivers who are situated in close proximity to one of the stations. For the purpose of assisting those who are so unfortunately located that two such stations are picked up by their receivers simultaneously, I will describe a number of methods which, if applied, should greatly assist those desiring to get either one of the two waves without being too greatly interfered with by the other. There is one case, however, which will be very difficult to assist, that is where the receiver is exceptionally close to a broadcasting station. By close is meant within a few thousand yards.

The assignment of two wave-

lengths so closely together will have the effect of stimulating construction of radio apparatus which will be capable of tuning more sharply, and it is the old case of "necessity is the mother of invention." Therefore, while there may be some inconvenience at the present time, this should be overlooked in order to help the radio game by creating a condition which will stimulate the construction of better apparatus and which will permit, perhaps, in the future the assignment of more wave lengths, thus creating a better situation in the air.

One of the greatest faults that the writer has found in connection with the installation of radio-receiving apparatus is that it is believed that the more wire and the larger the antenna, the more will be received. Exceptionally large antennae make it more difficult to tune sharply, and for this reason it is advocated that very short single-wire antennae, approximately 75 feet long measuring from the apparatus to the far end, be utilized, such single-wire antennae to be stretched

away from all metallic objects and run straight and clear of all obstructions.

Secondly, do not run the antenna or the lead-in over metal roofs, along water spouts or drains, or parallel to telephone and power wires.

Frank Conrad, assistant chief engineer of the Westinghouse Electric & Manufacturing Company, has made measurements and drawn resonance curves which show that a short low antenna tunes much more sharply than a large and long antenna. This holds true both for coupled and single-circuit tuners.

Another method to pursue in overcoming interference, especially where vacuum-tube receivers are used and where the receiver is located close to a broadcasting station, is to make use of the well-known directional properties of the loop antenna. A very simple loop may very easily be constructed by winding a half dozen turns of wire, spaced about one inch apart, on some framework, which can be rotated. It will then be easy to tune out a station which has a difference of 40 meters in wave length, especially so as a loop antenna forms a closed circuit which can be more sharply tuned than an open antenna. Both ends of the loop should be connected across the antenna and ground terminals, and no other ground or antenna used.

Radio enthusiasts who are more fortunately located—that is at but a short distance from a broadcasting station—may tune, without any difficulty, in either one of the wave lengths mentioned. They should, however, bear in mind that a single-wire antenna, not too long and kept free from obstructions, and not running near grounded metallic objects, will tune sharper. Where the amateur has a transmitting apparatus it is desirable to have a fairly large antenna, with more than one wire. If such is the case, he should use a separate wire for receiving.

The ideal condition will be when stations can operate independently on either side of two wave lengths without interfering with each other. Because the receiving apparatus is an important factor these suggestions are given in order that owners of receiving apparatus may have the necessary information to increase the efficiency of their apparatus.

In a New York Y. M. C. A. Radio School

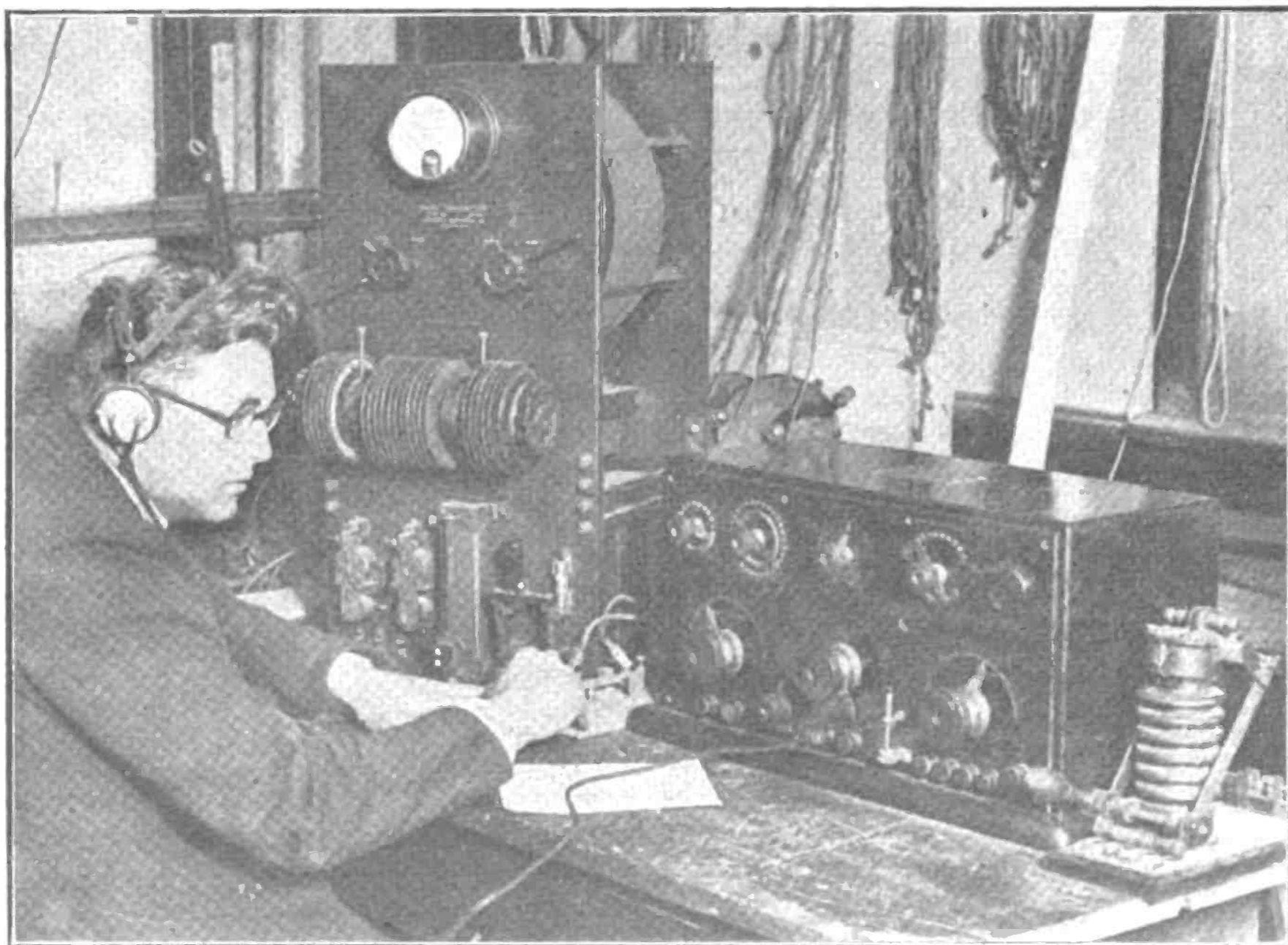

(C. Kadel & Herbert)

Operator William Pacquet sending a message in the radio school of the Y. M. C. A., New York. This school possesses some of the most up-to-date radio apparatus in the country. It is utilized for practice on commercial transmitting and receiving. The transmitter is at the left; the receiver at the right.

Another R-W Page of Hook-Ups

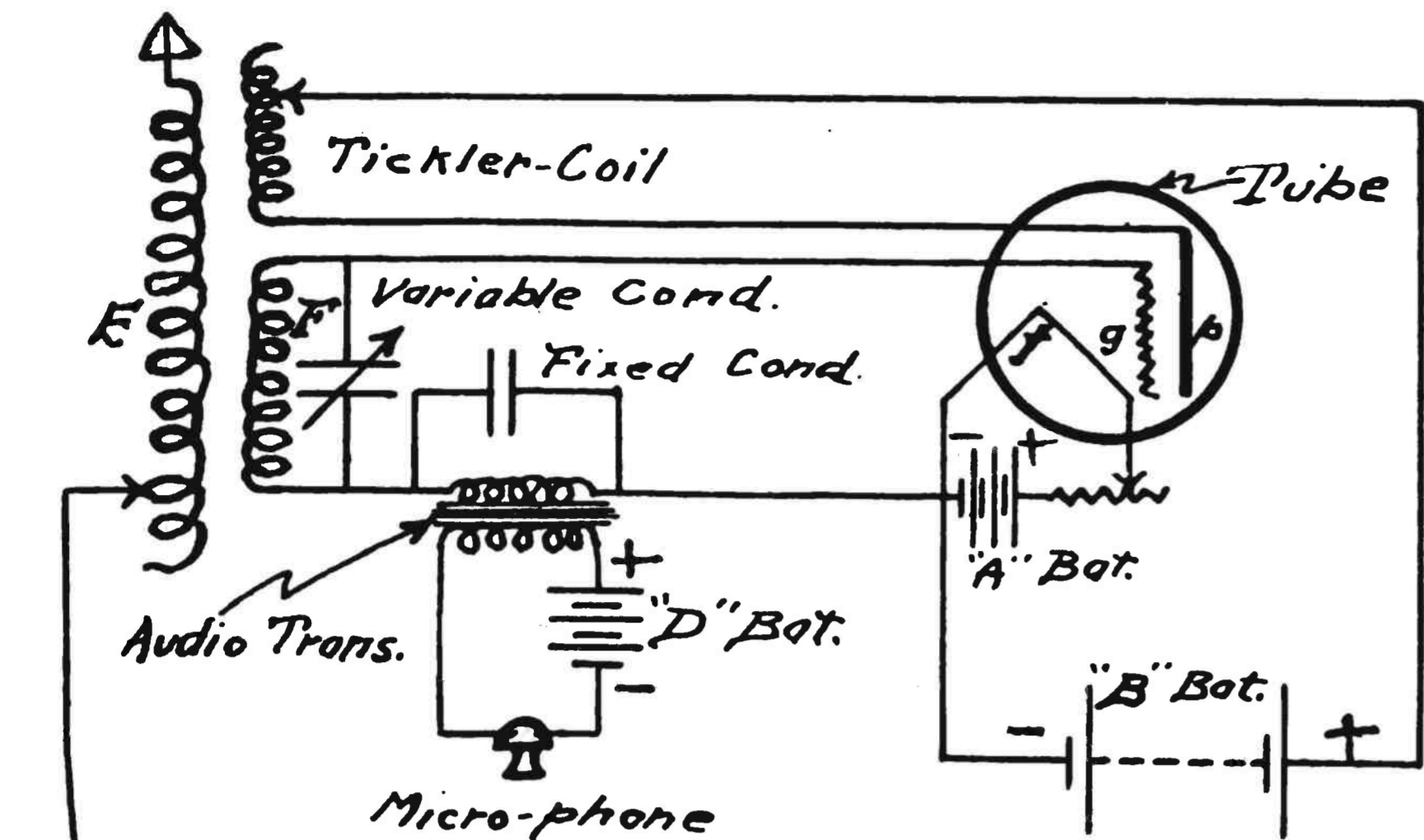

Schematic diagram showing common type of transmitter used in low-frequency tube sets. In this circuit, the microphone modulates on the grid of the tube. This is a very good telephone transmitter. Drawn by C. White.

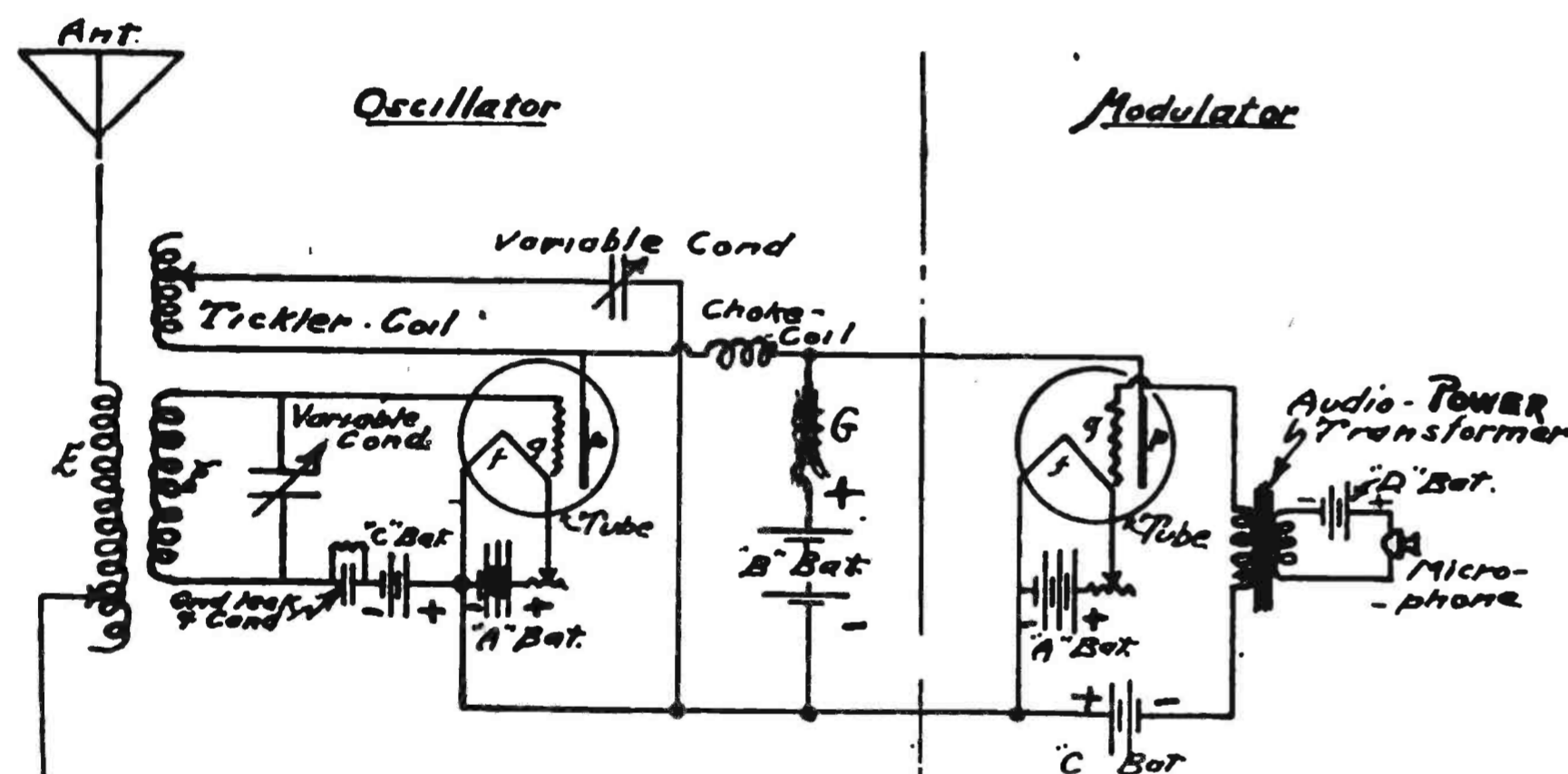

Schematic diagram of a set in which the tickler coil is employed as a direct feedback. Two tubes are used—one as a modulator, the other as the oscillator. A very satisfactory circuit for C-W work, especially for amateurs. Drawn by C. White.

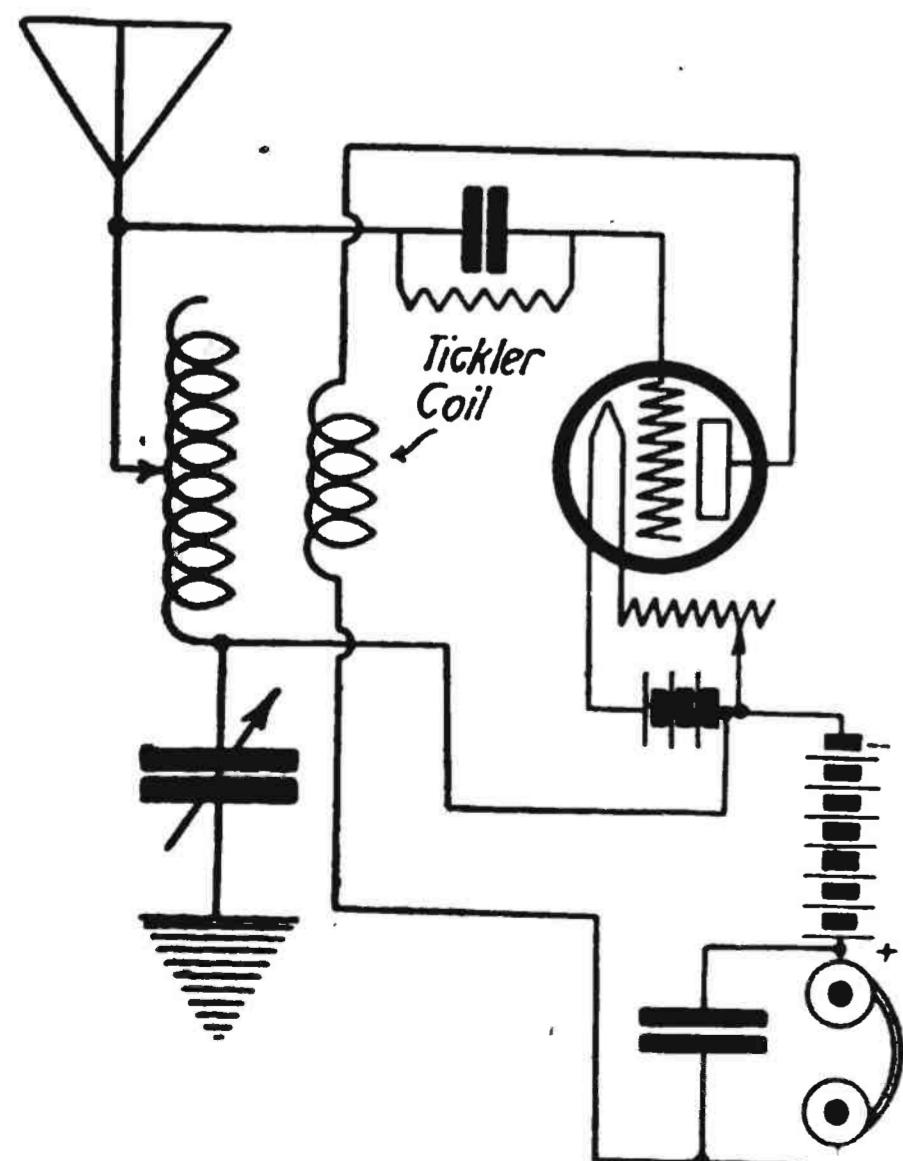

A unique method of employing regeneration is detailed in the above circuit. This is of the single circuit type. It also utilizes a tickler coil and is hooked in the circuit. Suggested by John Kent. Drawn by S. Newman.

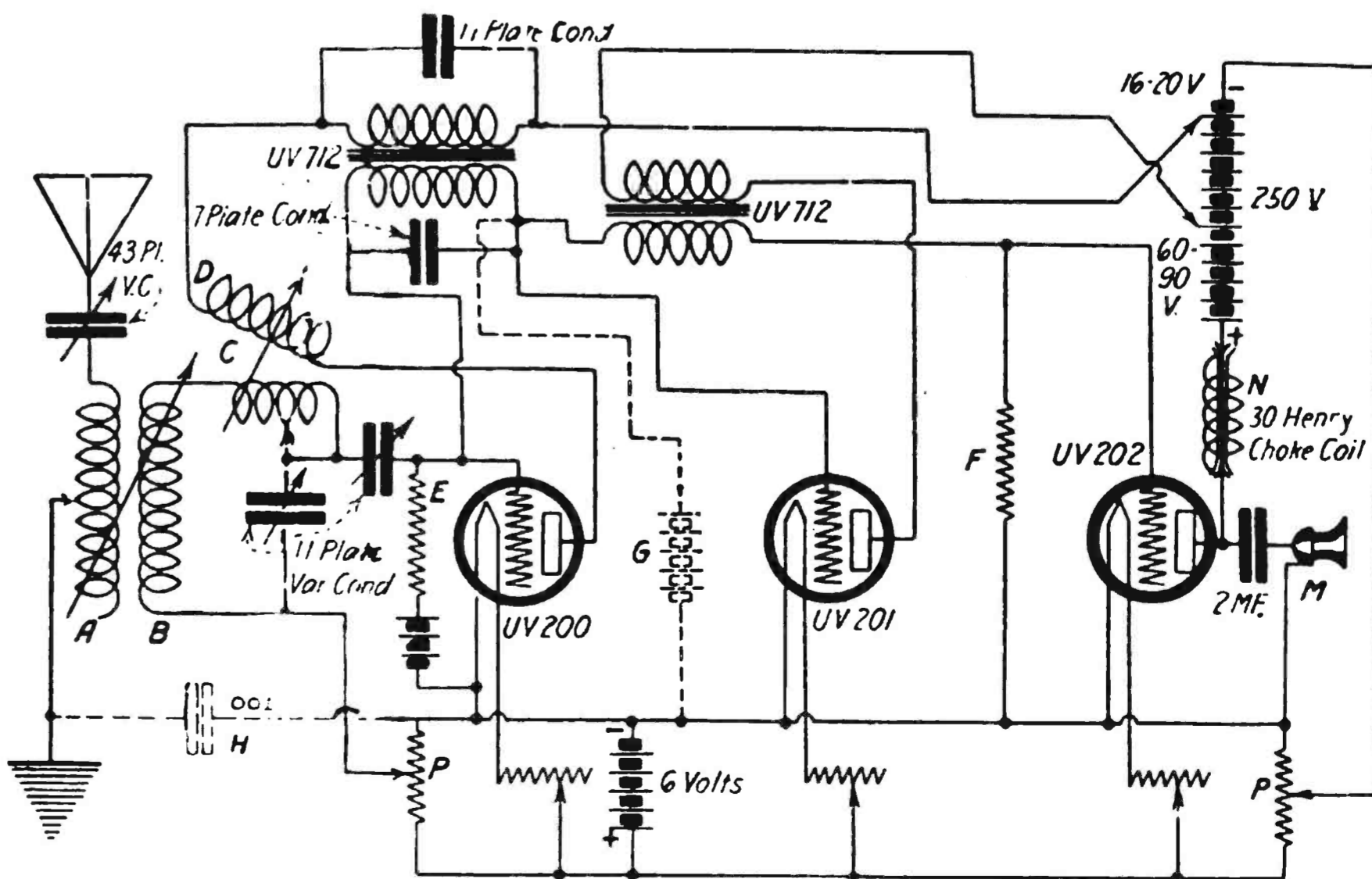

Schematic diagram of a practical circuit, employing the following apparatus: A-B is a vario-coupler; C-D is also a vario-coupler having a wave length from 180 to 600 meters. The tickler is wound with 125 turns of wire (bank wound). E is a variable grid-leak, 1½ to 3 volt bias. F is a fixed grid-leak of about 1 megohm. G-H shows optional connections, the grid bias being from 6 to 22½ volts. M is a loud speaker. N is a door-bell transformer (primary open) using 116 volts as choke. Suggested by Dr. O. S. Kelly. Drawn by S. Newman.

Realizing that the most interesting phase of radio with the average "fan" is the testing out of hook-ups, Radio World will publish, from time to time, a page of the most interesting diagrams, some of which have already appeared in its pages. An editor guides his policy by the wishes of his readers, and the number of requests for back numbers containing these diagrams indicates that there is an insistent demand for them.

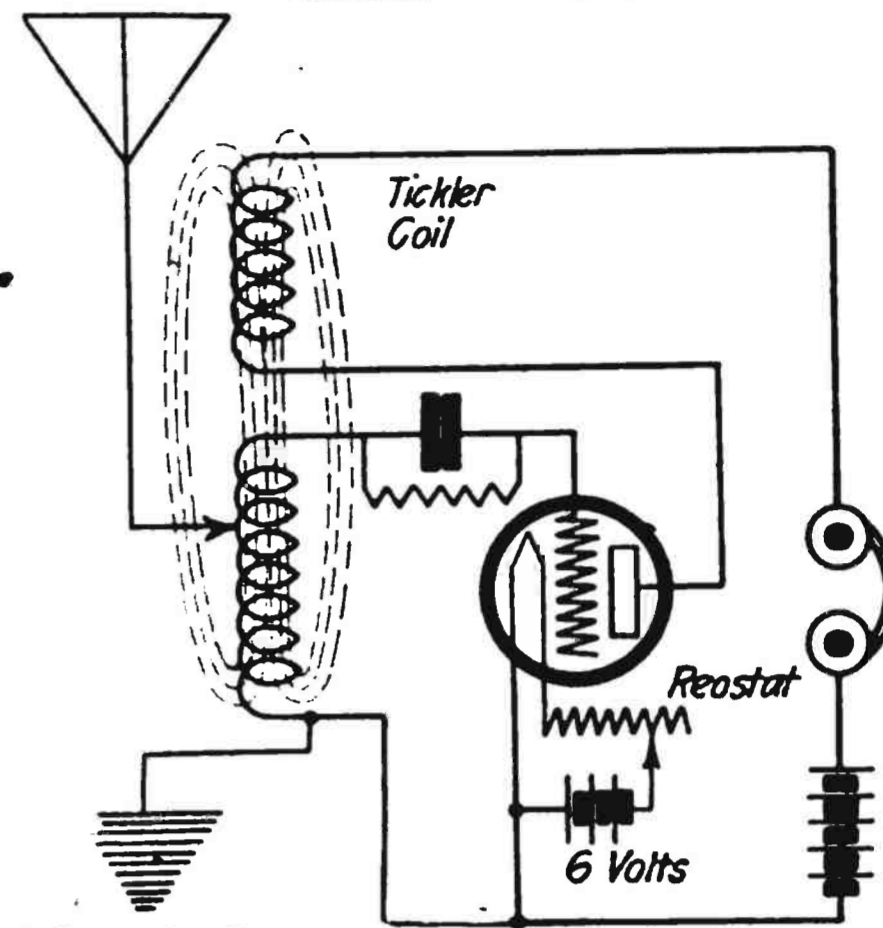

Schematic diagram of a regenerative circuit employing a tickler coil as means of regeneration. The dotted lines show how the magnetic lines of force act about the primary winding of the receiver and the tickler coil. Suggested by Fred Chas Ehlert. Drawn by S. Newman.

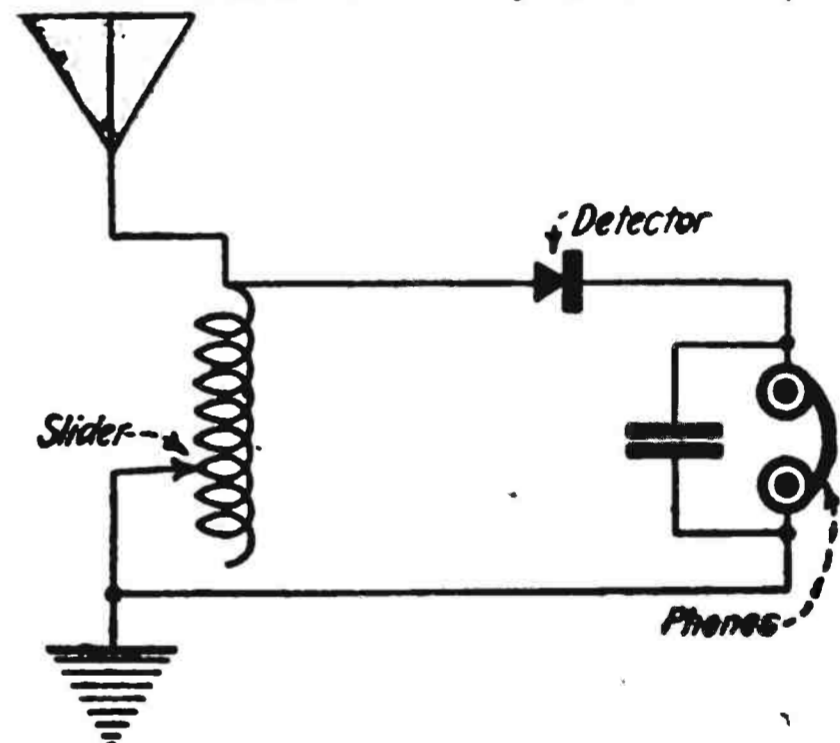

Single-slide tuner employing, as means of detection, a crystal detector. This type receiver is capable of receiving broadcast programs about twenty-five miles. Suggested by Horace Bears. Drawn by S. Newman.

Radiograms

Latest Important News of Radio Garnered from the World Over, and Reduced to Short Wave-Lengths for the Busy Reader.

NO. 64 BROAD STREET, New York City, the building to be purchased by the Radio Corporation of America for \$1,000,000, is known in the radio world as the "heart of world-wide wireless," as from here there are more circuits handled than in any other place or country in the world. The building itself is ideally located for the purposes of the company, because it is in the center of the financial and commercial district of New York from which a large percentage of the traffic handled originates. The building is within two blocks of the principal cable and telegraph forwarding offices and particularly near the Postal Telegraph Company's office with which the Radio Corporation has recently entered into a traffic arrangement whereby the Postal Company collects and distributes trans-Atlantic radiograms from and to all points in the United States. The building is ten stories high and contains 43,000 square feet. It is known as the White Oil Building, but the name, in all probability, will be changed to "Radio House." It will be remodeled to meet the needs of the corporation and to house the executive, sales, and engineering departments of the corporation, now located in the Woolworth Building.

* * *

Dr. Samuel Wesley Stratton, for the past twenty-one years director of the United States Bureau of Standards, and one of the leaders in radio legislation and standardization, was elected recently president of the Massachusetts Institute of Technology. He will take up his new duties on January 1, 1923.

* * *

During the next six years more than three hundred billion dollars will be spent in the additional electrification of America, said Frank E. Watts, New York, editor of the "Electric Record,"

He Telephoned by Radio from San Francisco to London



(C. International Keel Photo)

H. GORDON SELFRIDGE, JR.,

Son of the London merchant, was photographed in San Francisco, while telephoning by radio to his father, in London, 6,000 miles away.

in an address to the annual convention of the National Association of Electrical Contractors and Dealers. "The possibilities of electrical development are unlimited," said Mr. Watts. "Eight million homes in the United States are now wired for electricity, six million are not. Half of those will be wired within the next few years. How rapidly the central power stations are expanding is indicated by the fact that, last year, the light and power companies spent \$750,000,000 in new development. And in the next six years they will spend a total of four billion dollars to extend their electrical service to the homes and factories in America."

* * *

President Alfredo Zayas of Cuba has formally inaugurated radio broadcasting in Havana. His speech announcing this important event was delivered in the national palace and shot out into space from the sending station of the Cuban Telephone Company. Special transmitting apparatus was installed in the palace to carry the president's voice from that place to the radio room of the telephone company. The wave length used was 400 meters. The station was erected by the International Telephone and Telegraph Corporation of New York. Experimental tests made in Havana developed the fact that amateurs in the United States as far north as New Jersey were able to hear phonograph records broadcast from Cuba.

* * *

Captain Powhatan Page, vice-president and general manager of the Pan-American Wireless Telegraph and Telephone Company of Buenos Ayres, who has been in New York City negotiating international radio connections for his \$156,000,000 South American plant, says that a misapprehension has arisen through a paragraph which said "the combined plants represent an invested capital of \$170,000,000." "This is perfectly true, of course," Captain Page said, "but certain readers appear to have inferred that cooperation in operating resources involved also a combination of this huge capital under one board—in short, that the world's leading radio concerns had formed a trust. What I desire to make plain is that the figure \$170,000,000 represents the combined capital of all the radio interests mentioned, which is in no way affected by the international cooperative plan. Each company is as separate and distinct in its own sphere as before and absolutely directs its own affairs. The finances of the various radio companies concerned are not combined, as appears to have been understood in some quarters."

* * *

The United States Government now maintains ten broadcasting stations for the purpose of sending out crop and market news.

* * *

A feature of the Closed Car Show at the Grand Central Palace, was a radio-equipped automobile which operates without antenna and ground wires, a condenser made up of a copper screen and the chassis forming the wave collecting system. This car, a limousine, had the distinction of being the only machine at the show so equipped. One plate of the condenser, a copper screen, is fixed between the roofing and upholstery, thus completely concealing it from view. The metal parts of the machine, being all joined together, form the other plate of a large condenser, having air and passengers as a dielectric, the separation being about five feet. The preliminary tests of this apparatus proved that such an application of radio reception is highly feasible and very satisfactory.

* * *

It has been suggested that the President of the United States set aside ten minutes each day for a personal radio talk with the American people.

* * *

By operating on two different wave lengths, one 450 metres and the other 350 metres, a two-way radio talk was successfully carried on between Portland, Oregon, and Los Angeles, California.

* * *

Broadcasting descriptions of missing persons is now one of the most important uses to which radio is being put.

* * *

Radio insurance is now being offered, covering fire, lightning, breakage and theft.

* * *

French children are turning from mechanical toys to miniature radio sets. These tiny sets are being turned out in large quantities by French manufacturers.

Radio and the Woman

By
Crystal D. Tector

I WAS in the train from New York City to New Rochelle, the other day, and two women were chatting in the seat behind me. One of them remarked, "Well, women are in everything, to-day, even radio." She almost took my breath away—indeed, I nudged Friend Husband with sufficient force to jar him from his afternoon paper and, turning, looked the speaker squarely in the eye. I presume that the look on my face betrayed my surprise; but, realizing that I had put myself in a position to be criticized, I mustered every bit of courage at my command and asked: "Are you interested in radio, madam?"

* * *

"Oh, I have to be!" she exultantly exclaimed, as soon as she realized that I did not intend to be rude by my sudden intrusion.

Then we "got together," as the men say, and most formally introduced ourselves; and I whirled F. H. about in his seat and introduced him too. And my new acquaintance proved to be a most charming person—an instructress of radio classes in girls' private schools. Her brother, she said, was radio officer on a steamer in the Pacific, and he had told her so much about radio that she "just took to it as a duck takes to water," as she tersely put it. All that she knows her brother taught her; but she is putting the knowledge to the most practical use—making it earn her a living.

* * *

And why shouldn't radio appeal very strongly to women? It does seem to me that but few of its elements—if any—are beyond the reach of our sex. And, this week, I am pleased to show you a picture of Clara Kimball Young, who we all know as one of the most attractive of "movie" stars, actually putting together her own set. No doubt, any woman who cares to go deep enough into the mysteries of radio will be able to do the same thing. When we take into consideration the fact that little children are among the most ardent radio fans—that they seem to master its apparent intricacies—there is no reason why we grown-up women should hesitate to become fans, too.

* * *

I am told that radio is one of the most attractive things ever put before the little ones. I am told that no mother—or father, for that matter—should deny the little ones their right to become



(C. Pacific & Atlantic Photos, Inc.)

Miss Betty Bates, the California violinist, and the transmitting set into which she played music that was carried by radio to Havana.

Betty Bates, the San Francisco violinist, whose music, played in the City by the Golden Gate, was heard in Havana. Over 13,000 fans reported having heard her. Her music was sent over a 5,000-mile radiophone circuit connecting Havana, Cleveland and San Francisco. Miss Bates is a violinist of considerable merit whose playing by radio was a broadcasting event.

* * *

Here is a little advice in answer to many inquiries:

In all radio-frequency amplifying circuits it is absolutely necessary that a potentiometer be used across the A battery which lights the filaments of the tubes. This stabilizes the entire circuit and enables the operator to put the proper amount of negative on the grids of the radio-frequency tubes. This function will be further assisted by placing a by-pass condenser of at least .001 mfd. capacity across the grid lead and negative side of the potentiometer.

* * *

(The following letter is self-explanatory. We are pleased to gratify our correspondent's wish, though if her communication had arrived an hour later the presses would have started.—The Editor.)

Dear Mr. Editor:—I have just received this week's copy of RADIO WORLD and I am so enthused over your suggestion for a National Radio Week that I immediately phoned Friend Husband to his office and told him that we would certainly give a radio party during that week—a really big party to which mostly strangers to radio will be invited. You may count on me for all the help I can give. I think that the different broadcasting stations should announce it in some good slogan like, "Are you prepared for National Radio Week?" once a day, until the event gets started.

Yours for "The Big Week."—C. D. T.



(Melbourne Spurr, photographer, Los Angeles)

"Clara Kimball Young actually putting together her own set. Any woman who cares to go deep enough into the mysteries of radio will be able to do the same thing."

interested in this wonderful science. Just what is the particular psychology that makes it appeal so strongly to children, I do not know. Perhaps some of you mothers can tell me. Nevertheless, it is a fact that radio does possess some far-reaching interest for the little ones that—like electricity itself—cannot be explained.

* * *

I am glad to see that the broadcasting programs have their quota of women artists. But I want to tell particularly about Miss

Latest Radio Equipment for N. Y. N. G.

By Walter Miller

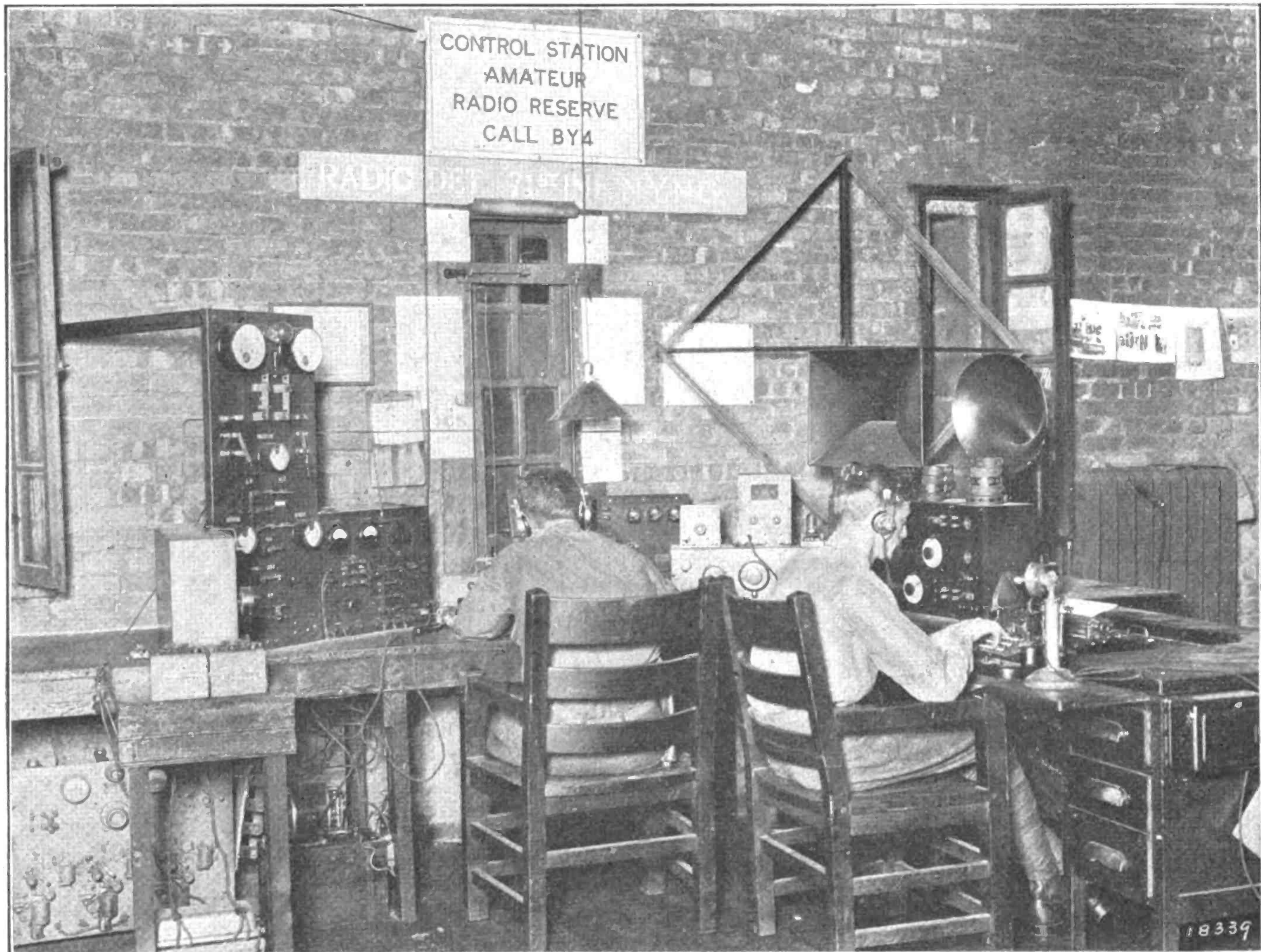

(Both photographs C. International News-Reel)

THE newest radio aids used by the radio detail of the 71st Infantry, National Guard of New York, are shown in the accompanying illustrations and the illustration on the front cover of this week's issue of *Radio World*. The 71st Infantry is a licensed station with the call BY4. Sending and receiving is accomplished at the same time by using the loop antenna for reception and an outdoor cage-antenna for transmitting. BY4 sends both telephone and telegraph signals and has been heard throughout the Eastern United States.

The upper illustration shows the interior of the radio room of BY4. The lower illustration shows how sending and receiving are accomplished simultaneously, on seventy meters, by the loop set. A break-in system is used which gives instantaneous message traffic without the necessity of throwing a send-receive switch.

Instructors who have qualified as experts in their respective lines, are in charge of the various classes; and the men of the battalion are enabled to enjoy the best of instruction and training.

Lieutenant Grant Layng is in charge of the radio work of this detachment of the 71st. An excellent opportunity is open in this organization for radio operators and other technical men who desire a radio education; but because of the limited number of men designated for the detachment those selected finally must qualify thoroughly both technically and in a military sense. Drills and classes are held on Tuesday night and Friday night of each week. Applicants should apply to the Armory, Park Avenue and 34th Street, on either night.

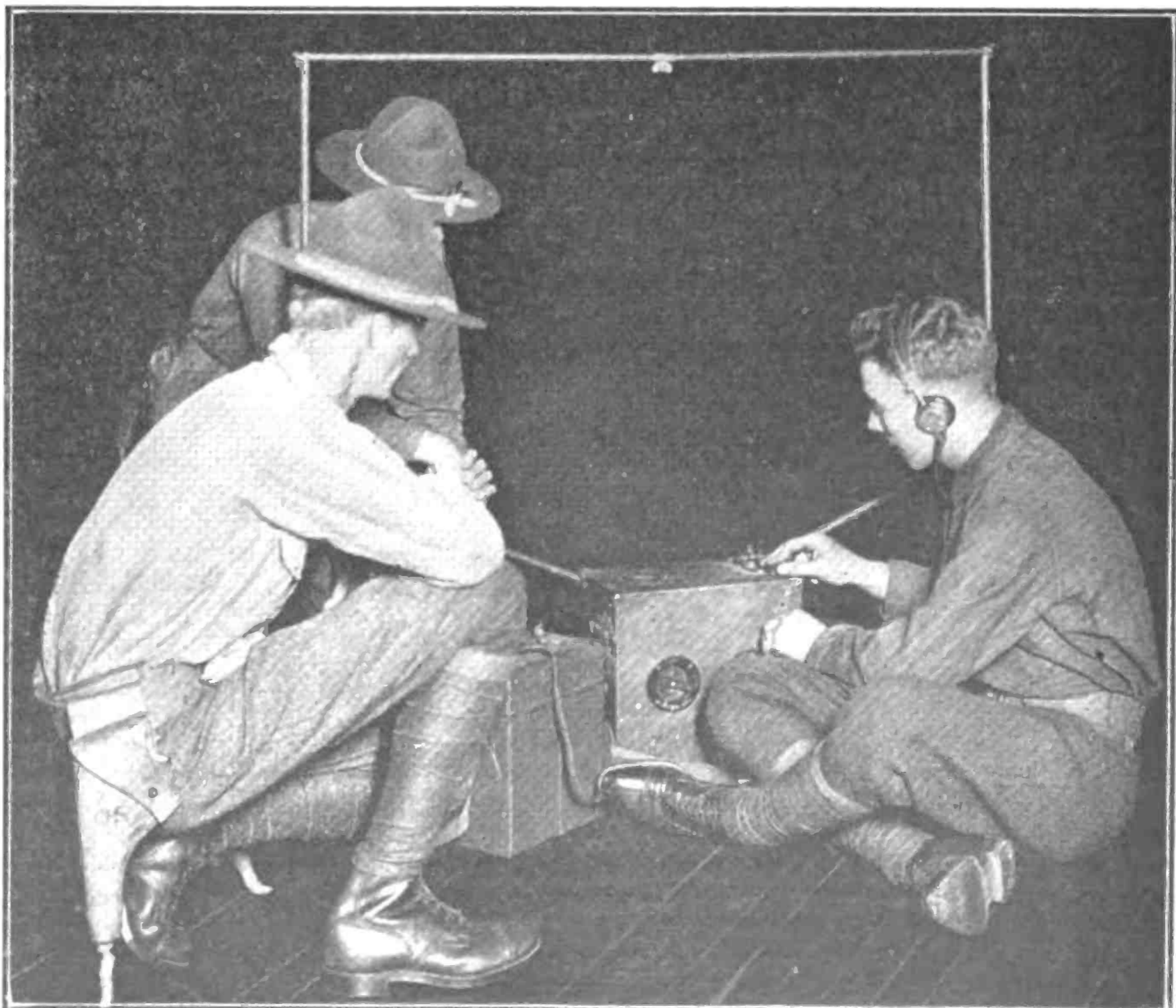

"Close-ups" of Recent Radio Devices



(C. Kadel & Herbert News Photos)

One of the most important elements in radio is the proper circuits in working out a telephone broadcasting-station. During the recent World Series it was most important that all the circuits were of the correct value. In order to accomplish this, each line had to be tested out. The above photograph shows the new special-type of voltmeter for testing the voltage by which messages were sent to WJZ for broadcasting.

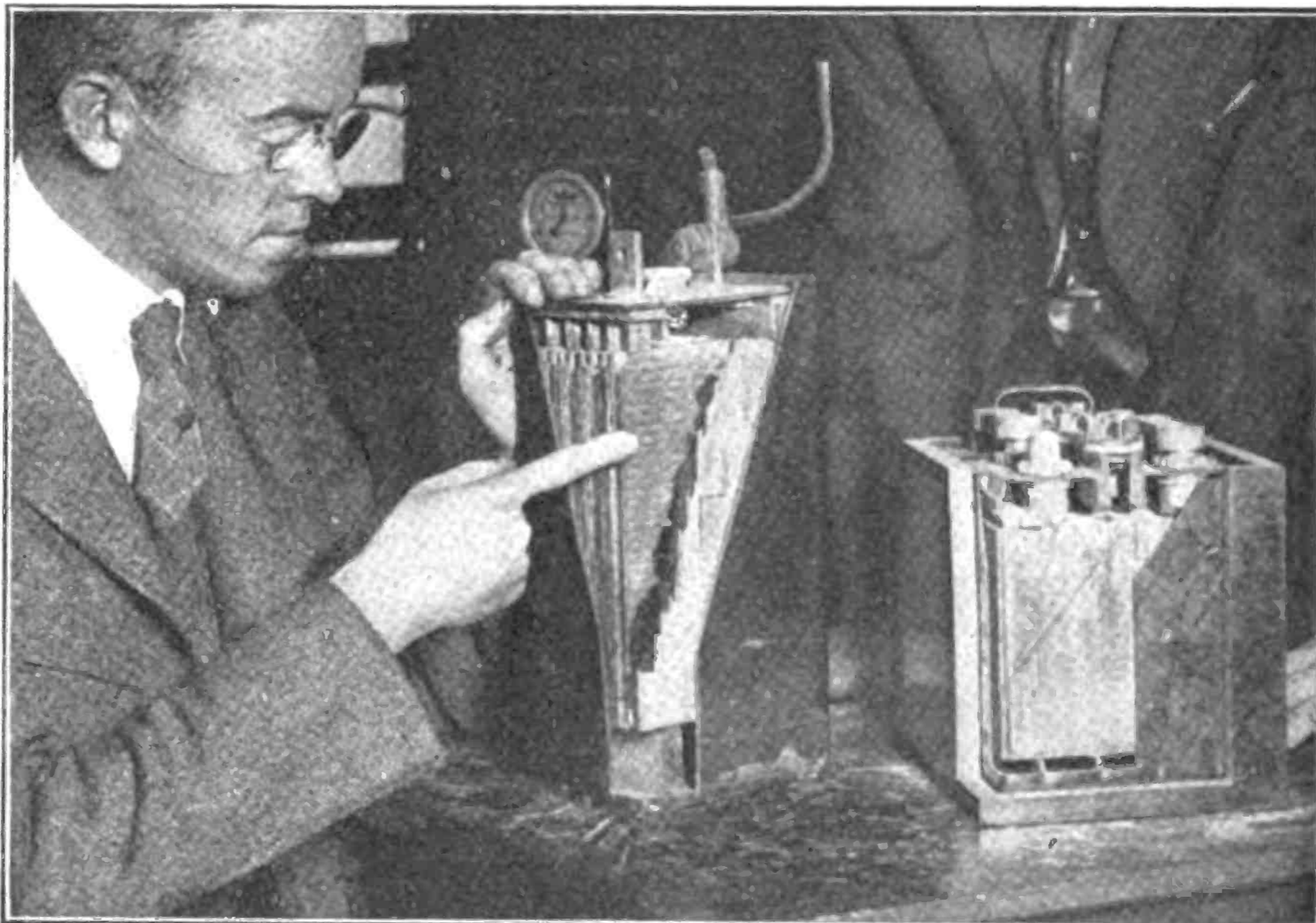

(C. Kadel & Herbert News Photos)

In radio work, the storage battery plays an important part. One of the first things the amateur is taught is an understanding of its functioning, and, also, how to take care of it. The storage battery is a necessary element in radio and one must know its main parts. The above photograph shows C. A. Peterson, director of the Department of Electricity, at the Y. M. C. A., New York, explaining a new battery.



(C. Kadel & Herbert News Photos)

John Frazier photographed speaking into the very latest thing in microphones. Mr. Frazier was sent by the Westinghouse Company, Pittsburgh, to assist New York City experts in the broadcasting of the recent World's Series. His object was to see that no energy was lost in the transmission lines.

The photograph below shows the Finch radio relay. It is a very recent radio invention which automatically receives and records code messages on paper tape—messages which may be read as reports are read on a stock ticker. All that is necessary is to connect the radio relay to a radio receiver. It will record and retransmit messages simultaneously.

(C. Photomews, N. Y.)

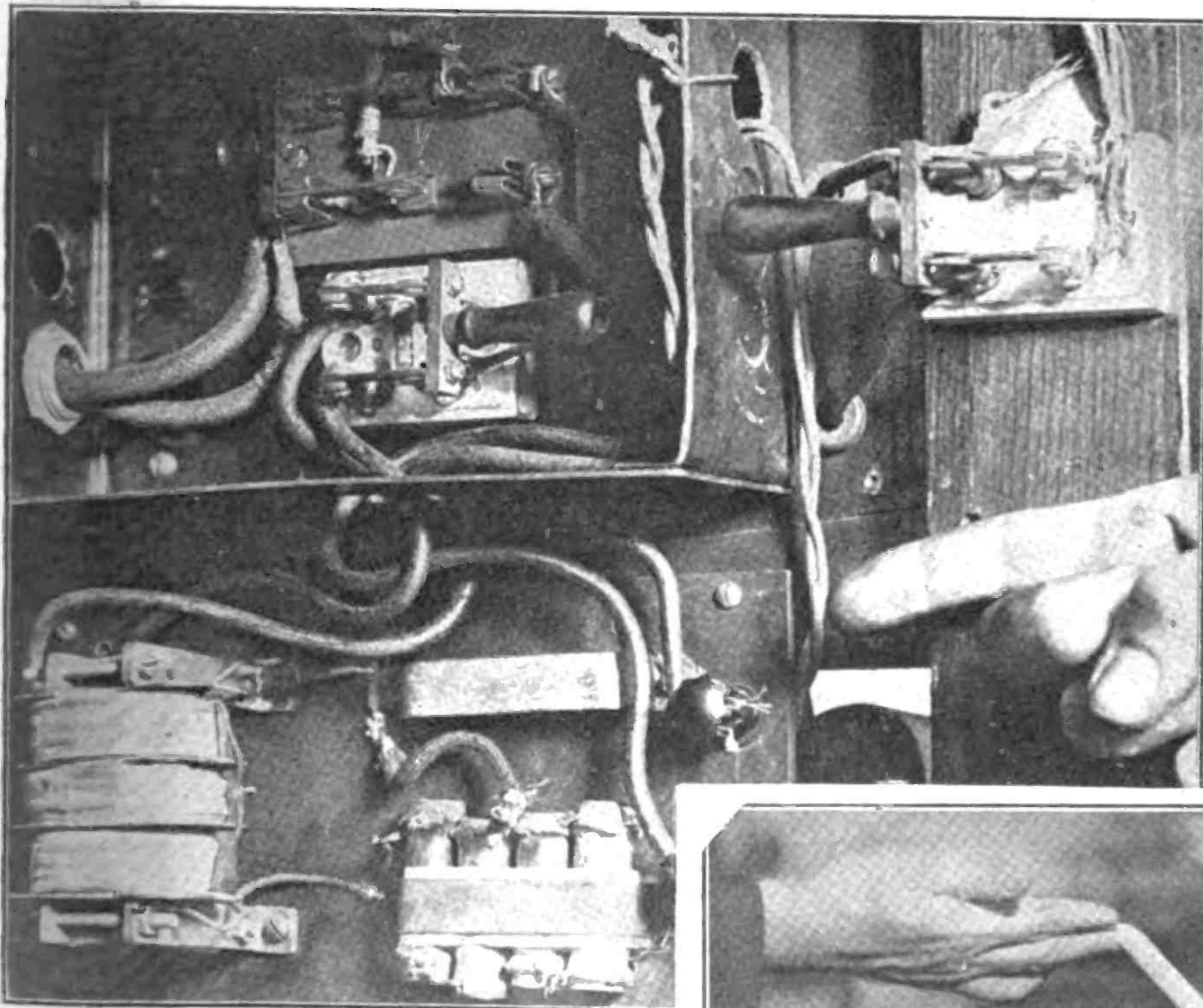

(C. Kadel & Herbert News Photos)

This little device tucked under a table in the operating room of WJZ, Newark, plays a most important part in the successful broadcasting of big news events. The telegraph wire carrying the news enters WJZ at this point, and the above device, consisting of resisting coils and transformers, eliminates all distortions on the line. This is a great relief, as it lessens all that unnecessary flaking which is experienced in the phones when receiving. From this point, the line enters the speech amplifier and from the speech amplifier it is transferred to the modulators, thence to the aerial. Contrary to the belief of many, a second microphone is not used in broadcasting an important news event, such as the recent World's Series.

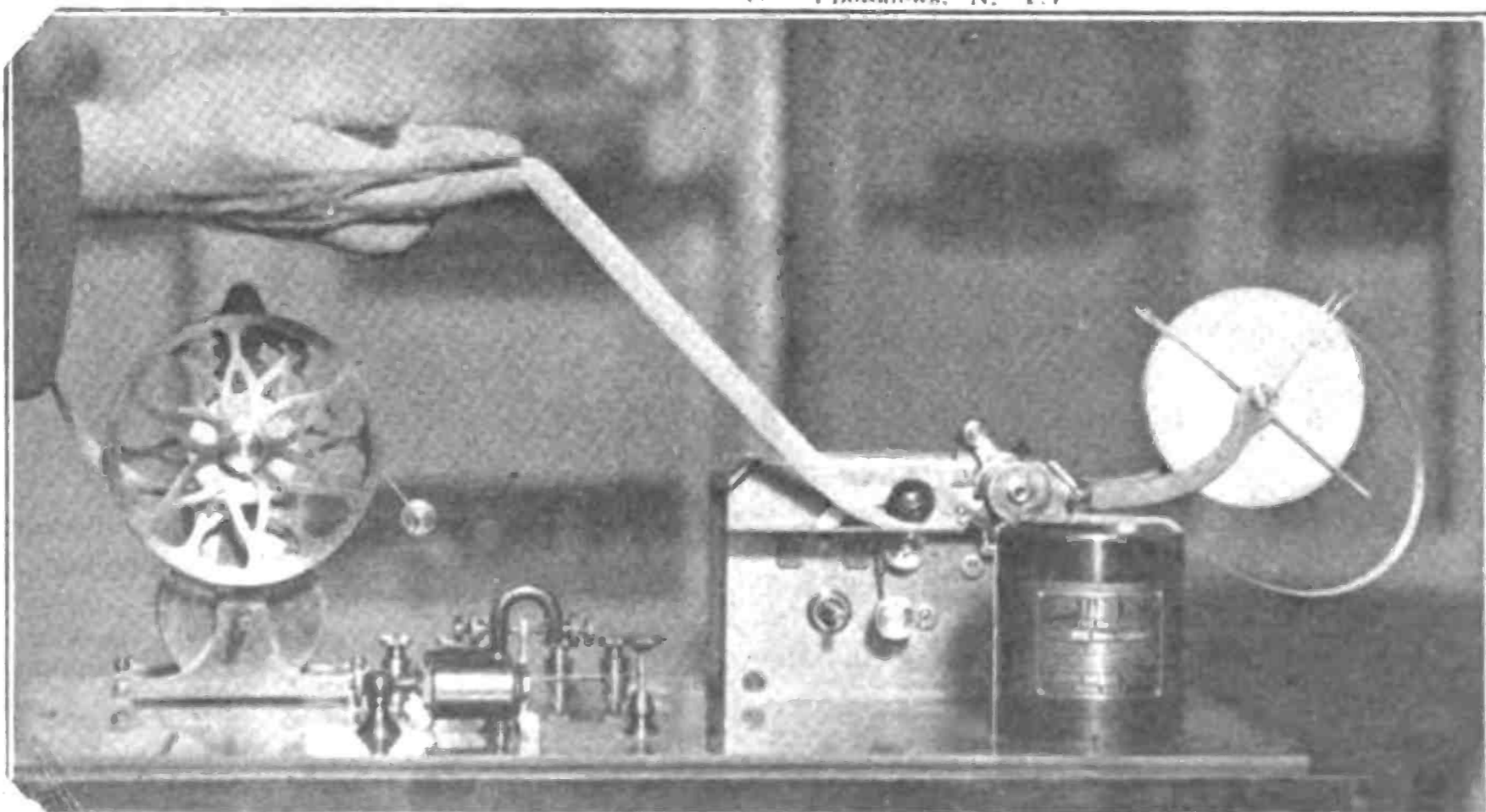

Secret Lines of Radio Communication

By Carl H. Butman

WASHINGTON, D. C.—Back of the commercial systems of world communication, known and used by both government and private interests, lie existing lines of communication little known to the public although not strictly "secret." Only recently, when the "Terrible Turks" threatened the Dardanelles and Southeastern Europe, the State Department asked the Navy if aid could be given in the transmission of dispatches to the Near East in the event that communication service to that quarter of the globe was broken. To this question, which caused the State Department some concern, the Naval Communications Service made reply as follows: "Our lines of communication to the embassy at Constantinople and all our naval craft in Turkish waters are established and in official use to-day. We can communicate with Admiral Bristol within a few minutes."

It has been stated justly that naval communication circles the world. So it does, with the exception of very few corners, and three-fourths of the communication is handled by radio.

To-day, when a dispatch for Admiral Bristol is filed in the Navy Department, it goes out at once through the Annapolis radio station to a French radio station, thence by land line to the office of the American Communication Service operated by naval personnel in Paris, where it is checked and forwarded by wire to Coblenz. The message is relayed electrically at Coblenz from the office of the Chief Signal Officer of the American forces in Germany, where Army operators handle the wires to Vienna. The Vienna station is in the Austrian Telegraph Building, but the station is operated by the United States Navy. From Vienna the message goes forward by naval radio service from the station at Laareburg direct to the receiving station at the American Embassy at Constantinople, where naval personnel again handle the dispatch and forward it to the naval ship on station there, which relays it to its destination. Admiral Bristol is in charge of all American naval vessels in Turkish waters, and the presence of his destroyers makes a sort of fan to all points of which messages can be relayed by radio and delivered from the vessels to other points. In the event of a break in the wires from Paris to Vienna, messages for Constantinople would be radioed by French stations to Vienna and to United States naval vessels in the Mediterranean.

The route of messages from points in the Black Sea to the United States is similar, except that the outlying ship transmits by radio to Constantinople, either to the station ship or the Embassy, but only the ship can send messages. From the station ship the message goes by radio to Vienna, thence to Coblenz by wire and through to Paris, where dispatches are turned over to French Radio Service for

transmission, either from Lyons or Lafayette, to Bar Harbor and delivered by land wire to the Navy Building in Washington.

This system, though seemingly somewhat roundabout, is nearly direct and is good except that it is subject to delay on account of schedules, as the Allies all use the same route in and out of Constantinople and keep it busy twenty-four hours a day.

The "Dashboard Special" Makes 40,000 Mile Tour, Equipped with Radio

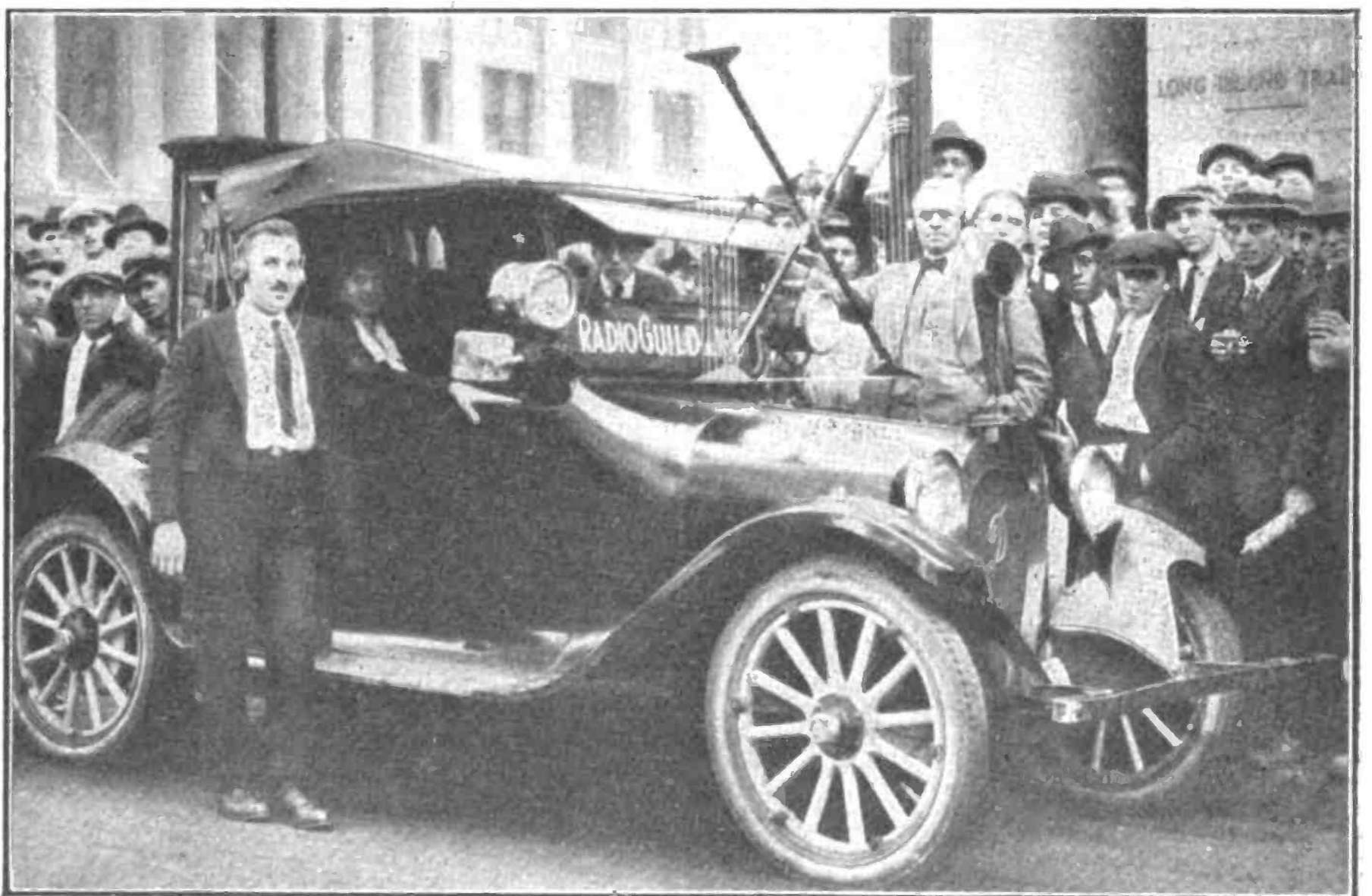

(Both photographs by General Photographic Service, N. Y. C.)



An automobile with a loop aerial in front of the wind screen and a receiving set on the dashboard recently made its appearance in the streets of New York. Crowds gathered wherever it stopped and listened to the music of broadcasting stations. Mr. and Mrs. J. C. Davenport, owners of the car, were testing out their new radio set, known as the "Dashboard Special." They had just completed a forty-thousand mile tour and were about to leave on a second tour of indefinite duration. The upper picture shows the "Dashboard Special" in front of the Pennsylvania Station, New York City. The lower picture shows Mr. Davenport and the arrangement of his car's fine radio equipment.

"Kamoi" Claims Prize Radio

*Japanese Naval Craft, Experts Say, May Now Boast
Finest Installation*

"KAMOI," fuel ship of the Imperial Japanese Navy, which steamed out of New York recently, en route to Japan, on her maiden voyage, has the most elaborate radio-equipment of any other ship afloat, according to radio engineers. The most recent inventions in the field of radio art have been included in the outfit, the greater part of which was furnished by the General Electric Company.

Included in the transmitting equipment are a 1-kilowatt radiotelephone and radiotelegraph set which may be used for telegraphy on continuous or interrupted continuous wave; a 20-kilowatt telegraph transmitter and a 2-kilowatt 500-cycle quench spark-transmitter for telegraph only.

The reception equipment comprises a long-wave receiver with a range of from 1000 to 30,000 meters and a short-wave receiver ranging from 200 to 7000 meters. In addition, there is a superheterodyne receiver for long and short waves, and a standard three-tube commercial-ship receiver with a range of from 200 to 7,000 meters.

An interesting feature of the installation is a radiotelephone exchange, by means of which the ship's operator can transfer control of radiotelephone transmitter and receiver to any one of several stations. These stations are located in the commander's room, the commander's office, the senior officer's ward room, and the bridge. By means of the telephone exchange, the commander, or any other officer, may communicate with any vessel in the fleet from any one of the sta-

tions on the "Kamoi." The exchange board differs very little from the usual telephone exchange. A red light indicates that the receiver has been taken from a phone hook, and the operator, by throwing a switch, puts the officer in immediate control of transmitter and receiver.

There is also a radio compass by means of which it is possible to find the direction of distant transmitting stations.

The "Kamoi" is the show ship of the Japanese Navy. She was recently completed by the New York Ship Building Corporation, and is the first vessel of any navy, other than the United States Navy, to be electrically propelled. The electric-drive equipment was designed and installed by the General Electric Company. The "Kamoi" is a 20,000-ton, 8000-horsepower vessel, and will make fifteen knots. Her main propulsion unit consists of an 8000-horse-power Curtis turbine generator which supplies power to two 4000-horse-power synchronous motors directly driving the twin-screw propellers. There are also two 400-kilowatt direct-current turbine generators which supply the excitation current as well as power to operate the auxiliaries, such as the main circulation pump, main condensate pump, sanitary pump, and blower motors. Another feature of the propulsion equipment is a 625-kilowatt auxiliary alternator which can be connected to either of the auxiliary turbines in case of the failure of the main driving-unit. This small generator will supply sufficient power to drive the ship at a speed of seven knots. The "Kamoi" will be used to carry coal and oil to ships of the fleet.

Experts Plan Big Radio Constructive Campaign

TO aid the government and the American people in peace or war, to eliminate the confusion of rapid development, to work with the Federal departments to devise a rational scheme of broadcasting for the Nation, to promote on a universal scale effective organization of all radio instrumentalities, and in general to undertake at once the solution of the pressing problems of the industry, now leading to conflict," are the declared purposes of the new National Radio Chamber of Commerce.

In a statement yesterday announcing the practical completion of the task of selecting the executive personnel of the chamber, which includes the appointment as general counsellor of Henry T. Hunt, No. 111 Broadway, late member of the Railroad Labor Board and former Mayor of Cincinnati, it was said that a committee had been appointed to investigate the whole question of broadcasting. One of the first steps in the committee's work will be to hold an open meeting of the chamber in Chicago during this week at the Chicago Radio Show.

William H. Davis, the president of the chamber, at its headquarters, No. 165 Broadway, summed up the chamber's general attitude toward broadcasting as follows:

"The only scheme of broadcasting which can prevail in any real sense is one in which the end to be attained

reconciles all conflicting elements, even to the submerging of private interests."

The vice-president of the chamber is Harold J. Power, the secretary, George Lewis, and the treasurer, Lloyd Marshall. The board of governors consists of A. H. Grebe, Richmond Hill, N. Y.; C. B. Cooper, New York; A. P. Morgan, New York; B. L. Moore, Buffalo; J. R. Crawford, Long Island City, N. Y.; E. R. Harding, Boston; Boden Washington, New York, and Gordon Sleeper, New York.

A plan of regional organization has been adopted by the chamber with the following district vice-presidents:

First district (Boston), O. K. Luskomb, Cambridge, Mass.; 2d district (New York and Northern New Jersey), to be elected; 3d district (Philadelphia, Baltimore, Washington), Atwater Kent, Philadelphia; 4th district (Atlanta, Savannah, Jacksonville), to be elected; 5th district (New Orleans, Memphis, San Antonio), to be elected; 6th district (San Francisco, Los Angeles, San Diego), Collin B. Kennedy, San Francisco; 7th district (Seattle, Portland, Tacoma), Robert H. Mariott, Seattle; 8th district (Pittsburgh, Cleveland, Toledo, Detroit, Cincinnati, Columbus), Powell Crosley, Jr., Cincinnati; 9th district (St. Paul, Milwaukee, Chicago, Indianapolis, St. Louis, Kansas City, Minneapolis, Denver), Harry Bradley, Milwaukee, and Dr. C. F.



Type R-3
Magnavox Radio
with 14-inch Horn

Why MAGNAVOX RADIO is

The "Reproducer Supreme"

MAGNAVOX Radio is not manufactured to help sell one make of receiving set, but to complete the service of every good quality wireless station.

1. **Universal Use:** The Magnavox can be used with any receiving set—the better the set, the better can Magnavox operate.
2. **Simplicity:** The hook up is as simple as that of the ordinary telephone headsets.
3. **Volumes:** With the Magnavox, the volume of sound is limited only by the amount of power input.
4. **Tone:** Official tests with the oscillograph prove that the Magnavox electrodynamic receiver reproduces incoming wave forms with maximum accuracy.
5. **Quality:** In refinement of workmanship, materials and finish, Magnavox products have no rivals in their field.
6. **Construction:** The electrodynamic principle involved in its construction makes Magnavox Radio the most efficient converter of electrical vibrations into sound waves.

The Magnavox Company have been pioneers in the development of devices for scientific sound amplification. When you purchase a Magnavox Radio or Power Amplifier you possess an instrument of the very highest quality and efficiency.

THE MAGNAVOX CO.

Oakland, California

New York Office: 370 Seventh Ave.

Latest Radio Patents

Coupling for Radio-telegraphy

No. 1,427,358. Patented, August 28, 1922. Patentee: Joseph Bethenod, Paris, France.

THIS invention, on which M. Bethenod has been granted letters patent, both in France and the United States, refers to an improved system of coupling between radiotelegraphic antenna and a high-frequency alternating-current generator of the type of those susceptible to furnishing, directly, a current of the frequency necessary for the feeding of the antenna. This system is applicable outside of any combination re-

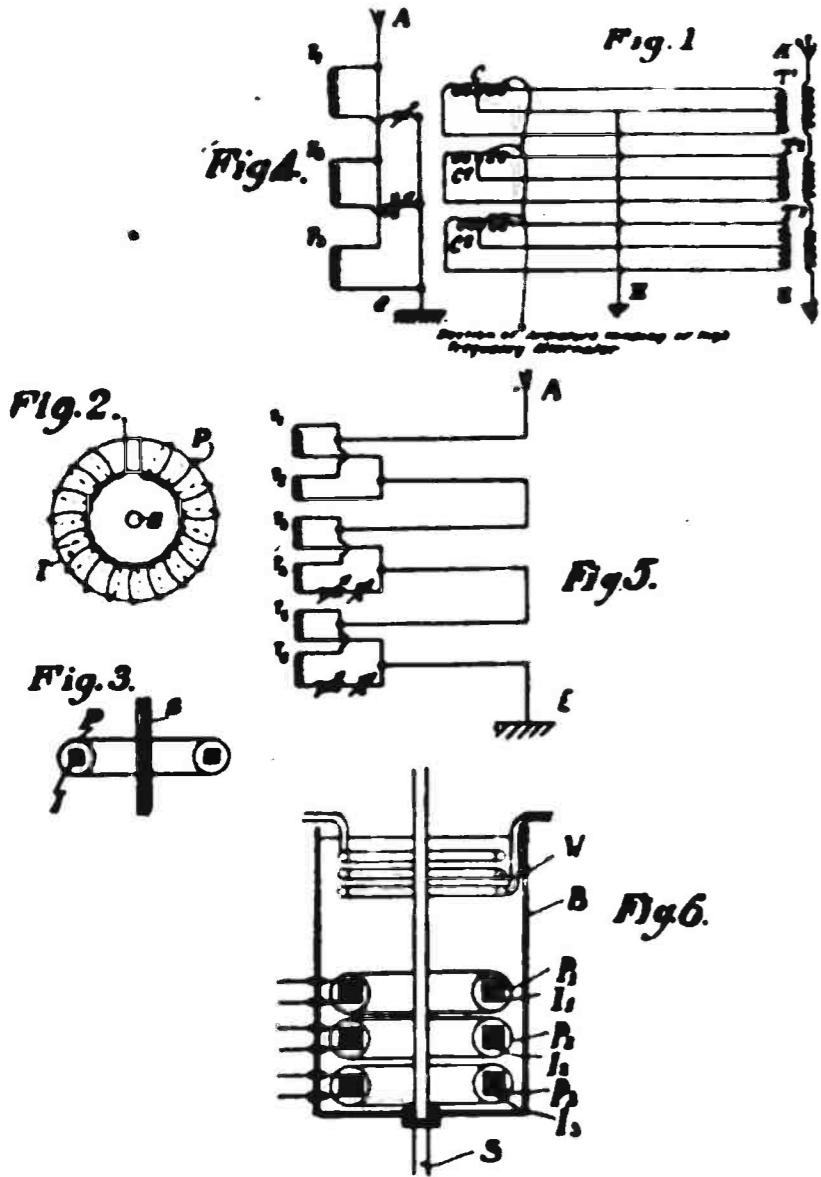

Mr. Bethenod's invention will be more easily understood by reference to the above diagrams. Figure 1 represents the fractioning of the winding of the alternator and the manner of tying with the antenna by means of independent coupling transformers; the Figures 4 and 5 each represent a modification in the mounting of the secondary windings of the transformers. Figures 2 and 3 represent, respectively, front and side view, the manner of preferred execution for the independent transformers. Figure 6 represent the manner of assembly of the various transformers used.

quired by the difference of phase that may exist between the currents engendered in the different notches of the armature and can be perfectly realized with a monophasic alternator. The inventor's chief purpose is to avoid, in such a machine, having the insulators stand an exaggerated tension; the means used is to fractionate the winding into several sections by taking the precautions indicated in the manner of the tying of these sections to the antenna so that the machine may not be the seat of internal circulation currents.

Mr. Dubilier's Condenser

No. 1,429,227. Patented, September 19, 1922. Patentee: William Dubilier, New York, N. Y.

A CONDENSER adapted to assume any desired capacity value between maximum and minimum limits, and more particularly to a condenser in which the above is accomplished by combining the capacity of a condenser of the fixed type in which the plates bear a permanent

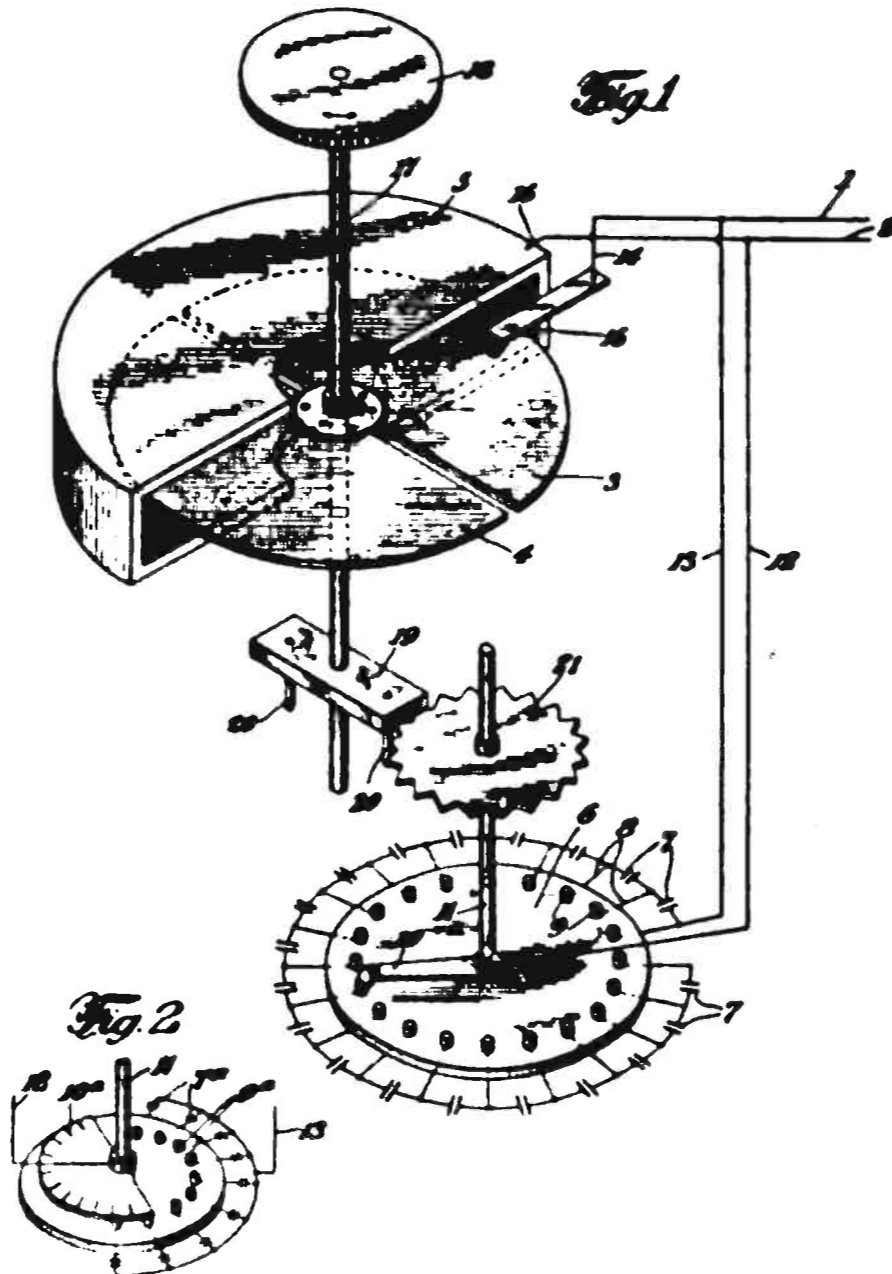

Figure 1 is a perspective view somewhat diagrammatically illustrating a condenser adapted to operate in accordance with Mr. Dubilier's invention. Figure 2 is a detailed view showing a modified form of fixed condenser adapted to be used in place of the fixed condenser illustrated in Figure 1.

and fixed relationship to each other, with the capacity of a condenser of the variable type having a plate or plates shiftable in position as regards plates of opposite polarity to vary its capacity—this is the basic principle of Mr. Dubilier's invention.

The fixed condenser is made up of sections, or units, which may be cut into or out of circuit to obtain what may be termed stepped capacity-values over the desired range of the instrument, and the variable condenser is arranged to supplement the capacity of the fixed condenser in order to obtain the resultant capacity values which are intermediate the values obtainable by adjustment of the fixed condenser alone.

Mr. Dubilier intends to provide a condenser of the above type which may be adjusted to cause the capacity to rise or fall progressively and uniformly, or which may be adjusted to produce a straight-line curve in capacity changes, and, in its preferred form, a single operating member is provided which serves both to adjust the capacity of the fixed condenser to different values and to shift the capacity of the variable condenser in such manner that, substantially throughout its entire range of movement, changes in capacity are effected substantially proportional to the amount or degree of movement imparted to the operating member.

Electron-Discharge Circuits

No. 1,424,826. Patented, August 22, 1922. Patentee: Harry C. Egerton, Passaic, New Jersey.

THIS invention relates to circuits for electron-discharge devices and pertains more especially to audion circuits. Its object is to improve the operation of vacuum tubes, such as the audion. The principal parts of an audion structure are a heated filament, or other source of

electrons, an anode and an electrode, preferably located intermediate the filament and the anode, the electrode being usually called the grid. These are preferably enclosed in an evacuated glass-vessel. The main characteristic feature of the audion is that the amount of the space current flowing between the filament and the anode is dependent on the potential of the grid electrode.

It has been found, however, that, when the grid is made considerably more positive than the filament, the tube operates less efficiently and an excessive positive charge may even cause the tube to "blue-haze," or to be destroyed. This is due to the fact that the grid, on becoming appreciably more positive than the filament, tends to become even more so through secondary electron emission by the grid, this secondary electron emission being caused by the bombardment of the grid by electrons. However, even if the grid does not acquire a charge sufficient to injure the vessel, the charge may hinder the action of the tube in the

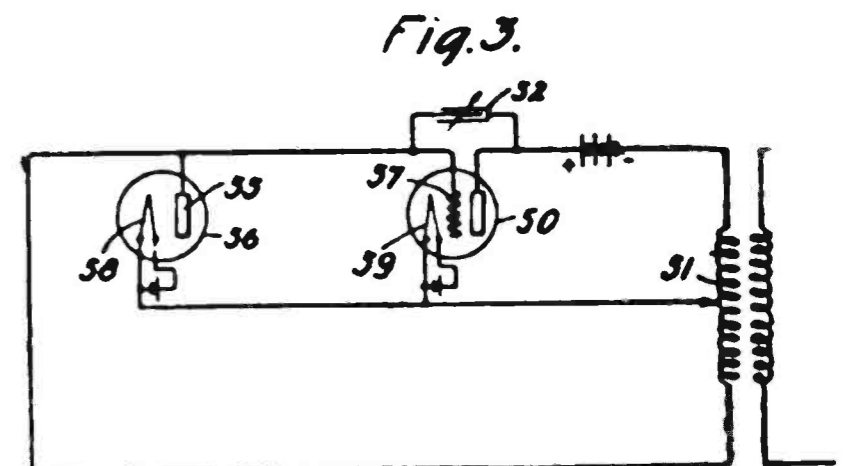
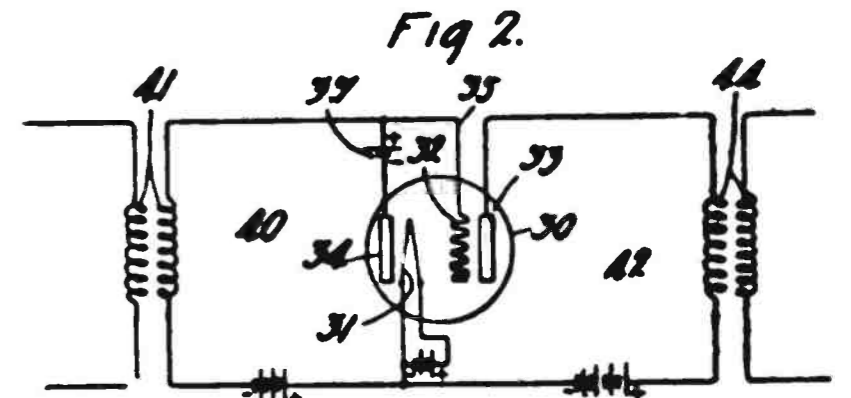
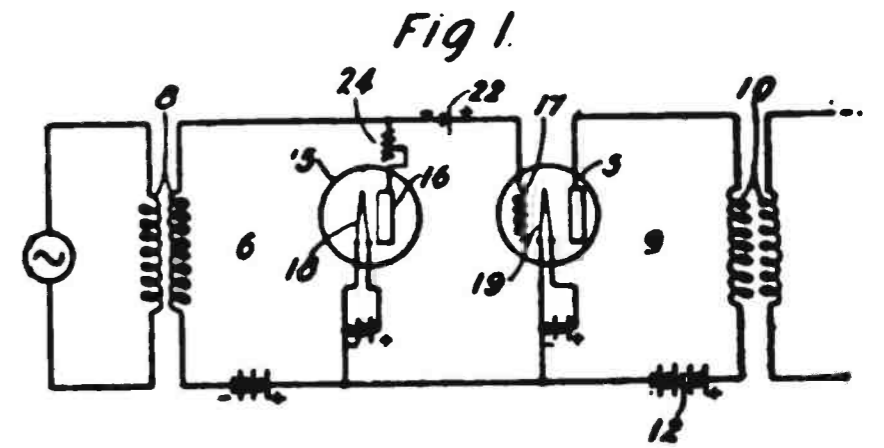

Figure 1 represents a vacuum tube of the audion type having its input circuit connected to the source of oscillations by the transformer, and having its output circuit connected by the transformer to a suitable outgoing line or consumption circuit. 12 is a source of current for the output circuit. With such an arrangement the transformer will impress upon the outgoing line, amplified oscillations of the form impressed on the input circuit. Figure 2 shows how the internal structure of an audion may be modified to conform with the purpose of this invention. 3 illustrates the invention in connection with an oscillation generator. In order to prevent the grid from becoming sufficiently positive to cause the tube to "blue haze," or generate oscillations of an undesirable complexity, the electrode of the unilateral device is connected to the grid and the filament to the filament.

case of a repeater or amplifier by starting free oscillations in the tube circuits. Such free oscillations would be undesirable also where the tube was employed as an oscillation generator.

In order to overcome these difficulties, it is proposed to afford a leakage path to the filament for the positive charge on the grid by connecting a unilateral impedance between these two electrodes in such manner as to allow current to flow from the grid to the filament, but not in the opposite direction.



Agents

L ARON MANUFACTURER OF SHIRTS wants Agents to sell complete line of shirts direct to wearer. Exclusive patterns. Big values. No capital or experience required. Write for free samples.
MADISON SHIRT MILLS
 507 Broadway New York, N. Y.

"MIRAD"

"Quality Radio Priced Right"

- 3 Plate Variable Condensers..... \$1.50
 - Mirad Variocouplers 1.75
 - 2000 Ohm Double Head Phones..... 2.50
 - 1500 Ohm Single Head Phone..... 1.50
 - (Money back guarantee.)
 - Mirad 23 Plate Condenser..... 1.50
 - Mirad 45 Plate Variable Condenser.... 4.50
 - Mirad Detector Unit..... 25.00
 - Mirad Two-Step Amplifier..... 25.00
- Postage Paid

Dealers' Sample of Above 25% OFF

Miracle Radio Mfg. Co.
 INTERURBAN BLDG., DALLAS, TEXAS

UNIT RADIO SETS

Our sets approved and installed in Borough President's Office of Queens, New York City.

PRICE and QUALITY our premier consideration

- Detector Units.....\$5.00 to \$12.00
- Amplifier Units..... 12.00 to 20.00
- Tuner Units..... 10.00
- Detector and 1 Step..... 25.00
- Detector and 2 Step..... 35.00
- Detector and 3 Step..... 45.00
- Tuning Unit Detector and 2 Step..... 62.00

Dealers write for proposition
 Immediate Delivery

American Radio & Electric Co.
 1123 Broadway, New York City

Radio Supplies

Variocouplers, Variometers, Headsets, Transformers, Sockets, Rheostats, Etc.

Guaranteed **Crystal Set** \$4
 Or Money Refunded PRICE.

Send fifty cents for 20 efficient blue-print hook-ups.

Any Radio Set Made to Order or Repaired

Sunbeam Electric Co.
 71 THIRD AVE. NEW YORK

Moving Picture Manager Objects to Radio

UNDER the heading, "Detroit Papers Rebuked by Trendle, Kunsy Manager," "Moving Picture World" publishes the following:

The following letter was sent recently by George A. Trendle, manager of the John H. Kunsy theatres, to the Detroit Free Press and the Detroit News:

"I have recently learned that the Government desires to curtail the operating of the radio broadcasting station of both your paper and the Detroit Free Press, and understand that in the very near future you will be called into conference for that reason, and am taking the liberty of again writing, in the hope that you will seriously consider the advisability of discontinuing the use of the radio outfit after 7 o'clock in the evening.

"We are spending many thousands of dollars with your publication each year to increase the attendance at our motion picture shows. Undoubtedly it is a selfish motive, but at the same time, an expensive one, while your publication at no profit to itself, makes a strenuous effort to keep as many of our patrons away as possible by giving them lavish entertainments during the evening, without expense. This does not seem to our organization to be a fair and just return for the co-operation we are giving your paper, and if you can eliminate the broadcasting during the evening hours, giving your patrons the benefit of it during the afternoon or morning, I am sure that you will eventually benefit by it.

"I am writing the Free Press and making the same request, not as a favor, but as a strictly fair and square business consideration, to which I feel that the theatres of Detroit are entitled in return for the enormous amount of advertising placed in your publication from week to week. Comments are heard from theatre managers daily with reference to this, and it certainly deserves some consideration on the part of the News.

"I sincerely hope that after careful thought you will agree with me that the News can carry its message to its many radio fans without so seriously interfering with the operation of amusement enterprises in Detroit, which, I am frank to say, have not come back to normal since the inception of the News and Free Press radios. Our residential houses particularly have been seriously affected and we can give no other reason for it."

New Broadcasters Licensed

THREE new broadcasting stations were licensed during the past week:
 KFDD—St. Michael's Cathedral, Boise, Idaho.
 WNAP—Wittenberg College, Springfield, Ohio.
 KFEB—City of Taft, California.

Only One Licensed Broadcaster in Berlin

There is only one licensed broadcasting station in Berlin at present, and this sends out mark and exchange quotations. Service charges range from 1,000 to 7,500 marks a month, to which must be added the cost of the Government license and the installation of a receiving set.

Rocky Mountain Crystals

BETTER THAN GALENA
 The most sensitive mineral rectifier known. Can also be used with one or more stages of amplification.
 Mounted, No.; Unmounted, No.; Postpaid
 Manufacturers, Jobbers, Dealers, Clubs,
 Apply for Special Trade Prices
Rocky Mountain Radio Products, Inc.
 6 CHURCH ST., NEW YORK, N. Y.

Recommended by Dealers for Reliability

RADIO STORES CORP.

VARIABLE CONDENSERS—PLUGS—RESISTANCE UNITS, ETC.
 If your dealer doesn't carry, address Dept. B,
 222 West 34th Street, New York

GOING—and Going Fast

We have only a few left and they are going fast, but while they last we will continue to sell them at the reduced price.

- VT 1 Detector and Amplifier.....\$7.50
- VT 2 Detector and Amplifier.....\$8.00

The above tubes are the genuine army J's and K's, respectively.

"RADIO BUILDER" PLANS FREE!
 By Mail, 5c.

LIBERTY RADIO CO.
 105 Liberty Street New York City

LEE RADIO CORP'N.

Manufacturers
 Haddonfield New Jersey

ANNOUNCES

THEIR "B-I" SET

(Patent Applied For)

NEEDS NO AERIAL

PRICE, \$35.00

Complete Except "A" Battery, \$22.00

Write for Proposition.



CRYSTAL RECTIFIER
 MULTIPPOINT

(Patent Pending)

A synthetic product sensitive over its entire surface

Eliminates all detector troubles. 50% increase in clearance and volume. Endorsed by Radio experts and press. Awarded certificate of excellence. Price **50c.** postpaid, mounted.....

Dealers and Distributors Quoted Attractive Discounts
RUSONITE PRODUCTS CORPORATION
 15 PARK ROW, NEW YORK

TUNE IN DISTANT STATIONS



F. R. S. Complete Two-Stage Long Range Receiver

Set includes two Federal Transformers, Condenser, two molded variometers, molded variocoupler, three V. T. sockets, filament rheostats, dials. Read 'Em binding posts, switch points; in attractive cabinet and drilled panel; complete, ready to hook up. **\$40**
 A \$125 Radio for.....

F. R. S. All-Wave Combination Molded Variometers, \$4.00.

Molded Variocouplers, \$5.00.

Molded Bank Winding, \$5.00.

Bank winding is interchangeable for direct mounting on either Variometer or Variocoupler.

This is the only all molded universal combination giving five units in three.

F. R. S. RADIO CORP.

409 East Fort St. Detroit, Mich.

NOVO "B" BATTERIES FOR RADIO

22½, 45 & 105 VOLTS



NOISELESS DEPENDABLE GUARANTEED

ASK YOUR DEALER

NOVO MANUFACTURING CO.

424-438 W. 33rd ST. NEW YORK

531 SO. DEARBORN ST., CHICAGO.

Advertising Rates, Display, \$5.00 per inch, \$150.00 per page

Radio Merchandising

Classified Quick-Action Advertising, 5 cents per word

Telephone Bryant 4796

To Radio Manufacturers!
Send This Firm and Its Branches Your
Catalogues

ASSOCIATED ADVERTISING CLUBS
OF THE WORLD

EXECUTIVE OFFICES, 110 WEST 40TH STREET
NEW YORK

Radio World, 1493 Broadway, City.

Gentlemen: We have to-day received the following letter from:

Och Freres,
 2, Rue du Marche,
 Geneva, Switzerland:

"Our Mr. Och is going to publish in the Swiss newspapers the result of your great expansion in radio. Would you be so kind as to let us have the catalog of your radio-equipment manufacturers and, if possible, samples of the special radio papers sold in the United States?"

Will you be good enough to comply with the above request and send samples of your magazine and advertising matter to Och Freres at Geneva?

The house of Och Freres has branches at Lausanne, Montreux, Neuchatel, Chaux-de-Fonds, Zurich, St. Gall and St. Moritz, and appears to be a reputable concern.

Very truly yours,
 M. S. THAYER,
 Associate Editor.

New Firms and Corporations

(The firms and corporations mentioned in these columns can be reached by communicating with the attorneys, whose addresses are given whenever possible.)

Lewis Electric Mfg. Co., Buffalo, \$100,000; J. N. Lewis, E. S. Yates, R. M. Stanley. (Attorneys, Stanley & Gidley, Buffalo, N. Y.)

Radio Installation Co., \$100,000; William T. Hughes, Earle Smyth, Alexander Jamison, Wilmington. (Alexander Jamison, Wilmington, Del.)

Guarantee Electric Co., Atlantic City, deal in goods, \$125,000; George P. Proffatt, Katherine B. Proffatt, Walter Hanstein, Atlantic City, N. J.

National Electric Products Corp., Wilmington, manufacture, \$500,000. (Corporation Trust Co. of America.)

Hutchison Radio Co., Del., 200,000 shares preferred stock, \$5 each; 400,000 common, no par value; reps., E. Fallows and J. Langner, Madison Av. and 44th St., New York, N. Y.

Orator Radio Corp., equipment, \$50,000; L. P. McArthur, Emmett M. Carter, R. B. Dickey, Washington. (Corporation Trust Co. of Delaware.)

Radio Corp., Wilmington, radio devices, \$50,000. (F. L. Mettler, Wilmington, Del.)

Electrical Club Starts Radio Class

THE Electrical Jobbers' Club of New York has organized a class in the practical and technical features of radio, open to any electrical contractor-dealer in the metropolitan district of New York City, or any of his men. No charge is made for tuition. The work covers merchandising, installation, and operation of radio sets.

A Persistent Advertiser

Robinson Crusoe advertised for a ship. His medium was of most limited circulation and had no A B C rating; but he got the ship.

Mr. Crusoe did not get immediate results. His advertisement flapped on the pole till the rains and winds tore it to shreds. But he renewed his "ad." In fact, he gave his last undershirt to his faith in persistent advertising; and through his persistence, Robinson Crusoe's name will be handed down from age to age.

You, too, will get satisfactory results and create a trade name of permanent value by persistent advertising.

Our suggestion is that you give RADIO WORLD a 52-time order obtaining our minimum rate of \$4.25 per inch by using a one-inch rate holder and larger space as desired. Among RADIO WORLD'S 70,000 readers we believe are numbered more radio manufacturers, live dealers, and enthusiastic fans than could be reached for double the money in other radio publications. For full details address RADIO WORLD, 1493 Broadway, New York.

Our Quick-Action Classified Ads., at five cents a word, bring big results in one week after receipt of copy.

Heard at the Radio Counter

A Conversation Between Customer and Radio Clerk

(Part II)

SAY, John, did you hear that 'bird' last night working C. W. with a note like a willow. Oh, boy! If I only had another tube in the circuit, believe me! I would have heard him all over the room."

"Yes, I guess you are right on that; because just when WJZ shut down for a few minutes, I started in tuning for whatever stations I could pick up. The first thing I knew, this 'bird' started up—but it was sure a good note."

"What do you consider a good audio-frequency transformer? I would like to add another step in the circuit."

"Here, this is a good make. I am using them and get wonderful results. Just try one and see what happens."

"All right—and, by the way, give me a tube socket, also."

"Have you any need for an extra B battery, rheostat, or leak condenser? You know, these will be needed when you add the extra tube."

"I guess you better let me have them. Also, better give me about two yards of spaghetti tubing. Now, there is one question I would like to ask before I go. What is the best method to determine the strength of my storage battery? I think I need some acid."

"Just a minute. What you need is this instrument—a hydrometer and holder. It will tell you the exact condition of your battery. See where it is marked 1275? This means that your battery is O. K., and needs but little charging. Now, when the hydrometer shows 1150, or even 1200, just say to yourself, 'I better put this baby on charge before it goes to the dogs entirely.' One good thing to remember: Never let your battery fall below 1225."

"Very well. Wrap up the hydrometer, too."

"See you again, O. M."

(To be Continued)

Coming Events

The editors of RADIO WORLD will gladly publish news items of all contemplated radio shows and expositions. Keep us posted by mailing full information.

SECOND NATIONAL RADIO EXPOSITION, direction International Trade Exposition Co., Chicago, January 13 to 20, inclusive, 1923, George A. King, director of publicity, 417 South Dearborn Street, Chicago, Ill.

PERMANENT RADIO FAIR FOR BUYERS, Hotel Imperial, New York City. Open from September, 1922, to May, 1923.

AMERICAN RADIO EXPOSITION, Grand Central Palace, New York City, December 21 to 31. Colwell & Korbell, Fisk Building, New York City, directors of publicity.

TRI-STATE TOBACCO GROWERS' RADIO SHOW, Covington, Ohio, October 21 to 28, inclusive.

INTERNATIONAL RADIO SHOW, Madison Square Garden, New York City, November 20 to 25, inclusive. E. C. Buchignani, director of publicity.

SOUTHEASTERN RADIO EXPOSITION, Auditorium Armory, Atlanta, Georgia, December 4 to 9, inclusive. Co-operative Radio Sales Assn., 295 Peachtree St.

WANTED: COPIES of RADIO WORLD, April 22 and May 29, 1922. Mail us copies of these issues, or either one, with an accompany postal and we will send you a copy of the latest issue for each copy so mailed. RADIO WORLD, 1493 Broadway, New York.

Navy Radio Sets Bring \$43,000

THE opening of bids by the United States Navy Surplus Sales Office revealed the fact that 47 firms and individuals were interested in the 390 radiotelephone sets offered for sale re-

cently. The highest bid received was \$251 for one set; the total receipts reaching \$43,000. The awards made were as follows:

Bidder	Address	Amount Each	Total Amount	No. Sets Purc'd
Simon Bitterman,	623 S. Wabash Ave., Chicago	\$150.00	\$450.00	3
Wm. Hansell,	116 E. Main St., Ottawa, Ia.	155.00	1
Henry KiENZLE,	501 E. 84th St., N. Y. C.	200.00	1
R. H. Parker,	33 Cony St., Augusta, Maine	175.00	1
Atlantic Marine Ex.,	14 Atlantic Ave., Boston	251.89
		176.89
		126.89	555.67	3
E. L. LeBaron Foundry Co.,	Brockton, Mass.	155.00	1
No. Western Radio Ser. Co.,	Seattle, Wash.	200.00	1
C. C. Tylee,	314 Sumter St., Charleston, S. C.	162.50	325.00	2
Klein's Radio & Elec. Co.,	34 Park Place, New York	200.00	600.00	3
Bion J. Arnold,	105 S. LaSalle St., Chicago	125.00	1,250.00	10
H. A. Braunstein,	248 First Ave., N., Minneapolis, Minn.	1,514.00	10
Alex. Rankin,	Frostberg, Md.	150.00	1
Catholic University,	Washington, D. C.	150.00	1
Frank L. Smith,	7 Newberry St., Worcester, Mass.	105.00	1
Eksaf Trading Co.,	1515 E. Parkway, Brooklyn	206.00	2,060.00	10
Department of Physics,	Cornell University, Ithaca, N. Y.	150.00	1
John W. Lee,	Radio Laboratory, Navy Yard, Phila.	160.00	1
Robt. J. McLain,	6 Chestnut St., Cooperstown, N. Y.	120.00	360.00	3
Greeley Madison Corp.,	26 West 23rd St., N. Y. City.	101.33	34,137.99	336

Limits Radio Talk to Coastal Areas

Norwegian Government Says Ships in Territorial Waters Must Observe Strict Rules of Radio Communication.

THE following regulations regarding the use of wireless stations on vessels belonging to foreign powers not at war, while in Norwegian territorial waters in times of peace, have been approved by government resolution, and came into force on September 1, according to the "Anglo-Norwegian Trade Journal."

1. In Norwegian territorial waters wireless telegraph or telephone stations on foreign vessels may not be used, except by special permission, unless for the following purposes:

(a) Communications concerning vessels in distress or for the prevention of accidents.

(b) Communications; (c) communications with the nearest Norwegian coastal station, and other ships' stations when each vessel is at least ten nautical miles distant from the nearest Norwegian coastal station.

In the cases of (a) and (b) communication must at once be stopped on request from the Telegraph Administration, the Naval Department or a station belonging to either of these authorities.

2. In Norwegian ports where there is a state wireless station and within certain prohibited districts laid down by the Norwegian authorities (regarding which information may be obtained from the nearest state coastal station), the ships' station may not be used except for communications as under 1 (a) unless special permission has been obtained.

3. Application for permission to use a station in Norwegian territorial waters for other communications than above mentioned should be sent to the Telegraph Administration (Telegrafstyret), which will give its decision after consultation with the Naval Administration.

4. (This paragraph concerns war.)

5. When a ship's station is used while in Norwegian waters this must be done with the observation of the provisions

of the International Telegraph Convention and its regulations.

6. The foregoing regulations remain in force only when Norway is not at war.

Textbook on Radio

THIS 350-page volume deserves the most unqualified praise for the thoroughness in which the publishers have endeavored to cover the interests of the radio enthusiast. There are a number of valuable suggestions in its pages which will be of value to both fan and amateur. It is written in a simple style, and, at the same time, it is a standard textbook for the technical radio student. It contains, the up-to-date material regarding circuits and hook-ups including data on superregenerative receiving sets. This book can be secured from your dealer or direct from the Technical Book Co., 130 West 42nd Street, New York City.

INSU-LITE

PANELS

1/8" —.01 per sq. in.
3/16" —.015 per sq. in.
1/4" —.02 per sq. in.

DEALERS: Write for discounts.

General Merchandise Co.
142 Market Street, Newark, N. J.

The Hoyt

PEEP-HOLE METER

A guaranteed Hoyt miniature voltmeter or ammeter for your board. Used with either A. C. or D. C. current, installed without screws.

Ranges: 0-10 Volts\$2.50
0-30 Volts\$3.10
0-.8 Amperes\$2.50
0-1.2 Amperes\$2.50

Other ranges and prices on application.

BURTON-ROGERS CO.

755 Boylston Street Boston 17, Mass.

GITHENS TRUTONE RADIO HORN-LOUD SPEAKER

First one to sell on ten day trial Money back Guarantee.



Retail Price \$21.00
Includes Loud Speaker

Trutone has been pronounced the best on the market by experts. It has a clear true tone. Every radio fan should try Trutone and compare it with others. If YOU don't find Trutone the best, your money will be refunded. It is sold on a ten-day trial money-back guarantee. If not carried by your dealer write us.

Distributors and Dealers, write!

AUTO PARTS MFG. CO.
1815 Trombly Ave., Detroit, Mich.

YOUR PHOTO IN THIS PAPER ATTENTION AMATEURS!

Have you built your own receiver?

Are you experimenting with any particular hook-up?

Are you improving your set?

Are you doing any interesting constructive work in radio?

Why not share this knowledge with your thousands of brother fans who read RADIO WORLD every week?

We want pictures of receiving sets with descriptions of how you overcame some difficulty, or of any additional part or unit that you have added to obtain better results. These are the things that, probably, the other fellow is looking for. Send in your information; pictures or whatever you have done to improve the art.

Remember the beginner is looking for them.

We intend to print in this paper, each week, pictured information and description of value to radio amateurs. If you have found a newer or better way of doing anything, don't keep the secret but tell it to your thousands of brother fans.

Send in a photograph of your set with or without accompanying diagrams and measurement. State whether you figure in the picture yourself, or not, and without any expense whatsoever to you we will make an engraving and publish it. Be sure to write your name and address plainly on photograph.

Send in your picture at once, or if you have not made a set or done anything else in making radio material, tell the boy next door all about this offer.

Address: Technical Editor

RADIO WORLD, 1493 Broadway, New York City, N. Y.

YOUR NEWSDEALER

will deliver RADIO WORLD to your home. In order to be sure of getting RADIO WORLD regularly, and of not missing a single issue, we suggest that you either subscribe direct or through your newsdealer at \$3.00 a year (52 issues) \$1.50 six months, and \$1.00 three months. Or instruct your newsdealer to deliver RADIO WORLD regularly to your home each week. Dealers will take standing orders and make deliveries of paper whenever requested. Radio World, 1493 Broadway, New York.

FEDERAL PHONES \$5
RADIO DISTRIBUTING
& AUTO SUPPLY CO.
 64 West 66th St., New York City
 See our Specials in next issue Radio World

Radio May Rob Volcanoes of Terror

PROBABLY never again will Vesuvius belch its fires of destruction upon an unprepared and unsuspecting populace, or Popocatepetl rain its death-dealing lava upon unprotected Mexican

peons, says Raymond Francis Yates in "The Evening Mail," New York.

Scientists and the wonderful vacuum tube of the everyday radio receiving-set are seeing to that.

Work of applying sound amplification to the study of volcanic activities within the earth has already reached the advanced stage. In fact, there has been constructed a device so sensitive that the moving waters of subterranean springs easily can be recorded by it.

This apparatus, which might be called the "sound microscope," is so tremendously sensitive to air vibrations that it permits one to hear things heretofore absolutely inaudible.

It is destined to become as great an aid to hearing and acoustics as the microscope and the telescope have been to vision.

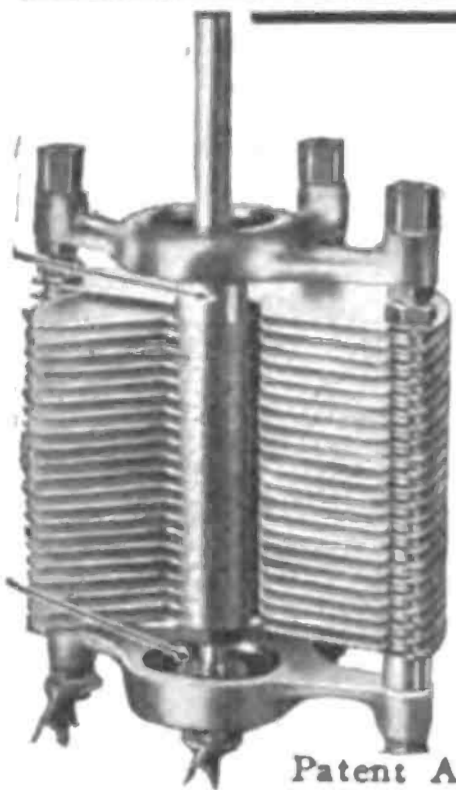

SOMETHING NEW!

Variable Condenser Built Right

Furnished either regular or vernier

Made in the most popular sizes, with aluminum plates, cast end brackets, with a 1" diameter Bakelite bushing therein. (A perfect insulator high in dielectric strength). Dealers write for discounts. Ask to see our Rheostat and Vacuum Tube Socket.

LOMBARDI RADIO MFG. COMPANY

67-71 Minerva Street, Derby, Conn.

P. O. Box 44

Patent Applied For

Does Good Work With Low Power

NIGHT by night, throughout the breadth of the land, there takes place a series of communications under the most efficient organization ever produced by voluntary methods, says "The Tribune," New York. The development and operation of this system are the work of the average American radio amateur, under the executive guidance of his national institution—the American Radio Relay League.

The work of this organization has to a certain extent been obscured in the phenomenal advance of public interest in radio due to the advent of broadcasting, and only occasionally does an inkling of its achievements appear.

Before outlining this, however, it should be pointed out that the amateur owning a transmitting station is restricted to a maximum output of one kilowatt of power by the government. Many of the amateurs are still further restricted by the exigencies of their financial standing, but they make up in enthusiasm what they lack in funds.

To still further understand the contribution of the American amateur to the development of radio as a means of communication, it should be stated that he also is compelled to work on 200-meter wave length as a maximum, where the frequency of the oscillating current is so tremendously high that it offers almost insurmountable difficulties.

Despite these obstacles, he has succeeded in communicating across the Atlantic Ocean with less than one kilowatt of power, where under the same conditions the big transAtlantic wireless stations are compelled to use 200 kilowatts. This is unquestionably his crowning triumph.

Day by day he maintains a network of communication across the country which has already proved its worth in cases of emergency and which is becoming more efficient every day. In addition, he also maintains a daily communication between the Pacific Coast and the Hawaiian Islands with the low power allowed him by the government.

For CORRECT RADIO MAILING LISTS Use THE POCKET LIST

of Radio Manufacturers, Jobbers and Dealers in the United States and Canada. Issued Quarterly—January, April, July and October. October, 1922, issue corrected to September 15th, 1922. Classified under three different headings—Manufacturers, Jobbers and Dealers—and alphabetically arranged by states, cities and towns and names of firms. Containing approximately 15,000 names and addresses.

We have been exceptionally careful to see to it that every Manufacturer, Jobber and Dealer is listed and under the PROPER CLASSIFICATION. Most mailing list concerns charge more than \$100 for a list of this kind and, as a rule, these supplied are far from being correct. Compare this list with any other, and you will find it to be the very best obtainable anywhere at any price.

October issue ready for distribution September 25th. Price \$5.00 per copy, or \$10.00 per year (four issues, including monthly supplements which keep the list absolutely correct and up to date at all times). October edition limited. Send your order with remittance today.

F. D. PICKENS, 1621 CARRINGTON STREET
 JANESVILLE, WISCONSIN

"TUNING IN"

TO THE RIGHT TUNE IS VERY SIMPLE WHEN YOUR CONNECTIONS ARE
 SOLDERED WITH THE NEW

"POST SOLDERING IRON"

(The Iron with the Platinum Heating Unit). Removable Soldering Tip



1/2 Actual Size
 LIST \$6.00

Designed especially to cover every requirement for delicate work. The smallest practical, efficient instrument on the market. Attached to any socket. Universal current. Fully guaranteed. From your dealer, jobber or write

POST ELECTRIC COMPANY

30 EAST 42ND STREET, Div. 500

NEW YORK

GREWOL DETECTOR

Nothing Like It
 Nothing as Good

\$2.00

The Grewol Detector has taken its place among the standard, nationally advertised parts. In a class by itself because it does what no detector has yet been developed to do and still sells at a popular price.

Asked for by name, sold by reputation.

If your dealer cannot supply you, send \$2 and we will fill your order.

Your Dealer has Grewols

Always Set
 and Ready

Glass Encased

Super-Sensitive

RANDEL WIRELESS CO.

Sole United States Distributors

9 CENTRAL AVENUE

NEWARK, N. J.



(Actual Size)

REPRESENTATIVES WANTED!

Seeking hustling subscription representatives in every college, school, town throughout the country. Send us your name and address for full particulars. 1403 Broadway, New York City.

RANDEL
 factory
 partic-

Cut Out This Radio World

Do you like clear tone—sharp
 and distinct—if so try

MARSH'S

Vernier Variable Condenser, Capacity
 .00056 to .00078 mfd.

Fully Guaranteed

This 23 plate condenser lists at \$3.50.
 To place before the Radio audience a
 limited number will be sold at \$4.75.
 Complete—Dial Knob and Screws.

F. P. Marsh, 145 Nicholl St.
 New Haven, Conn.

New Haven, Conn., U.S.A.

Ad and Mail with \$4.75

PATENT
Your Radio Ideas.
Call or Write
FREE ADVICE

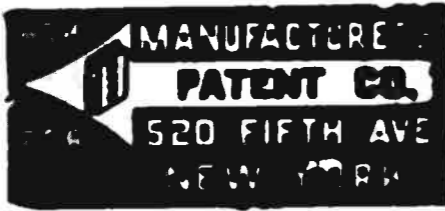

WELCOME! COME IN AND HEAR THE CORACO RADIO CONCERT

Daily, 9 A. M. to 8 P. M. 18th Floor, 220 W. 42nd St., next to Amsterdam Theatre
The Coraco Super-Radiophone is the latest and greatest improvement in radio. It has no outside connections—no installation expense—is as simple to operate as a phonograph. If you cannot call, write for full information.
THE CORACO COMPANY, INC.
220 West 42nd Street New York

ALADDIN ELECTRIC COMPANY, INC.

COMPLETE RADIO SETS
WRITE FOR PRICES.
71 West Broadway New York City

A B C Standardized Radio

Sectional Receiving Units and Radio Parts, give unqualified satisfaction at low cost.
Write for catalog.
Jewett Manufacturing Corp.
228 Sherman Ave., Dept. G, Newark, N. J.

Universal Phone Connector

Can be used with any type receiver. Makes possible the use of four sets of phones. Eliminates energy loss. Heavily nickel-plated, and guaranteed to give complete satisfaction.
Price 75c a pair
Dealers, Write for Liberal Discounts
Universal Phone Connector Company
Room 239, 1499 Broadway, New York City

RADIO MAILING LISTS

9276 Retail Radio Dealers, United Statesper M. 87.50
1184 Radio Manufacturers.....per list, 10.00
1399 Radio Supply Jobbers.....per list, 12.50
357 Radio manufacturers of complete setsper list, 4.00
300 Radio Stationsper list, 4.00
14000 Radio Amateurs and Managers of Radio Stations...per M. 7.50
Neatly typewritten and ready to send you on receipt of remittance covering the amount.
TRADE CIRCULAR ADDRESSING CO.
168 W ADAMS STREET CHICAGO, ILL.

RADIO CITIZENS WE SAVE YOU MONEY

Send us a list of your radio needs for our prices.

If It's Radio, we have it and we sell it for less.

JOHN R. KOCH COMPANY
CHARLESTON WEST VIRGINIA

Radio dealers since 1918

THE GOODMAN



PATENT PENDING

The Nickest Short Wave Tuner on the Market
Only \$6.00 & PP on 1 lb.
Send for pamphlet. Order through your dealer.

L. W. GOODMAN
DREXEL HILL, PA.

Dr. Miller, of Chicago, writes: "My perfectly good variometers and vario-coupler now go into the discard."

For Building Radio Apparatus at Home

THANKS to the Radio Research Laboratory of thoughtful Uncle Sam, three pamphlets on the construction and operation of radio receiving apparatus have been released for radio enthusiasts through the Bureau of Standards and the Government Printing Office. These supplementary circulars now give data and instructions on how to improve the previously described sets with auxiliary apparatus which can be constructed at home at a small cost. A limited number of the circulars are available at the Bureau.

Circular 46 describes two "fixed" condensers which are used with either of the radio receiving-sets described in the first or second circulars. One of the fixed condensers, which is connected in series with the antenna, is called the "series-antenna" condenser. The other fixed condenser, which is connected across the terminals of the telephone receivers, is called the "telephone-shunt" condenser.

The series-antenna condenser enables the receiving equipment to give signals of somewhat greater intensity when tuned to wave frequencies above 1000 kilocycles per second—that is, wave lengths of 300 meters or less. The effect of this condenser is just the opposite of the effect obtained by a greater number of turns of wire on a tuning coil, which permits the receiving equipment to respond to lower wave-frequencies.

The effect of the telephone-shunt condenser is to increase the intensity of some radio signals to which the receiving set may be tuned. In most cases the use of this condenser has no effect upon the intensity of signals which are received from a radiotelephone transmitting station, but it will increase the intensity of radio signals which are received from most spark transmitting stations. The cost of building both condensers is not over 80 cents.

Circular 47 describes a loading coil which is used in conjunction with the single-circuit radio receiving set described in Bureau of Standards Circular No. 120 or with the two-circuit set described in Circular No. 121.

The purpose of the loading coil is to enable the receiving equipment to respond to wave frequencies between 100 and 500 kilocycles per second—that is, wave lengths between 300 and 600 meters. In other words, the loading coil increases the wave-frequency (wave length) range of the receiving set. The receiving set described in Bureau of Standards Circular No. 120 has a wave-frequency (wave length) range of between 500 and 1500 kilocycles per second (wave lengths between 600 and 200 meters).

The use of this loading coil will increase the receiving distance of the equipment, because many stations using the lower wave-frequencies (longer wave-lengths) use a high-power radio transmitting set. For example, NAA, Arlington, Virginia, uses a wave frequency of about 113 kilocycles per second (2650 meters wave length) and uses sufficient power to be heard a distance of about 200 miles when the loading coil described is used with the receiving equipment previously described. The cost of the parts for the loading coil is approximately \$3.

Reliable and Beautiful RADIO-A RE-CHARGER

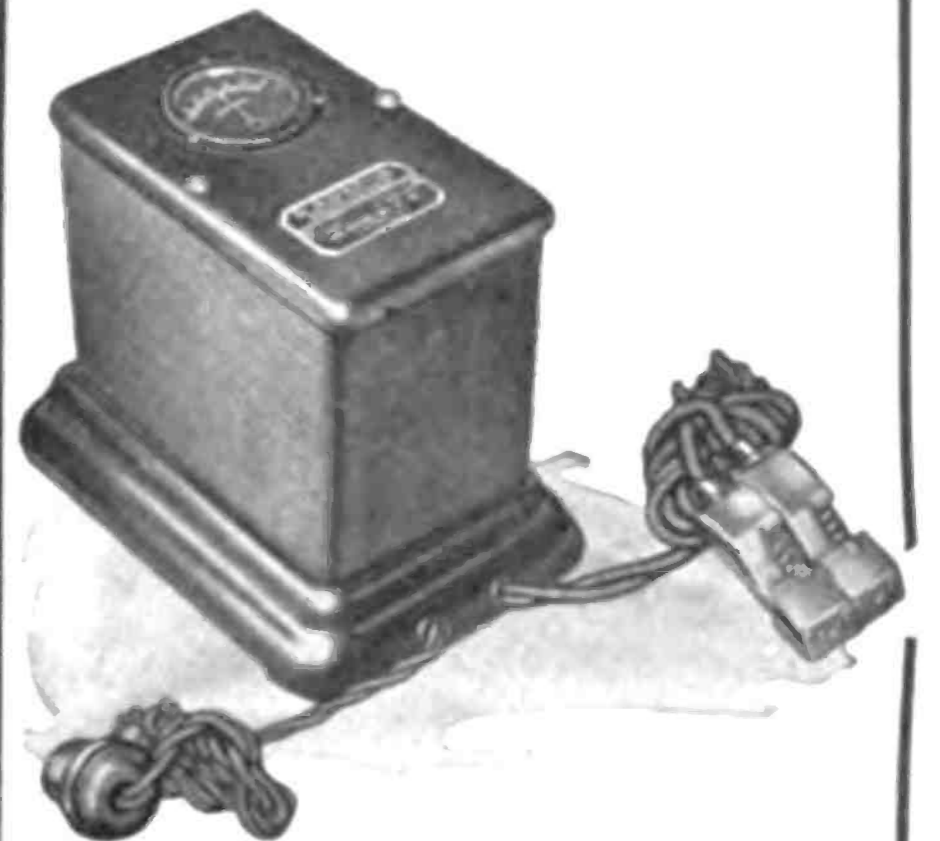

THE RADIO-A is a highly efficient dependable piece of apparatus, absolutely fool-proof, easily attached by simply plugging into ordinary 110-volt lamp socket. In case of current failure, the unit cuts out automatically until current is resumed, without discharging battery.

It is designed expressly for re-charging radio filament batteries, but may be used for automobile or any other storage battery of reasonable size and capacity.

Price, \$18.50

Dealers and Distributors

Here's a Winner! Write us for full particulars.

Simply screw into any 110 volt lamp socket and connect the terminals to your battery. Impossible to hook-up wrong—RADIO-A charges either way.



A compact portable Re-charging Unit that will fully charge a 100 A. H. Battery overnight, for from 5c to 10c, according to prevailing rates.

LAST A LIFETIME

King Electric Mfg. Co., Inc.

1681 FILLMORE AVENUE
BUFFALO, N. Y.

BUILD YOUR OWN

Complete 50c instruction book for 20c, only on radio reception and how to make eight classes of crystal and vacuum tube receiving sets. Wonderful information makes you understand radio. With every order we send free our price list of parts prepared especially for the several sets described. Buy direct from factory and save many dollars. Both instruction book and price list sent on receipt of 20c, only. Money back if not pleased.

20c

RADIO PARTS MFG. CO.
Dept. 15, Park Pl. W., Detroit, Mich.

Answers to Readers

35c. each, 3 for \$1.00



NA-ALD

Genuine Condensite Dial
The dial that runs true.
Numerals engraved on
bevel and knob so shaped
that fingers do not hide
them. Thin edge with
clear graduation to make
accurate reading easy.

Concealed set screw in metal insert. Will not warp
or chip. Finish and enamel permanent.

3-inch dial 35c
2-inch dial for rheostat potentiometer use..... 35c
3 1/2-inch dial 75c

Send stamps for literature.

ALDEN - NAPIER COMPANY
52 Willow St., Dept. L. Springfield, Mass.

Come to California

Must sacrifice established
WHOLESALE RADIO busi-
ness. Controls exclusive sales
agencies. Write Mr. Clay, 920
Chapman Bldg., Los Angeles,
Cal.

I AM building a set with a crystal detector. May I use enameled wire on my tuner and taps? Has enameled wire insulating qualities?—Eugene Martens, Glen Cove, Long Island, N. Y.

You can use No. 22 enameled wire very nicely for the winding of your tuner and taps.

Will I hear Newark, Pittsburgh, and Schenectady with the enclosed hook-up and apparatus as listed?—Yearle Travis, Tuckahoe, N. Y.

Your hook-up is almost completely use-
less. You will not be able to hear anything
with it as it is shown. Our best advice is
that you read carefully the article by C.
White, "Constructing a Radio-Frequency
Regenerator," in RADIO WORLD, Vol. II, No.
2, dated October 7. This circuit applies to
your ideas.

How far can I receive with a De Forest receiver, type DL-800, with two-stage amplifier? What length should my antenna be and in what direction should it be run to get best results? Will another stage of amplification enable me to receive further?

Which should I use—2000-ohm or 3000-ohm phones? Would two or more sets of receivers have any bad effects on my machine?—Arthur Walsh, Patchogue, L. I.

Your first question is too broad to answer; but with a good antenna satisfactory results should be obtained. Your antenna for receiving should be one straight wire about 100 feet long. The direction should be from where the lead-in starts. One more step of amplification will increase the volume and distance of your signals, but it is hard to say just how much distance this one stage will increase. You can use either the 2000-ohm or 3,000-ohm phones; but, remember, only one set may be used at one time.

Can two sets receive from the same aerial? Are all audion bulbs guaranteed to work? Where can I buy an electric soldering-iron? What is the price?—Radio World Reader.

Two sets cannot be used from the same aerial unless they operate at different times; otherwise, the tuning of one set would affect the tuning of the other. I do not believe that all audions are guaranteed to work, but if you buy one of the standard makes it is quite sure to give you satisfactory results. You can buy an electrical soldering iron in any electrical or radio shop for \$7.

Can a loud-speaker be used with a crystal detector?—John Rogers, Bedford, Mass.

A loud speaker cannot be used with a crystal set. Don't try it. It will not operate. At least two stages of amplification are necessary.

My receiving set consists of a single-wire antenna about 200 feet long, a loose coupler, two variometers, grid leak, vacuum tube and grid condenser. With this set how far should I receive? If I added a two-stage amplifier, how much further could I increase my range? I also have mounted on my set a shielding made of copper sheet, which has no effect on tube howling.—George Siegel, Coldwater, N. Y.

With a set of this description some operators have heard the broadcasting stations over some distance, using but one tube. In your case no exact distance can be given as this is right up to the operator himself. There is no doubt in our minds that you should at least hear WGY, Schenectady, New York. From other stations near you we have had reports that the following were heard, using one tube: KDKA, Pittsburgh; WJZ, Newark, N. J.; WBZ, Springfield, Mass. The addition of a two-stage audio-frequency amplifier will make these stations louder. We suggest that you connect the copper shield to the ground connection in order to eliminate the tube howling and other noises.

I added a two-step amplifier to my Westinghouse receiver. Will you please tell me how I can add to the wave-length range so that I may tune, say, up to 1,500 meters? Howard Mitchell, Galveston, Texas.

As the set you have is designed to do certain work, it is doubtful if you will be able to raise the wave length. You might try inserting a large single-slide tuning coil in the aerial lead before it comes to the set. This, possibly, may help you a little; but it is very doubtful. Certain sets cannot be loaded up successfully.

In some honeycomb coil hook-ups, the bridging condenser is connected from the positive side of the B battery to the filament; in others, it is connected from the filament direct to the plate. Which is correct?—(Continued on following page)

METRO JACKS

Nickel silver spring, coin silver contact points, all insulation is high grade bakelite. High class finish, made in 5 sizes:

No. 1—Single Open.....	\$0.55	No. 4—J Spring Filament Control.....	\$0.95
No. 2—Single Circuit.....	.85	No. 5—S Spring Filament Control.....	1.15
No. 3—Double.....	.85		

We also make regular V. T. Sockets with fibre and moulded base.

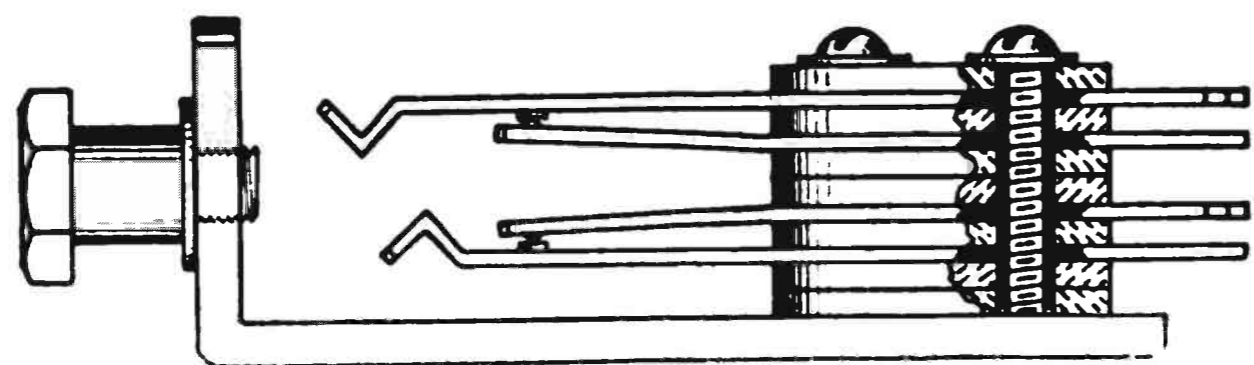

"METRO SOCKETS"
for Westinghouse Aeriotron
1 1/2 volt dry cell tube. This
socket is perfectly finished us-
ing a 2" square highly pol-
ished moulded base. This
base is supported with insu-
lated legs. Springs are of
nickel silver, insuring perfect
contact. Price.....60c.



MOULDED BASE
Single V. T. Socket—Brass
tube, heavy nickel plated and
countersunk contacts....\$1.99

FIBRE BASE
Single V. T. Socket....\$0.75
Double V. T. Socket.... 1.50
Triple V. T. Socket.... 2.25

METRO
ELECTRIC MFG. CO. INC.
121 PRINCE ST.
NEW YORK

SUBSCRIPTION BLANK

RADIO WORLD

RADIO WORLD 1493 Broadway, New York City.

Please send me RADIO WORLD for months, for which

please find enclosed \$

SUBSCRIPTION RATES:

Single Copy	\$.15
Three Months	1.50
Six Months	3.00
One Year (52 Issues).....	6.00
Add Year for Foreign
.....

Subscribe for Radio World, \$6.00 a



NA-ALD
DE LUXE
V. T. SOCKET

Contact strips of laminated phosphor bronze press firmly against contact pins, regardless of variation in length. No open current bridge possible. Socket moulded from genuine Condensite. Practically unbreakable. Special protected slot, with exterior reinforcement. Unaffected by heat of bulbs or soldering iron. All excess metal eliminated, aiding reception. May be used for 8 Watt power tube. Highest quality throughout. Price, 75c. Special proposition for dealers and jobbers.

ALDEN-NAPIER CO.

52 Willow St. Springfield, Mass.

Answers to Readers
(Continued from preceding page)

rect? Can a .001 condenser be used for the primary condenser instead of a .0015 condenser? Does choke-oil amplification eliminate distortion?—Raymond Finch, St. Louis.

The bridging condenser may be connected in the circuit in either way. Both circuits are correct. The primary condenser should be .001 mfd. capacity for best results. Choke-coil amplification will not eliminate distortion. Improperly adjusted circuits have more to do with it.

Is it necessary to have an aerial running east and west in order to hear Pittsburgh and Schenectady?—Leslie Meyers, Passaic, New Jersey.

It is not absolutely necessary to have an aerial running east and west in order to hear these stations. If the aerial is extremely long, it may help you a little to aim the free end of the aerial toward the transmitting station; but it will help very little.

What is the constant for the phone fixed-condenser used in connection with the Armstrong superregenerative circuit? What size vario-coupler should be used with the superregenerative? Can ordinary dry batteries be used for the C battery?—Thomas Meegan, Stapleton, N. Y.

The capacity of the phone condensers should be .0025 mfd. Any standard vario-coupler having a range from 150 to 600 meters. The secondary must be rewound twice the number of turns. Two flashlight batteries connected in series should be used with the first two tubes and a 22-volt battery with the third tube.

I would like to know what a two-slide tuning coil looks like? I intend buying one of these coils and want to know what I am purchasing.—Arthur Hanson, Phoenix, Ariz.

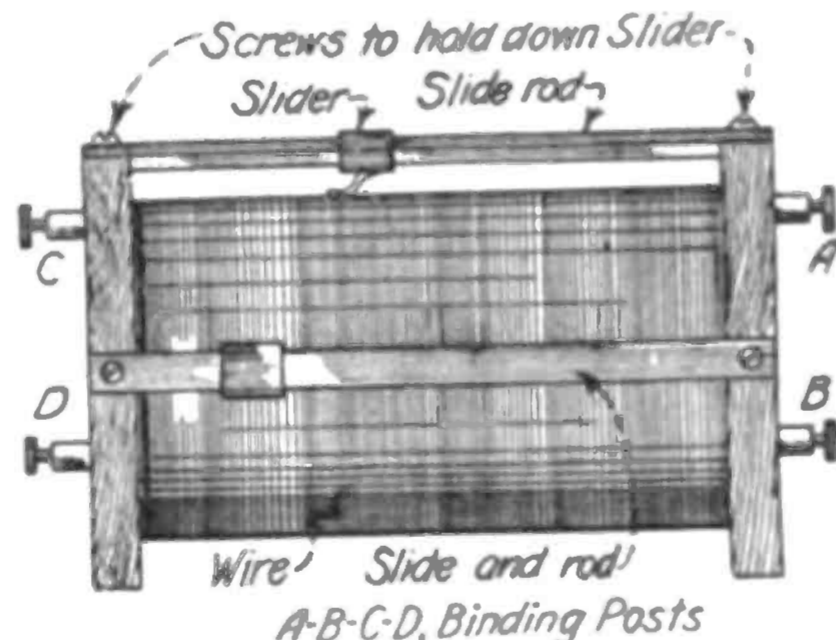

Diagram of tuning coil requested by Arthur Hanson, Phoenix, Arizona.

Above is an illustration of a tuning coil with two slides. This is used in connection with a receiving set as a means of the inductance in order to establish the necessary wave-lengths needed.

Why must I use 120 volts or more to operate my detector tube?—Peter Gray, Duluth, Minn.

Probably you have a hard tube—one with a fairly high vacuum. This is similar to a vacuum tube of the transmitter type and works best on a high voltage. However, it will not be very sensitive at best.

To your personal address: Radio World, 1 year (52 numbers), \$6.

Quality Radio Products
Diagraph Headsets and Loudspeakers
Cutting & Washington Radio Sets
Universal 3 Plate Vernier, 23 and 43 Plate
Condensers, Radio Storage Batteries
Jobbers and Dealers: Write or Wire
For the Biggest Proposition in Radio.
Frederick H. Pruden Incorporated
Larger Building
893 Bergen Avenue Jersey City, N. J.

B Batteries That Last For 5 Years
22-500 VOLTS
Send for interesting circular Dept. B.
Sidbenel Radio Equipment Mfg. Co.
1663 Jerome Ave. New York City

Superior Radio Products
All Parts, Receiving Sets Complete and in Units. Send for Catalogue and Prices.
Dealers Write for Proposition
RADIO OUTFITTING CORP.
Mfg. High Grade Radio Apparatus
418 East 34th St. New York, N. Y.

STANDARD HEADSET
2,500 OHM
Guaranteed to be equal of any phone on the market listing at \$6.00 **\$5.75**
Dealers and jobbers write.
Standard Electric Sales Co.
848 Broad Street Newark, N. J.

The Latest and Most Essential Part of an Efficient Tube Set

Variable Grid Leak and Micon Condenser
(combined)
Obtainable in an unbroken range from zero to 5 megohms—all intermediate points. Fixed capacity—.00025 M. F. Improves your set wonderfully by
Clarifying Signals
Lowering Filament Current
Increasing Battery Life
Eliminates Hissing
Price Only \$1.00
Manufactured by
CHAS. FRESHMAN COMPANY, Inc.
97 Beekman St. New York City
Home of Micon & Antenella

Spirola
TRADE MARK
Concert
Cabinet Loud Speaker with Built-in Unit
Made for music lovers

You can't afford to buy till you have heard SPIROLA CONCERT. You can hear it at our risk. Keep it ten days and then, if you wish you can return it and your money will be returned immediately.



"Spirola Speaks"

Fine hand-rubbed finish in either mahogany or dark oak with bronzed throat—a thing of beauty. Complete with special unit and cord, ready to hook up in place of your headset—no extras to buy or adjustments to make. At dealers or sent postpaid, carefully packed (sent C. O. D. if preferred)... **\$12.50**

L. H. Donnell Mfg. Co.
Dept. B, Box 70
ANN ARBOR, MICHIGAN

If you did not get a copy of Radio World No. 1, send us \$6.00 and we will send you this paper for one year, and start it with our first issue, which will be mailed to you as soon as possible after re-

WARNING TO OUR READERS!

RADIO WORLD accepts subscriptions thru the American News Co. and its branches, the regular news trade and subscription agencies. No others have any right to solicit or to accept payment for subscriptions unless they can show a properly signed subscription authorization from this publication.

RADIO WORLD, 1493 Broadway, N. Y. C.

Complete Your Files!

Technical Articles Published in Radio World to Date

APRIL 1.
A 500-Mile Radiophone Employing a 5-Watt Tube, by Frank A. Hahnel.
"Tell Me, Please, How Will This Set Receive?" by E. L. Bragdon.
Short Cuts in Receiver-Circuit Design, by O. C. Roca.
Making a Short-Wave Regenerator, by Fred. Chas. Ehlert.

APRIL 8.
Do You Know Your Receiving Equipment, by James D. Gordon.
Why a Crystal Is Called a Rectifier, by Walter Emmett.
Is Radiotelephony Dependable? by O. C. Roca.
Mounting Crystals in Your Detector, by E. L. Bragdon.
Storage Batteries for Radio, by Fred. Chas. Ehlert.

APRIL 15.
First Principles of Electricity as Applied to Radio, by John P. Miles.
Your Storage Battery, by E. L. Bragdon.
What Makes Radio Possible, by Edward Linwood.
Ground Connection as Vital as Antenna, by Fred. Chas. Ehlert.

APRIL 29.
Valuable Pointers on Aerial Construction, by Edward Linwood.
What is Meant by Tuning, by E. L. Bragdon.
Radio-Frequency Amplification and Regeneration, by Frank Armstrong.
Honey-Comb Coils and Condensers, by Edward Linwood.
Charging the Storage Battery, by E. L. Bragdon.
How to Construct the Variocoupler, by Frederick J. Rumford.

MAY 6.
The Advantages of Radio Frequency, by Harold S. Potter.
How to Construct, Protect and Operate a Storage Battery, by George W. May.
The Beginner's Catechism, by Edward Linwood.
Tuning and What is Meant by It, by Fred. Chas. Ehlert.
New Frequency Amplifier Brings Faintest Waves in Strong, by G. W. May.

MAY 13.
My Practical V. T. Detector and Two Stage Amplifier, by Frederick J. Rumford.
The Principles of Radiotelegraphy, by Walter J. Howell.
The Reason for the Loop Aerial, by George W. May.
Tuning and What is Meant by It, by E. L. Bragdon.
The Beginner's Catechism, by Edward Linwood.

MAY 20.
The Design of an Amateur Receiving Set, by C. White.
The B Battery and the Plate Current, by George W. May.
Radio Terms at a Glance, by Fred. Chas. Ehlert.
The Beginner's Catechism, by Edward Linwood.
Fire Undewriters' Rules, by Fred. Chas. Ehlert.

MAY 27.
The Beginner's Catechism, by Edward Linwood.
How to Make Your Own Condenser, by George W. May.
Tuning as Applied to Telegraphy, by Walter J. Howell.
Why the Condenser Doesn't Condense, by E. L. Bragdon.
Making Signals Louder with Two-Stage Amplifier, by George W. May.

JUNE 3.
The Cost of a Single-Circuit Receiver, by Howell W. Miller.
The Beginner's Catechism, by Edward Linwood.
How to Compute and Build a Fixed Condenser, by E. L. Bragdon.
Design for an Amateur's Receiving Set, by C. White.
Simple Method of Recharging a Storage Battery, by John Grayson.

JUNE 10.
Radio Receiver for Short Waves, by George W. May.
How to Filter Atmospheric Conditions, by C. White.
The Messenger Boys of Broadcasting, by E. L. Bragdon.
Are You a Member of the N. O. D. C.? by E. L. Bragdon.
The Beginner's Catechism, by Edward Linwood.
How to Construct One- and Two-Slide Tuning Coils, by George W. May.

JUNE 17.
The Vacuum Bulb's Start in Life, by C. White.
How to Select the Right Set, by E. L. Bragdon.
The Beginner's Catechism, by Edward Linwood.

Test of Inductance Coils, by Fred. Chas. Ehlert.
Short Waves from a Simple Receiver, by Stanley Bryant.

JUNE 24.
How to Make Your Radio Cabinets, by W. S. Standiford.
How the Crystal Detector is Used to the Best Advantage, by C. J. Williams.
How to Construct a Long-Wave Regenerative Receiver, by George W. May.
Tested Invention of Major Armstrong Amplifies Set 100,000 Times, by John Kent.
Repairing Cracks in Hard-Rubber Storage Battery Jars, by W. S. Standiford.
The Beginner's Catechism, by Edward Linwood.

JULY 1.
Novel Unit-Detector and Amplifier, by Frederick J. Rumford.
Why You Must Use a Condenser, by C. J. Williams.
How Wave Lengths Travel, by Fred. Chas. Ehlert.
Radio World's Revised Dictionary, by Fred. Chas. Ehlert.
The Beginner's Catechism, by Edward Linwood.
Use of the Vacuum Tube Detector, by George W. May.

JULY 8.
Radio's Place in the Phenomena of Nature, by E. L. Bragdon.
The Function of the Loose Coupler, by Charles H. Plath.
Armstrong's Superregenerative Amplifier Fully Explained, by John Kent.
Operating a Transatlantic Station, by Fred. Chas. Ehlert.
The Beginner's Catechism, by Edward Linwood.
Reducing Strays and Static, by Fred. Chas. Ehlert.

JULY 15.
Assembling a Detector and Two-Stage Amplifier, by H. S. Stanford.
Combined Radio and Audio Frequency Amplification, by C. White.
The Beginner's Catechism, by Edward Linwood.
Locating Your Aerial, by Harold Day.
Facts for Beginners, by Fred. Chas. Ehlert.

JULY 22.
When Your "Movies" Come by Radio, by Stanley Bryant.
Underlying Principles of the Vacuum Tube, by George W. May.
Practical V-T Detector Panel, by Frederick J. Rumford.
Revised Radio Dictionary, by Fred. Chas. Ehlert.
The Beginner's Catechism, by Edward Linwood.
Importance of Aerials to Radiation, by C. White.

JULY 29.
The Vacuum Tube as a Transmitter, by Charles H. Plath.
My 20-Kilowatt Tube and its Uses, by Irving Langmuir.
Importance of the Capacity Switch, by E. L. Bragdon.
The Truth about Lamp-Socket Aerials, by Harold R. Hart.
The Beginner's Catechism, by Edward Linwood.

AUGUST 5.
How to Construct and Operate the Armstrong Superregenerative Circuit, by John Kent.
Using Radio Frequency to Extend Range, by George W. May.
Things Every Radio Fan Must Know, by E. B. Hawley.
Revised Radio Dictionary, by Fred. Chas. Ehlert.
The Beginner's Catechism, by Edward Linwood.

AUGUST 12.
The Work of the Audio-frequency Transformer, by George W. May.
Practical Measurements of Capacity and Inductance, by W. A. Dickson.
Experimenting with Armstrong Circuit Produces Unusual Hook-up, by Dr. O. S. Kelly.
How to Secure Perfect Regeneration, by Fred. Chas. Ehlert.
The Beginner's Catechism, by Edward Linwood.

AUGUST 19.
How to Build a Portable Field Buzzer, by De Witt H. Thompson.
Using Two Tubes for Receiving, by C. White.
The Storage Battery as an Important Factor in Radio Reception, by Donald Van Wyck.
The Use of Capacity in a Circuit, by George W. May.
The Beginner's Catechism, by Edward Linwood.

AUGUST 26.
How to Build a Spider-Web Receiver, by Frederick J. Rumford.
My Detector and One-Step Amplifier, by Fred. Chas. Ehlert.
The Beginner's Catechism, by Edward Linwood.
Hints for Fans, by C. F. Rye.

SEPTEMBER 2.
Generating C-W for Transmission, by C. White.



NA-ALD
SMALL SPACE
V. T. SOCKET

35c each, 3 for \$1.00.
Moulded genuine Condensite.
Requires but small space
for mounting. Readily ac-
cessible binding posts. No
excess metal to interfere
with efficiency. Unaffected
by heat of bulbs or soldering iron. Plugs
brass contacts. Nickel plated brass binding
screws. Flush out slot. Price possible because
of large production.

Special proposition for
dealers and jobbers.

ALDEN-NAPIER CO.

Dept. L.
52 Willow St. Springfield, Mass.

Wonders of Radio-Frequency Amplification, by H. S. Potter.
How to Connect the Electric-Light Socket Aerial, by John Kent.
Practical Circuits for Regenerating Loud Signals, by O. S. Kelly.
The Beginner's Catechism, by Edward Linwood.

SEPTEMBER 9.
Radio Ideas for the Amateur to Test Out by Carl Masson.
How to Make a Practical Wave-Meter, by Frederick J. Rumford.
How to make a Honey-Comb Coil with a Two-Stage Amplifier, by Fred. Chas. Ehlert.
Perfect Short-Wave Radio-Frequency Amplification, by George W. May.
The Beginner's Catechism, by Edward Linwood.

SEPTEMBER 16.
How to Make a Two-Tube Superregenerator, by Frederick J. Rumford.
Methods of Amplifying Radio Signals, by E. Bradbury.
Voice Distortion in Vacuum-Tube Receivers, by W. A. Dickson.
Charging a Battery—from a French Radiolist's Point of View, by Marius Thouvala.
Working Diagrams for Beginners.

SEPTEMBER 23, 1922
New V T Hook-up Worth Testing Out, by P. F. Metzler.
New Method for Lighting Filaments, by C. White.
Why the Radio Compass is the Fighting Element of Science, by Ortherus Gordon.
Complete Table of Symbols Used in Radio Reception, by Fred. Chas. Ehlert.
The Radio Primer, by Edward Linwood.
Complete Method for Building an Electron-Tube Detector Unit, by Experts of the United States Bureau of Standards.

SEPTEMBER 30, 1922
Increasing the Wave Lengths of a Receiving Set, by George W. May.
The Importance of the Variometer to a Receiving Set, by Donald Van Wyck.
Successful Stunts of an Amateur Radiolist, by C. F. Rye.
Employing Jacks with a Two-Stage Amplifying Receiver, by Fred. Chas. Ehlert.
The Passing of Poldhu, by Arthur G. Shirt.

OCTOBER 7.
Superheterodyne Receiver as Applied to the Armstrong Superregenerative Circuit, by Charles R. Leutz.
Constructing a Radio-Frequency Regenerator, by C. White.
Why the Open Antenna is Best for the Radio Listener, by C. D. Wagoner.
Broadcasting Stations of United States and Canada.
The Radio Primer for the Beginner, by Lynn Brooks.

OCTOBER 14.
Neat Home-Made Tube Socket, by Gordon S. Arthur.
Vessels Now Guided Through Fog by New System of Radiotelegraphy, by Ortherus Gordon.
What Makes the Receiver Work, by Donald Van Dyck.
Using the Variocoupler in a Short-Wave Receiver, by George W. May.
Regenerative V-T Receiver for Short Waves, by Fred. Chas. Ehlert.

OCTOBER 21.
Important Improvements in Radio Receivers, by C. White.
Be Sure of Your Ground Connection, by Fred. Chas. Ehlert.
How Radio Was Installed in Our Home, by Hattie Briggs Hartman.
One-Tube Regenerator Hook-up for Loud Sigs, by Harold Day.
Every Radio Set Has a Reliable Range, by John Kent.
The Theory of Radio Communication, by Horace Beers.

Any single copy of Radio World, beginning with No. 1, mailed on receipt of 15 cents postpaid. Any seven issues for \$1.00. The full 29 numbers sent for \$3.45. Or send \$4.00 for 7 months (30 numbers), or \$6.00 for 1 year (52 numbers) and have your subscription start from No. 1. Radio World, 1493 Broadway, New York

CRYSTAL SET \$4

"THE LITTLE WONDER"
\$2.50 UNMOUNTED

Wonder in name and a wonder in performance. Cannot be equalled for the price. Catches distinctly everything broadcasted within 30 miles.

Send for FREE catalog, describing our "Little Wonder" set and listing radio supplies.

GUARANTEED, TESTED CRYSTALS

Galena and Radiocite.. 20c.

Radi-O-Plate Panels. All sizes cut to order.

Holloway Electric Supply Co., Inc.
238 Third Avenue New York City

Variometers \$3.95 Variocouplers EACH

REGULAR PRICE \$6.00

These are standard MOULDED instruments which is all that is necessary to say.

Order now as these prices will be withdrawn very shortly. Your money back if not satisfied

W. A. DICKSON

Detroit 403 E. Fort St. Mich.

Here's a Saving for Your Customers The "Suneco" Adapter

enables them to use the Aeriotron WD-11 dry cell tubes in any socket without re-wiring.

Eliminates the storage battery.

Send for circular W containing full description. Your customers will want this.

Sun Equipment Company
67 Exchange Place New York

That Armstrong Circuit

So much interest has been displayed in the special article, "TESTED INVENTION OF MAJOR ARMSTRONG AMPLIFIES SET 100,000 TIMES," by John Kent, that appeared in RADIO WORLD No. 13, dated June 24, 1923, the publisher decided to put aside a number of copies for those who were not able to get this issue when published. Copies will be sent, postpaid, on receipt of 15c. or send in your subscription, \$6.00, for one year (52 issues), \$3.00 six months, or \$1.50 three months, and subscription will be started with the issue containing the article about Major Armstrong's Amplifier.—RADIO WORLD, 1493 Broadway, New York.

Want to Know All About Aerials?

Send 15 cents for a copy of RADIO WORLD, No. 38, dated Oct. 7. This number contains an article on the erection, care, size, and style of aerials. It is informative, practical, and simple. It is brief and to the point. It was written by C. D. Wagner, a radio expert.
RADIO WORLD, 1493 Broadway, New York, N. Y.

Our supply of back numbers of RADIO WORLD (Nos. 1 to 16) is limited. We will take orders for the first sixteen issues until the supply is exhausted. If you want these numbers, or want your subscription to start with any special number, let us know.

RADIO WORLD

TELEPHONE, BRYANT 4798
PUBLISHED EVERY WEDNESDAY (Dated SATURDAY OF SAME WEEK)
FROM PUBLICATION OFFICE,
1493 BROADWAY, NEW YORK, N. Y.
BY HENNESSY RADIO PUBLICATIONS CORPORATION

ROLAND BURKE HENNESSY, President
M. B. HENNESSY, Vice-President
FRED S. CLARK, Secretary

ROLAND BURKE HENNESSY, Editor,
1493 Broadway, New York
FRED S. CLARK, Manager,
1493 Broadway, New York

ASSOCIATE EDITORS:

Robert Mackay Fred. Chas. Elliot

SUBSCRIPTION RATES:

Fifteen cents a copy. \$6.00 a year. \$3.00 for six months. \$1.50 for three months.

Add \$1.00 a year extra for postage to Canada and foreign countries.

Receipt by new subscribers of the first copy of RADIO WORLD mailed to them after sending in their order, is automatic acknowledgment of their subscription order.

Advertising rates on request.

Entered as second-class matter, March 28, 1922, at the Post Office at New York, New York, under the act of March 3, 1879.

IMPORTANT NOTICE:

While every possible care is taken to state correctly matters of fact and opinion in technical and general writings covering the radio field, and every line printed is gone over with a scrupulous regard for the facts, the publisher disclaims any responsibility for statements regarding questions of patents, priority of claims, the proper working out of technical problems, or other matters that may be printed in good faith and on information furnished by those supposed to be trustworthy. This statement is made in good faith and to save time and controversy in matters over which the publisher cannot possibly have control.

Mysterious Radio Metal

THIS metal of mystery was discovered by Berzelius in 1817, says "The Globe," New York. It has taken a hundred and some odd years to perfect it to such an extent that it is one of the most useful and promising of substances in the hands of the scientist, inventor, and experimenter. One, F. V. Madaler, has spent the past fifteen years of his life in research work on this metal at his selenium laboratories, and he has built cells of utmost sensitivity for all types of work in which such cells may be used. It is through this man that most of the data here included was obtained. Selenium is produced in two different forms: in rods and in powder. They are of different colors—reddish brown and black. When melted it has the consistency of sealing wax, and is of shiny black. When it is in this condition, it is practically a nonconductor, but by passing through a chemical process, it will change in color and become partially conductive, and will be very sensitive to changes in light. That is, its resistance will change, in a degree depending upon the amount of light reflected on it. At first, or in the dark, the resistance of the selenium is very high, and it gradually decreases to a small fraction of this resistance as the intensity of the light increases.

Dont's for Listeners

DON'T fail to insulate the antenna. Don't place the lightning switch indoors.

Don't listen in during a thunder storm. Don't cause interference with other stations.

Don't try to use a loud speaker with a crystal set.

Don't run wires parallel in making up receiving sets.

Don't neglect to read everything available on radio.

V-A-C-U-U-M-T-U-B-E-R-E-P-A-I-R-I-N-G
A C U U M T U B E R E P A I R I N G
Save on 1.50 | Save on 3.00
Detectors | Amplifiers
Repairing all detectors and amplifiers using a single tungsten filament such as the following listed tubes, Marconi, Marconi-head, DeForest, A. P. Weston Eby, Radiotron UV-200, UV-201, Cunningham C-200, C-201.
Detectors and Amplifiers repaired for \$2.50.
The repaired tubes, we warrant, will give you the same absolute satisfaction that you would expect to receive from new tubes.
We are now in a position to give guarantees for prompt deliveries with satisfactory results. A reasonable trial will confirm our reliability.
George H. Perell Co., Inc.
WEST SOMERVILLE, MASS.
V-A-C-U-U-M-T-U-B-E-R-E-P-A-I-R-I-N-G

GENUINE Nathaniel Baldwin Phones

\$16.00 a Pair

Do not confuse these with Master Baldwin Phones, which are not made by Nathaniel Baldwin of Salt Lake City.

Electric Service Engineering Co.
105 W. 47th Street N. Y. City



Made for All Phones Ask Your Dealer
THEY ARE GOOD PUT THEM ON YOUR PHONES
Slip out the metal disc and slip in the MICA-PHONE. Result—Clearer, better tone, all noises eliminated. Write for circular. Discounts to dealers and jobbers. MICA PHONES sell fast.
Radio Mica Products Co., 188 E. 43d St., New York

Nobody Believes Us

When we say that our exclusive Variometers and Variocouplers, which are specially wound for close tuning and hooked up according to our diagram, will listen in from New York to Kansas City.

Let Us Prove It To You
At Our Expense

Fair enough? What do you say?

OSLAND, INC., 122 Fifth Ave.
NEW YORK, N. Y.

"MAKE PERFECTION YOUR SELECTION"

Buy Direct From Distributor at
Wholesale Prices

Turney Phones\$4.45
Dictograph Phones\$9.75
Thordson Transformers\$3.85
Owl Radio Frequency
Transformer\$2.25
Kinsner Vernier Rheostats.....\$1.15
Unbreakable Dial and Knob.....30c.

We Pay the Postage!

Perfection Radio Corp. of America
140 West 23d Street New York City

DO YOU WANT TO BUY, SELL OR EXCHANGE RADIO OR OTHER GOODS? TRY THIS DEPARTMENT AT 5¢ A WORD

RADIO WORLD'S QUICK-ACTION CLASSIFIED ADS

This department is intended for everybody who wants quick action on short announcements covering the buying, selling, exchanging or general merchandising in the radio field. Readers of RADIO WORLD will find that it pays to read these columns every week. Advertisers will get a ten-day service here—that is, copy received for this department will appear in RADIO WORLD on the news-stands ten days after copy reaches us.

The rate for this RADIO WORLD QUICK-ACTION CLASSIFIED AD. DEPT. is 5c. per word (minimum of 10 words, including address), 10% discount for 4 consecutive insertions, 15% for 13 consecutive insertions (3 months). Changes will be made in standing classified advs., if copy is received at this office ten days before publication, RADIO WORLD CO., 1493 Broadway, N. Y. C. (Phone, Bryant 4796.)

TO THE TRADE—Fixed Phone and Grid Condensers. Write for price list and sample. **SALKEY RADIO CO., 2378 Eighth Ave., New York City.**

Manufacturers of Rogers Radio Receivers and Rogers Receiving Radiometers. Rogers Radio Company, 5133 Woodworth Street, Pittsburgh, Pa.

PATENTS—Electrical cases a specialty. Free-charge. B. P. Fishburne, Registered Patent Lawyer, 366 McGill Bldg., Washington, D. C.

Exchange jolly interesting letters through our Club! Stamp appreciated. Betty Lee, Inc., 4234 Broadway, New York City.

ISSUES OF RADIO WORLD from April 1 to Oct. 7 (7 numbers) for 15c a copy, or the whole lot for \$1.15. Or send us \$6.00 for one year and start with the first number. **RADIO WORLD, 1493 Broadway, New York.**

NEWS AND GOSSIP OF THE STAGE—Send 3c. for specimen copy of **NEW YORK STAR**, the great illustrated theatrical weekly. \$4.00 year, \$2.00 six months, \$1.00 three months. New York Star Co., 1493 Broadway, N. Y.

RADIO MAN, eleven years' experience in all sides of the game, capable of constructing, installing, operating broadcasting station of any power, desires permanent connection. Go anywhere. What can you offer? Evans, Momus Pier 48, N. R., N. Y. C.

BROADCASTING STATIONS: Letters and addresses of broadcasting station to-date appeared in Radio World for Oct. 7. Sent on receipt of 15c. Also a broadcasting map appeared in Radio World No. 8. Sent on receipt of 15c. Radio World, 1493 Broadway, N. Y. City, N. Y.

FRENCH TUBES, genuine (no bootleg with French name), most sensitive and economic. (Good for detectors, amplifiers, and especially for radio frequency. Will work very good on two dry cells.) Price \$3.90. **ATLANTIC & PACIFIC RADIO CO., 131 W. 37th St., near Bway., New Yrk.**

CASH FOR OLD GOLD, Platinum, Silver, Diamonds, Liberty Bonds, War, Thrift, Unused Postage Stamps, False Teeth, Magneto Points, Jobs, Any Valuables. Mail in today. Cash sent, return mail. Goods returned in ten days if you're not satisfied. **OHIO SMELTING CO., 337 Hippodrome Bldg., Cleveland, Ohio.**

PATENTS
Protect your invention today. Write for 1923 Illustrated Book Free. Radio, Electrical, Chemical and Mechanical experts. Over 30 years' experience. A. M. Wilson, Inc. (Radio 3 ARH), 110-18 Victor Building, Washington, D. C. (Successors to business established 1891 by A. M. Wilson.)

Are you familiar with all the radio symbols used in the various hook-ups published in Radio World? If not, secure a copy of Radio World No. 26, dated Sept. 23. In this issue was a complete table of all important symbols used in radio construction and testing. Send 15 cents for a copy, or \$6.00 per year, and have subscription start with that issue. **RADIO WORLD, 1493 Broadway, New York City, N. Y.**

SAVE 25 TO 50% ON ALL SUPPLIES. WE SELL SUPPLIES ONLY. LARGEST STOCK.
\$1.50 Round Telephone Plug, 79c.; Flat, 60c. \$6.00 Arrow Variometer, \$3.90. Moulded black Variometer, \$4.75. Six Dollar Manhattan Telephones, \$4.40. Best Quality V. Condensers with Dial, \$2.35. **MONEY BACK Guarantee.** Include postage.
AMALGAMATED RADIO SUPPLY COMPANY, 193A WILLIAM STREET, NEW YORK CITY

MAIL ORDER ideas and articles wanted. Buy outright or on royalty. Send full particulars. John O. Hofbauer, Bayside, Long Island.

SELL now set, perfect condition. Westinghouse RC Receiver, Radiotron detector and two amplifier tubes. Pair 2200 ohm Federal Receivers with Federal plug. Set cost \$160.00. First Money Order for \$105.00 takes it. Express prepaid. Wesley Robinson, Jr., St. Marys, Georgia.

FOR SALE—New \$30.00 regenerative set without detector—\$16.00; Two new variometers and coupler, value \$15.00—\$8.00; \$45.00 Willard Storage battery, \$20.00; Crystal set—\$8.00. John Keene, Mont Clare, Pa.

PATENTS—Send for form "Evidence of Conception" to be signed and witnessed. Form, fee Schedule, information, free. Lancaster and Allwine, Patent Attorneys, 259 Ouray Bldg., Washington, D. C.

WESTERN ELECTRIC power Amplifier, practically new, complete with tubes and horn. Cost \$161.00. Will sacrifice for \$120.00, \$30.00 down, Balance, C. O. D. Roscoe E. Magee, Box 71, London, Kentucky.

REGENERATIVE RECEIVER—two step amplifier, complete in cabinet, \$35.00. C. D. Lowndes, 2607 Wylie Ave., Pittsburgh, Pa.

ASTONISHING results Rokay Regenerative Hook-up without use of Variometers—vario-couplers, switches, taps, etc. **ONE SINGLE CONDENSER CONTROL ONLY.** The coming receiver. Simpler than a non-regenerative—better than any regenerative we have tested. Hook-up, \$1.00. Money Orders only. Saves you \$10.00 in building your own. With properly wound coils, \$3.50 post paid. Complete receiver parts on wood base with Vacuum Tube, \$8.00. Head set and "B" Battery, \$21.35, Express paid. Rokay Electric Co., Ingomar, Ohio.

VARIOMETERS AND VARIOCOUPERS, \$3.00 each. Can Handle any number of orders. Ralph R. Garrick, 126 North Redfield St., Philadelphia, Pa.

MURDOCK PHONES—type 56, 3000 ohms... \$5.50
MURDOCK PHONES—type 56, 2000 ohms... \$4.50
U. V. 200 (Detector tube)..... \$4.50
U. V. 201 (Amplifying tube)..... \$5.85
Postpaid in U. S.
Send 25c for 208-page radio manual and catalogue. A. V. Gregory, 42 Broad St., Redbank, N. J.

DO YOU USE A CRYSTAL DETECTOR? ARE YOU MAKING A CRYSTAL RECEIVER? Increase the efficiency of your crystal detector 1,000 per cent by using a "PT" Ultra-Sensitive Contact. Of special gauge and alloy; makes and holds a quick, ultra-sensitive, stable, adjustment. Endorsed by RADIO WORLD. Using galena, you may pound panel or table without disturbing sensitivity in slightest. Proved practical on ship-board by an oldtime Marconi operator. Using a "PT" Contact on galena, Arlington (NAA) was brought in clear at 3,300 miles (below the Equator); and Arlington came in loud at 2,200 miles (of Dutch Guiana). In both instances, nearby ships using vacuum tubes were unable even to hear NAA. As to stability, Cape May (WCY) was worked over 1,000 sending right through crystal with 2 KW spark, without affecting detector's adjustment. Replace your insensitive unstable spring or catwhisker with a Contact which will hold its adjustment in addition to giving louder signals and music. Indispensable for use in your crystal set, regardless of make. A novice can install. "PT" ULTRA-SENSITIVE DETECTOR CONTACT, with instructions, twenty-five cents, coin or M. O. "PT" CRYSTAL CONTACT CO., Box 1641, Boston & Massachusetts.

Broadcast Bill's Radiolays

(Copyright, 1922, Westinghouse Electric & Manufacturing Co.)

I'M glad it's gettin' cooler now, fer all these distant stations are comin' in lots better; an' since my wife's relations have packed their trunks an' journeyed home perhaps I'll get a chance to listen undisturbed by noisy chatter of her aunts. Last night I picked up Davenport an' Kansas City too, KDKA came in real loud, but, say, I wish I knew who tried to queer the program with a string of that there code; I'd like to bust his doggone set an' run him down the road. That's not the only QRM I'm gettin' here tonight, cause Willie's in the kitchen puttin' up his weekly fight. It bein' Saturday, you know, Young William's tub comes first an' next to dryin' dishes Willie hates his bath night worst. Then, after he's been put to bed, his mother takes her turn, an' when she's through I reckon, if you'll excuse me, I'll adjourn out yonder to the kitchen 'fore the water gets too cold, an' get the dern thing over with. I hope that Min won't scold if I set there an' lissen to some Military Band while I work with the scrubbin' brush, removin' soil and sand. We may not have a fancy tub with water runnin' hot, like some of our rich friends around the neighborhood have got; but bathin' set me to thinkin' to start a brand new set. I'm goin' to like it if I'm

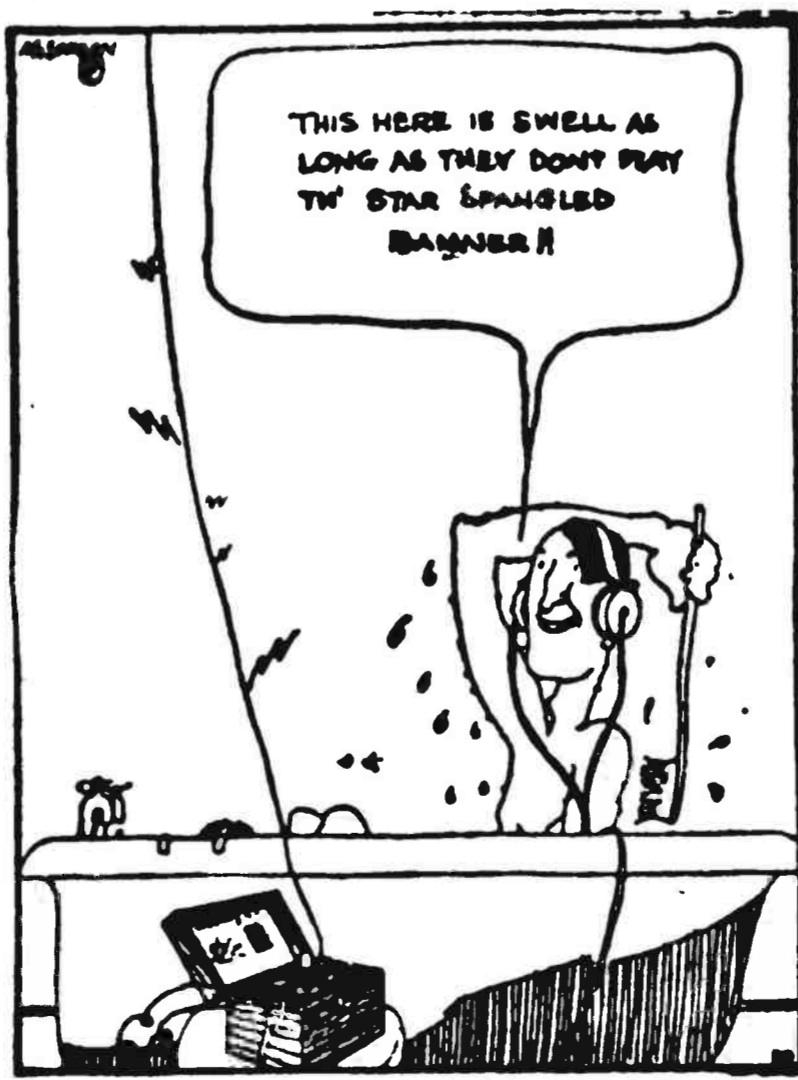

new bungalow I'm goin' to have a set built right in close beside the tub so I can always get the latest news an' gossip an' perhaps a tune er two; 'tain't such a bad idea an' there's one thing sure, it's new.

Subscribe direct or through your news dealer. \$6.00 a year, \$3.00 six months, \$1.50 three months. Radio World, 1493 Broadway, N. Y. C.

FOR IMMEDIATE DELIVERY!
500 LOTS
VARIOMETERS, Perfect, \$5.25 Net
ACT AT ONCE!
REISMAN
217 West 125th Street
New York City

Law Storage Battery
Constant voltage, large amperage. Will run two months without recharging.
Attractive Dealers' Discounts
Write for Details
WILLIAM LAW COMPANY
Aborn and Sabin Streets, Providence, R. I.

NA-ALD
COGSWELL
Variable Condenser
Most advanced design, with highest quality material and workmanship thruout.
Duraluminum end plates; pig tail connection. Accurate plate alignment, convenient binding posts and genuine Condensite Na-ald Dial. Best of shorted plates unknown in this condenser.
Prices range from \$2.50 for 3 plate Vernier with dial to \$4.70 for 43 plate Precision.
Send stamps for complete catalog.
ALDEN-NAPIER COMPANY
52 Willow St., Dept. L. Springfield, Mass.

Orange Label Tea

Special 10¢ Tins

The choice
of particular
people -
since 1836



You can readily appreciate that such a zestful flavor and mellow aroma is the result of three-quarters of a century of experience in the skilful blending of choice teas.

Also sold in 1 lb., 1/2 lb. and 1/4 lb. TINS

A Generous Sample will be sent on request. Address: Ridgways, Inc.,
Department K, 60 Warren St., New York.

Ridgways

Tea



GOLD MEDAL San Francisco 1915



GRAND PRIZE San Diego 1916

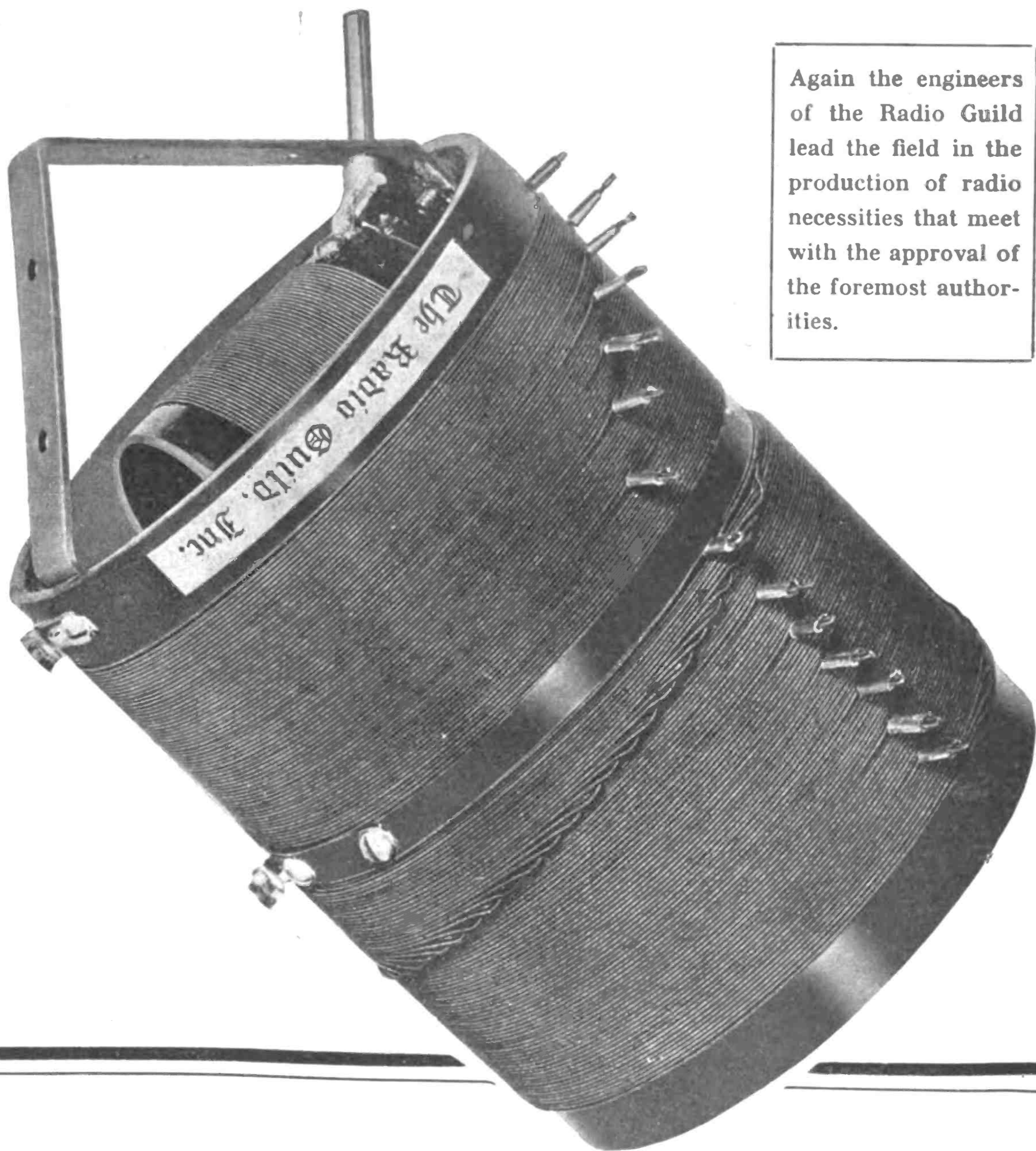

Again the engineers of the Radio Guild lead the field in the production of radio necessities that meet with the approval of the foremost authorities.



“Multi-Range” (Bank Wound Coupler)

Passed the strict requirements of the RADIO NEWS LABORATORIES and awarded their Certificate of Merit.

Pronounced by the “N. Y. Evening Mail” Laboratories as “the finest bank wound coupler produced” and awarded their Certificate of Excellence.

Scientifically designed by experts, the “MULTI-RANGE” Coupler permits the easy construction of an efficient short and medium wave receiver at low cost. Wave-length Range 150 to 3,400 meters.

Specifications

Bakelite Tubing; green double silk covered wire, wound by hand and moisture proofed; heavy nickel-plated metal parts; convenient solder taps; 180° coupling; Litz wire rotor leads.

List Price, \$11.00

DEALERS: The “Multi-Range” Coupler is widely advertised. Write for special discounts.

The Radio Guild, Inc.

256 W. 34th Street

RADIO-FREQUENCY SPECIALISTS
Designers and manufacturers of the VOX HUMANA, the Receiver with the Living Voice.

New York, N. Y.

VOLUME TWO

RADIO WORLD

[Entered as second-class matter, March 28, 1922, at the Post Office at New York, N. Y., under the act of March 3, 1879.]

A Weekly Journal, Published Every Wednesday and Dated Saturday, by Hennessy Radio Publications Corporation from Publication Office, 1493 Broadway, New York, N. Y. Telephone: Bryant 4796.

Vol. II, No. 6. Whole No. 32

November 4, 1922

15c. per copy, \$6.00 a year

Radio Frequency Set Operates in Interior of Automobile

THE day may arrive when the radio sets capable of receiving music clearly from distant points, will be reduced to the simplicity of one knob for tuning; for the present, however, simplicity exists only in the inexpensive receiving sets for the reception of radiotelephone and radiotelegraph signals, at short range. When it comes to receiving sets for long range, satisfactory results may be obtained only from elaborate equipment; and the more elaborate the apparatus the greater the care and skill required for its successful operation. Take the simple receiving sets, for example; there is little or nothing to master in the way of operation. Such sets generally have a multipoint switch to control the wave length and detector. If a crystal detector is used, it must be accurately adjusted for the utmost sensitiveness and this necessitates care. Of course, there are the tubes with audio-frequency and radio-frequency hook-ups. The radio-frequency type of receiver employing vacuum tubes is coming into general use among experienced amateurs for long-range reception. The loop aerial comes in connection with such a set. In the case of audio-frequency amplification, the amplifying is done after the signals have been passed through the detector and rectified so as to produce audio-frequency currents, while the radio-frequency amplification of the waves are amplified before they are passed to the detector.

The advantage of the radio-frequency amplifier lies in the fact that it amplifies only the wave and not the many little irregularities and imperfections which exist in the usual receiver and amplifier equipments.

The upper photograph shows a radio-frequency set made by Peter Smaney, a Newark amateur, to operate in an automobile owned in Lavalette, New Jersey, a town claimed by experts as "dead"

to all radio signals. Although expensive sets with big aeriels had failed to get a signal, this small portable outfit using an 18-inch loop for an aerial brought in Newark and Pittsburgh so clearly that music could be heard by persons twenty feet from the head sets. The complete set is shown in the lower picture. It utilizes three

stages of radio-frequency with a detector and three steps of audio-frequency for amplification. The loop aerial may be seen with the layout and home-made horn for loud signals. This set has been carried in this car for some time. With it the most satisfactory results have been obtained by using radio-frequency as a means of amplifying.

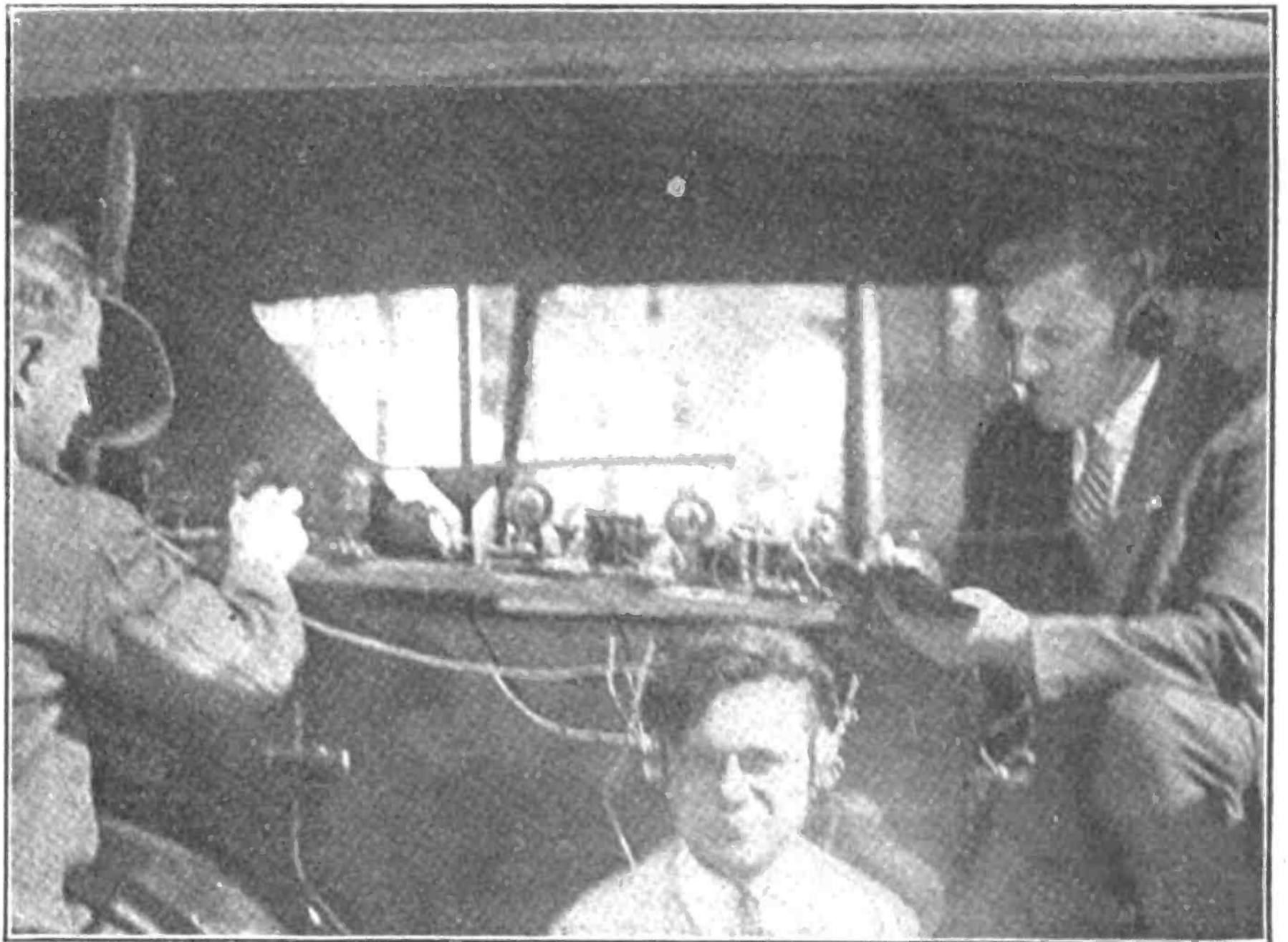

(Both photographs C. Underwood & Underwood, N. Y.)

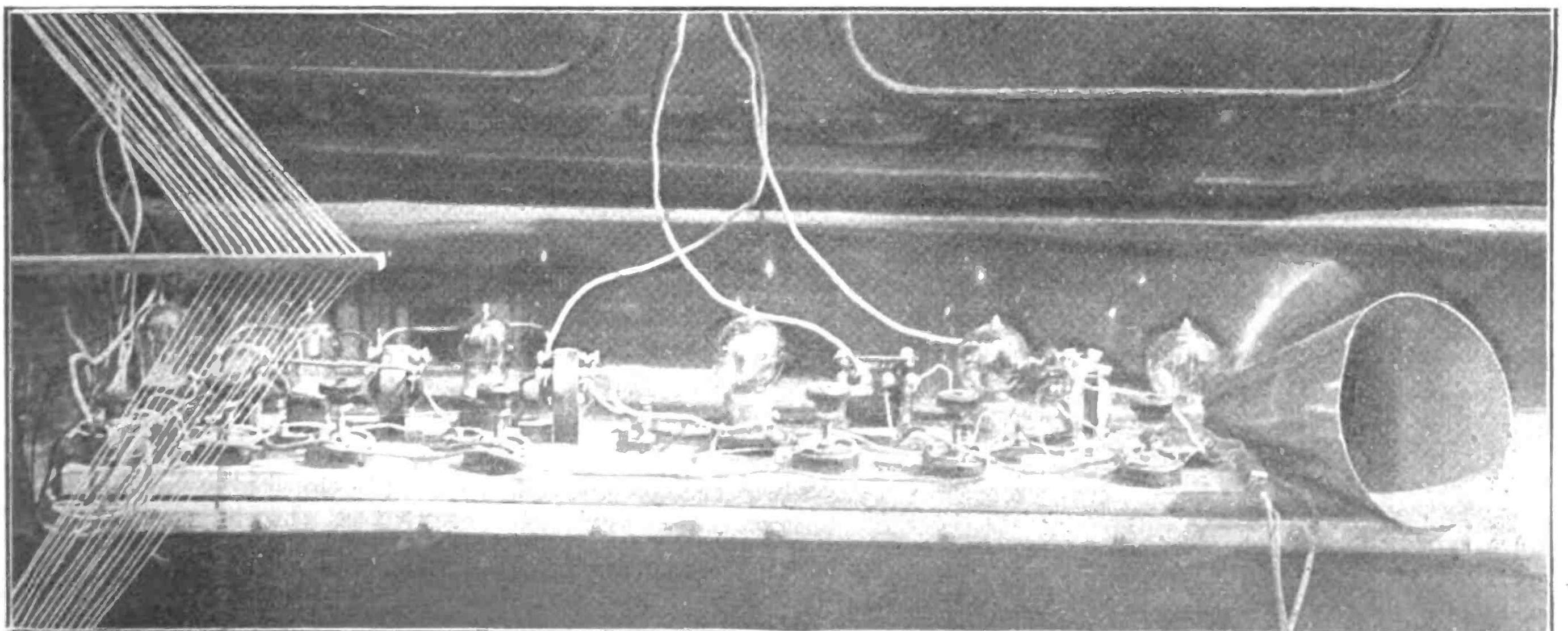

Detectors—and How They Work

By Donald Van Wyck

THE popularity of the receiving-set has caused a great many fans and amateurs to become interested in the broader aspect of radio. Not a few are familiar with electricity and handy with tools, but a large majority of them do not even care to learn the elementary principles of the game. The layman seems to think that all that is necessary is to connect up the set and it will gladly do the work. This is a great thing of which to boast. Many sets will work, but it is a question whether or not a set is working to its fullest efficiency. A little experimenting along well-developed lines may enable the beginner to greatly improve the strength of received signals.

The multiwire aerial, of course, is a waste of time and money; but the single wire cannot be beaten for receiving purposes. However,

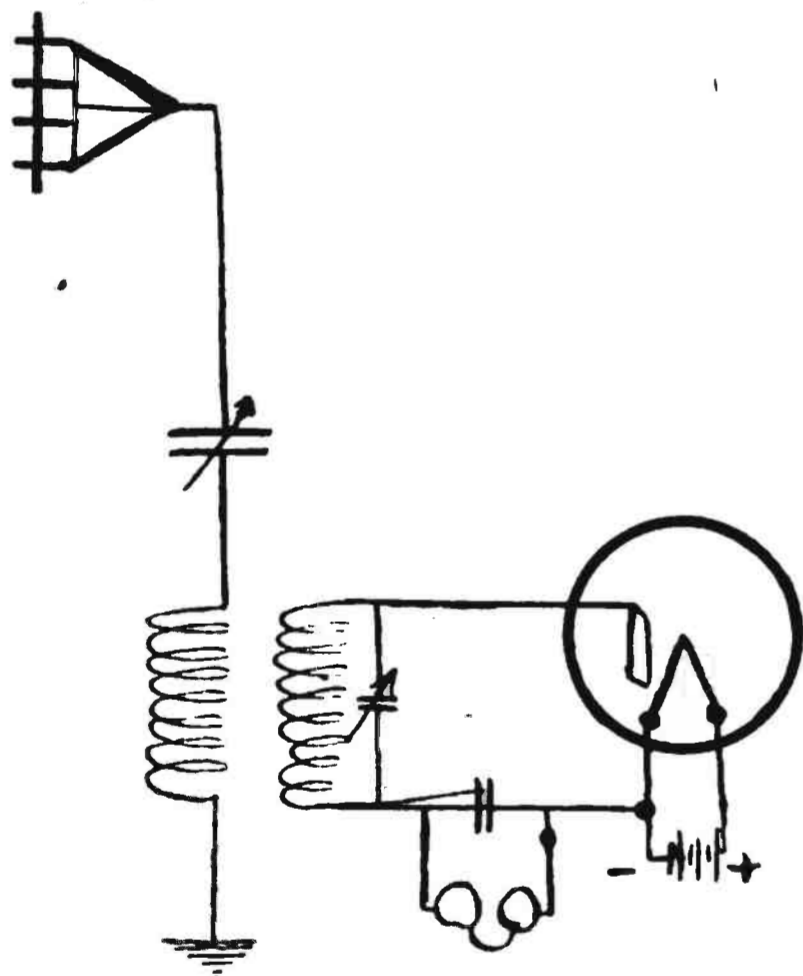

This diagram is the simplest way of showing a two-element tube detector. It is the original Fleming invention and acts as a rectifier in much the same way as does the crystal.

the direction in which the aerial points, as well as the location, has a lot to do with the matter. The direction will not make a great difference in the receiving; but, in radio receiving, the currents dealt in are so small that anything that will help in the least to make the signals louder may well be looked into. The direction that the aerial should be pointed is, of course, towards the station to be received.

The ground lead is another important factor in the set. Some amateurs are using several grounds, such as cold-water pipe, gas pipe, radiator, and the outside private ground. All of these grounds may work well together or may not work at all. No definite rule can be

laid down, because conditions will vary greatly with the locality.

The purpose and usefulness of the detector is to convert the received current of high frequency into the direct current necessary to operate telephone receivers. Various forms of detectors which accomplish this end have been used in the past, including the original coherer, the magnetic detector the electrolytic, crystal, the vacuum tube detector. All of these, except the two last mentioned, have become obsolete. We have previously read in RADIO WORLD that the crystal detector makes audible the high frequencies of incoming signals because it rectifies them. In other words, it allows the current to pass only in one direction. This rectified current consists of a series of pulsations which pass through the windings of the telephone receivers and cause the diaphragms to vibrate, at a frequency which, in the case of radiophone signals, would correspond with the tones of the music or voice being sent out. We have also seen that, for long-distance reception, a detector having more sensitive and stable characteristics than the crystal type is very desirable. These desired features are embodied in detectors of the vacuum-tube type.

When using the vacuum tube as a rectifier it must allow passage of the received alternating current in one direction and prevent the passage of current in the opposite direction. To bring about this result, it is obvious that something must be done to lower the resistance of the tube for current flowing in one direction and keep the resistance high when the current tends to reverse. The two metallic parts, or electrodes, are securely sealed into the glass tube and the tube is then pumped out until it is almost entirely free from air. One electrode, the plate, is generally formed of thin sheet-metal, while the other, known as the filament, is made of small wire and has both ends brought out through the glass. By connecting the two ends of a battery to this filament, it can be heated by the battery current to a temperature which will cause it to glow brightly. When the filament is thus heated, the space between it and the plate becomes a conducting path for the flow of current if the voltage on the plate is positive; but the resistance is maintained to pre-

vent the flow of current if the voltage on the plate is negative. In this way, as with the crystal, a pulsation current is produced which vibrates the telephone diaphragm and produces sound. The sensitiveness of the vacuum tube is greatly improved by the use of a third electrode, called the grid, which is essentially a metallic screen of fine mesh. This screen is placed between the plate and filament of the tube and connected into the circuit as shown. Its function is to control the flow of current from the plate to the filament, through the telephone circuit.

It will be seen that, besides the A battery for heating the filament, there is also a plate battery called the B battery. This is connected in series with the telephone receivers so that the positive ter-

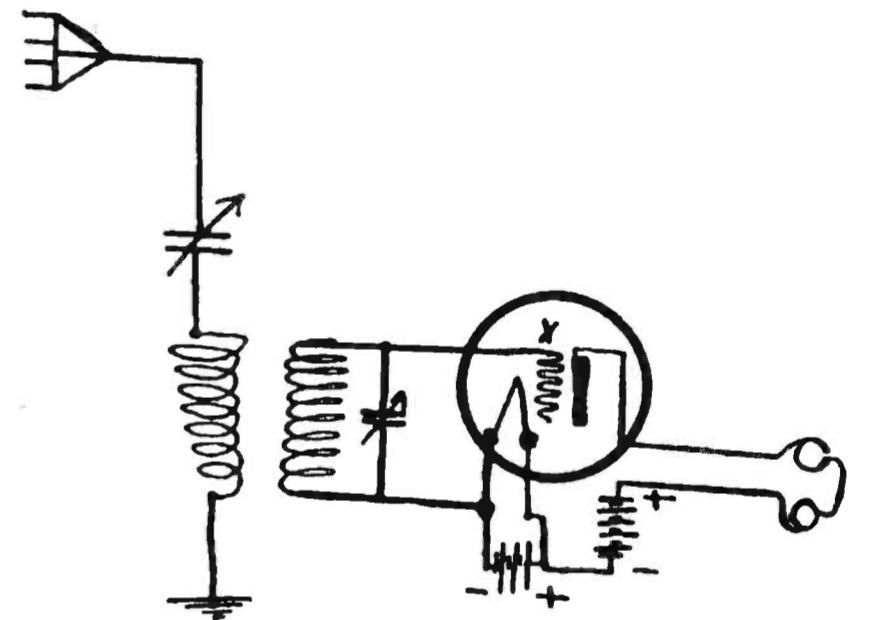

The three-element vacuum tube is shown here. The X in the circle represents the grid which makes the vacuum tube the most sensitive rectifier of radio signals. The third element, or electrode, is the work of Dr. Lee de Forest.

minial is next the plate and the negative terminal is next the filament. When the battery is connected in this way, there is a steady flow of current from the B battery through the tube. This current may be controlled by applying a small voltage between the grid and filament. When the voltage on the grid is negative, it has the effect of decreasing the current in the telephone circuit; and when the grid voltage is positive, it allows the plate current to increase. In this way, the feeble alternating currents of an incoming signal may be applied to the grid and filament and used to control the flow of direct current from the B battery through the telephone receivers. Thus the effect of the signal is multiplied through the relay action of the tube and produces considerably greater action of the telephone receivers than could be obtained by simple rectification.

Hermit Radioist of Canadian Wilds

By Peter Gray

THE unique circumstances and exceptional radio accomplishment of M. J. Caveney, a lonely trapper with a penchant for companionship by radio, should stir the admiration of all radio enthusiasts. Mr. Caveney occupies a cabin at Sandy Falls, near Timmins, Northern Ontario, Canada. He has assembled one of the most powerful radio sets. It includes a complete transmitter and a receiving layout. The accompanying photograph shows the interior of Mr. Caveney's radio shack. To the left of the receiving set, to the right is the transmitting gear.

An oscillation transformer makes it possible for Mr. Caveney to insure amateurs that he can give them sharp coupling, which, in turn, will bring sharp tuning at the receiving end. Mr. Caveney claims that with this spark transmitter, he has reached and communicated messages to amateurs within twenty-five States of the United States. This the trapper can prove by the collection of postal cards, shown in another picture. In looking over the list, most amateurs who have heard Mr. Caveney were from the eighth and ninth districts. Yet there may be read the call letters of some from the third, fourth, and fifth districts. Some very fine work of transmission, indeed!

Mr. Caveney no doubt intends to keep plastering his walls with postal cards from radio amateurs who listen in when he is using his transmitter.

Probably his transmitter may be heard at a greater distance when the transatlantic tests are being made in December. If so, this would prove the importance of utilizing radio as a means of long-distance communication between amateurs.

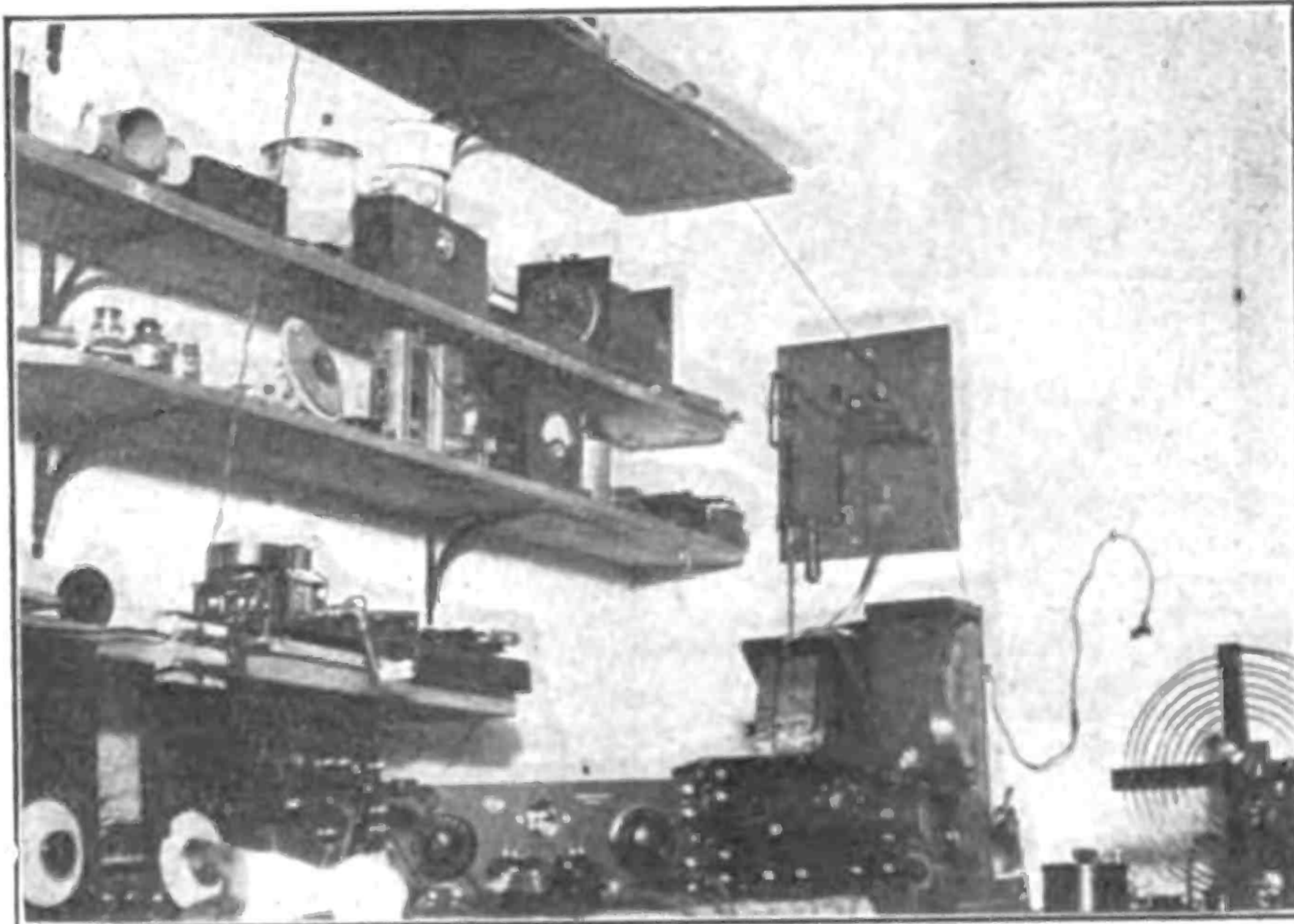

(C. Underwood & Underwood, N. Y.)
Mr. Caveney's set. He calls this corner of his cabin his "radio junk shop."

Italy Demands Radio

THERE is a growing interest on the part of the Italians in American production of radio apparatus. Inquiries are being received both for transmitting apparatus to be used in broadcasting and for radio telephone receiving sets. If American manufacturers interested in the possibilities of the Italian market for their product will send catalogues and other descriptive literature to the office of the American Commercial Attache, care of the American Embassy, Rome, such material will be made available to all persons inquiring.



(C. Underwood & Underwood, N. Y.)
A few of Mr. Caveney's radio post cards. Nearly every American radioist who has "heard him" has sent him a card—and he has quite a collection.



(C. Underwood & Underwood.)

The cabin where C. J. Caveney, Canadian trapper, spends twelve months of the year—and it looks like this the long winter round. But Mr. Caveney is not lonesome. His radio set keeps him in touch with so much of the rest of the world that he has a goodly quota of conversation and entertainment when not engaged in his interesting occupation.

Working Right!

Jimmy—You take this wireless receiver I just finished making, and go down stairs in the cellar; hold it close to your ear and listen.

Freddy—(after waiting in suspense for several moments in the cellar)—Aw—it's a fake; I didn't hear a thing.

Jimmy—Good! That shows it's workin' right. I didn't say anything yet.

One of the Most Delicate Parts of a Receiver

By George W. May, R. E.

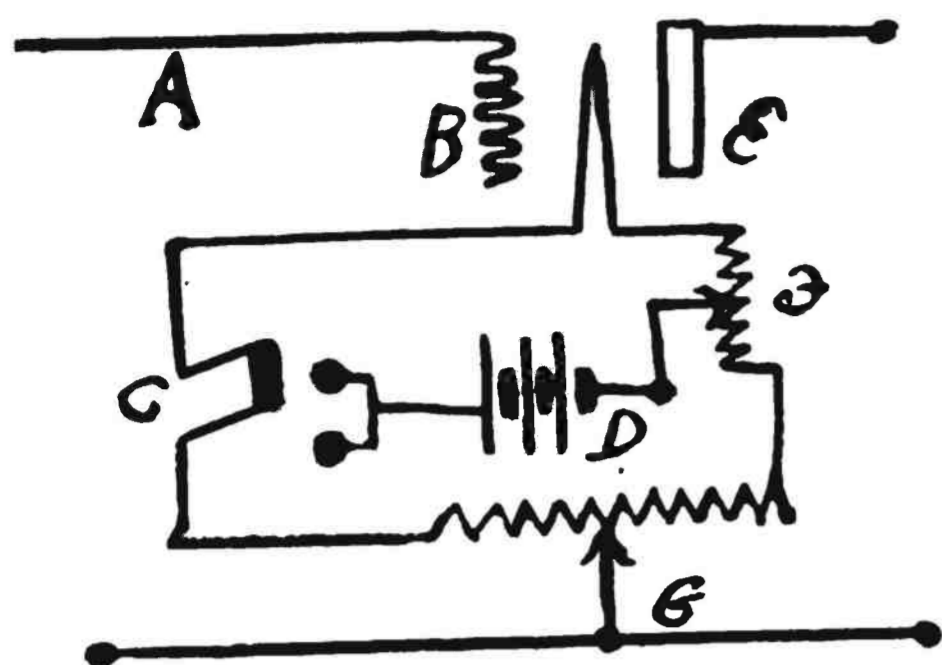

Figure 1—Schematic hook-up of the vernier rheostat. A is the grid circuit. B the grid of the tube. E the plate of the tube. C the switch. D the A battery. F the rheostat. G the potentiometer and arm.

THE detector tubes now on the market require careful attention and correct adjustment of the plate battery for satisfactory results. As a matter of fact, here are no two tubes possessing the same characteristics either in filament current or plate voltage. It is very easy to make adjustments on the filament, since the rheostat gives very fine control of the current. Vernier rheostats may be purchased. These vernier rheostats have an extra arm built on the same shaft as the regular arm, and it travels over a single fine wire tightened around the body of the instrument. This is very practical as it enables the operator to regulate the filament temperature *very* closely which, sometimes, is very desirable.

The high-voltage batteries may be purchased tapped; the battery should, in fact, be tapped. Changing the number of cells in a B battery would change

the positive potential on the plate. If the positive potential on the plate became greater, it would have a greater attraction for the flying electrons in the tube; hence, in a given time, more electrons would arrive at the plate and be pumped around the circuit by the battery. Such B batteries as are used for this change of high potential are of the high-voltage type, as previously explained. They have five or more brass strips on binding posts secured into the sealing compound. Each one of these cells is connected to a cell in the battery. So by connecting with the different posts, different values of voltages may be obtained.

Jumping from one post to another on the battery may be done by employing a clip; but it is much more convenient and easier to put five contact points and a switch arm on the panel of the receiver and so be able to vary voltage by simply turning the switch arm. Of course, this necessitates a little hard work, but it is compensated for by the ease and rapidity with which tubes may be tested to determine the relative efficiency of different makes.

The connections are shown herewith. Each strip on the battery is connected to a contact point on the panel, while the switch goes in the rest of the hook-up, as indicated. There is one interesting point here which must be noticed. If the switch arm is so wide, or the contact points so close together that the end of the blade touches two posts at the same time, the cell between these two posts will be short circuited. In other words, if the switch is kept in

this position for more than a few minutes, the cell will be ruined and it may be necessary to purchase a new battery. To overcome this it would be a wise stunt to insert an extra switch point in between the five regular ones; the extra ones will not be connected with anything. These will simply act as spacers and be dead.

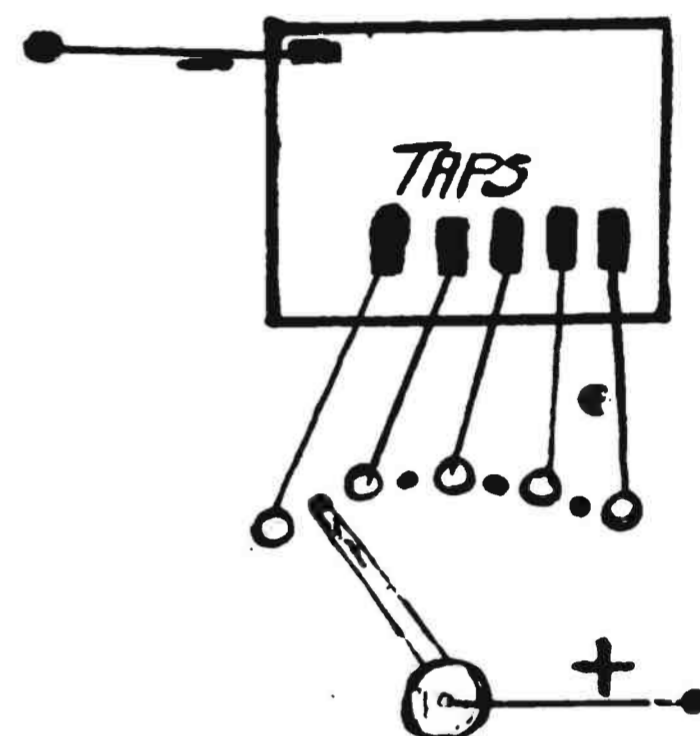

Figure 2—The tapped B-battery with control of voltage utilizing a switch arm.

As an added instrument, an A battery potentiometer may be used. This gives extra-fine adjustment of the tube; but it really is not necessary except in radio-frequency amplifiers. The correct method is shown in the accompanying sketches. The ends of the winding go directly across the 6-volt battery, while the arm is the common terminal for the input and output circuits of the tube. It will be noticed that the potentiometer, notwithstanding its high resistance, acts as a drain on the battery in order to do away with this loss and to have the instrument connected only when the set is used. It is suggested that a double-throw switch be used. This cuts off the filament as well the potentiometer at the same time.

The use of this device is simple. Before making any other adjustments, set the arm at the middle of the winding. Now proceed to experiment with the values of the other elements of the tube control, get what you think are the correct amounts, and then listen in. While doing so, move the potentiometer arm slowly either way until signal strength is secured. Remember that the action of the B battery may be compared to a pump. When it forms part of a circuit, it pumps electrons out of its negative terminal and into its positive terminal. The flow of electrons is around the circuit. This flow is a current of electricity. It may be measured by an ammeter placed at any convenient point in the circuit.

Yes, Radio Is Quite au fait!



(C. Underwood & Underwood, N. Y.)

The leading hotels of America now have their radio rooms, and guests hear the finest concerts. This photograph was taken in the "Radio Room" of the Greenbrier Hotel, White Sulphur Springs, West Virginia. Harry Sadenwater, radio engineer of the General Electric Company, New York, is announcing the next number on the program; Mrs. Charles F. Thompson of Washington, D. C., and Mrs. A. N. Fay of Pittsburgh listening in.

National Radio Week Has Been Set for December 23 to 30 (inclusive)

Major J. Andrew White Appointed Chairman of Executive Committee. Preparations and Programs to Be Planned At Once

NATIONAL RADIO WEEK has been definitely set to take place from December 23 to December 30 (inclusive). This was decided unanimously at the meeting of radio magazine editors, publishers, and representatives of the radio trade, the National Radio Board of Trade, and the American Radio Exposition, held at the Bankers Club, New York, on October 24.

So the idea suggested by Radio World, in its issue of October 21, becomes an assured fact. Radio World is pleased—happy beyond expression—that National Radio Week is not to be confined to its efforts alone, but is to be—as it should be—a big, broad, national affair in which every radioist—man, woman and child—may not only take active part but feel that he is an integral factor in its success.

The meeting at the Bankers Club—preceded by a luncheon at which the greatest optimism in the future of radio was expressed—was presided over by L. S. Byers. Among those present were: Frank Hitchcock, Postmaster General under President Roosevelt; H. Gernsback, Editor of "Radio News"; Lawrence A. Nixon, managing editor, "Radio Dealer"; Amedee J. Casey, "American Radio Journal"; John Gillette, "Electrical Merchandising"; Austin C. Lescarbours, "Scientific American"; Mr. Crosby, "Modulator"; Mr. MacAttammany, "Radio Retailer and Jobber"; Mr. Wardrop, "Radio Merchandising"; Arthur H. Lynch, "Radio Broadcast"; Kenneth B. Warner, "Q. S. T."; Mr. Henderson, "Talking Machine Journal"; Mr. Robertsen, "Talking Machine World"; Mr. Miller, "Radio Digest"; Mr. Callahan, "Radio Topics"; Kenneth Payne, "Popular Science Monthly"; Roland Burke Hennessey, editor, "Radio World"; Walter Gordon Clark, Harold Bolster, George Brokaw Compton, Chester D. Humphrey, and Messrs. Davis and Hunter, of the National Radio Chamber of Commerce.

Major White was appointed chairman of an executive committee to take charge of the details of preparations for National Radio Week.

A supplementary committee of one hundred will be appointed. The members of this committee will be published in the next issue of Radio World.

So National Radio Week takes definite shape and form! The week (December 23 to 30 inclusive) was chosen not only because this is to be actually "A Radio Christmas," but because it will give wider scope for broadcasting and for amateur transmitting. It is a week when the younger element—whose interest in radio is as keen as that of the grown-ups—

will have ample time to join in the many festivities that will be planned and carried out.

National Radio Week, remember, is not a local affair. It extends to every hamlet in the country. Every fan and amateur is expected to take part—and particularly, for the future of radio, to interest his friends in the new science; to bring strangers into the evergrowing radio field.

Watch Radio World for National Radio Week news. And let us hear from you if you have any practical suggestions that will help to make the week a history-making one.

"What would you do to make National Radio Week a success?"

Let us have your answer to this question.

Letters commending National Radio Week continue to pour into the office of RADIO WORLD. Here are just a few of the many received. They show the trend of opinion:

O. H. Caldwell, editor of "Electrical Merchandising," will give his publication's aid:

Congratulations on your plan for a National Radio Week! "Electrical Merchandising" will publish an announcement in its next issue regarding this idea. It opens up interesting opportunities. Please keep us in touch with any developments that take place in your program.

Major General George O. Squier, Chief Signal Officer, U. S. A., will cooperate:

I believe it is a very good idea. Anything that will help to stimulate an interest in the radio art and bring about a wider diffusion of the knowledge of the art is worthy of every effort. I have no specific suggestion to offer; but I shall be glad, in a general way, to cooperate in any way I can to help towards the success of this enterprise.

Major J. D. Felsenheld, Radio editor, "The Jerseyman," Morristown, N. J., is in line:

This department will be glad to cooperate with you to the fullest extent in putting over a big National Radio Week. If you can go through with it, the stadium stunt will suffer a total eclipse. Let us know if we can be of any assistance.

Glenn Howell, Lieutenant-Commander United States Navy, says N. R. W. should accomplish results:

Your suggestion for National Radio Week is believed to be very appropriate and, no doubt, should accomplish results which would be beneficial to the radio business and science as a whole. Should it be desirable for the Navy to take an active part in such a celebration, it would be necessary to consult the Secretary of the Navy. You have my best wishes for the success of this venture.

Be a National Radio Week Booster

Last-Minute Radio News

WIRED RADIO is the latest corporation to file its charter in Wilmington, Delaware. Its purpose is to develop systems. The capital stock is \$10,000,000. The holding company is the Corporation Trust Company of America.

Recent modification of the rigid laws governing the installation of radio telephone and telegraph stations have made possible the installation of radio broadcasting, according to Vice-Consul Edwin B. Montgomery of Montevideo. Applications are now pending which, if granted, should mean the opening of a splendid market for radiotelephone receiving apparatus in Uruguay.

Application for Government sanction to establish a radiotelephone system has been made by the Daido Electric Power Company, of Nagoya, Japan, according to advices received by the Department of Commerce. The company proposes to operate this system primarily for its own convenience in connecting the various stations with its electric light and power system, but its

use may be extended to the general public. As at present planned the wireless system will start from Okuwa in Nagano Prefecture on the Central Japan Railway Line, from which point communication will be established through Nagoya and as far as Osaka, a distance of about 150 miles. American firms interested in the possibilities of supplying equipment may obtain the name of the purchasing agents for the Daido Company in the United States from the Electrical Equipment Division, Bureau of Foreign and Domestic Commerce.

More About the Telephone Mystery

Editor, RADIO WORLD:

In your issue No. 28, dated October 7, I read the letter from Albert Lundberg, Fairdale, North Dakota, in regard to re-

ceiving telephone messages from a near-by telephone line.

I had a similar experience. Sometime back, a friend and myself, while experimenting with standard regenerative receiver-circuits, put in a short ground line house-telephone system so that we could compare notes on our work. By accident we discovered that we could talk to each other through the transmitter of the house phones and receive through the radiophones. Further experiments convinced us that a standard ground-telephone system would radiate sufficient induction to be received by a radio receiver (regenerative) as far as 50 feet from the receiving instrument. This experience may afford some one a chance to do some work along this line.—R. O. Nemeyer, 497 Winona Avenue, Pasadena, Calif.

Radio-Equipped Polar Weather-Stations Sought

By Washington R. Service

WITH the perfection of radio communication, great progress has been made in another science which is, perhaps, of equal value to the world at large, particularly the seafaring and agricultural nations. Meteorology has advanced with leaps and bounds during the past few years. Due chiefly to radio, the outposts of meteorological knowledge have been pushed far afield into distant and unpopulated wilds where, previously, lack of communication has withheld local weather conditions from the world.

Last winter, an American engineer, Hagbard D. I. Ekerold, spent months on a barren rock 400 miles north of Iceland, in the Arctic Ocean, as the leader of a meteorological expedition backed by the Bergen Geophysical Institute. His observations were believed so important to the rest of the world that an observatory was established by the Norwegian Government at Jan Mayn, this lonely spot of rock in the Arctic sea.

This new northern observatory has a wireless station, so that weather observations may be broadcast as fast as noted. Scientists hold that this, the station farthest north, is the beginning of a new epoch in the history of science, admitting that credit is due to radio.

Meteorology is fast becoming an international study, for the storms and weather of one country soon affects the situation in another, and, to-day, the immense area covering the whole of Europe, Northern Africa, and the Near East, as well as the United States and Canada, is combed with great care by weather observers and their reports received at central points, abstracted and broadcast by radio daily from Washington, Paris, and a few substations. Thus it has become possible for meteorologists to obtain within twelve hours of the taking of the observations, a representative meteorological situation over the greater part of the Northern Hemisphere, extending from the Pacific Coast of America to Russia and Egypt.

Professor Bjerknes, of Norway, who has done much to advance our knowledge of cyclones forming in the temperate zones, holds that weather conditions there depend chiefly on the conflict between two streams of air—a cold current flowing southward from the north Polar regions and a warm current drifting northward from equatorial sources already well known. These air streams, he believes, meet along a wavering front in the temperate zone, and in their intermingling create those mysterious swirls in the

atmosphere which are called cyclones. To study these possibilities, he desires to establish a chain of radio-equipped observation stations near the Pole, from the records of which the tracks followed by the Polar current southward and the centers of conflict with the warm currents may be definitely determined. Such a series of circumpolar meteorological posts will have more than theoretical importance when regular forecasts for the North Atlantic are required in connection with daily air flights between Europe and America, he says.

This Observatory at Jan Mayn, which transmits by radio observations six times daily, constitutes the first link in the chain with Spitzbergen. Mr. Ekerold has made a proposition to England, the United States, and Canada, to establish a third link in the Arctic chain at Baffin Island, on Davis Strait near Western Greenland, over a thousand miles from Jan Mayn, Iceland, and Newfoundland. This third radio station would aid materially in studying the weather in the Far North which is practically unknown. From these stations observations aiding in establishing forecasts for the Northern hemisphere and the North Atlantic trade and air routes would emanate.



(Cartoon by Lawrence B. Hinkley)

TOO DEEP FOR DAD

Young Amateur: "Say, father, if I hook up a five ten-thousandth-microfarad condenser on the antenna circuit, and a variometer in the plate circuit of the electron... to you think my set w..."

19 More Broadcasters Are Licensed

TWELVE licenses were issued by the Department of Commerce to 360-meter broadcasters and seven to Class B Stations operating on 400 meters, as follows:

Limited Commercial or Broadcasting Stations for 360 Meters, Licensed Between October 14 and 21, 1922.

WMAY—Kingshighway, Presbyterian Church, St. Louis.

WNAT—Lennig Bros. Co., Philadelphia.

WNAH—Manhattan Radio Supply Co., Manhattan, Kansas.

WOAV—Pennsylvania National Guard, Erie, Pa.

WMAW—Wahpeton Electric Co., Wahpeton, N. D.

WTAW—Agricultural & Mechanical College of Texas, College Station, Texas.

WPAA—Anderson & Webster Electric Co., Waco, Nebraska.

WNAJ—Benson Co., Chicago.

WMAN—Broad Street Baptist Church, Columbus, O.

KFBV—Clarence O. Ford, Colorado Springs, Colo.

WMAX—K. & K. Radio Supply Co., Ann Arbor, Mich.

WSAV—Clifford W. Vick, Radio Construction Co., Houston, Texas.

Class B Station to Operate on Wave Lengths of 400 Meters, Licensed Between October 14 and 21, 1922.

WDAF—Kansas City Star, Kansas City, Mo.

WOC—Palmer School of Chiropractic, Davenport, Iowa.

WHB—Sweeney School Co., Kansas City, Mo.

KDKA—Westinghouse Electric & Manufacturing Co., East Pittsburgh.

WSB—Atlanta Journal Co., Atlanta, Ga.

WFI—Strawbridge & Clothier, Philadelphia, Pa.

WBAP—Wortham-Carter Publishing Co., The Star Telegram, Fort Worth, Texas.

"My short experience with radio convinces me that future generations have something to live for."

—Sir Thomas Lipton.

Keep Your Clocks Right by Radio

By Carl H. Butman

WASHINGTON, D. C. — Through Naval Radio broadcasts, it is now possible to set clocks and watches to standard time twice daily. At noon, and at 10 o'clock every night, the Naval radio stations at Arlington, Annapolis and Key West transmit radio signals, indicating the exact time for the 75th meridian or standard eastern time.

The actual time is kept at and sent from the Naval Observatory in Washington, the source of standard time for the territory east of the Rocky Mountains, the chronometer and time office at the Naval Station at Mare Island, California, serving the western territory and ships off the Pacific Coast.

In a deep, even-temperature vault at the Naval Observatory three Riefler clocks keep sidereal, or star time, and although they are not quite correct, it doesn't matter. They are checked by the observation of certain stars as they cross the meridian, and their exact error and rates of error calculated. Having obtained the exact Washington sidereal time, a correction for the difference in longitude of Washington and the 75th meridian—which is 8 minutes and about 15 seconds—is made to secure Eastern Standard time. This is kept on two transmitting clocks, one of which sends out the time signal to the three radio transmitting-stations by means of a relay.

Previously to sending the time signals, the sending clock is checked with one of the standard Riefler clocks by comparing their ticks which are recorded on a chronograph, wavy pen lines indicating the separate ticks. These are measured by a finely divided scale and compared. Determining the error, the sending clock is speeded up or slowed electrically until its ticks correspond exactly with the standard clock.

The ticks of the transmitting clock are sent to the three transmitting stations by closing a switch at the observatory, but they are broadcast by radio from the three stations. Five minutes is required to send a complete time-signal, starting at 11:55 and running to noon, and from 9:55 to 10 p. m. The time signals consist of telegraphic dashes every second except the 29 of each minute, the 55th to 59th seconds of the first four minutes, and the 50th to 59th seconds inclusive of the last

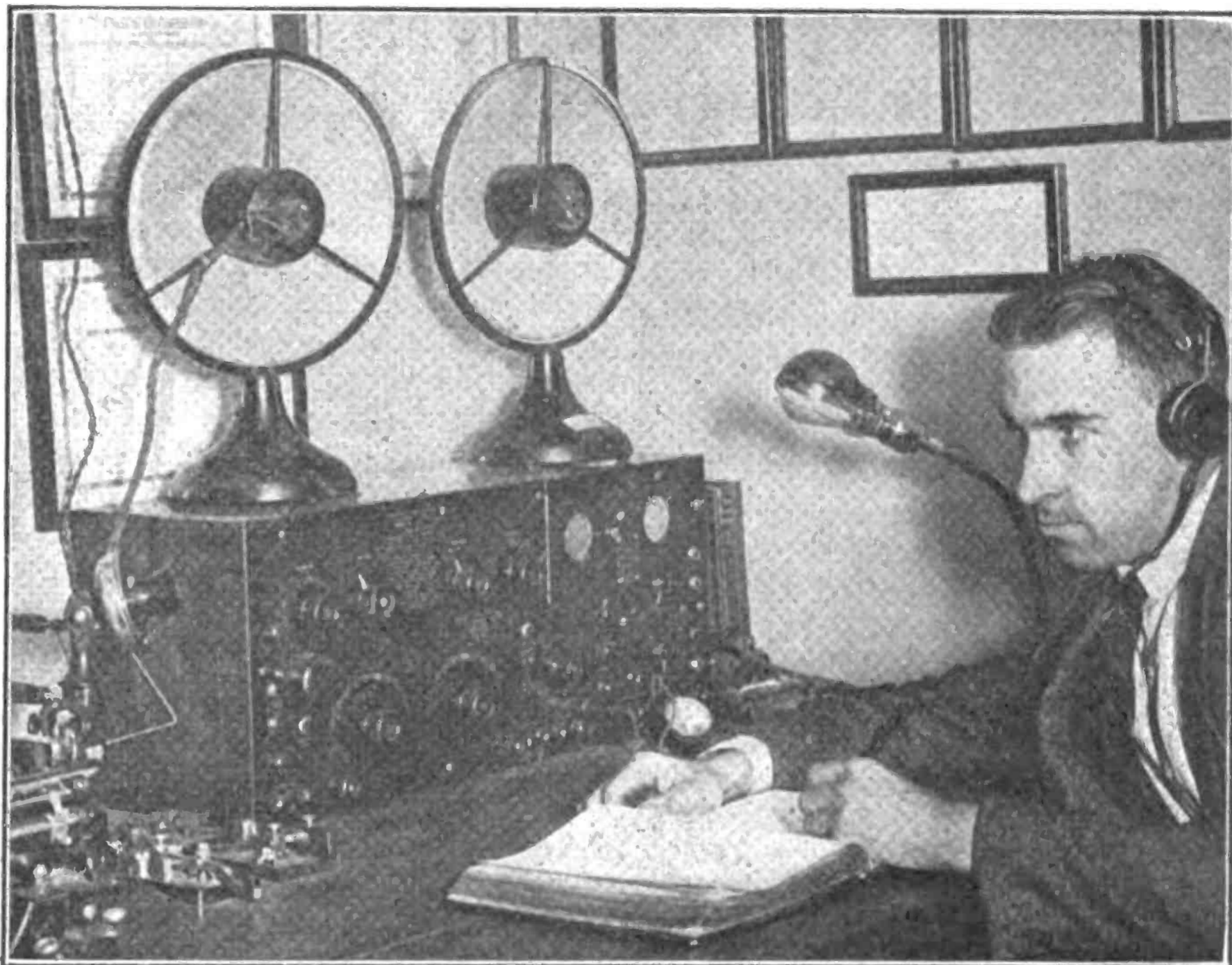

(C. Kadel & Herbert)

Radio fans wonder how WJZ, Newark, New Jersey, retransmits the Arlington, Virginia, time signals every day. The time signals are received from Arlington on this heterodyne receiver, after which they go through the amplifiers to the aeriols. This heterodyne receiver operates on from 250 to 2500 meters. The photograph shows Raymond F. Guy, well known to radio audiences as "O.G.N.," retransmitting the Arlington time signals.

minute before the hour. Each of these blanks is caused by a missing tooth on an otherwise complete gear-wheel. Following the 59th second of the last minute, there is a long dash commencing at the beginning of the new hour. Listen in for NAA on 2650 meters and set your clocks then.

By means of a radio receiving set at the observatory the message of ticks may be caught and recorded

on a chronograph for comparison with the sending clock's record to determine the loss in transmission. It average about .09 of a second. The time signals sent from Annapolis on a wave length of 16,900 meters have been heard in Australia, while in the Antipodes time signals have been heard coming around the world both ways. With a receiving set it is now no excuse to say "my clock was wrong."

Better Radio for Infantry Units

SIGNAL Corps radio engineers are perfecting a better field-radio set for army infantry units. The present spark set, SCR 105, developed during the World War, has become practically obsolete and continuous-wave sets are desired.

A board of Signal Corps officers, which met at Camp Vail, New Jersey, recently, has recommended that surplus sets such as SCR 79-A, 127 or 130 be issued to infantry regiments for training purposes until continuous-wave sets can be developed and distributed to replace the old 105s. Recently the continuous-wave sets were adopted for all Army radio communication.

The old 150 sets are quenched-spark sets used for transmitting and receiving between headquarters, usually not more than five miles apart, but if an amplifier was employed by receiving stations it was useful up to about thirteen miles.

The SCR 79-A, one of the sets recommended by the board as a temporary

substitute, is a vacuum-tube set designed for transmitting undamped waves and for receiving either damped or undamped signals. The transmitter delivers about ten watts to the antenna, and the messages will carry about twenty miles on waves between 500 to 1100 meters. This set was designed for use at command posts, or at headquarters, where transportation is available.

Details of the new sets are not completed, but it is understood that they have a range of about ten miles, and will be used between regiments and brigade headquarters.

Radio Don'ts

Don't attach ends of antenna to power or telephone poles.

Don't connect a radio set direct to the electric light circuit.

Don't forget that tickler coils are not used with crystal detector sets.

The Radio Primer

For Thousands of Beginners Who
Are Coming into Radio Circles

Weekly A B C of Radio Facts and Principles Fully and Tersely Explained

By Lynn Brooks

What is a variable condenser?

A VARIABLE condenser consists of a number of semicircular metal plates arranged in two sets. One set is stationary; the other may be moved on a pivot so that both enter between the stationary plates but without touching them. All the stationary plates are connected and, likewise, the rotating plates. The plates may be of aluminum, brass, or any other metal that retains its shape.

* * *

What is the function of the variable condenser?

The variable condenser supplies an electrical quantity known as capacity. Radio circuits are made up of inductance and capacity. Tuning coils supply much of the inductance while condensers are depended on to supply the capacity. Perhaps a clearer idea of capacity would be gathered if a condenser were to be considered as a miniature storage-battery which catches and holds the minute electrical impulses until there are sufficient to make an impression on the head phones.

* * *

How does a variable condenser store up these impulses?

Strange as it may seem, it is not the metal plates in a condenser that hold the impulses, but rather the air between the plates. The impulses come in from the aerial and are transferred to the detector circuit by simple tuner, loose coupler, variometer, or vario-coupler. The sounds are made up of little trains

of waves. These trains come into the metal plates of the condenser and cannot jump from one set of plates to the other. Thwarted, they are still able to strain or twist the air between the plates. This action is the same as when a piece of soft rubber is twisted in one's hands. So long as the pressure is maintained, the twist will remain; but if one hand is removed, the rubber returns to its former shape and size. In the condenser, the waves strain the air and the air holds the strain until it has stood all it possibly can. Then it "back fires," to use a common term.

* * *

Are other than variable condensers used in radiophone sets?

Yes. There are grid condensers, fixed condensers and the by-pass condenser. These are used in receiving sets.

* * *

What is the grid condenser?

When a train of waves enters from the aerial through the secondary of the loose coupler or vario-coupler, the grid is affected with an alternation of positive and negative waves. As previously described, the flow of electrons from the filament is helped when the grid is positive, and hindered when the grid is negative.

* * *

What is a grid condenser made of?

A few square inches of tin foil separated by a good grade of waxed paper, both materials being folded several times to conserve space.

cuit, thus increasing the grid current and, likewise, the current in the phones. This feed-back is accomplished by either tuning the plate circuit, or by using a tickler coil or a coupler condenser.

Lines of Force—Those invisible streams of magnetism that surround a coil of wire, such as tuning coil, loose coupler, or vario-coupler. It is these lines of force that transfer the electrical energy from the primary coil of a tuning device to the secondary coil. That these lines actually exist can be proved easily by laying a piece of paper on which fine iron filings have been strewn. The filings will assume positions along curved lines which lead

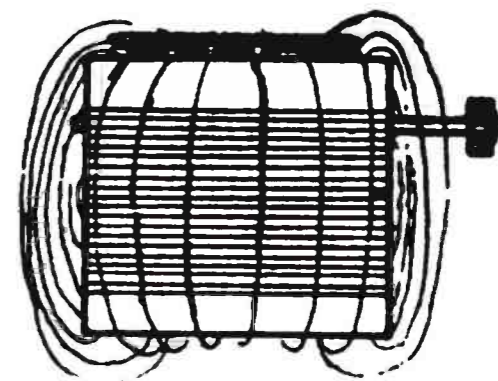

How lines of force act in a radio loose-coupler

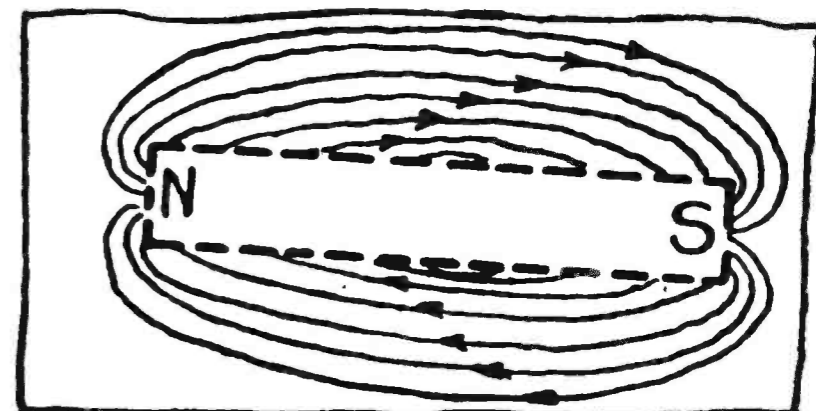

How the lines of force would affect iron filings if the metal particles were spread on a sheet of paper over a bar magnet.

from one end of the magnetized strip to the other. Although there is no metal around tuning coils except the copper wire—which is nonmagnetic—these lines of force exist. They pass out of the individual turns of the coil down through the center and around to the other side.

Non-magnetic—The term applied to some common metals which are not attracted, or repulsed, by a magnet. Copper, brass, carbon, and gold are nonmagnetic metals.

Radio Notes

SOMETIMES it is difficult to find a sensitive spot on your crystal. Try the following plan: Take a discarded crystal, and pulverize it, but not very finely. Put some of this inside a metal casing and screw it into the cup of your detector. You will be surprised to note how quickly you can find a good spot.

The receiver is capable of all sorts of refinement. The best way to perfect one is not to hurry the job. Some amateurs take months to build their sets; but when the sets are finished, they are real ones. *The secret of radio construction is patience.* Even after the set is completed it is well to try making a few changes in the wiring provided this seems necessary.

Radio Terms That Puzzle Beginners

NEW radio fans seem to have difficulty in understanding many of the technical terms connected with the art. In many cases, incorrect definitions are published. These frequently cause confusion, and poor results when applied to the operation of radio instruments. A few of the more important terms are herewith defined:

Crystal Set.—This type of receiver derives its name from the form of detector used with it. A detector of this sort depends for its rectifying qualities on a little crystal

of one of the number of crystals, such as galena, silicon, carborundum and others. The disadvantage of the crystal is the range which it offers. It is satisfactory in a range from 15 to 20 miles. Its advantage is due to the fact that its upkeep is low—comparatively inexpensive. For short-distance work, it gives satisfaction.

Regenerative Set.—This is the vacuum-tube set; for crystals cannot regenerate. The regenerative action depends on feeding part of the current flowing through the plate circuit back into the grid cir-

Receiver for Amplifying Weak Signals

By Horace Beers

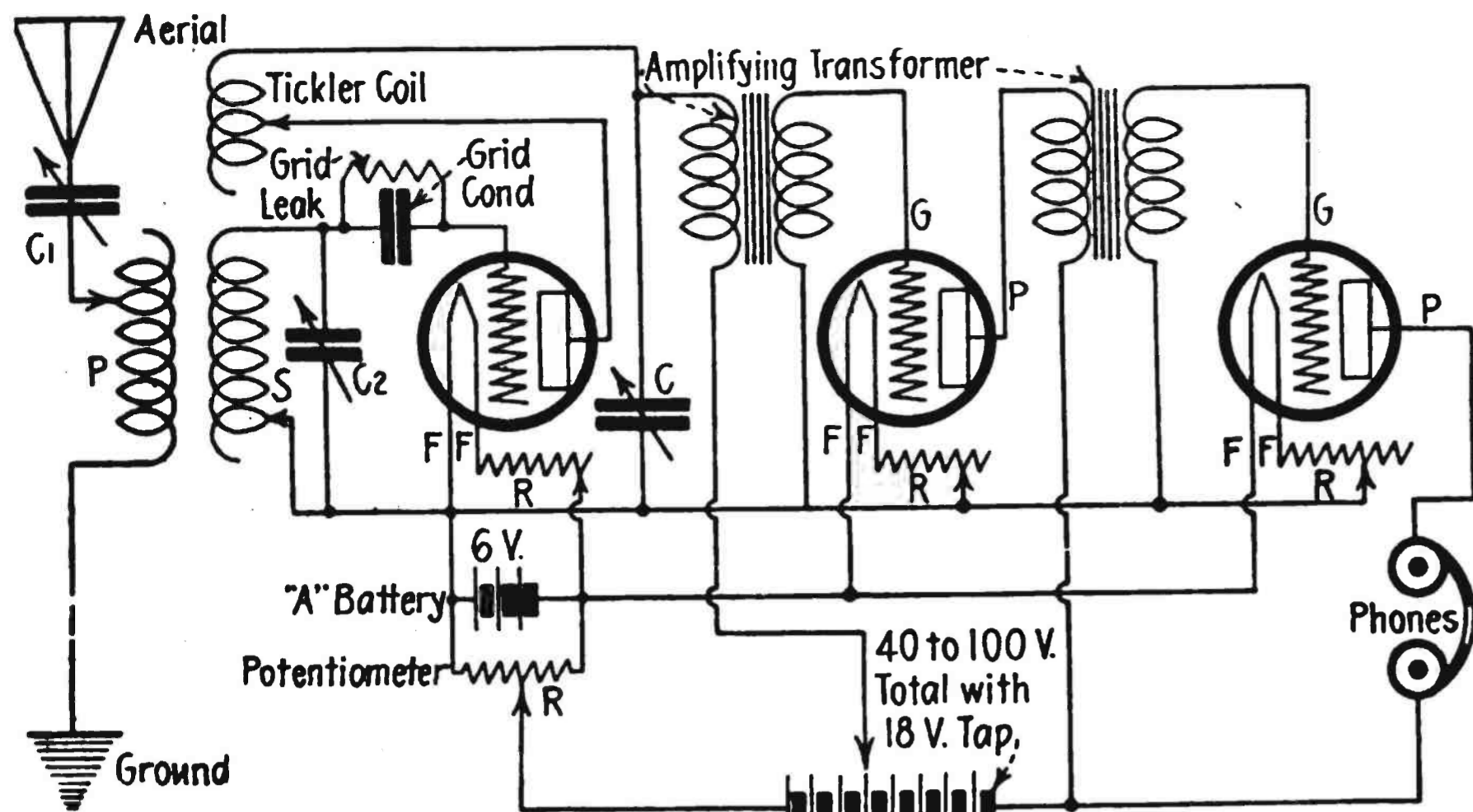

Complete schematic diagram of a detector and two-stage amplifier as described in the accompanying article.

THE regenerative type of receiver has come into very common use in the reception of both radio-phone and radiotelegraph communication, and the added increase in strength of signals makes it possible for this type of receiver to catch the very weak signals from exceedingly long distances whereas with other types of receivers amplifying transformers are employed for loud signals.

It is my idea that we employ the amplifying transformers in connection with a receiver of the regenerative type. This would in turn give very satis-

factory results, especially to those interested in listening to the broadcasting stations. The accompanying illustrates a detector and a two-stage amplifier of the regenerative type. This form of receiver is unusually selective in its tuning, and requires critical adjustment in order to get the best results. The amplifier acts as a magnifier of the signals received by the detector. With each stage of amplification, the incoming signals are magnified many times.

With this regenerative receiver, distant stations may be brought in and the fan will experience for the first time

the complete satisfying thrill of hearing a faint voice announce, "This is broadcasting station WOC, Davenport, Iowa," or "this is 'Atlanta Journal' station WSB." True enough, the signals will be weak and they'll fade in and out as is customary with all distant transmitters, but they are *there!*

Most every listener is gifted with patience beyond the ordinary; for it requires considerable practice before the operator is sufficiently skilled to tune in these faraway stations. It is usually necessary to become somewhat of a "night" owl as these long-distance stations cannot be picked up with just a turn of the knob. However, until WJZ and WOR "sine off" for the night, the local interference is apt to make such an attempt hopeless.

In using a regeneration set, especially those who are not familiar with oscillation, a rushing sound like that of falling water is heard just at the point where the secondary and primary are tuned to the same wave-length. The broadcasting wave will make known its presence by a squeal, or whistle, the pitch of which may be varied at will. When this is tuned in, the primary circuit should be varied until it is as loud as it possibly can be made, then the plate and secondary circuit-condensers should be readjusted sufficiently to eliminate the whistle and bring in the broadcasting clearly.

Radiomen at WJZ We Hear But Never See



(C. Kadel & Herbert)

THOMAS H. COWAN, "A.C.N."

Mr. Cowan is concert manager at WJZ and one of the pioneer announcers. He has the distinction of having announced the first radio concert ever given and the first World's Series baseball games. He is 25 years old, single, and formerly was connected with the Metropolitan Opera Company.

RAYMOND F. GUY, "O.G.N."

Mr. Guy, who is 24 years old, and married, has been with WJZ since December 1, 1921. He is one of the best known operators in the country—for WJZ, Newark, N. J., is widely heard. The initials are arranged to read, if one wants to know: (O) operator, (G) Guy, (N) Newark. In the instances of Messrs. Cowan and Watt, (A) is for announcer.

JOSEPH L. WATT, "A.W.N."

Mr. Watt is in his 30th year, and married. His particular work is to announce the many literary features sent out by WJZ. When you hear the familiar voice saying, "'A. W. N.' announces this or that," then you know that Mr. Watt is speaking. His cheery voice has been heard, it is estimated, in almost every State in the Union. He is a pioneer among radio announcers.

How to Learn the Code This Winter

By Ortherus Gordon

RADIO WORLD has suggested since its beginning, that the newcomers in radio learn the Continental Code. That this was appreciated was made evident when it was necessary to republish the code for the benefit of those who were lacking a copy of it and were requesting the editor to supply it. In this article, I suggest the use of a practice outfit for learning code and offer an outfit that may be constructed by the ambitious amateur at very little cost.

If you are the only amateur in your community, owning such a set, you can command the interest of the other radio enthusiasts by inviting them over for code practice. They should bring their headsets, plug in on the buzzer, and take down the messages as you send them from your own home-made key and buzzer. Hide or muffle the buzzer so that its sound is not audible, or put it in the next room, and you will treat your friends to actual receiving conditions combined with a speed they can read and understand.

The outfit I describe is, also, ideal for radio clubs wishing to organize code classes for work during the winter. Only two instruments are needed—a key and buzzer, with a dry cell for operating them. If you own a crystal set, then you already have the buzzer; but since it is desirable to have this practice set mounted on a single board, you may want to build another. Amateurs who own regenerative outfits do not use buzzers as detector tests and, therefore, should follow the plans as they appear in this article.

While definite instructions are given, it is understood that the dimensions and other features of the drawings are not rigid by any means.

The key shown is a serviceable and yet simple affair. For its lever use a 5-inch piece of $\frac{1}{4}$ -inch solid-brass rod. This rod is drilled as

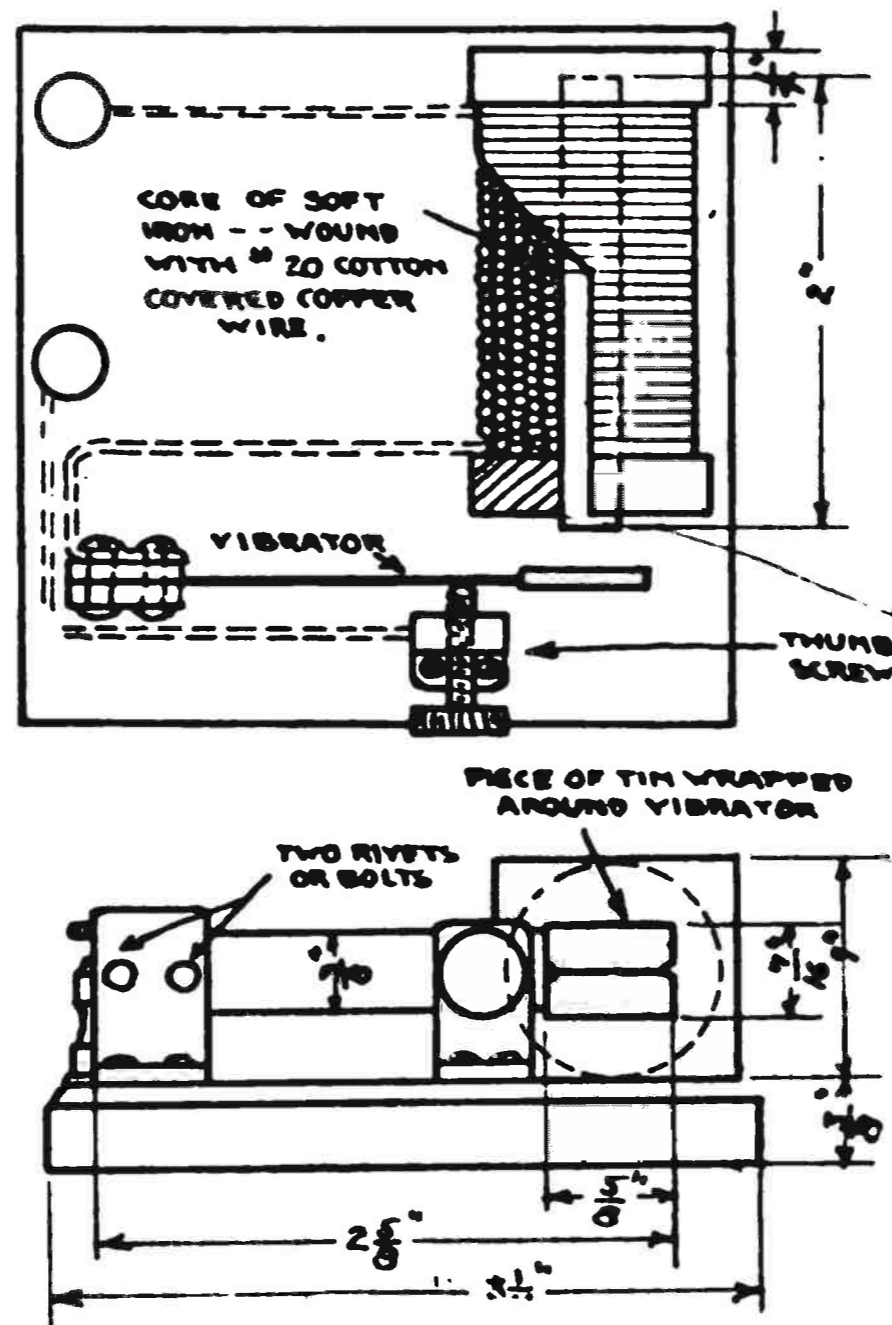

Figure 2. The buzzer. Made according to these dimensions, it will have a high, pleasant pitch.

shown in the drawing—all taps being the useful $\frac{8}{32}$. The knob is made of wood or hard rubber.

If the amateur wants a good-looking knob, consider the tops of ink-bottle corks. I mean the two or four-ounce bottles and not the office size.

The spring is made of spring brass and may be cut to suitable dimensions. The uprights are made of brass plate or of wood, the only requirement being that they afford a rigid fulcrum for the lever. The fulcrum pin is a brass rod passed through the lever at right angles and fitted snugly into holes in the uprights.

A convenient feature of this key is the use of battery binding posts for contacts. Take the nut of any dry-cell binding post and saw it in half. This will give you the upper and lower parts of the contact. Fasten the lower part to the base of the

key and the upper to the lever, as shown, and then file them flat so that a perfect contact is made when the key is pressed. Only the principal dimensions are given.

The buzzer—full plans of which are shown in Figure 2—may be explained as consisting of three parts, each part to be made separately and put together last. They are the coil, the vibrator, and the thumbscrew.

The coil has a soft-iron core. In this buzzer it is 2 inches long and $\frac{1}{4}$ -inch in diameter. This core may be either a solid piece of iron or a bundle of thin iron wires; but they must be soft iron. If steel is used, it becomes permanently magnetized and defeats the principle on which the buzzer works. The core is held firm by two wooden ends, 1 inch square and $\frac{1}{4}$ inch thick. It is embedded in the after end, as shown, but protrudes through the forward end $\frac{1}{16}$ of an inch. When it is rigidly set up in these supports, wind it with six or seven layers of No. 18 or 20 cotton-covered copper wire. Bring both ends out free. If you wish, give the coil a coat of shellac or cover with tape for appearance sake.

The vibrator is a strip of copper or brass $2 \frac{5}{8}$ inches long by $\frac{3}{8}$ -inch wide. You may use spring brass if you wish, but it is not necessary. One end of the vibrator is made fast to the standard while the other end is wrapped with a piece of tin. This tin is placed directly in line with the center line of the core, as shown in the sketch. This is necessary because an electromagnet does not attract copper or brass.

The thumbscrew hardly needs explanation. It is merely an $\frac{8}{32}$ screw fitted into a brass standard, or support, and placed so that it is just to the side of the tin plate on the vibrator and touching it.

The connections are as follows: One end of the coil goes directly to

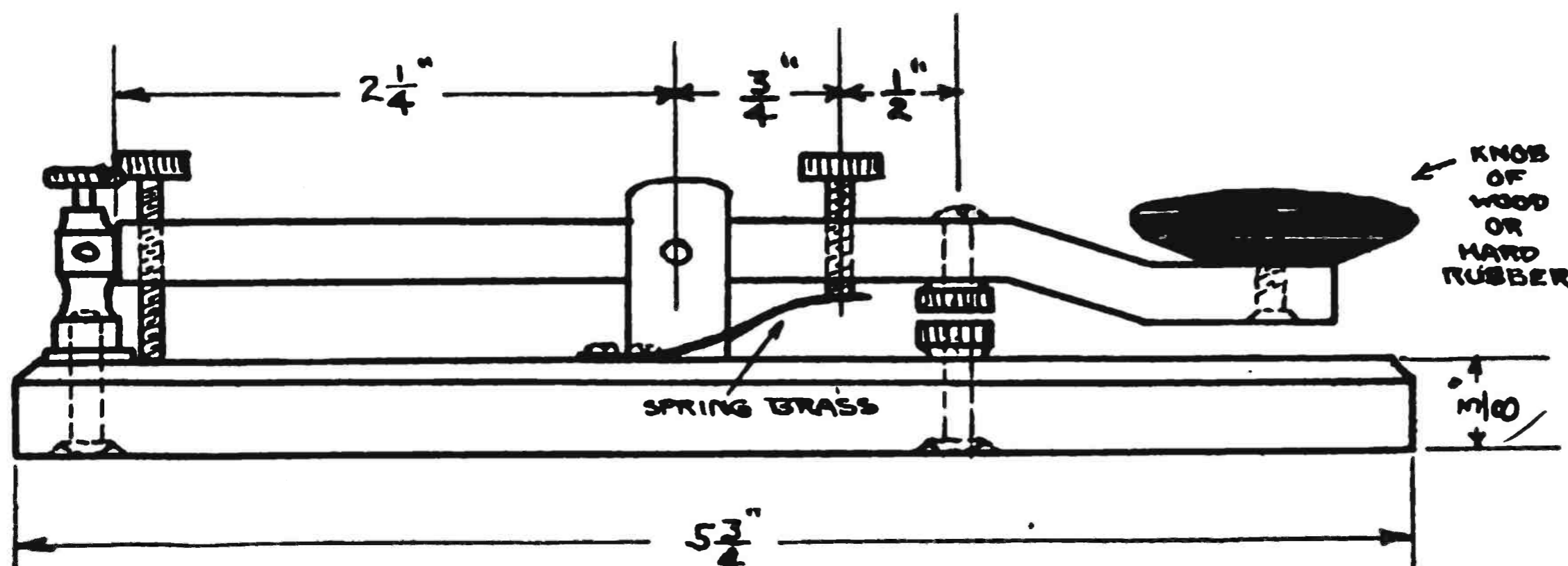

Complete schematic diagram, giving the necessary dimensions for the construction of a transmitting key. For the lever use a 5-inch piece of $\frac{1}{4}$ -inch solid-brass rod. The knob may be of wood or hard rubber. The spring is of spring brass, and the uprights of brass plate or wood. The fulcrum rod is a large brass pin. Battery binding-posts are used for contact. Read the accompanying article carefully for further detailed instructions which the amateur builder should follow closely.

Conductive Amplifying Receiver Picks Up Long Distances

By Herbert K. Dale

DR. FRANCIS LEROY SATTERLEE, noted X-ray specialist who is now devoting himself to radio research at his laboratories, Flushing, New York, is shown in the accompanying photograph with his "inductive amplifier," a non-regenerative radio-receiver working on an entirely new principle. With it he has reached unusual distances, having heard from Ontario, as far south as Louisville, Kentucky, and over a sweep from Memphis to Denver. The apparatus has the effect of radio-frequency amplification without employing radio-frequency bulbs and transformers, the receiver using only one bulb for radio-frequency detection. The signals are then amplified by two or more steps of audio frequency in the usual manner. This is the same set

that interested Major-General George O. Squier, Chief Signal Officer, U. S. A., who said he would give fifteen minutes to see a test of this receiver, but actually gave three hours.

The novelty in Dr. Satterlee's set is the arrangement of the inductances. He uses three flat spiral-wound coils which look a great deal like a small talking-machine record. Two operate with a "butterfly" motion. The third moves through an arc between the

other two, similar to a bookmark slipped between pages of a book. Rough tuning is accomplished by a variable condenser, and thence finer tuning by the variation of the positions of the three coils.

Extreme ease of manipulation and freedom from distortion are features of this set. With a 125-foot aerial, Dr. Satterlee hears distant points.

The large set on left of the lower illustration shows the original set made by him, while the small set on the extreme right is the present-day model embodying the same principles.

(Continued from preceding page)
the binding post. The other end goes to the vibrator, while the second binding post is connected with the thumbscrew. Figure 3 shows the hook-up for the key, buzzer, and dry cell—together with the headpieces as they should be connected in order to hear the buzz of the instrument loud and clear. There is no limit to the number of headphones that may be connected to the buzzer outfit in this manner. In fact, in radio schools where the

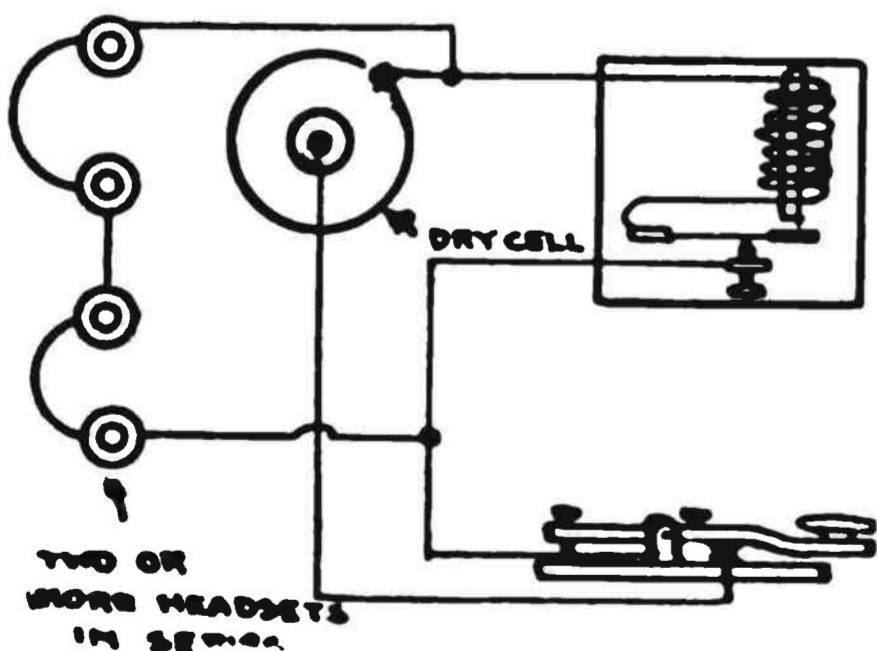
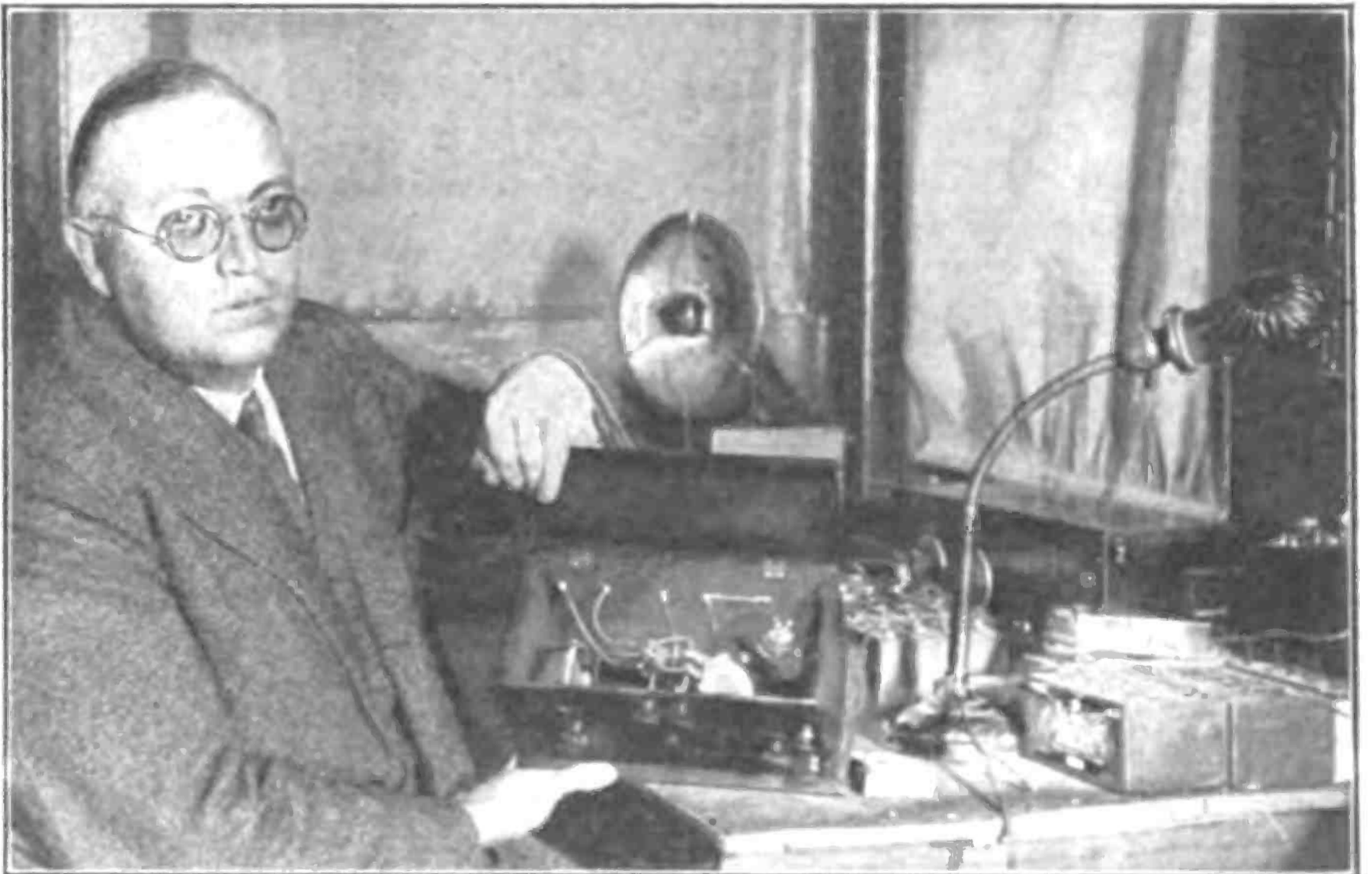

Figure 2. Hook-up for buzzer set with two or more headphones attached for code practice.

teaching of code is an important part of radio work, the headphone extension is run down the center of a long table, with jacks at every chair, so that at times as many as one hundred students are listening in on what the instructor is sending.

These instruments have been designed separately; but you can put them both on the same base and save binding posts. Such a set is invaluable to the amateur who is eager to learn code.



Both photographs (c) Kadel & Herbert.

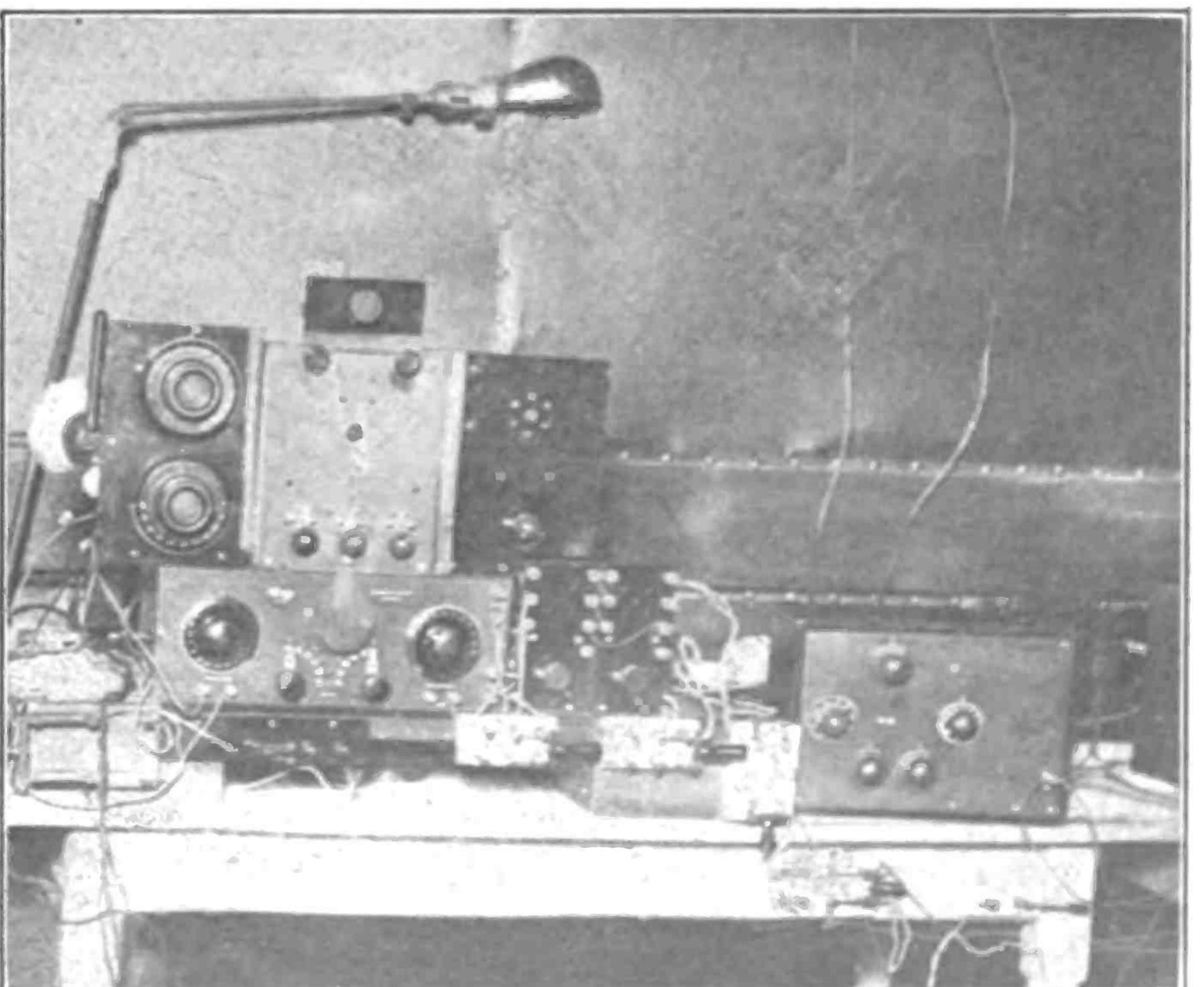

(Above)—Dr. Satterlee and his small one-bulb set. (Below)—Original large set, and (at extreme right) his new invention.

Radiograms

Latest Important News of Radio Garnered from the World Over, and Reduced to Short Wave-Lengths for the Busy Reader.

THE possibilities of the radiotelephone as a newsgathering agency were demonstrated in a dramatic manner, recently, when "The Inquirer" was the first newspaper in Philadelphia to receive word of the disastrous fire which swept the business district of Atlanta, Georgia. Through Edwin A. Hoban, a member of "The Inquirer's" local staff, a radio enthusiast, the news came into "The Inquirer" office even before the first flash from the Associated Press reached Philadelphia. The information came from station WSB, operated by the Atlanta "Journal," and located in that newspaper's building. The news, announced by the speaking voice instead of by the more conventional medium of the telegraph instrument, came floating through the air, a distance of approximately 760 miles.

The Bureau of Mines of the Department of the Interior is seriously considering the problem of equipping mines with radio apparatus for use in the event of accident. The stringing of telephone wires is impracticable, but officials state that it would be fairly simple to equip certain distant rooms, or chambers, with crystal receiving sets so that rescue parties could communicate with imprisoned miners. The real problem is to find a simple and portable transmitting set by which the miners could communi-

Corkscrew Radio May Serve to Pick Up Rum Runners



(C. Fotograms, N. Y.)

Don't throw away that corkscrew—even if the Volstead Act is in force. There still is a good reason for keeping it around the house. It can be improvised into a real radio outfit, that may do everything a radio outfit should do. This photograph shows Jack Riley with his corkscrew radio. It is not a complete outfit, but it will serve to pick up warnings for the rum fleets. Two receivers are attached to the device, which is guaranteed to pick up all radio messages within a fifteen-mile circle. It is only necessary to attach it to a light plug or charged wire in order to hear music or bed-time stories as you drink.

cate with the mouth of the mine of the outside world in the event of being injured in or imprisoned after an accident.

* * *

Several types of speaking movies, based on the principles of radio will be tried out on the New York public in the next few months. The most serious competition will be probably between the General Electric Company, which is reported to be perfecting its talking film in a studio on Long Island, and Dr. Lee de Forest, who is working with motion-picture actors and directors at a studio near this city. The General Electric talking film and the de Forest invention both consist of films in which the voice and other sounds are photographed at the edge of the motion-picture film itself. The photographed sound waves are reproduced in each case with the aid of the photographic cell. Those who have heard the Lee de Forest phono film and the General Electric talking film say they have both reached a high degree of perfection and reproduce the human voice.

* * *

Rear Admiral W. H. Bullard, U. S. N., who was in charge of the navy radio service during the world war, says that five powerful radio stations would soon be in operation in China with sufficient energy to communicate direct with San Francisco. Admiral Bullard says that radio will not supplant, but would supplement, cable lines, telegraph and telephone.

* * *

Great Britain is just beginning to regulate radio broadcasting. The British scheme is to have all broadcasting done by a single organization which will be sanctioned by the government, operated by manufacturers of receiving sets, and financed by both. Present plans call for the establishment of eight stations in the British Isles, at London, Manchester, Birmingham, Glasgow, Cardiff, Plymouth, Newcastle and Aberdeen.

* * *

The Mercantile Trust Company of San Francisco has established a broadcast station on Telegraph Hill, and will broadcast financial, industrial and general business information throughout the territory west of the Rocky Mountains.

* * *

"Ariograms" is the name given to United States Department of Agriculture radio reports.

* * *

The Los Angeles "Evening Herald" is broadcasting lessons in code fifteen minutes every week day. This is the first step in the way of definite instruction by radio. The University of California extension division, Berkeley, is supplying a correspondence course in elementary radio. California is keeping to the fore in radio enterprise.

* * *

Dr. Nicholas Murray Butler, President of Columbia University, believes that the motion picture and the radio-telephone are going to become invaluable in the educational work of the future. He lays stress, however, on the necessity for the right material being filmed or broadcast.

* * *

Here are three extraordinary transmission records. Two western correspondents, E. J. Conkelman, Enterprise, Oregon; and E. M. Bacigalupi, Hillyard, Washington, reported successful reception of the WGY concert of September 26 and, in both cases, their reports checked up accurately with the WGY station log. Hillyard is seven and one-half miles northeast of Spokane and 2,200 miles from Schenectady. The distance has been bettered by WGY but never during the early fall. Mr. Bacigalupi reported that his reception was made on detector alone with a Grebe Cr-9 and no amplification. His time of reception was 6:15 to 6:30 p. m., Pacific time.

On September 29, Private G. G. Westfall, operator at Fort Randolph, Canal Zone, Panama, 2,250 miles from Schenectady, reported that he had on that date heard WGY in spite of a powerful arc set which operates twenty miles away at the Balboa station. Mr. Westfall is operator at the United States Army station. His call is WNCI. This reception is the more remarkable because of the heavy static which prevails in the warmer climate of the Isthmus of Panama.

Still another unusual reception is reported by J. C. Grindell, manager of the Rectifier Department of the Valley Electric Company, St. Louis. Mr. Grindell reports that he heard WGY's program Friday evening, September 29, on a home-made crystal set without amplification. His aerial, he explained, is one wire 65 feet long and 30 feet high. St. Louis is approximately 875 miles from Schenectady.

Radio and the Woman By Crystal D. Tector

I CALLED at the office of RADIO WORLD, the other day, to have a little chat with the editors about National Radio Week. Friend Husband advised me not to do so. He told me that the editors are usually so busy they become ferocious and devour people on sight—that they imagine that every woman who enters a sanctum wants to sell a poem on spring—that women talk editors to death, and all that sort of chatter. Well, I didn't heed F. H.'s warning.

* * *

I must admit that editors are just like any other type of human beings and will stand perfectly still without being hitched. They don't bite, or even bark; in fact, they seem to have all the necessary elements of kindness that one expects to find in ordinary men. When I reached home and told this to Friend Husband, he simply laughed and snickeringly asked if I hadn't got in the wrong pew! Fancy! I found the editors of RADIO WORLD not only willing to talk but very (*We modestly delete the rest of Miss Detector's flattering comment. She is entitled to her opinions; but the power of the blue pencil must be preserved—The editors.*)

* * *

Well, I left their offices convinced that National Radio Week will be about the biggest thing in the United States this winter. The date—December 23 up to and including the 30th—could not be more satisfactory, for we will have two Saturdays during the time of the year when everyone will be on the alert for fun of some sort. And as so many of us are looking to radio to provide something new in the way of pleasure, it does seem that the prevailing slogan: "This is a radio Christmas," is most appropriate.

* * *

Mother was telling me that she remembers when the automobile first came into popularity. There was such a week celebrated in her home town. It wasn't a big national affair such as our National Radio Week will be; but a purely local occasion. Although there had only been about two automobiles in the town up to the time "Automobile Week" was announced, everybody got so het up over the event, ma says, there were nearly a hundred cars in the parade—and some of them were the worst looking home-made affairs imaginable. It seems that everybody who was able produced a car for that occasion, and some folks even made their own. Ma says that she will always remember "Automobile Week" at home because an old-maid sister whom the folks thought would never marry found a willing beau.

* * *

From the stories she tells, the spirit of the people in making that week a success must have been something wonderful. And if such a spirit existed in one little town a quarter of a century ago, what must it amount to in this huge nation today? Personally, I am full to the brim with energy to make National Radio Week a success. I'm going to be the best little booster of them all. And I'm asking every one of my big family of readers to get right in and help me enthuse women all over the land.

* * *

I want you to send me suggestions. For instance: we should have an emblem, or a pin, or a hat band, or something else that can be worn that week. Who will be the first to suggest some attractive design or monogram? Who will be the first to send in an appropriate slogan? Who can think of something absolutely original for that week? Who will organize a committee to get the shopkeepers busy with window displays?

* * *

My first suggestion is that radio parties be made a bright particular feature of the occasion. They will blend most attractively with the Christmas festivities—particularly as so

many churches are interested in broadcasting and so many ministers are broadcasting their sermons. Why, I am told that thousands of poor people and cripples who never have a chance to attend church now thank God that radio can bring words of sacred cheer to them in their loneliness. Can't someone suggest something unusual for these unfortunates during National Radio Week?

* * *

And for the radio parties we will want all sorts of new radio dishes—dishes that are tasty and easy to make. Girls, haven't some of you a recipe for a radio pie? Can't some one think of a radio cake?—or a radio salad? If you will send in something along the line of edibles, I will have Friend Husband make up a radio drink. I'll promise that it will be quite in keeping with all the prevailing laws and that the recipe will be published in plenty of time for all who wish to use it.

* * *

Here in New York the spirit of National Radio Week is already apparent among radio fans. You hear it talked about already, and many plans are being made. But we want it to move westward with the sun. We want it to get so deep under the skin of every fan that he will not be content to enjoy it by himself or in the company of other fans, but will bring strangers into the vortex of things. One of its principal objects is to bring new fans into the fold. And if every radioist is responsible for at least one genuine beginner, radio will receive an impetus that will help all of us.

* * *

Friend Husband told me at dinner, the other day, that there is a fan in the office—remember, not an amateur but a fan. F. H. says that he asked the man, in a casual sort of way, if he really cared for radio. "Care for it!" the man flared up. "Why, I wouldn't be without it." Then he went on to tell of all the wonderful pleasures that his set had brought him. This man is just one of many—but there are millions more like him who do not know what a truly satisfying pleasure maker radio really is. We want these unknowns in the ranks of radio and we are going to get as many of them as possible in the ranks during the big week.

* * *

Now, don't think I am preaching or asking you to do missionary work. Far from it. We who know radio—we pioneers—want to share it with those who do not know. Why, for months I heard F. H. bawl out the man next door because he would not go to the ball games—and F. H. knows batting averages better than I know how to tune in KDKA. Finally the neighbor reluctantly consented to go with F. H. Last season you couldn't keep Mr. Neighbor away from the Polo Grounds with chains. That is the way it will be with thousands who don't know, to-day, whether radio is a science or a door mat.

* * *

I have given up largely of my space, this week, to National Radio Week. But I feel its great importance and I realize that it is going to be one big occasion. I know, too, that much depends on the women of radio to make it a success; because they are nearer to the little ones than the men are. And we all know that it was our boys who really made radio possible—who ignited its first impulse. Think what a combination of radio and Christmas mean to them!

* * *

Let me hear from you all. Start something in your town. Get the spirit. As our editors say: "Be a National Radio Week booster!" I will keep in touch with you regarding all my plans—but you must help to swing this great radio event into one of the most national joy festivals this big bustling country of ours ever knew.

How One of Our Hook-ups Worked

Editor, RADIO WORLD: In regard to the circuit on page 19 of RADIO WORLD (No. 30, dated October 21) issue, I tried it with one small change and brought in San Antonio, Texas, very clearly and fairly loud, using a one-step amplifier. The change made was the use of a variometer in place of the DL-50.

I was greatly surprised by the amount of regeneration obtainable and the ease with which regeneration was controlled by the condenser which would not appear to be in the plate circuit at all.

In the near future, I expect to try several long-wave hookups (1,500 to 30,000 meters) using a single coil, in the hope of finding one which will tune fairly close and give good regeneration with the use of DL coils. I shall certainly try this one with larger coils,

although I am afraid that the size of the condenser will limit the wave-length range to some extent.—L. J. Coleman, Sioux City, Iowa.

(The hook-up referred to by Mr. Coleman was sent to RADIO WORLD by Mr. W. Miller, Southern Methodist University, Dallas, Texas.—The editor.)

Complete Your File of RADIO WORLD
52 Weeks for \$6.00

Latest Radio Events Keep

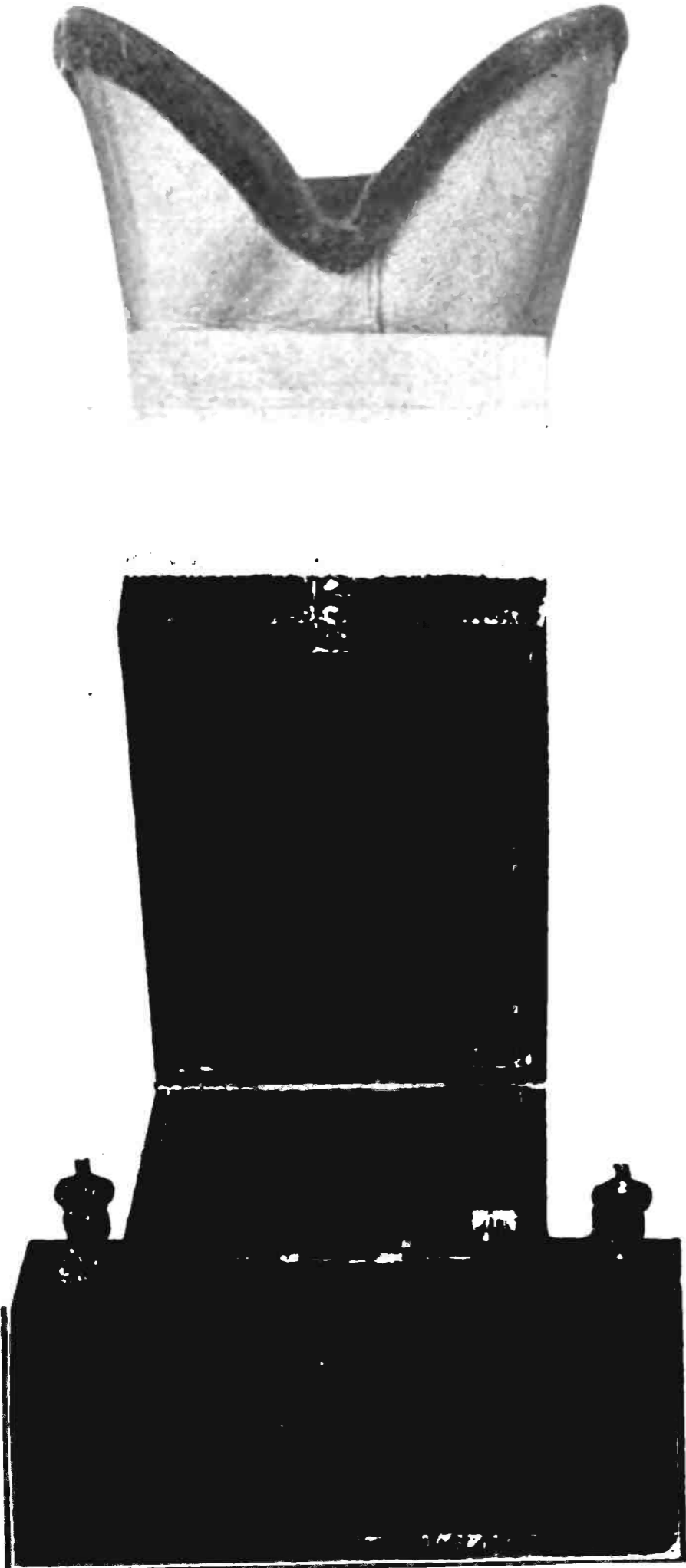

(C. Kadel & Herbert)

(Above) This is the mysterious "Black Box" of Thomas A. Edison, photographed for the first time. Through this mysterious device he discovered what he termed "athetic force," and which is, in reality, the wireless spark of today as perfected by Marconi. Ether is an hypothetical medium supposed to fill all known space, even those portions occupied by fluids and solids. The functions assigned to ether, such as the transmission of transverse waves with the velocity of light and the production, when under certain strains or subjected to certain motions—of all the phenomena due to electric and magnetic fields of force—indicate properties unlike those of any known form of matter.



(C. Kadel & Herbert)

Eight-year-old Robert Scott holding his tiny receiving set and a 50-watt transmitting tube to make a comparison.



(C. International News (Reel))

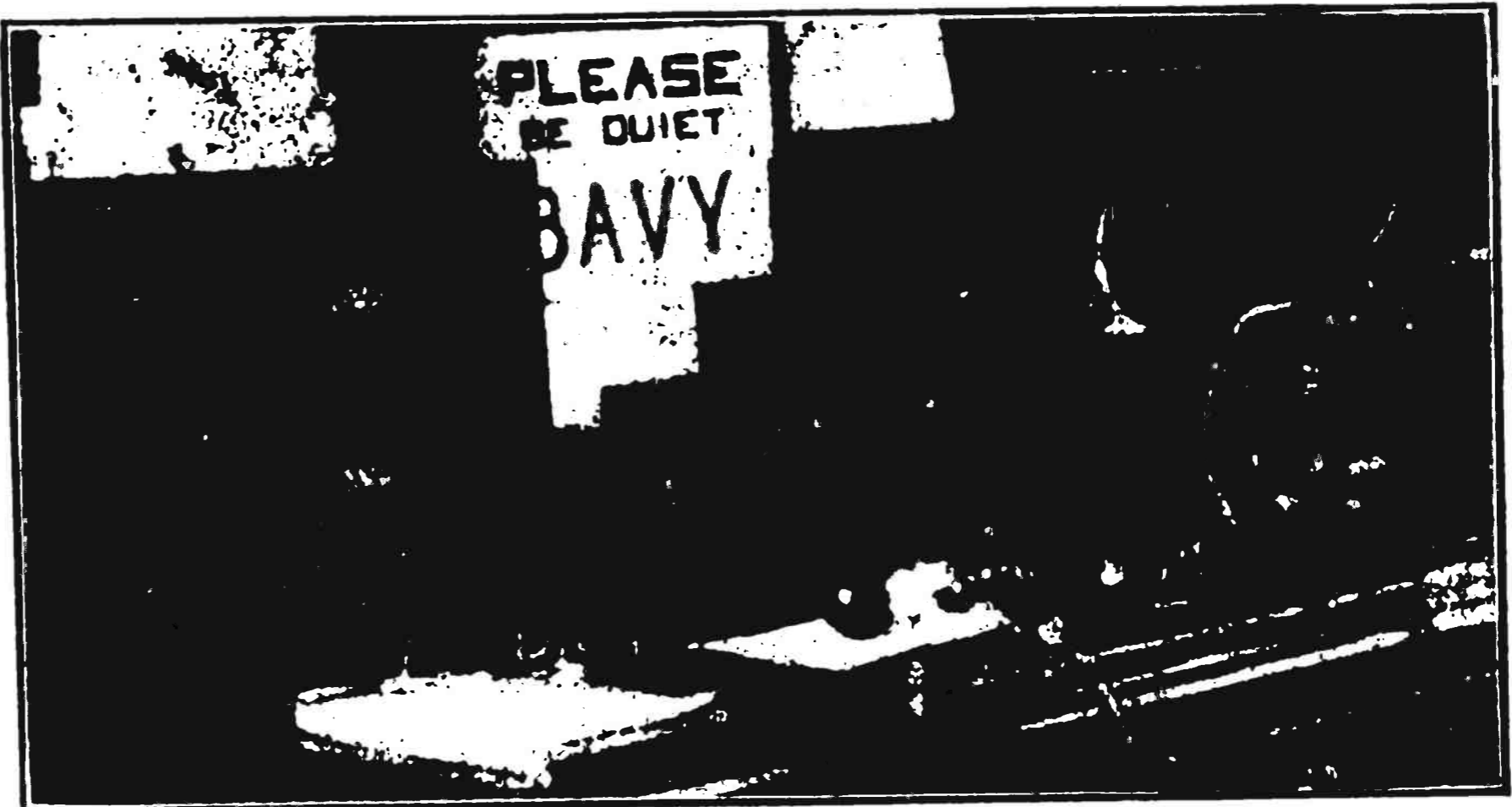

(Above) Dan...
naval expert...
the photogr...
Georgia Tech...
by radiophon...
was a huge...
mission could

(Left) "Close...
Couch, 78 W...
Miss Couch...
throughout...
who have ph...
type, with...
used which...

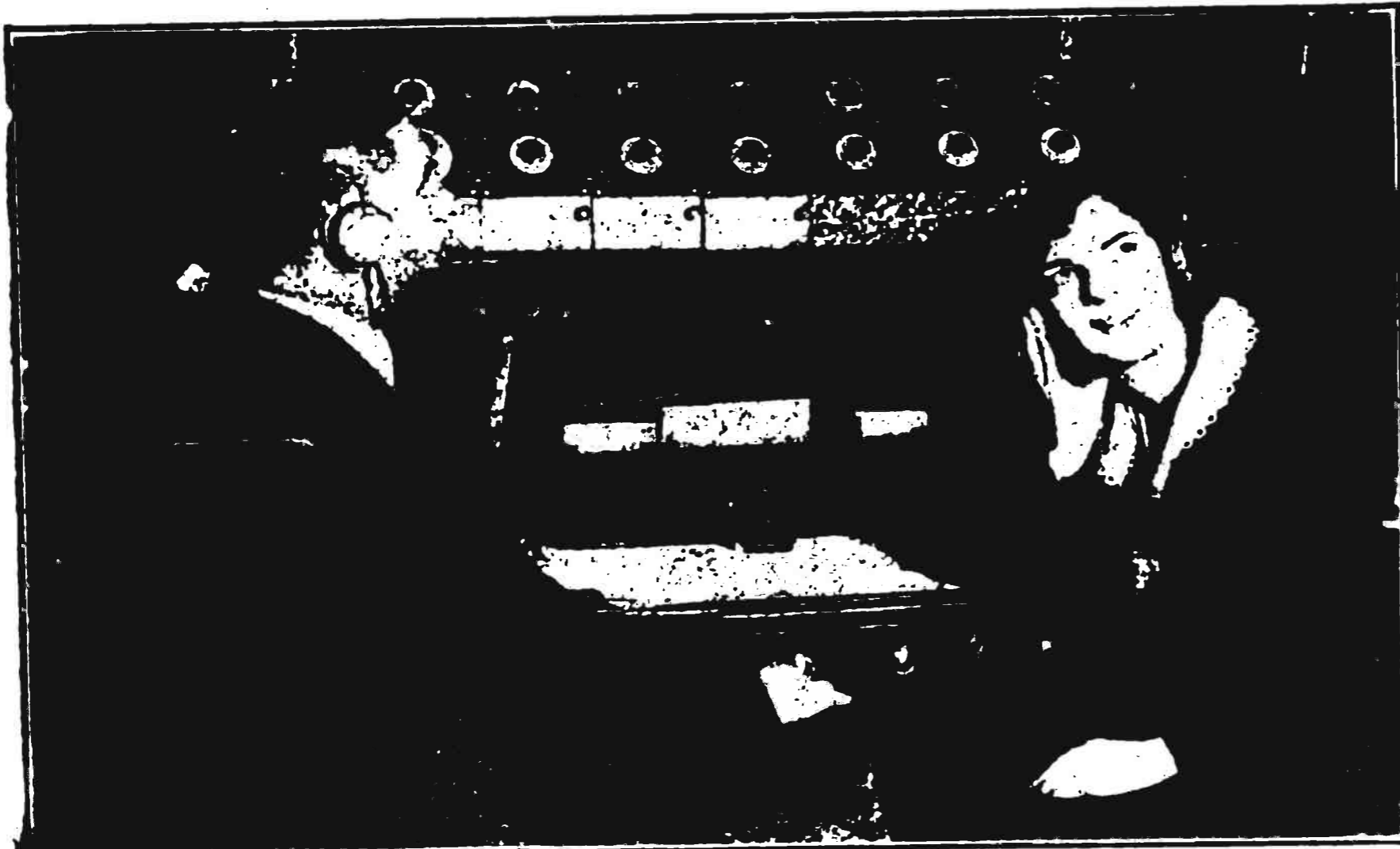

(C. Underwood & Underwood, N. Y.)

(Left) Listening to a concert by radio inside a steel passenger car traveling over sixty miles an hour. This is a photograph of the interior of the car. The experiment took place on the Broadway Limited of the Pennsylvania lines, running from New York to Chicago. An 18-inch loop, installed in seventeen minutes in an all-steel car was used. The reception was successful, broadcasting being heard during the entire trip.

(Right) The ever-smiling Mr. Fairbanks has become a radio "bug." He is talking so that many who have never heard him speak may know what the voice of this star of the silent drama sounds like.

(C. Photonews, N. Y.)

Photographers Busy



Captions
by
John
Kent

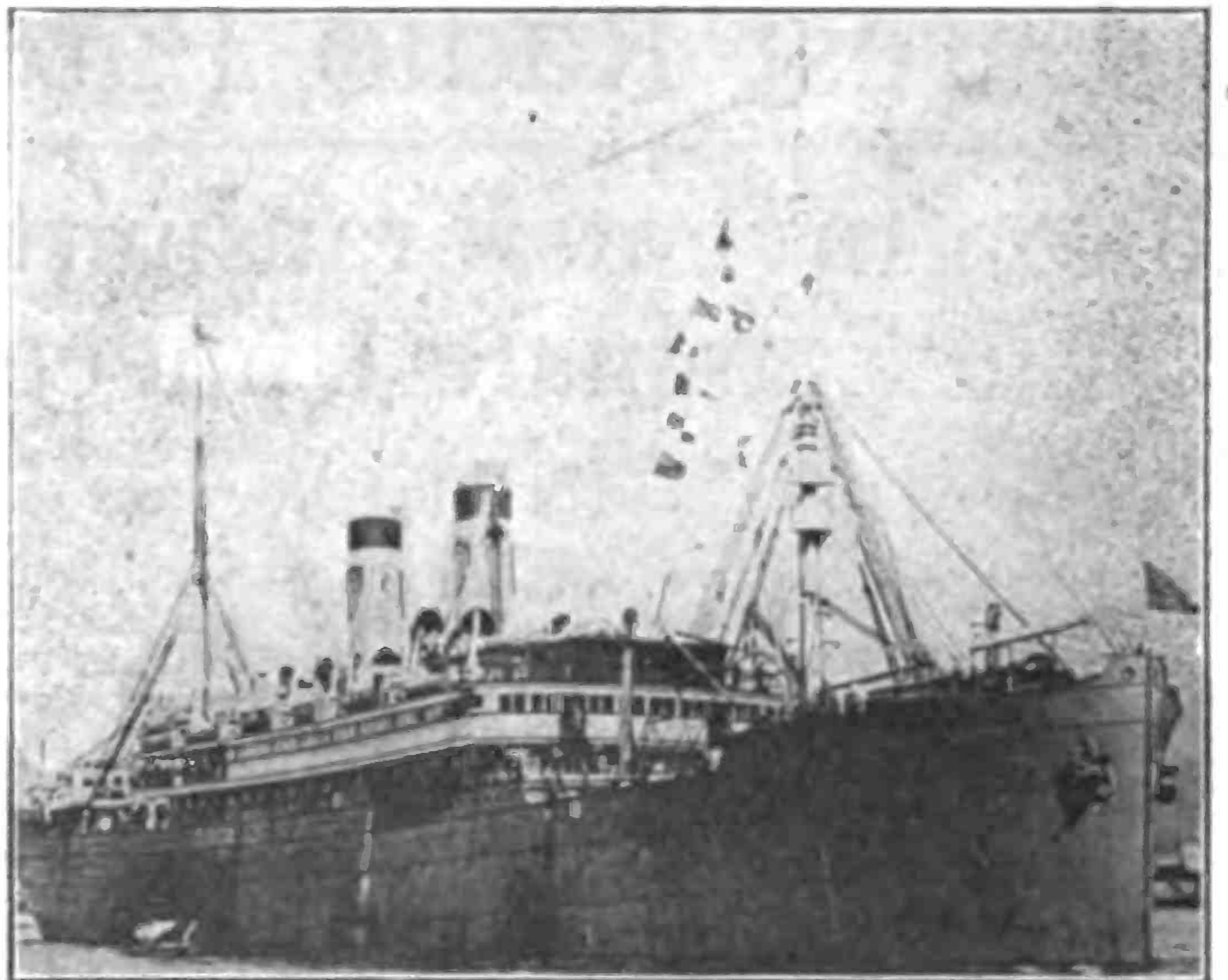

(C. Wide World Photos)

ing to music played by a band nearly two miles away was the
s of members of the Club de Vingt of Atlanta, Ga., shown in
listening to a special number. The music, played by the
Band, was transmitted to the roof of the Capital City Club
Radiomen who witnessed the demonstration said the dance
cess and that the few slight difficulties encountered in trans-
nally be overcome. A loud-speaker was used at the receiv-
ing end.

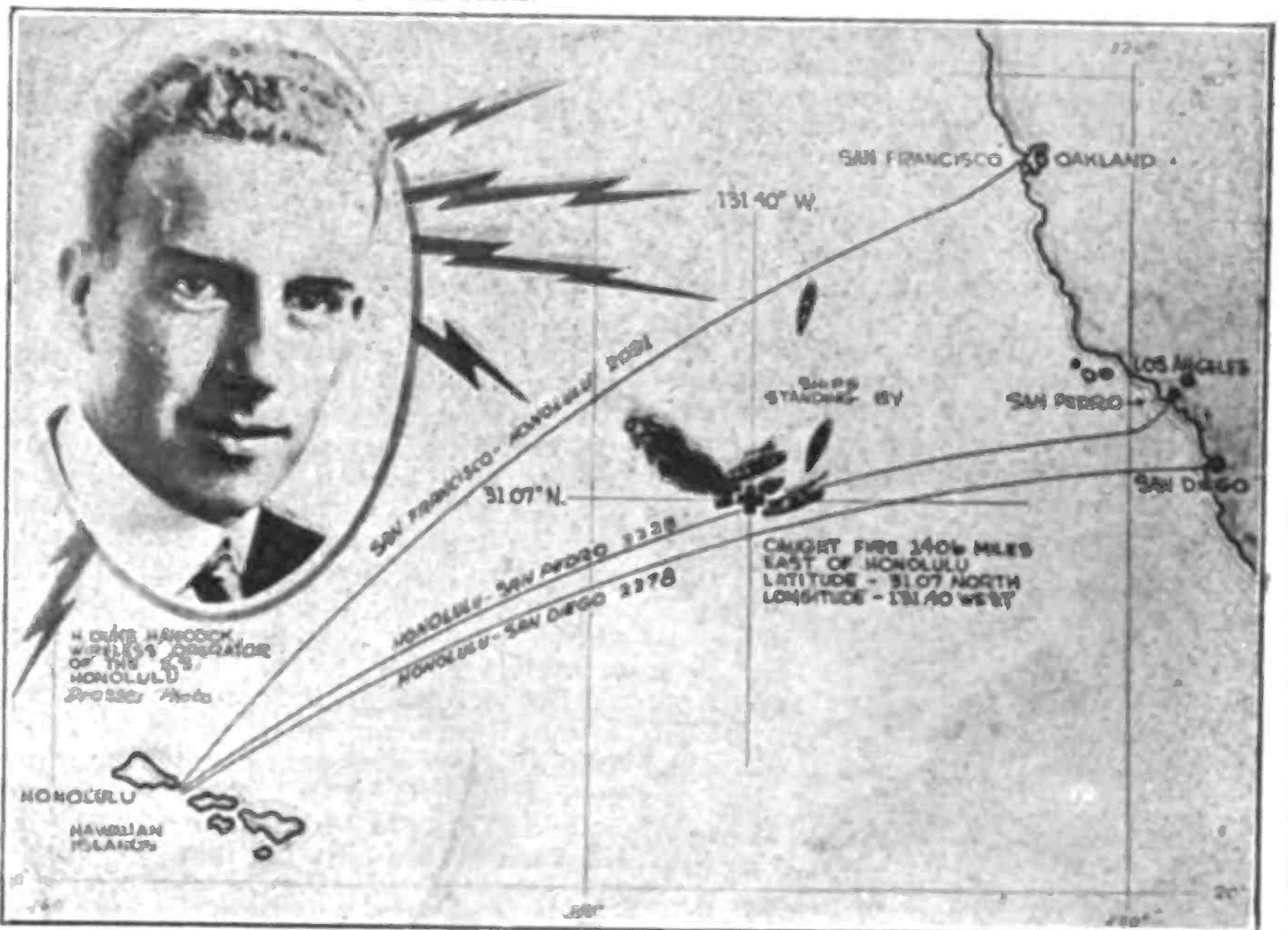

(C. International News Reel)

(Above) The upper photograph shows the "City of Honolulu," which burned to the waterline, 670 miles off San Pedro, California, on October 12. Her 217 passengers owe their safety to the prompt reply for help sent broadcast by her radio. The photograph directly underneath is an excellent chart of the scene with a good likeness of Chief Operator Hancock. This sea catastrophe made radio history. It proves that radio must be a part of the equipment of every vessel that carries human beings from one port to another. It is as necessary as steam.

(Below) The radio apparatus in this photograph is a loop aerial or direction finder—one of the most useful things now in use aboard all vessels that ply the high seas. This photograph was made in port—that is why Miss Claire Tarwell is in the picture.

" of the radio station owned and operated by Miss Catherine
ington Street, Carbondale, Pennsylvania. Her call is SAVY.
s of the pioneer radio amateurs of America. SAVY is known
Lackawanna Valley and there are fans beyond the borders
d it up. The receiver shown at the right is that of a Grebe
ve-stage audio-frequency amplifier. A loud-speaker is also
s on the amplifier. The transmitter is at the extreme left.



Latest Radio Patents

Edison Invents Transmitter That Will Eliminate Unnecessary Noises

No. 1,425,183. Patented, August 8, 1922. Patentee: Thomas A. Edison, East Orange, N. J.

My invention," declares Mr. Edison in a description published by the United States Patent Office, "relates to transmitters, and more particularly to microphone transmitters wherein the desired variations in current are produced by variations in electrical resistance caused by varying the pressure upon a quantity of granular conductive material, such as carbon, which is disposed between electrodes in the circuit carrying the current, preferably in a somewhat loose state, the requisite changes in pressure being effected between the electrodes and the granular material by a diaphragm, or other means, to be set into vibration by sound waves such as the human voice."

Practically all microphone transmitters of this type such as are now used are seriously and adversely affected by phenomena extraneous to the sounds they are designed to transmit, such, for example, as shocks, jars, vibrations, concussions, etc. These phenomena often

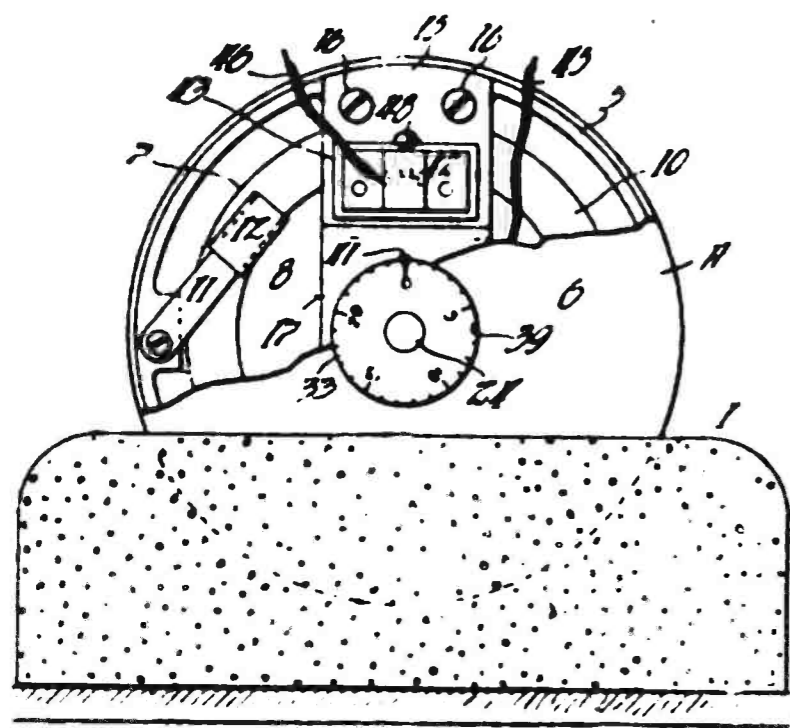
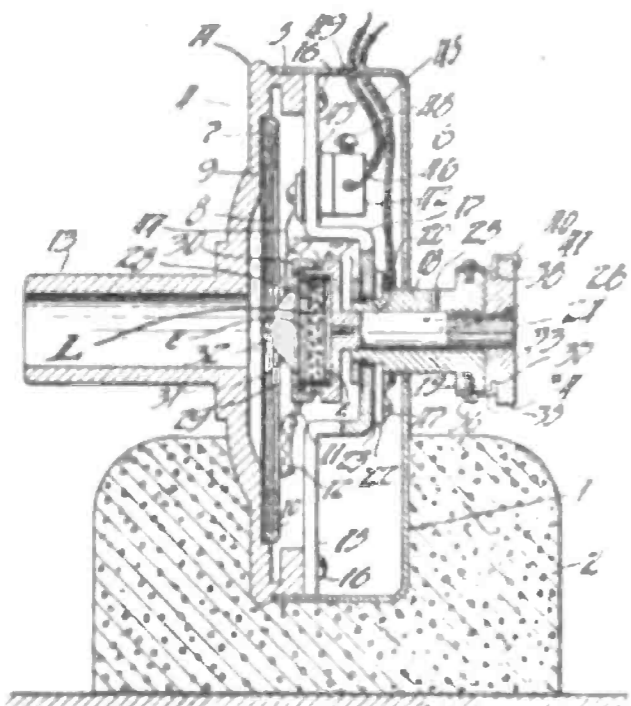

Figure 1 (above) is a vertical sectional view, partly in elevation, of a microphone transmitter constructed and mounted.

Figure 2 is a view in front elevation, partly broken away, of the structure shown in Figure 1.

create such relative movement of the conductive granules disposed between the electrodes of the microphone transmitter as to produce extraneous or foreign sounds, loud enough when amplified to practically obliterate and render

it impossible to understand or even detect the sounds which the microphone is intended to transmit.

The principal object of Mr. Edison's invention is to produce a microphone transmitter which will be extremely sensitive to very weak as well as to loud sounds and at the same time to substantially eliminate or prevent the production of extraneous sounds, making it possible to employ powerful amplifying devices, such as the audion, with the transmitter.

Operating Vacuum - Tube Circuits

No. 1,426,755. Patented, August 22, 1922. Patentees Robert C. Mathes, New York City, and Harry S. Read, East Orange, N. J.

THE invention on which Messrs. Mathes and Read have received letters patent, relates to vacuum-tube circuits, more particularly to multistage amplifier-circuits in which vacuum tubes are employed in the various stages.

It is well known that a vacuum tube of the three-electrode type will reproduce in amplified form in its output circuit impulses impressed upon its input terminals, and that the amplified impulses may be impressed on the input terminals of other tubes to give any desired degree of amplification. When such a multistage amplifier is employed to amplify low frequency impulses, it is generally preferable to have a direct coupling instead of an inductive coupling between stages in order that the low fre-

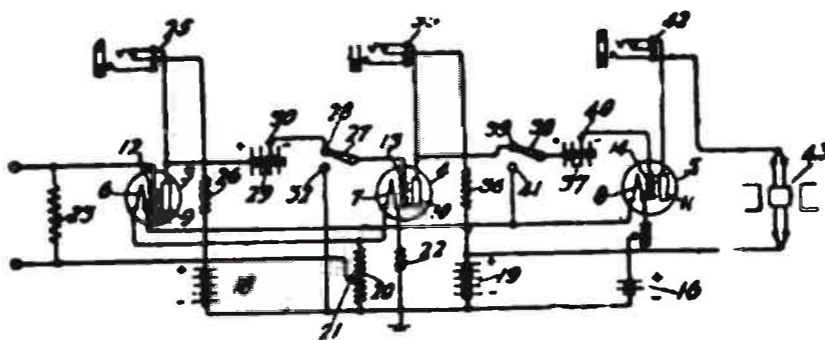

Schematic diagram of the Mathes-Read Vacuum-Tube Circuit

quency impulses will be accurately reproduced by the amplifiers. But when such a direct coupling is employed considerable difficulty is experienced when signals are being received from preventing the output current of one tube from so affecting the potential applied to the control electrode of a second tube that the second tube is either blocked or has its amplifying action destroyed on account of its control electrode becoming too positive or too negative.

In accordance with this invention, it has been found that the operation of such a multistage amplifier-set is considerably improved by providing adjustable sources of potential for the control electrodes of the tubes, and by providing switching means between the stages whereby the output current of each tube may be given its proper value by adjusting the normal source of potential for its control electrode independently of this influence of the output current of the preceding tube.

New Signal Receiving System

No. 1,430,533. Patented, October 3, 1922. Patentee: Burke Bradbury, Schenectady, N. Y.

MR. BRADBURY'S invention is to provide a simple and efficient means for providing an audible indication of signals transmitted by means of radio-frequency continuous currents. The receiving station is provided with a source of audio frequency current which is associated with an electron discharge device and a detector in such a way that when no signaling currents are impressed upon the system there will be no ap-

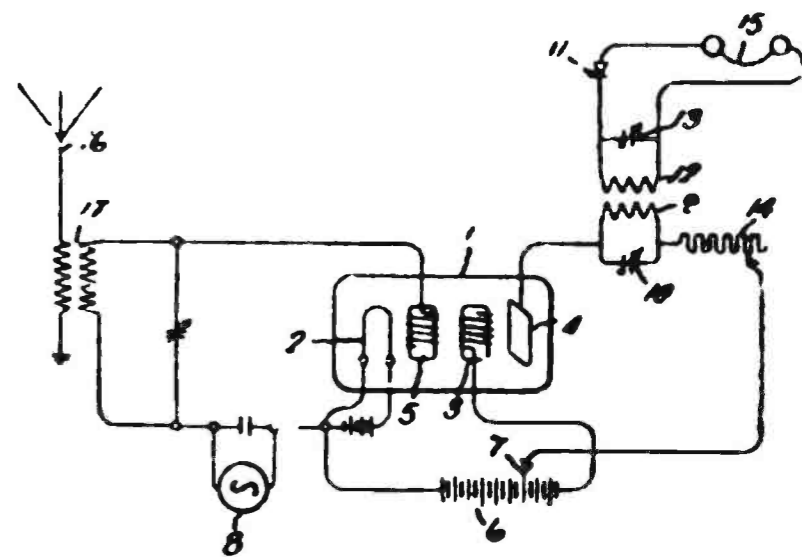

Schematic diagram of Mr. Bradbury's system.

preciable flow of audio frequency current in the detector circuit. When, however, a radio frequency signaling current is impressed upon the system this signaling current is modulated by means of the audio frequency source and the modulated radio frequency signaling current is transmitted to the detector circuit where it is rectified and the rectified current is used to produce the desired audible indication.

Will Help Voltage

No. 1,430,007. Patented, October 3, 1922. Patentee: William C. White, Schenectady, N. Y.

IT has been discovered that the current which will flow through an electron-discharge device comprising an incandescent cathode and an anode enclosed in a highly evacuated envelope will, between certain limits, vary approximately as the 3/2 power of the applied voltage. In other words, the apparent resistance of such a device varies with the voltage applied to it. In some cases, this characteristic is objectionable; for example, when such a device is included in a measuring circuit which comprises other resistance. In such a case the relation between current and voltage in the circuit will be a complex one and a calibration will be necessary to determine this relation.

The object of Mr. White's invention is to overcome this disadvantage by constructing and arranging an electron-

Fig. 1.

Fig. 2.

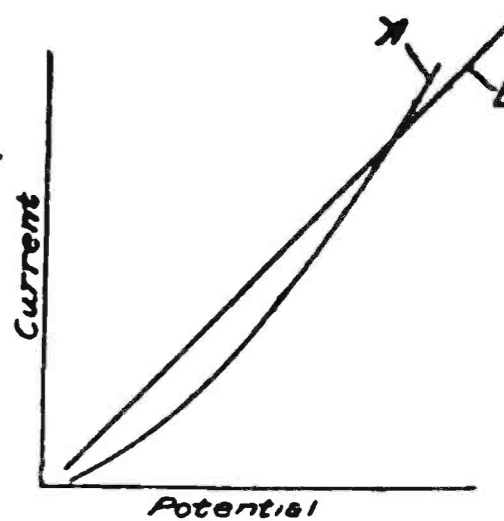
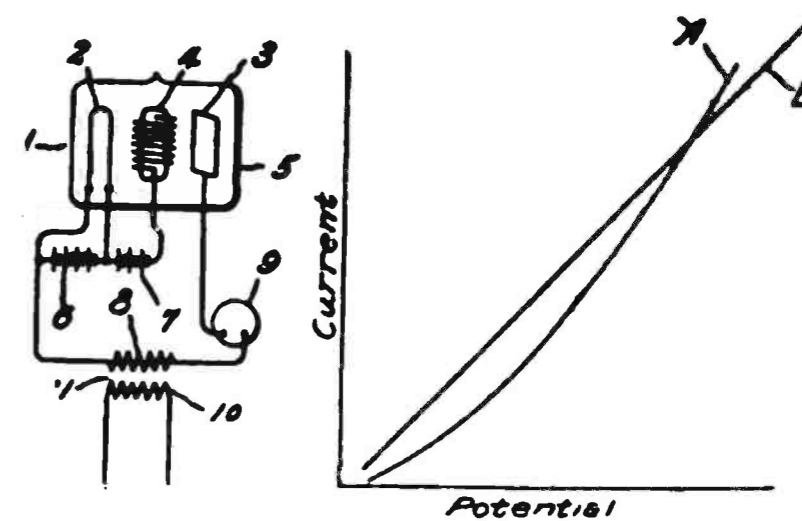

Figure 1 shows diagrammatically a circuit connection.

Figure 2 shows the current-voltage characteristics of an ordinary high-vacuum electron discharge device.

discharge device in such a way that the current will vary directly as the applied voltage between certain well defined limits.

Answers to Readers

1. How far could you hear with the hook-up you have on page 7, RADIO WORLD, No. 27, dated September 30, using an aerial of four wires, each eighty feet long?

2. What size fixed-condenser do you recommend on the stopping condenser and condenser before the grid of the third tube?

3. What kind and size tubes are recommended for all three shown?

4. The lead from B battery to 2-circuit jack is about 22 volts. Am I correct?

5. To make a 45-volt B battery may I connect two 22-volt batteries in series?

6. Would the addition of my honeycomb coils help any?

7. Are the two transformers the same size?

8. Will a potentiometer help?

9. What size is the grid condenser and leak?

10. What rheostats are best—the wire type or the carbon type?—F. Bruhns, Oakland, Cal.

1. Everything depends on the way a set is constructed, also the locality, erection of antenna, etc. No exact figures can be given, but there is no reason why considerable distance cannot be received.

2. Usually about .00025 mfd., but this may be omitted from this particular place in the circuit.

3. The first tube is that of a UV-200 detector tube; the next two are the UV-201 amplifying tubes. Be sure to see that the detector tube is used in the first socket.

4. The B-battery voltage on the first tube is about 22 volts.

5. Yes. By connecting two 22½-volt B batteries in series with each other you are able to secure the necessary 45 volts.

6. No. They will not help the circuit in any manner.

7. The two transformers used are the same in size.

8. A potentiometer is of no use with this particular circuit.

9. The grid leak is of 2 megohms and the grid condenser of about .00025 mfd. capacity.

10. This all depends on the radioman who is building the set. Some prefer the wire rheostats, while others like the carbon. A vernier on the detector tube will be of great value.

I have a receiver using duo-lateral coils, and believe I have the wrong hook-up. Note my diagram and let me know what error I have made.—Gustav Altrock, Manchester, Pa.

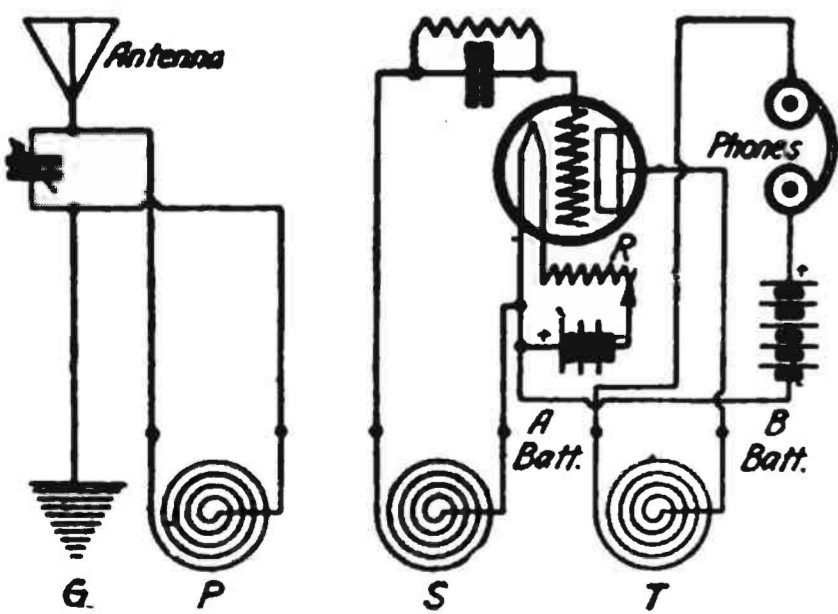

Hook-up requested by Mr. Gustav Altrock, Manchester, Pa.

The accompanying diagram is the correct method by which you should wire your set. Follow each and every connection carefully and you will get the desired result.

I am building a regenerative receiver with two variometers and a vario-coupler. Can

a dry-cell tube be used with as good results?—Vincent Delapotteries, Wichita, Wis.

Certainly. Use the same circuit, merely connecting a single dry-cell to the A battery terminals.

Will you publish a diagram of a single-tube regenerative set employing three honeycomb coils?—Fred Loveland, Niagara Falls, N. Y.

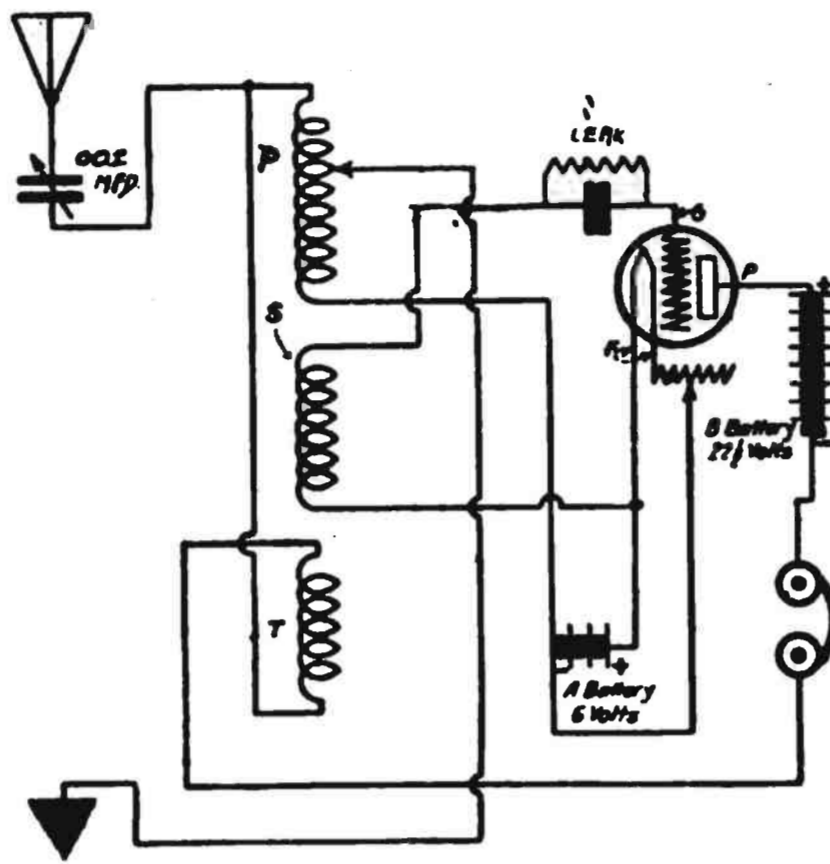

Diagram requested by Mr. Fred Loveland, Niagara Falls, N. Y.

Herewith is a schematic diagram of a three-coil regenerative circuit employing one of the coils as tickler: P is for primary, S for secondary, and T for tickler coil.

May I run my aerial from a pole to and through the gable of my house, a total distance of 100 feet, and then bring my lead from center of aerial?—Harry Alexander, Staten Island, N. Y.

Leave your aerial an inverted L. Don't run it through the house. We advise you to experiment with it for results, but the outside aerial still holds the record for long-distance reception.

Please publish a hook-up of a regenerative circuit using three tubes, used with variometers and vario-coupler.—Kenneth H. Jones, London Mills, Ill.

A hook-up of this circuit was published in RADIO WORLD, No. 27, dated September 30.

What is wrong with my set? The diagram is enclosed. The aerial is 100 feet long with a 70-foot lead-in. I am using a crystal detector.—Matthew Rasmussen, Syracuse, New York.

Your diagram is wrong. Connect aerial to the switch arm and the ground to the other. Then connect one side of the detector to one switch arm and one side of the phones to the other. Now join together the remaining posts and detector. The phones should then be shunted by the phone condenser.

I have an aerial plug, tuning coil, ground clamp, crystal detector, variometer, phones, and variable condenser. What broadcasting station should I receive with this set?—William Bruns, Boston.

Unless you have an unusual location or live within a mile or two of some broadcasting station, you are doomed to disappointment with the antenna plug. The lighting system makes a fairly good aerial for vacuum-tube sets, though for crystal sets it is practically ruined out.

Subscribe for Radio World, \$6.00 a year, \$3.00 six months, \$1.50 three months.



After the THANKSGIVING DINNER hear the voice of the Outer World~

THE finest of soloists and orchestras—the most interesting and amusing of speakers—all are at your service, rendered by the wonderful power of Magnavox Radio the Reproducer Supreme.

Until you have heard a wireless program reproduced by the Magnavox, you cannot realize the enjoyment that radio brings to the home.



R-2 Magnavox Radio with 18-inch horn: this instrument is intended for those who wish the utmost in amplifying power; for large audiences, dance halls, etc. . . . \$85.00

R-3 Magnavox Radio with 14-inch horn: the ideal instrument for use in homes, offices, amateur stations, etc. . . . \$45.00

Model C Magnavox Power Amplifier insures getting the largest possible power input for your Magnavox Radio.

2 stage AC-2-C . . . \$80.00
3-stage AC-3-C . . . 110.00

When you purchase a Magnavox product you possess an instrument of the highest quality and service.

Magnavox products can be had of good dealers everywhere. Write us for copy of new illustrated booklet.

THE MAGNAVOX CO.
Oakland, California
N. Y. Office: 370 Seventh Ave.

MAGNAVOX
Radio
The Reproducer Supreme

Wave Meter for Amateur Operators

How to Construct the Device Which Enables You to Adjust Your Set and Comply with the Law

Prepared by the United States Bureau of Standards Experts

THE construction of a portable short-wave radio wave-meter for use of amateur transmitting stations is fully explained in the following article which was carefully prepared by the Bureau of Standards of the United States Department of Commerce. The device is for measuring the frequency or length of radio waves.

According to the Bureau of Standards, amateur radio stations in the United States at present are required by law, when transmitting, to use wave lengths not exceeding 200 meters, and, therefore, it is important that amateur operators should have a wave meter available so that they may adjust their sets to comply with the law. The device should be adapted to measure short wave lengths, such as 200 meters as well as other short lengths such as 300 and 485 meters now used for radiotelephone broadcasting.

The Radiotelephony Conference which met in Washington in February, 1922, recommended narrow bands of waves for particular services, some bands being only 10 meters wide. Stations which must work within such narrow wave bands must be provided with well-designed wave meters if they are to comply with the requirements of the law, and the design of a portable short-wave meter is a matter of importance, according to Bureau of Standards experts.—The Editor.

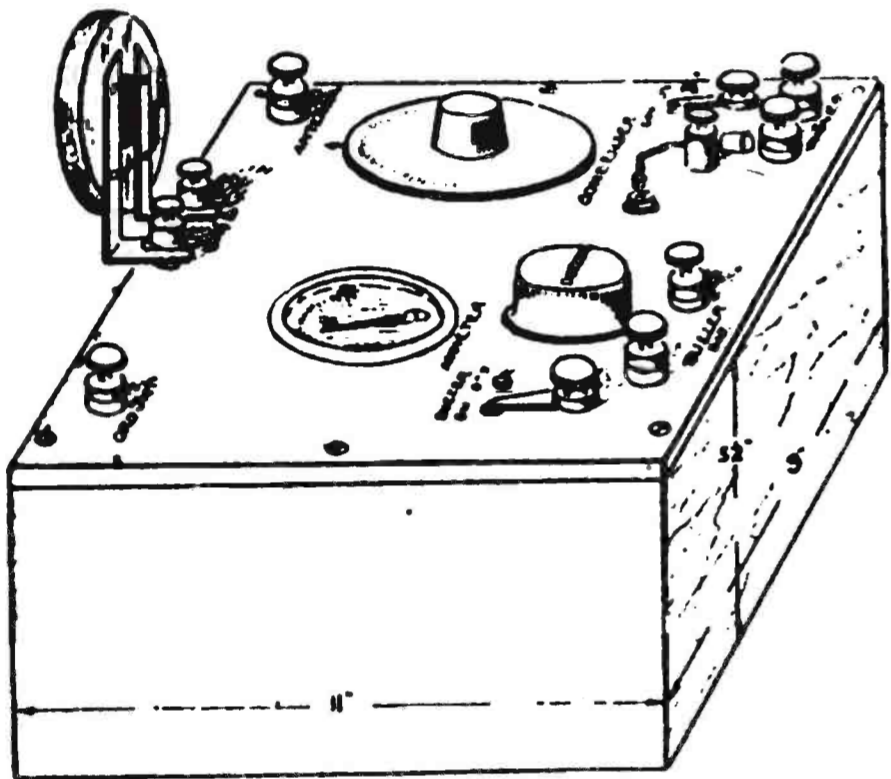

Figure 1. Arrangement of the wave-meter box and assembled units.

A WAVE METER is a device for measuring the frequency, or length, of radio waves. Radio waves always travel with the same velocity. If the frequency is known, the wave length is also known. Amateur radio stations in the United States at present are required by law, when transmitting to use wave lengths not exceeding 200 meters. It is important, therefore, that amateur operators should have a wave meter available so that they may adjust their transmitting sets to comply with the law, and it is necessary that this wave meter should be adapted to measure short wave-lengths such as 200 meters. Other comparatively short wave-lengths, such as 360 and 485 meters, are now used for radiotelephone broadcasting, and it is important to have a wave meter which can measure these wave lengths. The Radiotelephony Conference which met in Washington, in February, recommended narrow bands of waves for particular services, some bands being only 10 meters wide. Stations which must work within such narrow bands must be provided with well-designed wave meters if they are to comply with the requirements of the law. The design of a portable short-wave meter is, therefore, a matter of importance. It is the purpose of this article to point out the most important considerations in the design of such a wave-meter, and to describe the construction of a wave-meter suitable for the measurement of frequencies from about 3,000 kilocycles per second to 530 kilocycles per second (wave lengths from 100 to 570 meters).

The parts of a wave meter are, usually, a variable condenser, a fixed inductance-coil, and a device to indicate current flow. The condenser will first be considered.

It will be well at the start to eliminate certain large classes of Condensers unfit for use in wave meter circuits. Variable condensers employing other dielectrics than air, and condensers whose capacities are varied by a screw to change the distance between plates, however serviceable they may be for furnishing a variable capacity, will not in general retain their calibration and are untrustworthy for use in a wave meter. This elimination leaves only air condensers whose capacity is varied by changing the overlapping area of parallel plates—the usual type of variable condenser.

All condensers of this type can by no means be used in wave meters. A condenser to be used in a wave meter should have fairly heavy plates rigidly held together with ample tie-rods and nuts, spacing washers of large diameter and sufficient thickness, adequate con-

ditions in which variable condensers commonly fail to meet these and other requirements are: too thin plates, spring-supported bearings, extremely close spacing of plates, vertical or lateral play of the shaft in its bearings, contacts made by brushes wiping on movable parts, stops which in arresting the rotating plates shift them out of line, shifting scales or indices, and faulty workmanship which allows short-circuiting of the condenser at some settings. In general, anything that allows a capacity change without a change in scale reading or a change in reading without a capacity change destroys the usefulness of a condenser for wave meter purposes. Some method of shielding is desirable to eliminate any change of condenser capacity owing to movements of surrounding bodies. The shield usually is a grounded metal case placed around the condenser.

Regarding the inductance coils: The requirements of a wave meter coil are: (1) that its inductance be such that with the condenser used the desired range of wave frequency can be covered. (2) that its effective resistance and effective capacity be low; (3) that its inductance, resistance, and capacity all be constant.

The first requirement, which has to do with the range of wave frequencies, will first be considered. It is well to restrict the part of the condenser scale used for frequency measurements to the sector between 15 degrees and 170 degrees on a scale graduated in degrees, or between the eighth division and ninety-fifth division on a scale graduated in hundredths. Since capacity at 170 degrees or 95 hundredths will almost always be more than six times the capacity at 15 degrees or 8 hundredths, the frequency obtained with any one coil at the lower end of this region will be not less than about $2\frac{1}{2}$ times the frequency obtained with the same coil at the upper end. This will make it possible, with one coil, to cover the range from 3000 to 1200 kilocycles per second (100 to 250 meters) and with a second coil to cover the range from 1330 to 530 kilocycles per second (from 225 to 570 meters).

Range of Wave Frequencies

The following table gives the number of turns required for two single-layer inductance coils which will cover, approximately, the stated ranges with each of the maximum capacities indicated in the table. It will be noted that the size of the wire and the spacing between turns are not specified. The inductance is nearly independent of the size of wire used, and the spacing is controlled by the number of turns and the length of the inductance coil, both of which are given. The length of the coil, as indicated, is the length of the actual winding, not the length of the supporting core.

Single-Layer Inductance Coils for Short-Wave Portable Wave Meter.

Coil 1.—Range 3000-1200 kilocycles per second (100-250 meters). Diameter, 10 cm. (4 inches); length of winding, 2.5 cm. (1 inch).

Maximum capacity of condenser	No. of turns
0.0005 microfarad	16
0.0007 microfarad	13
0.0010 microfarad	11

Coil 2.—Range 1330-530 kilocycles per second (225-570 meters). Diameter, 10 cm. (4 inches); length of winding, 5 cm. (2 inches).

Maximum capacity of condenser	No. of turns
0.0005 microfarad	42
0.0007 microfarad	35
0.0010 microfarad	30

The second requirement stated for the coil is that the effective resistance and the effective capacity be low. Low resistance is desirable in order to secure sharper indication of resonance. The practice of surrounding an

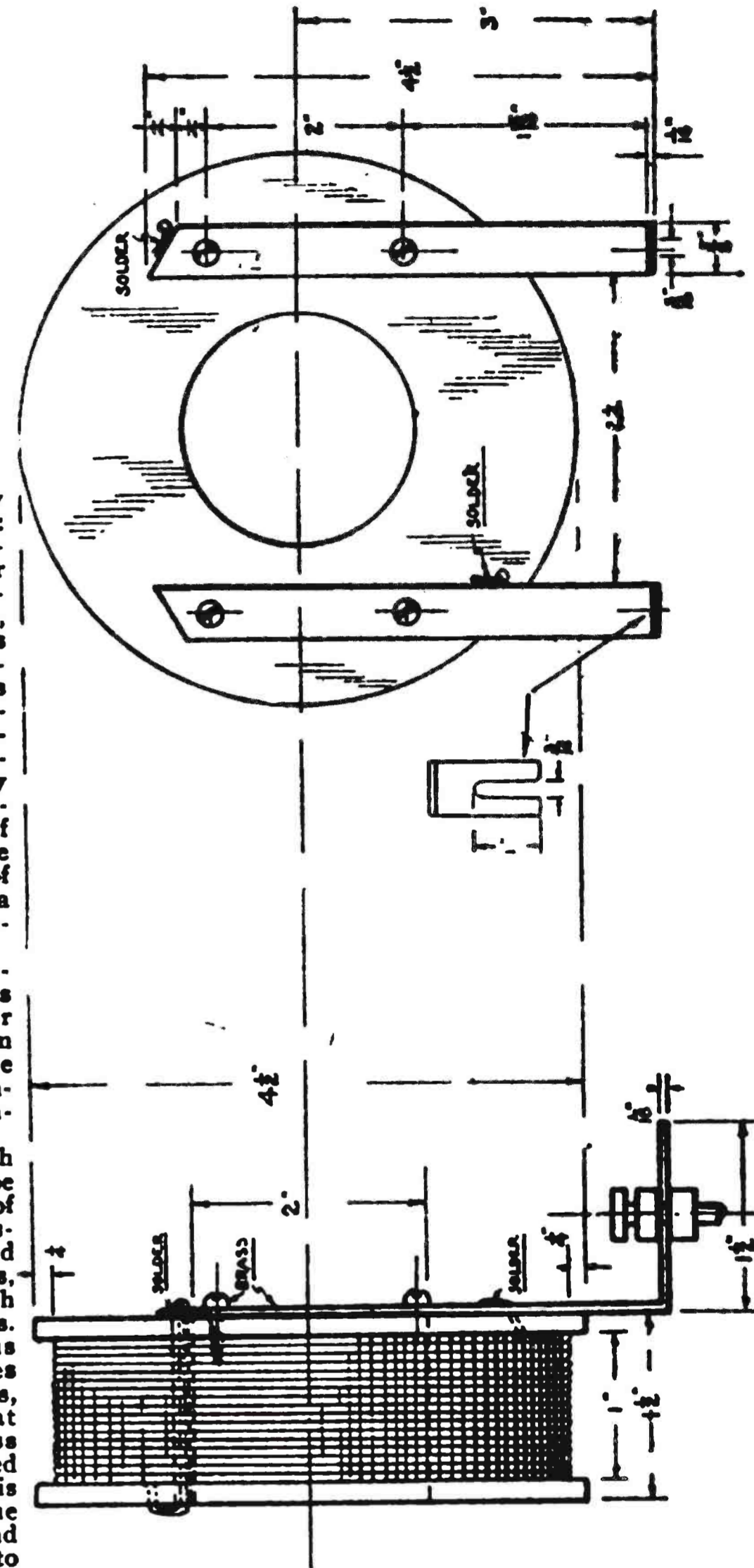

Figure 3. Schematic details of wave-meter coil. Turn page sideways when reading.

radio circuit and is especially to be avoided in the case of wave meter coils. Imperfect insulating materials so used increase not only the effective capacity but also the effective resistance of the coil. This does not mean that all types of manufactured insulating materials are unsuitable for use in frames for wave meter coils. Probably, however, the best form on which to wind the coil of a wave meter like that here described is a hollow spool of thoroughly dry wood lightly varnished with an extra grade of insulating varnish. The use of shellac is not considered advisable under any circumstances. The use of wood having even a comparatively small moisture-content may seriously affect the accuracy of the wave meter. Properly selected wood is chosen in preference to manufactured insulating materials, glass, or pasteboard. Many available manufactured insulating materials largely increase both the resistance and the capacity of the coil. While the electrical properties of glass make it well suited for a form, it presents too great mechanical difficulties. Pasteboard is not rigid enough and should not be used under any circumstances. The wire used may be solid copper double cotton covered, No. 24 B & S, or larger. The wire should be lightly varnished with a single coat of an extra grade of insulating varnish. Further insulation merely increases the effective resistance and capacity of the coil without compensating advantages. The resistance frequently can be considerably reduced by

Advertising Rates, Display, \$5.00 per inch, \$150.00 per page

Radio Merchandising

Classified Quick-Action Advertising, 5 cents per word

Telephone Bryant 4796

Radio Goods that Stand the Test

Manufacturers, send a sample of your goods to our Technical Editor, Fred. Charles Ebert, 8088 Pleasant Street, Queens, Long Island, N. Y. It will be carefully tested and returned. If your goods satisfy our experts, RADIO WORLD'S endorsement will be published in our merchandise department without charge or obligation of any kind on your part. This is a free service on the part of RADIO WORLD, calling for no expense whatsoever on the part of the manufacturer, except the sending of a sample of his goods.

A Well-Constructed Variable Condenser

Manufactured by Caldbeck Tool & Manufacturing Co., Des Moines, Iowa.

A WELL-DESIGNED and well-constructed 23-plate variable condenser, the capacity of which was found to be, approximately, .0005 mfd. The construction of this condenser is as follows: All plates are of the best-grade even-gauge hard aluminum, and are laid out mathematically correct so that the area increases with the square of the angle.

The edges are so cut as to prevent burrs. This keeps down the leakage when using it with C-W transmitters. All of the insulating bushings used in this condenser are treated in boiling beeswax to prevent the absorption of moisture. This treatment also makes the bushings self-lubricating.

The condenser is nicely finished and when used with a set comprises a satisfactory receiver ready for panel mounting. It was tested out in all sets and found to stand up under all conditions.

"Make Your Own Variometer"

Racine Radio Parts Co., Racine, Wis.

A "Make Your Own Variometer" has been tested out after being assembled. By the instructions and illustrations that accompany, it will be found easy and interesting to assemble. The parts come complete. In one hook-up, it was placed in the aerial circuit of an oscillating receiver and found to have a wave-length range from 150 to 450 meters. It behaved well, without showing signs of being noisy. The rotor and stator are wound with cotton-covered magnet wire. In construction and appearance it is very attractive, and neatly finished for panel use.

New Firms and Corporations

(The firms and corporations mentioned in these columns can be reached by communicating with the attorneys, whose addresses are given whenever possible.)

Victo-Rad Radio Co., Wilmington, Del., manufacture radio equipment, \$500,000. (Colonial Charter Co.)

Guarantee Electric Co., Atlantic City, N. J., \$125,000; George P. Proffatt, Katherine B. Proffatt, Walter Hanstein, Atlantic City.

Precision Instrument Co., Wilmington, Del.; \$500,000. (Corporation Service Co.)

Lewis Electric Mfg. Co., Buffalo, \$100,000; J. N. Lewis, E. S. Yates, R. M. Stanley. (Attorneys, Stanley & Gidley, Buffalo.)

Capital Increases

Halsey Electric Service & Contracting Co., New York City, \$10,000 to \$25,000.

Continental Radio & Electric Corp., New York City, \$30,000 to \$60,000.

Coming Events

The editors of RADIO WORLD will gladly publish news items of all contemplated radio shows and expositions. Keep us posted by mailing full information.

SECOND NATIONAL RADIO EXPOSITION, direction International Trade Exposition Co., Chicago, January 13 to 20, inclusive, 1923, George A. King, director of publicity, 417 South Dearborn Street, Chicago, Ill.

PERMANENT RADIO FAIR FOR BUYERS, Hotel Imperial, New York City. Open from September, 1922, to May, 1923.

AMERICAN RADIO EXPOSITION, Grand Central Palace, New York City, December 21 to 31. Colwell & Korbell, Fisk Building, New York City, directors of publicity.

INTERNATIONAL RADIO SHOW, Madison Square Garden, New York City, November 20 to 25, inclusive. E. C. Buchignani, director of publicity.

SOUTHEASTERN RADIO EXPOSITION, Auditorium Armory, Atlanta, Georgia, December 4 to 9, inclusive. Co-operative Radio Sales Assn., 295 Peachtree St.

Heard at the Radio Counter

A Conversation Between Customer and Radio Clerk
(Part III)

"FINISHING up my set the other night, I noticed that the signals came in weak at times and, at other times, the set went absolutely dead. With a move or adjustment of the condenser, or plate variometer, everything was 'jake.' Must need a rheostat—don't you think?"

"I believe your trouble lies right there."
"Do you think a vernier rheostat would help the set?"

"Absolutely."
"How do vernier rheostats come, and how do they operate?"

"Well, there are the different makes and types; and anyone will supply the need of vernier control."

"All right, then; I'll take one and try it out to-night. And, by the way, will I also need a vernier on my amplifiers?"

"No—not at all. Just use one on the tube in your detector circuit."

"Very well, then. I hope this will keep the signals in at all times—especially when giving a concert to my friends who are on the verge of buying sets."

"If you are in any more trouble, Mr. Customer, with that set of yours, come in and fire away. That's what we're here for. We are here to give you advice as well as sell you merchandise."

"Will see you shortly."
(To be continued)

THOSE BROKEN AND BURNED-OUT

VACUUM TUBES CAN BE REPAIRED

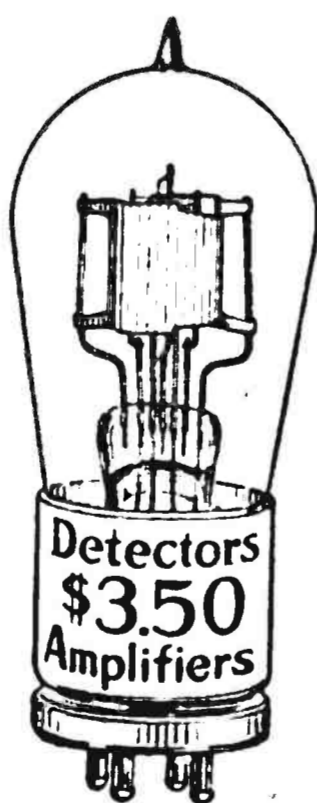

AND GUARANTEED TOO!

If your dealer does not know
send direct to us

HARVARD RADIO LABORATORIES
165 HIGH STREET BOSTON, MASS.

Tubes Returned P. P. C. O. D.

Foreign Orders for American Business Men



Lynn W. Meekins, New England district manager of the United States Bureau of Foreign and Domestic Commerce, broadcasting foreign inquiries from the Amrad Station of the American Radio and Research Corporation at Medford Hillside, Massachusetts. This is the first office of the Department of Commerce to use the Radio and the first station to send out foreign trade information. "A firm in Switzerland wants to buy thousands of electric light sockets," says radio. The next morning the bureau's office in Boston receives scores of applications from firms throughout New England for the name and address of the Swiss importer. This is the highest speed that foreign trade promotion has yet attained.

Million - Watt Vacuum Tube May Send Human Voice Across Atlantic

A MILLION-WATT vacuum tube has been developed in the General Electric research laboratory, Schenectady, New York, by J. H. Payne, Jr., says "The World," New York. The huge capacity tube is a magnetron, involving the principle of magnetic control as developed by Dr. Albert W. Hull of the laboratory.

The tube is expected to be of much importance both in radio work and long-distance power transmission. Its output is about forty amperes at 25,000 volts, and serves as a rectifier to change alternating to direct current, and also to change direct to alternating current of any frequency or to convert low frequency alternating current to high frequency.

It is thought that one tube will be sufficient to carry radiotelephone signals across the Atlantic. This tube consists essentially of a water-cooled cylindrical anode 30 inches long and 1 3/4 inches in diameter. In the axis of the anode is a tungsten filament four-tenths of an inch in diameter and 22 inches long. This filament is excited by a current of 1,800 amperes at 10,000 cycles, the filament excitation requiring about 20 kilowatts.

The magneto field produced by this large heating current is sufficient to "cut off" the electrical current from the cathode to the anode during a portion of each half cycle of the current passing through the cathode; this action taking the place of that of the grid in the three-electrode tube. The electron current to the cathode is thus interrupted 20,000 times per second.

By the use of properly tuned circuits this can be used for the production of high-frequency power radio or any other purpose.

Don't expect to get loud signals with a crystal detector set while using an indoor antenna.

Non-liquid Storage A- and B-Batteries

THERE are now on the market A- and B-storage radiobats which incorporate a number of revolutionary new features of considerable interest to every radio fan. Both A and B types of these new principle-batteries contain a solid electrolyte which makes them absolutely nonspill. This feature will be appreciated by every radioist who has ever spilled acid from his battery on his carpet or clothes.

Another interesting feature is the total absence of separators which reduces internal resistance to a minimum. The radiobat grid (the metal mesh into which is pressed the "active material," forming the "plate") has a double reinforced construction. This construction adds from 25 to 30 per cent. more actual metal per square inch. The plate is, consequently, just that much more rugged and does not buckle. This reinforced strength plus the solid electrolyte makes the use of separators unnecessary. Due to the fact however, that the secondary reinforcing mesh in the grid does not come to the surface of the plate, there is actually more active surface per square inch of plate area. In the case of the radiobat A, this results in a battery from 25 to 30 per cent. smaller and, consequently, easier to handle than any other A battery of equal rating.

The radiobat storage B is even more unusual and interesting. It is compact—only four inches square by seven inches long—scarcely larger than a large-size dry-cell B. It has no glass jars to break, no liquid to leak. The most notable feature is its utter noiselessness of operation.

It substitutes the steady, sustained voltage characteristic of a storage battery in place of the irregular constantly dropping voltage of a dry cell, thus eliminating all hissing and crackling noises with which all radio operators are familiar. Changing voltage in the plate circuit is the direct cause of most tube noises and most of what is blamed on static. Sustained voltage does away with this and results in a marvelously clear true-tone reproduction of each word and note.

The Radiobat Storage B is economical as well. It is easily rechargeable at home from either AC or DC and outlasts its value in dry cell Bs on each home charge.

Honeycomb Coils Suggested for Usual Wave Length Ranges

By Harold Day

Type of Service	WaveLength Range (Meters)	Primary Coil Cat. No.	Secondary Coil Cat. No.	Tickler Coil Cat. No.	Condenser
Amateur	145-350	DL-35	DL-25	DL-35	Series
Special Amateur	305-710	DL-75	DL-50	DL-35	Series
Commercial	635-1660	DL-150	DL-100	DL-75	Series
Navy Calling	845-1970	DL-200	DL-150	DL-100	Series
Arlington Time	1420-2850	DL-300	DL-250	DL-150	Series
Navy Ship Arcs	2550-4250	DL-200	DL-300	DL-150	Parallel
Navy Station Arcs	4200-6300	DL-500	DL-400	DL-200	Parallel
Foreign and Press	6250-14500	DL-1250	DL-750	DL-400	Series
Foreign and Press	13600-21000	DL-750	DL-1250	DL-400	Parallel



I Want a Radio Worker In Each Community To Work For Me

My work fits in nicely for those men and women who have spare hours or full time at home and wish to earn from \$5.00 to \$40.00 weekly, depending on time you devote to it. It is not radio work, but I believe anyone energetic enough to interest themselves in Radio will make an excellent "TANGLEY BRANCH MANAGER," to operate a branch for us in their home. Pleasant, easy work, no canvassing, immediate profits. No experience or special talents necessary. We furnish complete outfit, train you for the work, and assist you in building up a business you will be proud of. Don't wait until another grasps this offer, write today for literature, and make your spare hours earn.

TANGLEY CO., 187 Main, Muscatine, Iowa

No Experience Necessary

Full or Spare Time at Home

PATENT
Your Radio Ideas.
Call or Write
FREE ADVICE



**ALADDIN ELECTRIC
COMPANY, INC.**
COMPLETE RADIO SETS
WRITE FOR PRICES.
71 West Broadway New York City

Wave Meter for Amateur Operators

(Continued from page 21)

cuit as will be used in measuring frequencies. An inexpensive indicating device and one which is satisfactory when the power output of the generating circuit is large enough, is a miniature lamp, such as a flashlight lamp, inserted directly in the wave meter circuit. To avoid any possibility of changing the calibration of the wave meter, the lamp should not be changed if it can be avoided. If it must be changed, it should be replaced by one of identically the same kind. The sensitiveness of this device can be greatly increased by having a dry cell and a rheostat in parallel with the lamp in the wave meter circuit. By ad-

justing the rheostat until the temperature of the lamp filament is raised almost to the point of illumination, it is possible to have the lamp lighted by induced currents much smaller than would otherwise be required. However, changes in the battery and rheostat will be likely to change the characteristics of the circuit and hence the calibration of the wave meter. This device, therefore, should be used with caution.

The wave meter may be excited by impact, that is by a source of highly damped waves having only a very few waves in a train. The wave meter can then be used as a source of damped waves to determine the frequency to which a receiving set is tuned. The buzzer, in series with the battery, is connected across the condenser terminals, completing its circuit when the contact is closed—through the inductance coil of the wave meter. Not more than four volts should be used to operate the buzzer. The buzzer will add to the capacity of the circuit, thereby decreasing its frequency. This decrease will be especially noticeable at the lower part of the condenser scale, where it may amount to several per cent. of the frequency. It can be reduced by having short, widely spaced leads to battery and buzzer. If the wave meter is equipped with both a buzzer and an ammeter, or current-square, meter, the ammeter must be so connected in the circuit that the current from the buzzer battery cannot pass through the ammeter. If this is not done the ammeter or current-square meter may be burned out by the current caused to pass through it by the buzzer battery.

The assembling of the parts of the wave meter must be such that each part is rigidly joined to the rest of the circuit. Mounting in a box is as good a means to this end as any from the standpoint of rigidity and is superior to any in portability and in the protection afforded to the parts. A convenient box mounting is shown in Figure 1.

The over all dimensions are left to the constructor since the size of the component parts will vary. The box should be substantially constructed so that it will stand considerable handling. The component parts are all mounted on a panel of rigid electrical insulating material which will not absorb moisture. This panel is, in turn, secured to the supporting box. It is possible to use a panel of thoroughly dried and seasoned hard wood thoroughly varnished with an extra grade of insulating varnish.

Figure 1 shows one possible distribution of the component parts. Attention should be given to the convenience of operation and advantageous wiring of the circuit to keep distributed capacities at a low value. The most advantageous arrangement of the instruments on the panel will depend in part on the particular instruments used, and the constructor should work out the best arrangement in each case.

Figure 2 gives a circuit diagram showing the connections as they should appear underneath the panel. These connections should be made of No. 12 solid copper wire soldered into lugs. Where bending is necessary, sharp right angle bends are used. If it is desired to make a short-wave portable receiving set, terminals for antenna and ground connections can be supplied without decreasing the value as a wave meter in any way, provided suitable care is used in handling the instrument. A wave meter should be handled more carefully than an ordinary receiving set. If it is desired to shield the wave meter, a copper, or brass, sheet may be permanently fixed on the under side of the panel and spaces cut in it to allow for the terminals and supports of the various units. There should be at least $\frac{1}{8}$ of an inch clearance for the terminals.

Figure 3 gives the dimensions and construction of the inductance coils.

The forms are turned in a lathe from thoroughly seasoned wood. Several coats of extra grade insulating varnish applied to this form will be desirable in keeping low the absorption of moisture. The proper number of turns of the correct size of wire is wound in a single layer in the recess provided for this purpose. A light coat of extra grade insulating varnish is applied to the wire to keep it in place and to prevent moisture from changing the distributed capacity of the coil. The terminals of the inductance coil are brought out through the wood form and soldered to the supporting brass terminals. The wood screws holding the coil form to the brass supports should be of brass rather than a magnetic material.

It is desirable that the box be provided with a protecting cover and a carrying handle.

After the wave meter has been constructed it must be calibrated. Consideration has been given to the transmission of standard wave length signals from laboratories equipped with precision measuring apparatus. This would make it possible to determine accurately several points on the calibration curve of a wave meter without sending it to a standardizing laboratory. The carrier waves of some radio-telephone broadcasting stations may be adjusted to some particular wave, such as 360 meters, and one point on a wave length calibration can thus be determined. A wave meter transported for standardization should be packed in a wooden box large enough to give room for three inches of excelsior.

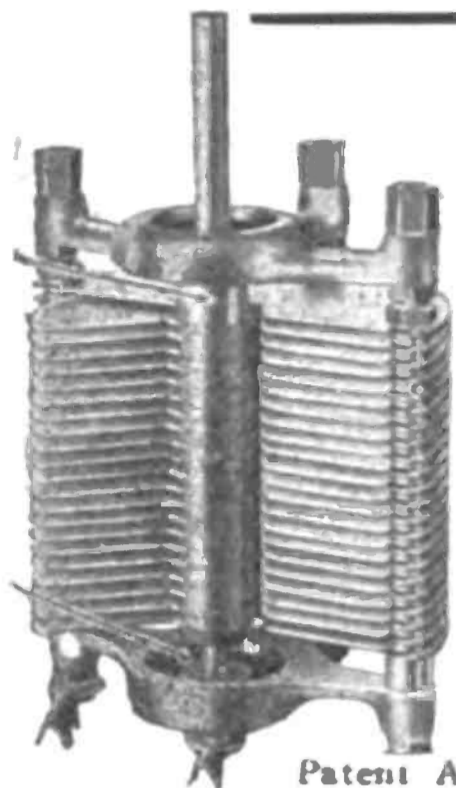

SOMETHING NEW!

Variable Condenser Built Right

Furnished either regular or vernier

Made in the most popular sizes, with aluminum plates, cast end brackets, with a 1" diameter Bakelite bushing therein. (A perfect insulator high in dielectric strength). Dealers write for discounts. Ask to see our Rheostat and Vacuum Tube Socket.

LOMBARDI RADIO MFG. COMPANY

67-71 Minerva Street, Derby, Conn.

P. O. Box 44

Patent Applied For

For CORRECT RADIO MAILING LISTS Use THE POCKET LIST

of Radio Manufacturers, Jobbers and Dealers in the United States and Canada. Issued Quarterly—January, April, July and October. October, 1933, issue corrected to September 15th, 1933. Classified under three different headings—Manufacturers, Jobbers and Dealers—and alphabetically arranged by states, cities and towns and names of firms. Containing approximately 15,000 names and addresses.

We have been exceptionally careful to see to it that every Manufacturer, Jobber and Dealer is listed and, under the PROPER CLASSIFICATION. Most mailing list concerns charge more than \$100 for a list of this kind and, as a rule, those supplied are far from being correct. Compare this list with any other, and you will find it to be the very best obtainable anywhere at any price.

October issue ready for distribution September 15th. Price \$5.00 per copy, or \$10.00 per year (four issues, including monthly supplements which keep the list absolutely correct and up to date at all times). October edition limited. Send your order with remittance today.

F. D. PICKENS, 1621 CARRINGTON STREET
JANESVILLE, WISCONSIN

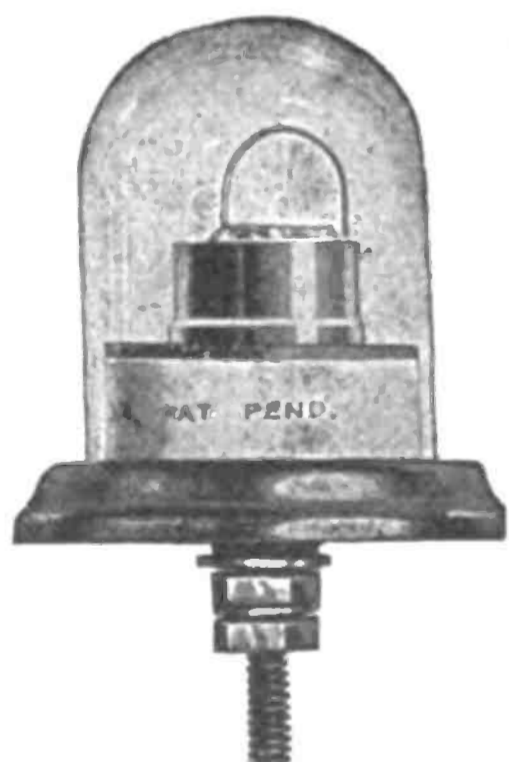

(Actual Size)

GREWOL DETECTOR

Nothing Like It
Nothing as Good

\$2.00

The Grewol Detector has taken its place among the standard, nationally advertised parts. In a class by itself because it does what no detector has yet been developed to do and still sells at a popular price.

Asked for by name, sold by reputation.

If your dealer cannot supply you,
send \$2 and we will fill your order.

Your Dealer has Grewols

Always Set
and Ready

Glass Encased

Super-Sensitive

RANDEL WIRELESS CO.

Sole United State Distributors

9 CENTRAL AVENUE

NEWARK, N. J.

"TUNING IN"

TO THE RIGHT TUNE IS VERY SIMPLE WHEN YOUR CONNECTIONS ARE
SOLDERED WITH THE NEW

"POST SOLDERING IRON"

(The Iron with the Platinum Heating Unit). Removable Soldering Tip



$\frac{1}{2}$ Actual Size
LIST \$6.00

Designed especially to cover every requirement for delicate work. The smallest practical, efficient instrument on the market. Attaches to any socket. Universal current. Fully guaranteed. From your dealer, jobber or write

POST ELECTRIC COMPANY

17 D STREET, Div. 508

NEW YORK

Recommended by Dealers for Reliability

RADIO STORES CORP.

VARIABLE CONDENSERS—
PLUGS—RESISTANCE UNITS, ETC.

if your dealer doesn't carry, address Dept. B,
222 West 34th Street, New York

LEE RADIO CORP'N.
Manufacturers
Haddonfield New Jersey

ANNOUNCES
THEIR "B-P" SET
(Patent Applied For)

NEEDS NO AERIAL

PRICE, \$35.00

Complete Except "A" Battery, \$53.00
Write for Proposition.

RUSONITE

CRYSTAL RECTIFIER -
MULTIPOINT

(Patent Pending)
A synthetic CRYSTAL DETECTOR
sensitive over its entire surface.
Eliminates all detector troubles. 50% increase in
clearness and volume. Endorsed by Radio experts
and press. Awarded certificates of excellence. Sets
a new standard of efficiency.

Price postpaid, mounted } 50c.
Benefitiveness guaranteed }

Dealers and Distributors Quoted Attractive Discounts
ELSONITE PRODUCTS CORPORATION
Dept. W 18 PARK ROW, N. Y.

"MIRAD"
"Quality Radio Priced Right"

3 Plate Variable Condensers.....	\$1.50
Mirad Varicouplers	2.75
2000 Ohm Double Head Phones.....	6.00
1500 Ohm Single Head Phone.....	3.00
(Money back guarantee.)	
Mirad 23 Plate Condenser.....	3.00
Mirad 43 Plate Variable Condenser....	4.50
Mirad Detector Unit.....	30.00
Mirad Two-Stop Amplifier	30.00
Postage Paid	

Dealers' Sample of Above 25% Off

Miracle Radio Mfg. Co.
INTERURBAN BLDG., DALLAS, TEXAS

NOVO

BATTERIES
FOR RADIO

45 & 105 VOLTS

UNSESS
DEPENDABLE
GUARANTEED

YOUR DEALER

NOVO MANUFACTURING CO.

531 SO. DEARBORN ST. CHICAGO.

Radio Services Are Deeply Appreciated

RELIGIOUS services at 10:30 a. m. and 4:30 p. m. every Sunday have become a regular feature of the broadcasting program of WGY, the General Electric Company's radio broadcasting station at Schenectady, N. Y. The morning service, in every case, will consist of the entire service of one of Schenectady's churches, which will be connected with the transmitting equipment of the big radio station by telephone wire. The afternoon or vesper service will be conducted in the station studio.

The expansion of WGY's program to include Sunday has come as a result of thousands of letters from radio listeners within the station's transmitting radius. A great many of the letters were from aged people, too feeble longer to go to their churches but earnest in their desire for spiritual uplift. Among the letters were also a great many pathetic appeals from invalids, some of whom must spend their life in a single room. To such as these the deep swelling tones of the organ, the singing of hymns, the responsive readings, and the sermon are a real inspiration—a boon that lifts them out of the monotony of their existence and gives them a share in the activities which have failed to touch them.

Another class, and probably the most numerous, that has requested radio church-services are residents of country districts too remote from churches, or of localities where churches are closed because of the scarcity or expense of a regular pastor. In one case, it is known that a little group of neighboring farmers has gathered at the home of one of their number who had a powerful receiving set with loud speaker, and listened in, following the scripture reading in their own Bibles, making the responses in the psalter reading and joining in the congregational singing.

The first service sent out by WGY was from the First Methodist Episcopal Church, the Reverend Philip Frick, pastor. Three microphones were placed in the church, one located near the singers and the organ, the second at the pastor's reading desk, and the third in an ante-room for the announcer. Controlling switches brought any of these three microphones into the circuit.

While wandering from one radiophone to another we often wonder what it is all about—whether anything really matters after all, and, if it does matter, what are we going to do about it. Perhaps we are getting to be a radiofanatic.—"The Sun," New York.

Radio

Inland so deep all roaring waves are still;
So far at sea that dock lights long have died
And there's no sound of any train or mill;
Across the mountains high and deserts wild;
Where arc lights flare, or candles softly glow;
Past harbors where ships lie with canvas furled;
From sunrise to the twilight's afterglow
Man's puny voice is heard around the world.
—Walter Trumbull, in "The Herald," New York.

Although the domestic demand is light, numerous firms in and about Berlin manufacture radio apparatus. Curiously, vacuum tubes are "almost unavailable," says Vice-Consul Davis.

Fifty-two issues for \$6.00. Sub. Department, Radio World, 1493 Broadway, N. Y. C.

WELCOME! COME IN AND HEAR THE
CORACO RADIO CONCERT
Daily, 9 A. M. to 5 P. M. 10th Floor, 220 W. 42nd St., next to Amsterdam Theatre
The Coraco Super-Modophone is the latest and greatest improvement in radio. It has no outside connections—no installation expense—is as simple to operate as a phonograph. If you cannot call, write for full information.
THE CORACO COMPANY, INC.
220 West 42nd Street New York

BUILD YOUR OWN

Complete 100. Instruction book for \$20. only on radio reception and how to make eight classes of crystal and vacuum tube receiving sets. Wonderful information makes you understand radio. With every order we send free our price list of parts prepared especially for the several sets described. May direct from factory and save many dollars. Both instruction book and price list sent on receipt of \$20. only. Money back if not pleased.
RADIO PARTS MFG. CO.
Dept. 15, Park Pl. W., Detroit, Mich.

GOING—and Going Fast

We have only a few left and they are going fast, but while they last we will continue to sell them at the reduced price.

VT 1 Detector and Amplifier.....\$7.50
VT 2 Detector and Amplifier.....\$8.50

The above tubes are the genuine army 7's and 7's, respectively.

"RADIO BUILDER" PLANS FREE!
By Mail, 1c

LIBERTY RADIO CO.
106 Liberty Street New York City

HOMCHARGE
YOUR RADIO BATTERY
for a Nickel

ENJOYABLE Radio Concerts and Maximum Receiving Range are obtained only when your battery is fully charged. The

RADIO HOMCHARGER DE LUXE

charges your "A" or "B" battery over night. Silent and clean in operation—requires no watching—may be used right in your living room.

Connects to any lamp socket. Self-polarizing—fully automatic—cannot overcharge or injure the battery.

Entirely enclosed—approved by Underwriters. Unconditionally GUARANTEED. Lasts a lifetime.

Beautifully finished in Mahogany and Gold—the most efficient and handsome rectifier ever produced. Bulletin 637 proves it—send for your copy today—IT'S FREE. Sold by all good dealers or shipped prepaid for \$18.00, complete.

Dealers—Jobbers: The HOMCHARGER Merchandising Plan offers the best proposition in the entire radio field—send for details.

THE AUTOMATIC ELECTRICAL DEVICES CO.
125 West Third Street
Cincinnati, Ohio

EXTRA SPECIAL

GENUINE WESTERN ELECTRIC TUBES
with Western Electric Bases

Not Rebased
Not Refilled

LIMITED SUPPLY

ORDER AT ONCE

V. T. 1—\$7.50
V. T. 2—\$10.00

Sent upon receipt of money order.

WM. CONNOR CO.
790 Broad St. Newark, N. J.

REAL RADIO VALUES

ORDER DIRECT AND SAVE MONEY

LOOK OVER THESE HOLIDAY SPECIALS

	Regular Price	Our Price
Unit Audion Control Panels (Detector)	\$ 6.50	\$5.00
Unit Audion Control Panels (Amplifier)	13.50	10.00
Glass Enclosed Crystal Detectors—less crystal	2.00	1.50
23 plate Universal Condenser, bakelite ends, .0005 Mfd....	4.00	2.50
43 plate Universal Condenser, bakelite ends, .001 Mfd....	5.00	3.00
3 plate Universal Vernier Condenser, .000246 Mfd....	1.50	.75
Keystone Variometers, 150-580 meters	5.00	4.00
6 V. 60-80 Amp. Storage Batteries	16.00	12.00
Open Circuit Jack.....	.60	.33
Single Circuit Jack.....	.75	.40
Double Circuit Jack.....	.90	.48
Double Circuit Jack Filament Control	1.00	.55
Single Circuit Jack Filament Control	1.20	.63
Saturn Automatic Grip Telephone Plug	1.50	.98
Ajax Socket Rheostat.....	2.00	1.40
Dictograph Headsets, 3,000 ohms	8.00	8.00
Dictograph Loudspeakers....	20.00	20.00
Bestone Filament Rheostat..	1.00	.60
Bestone Variocoupler, 3 inch dial, 150-600 meters.....	8.00	5.75
Bestone Variocoupler, 3 inch dial, 150-580 meters.....	7.00	4.75
Bestone Socket, metal shell, bakelite base	1.00	.75
Federal Jr. Receiving sets, Dictograph Headset.....	25.00	15.00

Everything sent F. O. B. Jersey City the same day we receive your order. Send Money by Registered Mail, Post Office or Express Money order.

All Goods Guaranteed the Best There Is

HOLMES
RADIO PRODUCTS
999-C BERGEN AVENUE
JERSEY CITY, N. J.

Broadcast Bill's Radiolays

By William E. Douglass

(Copyright, 1922, Westinghouse Electric & Manufacturing Company.)

I'VE been to lots of parties, but the best I've ever seen wuz one we had at our place, in the barn, on Hallowe'en. I had the haymow all fixed up with punkins an' with corn an' them there fancy lanterns; when I's through you would a sworn the place wuz built fer parties. I had apples hung on strings an' some others to be bobbed fer, an' a lot of crazy things. When the folks begun arrivin', I got dressed up in a sheet—one that covered me all over, couldn't even see my feet. Then I met 'em at the doorway 'fore they climbed up in the mow, pointed out how they could get their, givin'



"It don't seem to faze her—boys; I'll tell you, she's a bear."

each a little bow. Abe an' Milly were the last ones, they drove up in their new flivver, an' I guess I musta scared it; when Abe stopped I saw it shivver. Well, us three went up together fer the party had begun. They were workin' on those apples an' in general havin' fun; we had cider an' some doughnuts, an' a lot of things to eat; an' those punkin pies that Min makes, let me tell you, can't be beat. We played a lot of games an' then I walked right out in front an' sez, "Each person present has to do a little stunt. If you can't sing a song, you'll have to hand us out a joke. Abe Jenkins, you kin start it off, then we kin watch your smoke." Well, everything wuz goin' smooth until Rebecca Vance sed if she had some music, she'd put on a ballet dance. Now Becky's eddicated—been away to school a heap, an' she kin do them dances, almost does 'em in her sleep. The stunt that I had planned to pull wuz with my Radio an' I wuz waitin' so I'd be the headline of the show. But, when Rebecca wouldn't do her dance without a tune, I 'lowed as how my act would slip fer I would just as soon pick up some real jazz music so that she could do her bit. I thought that she wuz stallin' an' that she would throw a fit when she found out that I could get the "music in the air." It didn't seem to faze her—boys, I'll tell you she's a bear. The first piece I tuned in wuz "Stumbling," which you've heard before an' so she stumbled in her dance—you ought to heard 'em roar. She'd taken several encores, an' an' we'd all quit clappin' when the chap announced the band would play that tune, "Do it Again."

Subscribe for Radio World, \$6.00 a year, \$3.00 six months, \$1.50 three months.

TURNEY PHONES

List \$6.50—Special Price \$3.50
3000 ohms

Amateurs: We pay postage

Perfection Radio Corp. of America
149 W. 23rd St. New York City

FOR IMMEDIATE DELIVERY!

500 LOTS

VARIOMETERS, Perfect, \$1.25 Net
ACT AT ONCE!

REISMAN

217 West 125th Street
New York City

Nobody Believes Us

When we say that our exclusive Variometers and Variocouplers, which are specially wound for close tuning and hooked up according to our diagram, will listen in from New York to Kansas City.

Let Us Prove It To You
At Our Expense

Fair enough? What do you say?

OSLAND, INC., 122 Fifth Ave.
NEW YORK, N. Y.

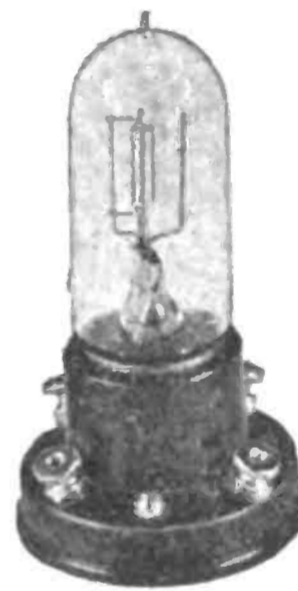

NA-ALD

Special
Socket W. D. 11

Designed especially for the new tube of the Radio Corporation which is operated by a single dry cell. Special clips of phosphor bronze with side wipe and strong gripping action on contact pins. Nickel plated binding screws. Highest quality throughout. Moulded from Condensite.

ALDEN-NAPIER COMPANY
52 Willow St., Dept. L. Springfield, Mass.

Spirola
TRADE MARK
Concert
PATENT PENDING
Loud Speaker
Complete with Unit
The First High Grade Low Priced Loud Speaker Remains Supreme.

Unequaled for Pure Natural Tone
Beautiful — Compact — Powerful

Beautiful cabinet type, hand rubbed mahogany or dark oak finish, bronzed throat, complete with cord—no extras to buy,
\$12.50

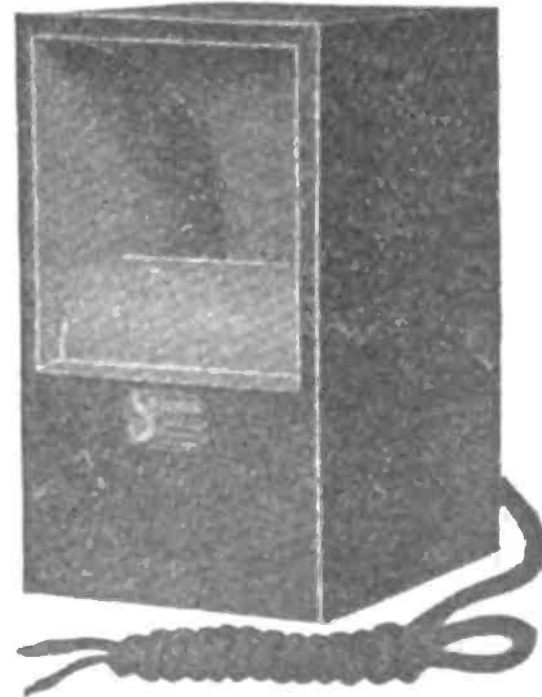

At dealers or postpaid (C. O. D. if preferred). Money-back guarantee if returned in ten days.

"Spirola Speaks"

L. H. DONNELL MFG. CO. Dept. B, Box 70
Ann Arbor, Mich.

YOUR NEWSDEALER

will deliver RADIO WORLD to your home. In order to be sure of getting RADIO WORLD regularly, and of not missing a single issue, we suggest that you either subscribe direct or through your newsdealer at \$6.00 a year (12 issues) \$3.00 six months, and \$1.50 three months. Or instruct your newsdealer to deliver RADIO WORLD regularly to your home each week. Dealers will take standing orders and

A Broadcasting Record

WHAT is believed a record-distance for daylight broadcasting was made by WGY, the General Electric Company, broadcasting station, in reporting the recent World Series. Baseball fans in Havana, Cuba, 1500 miles from Schenectady, reported distinct reception of the game of Thursday, October 4.

The series was reported, play by play, by W. O. McGeehan, sporting editor of the New York "Herald." A leased wire carried the story of the game from the press box in the Polo Grounds, New York, to the transmitting apparatus of WGY, 150 miles away. From WGY, the story traveled on Hertzian waves to listeners within hundreds of miles. Many letters and telegrams were received expressing appreciation for the prompt baseball service. Fans were able to follow every play and actually visualize the game.

The following cablegram was received from Havana:

"Havana Life" published a front-page story which in part, states: "The broadcasting of the World Series games by the New York Herald and WGY has made a great hit in Cuba. In was heard distinctly throughout the republic, according to reports received by 'Havana Life.' Our managing editor, Fred M. de Stefano, heard the report from the receiving station of Cecil J. Dale at Marianao, near the Oriental Park Race Track. F. W. Borton, president of the Electrical Equipment Co., of Cuba, leading radio fan, pays a great compliment on the clearness with which the report was received here."

A Radio Newspaper

A PARIS newspaper has ceased to be printed and is published orally. The subscribers meet in a hall and listen to the editors and reporters. The editorial staff has specialists who address the subscribers on topics of the day. So far the experiment has proved profitable. It saves the mechanical cost of publication and the white paper, says "The Globe," New York.

Here is an idea that might be adopted by one of the radio stations. The main cost of a daily newspaper is not the pay of the reporters, copyreaders and editors; but the cost of the mechanical departments and the white paper. By substituting radio broadcasting all the typesetting, stereotyping, and printing-press machinery would be dispensed with. There would be no expensive system of distribution, such as wagons and trucks. The hundreds of tons of white paper could be left to grow into spruce trees in the forest.

This may come some day; but the difficulty at present would be in collecting from the subscribers and in preventing anybody with a receiving apparatus from getting his daily news and editorials without paying for them. The subscribers would also have to go without cartoons and illustrations, unless they installed the more expensive and complicated apparatus recently invented, by means of which pictures can be electrically transmitted.

May—What did Noah do for laughs on his voyage in the ark with no radio to tune in on jokes from ABC and XYZ?

Ray—You recall that he took two of every animal known?

May—Yes.

Ray—Well, the hyenas were the laughing stock of the ark.

—"Topics of the Day" Films.

Fifty-two issues for \$6.00. Sub. De-

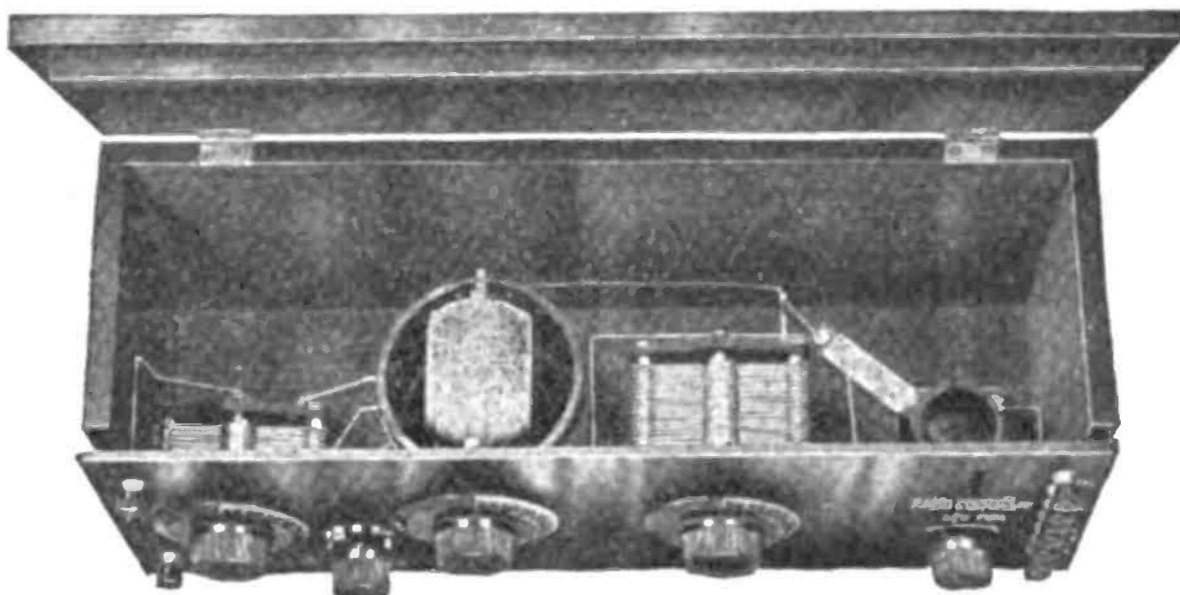

The Assembly \$27.50 Detector and Tuning Unit

A high-grade tube set that costs less than price of parts used. Super-sharp tuning through double circuit and Litz-wound rotor. A real tube set for the price of a good crystal set. All the fun of assembling—but correct assembling made absolutely certain and easy. Supplied in knock-down form, panel drilled and engraved, all parts packed inside cabinet, including connecting wires cut and bent ready for soldering. If your dealer can't supply you, send check or money order.

PROGRESSIVE DEALERS AND JOBBERS

You want this sure-selling Assembly Set. It meets the needs of the biggest buying class—those who want a real tube set at a low price. Attractive discounts. Order now for early delivery. Solve your book problem with the Radio Reading Course set of five books. A fast selling item. Write for discounts and order sample copy.

RADIO COURSES, INC. (Dept. RW3), 552 Seventh Avenue, New York

MASTER BALDWIN PHONES

AN IMPROVEMENT ON WHAT WAS CONSIDERED THE BEST

Those who know, in the radio world, have always used the Baldwin Phone. It has been ever-present where exacting work was to be done. It was conceded to be eight times more sensitive than any other known phone.

Not satisfied with even such a meritorious article as this, the manufacturers have now produced the Master Baldwin Phone. A 40% improvement in refinement and workmanship. Going still further, they have designed the Clarophone, the most marvellous speaker yet produced. Prices:

Singles, \$9.00 Headset, \$16.00 Clarophone Loud Speaker, \$22.50

THE MOST SENSATIONAL

radio development since the Vacuum Tube. After years of experiment and proof, this genuine fixed Radio detector is now available to amateur and professional operators. Its introduction marks the third GREAT step in the progress of Radio—first the crystal then the vacuum tube and now the wonderful Phonophone. Price, \$3.50, sent postpaid.

Direct or at your dealers.

CLARK & TILSON

1 EAST 42d STREET

NEW YORK CITY

RADIO PARTS AT CUT PRICES

VACUUM TUBES

UV200	\$4.00
UV201	5.00
VT1	6.25
VT2	7.25
WD11 1½ Volt.....	6.90
Meyers	3.75

VARIABLE CONDENSERS KOEHLER HIGH GRADE MOULDED ENDS

3-Plate	\$8.95
11-Plate	1.35
21-Plate	1.75
43-Plate	2.15

HEAD SETS

\$6.00 Murdock's	\$4.95	\$10.00 Stromberg-Carlson	\$5.75
8.00 Brandes'	6.90	16.00 Baldwin Master	12.75
22.00 Brown's	14.00	9.00 Baldwin Single	7.75
6.50 Turney's	2.95	8.00 Federal's	6.45

WESTERN ELECTRIC HEAD SETS, THE SUPERSENSITIVE PHONE USED BY THE SIGNAL CORPS AND NAVY. BOUGHT FROM THE U. S. GOVERNMENT. TYPE 194W (THE BEST MADE).....\$8.90

MAIL MONEY ORDERS—NO CHECKS

LIBERTY RADIO COMPANY

106 LIBERTY STREET, N. Y. CITY

Reference: Bradstreet's and Bank of The Manhattan Co. Broadway Park N. Y.

GIVEN FREE

**Aerial Equipment or
Dust-Proof Crystal Detector
with \$10.00 Purchase**

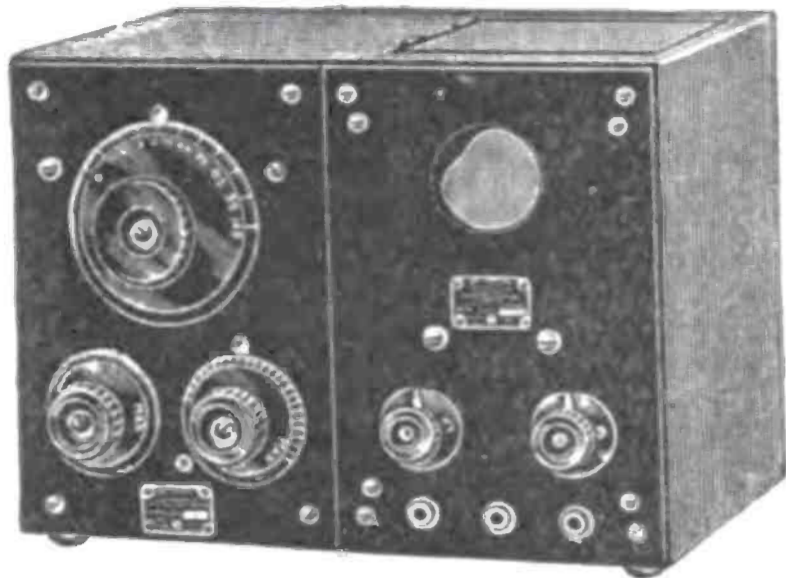

**IT WILL PAY YOU TO BUY NOW
SAVE \$40.00**

Special at..... \$92.50
List price..... \$132.50

The above is the popular and widely known E. C. Model Set. It is a highly sensitive long distance RECEIVER—a set you will be proud of—Regenerative, with TUNER, DETECTOR, and TWO-STAGE AMPLIFIER. Only a limited quantity at this price.

ACCESSORIES TO GO WITH THE ABOVE SET (less Storage Battery), \$19.20, and your option of a Magnavox or Head Set at price listed below:

LOUD SPEAKERS	
MAGNAVOX	\$33.00
PHONOTONE, slightly shop worn	17.00
HEAD SETS	
FEDERAL	\$5.00
Western Electric	9.00
Rebt. Imported Set	8.00
Kallogg	8.00
Error in our last advertisement for Kallogg Phones. Should have been \$3.00 instead of \$5.00.	
VACUUM TUBES	
Guaranteed U. V. 200	\$8.35
Guaranteed U. V. 201	4.38
B BATTERIES	
2 1/2 Volt	\$6.65
5 Volt	2.25
1 1/2 Volt, Large Size	1.85
STORAGE BATTERIES	
6 Volt, 80 Amp., Exide, Guaranteed	\$14.95
6 Volt, 60 Amp., Exide, Guaranteed	11.10
BATTERY CHARGERS	
E. F. Battery Booster	\$11.40
G. E. Tungar Rectifier	14.00
LOUD SPEAKER HORNS	
Just attach one phone	\$3.00
Just attach your head set	6.00
PHONOGRAPH ATTACHMENTS	
Fits any Phonograph and Phone	\$0.75
SPECIAL VARIOMETER	
Guaranteed perfect	\$2.00
DUG LATERAL COILS	
DL 25, 35 and 50	ca. \$0.35
DL 75, 100 and 200	ca. .50
DL 250	.65
DL 1250	1.35
DL 1500	1.48
DL COIL PLUGS	
Complete with strap	\$0.50
TRIPLE COIL MOUNTINGS	
Complete with Leads	\$2.50
SIGNAL CORPS VT. 1 VACUUM TUBES	
Guaranteed originals	\$5.45
NEW 1 1/2 VOLT DRY CELL TUBE	
TYPE WD-11	\$8.00
MAGNET WIRE—Write your inquiries.	
AERIAL WIRE	
Bare Copper—100 ft.	\$0.35
7-STRAND PHOSPHOR BRONZE—100 ft.	.50
AIRPLANE NAVY WIRE—100 ft.	.75
STANDARD MAKE DETECTOR AND TWO-STAGE	
Samples which are out of their boxes, but have not been used, values that were as high in price as \$75—a few at..... \$39.00	

Add postage, deliveries made daily.

RADIO DISTRIBUTING and AUTO SUPPLY COMPANY

4 West 66th Street, New York City
Columbus 8584
Avenue Subway
Avenue L

John Bull's Radio Exchange

WHAT is said to be the first radio-
phone exchange in the world was
recently opened at Croydon, England, the
point from which the air lines to the
European Continent take their departure,
according to Consul Linnell.

The chief use made of this exchange
is to connect the serial-traffic controller,
who has his headquarters in a control
tower at Charing Cross, London, with
the pilots of the air express flying be-
tween Croydon and the Continent.

This wireless exchange can also con-
nect the phones of the airships and air-
planes while in flight with any office at
the aerodrome at Croydon, making direct
telephone conversation possible.

The pilot of each aerial transport is
now required to report his position to
the traffic controller every fifteen min-
utes, so that the progress and position
of each plane is known throughout its
journey. The controller is of particular
value in directing the course of the air-
craft in cases of fog, and in giving them
special directions for landing.

The Radio Bug

I WAS sitting one day at my office
desk,
Writing of boys and men,
When a radio bug crawled out of a crack
And perched on the tip of my pen.

He scratched his neck with a wiry paw
And gazed at my half-writ poem,
Then settled back with a sleepy air
And ohmed an indolent ohm.

"Your room is chilly," said he to me,
As he shivered his aerial wire;
"If I were you I know what I'd do—
I'd build me an ampli-fire."

Then, tipping back 'till the pen point
cracked,
He ohmed again and said,
"I swallowed a couple of codes to-day
Any they gave me a pain in the head."

I asked him about his sister Ann,
And Galena so crystal fair.
"Oh, Gale is tickling the cat," said he,
"And Antenna is up in the air."

"I think that Ann's getting sour because
Of the unripe currents she ate,
For when I come with 'the weather' she
scolds,
'Now, wi-re you in-su-late?'"

He kicked his foot in a drop of ink,
Then slid from my pen with a snap—
Gave a switch to his tail and disappeared
Where the spark had begun to gap.
—Le Roy W. Snell in "The American
Boy."

"If I buy a radio apparatus, is there
any danger of getting a shock?"
"Only when the dealer tells you the
price."
—James Madison's Comedy Service.

Reliable and Beautiful RADIO-A RE-CHARGER



THE RADIO-A is a highly
efficient dependable piece
of apparatus, absolutely fool-
proof, easily attached by sim-
ply plugging into ordinary 110
volt lamp socket. In case of
current failure, the unit cuts
out automatically until current
is resumed, without discharg-
ing battery.

It is designed expressly for
re-charging radio filament bat-
teries, but may be used for
automobile or any other stor-
age battery of reasonable size
and capacity.

Price, \$18.50

Dealers and Distributors

Here's a Winner! Write
us for full particulars.

Simply screw into any 110 volt lamp
socket and connect the terminals to your
battery. Impossible to hook-up wrong—
RADIO-A charges either way.

RADIO-A RE-CHARGER

A compact portable Re-charging Unit
that will fully charge a 100 A. H. Bat-
tery overnight, for from 5c to 10c, ac-
cording to prevailing rates.

LAST A LIFETIME

King Electric Mfg. Co., Inc.
1681 HILLMORE AVENUE
BUFFALO, N. Y.

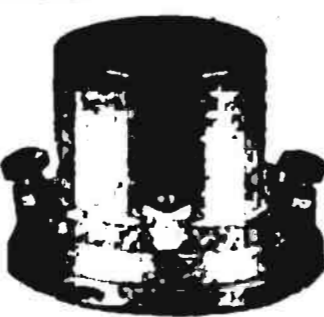

NA-ALD DE LUXE V. T. SOCKET

Contact strips of laminated
phosphor bronze press firmly
against contact pins, re-
gardless of variation in
length. No open current
trouble possible. Socket moulded from genuine
Condensite. Practically unbreakable. Special pro-
tected slot, with exterior reinforcement. Unaffected
by heat of bulbs or soldering iron. All excess
metal eliminated, aiding reception. May be used
for 5 Watt power tube.
Highest quality throughout. Price, 15c.
Special proposition for
dealers and jobbers
ALDEN-NAPIER CO.
Dept. L.
52 Willow St. Springfield, Mass.

Cavite to Washington, by Radio, in Four Minutes

THE transmission of a routine radio-message from the Naval Station at Cavite, Philippine Islands to Washington, D. C., was accomplished recently by the Naval Communications Service within four minutes. The total distance is 11,500 miles, establishing a new record for long-distance land and transpacific communication.

Ordinarily, with the delay on account of schedules, a message from Cavite to the Navy Department would not be delivered in less than several hours, and sometimes a whole day is required in the transmission, due to relaying and other causes.

Of course, the message was relayed at San Francisco, where it was received from Cavite, but as the radio circuit to Washington was "set up" the message was relayed immediately. Within four minutes after the sixteen-word dispatch left Cavite, it was received on the aerials on top of the Navy Building in Washington and read in the receiving room below. Radio communication is said to be instantaneous, and a signal is instantaneous; but a message is slower due to

the fact that time is required to transmit it, record it, retransmit and again record.

Westward, transpacific radio messages are relayed to Guam and Cavite through Honolulu. Recently through the operation of the Fanning electrical relay at Honolulu, 184 words were automatically relayed to Guam from San Francisco without being transcribed or retransmitted, thus saving considerable time in their dispatch.

Radio Jokes

Jay—How is your new Radio set?
Ray—Great, but my wife is kind of jealous of it!

Jay—Howzzat?
Ray—I have a loud speaker.

—“Topics of the Day” Films.

“The Radiophone has wonderful possibilities.”

“Yeah. When they get it perfected we can visit with relatives without having to feed 'em.”

Spinkus—Old Henpeck doesn't look as downhearted as he used to.

Spunkus—No, he doesn't have to listen to his wife talk any more. He has a

radio set and wears receivers around the house all the time.

—New York Globe.

INSU-LITE

PANES
1/8" —.01 per sq. in.
3/16" —.015 per sq. in.
1/4" —.02 per sq. in.

DEALERS: Write for discounts.

General Merchandise Co.

142 Market Street, Newark, N. J.



NA-ALD SMALL SPACE V. T. SOCKET

35c each, 3 for \$1.00. Molded genuine Condensite. Requires but small space for mounting. Easily accessible binding posts. No ozone metal to interfere with efficiency. Unaffected by heat of bulb or conducting iron. Flange for brass connects. Nickel plated brass binding screws. Blush out slot. Price possible because of large production.

Special proposition for dealers and jobbers.

ALDEN-NAPIER CO.

12 Willow St. Dept. L. Springfield, Mass.

Hearing Atlanta in Des Moines

EDITOR, RADIO WORLD: I noticed in RADIO WORLD (No. 29, dated October 14) that a Des Moines, Iowa, man heard Atlanta, Georgia. We pick up Atlanta every time they are on—and they come in perfectly. We also pick up the Norton Laboratories, Lockport, New York; also Schenectady, New York, and both come in loud and clear—just as natural as if in the same room. Our outfit is only a single detector-bulb regenerative set, but it works fine! —Newby Auto Electric, Milford, Iowa.

Clever Lawyer—Now, if you will let me have some of his love letters—

Breach-of-promise Gertie—I haven't any. We both had radio sets.

—“Topics of the Day” Films.

FRS

ALL MOLDED UNIVERSAL COMBINATIONS 5 Units in 3

F. R. S. Molded Variometers..... \$6.00
F. R. S. Molded Variocouplers..... \$5.00
F. R. S. Molded Bank Windings... \$5.00

Bank Windings are interchangeable for direct mounting on either Variometer or Variocoupler.

Universal—Accurate—Interchangeable

Dealers Send for Quotations

A Complete

Two-Stage Long Range Receiver



Set includes two Federal Transformers, Condenser, two-molded variometers, molded variocoupler, three V. T. sockets, filament rheostats, dials. Read 'Em binding posts, switch points: in attractive cabinet and drilled panel: complete, ready to hook up. **\$40**
A \$125 Radio for.....

F. R. S. Radio Corporation

400 East Fort St. Detroit, Mich.

DIALS

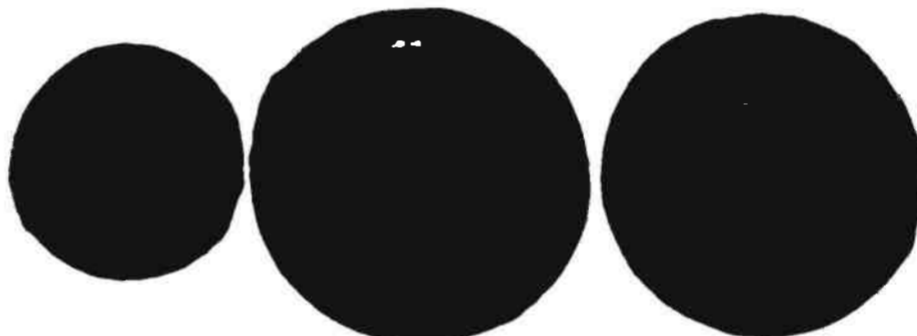

2" —20c. 2 3/4" —25c. 3" —27c.

with brass insert and set screw. Specify 3/16th or 1/4" insert.

\$1.75



Sesco Variocoupler, 600 meters.

One-half with order. Balance C. O. D.

Standard Model 8 Phones 2500 ohms, \$5.75

Standard Electric Sales Company

843 BROAD STREET

NEWARK, N. J.

\$2.50

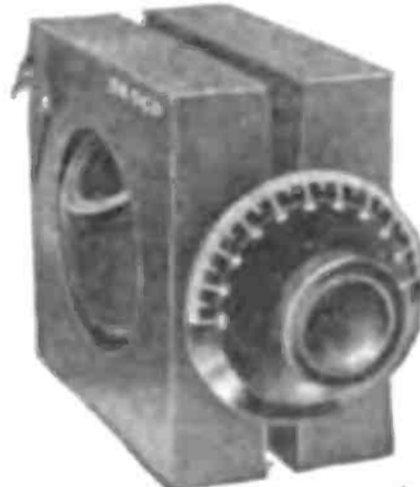

Sesco Variometer.

SUBSCRIPTION BLANK

RADIO WORLD

RADIO WORLD

1493 Broadway, New York City.

Please send me RADIO WORLD for months, for which

Please find enclosed \$

SUBSCRIPTION RATES:

Single Copy \$.15
Three Months 1.50
Six Months 3.00
One Year (52 issues)..... 6.00
Add \$1.00 a Year for Foreign and Canadian Postage.

DO YOU WANT TO BUY, SELL OR EXCHANGE RADIO OR OTHER GOODS? TRY THIS
DEPARTMENT AT 5c A WORD

RADIO WORLD'S QUICK-ACTION CLASSIFIED ADS

This department is intended for everybody who wants quick action on short announcements covering the buying, selling, exchanging or general merchandising in the radio field. Readers of RADIO WORLD will find that it pays to read these columns every week. Advertisers will get a ten-day service here—that is, copy received for this department will appear in RADIO WORLD on the news-stands ten days after copy reaches us.

The rate for this RADIO WORLD QUICK-ACTION CLASSIFIED AD. DEPT. is 5c. per word (minimum of 10 words, including address), 10% discount for 4 consecutive insertions, 15% for 13 consecutive insertions (3 months). Changes will be made in standing classified advs., if copy is received at this office ten days before publication, RADIO WORLD CO., 1493 Broadway, N. Y. C. (Phone, Bryant 4796.)

FOR QUICK SALE—Westinghouse R C at best offer. Daryl McClung, 1221 9th Avenue, Huntington, W. Va.

FREE APPARATUS FOR SECURING SUBSCRIPTIONS FOR "RADIO." Write today for complete list of premiums and our special subscription offer. "RADIO," Pacific Bldg., San Francisco, Cal.

RADIO HOSPITAL. Radio sets repaired by practical radiotrician, and experimentations under customer's supervision. Mail orders filled MELCO RADIO, 37-A Bedford Street, New York City.

RADIO ENTHUSIASTS: For Sale—A Complete Colin B. Kennedy Universal Receiving Set, almost new and in excellent condition. Remarkable long distance set, giving range of wave lengths from 175 to 25,000 meters. Have continually heard European stations. Owner is in a position where he can not use set. All communications may be addressed to Frederic W. Proctor, The Ambassador Hotel, Park Ave. and 51st St., New York City.

ADAPT your socket for Westinghouse dry cell tubes—no changing of connections needed. The Suneco adapter costs only \$1.50. Sent postpaid on receipt of price. Clark & Tilson, 1 E. 42nd St., New York City.

UNWIRED REGENERATIVE SETS

Details, Cabinet, 2 Condensers, 2 Honeycomb Coils, Coil Mountings, Socket, 1 Tusko Dial Bevel, Formica Panel, Grid Condenser and Leak, Bradley Stat. Price \$16.00. Frost Phones, \$4.25. Also, Phones rewound.

LOUIS WERTS, 400 St. Julian St., Pekin, Ill.

BRILLIANTONE RADIO PRODUCTS

Dept. E, 874 Columbus Ave., New York City

\$3.50 23-Plate Var. Condensers, .0005.....	\$1.75
4.50 43-Plate Var. Condensers, .001.....	2.25
4.50 Thordarson Audio Amp. Trans.	3.00
5.00 B. R. P. Audio Freq. Trans. (11 tol)....	4.00
7.00 U. V. 712 and Freq. Trans. (Radio Corp.)	6.00
6.50 U. V. 1714 Radio Freq. Tr. (Radio Corp.)	5.50
.70 Jacks single open or closed (Firth).....	.35
.90 Jacks double closed (Firth).....	.50
.002 and .005 Mica Bakelite Condensers.....	.25
.0005 and .00025 M. B. Cond. with Var. Leak...	.25
.0005 and .001 Fixed Mica Bakelite Cond.....	.20
Tub. Grind Leaks, ½, 1, 1½, 2, 2½, 3 Megohms	.45
Arrow Variometer	2.25
B. R. P. Variometer (to 800 Meters).....	3.00
180 Degree Vario Coupler (wound Green Wire)	1.65
B. R. P. Vario Coupler (Panel & Lab. Type)	3.50

Send Money Order, but do not add postage for mailing. Pkg. will come Parcel Post Collect.

MURDOCK PHONES—type 56, 3000 ohms... \$5.50
MURDOCK PHONES—type 56, 2000 ohms... \$4.50
U. V. 200 (Detector tube)..... \$4.50
U. V. 201 (Amplifying tube)..... \$5.85
Postpaid in U. S.

Send 25c for 208-page radio manual and catalogue. A. V. Gregory, 42 Broad St., Red Bank, N. J.

ISSUES OF RADIO WORLD from April 1 to Oct. 7 (27 numbers) for 15c a copy, or the whole lot for \$3.15. Or send us \$6.00 for one year and start with the first number. RADIO WORLD, 1493 Broadway, New York.

BROADCASTING STATIONS: Letters and addresses of broadcasting station to-date appeared in Radio World for Oct. 7. Sent on receipt of 15c. Also a broadcasting map appeared in Radio World No. 8. Sent on receipt of 15c. Radio World, 1493 Broadway, N. Y. City, N. Y.

Manufacturers of Rogers Radio Receivers and Rogers Receiving Radiometers. Rogers Radio Company, 5133 Woodworth Street, Pittsburgh, Pa.

PATENTS—Electrical cases a specialty. Pre-war charges. B. P. Flashburne, Registered Patent Lawyer, 306 McGill Bldg., Washington, D. C.

PATENTS—Send for form "Evidence of Conception" to be signed and witnessed. Form, fee Schedule, information, free. Lancaster and Allwine, Patent Attorneys, 259 Ouray Bldg., Washington, D. C.

FRENCH TUBES, genuine (no bootleg with French name), most sensitive and economic. (Good for detectors, amplifiers, and especially for radio frequency. Will work very good on two dry cells.) Price \$3.25. ATLANTIC & PACIFIC RADIO CO., 131 W. 37th St., near Bway., New York.

Exchange jolly interesting letters through our Club! Stamp appreciated. Betty Lee, Inc., 4254 Broadway, New York City.

Are you familiar with all the radio symbols used in the various book-ups published in Radio World? If not, secure a copy of Radio World No. 26, dated Sept. 23. In this issue was a complete table of all important symbols used in radio construction and testing. Send 15 cents for a copy, or \$6.00 per year, and have subscription start with that issue. RADIO WORLD, 1493 Broadway, New York City, N. Y.

RADIO MAN, eleven years' experience in all sides of the game, capable of constructing, installing, operating broadcasting station of any power, desires permanent connection. Go anywhere. What can you offer? Evans, Momus Pier 48, N. R., N. Y. C.

NEWS AND GOSSIP OF THE STAGE—Send 10c. for specimen copy of NEW YORK STAR, the great illustrated theatrical weekly. \$4.00 year, \$2.00 six months, \$1.00 three months. New York Star Co., 1493 Broadway, N. Y.

ASTONISHING results Rokay Regenerative Hook-up without use of Variometers—varicouplers, switches, taps, etc. ONE SINGLE CONDENSER CONTROL ONLY. The coming receiver. Simpler than a non-regenerative—better than any regenerative we have tested. Hook-up, \$1.00. Money Orders only. Saves you \$10.00 in building your own. With properly wound coils, \$3.50 post paid. Complete receiver parts on wood base with Vacuum Tube, \$8.00. Head set and "B" Battery, \$21.35, Express paid. Rokay Electric Co., Ingomar, Ohio.

HELP WANTED—MALE

EARN \$110 to \$250 Monthly, expenses paid, as Railway Traffic Inspector. Position guaranteed after 3 months' spare time study or money refunded. Excellent opportunities. Write for Free Booklet G-151. Stand. Business Training Inst., Buffalo, N. Y.

DO YOU USE A CRYSTAL DETECTOR? ARE YOU MAKING A CRYSTAL RECEIVER? Increase the efficiency of your crystal detector 1,000 per cent by using a "PT" Ultra-Sensitive Contact. Of special gauge and alloy; makes and holds a quick, ultra-sensitive, stable, adjustment. Endorsed by RADIO WORLD. Using galena, you may pound panel or table without disturbing sensitivity in slightest. Proved practical on shipboard by an oldtime Marconi operator. Using a "PT" Contact on galena, Arlington (NAA) was brought in clear at 3,300 miles (below the Equator); and Arlington came in loud at 2,200 miles (off Dutch Guiana). In both instances, nearby ships using vacuum tubes were unable even to hear NAA. As to stability, Cape May (WCY) was worked over 1,000 miles, sending right through crystal with 2 KW spark, without affecting detector's adjustment. Replace your insensitive unstable spring or catwhisker with a Contact which will hold its adjustment in addition to giving louder signals and music. Indispensable for use in your crystal set, regardless of make. A novice can install. "PT" ULTRA-SENSITIVE DETECTOR CONTACT, with instructions, twenty-five cents, coin or M. O. "PT" CRYSTAL CONTACT CO., Box 1641, Boston & Massachusetts.

CASH FOR OLD GOLD, Platinum, Silver, Diamonds, Liberty Bonds, War, Thrift, Unused Postage Stamps, False Teeth, Magneto Points, Jobs, Any Valuables. Mail in today. Cash sent, return mail. Goods returned in ten days if you're not satisfied. OHIO SMELTING CO., 337 Hipodrome Bldg., Cleveland, Ohio.

A Vacuum Tube Dry-Cell Set

But has a wave-length of 150 to 1000 meters.
Dealers and Jobbers Write to

LINCOLN RADIO CORP.

Manufacturers

116 West 69th Street New York, N. Y.

What Is It?

THE State Music Dealers' Association, of Iowa, met a few days ago and discussed the radio situation, says "The Mail," New York. Whether a radio set is a musical instrument or a scientific commercial device was one of the "big" questions that occupied the attention of the members. The delegates decided that should they class the radio receiver as a musical instrument the various members would lend support in exploiting radio.

This was an odd discussion. That it should occupy the attention of a business-getting organization is one of those things that cannot be understood. In the first place, whether the radio instrument is a musical device or another class of utility, is of no importance. Is the phonograph a musical device? Not essentially, although 95 per cent of the records we have are of a musical nature.

Attention! Fans and Amateurs!

Have you built your own receiver?

Are you experimenting with any particular hook-up?

Are you improving your set?

Are you doing any interesting constructive work in radio?

Why not share this knowledge with your thousands of brother fans who read RADIO WORLD every week?

We want pictures of receiving sets with descriptions of how you overcame some difficulty, or of any additional part or unit that you have added to obtain better results. These are the things that, probably, the other fellow is looking for. Send in your information; pictures or whatever you have done to improve the art.

Remember the beginner is looking for them.

We intend to print in this paper, each week, pictured information and description of value to radio amateurs. If you have found a newer or better way of doing anything, don't keep the secret but tell it to your thousands of brother fans.

Send in a photograph of your set with or without accompanying diagrams and measurement. State whether you figure in the picture yourself, or not, and without any expense whatsoever to you we will make an engraving and publish it. Be sure to write your name and address plainly on photograph.

Send in your picture at once, or if you have not made a set or done anything else in making radio material, tell the boy next door all about this offer.

Address Technical Editor

RADIO WORLD, 1493 Broadway, New York City, N. Y.

Be a Booster for National Radio Week

**RHEOSTATS—SOCKETS
POTENTIOMETERS
SWITCH LEVERS**
ROYHELE MFG. COMPANY
Mfrs. of quality products
169 Mercer Street New York City
Write for prices—Representatives wanted

**Variometers \$3.95
Variocouplers EACH**
REGULAR PRICE \$6.00
These are standard MOULDED instruments which is all that is necessary to say.
Order now as these prices will be withdrawn very shortly. Your money back if not satisfied.
W. A. DICKSON
Detroit 400 E. Fort St. Mich.

**RADIO CITIZENS
WE SAVE YOU MONEY**
Send us a list of your radio needs for our prices.
If It's Radio, we have it and we sell it for less.
JOHN R. KOCH COMPANY
CHARLESTON WEST VIRGINIA
Radio dealers since 1918

85c. each, 8 for \$1.00
NA-ALD
Genuine Condensite Dial
The dial that runs true.
Numerals engraved on bevel and knob so shaped that fingers do not hide them. This edge with clear graduation to make accurate reading easy.
Concealed set screw in metal insert. Will not warp or chip. Finish and enamel permanent.
3-1/2 inch dial 85c
2-1/2 inch dial for rheostat potentiometer use 85c
3-1/4 inch dial 75c
Send stamps for literature.
ALDEN - NAPIER COMPANY
82 Wilcox St., Dept. L. Springfield, Mass.

Antenella
No Antenna or Aerial Needed
CHAS FRESHMAN CO. Inc.
ANTENELLA
Does away entirely with antenna and all outside wiring, lightning arresters, switches and all other inconveniences.
ANTENELLA enables you to enjoy Radio pleasures in any room in your house. Place your receiving set anywhere and merely attach Antenella to any electric light socket. No current consumed.
At your dealer's—\$2.00
If he can't supply you send purchase price and you will be supplied promptly without further charge.
Chas. Freshman Co., Inc.
87 Beckman St. New York City

RADIO WORLD
TELEPHONE, BRYANT 4786
PUBLISHED EVERY WEDNESDAY (Dated SATURDAY OF SAME WEEK)
FROM PUBLICATION OFFICE,
1498 BROADWAY, NEW YORK, N. Y.
BY HENNESSY RADIO PUBLICATIONS CORPORATION
ROLAND BURKE HENNESSY, President
M. B. HENNESSY, Vice-President
FRED S. CLARK, Secretary
ROLAND BURKE HENNESSY, Editor,
1498 Broadway, New York
FRED S. CLARK, Manager,
1498 Broadway, New York
ASSOCIATE EDITORS:
Robert Mackay Fred Chas. Ehlert
SUBSCRIPTION RATES:
Fifteen cents a copy. \$6.00 a year. \$3.00 for six months. \$1.50 for three months.
Add \$1.00 a year extra for postage to Canada and foreign countries.
Receipt by new subscribers of the first copy of RADIO WORLD mailed to them after sending in their order, is automatic acknowledgment of their subscription order.
Advertising rates on request.
ADVERTISING RATES:
One page: One time—\$150.00.
Half, Quarter, Third and Two-thirds pages at proportional rates.
One inch, one time—\$5.00. Per agate line, \$0.40.
On four consecutive issues, 10% discount.
On thirteen consecutive issues, 15% discount.
Cover and preferred-position rates made known on application.
Terms: 30 days Net. 2% 10 days.
CLASSIFIED ADVERTISEMENTS:
Five cents per word. Minimum, 10 words. Discount of 10% on 4 consecutive issues—15% on thirteen consecutive issues. Cash with order.
Entered as second-class matter, March 28, 1922, at the Post Office at New York, New York, under the act of March 3, 1879.
IMPORTANT NOTICE:
While every possible care is taken to state correctly matters of fact and opinion in technical and general writings covering the radio field, and every line printed is gone over with a scrupulous regard for the facts, the publisher disclaims any responsibility for statements regarding questions of patents, priority of claims, the proper working out of technical problems, or other matters that may be printed in good faith and on information furnished by those supposed to be trustworthy. This statement is made in good faith and to save time and controversy in matters over which the publisher cannot possibly have control.

Since Railroads Took to Radio
ELDERLY Lady: "Can you tell me whether this train plays 'Silver Threads Among the Gold?'"
Train Caller: "No, ma'am. Take the WJZ local for that number."
* * *
Beautiful Young Lady: "Can you show me what train to take to hear 'Kiss Me Again,' 'Love's Sweet Song,' 'I'm Crazy Over You?'"
Train Caller (very embarrassed): "I certainly can. Step this way, please!"
* * *
Indignant Commercial Traveller: "My train is two hours late again. What-zamatah?"
Station Master: "It ran out of violin solos at Pittsburgh."
* * *
Wild Business Man: "Say, looka here! What's the trouble with the 2.15 express?"
Station Master: "Three hours behind time. It had to stop at Gopher Prairie for a new crystal set."
* * *
Railroads may shortly announce the suspension of certain trains because of unfavorable static conditions.
* * *
Travel Note: Mr. and Mrs. O. Howe Dumm, accompanied by Mr. and Mrs. A. Lott Dummer and radio sets, left today on the 12.20 for an extended railroad trip.—W. I. Phillips, in "The Globe," New York

B Batteries That Last For 5 Years
22—500 VOLTS
Send for interesting circular Dept. B.
Sibbenel Radio Equipment Mfg. Co.
1663 Jerome Ave. New York City

DOUBLE HEAD PHONES
BOYS! A REAL RADIO SET ABSOLUTELY FREE
RUSH your name and address and we will tell you HOW you can get this RADIO SET ABSOLUTELY FREE. RADIO SET comes to you complete, with single slide tuning coil, crystal detector and phone condenser, AND DOUBLE HEAD PHONES. No batteries required; no experience.
Write To-day for Free Radio Plan.
HOME SUPPLY CO.
110 Nassau St., Dept. 204
New York City



VARIO COUPLERS
GEM
\$1.25
List
We also make 6 other styles That List \$2.50 up
Jobbers—Dealers—Agents
Write for Discounts
Jewell Radio Sales Co.
90 West St. New York City
Phone Rector 1635



ALWAYS FOREMOST IN THE FIELD
Spirola
Announces the New Duplex Cabinet
LOUD SPEAKER USING YOUR OWN HEADSET
Two complete loud speakers in one—one for each phone—eliminates the interference between phones of the usual type, giving much greater volume. Each tone chamber is two feet long but the SPIRAL construction allows a very compact instrument besides absolutely eliminating metallic distortion—REALLY GIVES A PERFECTLY NATURAL TONE.
Beautiful hand rubbed mahogany or dark oak finish, brazed throat and fittings... \$4.85
Hand rubbed black finish all over, nickel fittings \$3.85
At dealers or postpaid (C. O. D. if preferred). MONEY-BACK GUARANTEE.
For those who own a Baldwin or other
LOUD SPEAKER UNIT
we make a single type SPIROLA with special clamp. Same prices as above.
L. H. Donnell Mfg. Co.
Dept. B. Box 70
Ann Arbor Mich.



Fifty-two issues for \$6.00. Sub. Department, Radio World, 1493 Broadway, N. Y. C.—Advt

Most Complete—Interesting—Informative Book
Ever Compiled on Radio

Textbook on Radio

By JAMES R. CAMERON

Whose textbooks are used and indorsed by the
U. S. Army, Navy, and Department of Public Instruction

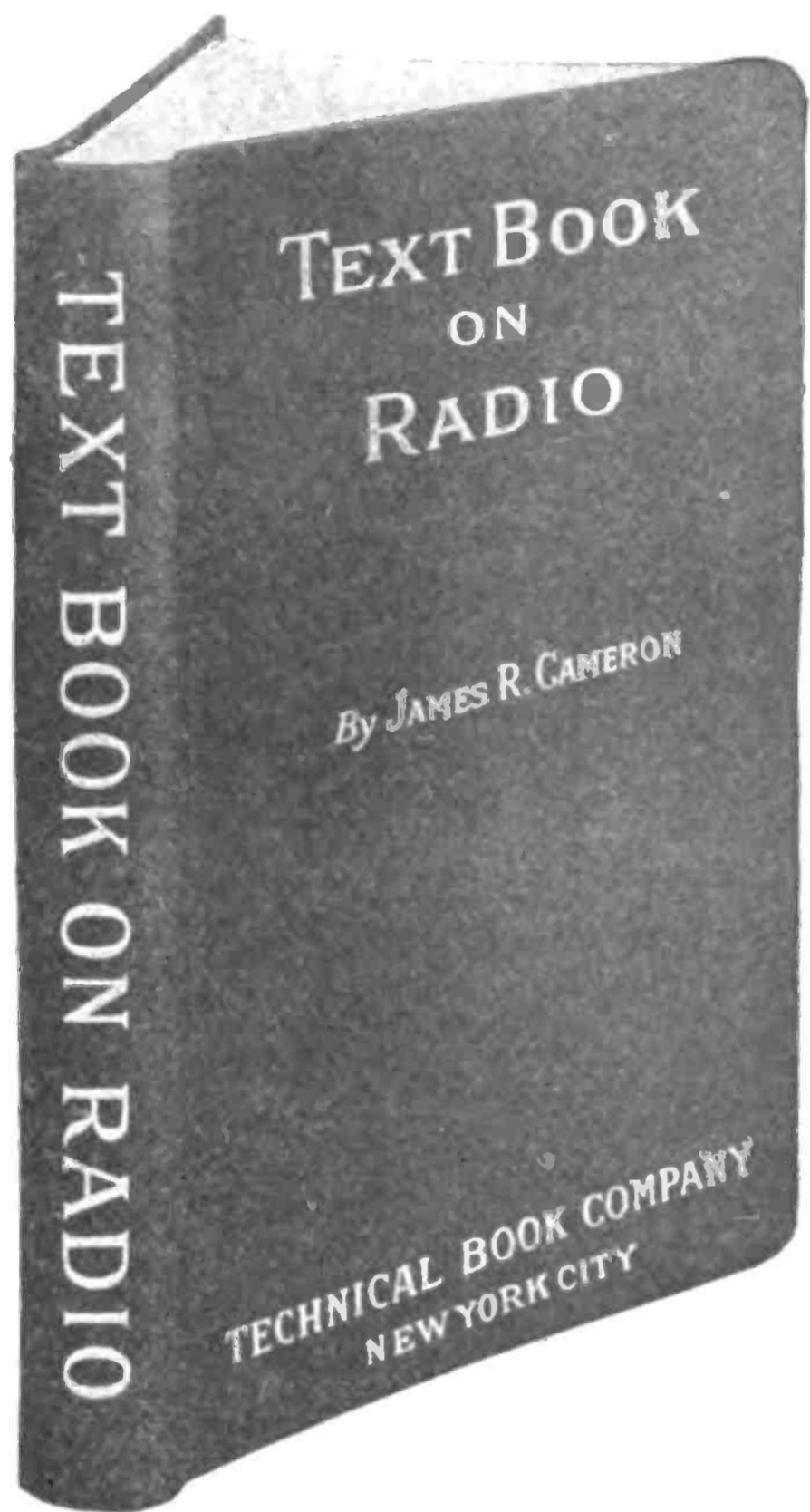

350 Pages. Profusely Illustrated. Written so the amateur can understand it. At the same time—TEXTBOOK ON RADIO—is a standard textbook for the technical radio student.

Over four thousand mail orders received before this book was off the press.

“RADIO’S THREE BEST SELLERS!”

HOW TO BUILD YOUR OWN RADIO SET, 25c

RADIO DICTIONARY, 50c

RADIO FOR BEGINNERS, \$1.00

Buy From Your Dealer or Use This Order Blank

-----ORDER BLANK-----

TECHNICAL BOOK COMPANY,

130 West 42nd Street,

Dept. W., New York

Please send me by return of post your 350-page, profusely illustrated Textbook on Radio, for which I am enclosing you \$.....

Cloth Bound \$2.50

Flexible Leatho \$3.00

HOW TO BUILD YOUR OWN RADIO SET, 25c

RADIO DICTIONARY, 50c

RADIO FOR BEGINNERS, \$1.00

Name

Address