

*Radio-Television*  
**SERVICE  
 DEALER**  
 TV-AM-FM-RADIO-ELECTRONICS

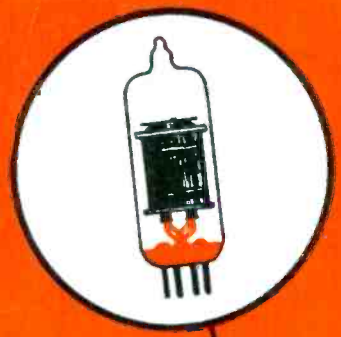

**PORTABLE RADIO SEASON**

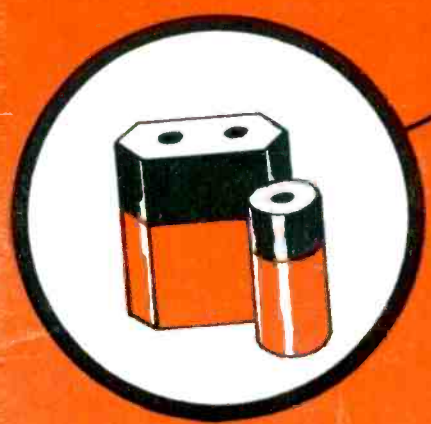

**SERVICE DEALER TOPS 'EM ALL**

Distribution of this issue exceeds 71,500 copies—  
 the largest servicemen coverage in the field.

N2B A 2K 952 MAR 59  
 ROBERT G WALRAVEN  
 1148 S OMEIDA ST  
 GREEN BAY WISC

a complete NEW line!

# RADIART SEAL-VENT Communication Vibrators



Based On Rigid  
U. S. Government  
Engineering Specifications

NOW... RADIART makes available to commercial users of communications equipment, a new line of vibrators based upon experience of producing over 2 million similar units to the exacting requirements of U.S. Signal Corps Specifications.

These Eight Types Offer Complete Replacement for ORIGINAL Communication Equipment:

Old No.	New No.
5515	<b>5715</b>
5518	<b>5718</b>
★	<b>5721</b>
★	<b>5722</b>
5605	<b>5805</b>
5620	<b>5820</b>
5621	<b>5821</b>
5622	<b>5822</b>

**It's ready now!**  
**The new 1955**  
**Radiart Vibrator**  
**Replacement Guide**



THE **RADIART** CORPORATION  
CLEVELAND 13, OHIO

TV ANTENNAS • AUTO AERIALS • VIBRATORS • ROTORS • POWER SUPPLIES

# TUNG-SOL "Magic Mirror"

## ALUMINIZED

# PICTURE TUBE

**BRIGHTER-SHARPER  
MORE DETAIL  
MORE CONTRAST**



The "Magic-Mirror" Aluminized Picture Tube creates the brightest, most realistic TV picture you can bring into the homes of your customers. The "Magic-Mirror" tube effectively utilizes *all* the light generated by the phosphor screen.

Tung-Sol has developed a unique "fogging" method of backing up the phosphor screen with a mirror-like aluminum reflector. This reflector prevents light radiating uselessly back into the tube. It brings out all the detail of which the receiver circuit is capable. So smooth and true is the Tung-Sol aluminum reflector that mottling, streaks, swirls, "blue-edge", "yellow-center" and other objectionable irregularities are eliminated.

Tung-Sol pin-point-focused electron gun assures a steady, brilliant picture—free from alternate fading and overlighting. Tung-Sol's exacting standards of quality control, manufacture and testing further guarantee the high uniformity and maximum performance of the "Magic-Mirror" TV Picture Tube.

For further details, including Tung-Sol's sales aids and advertising support, call your Tung-Sol supplier today.

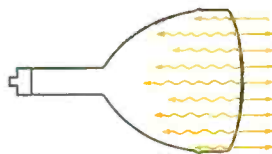

**ORDINARY TUBE**—Only *half* the light produced by the phosphor screen is utilized in the picture. Other half radiates wastefully back into tube.



**RESULT**—A light background within the tube which reduces picture contrast.

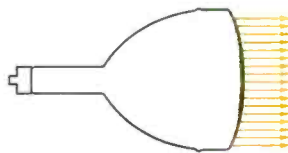

**MAGIC-MIRROR ALUMINIZED TUBE**—Aluminized reflector allows electron beam through. Blocks wasted light from backing up into tube. Reflects *all* the light into picture.



**RESULT**—Pronounced increase in contrast to make a bright, clear, more realistic picture.

## TUNG-SOL ELECTRIC INC., Newark 4, N. J.

Sales Offices: Atlanta, Chicago, Columbus, Culver City (Los Angeles), Dallas, Denver, Detroit, Montreal (Canada), Newark, Seattle.

Tung-Sol makes All-Glass Sealed Beam Lamps, Miniature Lamps, Signal Flashers, Aluminized Picture Tubes, Radio, TV and Special Purpose Electron Tubes and Semiconductor Products.





### EDITORIAL STAFF

*Publisher*  
**SANFORD R. COWAN**

*Editor*  
**SAMUEL L. MARSHALL**

*Editorial Production*  
**ROBERT CAMPBELL**

*Contributing Editors*  
**ROBERT T. DARGAN**  
**PAUL GOLDBERG**  
**OSCAR FISCH**  
**SAN D'ARCY**

*Cover by*  
**MIKE LOYER**

### BUSINESS STAFF

*Advertising Manager*  
**HARRY N. REIZES**

*Advertising Sales*  
**LAWRENCE STEINER**

*Production Manager*  
**DAVID SALTMAN**

*Circulation Manager*  
**HAROLD WEISNER**

*Ass't Circ. Mgr.*  
**C. J. BINDERMAN**

### BRANCH OFFICE

**LOS ANGELES**  
**TED E. SCHELL**  
**2700 West Third Street**  
**Dunkirk 2-4889**

**EVERY SERVICE FIRM OWNER IN THE U.S.A.  
Receives SERVICE DEALER Monthly  
Distribution of this Issue over 71,500**

Member **EPA** —Circulation Statement sent on request

**COWAN PUBLISHING CORP., 67 West 44th Street, New York 36, N. Y.**

VOL. 16, NO. 6

JUNE, 1955

### FEATURE ARTICLES

- Color Signal Output Systems**, by Bob Dargan and Sam Marshall..... 6  
Introduction to output system theory and circuitry used in color TV receivers
- A Roundup of 1955 Portable Receivers**, by Sol Heller ..... 12  
General design and circuit features of the new line of current portables
- Electrostatic Speakers in new Hi-Fi Units**, by Steve Travis ..... 16  
Description and application of a new and promising type of speaker
- Video Problems (a Work Bench feature)** by Paul Goldberg..... 21  
Solving video amplifier problems
- Compound Diffraction Projection Loudspeakers**, by Charles Eastman 22  
A simplified explanation of the how and why of compound diffraction speaker operation
- TV Service Information Sheets** ..... 25-32  
Complete preliminary service data for Westinghouse Model H-838K21, A, B, -841T21, -842T21, etc.
- Circuit Analysis**, by the RTSD Technical Staff..... 37  
Analysis of the Noise Control Circuit of the Emerson Chassis 120174B
- A New High in VTVM Compactness**, by P. James Connor ..... 41  
Description of a VTVM with compactness as one of its outstanding features

### CIRCUIT AND SERVICE FORUM

- The Work Bench**  
Westinghouse 1250-101: Low video gain..... 21  
DuMont RA 109: Smearred pix..... 21
- Video Speed Servicing Systems**  
Philco chassis TV 350 ..... 33  
Philco chassis TV 300 ..... 35
- Circuit Analysis**  
Noise control circuit, Emerson Chassis 120174B..... 37
- Rider TV Field Manual Service Data Sheets**  
GE model 17C127, 17T15-17, 21C114-115, etc..... 39
- Answer Man**  
6BK7-6BQ7 Substitution ..... 46  
Ion trap adjustment and tube life ..... 46  
Snow reduction in fringe areas..... 46

### DEPARTMENTS

- |                       |    |                         |    |
|-----------------------|----|-------------------------|----|
| Editorial .....       | 20 | New Products .....      | 42 |
| Work Bench .....      | 21 | Answer Man .....        | 46 |
| Circuit Analysis..... | 37 | Advertising Index ..... | 56 |

RADIO-TELEVISION SERVICE DEALER is published monthly by Cowan Pub. Corp., 67 West 44th St., New York 36, N. Y. Subscription price: \$1.00 per year in the United States, & U.S. Poss. Elsewhere \$1 per year additional. Single Copies 25c. Second Class mail privileges authorized at New York, N.Y. Copyright 1955, Cowan Publishing Corp.

POSTMASTER: SEND FORM 3579 TO RADIO-TELEVISION SERVICE DEALER,  
67 WEST 44th ST., NEW YORK 36, N. Y.

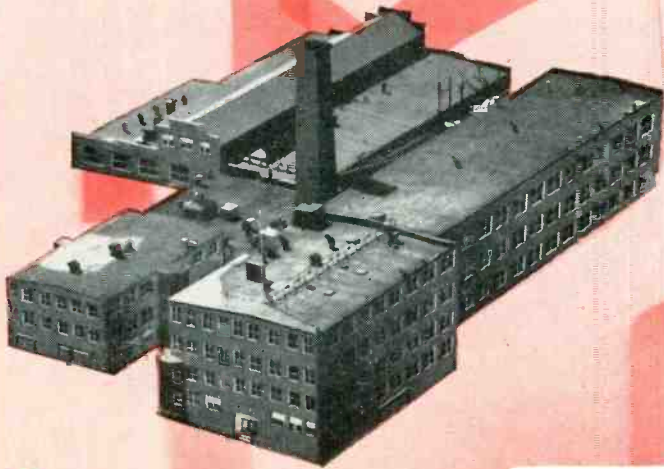

Raytheon's Receiving Tube Plant  
No. 1 — Newton, Mass.



Raytheon's Microwave and  
Power Tube Plant No. 1  
Waltham, Mass.

# RAYTHEON LEADS THE WAY

## In TUBES and SEMICONDUCTORS

### Here are a few reasons why:

**RAYTHEON** employs 18,000 people. Approximately 10,000 of them work in Raytheon's modern tube and semiconductor manufacturing plants.

**RAYTHEON** has more than 1,000,000 square feet devoted exclusively to the manufacture of Raytheon quality tubes and semiconductors.

**RAYTHEON** employs over 500 engineers and scientists who work exclusively in the electron tube and semiconductor fields.

**RAYTHEON** has had 33 years' experience in the manufacture of electron tubes.

**RAYTHEON** has made tubes of every type of construction — Standard Glass, "G", GT, Bantal, Lock In, Metal, Miniature and Subminiature Tubes.

**RAYTHEON** Receiving and Cathode Ray Tube Operations have produced more than a third of a billion tubes and semiconductors.

**RAYTHEON** perfected the first practical rectifier tube types (BA and BH) to eliminate the need for "B" batteries to operate home radios. This revolutionized the design of home radio sets. Raytheon later developed the cold cathode rectifier tube for auto radios and has produced more of these tubes than all other companies combined.

**RAYTHEON** developed the famous 4-pillar construction that strengthened internal structure resulting in sturdier tube design.

**RAYTHEON** developed and was first to mass-produce the octal button stem receiving tube — today's most imitated construction for premium TV performance. Raytheon was first to make millions of these tubes as far back as 1946. These tubes featured a planar button stem and 8 straight leads (8-pillar) which go directly into a standard octal base. Raytheon's Patent Numbers 2310237, 2321600 and 2340879 apply to this invention.

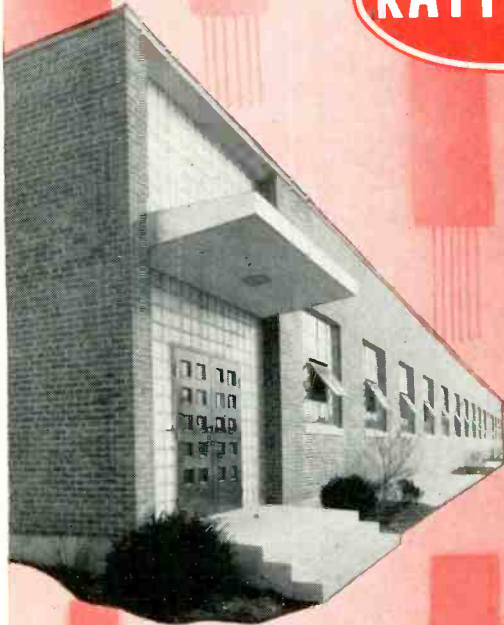

Raytheon's Research Center  
Waltham, Mass.

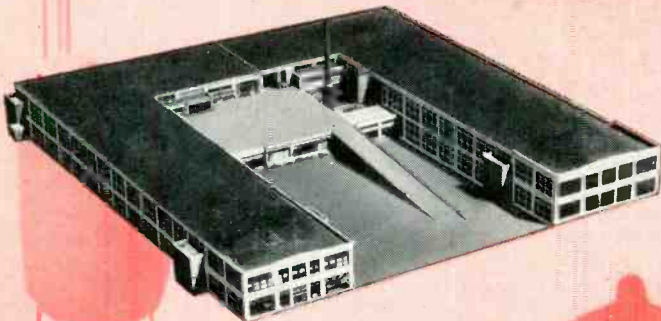

Raytheon's Semiconductor Plant No. 2  
and Raytheon's Special Tube Plant No. 2  
Boston, Mass.



Raytheon's Cathode Ray Tube Plant  
Quincy, Mass.



Raytheon's Receiving Tube Plant  
No. 2 — Quincy, Mass.

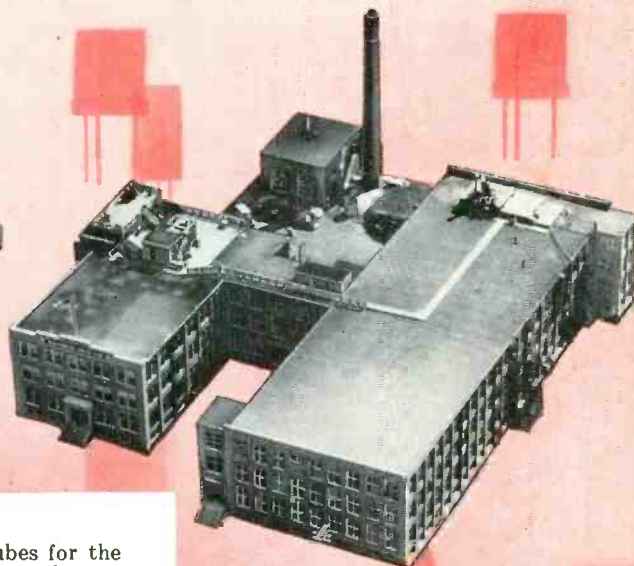

Raytheon's Semiconductor Plant  
Newton, Mass.  
(Being Assigned to Semiconductor  
Division starting Dec. 1, 1955)

**RAYTHEON** developed and first mass-produced subminiature tubes for the hearing aid industry — the forerunners of the fuse tubes which made possible the famous proximity fuses of World War II. There are more commercial Raytheon subminiature tubes in use today than all other makes combined.

**RAYTHEON** developed a method of mass producing magnetrons (the power tube that is the heart of radar) early in World War II, that broke a serious bottleneck, and continues to produce more magnetrons than all other manufacturers combined.

**RAYTHEON** is the largest producer of klystrons and has manufactured more than all other companies combined.

**RAYTHEON** was the first commercial producer of Transistors — the "mighty mite" — a Raytheon achievement that revolutionized the hearing aid industry.

**RAYTHEON** first commercially produced fusion-alloy RF Transistors, expected to revolutionize the portable radio, auto radio and computer industries.

**RAYTHEON** has produced many more transistors than all other manufacturers combined — nearly 2,000,000 in use.

**TODAY, RAYTHEON** makes Receiving and Picture Tubes, Reliable Miniature and Subminiature Tubes, Semiconductor Diodes and Transistors, Nucleonic Tubes and Microwave Tubes.

*These facts and figures show why you can use Raytheon Television and Radio Tubes with complete confidence that they are Right . . . for Sound and Sight — Right for you and your customers, too.*



Raytheon's Microwave and  
Power Tube Plant No. 2  
Waltham, Mass.

**A Company second to none in**

*Excellence in Electronics*



**RAYTHEON MANUFACTURING COMPANY**

Receiving and Cathode Ray Tube Operations

Newton, Mass. • Chicago, Ill. • Atlanta, Ga. • Los Angeles, Calif.

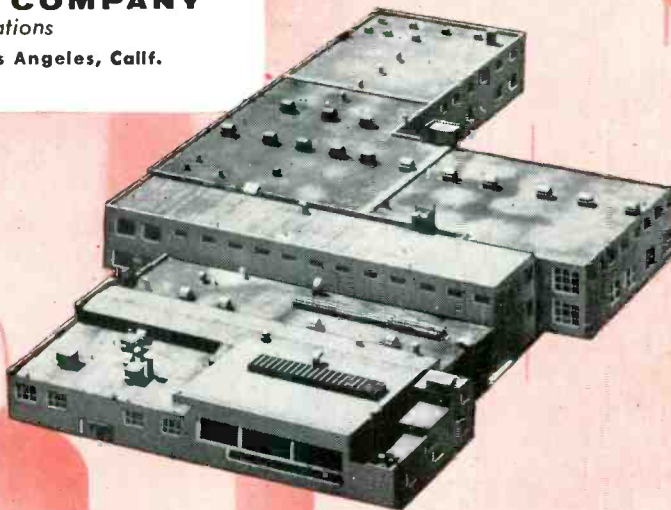

Raytheon's Special Tube Plant No. 1  
Newton, Mass.

# color signal

by  
Bob Dargan  
and  
Sam Marshall

# output systems

Fig. 1 — Simplified block diagrams of color output sections of I/Q, R-Y/B-Y, and High-Level 2-triode receivers.

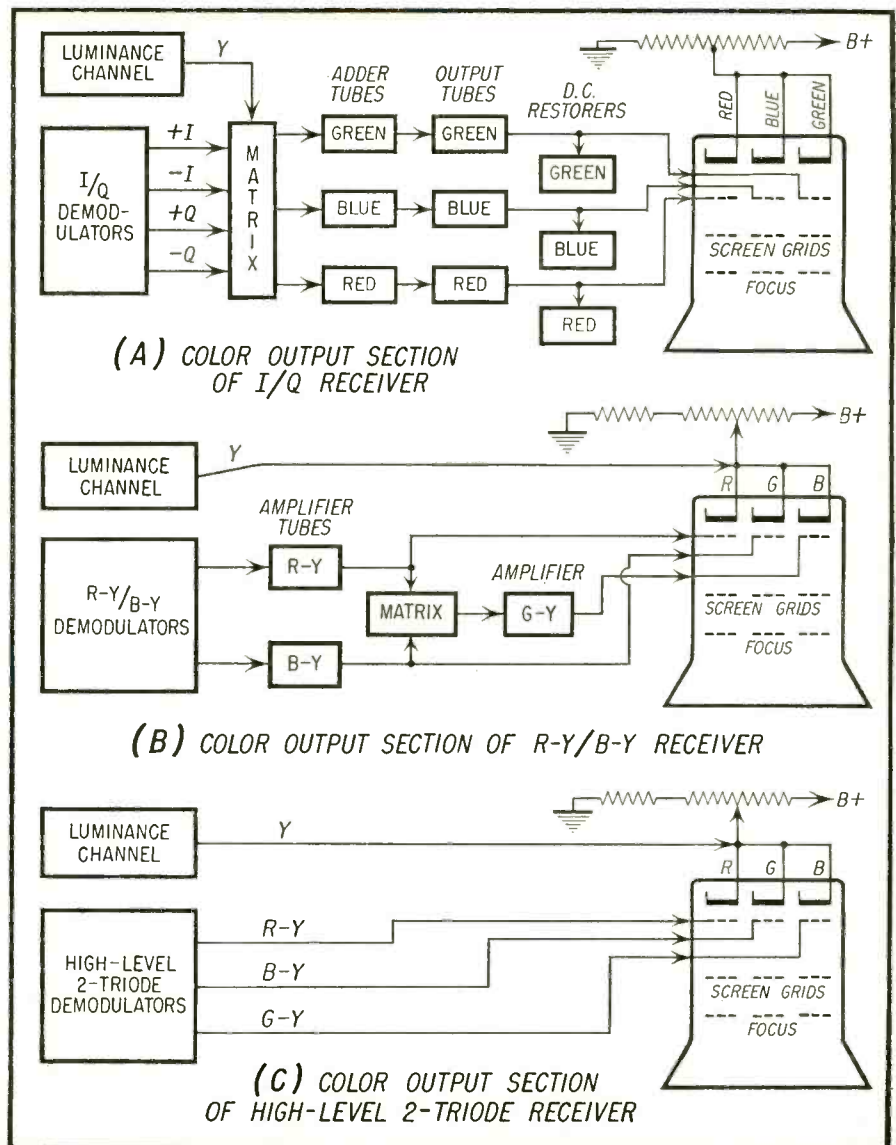

IN the previous section, dealing with demodulation, it was pointed out that the two basic commercial systems of demodulation used at present are the I/Q, and the B-Y/R-Y. The B-Y/R-Y system can be further categorized into two distinct types, one type employing low-level and the other type high-level demodulation. These separate systems determine the manner in which the demodulated color information is processed in the color output stages for application to the picture tube.

In Fig. 1 are shown the simplified block diagrams of the color output sections for the three systems used. These will all be analyzed in detail. However, a brief comparison of the three block diagrams will first be made; this for the purpose of emphasizing the basic function of all color output sections this function being to provide the correct red, green, and blue signal voltages to the picture tube grids.

The demodulated output of an I/Q receiver as shown in Fig. 1A provides positive and negative values of I and Q.



# Simpson

MODEL

## 260

MULTI-TESTER

### outsells all others combined!

More technicians are using the Model 260 than any other high-sensitivity VOM. Over half a million Model 260's have been sold to date! 20,000 Ohms per volt. You'll find it wherever quick, accurate, electrical checks are needed. It's so handy, so dependable, so sensibly priced. Ask your jobber to show you the Simpson Model 260. Only **\$38.95**, including Adjust-A-Vue Handle. Carrying cases from **\$6.75**.

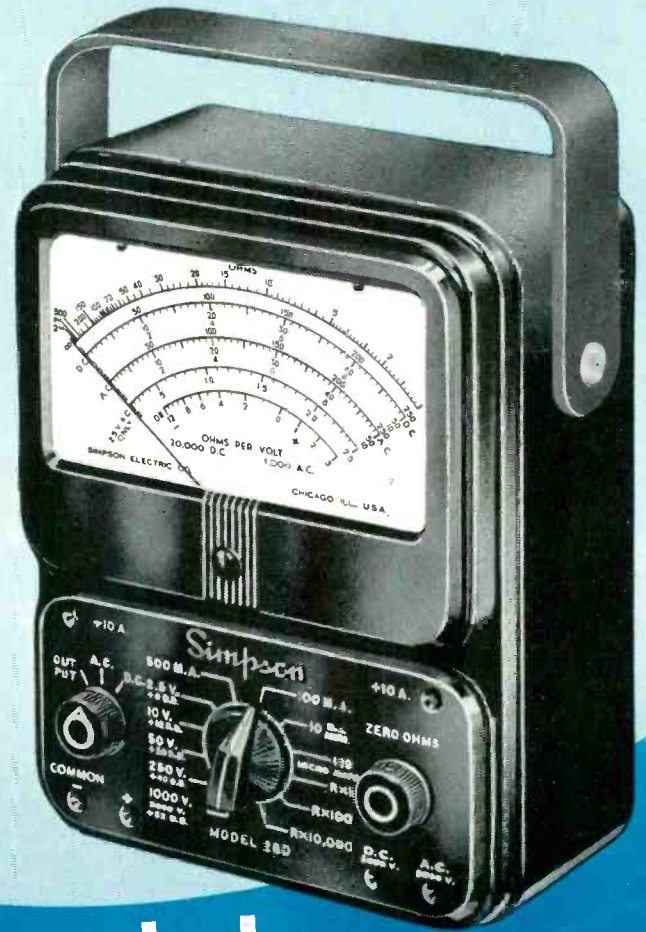

**world's most popular!**

MODEL

## 262

the new vom with a 7" meter

20,000 Ohms per volt DC. 5,000 Ohms per volt AC. 33 RANGES

DC VOLTAGE: 0-1.6, 0-8, 0-40, 0-160, 0-400, 0-1600, 0-4000 volts (20,000 ohms per volt sensitivity)

AC VOLTAGE: 0-3, 0-8, 0-40, 0-160, 0-800 volts (5,000 ohms per volt sensitivity)

AF OUTPUT VOLTAGE: 0-3, 0-8, 0-40, 0-160 volts (0.1 microfarad internal series capacitor)

VOLUME LEVEL IN DECIBELS: -12 to +45.5 DB in 4 ranges.

Zero DB Power Level, .001 watt in 600 ohms.

DC RESISTANCE: 0-500 ohms (4.5 ohms center); 0-5,000 ohms (45 ohms center);

0-50,000 ohms (450 ohms center); 0-500,000 ohms (4,500 ohms center);

0-5 megohms (45,000 ohms center); 0-50 megohms (450,000 ohms center)

DC CURRENT: 0-80, 0-160 microamperes, 0-1.6, 0-16, 0-160 milliamperes,

0-1.6, 0-16 amperes (267 millivolts maximum drop)

MODEL 262 complete with 2 test leads with removable alligator clips, 4,000 v. DC multiplier

Dealer's Net Price, including Adjust-A-Vue Handle. **\$59.50** Carrying Case. **\$9.95**

Accessory High Voltage Probe

for 16,000 volts DC. **\$11.50**,

40,000 volts DC. **\$12.50**



*Deluxe!*

SEE THEM AT YOUR JOBBER, OR WRITE . . .

# Simpson ELECTRIC COMPANY

WORLD'S LARGEST MANUFACTURER OF ELECTRONIC TEST EQUIPMENT

5204 W. Kinzie St., Chicago 44, Illinois, Phone: EStbrook 9-1121

In Canada: Bach-Simpson, Ltd., London, Ontario

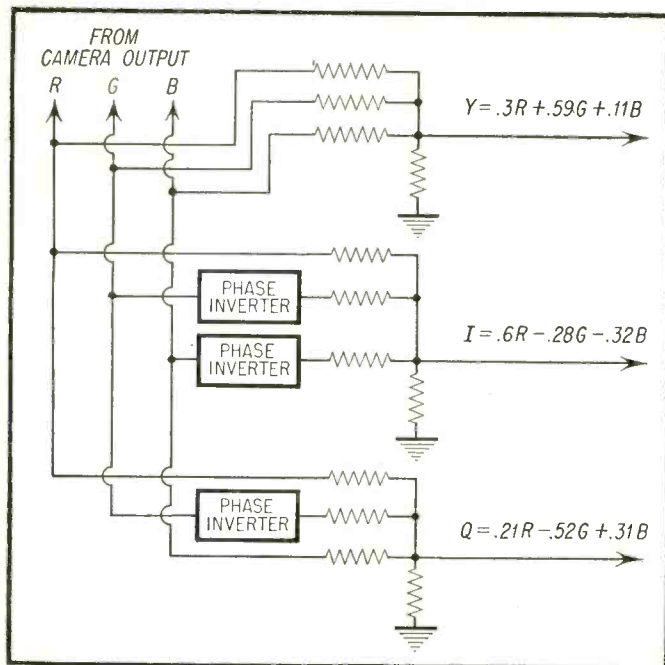

Fig. 2—Circuit diagram (partial) of typical matrix network employed at transmitter end of color system. Note use of phase inverters for  $-G$  and  $-B$ .

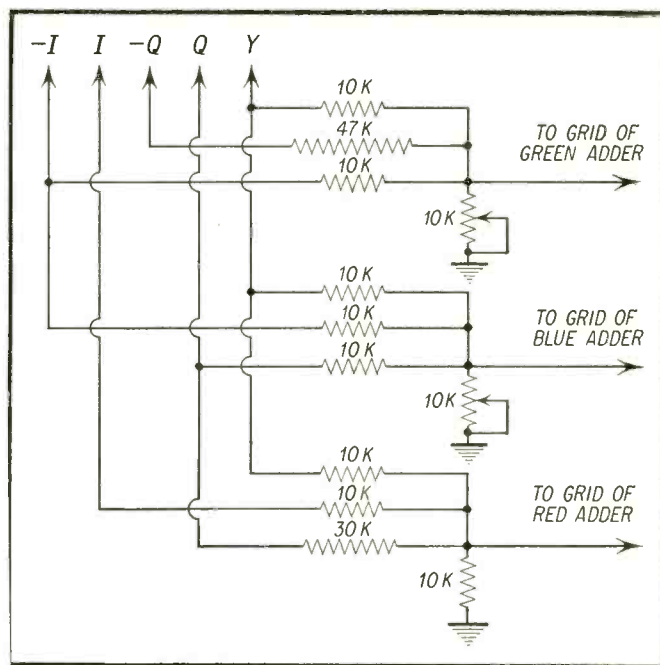

Fig. 3—Partial circuit diagram of matrix network employed in typical I/Q receiver. Note fixed value of red gain control as compared to variable  $B$  and  $G$ .

To obtain the red, green, and blue signals, certain percentages of the positive and negative quantities of  $I$  and  $Q$  are added to the  $Y$  signal in a matrix and applied to the individual red, green and blue adder tubes. The outputs of the adder tubes are then fed into individual color amplifier tubes and thence into the respective color grids of the picture tube. Inasmuch as present day I/Q circuitry involves capacitive coupling between the plates of the output tubes and the picture tube grids,  $dc$  restorers are necessary.

In the R-Y/B-Y block diagram of Fig. 1B we are provided with individual R-Y and B-Y signals at the output of the demodulators. These signals are then combined in a matrix network to provide a G-Y signal. Then all three signals are individually fed into their respective red, green and blue grids. At the same time the  $Y$  signal is fed into the cathodes of each tube thereby resulting in an addition of the luminous and color difference signals directly in the tube itself. This addition results in the production of the desired primary color signal between grid and cathode of each gun. In comparison with the I/Q system where nine tube functions (4 tubes) are employed, the R-Y/B-Y system employs only three tube functions (2 tubes); also no  $dc$  restorers are required.

Proceeding to the high level demodulator of Fig. 1C we observe the all three color-difference signals are directly obtained at its output. These signals are fed directly into their respective color grids where they are added to the  $Y$

signal fed into the cathode, and produce the correct primary color signals between grid and cathode. There is no need in this system for matrixing to produce G-Y as in the R-Y-B-Y demodulator because the high level demodulator provides this signal directly. Neither is there any need for amplification of the color-difference signals at the demodulator output because of its inherent high signal output; high enough to drive the grids of the picture tube directly. Notice that compared to the I/Q system with its nine tube functions and the R-Y/B-Y system with its three tube functions, no tubes are required in the high level output section. Also, no  $dc$  restorers are required.

Up to this point the discussion relative to the color signals applied to the picture tube grids has been of a general nature. We shall now proceed to analyze each system separately from the point of view of specific relative color signal requirements and the control voltages on the various tube elements required to produce a proper color and B&W picture.

#### I/Q Output Circuit

In one of the early installments it was pointed out that the  $I$ ,  $Q$  and  $Y$  signals are developed at the transmitter by combining certain proportions of the compensated red, green and blue camera output signals in a voltage divider or matrix network as shown in Fig. 2. These proportions are as follows:

$$\begin{aligned} Y &= .3R + .59G + .11B \\ I &= .6R - .28G - .32B \\ Q &= .21R - .52G + .31B \end{aligned}$$

By a reciprocal process, in an I/Q receiver the individual color signals are recovered from the  $Y$ ,  $I$ , and  $Q$  signals by combining certain proportions of  $Y$ ,  $I$  and  $Q$  in a matrix network as shown in Fig. 3. These proportions are as follows:

$$\begin{aligned} R &= .96I + .62Q + Y \\ G &= -.28I - .64Q + Y \\ B &= -1.1I + 1.7Q + Y \end{aligned}$$

As an example of the manner in which the matrix performs its task in a receiver a partial simplified circuit of the green signal portion of a matrix is shown in Fig. 4. The matrix resistors are proportioned so that the following relative  $Y$ ,  $I$  and  $Q$  signal values appear at the grid of the green adder: 100%  $Y$ , 28% of  $-I$ , and 64% of  $-Q$ . These values provide us with a pure green signal.

In a similar manner the matrix resistors for the blue section are proportioned so that the following relative  $Y$ ,  $I$ , and  $Q$  signal values appear at the grid of the blue adder:

100%  $Y$ , 110% of  $-I$ , and 170% of  $Q$ . These values provide us with a pure blue signal.

Finally the matrix resistors for the red section are proportioned so that the following relative  $Y$ ,  $I$  and  $Q$  signal values appear at the grid of the red adder:

$$100\% Y, 96\% I, \text{ and } 62\% Q$$

These values provide us with a pure red signal.

In the typical matrix network shown in Fig. 3 it will be observed that gain controls are provided in the green and

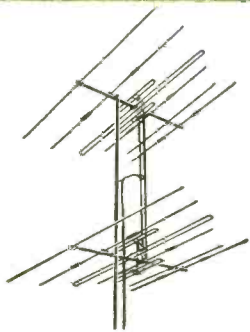

**NEW!**  
Narrow-space  
stacking!

Channel Master's RAINBOW and SUPER RAINBOW can now be stacked only 60" apart. These new, extremely efficient, 2-stage, impedance-matching stacking rods permit easier installations with an absolute minimum sacrifice of gain.

model no. 331-7

Champion Rainbow  
330 series  
Super Rainbow  
331 series  
Challenger Rainbow  
332 series

**Warm  
weather  
is  
profit  
weather!**

Patent No. 2,691,730  
Other Patents Pending

Copyright 1955, Channel Master Corp.

The weather's warmer! Days are longer! *This* is the time of year to go after that gold mine in your own backyard: the replacement of the antennas in your area that are damaged, worn, and obsolete.

Channel Master's RAINBOW is the favorite replacement antenna of America's TV installation men — and here's why:

- There's a RAINBOW model for every installation ... for every signal area ... for every budget.
- Regardless of competitive claims—Channel Master's RAINBOW antennas are *still* the most powerful antenna series available today! Advanced engineering and the exclusive Tri-Pole make the difference!
- Featuring the fastest and strongest of all preassemblies: trigger-fast "Snap-Lock" action, Channel Master's fabulous preassembly that *snaps* open, *locks* open, without hardware or tightening.
- All-aluminum construction. Rugged, durable, reinforced at all stress points.

**Today's greatest all-channel antenna value — bar none!**

**CHANNEL MASTER'S  
RAINBOW\***

the ideal replacement antenna



**CHANNEL MASTER CORP.**

ELLENVILLE, N. Y.

The World's Largest Manufacturer of Television Antennas

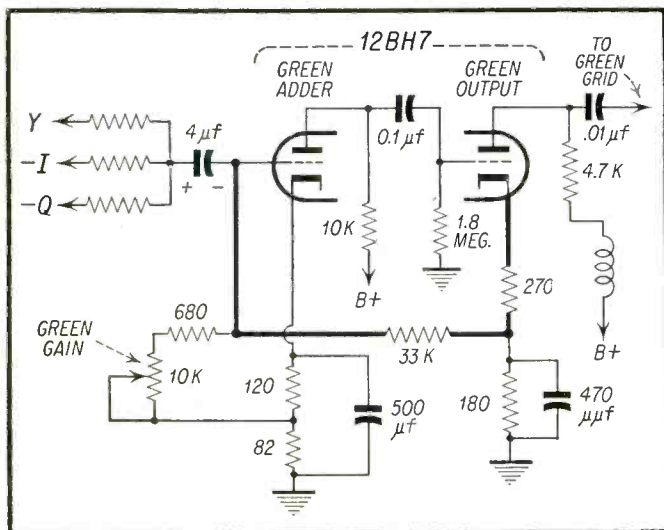

Fig. 6—Partial schematic of CBS-Columbia Model 205 color TV receiver showing green adder and green output stage. Heavy lines indicate feedback loop.

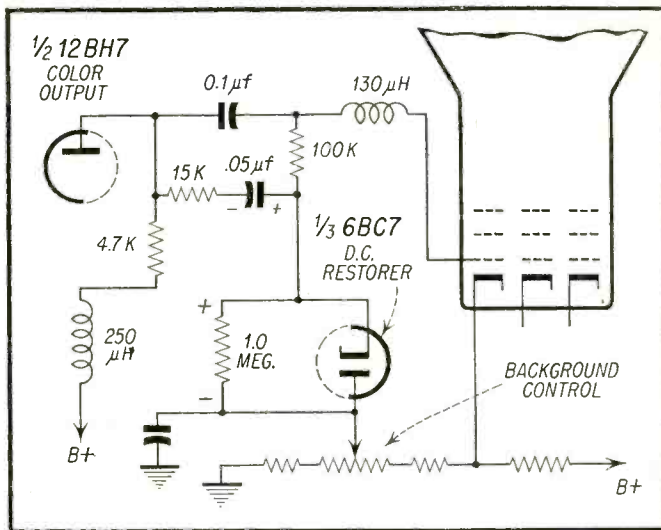

Fig. 7—Partial schematic of either green or blue output stages employed in CBS-Columbia Model 205 color TV receiver. Separate background controls are used.

blue sections only, the grid load resistance in the red section having a fixed value. This enables a greater signal drive to be placed on the red grid with respect to the blue and green grids, and a greater green signal as compared to the blue grid. This is made necessary

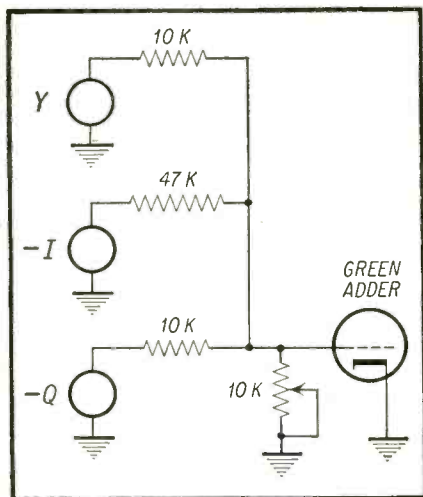

Fig. 4—Partial simplified schematic of green matrix and adder.

by the unequal phosphor efficiencies of the picture tube; these efficiencies being approximately in the order of 1:0.8:0.3 for the blue, green and red phosphors respectively as shown in Fig. 5. Following the matrix and adder functions all primary color signals must be amplified so that sufficient drive voltage is made at the grids of the picture tube. A typical circuit following a matrix color section such as green, blue and red is shown in Fig. 6. Here we see a partial schematic of the CBS-Columbia Model 205 I/Q Receiver indicating the green adder and ampli-

fier circuitry. This circuitry is duplicated in the blue and red sections except for a fixed 10K resistor instead of a variable one as discussed previously. Circuit stability is obtained by providing controlled degeneration via the feedback loop shown in heavy lines in the figure. Additional degeneration and stability is effected by bringing the grid return of the adder tube to an unby-passed tap on the cathode resistor as shown.

DC restoration is necessary in color receivers because of the wide range of video voltages present in color scenes. This means the inclusion of a dc restorer for each output stage for a total of three. The primary function of a dc restorer is to establish a reference operating bias so that the blanking level of the sync pulses results in beam cut-off. Under these conditions the sync pulses extend into the region beyond cut-off, and the signal itself extends into the region where beam current flows.

A circuit of this type is shown in Fig. 7. Initially, during a scene of certain brightness with a given dc component (amplitude between blanking and average signal level) the first negative going sync pulses drives the diode plate positive causing a voltage equal to the dc component to appear across the .05 μf condenser with the polarity developed as shown. During subsequent horizontal lines the capacitor voltage being equal and opposite to the dc component prevents any further conduction of the diode. During this time the capacitor discharges through the 1 meg resistance in accordance with a suitable value of time constant which is about three vertical frames.

By adjusting the background control correct light values for a particular

scene are obtained on the picture tube. Now if the average brightness of the scene increases, the dc component increases, the drive on the diode plate increases and the dc voltage recovered by the restorer is applied as an additional positive bias to the grid of the picture tube, thereby resulting in an

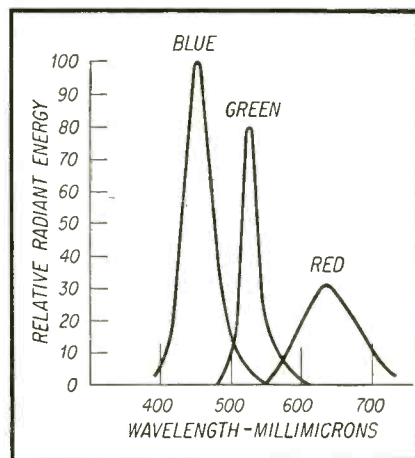

Fig. 5—Light emission characteristics of phosphors for equal excitation of these phosphors.

increase in brightness. Similarly a scene with reduced brightness ultimately causes the grid to go less positive with a resultant decrease in brightness. Thus, the action of the dc restorer clamps the black level (blanking) of the signal at picture tube cutoff for all variations in average brightness levels of the scene. The cut off value of each gun of the picture tube is adjusted independent of the restorer action by the individual background controls of the blue and green guns and by a master background control for the red gun.

[To Be Continued]

Let Satisfied Customers . . .

Build Repeat Sales

Use *Genuine*

**PHILCO<sup>®</sup>**

**RECEIVING  
TUBES**



Unexcelled research plus better materials and advanced production methods make Philco receiving tubes leaders in the field . . . assure top performance . . . build complete customer satisfaction and repeat sales for you!

Advanced Philco engineering and production methods insure mechanical and electrical superiority, uniform operation and trouble-free performance. Rigid quality control, exhaustive tests and extensive performance checks guarantee that every Philco tube you install is right in every detail.

### **Philco Receiving Tubes Improve the Performance of any Radio or TV Receiver**

Built-in Philco quality is the reason why. Now you can eliminate costly call backs and build solid future business that means greater profit.

Millions of Philco set owners and millions of owners of other make receivers demand the full measure of performance that Philco tubes provide. Stock the Philco line of conveniently packaged tubes that assure you this ready-made market. Call your Philco Distributor today.



**PHILCO CORPORATION**

*Accessory Division*

Philadelphia 34, Pa.



**a**



**roundup**



**of**



**1955**

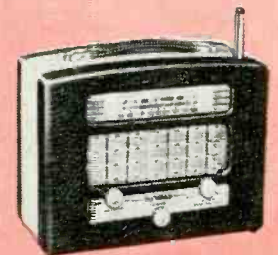

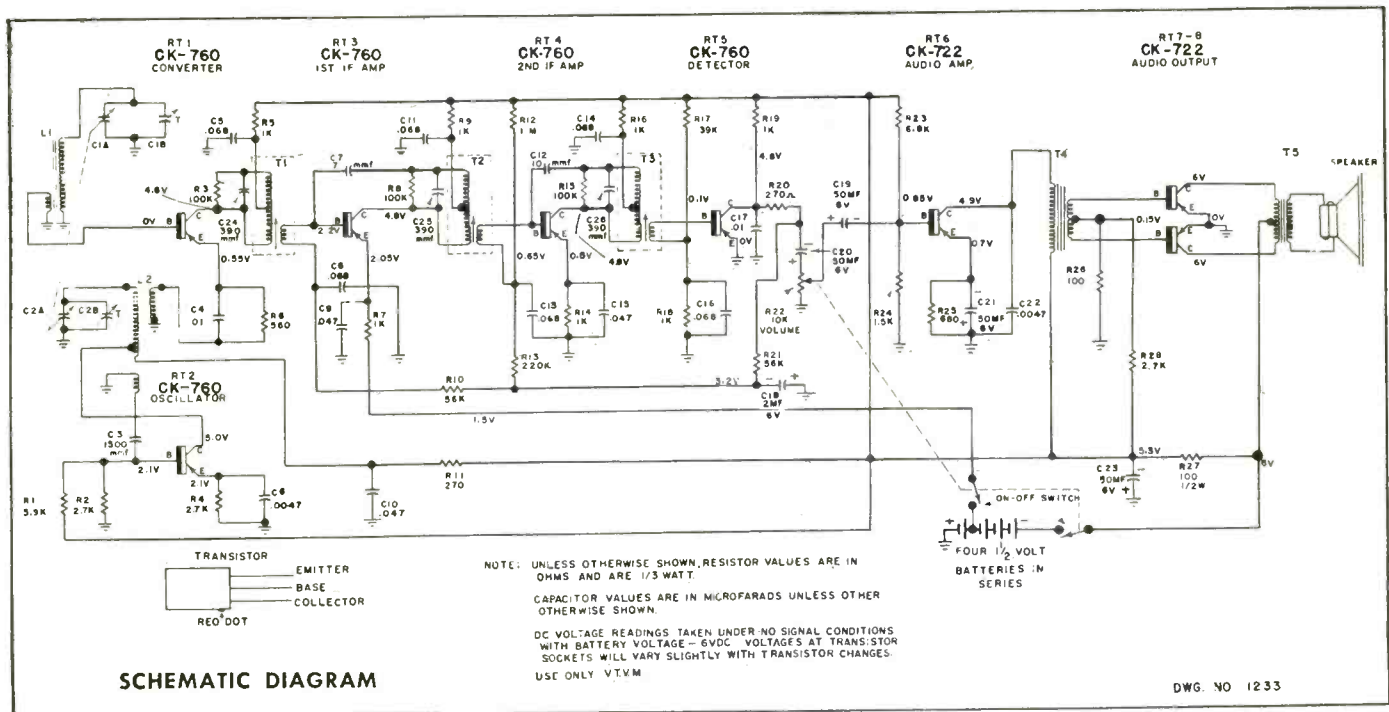

IT'S summer time again—the season when home radio service drops off, and portable set repairs pick up. This is a good time to look into circuitry and other features of current models, note what has changed — and what hasn't—and to prime ourselves for profitable service on these receivers.

about sixty cents, compared with an upkeep of from \$15 to \$35 on portables using vacuum tubes.

Four conventional, one-cell flashlight batteries provide all the power needed for one full year of T-radio operation. A single set of mercuric oxide batteries will power the set for two

by **Sol Heller**

realignment. When a defective component (i.e., a bad condenser, resistor, etc.) which is connected to a transistor socket must be replaced, the transistor should be removed from the socket before soldering operations are performed. The reason is, excessive heat may damage the transistor.

If resistance tests are to be made in the transistorized receiver, remove all the transistors first, to eliminate the shunting effect of these units, and to prevent the masking of short-circuits and resistance changes. Battery substitutions are recommended in the T-radio when the sound seems muffled or distorted, as well as lower than normal in volume. Replacement of all four batteries even when only one has been found weak is recommended.

The alignment procedure for Raytheon's transistorized portable differs in a number of respects from the procedure used in tube-type sets. Details of the alignment may therefore interest servicemen. The preliminary steps are as follows: 1—Turn volume control off. 2—Connect an output meter with an impedance of 15 ohms in place of the speaker. 3—Turn the volume control up fully clockwise. 4—Use a signal generator output of 100 microvolts, with a 30% modulation at 400 cycles. 5—Both knobs of the receiver must be in place. The alignment procedure itself is given in Fig. 2.

One of the new features in Zenith portables (Models R600 and R600L, chassis 6R40 and 6R41) is the use of

# portable receivers

The most significant development in the portable radio field is transistorization. The first portable using an all-transistor set-up was the Regency Model TR-1 (described in the Dec. '54 issue of RADIO-TELEVISION SERVICE DEALER). Now Raytheon is producing one. Since the transistorized portable is very much more economical to maintain than the conventional tube type, it is not at all unlikely that it will supersede the tube type within a few years.

Some idea of why the tube-using portable may be on the way out is obtained from a comparison of maintenance costs. Raytheon, points out that its transistorized T-radio shown above will operate for one year at a cost of

and a half years. The eight transistors have an indefinite life and will not, under normal circumstances, need replacement. They can't burn out or disintegrate, and are not readily damaged or broken. Since the transistors use only tiny currents and very low voltages, the shock hazard to user and serviceman is practically eliminated.

To check a transistor, Raytheon recommends substitution of another equivalent unit. To facilitate the correct insertion of the transistor in its socket, a red dot is provided on the transistor. This dot must line up with a dimple on the socket.

Substitution of a transistor in the *if* or *rf* sections of the receiver—particularly the *rf*—may necessitate a slight

a thermal regulator tube—the 50A1—in series with the tube filaments (see Fig. 3). The 50A1 functions as an automatic rheostat, keeping the current in the tube filaments constant in the face of supply voltage changes. Since portable tubes—particularly the converter—are extremely sensitive to such fluctuations in voltage, use of the thermal regulator may be expected to minimize fading and operation over part of broadcast band only—symptoms that reduced line voltage and aging of the selenium rectifier tend to produce. (Other troubles may, of course, produce the same symptoms.) The tendency of increases in line voltage to reduce tube life by increasing the filament voltages will also be counteracted.

A number of G.E. and Stromberg-Carlson portables—and possibly other makes as well—are using a battery-saver

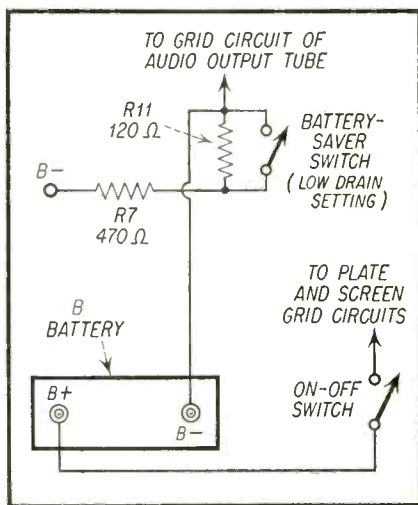

Fig. 4—Partial schematic of G.E. "Battery Saver" circuit.

switch circuit (see Fig. 4). This circuit contains a switch and a resistor. In areas where the signal strength is good,

SIGNAL GENERATOR				OUTPUT METER	GANGED CAPACITY	ADJUST FOR MAXIMUM OUTPUT IN METER.
FREQUENCY	COUPLING CAPACITY	CONNECTION TO RADIO	GROUND SIDE			
I.F.	455KC	.5MF.	to Base of RT1	To Chassis	Connected in place of speaker	Top cores of T3, T2 & T1
Repeat above step two or three times for best results, keeping generator output in all cases as low as possible as to prevent overloading of audio.						
Osc.	1620KC	.5MF.	To base of RT1	To Chassis	Connected in place of speaker	Open Gang (Fully clockwise) Adjust C 2B
Caution: Too high an input from signal generator may cause setting of trimmer on a spurious response.						
Ant.	1400KC.	Connect 3 turn loop to generator and place near loop on receiver.		Connected in place of speaker	Ganged Condenser should be rocked.	Adjust C 1B
Check for alignment and dial calibration at 1000 KC and 600KC.						

Fig. 2—Alignment procedure for Raytheon transistor radio.

the switch is moved to its low position. At this setting, the resistor is in series with the B battery, and reduces the latter's drain. The B voltages go down a bit, but the battery's life tends to be prolonged. In areas where the signal strength is not as good, the switch is set to high, at which setting the resistor is shorted out, full drain is restored, and higher B voltages are developed.

Circuitry and components used in current portables are pretty well standardized; a number of differences, however, are worth calling attention to. With respect to antennas, the built-in loop is employed most often. A photo of such a loop in a personal-type set is shown in the Olympic. On portables providing short-wave reception, a telescopic-type antenna (Fada) may be provided. Small "ferrite-rod" or "stick-loop" antenna units are used in some portables. One advantage provided by a "stick-loop" is its elimination of electrostatic interference pick-up. A portion of the circuit associated with one of these iron-core units is shown in Fig. 5.

Some Zenith portables (Model T505, chassis 5L41 for instance) use a "wavemagnet" type antenna. In strong signal areas, the wavemagnet unit can be left

in place on the cabinet. In localities where the signal strength is low, or where greater sensitivity or selectivity is required for one or more stations, the wavemagnet may be pulled out from

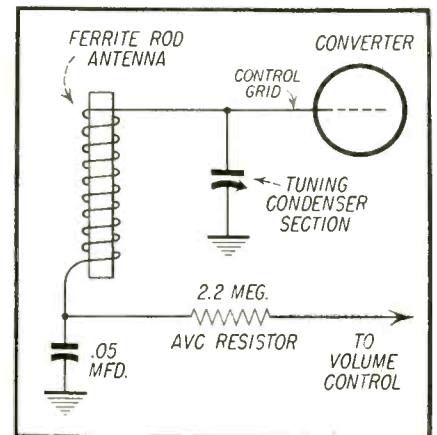

Fig. 5—Partial schematic of Fada stick-loop antenna unit.

the cabinet till it makes an angle of 30 degrees with the latter. Zenith warns against attempting to tilt the magnet any further than this with respect to the cabinet.

In steel building (as well as on trains, boats, planes, etc.) the wavemagnet is placed on the glass of an outer window, for best reception. Suction cups and an extension cable have been attached to the wavemagnet to facilitate such placement. The suction cups should be moistened before being attached to a window. The wavemagnet may be readily lifted out, if it is first opened to an angle of 30° from the cabinet.

Some preliminary movement of the unit on the window glass, to locate the position where reception is optimum, may be necessary. The best location is generally the center of the window. The wavemagnet must be kept away from any line-carrying wires (such as lamp cords, etc.) to avoid pickup of electrical interference or noise.

Most current portable radios use a selenium rectifier type power supply for

[Continued on page 55]

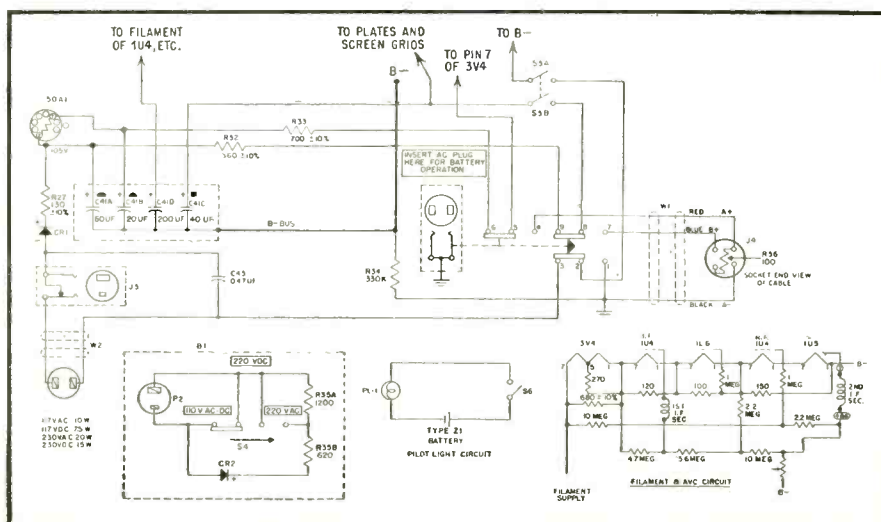

Fig. 3—Partial schematic of Zenith Ch. 6R40, 6R41 portable.



# MERIT

**T**HE most complete  
replacement line

a transformer or coil  
for every TV-radio need.



**Power transformers**

**P-3059** *this and 57 others.*

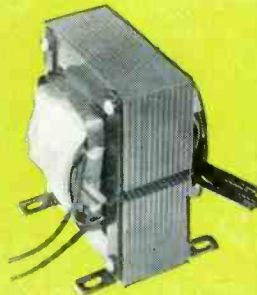

**Vertical output transformers**

**A-3035** *with 6 companion types*



**Line voltage regulators**

**P-3138** *and P-3139*

# MERIT

COIL AND TRANSFORMER  
CORPORATION

4427 N. Clark Street, Chicago, Ill.

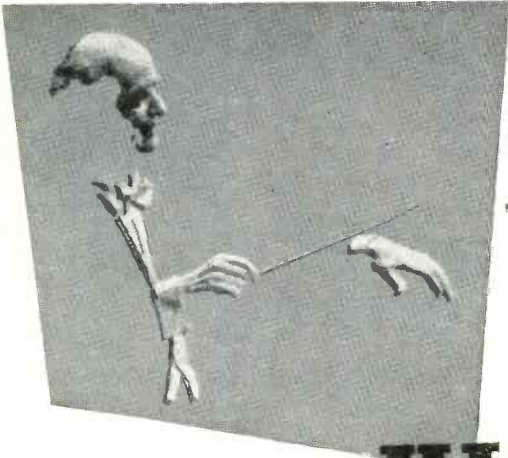

# Electrostatic Speakers

in  
new

**HI-FI**

**Units**

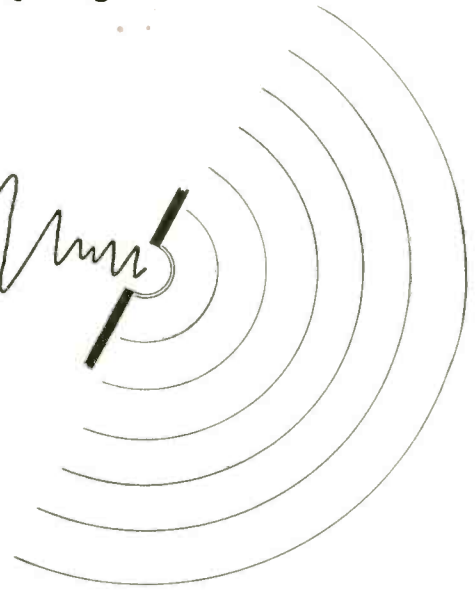

by | Steve Travis

**P**HILCO'S new electrostatic speaker (Fig. 1) incorporated in the 1955 line of Philco phonographs and radio-phonograph combinations, marks the first time a high-frequency speaker based on the electrostatic principle has been generally available to the public. The new speaker unit combines high efficiency, low distortion and freedom from directional effects. It covers the frequency range from 7000 cycles per second to well beyond the upper limit of audibility.

An urgent need for such a speaker has arisen from steady improvement in the high-frequency performance of microphones, phonograph pickups, amplifiers and phonograph records. So great has been the advance in these components that in recent months the weak link in high-quality sound-reproducing systems has been the high-frequency loudspeaker.

High-frequency speakers previously available fall in two classes: the horn-loaded tweeter and the cone tweeter. The horn-loaded unit is expensive and, in many cases, has only fair efficiency and exhibits transient distortion. The cone tweeter is of more reasonable cost, but often suffers from severe distortion due to the phenomenon known as "cone breakup" which results from the cone being driven from its center. Finally many cone tweeters tend to radiate sound in a narrow beam which restricts the high-frequency sounds to listeners sitting directly in front of the speaker.

For some time it has been known that the answer to the problem of distortion due to cone breakup lay in some form of electrostatic speaker, in which the sound producing membrane is driv-

en uniformly over its entire surface. But early attempts to produce a suitable electrostatic speaker failed due to the lack of a suitable membrane material and the lack of rugged and reliable mechanical design which could be produced at low cost. Improvement in plastic membranes removed the first difficulty and ingenious mechanical design solved the second.

### Construction of the Electrostatic Speaker

Because this speaker operates on the principle of a condenser it has also been called a condenser speaker. To understand its operation it is desirable to examine the construction of the speaker.

Fig. 2 shows a cross section of the electrostatic speaker which consists of a rigid aluminum frame that is used as one plate in the condenser action. This frame is also employed in the mounting of the speaker to the cabinet. The outer surface of the frame is semi-circular in nature as shown but it is actually

composed of 16 flat longitudinal segments. Each of these segments are perforated with very small holes to prevent back pressure which would introduce distortion in the audio output. The 16 segments might be thought of as 16 small high frequency speakers in a half circle. Thus, directional characteristics are of little concern since 180 degree sound distribution is made available as shown in Fig. 3. Also, it might be noted that baffling is unimportant and all that is necessary is some means of protecting the speaker from damage to possible tearing or bumping.

From Fig. 2 it can be seen that the semi-circular rigid form has stretched on it a thin sheet of polyester film. This polyester film performs the function of the dielectric. On the outer side of the polyester sheet a thin layer of pure gold is deposited. This vapor gold film is the other plate of the condenser and it is connected to terminals for wiring into the electrical circuit.

The polyester material is of great im-

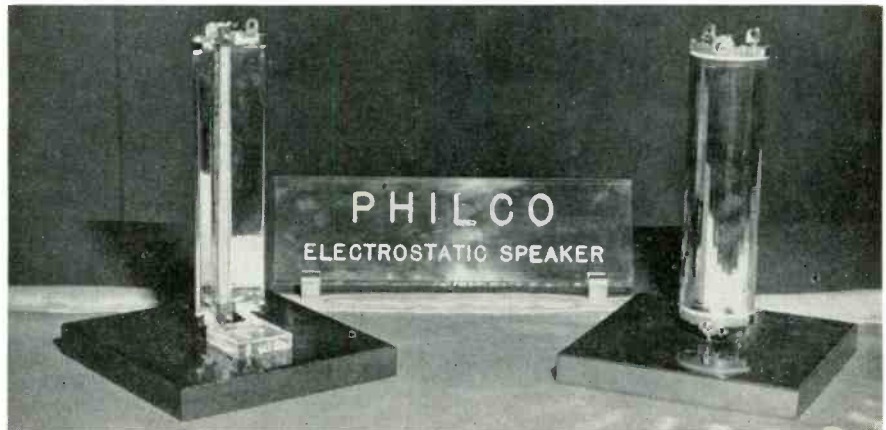
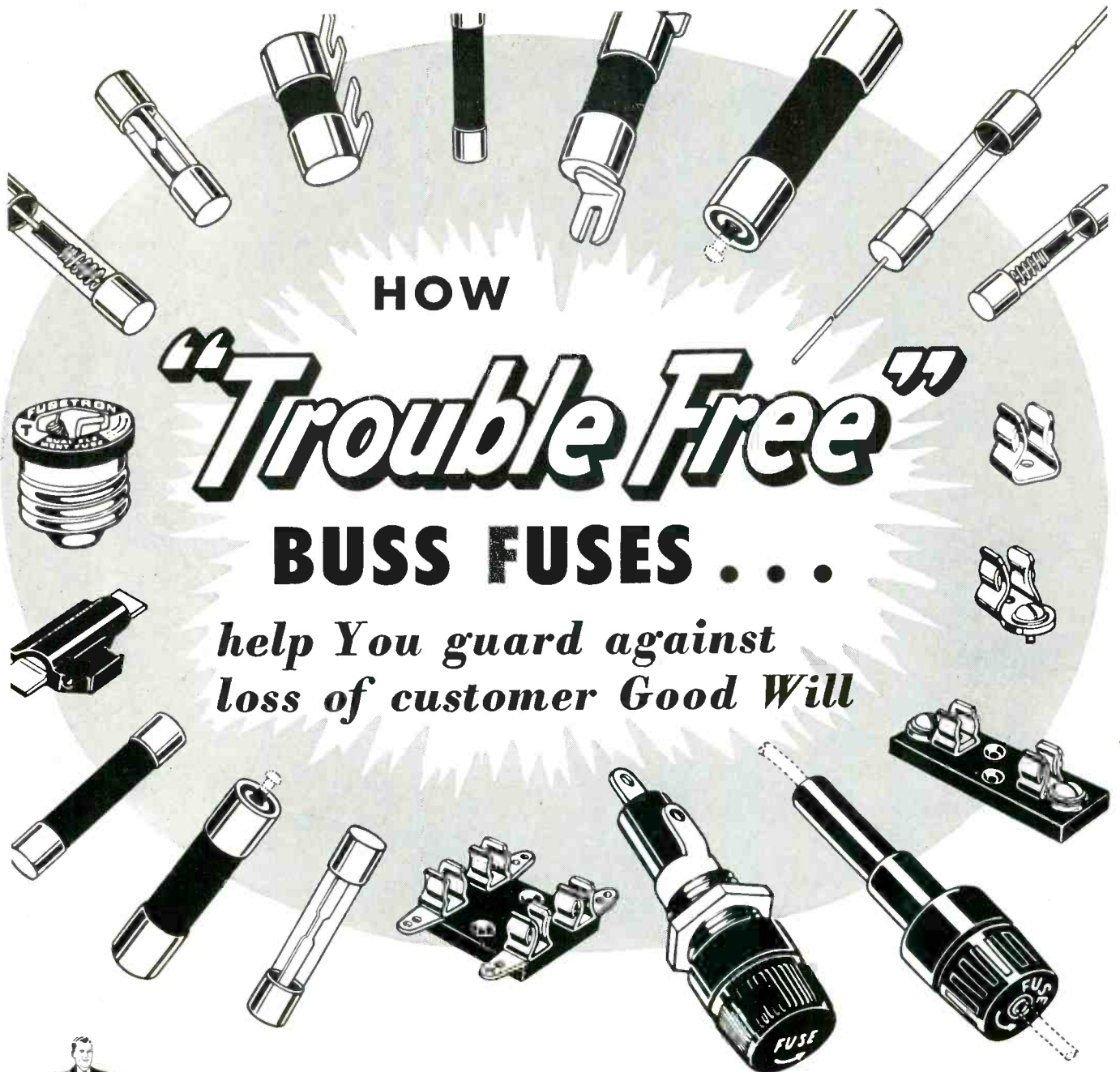

Fig. 1—Front and back views of electrostatic speaker.



HOW

# "Trouble Free"

## BUSS FUSES . . .

*help You guard against  
loss of customer Good Will*



Dependable BUSS fuses can help safeguard your product or service against loss of user satisfaction because . . .

When there is trouble on the circuit, BUSS fuses open and prevent further damage to equipment—saving users the expense of replacing needlessly burned out parts.

However, BUSS fuses won't give a "false alarm" by blowing when trouble doesn't exist. Users are not annoyed with shutdowns caused by needless blows.

To make sure of unfailing dependability — every BUSS fuse, normally used by the Electronic Industries, is tested in a sensitive electronic device that rejects any

fuse not correctly calibrated, properly constructed and right in all physical dimensions.

### Capitalize on the BUSS Trademark

To your customers too, the BUSS trademark represents fuses of unquestioned high quality. Millions upon millions of BUSS fuses used in homes, on farms and in industries over the past 40 years have established their ready acceptance. Handling quality products, like BUSS fuses, help you maintain your reputation for quality and service.

MAKERS OF A COMPLETE LINE OF FUSES . . .



FOR HOME, FARM, COMMERCIAL, ELECTRONIC, AUTOMOTIVE AND INDUSTRIAL USE.

**BUSSMANN MFG. CO.**

(Div. McGraw Electric Co.)

University at Jefferson St. Louis 7, Mo.

655

portance in the speaker design. It has great tensile strength and is not affected by dampness or other atmospheric conditions to any significant degree. Thus, its important characteristic is that it will not shrink or stretch. With its layer of gold, the diaphragm is so thin that light can be seen through it. This sheen, then, provides a diaphragm with the characteristics of having practically no mass. Therefore, the gold plated polyester possesses excellent transient response characteristics since it is completely controlled by the audio voltages and momentum of the sheet

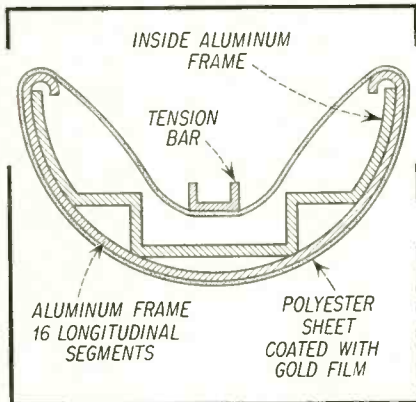

Fig. 2—Cross-section of electrostatic loudspeaker.

or diaphragm does not enter into its operation to introduce distortion.

### Theory of Operation

As has been pointed out, the frame is used for mounting purposes and is grounded to the chassis. The other plate of this condenser speaker is the gold layer on the polyester material. To this gold film is applied a polarizing potential as shown in Fig. 4. The application of this voltage establishes a static or polarizing potential between

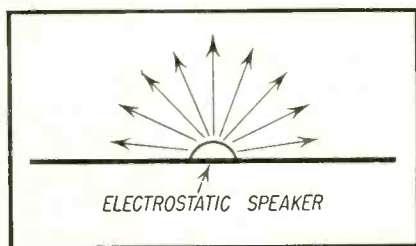

Fig. 3—Spatial audio paths from an electrostatic speaker.

the two elements of the speaker. In other words, it provides an axis about which the audio signals will swing. This sets up a strain or an electrostatic field between the two plates. Since it is a *dc* voltage that is applied one side must be positive and the other side negative as shown in Fig. 5.

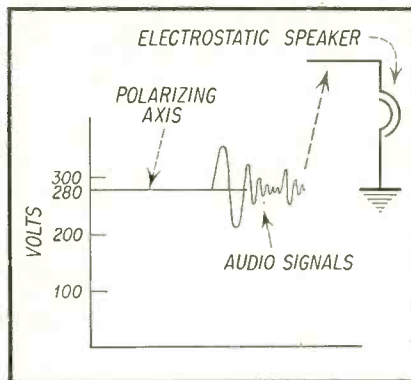

Fig. 4—Polarizing axis around which audio signal swings.

It is about the polarizing potential of 280 volts that the audio signal will vary. The audio voltage fed to the gold layer produces a corresponding change in the electrostatic field shown in Fig. 5. As the signal varies about its polarizing axis an increasing or decreasing attraction is developed between the two plates, the movable layer on the polyester film and the grounded frame. The polyester on which the gold layer has been placed is pulled in and pushed away from the frame in accordance with the audio voltages reproducing a movement of air about the speaker and thus the audio signals.

In Fig. 6 is shown the manner in which the electrostatic speaker circuit is connected into an audio output system. Of course, the high audio frequencies must be present, supplied by the audio output tube plate circuit for these signals to be reproduced by the electrostatic speaker.

Examining Fig. 6 it can be seen that the polarizing voltage is obtained at the plate of the audio output stage and is applied to the gold layer of the electrostatic speaker through a 4.7 megohm resistor. The other circuit arrangement can be considered as a high pass filter which attenuates the low frequency signals from the electrostatic speaker. If

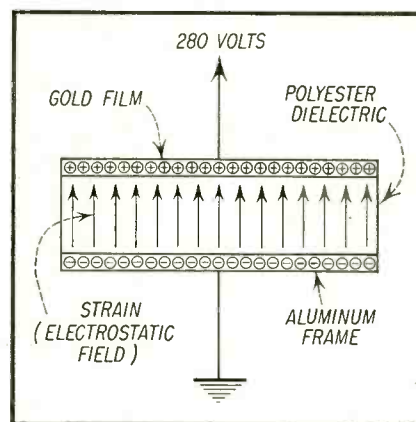

Fig. 5—Condenser action of electrostatic speaker.

this filter were not employed the large voltage swings of the low frequency signals would most probably tear the polyester material apart. High frequency audio signals do not have amplitudes anywhere near as large as the low frequency signals. Also, the high pass filter blocks the audio signals below

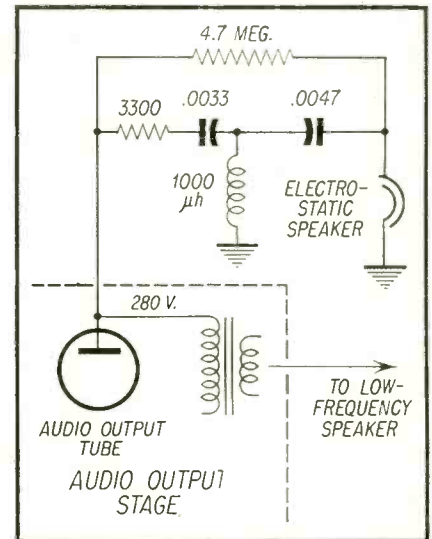

Fig. 6—How electrostatic speaker is connected to output tube.

7,000 cycles per second because the electrostatic speaker can not reproduce them without distortion.

The extent of frequency coverage by the electrostatic speaker is from about 7,000 cycles to beyond 20,000 cycles per second. When this unit is coupled with a good woofer, audio frequencies from 20 cycles to beyond the range of hearing are possible as shown in Fig. 7.

This new tweeter speaker provides a relatively inexpensive means of ob-

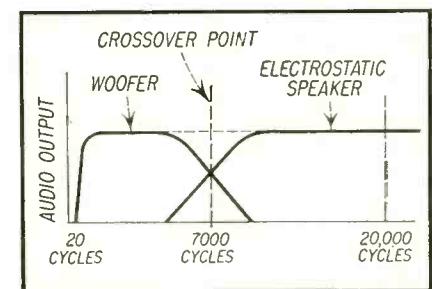

Fig. 7—Combined audio response of woofer and electrostatic unit.

taining high fidelity when it is connected into a circuit in which the high frequency audio signals are present to be reproduced.

The speaker develops no transient oscillations or peaks in frequency response due to natural resonance as frequently happens with other types of more expensive tweeters.

# WHAT'S YOUR SERVICE PROBLEM?

FM Radios • Amplifiers and Tuners • Auto Radios • Record Changers

# PHOTOFACT HELPS YOU SOLVE IT FASTER, EASIER, BETTER, MORE PROFITABLY!

## THE WORLD'S FINEST SERVICE DATA

PHOTOFACT Service Data is the *only* service information based upon first-hand examination of the actual production-run receivers and equipment. It is authentic, uniform data developed through actual study and analysis by service engineers in the Howard W. Sams Laboratories. PHOTOFACT is the *only* data prepared from the practical point of view of the Service Technician.

Thousands of Service Technicians use PHOTOFACT daily for time-saving, profit-boosting service operations. If you've never used PHOTOFACT, you've never realized your full earning power—you've never given such complete customer satisfaction. So get the proof for yourself. Try PHOTOFACT—use it on any job. Your Parts Distributor has the Folder Sets you need for any of the 17,000 TV and radio receivers, changers, recorders, etc., covered in PHOTOFACT. Once you use this great service, we know you'll want the complete PHOTOFACT Library.



THESE GREAT FEATURES ARE EXCLUSIVE IN PHOTOFACT—THEY HELP YOU EARN MORE DAILY, HELP INSURE CUSTOMER SATISFACTION

### FULL SCHEMATIC COVERAGE

1. Famous "Standard Notation" uniform symbols are used in every schematic.
2. The same standard, uniform layout is used for each schematic.
3. Diagrams are clear, large, easy to read, easy to handle.
4. Wave forms are shown right on the TV schematics for quick analysis by 'scope.
5. Voltages appear on the schematics for speedy voltage analysis.
6. Transformer lead color-coding is indicated on the schematic.
7. Transformer winding resistances appear on the schematic.
8. Schematics are keyed to photos and parts lists.

### FULL PHOTOGRAPHIC COVERAGE

9. Exclusive photo coverage of all chassis views is provided for each receiver.
10. All parts are numbered and keyed to the schematic and parts lists.
11. Photo coverage provides quicker parts identifications and location.

### ALIGNMENT INSTRUCTIONS

12. Complete, detailed alignment data is standard and uniformly presented in all Folders.
13. Alignment frequencies are shown on radio photos adjacent to adjustment number—adjustments are keyed to schematic and photos.

### TUBE PLACEMENT CHARTS

14. Top and bottom views are shown. Top view is positioned as chassis would be viewed from back of cabinet.
15. Blank pin or locating key on each tube is shown on placement chart.
16. Tube charts include fuse location for quick service reference.

### TUBE FAILURE CHECK CHARTS

17. Shows common trouble symptoms and indicates tubes generally responsible for such troubles.
18. Series filament strings are schematically presented for quick reference.

### COMPLETE PARTS LISTS

19. A complete and detailed parts list is given for each receiver.
20. Proper replacement parts are listed, together with installation notes where required.
21. All parts are keyed to the photos and schematics for quick reference.

### FIELD SERVICE NOTES

22. Each Folder includes time-saving tips for servicing in the customer's home.
23. Valuable hints are given for quick access to pertinent adjustments.
24. Tips on safety glass removal and cleaning.

### TROUBLE-SHOOTING AIDS

25. Includes advice for localizing commonly recurring troubles.
26. Gives useful description of any new or unusual circuits employed in the receiver.
27. Includes hints and advice for each specific chassis.

### OUTSTANDING GENERAL FEATURES

28. Each and every PHOTOFACT Folder, regardless of receiver manufacturer, is presented in a standard, uniform layout.
29. PHOTOFACT is a current service—you don't have to wait a year or longer for the data you need. PHOTOFACT keeps right up with receiver production.
30. PHOTOFACT gives you complete coverage on TV, Radio, Amplifiers, Tuners, Phonos, Changers.
31. PHOTOFACT maintains an inquiry service bureau for the benefit of its customers.

**ONLY \$25 DOWN**

Puts a Photofact Service Data Library in Your Shop. Ask Your Photofact Distributor—He Has the Full Easy-Pay Details.

## FREE PHOTOFACT CUMULATIVE INDEX



Send for it! Your guide to virtually any model ever to come into your shop; helps you locate the proper PHOTOFACT Folder you need to solve any service problem on any model. Once you have the make and chassis number, it takes just 60 seconds to find the applicable PHOTOFACT Folder. Send coupon now for your FREE copy of the valuable Cumulative Index to all PHOTOFACT Folders.

## HOWARD W. SAMS & CO., INC.

Howard W. Sams & Co., Inc., Dept. 4-F5  
2201 E. 46th St., Indianapolis 5, Ind.

Send FREE Photofact Cumulative Index.

Name.....

Address.....

City.....Zone...State.....

**HELPS YOU EARN MORE DAILY**



# EDITORIAL...

by S. R. COWAN  
PUBLISHER

## An Outrage

Recently, several Brooklyn, New York service dealers sent us an advertisement they had clipped from a local newspaper. It is an absolutely outrageous example of the unfair competition to which they are subject, and which is unpardonable if tolerated by RETMA members who recognize the offender and sell him, or other firms like his, as a distributor. That advertisement is reproduced for your examination.

## D. A. Urges 'Fixit-Yourself' Plan to Curb TV Repair Abuses

**DON'T SPEND UNNECESSARY MONEY**

(We all work too hard for it these days.)

**YOU CAN NOW FIX YOUR OWN TV SET YOURSELF**

**IT'S EASY**

Nine out of ten cases your TV set is not working because of faulty tubes. We will check them for you FREE of charge; and if any are bad we will sell them to you for 50% off the regular selling price.

If your antenna is bad, YOU can replace it for as low as \$3.95 depending on your location. We will give you FREE instructions on how to install it YOURSELF.

If your set needs parts, we will sell you what parts are defective

and show you how to replace them YOURSELF.

You can now replace your old PICTURE TUBE yourself for as low as \$12.00 depending on its size. We will give you all the instructions and technical advice FREE of charge.

If you feel you are unable to remove your tubes yourself, bring down your entire set and we will BENCH CHECK it for you FREE OF CHARGE.



**\$12 UP**



**\$3.95**

**CONCORD ELECTRONICS CORP.**

*Wholesale Distributors of Electronic Parts*

246 East 98th St., Bklyn. (Off Kings Highway)

**HYacinth 8-2859-1871**

For your convenience we are open 9 to 9, 6 days a week.

Having read the advertisement, don't you concur? This sort of "distributor" typifies what is wrong with the present system of manufacturer recognition.

## Correction

In the May 1955 issue of Radio Television Service Dealer, the by-line for the article on the new EICO #232 Peak-to-Peak Vacuum Tube Voltmeter should have read as follows:

*by the Engineering Department of Electronic Instrument Co., Inc., Brooklyn, N. Y.*

## Transistorization

Some months ago we were apprised of, but held to secrecy about, a new line of auto radios that would be tubeless, using transistors in their stead.

Now it is public knowledge that Philco produces these receivers and they are used in the new line of Chrysler cars.

Basic features include low power supply drain, (about 85% less than is required for conventional radio tube models); immediate operation, (no lag needed to heat tubes); elimination of vibrators; more compactness, simplicity of installation, and fewer components making the chassis easier to service.

It is believed that momentarily there will be another and newer version of transistorized auto radio released. This one will be "dual duty-dual powered." By that we mean that the receiver can be used in its slot in the dashboard of the automobile, and it also can be removed instantly by the car owner for carrying as a portable. When in the car power will be derived from the car battery—when removed to use as a portable, the power will be furnished by an in-built lightweight dry battery.

## Printed Circuitry and Transistors

Radio receivers, TV sets and even test instruments are now being produced, all having either printed, etched or dipped solder circuits. The makers concur that at present there is no noticeable saving in production costs of such processed circuits as compared to the conventional wired schematic types. But the big advantage lies in uniformity of high production standards by eliminating potential human error.

One big problem facing service dealers nowadays is this: "How will our income be affected by the ever-increased use of transistors, it being a known fact that transistors have much longer life than tubes?" Well, the outlook is not at all as dark as one might suppose. In the main, components will continue to break down, even those in printed circuits, and when they do the service dealer will be called upon to do the job of repair. But as the methods of replacing defective components are different in printed circuits, as contrasted with conventional wired circuitry, then the manner of determining labor and parts charges must be changed by the service dealer. Stated another way—henceforth, when you deal with and service a printed circuit receiver, perhaps you'd better have a proper price scale arranged for that sort of job. Servicing printed circuit and transistorized units requires completely new know-how and techniques—therefore such work must have a labor price scale accordingly pre-arranged.

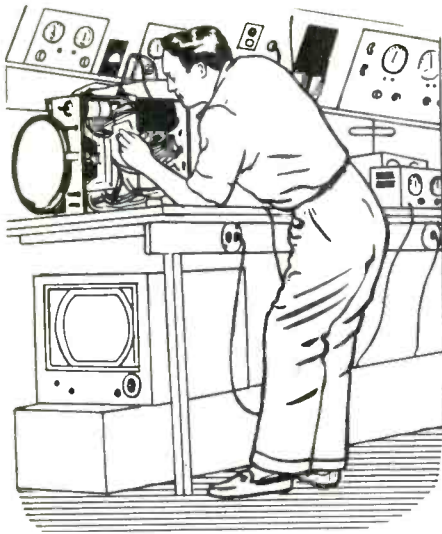

# The Work Bench

by PAUL GOLDBERG

## This Month:

### VIDEO AMPLIFIER PROBLEMS

VIDEO problems can be solved with greater ease with the use of an RF signal generator and an oscilloscope. This installment is devoted to two such problems where these instruments come into use.

#### Westinghouse 2150-101

The receiver was turned on and it was observed that the picture had very low video gain. There was no snow in the picture, the sound was good and all stations, though weak, were receivable. Thus because there was no snow and the sound was good the tuner was eliminated as a possibility of causing the trouble. The *if* tubes were all replaced individually without effect. See Fig. 1.

Studying the diagram it was noted that the sound was taken off at the video detector (1N34) load resistor R319. It didn't seem plausible that the 1N34 could produce good sound and weak picture. Thus, we moved to the

6AH6 video circuit in order to discover the trouble. The 6AH6 was replaced but had no effect.

The oscilloscope was now set up and a wave form was first taken at the control grid of the 6AH6, pin #1. The wave form was correct. A wave form was next taken at the plate pin #5 of the 6AH6. Here there was an increase in the wave form voltage of about ten times that of the grid voltage. This wave form voltage also seemed correct. A wave form was next taken directly at the cathode of the C.R.T. Here the wave form voltage dropped to about 1/4 the wave form voltage at the plate of the 6AH6. Here was our trouble. Because the 6AH6 seemed to me amplifying properly, no voltage checks were made. However, resistance checks were made immediately of R326 and R332. These resistors nevertheless, checked correctly. It seemed that the only possibility left was C322, .1  $\mu$ f. A .1  $\mu$ f condenser was now connected in par-

allel with C322 and immediately the video gain jumped up to normal. Thus, C322, .1  $\mu$ f was open. A new condenser was installed and the receiver functioned properly.

One can easily see that C322 offers a short circuit to the video frequencies across R326. With C322 open, the voltage drop across R326, 100K will reduce the input voltage to the C.R.T. cathode considerably.

#### DuMont RA 109

The receiver was turned on and a very bad smear was observed in the picture. It was deduced that this smear was due to excessive low frequency response. Tubes rarely cause this type of trouble. However, just to be sure, the 6AL5, 6BA6, and 6AQ5 were replaced but without effect. Occasionally, *rf* or *if* misalignment causes this type of trouble but studying the picture quality

[Continued on page 50]

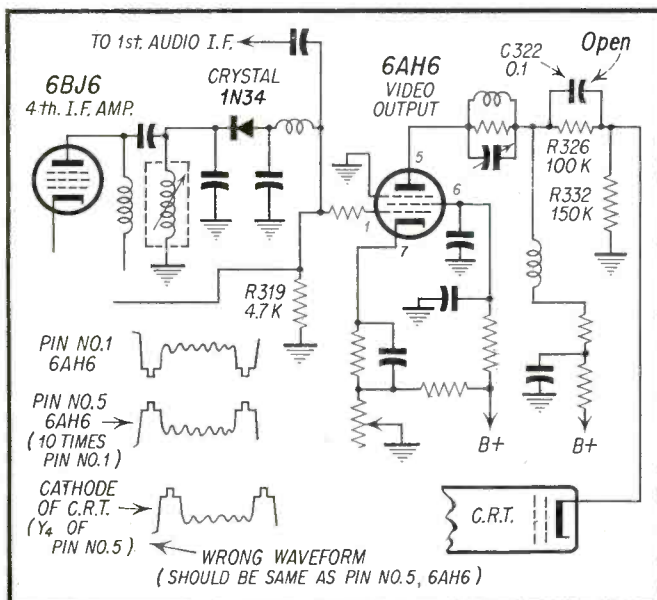

Fig. 1. — Partial schematic of Westinghouse 2150-101 receiver.

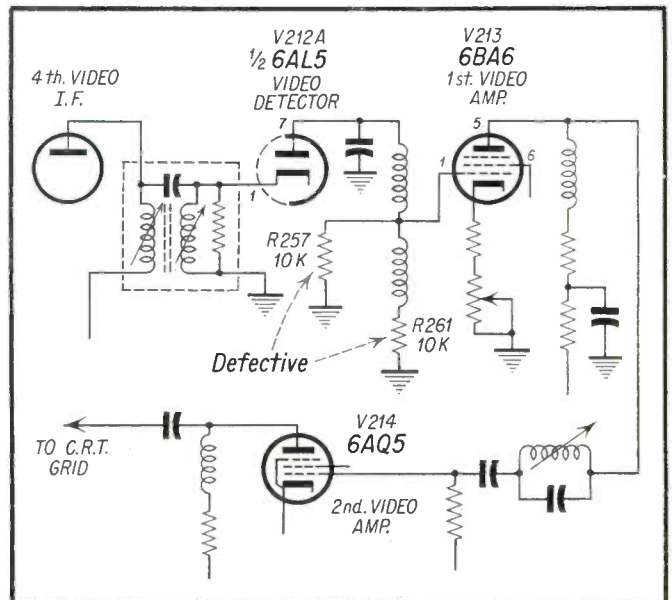
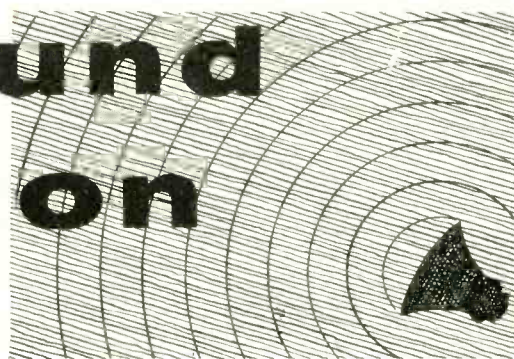

Fig. 2. — Partial schematic of DuMont RA-109 receiver.

# compound diffraction

## Projection Speakers



by Charles Eastman

Many of the illustrations in this article have been reproduced from the original appearing in "The Public Address Handbook for the Compound Diffraction Projector," published by Electro-Voice, Inc., by courtesy of Electro-Voice, Inc.

THE compound diffraction projector loudspeaker is a comparatively new type which has appeared on the P.A. market in recent years. Its use is becoming more and more widespread. It is the purpose of this article to discuss the construction, operation and characteristics of this type of speaker. In discussing any speaker used in the P.A. field, the important factors to be considered are its efficiency, its dispersion, its frequency response, and its distortion.

The design of this speaker is based on a principle long known and used in the field of optics, namely, the principle of diffraction. Applied to sound the principle states, in effect, that if a sound

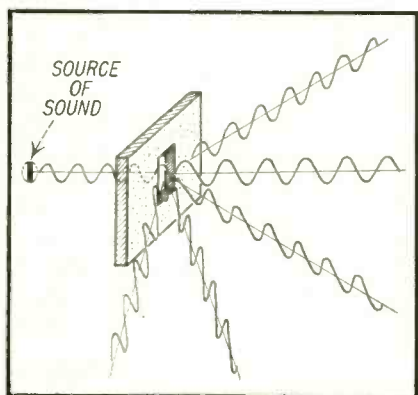

Fig. 1—The diffraction of sound. Dispersion takes place when the incident waves pass through the rectangular opening.

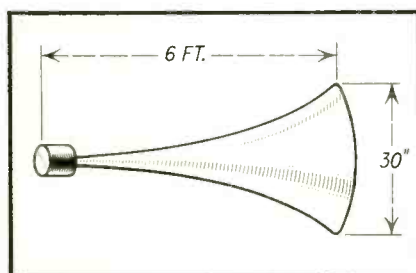

Fig. 2—Straight trumpet. A typical horn of this type has a low frequency cut-off of 115 cps, but concentrates the high frequencies into a narrow band.

wave is made to pass through a "slit" or rectangular opening, where the width of the opening is shorter than the wave length of the sound, the sound will spread out from this opening as if the opening were the source of the sound rather than the original vibrating body. The spread would be in direction of the width of the rectangular opening. Fig. 1 is a sketch illustrating such a rectangular opening, and the dispersion of the emerging sound waves. The application of this principle to loudspeaker design has resulted in a marked improvement in the angular dispersion of sound, particularly at the higher frequencies.

### Efficiency

The efficiency of a loudspeaker is a measure of how much of the electrical energy fed to it is converted into useful sound energy. The efficiency of a speaker is not an important factor in home amplifiers, since a very small amount of power can produce an uncomfortably loud sound in one's living room. Not so however in P.A. systems where the sound must reach out and cover large areas. Any substantial increase in the efficiency of the speaker

for P.A. installations pays off in smaller and less expensive amplifiers.

It has been found that a horn of one type or another is the most efficient means yet developed for coupling the vibrations of a diaphragm to the atmosphere. Thus speakers have gone through a process of evolution from the early straight trumpet shown in Fig. 2, to the present day multicellular horns and re-entrant horns shown in Figs. 3 and 4, and finally to the horn used in the compound diffraction projector shown in Fig. 5.

### Dispersion

The geometry of the horn used in the compound diffraction projector, as previously explained, results in an unusually wide dispersion angle. Fig. 6 is a polar diagram which illustrates this point. The solid lines in this diagram represent the response of the CDP for the frequencies indicated. For comparison purposes, the dotted lines show the polar patterns at the same frequencies

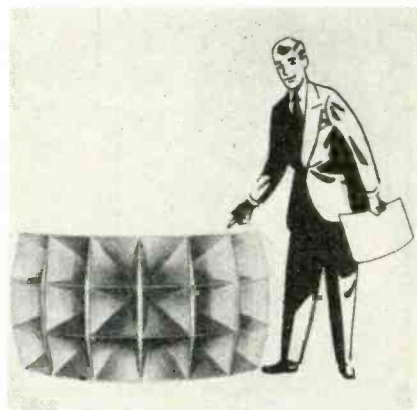

Fig. 3—Typical cellular horn covering  $60^\circ \times 120^\circ$  angle. Horn is normally crossed over at 400 cps to protect driver units from excessive bass excursions and has a 250 cps cut-off.





Fig. 4—Typical reentrant trumpet with 20" bell diameter.

but using a reentrant horn. These are the conditions when the CDP is mounted in a vertical position. If the CDP is mounted horizontally, the polar distribution is somewhat narrowed. As will be shown later there are occasions when this narrower distribution is desirable. A typical CDP has a dispersion of 120° when mounted vertically and 90° when mounted horizontally. A glance at Fig. 5 will show that in this CDP two horns are mounted coaxially. The crossover point of these two horns is at 1000 cps. The smaller high frequency horn can be rotated within the larger horn. Thus there are four distinct ways in which the horns may be oriented. These are,

1. Both horns vertical.
2. Both horns horizontal.
3. High frequency horn horizontal and low frequency horn vertical.
4. High frequency horn vertical and low frequency horn horizontal.

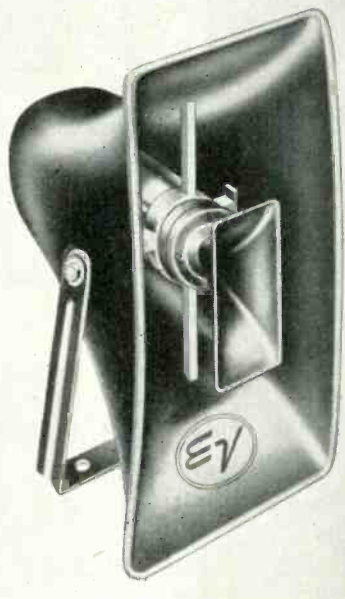

Fig. 5—Horn used in compound diffraction projector.

Each of these orientations has its own characteristic polar distribution. One of the main advantages of this versatility lies in the control it gives over feedback. In many cases, for example, feedback peaks occur at frequencies over 1000 cps. By properly orienting the high frequency horn, it is often possible to reduce the feedback condition considerably. Another advantage lies in the ability to adjust the speakers to the audience it is desired to reach. In most cases, the audience is widespread, and the horns would be adjusted for maximum dispersion. There are instances, however, where the audience would be concentrated along the axis of the horn, and in these cases a narrower polar distribution would reach out further.

### Frequency Response

The basic straight trumpet is no longer widely used. The reason for this lies primarily in its large size. However, since the multicellular horn and the re-

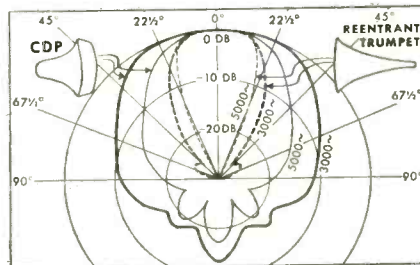

Fig. 6—Distribution at important high frequencies in a compound diffraction projector. The dispersion of a 20" bell reentrant horn is shown with dotted lines.

entrant trumpet are derived from this basic straight horn, the same basic factors govern the dispersion and the frequency response of all three. These factors are:

1. A good low frequency response requires a horn with a large mouth.
2. A horn with a large mouth concentrates the higher frequencies in a narrow beam along the axis.

In addition, good low frequency response calls for a driver unit with a larger throat than that required for good high frequency response. It can be seen then, that a single horn cannot accomplish both good response at the low frequencies and good dispersion at the higher frequencies. One attempt to remedy this situation is by the use of a combination of a large woofer horn for the lows and multicellular horns for the highs.

Each cell of the multicellular horn acts like straight trumpet with a small mouth, thus providing improved dispersion for high frequencies. The multi-

cellular horn simply combines a number of these cells, each with a slightly different orientation, to obtain the desired dispersion. The low frequency response however is poor, necessitating the use of a separate woofer. Such an arrangement however is bulky and expensive.

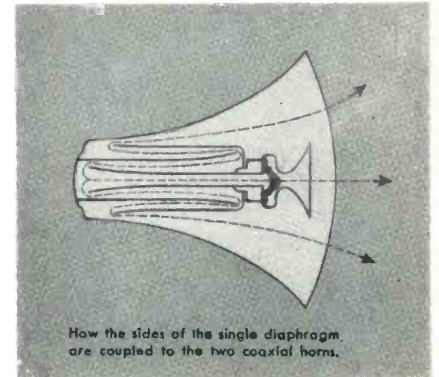

Fig. 7—Two horns of different sizes are driven by a common diaphragm as shown above.

In addition, the high frequency response is impaired by the constriction formed at the throats of the cells.

The CDP illustrated in Fig. 5 is a coaxial speaker assembly, expressly designed for high quality speech and music reproduction. It has a flat response within  $\pm 5$  db from 175 to 10,000 cps. It does this by making use of two horns of different sizes, driven by a common diaphragm, as shown in Fig. 7. The large horn is especially designed for the propagation of the low frequencies, while the small horn, inside the mouth of the large horn is designed primarily

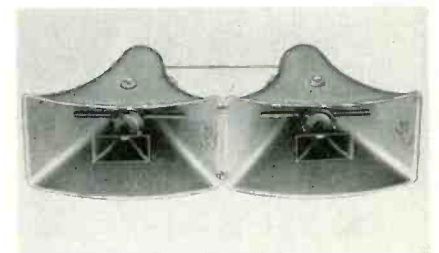
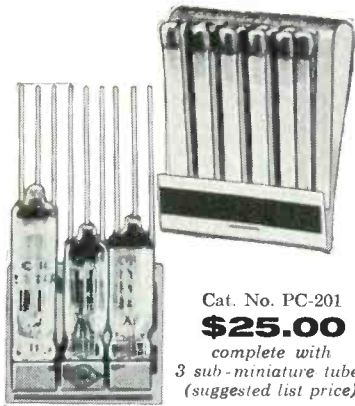

Fig. 8—Horizontal placement of multiple CDP's for increased power handling and augmented bass capacity. Horns may be stacked vertically as well as horizontally.

for the high frequencies. The crossover frequency is at 1000 cps. The throat of each horn is designed for optimum operation at the frequencies to be handled by each.

When CDP's are stacked, a further improvement of low frequency response is obtained, as described below. When a single CDP is mounted in a corner, the walls act as an extension of the horn

[Continued on page 50]



Cat. No. PC-201  
**\$25.00**  
 complete with  
 3 sub-miniature tubes  
 (suggested list price)

## Here's where spare-time fun begins!

### Centralab Ampec® 3-stage P.E.C.\* Audio Amplifiers

*You can use them to build all sorts of exciting, miniature projects — pocket radios, mike preamplifiers, signal tracers, portable megaphones, phonograph pick-ups, hearing aids, model controls — even stethoscopes*

For your work or your hobby, you can have a "picnic" with Ampec. It's the highest form of Printed Electronic Circuits and provides complete electrical service from input to output. Wiring, capacitors, resistor, and tube sockets are bonded to a single, master plate.

Even with tubes, Model 2 Ampec is smaller than a book of matches. Model 3 is smaller than a postage stamp — and it has a tone circuit, besides! You can get either model with or without tubes. The quality of both models measures up to the same high standards you enjoy in the Centralab components you install every day.

Ask your Centralab distributor to tell you more about Ampec. And send coupon for Booklet 42-142 with complete specifications and application "ideas".

\*Trademark

# Centralab

Y-1655

CENTRALAB  
 A Division of Globe-Union Inc.  
 944F E. Keefe Ave., Milwaukee 1, Wis.

Send me free Booklet 42-142.

Name.....  
 Company.....  
 Address.....  
 City..... (.....) State.....



# Association News

## National Alliance of TV & Electronic Service Association

Business idea of the month: Spruce up your shop. Discussed also is the evil of low-fee service calls. Taken to task are those operators who are advertising bargain rates and thereby injuring other technicians, the public and themselves.

NATESA lauds the proposed RETMA program for upgrading TV technicians. However, they take issue with the manufacturers' group on its allegation that "the independent service industry has not rendered good and proper service." Finally, NATESA believes that what is needed now is the launching of an "accreditation program."

## Utah Association of Radio & TV Servicemen

From NATESA Scope: The state licensing bill which was sponsored by this group passed in the Senate by a 20 to 1 margin and in the House by a 39 to 17 margin, only to be vetoed by the Governor. He gave as his reason the fact that he felt that authority was already vested in cities and counties to control TV service.

## Philadelphia Radio Servicemen's Association

Radio and television servicemen of the Hazleton area have begun organizing a servicemen's association for the mutual exchange of information.

A program committee has been set up to plan meetings at which representatives of various electronics manufacturers will lecture on latest developments in equipment.

Named to a membership committee were Bernard Pora, of Pora's Radio City; Paul Gombada of Residential Radio & Electric Service; Joseph Gans,

of Gans Television; George Sabol, of Sabol TV; Robert Pensock, of S. J. Pensock Co.; Paul Wensko, of Wensko TV Service; and Dominic Cerrito, of Cerrito Radio & Television.

## Federation of Radio Servicemen's Association of Pa.

In a letter addressed to the FCC, Washington, D. C., FRSAP expresses its concern with regard to the possibility that manufacturers of subscription television units will probably insist that they control and monopolize the installation, maintenance, and servicing of such units. If this is allowed subscription television will completely eliminate the established servicing agencies of independent radio and television shop owners from subscription television. FRSAP therefore petitioned the FCC to issue rules and regulations which will prohibit manufacturers from such practices.

## Television Service Dealers Association of Philadelphia

TSDA has gone on record protesting Philco's advent into TV servicing; also requesting FCC action on Subscription TV to protect independent service shop owners.

## Syracuse Television Technicians Assoc. (NY)

Advises members to "Police" wholesalers who sell retail and let them know feelings of service technicians on this subject.

## Milwaukee Association of Radio & TV Services

From NATESA Scope: The election of officers was held at the February meeting of the Milwaukee Association of Radio & Television Services. Nor-

[Continued on page 44]





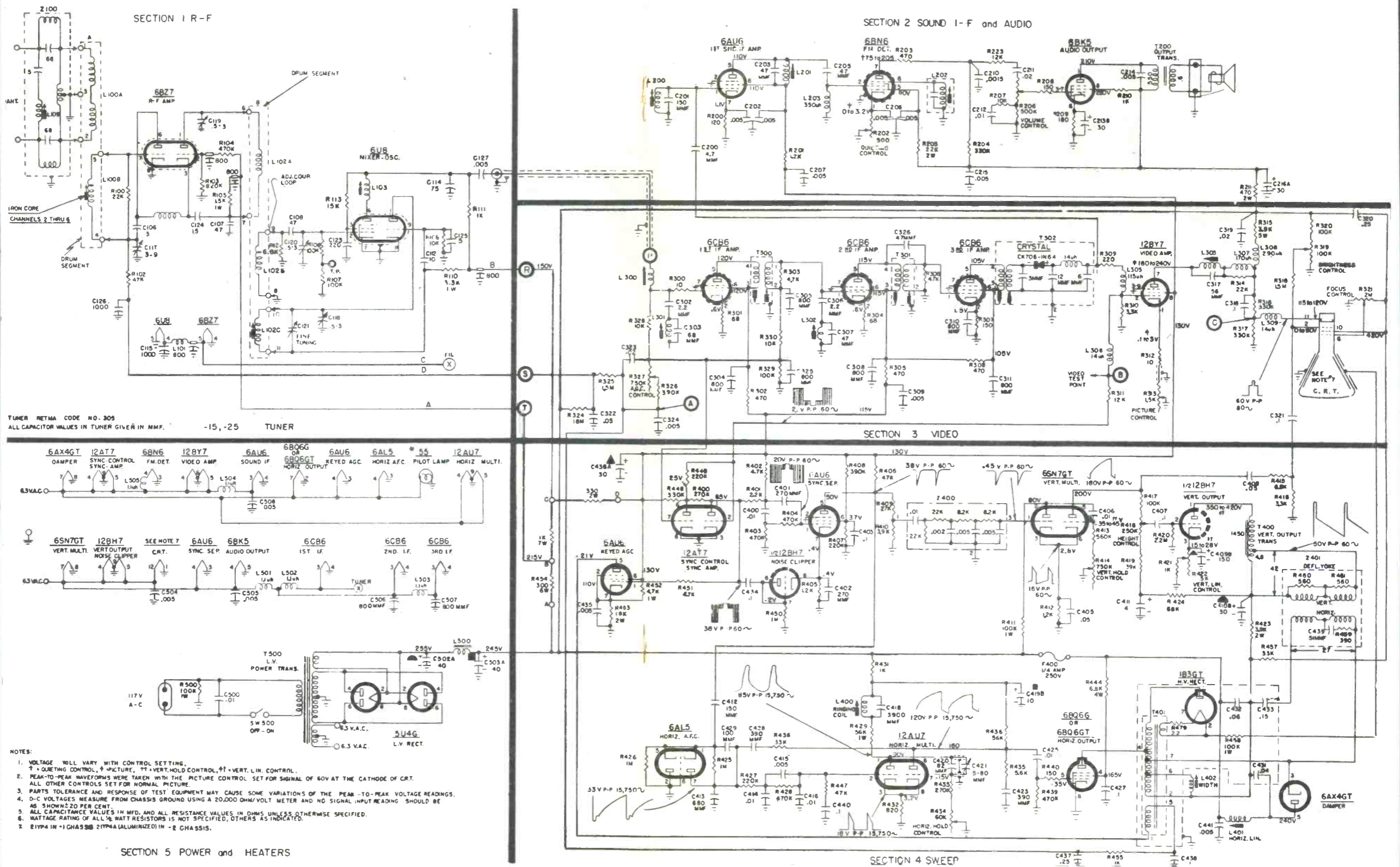

- NOTES:**
- VOLTAGE WILL VARY WITH CONTROL SETTING.
  - PEAK-TO-PEAK WAVEFORMS WERE TAKEN WITH THE PICTURE CONTROL SET FOR SIGNAL OF 60V AT THE CATHODE OF CRT. ALL OTHER CONTROLS SET FOR NORMAL PICTURE.
  - PARTS TOLERANCE AND RESPONSE OF TEST EQUIPMENT MAY CAUSE SOME VARIATIONS OF THE PEAK-TO-PEAK VOLTAGE READINGS.
  - D-C VOLTAGES MEASURE FROM CHASSIS GROUND USING A 20,000 OHM/VOLT METER AND NO SIGNAL INPUT READING SHOULD BE AS SHOWN ± 20 PER CENT.
  - ALL CAPACITANCE VALUES IN MFD. AND ALL RESISTANCE VALUES IN OHMS UNLESS OTHERWISE SPECIFIED.
  - WATTAGE RATING OF ALL 1/2 WATT RESISTORS IS NOT SPECIFIED, OTHERS AS INDICATED.
  - 81YP4 IN -1 CHASSIS 21YP4A (ALUMINIZED) IN -2 CHASSIS.



Mfr: Philco Chassis No. TV-350

Card No. PH 350-1

Section Affected: Sound

Symptoms: Insufficient bass quality

Reason for Change: Circuit improvement

What to Do:

Change: R84 from 22K to 10K

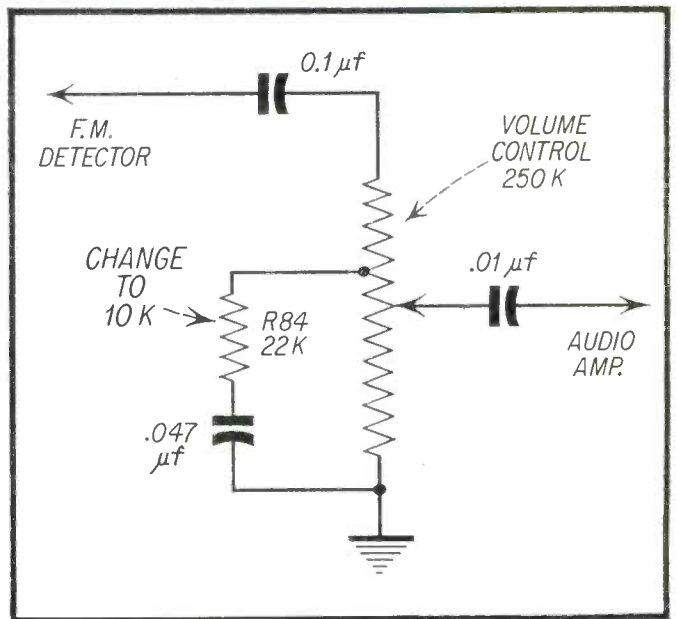

Mfr: Philco Chassis No. TV-350

Card No. PH 350-2

Section Affected: Sync

Symptoms: Insufficient horizontal hold range

Reason for Change: Circuit improvement

What to Do:

Add: 39K resistor across horizontal hold control

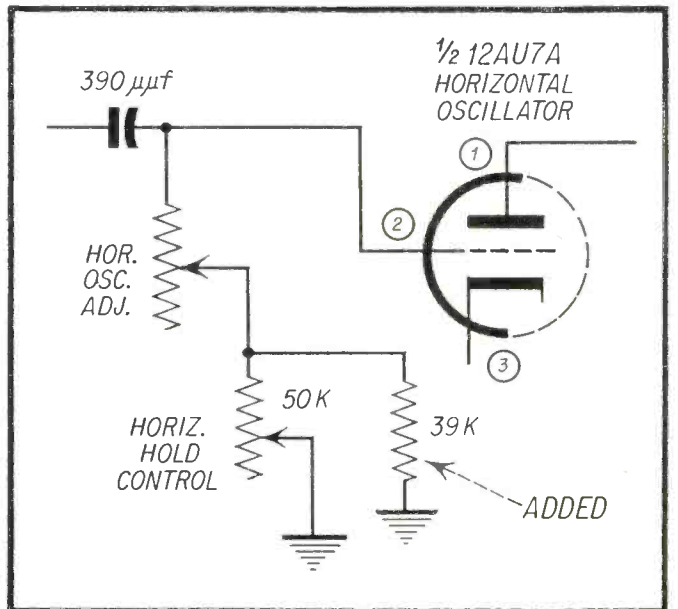

Mfr: Philco Chassis No. TV-350

Card No. PH 350-3

Section Affected: Sync

Symptoms: Poor vertical lock-in on sub-standard signal

Reason for Change: Circuit improvement

What to Do:

Change: C55 from .068 μf to .15 μf  
R71 from 1 meg to 330K

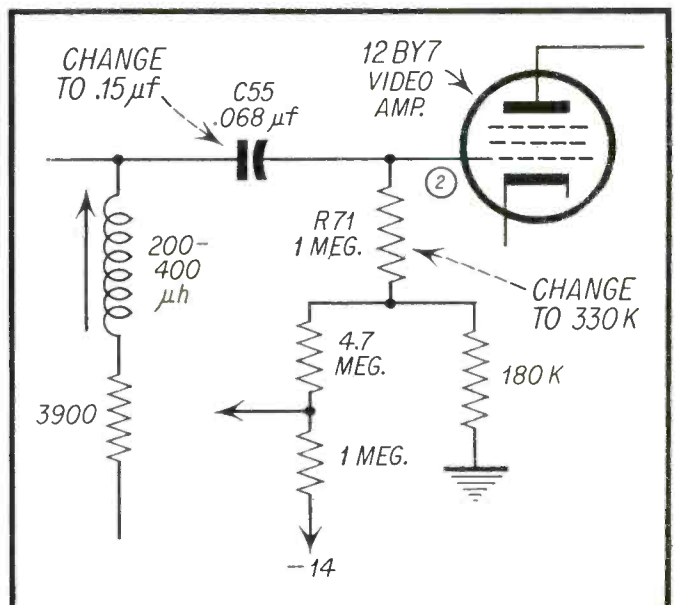

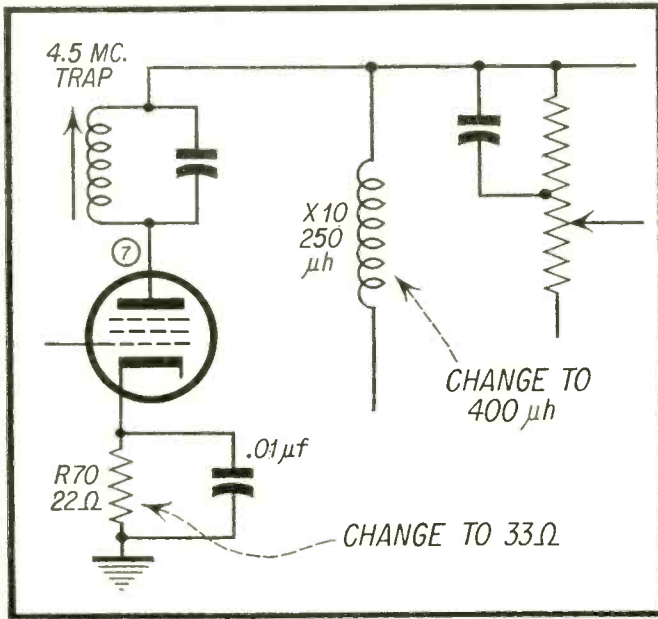

Card No. PH 350-4

Section Affected: Pix

Symptoms: Trailing white edges in pix

Reason for Change: To reduce transients

What to Do:

Change: X10 from 250  $\mu$ h to 400  $\mu$ h

R70 from 22 to 33 ohms

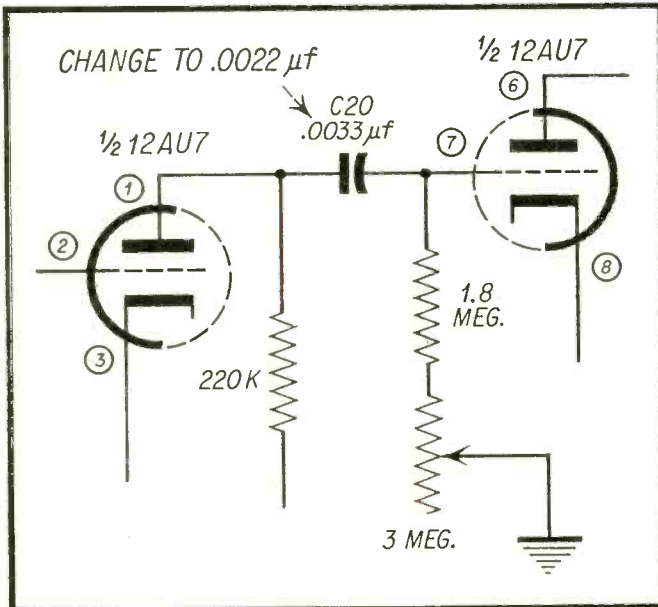

Mfr: Philco

Chassis No. TV-350

Card No. PH 350-5

Section Affected: Sync

Symptoms: Vertical instability

Reason for Change: Component failure

What to Do:

Replace: C20 with .0022  $\mu$ f, 10%

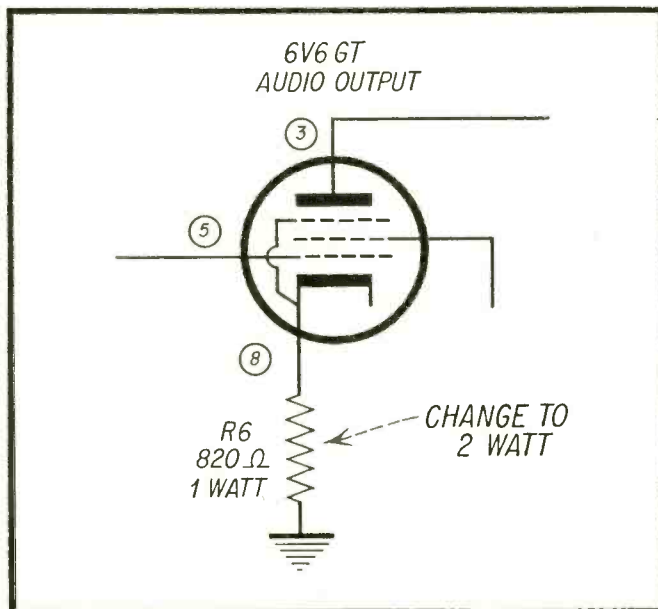

Mfr: Philco

Chassis No. TV-350

Card No. PH 350-6

Section Affected: Sound

Symptoms: No audio

Cause: Component failure

What to Do:

Replace: R6 (820 ohms). Use two watt resistor



Mfr: Philco Chassis No. TV-300  
 Card No: PH300-1  
 Section Affected: Pix  
 Symptoms: Weak Picture  
 Reason for Change: To increase output signal

What to Do:  
 Change: R48 from 18K to 10K, ½ watt

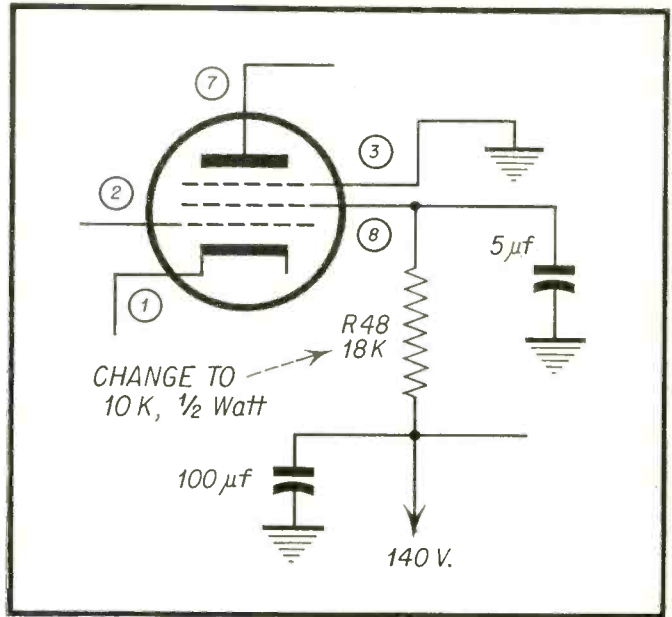

Mfr: Philco Chassis No. TV-300  
 Card No: PH300-2  
 Section Affected: Pix  
 Symptoms: Poor picture detail  
 Reason for Change: To increase high frequency response

What to Do:  
 Interchange: X8 with X9  
 Remove: RF choke, connecting junction of X9 and 6.8K resistor to CRT cathode.

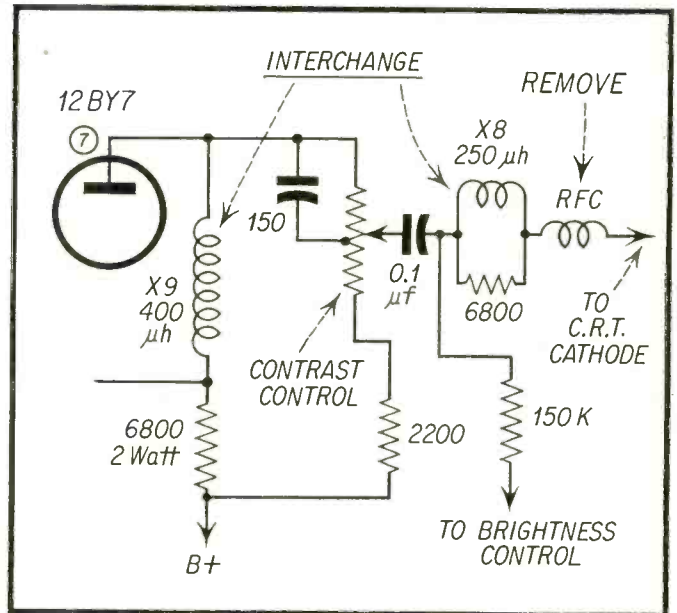

Mfr: Philco Chassis No. TV-300  
 Card No: PH300-3  
 Section Affected: Pix  
 Symptoms: Trailing white edges in pix  
 Reason for Change: To reduce transients

What to Do:  
 Change: C38 from .003 uf to .002 uf

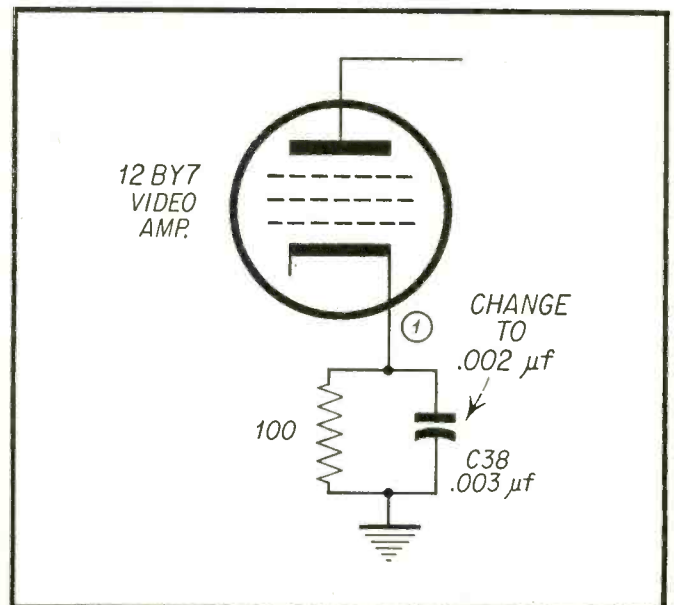

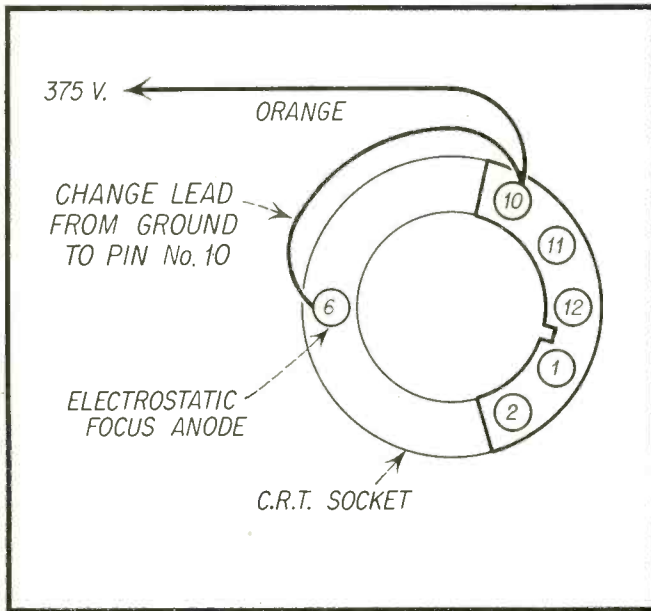

Mfr: Philco Chassis No. TV-300

Card No: PH300-4

Section Affected: Pix

Symptoms: Poor focus

Reason for Change: To improve electrostatic focus picture tube operation

What to Do:

Change: Focus anode lead from ground to a convenient 260 Volt B plus point in chassis.

Further improvement can be obtained by connecting focus anode lead to accelerating anode of picture tube at pin 10 of CRT socket.

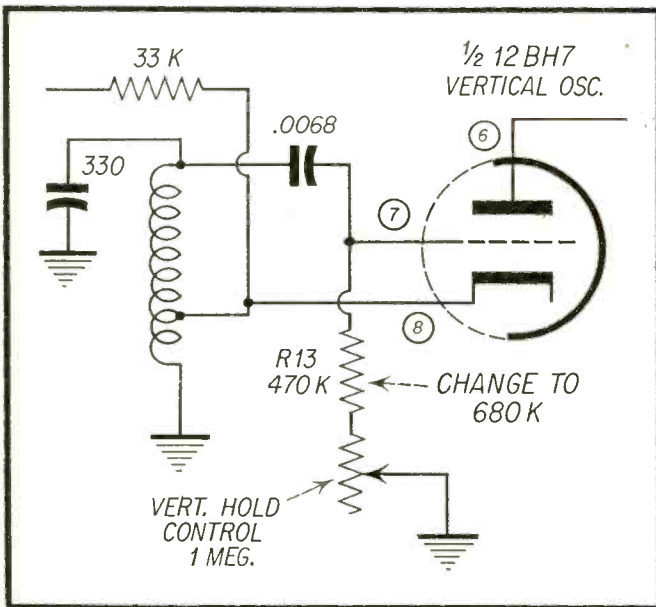

Mfr: Philco

Chassis No. TV-300

Card No: PH300-5

Section Affected: Sync

Symptoms: Vertical Hold not in center of control range

Reason for Change: To improve circuit operation.

What to Do:

Change: R13 from 470K to 680K

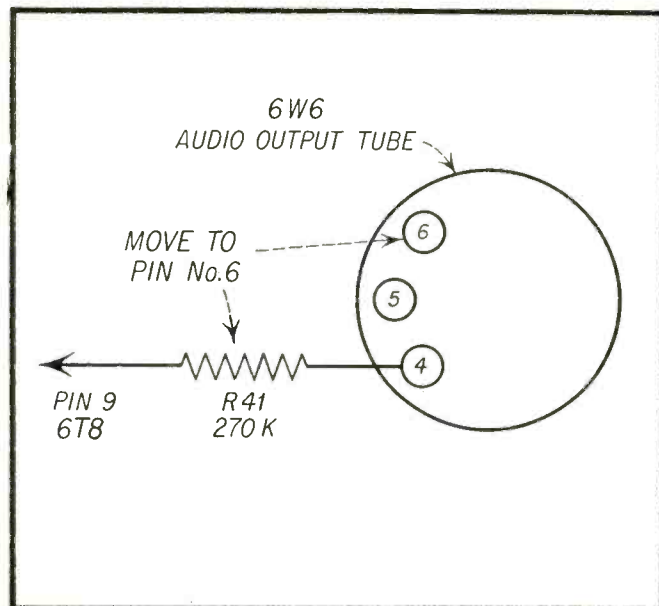

Mfr: Philco

Chassis No. TV-300

Card No: PH300-6

Section Affected: Sound

Symptoms: Buzz in Audio

Reason for Change: Circuit improvement

What to Do:

Move: R41, 270K resistor from pin 4 to pin 6 of 6W6 audio output tube.

# Circuit

# Analysis

by Radio Television  
Service Dealer  
Technical Staff

This Month's Circuit—  
Noise Control Circuit:  
Emerson Ch. 120174B

THE term "signal to noise ratio" is used over and over again in discussing the reception of radio and TV signals. In essence this ratio is a number that compares the strength of the desired signal to that of undesired noise signals from various sources such as atmospheric static and electrical machinery of different types. Thus a signal to noise ratio of 10 to 1 means that the signal is ten times as strong as the noise. A 1 to 1 ratio means that the signal and the noise are equal in amplitude.

In the reception of TV signals the presence of noise signals of appreciable strength compared to the desired TV signal (low signal to noise ratio) shows up in two important ways. These are:

**1. Unstable picture synchronization.** The picture rolls or tears or does both. Thus, when the noise signal becomes larger than the sync pulses, the operation of the sync clipper is upset. This will be described in detail later.

**2. Poor picture quality.** When the noise signal is due primarily to atmospheric noise (static), it shows up in the picture as snow. When the interference is from man-made sources such as vacuum cleaners, ignition systems, etc., the effect on the screen in most cases might be described as short horizontal light and dark lines racing across the screen.

Noise control circuits are designed to minimize these undesirable effects of noise. Since the noise signal produces the two different types of symptoms mentioned above, it might be expected that two general types of noise control circuits are used, one for each of the symptoms mentioned. Such is actually the case. One type is designed to stabilize synchronization, while the other produces better picture quality.

## Block Analysis

Figure 1 is a block diagram of a commonly used circuit for improving sync stability in fringe areas, where low

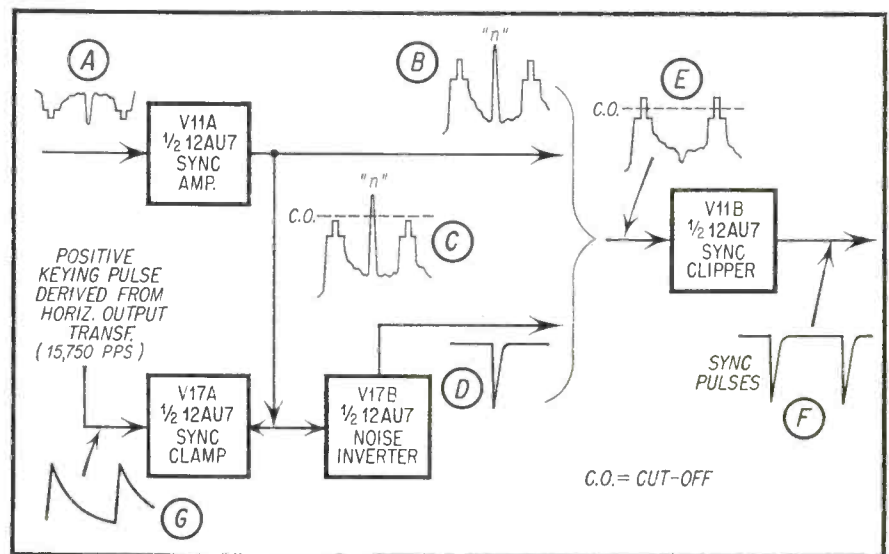

Fig. 1—Block diagram of Noise Cancellation circuit used in Emerson Chassis 120174B. This circuit is designed to improve sync stability in fringe areas where low signal to noise ratios are encountered.

signal to noise ratios are encountered. (Emerson Chassis 120174B). Let us examine the function and waveforms associated with each of the stages involved.

**1. Sync Amplifier**—This is a conventional sync amplifier stage. It receives a negative going composite video signal from the video detector as shown at "A". Suppose that a noise pulse is superimposed on the video information as indicated at "n" of this waveform. At the output of this stage, there appears an amplified and inverted replica of the input signal, as indicated at "B". This signal is fed simultaneously to the sync clipper, the noise inverter, and the sync clamper stages.

**2. Noise Inverter**—The noise inverter receives the signal described above as an input. Its function is to produce only the noise signal at its output, and to produce this noise signal in the negative phase. Thus the name "in-

verter." This is accomplished by setting the bias of the stage at such a point that all portions of the incoming signal are cut off except those which are above the level of the sync pulse tips. Since the interfering noise pulses are usually greater in amplitude than the sync pulses, they will be the only portions of the signal capable of producing an output signal in this stage. Thus, the only effective portion of the input signal is shown by the shaded portion of waveform "C" in Fig. 1. The noise inverter stage then amplifies and inverts this pulse of noise, producing an output consisting of only the noise and in the negative phase. This negative noise pulse, shown as waveform "D" in Fig. 1, is then fed into the input of the sync clipper stage along with the "B" signal from the sync amplifier.

**3. Sync Clipper**—The only essential difference between the sync clipper used here and the conventional sync clipper

is found in the input signal received by this stage. The ordinary sync clipper would receive an input signal similar to "B" of Fig. 1. It would be automatically biased, to allow only those portions of the signal above the blanking level to pass through.

The sync clipper nearly always uses a grid condenser and grid leak resistor for producing a negative bias nearly equal in value to the peak of the incoming sync pulse. As a result of the greater peak value of the noise pulse, the sync clipper is biased sufficiently negative to drive the sync pulses into the cutoff region. The tube remains cut off until the grid condenser has time to discharge sufficiently. During this time however, the sync pulses are lost at the output and synchronization of the picture is temporarily lost.

The input signal to this sync clipper stage, however, consists of the combination of "B" and "D". The negative noise pulse at "D", having been amplified by the noise inverter stage, and occurring at the same instant as the positive noise pulse in "B" completely cancels this noise pulse and results in the waveform shown at "E". It will be observed that the noise pulse is no longer present. As a matter of fact, the slight dip in the waveform at the point where the noise pulse previously appeared, shows that negative pulse from the inverter was even stronger than the original noise pulse. This assures complete elimination of the noise pulse from the combined signal entering the clipper. The stage is biased to allow conduction only above the dotted line in wave form "E", thus producing an output containing sync pulses only. The noise pulses can no longer block the tube, and this, you will remember was the objective of the circuit.

**4. The Sync Clamper** — Since the strength of the signal picked up by the receiver may vary over a wide range of values, there is a danger that the sync pulses would rise above the cutoff level indicated in waveform "C". If this were to happen the sync pulses would also cause the noise inverter to conduct, producing amplified negative sync pulses at the output. If this were allowed to happen, the sync pulses at the input to the sync clipper would be cancelled out by the same process previously described for the noise pulse. It is the function of this clamping circuit to prevent such an occurrence. The clamping tube is biased beyond cutoff. A positive pulse of voltage at the horizontal sweep frequency, waveform "G" in Fig. 1, is derived from the horizontal output transformer and fed to the control grid. At the same time that this positive pulse appears at the grid, the sync pulse portion of the composite video signal appears at the plate. This combination

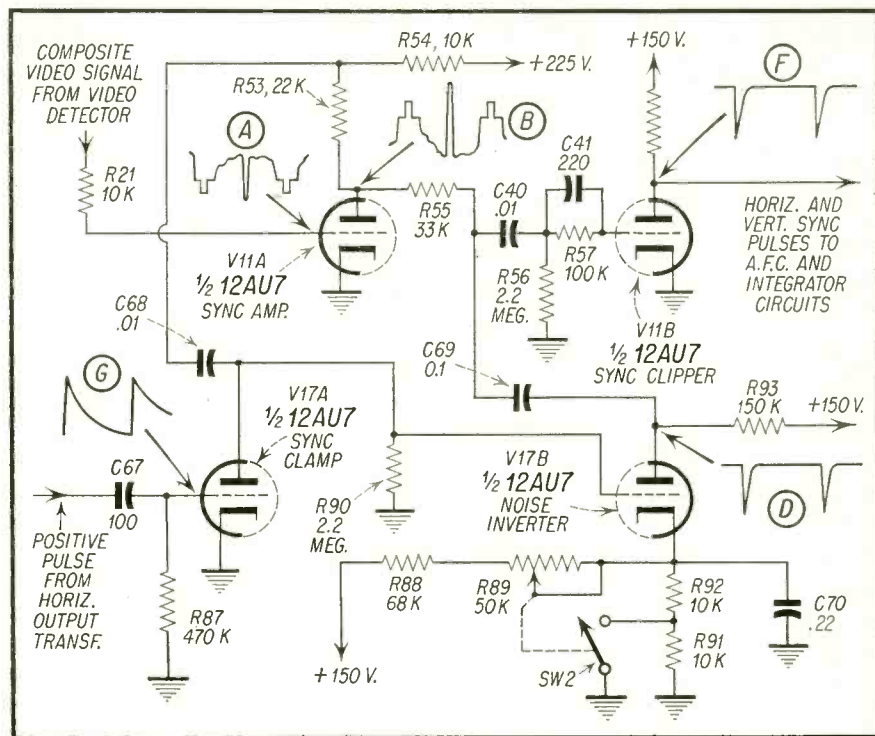

Fig. 2—Partial schematic of Emerson Chassis 120174 B illustrating Noise Cancellation Circuit. Waveforms are shown for each signal.

causes the tube to conduct at the time of the sync pulse but at no other time. The circuit is designed to clamp the level of the sync pulse tips at approximately zero volts. Since the noise inverter is biased beyond cutoff, this zero level will not be sufficient to cause conduction in the noise inverter, so that sync pulses are effectively eliminated from noise inverter output. The noise pulses do get through since the clamping tube is cut off between sync pulses.

#### Circuit Analysis

A thorough understanding of the analysis by blocks which we have just completed should help greatly in understanding the circuit analysis which follows. Fig. 2 is a schematic showing the stages and components in the circuit under discussion.

**The Sync Amplifier**—The negative going composite video signal is taken directly from the video detector load resistor (not shown here) and coupled to the grid of V11 A via R21 which acts as isolating resistor. This resistor prevents V11 A from affecting the signal across the video detector load resistor. V11 A amplifies the composite video signal and simultaneously inverts it. We now have an amplified positive going signal at the plate of V11A. C-40 couple this signal to the sync clipper, V11 B. R53 and R54 make up a voltage divider for the signal at the plate. Thus a portion of this signal (waveform B) is fed to the plate of V17A, the sync clamper, as well as to the grid of V17B, the noise

inverter. The signal reaches these points via C68, and has the same waveform as that shown at "B".

**The Noise Inverter.** Before describing the operation of this circuit it should be pointed out that in strong signal areas the noise inverter should be made inoperative, since if this is not done unstable synchronization of the picture may result. Because the signal to noise ratio is high in these areas, the noise circuits are not necessary, so no harm is done by making them inoperative.

The "Fringe Compensator Control" (R89) and the switch SW-2, which is linked to this control, supply the means for making the noise inverter inoperative. With the switch closed as shown in Fig. 2, the noise inverter is in operating condition. R88, R89, and R92 form a voltage divider across the 150 volt section of the B+ power supply. R91 is out of the picture since it is shorted by the switch. The cathode receives a positive voltage equal to the voltage across R92. This voltage may be varied by changing the setting of R89. When R89, is turned to the OFF position, the switch opens and R89 is shorted out. The opening of the switch adds R91 to the voltage divider, thus increasing the positive voltage on the cathode. The shorting of R89 has the same effect, since a larger portion of the 150 volts will appear across R92 and R91 than did before. These two actions combined are sufficient to drive the noise inverter well beyond cutoff. (A high posi-

[Continued on page 44]

# GENERAL ELECTRIC

Model No.  
 17C127, 17T15-17,  
 21C114-C115, C116, C117, C119  
 21C120-C121  
 21T10-T11-T12-T14-T15-T19  
 ("F" Series Chassis)

## TUBE LIST

SYMBOL TYPE	CIRCUIT FUNCTION
V101 6BC5	R-F Amp
V102 6J6	Converter-Oscillator
V102 12AT7	Converter-Oscillator
V103 6CB6	1st Video I-F Amp
V104 6CB6	2nd Video I-F Amp
V105 6CB6	3rd Video I-F Amp
V106 12AT7	Sync Amp & Noise Cancellor
V107	Sync Clipper & Horiz Phase Detector
V108 6AG7	Video Amp, first production
6CL6	Mid & late production
V109	Picture Tube
17QP4	17" Models
21EP4-A	21" Models
21JP4	
21Z4147	
21FP4-A	Model 21T15A
21EP4-B	Model 21T19 & late Prod. 21T10
21ZP4-B	
V110 6J5	Vertical Oscillator
V111 6AH4-GT	Vertical Output
V112 12AU7	Horiz Oscillator
V113 6BQ6	Horiz Output
V114 1B3-GT	High-voltage Rectifier
V115 6AX4	Damper
V116 6CB6	Audio I-F Amplifier
V117 6AU6	Audio I-F Limiter
V118 6T8	Ratio Detector & Audio Amp

V119 6V6-GT Audio Output  
 V120 5U4-G Power Rectifier  
 V121 5U4-G Power Rectifier  
 Y151 RED-003 Crystal Diode

## KEY VOLTAGES

B+, plate of damper, V115 pin 5 260 vdc  
 Boosted B+, cath. of damper, V115 pin 3 500 vdc  
 Plate of VERT. OSC., V110 pin 3 27 vdc  
 Plate of Vert. Out., V111 pin 5 235 vdc  
 Plate(s) of Hor. Osc., V112 pin 1 190 vdc  
 V112 pin 6 165 vdc  
 Grid of Hor. Out., V113 pin 5 -17 vdc  
 (All voltages are measured with a 20,000 ohms per volt meter connected between the tube pins and chassis.)

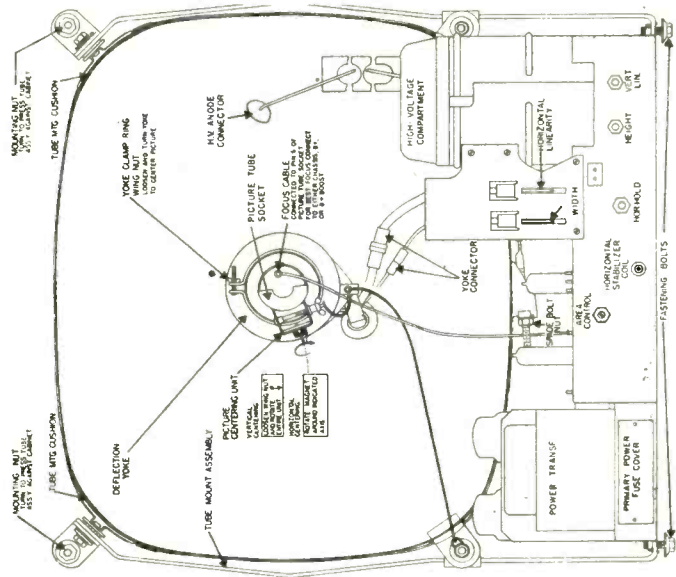
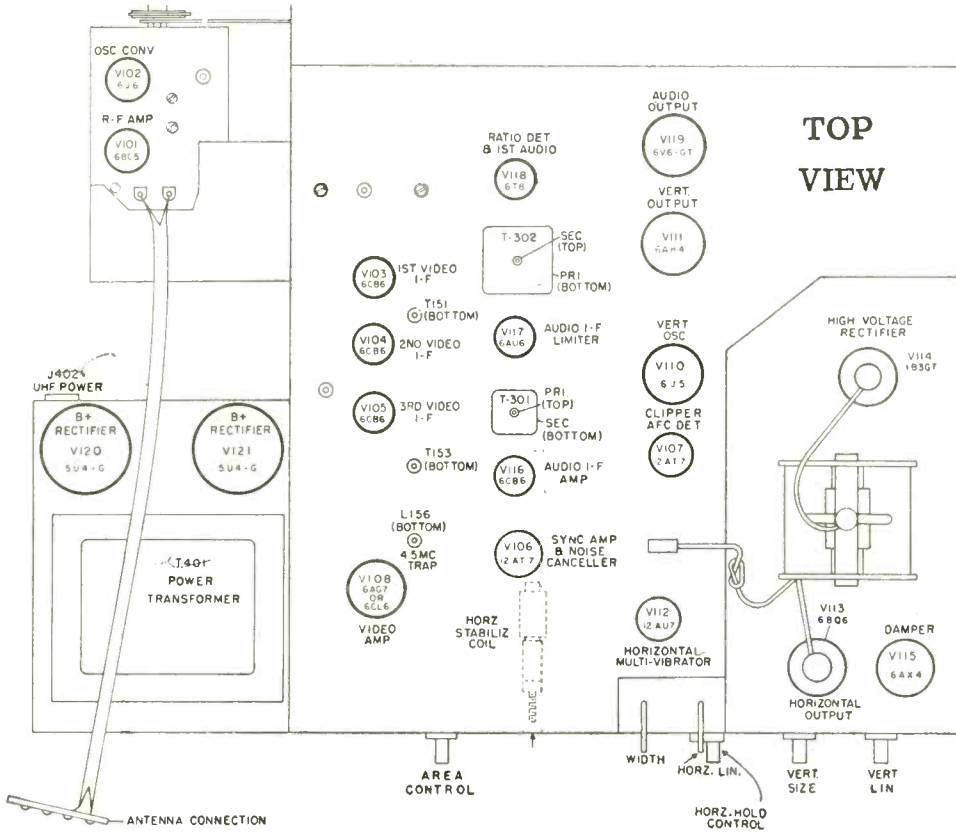

REAR CONTROLS  
 ELECTROSTATIC PICTURE TUBE

**TV FIELD SERVICE**  
 Pre-published from Rider "TV Field Service Manual"  
 by Rider & Alberg  
 Copyright 1954, John F. Rider, Publisher, Inc.

## ADJUSTMENTS

### ELECTRICAL INSTALLATION ADJUSTMENTS

It is recommended that the receiver be permitted to operate for at least 15 minutes before the final raster adjustments are made.

**HORIZONTAL STABILIZER COIL**—The coil should be adjusted so that the horizontal sync will remain locked over the entire range of the horizontal hold control. Also, the "pull-in" range of sync should be evenly distributed on each end of the horizontal hold control range. This may be checked by switching off and on a station and observing the "pull-in" ability at different settings of the control.

In order to adjust the coil properly follow the given procedure:

1. Remove tube V106. Tune in a very weak television signal.
  2. Short circuit terminals of stabilizer coil.
  3. Adjust horizontal hold control to bring received picture closely into sync.
  4. Remove short circuit from across terminals of stabilizer coil.
  5. Tune the stabilizer coil to bring picture back into a closely synced condition. The stabilizer coil will tune to two positions which will bring the picture into sync. The correct position is the one with the core almost all the way into the coil.
  6. Replace tube V106; check lock-in ability of horizontal sync on available channels.
- It is absolutely essential that the stabilizer coil and the horizontal hold control be correctly adjusted, and once adjusted, be left alone.
- It should be noted that in some receivers the stabilizer coil has been relocated and is available at the top rear of the chassis
- OVERLOAD PROTECTION**—A slow-blow 4-ampere fuse, F401, is incorporated in this receiver to protect the power supply rectifiers from overload. Should the receiver fail to operate, the fuse should be checked and the cause of the overload remedied. This fuse is located in the power supply compartment.

### TO REMOVE PICTURE TUBE

Electrostatic Picture Tubes

#### MODELS 17T15, 21T10-T11-T12

1. Remove chassis.
2. Lay cabinet, face down, on a soft non-scratching surface.
3. Remove ion trap.
4. Loosen the two focus unit securing nuts and slide out focus unit.
5. Loosen the two nuts holding focus unit disc and remove disc.
6. Loosen clamp ring mounting screw and slide out deflection yoke.
7. Loosen the focus picture tube rod nuts and swing the rods out of the picture tube holder slots and remove holder and rods.
8. Loosen the two bolts fastening the tube mount assembly to the bottom of the cabinet and remove the two tube mount fastening nuts.

## GENERAL ELECTRIC TROUBLE SHOOTING CHART

### SMEARED PIX

9. Carefully slide tube with tube mount assembly out of the cabinet and lay the assembly on a non-scratching surface with picture tube face down.
10. Loosen the hex nut on the spade bolt.
11. Lift picture tube out of the strap assembly.

#### Internal Magnetic Focus Units (IMF)

#### MODEL 21T10

1. Remove chassis.
2. Lay cabinet, face down, on a soft non-scratching surface.
3. Remove the ground clip on focus unit, loosen focus unit using nut and slide out assembly.
4. Remove the ground lead from the yoke assembly, loosen the yoke wing nut and slide out deflection yoke.
5. Loosen the two bolts fastening the tube mount assembly to the bottom of the cabinet and remove the two mounting nuts at the top of the tube mount.
6. Carefully slide the tube with tube mount assembly out of the cabinet and lay assembly on a non-scratching surface with picture tube face down.
7. Loosen the hex nut on the spade bolt.
8. Lift picture tube out of the strap assembly.
9. Be sure to use for replacement the picture tube 21P4A.

#### A. External Magnetic Focus Tubes

#### Models 17T1, 17C127, 21C115-C116-C117-C119-C120-C121, 21T14-T15-T19

1. Remove chassis.
  2. Lay cabinet, face down, on a soft non-scratching surface.
  3. Remove ion trap.
  4. Loosen the two focus unit securing nuts and slide out focus unit.
  5. Loosen the two nuts holding focus unit disc and remove disc.
  6. Loosen clamp ring mounting screw and slide out deflection yoke.
  7. Loosen the four picture tube rod nuts and swing the rods out of the picture tube holder slots, unhook them, and remove picture tube holder.
  8. Remove the two Phillips screws holding mask to cabinet, and tilt tube slightly so that the mask will slide out the top rail and remove assembly from cabinet.
  9. Carefully lay the assembly with the picture tube, face down, on a non-scratching surface. Loosen the picture tube strap by unscrewing the hex nut on the spade bolt.
  10. Remove picture tube from the strap assembly.
- PICTURE CENTERING**—Centering is achieved by rotating the two adjustment arms, see Fig. 9, either individually or both together, depending on the degree of centering required.
- FOCUS**—Loosen wing nut of focus unit and move unit forward and backward until good focus is achieved and re-tighten wing nut. For final adjustment insert screw driver in slot of focus adjustment, see Fig. 8, and slowly turn for best focus.

### POOR PIX DETAIL

- Tuner fine tuning  
Focus con.  
V103, V104, V105, V109  
Check Vid. Det. and Amp. peaking coils  
Check Vid. Det. xtal Y151  
IF and RF alignment

### ENGRAVED EFFECT IN PIX

- Tuner fine tuning  
Contrast con.  
V102, V103, V104, V105, V108, V109  
Check Vid. Det. xtal Y151  
Check Vid Det. and Amp. peaking coils  
IF and RF alignment

### VERT. BARS

- Hor. Drive con.  
V113, V115  
Check 240 $\mu$ f cap. connected to hor. out. trans. terminals 1 and 2  
Defl. yoke ringing

### PIX. BENDING

- Hor. Hold and Stabilizing con.  
V106, V107, V112, V113  
Check 0.001  $\mu$ f cap. connected to pin 2 of V112  
Check 0.001  $\mu$ f cap. connected to pin 6 of V107

### WEAK OR NO PIX—SOUND WEAK—RASTER OK

- Tuner fine tuning  
V101, V102, V103, V104, V105, V106  
Check Vid. Det. xtal Y151  
RF and IF alignment

### INSUFFICIENT BRIGHTNESS

- Ion trap  
Brightness and Hor. Drive con.  
V109, V112, V113, V114, V115, V120, V121  
Low line voltage

### EXCESSIVE RASTER (PIX SIZE)

- Hor. Drive con. Size  
Hor. and Vert. con.  
V109, V113, V114  
Check 15k  $\Omega$  res. and 0.1  $\mu$ f cap. connected to pin 4 of V113

### WEAK PIX—SOUND AND RASTER OK

- Tuner fine tuning  
Contrast con.  
V103, V104, V105, V108  
Area con.  
Check Vid. Det. xtal V151

### INSUFFICIENT RASTER WIDTH

- Hor. Drive and Size con.  
V112, V113, V115, V120, V121  
Check 560  $\mu$ f and 0.01  $\mu$ f cap. connected to pin 6 of V112  
Hor. Out. trans.  
Low line voltage

### INSUFFICIENT RASTER HEIGHT

- Vert. Size and Lin. con.  
V110, V111, V120, V121  
Check 0.022  $\mu$ f caps. connected to pin 1 of V111  
Vert. Out trans.  
Low line voltage

### NO. VERT. DEFL.

- V110, V111  
Check 0.022  $\mu$ f caps. connected to pin 1 of V11  
Check 0.001  $\mu$ f cap. connected to pin 5 of V110  
Vert. Defl. coils (yoke)  
Vert. Out. trans.

### NO VERT. SYNC.—HOR. SYNC. OK

- Vert. Hold con.  
V107, V110, V111  
Check 0.001  $\mu$ f cap. connected to pin 5 of V110  
Check 0.022  $\mu$ f cap. connected to pin 1 of V111

### NO HOR. OR VERT. SYNC.—PIX SIGNAL OK

- V106, V107  
Check 0.01  $\mu$ f cap. connected to pin 2 of V106

### NO HOR. SYNC.—VERT. SYNC. OK

- Hor. Hold and Stabilizing con.  
V107, V112  
Check 560  $\mu$ f cap. to pin 7 of V112

### NO SOUND—PIX OK

- Tuner fine tuning  
Vol. con.  
Speaker (open voice coil or defective connection)  
Sound and Vid. IF alignment L156, T301  
Det. alignment T302  
V116, V117, V118, V119

### NOISY SOUND—PIX OK

- Vol. con.  
V116, V117, V118, V119  
Check sound system for loose connections  
Speaker  
Sound IF and Det. alignment L156, T301 and T302

### SYNC. BUZZ IN SOUND

- Tuner fine tuning  
Check Vid. Det. xtal Y1  
V116, V117, V118  
Sound IF and Det. alignment L156, T301 and T302

# a new high in VTVM COMPACTNESS



by James P. Connor

**T**HE Precision Model 88 VTVM is a compact unit which, among its many other features, fits conveniently into many tube carriers. This convenience contributes to more effective home servicing of TV receivers. A view of the front panel of the instrument on Fig. 1 reveals many valuable test functions and ranges. These provide the service technician with a powerful and versatile tool in his daily tasks.

### Zero Center Measurements

One of the features of this instrument is a voltage regulated true zero-center range and scale. Fig. 1 above illustrates the zero center scale on the face of the meter and a special zero center function switch which brings the pointer to the middle of the scale for this purpose. Six overlapping ranges from 0- 1.2 V and 1200 V, are provided for this function. Thus, in one operation, both magnitude and polarity measurements may be made with no

reversal of the test prods. This feature is invaluable in tests involving FM discriminator adjustments, bias measurements and "blind tests" where polarity and voltage are unknown factors.

### Peak to Peak Measurements

A special circuit for peak to peak measurement is also provided. This feature on the part of a VTVM in present TV servicing techniques is highly desirable. Notice that a special position [Continued on page 53]

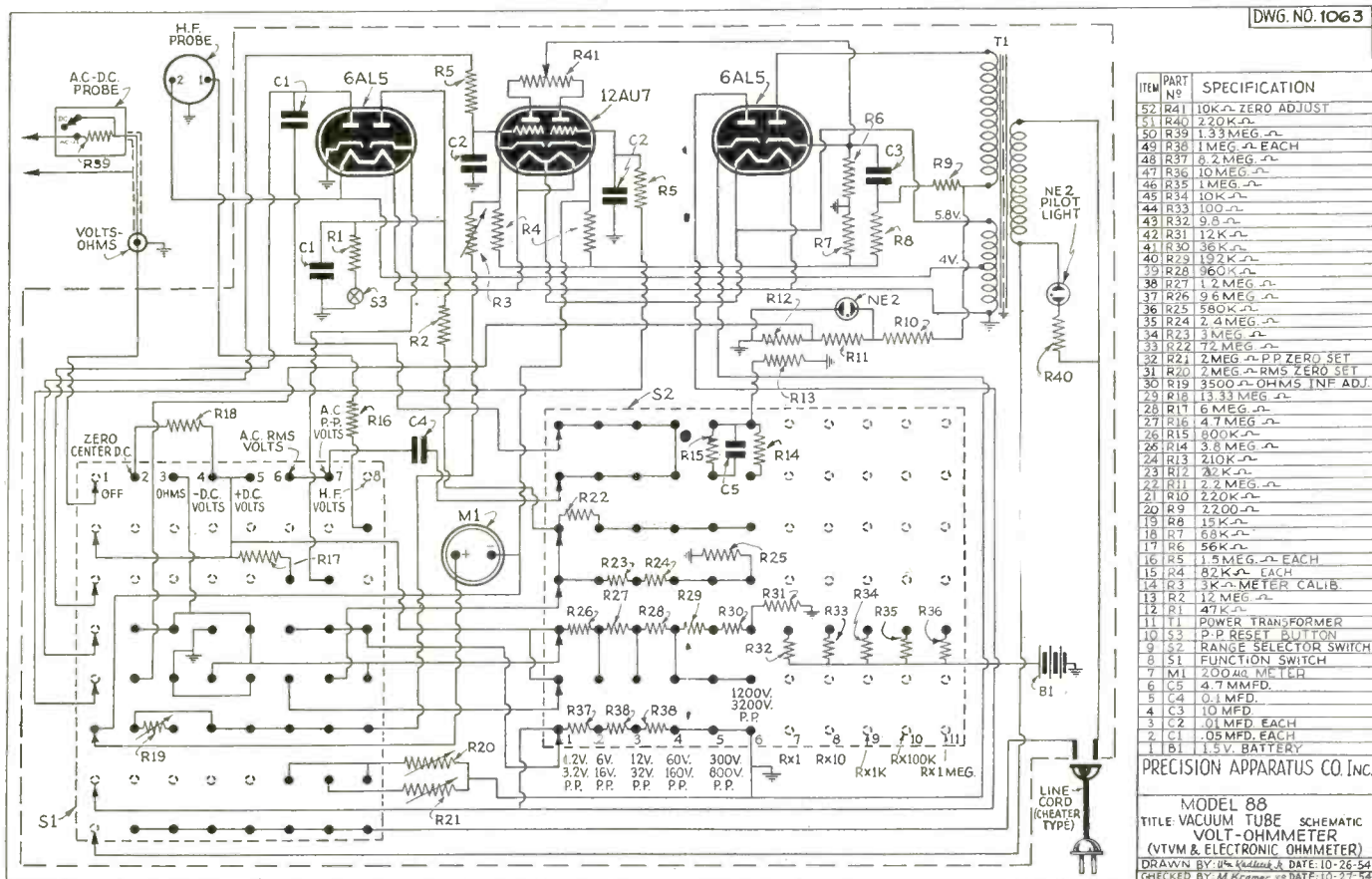
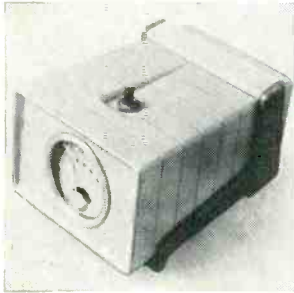

Fig. 3—Circuit diagram of Precision Model 88 VTVM

# NEW

# products

## for better sales and service



### Crown Rotator

The latest addition to the Crown Line of antenna rotators, the CAR-6-B, will be sold as a deluxe unit in addition to their standard CAR-6-A model. Features: low, modern, design, two-tone styling, finger-tip control, constant directional indication, and illuminated dial. For additional information write: Crown Controls Company, Inc., New Bremen, Ohio.



### Du Mont Mobile Radio Tester

Compact and versatile Du Mont test meter for rapid servicing and tuning of two-way mobile radio equipment. This unit, designated as the Du Mont Test Meter Type 5819-A, permits speedy and convenient testing of two-way mobile radio equipment. The meter also may be used in testing base station transmitters and receivers, and any dc equipment within meter ranges. For details, write: Mobile Communications Department, Du Mont Laboratories, Inc., 1500 Main Ave., Clifton, N. J.

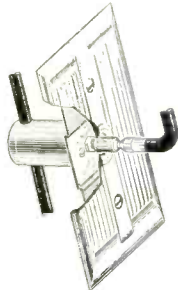

### Blonder-Tongue Tapoffs

Blonder-Tongue Laboratories has added two new spliceless tapoffs to its "Masterline" series of TV distribution equipment. The Model MTO-11 tapoff for Community systems and the Model MTO-59 for indoor use both feature air dielectric insulation to minimize shunt capacitance. They provide uniform 17 db RF isolation, and positive electrical protection thru a spring contact resistor-capacitor network. For info write: Blonder-Tongue Labs, Inc., 526 North Ave., Westfield, N. J.



### EICO Capacitor Substitution Box

The Electronic Instrument Co., Inc., 84 Withers St., Brooklyn 11, N. Y., has produced a capacitor substitution box especially designed to help the technician do a faster and more efficient job in radio-electronic servicing, the new EICO Capacitance Substitution Box enables rapid substitution of a wide range of RETMA capacitance values in an operating circuit to determine the value needed for optimum performance.



### Superex Filta-Coupler

By combining a High Pass interference eliminator with a 2 set coupler in Filta-Coupler, perfect reception for 2 TV sets is assured. This concept provides for 2 set operation from one antenna, and eliminates outside interference from both sets. Another feature is the freedom from inter-set interference. For info, write Superex, 23 Atherton St., Yonkers, N.Y.

### Alliance Lift-A-Door

The Alliance Manufacturing Company has announced a new radio-controlled garage door opener. Genie Model A is the completely automatic, radio-controlled model which opens and closes the door, turns the light on and off, locks and unlocks the door. It is operated from the dash of the car and set with an individual transmitter.

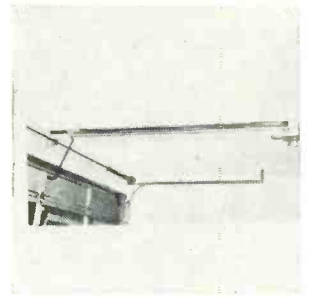

### Trio Array

A new antenna, the TRIO "99" for Channels 2-13, has been announced by the Trio Mfg. Co. of Griggsville, Ill., which uses two dual purpose active elements each consisting of three half waves in phase on the high channels and, at the same time, a single half wave on the low channels. To this is added a combination of three parasitic elements on the low channels and five on the highs, yielding high forward gain and maximum side-rear rejection as a result of more critical element lengths and spacing.

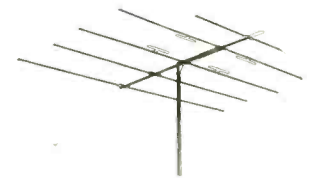

### Beaver Lab's Lubricant

Formulated for the electronic and electro-mechanical industries by Beaver Laboratories, 86-51 Palo Alto Street, Hollis 23, New York, "contact's" super-capillary penetrating action forces it into inaccessible places where it instantly cleans and deposits a coating of "duralube"—a hard-bonded dry lubricant which resists corrosives, heat and cold. "CONTACT" leaves no gummy deposit and does not effect resistance, capacitance or inductance.



### RMS Indoor Antenna

Radio Merchandise Sales, Inc., 2016 Bronxdale Ave., Bronx 62, N. Y., announced the release of their latest indoor TV Antenna Model B-29. Model B-29 features the famous RMS 6 position selector switch. In addition, this latest RMS innovation incorporates an adjustable 3-section telescoping phasing bar. This added feature enables the viewer to "fine tune" his antenna for peak performance.



### Channel Master "Maverick"

Channel Master Corp., Ellenville, N. Y., has announced its "Maverick" antenna line, two complete series of conicals in both preassembled and non-assembled versions. The "Maverick 300" series, comprising 12 different models, is "Super-simplified." There is no hardware to be tightened. Every element merely swings open and automatically locks into position.

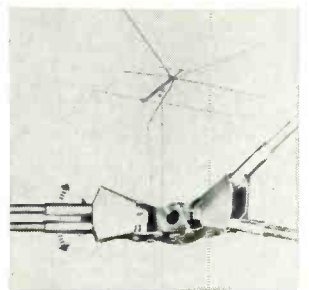



THE FIRST COMPLETE ASSORTMENT OF PHONO DRIVES AND BELTS...

at  
your  
fingertips

**WALSCO**



The new WALSCO Dealer Kit provides an assortment of 23 drives and belts... all packaged in a durable, transparent plastic case. This handy, compact kit with replacements for 85% of today's changers is available for only \$14.97 dealer net.

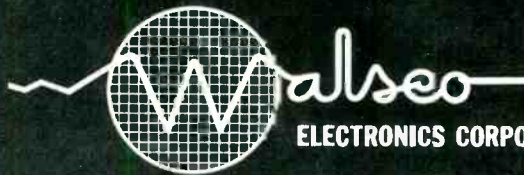

**ELECTRONICS CORPORATION**

3602 Crenshaw Blvd.,  
Los Angeles 16, California

CANADIAN REPRESENTATIVE:  
Atlas Radio Corp. Ltd.,  
50 Wingold Ave., Toronto, Canada

OVERSEAS REPRESENTATIVE:  
Ad Auriema, Inc.,  
89 Broad St., New York 4, N.Y.

For the first time... a brand new idea in buying and selling phono-recorder drives and belts. Now there is *one* source... *one* display for a complete replacement line to service all major record changers and tape recorders. Every jobber will have the new WALSCO display on hand to fulfill, quickly and economically, the service-dealer's replacement needs.

## CIRCUIT ANALYSIS

[from page 38]

tive voltage on the cathode, you will remember has the same effect as a high negative bias on the grid). Thus the stage is made inoperative, which was the desired objective for strong signal areas.

In fringe areas, where the action of this circuit is desired, R89 is turned to the ON position. This closes the switch, decreases the positive cathode voltage and allows R89 to adjust this voltage.

Fig. 3 indicates the waveform of the signal fed to the grid of the noise inverter. As previously mentioned, it is a positive going signal having the same waveform as that of "B" at the output of the sync amplified, since it receives the signal from this stage via C68.

Reference to Fig. 3 indicates that the cutoff voltage is at a fixed level as shown by the dotted line. Adjusting R89 changes the value of the cathode voltage which adds to the signal input, and thus can move this signal above or below the cutoff line. R89 is adjusted to bring the sync tips slightly below cutoff. In practice this is done simply by

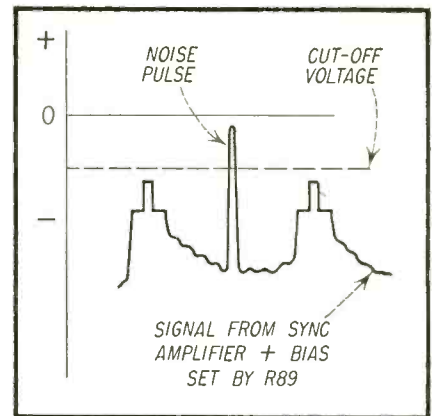

Fig. 3—Signal and bias at input of Noise Inverter

turning the control to the position of best sync stability. It can be seen, then, that only the shaded portion of the noise pulse shown in Fig. 3 will bring the tube out of cutoff. This shaded portion then is amplified and inverted by the tube resulting in a negative going pulse at the output.

[To Be Continued]

# Follow the Leader.

## RMS

Stereoscopic indoor antenna with criss-cross phasing bar . . . 6-position switch. UHF-VHF. K-38 (brass) LIST 9.95 KN-38 (nickel) LIST 10.95



Miniature version of K-38 with 6-position switch and criss-cross phasing bar. UHF-VHF. KV-3 LIST 9.95

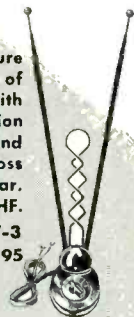

The World's Most Complete Line Of Indoor Antennas

Featuring the NEVATIP Vee-Ball sensations

Same as K-38 without phasing bar and switch. For VHF. SV-A3 (aluminum) LIST 8.95 SV-B3 (brass) LIST 9.95 SV-N3 (nickel) LIST 10.49

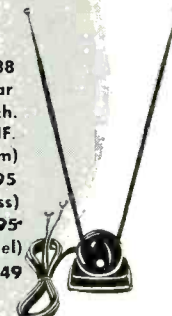

Miniature Vee-Ball antenna . . . perfectly balanced . . . power-packed . . . performance proven. V3-A (aluminum) LIST 7.50 V3-B (brass) LIST 8.50 V3-N (nickel) LIST 8.95



UHF golden loop antenna for maximum performance. KT-34 LIST 4.95



**FREE:** Powerful sales aids; complete RMS catalog on request.

LOOK FOR THE RMS MAN for top quality . . . prestige . . . bigger profits!



## ASSOCIATION NEWS

[from page 24]

bert Kluhsman was elected President for the new year. Other officers are as follows: Vice President, W. Gregg; Secretary, Mrs. Betty Dobbertin; Treasurer, J. Hall; Board of Directors, D. H. Goodearle and Ken Peters.

### Radio TV Association of Kalamazoo, Michigan Inc.

Minimum insurance requirement necessary for the protection of the shop owner as well as his liability to the customer were discussed at the last meeting of RTA of Kalamazoo. These basic coverages are:

1. Car or truck public liability and property damage.
2. Operational liability (state controlled).
3. Liability as regards public.
  - a) Injury while in store or shop (personal)
  - b) While on customers premises: Damage to walls, woodwork, floor covering, etc., covered by Compr. General Liability Policy. Damage to **EQUIPMENT CALLED TO SERVICE NOT COVERED.**
4. Fire insurance on your shop and/or equipment.
  - a) If, for instance, a fire is caused by a piece of your equipment, for example, a soldering iron, you forgot to unplug, and in the resulting fire **YOUR NEIGHBOR'S PROPERTY IS DAMAGED, YOU ARE LIABLE.**
5. Motor cargo coverage, set pickup and delivery, etc.

# Federal

THE SELENIUM RECTIFIER  
WITH THE GREATEST











Manufacturer

Aceptance



When you replace with Federal Selenium Rectifiers you give your radio-TV customers PERFORMANCE that builds *lasting* good will—and PROFITS!

## And HERE'S why— point by point:

-  **LONGER LIFE** ... 5,000 hours life expectancy in approved applications.
-  **HIGHER OUTPUT VOLTAGE** ... 3 to 6½ higher B+ output volts than competitive selenium rectifiers in conventional doubler circuits.
-  **LOWER TEMPERATURE RISE** ... 2° C to 10° C lower average operating temperature than competitive selenium rectifiers.
-  **SUPERIOR HUMIDITY RESISTANCE** ... passes 1,000-hour life test in 95% relative humidity at 40° C.
-  **PROVEN MECHANICAL CONSTRUCTION** ... brass eyelet or aluminum stud construction used exclusively. Patented "dead-center" construction allows stack to be tightened until rigid, without affecting the pressure-sensitive selenium characteristic.
-  **UNDERWRITERS LABORATORY ACCEPTANCE FOR 85° C OPERATION** ... Federal's popular radio-TV types have been tested and accepted by UL for operation at cell temperatures of 85° C.
-  **CONSERVATIVE RATINGS** ... rectifiers offered to the industry are rated only after exhaustive temperature rise and aging tests on minimal grade units to insure full value and satisfaction.
-  **MORE UNIFORM QUALITY** ... Federal rectifiers are automatically 100% tested and inspected to meet standard forward and reverse current specifications, as well as for dielectric strength.
-  **LARGEST PLANT CAPACITY** ... production facilities to satisfy any quantity requirement.
-  **MORE ENGINEERING KNOW-HOW** ... the research and design facilities of the world-wide, American-owned International Telephone and Telegraph Corporation assure continued product leadership.

# Federal



See your Federal Distributor today!

**Federal Telephone and Radio Company**

A Division of INTERNATIONAL TELEPHONE AND TELEGRAPH CORPORATION  
COMPONENTS DIVISION • 100 KINGSLAND ROAD • CLIFTON, N. J.

In Canada: Standard Telephones and Cables Mfg. Co. (Canada) Ltd., Montreal, P. Q.  
Export Distributors: International Standard Electric Corp., 67 Broad St., New York

Dear Answer Man:

I just serviced a Truetone chassis 21T2A in which I found a weak 6BZ7 rf amplifier tube. I replaced this tube but the picture is not what it should be. It gives the impression that the receiver is out of alignment or has insufficient bandpass in the if strip. Since the picture did not have the detail that it should I checked all tubes and voltages and found nothing wrong. The if alignment does not seem to have been disturbed; in fact I used my sweep generator and scope to verify that it was correct. The video amplifier circuits also checked out and the audio is normal.

Do you have any idea what might be at fault?

T.F.  
Washington, D. C.

In checking the schematic for the Truetone chassis 21T2A it was noted that the rf amplifier tube employed is designated as 6BK7. Now, this tube is very similar to the 6BZ7 and 6BQ7 tubes except for interelectrode capacitances. This difference in internal capacitances of rf amplifier tubes can be significant especially for the high channels. The rf amplifier stages are adjusted with the internal capacitances of the tube as an integral part of the tuned circuits. Changing the rf amplifier tube to a 6BZ7 tube, as has been done in this case, will certainly cause difficulties in certain receivers. Manufacturers of TV receivers have emphatically stated that this changing of rf amplifier tubes will not give good results in many cases. Technicians have been getting away with this substitution but it does not permit a receiver that has been aligned for a 6BK7 tube to present the best performance it is capable of.

Dear Answer Man:

I replaced a 24 inch picture tube recently and within a month the new tube failed. I now have to go back and change this tube without being able to collect for this additional labor involved in transporting the tube to the manufacturer, obtaining a new one and reinstalling it in the customer's set. I know the manufacturer will replace the under warranty but why should I have to do this without some recompensation since it has come about through no fault of mine?

W. S.  
Chicago, Ill.

Just about everyone in the service industry is fully aware of the loss that is sustained when this type of failure occurs. However, although it is little help or satisfaction, it might be pointed out that the same loss is borne by the

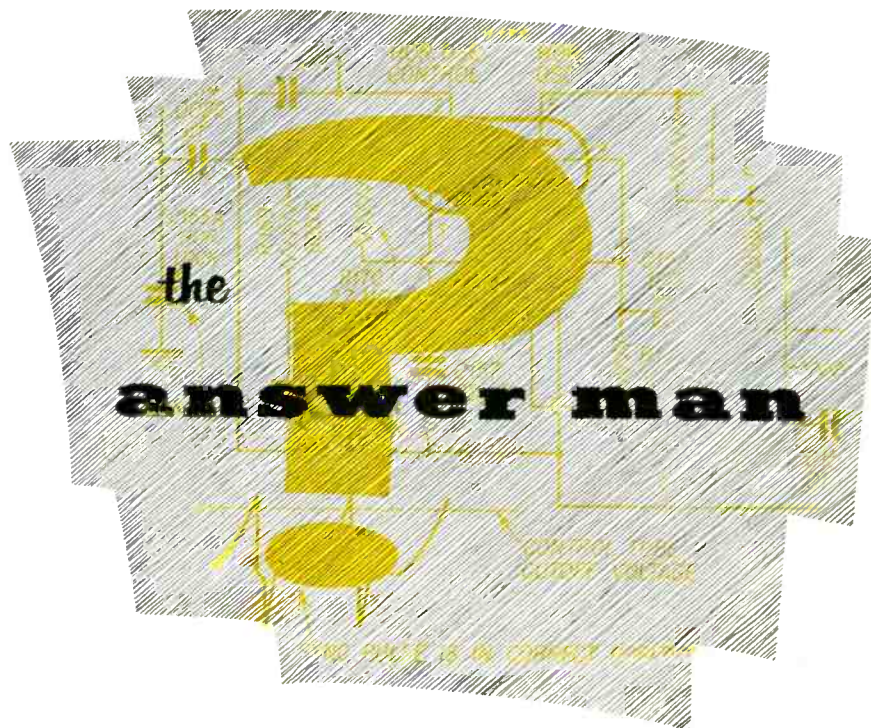

refrigeration service business as well as air conditioning service business where a hermetically sealed unit is replaced only to have the replacement one go bad.

One of the ways a serviceman can help ward off this type of loss is to make sure that his service charges are sufficient to cover his 90 day guarantee period on parts and labor that he usually extends, and should rightfully extend.

Concerning picture tubes there is one point that has been sadly neglected by technicians. This is the adjustment of the ion trap magnetic.

In replacing picture tubes the adjustment of the ion trap magnetic is extremely important. This is particularly true if there is the slightest corner or neck shadow on the picture tube or raster that is not due to the positioning of the yoke. If the ion trap magnet has not been correctly adjusted, the electron beam will impinge upon the electron gun aperture. The bombardment of the aperture will produce gas that is harmful to the picture tube. This is particularly aggravated when the brightness control is turned on full to produce sufficient brightness when the ion trap magnet adjustment is actually at fault. Picture tubes have been permanently damaged in a very short period of time due to this condition.

In the adjustment of the ion trap magnet it should always be set at the point that provides maximum brightness. During the setting the brightness control should *not* be set to the fully clockwise (maximum brightness) position. Sometimes there are two positions where the magnet will produce what

appears to be the maximum illumination. Select the position for the magnet that is nearest to the base of the tube. An important point to be recognized is that the magnet should *not* be repositioned to remove a neck shadow if the brightness is thereby decreased.

Perhaps one of the most important points regarding this is that the adjustment be performed immediately with the turning on of the receiver as it is possible during this period to render the tube worthless.

Dear Answer Man:

I service a number of receivers in an extreme fringe area and the pictures have considerable snow. I was wondering if there is anything that I can do to make the snow less pronounced?

S. R.  
San Diego, Cal.

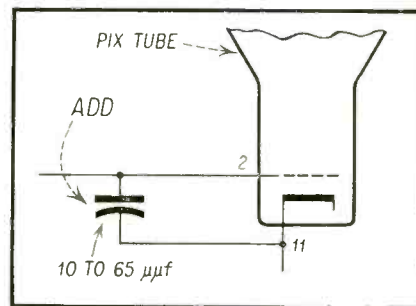

Fig. 1—Snow reduction

In these signal areas where the signal is extremely weak the snow can be reduced by placing a small capacitor, [Continued on page 50]

# More Ranges - More Visibility - More V.O.M.

## the **PRECISION** MODEL **120**



Gives You What You Want in a

### HIGH SENSITIVITY MULTI-RANGE TEST SET

20,000 OHMS PER VOLT D.C.  
5,000 OHMS PER VOLT A.C.

- ◆ **MORE RANGES** — The '120' gives you 44 . . . which start lower and go higher . . . to outrange any professional V.O.M. of similar size or type.
- ◆ **AN EXTRA-LOW RESISTANCE RANGE** — The '120' gives you a 2-ohm center scale range, powered by long-lived, internal 1.5 volt battery source.
- ◆ **AN EXTRA-LOW VOLTAGE RANGE** — The '120' gives you 1.2 volts full scale, A.C. and D.C.
- ◆ **AN EXTENDED LOW CURRENT RANGE** — The '120' gives you a 60 microampere first D.C. current range.
- ◆ **A LARGER AND EASIER READING SCALE FACE** — The '120' gives you a new, extra-large 5¼" meter with full 4¾" extra-wide window.
- ◆ **SIMPLE, POSITIVE RANGE SELECTION** — The '120' gives you an 18-position, positive-detenting, master range selector with low resistance, dependable, silver-plated contacts.
- ◆ **RUGGED, POSITIVE CONTACT JACKS and PLUGS** — The '120' gives you specially designed, low resistance, solid brass, banana type plugs and jacks.

Compare These Wide-Spread Ranges and Special Features:

- ★ **8 DC VOLTAGE RANGES:** 20,000 ohms per volt. 0-1-2-3-12-60-300-600-1200-6000 volts.
- ★ **8 AC VOLTAGE RANGES:** 5,000 ohms per volt. 0-1-2-3-12-60-300-600-1200-6000 volts.
- ★ **8 AC OUTPUT RANGES:** same as AC volt ranges. With built-in 600 volts blocking capacitor.
- ★ **7 DC CURRENT RANGES:** 0-60-300 Microamperes. 0-1-2-12-120-600 Ma. 0-12 Amperes.
- ★ **5 RESISTANCE RANGES:** self-contained batteries. 0-200-2000-200,000 ohms. 0-2-20-megohms.
- ★ **8 DECIBEL RANGES:** from -20 to +77 DB. 0 DB = 1 Milliwatt, 600 ohms.

- ★ **EXTRA LARGE 5¼" RUGGED 'PACE' METER:** 40 microamperes sensitivity, 2% accuracy.
- ★ **1% MULTIPLIERS and SHUNTS:** wire-wound and high stability deposited-film types employed throughout.
- ★ **ONLY 2 PLUG-JACKS SERVE ALL STANDARD RANGES:** separately identified and isolated jacks provide for extra-high ranges.
- ★ **"TRANSIT" SAFETY POSITION:** on master range selector protects meter during transportation and storage.
- ★ **CUSTOM-MOLDED PHENOLIC CASE and PANEL:** set a new standard for compact, efficient, laboratory instrument styling. Deeply engraved panel characters afford maximum legibility throughout the life of the instrument.

MODEL 120: complete with internal ohmmeter batteries, banana-plug test leads and operating manual. Over-all case dimensions: 5 3/8" x 7" x 3 1/8" . . . . . Net Price: \$39.95

### WILL COLOR TELEVISION MAKE PRESENT TEST EQUIPMENT OBSOLETE?

**THE ANSWER IS NO!** It will create even more uses for your PRECISION instruments! Color servicing will merely add one or two special-purpose units . . . which PRECISION will produce when field requirements are clearly defined.  
As for V.O.M.'s — a volt is a volt, an ohm is an ohm and a mil is a mil . . . in color TV, monochrome or plain ordinary radio!



**PRECISION Apparatus Company, Inc.**  
70-31 84th Street, Glendale 27, L. I., N. Y.

EXPORT: 458 BROADWAY, N. Y. 13, N. Y. U. S. A. Cables: Morhanex  
CANADA: Atlas Radio Corp. Ltd., 560 King St. West, Toronto, 2B

# SPECIAL OFFER TO OUR READERS!

By special arrangement with John F. Rider Publisher, Inc., RADIO-TV SERVICE DEALER now brings you a COMPLETE diagram service to help you do a faster, easier servicing job!

**ALL COMPLETE!**

**ALL FACTORY PREPARED!**

**ALL FACTORY AUTHORIZED!**

- ✓ Just \$1.25 for COMPLETE SERVICING INFORMATION on any TV receiver . . . any year, any make, any model . . . from 1946 on!
- ✓ Just 75¢ for COMPLETE SERVICING INFORMATION on any radio . . . any year, any make, any model . . . from 1941 on!

**TAKE ADVANTAGE OF THIS SPECIAL OFFER . . . MAIL THE COUPON TODAY!**

Radio-TV Service Dealer, 67 W. 44 Street, New York 36, N. Y.

Please RUSH me the following diagrams:

RADIO DIAGRAMS @ 75¢ EACH		
CHASSIS #	MAKE	MODEL #

TV DIAGRAMS @ \$1.25 EACH		
CHASSIS #	MAKE	MODEL #

MAKE ALL CHECKS & MONEY ORDERS PAYABLE TO Radio-TV Service Dealer  
(For all New York City orders, please submit additional 3% sales tax.)

Name .....

Address .....

City ..... State .....

## TRADE LITERATURE

(Catalogues)

A completely new type of parts and accessories catalog is currently being offered all Philco dealers and servicemen. It contains current information on all products, including over 24,000 Philco service parts and universal replacement parts, as well as other make electronic and appliance products, has been catalogued by part number for convenience in ordering. Newly developed technical material on standard and special parts based on field experience and laboratory information is incorporated to provide valuable library reference.

The 25-page catalog #55A illustrates and describes the entire RMS line of antennas and accessories. It incorporates list prices with each item shown, groups the entire line into various sections for ease in ordering, and is completely indexed. Conveniently 3-hole punched for ease in inserting into binders, this catalog is available by writing Catalog Division, Radio Merchandise Sales, Inc., 2016 Bronxdale Avenue, New York 62, New York.

A 72-page catalog is offered by Guardian Electric Mfg. Co., covering the company's complete line of basic type relays. Each relay is fully described as to physical and electrical characteristics, also complete operating data and suggested applications are included. A free copy is obtainable by writing to Guardian Electric Mfg. Co., 1621 W. Walnut Street, Chicago 12, Illinois.

Allied Radio Corporation, Chicago, announces the release of a 68-page booklet (#144) which combines an illustrated information section explaining high fidelity, with listings of hi-fi music systems and separate components. Called, This Is High Fidelity, it provides an introduction to high fidelity in the opening pages. Written in non-technical language, it explains the functions of the basic units used in home high-fidelity music systems, and is available without charge from Allied Radio Corporation, 100 N. Western Avenue, Chicago 80, Illinois.

This multicolored catalog, available without charge from South River Metal Products Co., Inc., South River, N. J., illustrates the newly expanded line of antenna mountings and accessories, and illustrates the manner in which the mountings and accessories are used by the service-installation man. It describes in detail the quality construction of each bracket and accessory, and lists the prices, standard packaging, and weight on the page the item appears.

The Cardwell Electronics Productions Corp. catalog 823 on the line of fixed and variable Air Capacitors. This catalog gives mechanical and electrical specifications on all standard models as well as information on "special items" available on your request. For your copy write the Allen D. Cardwell Co Electronics Products Corp., Plainville, Conn.

General Transistor Corp., 95-18 Sutphin Blvd., Jamaica 35, N. Y., has just released their catalog of diffused p-n-p junction transistors, which illustrates General Transistor's double sealing process—(1) encapsulated in plastic and (2) hermetically sealed in a can. It also includes absolute maximum transistor ratings and characteristics.

The Columbia Wire & Supply Co. announces a supplement to their Catalog #104, illustrating Permaline TV transmission line; Permaline Rotor Cables; Permaline Intercom and Telephone wire for outdoor use; a new hook-up wire display; new connectors, cords, cables, etc. For your copy write to Columbia Wire & Supply Company, 2850 Irving Park Road, Chicago 18, Illinois.

# HAVE YOU HEARD WHY THEY'RE PLUGGING THEM IN ?



All  
Sarks Tarzian  
Replacement  
Rectifiers  
plug into  
Conversion  
Chassis CC1.

See your distributor.

Smart  
servicemen are  
making more  
money by  
modernizing  
current TV sets  
with Sarks  
Tarzian Plug-In  
Rectifiers  
and  
conversion  
chassis CC-1

...and  
it's so easy



Dept. B-2, 415 North College Avenue, Bloomington, Indiana

In Canada: 700 Weston Rd., Toronto 9, Tel. Murray 7535

Export: Ad Auriema, Inc., New York City

# it takes BOTH HALVES to do the job

## SERVICE FIRMS

A Service Firm is one that does servicing only—no retailing

Only "Service Dealer" magazine reaches all the owners or managers of the nation's 30,000 service firms.

## SERVICE DEALERS

A Service Dealer is a Retail Firm that operates its own radio-TV service department

Only "Service Dealer" magazine reaches all the owners or managers of the nation's 24,000 Service Dealer firms.

Electronic Parts Distributors' sales volume will exceed \$1,333,000,000 this year. Distributors say that the Nation's 30,000 professional Service Firms will account for 50.1%—or \$667,833,000—and that Service Dealers will account for 38.6%—or \$514,538,000—of that total dollar volume. All others, such as industrials, part-time servicemen, hobbyists, hams, etc., will account for the 11.3%, or \$150,629,000 balance.

You can readily see that the vital bulk of distributors' business is done with professional Service Firms and established Service Dealers. Manufacturers cannot afford to advertise in a magazine that does not reach the executives of BOTH GROUPS. Only one magazine does reach BOTH GROUPS' executives—that magazine is "SERVICE DEALER."

Scan "Service Dealer's" latest audited circulation figures. Compare them with other magazines' latest audited circulation statements. You'll see that our coverage in the Service field is 25,000 greater every month than our nearest competitor's. And our advertising rates are 33% lower.



A copy of "Radio-TV Service Dealer's" latest BPA Circulation Audit Report will be sent upon request.



New...  
Exclusive...  
**Columbia**  
**Permaline**

Eliminates need of replacing transmission lines and rotor cables. Aging tests show useful life of 20 to 50 years in outside use. Na deterioration... resists sunlight... resists far below zero temperatures... extraordinary moisture resistance... resists salt air, acids, smog and abrasion... **STRONG AND TOUGH!**

1 "Columbia" Permaline 300 Ohm Transmission Line



2 In attractive spools or dust-proof sealed packages

3 "Columbia" Permaline Rotor Cables for all Rotors



4 On spools or sealed packages

5 "Columbia" Permaline Intercom and Telephone Wire... will not stretch... high abrasion resistance... for inside or outdoor use.

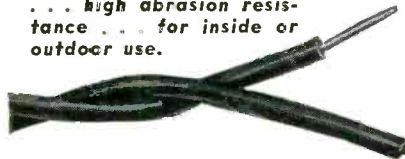

Write for your sample of the Permaline wire which is most suited for your applications.

"Columbia" Wire and Wire Products are sold through recognized distributors.

**Columbia**  
**WIRE & SUPPLY CO.**

2850 Irving Park Road, Chicago 18, Ill.  
"America's Most Complete Wire Line"

## COMPACT VTVM

[from page 41]

of the function switch in combination with a separate set of scale reading provide for these measurements. Due to the time constant characteristics of the peak to peak circuit a special P-P reset button is provided for rapid "Zero" return of the pointer. Six peak to peak ranges, from 0 to 3.2 V and 3200 V ac are provided.

### High Frequency Measurements

Provisions for high frequency (to 300 mc) measurements with an effective input capacitance of 5  $\mu\text{f}$  are available in conjunction with a high frequency probe and socket (Fig. 1). This probe shown in Fig. 2, contains a 9002 tube in a self shielding diode circuit.



Fig. 2—High Frequency Probe used in conjunction with compact VTVM provides measurements with an effective input capacitance of 5  $\mu\text{f}$  at frequencies up to 300 mc, making it an excellent device for RF signal tracing.

It is an invaluable accessory in servicing signal tracing rf or if circuits inasmuch as it converts the Model 88 a high frequency rf voltmeter with the following probe ranges: 0-1.2-6-12-60-300 V rms.

### Other Measurements

Other conventional functions ranges on this instrument are as follows:

DC VTVM: 0 to 1.2 V through to 1200 V in six overlapping ranges.

Ohmmeter: 0-1000 megohms in 5 ranges. Center scale reading of R X 1 scale is 10 ohms.

AC VTVM: 0 to 1.2 V through to 1200 V in six ranges.

### Input Characteristics

The input characteristics of this instrument on the ac rms VTVM ranges are as follows:

Up to 160 V range; 6 megs, 90  $\mu\text{f}$

Up to 800 V range; 1 meg, 70  $\mu\text{f}$

Up to 3200 V range; 4 meg, 67  $\mu\text{f}$

For the peak-to-peak function the input characteristics are as follows:

Up to 160 V range; 6 megs, 90  $\mu\text{f}$

Up to 800 V range; 1 meg, 70  $\mu\text{f}$

[Continued on page 55]

## DOES YOUR TROUBLE-SHOOTING FOR YOU!

### PICTURE BOOK OF TV TROUBLES, VOL. 3 (Video I-F & Video Amplifier Circuits)



Here's the only book ever devoted exclusively to Video I-F and Video Amplifier circuits! Rider's expert lab staff tells you about sixty different troubles found in these circuits—all based on actual trouble-shooting done right in the Rider lab! To describe these troubles, they show you 72 "faulty" picture tube pattern illustrations—and right next to each one, you see the "abnormal" waveforms they got while checking key points... the same waveforms you'd see on your scope screen if you'd done the checking! And here's a very special feature: the last 5 pages of the book form a handy pull-out section that shows you exactly what the RIGHT waveform should look like! It takes just seconds to compare any "abnormal" waveform in the book with its "normal" version shown on this pull-out. There's no theory—no "maybe's"... this series tells and shows you how to diagnose TV receiver troubles by picture and waveform observation—how to do that servicing job faster, better, easier! Order today!

**VOLUME 3** (just published) Video I-F & Video Amplifier Circuits; cat. #168-3; only \$1.80

**VOLUME 2** (Vertical Sweep-Deflection Circuits) cat. #168-2; only \$1.80

**VOLUME 1** (Horizontal AFC-Oscillator Circuits) cat. #168; only \$1.35

## TUBE LOCATIONS PLUS ALL THESE FEATURES:

### TV FIELD SERVICE MANUAL WITH TUBE LOCATIONS, VOLUME 4



A complete TV tube location handbook... plus all these other valuable features: for each model, a table of more than 30 trouble symptoms, showing tubes to check, parts to check, adjustments to make (field and shop) on horizontal oscillators, tuner oscillators, AGC controls, picture tubes! Explanations of 40 most-commonly-found troubles, with picture tube patterns to illustrate each one! Drawings of front and rear preset controls and tuner dial stringing, tube complement, key voltages, series filament wiring. 7 years (starting with 1947) of TV receiver production in each volume! Special bonus: each volume is spiral bound—open the book and it stays open for easier use.

**VOLUME 4** (just published) covers: GE, Hallcrafters, Hoffman; cat. #155-4; only \$2.40

**VOLUME 3** covers: Emerson, Fada; cat. #155-3; only \$2.10

**VOLUME 2** covers: Bendix, Capehart, CBS-Columbia, Crosley, DuMont; cat. #155-2; only \$2.40

**VOLUME 1** covers: Admiral, Affiliated Retailers (Arione), Aimcee (AMC), Air King, Air Marshall, Allied Purchasing, Andrea, Arvin, Automatic; cat. #155; only \$2.10

## COVERS EVERY MOTOROLA AUTO RADIO... 1948-1955!

### RIDER'S SPECIALIZED AUTO RADIO MANUAL, VOLUME 6



Just look at what you get—all in one handy volume: FACTORY-ACCURATE, FACTORY-PREPARED installation and service data on all Motorola auto radios—for any make car or truck produced between 1948 and 1955!

Whether it's servicing a set already installed, or actually installing a new radio in the car—you get all the facts you need to know—straight from the Motorola engineers! Every page shows you exactly what to do. There's no guesswork, no "maybe's." Plenty of big clear diagrams and illustrations to guide you every step of the way! Here are just a few of the handy features you'll find in this practical manual:

Noise suppression; schematics; tube layout; voltages; pushbutton setups; alignment; dial stringing; trimmer location; installation instructions; parts lists; chassis views.

Vol. 6 (Motorola) cat. #5006-A; only \$3.00

**VOLS. 1 TO 5 COVER OVER 12,000,000 FACTORY-INSTALLED AUTO RADIOS!**

(Any new car produced from 1950 to 1954!)

ORDER TODAY! Rider books are sold by parts jobbers and book stores throughout the country. In Canada, all prices approximately 5% higher.

**JOHN F. RIDER PUBLISHER, INC.**  
480 Canal Street, N. Y. 13, N. Y.

the greatest value  
ever offered in a

# Tube Tester . . .

to meet all of today's tube  
testing needs plus tomorrow's  
color television tubes

## Model 327-P

**A** BRAND NEW TESTER that is ideal for the test bench and small and light for easy portability to take on the job. A new approach in the development of a tube tester. Streamlined to meet all of today's requirements for accuracy, speed, compactness yet with more testing performance than other more costly testers. Tests all tubes in all current radio and television receivers, tests all tubes in color TV receivers; will check transmitting, hearing aid, ballast, gaseous rectifiers, and tuning indicator types.

A new approach to tube testing data permits easy and rapid insertion of new information when available. Data is also given on current color TV tubes. It will check CR Picture Tubes both black and white and color by use of CR adapter cable (available at slight additional cost). Black and white picture tubes can readily be reactivated with this tester.



Tests all new series tubes.

In solid oak carrying case with slip-hinge cover. Size 9½" x 11" x 5½". Weight: 9½ lbs. For 105-125 volt, 50-60 cycle operation. \$51.95 Net

Picture Tube adapter cable—Will permit checking and reactivation of all magnetic, deflection types while in the set or carton.

PTA-1 for Blk/Wht Picture Tubes \$3.95 Net

PTA-2 for 3 Gun Color Picture Tubes \$9.95 Net

456 Tube Adapter for use in checking old type 4, 5, 6 pin tubes \$2.85 Net

# RADIO CITY PRODUCTS CO. Inc.

Centre & Glendale Sts.

Easton, Pa.

## The NEW YEATS "Shorty" STATION WAGON & PANEL PICK-UP APPLIANCE DOLLY



Only 47" tall, this new Yeats dolly is designed for TV and appliance men who make deliveries by station wagon or panel delivery. No need to detach appliance for loading . . . the YEATS "Shorty" will slide into your vehicle with ease. Has same aluminum alloy frame, 30 second strap ratchet and caterpillar step glide as the standard size YEATS dolly! See your dealer today!

### YEATS "Everlast" COVERS & PADS



Furniture Pad

Washer Cover

SEND postcard for full information on our complete line TODAY!

**YEATS** appliance  
dolly sales co.

2133 N. 12th St.

Milwaukee 5, Wis.

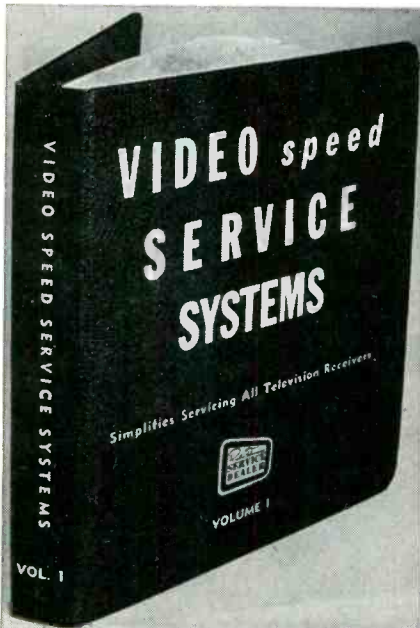

## FOR GREATER PROFITS

### SPEED UP YOUR SERVICING with THIS NEW BOOK

which shows you how to take care of and repair in the quickest possible time:

- Common troubles characteristic of certain receivers
- "Bugs" which might take you hours to find
- Factory and field service changes

SET UP SO THAT YOU CAN MAKE THESE REPAIRS IN THE SHOP OR IN THE FIELD WITHOUT REFERENCE TO ANY OTHER SOURCE.

Contains over 600 Service Items representing over 1000 of the most-serviced Television models now in use. Over 25 different manufacturers' lines are covered.

\$ **4.95** postpaid

(Add 3% Sales Tax in New York City)  
**DISTRIBUTORS—ORDER YOUR SUPPLY NOW!**  
Service Dealers—get your copy of VSSS from your Distributor. If he can't supply you, order direct by mail from us.

Video Speed Servicing Systems IS GUARANTEED to Simplify Servicing All TV sets. A number of new Data Items are published in every issue of "Radio-Television Service Dealer" as a regular monthly feature.

— TEAR OFF AND MAIL NOW —

RADIO-TELEVISION SERVICE DEALER, 67 West 44th Street, New York 36, N. Y.

Please send me post-paid VIDEO SPEED SERVICING SYSTEMS Volume 1. Enclosed herewith is my  check  money order for \$\_\_\_\_\_ for \_\_\_\_\_ copies at \$4.95 each. (Add 3% Sales Tax in New York City)

Name .....

Address .....

City ..... Zone ..... State .....

The  
**ASD**  
Model TV-20F

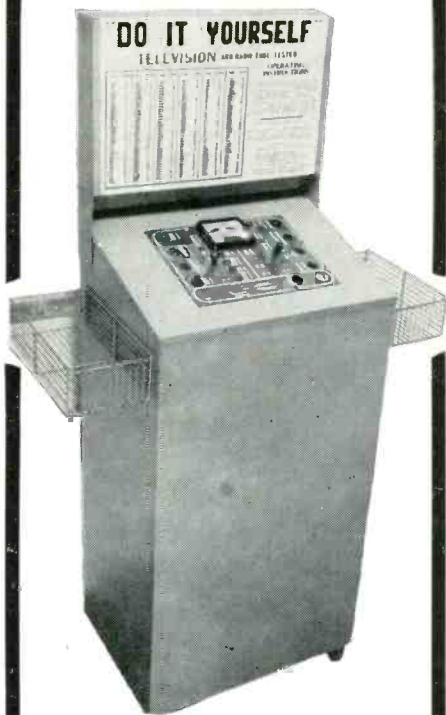

**"SELF SERVICE"**  
TUBE TESTERS

THESE TESTERS ARE SO EASY TO USE THAT ANYONE ABLE TO FOLLOW 3 SIMPLE STEPS IN THE OPERATING INSTRUCTIONS CAN TEST HIS OWN TV TUBES.

This tester, if placed in front of the counter of a service shop, or on the appliance sales floor, will help the service dealer to greatly increase his profit from tube sales. A serviceman's valuable time need no longer be taken up testing paper bags full of TV tubes.

By letting the customer test his own tubes he will not hesitate to buy tubes that read BAD after he set up the load dial HIMSELF.

Model TV-20 F Floor model shown above \$149.50

Model TV-20 FD Floor model with 5 drawers, a door, and cabinet lock \$167.50

Write for details or see your distributor

**AMERICAN SCIENTIFIC DEVELOPMENT CO.**

334-336 S. MAIN ST.  
FT. ATKINSON WISCONSIN

Up to 3200 V range: 4 meg, 67  $\mu$ f  
A circuit diagram of the instrument is shown in Fig. 3.

**PORTABLES**

[from page 14]

powered operation; a very small number use a tube rectifier. The basic advantages of the selenium type supply are instantaneous receiver operation (compared to the short delay while a tube heats up); greater ruggedness; and cooler operation.

A rather unique form of inverse feedback is used in Zenith chassis 4T42 and other portables to improve fidelity. A special winding on the output transformer is inductively coupled to the voice coil, and feeds back an out-of-phase signal to the volume control (see Fig. 6). If the output transformer becomes defective, an identical replace-

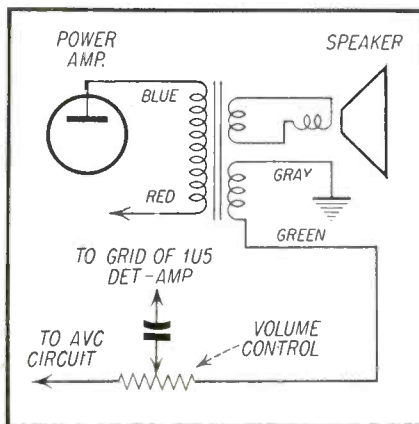

Fig. 6—Inverse feedback winding used on Zenith Ch. 4T42 output transformer.

ment unit becomes necessary. The windings of the replacement output transformer must be connected in the proper polarity (as indicated by the color coding) to avoid regenerative (instead of degenerative) feedback.

Westinghouse and Emerson, among others, are using printed-circuit couplers in the audio section of some of their portable receivers. Service on these sets will probably necessitate the use of a schematic in most cases, to identify the terminals of the different resistors and condensers in the couplers.

If you find worn-out batteries in a portable, remove them. (It is assumed that the customer is using his set on electric operation only, and doesn't want the batteries replaced.) Worn-out batteries tend to swell, and sometimes to leak with resultant damage to the receiver. The batteries should also be removed (or the customer warned to do so) if the set is not going to be used on battery setting for an extended period.

**Snyder**  
PHILADELPHIA

**Auto Antennas**

**WORLD'S MOST COMPLETE LINE**

**40 MODELS+**

**EICO® SAVE 50%—BUILD EICO KITS!**

Sig. Gen. \$19.95

**OVER ONE-HALF MILLION IN USE!**

EICO KITS are top-quality professional TV-radio-electronic test instruments — embody latest performance-proven design. Complete with all components, pre-punched chassis, deep-etched aluminum panel, rugged steel case. Easy-to-build with step-by-step instructions. Lifetime service guarantee.

5" Scope \$44.95

VTVM \$25.95

VOM \$12.90

See EICO's 38 Kits & 42 Wired Instruments in stock at your local jobber. Write for Catalog D6

Prices 5% higher on West Coast.

**EICO** 84 WITHERS STREET, BROOKLYN 11, N. Y.

*It's got the Rotor Industry in a spin!*

**RMS ROTOR QUEEN**

only **1995** list

(all the quality features of high priced rotors... and more)

Liberal trade Discounts

Radio Mdse Sls, Inc. N. Y. 62

**Advertising Index**

Airex Radio Corp. .... 56

American Scientific Development Co. 55

Belden Manufacturing Co. .... 2

Bussmann Manufacturing Co. .... 17

Cadillac Trading ..... 56

Centralab ..... 24

Channel Master Corp. .... 9

Columbia Wire & Supply Co. .... 53

EICO ..... 56

Federal Telephone & Radio Corp. .... 45

Great Eastern Mfg. Co. .... 51

Jensen Industries ..... 56

Merit Coil & Transformer Co. .... 15

Philco Corporation ..... 11

Planet Sales Corporation ..... 51

Precision Apparatus Co., Inc. .... 47

Radiart Corporation ..... Cover 2

Radio City Products Co., Inc. .... 54

Radio Merchandise Sales, Inc. .... 44, 56

Raytheon Manufacturing Co. .... 4, 5

RCA Tube Dept. .... Cover 4

Rider, John F. Publisher. .... 53

Sams, Howard W. & Co. .... 19

Sarkes Tarzian, Inc. .... 49

Simpson Electric Co. .... 7

Snyder Manufacturing Co. .... 55, Cover 2

Tele-Scopic Products, Inc. .... 51

Tung-Sol Electric, Inc. .... 1

Vaco Products Co. .... 50

Walsco Electronics Corporation. .... 43

Yeats Appliance Dolly Sales Co. .... 54

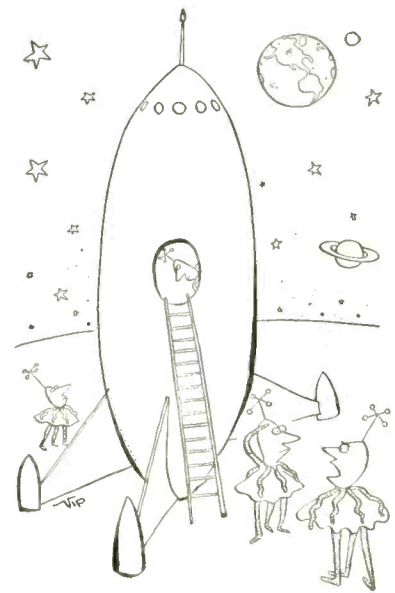

*"Your mission is to bring back JENSEN NEEDLES no matter what."*

**TUBES**  
**70% to 90% DISCOUNT**

Government, manufacturers, jobbers, etc. surplus. Guaranteed 1 year. Free catalog on request.

**CADILLAC TRADING**  
Dept. AB, 231-07 Linden Blvd., Jamaica 11, N.Y.

**Webster (Latest)**

#140 with Ronette cartridge & 2 sapphire styl. Intermix & automatic shut-off feature **\$22.87**

#1121 with GE RPX 050 cartridge & heavy duty 4 pole motor. **\$26.73**

No C.O.D.'s. Send card to be put on mailing list

**Airex Radio Corp.** Box SD, 171 Washington St., New York 7, N. Y.

**MOVING?**

Please Mail Us Your Change of Address Today

Also include old address and code line, if possible. Thanks.

**RADIO-TELEVISION SERVICE DEALER**  
67 West 44 St., New York 36, N. Y.

# SELL THE HUGE DO-IT-YOURSELF MARKET

WITH  
**Snyder**  
PHILADELPHIA

**Directronic**<sup>®</sup>  
**TV 'TENNA KITS**



# SNYDER

SNYDER MFG. CO., PHILADELPHIA 40, U. S. A.  
BELLEVUE TUBE MILL, INC., PHILADELPHIA  
SNYDER ANTENN-GINEERS, LTD., TORONTO 14, CANADA  
WORLD EXPORT: ROBURN AGENCIES, INC., N. Y.  
VAN DER HOUT ASSOC., LTD., TORONTO 14, CANADA

**"DO IT YOURSELF"**

**24.75**

**Snyder**  
PHILADELPHIA  
Directronic

VHF **TV** UHF  
**'TENNA KIT**

*Featuring....*

- 6-POSITION BEAM SELECTOR
- 12 ALUMINUM ELEMENTS
- HI-PAQ BAKELITE INSULATION
- 2 MAST SECTIONS
- GUY WIRE
- TRI-X CABLE
- ROOF MOUNT
- HARDWARE AND ACCESSORIES

**NO** ~~X~~ MOTORS OR MOVING PARTS

**NO** ~~X~~ ELECTRIC POWER

**NO** ~~X~~ ROOF ORIENTATION

**NO** ~~X~~ GHOSTS

**COMPLETE NOTHING ELSE TO BUY**

**K-80**

**DO IT YOURSELF TV TENNA KIT K-80**

# Battery Business is REPEAT Business!

... if YOU keep repeating, "Does your Portable need new Batteries?"



Every time you ring up a sale for anything, always ask that question. Every time you make a service call, always ask that question. You'll be surprised at the battery business that's yours for the "asking."

There are over 15 million portables in this country, and whether they're in use or on the shelf, the batteries run down. Here's a big market full of repeat business potential. Here's a growing market to which you can sell fresh, full-powered RCA Batteries time and time again during the course of a season.

You can depend on RCA Batteries to give your customers the kind of product performance that keeps them coming back for repeat business throughout the year. RCA Batteries are radio-engineered for extra listening hours . . . manufactured to the highest performance standards of the greatest name in radio.

Your RCA Distributor is ready now to supply you with fast-moving RCA Radio Batteries for every leading portable radio. Stock-up now. Then use RCA's potent selling aids . . . mention batteries during every sale and service call . . . and you'll be in this business of selling batteries—RCA Batteries—in a big way, profitably.

**FREE!** "This Business of Selling Batteries." It's loaded with hot selling tips and promotional ideas. Ask your distributor or write RCA Commercial Engineering, Section E42N, Harrison, N. J.



**RADIO CORPORATION of AMERICA**  
**RADIO BATTERIES**

**HARRISON, N. J.**