

APRIL, 1952

Radio-Television SERVICE DEALER



The Professional Radio-TVman's Magazine

IN THIS ISSUE:

- New TV Circuits
- Using The Oscilloscope, Part I
- V-H-F Antennas
- Video Detectors
- Cost Considerations In Customer Service

21 OCT 52-50H-160
 MR HARRISON CRAIG JR
 WISCONSIN SHULLSBURG

AM-FM-TV-SOUND

TAKE IT FROM AN EXPERT



H. L. DALIS, INC.
New York

For 18 Years It Has **Paid** to be

a **Snyder** PHILADELPHIA **DISTRIBUTOR**

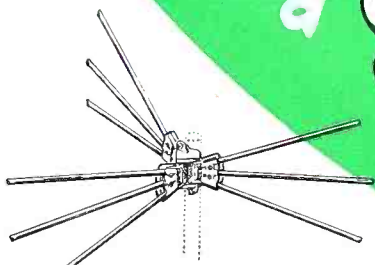

Directronic



YAGI

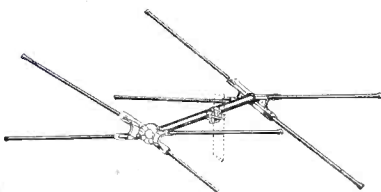

CONICAL

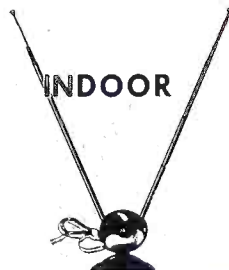

INDOOR



AUTO

BECAUSE SNYDER GIVES

- complete line TV and AUTO aerials
- products with a "Market Edge"
- new products first
- advanced engineering
- consistent advertising
- participation promotion planning
- proper pricing
- fair merchandising
- 21 years of know-how

SNYDER MFG. CO.

PHILADELPHIA

H. L. DALIS, INC., 175 VARICK ST.—METROPOLITAN NEW YORK DISTRIBUTOR

the PERMO Line

MADE TO ORDER FOR THE COMPONENT PARTS TRADE



Developed Scientifically

Engineered Specifically

Made Precisely

Priced Competitively

Packaged Practically

Simple Inventory Control

Installation Tools, Accessories and Instructions Supplied

Complete Service Data

National Distribution

The Permo Line gives you everything you need to make needle replacements fast, easy and profitable. You get (1) Handy and accurate service data, (2) Individual needle packages complete with (3) Installation tools and accessories with instructions, and (4) Stock-display and re-order case. See your jobber for fast-moving assortments or individual needles.

PERMO, INC.

6415 Ravenswood, Chicago 26, Illinois

MANUFACTURERS OF 'FIDELITONE', 'PERMO-POINT' AND 'PERMO' PRODUCTS
 LONG-LIFE PHONOGRAPH NEEDLES • RECORDING TAPE AND WIRE • RECORD BRUSHES

PRECISION CR-30 CATHODE RAY TUBE TESTER

TESTS ALL TV PICTURE TUBES

(MAGNETIC AND ELECTROSTATIC)

'SCOPE TUBES AND INDUSTRIAL CR TYPES

for True Beam Current (Proportionate Picture Brightness)
Tests ALL CR Tube Elements—Not Just a Limited Few

IN FIELD OR SHOP

Tests CR Picture Tubes
Without Removal from
TV Set or Carton!

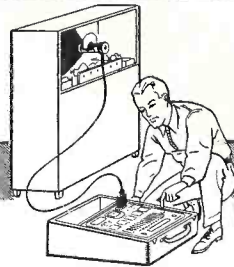
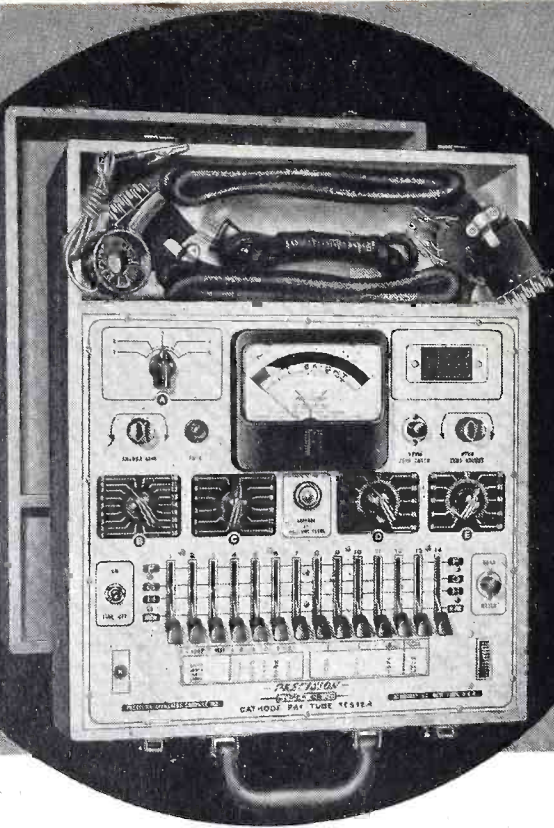

The Precision CR-30 fills an obvious gap in the test equipment facilities employed by TV service and installation technicians.

Because of the absence of a reliable cathode ray tube tester, up to 50% of so-called "rejected tubes" are found to be fully serviceable and should rightfully never have been "pulled out."

Proven product of extended development, the CR-30 has been

specifically engineered to answer the question, "Is It the TV Set or is it the Picture Tube?"

The Precision CR-30, a complete and self-contained *Electronic Instrument*, incorporates a TRUE BEAM CURRENT Test Circuit. The CR-30 checks overall electron-gun performance for proportionate picture brightness as well as additional direct testing facilities for accelerating anodes and deflection plate elements.

The Precision CR-30 should not be confused with mere adapters connecting to ordinary receiving tube testers which were never designed to meet the very specialized needs of CR tube checking. Similarly, it is not to be confused with neon-lamp units or similar devices of limited technical merit and which do not check all CR tubes or all tube elements.

GENERAL AND TECHNICAL SPECIFICATIONS

- ★ Tests All Modern Cathode Ray Tubes:—Magnetic and Electrostatic, 'Scope Tubes and Industrial Types.
- ★ Tests All CR Tube Elements:—Not just a limited few.
- ★ Absolute Free-Point 14 Lever Element Selection System, independent of multiple base pin and floating element terminations, for Short-Check, Leakage Testing and Quality Tests. Affords maximum anti-obsolescence insurance.
- ★ True Beam Current Test Circuit checks all CR Tubes with Electron-gun in operation. It is the Electron Beam (and NOT total cathode emission) which traces the pictures or pattern on the face of the CR tube.
- ★ Voltage Regulated, Bridge Type VTVM provides the heart of the super-sensitive tube quality test circuit. Such high sensitivity is also required for positive check of very low current anodes and deflection plates.
- ★ Micro-Line Voltage Adjustment
Meter-monitored at filament supply.
- ★ Accuracy of test circuits closely maintained by use of factory adjusted internal calibrating controls; plastic insulated, telephone type cabled wiring; highest quality, conservatively rated components.
- ★ Built In, High Speed, Roller Tube Chart.
- ★ Test Circuits Transformer Isolated from Power Line.
- ★ 4 1/4" Full Vision Meter with scale-plate especially designed for CR tube testing requirements.
- ★ Heavy Gauge Aluminum Panel etched and anodized.
- ★ PLUS many other "PRECISION" details and features.

Total cathode emission can be very high and yet Beam Current (and picture brightness) unacceptably low. The CR-30 will reject such tubes because it is a true Beam Current tester. Conversely, total cathode emission can be low and yet Beam Current (and picture brightness) perfectly acceptable. The CR-30 will properly pass such tubes because it is a true Beam Current tester. The significance of the above rests in the fact that Beam Current (and picture brightness) is primarily associated with the condition of the center of the cathode surface and not the overall cathode area. (See illustration below)

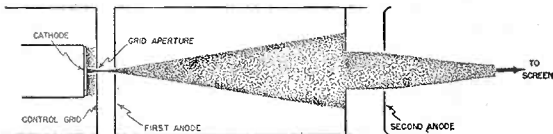

SERIES CR-30—In hardwood, tapered portable case, with hinged removable cover. Extra-Wide Tool and Test Cable Compartment. Overall Dimensions 17 1/4" x 13 3/4" x 6 3/4". Complete with standard picture tube cable, universal CR Tube Test Cable and detailed Instruction Manual.

Shipping Weight:—22 lbs. Code: Daisy
NET PRICE:—\$99.75

See the CR-30 on display at leading electronic equipment distributors. Order now to assure earliest possible delivery.



PRECISION APPARATUS CO., INC.

92-27 Horace Harding Boulevard, Elmhurst 8, New York

Export Division: 458 Broadway, New York, U.S.A. Cables—Morhanex
In Canada: Atlas Radio Corp., Ltd., Toronto, Ontario

EDITORIAL

by S. R. COWAN

S-D's Birthday Statistics

This issue finds "SERVICE DEALER" entering its 13th year of endeavor. The record shows that our last issue carried the largest dollar volume of advertising, and that this issue has more paid subscribers (over 30,000) than any issue published heretofore. To both groups, advertisers and subscribers alike, our staff is grateful and thanks you for your continued patronage and support.

In retrospect: 12 years ago the service-replacement business approximated \$40 million annually; \$20 million being the value of components bought and \$20 million the profession's income for services rendered. Less than 22 thousand men were engaged in service work and many were glad to earn as much as \$25 a week for 70 hours of labor. Today the 55 thousand technicians engaged solely in radio-TV service work, and not including those servicers of industrial electronics or commercial sound systems installations, buy over \$375 million worth of replacement tubes, parts, accessories and test equipment and earn for themselves close to \$70 million annually.

Slowly but surely independent servicemen and service dealers are learning how to command and get fair prices for their services. Their income and the earnings of employed technicians is reaching sounder levels. Much still must be done in this regard. Frankly, by present-day inflationary standards the service profession's earnings should be over \$100 million a year instead of \$70 million. As publishers and educators we still deem it our basic goal to teach the nation's technicians how to do their work more efficiently, in less time and at greater profit. Dedicated to that objective—higher living and public acceptance standards for our profession—we now begin another year.

Our New Free Service To Subscribers

Effective with this issue we provide our subscribers with a unique, exclusive and valuable service which is explained in detail on page—of this issue. Now, thanks to our arrangement with United Catalog Publishers, Inc., publisher of "Radio's Master" we will make available FREE every month to all "SERVICE DEALER" subscribers who request it a complete section of manufacturers' literature on various electronics components or equipments. Said 64 to 86 page co-ordinated catalog compilations are actually the ones that all Parts Distributors use as their sales guides.

Although by giving you subscribers free catalogs (one month on sound and P.A. equipment, the next month on tubes, the next on transformers or condensers, etc.), we will spend tens of thousands of dollars annually, we deem the expense justified because we feel that all service benches

[Continued on page 48]

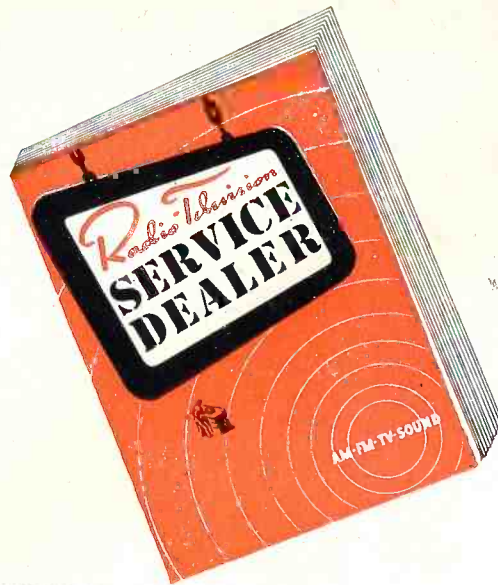

Sanford R. Cowan
EDITOR & PUBLISHER

Samuel L. Marshall
MANAGING EDITOR

COWAN PUBLISHING CORP.
67 WEST 44TH ST.
NEW YORK 36, N. Y.



VOL. 13, NO. 4

APRIL, 1952

Editorial	3
Trade Flashes	4
Sync Pulses, by <i>San D'Arcy</i>	12
New TV Circuits, by <i>Daniel Lerner</i>	17
New circuits employed in TV receivers; their theory and operation.	
Using the Oscilloscope, Part 2, by <i>Allan Lytel</i>	20
Concluding installment deals with the use of the scope together with a sweep generator.	
V-H-F Antennas, by <i>Douglas H. Carpenter</i>	23
A timely and well rounded discussion of TV antennas; their operation and applications.	
Video Detectors, by <i>Leonard Lieberman</i>	25
Basic theory and operation of modern video detectors.	
Cost Considerations In Custom Installations, by <i>C. A. Tutthill</i>	30
Overall picture of how much you can expect from installations of various types and their relative costs.	
Association News	32
Trade Literature	33
Personnel Notes	34
Shop Notes	35
Admiral-21B1 Series: Reducing picture Smear. Spotting Focus Trouble. Repairing G.E. Vibrators. Silvertone—132-841: Intermittent.	
Circuit Court	36
Rembrandt—Model 721: D-C Restorer, A.G.C., and Sync Take-Off analysis.	
New Products	38
Circuits:	
Philco—1952 tuner	17
Philco—1952 Horizontal frequency control system	19
Philco—1952 Horizontal output circuit	19
Philco—Automatic brilliance and width control	19
Magnavox—Model 214—partial schematic of detector	27
Magnavox—Model 247—partial schematic of detector	27
Push-pull amplifier—Miller type	30
Rembrandt—Model 721—d-c restorer, a.g.c. sync take-off	36

SANFORD L. CAHN, Advertising Director HARRY N. REIZES, Advertising Manager
DAVID SALTMAN, Production Mgr. CHARLES LO CICERO, Circulation Mgr.

TED E. SCHELL, 112 West 9th St., Los Angeles 15, Calif., VANDIKE 8921

RADIO-TELEVISION SERVICE DEALER is published Monthly by Cowan Pub. Corp., 67 West 44th St., New York 36, N. Y. Subscription price: \$2 per year in the United States, U.S. Poss. & Canada: elsewhere \$3. Single Copies: 25c. Reentered as second class matter Sept. 25, 1960 at the Post Office at New York, N. Y. under the Act of Mar. 3, 1879. Copyright 1952, Cowan Pub. Corp.

PHOTOFACT Users Write Our Best ADS!

Hundreds of unsolicited letters tell what the world's finest Radio & TV Data means to Service Technicians



Mac Kellman
306 Garfield Place
Brooklyn 15, N. Y.

"Just as a technician can't do without a V.O.M., he can't do without PHOTOFACTS! In our shop—as well as thousands of TV service organizations—we pride ourselves on having the first to the latest sets of PHOTOFACT. SAMS has helped us out of many TV and radio headaches with its simple, precise layouts, schematics, alignment data and parts replacements."



Douglas G. Thompson
224 E. Woodrow St.
Tulsa, Okla.

"PHOTOFACTS are the best of all schematics. I get them all as soon as they are published."



Reuben C. McClenon
1628 N. Rockeblave St.
New Orleans, La.

"I never fail to get PHOTOFACTS, as they make servicing very easy. Keep up the good work."

NOW! GET THE PROOF FOR YOURSELF!

FREE We'll send you a Free Photofact Folder on any receiver listed in "PF Index & Technical Digest."

Learn for yourself—at our expense—how PHOTOFACT pays for itself by earning bigger repair profits for you! Select any Folder from the PF Index (if you haven't an Index, get a free copy from your distributor). When you write us for your Free Folder, be sure to state Photofact Set and Folder Number as shown in the Index. Get your Free Folder now. Examine, use, compare—see why you can't afford to be without PHOTOFACT!

HOWARD W. SAMS & CO., INC.
2201 East 46th Street • Indianapolis 5, Indiana

TRADE FLASHES

A "press-time" digest of production, distribution, and merchandizing activities

RTMA Appoints Award Committee

Chairman Robert C. Sprague of the board of directors of the Radio-Television Manufacturers Association has named an Annual Awards Committee for the Association with Treasurer Leslie F. Muter as chairman.

In carrying out provisions of a resolution passed by the RTMA board of directors, Mr. Sprague named a 10-man committee to make an award annually to the "person, group, or company which in the opinion of authorized judges has performed outstanding services for the advancement of the radio-television industry."

Larger Pix Tubes Used

Ninety-eight percent of the television picture tubes sold to set manufacturers in January were rectangular in form and 16 inches and larger in size, the Radio-Television Manufacturers Association reported. These same tube types represented 74 percent of sales to manufacturers in the corresponding month of 1951.

January TV picture tube sales totaled 340,192 units valued at \$7,691,858.38 compared with 580,317 units valued at \$16,272,654 in the same 1951 month and 371,751 units valued at \$8,213,251 in December of last year.

Tubes 16 and 17 inches in size accounted for 51 percent of the sales to manufacturers in January and tubes 18 inches and larger represented 47 percent.

5,000,000 TV Sets Shipped in 1951

Over five million television sets were shipped to dealers during 1951, the Radio-Television Manufacturers Association reported. The 5,095,563 sets shipped during 1951 compares with 7,068,000 sets shipped in 1950.

For the month of December, shipments to dealers totaled 680,141 television sets, the RTMA report showed. In November 409,681 units were shipped and in December 1950 the figure was 691,000.

January Tube Sales Less Than Year Ago

Sales of receiving tubes in January decreased substantially under sales in the corresponding month of 1951, the Radio-Television Manufacturers Association reported. Sales in January

totaled 26,736,695 units valued at \$18,895,527.20. This compares with sales of 37,042,303 receiving tubes in the same 1951 month.

Sylvania Announces 1952 Promotion of Public-Servicemen Good will

Sylvania will continue and expand its national promotion of TV-radio servicemen during 1952, according to announcement by Terry P. Cunningham, director of advertising for Sylvania, and originator of the industry's first million-dollar campaign to promote the interest of TV-radio servicemen.

"This year," Cunningham said, "Sylvania will use Life, Collier's, the Saturday Evening Post and Better Homes & Gardens, to carry messages from Jane Russell, Ann Blyth, June Havoc, Laraine Day and Leo Durocher to the public. These celebrities will testify that the TV-radio serviceman displaying the Sylvania seal does a good job. They will also tell the public how to select a reliable serviceman.

"Supplementing these attention-getting messages," Cunningham continued, "Bill Shipley, crack CBS-TV announcer, will dramatize the importance of TV service with an actual TV set chassis. Bill will be a part of Sylvania's popular 'Beat the Clock' TV program that features Bud Collyer and Roxanne every week over 34 CBS-TV stations."

Describing Bill Shipley's TV program presentations, Cunningham explained that he will stress the fact that TV repair requires a specialist; that he must study constantly to keep up with ever-changing TV circuit design in more than 1000 set models; that he must maintain a stock of more than 600 different types of tubes and parts; that he must purchase expensive test and repair equipment; and that he must be familiar with at least 300 possible trouble sources.

Rolls of serviceman's stickers and a 60-page brochure suggesting local spot radio and TV announcements are also included in Sylvania's service dealer's kit that is supplied direct from the advertising department, Sylvania Electric Products Inc., Emporium, Pennsylvania. Charges for kits

ACCEPTED



by servicemen and electronics experts . . .

as the **GREATEST** Improvement in Vibrators in 17 Years

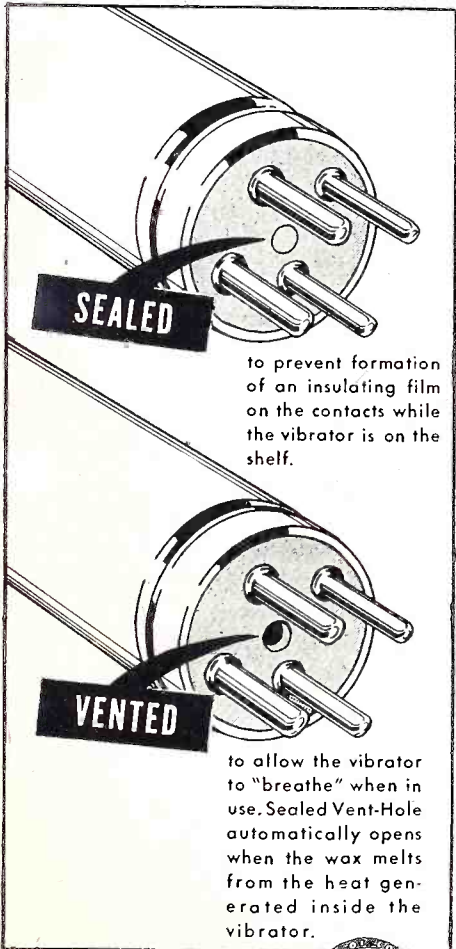

STANDARD OF COMPARISON

RADIART

Seal-Vent

RED SEAL VIBRATORS

Experts everywhere agree that this is the greatest advancement in vibrator design in the last 17 years! That's because NOW . . . with the RADIART SEAL VENT . . . the vibrator is sealed BEFORE it is used . . . and VENTED after it is put into use! The RED SEAL rubber-faced bakelite plug prevents formation of an insulating film on the contacts. Heat generated when the vibrator is put into service melts the wax out of the sealed vent-hole and permits air circulation . . . FOR LONGER LIFE AND EVEN GREATER PERFORMANCE! Give your customers the best . . . give them RADIART . . . the STANDARD OF COMPARISON.

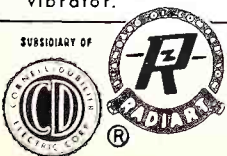

THE **RADIART** CORPORATION CLEVELAND 13, OHIO

VIBRATORS • AUTO AERIALS • TV ANTENNAS • ROTATORS • POWER SUPPLIES

SERVICEMAN'S DIARY... by Ben Grim

MY HUSBAND TOOK THE SET APART LAST NIGHT, TO MAKE THINGS EASY FOR YOU. HE SAYS THE TROUBLE ISN'T SERIOUS AND YOU CAN FIX IT IN A FEW MINUTES WITH THE RIGHT TOOLS.

IF YOU ASK ME, EVEN A MAGICIAN COULDN'T FIX THAT SET IN LESS THAN A WEEK NOW THAT HER OLD MAN WORKED ON IT!

IT TOLD HER HUSBAND I THOUGHT THE ONLY TROUBLE WAS THAT THE BABY HAD PULLED THE AERIAL WIRE LOOSE BUT HE WOULDN'T LISTEN TO ME.

CENTRAL
RADIO-TV
SERVICE

HEAVEN SAVE US FROM SCREWDRIVER MECHANICS WHO TRY TO FIX THEIR OWN TVS!

AMERICA'S NO. 1 CAPACITOR FAVORITE

Over 200 million Sprague Black Beauty Telecap molded paper tubular capacitors in use today tell their own story of unsurpassed quality! And they cost no more!

These sturdy molded tubulars are the only capacitors in radio-television parts history that have been imitated but *not* duplicated. Only Sprague Telecaps are made by the exclusive *dry* assembly process... and that's why they're unmatched for dependable performance!



TELECAP® MOLDED TUBULARS

Sprague's Famous
"Black Beauties"



SPRAGUE PRODUCTS COMPANY
(Distributors' Division of Sprague Electric Co.)
71 Marshall Street
North Adams, Massachusetts

are limited to two cents each for mailing pieces ordered, all display material being furnished free by Sylvania.

RCA Service Mgrs. Honored

Frank M. Folsom (third from left), president of the Radio Corporation of America, presents special "President's Cup" trophies to managers of four RCA Service Co. television service branches. Awards were made in recognition of the branches' achievements



in "serving the community" during a three-month contest just concluded. Looking on, at extreme right, is E. C. Cahill, president of the RCA Service Co. Displaying their trophies are branch managers (from left to right) R. E. Hartleb, Oklahoma City; J. T. McAllister, Hollywood; R. F. Adams, Dallas; and J. W. Van Cleve, Columbus. The winning branches were selected on the basis of their customer relations achievements and general excellence in the quality and efficiency of television installation and service work.

LaPointe Plascomold Expands

Two major steps in the long-range expansion program of the LaPointe Plascomold Corporation have now been completed, it was announced by Jerome E. Respass, Vee-D-X President. The first was the recent acquisition of Press Wireless Manufacturing Co., Inc. of Hicksville, Long Island. This concern is well-known throughout the World for electronic and communication equipment. The second was the purchase of the Springville Mill in Rockville, Conn., a large four-story brick building with 156,000 square feet of production space. This new plant is about 15 miles from the Windsor Locks home of Vee-D-X and will be used to house Press Wireless which is now in the process of being moved from Hicksville.

Along with the Press Wireless facilities, many new electronic products have been acquired including radio, telegraph and telephone transmitting equipment, radio-photo receiving equipment, frequency shift and associated terminal equipment such as

For YOU, the Local Radio Dealer and Serviceman . . .

We're beating a path to your door

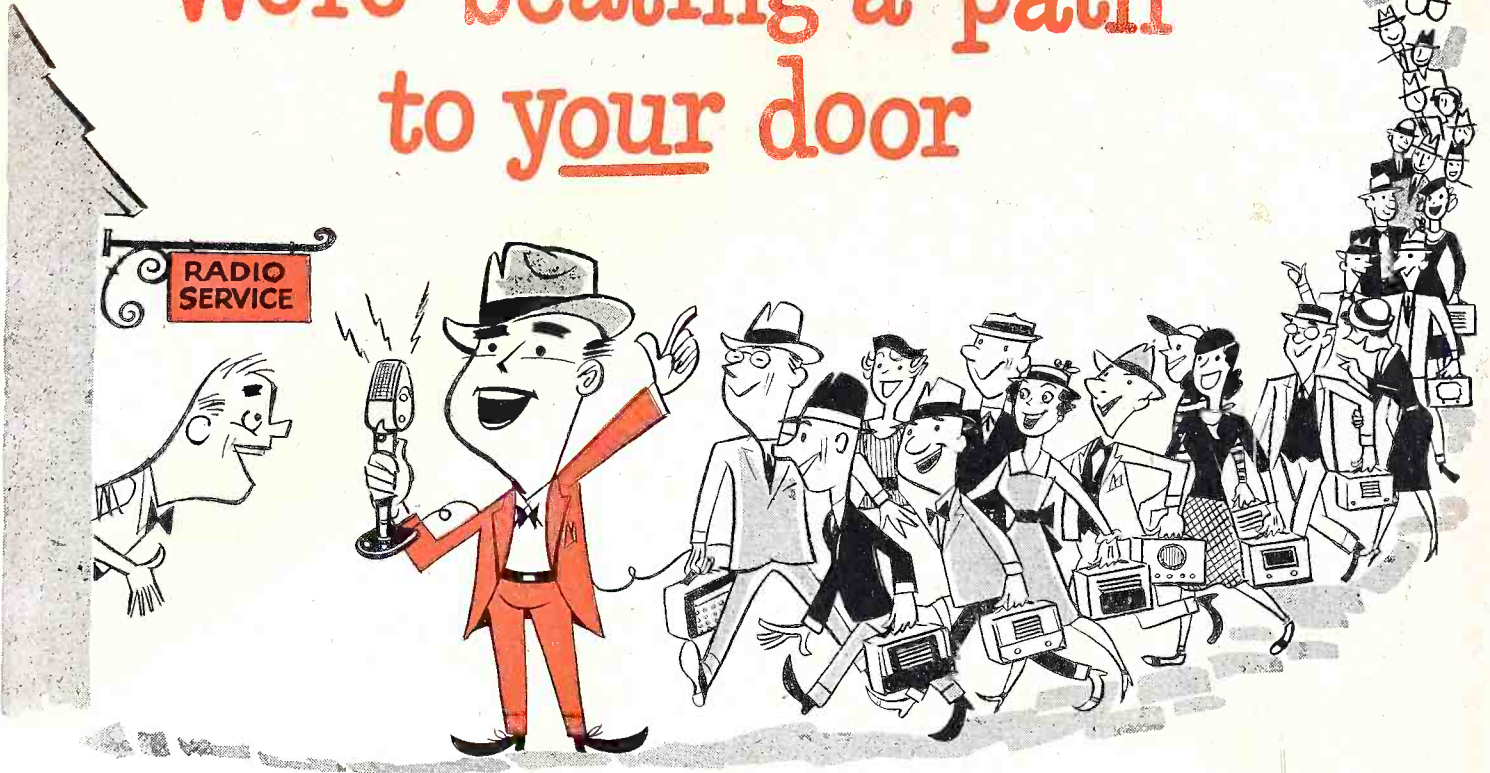

HOW? By telling millions of radio listeners and television viewers that *you, the local Radio dealer-serviceman . . .* are best qualified to sell and install RCA Radio Batteries. The RCA Battery message, beamed out on our big national

network radio and TV programs, is building BIG RCA Battery demand for you. Portable radio owners everywhere will be *beating a path to your door*. Be ready for them . . . stock, promote, and sell RCA Radio Batteries.



Here are 3 more ways we are helping you

1. We help you advertise on the RCA Battery carton itself. A printed message on the carton of each volume-type RCA Battery

tells the owner of a portable radio to come to you, his radio dealer, when it's time to buy replacements. And right on the batteries there's a space where you can stamp your own name and address to pull repeat business back to you.

2. We channel our principal battery distribution to YOU as a radio dealer and serviceman. And because radio outlets are the primary source for RCA Batteries, you get profitable repeat business from portable-radio owners in your community.

3. We will continue to provide fast, reliable battery service backed by a nation-wide warehousing and

distribution organization geared to the needs of the radio trade.

Now! Get ready to fill the sizzling demand for RCA Batteries . . .

They're *competitively priced* for fast, easy sales. They're *geared to your Radio trade*. And your personal stamp on the batteries you sell directs new customers and old friends *to your door*. So call your RCA Battery Distributor . . . get lined up for this profitable big volume business . . . **RIGHT NOW.**



RADIO CORPORATION of AMERICA
RADIO BATTERIES
HARRISON, N. J.

BUILD A BIGGER ON POWERFUL G-E



AMERICA'S BIGGEST MAGAZINES PRESELL G-E TUBES!

- 35,000,000 people read G-E full-page tube ads. 35,000,000 TV owners and enthusiasts see *proof* month after month that General Electric tubes are superior!
- Every message emphatically directs these owners to you—the serviceman with the General Electric tube sign. The ads tell

why patronizing *your* shop means brighter, sharper, more lifelike television pictures in the home.

- Take advantage of the big local market that G-E tube advertising creates for you! Make real money by selling G-E tubes to a *presold* television public!



BUSINESS "LIFE" AND "POST" ADS!



We install
Aluminized TV Picture Tubes
"up to 100% brighter"

AS ADVERTISED IN LIFE AND SATURDAY EVENING POST

**THIS SIGN PUTS G-E
NATIONAL ADS
TO WORK FOR YOU!**

EVERY MINUTE of every hour, people who have read G-E tube advertising pass your shop. They want to know where to go for service. Use these colorful gummed streamers to tell them *you* install G-E tubes!

21" WIDE, the streamer is just the right size for your door or window. Blow-ups of LIFE-POST ads, supplied from time to time, can be mounted beneath. For counter giveaway, or for display where space is limited, actual-size ad reprints are available to you regularly.

YOUR G-E TUBE DISTRIBUTOR will be glad to supply you with streamers and reprints. See, phone, or write him today! Get *all* the tube and service business "Up to 100% brighter!" will bring to your door! *Tube Department, General Electric Company, Schenectady 5, New York.*

GENERAL



ELECTRIC

161-1A2



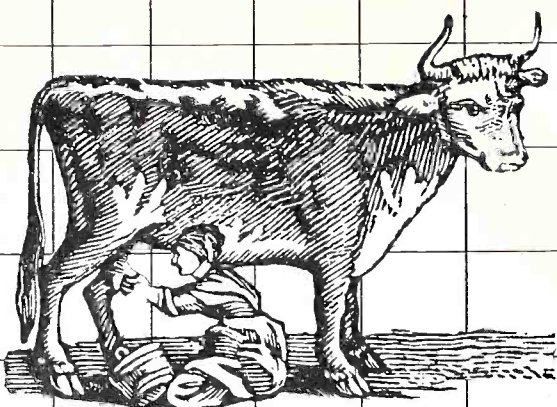

PRODUCES PROFITS

any season!

Fast or slow market — it makes no difference to Bossy ... she keeps on giving. That's the way it is with the Radion indoor TV antenna too! When business is bustling, Radion installations are profitable because they save you time and manpower. When the market slows, Radion's "Free Installation" promotion produces profitable action for you.

Finest quality ... high profit has made Radion the Industry Standard ... 2,500,000 units sold steadily since Radion originated the indoor antenna prove Radion's leadership — prove smart dealers use Radion in *all* seasons to sell TV. Get on the year-round profit wagon ... write Radion today!

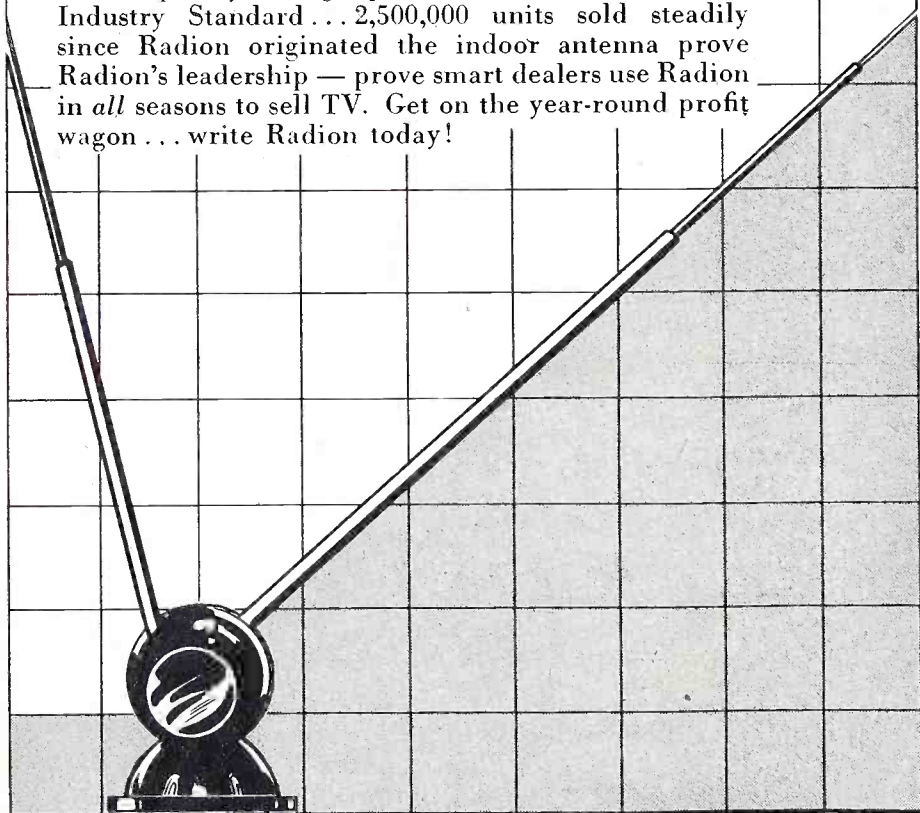

Radion

The Radion Corp., 1130 Wisconsin Ave.
Dept. RSD-4, Chicago 14, Illinois
Send me free "8 ways to profit with Radion"

Name _____

Firm _____

Address _____

amplifiers, filters, oscillators and antenna multicouplers.

Raytheon Service Forums Continue

In answer to the great popular demand by distributors and service dealers for showings of their unique "How to Interpret What You See" meeting, the Raytheon T.V. Service Dept. in conjunction with the Raytheon Replacement Tube Department's Bonded Dealer Program is continuing to sponsor these TV service forums. At a recent meeting held in Minneapolis, Minnesota new service dealer attendance records for meetings of this type in the Twin-City area were made.

The Minneapolis meeting was held at the Leamington Hotel under the auspices of the Lew Bonn Company, distributors of Raytheon Tubes for dealers in the Minneapolis, St. Paul and Duluth vicinity. Over 350 attending service dealers from this area gave Mel Moore of the Raytheon T.V. Service Dept., who was the main speaker of the evening, a standing ovation at the completion of the lecture portion of the meeting.

DuMont Demonstrates UHF

Allen B. Du Mont Laboratories, Inc., recently gave the first demonstration to an invited audience of UHF television reception utilizing a transmitted signal emanating from a New York City UHF experimental broadcast station.

The demonstration was put on at the Institute of Radio Engineers National Convention currently in progress at Grand Central Palace with a new Du Mont 17-inch table model combination VHF-UHF Teleset. The receiver, exhibited in actual operation, received its signal in the frequencies between 708-714 megacycles from the Du Mont experimental UHF transmitter located atop 515 Madison Avenue, N. Y. City. This was the previous location of Du Mont network station WABD which is now atop the Empire State Building.

In addition to the demonstration of the VHF-UHF Teleset, Du Mont displayed a new UHF converter and a new UHF Diplexer.

The new UHF Teleset converter, Du Mont engineers said is operable with any VHF receiver presently on the market. The converter displayed, covered the range from 470-890 megacycles with continuous tuning throughout the band.

A UHF converter, it was explained, is used for the purpose of converting the UHF signal to a VHF one, so that it may be used to operate a common VHF receiver of the type in use

[Continued on page 14]

Fast . . . easy replacement for any set



MALLORY MIDGETROL®

Dual Concentric Volume Controls

DO THE JOB WITH SMALL STOCKS

- You can match 10,000 combinations of resistance values, taps and tapers with a minimum inventory of Mallory Dual Concentrics.
- Assembly involves just five simple steps. Takes less than five minutes. You need no special tools . . . do no soldering.
- Front and rear sections are factory-assembled and inspected.
- Instant AC switch attachment without control disassembly.

PERFORMANCE THAT PAYS OFF

- Longer-lasting resistance elements even in extremes of temperature and humidity.
- Better and more accurate taper curves resulting from precision processing methods.
- No pigtail connections to break—thanks to Mallory's exclusive sliding contact that gives EXTRA quiet operation.
- Minimum wobble with Mallory exclusive two-point shaft suspension.

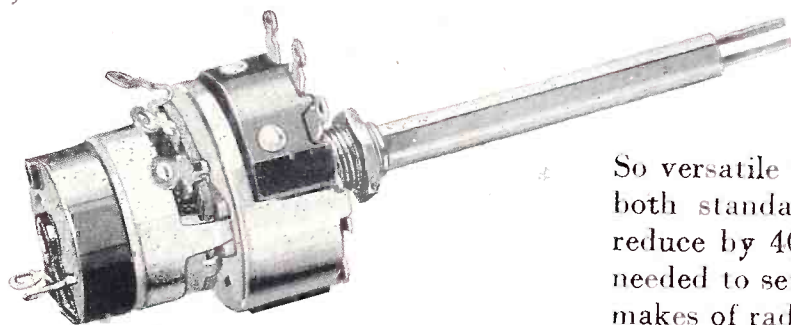

So versatile are Mallory Midgetrols—both standard and dual—that they reduce by 40% the cost of inventory needed to service the 10 most popular makes of radio and TV sets.

**Make Sure!
Make it Mallory!**

Shown here is the Mallory Dual Concentric Midgetrol with a wire wound front section, available for such uses as TV focus controls. The Mallory Midgetrol line, in addition to dual concentrics, includes round shaft, standard controls with the advantages of stable, two-point shaft suspension, instant AC switch attachment, ready adaptability to split-knurl and flatted type knobs.

P. R. MALLORY & CO. Inc.
MALLORY

CAPACITORS • CONTROLS • VIBRATORS • SWITCHES • RESISTORS
• RECTIFIERS • VIBRAPACK* POWER SUPPLIES • FILTERS

*Reg. U.S. Pat. Off.

APPROVED PRECISION PRODUCTS

P. R. MALLORY & CO., Inc., INDIANAPOLIS 6, INDIANA

SYNC PULSES

by San D'Arcy

Rider Wins "Oscar" — The Plaque for 1951, awarded annually by the Federation of Radio Servicemen's Associations of Pennsylvania, to "one who has rendered outstanding and useful service to the radio-television servicing profession" was presented to John F. Rider on Sunday, March 16th in fitting ceremony at Harrisburg, Pa. Previous winners of the Plaque, which is in effect equivalent to the motion picture industry's "Oscar" were: Howard W. Sams, publisher of Photofacts; Philco Corp.; Sylvania Electric Products, Inc.; and Sandy Cowan, as publisher of the technical monthly magazine "Radio-TV Service Dealer." With reference to the current recipient, it couldn't have happened to a nicer guy!

For over a quarter century (even though stating it that way may make Mr. Rider feel old), J. F. has contributed much time, effort and money towards the betterment of servicemen, their living standards, and their effort to enjoy greater appreciation by the set-owning public which they are obligated to serve. In like manner the FRSA itself is a most worthy undertaking because it pioneered in the arduous endeavor of interrelating the doings of many independent Pennsylvania servicemen's associations for the benefit of all parties concerned. Free enterprise is a basic tenet of this Nation, and yet, the record shows that only by means of unity and organization can any working group survive and prosper. It is truer in the service profession than anywhere else that while all servicemen should retain their identity as independent operators, nevertheless they would be wiser if they were to affiliate with some association of servicemen so that their efforts can be co-ordinated.

Replace Old TV Antenna Campaigns are being started by enterprising service organizations all over the country. Indices show that the average life of a TV antenna is somewhere close to 27 months. Either the TVset owner moves and thus needs a new antenna, or the old one blows down or disintegrates because of acidic elements in the air, or for many reasons too numerous to mention. Now we know that the average TV antenna is going to require replacing in about 2 years after its original installation.

This is a fine prospect for the TV service profession, and of course for makers of TV antennas, and antenna accessories. Much better antennas are available today than were obtainable two years, or even one year ago. Gain is higher and consequently reception is better and ultimately set-owner satisfaction is greater. The idea, of course, is for every technician to get behind this campaign. It stands to reason that with the coming of better weather, installation work is easier, or at least much less hazardous. And, regardless of what any TVset manufacturer may claim, it is an established and incontrovertible fact that a properly installed outdoor antenna will provide a better picture than an indoor or built-in one.

New Service Techniques — Several are in the offing and as soon as the inventors have had an opportunity to prove their theories, complete reviews of their findings will be published in this magazine's columns. Remember, there are still well over 100 million conventional AM-FM radios in daily use and some of the newer crop of "TV experts" are not even competent to repair them because to date all of their experience has been on the TV side rather than on radio per se.

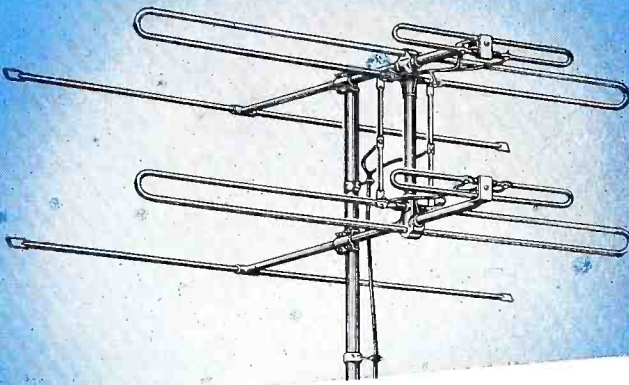

AMPHENOL

this 
Book



... contains information never before available in a concise, readable form. It presents a complete discussion of the factors and conditions which affect television reception and the reasons for good TV pictures. The one single factor which contributes the most to Better TV Picture Quality is the television antenna. The best and most expensive TV set can present a picture no better than that received by the antenna.

This book gives a detailed discussion, complete with illustrations and graphs, of the various types of antennas, their characteristics and performance under given conditions. In addition, the book contains information on the problem of coordinating the antenna with the location.

Your Authorized Amphenol Distributor has a free copy of this book waiting for you — ask for yours today!

AMERICAN PHENOLIC CORPORATION
1830 SOUTH 54th AVENUE • CHICAGO 50, ILLINOIS

AMPHENOL



New CBS-Hytron
cylindricals
17LP4 and 21FP4A low-
voltage electrostatics
17QP4 and 21EP4A
electromagnetics

Facts

YOU'LL WANT TO KNOW ABOUT NEW CBS-HYTRON Cylindricals

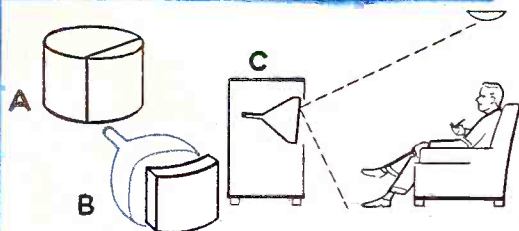

WHY CBS-HYTRON CYLINDRICAL?

To eliminate reflected glare? How? Simple as ABC: A. Imagine a cylinder; slice it vertically. B. You now have the shape of the face plate of a cylindrical tube: curved horizontally; straight, vertically. C. Light falling on this surface at an angle from above is reflected at the same angle... downward. Tilting the tube directs glare downward even more, away from the viewer's eyes.

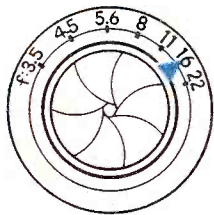

WHY CBS-HYTRON SHIELDED LENS?

With this shielded lens in the electron gun, greater depth of field and better definition are achieved. Just as when you stop down the diaphragm of a large, fast camera lens (f/3.5) to a small aperture (f/16). Distortion caused by interaction of external electrostatic fields used to focus and accelerate the electron beam is avoided. Focusing is easier, less critical. Slight changes in voltages and currents do not cause drift.



WHY CBS-HYTRON BLUE-WHITE SCREEN?

Ever notice how a shirt laundered with bluing appears whiter? With the CBS-Hytron blue-white screen, whites appear whiter; blacks, blacker. Picture definition is crisper. In fringe areas, the expanded gray scale of the blue-white screen gives noticeably clearer pictures. No wonder CBS-Hytron's original blue-white screen is fast becoming the standard preferred by consumers for best definition.



MAIN OFFICE: SALEM, MASSACHUSETTS

These are just a few reasons why it's smart to demand CBS-Hytron... original studio-matched rectangulars. Try the new CBS-Hytron cylindricals yourself. Discover for yourself why 9 out of 10 leading set manufacturers pick CBS-Hytron.

CANNON PLUGS

*the highest quality
and greatest variety
for the instrument industry*

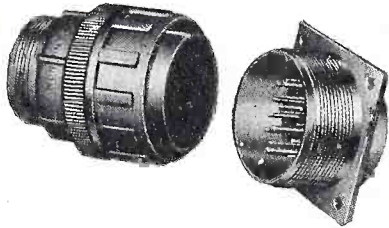

AN Originally designed for Army-Navy Specification requirements. Now used widely for instruments. Connects and disconnects by screw action of threaded coupling ring. Made in 2 plug types—3 receptacles with variations and accessories, in 15 shell sizes and more than 200 insert arrangements.



K Light weight, aircraft type connector ideal for many instruments. Connects and disconnects manually. Is held together by Acme thread coupling ring. Made in 7 shell types in 8 different diameters and more than 190 insert arrangements.



GS Hermetically sealed by use of glass fused to shell and contact, both machined from cold rolled steel. Made in 2 shell types—10 diameters and currently having 30 layout arrangements. Additional arrangements are being designed.



RS Hermetically sealed with special resilient rubber inserts. Specially adapted to aircraft relays and other sealed components. These fittings mate with standard "AN" Connectors having corresponding inserts.

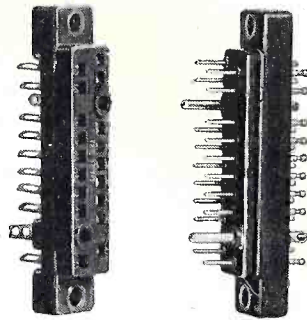

DPM This series used primarily on electronic equipment where a multiple contact, rack and panel connector of extremely small dimensions is required. Both plug and receptacle are rigidly mounted. Connect and disconnect automatically when assemblies, to which they are mounted, are joined or separated. Made in 2 sizes having 2 contact arrangements.

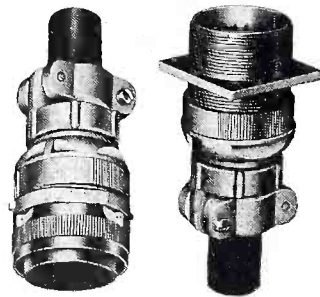

AN-M For the tough jobs. Moisture-proof, vibration-proof and pressurized. Radio shielding is provided and all threaded parts are drilled for safety wiring. Connect and disconnect by screw action of threaded coupling ring. The variety of sizes and layout arrangements is nearly as great as the AN line.

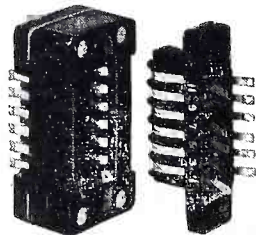

RTC Is a quick disconnect requiring low separation force and having simple mounting requirements for chassis or wall types. Moisture drain holes provided in receptacle section. Plug section provides for lacing down wires after soldering. Made in five sizes.

CANNON ELECTRIC

Since 1915

CANNON ELECTRIC COMPANY

FACTORIES IN LOS ANGELES, NEW HAVEN, TORONTO

REPRESENTATIVES IN PRINCIPAL CITIES

For engineering data on any of these Cannon Plugs request free bulletins by type, such as "K", "GS", "RTC", etc. Address Department D-127, Cannon Electric Company, P. O. Box 75, Lincoln Heights Station, Los Angeles 31, Calif.

TRADE FLASHES

[from page 10]

today. The Du Mont converter displayed, converts the UHF signal receiver to either Channel 5 or 6 in the Very High Frequency range.

Sams Calls Conference

Thirty-four persons from seventeen firms of sales representatives of Howard W. Sams & Co., Inc., Indianapolis electronics technical publishers, attended a two day "Hoosier Style" sales conference here February 8th and 9th at which company sales plans, promotions and policies for the Photo-fact publications were the subjects of a series of meetings.

Speer Resistor Co. Expands

A new plant for the manufacture of fixed carbon composition resistors has been completed in Bradford, Pa., by the Speer Resistor Corporation, a subsidiary of Speer Carbon Company, St. Marys, Pa. Six of the eight proposed production lines are now in operation. With all eight working the company's production will be doubled.

Webster-Chicago Awards Prizes

First prize of \$500 in the nationwide window display contest for dealers handling Webeor tape and wire recorders was won by a window planned and installed by J. H. Fisher of Pound & Moore Company, 304 South Tryon Street, Charlotte, N. C., it was announced by Norman C. Owen, distributor sales manager of Webster-Chicago Corporation.

Second prize in the contest, with an award of \$250, went to McGowan's Radio & Appliances, Inc., 23 West 6th Street, St. Paul, Minn., for a display by C. J. Vokoun, Jr., and the \$100 third prize to Schwabacher-Frey Company, 736 South Broadway, Los Angeles, Calif., of which Thomas F. Burke is display director.

Besides the prizes for the three best wire and tape recorder window displays, the contest also provided cash prizes of \$100, \$50 and \$25 for the Webeor distributor salesmen serving the prize winning retailers. These were won, in the order listed, by L. H. Shuler of Dixie Radio Supply Company, Don Guies of Lew Bonn Company and Joseph Klempner of the Kierulff Company.

The winning displays were selected by a group of independent experts.

Jensen Announces Needle Cabinet

A new counter display-merchandise for replacement phono needles has just been introduced by Jensen In-

[Continued on page 44]

Radio-Television SERVICE DEALER

*Yours for the
A-Things*

- **FREE!** 68 page catalog section from Radio's Master.
- Catalogs the products of 30 manufacturers of Recording, Phono Equipment and Accessories.
- Complete descriptions, specifications and illustrations of such products as: Recorders, Phono Motors, Turntables, Record Changers, Cartridges, Pickups, Discs, Tape, Needles, etc.

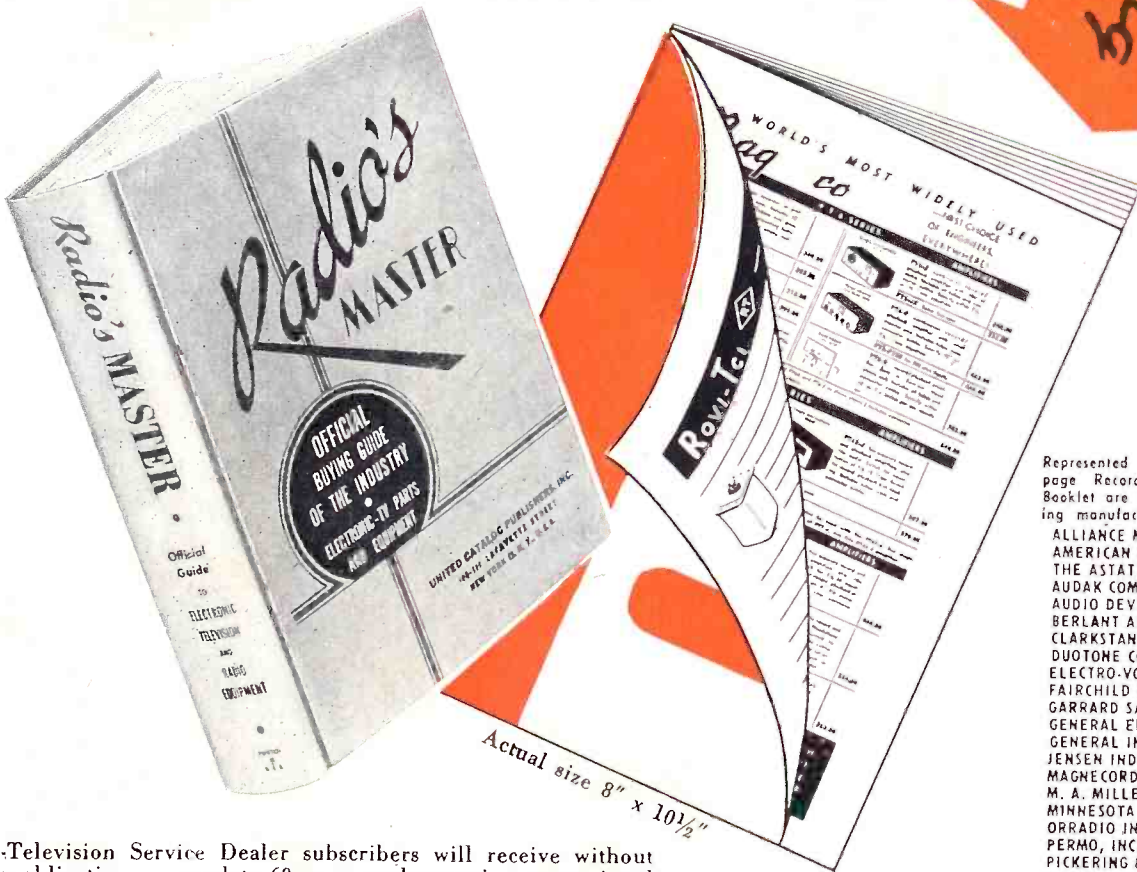

Actual size 8" x 10 1/2"

Represented in RADIO'S MASTER 68 page Recording & Phono Equipment Booklet are the products of the following manufacturers:

- ALLIANCE MANUFACTURING CO.
- AMERICAN MICROPHONE CO.
- THE ASTATIC CORP.
- AUDAK COMPANY
- AUDIO DEVICES, INC.
- BERLANT ASSOCIATES
- CLARKSTAN CORP.
- DUOTOHE CORP.
- ELECTRO-VOICE, INC.
- FAIRCHILD RECORDING EQUIPMENT CO.
- GARRARD SALES CORP.
- GENERAL ELECTRIC COMPANY
- GENERAL INDUSTRIES CO.
- JENSEN INDUSTRIES, INC.
- MAGNECORD, INC.
- M. A. MILLER MFG. CO.
- MINNESOTA MINING & MFG. CO.
- ORRADIO INDUSTRIES, INC.
- PERMO, INC.
- PICKERING & CO., INC.
- PRESTO RECORDING CORP.
- RECORDISC CORP.
- RECOTON CORP.
- REEVES SOUNDCRAFT CORP.
- REK-O-KUT COMPANY
- SHURE BROS., INC.
- V-M CORPORATION
- WALCO PRODUCTS, INC.
- WEBSTER-CHICAGO CORP.
- WEBSTER ELECTRIC CO.

Radio-Television Service Dealer subscribers will receive without cost or obligation, a complete 68 page catalog section as reprinted from the Industry's Official 1100 page Radio's Master, 16th edition.

This section catalogs in detail the products of the leading Recording and Phono Equipment manufacturers — all in 1 handy booklet. It is complete with descriptions, specifications and illustrations as written by each manufacturer. Whether you buy, sell or specify these products, you will find this booklet extremely helpful.

This offer is made possible by a special arrangement between Radio-Television Service Dealer Magazine and the publishers of Radio's Master. Be sure to get your copy now. Fill in the coupon and mail.

If you need catalog data on any other products, let us know.

RADIO-TELEVISION SERVICE DEALER 67 WEST 44th STREET, N. Y. 18, N. Y.

Please send me, without cost or obligation, the 68 page Recording & Phono Equipment and Accessories Booklet as reprinted from Radio's Master.

Name

Address

City..... Zone..... State.....

MAIL TODAY

HIS CHOICE IS

Regency

LARGEST
SELLING
VHF
BOOSTER
AT ANY PRICE!



MR. JACK HUGHES
PROMINENT VICE PRESIDENT
LITTELFUSE, INC.
PHOTOGRAPHED IN HIS HOME

ALSO MAKERS OF THE

Regency

UHF CONVERTER

Fig. 1. Remote control version of the new Philco tuner.

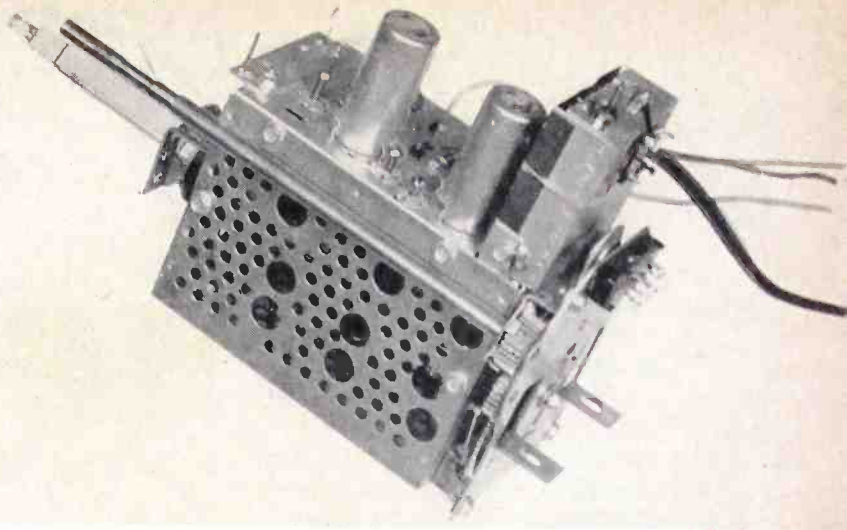

by Daniel Lerner

NEW TV CIRCUITS

Presenting new circuit features and components used in the 1952 line of receivers featured by one of the largest manufacturers of TV receivers.

AMONG the many new developments in TV circuit design a new tuner which has been added to the long list of r-f heads made by numerous manufacturers. This particular one pictured in Fig. 1, contains many new worthwhile features.

This tuner can be called a semi-incremental low-noise type. The os-

illator circuit represents a distinct departure from previous designs. The plate of the oscillator is at low r-f potential and the output is taken from the grid circuit. The cathode of the oscillator is at high r-f potential and the tank circuit components are switched in the grid circuit. See Figs. 2 and 3. This type of oscillator has a

distinct advantage over the usual high plate impedance type such as is generally used. The advantage lies in the great reduction of radiation from the local oscillator which if of sufficient amplitude may cause interference with adjacent receivers.

In this tuner the local oscillator radiation is reduced at least ten times from previous high plate impedance types. The tube used, a 12AZ7, is a high transconductance type which serves admirably as a combination mixer-oscillator. In the mixer tube the tank circuit constants are also switched incrementally in the grid circuit.

The tapered line input section is connected as a transformer thus isolating the antenna from chassis. This feature is valuable when the tuner is used with line-connected types of chassis. Two one megohm resistors are connected from each antenna terminal to chassis at the tapered line section in order to bleed off static charges which may build up on the antenna system. Only a 300 ohm input impedance is available with this tuner. No switching provisions are provided for 72 ohm input. If coaxial cable transmission line is required a matching transformer may be used if needed for any reason.

The r-f input tuned circuit is connected as a parallel resonant circuit from grid to ground. No B plus voltages are present on any contact points. This feature insures prolonged contact life with good positive connection.

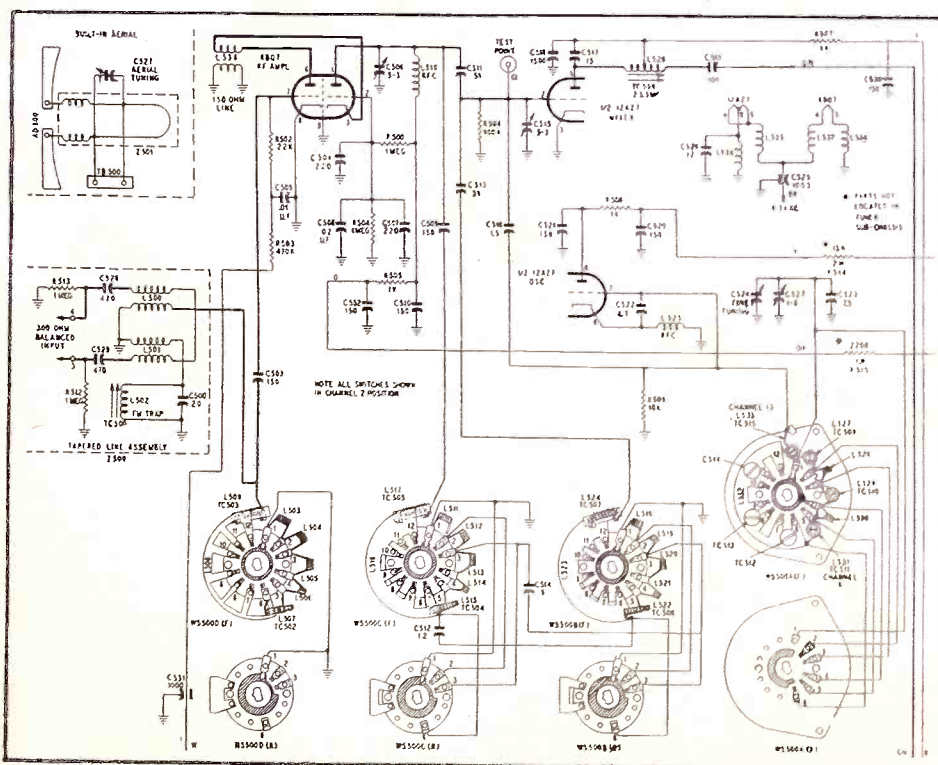

Fig. 2. Circuit diagram of new tuner. The design of this tuner results in reduced local oscillator radiation.

since no danger of voltage scarred contact points is present.

The first triode section of the 6BQ7 acts as an impedance transformer to match the relatively high impedance of the tuned circuit to the low cathode impedance of the second triode section functioning as a grounded grid voltage amplifier. See Fig. 4.

An important new feature in the r-f section is a special transformer which is connected between the plate of the first triode, and the cathode of the second section to neutralize the amplifier. This neutralization is fixed and is done in order to improve the signal to noise ratio of the amplifier. It is not needed to prevent instability. The special transformer is actually a section of 150 ohm, open wire transmission line wound on a coil form. Neutralization is obtained because attenuation through the line in a forward direction is low since the line is terminated by the low cathode impedance of the second section. Attenuation in the reverse direction would be high because the plate impedance of the first triode would be relatively

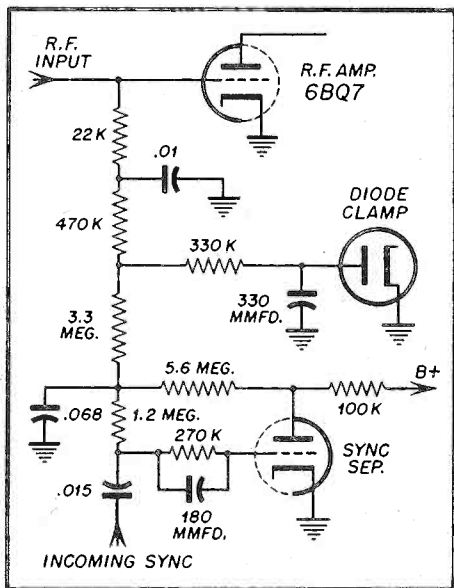

Fig. 5. Source of a-g-c voltage.

high resulting in a mismatch for transmission in that direction. The overall noise figure of this tuner is equal to the theoretical limit of signal to noise ratio on many channels and on some channels it actually exceeds the theoretically perfect r-f amplifier.

A New R-F A-G-C Circuit

Another interesting new circuit used in a new TV model is the a-g-c supply circuit for the r-f amplifier. The a-g-c voltage for the r-f amplifier (see Fig 5) is obtained from a separate source, the sync separator. The negative voltage at the sync separator grid is a function of the sync pulse amplitude. This voltage is due to the

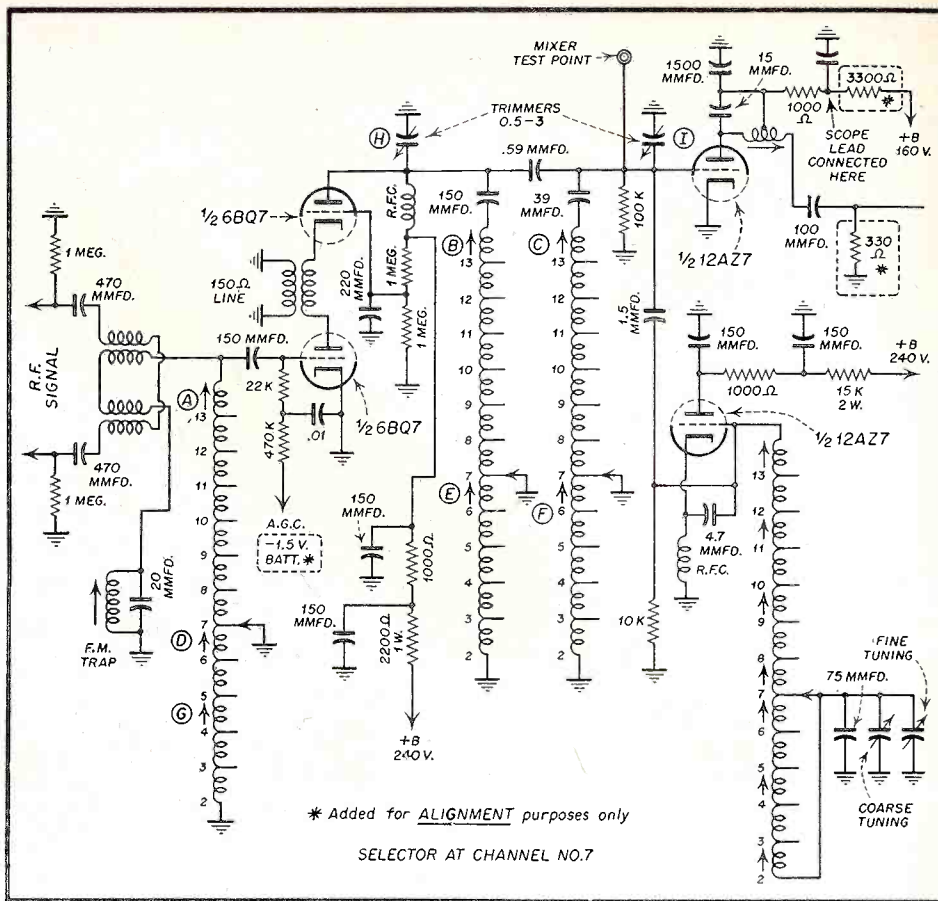

Fig. 3. Detailed circuit schematic of new tuner.

grid current flow and is therefore proportional to the level of the incoming composite video signal.

The bias voltage is actually the algebraic sum of a small positive voltage from B plus and the negative voltage from the sync separator. Since loss of input signal may cause a positive a-g-c line, a diode is connected effectively from the a-g-c line to ground. Thus if the input signal disappears the diode conducts and returns the line to ground potential. The combination bias voltage from the separator is filtered and then applied to the r-f amplifier grid. The above circuit

provides essentially flat a-g-c control under all types of signal conditions from very strong to very weak signal levels.

A New Horizontal Deflection System

A new horizontal deflection system is used. The familiar phase comparator circuit is used with some variations. See Fig. 6. The controlled horizontal blocking oscillator has a manual positive voltage applied to the control grid from the Freq. Control potentiometer. The combination of the automatic positive control voltage from the phase comparator and the manual control volt-

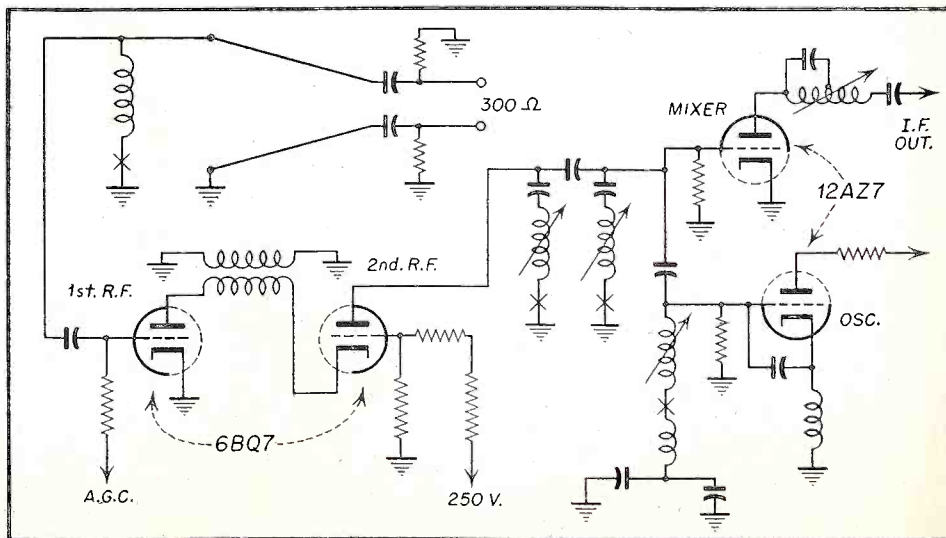

Fig. 4. Simplified schematic of new tuner.

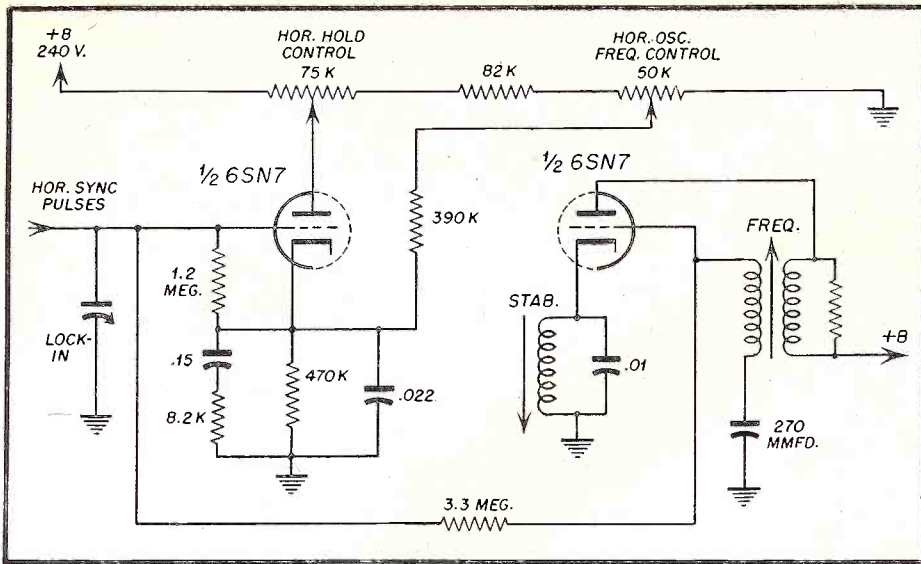

Fig. 6. Horizontal frequency control system employing variation of phase comparator circuit.

age from the Freq. Control determines the frequency of the blocking oscillator. Naturally, a more positive control voltage will cause the oscillator to increase its frequency. This is true because the blocking oscillator will come out of cut-off more quickly.

A parallel resonant circuit is used in the cathode circuit of the 6SN7 blocking oscillator. This tank circuit, called the stabilizer winding, has the following function. When the oscillator plate current is cut off by the blocking action, the tank circuit is shock excited into one cycle of oscillation at the horizontal oscillator frequency. This sine wave voltage developed in the cathode tank circuit helps to stabilize the oscillator and maintain the tube cut-off during the blocked periods.

Compared to previous designs this particular type of combination phase comparator type of system is comparatively simple to trouble shoot. This is true because its B supply is fed directly from the low voltage power supply. In previous designs the B supply was from the damper output, thus incorporating a regenerative type of B

supply and posing many problems when troubleshooting defects in the horizontal system.

A New Horizontal Output Stage

The new horizontal output system

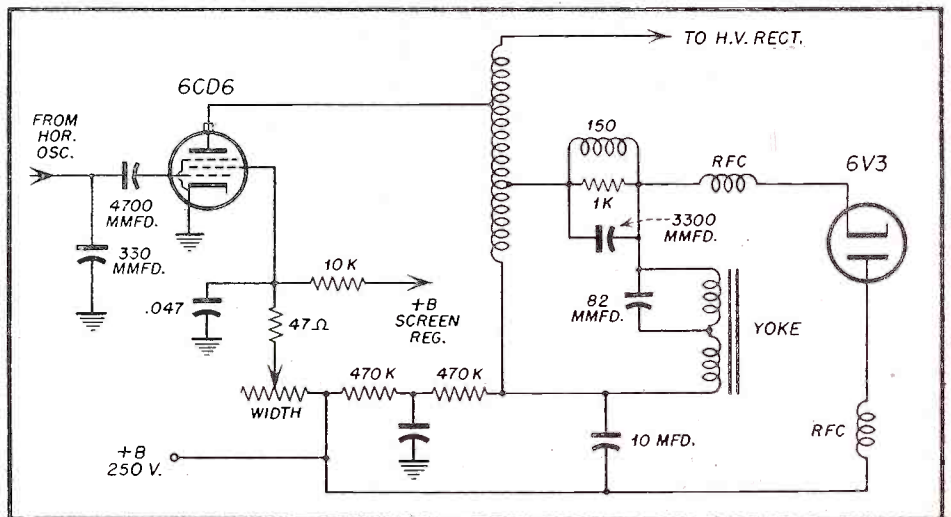

Fig. 7. High efficiency type of horizontal output circuit which reduces possibility of horizontal foldover.

represents a brand new design. See Fig. 7. The output transformer is an

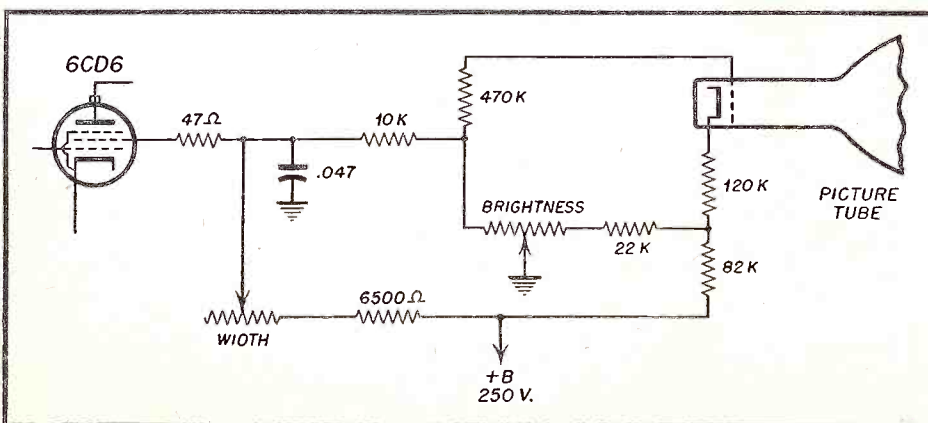

Fig. 8. Automatic brilliance and width circuit.

autotransformer type. Due to the close coupling in an autotransformer very high deflection efficiency is effected. In addition the horizontal flyback time is shortened considerably thus minimizing considerably the effects of possible horizontal foldover.

A brand new type of damper tube, a 6V3, is used. It is a nine pin miniature type tube with the cathode connection brought out to a top cap. This construction is used since the cathode is necessarily the high potential point in the circuit. The damper tube is connected so that it draws no current from the B plus supply.

The boosted B plus (560 volts) from the damper is used directly to supply the plate of the horizontal output tube and is divided down to 350 volts to supply the vertical sweep oscillator and the first anode of the picture tube.

An Automatic Regulating Circuit

One of the most interesting features is the interconnection of the width and brightness controls to form an automatic brilliance and width regulating system. See Fig. 8.

The screen of the horizontal output tube is connected through a 10,000 ohm resistor to the picture tube grid side of the brightness control. This circuit acts to automatically compensate for width and height changes which usually take place when the picture brilliance and, thus, second anode voltage is changed. Increasing brilliance with the new circuit also increases screen voltage on the 6CD6 thus increasing picture width and height. Picture width is increased by the direct effect of changing the horizontal output tube screen voltage. Picture height is increased by the indirect effect of increasing the boosted B plus which is applied to the vertical system.

Using the OSCILLOSCOPE

by ALLAN LYTEL

Part 2

The cathode ray oscilloscope when used in conjunction with auxiliary apparatus may perform many versatile measurements such as voltage, time calibration wave comparisons, a-f and r-f visual observation and alignment.

The Frequency Modulated Signal Generator

Essentially, this frequency modulated oscillator is a radio frequency signal generator with the addition of one method whereby the output is varied over a range of frequencies. By any one of several available means, a signal output is obtained which is constant in amplitude but variable in frequency. The exact width of the band or frequency swing is made variable and the center frequency may also be adjusted to cover any of the necessary bands. When using the sweep generator, the center frequency which is chosen to represent an approximate mid-point of a desired band, is first tuned by the dial calibration. An auxiliary control then adjusts the sweep width or the frequency deviation on either side of the dial calibration.

The constant amplitude variable frequency signal output is applied to the input of the circuit under test. Output from the circuit is applied to the vertical amplifier of the oscilloscope and the sweep voltage for the horizontal amplifier in the oscilloscope is obtained from the sweep generator itself. It is essential for proper sweep alignment that there be a complete stable picture on the oscilloscope at all times. Since most sweep generators do not have a linear change in frequency with respect to time it is impossible to use the time base sweep generator of the cathode ray oscilloscope itself, rather, the same signal which frequency modulates the sweep generator is applied to the horizontal circuit of the oscilloscope where this voltage becomes the time base.

The sweep generator or sweep gen-

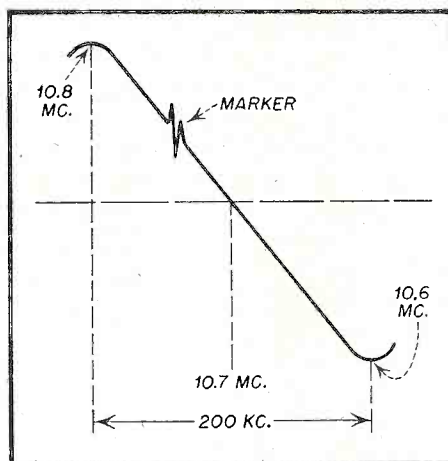

Fig. 10- Alignment curve of the detector showing the marker.

erators must apply frequency modulated signals to cover the carrier frequency range, the picture intermediate frequency band, and the sound intermediate frequency band of the television receiver. It is possible for the same sweep generator to also cover the Frequency Modulation band as well.

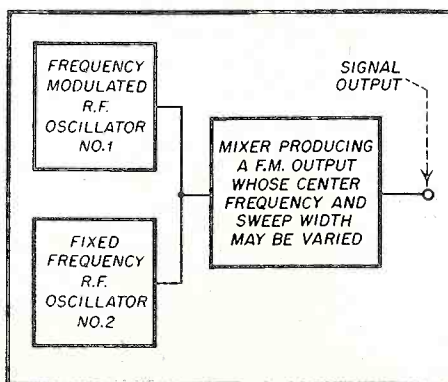

Fig. 11- Basic operation of the Frequency Modulated sweep generator.

In addition to the signals covering the above band by sweeping over a frequency range, marker signals are necessary to identify the alignment curve. These identification signals are known as markers, pips, or calibrating signals. If the sweep generator has its own source of marker signals, they may be used in addition to the sweep generator output. If these signals are not present as a part of the sweep generator circuit, an additional separate external signal generator covering the same frequency range is needed. The sweep generator will not have its total sweeping range or width precisely defined. The marker frequencies supply check or calibration points by which the exact sweep width may be found as well as individual points on the sweep located.

For example, in using the sweep generator to align a FM intermediate frequency amplifier, the center frequency of the sweep generator would be tuned to 10.7 megacycle per second. Because the required width of the tuned circuits in this amplifier necessarily must pass a 200 kilocycle signal, the sweep width control of the generator would be adjusted to approximately 150 kilocycles on either side of the center frequency. A somewhat wider sweep than is necessary for the tuned circuit must be used from the sweep generator so that the complete overall response curve will be visually indicated. A marker generator is used to supply a single frequency signal which rides along and becomes a part of the alignment curve shown in Fig. 10. The marker is first tuned to 10.8 megacycles and it should now be exactly in the upper peak of the alignment curve.

When the marker is tuned to 10.6 megacycles, it should indicate the lower peak of the overall band pass. With the marker generator tuned to 10.7 megacycles, the corresponding point should be indicated at the center frequency. This indicates that the response curve completely covers the required band width which in this case is 200 kilocycles. The sweep generator output, however, covers more than this range in order that the entire trace will be presented on the oscilloscope screen.

The sweep generator and marker system is necessary in order to align a particular tuned circuit. In view of the frequencies on either side of the particular circuit to be aligned, it is insufficient to tune a particular circuit so that the proper band width is passed. Provision must be made for passing the proper band and at the same time preventing an interference on either side of the band. This is particularly true in television where a band of frequencies must be passed

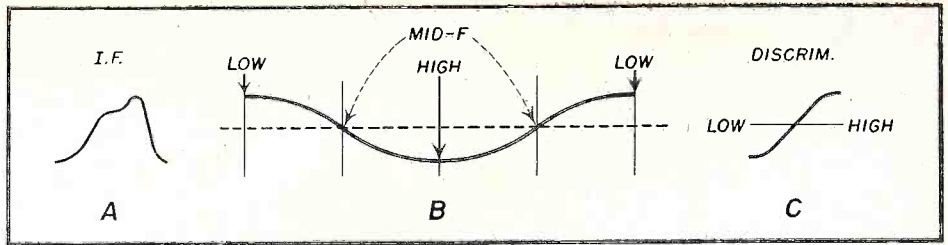

Fig. 12- Frequency swept alignment curves.

the center frequency is 25 mc is difficult because it is a large proportion of the oscillator center frequency.

A single frequency oscillator having no modulation is incorporated into the sweep generator. This output is heterodyned in a manner quite similar to the super-heterodyne circuit in a radio receiver so that a frequency modulated output is obtained. The center frequency of this output is the difference between the center of the frequency modulated signal and the output of the unmodulated oscillator. It is possible using this system to ob-

The sweep generator produces a sweep output by heterodyning a single frequency oscillator with a frequency modulated oscillator. Tuning arrangements in common use are simplified so that in operation the service technician turns the dial calibration to the desired center frequency and an auxiliary control to the sweep width. In addition to the frequency modulated signal output, the sweep generator supplies a signal which is used as the horizontal input for the oscilloscope. This signal is a part of the original frequency modulation of the sweep generator so that the sweep in the oscilloscope follows the sweep of the signal generator and a visual alignment curve may be plotted by the oscilloscope.

Sweep generators are used to provide visual alignment curves in conjunction with the cathode ray oscilloscope. A number of various alignment patterns can result depending on the sweep generating mechanism of the signal generator and the method of connection to the oscilloscope.

The sweep signal generator constantly covers a range of frequencies which are presented visually by an oscilloscope. The pattern is a curve showing the amplitude versus frequency relationship of the amplifier being tested. The same results theoretically could be obtained by manually moving the tuning control on the signal generator to cover the band of frequencies. This of course is accomplished in the signal generator by either an electronic or a mechanical system.

In order to check wave forms, a typical oscilloscope is used with the

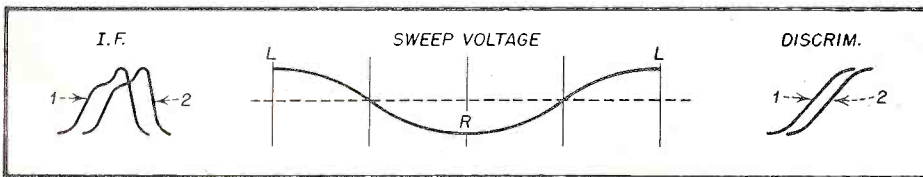

Fig. 13- Equal sweep and retrace times.

for one channel and at the same time there must be no interference outside of this band which would cause difficulties on another channel.

A block diagram of a sweep generator is shown in Fig. 11. As the heart of this equipment, there is an oscillator which may be frequency modulated by any one of several methods. A common method is the use of a motor driven capacitor which constantly changes the tuning of the oscillator tank circuit. In this way the oscillator frequency is constantly varied over the desired range. Another common method is to connect a part of the oscillator tank coil in the field of mechanical vibrations where motion of the oscillator coil produces frequency a change.

The frequency modulated signal generator is of a comparatively high frequency since the necessary frequency modulation is most easily obtained from a high frequency rather than a low frequency oscillator. There are few difficulties involved in obtaining a frequency deviation of 10 mc when the center frequency of the oscillator is between 100 and 200 mc. However, obtaining this frequency swing when

tain wide frequency deviations with a comparatively low center frequency.

A few numerical examples will show how this system operates. If oscillator number 1 which is frequency modulated has a center frequency of 100 mc a sweep width of plus or minus 10 megacycles may be obtained. If this output is coupled to the terminals of the sweep generator without oscillator number 2 operating, there is a sweep output from 90 to 110 megacycles. Oscillator number 2, if it operates at 50 megacycles, will beat against oscillator number 1 producing an output whose center frequency is 50 megacycles and whose sweep width is from 40 megacycles to 60 megacycles.

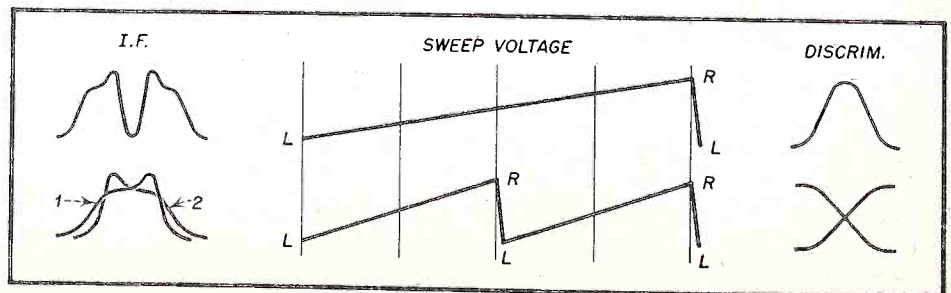

Fig. 14- Saw-tooth sweep

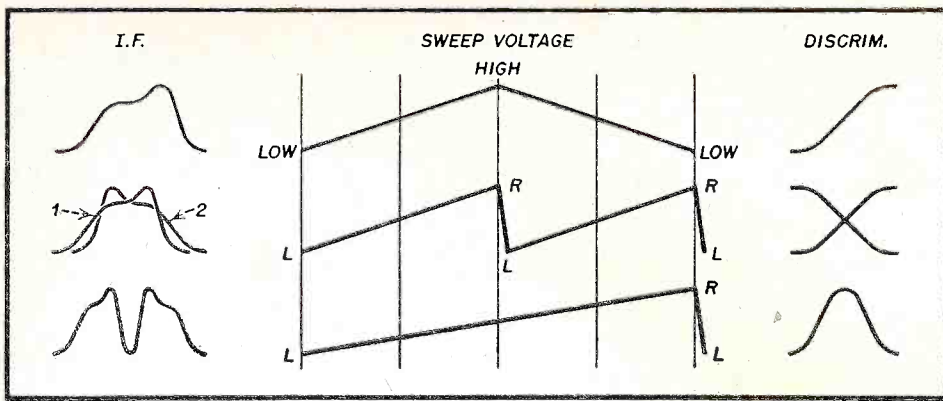

Fig. 15- Triangle and saw-tooth compared.

horizontal signal coming from the internal time base oscillator of the oscilloscope itself. This time base is, of course, a saw-tooth voltage which changes in a linear fashion with respect to time. Thus the picture on the cathode ray tube screen is an actual plot of the voltage versus time relationship of the test signal. The saw tooth sweep is not always the most convenient type to use for visual alignment. A sine wave frequency excursion is the most popular type of frequency modulation for these sweeping oscillators. Fig 12 shows the sinusoidal frequency change of a typical frequency modulated oscillator. Positive voltage maximums correspond to the low frequency output while the most negative portion of the sine wave corresponds to the high frequency output. Thus, as the sine wave goes from maximum positive through zero through maximum negative, the oscillator goes from low frequency to high frequency. As the sine wave passes through zero, the frequency modulated signal generator is working at its mid-frequency.

Figure 12 also shows three typical alignment curves; part A shows an intermediate frequency response curve, with two humps and is distorted deliberately. Part B is single stage of

amplification. A discriminator response curve showing the characteristic "S" shape is shown in part C. Both of these curves are representations of what might be expected from a visual alignment procedure.

Since a sine wave frequency excursion is used for the frequency modulated oscillator, the same frequency sine wave (usually 60 cycles per second) may be used for the horizontal time base. Since both the vertical signal and the horizontal signal are changing at a sinusoidal rate, the information plotted on the cathode ray tube screen will be essentially linear.

Figure 13 shows the motion of the electron beam under the influence of a sinusoidal sweep. Maximum positive voltage is to the left of the screen and maximum negative voltage is to the right of the screen. As the sine wave sweep goes from a maximum positive through zero to a maximum negative, the electron beam moves from left to right across the screen. Under these conditions, retrace time will be equal to the trace time. Since the signal generator now supplies the entire sweep voltage, the oscilloscope is used with the Horizontal Amplifier ON and the Internal Time Base Generator OFF. The controls affecting the internal sweep oscillator of the

oscilloscope thus will not affect the trace on the screen. Positioning controls will still be effective and the Horizontal Gain Control can change the width of the pattern on the screen.

Since the trace and retrace times are equal, there will be two visual traces on the screen. One is the left to right trace and the other is the return or right to left trace. Both of these contain the same visual information. A Phasing Control is usually available so that these two traces may be superimposed giving the impression of a single trace. In Fig. 13 these individual traces are drawn so as to illustrate the trace and retrace. In actual practice, they are made to coincide.

It is possible to use the sine wave signal to synchronize the internal time base oscillator of the oscilloscope rather than use the sine wave itself as the time base. This is illustrated in Fig. 14 showing the sine wave synchronizing input to the saw-tooth oscillator of the oscilloscope. In the top portion of the drawing, the saw tooth is used for sweep and there are two frequency excursions of the vertical signal for one saw-tooth. That is, as the electron beam moves from left to right, the signal oscillator goes from low frequency to high and then from high to low. There are thus, two complete traces present on the cathode ray tube face as before. Now, however, these two traces are mirror images that is, one is the right to left inversion of the other. As shown, this provides two traces for both the response curve and the discriminator curve.

If the saw-tooth oscillator still synchronized by the sine wave signal is adjusted for twice the frequency, the two mirror image traces will now be superimposed. This leads to the double S shaped curve for the discriminator and to the super-imposed intermediate frequency response as in the lower part of the figure. A type of sweep oscillator infrequently used provides a back to back saw-tooth or a triangular sweep voltage for the frequency modulated oscillator. This is shown in Fig. 15 where the signal oscillator goes from low frequency to high to high frequency and then back to low at a linear rate. This signal generator provides a synchronizing signal for the oscilloscope. Where the oscilloscope operates on exactly the same frequency as this back to back saw tooth, a mirror image of two side by side traces will be present. This is somewhat similar to the image presentation shown in Fig. 14. If the sweep circuit oscillator has its fre-

[Continued on page 55]

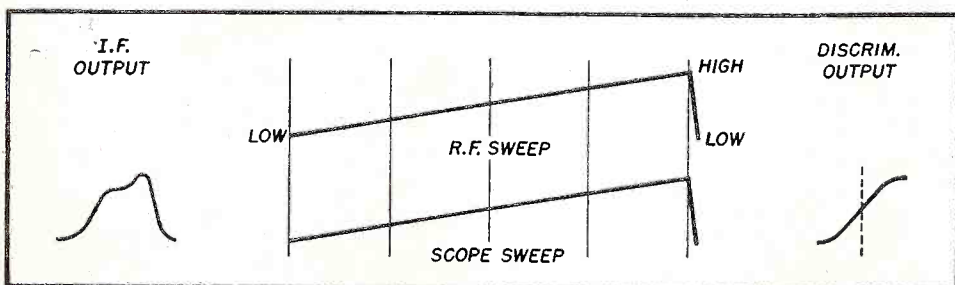

Fig. 16- Example: Megasweep- Kay Electric Company. Conditions: Signal generator produces scope sweep. Scope sweep oscillator turned off (or not connected to horizontal circuit) and scope horizontal amplifier turned on. No phasing need- one sweep on scope for one frequency excursion (plus flyback to original low r.f.)

V-H-F ANTENNAS

by Douglas H. Carpenter

SINCE the popular acceptance of television programming, many different forms of TV antenna systems have been employed by the service technician in an attempt to standardize on a particular array for a specific area. The problems encountered vary almost sectionally, and usually as a direct function of the distance from the television station. The selection of the best antenna system for a particular job is many times clouded by false advertising claims, and the lack of knowledge on the part of busy installation companies as to the true virtues of each individual type. This condition has resulted in a "cut and try" method of antenna selection, with consequent standardization in many areas of one type to the exclusion of new and higher gain systems. It will be found that many times these newer types can produce better results, and fit just as well into today's limited installation budget. It is the purpose of this article to review the basic theory of antenna operation, and to present an unbiased summation of the practical limitations of all popular types presently available to the service trade.

Basic Antenna Principles

In order to properly understand the operation of multi-element systems

A general summary of television receiving antennas; why they work, and their practical limitations. This article should prove of immense value to the TV technician.

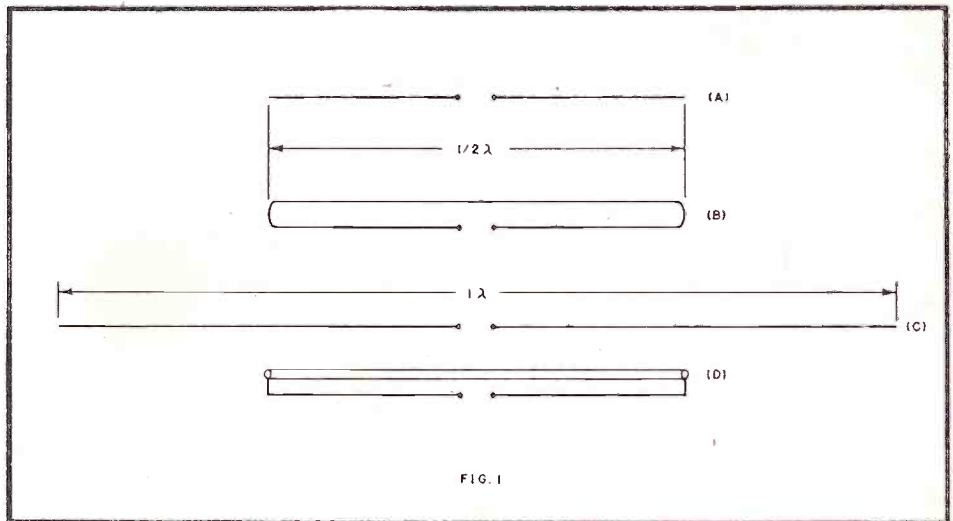

Fig. 1. Some basic types of antenna radiators used in v-h-f antennas.

it is first necessary to accept the theory of resonant impedance of the radiator or driven element. To thoroughly explain the reasons why different forms of radiators exhibit their varying impedance characteristics would require a rather involved discussion

of space coupling, and the application of Maxwell's equations to each individual type. Suffice it to say that the characteristic impedance of a simple half wave dipole (Fig. 1a) is very close to 72 ohms, that of the folded dipole approximately 300 ohms (Fig. 1b), and the full wave type roughly 1500 ohms (Fig. 1c). The radiator illustrated in Fig. 1d is almost universally used in yagi antennae, and its impedance is a function of the ratio of the diameters of the upper and lower tubular elements, and the spacing between them. This is an extremely convenient design, as it permits a direct adjustment of the center impedance of a parasitic array.

The second important factor to be considered is the bandwidth or frequency range that can be covered with only a small impedance change. As the frequency shifts above and below

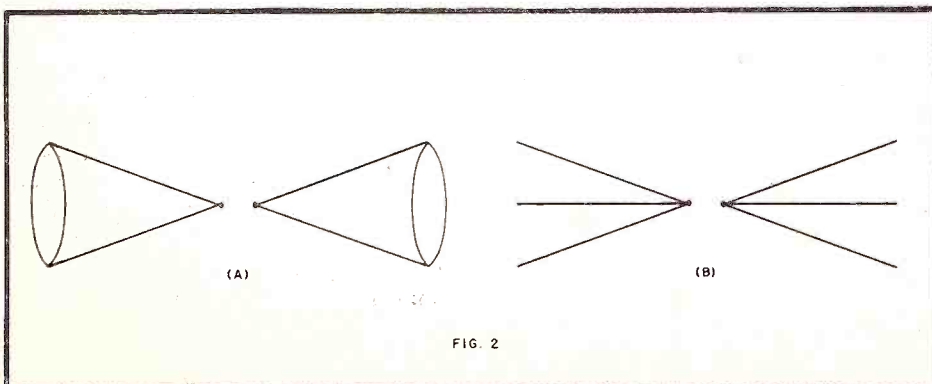

Fig. 2. Development of the "V" type of antenna from the basic conical.

the center resonant design point the radiator "looks" like either a capacitive or inductive load. This presents an extreme mis-match to the fixed load (transmission line) and results in a high standing wave ratio. Of course, at the center design frequency, the antenna is a pure resistance and in theory will match perfectly a transmission line of the same characteristic impedance. The only factor that determines the band-width of the radiator is the diameter of the element itself. As the diameter of the radiator element is increased the "Q" of the total section is lowered and the band-width proportionally extended.

Conical Antenna

There are several mechanical forms of achieving this electrical similarity without actually employing large diameter tubular elements. These systems are all evolved from the basic conical antenna design illustrated in *Fig. 2a*. The low frequency limit is actually determined by the physical distance from the center transmission line feed point to the outside of the cone circumference termination. This particular design will result in a frequency ratio of approximately 4:1. The design illustrated in *Fig. 2b* is a derivation of the true conical, and is actually a V antenna although popularly marketed under the conical name. Its operation is similar to the conical because of the mutual coupling existing between the separate elements forming the V. The bandwidth of the V is not as extended as that of the true conical, but with additional elements can be made to cover a frequency range of some 3:1. For this reason most so-called conicals have a low frequency limit of 70 mc. for television use. This sacrifices Channels 2 and 3, but insures coverage of the frequencies between 70 and 210 mc. All broad

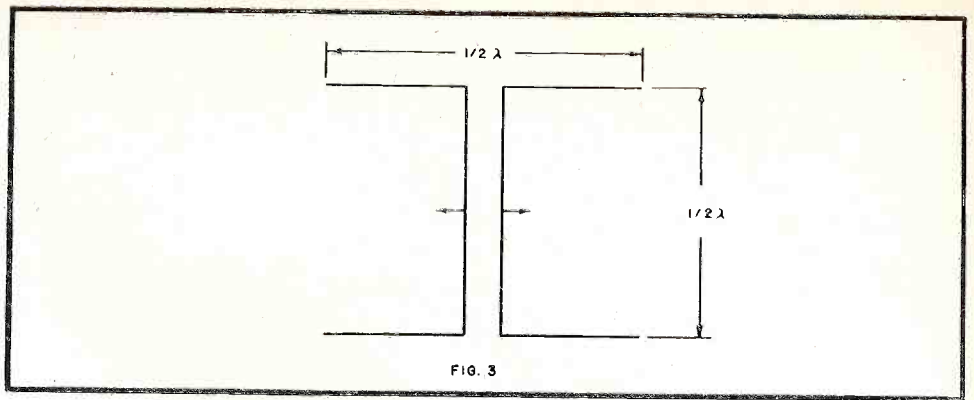

Fig. 3. Lazy "H" antenna with phasing harness.

band antennae in this category are of the low Q variety but exhibit fairly good gain because of the large wave front acceptance area. The same thing holds true for the full wave frequency selective type (*Fig. 1c*). Because a full wave antenna covers twice the physical area its collecting surface is greater, and consequently the gain is higher than that of the half wave type.

Parasitic Elements

To appreciate the function of parasitic elements in any multi-element array it is first necessary to consider the effect upon radiator impedance. Due to current distribution in any half wave radiator, a parasitic element (reflector or director) will cause a drop in center impedance almost directly proportional to its spacing. Conversely any parasitic element in association with a full wave radiator will cause an increase in radiator impedance. Since most receiver inputs have been standardized at 300 ohms it is common practice to design antennae and transmission lines at this value. The problem then becomes a question of exact matching between the fixed transmission line impedance (load) and the antenna proper. To match a simple dipole of 72 ohms to the stand-

ard 300 ohm transmission line some sort of a matching network is required. The formula used to determine the impedance of the matching network is:

$$Z_m = \sqrt{Z_a \times Z_1}$$

In this equation Z_a is the antenna impedance, and Z_1 is that of the transmission line. Thus the matching network is roughly 150 ohms. This is a simple example used only to illustrate the integral design incorporated in multi element stacked arrays.

Figure 3 illustrates one of the first antennas to appear on the TV market some 6 or 7 years ago. This particular system is popularly known as the Lazy H, and represents a frequency selective system of the half wave variety. With parasitic reflectors the impedance of the individual bays is in the neighborhood of 50 ohms. This antenna exhibits a gain in the neighborhood of 7 db over a simple half wave dipole. Because of the reflector action, pick-up from the back is slight at the design frequency. The gain of this antenna is flat over approximately 4 mc. The figure for gain is based on the assumption of a perfect match between the transmission line and the center impedance characteristic of the array. This is accomplished by using the interconnecting phasing harness as the quarter wave matching transformer.

It is impractical to continue stacking half wave radiators because of the problem of matching the total load to the transmission line at any value near 300 ohms. As each individual bay is paralleled the total impedance becomes smaller, and the tolerance of phasing harness spacing is very critical. A much more practical approach to this problem would be to use full wave radiators and reflectors. This combination would result in a high impedance in the individual sections, connected in parallel by the common phasing harness (matching transformer).

Proper matching between the phas-

[Continued on page 53]

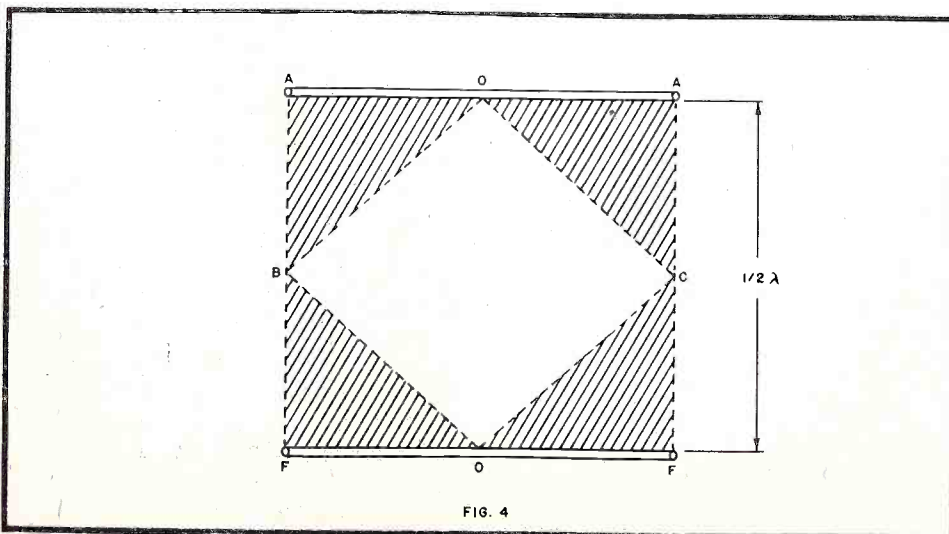

FIG. 4

Fig. 4. Diagram representing reception areas of two stacked $1/2$ wave dipoles.

VIDEO DETECTORS

by Leonard Lieberman

THE video detector is a device for converting a modulated i-f amplifier wave-form envelope so that the modulation intelligence can be obtained. As in all super-heterodynes, the i-f wave-form envelope is fed to a rectifier. The rectifier operating conditions are such that the positive or negative half of the envelope appears across the detector load resistor. An adequate RC network filters the i-f component out. (Figs. 1f and 1g) This leaves a complex sine-wave super-imposed on a d-c voltage. This wave shape is fed either directly or through a condenser which removes the d-c component to a voltage amplifier which is called the video amplifier.

In AM radio design, the second detector poses a number of complex problems. In video operation, these basic problems have, added to them, problems inherent in TV operation. An example of this is seen in the fact that in radio the detected side band components of the carrier frequency have a width of only 10 kc. In TV, the detector should have a linear frequency phase and amplitude response, at least, up to 4 mc. In addition, the response to the sync wave-form must be accurate, since in a number of designs, the sync pulse is taken off the detector for feeding the sync circuits. The sync amplitude response is, in addition, generally used to determine the a-g-c voltage (Fig. 2).

The i-f component is filtered out by means of $L1$, $L2$, $R1$, $C1$ and the shunt wiring, tube input and tube output capacities of the circuit. (Fig. 3a). The component values are such that the response of the network is essentially flat through 4 mc, but will sharply attenuate the i.f.'s, which, in present-day sets can be from 20 to 45 mc (Fig. 3b). The network constants are such that the cut-off frequency is approximately twice the value of the highest video frequency to be detected.

This article deals with the requirements of detectors in TV receivers and the general circuitry of this portion of the receiver. An explanation of the components and their required values in video detectors is included.

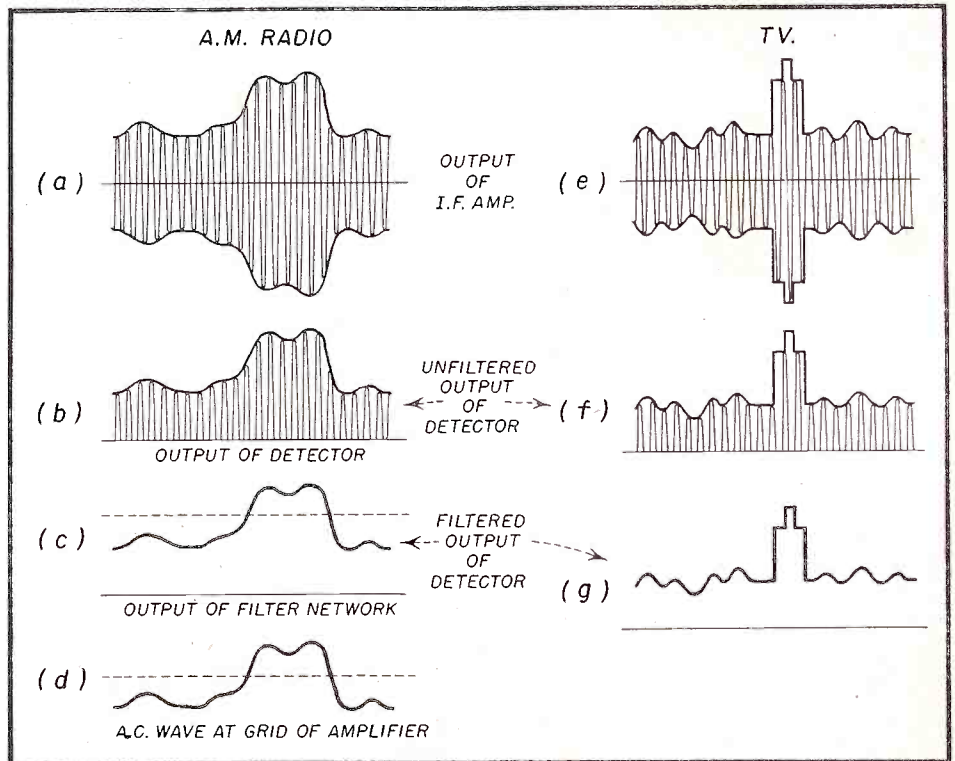

Fig. 1. Comparison of waveforms in AM Radio and TV receivers with reference to detection. Note the presence of the sync pulse in the TV waveform.

$R1$ which is the load resistor of the network is chosen so that it is equal to the surge impedance of the network. $R1$ is calculated by the formula:

$$R = \sqrt{\frac{L}{2C}}$$

The value of R as a result is generally in the order of 2,000 to 6,000 ohms. The L/C ratio is chosen so that

C is made as small as possible and L as large as possible within the limits of the required cut-off frequency. The network design is such that C_{s2} can be twice the value of $C1 + C_s$ or C_{s3} . As a result, the mid-point of the filter is the point at which the a-g-c or the sync take-off systems can be connected.

Because the value of $R1$ is deter-

mined by the requirement of the network, its value becomes such that the ratio of $R1$ to the internal resistance of the diode is approximately 2:1. This ratio becomes a factor which must be taken into consideration. The reason for this is that the internal resistance of the diode varies in a non-linear manner (Fig. 4). This variation causes a slight phase shift in the output wave-form. Fortunately under normal operation conditions, this phase shift is of such a character that it is not noticeable to the eye. If, however, there is a serious upset in the circuit constants, such as a change in the value of R or the internal resistance of the detector, the phase shift and subsequent smear could be objectionable.

The amplitude distortion caused by the value of $R1$ in a non-compensated circuit would commence at the higher frequencies when the impedance of the shunt capacities equals $R1$. How-

by changing the cathode and anode connections in relation to the secondary coils of the coupling network from the last i-f stage. This polarity is de-

current. Because of this, if the picture tube is grid fed, it is desired that the signal presented to the grid be of the form shown in Fig. 5a. With this

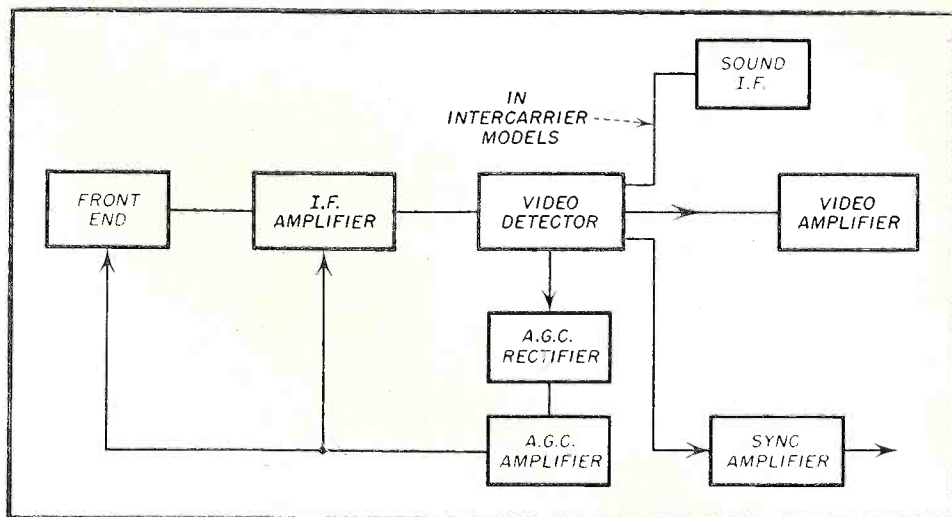

Fig. 2. Partial block diagram of typical intercarrier receiver showing position of detector and other circuits.

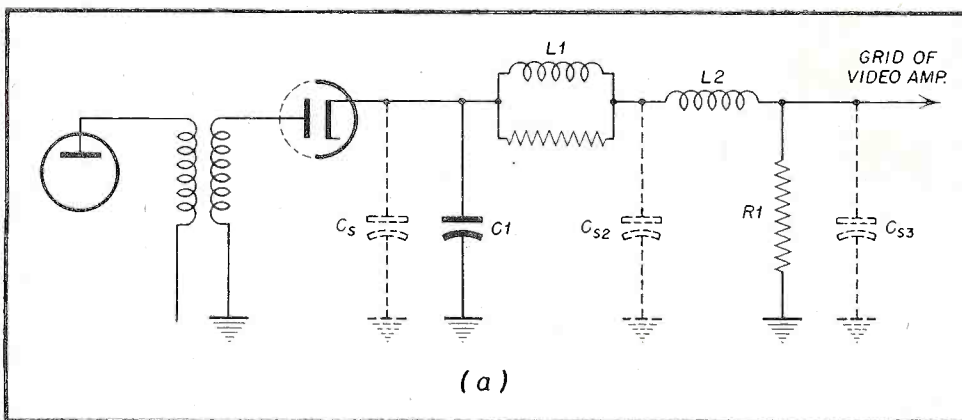

Fig. 3a. Simplified video detector circuit.

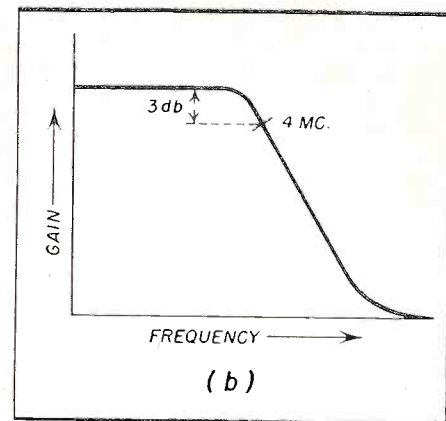

Fig. 3b. Attenuation above 4 mc.

ever, the use of the coils $L1$ and $L2$ peaks the high frequency response so that the amplitude response is comparatively level through 4 mc.

Detector Polarity

The polarity of the detector output is reversible. This reversal is achieved

terminated by a number of considerations the first of which is whether the CRT is grid fed or cathode fed. This must be considered because in the television picture presentation, the CRT requires that the brightest or whitest part of the pix draw the most

input, the blacker than black part of the picture (sync pulse), is the most negative, and the whitest of the pix is the least negative, resulting in the desired picture polarity.

If the CRT is cathode fed (Fig. 5b), then the so-called *negative picture phase* input is required. This results from the fact that in cathode fed circuits, a positive voltage fed to the cathode develops a negative grid to cathode bias.

The number of video amplifier stages used between the CRT and detector also determines the polarity of the detector output wave-form. Since a 180° phase reversal takes place between each amplifier grid input and plate output, it can be seen that with an even number of amplifier stages, the detector output would be the same as the CRT input. Whereas, if an odd number of amplifier stages are used the detector output would be 180° phase reversed from the CRT.

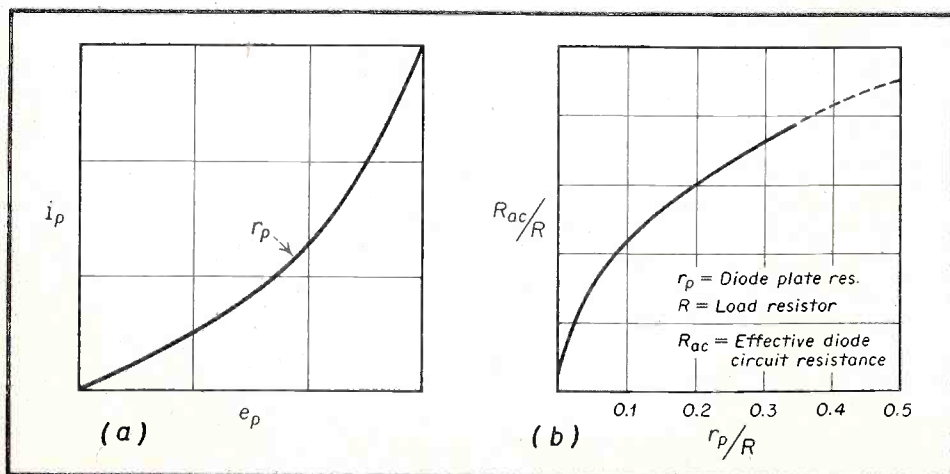

Fig. 4a. Typical plate resistance curve of a diode.

Fig. 4b. Variation of diode output with plate resistance.

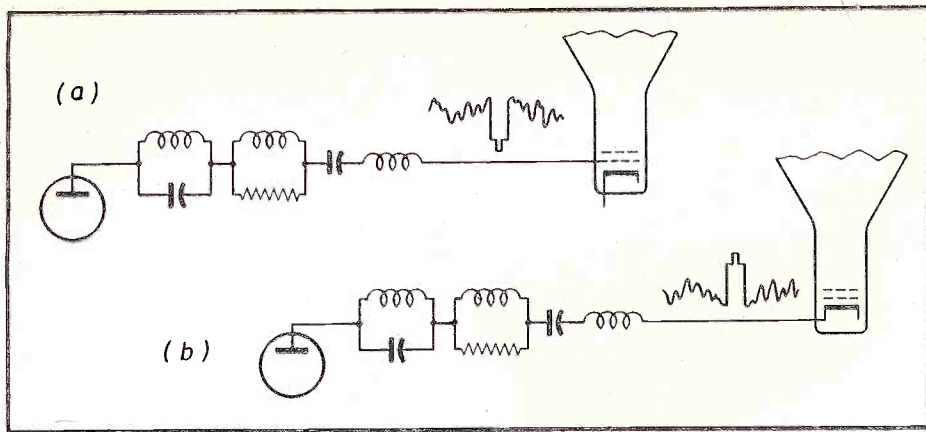

Fig. 5a. Positive picture phase circuit.
Fig. 5b. Negative picture phase circuit.

Other Detectors

In addition to diode tubes, several other methods have been utilized for video detection. In some early models, a triode was used with grid-leak detection. The limitations of this system with respect to good linear phase and amplitude response caused it to be discarded as the CRT sizes increased and with it the resolution requirements for sharply defined pictures.

A crystal has been the most frequently used alternative. Its use is limited since in a number of current designs, the video amplifier is directly coupled to the detector output. This results in the detector being above or below chassis ground (Fig. 6). This in turn can cause it to be burnt out very easily. Another drawback to the

use of crystals is the problem of back-to-front resistance. The back-to-front resistance of a diode tube is infinite since the tube will not conduct when the signal polarity is reversed. In the crystal, however, there is a finite back-to-front ratio. Therefore, there

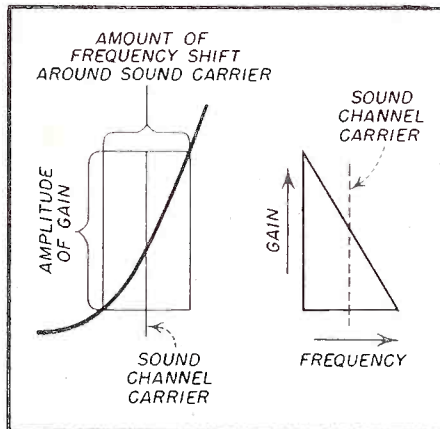

Fig. 7. Amplitude detection of FM signal with slope detection.

will be some current flow in the opposite direction. This will cause some distortion in the output.

Intercarrier Considerations

In addition to the above design considerations for video detectors, further factors must be considered when being used in TV sets of the inter-carrier type. Before going into the function of the detector in an inter-carrier system, it might be advantageous to examine the transmitted signal for those features on which inter-carrier operation is based.

The television signal transmitted in the system used in the U. S. under F.C.C. standards has to meet the following requirements:

1. That the carrier side-bands be of the vestigial single side-band mode.
2. That the video intelligence modulation of the carrier be amplitude modulated.

3. That the sound carrier be 4.5 mc removed from the carrier frequency.
4. That the sound carrier be frequency modulated.

Since in any rectifier a fixed frequency will beat with all other frequencies to produce addition and subtraction frequencies, this interaction occurs in the TV detector circuit between picture-carrier and sound-carrier. The result is the picture frequency plus or minus the 4.5 mc variations around the sound carrier. In addition, there would be amplitude detection of the FM signal as can be seen from Fig. 7. That is, there would be a variation in the amplitude of the FM signal if it were located on the slope of the i-f curve.

In the conventional split-sound system, these beat frequencies, and also any amplitude modulation which would result from slope detection is reduced to a very minor status by means of shaping the i-f curve (Fig. 8a), so that there is a 1,000:1 relationship between the pix carrier level and the sound level at the video detector. Generally, one or more traps are used in the i-f system. In addition a 4.5 mc trap is inserted between the video amplifier and the CRT to keep out any 4.5 mc beat which may have trickled in. This 4.5 mc beat if present, would show up in the picture as a series of crawling dots.

In the intercarrier system, the beat characteristic is utilized to develop the sound output. Since slope detection is undesirable, the i-f curve is established as in Fig. 8b. The step is set so that there is no slope detection and it is never more than 10%

[Continued on page 52]

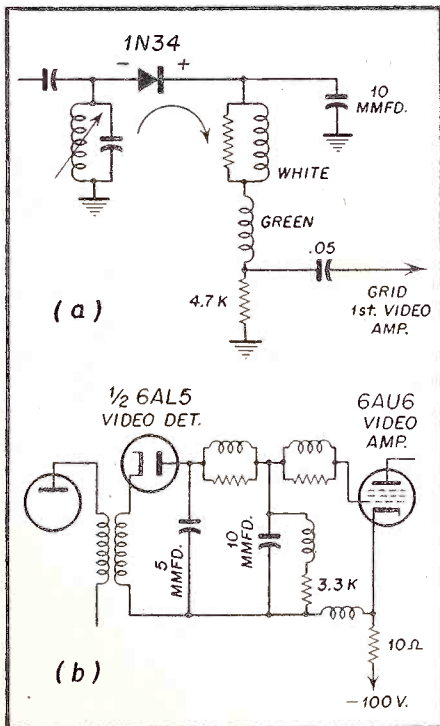

Fig. 6a. Magnavox Model 214 circuit using crystal as detector.
Fig. 6b. Magnavox Model 247 circuit using diode detector.

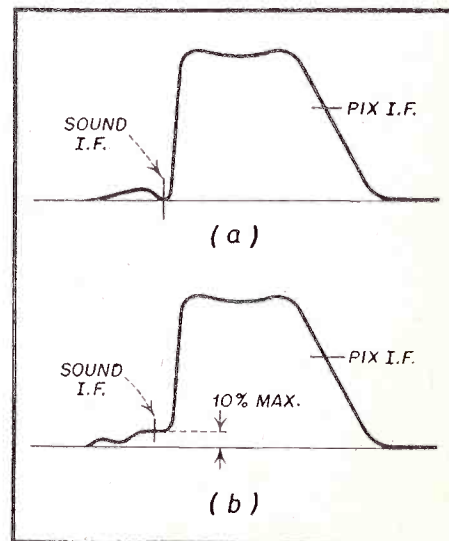

Fig. 8a. I-F response in split-sound receiver.
Fig. 8b. I-F response in inter-carrier receiver.

Here's why it saves you Centralab switches —

*You'll get the switch you want...when you want it...at one source!
Your nearby Centralab distributor offers the most complete line of
switches, kits and parts available to the industry!*

"If it's available at all — my Centralab distributor will have it."

That's what more and more servicemen are saying. And that's why the trend to Centralab is growing every day. Today's servicemen know that Centralab carries the most complete line of switches and switch parts available to the industry.

If you need standard or special-purpose switches for AM, FM or TV repair, intercom installations, P. A. systems or medium-duty power applications — your

Centralab distributor has them in stock. Single- and multi-pole. Rotary or lever action (phenolic or steatite). Shorting or non-shorting contacts.

If you are building your own switches for test gear, etc. — you'll find switch parts, indexes, kits in Centralab's standard or "DD" line that meet your requirements. And that goes for highly rated switches for custom installations or high fidelity power supply, too.

When you need switches or switch parts, make your choice Centralab — the most complete line available.

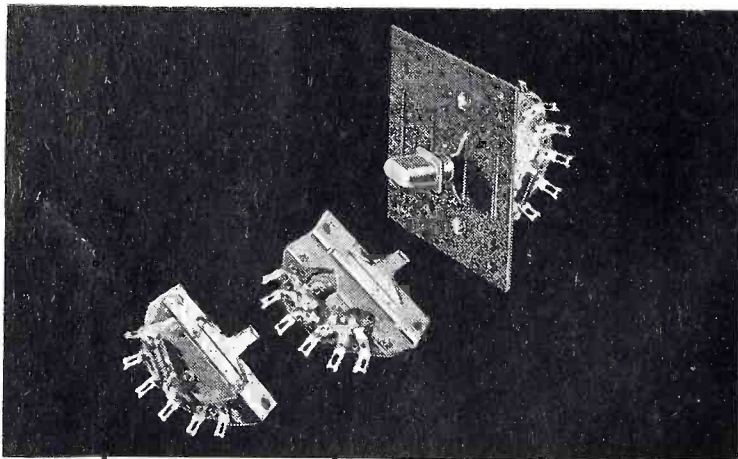

LEVER ACTION SWITCHES—for speech input equipment for line and program switching-monitoring, transceivers, band change, P. A. and intercoms, model railroad systems and industrial test equipment. Available in positive, spring return or combination. Coil spring index has minimum life of 150,000 switching cycles.

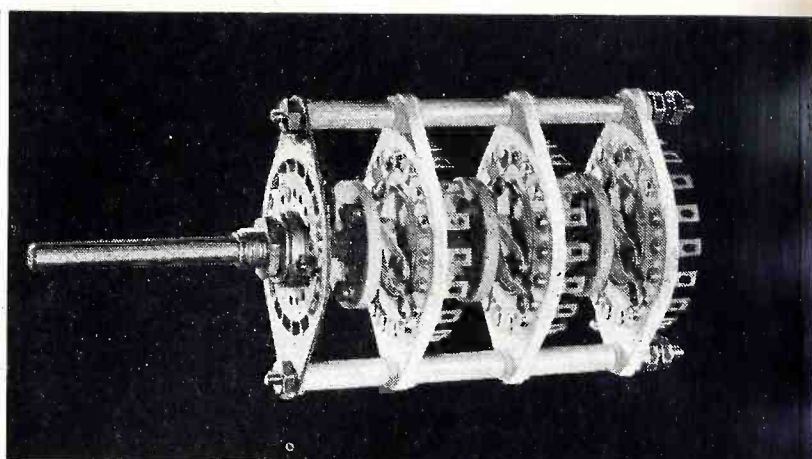

MEDIUM DUTY ROTARY SWITCH — for medium high power and excellent accuracy in transmitter, industrial control and balancing, laboratory testing, power supply converter and many other special applications. Rated at 750 watts ($7\frac{1}{2}$ amps, 60-cycle, 115 volts AC). 1, 2 or 3 poles... 18 contact sections... up to 20 sections per shaft.

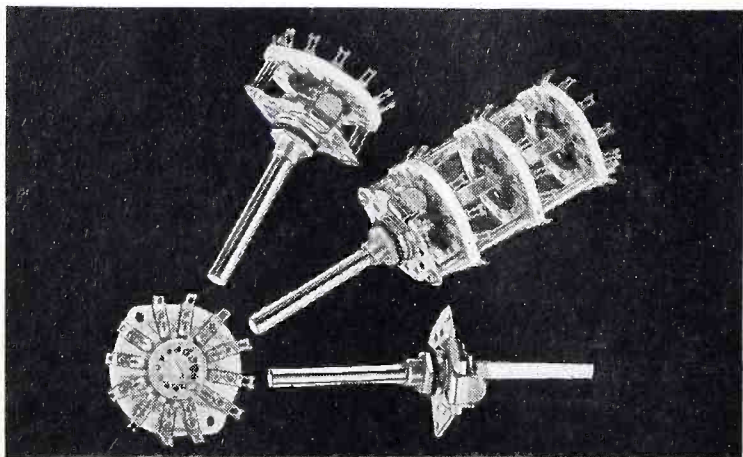

ROTARY SELECTOR SWITCHES — for use in fast, positive band switching in critical radio frequency circuit applications — in the oscillator, buffer or final amplifier stages of transmitters with input up to 75 watts and plate voltages up to 850 v.d.c. Also amateur rigs, test equipment and low current switching. Steatite or phenolic insulation.

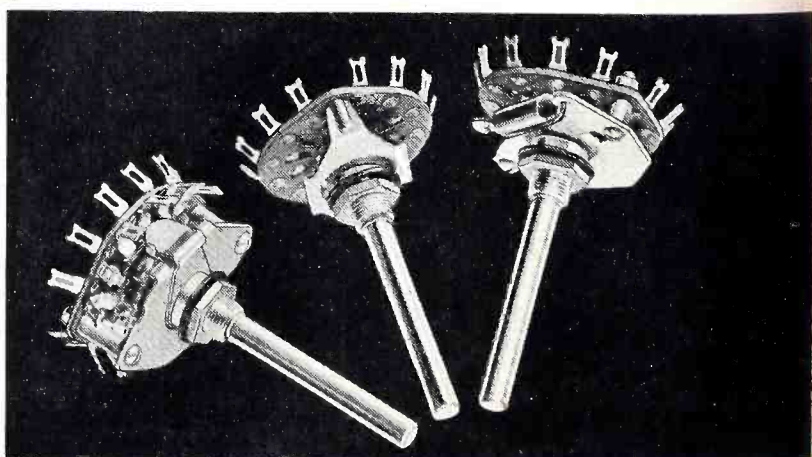

ROTARY ACTION FLAT SWITCHES—for program switching — monitoring, transceivers, band change, P. A. and intercoms. Phenolic insulation. Cadmium plated metal parts. A 4-pole, 2-position, non-shorting type with positive leaf spring index. Can be used a SPST, SPDT, DPST, DPDT, 3PST, 3PDT, 4PST or 4PDT.

time and money to buy

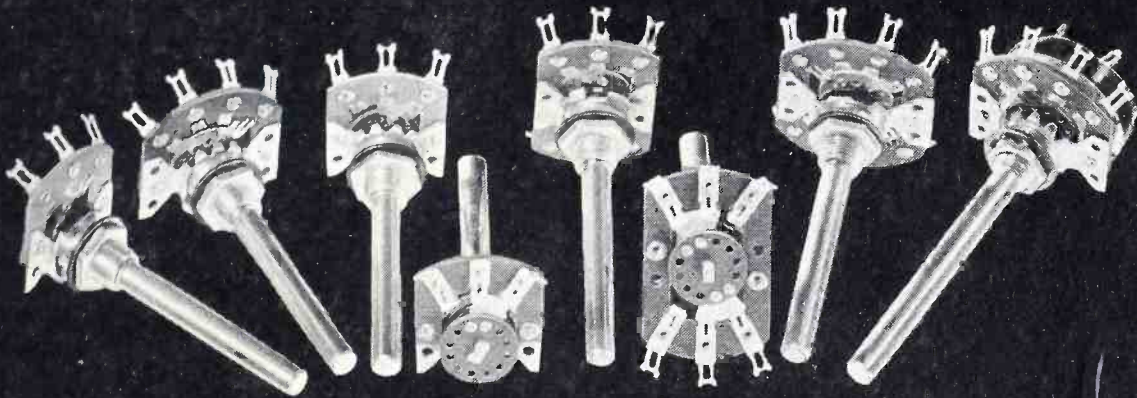

SMALL GENERAL PURPOSE SWITCHES—on-off and step control switches for radio, P. A. channel selectors, wave band, meter reversing, meter selector, intercom talk-listen,

momentary line or remote speaker return and dual auto radio speaker control. Clips and contacts heavily silver plated. Phenolic insulation. SPST, SPDT, DPST, DPDT, etc.

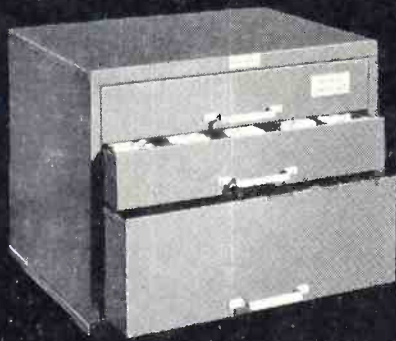

414-419 ROTARY SWITCH KITS—give you a convenient, easily available source of stock sections, indexes and hardware for assembling practically any standard or special switching arrangement desired. Contain Centralab "DD" Index and Section construction. Attractive steel cabinet, fits standard steel shelving. 17" x 11¹⁵/₁₆" x 12³/₄".

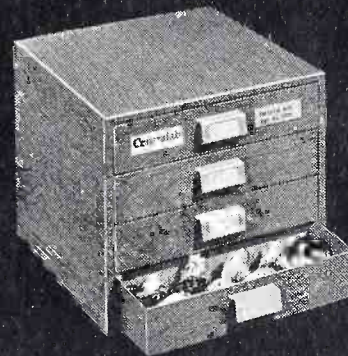

1500 SELECTOR SWITCH KIT — ideal convenience for labs, design and service engineers, industrial electronic maintenance departments, hams and experimenters. 33 standard rotary switch phenolic sections, 16 index assemblies and adequate supply of flat shafts, spacers, nuts, bolts, lockwashers and knobs. 8" x 8" x 7".

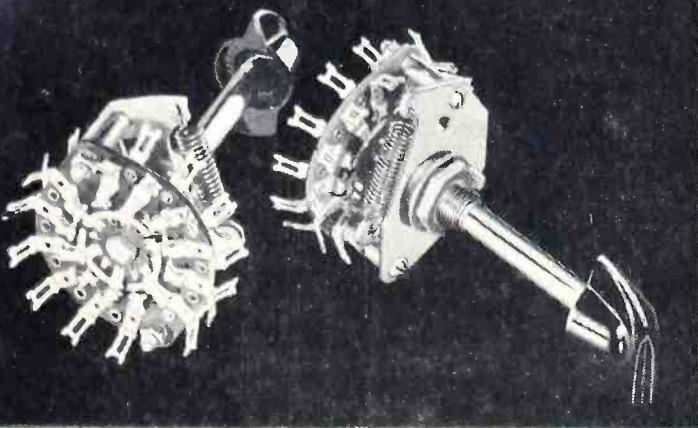

INTERCOM SWITCHES — for public address and intercom talk-listen systems. Six pole, 3 position. Available in two types — spring return from both sides to center and spring return one side, positive opposite side. For long, hard use in industrial test equipment. They are Centralab De luxe, "DD", style.

Centralab

A Division of Globe-Union Inc.
944 E. KEEFE AVE., MILWAUKEE

Get the whole story of Centralab switches for electronic and industrial uses. Write for Centralab Catalog.



Cost Considerations in CUSTOM INSTALLATIONS

by C. A. TUTHILL

The high fidelity market has grown to the extent that it is practically an industry in itself. This article deals with various type of installations from the point of view of cost factors and customer requirements.

SEVERAL firms have recently declared that custom sound installations are accounting for a continually increasing proportion of their business plus a correspondingly larger share of their profits. Such declarations can not be taken lightly. To capable sound technicians today, an increasingly lucrative market is unfolding.

There will be the customer who insists upon doing his own tinkering as compared to the one who wants merely to press a button. However, on the subject of *custom installation*, most writers agree that preferences of the prospects should be satisfied whenever practical. After all, it is *their* living-room you men are going to enter. Consider an intruder in your own.

Cost to some customers will be of no concern. To others it will be the utmost. Where cost is of great concern, the unit by unit long term scheme for partial installation may ring the bell. Separate units on individual chassis will facilitate a slow growth of the final system. An acceptable *AM* tuner, audio amplifier and associated phonograph unit may serve presently. If only the first audio stage is retained modifications may be introduced for less distortion over a wider spectrum. To this may be added an *FM* tuner on a separate chassis. Certain opinions insist that an *AM* and an *FM* tuner should never be

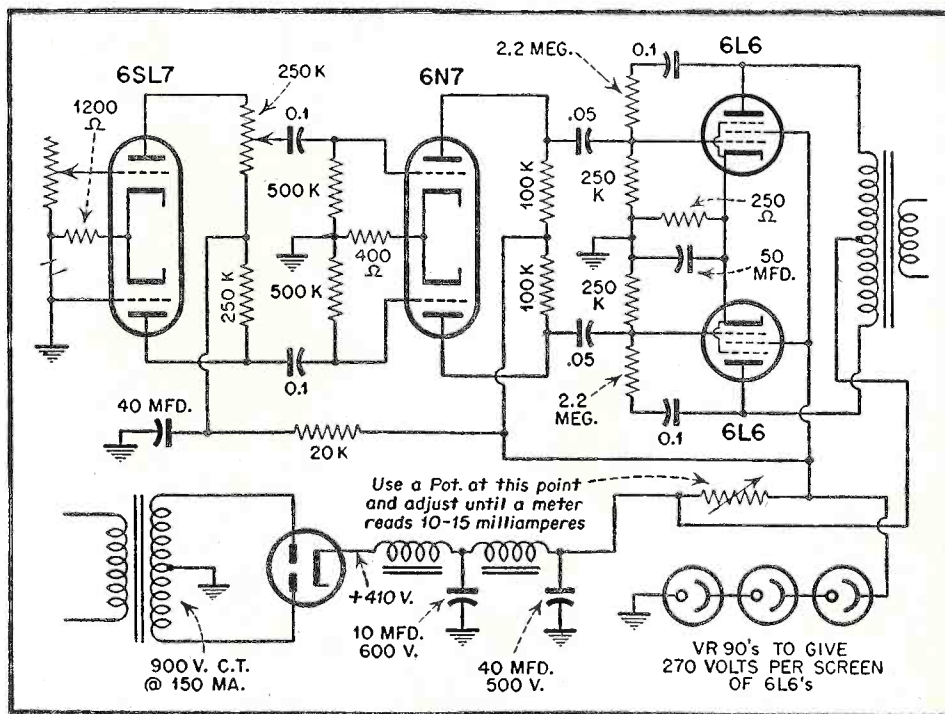

Fig. 1. Well regulated push-pull amplifier of the Miller type which serves well in the majority of installations.

mounted on a common chassis due to resultant stray capacitances. These authorities have the horrors when the *i-f* transformers for both channels are wound on a single form. In any case it is easy to sell a well regulated push-pull amplifier such as the Miller type shown in *Fig. 1*. It and the *FM* tuner

might well become two units in a final custom installation.

Arguing for custom installation, Altec Lansing declares that 30% of the cost of a console unit lies in the cost of the cabinet whereas unnecessary and bulky space-consuming furniture can be completely eliminated.

Further they state that a review of architects, home plans indicate that one out of every ten living-room designs has an ideal place for location of a concealed loudspeaker. Amplifiers, record changers, power supplies and tuners can usually be mounted in existing furniture, closets, bookcases, end tables or other convenient places where high voltage is well guarded from tiny hands.

One means of counteracting the cost hazard for apartment dwellers is to provide demountable panel units, cabinets and such, so that, despite a change of address, the owner is spreading his investment over a period of years. Cabinet or corner panel units may be mounted on castors to lend flexibility to furniture arrangement in limited quarters or in new addresses.

Where equipment is to be constantly used by critical music lovers, a substantial initial investment is indicated. In such cases the highest grade of system components must be employed from the input to the loudspeaker. The complete installation is designed with consideration for *nothing but the best* and must be adaptable, through equalization and other controls, to the individual requirement and taste. True music lovers may prove a better judge of genuine reproduction than an engineer soliciting their trade. For those who dislike an obviously single sound source, there are at least two practical approaches described in later paragraphs.

Whatever the approach or initial cost, ample facility must be provided for servicing accessibility and ventilation of heat generated by electronic equipment and motors. Emphasis is stressed at this point that all wiring must meet the Fire Underwriters' requirements. In the final analysis cost will be determined by such basic factors as,—

1. Frequency response desired.
2. Amount of distortion acceptable.
3. Power Output required.
4. Whether or not TV facilities are included.

Design Considerations

Frequency Response — It is well known that the human ear is a pressure-actuated device and that its response varies with the intensity level of the sound; that the ear is most sensitive to the 3000 to 4000 cps region and that it is least sensitive for low intensities in the low frequency region. Cost rises rapidly at the upper limiting frequency of a system if it is expanded upward beyond 5000 cps. Representative estimates are given in Fig. 2. The curve indicates costs which pertain to systems of the same power

rating. This is of concern since statistics have proven that a range between 75 and 8000 cps will provide the same perceivable frequency spread as will reproduction of the entire FM range between 40 and 15,000 cps. Evaluation then involves a personal judgment of quality. It may prove very difficult to sell a truly wide range system to customers other than those with above average acuity in tone detection. Regardless of the spread, the high and low frequency cut-offs must be properly related for the most pleasing satisfaction to any type of customer. Greater detail on this subject is well presented in the Jensen Technical Monograph No. 3.

Distortion — Because of the foregoing, the higher order harmonics are more easily discerned than the lower order harmonics. It is known that

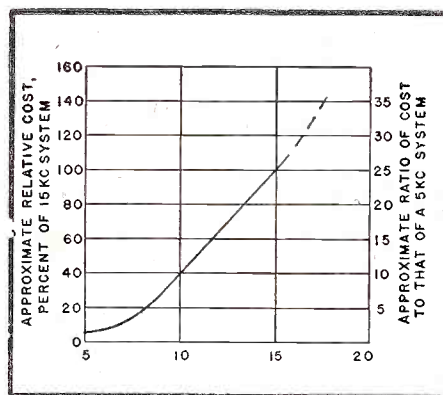

(Courtesy Jensen Mfg. Co.)

Fig. 2. Approximate relative costs of electro-acoustic and associated components of a sound reproducing system at various upper limiting frequencies.

masking of harmonics increases as the signal level increases whereupon detection of harmonics becomes less. Distortion meters may register an element to which the listener is oblivious. Subjective distortion may be perceptible, tolerable or objectionable. Personal opinion will determine tolerable or objectionable distortion. Therefore these elements become a factor of customer decision. It has been shown that a total rms distortion of 0.75% is perceptible to a few critical listeners. We may therefore say that this figure is ideal for excellent reproduction. The content of distortion generally grows with increased levels of projection and one authority has stated that for levels of 90 db, total rms, distortions of 2 to 3% are tolerable. These figures are for system distortion only. Distortion due to room acoustics is not a subject of this article.

Ref: #1—Marvin Camras, Armour Research Foundation

Power Output Required—The plate-to-voice coil transformer must reflect the proper impedance into the plate circuit to net maximum undistorted power output. It must also be of adequate proportion to handle the total load which, for the average living-room will total but one or two loudspeakers. High loudspeaker efficiency means much to final power output. Popular sound levels in the home are set for speech and often untouched for music reproduction. A survey reports these levels to average between 65 to 75 db. The power corresponding to a level of 75 db approximates 0.016 watt. Allowing for a 10 db margin, the peak power would approximate 0.160 watt. Calculation indicates that a moderate safety factor would, at this level, be derived from a ½ watt driving amplifier. Such an installation is only recommended where costs must be minimized. In contrast, most customers occasionally wish to drive their loudspeakers until the sound approaches orchestra presence whereupon the power requirements of amplifier and loudspeaker should be limited to no less than five watts. Custom installations rate reserve power but costs rise rapidly with power and in many cases a two watt output will satisfy everyone. It is readily seen that an efficient loudspeaker is a good investment.

TV Facilities — Eventually all custom installations will embrace TV facilities hence room for equipment expansion and space for picture tube mounting should be included in an original layout. Once a customer agrees to such a provision, follow-up calls are bound to pay off. It is easily proven that such inclusion is less costly than a secondary installation. Always remember that for proper illusion the loudspeaker and picture tube should be in close proximity.

Sound Diffusion

For customers without TV who dislike a single source of sound, there are several treatments. Probably the least costly for a small living-room is a single radial speaker hung centrally overhead. At greater cost, and in larger rooms, discreetly scattered flush-mount ceiling speakers can be operated at low level.

Another interesting treatment employs the *dihedral* type of speaker system reported by Camras.¹ The arrangement shown in Fig. 3, is the result of considerable experiment. An even yet diffused distribution of sound results throughout the room. Should an unbalanced acoustic condition oc-

[Continued on page 51]

ASSOCIATION • NEWS •

Local, State, and National Associations are urgently requested to send in news of their activities so that we may print them in these columns.

Society of Radio and Television

Technicians Inc.-Glendale, California

To Radio Television Service Dealer:
—We have formed a new Technicians' group in the San Fernando Valley. This is an outgrowth of the old Radio Technicians Association, San Fernando Valley Chapter, which disbanded. We received our charter and incorporation papers from the State of California early in January, and are off to a healthy start. Dinner meetings are held twice monthly, with the program being aimed directly at the practicing technician. With the first fifteen minute period being devoted to the practice of business, the remainder of the program becomes entirely technical. Meeting adjourns 10:15 sharp. Many of the members who are unable to make the dinner usually arrive later. So far we've had the banquet hall jammed. Meeting are held at Airlines Cafe banquet room, 2704 N. Hollywood Way, Burbank, California, across the street from Lockheed Air Terminal. With the meeting being run in typical service club style the speakers are strictly limited to time. Fines are assessed against any member talking or interrupting. The fines are then placed in the form of one dollar bills on a clothes line running across the room. Each meeting one name is drawn from a box containing the names of paid up members. If this member is present he takes down the wash, if not a new name will be drawn next meeting. The person who was not present will undoubtedly be told many times what he missed that night.

From the above you can see that this is truly a technicians' group, being run by the technicians themselves. However, we have other classifications, such as associate membership, which is open to non-practicing technicians, jobbers and their salesmen. Particular

encouragement is given to apprentices.

If you see fit to publish any portion of the above or rewrite it, please feel perfectly free to do so. Since your publication is well read in this area, it would reach many technicians we have not as yet reached, to everyone's mutual benefit. In this day of fast moving technical developments, public pressure, and licensing in the offing, it behooves all technicians to belong to a group and help strengthen the organized voice of the industry, which is pitifully weak. This is an invitation for any interested persons to attend our meetings. Your interested co-operation is earnestly solicited. I will keep you advised of interesting developments from time to time.

*Dell Davis, Chairman
Public Relations Committee
Society of Radio and Television Technicians Inc.
1745 W. Glenoaks
Glendale 1, California*

National Electronic Technicians and Service Dealers Association-NETSDA

Radio & TV Technicians Guild of Florida, Inc., Joins NETSDA—The regular monthly meeting of the National Electronic Technicians and Service Dealers Associations was held at the Harrisburger Hotel, Harrisburg, Pa., Sunday, March 2nd, 1952. President Max Liebowitz presided. Dinner was served at 1:00 PM after which the business of the Association was transacted.

The application of the Radio & TV Technicians Guild of Florida, Inc., was unanimously accepted and messages of congratulations were forwarded to the officers of the Florida group by the various Associations attending.

The matter of incorporating NETS-DA was acted upon. Joseph Forman, Attorney for the New York Group will file the application as a non profit

corporation with the State of New York.

National Headquarters of NETS-DA have been moved from the Dorchester House, Washington D.C., to 165 E. Broadway, New York City. Telephone: Circle 6-1861.

The Annual election of officers next took place with the following being elected:

President—Max Liebowitz of
New York City
V. President—Roger Haines of
Haddonfield, N.J.
Rec. Sec'y—Richard G. Devaney of
Philadelphia, Pa.
Corres. Sec'y—David VanNest of
Trenton, N.J.
Treasurer—T. L. Clarkson of
Harrisburg, Pa.
Sargent at Arms—John Wheaton of
Long Island

The next meeting of the Association will be held in *New York City* on Sunday, May 4th, 1952.

*Edward A. Lucas
36 Crych St.,
Kingston, Pa.*

Chairman Publicity Committee

National Alliance of Television & Electronic Service Associations

—NATESA

It has come to the attention of this office that there is pending before the United States Congress, House Bill #HR 6219 which would require the manufacturers of all electrical appliances, including radio and television, to include with each set a booklet on the repair of the appliance. Under the provisions of this Bill, the FTC could refuse to permit the delivery of any sets not accompanied by a booklet.

We believe it is imperative that every service company and serviceman write to his Representative and Senator in Congress expressing opposition

[Continued on page 50]

TRADE LITERATURE

The RCA Tube Department has released a revised edition of its novel "Triple Pindex" socket manual, in which are compiled, for ready reference by radio and television service dealers, socket-connection diagrams for more than 660 receiving tubes and kinescopes, including recently announced types.

Specially designed to provide information at a glance, the book is divided into three identical horizontal sections, each connected to the same flip-over-type binding. This arrangement enables the serviceman to refer to a single composite page for simultaneous reference to any three of the more than 660 socket diagrams, thus minimizing the necessity for leafing back and forth through the book.

The revised edition also contains a handy cross-index reference supplement which lists a variety of tube types used only occasionally by servicemen. Although socket-connection diagrams for these tubes are not indicated in the "Pindex" section of the book, reference is made in each case to another tube with an identical socket arrangement, for which a diagram is included.

The new "Triple Pindex" is priced at 75 cents, and is available from all RCA tube distributors and from the Commercial Engineering Division, RCA Tube Department, Harrison, N. J.

* * *

Rider Tek-File, monthly packaged service data, published by John F. Rider Publisher, Inc., 480 Canal St., New York, N. Y., offers the TV servicing trade eight new Tek-File Packs containing 222 TV models. With the release of the new Packs, 49 through 56, servicing data on 2,196 TV models are available in Tek-File form. This comprehensive coverage of factory-authorized TV receiver servicing data has been released during the four months the Tek-File program has been in effect.

* * *

A report "The Impact of TV Expansion", was prepared by a "task force" committee of the RTMA Television Committee under the chairmanship of William H. Chaffee, vice president and director of purchasing, Phil-



"You—and your ideas in furniture—!"

co Corp. The "task force" committee was appointed on November 2 by Dr. W. R. G. Baker, chairman of the RTMA Television Committee, to determine what the effect on materials and manpower would be if the TV "freeze" were lifted. The "task force" committee also was directed to explore the effect on industry if the freeze were not lifted for a further extended period of time.

* * *

The detailed contents of each of the 38 chapters in the first two volumes of the new Ghirardi Modern Radio & Television Servicing Library are described in detail in two new illustrated circulars just issued by Rinehart Books, Inc., 232 Madison Avenue, New York 16, N. Y.

These new books, 669-page *Radio & TV Receiver Troubleshooting and Repair*, and 822-page *Radio & TV Receiver Circuitry & Operation* by Ghirardi & Johnson, provide a gold mine of up-to-the-minute, practical circuitry and servicing information that is invaluable in today's TV and Radio receiver service work. Free copies of these circulars are available from the publishers.

* * *

Philco Corp., Phila. Pa., makes available four new handbooks: PR 1946 — *Alignment Techniques*; PR 2132 — *Trouble Shooting Techniques*; PR 2131 — *Cabinet Repairing and Refinishing*; PR 2114 — *Record Changer Handbook*.

* * *

Sun Radio & Electronics Co., Inc., 122-124 Duane St., N. Y. 7, N. Y. makes available its new *Catalogue No. 52* of radio and electronic supplies.

* * *

General Electric Company, Receiver Part Sales, Electronics Park, Syracuse, N. Y. makes available its brochure, "Why Variable Reluctance," a technical treatise on G.E. phono accessories.

* * *

Andrew Corp., 363 East 75 St., Chicago 19, Ill., makes available its new *Bulletin 10-E*, a general price list of its products.

A new four-page bulletin has been prepared on *Stupakoff Printed Circuits*. Copies of *Bulletin 1151* may be obtained from Stupakoff Ceramic and Manufacturing Company, Latrobe, Pa.

* * *

University Loudspeakers, Inc., 80 South Kensico Ave., White Plains, N. Y. makes available its "Technilog", a catalogue of its products combined with a compilation of useful information that explains and simplifies the application of loudspeakers.

* * *

The latest volume in *Rider's Television Manual series, Volume 9*, is now in production. The distributors of John F. Rider Publisher, Inc., 480 Canal St., New York, N. Y., will receive shipment of this 2,112 page (8½ x 11) manual in April.

Over 40 manufacturers contributed their factory-authorized servicing data for the period October 1951-February 1952. Much of the data represents the 1952 lines. Resuming from the point where TV Manual Volume 8 leaves off, the latest manual, 12 x 15 inches in size, includes unabridged manufacturers' servicing information on all models. All pages are filed in their proper places enabling the TV service technician to use the volume immediately. A single index covering all nine of the Rider TV Manuals makes all models accessible instantly.

Full coverage is given to the manufacturers' various production runs and chassis modifications. Pilot run and modified schematics are shown. Also included are chassis views, voltages, resistance readings, complete alignment procedures, troubleshooting waveforms, complete parts lists and values, test patterns, boosters, tuners, and a special section devoted to manu-

[Continued on page 49]

PERSONNEL NOTES



Sylvania Electric Products Inc. announces the appointment of *George L. Loomis* as Manager of the Radio Tube plant at Burlington, Iowa.

Mr. Loomis succeeds *Walter A. Weiss*, Sylvania's first Plant Manager at Burlington, who has been appointed General Manufacturing Manager of the Radio Tube Division, with headquarters at Emporium, Pa.

Walter A. Weiss has been appointed General Manufacturing Manager of the Radio Tube Division of Sylvania Electric Products Inc., it was announced by *Matthew D. Burns*, General Manager of the Division.

W. H. Lamb, General Manager of the Television Picture Tube Division, announced the appointments of *Willis C. Toner* as Manager of the plant at Seneca Falls, N. Y., and of *Gordon L. Fullerton* as Manager of the plant at Ottawa, Ohio. Mr. Toner previously was Plant Manager at Ottawa and Mr. Fullerton was Manufacturing Superintendent there.

James J. Sutherland, General Manager of the Electronics Division, announced the appointment of *Homer D. Broker* as staff assistant to the divisional Manufacturing Manager. Mr. Broker, whose headquarters will be in Boston, Mass., formerly was Plant Manager at Seneca Falls.

Louis B. Calamaras, executive vice president of National Electronic Distributors Association, was appointed a member of a special Wholesale Trade Advisory Committee which is to meet with *Charles Sawyer*, secretary of the United States Department of Commerce, February 20, Washington, D. C.

John T. Harrington has been appointed a Regional Manager for General Electric communication equipment, it has been announced by *Lacy W. Goostree, Jr.*, communication equipment sales manager.

Mr. *John Q. Adams*, Vice President in charge of sales of Hytron Radio & Electronics Co., A Division of Columbia Broadcasting System, Inc., Salem, Massachusetts, announces the appoint-

ment of *Mr. Louis H. Niemann* as Eastern Sales Manager. Mr. Niemann is taking the place of *Mr. Fred Garcelon* who has been promoted to Assistant to Mr. Adams.

Permoflux Corporation assigns as its new representative for the Missouri Valley territory the *L. F. Waelterman Company* which was formed November 1, 1951, as Manufacturers Representatives covering Missouri, Kansas, Iowa, and Nebraska (except counties of Sioux, Scotts Bluff, Banner and Kimball).



Russell C. C. Dubois, Jr., has been appointed sales manager for RCA mobile and microwave communications equipment, it was announced by *A. R. Hopkins*, General Sales Manager of the RCA Engineering Products Department.

Mr. Dubois succeeds *Dana Pratt*, who has moved into the position of product manager for RCA broadcast transmitters.

In addition to Mr. Dubois' appointment, Mr. Hopkins also announced the promotion of four communication field sales representatives to the rank of district supervisors. They are: *H. G. Boyle*, for the eastern region; *O. H. Mackley*, southwestern region; *F. C. Gusler*, central region; and *S. J. Coombs* western region.

The announcement of several new appointments within the Bendix Tele-

vision and Broadcast Receiver Division, Bendix Aviation Corporation, was made known by *R. W. Fordyce*, General Sales Manager.

L. D. Shiplett formerly assistant service manager has been appointed to the post of Service Manager. With Bendix Radio for the past 11 years, he served as inspection supervisor in the Communications Division prior to his connection with the Television Division. He is being succeeded by *C. E. Bowers*, former field service engineer who has been appointed Assistant Service Manager.

It was also announced that *M. Fagan*, formerly associated with the styling department as liaison engineer, has become assistant to *W. P. Muller*, Product Manager of the Television Division, coordinator of the activities covered in these new appointments.

Promotion of five top members of the Instrument Division, Allen B. Du Mont Laboratories, Inc., to new key posts within the division, was announced by *Rudolf Feldt*, Manager of the Du Mont Instrument Division, at its national headquarters, 1500 Main Avenue, Clifton, New Jersey.

The five appointees and their new posts are as follows:

Dr. P. S. Christaldi, 132 Squire Hill Road, Upper Montclair, New Jersey, has been named Assistant Division Manager. He was formerly Engineering Manager.

G. Robert Mezger, 617 Beverly Road, Teaneck, New Jersey, has been named Engineering Manager. He was formerly Technical Sales Manager.

Emil G. Nichols, 13 Grant Avenue, Clifton, New Jersey, has been appointed Technical Sales Manager. He was formerly Assistant Technical Sales Manager.

Melvin B. Kline, 267 Santiago Avenue, Rutherford, New Jersey, and *William G. Fockler*, 78 Chestnut Drive, Packanack Lake, New Jersey, have been appointed Assistant Engineering Managers. Mr. Kline is the former head of the Special Projects Section

[Continued on page 49]

SHOP NOTES

Write up any "tricks-of-the-trade" in radio servicing that you have discovered. We pay from \$1 to \$5 for such previously unpublished "SHOP NOTES" found acceptable. Send your data to "Shop Notes Editor."

Admiral—Reducing Picture Smear—21B1 Series Chassis

We have had a few field reports on picture smear or poor picture definition. When investigating these reports, we found that the receivers were being tuned incorrectly due to 4.5 mc beat interference being present in the picture when the tuning control was tuned to best picture position. The natural tendency was to tune the set to eliminate the 4.5 mc interference in the picture, but this resulted in incorrect setting of the fine tuning control for best picture.

To reduce or eliminate 4.5 mc interference in the picture, the following is recommended; also see partial schematic below. Note: Some later production sets may have this change incorporated.

The following video amplifier circuit changes are required to reduce picture smear (Components drawn in dotted lines should be used only if peaking coils 73A11-1 and 73A5-14 are not available.)

1. Remove peaking coil L304 (part number 73A5-9) and replace it with peaking coil, part number 73A11-1. Peaking coil 73A11-1 has a three pi winding.

If part number 73A11-1 is not available, use two 73A5-9 peaking coils

connected in series, with short leads, so that the coils are not more than $\frac{3}{4}$ inch apart. Connect a 22,000 ohm, $\frac{1}{2}$ watt resistor (part number 60B8-223) across this two coil assembly.

2. Remove peaking coil L303 (part number 73A5-13) and replace it with peaking coil, part number 73A5-14. Peaking coil 73A5-14 is coded with a blue dot.

If part number 73A5-14 is not available, part number 73A5-13 should be left in the receiver and a 33,000 ohm, $\frac{1}{2}$ watt resistor (part number 60B3-333) should be wired across it.

3. Connect a series resonant trap L308, part number 72B99-3 (used in 20T1 receivers), between pin 4 of V305 (6AC7) and chassis ground.

Mount the trap in the chassis hole located between tubes V305 (6AC7) and V403 (12AU7, with the 6.8 mmfd. condenser C322 connected to pin 4 of V305.

4. The trap should be tuned by watching the picture and adjusting the slug for minimum 4.5 MC interference. If greater accuracy is required, the trap should be adjusted in the following manner.

(a) Using clip leads, short circuit pin 1 of V201 (6AU6) to chassis ground and connect a 50 mmfd.

condenser between pin 8 of V305 and pin 7 of V201.

(b) Set the channel selector to a TV station having the strongest signal. Tune the fine tuning control for loudest sound. Using a non-metallic alignment screwdriver, carefully adjust the trap slug for minimum sound. Warning: Do not attempt to adjust the 4.5 MC trap by using a grid dip meter since the reading will not be correct.

Admiral Corporation
Service Division

Spotting TV Focus Trouble

Some video receivers will operate nicely for a half-hour or so, then jump slightly out of focus to the point where the focus control is helpless to rectify this condition. Checking by any routine method generally fails to uncover this intermittent fault.

Go over the various components with a rubber mallet, striking each part briskly and ending up with the focus coil itself. Almost invariably it is here that the elusive trouble will be located, and not because it is shorting out to its base!

What happens is that a bad focus coil shorts out between turns *only* after the wire has heated to the point where it expanded and loosened enough to vibrate from the speaker sound.

Henry Josephs
Gardenville, Pa.

Repairing G. E. Vibrators

Many of the G.E. or the ribbed type vibrators on some of these new automobile car sets are being replaced without thought of examining them. Remove the can and 9 out of 10 are found to be dead because the leads from the prongs are spot welded on. This hardens the copper and causes it to snap, putting the vibrator out of service. A neat repair here and with solder instead put in back and the vibrator is no longer defective.

Submitted by:
Beckham's Radio Shop
Waxahachie, Texas

Silvertone 132-841

Intermittent

The intermittent operation of this set on FM proved to be quite a headache. When the set was turned on after not being operated for some time it would play very well. After playing for ten minutes or so the station to which you were listening would suddenly be replaced by the customary hiss of a no signal FM receiver.

A VTVM placed on the grid of the

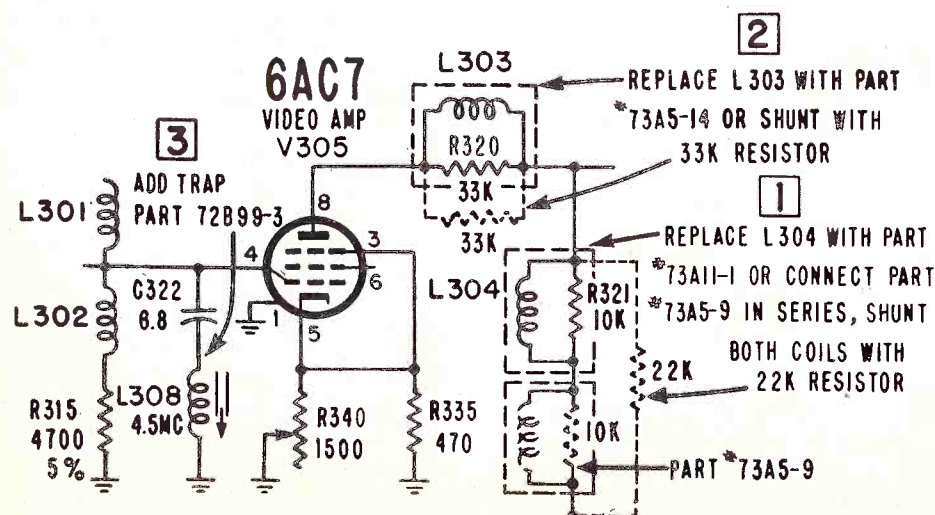

Circuit changes required to reduce picture smear in Admiral 21B1 Series chassis

[Continued on page 49]

CIRCUIT COURT

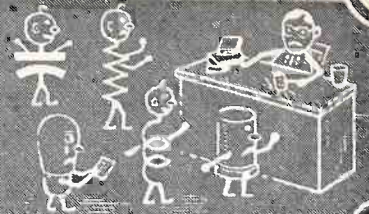

Rembrandt Model No. 721

D-C Restorer, A.G.C., and Sync Take-off

In the Rembrandt Model #721 (Fig. 1) we find an unusual use of diodes. Instead of the usual sync take-off point and peak a-g-c network, the output of the d-c restorer is employed.

The d-c networks are comparatively simple to follow. The plate and screen of V8 (6AG7), the video amplifier, are returned to B+ through suitable load resistors. The d-c path of V7 is through R35 to the cathode and from the plate through R34 to ground. Further examination will show that this particular network is not quite so simple. V23A is biased by the negative voltage across R34 and the voltage appearing at C58. When it conducts its d-c path is through R101 and R5.

V23B is a clamp across the a-g-c line to insure that the line will not go positive. In the event that a positive voltage starts to appear across R101, the point at which it is connected at R5 will start to appear positive. When this occurs, the top of R5 appears positive and V23B starts to conduct. The conduction path of V23B is such that it bucks the positive voltage. A resultant negative or zero voltage appears on the a-g-c line.

Now let us examine the dynamic a-c operation of this circuit. The video signal appears across R41 the video amplifier plate load resistor. The signal is fed to the cathode of V7 through R42 and C44. Since the signal appears as a complex sine-wave, the tube only conducts on the half of the signal which is negative in reference to the average d-c level of the signal (Fig. 2). By average d-c level is meant the level

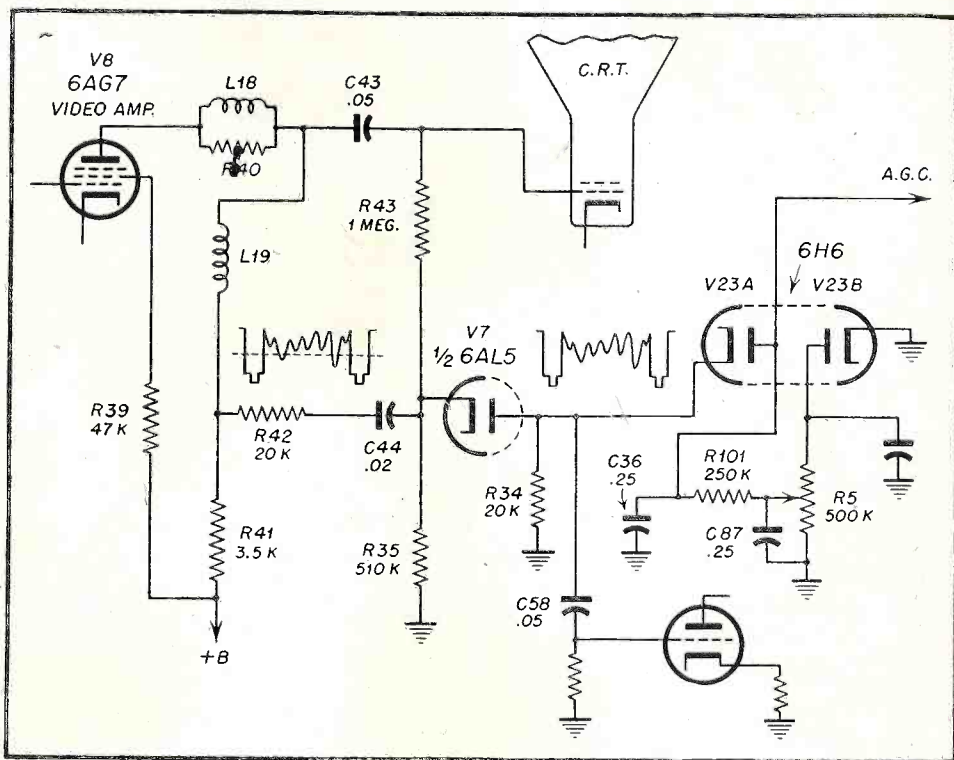

Fig. 1. Partial schematic of Rembrandt Model 721, illustrating d-c restoration, a.g.c., and sync take-off. Latter is taken off plate of V7 (6AL5) through C58 (.05).

at which the sum of the voltages in the positive direction equals the sum of the voltages in the negative direction during a given time period.

This average voltage is impressed on C44 which charges very slowly. R43 in grid circuit of the CRT is connected to the junction of the V7 cathode and C44. The negative voltage is thus impressed on the grid of the CRT and, thereby, sets its bias. It can be seen that this bias will vary with the average d-c level of the video signal. This in turn is a function of the over-all brightness of the picture.

The average d.c., which is the over-all background brightness of the scene, is added to the signal by means of the d-c restorer and appears in its correct value in the picture.

Let us continue to follow the a-c signal wave shape which results because of the action of the diode in dividing the wave form at the average d-c level. Since V7 conducts only on those portions that go negative there appears across R34 the diode load resistor, the portion of the original wave form containing the sync pulse, some of the blanking pulse and a small portion of the video signal. Thus the circuit serves to supply a take-off point for the sync amplifier. It will be noted that this method of operation also separates the sync pulse from most of the video making sync operation simple. V23A will conduct as soon as the signal appears across R34. The electron source comes from C58 and the tube conducts through R101 and R5 to ground. R5 determines how much voltage is dropped across the circuit and

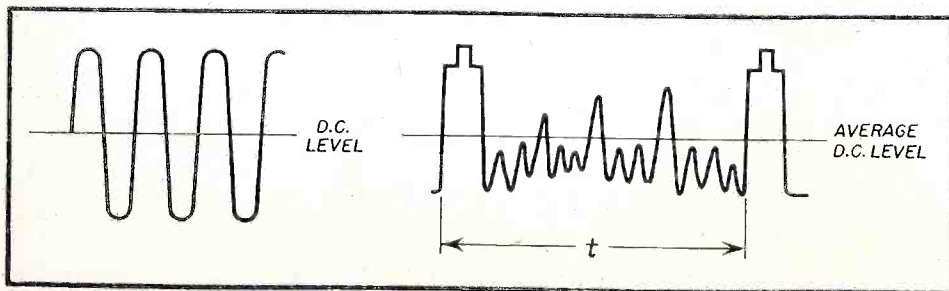

Fig. 2- D-C level and average d-c level.

It's Here!

TV9

The latest Rider Television manual designed to make your TV servicing easy. Large, easy-to-follow schematics — lots of photos — troubleshooting test patterns — waveforms — complete factory parts lists — enlarged chassis views — circuit changes — everything you need to do a fast, easy and thorough servicing job!

With a Rider TV Manual you eliminate call-backs and repairs are positive and final . . . because for each set you service, Rider provides you with all the factory-issued data direct from the manufacturer. No one knows his receiver better than the manufacturer who made it. Nothing cut — nothing edited . . . everything is organized and indexed for speed and accuracy.

Rider's TV9 contains more than 2,000 pages (8½ x 11") covering new models\$24.

BUY IT AT YOUR JOBBER'S

Note: A complete Rider TV manual and radio manual shelf is the solution for all your servicing problems. They make servicing easy! Get these vital editions at your jobber's . . . today.



JOHN F. RIDER

PUBLISHER, INC.

480 Canal St., N.Y. 13, N.Y.



NEW PRODUCTS

TAPE RECORDER HEAD

Shure Brothers, Inc., Chicago, announced the Shure TR-16, a low-cost magnetic tape recording head which makes available to manufacturers of tape recording equipment, high-quality reproduction in even the most moderately priced equipment.

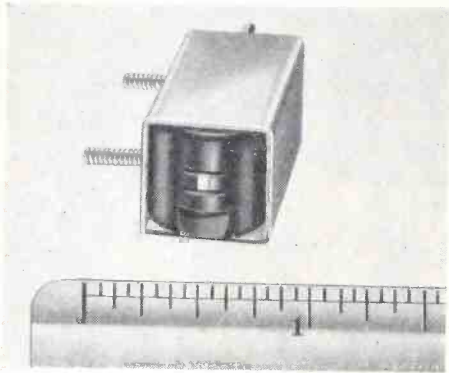

Features of the Shure TR-16 include excellent frequency response; compactness (.765" wide by .845" long by .609" thick); precision-controlled track width—may be furnished with a track of from .025 to .100 inches; flexibility of mounting, using standard 2-56 mounting screws, and may be adapted to specific mounting bracket or used with Shure mounting bracket which provides vertical and angularity adjustments.

The Shure TR-16 may be used for multiple-track applications; utilizes Shure pin-jack pin-terminal combination method of attaching leads; is ideal for use with pre-recorded tape; is recommended for use in dictating or low-cost playback machines, and has effective mu-metal shielding for optimum hum reduction and simplification of placement of hum-producing components. The TR-16 is designed to provide low-cost production assembly and simplify field replacement.

TORROIDS

The Raytheon Manufacturing Company of Waltham, Massachusetts, announce that they have complete facilities for large volume production, as well as for engineering design and production of Torroids.

More than ten years experience in designing and building Torroid-L units enables Raytheon to design Torroid-L-Coils from the problem up, or wind to specified C.L. and Q. values... precision wound on temperature stabilized, powered permalloy cores, high permeability solid materials or stamped "O" cores. They

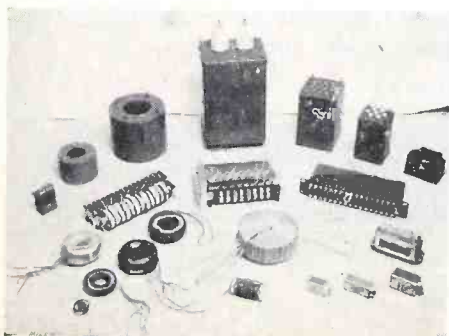

are able to wind #20 to #42 wires on "welding ring" cores to small ultimate I.D.

Raytheon is one of the few sources equipped for litzendraht coil windings. In fact, facilities for all types of winding are available including square coils from strip materials for improved geometry.

HI-FIDELITY SPEAKERS

Oxford Electric Corporation, announces the newest Oxford development... a Hi-Fidelity Speaker group.

The units constitute a complete cross-section of Hi-Fidelity speakers, applicable to all types of installations calling for extended-range, power handline speakers.

The Hi-Fidelity speakers are individually boxed... the finest Hi-Fi Speakers at nominally low cost.

Included are: 8" speaker, Model # HF8JB, 6.8 oz. magnet, 10 power handling watts maximum, 1" voice coil diameter; the 10" Hi-Fi, Model HF10JB also has a 6.8 oz. magnet, 10 power handling watts maximum, and 1" voice coil diameter; there are two 12" models... Model HF12JB with 6.8 oz. magnet, 10 power handling watts max., 1" voice coil diameter... the other 12" speaker Model HF 12LN has 14.0 oz. magnet 25 power handling watts max., and 1½" voice coil diameter.

Each of these speakers has a voice coil impedance of 8 ohm. The list prices vary and these new speakers are available at leading jobbers.

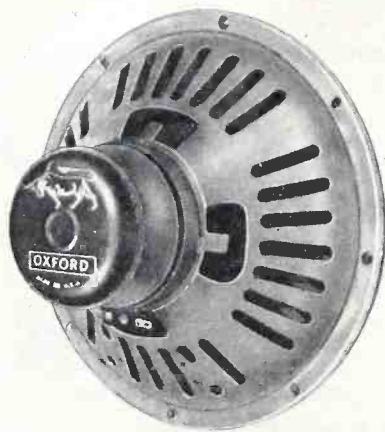

For further information, illustrated literature, and special data... write, Oxford Electric Corporation, 3911 South Michigan Avenue, Chicago 15, Illinois.

LOW VOLTAGE - ELECTROSTATIC FOCUS CRTS

Just announced by the RCA Tube Department are two new types of rectangular picture tubes utilizing low-voltage electrostatic focus and magnetic deflection. They are the 20MP4, a 20-inch glass kinescope, and the 21MP4, a 21-inch metal-shell kinescope.

The 20MP4 has a spherical Filterglass faceplate; an external conductive bulb coating which with the internal conductive coating forms a supplementary filter capacitor; a screen size of 17-¼" x 13¼"; and a weight of 27 pounds approximately.

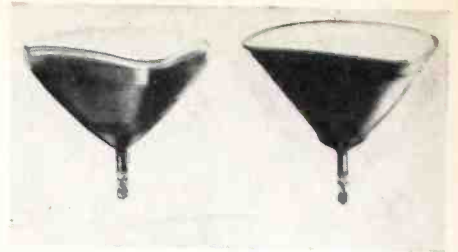

The 21MP4 has a spherical, frosted Filterglass faceplate; a screen size 18¾" x 14"; and a weight of about 18 pounds.

Both types have a design-center maximum ulior-voltage rating of 16000 volts; an ion-trap gun requiring an external, single-field magnet; a diagonal deflection angle of 70°; and a horizontal deflection angle of 66°. The focusing electrode in each type has its own base-pin terminal so that designers can have a choice of focusing voltage for best results. The voltage for the focusing electrode can be obtained from the low-voltage dc supply of the receiver.

TV CRYSTAL CONTROLLED CALIBRATOR

Accurate to .05%, the Model 680 is a crystal calibrated standard for use in the shop, laboratory and factory, to check oscillators, generators and front-end or overall response curve



of a television receiver; or as a crystal calibrator to check the calibration of any signal generator. A built-in heterodyne detector and magic-eye tube provides a zero-beat indicator for most accurate calibration. Designed to rapidly solve TV tuner alignment problems to a crystal accuracy of .05%.

For complete information write to The Hickok Electrical Instrument Co., 10533 Dupont Avenue, Cleveland 8, Ohio. Ask for Form: 680.

CRT REACTIVATOR

Transvision Inc., of New Rochelle, N. Y., announces release to the television industry of its new CR Tube Reactivator.

Weighing only 3 lbs., this portable instrument plugs into any convenient 110 V receptacle. It is self-powered and completely self-contained and independent.

The reactivation of the CR Tube can be done in the customer's home, if necessary,





RCA
Quality-Engineered Speakers
COST NO MORE

6" x 9" Field-Coil

5" PM

8" PM

12" PM

Famous RCA-515S2 15" Duo-cone high-fidelity speaker

A complete line of quality speakers from one dependable source

RCA *quality-line* speakers employ *full-size Alnico V magnets* for top efficiency and performance... yet they are popularly priced for replacement needs. You'll find a PM or field-coil type to meet virtually every requirement for home and auto radios, for television receivers, as well as for public address and high-fidelity systems.

From the miniature 2" x 3" to the superb 15" Duo-cone—each RCA *quality-line* speaker is skillfully designed, fabricated from the finest materials, and produced under the most rigid quality-control methods.

RCA *quality-line* speakers offer you a better selling potential, because they're backed by the greatest

name in radio—a name that insures unqualified customer acceptance.

Look to RCA—and your *RCA Parts Distributor*—as the dependable source for *all* your speaker requirements.

Get the Handy RCA Flip-Up Speaker Index

Here are all the electrical and mechanical specifications on the complete line of RCA speakers—right at your fingertips. Get your free copy today from your *RCA Parts Distributor*.



RADIO CORPORATION of AMERICA
ELECTRONIC COMPONENTS **HARRISON, N. J.**

without removing the picture tube from the TV set. In the majority of cases the reactivation is complete and permanent, amounting to a virtual rejuvenation.

In brief, the history of CR Tube degeneration follows this pattern: Gases are released by tube elements and casing walls after prolonged heated operation. These gases combine with the pure barium on the surface of the cathode, poisoning the cathode so that electrons are no longer emitted from the surface.

The Transvision CR Tube Reactivator gives a full complex reactivation complete with short aging cycle . . . Then it is completely removed and the tube is replaced into service. The instrument is priced at \$14.95 net. Full instructions and theory of operation accompany each unit.

For further information, write Transvision Inc., Dept. DG, New Rochelle, N. Y.

TUBE RACK

A newly-developed tube rack for radio and television receiving tubes is now available to servicemen through General Electric tube distributors, the General Electric Tube Department announced today.

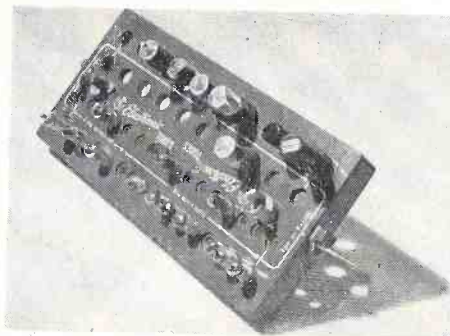

The new serviceman's aid, known as a "tube-saver," contains holder for as many as fifty-two tubes, including 22 seven-pin miniatures, ten nine-pin miniatures, and 20 octal base tubes. A special tempered rubber insert in each tube holder secures the tubes tightly in place no matter which way the tubesaver is tipped.

The tubesaver also includes pin straighteners for seven and nine-pin miniatures.

The tubesaver can be set flat on the table or tilted into an easel position with the help of the carrying handle which can also be used to support the tubesaver at an angle.

The tubesaver can be used on the service bench as a holder for the serviceman's test tubes, as a tube holder for use at the tube tester, and to maintain correct tube order when testing all tubes in a TV receiver.

INDOOR TV ANTENNA

Bearing a list price of \$1.95, a brand new indoor television aerial has just been introduced to the trade by Snyder Manufacturing Company of Philadelphia, makers of radio, television and automotive accessories.



Designated the P-TZ, the new Snyder indoor television aerial is an all-channel model with all-day orientation. The P-TZ comes complete with a 42" twin-x cable and features 4 telescopic dipoles, mirror finish and a topple-proof heavy cast base of modern design to make it blend attractively with the television set and room furnishings.

The Snyder P-TZ will be sold only through authorized Snyder distributors and gives the trade a quality television aerial at a highly competitive price.

MASTER ANTENNA CHANNEL SEPARATOR

A new Channel Separator manufactured by Technical Appliance Corporation, Sherburne,

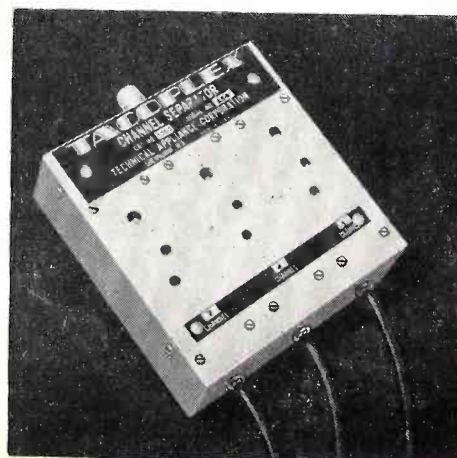

Consumer Demand

Makes The Turner TV Booster

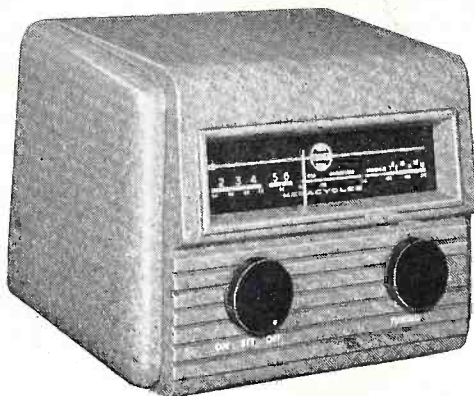

a RED HOT profit item!

When Jack Jones installs a Turner Booster in a fringe-area home it doesn't take long for the word to get around . . . "Jack Jones has the best reception in town!" When that happens, brother, make sure you're stocked up on the Turner Booster!

Simple but effective word-of-mouth advertising will sell more Turner Boosters for you than all the direct mail, newspaper space or radio time you can buy.

In city after city, TV installers are turning to the Turner Booster — recommending it to solve their knottiest fringe area reception problems. They have discovered that Turner's low-noise-level Cascode circuit stabilizes the picture, reduces noise and snow to a minimum, and produces a good picture when many other boosters are unable to even lock the picture in!

Place an order with your Jobber or write direct. You'll soon be convinced that the Turner Booster is the hottest profit item in your store.

List Price **\$57.50**

THE TURNER COMPANY

937 17th Street N. E. Cedar Rapids, Iowa

IN CANADA:
Canadian Marconi Co., Ltd., Toronto, Ont., and Branches

EXPORT:
Ad. Auriema, Inc., 89 Broad St., New York 4, N. Y.



This Amazing MAGNA-TIP SCREW DRIVER!

4 Screw Drivers in 1

Yours
FREE!

...with every 100 Sylvania
Receiving Tubes or 4 Picture Tubes
purchased between April 1st and May 15th

"SAVES HOURS
IN RADIO
AND TV WORK!"

It's the greatest time-saving tool you ever saw! Just slip the right-sized bit in place and a permanent Alnico magnet charges the bit...holds both your bit and screw in place for fast, easy, one-hand operation.

Lifetime quality

Made of fine tool steel, this slim-shaft driver is 8½ inches long. Equipped with 2 Phillips and 2 slotted bits, (3 bits in handle compartment and one in shank). And the shank itself is a power driver for ¼-inch hex-head screws.

You get it FREE when you buy 4 Sylvania TV Picture Tubes or 100 Sylvania receiving tubes. But, better hurry! Offer closes May 15th. Your Sylvania Distributor is the man to see . . . TODAY!

"NEVER LOSES
ITS MAGNETIC
GRIP!"

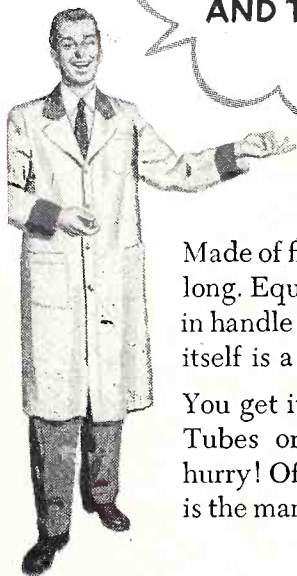

SYLVANIA



RADIO TUBES; TELEVISION PICTURE TUBES; ELECTRONIC PRODUCTS; ELECTRONIC TEST EQUIPMENT; FLUORESCENT TUBES, FIXTURES, SIGN TUBING, WIRING DEVICES; LIGHT BULBS; PHOTOLAMPS; TELEVISION SETS

N. Y., for use with the Tacoplex Master Antenna Distribution System in community installations, is now available through Tacoplex distributors. The new unit is available as a two-channel model designated as Cat. No. 1512, or a three-channel model designated as Cat. No. 1513.

The new Channel Separators feature a high transfer of energy with extremely low loss. The purpose of these units is to separate the television channel signals traveling along a common transmission line and feed the separated signals through individual outputs to their respective amplifier strips. Such units are employed in a community system at all "booster stations." The basic principle of the unit is to provide proper termination of the transmission line and to select the proper channel without amplification of adjacent channels.

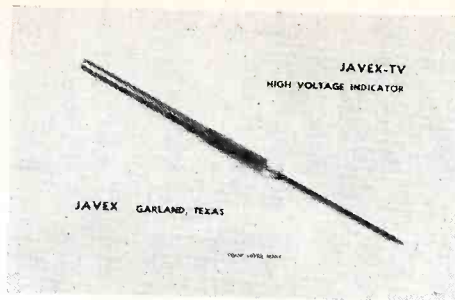

R7 HIGH VOLTAGE INDICATOR

This new (Javex, Garland, Texas) pocket size instrument has been created for the service man who wants an immediate check for high voltage presence. There is no need to disassemble a TV to determine the condition of the high voltage circuit, and no

VTVM is required. Merely probe through back of set into immediate vicinity of high voltage power supply. The proper functioning of the circuit being tested is immediately shown.

Other practical advantages are revealed in the descriptive literature and information to be had from your local jobber or from the manufacturer.

AUTO RADIO VIBRATORS

Radiart Corporation of Cleveland, Ohio, announces an important basic improvement in the firm's line of replacement auto radio vibrators. An automatic vent has been incorporated in the "Red Seal" base and is hailed as the greatest improvement in vibrators in 17 years.

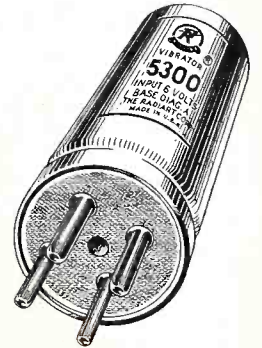

This vent is wax sealed at the factory and when the vibrator is put into use, the temperature rise inside the vibrator melts out the wax and permits air circulation for even greater performance and longer life. With this great new feature, Radiart vibrators are not only sealed to prevent oxidation of the points prior to being put in use, but are also vented so that there may be air circulation during operation.

ALL-CHANNEL AMPLIFIER

Blonder-Tongue Laboratories, 88 N. Second Ave., Mt. Vernon, N.Y., has just introduced a new type commercial TV amplifier. This firm is already well-known to the trade as the manufacturer of the popular B-T Home Antensifier.

Their new unit, called the Commercial Antensifier, is a 4-tube, 4-stage TV signal amplifier that will supply a gain of 30 times

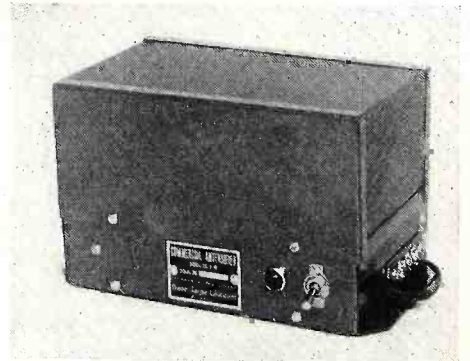

(30 db) on all channels simultaneously. Operation is automatic, without tuning or adjustment. It is the only all-channel TV amplifier available that fulfills all commercial installation requirements.

This unit can be used with the Blonder-Tongue, and every other master antenna distribution system, to overcome line losses at any point in the system. In weak signal areas, it can be used as a pre-amplifier for the distribution system. It will now be possible to supply up to 2000 TV sets, in a master antenna installation, by the use of B-T Commercial Antensifiers.

Now... Get ALL Your DRIVERS FROM VACO



Only Vaco offers the complete, fine quality line of drivers that daily is proving its superiority in service shops and on factory production lines... in terms of performance at low cost. Made of specially heat treated chrome vanadium blades mounted in break-proof, shock-proof plastic handles, Vaco drivers are the choice of experts in TV and radio.

SPECIAL RADIO AND TV DRIVERS

Investigate Vaco's new non-metallic aligners, non-magnetic beryllium copper focalizer screw drivers and other unusual products. They are made especially for radio and TV and have proved themselves most practical in delicate adjustment work.

NEW 27 PIECE TV SERVICE KIT

Also available from Vaco is a new 27-piece TV Service Kit made up at the request of TV men. You'll find a full description of this kit and other Vaco products in the new Vaco three-color catalog. Send for it, today.



At Your Supplier or Write to:

VACO PRODUCTS COMPANY

317 East Ontario Street • Chicago 11, Illinois

In Canada: Vaco-Lynn Products Co., Ltd.,
204 Laurier Ave., W., Montreal 8, Quebec

For the **clearest** picture of campaign progress...



Rauland PICTURE TUBES

Man, what a year for TV—and TV service profits! The richest menu of regular attractions ever offered to viewers... PLUS the party conventions, the campaign, the elections and inauguration! When viewers need replacement picture tubes, they'll want them fast—and good.

So remember that Rauland alone

offers these replacement profit advantages:

- The *most complete* line of replacement picture tubes... a far better supplement for your regular tube line than a second line of receiver tubes.
- The faster, *surer* installation adjustment made possible by the patented Indicator Ton Trap.

- The dependable, uniform *extra* quality that so many smart service men depend on for assured customer satisfaction.

Remember, Rauland research has developed more "firsts" in picture tube progress since the war than any other maker. And this leadership pays off... in your customers' satisfaction.

THE RAULAND CORPORATION

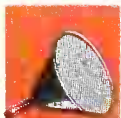

Perfection Through Research

4245 N. KNOX AVENUE • CHICAGO 41, ILLINOIS



Hi-Q

STANDS FOR

**HIGH-VOLTAGE
CERAMICS**



It's just common sense. By settling on one 6000-volt rating, your essential tubular ceramic needs boil down to this handy SE-TV series.

Adequate safety factor avoids voltage breakdowns. These Hi-Q* tubular ceramics are available in eleven capacitance values — 4.7 to 47 mmf. Packed five to the unique Aerovox window-carton, but also available as individual pieces.

And of course the Hi-Q* line includes other tubulars, discs, stand-offs, high-voltage, feed-thru and other popular ceramics.

Ask your distributor for Aerovox Hi-Q* Ceramics for any and all your ceramic capacitor needs.

*Trade Mark registered U. S. Pat. Off.
by AEROVOX CORPORATION



**FOR RADIO-ELECTRONIC &
INDUSTRIAL APPLICATIONS
AEROVOX CORPORATION
NEW BEDFORD, MASS., U. S. A.**

In Canada: AEROVOX CANADA LTD., Hamilton, Ont.
Export: 41 E. 42nd St., New York 17, N. Y.

TRADE FLASHES

[from page 14]

dustries, Inc., Chicago. Constructed in modern design of blond mahogany, this new cabinet provides space for a balanced stock of needle replacements for every type of phonograph and record player.

Said to be of unusual assistance in finding the correct replacement needle among the dozens now being required, the new dispenser makes the proper selection in just 30 seconds, with a complete sale possible in one minute. Small and compact, the cabinet is both quickly accessible and theft-proof. Each Jensen needle, moreover, is quickly identified, being packaged on a see-through card with complete installation instructions on the back.

Dealers may get additional information on the new Jensen cabinet from their jobbers or by writing direct to Jensen Industries, Inc., 329 South Wood Street, Chicago 12, Illinois.

Clearbeam Combats TV Carpetbaggers

Peter S. Wald, President of Clearbeam TV Antennas and Accessories, has launched an intensive Southland magazine advertising campaign against the fly-by-night "Manufacturing Peddlers" who are undermining the legitimate Radio-TV Dealers and Servicemen by selling TV antennas and accessories direct to price-slashing auto supply stores, five-and-dimes, and cut-rate drug chains.

Wald, long a staunch opponent of the unfair competition created for legitimate dealers, is taking direct action against what he calls "cut-throat tactics which rob the dealer and servicemen of legitimate profits."

Regency Booster Mfr. Expands

Effective Feb. 18th all activities of Industrial Development Engineering Associates, Inc., manufacturers of Regency Boosters and other electronic devices, were moved to a new modern factory at 7900 Pendleton Pike, Indianapolis 26, Ind. Telephone Cherry 2466.

Future Event

National Electronics Conference. 8th annual conference. September 29, 30 and October 1, 1952, Sherman Hotel, Chicago, Illinois.

RCA Shows UHF-TV Converters

Initial models of RCA Victor converters, which will enable owners of present television sets to receive broadcasts in the ultra-high-frequencies,

Columbia

Again—
a "New"
TV Service Aid!

now—the
"Television
Picture TUBE
Extension Cable"

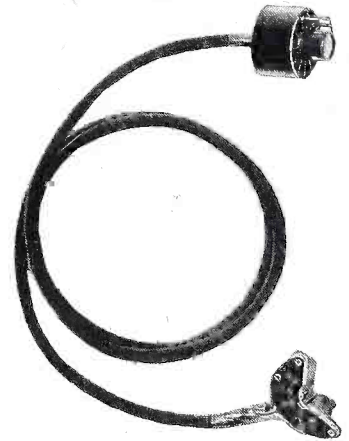

... just what every television serviceman should buy!

Here is another labor and time-saver from "Columbia". NOW... you can service the chassis without moving the picture tube; or remove the tube for testing without touching the chassis.

The complete cable is engineered for maximum performance... durable cotton braid covers 5 heavily insulated plastic wires... 4 feet long. Bakelite plugs on each end have positive contacts.

Carried by Leading Jobbers!

Have you seen our NEW "TV Service Light" and "All-Purpose TV Service Cord"?

We mfr. cord sets and cables to gov't and civilian specifications.

Columbia

WIRE & SUPPLY CO.

2850 Irving Park Road • Chicago 18, Ill.

"National distributors and warehouse for ANACONDA densheath television and radio wires and cables"

MANUFACTURERS OF A COMPLETE LINE OF FUSES

For
TELEVISION • RADIO • RADAR
INSTRUMENTS • CONTROLS • AVIONICS

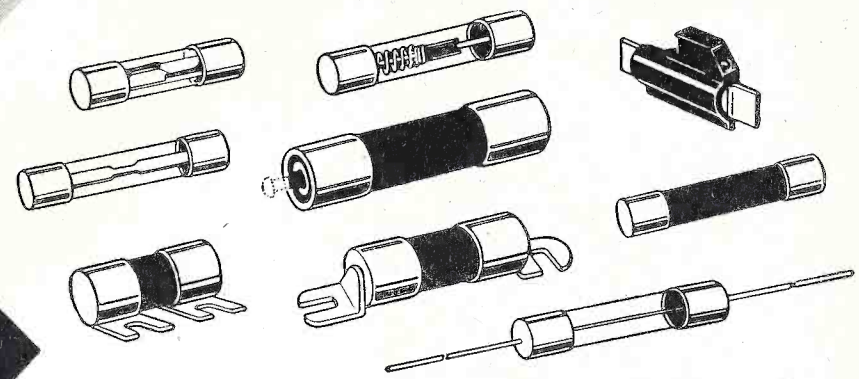

plus companion lines of BUSS Fuse Clips, Blocks and Fuse Holders. Made in many types to make it easy to select the fuse and fuse mounting needed to give required protection.

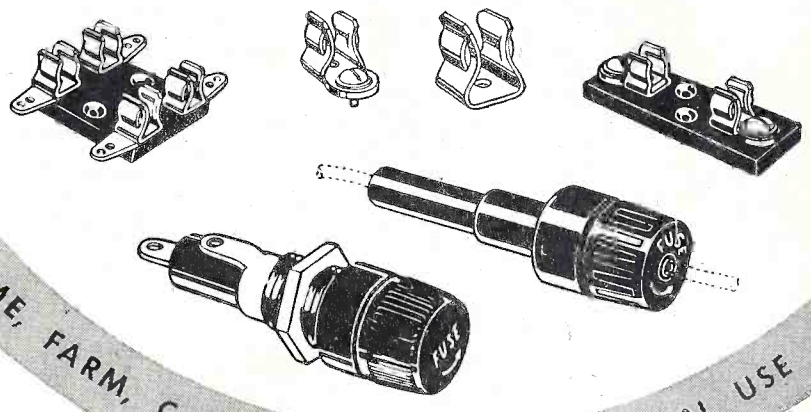

FOR HOME, FARM, COMMERCIAL AND INDUSTRIAL USE

Let
BUSS FUSES
Help Protect
Your
Reputation

As a User
of High Quality
Materials

The makers of BUSS Fuses take every precaution to be sure that the highest standards of quality are maintained. EVERY BUSS FUSE IS ELECTRONICALLY TESTED. A sensitive testing device rejects any fuse that is not correctly calibrated, properly constructed and right in all physical dimensions.

This insistence on perfection is the reason why you can always rely on BUSS Fuses. Manufacturers and service men the country over have learned they can depend on BUSS Fuses for the right protection under all service conditions.

Here's another reason why it pays to

SEND THE COUPON for complete facts . . .

standardize on BUSS Fuses: You can get all your fuses from one source. The line is complete—dual-element (slow blowing), renewable and one-time types . . . in sizes from 1/500 ampere up.

You can help protect your good-will, reputation and profits by standardizing on BUSS Fuses.

Can you afford to take a chance on anything less than BUSS quality?

BUSSMANN Mfg. Co. (Division of McGraw Electric Co.)
University at Jefferson, St. Louis 7, Mo.

Please send me bulletin SFB containing complete facts on BUSS small dimension fuses and fuse holders.

Name _____
 Title _____
 Company _____
 Address _____
 City & Zone _____ State _____ 452

ATR

For
**AC CURRENT
ANYWHERE**



**STANDARD
AND HEAVY DUTY
INVERTERS**

For Inverting D. C. to A. C.
Specially Designed for operating A. C.
Radios, Television Sets, Amplifiers, Ad-
dress Systems, and Radio Test Equip-
ment from D. C. Voltages in Vehicles,
Ships, Trains, Planes and
in D. C. Districts.

ATR

NEW MODELS

NEW DESIGNS

NEW LITERATURE

"A" BATTERY ELIMINATOR
AC-DC INVERTERS
AUTO RADIO VIBRATORS

See your jobber or write factory

AMERICAN TELEVISION & RADIO CO.

Quality Products Since 1931

SAINT PAUL 1, MINNESOTA-U.S.A.

(UHF) when they are available, were publicly unveiled on Mar. 3, at the annual convention of the Institute of Radio Engineers in the Grand Central Palace.

It is expected that TV channels in the UHF area of the radio spectrum will soon be established and allocated by the FCC for the use of TV broadcasters. The opening of the new band and new assignments in the present very-high-frequency band will provide transmitting space for more than 2,000 TV stations from coast to coast, reaching virtually every home in the United States.

The equipment unveiled by RCA Victor today includes a multi-channel converter, designed to receive programs on all channels in the UHF band, and simple, low-cost one-channel and two-channel converters to be added to VHF receivers in areas where one or two UHF stations go on the air. All three converters can be installed with any make of television set.

I.R.E. Convention

Members of the Institute of Radio Engineers, some 27,500 experts representing nearly every country except Russia, gathered at the Hotel Waldorf-Astoria and Grand Central Palace between Mar. 3 to Mar. 6.

A \$10,000,000 exhibition of all sorts of radio and electronic apparatus, much of which was of direct interest to the public, was held during the four-day conclave on four floors of Grand Central Palace. There were 356 exhibits by the country's leading research laboratories and manufacturers.

Much of the equipment which was demonstrated, ranging from diminutive bits known as "transistors," which in the future are expected to perform nearly every function of the modern-day vacuum tube and do it better, to full-size television transmitters occupying as much space as two average-sized living rooms.

The transistor, a device which will soon replace the vacuum tube in many applications, received a large share of the attention of the 27,500 radio engineers and scientists who attended the opening session of the annual four-day convention of the Institute of Radio Engineers this afternoon. Transistors can perform most of the functions of conventional vacuum tubes as well as or better than the tubes themselves, and are much smaller, more rugged, more reliable, and require a great deal less power.

Design data and performance of "printed" unit assemblies for television receiver production, that should

JETENNA

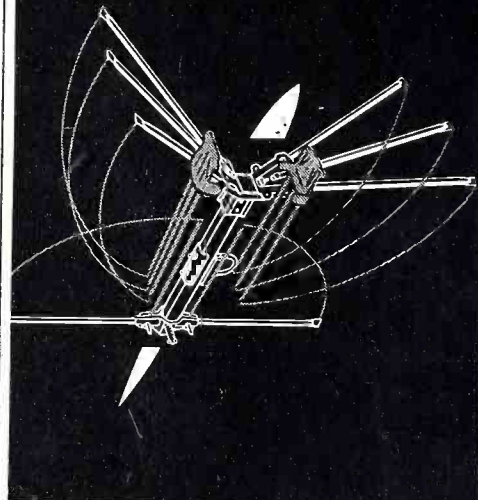

**no other fan conical
assembles so fast
performs so well!**

JFD JETENNA, the conical with the jet-action assembly, has absolutely no separate parts to put together—the slowest part is opening the carton! Just swing out the elements, tighten two "T" bolts and two wing nuts and it's assembled! Front elements automatically fan out as they are swung forward. Reflector elements are spring-loaded to lock into position for tightening. 1" square seamless crossarm, seamless elements and element brackets are of high tensile strength aluminum—unbreakable head is of all weather, high dielectric material. Solid, unbreakable "vibration dampers" do not absorb moisture or swell and will not rot out. See your Jobber or write for further information about this revolutionary new antenna.



JFD MFG. CO.
BROOKLYN 4, N. Y.
BENSONHURST 6-9200

world's largest
manufacturer of TV antennas
and accessories

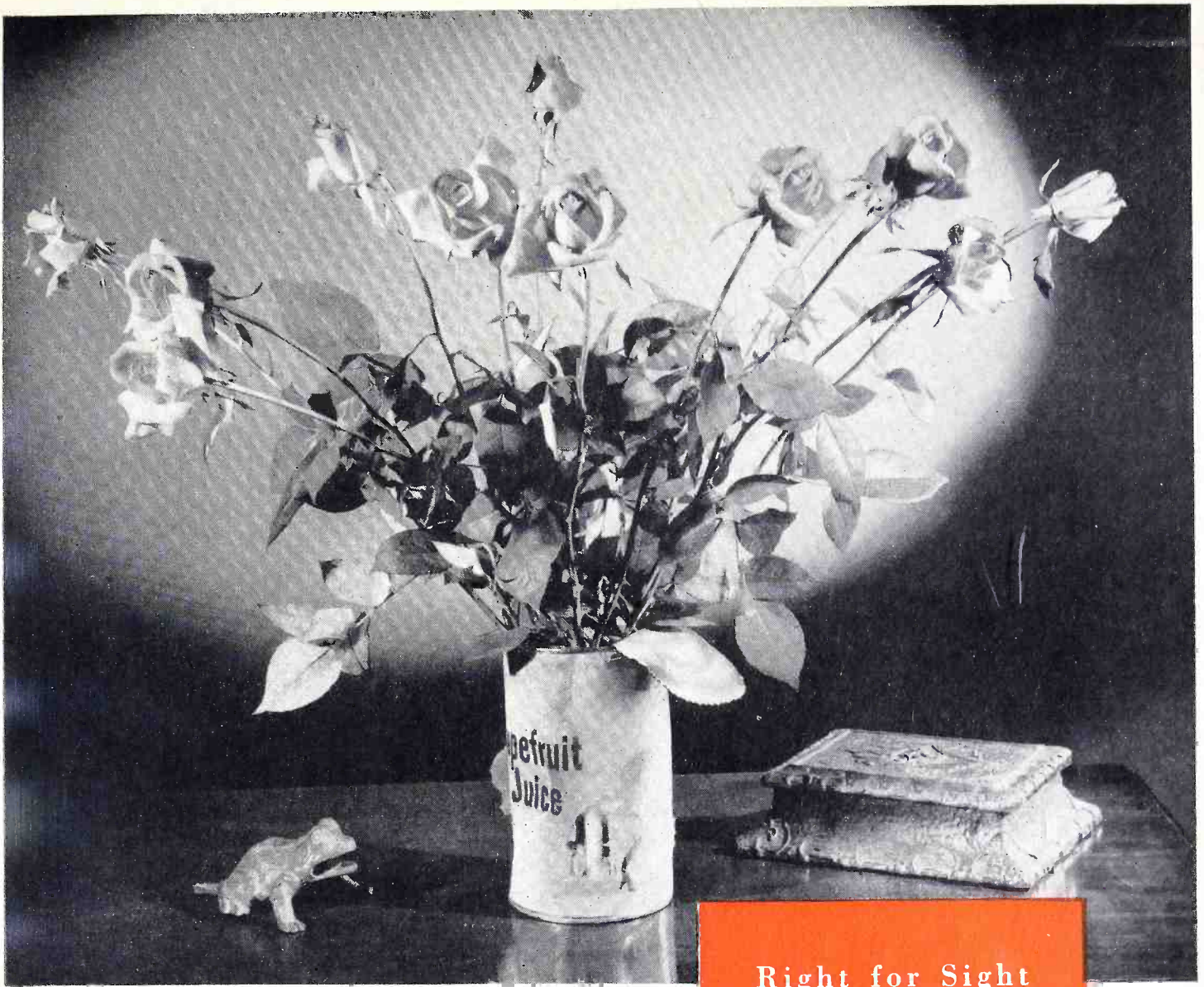

Makeshift Replacements
Reduce Picture Quality

Replacements with
Raytheon Television Tubes
assure picture quality

Right for Sight



RAYTHEON PICTURE
TUBES



Excellence in Electronics

RECEIVING AND PICTURE TUBES • RELIABLE SUBMINIATURE AND MINIATURE TUBES • GERMANIUM DIODES AND TRANSISTORS • RADIAC TUBES • MICROWAVE TUBES

Don't forget! Raytheon Picture Tubes with Corona Inhibitor
give constant picture clarity whatever the weather.

RAYTHEON MANUFACTURING COMPANY

Receiving Tube Division

Newton, Mass., Chicago, Ill., Atlanta, Ga., Los Angeles, Calif.

there is only **1** **JC** **YAGI**

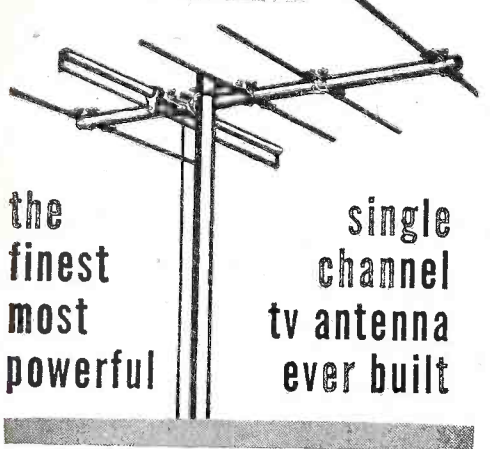

the finest most powerful

single channel tv antenna ever built

FOR SUPERPOWER

INSTALL JC STACKED ARRAYS

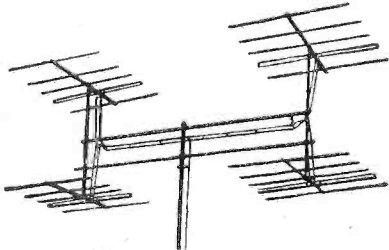

↑ 4 stacked side-by-side array. Ideal for powerful long distance reception in hilly and mountainous terrain.



4 stacked vertical array. Extremely high gain and excellent signal-to-noise ratio. Ideal for areas with relatively flat terrain.

Double-stacked array with half-wave spacing. Provides added gain and better signal-to-noise ratio.

VEE-D-X

The World's Most Powerful TV Antenna Systems

THE LaPOINTE-PLASCOMOLD CORPORATION
Windsor Locks, Connecticut

Gentlemen:

Send me complete technical information on the JC Yagi and its stacked arrays.

Name

Street

City..... Zone..... State.....

Please check Jobber Dealer Technician

save critical materials and reduce labor required to produce television sets, was described by W. H. Hannahs and Norman Stein of Sylvania Electric Products Inc. during technical sessions of the National Convention of the Institute of Radio Engineers, held in the Waldorf-Astoria Hotel here this morning.

The new production technique, was described by Hannahs and Stein, as dividing a television set into about twenty subassemblies, each containing an electron tube and associated components. Each unit is made by printing the associated components on two small "cards," one made of a ceramic material and the other made of plastic.

Multiple electrical points between the "cards" are made simply by dipping them in molten solder, thus eliminating the need of interconnecting wires. The new technique contrasts with conventional TV set assembly requiring hand soldering for hundreds of parts and wires.

During their presentation of the new technique, Hannahs and Stein reported that etching and silk screening techniques are combined to produce the new TV circuit "cards."

They also gave engineering data and performance for an intermediate frequency amplifier such as is commonly used in TV receivers for operation at 25 megacycles. The amplifier, of the new printed assembly type, contained resistors that were fabricated within commercial tolerances.

[Continued on page 56]

EDITORIAL

[from page 3]

should have such reference literature available at all times to aid in the selection of needed replacement parts or accessories, etc., and to assure you that you will choose the highest quality, most reliable and fully guaranteed items, all nationally advertised brands. Take advantage of our new free Subscriber Service. Be sure to request your monthly catalog section by using the coupon provided in each issue of "Service Dealer" for that purpose.

..STOP... RIDER TV 9

... AT YOUR JOBBERS

ORDER NOW

.....SEE PAGE = 37

set 'em...
forget 'em!

Fully Automatic
AUTOBOOSTERS

by 

NO Tuning NO Switching Necessary

**COMPLETELY AUTOMATIC
HIGH UNIFORM GAIN
SINGLE OR DUAL INPUT
FULL, 5 MC BANDWIDTH
CLEARER PICTURES
CONCEALED INSTALLATION**



LIST PRICE

39.95

IT-75A Fully Automatic, All-Channel *AUTOBOOSTER*—Up to 19 db (9 times) gain • Separate inputs for high and low band antennas or single high-low antenna • May be peaked in the field for maximum performance on any channel • Installed at rear of receiver.



LIST PRICE

69.95

IT-90A Fully Automatic, All-Channel Cascade *AUTOBOOSTER*—Up to 30 db (30 times) gain • Extremely low signal-to-noise Cascade input circuit • Ideal for sub-fringe areas, community antenna systems • 2 stage amplification • Separate controls for independent gain adjustment on high and low channels (set by installer) • Automatic on-off • By-pass switch removes unit from line but does not alter impedance • Installed at rear of receiver.

WRITE FOR SPECIFICATION SHEETS. AUTOBOOSTERS ARE AVAILABLE AT JOBBERS EVERYWHERE. ORDER THE ONES YOU NEED TODAY!

Are you using the

Tenna-Clip

Write for FREE sample

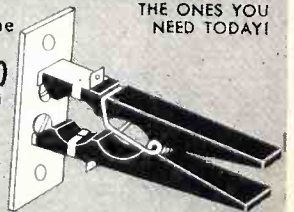

Industrial Television, Inc.

359 LEXINGTON AVENUE CLIFTON, N.J.
GRegory 3-0900

PERSONNEL NOTES

[from page 34]

of the Instrument Engineering Department; and Mr. Fockler the former head of the Development Section of the same department.

Alexander G. Evans has been appointed assistant national sales manager for the receiver sales division, Allen B. Du Mont Laboratories, Inc., it was announced by Walter L. Stickle, national sales manager. The appointment is effective immediately.

Herbert Bloomberg, Central District Sales Manager for the Television Transmitter Division, Allen B. Du Mont Laboratories, Inc., has been named to supervise the Division's sales activities in its newly realigned central sales territories, it was announced recently by James B. Tharpe, national sales manager of the Transmitter Division. The announcement was made at the company's heavy equipment headquarters, 1500 Main Avenue, Clifton, New Jersey.

Fritz P. Rice has been named manager of the Cathode-ray Tube Division, of Allen B. Du Mont Laboratories, Inc., it was announced by Irving G. Rosenberg, Director of Operations.

Sangamo Electric Company, Springfield, Illinois, recently announced the appointment of Bruce E. Vinkemulder as Distributor Sales Manager of the Capacitor Division located at Marion, Illinois. He will make his headquarters at the Marion factory.

CIRCUIT COURT

[from page 36]

thus how much a.g.c. is developed. The network of C36 and R101 becomes charged with a negative potential. This prevents V23A from conducting except at the peaks of the sync pulses. The a-g-c voltage is taken off the top of R101 and applied to the r-f and i-f stages.

SHOP NOTES

[from page 35]

oscillator gave a comparable reading with the published data for the set. As too often happens in intermittents the set began to play normally again after we removed the test probe.

That the oscillator was functioning seemed to be a pretty well established fact so it was decided that the oscillator must be jumping off frequency.

Checking the circuit we found a 100 $\mu\mu\text{f}$ ceramic capacitor used as a padder. We replaced it on general principles and the set was cured.

Do not try to use a regular mica capacitor in this location as it is apt not to work. Altho ceramic capacitors are frequently unstable creatures we had very good success with tubular type with a 20% tolerance rating.

Wayne E. Lemons
Buffalo, Mo.

TRADE LIT

[from page 33]

facturers' production changes. Circuit action descriptions and unpacking and installation data further help the service technician make faster and easier TV repairs. Television Manual Volume 9 is priced at \$24.00.

* * *

The new 1952 electronic equipment catalog announced by Grayburne Corporation, 103 Lafayette Street, New

MORE TV OUTLETS PER DOLLAR!

AMPLIFIED, ALL-CHANNEL MASTER ANTENNA SYSTEMS

FOR 2 TO 2000 TV SETS

NO Special connectors
NO Matching transformers
NO Engineers
NO Individual channel equipment

INSTALLED WITH THE TURN OF A SCREW



BLONDER-TONGUE systems are based on the use of "no loss" Distribution Amplifiers which split the signal from the antenna into the desired number of outlets. . . all having the same signal level and picture quality as though each TV set used the antenna alone.

The B-T Automatic, All-Channel systems, using three basic units in any desired number and combination, can be easily installed by any TV service man.



DISTRIBUTION AMPLIFIER, MODEL DA8-1-M
8 TV Outlets
Amplified and Isolated
List Price \$87.50



Model #CA-1-M
Commercial Antensifier
(30 Times Gain)
Use As Pre-Amplifier, Line Amplifier or do-luxe Booster
List Price \$27.50



BLONDER TONGUE Laboratories Inc.



MODEL #DA2-1-M
Distribution Amplifier
2 TV Set Outlets
List Price \$39.50

See us in Chicago-Booth 6

FINEST ALL-CHANNEL TV BOOSTER. Fully Automatic, 16 Times Gain. In Metal Cabinet. List Price \$57.50

FREE INSTRUCTION BROCHURE ON MASTER ANTENNA SYSTEMS..Write Today. Dept. K3

Blonder-Tongue Labs., Inc. Mt. Vernon, N. Y.

York 13, N. Y., contains four two-color pages comprehensively describing the complete Grayburne line. An outstanding feature of this catalog is its detailed analysis of the specific market potential for each Grayburne product—from the Service Dealer's viewpoint—combined with specific recommendations for the exploitation of these markets.

For a free copy of this valuable catalog, write directly to Grayburne Corporation.

* * *

A new, completely illustrated, multi-colored *catalog* has just been released

by *Tru-Ohm Products*, division of Model Engineering & Mfg. Inc.

This leading manufacturer's new catalog includes illustrations of the various Tru-Ohm products: power rheostat, fixed resistors, adjustable resistors, "Econo-ohm" resistors. In addition to the illustrations, complete technical and engineering data is included as well as other pertinent information which is ideal for manufacturers and jobbers.

For your free copy of this new, complete catalog, write to General Sales Office, Tru-Ohm Products, Division of Model Engineering & Mfg.

Inc., 2800 N. Milwaukee Ave., Chicago 18, Illinois.

* * *

A new 1952 edition of the *National Appliance Trade-in Guide* is announced today by the National Appliance Trade-in Guide Company. Over 9,000 models of 78 manufacturers of refrigerators, electric ranges, gas ranges, vacuum cleaners, washers and food freezers are represented in this year's guide.

Dealers and distributors wishing to show their customers that they are being treated fairly will find this year's suggested trade-in values fair and workable. Handy, pocket-size, with over 200 pages, the 1952 National Appliance Trade-in Guide can be purchased for \$5.00 per copy. Quantity discounts.

For further information write National Appliance Trade-in Guide Company, 2132 Fordem Avenue, Madison 4, Wisconsin.

ASSOCIATIONS

[from page 32]

to this Bill on the following basis:

1. It would be an invasion of your prerogatives to be in the service business.
2. It would endanger the general public through attempts at service without proper qualifications.
3. It would cause untold loss to dealers selling sets on time through tampering by customers.

Many other faults can be found with this Bill. We believe, however, that it is of paramount importance that we realize as service people that we already have too many people tampering with our business without having John Q. Public and Washington adding their unqualified interference.

Get those letters out today!

Radio & Television Technicians

Guild of Florida-Dade County Chapter

March Meeting: Our First Annual Installation Banquet was held Tuesday, March 4th, 7:30 P.M. at Jackie Heller's Dinner Key Terrace Restaurant. This was a dinner and dance. The newly elected officers were officially installed at this meeting, after which all other business was set aside in order that the members and their guests may enjoy an evening of dancing.

Our guest for the evening was Mayor Chelsie J. Senerchia, who is interested in our aims and problems and wishes to make our acquaintance.

Sam Kessler is Chairman in charge



HEAVY WEB TV LEAD-IN WIRE CUTS DOWN COSTLY "CALL-BACKS"

Have you seen the new SYNKOTE 300 ohm TV lead-in? It has a .100 web with a maximum variance of five thousandths of an inch! Tough polyethylene construction that stands up against sun, snow, rain, cold and abrasion.

Ask your jobber to show you this as well as the complete SYNKOTE line of dependable wires . . . used and recommended by leading manufacturers everywhere.

Synkote®

DEPENDABLE

HOOK-UP WIRE • COAXIAL CABLE • TV LEAD-IN WIRE
Plastoid Corporation • Long Island City 1, New York



"manufactured by the mile — tested by the inch"

of arrangements and has done a swell job.

We are now two years old as an organization, and the membership in general is to be complimented on the growth and progress during this time. The exchange of thoughts, ideas and problems during the past year has given us a clearer view of the common problems that affect us all. Concerted effort both as a group and individually cannot help but result in benefits to all of us.

Radio and TV Service Groups:- All over the country individual service groups are educating the public by means of newspaper items and radio and television broadcasts that TV service is not a game. In several cities they have been having results. The public wants to know why it costs so much to service a TV set and they are finding out.

High Voltage:- The anode connector on some TV sets that inject the HV into the CRT may cause some serious trouble resulting in arcing. This is caused by the little rubber cup that is used to hold the lead in place. Some of the rubber that is used is low grade and easy to contaminate. This will give the HV a path of little resistance and allow St. Elmos Fire To Burn. Change the cap with one of a good grade.

Thomas Middleton
Editor

CUSTOM INSTALLATIONS

[from page 31]

cur, the gain between the two speakers can be adjusted until results are gratifying. From Fig. 3, we see that any initial angle of projection from speaker No. 1 is reflected from the wall the speaker faces, next contacts the side wall whence it is again reflected angularly into the room. The same occurs for all angles throughout the beam of the speaker. The same holds for speaker No. 2. The virtual sources become points 1' and 2' external to the room. The overall effect of dispersion is only prominent for high frequency sounds but it is those frequencies that the human ear uses for locating a sound source.

The dotted line *x-y* (Fig. 3) can house a third speaker faced forward if it is more desirable to the customer to augment the effect with a low level direct beam. For a greater understandability of speech, this third speaker could be switched in or left connected. In either case, final construction includes but one single unit



"CONICAL-V-BEAMS"

® REGISTERED TRADE MARK

Now! Customized for your locality
CUSTOM-DESIGNED ANTENNAS
at mass production prices!



Another Telrex first in superior antenna service. Famous Conical-V-Beams custom designed for best results in your particular area. Regular list prices prevail, meaning you get better performance, more satisfied customers and your selling territory for TV receivers is increased tremendously. Installing customized Telrex antennas is insurance against callbacks due to antenna adjustments and you enjoy the added protection of Telrex super-durable, all weather construction. Just specify the installation area when ordering, Telrex will supply your antennas cut-to-area for the finest pictures ever!

—for superior reception on TV, FM and UHF

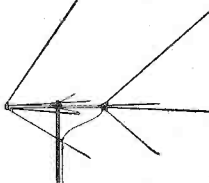

**DUBL
CONICAL-V-BEAM**
For outstanding all station performance. Has new HI-V-REFLECTOR.

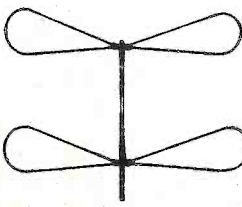

**CLOVER-V-BEAM
NEW E-Z-RIG**
A high-gain, compact indoor or outdoor array.

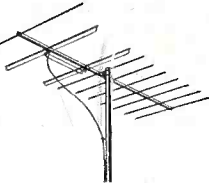

TELREX "FISHBONE"
Ten WORKING elements. Guaranteed to outperform any Yagi.

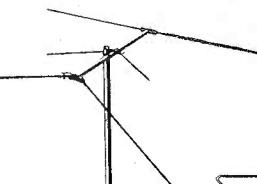

TELREX-V-BEAM
For superior in-line all station reception at low cost.



TELREX "BAT-WING"
Outperforms any top-of-set antenna with no tuning or pruning.

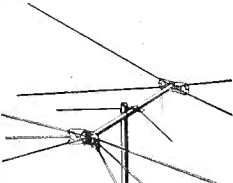

**TELREX
CONICAL-V-BEAM
WITH HI-V-REFLECTOR**
Standard on Monarch and Universal Series.

"CONICAL-V-BEAMS" are covered by Patent No. 23,346
 CANADIAN and FOREIGN PATENTS PENDING



CONICAL-V-BEAMS

AMERICA'S
OUTSTANDING
TELEVISION
BEAM

Be sure it's a
"CONICAL-V-BEAM"
— look for the
telrex
TRADEMARK

ASBURY PARK 5, N. J.

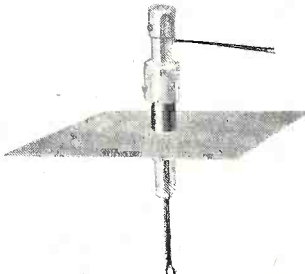

MOSLEY ROOF-THRU

The Leak-Proof Roof Entrance for
TV and FM Transmission Line
and Rotator Control Cable.

- Permits shorter lead-in with less loss of signal energy—less interference pick-up!
- Prolongs life of transmission line by keeping it out of weather!
- Eliminates unsightly wires on outside of house!
- Easy to install on new or old buildings!
- Copper flashing and plastic bushing unaffected by weather—provides perfect seal against weather leaks! Available from your Radio Parts Jobber.

Cat. No. 624

MOSLEY ROOF-THRU

LIST PRICE \$5.84

We're looking forward to meeting you at the May show. We cordially invite you to visit us in Space 119.

MOSLEY

2125 Lackland Road

ELECTRONICS

Overland, Missouri

DON'T BE A



DISAPPOINTED MUSICIAN!

Remember the old lament: "I blew it in so sweet und it came oudt so sour!"

Mf'rs who want sweet results when they blow their horn always choose a good instrument and they play to a responsive audience.

"SERVICE-DEALER" has the radio-TV service industry's best, most appreciative audience. Our readers are the top-ranking, most progressive technicians serving their respective communities.

"SERVICE-DEALER" is a sweet horn and you can toot your message in it with pride. All the manufacturers who enjoy the reputation of being tops in their respective categories are consistent advertisers.

Being a member of the Audit Bureau, and now having over 30,000 paid subscribers, "Service-Dealer" does not believe in having so-called "special issues" that are merely aimed at getting special increases in billing from advertisers. We publish 12 uniformly fine issues each year for the men whose jobs require them to work at peak efficiency 52 weeks a year.

However, extra copies of the MAY issue of SERVICE-DEALER" will be distributed at the Annual Radio-Parts & Electronic Equipment Show & Audio Fair being held at the Conrad Hilton (Stevens) Hotel, Chicago, May 23-26. Our June issue will be the "Show Review" number. Advertising forms for May close April 15th and for June on May 15th. Both are fine issues in which to "Blow YOUR Horn"!

For Space Reservations, Wire or Phone:

COWAN PUBLISHING CORP., 67 W. 44th St., New York 36, N. Y.

MUrray Hill 7-2080-1-2-3-4-5

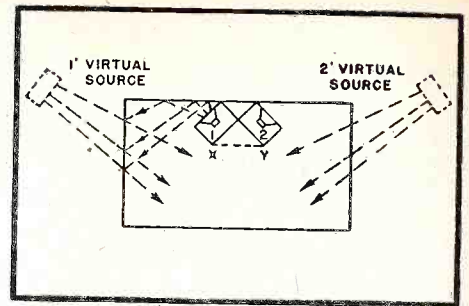

Fig. 3. Dihedral Loudspeaker System.

which may be readily moved when the owner is an apartment dweller about to change his address.

Dealer Opportunities

Extensive housing projects now under construction offer a ripe opportunity for coordination with architect and builder. Cabinets, blind walls and wiring facilities may be included during original construction. Ample space for inclusion of TV facilities should of course be included. In all cases the plans must allow for adequate ventilation and for generous rear cavities for flushmount or concealed loudspeakers. Ample space should be provided for tape and/or disc reproduction, record storage and future servicing. Discreet tuner and speaker mounts in bedrooms, kitchens, living-rooms and dens can be sold to the modern trend of living.

Adjuncts to existing PA systems in hotels, clubs and restaurants are being sold which include tuners and amplifiers for TV. Portable speakers with local volume controls are growing increasingly popular for swimming pools, patios and porches of both public and private buildings. An eventual market will develop, especially in public buildings, when present equipment has to be moved or modified to accommodate lens-amplified pictures projected upon a wall or screen.

VIDEO DETECTORS

[from page 27]

of the total amplitude. The second detector acts as the converter in which the pix carrier frequency beats with the sound carrier. The sum frequency is attenuated in the output. The difference frequency is a 4.5 frequency modulated signal which is taken off either at the output of the detector or at the output of the video amplifier.

There is some amplitude variations of this new 4.5 mc FM i.f.

but with suitable sound i-f amplification, the action of limiter eliminates these variations.

V-H-F ANTENNAS

[from page 24]

ing harness, transmission line, and antenna bays results in a fairly selective antenna system of high gain and sharp directivity. In order to maintain a fairly high average gain across an extended bandwidth and still keep the sharp directivity characteristics, it has been commercial practice to space the individual bays $\frac{1}{4}$ wavelength apart. The effect of such spacing is to introduce intercoupling of the separate sections, or as a more simplified explanation "loading" of the high Q sections (bays) occurs. The end result is the same as resistive loading of a tuned circuit: broad frequency response. Since we are dealing with a low impedance load circuit, the reason for lowered gain is not the loading effect, but reduced area coverage which is explained in the following section.

Coupling Theory of Stacked Arrays

When dealing with a stacked array there is a theoretical spacing point for optimum gain, and consequent sharp horizontal and vertical directivity. The reason that antenna sections must be spaced at a specific distance vs. frequency is more easily understood by reference to the diagram of Fig. 4. The distance AOA represents a half wave dipole spaced $\frac{1}{2}$ wavelength above a similar dipole FOF. The tangent BO and CO enclose a triangular area $\frac{1}{4}$ wavelength on a side at the dipole ends. This is generally regarded as the signal collecting area of the half wave antenna. A similar diagram would exist for instance for the radiator section of a Yagi, or the "fed" element of any half wave antenna. If we visualize the two dipoles spaced at a distance of less than $\frac{1}{2}$ wavelength, the collecting areas would overlap, and the effective total pickup area would be reduced. The so-called fields of the individual antennae would intercouple, and the impedance as seen at the centers of the dipole elements would be lowered. The net effect would be reduced signal gain, and broader bandwidth acceptance due to the lower Q of the dipole sections. It can be seen from the above that there is a practical physical limitation in multi-stacked arrays particularly when one considers the dimensional requirements for a four stack yagi operating on Channel 2. When selecting a stacked yagi for best fringe area performance the above

should be borne in mind. In the case of the conical type the "fanned out" construction is essentially coupled electrically at all frequencies. Rather than a disadvantage this contributes to the flat impedance characteristic inherent in the conical.

Characteristics and Limitations of Popular Antennae

Conical:

Essentially flat over the entire TV spectrum. Poor front to back ratio on Channels 2-6, good power gain on Channels 7-13. Poor noise and adjacent channel interference rejection.

Double V:

Extremely poor directivity on Channels 2-6 because of pattern distortion due to angle of elements. Good gain on Channels 7-13. Poor noise and adjacent channel interference rejection. *Collinear $\frac{1}{4}$ wave spaced:*

Essentially the same as the Double V if cut to center of the high channels. The reverse if cut to the center of the lows. Generally much higher power gain, particularly if of the full wave type.

True Cone:

Although not in general use the

the **BIG 10** is terrific!

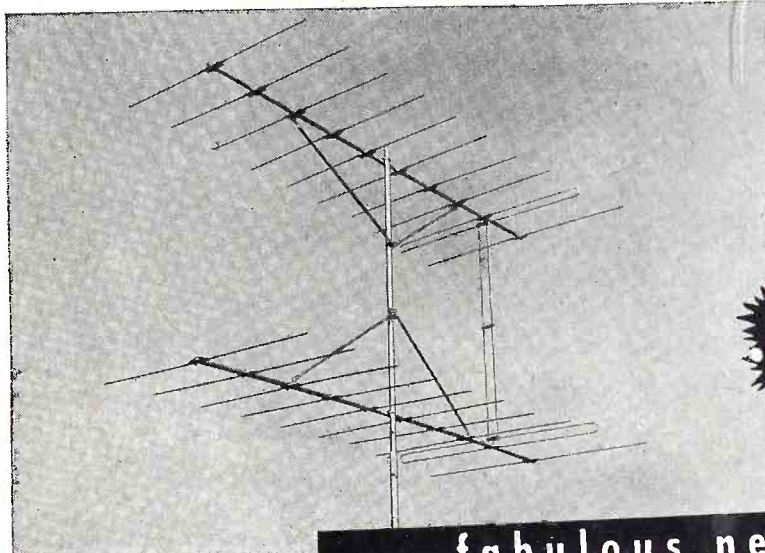

12
DB single

14 1/2
DB stacked

CHANNEL MASTER'S

fabulous new
10 Element Yagi

COMPARE these 10 Terrific Features!

- 1 10 Elements — more signal, less noise, less rear pickup.
- 2 Highest gain of any Yagi ever developed.
- 3 Over 30% more gain than any 8 element Yagi.
- 4 This antenna can be stacked, with 78% additional gain over single bay.
- 5 Includes the famous Z-Match system.
- 6 You don't pay for stacking bars.
- 7 Excellent 300 ohm match in all installations.
- 8 "Boom Braced" to prevent crossboom "bounce" which causes picture flicker.*
- 9 Two piece "Swej-Lok" cross-boom for simplified stocking, handling, and installation.*
- 10 Completely pre-assembled.

*Low Band only

LIST PRICES	
ch. 7-13	ch. 2 or 3 31.94
\$13.88	ch. 4 or 5 28.47
	ch. 6 25.69



CHANNEL MASTER CORP.

ELLENVILLE, N. Y.



MATTISON

SILVER ROCKET

630 CHASSIS with

● **TUNEABLE** ●

BUILT-IN BOOSTER

for Better DX Reception

Featuring **NEW CASCODE TUNER, 70° COSINE YOKE** and **VARIABLE AGC CONTROL!**

Tube Complement:
28 tubes
3 rectifiers
1 CRT
32

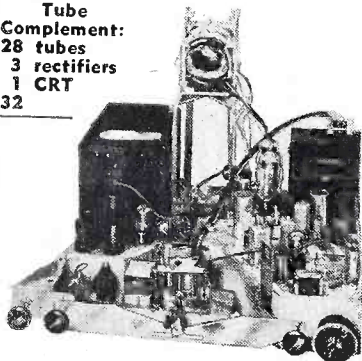

All Channel Booster

● Broad band single knob control pre-amplifier built in to eliminate long leads which may cause regeneration and attenuation of signal.

● **ONLY THE MATTISON 630 CHASSIS HAS AN ALL CHANNEL TUNEABLE BUILT-IN BOOSTER THAT INCREASES SIGNAL STRENGTH UP TO 10 TIMES. THE SILVER ROCKET WILL OUT-PERFORM ANY CHASSIS MADE AND IS PRICE RIGHT TO SELL FAST WITH**

AN EXTRAORDINARY MARGIN OF PROFIT FOR YOU. WRITE FOR CONFIDENTIAL PRICE SCHEDULE.

● Mattison features a complete line of cabinets **MADE IN MATTISON'S OWN CABINET FACTORY.** 36 breathtaking designs that blend perfectly in any setting, traditional or modern.

DEALERS!

SERVICE-DEALERS!

Here is YOUR opportunity to become the "important" TV Dealer in your area for **THE FINEST CUSTOM-BUILT LINE OF TELEVISION RECEIVERS.** **FREE! Write for MATTISON'S merchandising portfolio explaining:**

"THE MATTISON UNASSEMBLED PLAN"

and

"THE MATTISON \$1,000,000 FLOOR PLAN"



Manufactured with integrity

When you buy from Mattison you need only one source of supply! You can buy a Mattison Chassis, a Mattison Cabinet or a complete Mattison TV Set!

Mattison Television & Radio Corp.
893 Broadway, Dept. SD, N. Y. 3, N. Y.

characteristics are much the same as that of the conical, with a greatly improved impedance match.

5 Element Yagi:

High forward gain, excellent front to back ratio, and sharp horizontal pattern. Frequency response limited to one channel. Good noise and adjacent channel interference rejection.

8 Element Yagi

Characteristics similar to the 5 element type with approximately 40% voltage increase. Both types may be stacked for increased horizontal gain and sharper vertical pattern. Stacking (or doubling) antenna elements increases gain 3 db.

Collinear 1/2 wave spaced:

Excellent gain, high front to back ratio and sharp horizontal and vertical pattern. Full wave type makes a good fringe area antenna where adjacent channel reception is desired. This is not a broad band type except in conjunction with a rotator where advantage may be taken of sharp lobes at harmonic frequencies.

The general thought that should be kept in mind when considering an antenna system for a particular location is the number of channels desired, and their frequency separation. If for instance Channels 4, 7 and 11 were required the above summation would indicate the conical type. The horizontal double V might work very well if the field of Channel 4 were much stronger than that of the high channels. Similarly the collinear would give much better performance than these types under this particular circumstance. If two adjacent channels, or one single channel is required the collinear and yagi types are definitely preferable.

Electrical broad-banding of an antenna to this date at least has only been accomplished by making the elements appear larger (fanning), and forming the axis of the radiator so that the lobes at harmonic frequencies will exactly overlap. This results in a fairly constant impedance, and a fairly high power gain at all frequencies. Over the low frequency range, however, the major lobe is displaced, resulting in a wide horizontal pattern. At this writing such practice represents the only solution of this problem. As in all antennae this construction

.. STOP... RIDER TV 9

... AT YOUR JOBBERS

ORDER NOW

.....SEE PAGE = 37

It COUNTS and CARRIES your TUBES

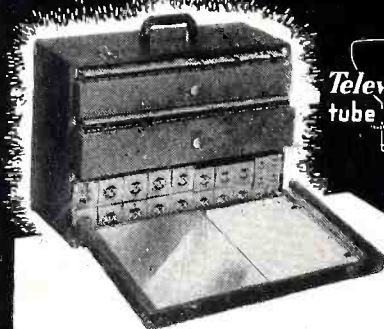

Television tube caddy

Specially designed for the television serviceman. Makes work easier and quicker—and YOU more efficient.

You take **INVENTORY AT A GLANCE**—and always have the right tube with you.

Thin, easy-to-carry leatherette cabinet, 20 1/2" x 14" x 9" deep. Holds up to 249 tubes, or less with space for **TOOLS** and **METER.** Clips in cover for price list or mirror.

Ask your parts jobber how it can **PAY FOR ITSELF** in 3 WEEKS, or write

\$13.50
Net to Dealer—
Higher on West Coast

Also TV Cabinets, Wall Baffles

ARGOS PRODUCTS CO.

310 MAIN STREET • GENOA, ILLINOIS



Low Cost Powerful P.A.!

COMPLETE • READY TO USE

Tops for powerful indoor-outdoor use; ideal for electioneering. Easy portability. Covers 4,000 persons indoors, up to 25,000 sq. ft. outdoors. Full 30 watts usable output; 2 high-imp. mike inputs, 1 phono input, each with separate volume control; tone control; fidelity ±2 db from 40-20,000 cps. Complete system includes: 30 watt amplifier and tubes, Electro-Voice "Cardax" unidirectional mike with adjustable floor stand and 20' cable; 2 General Electric 12" PM speakers, each with 30' cable; portable carrying case holds all, 16 1/4" x 12 1/4" x 25". For 110-130 v., 60 cy. A.C. Shpg. wt., 75 lbs. Complete, less only phono top.

93-372. Complete 30 Watt System. Only \$119.75
93-340. 3-Speed Phono Top for above. Only \$16.95

Available on Easy Terms—write for details

FREE See the 212-Page **ALLIED** Catalog for other Sound Systems, ranging from 8 to 80 watts. Write for Free copy of Radio's leading Buying Guide today.

ALLIED RADIO

833 W. Jackson Blvd., Dept. 26-D-2, Chicago 7, Ill.

is a compromise between gain and bandwidth. The opposite is true of the yagi that delivers high gain over a restricted bandwidth.

A little considered fact in the selection of antenna and accessory equipment by the service technician is this basic problem of gain vs. bandwidth. This boils down to signal to noise ratio determined by the design of the antenna, booster and the front end of the TV set. The common enemy of a weak signal is random noise commonly referred to as thermal, and that generated in the first stage of the receiving equipment. The amount of noise (snow) that is seen on the TV screen is a direct function of the power gain of the antenna, and the bandwidth that is amplified. This means that a yagi for instance would cut off sharply at the channel edges, and would not "force" through noise and interference existing at frequencies adjacent to the desired channel. The signal to noise ratio would be greatly improved over that of the broad band type even though the power gains were the same. The same basic problem exists in the design of boosters. For this reason, a tunable booster (selective type) at the set will usually give better results than a mast mounted broad band type.

An ideal installation for fringe area reception that would probably provide service in areas now considered impractical might be the following. A four stack yagi cut sharply to the video carrier with a bandwidth of 2 mc. A similar stack cut to the sound carrier. The feed points of the two stacks should be connected to separate selective (low noise figure) mast mounted boosters having similar selectivity curves, and fed through isolation networks to a common transmission line. Although to this author's knowledge such a system is not presently available, it raises interesting possibilities in the quest of extended television coverage.

USING THE SCOPE

[from page 22]

quency doubled, the two mirror images will again be super-imposed. Under the conditions shown in *Fig. 14* and *15*, all of the controls affecting the time base of the oscilloscope will affect the sweep and will affect the visual alignment curve presentation.

Figure 16 represents a sweep oscillator whose frequency excursion is a linear saw tooth voltage with the same

KNOCK OUT

TV INTERFERENCE

with

4

GRAYBURNE

Dual Tunable INTERFERENCE FILTERS

- Model SW10—eliminates Amateur Harmonic interference (10 meter band)
- Model SW20—eliminates Amateur Harmonic interference (20 meter band)
- Model DT—eliminates Diathermy interference
- Model FM—eliminates FM Image interference

A model for every type of interference

Research shows 16,000,000 set-owners want to get rid of some form of annoying interference. Here's a new market loaded with high profits—yours just for the asking on every service call! Grayburne gives you 4 new Filters to throw the right kayo punch at each of the 4 major sources of interference!

Precision-Engineered: Network of 2 iron-core precision-wound coils and condensers tunable over specific interference band.

Dual Tunable Feature: By tuning both sides of the line, each model achieves maximum interference rejection and maintains line balance.

Simple, Concealed Installation: Bracket mounts in any convenient position near antenna terminals.

Parallel Assembly: To knock out more than one type of interference, just assemble each model in parallel.

The Box is Your Salesman: Photo of interference pattern on package shows which type of interference each model removes. Helps your customer recognize his interference—helps you make the sale!

Specifications: Plated L-shaped bracket, 3 x 1 3/4 x 5/8". Matching 300-ohm lead. Each individually boxed with complete instructions. \$2.75 list, each model.

Always have a set of 4 Grayburne Filters in your kit. Show them to your customer on your next call. Watch how quickly he tells you to install one or more in his set. Make every call a plus profit call with Grayburne Filters. Write now for complete catalog and name of your distributor.



GRAYBURNE CORPORATION, 103 Lafayette St., New York 13, N. Y.

THIS IS IT! THE RELAY

WITH Interchangeable Coil

FOR A WIDE RANGE OF RADIO APPLICATIONS

GUARDIAN Series 200

Interchangeable
COIL and CONTACT
Switch Assembly

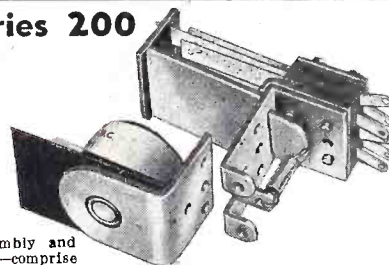

Two basic parts—a coil assembly and a contact switch assembly—comprise this simple, yet versatile relay. The coil assembly consists of the coil and field piece. The contact assembly consists of switch blades, armature, return spring and mounting bracket. The new Guardian Midget Contact Assembly which is interchangeable with the Standard Series 200 coil assembly, is also available in either single pole, double throw; or double pole, double throw.

CONTACT SWITCH ASSEMBLIES

CAT. NO.	TYPE	COMBINATION	
		Single Pole	Double Throw
200-1	Standard	Double Pole	Double Throw
200-2	Standard	Double Pole	Double Throw
200-3	Contact Switch Parts Kit		
200-4	Standard	Double Pole	Double Throw
200-M1	Midget	Single Pole	Double Throw
200-M2	Midget	Double Pole	Double Throw
200-M3	Midget Contact Switch Parts Kit		

13 COIL ASSEMBLIES

A.C. COILS*		D.C. COILS	
CAT. NO.	VOLTS	CAT. NO.	VOLTS
200-6A	6 A.C.	200-6D	6 D.C.
200-12A	12 A.C.	200-12D	12 D.C.
200-24A	24 A.C.	200-24D	24 D.C.
200-115A	115 A.C.	200-32D	32 D.C.
		200-110D	110 D.C.

*All A.C. coils available in 25 and 60 cycles

GUARDIAN ELECTRIC

1606-D W. WALNUT STREET

CHICAGO 12, ILLINOIS

A COMPLETE LINE OF RELAYS SERVING RADIO AMATEURS

SO IMPORTANT — it was
Featured in Special Article
in

The New York Times

Jan. 28, 1952
FREE copy
of article on request

**UNIT REACTIVATES
TV PICTURE TUBES**

Small Electronic Device Tests
Sets at Home and May Add
Year or More of Use

By T. R. KENNEDY Jr.

A small electronic device that can be applied to home television receivers to test and reactivate the picture tube without removing it from the set, resulting in renewed brightness in many and considerably longer useful life, has been placed on the market for the first time by a New York manufacturer.

In some cases, it was said, the picture tube may be made almost as good as new and given as much as a year's useful life before replacement is necessary.

The instrument is small and compact, it weighs three pounds, is as large as the average lunch box, costs little and is simple to operate. Picture tubes, some of them new and never in a receiver, have shown remarkable improvement in brilliance and definition after a few minutes of reactivation here in the last few days.

Although the principle of its operation is not new, cathode-ray tube manufacturers have used it for years in the initial making of picture tubes—its incorporation

The almost immediate urgent need for such an instrument, which also soon may be produced in kit form for home assembly, is apparent. Eight to ten million TV picture tubes, Transvision engineers estimate, have now been in use for three to four years or more, and "probably are in need of test and reactivation to 'renew' their brightness." Unfortunately, their brightness, it was pointed out, seldom can be detected short of comparing the old tubes with new ones in lately produced sets.

Furthermore, picture tubes may have lost some of their brightness, which has been described as a "kind of aging process" to which all large cathode-ray tubes and similar devices are subject. Such tubes, in the current sizes most in use today, cost from \$25 to \$85.

New picture tubes can be tested and reactivated without removing them from their cartons, and tubes in TV sets without removing the tubes from the receivers. It is done by attaching a standard picture-tube socket to the tube, linking by wires from the new instrument, turning a switch on the tester-reactivator, and noting a glow of a small neon bulb as a dial on the tester is indicated.

Condition of the tube is indicated directly on a dial of the tester, which is plugged into an AC home electric socket. The receiver, meanwhile, is not turned on.

In some cases the test and reactivation is accomplished in less than a minute.

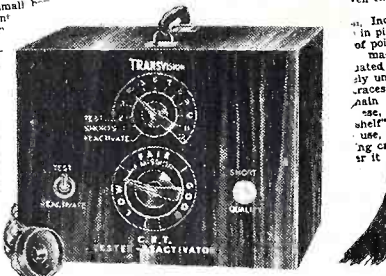

**TRANSVISION CR TUBE
TESTER - REACTIVATOR**
performs 2 vital functions:

- Tests Picture Tubes
- Renews Brightness of Dim Picture Tubes

It's a **TESTER**:

Without removing picture tube from set, you apply this precise instrument to:—

- Measure Cathode emission
- Locate shorts between elements
- Locate high resistance shorts or leakage as high as 3 megohms

It's a **REACTIVATOR**

for dim CR Picture Tubes

Revives dim TV Picture Tubes, without removal of tubes from sets. Works on a great many tubes with low light output, if there's no mechanical defect in tube. 110 V—60 cycles. Weighs only 3 lbs. One or two applications pays for instrument.

SATISFACTION GUARANTEED
or money refunded if you return the instrument in 10 days in good condition.

\$19.95
NET

—RUSH THIS COUPON—
TRANSVISION, INC.
DEPT. SD4 NEW ROCHELLE, N. Y.
() Send me CR Tube Tester-Reactivator(s).
() Enclosed find \$___ deposit. Balance C.O.D.
() Enclosed find \$___ in full. Send prepaid.
Name _____
Address _____
City _____ State _____

AD INDEX

Aerovox Corporation	44
Allied Radio Corp.	54
American Phenolic Corp.	12
American Television & Radio Co.	46
Argos Products Co.	54
Astron Corporation	56
Blonder Tongue Labs, Inc.	49
Bussman Manufacturing Co.	45
Cannon Electric Company	14
Centralab	28, 29
Channel Master	53
Columbia Wire & Supply Co.	44
General Electric Company	8, 9
Grayburne Corporation	55
Guardian Elec. Mfg. Co.	55
Hytron Radio & Electronics Co.	13
Industrial Television, Inc.	48
JFD Manufacturing Co., Inc.	46
LaPointe-Plascomold Corp.	48
Mallory, P. R. & Co., Inc.	11
Mattison TV & Radio Corp.	54
Mosely Electronics	51
Permo, Inc.	1
Plastoid Corp.	50
Precision Apparatus Corp.	2
Radiart Corporation	5
Radion Corp., The	10
Radio's Master	15
Rauland Corporation	43
Raytheon Mfg. Co.	47
RCA Tube Dept.	
RCA Batteries	7
RCA Electron Tubes	Cover 4
RCA TV Components	39
Regency Div., I.D.E.A. Inc.	16
Rider, John F. Publisher, Inc.	37, 48, 54, 56
Sams, Howard W. Co., Inc.	4
Simpson Electric Company	Cover 3
Snyder Manufacturing Co.	Cover 2
Sprague Products Co.	6
Sylvania Electric Products, Inc.	41
Telrex, Inc.	51
Turner Company, The	40
Transvision	56
Vaco Products Company	42

voltage being used as the sweep. The oscilloscope has the horizontal amplifier turned ON but its Internal Time Base Oscillator turned OFF. The signal generator provides both a frequency modulated signal oscillator and exactly the same signal for the sweep source. Under these conditions, a single trace is always present on the oscilloscope screen since the frequency excursion and the horizontal sweep are always in synchronism. As shown this presentation results in a single complete curve both for the intermediate frequency amplifier and for the discriminator.

Depend On . . .
Insist on . . .

ASTRON
CAPACITORS

You can depend on Astron for a complete line of multi-tested dry electrolytic and molded paper tubular capacitors for every radio, and television replacement job.

For quality next time . . . insist on Astron.

Write for catalog AC-3

ASTRON CORPORATION
255 Grant Avenue, E. Newark, N. J.

.. STOP... RIDER TV 9
... AT YOUR JOBBERS
ORDER NOW
.....SEE PAGE = 37

\$1.00 to \$5.00 PAID
"for SHOP NOTES"

Write up any "kinks" or "tricks-of-the-trade" in radio servicing that you have discovered. We will pay from \$1 to \$5 for such previously unpublished "SHOP NOTES" found acceptable. Send your data to "Shop Notes Editor," RADIO-TELEVISION SERVICE DEALER, 67 West 44 St., New York 18, N. Y. Unused manuscripts cannot be returned unless accompanied by stamped and addressed return envelope.

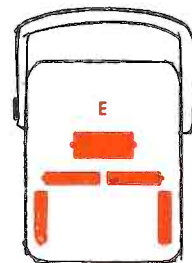
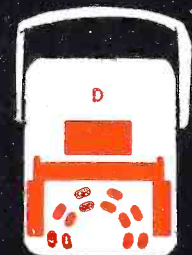
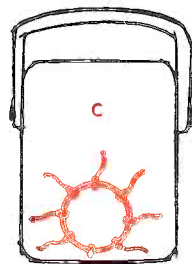
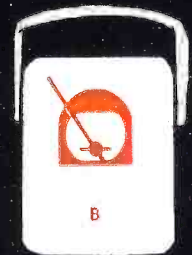
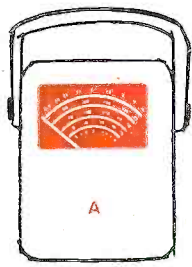

THE SIMPSON MODEL 260 VOLT-OHM-MILLIAMMETER OUTSELLS ALL OTHERS COMBINED BECAUSE

- A** covers all ranges necessary for Radio and TV set testing
- B** includes the Simpson 50 Microampere Meter Movement known the world over for its ruggedness
- C** no bulky harness wiring, thus eliminating all intercircuit leakage at this high sensitivity
- D** molded recesses for resistors, batteries, etc.
- E** easy battery replacement
- F** covered resistors to prevent shorts and protect against dust and moisture
- all components—including case and panels—are specially designed and completely tooled for maximum utility...not merely assembled from stock parts

ranges

20,000 Ohms per Volt DC,
1,000 Ohms per Volt AC
Volts, AC and DC: 2.5, 10, 50,
250, 1000, 5000
Output: 2.5, 10, 50, 250, 1000
Milliamperes, DC: 10, 100, 500
Microamperes, DC: 100
Amperes, DC: 10
Decibels (5 ranges):
-12 to +55 DB
Ohms: 0-2000 (12 ohms
center), 0-200,000 (1200 ohms
center), 0-20 megohms
(120,000 ohms center)

prices

Model 260 \$38.95; With Roll
Top \$46.90. Complete with
test leads and operator's
manual. 25,000 volt DC Probe
for use with Model 260, \$9.95.

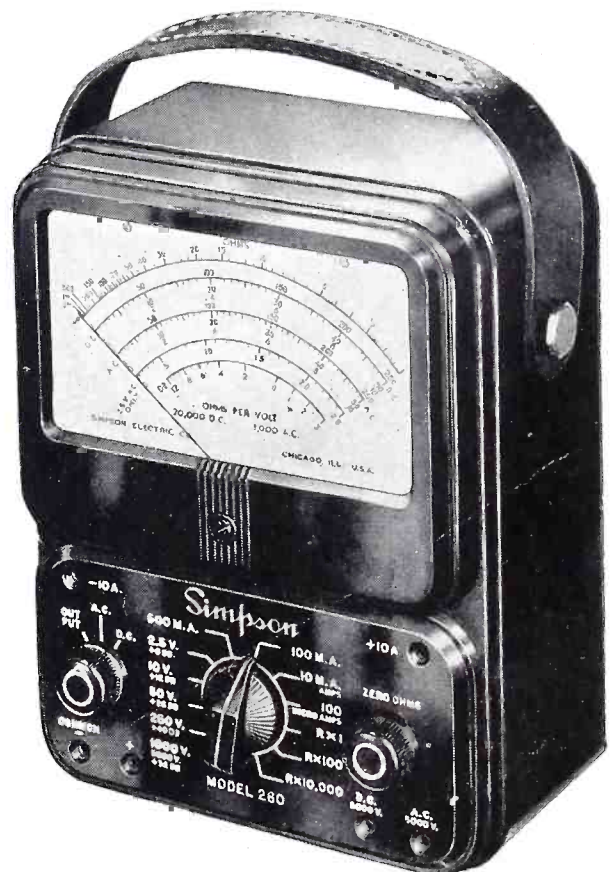

Simpson Instruments That Stay Accurate Are Available From All Leading Electronic Distributors.

SIMPSON ELECTRIC COMPANY

5200 W. Kinzie St., Chicago 44, Illinois • Phone: COLUMBUS 1-1221

In Canada: Bach-Simpson, Ltd., London, Ont.

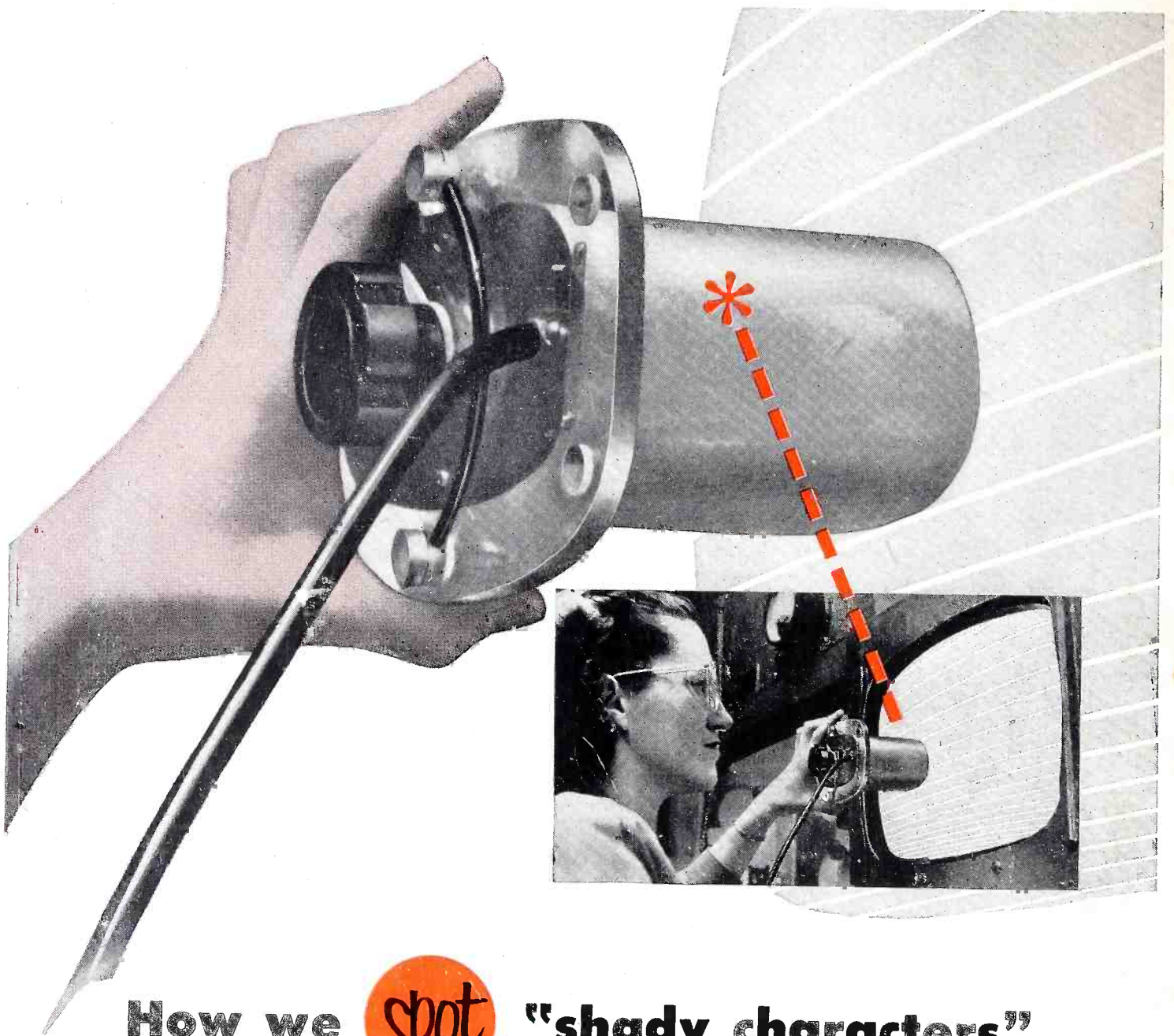

How we **spot** "shady characters"
before they can damage your business

THE instrument you see is working for you. A sensitive light-measuring device, it is used like a doctor's stethoscope, to explore the surface of a picture tube for screen imperfections the unaided eye would fail to detect.

Employing a photosensitive surface and color filters, this device does two jobs. It checks not only the uniformity of brightness, but also the *color* values from center to edges of the faceplate.

Why is this important? It is important because RCA has learned, through long

experience in the manufacture of picture tubes, that the best picture—the picture having superior quality—calls for unusually rigid processing controls of the phosphor and its application. The light-measuring device spots any departure from RCA's established brightness and color standards. Result? "Shady characters"—those tubes that would produce pictures lacking in fine quality—*never reach your shop.*

This constant vigilance and *quality control* at all stages of manufacture assure

that RCA standards will be met. In this way, RCA guards its own reputation for quality . . . and yours as well.

With RCA Receiving Tubes, as well as RCA Kinescopes, TOP-QUALITY CONTROL makes the difference.



RADIO CORPORATION of AMERICA
 ELECTRON TUBES

HARRISON, N. J.