

FEBRUARY, 1952

Radio-Television SERVICE DEALER



The Professional Radio-TVman's Magazine

IN THIS ISSUE:

Capacitor Troubles In TV Receivers

U-H-F Converters

Reactance Tube Applications In Horizontal A-F-C Circuits

A.G.C. In TV, Part 2

M. HARRISON CRAIG, JR.
SHULLSBURG
21 OCT 52-50H-160

AM **W-SOUND**

The "Fittingest" thing you ever saw . . .

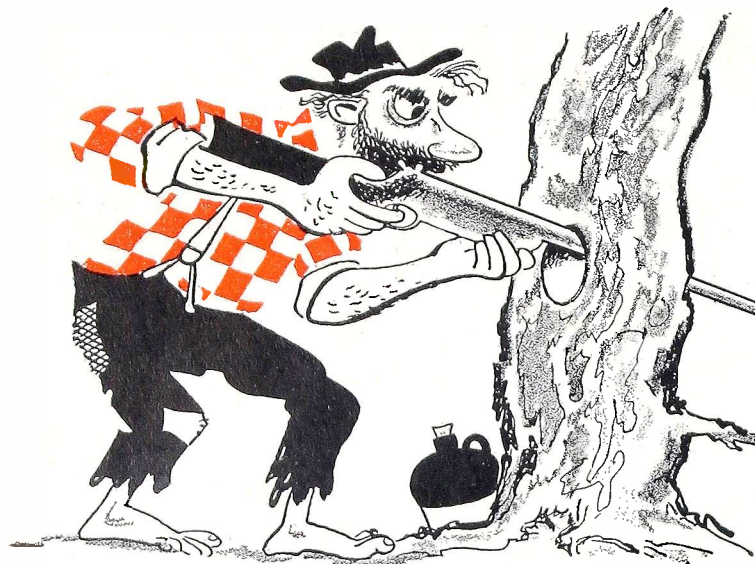

MALLORY MIDGETROL®

Dual Concentric Volume Controls

MAKE YOUR CUSTOMERS HAPPY

FIT 'EM FAST . . . FIT 'EM EASY

- In just five steps that take less than five minutes, you assemble a dual control that gives you the precise resistance values you need.
- Directions are short, easy to follow and you need no special tools . . . no soldering.
- Front and rear sections are factory-assembled and inspected.
- Instant AC switch attachment without control disassembly.

- Longer lasting resistance elements even in extremes of temperature and humidity.
- Better and more accurate taper curves resulting from precision processing methods.
- No pigtail connections to break—thanks to Mallory's exclusive sliding contact that gives EXTRA quiet operation.
- Minimum wobble with Mallory exclusive two-point shaft suspension.

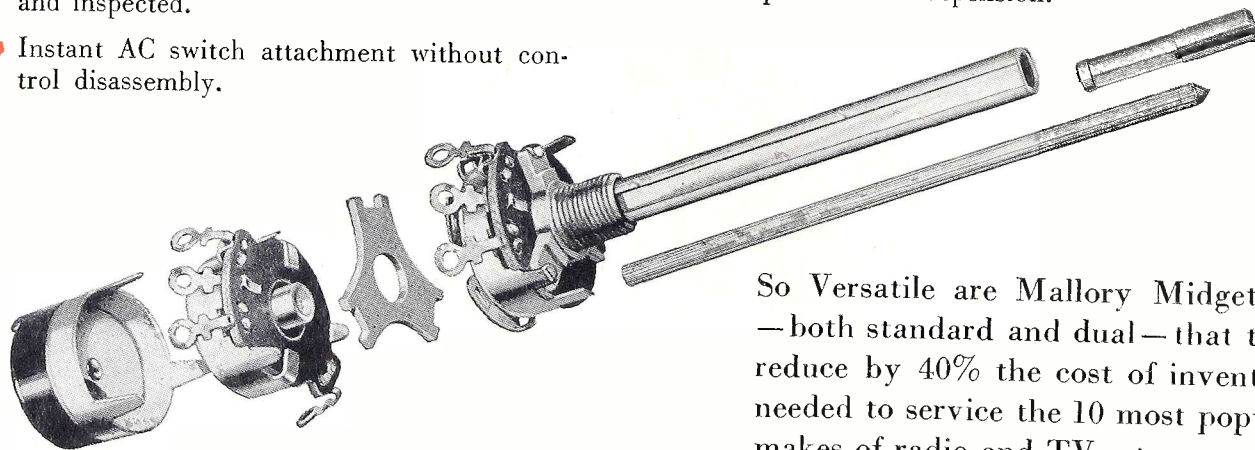

So Versatile are Mallory Midgetrols—both standard and dual—that they reduce by 40% the cost of inventory needed to service the 10 most popular makes of radio and TV sets.

**Make Sure!
Make it Mallory!**

You can build more than 10,000 different combinations with Mallory Midgetrols and do it fast . . . easily. Each dual control you build duplicates exactly the control it replaces. The Mallory Midgetrol Line, in addition to dual concentrics, includes round shaft, standard controls with the advantages of stable, two-point shaft suspension, instant AC switch attachment. Ready adaptability to split-knurl and flatted type knobs.

P. R. MALLORY & CO Inc.
MALLORY

CAPACITORS • CONTROLS • VIBRATORS • SWITCHES • RESISTORS
• RECTIFIERS • VIBRAPACK* POWER SUPPLIES • FILTERS

APPROVED PRECISION PRODUCTS

*Reg. U.S. Pat. Off.

P. R. MALLORY & CO., Inc., INDIANAPOLIS 6, INDIANA

130,000 qualified TV servicemen needed

Here is how you can be one of them

INDUSTRY EXPERTS HAVE ESTIMATED OVER 130,000 qualified TV technicians will be needed for the installation, trouble-shooting and repairing of the television receivers in use by 1955.

There are far fewer than 50,000 fully trained TV technicians available today. This means more jobs, unrivaled future for security, greater earning power for thousands and thousands of additional TRAINED and EXPERIENCED TV Servicemen. Will you be one of them?

OUTSTANDING FUTURE FOR QUALIFIED TV SERVICEMEN

Men now in radio servicing as well as men in the radio-electronics industry with no experience in TV servicing... here is your opportunity. The RCA Institutes Home Study Course in Television Servicing makes it possible for you to convert your skill in radio servicing, or interest in radio-electronics, to the important money-making field of TV servicing.

The RCA Institutes Course gives you a sound knowledge of television fundamentals... intensive practical instruction in the proper maintenance and servicing of complex TV receiver circuits—including color TV and UHF... teaches you the "short cuts" on TV installation and trouble-shooting, saving you many hours of on-the-job labor.

TRAINING MEETS MODERN REQUIREMENTS

This course is in step with the progress of the television industry. It is backed by RCA—pioneer in television development. It is based on the actual experience of the RCA Service Company in servicing thousands of home television receivers. The

course is constantly being revised, improved and kept up-to-the-minute. It will help you to a more profitable and productive future in these ways:

PREPARE YOU to take the required technical examination with confidence, in those areas that require a license or permit to engage in TV servicing.

TRAIN YOU, if you are a serviceman in a non-TV area, to become a qualified TV technician by the time TV comes to your area. In TV areas, TV servicing has substantially replaced radio servicing as the chief source of income.

IF YOU ARE A QUALIFIED TV SERVICEMAN, it will keep you in step with the latest industry developments including color TV and UHF.

IT DEVELOPS the latent talents of installers into skilled trouble-shooting TV technicians.

TRAINS MEN in radio-electronics with no previous servicing experience to fill jobs as TV technicians, to win promotions and better pay.

RCA INSTITUTES HOME STUDY COURSE PLANNED TO YOUR NEEDS

You keep your present job in radio—television—electronics. In your spare time, you study at home. You learn "How-to-do-it" techniques with "How-it-works" information in easy-to-study lessons prepared in ten units. Cost of RCA Home Study Course in Television Servicing has been cut to a minimum—as a service to the industry. You pay for the course on a "pay-as-you-learn" unit lesson basis. You receive an RCA Institutes certificate upon completion of the course. The RCA Institutes Home Study Course in Television Servicing is approved by leading servicemen's associations.

RCA Institutes conducts a resident school in New York City offering day and evening courses in Radio and TV Servicing, Radio Code and Radio Operating, Radio Broadcasting, Advanced Technology. Write for free catalog on resident courses.

Send for FREE BOOKLET

Mail the coupon—today. Get complete information on the RCA INSTITUTES Home Study Course in Television Servicing. Booklet gives you a general outline of the course by units. See how this practical home study course trains you quickly, easily. Mail coupon in envelope or paste on postal card.

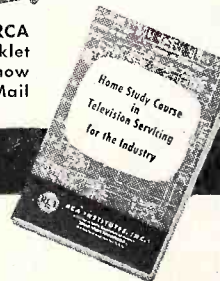

MAIL COUPON NOW!

RCA INSTITUTES, INC.
Home Study Department, RSD-252
350 West Fourth Street, New York 14, N.Y.

Without obligation on my part, please send me copy of booklet "RCA INSTITUTES Home Study Course in TELEVISION SERVICING." (No salesman will call.)

Name _____
Address _____ (Please Print)
City _____ Zone _____ State _____



RCA INSTITUTES, INC.
A SERVICE OF RADIO CORPORATION of AMERICA
350 WEST FOURTH STREET, NEW YORK 14, N.Y.

PRECISION CR-30 CATHODE RAY TUBE TESTER

TESTS ALL TV PICTURE TUBES

(MAGNETIC AND ELECTROSTATIC)

'SCOPE TUBES AND INDUSTRIAL CR TYPES

for True Beam Current (Proportionate Picture Brightness)
Tests ALL CR Tube Elements—Not Just a Limited Few

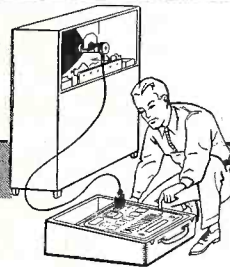

IN FIELD OR SHOP
Tests CR Picture Tubes
Without Removal from
TV Set or Carton!

The Precision CR-30 fills an obvious gap in the test equipment facilities employed by TV service and installation technicians.

Because of the absence of a reliable cathode ray tube tester, up to 50% of so-called "rejected tubes" are found to be fully serviceable and should rightfully never have been "pulled out."

Proven product of extended development, the CR-30 has been

specifically engineered to answer the question, "Is It the TV Set or is it the Picture Tube?"

The Precision CR-30, a complete and self-contained Electronic Instrument, incorporates a TRUE BEAM CURRENT Test Circuit. The CR-30 checks overall electron-gun performance for proportionate picture brightness as well as additional direct testing facilities for accelerating anodes and deflection plate elements.

The Precision CR-30 should not be confused with mere adapters connecting to ordinary receiving tube testers which were never designed to meet the very specialized needs of CR tube checking. Similarly, it is not to be confused with neon-lamp units or similar devices of limited technical merit and which do not check all CR tubes or all tube elements.

GENERAL AND TECHNICAL SPECIFICATIONS

- ★ Tests All Modern Cathode Ray Tubes:—Magnetic and Electrostatic, 'Scope Tubes and Industrial Types.
- ★ Tests All CR Tube Elements:—Not just a limited few.
- ★ Absolute Free-Point 14 Lever Element Selection System, independent of multiple base pin and floating element terminations, for Short-Check, Leakage Testing and Quality Tests. Affords maximum anti-obsolence insurance.
- ★ True Beam Current Test Circuit checks all CR Tubes with Electron-gun in operation. It is the Electron Beam (and NOT total cathode emission) which traces the pictures or pattern on the face of the CR tube.
- ★ Voltage Regulated, Bridge Type VTVM provides the heart of the super-sensitive tube quality test circuit. Such high sensitivity is also required for positive check of very low current anodes and deflection plates.
- ★ Micro-Line Voltage Adjustment
Meter-monitored at filament supply.
- ★ Accuracy of test circuits closely maintained by use of factory adjusted internal calibrating controls; plastic insulated, telephone type cabled wiring; highest quality, conservatively rated components.
- ★ Built In, High Speed, Roller Tube Chart.
- ★ Test Circuits Transformer Isolated from Power Line.
- ★ 4 5/8" Full Vision Meter with scale-plate especially designed for CR tube testing requirements.
- ★ Heavy Gauge Aluminum Panel etched and anodized.
- ★ PLUS many other "PRECISION" details and features.

Total cathode emission can be very high and yet Beam Current (and picture brightness) unacceptably low. The CR-30 will reject such tubes because it is a true Beam Current tester. Conversely, total cathode emission can be low and yet Beam Current (and picture brightness) perfectly acceptable. The CR-30 will properly pass such tubes because it is a true Beam Current tester. The significance of the above rests in the fact that Beam Current (and picture brightness) is primarily associated with the condition of the center of the cathode surface and not the overall cathode area. (See illustration below)

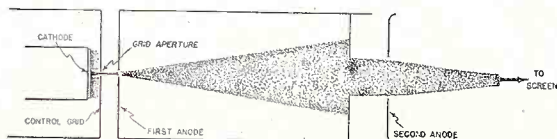

SERIES CR-30—In hardwood, tapered portable case, with hinged removable cover. Extra-Wide Tool and Test Cable Compartment. Overall Dimensions 17 1/4 x 13 3/4 x 6 3/4". Complete with standard picture tube cable, universal CR Tube Test Cable and detailed Instruction Manual.

Shipping Weight:—22 lbs. Code: Daisy
NET PRICE:—\$99.75

See the CR-30 on display at leading electronic equipment distributors. Order now to assure earliest possible delivery.



PRECISION APPARATUS CO., INC.

92-27 Horace Harding Boulevard, Elmhurst 8, New York

Export Division: 458 Broadway, New York, U.S.A. • Cables—Morhanex
In Canada: Atlas Radio Corp., Ltd., Toronto, Ontario

EDITORIAL

by S. R. COWAN

Protect Yourself

Most radio and TVset owners carry, as a matter of course, a fire insurance policy to protect themselves financially should a fire damage their home. Most policy holders don't know that their insurance policy is voided automatically (by a clause in small print) if a fire is caused by lightning striking the antenna unless an approved type of lightning arrestor is installed between the receiver and antenna. Insurers assume such a protective device will eliminate the possibility of a fire occurring.

Fires have occurred in homes because lightning struck a radio or TVset antenna. Courts have held that when the set installer failed to protect fully his customer (by neglecting to include a lightning arrestor) such installer, rather than the insurance company, should be held liable for damages caused by his negligence.

Surveys show that many TV service contractors still fail to include the use of a lightning arrestor as a part of their standard installation. Such firms risk much too much. We urge that no TV installation ever be made without including a lightning arrestor. Of course the customer should pay for the unit and labor involved. If he objects, get a release in writing. (The demand for such a release invariably clinches the sale) Also, be on the look-out when working presently installed sets, and you'll be surprised at the number of extra lightning arrestor installation jobs that can be obtained merely for the slight effort required.

Price Ceilings — Bah!

The threats by OPS to check all types of "service trades" to make sure there aren't violations of price-ceilings should not disturb radio-TV servicemen because to all practical purposes our profession cannot be bound by a price-fixing scale or government edict any more than a surgeon can.

Contrast TV repairing to other "service trades" like barbers or shoe repairers and you'll see why this is our contention. A shoe repairer knows that it costs so much to replace soles on men's shoes . . . all men's shoes . . . and he can set prices accordingly. But, no radioman can tell in advance that "to replace certain resistors so much time is needed or so much must be provided for the replacement unit" . . . for there are too many variables involved. In one chassis it might take 9 minutes just to reach a buried defective resistor while in another brand of set the resistor serving the identical circuit purpose might cost 3 times as much and yet be situated right at instant's reach.

Gentlemen, let's be patriotic and hold prices in line for common-sense reasons and not merely because of edicts and regulations. Ever remember we're part of a technical, complex profession requiring know-how and experience.

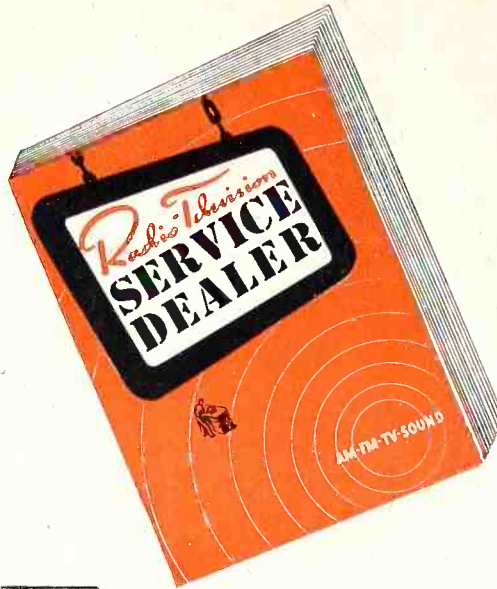

Sanford R. Cowan
EDITOR & PUBLISHER

Samuel L. Marshall
MANAGING EDITOR

COWAN PUBLISHING CORP.
67 WEST 44TH ST.
NEW YORK 18, N. Y.



VOL. 13, NO. 2

FEBRUARY, 1952

Editorial	3
Trade Flashes	4
Sync Pulses, <i>by San D'Arcy</i>	10
Capacitor Troubles In TV Receivers, <i>by Matthew Mandl</i>	15
Pinpointing sources of capacitor troubles in various circuits of a TV receiver.	
U-H-F Converters, <i>by Allan Lytel</i>	18
Analysis of the P. R. Mallory u-h-f tuner	
Reactance Tube Applications In Horizontal A-F-C Circuits, <i>by Samuel L. Marshall</i>	20
The "how" and "why" of reactance tube circuits in a.f.c.	
A.G.C. in TV, Part 2, <i>by Leonard Lieberman</i>	23
Peak-type a-g-c circuits of various types discussed and analyzed	
Association News	26
Shop Notes	27
Bendix 1950 Models-Pix Tube Spots. G.E. Models 600, 601, 603, 604-Weak R-F Oscillator; Loose Speakers	
Trade Literature	28
Circuit Court	29
Radio Craftsman RC 100-A—Vertical A.F.C. Stromberg-Carlson Model 317 RPM—Retrace Blanking	
New Products	30
Here's How & Why, <i>by Chet Jur</i>	33
Ringing Coil	
Personnel Notes	46
Ad Index	48
Circuits:	
Testing capacitor leakage with a VTVM	15
Input circuit of P. R. Mallory tuner	18
Simplified diagram of reactance tube circuit	21
Applying control voltage from discriminator to reactance tube	21
630 type chassis-reactance tube circuit	22
Crosley Model 9-422M-LD reactance tube circuit	22
Basic peak-type a-g-c network	24
Air King Model 2017R a-g-c system	24
Arvin Model 2160 a-g-c system	24
Capehart Model 461-P a-g-c system	25
Stromberg-Carlson retrace blanking in Model 317-RPM receiver	41
Circuit diagram of Mallory U-H-F tuner	42
Fada Model 1025 a-g-c circuit	44

SANFORD L. CAHN, Advertising Director HARRY N. REIZES, Advertising Manager
DAVID SALTMAN, Production Mgr. CHARLES LO CICERO, Circulation Mgr.

TED E. SCHELL, 112 West 9th St., Los Angeles 15, Calif., VANDIKE 8921

RADIO-TELEVISION SERVICE DEALER is published Monthly by Cowan Pub. Corp., 67 West 44th St., New York 18, N. Y. Subscription price: \$2 per year in the United States, U.S. Poss. & Canada: elsewhere \$3. Single Copies: 25c. Reentered as second class matter Sept. 25, 1950 at the Post Office at New York, N. Y. under the Act of Mar. 3, 1879. Copyright 1952, Cowan Pub. Corp.

PHOTOFACT Users Write Our Best ADS!

Hundreds of unsolicited letters tell what the world's finest Radio & TV Data means to Service Technicians

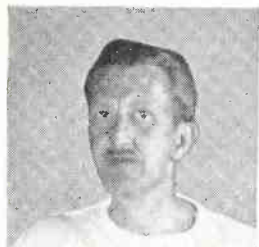

James Goodwin
315 Mt. Eden Ave.
Bronx, N. Y.

"We want to tell you how wonderful and simple it is to repair receivers with PHOTOFACT Folders. Their usefulness and efficiency are especially brought out in TV work, where the mechanism is very complicated, and you must have complete and accurate information and pictures."



George W. Scott
Greenfield, Mo.

"I am a regular subscriber to PHOTOFACTS and think they are the best equipment a serviceman can own. Couldn't do without them."



Francis H. Curry
1018 W. Locust St.
Milwaukee, Wis.

"You're really doing a fine job to help the radio and television serviceman. PHOTOFACTS and the PF Index and Technical Digest can't be beat."

NOW! GET THE PROOF FOR YOURSELF!

FREE

We'll send you a Free Photofact Folder on any receiver listed in "PF Index & Technical Digest."

Learn for yourself—at our expense—how PHOTOFACT pays for itself by earning bigger repair profits for you! Select any Folder from the PF Index (if you haven't an Index, get a free copy from your distributor). When you write us for your Free Folder, be sure to state Photofact Set and Folder Number as shown in the Index. Get your Free Folder now. Examine, use, compare—see why you can't afford to be without PHOTOFACT!

HOWARD W. SAMS & CO., INC.
2201 East 46th Street • Indianapolis 5, Indiana

TRADE FLASHES

A "press-time" digest of production, distribution, and merchandizing activities

More Than 347 Million Tubes Sold in First 11 Months of 1951

More than 347 million receiving tubes were sold in the first 11 months of 1951, the Radio-Television Manufacturers Association announced. Sales in the 11 month period totaled 347,643,226 tubes compared with 344,236,998 in the corresponding 1950 period.

Of the total tubes sold through November, 231,678,712 units were shipped for use in new sets and 87,479,522 were sold for replacements. Sales to government agencies accounted for 7,053,620 units and 21,431,372 tubes were exported.

Sales in the month of November totaled 32,710,369 tubes compared with 39,326,641 units in November 1950 and 34,137,519 in October 1951.

November Radio-TV

Production Drops

Production of radio and television receivers in November totalling 747,914 and 415,332 sets, respectively, represented a decrease of 40 per cent under the corresponding month of 1950, the Radio-Television Manufacturers Association reported. RTMA's estimates showed a drop of 38 percent in radio receiver production and 44 percent in the TV set output.

However, production of more than five million TV sets and 12 million radios for the year 1951 was assured as the eleven-month totals reached 4,798,056 TV sets and 11,701,115 radios. RTMA estimates represent production by members of the Association and non-members.

The November output compared with 738,800 TV sets and 1,215,600 radios in the corresponding 1950 month. Radios with FM facilities produced during November were estimated at 40,092. In addition 16,873 TV sets containing FM circuits were manufactured.

Electronic Parts Show News

Tense moment at the 1952 Electronic Parts Show space drawing, held at the Hotel New Yorker, December 14th. In the photo, Kenneth C. Prince, Show Manager (center, with microphone) stands by while a member-



exhibitor chooses space for his exhibit. Rear, left, a group of Show directors is seen in a huddle: Hy Ruble, of NEDA; Lew Howard, WCEMA; John H. Cashman, EP&EM and Walter W. Jablon, SMCEG. Back of the floor plan is seen George Wedemeyer, NEDA, checking a floor plan with Sam Baraf, SMCEG. Far right, Jules Bressler, New York, representative, converses with Aaron Lippman, NEDA. In the front row may be identified V. N. Zachariah, NEDA; Sam Spector, Insuline Corporation of America and Dick Mitchell, Regency Co., Indianapolis, among others.

Dr. Allen B. Dumont Predicts Important Year For TV

Dr. Du Mont's year-end statement is in part as follows:

"We look for more attention to be given not alone to video entertainment but to areas of interest in the domain of public relations, to the development of electronic journalism, to sight and sound exploration in the realm of everyday politics, to adult education, to the illustration of how the tenets of religion can and should be applied to everyday life.

"With electronics playing an increasingly important role in the blueprints of our military and naval planners, electronics, next to steel and aircraft, will play industry's most important role in our national rearmament program. By the end of 1952, the electronics industry will be producing at the annual rate of \$4,500,000,000 which equals the peak industry production figure in World War II.

"Because of this tremendous manufacturing effort for the national defense, the production of television re-

NOW

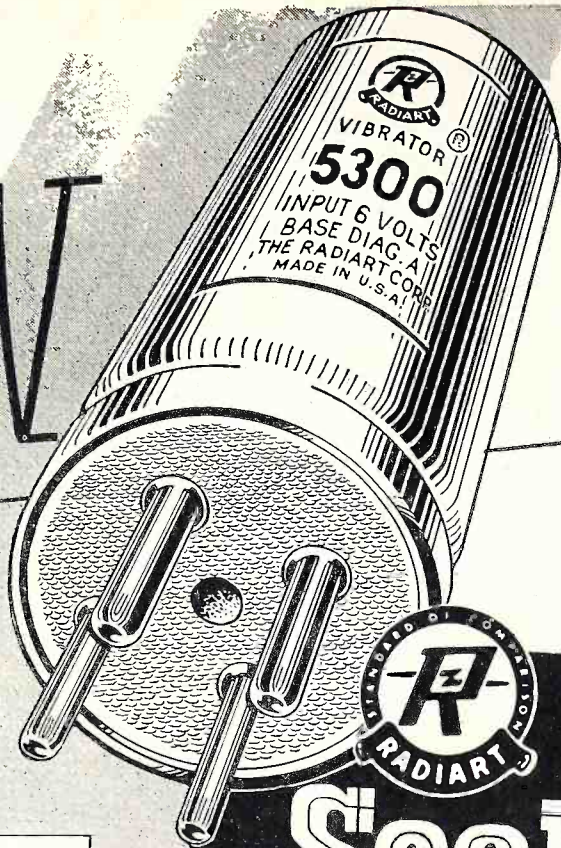

the greatest improvement in vibrators

in 17 years*



RADIART Seal-Vent RED SEAL VIBRATORS

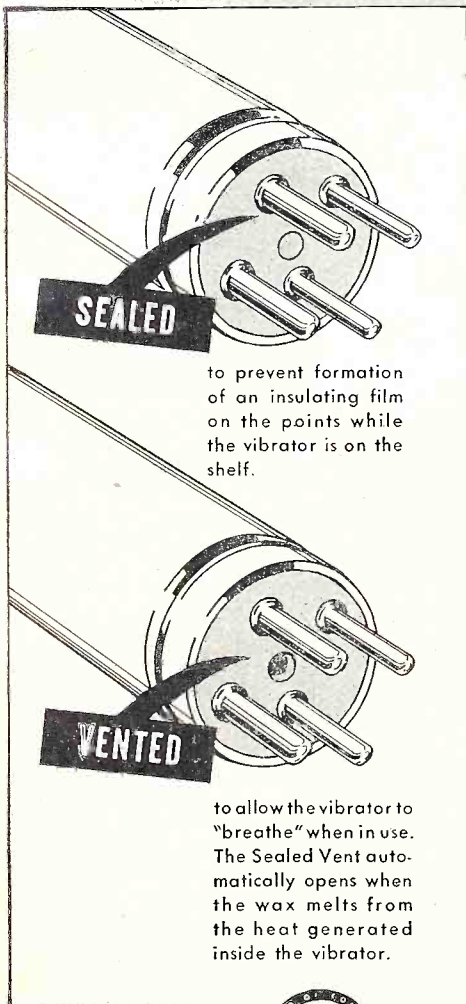

Who said you can't have your cake and eat it, too? WE'VE FOUND A WAY! The famous RADIART "RED SEAL" Vibrator that has been the standard of comparison of the industry for decades now is better than ever! The RED SEAL sandwich of rubber and bakelite NOW has a vent that is wax-sealed at the factory to prevent oxidation of the points. When the vibrator is put into use, the wax melts out and permits air circulation for EVEN GREATER PERFORMANCE AND STILL LONGER LIFE! Unquestionably, this is the GREATEST ADVANCEMENT IN VIBRATORS SINCE THE CHANGE TO PLUG-IN DESIGN . . . get yours NOW!

*in our opinion the greatest improvement since the change from a permanently-wired-into-the-set vibrator to the plug-in design.

for additional literature and catalog sheets, see your jobber or write



THE RADIART CORPORATION CLEVELAND 2, OHIO

VIBRATORS • AUTO AERIALS • TV ANTENNAS • ROTATORS • POWER SUPPLIES

SERVICEMAN'S DIARY....by Ben Grim

WHAT! \$4.68 FOR FIXING
A SIMPLE THING LIKE THAT!

THERE WAS AN
INTERMITTENT SHORT
IN THE SET. IT TOOK
3 DAYS TO
LOCATE IT!

THAT'LL BE \$5.00 FOR MY
TIME - PLUS \$2.50 FOR THE
PENICILLIN. WE'LL TRY A COUPLE
MORE SHOTS NEXT WEEK. IF
THEY DON'T WORK I'LL GIVE YOU
AN EXAMINATION!

THE
TROUBLE
A BOIL ON THE
BEEZER

.... BUT ONE WEEK LATER
WHEN THE SERVICEMAN CALLS ON THE "DOC."



\$10.00

FOR YOUR CARTOON IDEA

Have a pet peeve about service customers and their peculiarities? Help us keep the above "SERVICEMAN'S DIARY" cartoon series going by sending in your idea. No need to draw it—just write it out. Sprague will pay \$10.00 for every idea that is used.

Unequaled Dependability

Actual service records prove that Sprague Twist-Lok dry electrolytic capacitors are tops for keeping you out of trouble with service customers—by keeping their TV sets working right!

And Sprague has the *most* complete listing of *every type* of television electrolytic. Ask your Sprague distributor for a catalog or write to: SPRAGUE PRODUCTS COMPANY, 71 Marshall St., North Adams, Mass.



TWIST-LOK* 'LYTICS

The easiest to use, most reliable electrolytics
for television replacement use

* T.M. (Sprague Products Company is the Distributors' Division of the Sprague Electric Company)

ceivers will, of necessity, have to be curtailed. The industry which manufactured upwards of 5,000,000 receivers in 1951, following an unprecedented seven and a half million figure in 1950, will produce approximately 4,000,000 sets, due to shortages of critical materials."

"Halolight" For 17" Sylvania TV Sets

"Halolight", Sylvania's exclusive surround lighting built into television sets, has been adapted for 17" models, John K. McDonough, general sales manager for the Radio and Television Division of Sylvania Electric Products Inc., announced.

The revolutionary feature, which frames the television image in a band of soft light, is incorporated in three 17" models of the January 1952 line.

Previously "Halolight" had been offered only on console 20" sets, but the enthusiastic reception to it had made it imperative to bring the benefits of "Halolight" to purchasers of small sets, McDonough said.

Raytheon Develops New Pix Tube

Treatment For Corona

The Receiving Tube Division of Raytheon Manufacturing Company announce that the company has developed and are now producing Picture Tubes treated with the new Raytheon Corona Inhibitor.

Under certain atmospheric conditions, servicemen have been plagued by a loss of picture brightness due to leakage, corona, and arc-over at the second anode connector on the bulb of a Television Picture Tube. This leakage from the second anode connection reduces the second anode voltage, and consequently the brilliance of the picture. In addition, there may be audible effects from the corona, which can be a source of alarm to the set owner. This difficulty has been experienced in varying degrees of intensity and in those cases where the leakage or corona has been slight, many valuable man-hours have been lost tracking down the source of trouble. Raytheon Picture Tubes treated with Corona Inhibitor eliminate trouble from this source.

RCA Announces 17" All-Glass

Electrostatic Focus Tube

To meet an active demand for television picture tubes utilizing low-voltage electrostatic focus, the RCA Tube Department has announced a 17-inch all-glass rectangular type. A similar kinescope of the metal-shell type was introduced by RCA recently.

The mounting demand from set manufacturers for the low-voltage focus type of kinescope was attributed

[Continued on page 12]

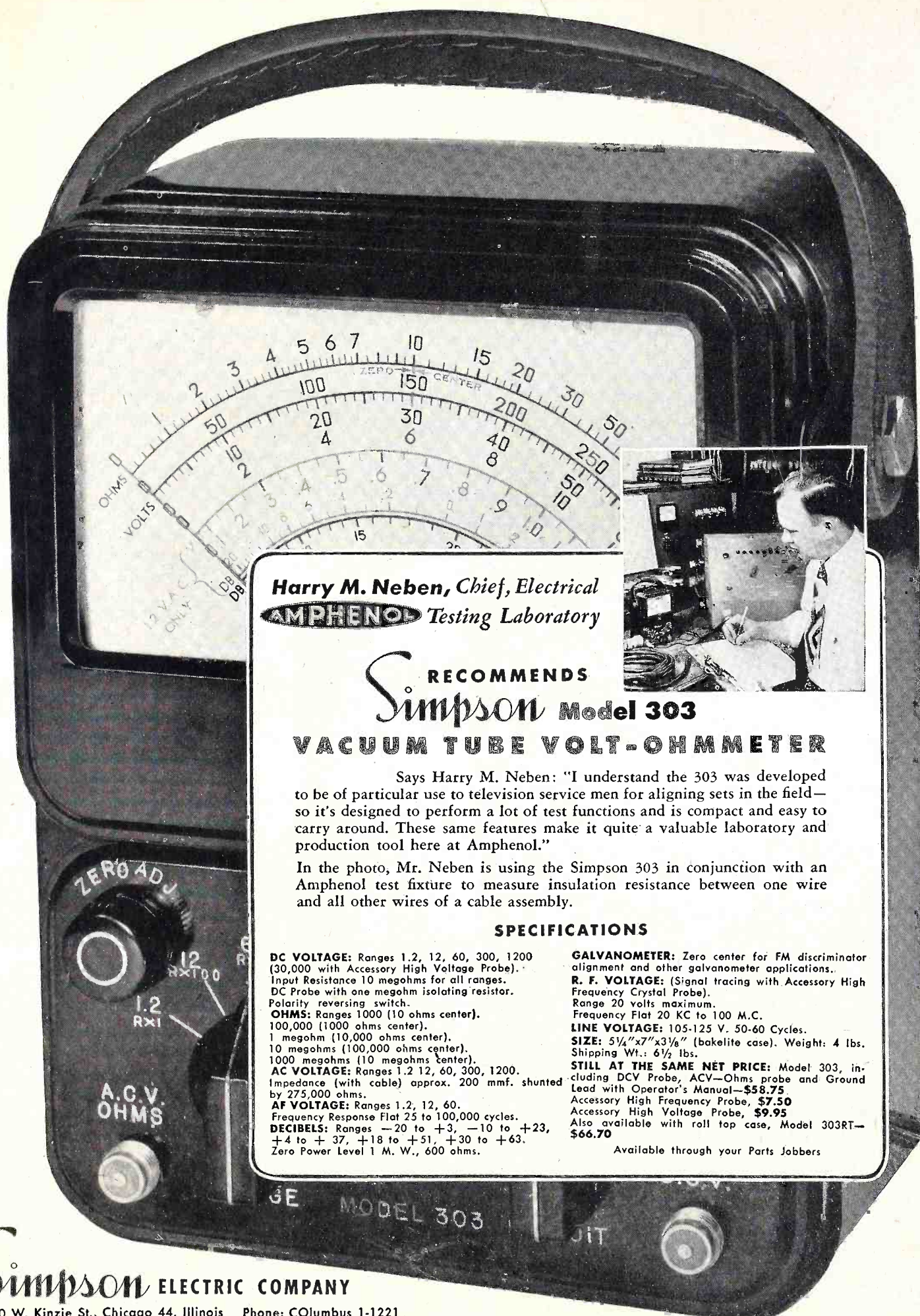

Harry M. Neben, Chief, Electrical
AMPHENOL Testing Laboratory



RECOMMENDS
Simpson Model 303

VACUUM TUBE VOLT-OHMMETER

Says Harry M. Neben: "I understand the 303 was developed to be of particular use to television service men for aligning sets in the field—so it's designed to perform a lot of test functions and is compact and easy to carry around. These same features make it quite a valuable laboratory and production tool here at Amphenol."

In the photo, Mr. Neben is using the Simpson 303 in conjunction with an Amphenol test fixture to measure insulation resistance between one wire and all other wires of a cable assembly.

SPECIFICATIONS

DC VOLTAGE: Ranges 1.2, 12, 60, 300, 1200 (30,000 with Accessory High Voltage Probe).
 Input Resistance 10 megohms for all ranges.
 DC Probe with one megohm isolating resistor.
 Polarity reversing switch.
OHMS: Ranges 1000 (10 ohms center), 100,000 (1000 ohms center), 1 megohm (10,000 ohms center), 10 megohms (100,000 ohms center), 1000 megohms (10 megohms center).
AC VOLTAGE: Ranges 1.2, 12, 60, 300, 1200. Impedance (with cable) approx. 200 mmf. shunted by 275,000 ohms.
AF VOLTAGE: Ranges 1.2, 12, 60. Frequency Response Flat 25 to 100,000 cycles.
DECIBELS: Ranges -20 to +3, -10 to +23, +4 to +37, +18 to +51, +30 to +63. Zero Power Level 1 M. W., 600 ohms.

GALVANOMETER: Zero center for FM discriminator alignment and other galvanometer applications.
R. F. VOLTAGE: (Signal tracing with Accessory High Frequency Crystal Probe). Range 20 volts maximum. Frequency Flat 20 KC to 100 M.C.
LINE VOLTAGE: 105-125 V. 50-60 Cycles.
SIZE: 5 1/4" x 7" x 3 1/8" (bakelite case). Weight: 4 lbs. Shipping Wt.: 6 1/2 lbs.
STILL AT THE SAME NET PRICE: Model 303, including DCV Probe, ACV—Ohms probe and Ground Lead with Operator's Manual—\$58.75
 Accessory High Frequency Probe, \$7.50
 Accessory High Voltage Probe, \$9.95
 Also available with roll top case, Model 303RT—\$66.70

Available through your Parts Jobbers

Simpson ELECTRIC COMPANY
 5200 W. Kinzie St., Chicago 44, Illinois Phone: COLUMBUS 1-1221
 In Canada: Bach-Simpson, Ltd., London, Ont.
World's Largest Makers of Electronic Test Equipment

SYLVANIA NATIONAL ADVERTISING

**5 Stars Endorse
Your Business in these
Smashing Magazine
ads**

Jane Russell says:

"For the finest radio and television service, I advise my friends to depend on the man who displays the Sylvania sign. Believe me, he's a post-master at keeping sets in splendid shape."



... Russell is no star...
... will find Miss Russell's advice is
... Sylvania sign is trained and
... is perfect condition. Of course,
... sets these famous Sylvania
... sets perform like new.

SYLVANIA TUBES
RADIO AND TELEVISION PICTURE

Sylvania Electric Products Inc. 1740 Broadway, New York 19, N. Y.
Manufacturers of Radio Tubes, Television Tubes, Electronic Tubes, Vacuum Tubes, X-ray Tubes, Photo Tubes, Sign Tubes, Light Tubes, Neon Tubes, Fluorescent Tubes, and

June Haver says:

"I've made a wonderful discovery. When I have trouble with my radio or TV set, I simply call the man who displays the Sylvania service sign. He gives me prompt, courteous and competent repair service. Try it - and see if you don't agree."



... right, June! The man behind this
... sign is a radio and television
... He can banish radio squeaks
... He can banish TV streaks
... like new. Of course, he also
... Sylvania Radio and Television Tubes
... most made anywhere.

SYLVANIA TUBES
RADIO AND TELEVISION PICTURE

Sylvania Electric Products Inc. 1740 Broadway, New York 19, N. Y.
Manufacturers of Radio Tubes, Television Tubes, Electronic Tubes, Vacuum Tubes, X-ray Tubes, Photo Tubes, Sign Tubes, Light Tubes, Neon Tubes, Fluorescent Tubes, and

Says Leo Durocher:

"Learn and I don't fool around with just any radio and TV service. We like an expert who knows how to call things right. That's why we call the man who shows the Sylvania sign."



You, too, will appreciate the prompt, dependable service offered by the man who displays this Sylvania sign. He's a trained technician who will spot trouble instantly with Sylvania's production test equipment and install long-lasting Sylvania Tubes.

SYLVANIA TUBES
RADIO AND TELEVISION PICTURE

Sylvania Electric Products Inc. 1740 Broadway, New York 19, N. Y.
Manufacturers of Radio Tubes, Television Tubes, Electronic Tubes, Vacuum Tubes, X-ray Tubes, Photo Tubes, Sign Tubes, Light Tubes, Neon Tubes, Fluorescent Tubes, and

Says Ann Blythe

"I've found a man who knows all the answers... at least to radio and TV troubles. He's the man who displays the Sylvania radio and television service sign. So whether I'm in Hollywood or in New York, I look for this sign for dependable service."



You, too, can enjoy true-to-life radio performance, and keep television reception clear as a polished mirror by calling the expert who displays this Sylvania sign. He uses those extra fine Sylvania Radio and Television Tubes.

SYLVANIA TUBES
RADIO AND TELEVISION PICTURE

Sylvania Electric Products Inc. 1740 Broadway, New York 19, N. Y.
Manufacturers of Radio Tubes, Television Tubes, Electronic Tubes, Vacuum Tubes, X-ray Tubes, Photo Tubes, Sign Tubes, Light Tubes, Neon Tubes, Fluorescent Tubes, and

Every one of your prospects will see and read these appealing ads in famous national magazines. These ads recommend your service... when you display the Sylvania Service Emblem, shown above. So, make sure these emblems are on your doors, your windows, and trucks. They're FREE from your Sylvania Tube Distributor NOW!

These ads will appear in the 4 famous magazines your prospects read most!



Will Sell Your RADIO-TV SERVICE in '52

Nation-wide weekly TV Show "BEAT THE CLOCK"
will sell your service to every TV set owner



You're an "expert, reliable service-man who does a tough job well," Bill Shipley, crack CBS-TV announcer, tells your prospects. And, he adds: "Always look for that Sylvania Service Emblem." That's how the hard-hitting, full-minute commercials on Sylvania's CBS-TV show, "Beat the Clock," put Bill Shipley, Roxanne, and Bud Collyer on your sales staff.

Roxanne and Bud Collyer are seen weekly over CBS-TV in 35 cities... selling your service... when you display the Sylvania Service Emblem.



Make this great national ad campaign pay off in your store

Mail the coupon below for FREE, full-color folder giving complete details about Sylvania's compelling Spring Service Dealer Advertising Program. It contains everything to identify you unmistakably as the dealer advertised in Sylvania's magazine and TV advertising. If you want more business, you can't afford to miss it. But, time's awastin'... get that coupon in the mail NOW!



SYLVANIA

RADIO TUBES; TELEVISION PICTURE TUBES; ELECTRONIC PRODUCTS; ELECTRONIC TEST EQUIPMENT; FLUORESCENT TUBES, FIXTURES, SIGN TUBING, WIRING DEVICES; LIGHT BULBS; PHOTOLAMPS; TELEVISION SETS

Sylvania Electric Products Inc.
Dept. R-2892, Emporium, Pa.
Please send me full details about Sylvania's powerful business-building campaign for Service Dealers.

Name _____

Street _____

City _____ Zone _____ State _____

Safety ALL WAYS

with **AMPHENOL**

INLINE ANTENNA

Because your TV antenna is continually being exposed to the rigors of Mother Nature—wind, ice and storm—choosing an antenna that is structurally strong is very important. The Amphenol Inline Antenna is engineered to repeatedly withstand winds of 70 miles per hour and one-half inch annular ice loadings. It is clean in design and presents no surface unduly exposed to wind. Its aluminum construction is strong and light in weight. In addition, the aluminum is rust and corrosion resistant and is especially suited for use in sea coast areas and other places where salt or other corrosive conditions are encountered.

LIGHTNING ARRESTOR

The National Electric Code states that every unshielded outdoor antenna lead-in should have an approved lightning arrester. The Amphenol Lightning Arrester is approved for this purpose and also carries the Underwriters' Laboratories seal of approval. It eliminates the danger of lightning causing damage to your TV set or home and also carries off the minor static discharges that interfere with good picture reception.

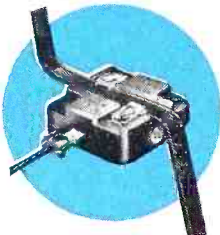

AMERICAN PHENOLIC CORPORATION
1830 SOUTH 54th AVENUE • CHICAGO, ILLINOIS

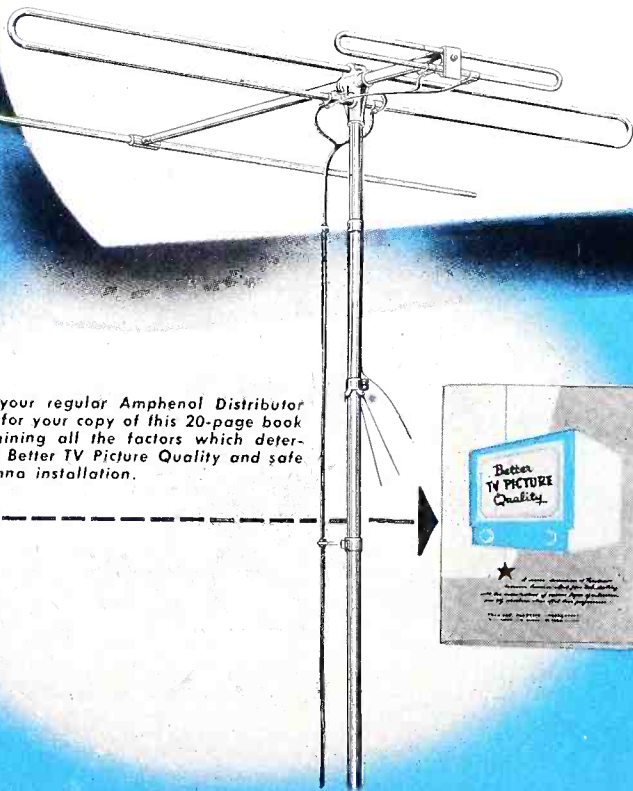

See your regular Amphenol Distributor now for your copy of this 20-page book containing all the factors which determine Better TV Picture Quality and safe antenna installation.

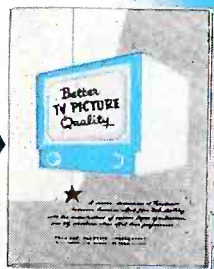

SYNC PULSES

by San D'Arcy

WARNING! — "Juke-Box repair parts may be hard to get during 1952" according to a contemporary Service publication. So what! No independent radio-TV serviceman in his right mind would attempt to crash into the juke box service field. Some years ago this author disclosed that although the juke box field seemingly would appear to be a fertile one for radio servicemen to go after, it would be tantamount to committing suicide if one attempted such a rash move. Jukes are, in over 99.99% cases, Syndicate owned and serviced. In case you didn't know it, the Syndicate is a racketeering mob of gangsters. The Syndicate owns what in many cases appears to be a legitimate business, such as juke box distributing firms. Read all about it in Mortimer & Lait's book "Chicago-Confidential", now selling for 25¢ per copy on most newsstands. It's cheaper to buy the book and be forewarned about servicing jukes rather than take the tip of a magazine editor who is supposed to cater to the interests of radio servicemen — an editor whose stupidity or ignorance might cause you to get beat-up or murdered.

Tall TV mast installing isn't an easy job even when all the conditions are most favorable. Last week, watching experts, we came to the conclusion that it is a specialty field and should be treated as such. For example, a qualified technician, with years of experience behind him, might job-rate his time at \$6 per hour. In our opinion, such a technician should merely supervise tower installations. The most time-consuming part of a high TV tower installation is that of assembling the components—the antenna array, the mast itself, and affixing the guy wires. All of which must be done before the erection of the tower or mast can be undertaken. And, all such work can easily be done by men who are not necessarily trained technicians. Apprentices who work for \$1 or slightly more per hour should be the "work boys" for this type of effort. Then, having finished the basic assembly phase of the tower-antenna, these "work boys" can step into the subordinate position of assistants to the technically qualified installer, their final job being that of tying down the guy wires, etc., after the technician has established where the guy-points should be.

Coin operated radios in hotel rooms are, in many cases, gypping the public. A hypothetical case: the radio is supposed to give the room-renter two hours of service for a quarter, but when the coin is inserted the timing mechanism only clicks off to permit an hour of operating time. (It's happened to me often, and in some cases I've only gotten 20 minutes of playing time). The result is that the renter is actually being robbed, and in most cases is too much of a gentleman to register a complaint with the hotel clerk or bell captain, demanding a refund. The solution, of course, is simple. Radio service firms who own and distribute hotel radios on a percentage basis should carefully check their machines and fix all which are not giving the renter his proper time allowance. Actually, under the law in most states, a criminal charge of petty theft can be lodged against any machine owner or operator if the machine fails to give full and complete service as intimated on its face. On the other hand, in towns where the hotels themselves own the coin-operated radios, it would be worthwhile for the local service dealer to solicit an over-all checkup job on a flat fee basis. This sort of preventive maintenance work on regular contract is mutually beneficial.

For accurate
flexible and
quick tube
testing at
low cost...
model 3413-A

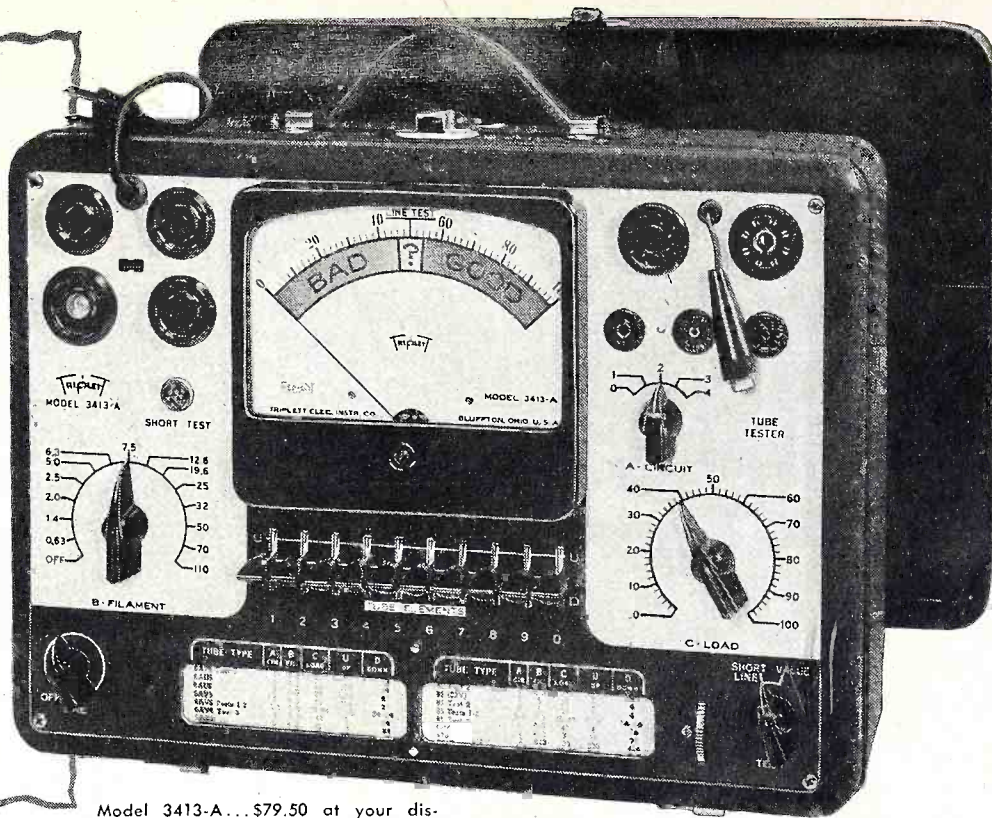

Model 3413-A...\$79.50 at your distributor. (Price subject to change.) BV Adapter, \$7.90 Add'l.

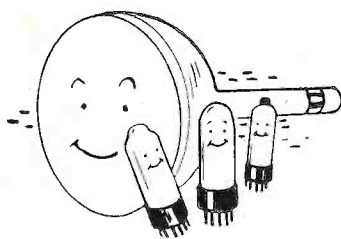

1. YOU CAN TEST MORE TYPES of tubes, also appliances for shorts and open circuits.

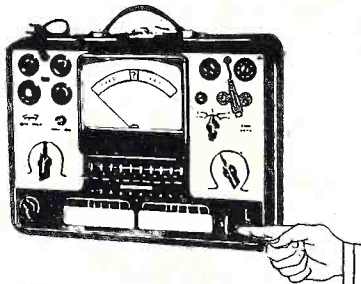

2. JUST SPIN THE KNOB—for correct, last-minute data, on the speed roll chart. Lists 700 tubes.

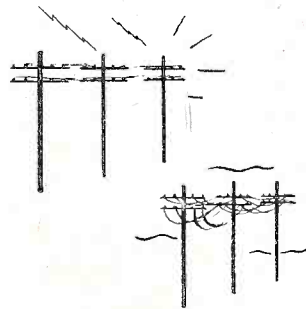

3. YOU CAN COMPENSATE for line voltage—just throw snap-action switch.

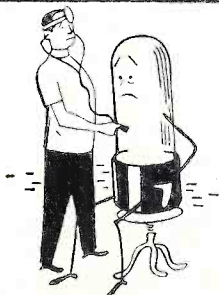

4. YOU CAN TEST EACH ELEMENT in each tube—by a simple flip of the switch.



5. YOU CAN TEST THE NEW TUBES—including those with low cathode current.



6. YOU GET NEW TUBE DATA—immediately, while it is still news. No waiting.

Nearly Half a Century of Service to the Service Man

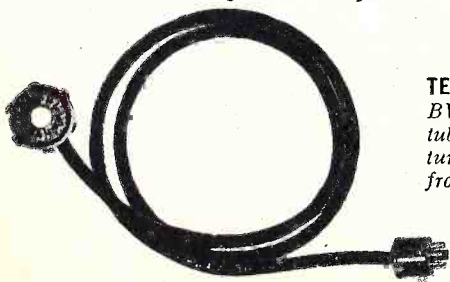

TESTS PICTURE TUBES, TOO! With this BV Adapter, Model 3413-A tests every tube in a TV receiver, including the Picture Tube—without even removing tube from receiver or carton! Saves time!

FOR THE MAN WHO TAKES PRIDE IN HIS WORK

Triplet

TRIPLETT ELECTRICAL INSTRUMENT CO., BLUFFTON, OHIO, U. S. A.

Snyder
PHILADELPHIA

YEARS AHEAD

Directronic
MOTORLESS
TV AERIAL
SYSTEMS

360° ELECTRONICALLY SWITCHED BEAM

GIVES SAME CLEAR PIX AS MOTOR
DRIVEN AERIALS AT $\frac{1}{3}$ THE COST

SIMPLE FLICK OF SWITCH
CLEARS PICTURE **INSTANTLY**
NO WAITING

OPENS BIGGEST
REPLACEMENT MARKET
IN **TV** HISTORY

MAIL THIS COUPON TO-DAY!

SNYDER MFG. CO. C
22nd & Ontario Sts., Phila. 40, Pa.

Please send me free copy of authoritative
booklet **TENNA TIPS** on Directronic and
all other types of aerials, plus catalogs.

NAME _____
ADDRESS _____
CITY _____ ZONE _____ STATE _____

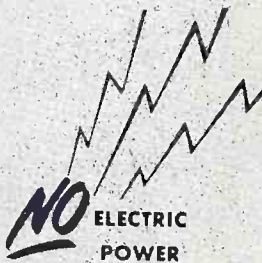
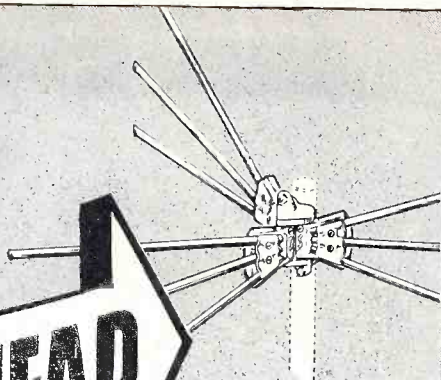
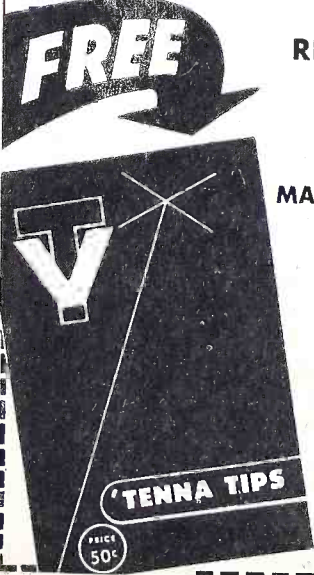

(From page 6)



RCA's 17-Inch all-glass kinescope with low-voltage electrostatic focus.

by the company to the savings in critical materials made possible by its use. Employment of low-voltage electrostatic focus makes it possible to secure the voltage required for the focusing electrode direct from the television receiver's low-voltage d-c supply. It also eliminates conventional focusing coils and magnets.

The focusing electrode in this tube has its own base-pin terminal so that designers can have a choice of a focusing voltage for best results. Whether the equipment designer uses fixed focus or provides for adjustment of the focusing voltage, the focus can be maintained automatically, despite variations in line voltage or changes in picture brightness.

Because the tube's cathode is not connected to any other electrode, the RCA-17HP4 retains the advantage of low input capacitance when employed in a cathode-drive circuit. Similarly, because the focusing electrode is not connected internally to grid No. 2, the focusing voltage can be reduced as the grid-No. 2 voltage is raised—a necessary relationship for optimum focus.

The RCA-17HP4 has a Filterglass faceplate, an external conductive bulb coating, and an ion-trap gun. Its picture screen is 14-3/8 by 11-1/16 inches.

Federal's 1952 Merchandising Program

Plans for the 1952 merchandising of miniature and industrial selenium rectifiers, rectifier equipment, and HF cable manufactured by Federal Telephone and Radio Corporation, Clifton, N. J., associate of International Telephone and Telegraph Corporation, designed to emphasize to distributors, dealers, service men and service organizations the profit opportunities of Federal products were arranged. The program consists of a "Five Star Profit Center", the main item of which is an attractive, three colored self-feeding counter dispenser for minia-

[Continued on page 39]

"And Why Should I Sell Buss Fuses?"



"There's One Important Answer..."

BUSS

FUSES PROTECT YOUR PROFITS and GOOD NAME"

Because...
BUSS FUSES

Are best known—have greatest consumer acceptance.

Protect your profits—by eliminating "comebacks" due to faulty fuses—there is no substitute for BUSS quality and performance.

Protect your good name—they are made to protect, not to blow needlessly.

Are individually tested in a highly sensitive electronic device to make sure that every fuse is perfectly manufactured and calibrated.

Are available in a complete range of types and sizes—from $\frac{1}{300}$ amp. up—get all your fuses from one source—keep your inventory down.

Are sold under a "fair-play" policy that protects the distributor and dealer.

Why take a chance on any other fuse? The unquestioned high quality of BUSS fuses is the result of 37 years of specializing in fuses. Standardize on BUSS fuses and thereby protect your profits and good name.

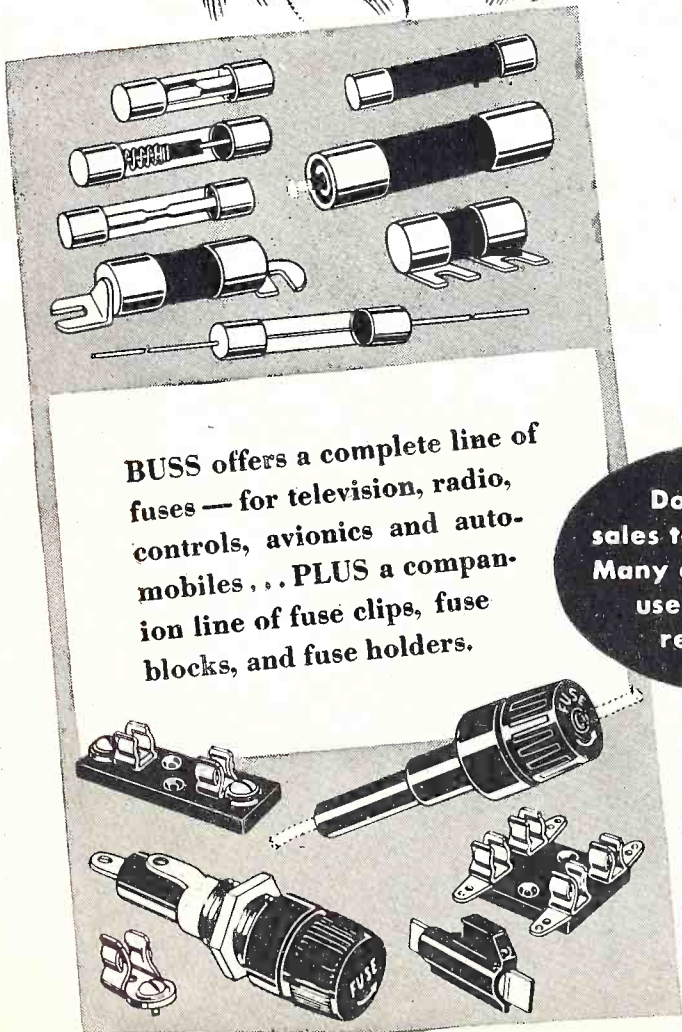

BUSS offers a complete line of fuses — for television, radio, controls, avionics and automobiles... PLUS a companion line of fuse clips, fuse blocks, and fuse holders.

Don't overlook sales to manufacturers. Many of them make or use devices that require fuses.

BUSSMANN MFG. CO.

University at Jefferson St. Louis 7, Mo.
Division of McGraw Electric Company

USE THIS COUPON — Get all the Facts SD-252

Bussmann Mfg. Co., University at Jefferson
St. Louis 7, Mo. (Division McGraw Electric Co.)

Please send me Bulletin SFB on BUSS Small
Dimension Fuses and Fuse Holders.

Name _____

Title _____

Company _____

Address _____

City & Zone _____ State _____ 252

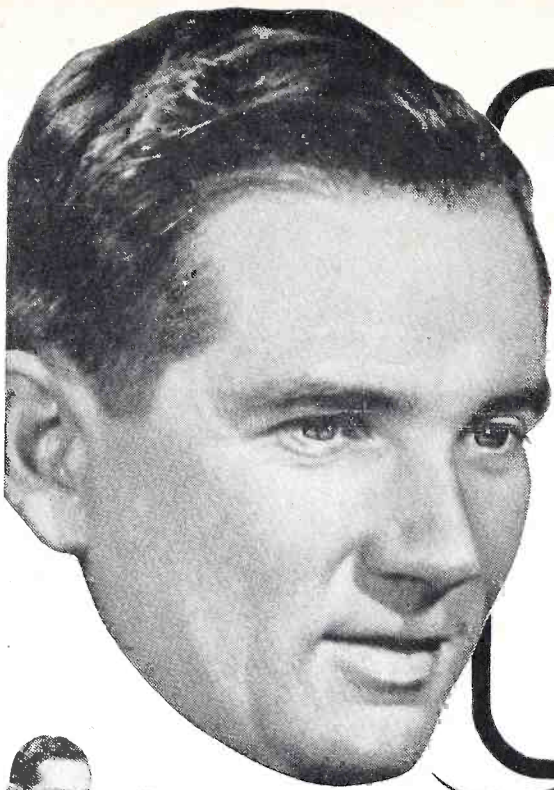

*How come you
sell so many
picture
tubes,
Sam?*

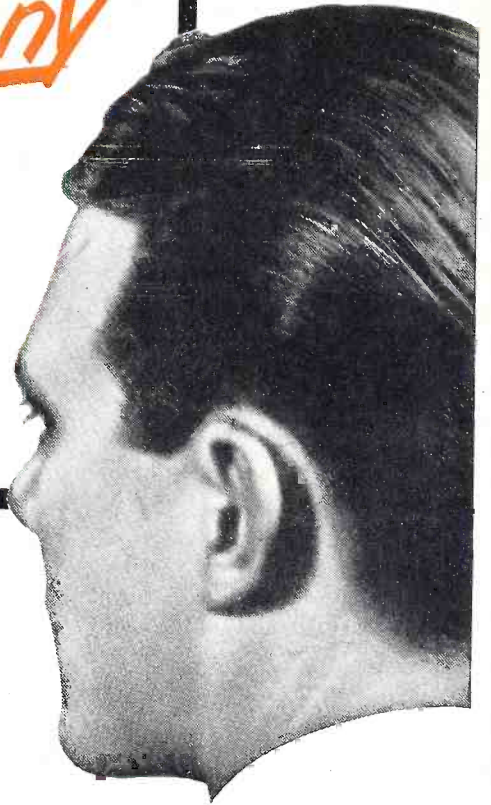

"I'm using the CBS-Hytron Easy Budget Plan, Joe. My CBS-Hytron distributor gave it to me."

"Tell me more."



"Well, CBS-Hytron's Plan helps me sell TV picture tubes and service to many a customer who just doesn't have \$50 cash. Now I make sales I'd lose otherwise. My customer pays for the job painlessly a few dollars a month. Yet I get my cash right away — and can discount my bills with my distributor."

"Fine! How does it work, Sam?"



"Simple. I introduce my customer to the finance company authorized by CBS-Hytron. The finance company does the rest. Acts as my credit department to secure me against losses. Takes care of all the details . . . paper work, collections, etc. My customer gets his tube and I get my cash — at once."

"That's swell, Sam. Now I can see why you always have plenty of working capital."

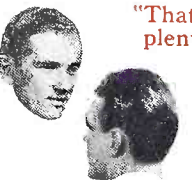

"That's right. And talk about service! This CBS-Hytron Easy Budget Plan has even brought me immediate cash from old accounts I'd written off as bad debts. CBS-Hytron is perfectly willing, too, that my regular budget loans include my service work and other components besides CBS-Hytron tubes. I owe my CBS-Hytron distributor a vote of thanks for letting me in on this wonderful Plan."

"Fair enough! I've sure been losing sales I shouldn't, Sam. I need the CBS-Hytron Easy Budget Plan. CBS-Hytron tubes are tops, too. Thanks for the tip. I'll see my CBS-Hytron distributor today."

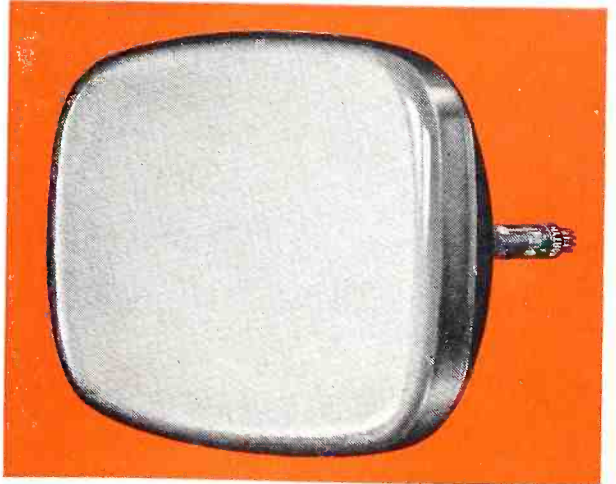

SAVE THE SALE No need for you to miss a single profitable picture-tube sale . . . just because your customer does not have the cash. Get the details on this original CBS-Hytron service for you. See your CBS-Hytron jobber . . . or mail this coupon . . . today!



MAIN OFFICE: SALEM, MASSACHUSETTS



HYTRON RADIO & ELECTRONICS CO.
SALEM, MASSACHUSETTS

Please rush me details on the CBS-Hytron Easy Budget Plan.

NAME.....
(Please print)

STREET.....

CITY..... STATE.....

RADIO-TELEVISION SERVICE DEALER • FEBRUARY, 1952

CAPACITOR TROUBLES IN TV RECEIVERS

by MATTHEW MANDL

Faulty coupling capacitors in TV receivers give rise to a variety of symptoms which are described and discussed in this article. Methods of testing condensers for leakage and shorts with a VTVM are also described.

OFTEN beginners in television servicing overlook the lowly coupling capacitor as a source of many troubles. Even the advanced technician on occasion will disregard the coupling capacitor as a likely source of trouble, particularly if the symptoms which occur are not too severe. Thus, several major faults in a receiver may be repaired while minor defects caused by a poor coupling capacitor are overlooked.

This is particularly true if the coupling capacitor of a specific stage is just beginning to go bad and has only a small leakage. Picture or sound quality may suffer slightly but may not be sufficiently poor to arouse suspicion of the true cause. Eventually complete breakdown occurs.

Coupling capacitors which have been in service for a number of years become quite unreliable. For this reason many service shops replace all as a matter of routine during radio servicing. Because of the greater number involved in television, however, this is not feasible. It would, however, certainly be preferable with all receivers which have been in use for several years if the customer were willing to underwrite the additional expense involved. In lieu of this, however, the technician should be able to recognize the symptoms of specific circuit failures, and replace any capacitor which gives the least indication of having a slight leakage.

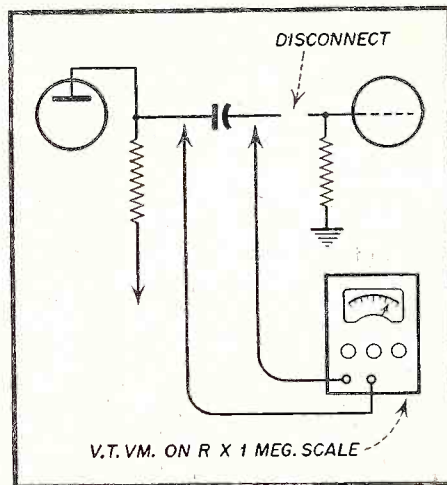

Fig. 1. Testing capacitor leakage with a VTVM.

Methods of Testing

The leaky coupling capacitor can be checked by using a standard capacitor checker. These give a reading of the capacity and also the power factor. The power factor rating will establish the amount of leakage which a coupling capacitor possesses. The capacity value of the coupling capacitor is unimportant in leakage checks, however. For this reason a simple check of leakage can be made by utilizing the ohmic scale of a vacuum-tube voltmeter. The $R \times 1$ megohm scale of a vacuum-tube voltmeter will read up to 1,000 megohms while special vacuum-tube voltmeters have higher ranges. This permits a fairly

accurate check of leakage resistance because a good coupling capacitor should not show any leakage resistance below 500 megohms.

When coupling capacitors are new their leakage resistance is well over several thousand megohms, depending on whether they are the paper or mica type. Regardless of this, however, a test of leakage on any type can be made with the VTVM. One side of the capacitor must be disconnected from the circuit as shown in *Fig. 1* so that false readings are not obtained due to shunting circuit components. When disconnecting the coupling capacitor from the grid of a tube, make sure it is also disconnected from the associated grid leak as shown in *Fig. 1*.

When applying the test prods to the capacitor make sure your hands do not touch the ends of the probes because this will give false readings. Initially, check to see that the needle reads zero with the prods shorted together and reads maximum resistance with the prods open. For values of capacitors between .5 and .001 μf the needle will swing toward the zero point upon application of the test prods across the capacitor. If the capacitor then charges the needle will slowly rise. If it fails to go beyond the 500 megohm reading, the capacitor should be replaced. (If the needle remains at zero, it would, of course, indicate a shorted capacitor or one having extreme leakage.)

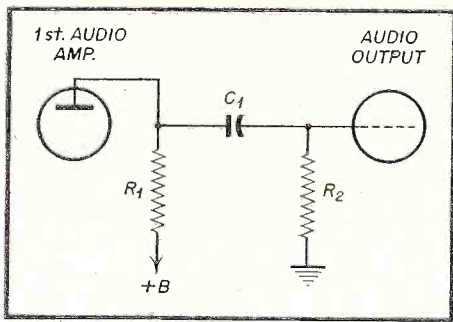

Fig. 2. Typical capacitor connections in resistance-coupled amp.

If the capacitor has already been charged, the needle may not move from the maximum scale. If this is the case, reverse the test prods and the charge of the capacitor should again be in evidence by the needle climb. If the needle does not fluctuate at all upon application of the test prods it may indicate an open capacitor or one having a very small value and thus insufficient to show its charge by needle movement. Most all will, however, show slight needle movement at the instant of test prod application.

An open capacitor can be checked by placing a new one across it. It must be remembered, however, that shunting an existing capacitor with an additional one is no check in case of leakage because the offending capacitor would still be in the circuit.

A check can also be made of the bias voltage on an amplifier tube by using a low DC scale of the vacuum-tube voltmeter. A reading between the grid and cathode should show a minus voltage on the grid. A zero or plus voltage would indicate either a leaky coupling capacitor or a gassy tube. In some instances, both conditions may prevail because a leaky coupling capacitor permits d.c. to leak into the grid of a vacuum tube and thus reduce or nullify the bias. This will cause excess current to flow and may damage the tube as well as make it gassy.

Typical Symptoms

Some of the more common symptoms which appear for defective coupling capacitors are listed below:

1. Distorted Tone
2. Foldover
3. Sync Instability
4. Sync Loss
5. Overly-contrasty picture
6. Repeated tube failures
7. Absence of picture
8. Absence of sound
9. Absence of both picture and sound

Thus, a variety of troubles can occur, depending on the particular stage of the television receiver in which the capacitor defect occurs. An analysis of various stages and the associated symptoms follows:



Fig. 4. Blurred picture caused by leaky video amplifier condenser.

Figure 2 shows a coupling capacitor between a conventional audio amplifier and output tube combination. If the capacitor develops a leakage it will cause the sound to become quite distorted. Should the leakage resistance fall below 500 megohms, the distortion will be very pronounced. If this capacitor opens it would, of course, cause the sound output to drop to zero.

Figure 3 shows the coupling capacitor between the video detector and the video amplifier. L_1 is the peaking coil, while R_3 is the shunting resistor

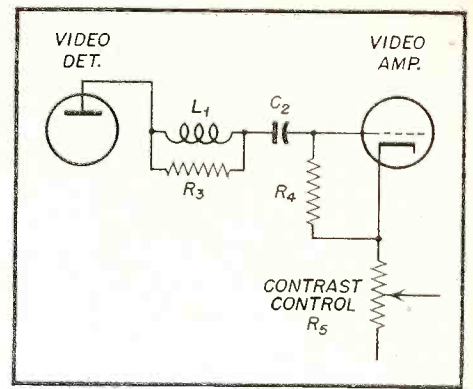

Fig. 3. Coupling capacitor connections in typical video amplifier.

which lowers the Q of the coil. If the coupling capacitor (C_2) leaks, it will lower the bias on the video amplifier and increase the contrast beyond normal. This would make it very difficult to secure proper contrast with the control. Fig. 4 shows the type of picture obtained even when there is only a very small leakage in the coupling capacitor. While the detail is not too poor, it has been affected to some extent. The contrast, too, is not ideal though it might be passable by careful manipulation of both brilliancy and contrast controls. This indicates how a slight leakage may sometimes be overlooked because the effect is not too pronounced. A check with a vacuum-tube voltmeter would, however, indicate a leakage around 500 megohms and replacement would improve picture detail and contrast. Severe leakage will give excessive contrast and would also affect sync stability because the sync take-off is usually in these circuits.

Besides amplifier tubes, coupling capacitors can also cause serious troubles in other circuits. Fig. 5 shows a typical sync clipper feeding both the vertical oscillator and the horizontal sweep circuits. Here, if a C_3 becomes defective, it will upset horizontal sync stability, while a defective C_7 would cause vertical instability. The same

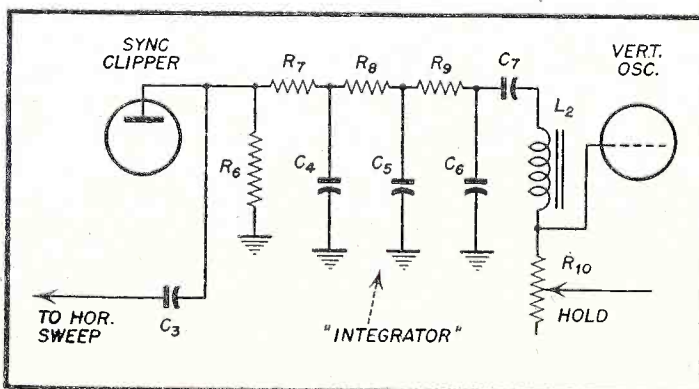

Fig. 5. Defective sync output coupling capacitors result in faulty H or V sync.

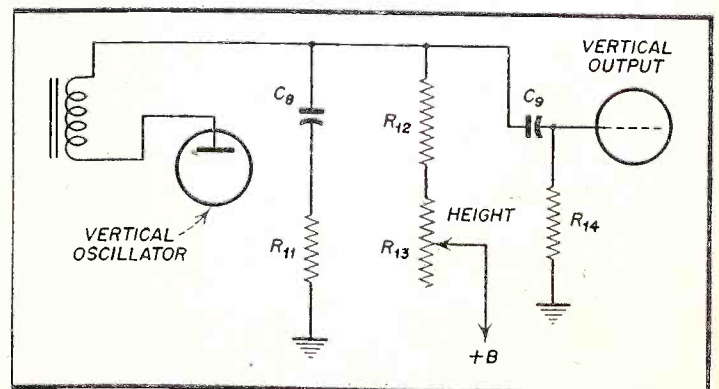

Fig. 6. Defective coupling capacitors in vertical circuit may cause foldover.

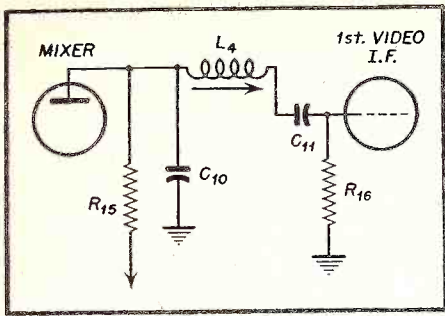

Fig. 8. Coupling capacitor in output of mixer stage.

holds true for coupling capacitors between the sync take-off point, sync separator, sync amplifiers, and the sync clipper. Troubles in any capacitors from sync take-off to the sync distribution point would affect both vertical and horizontal stability at the same time. Defective capacitors or resistors in the "integrator" circuit will not only cause vertical instability but will also destroy interlace and may also cause foldover

Foldover can also be caused by leakage of the coupling capacitor to the vertical output tube. Thus, if C9 of Fig. 6 develops a leakage, foldover will occur to a degree depending upon the amount of leakage present. Fig. 7 shows the appearance of foldover on a receiver where the coupling capacitor C9 had a severe leakage. A check of this capacitor as previously detailed should be made whenever foldover is present. The discharge capacitor, C8, should also be checked as well as the coupling capacitor previously mentioned (C7).

Depending on design, coupling capacitors may be found in virtually all stages. Of course some manufacturers use transformer coupling on occasion, but inspection of the schematic for a particular receiver will soon establish the various locations of the coupling capacitors. Usually an evaluation of symptoms with respect to picture and sound will help initial localization. Thus, if both picture and sound are

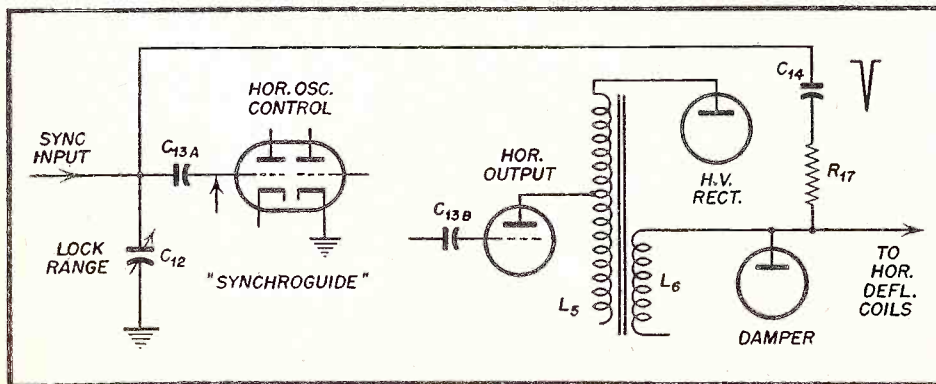

Fig. 9. Partial schematic of Synchroguide horizontal lock system showing coupling capacitors.

missing but the raster is present, it would indicate some defect in the receiver prior to sound take-off. This could very well be a coupling capacitor such as shown in Fig. 8. Here C11 is used as an interstage coupling between the mixer and the first video i-f amplifier tube. An open capacitor would cause loss of both picture and sound, while leakage could impair the quality of both the picture and sound.

Special Circuit Coupling

Coupling capacitor troubles can also occur in circuits such as a-g-c, restorer, and sync lock systems. With the modern Synchroguide horizontal lock system, several coupling capacitors will be encountered. Fig. 9 shows a partial schematic of a typical circuit. Here C13 not only couples the sync to the grid of the control tube,



Fig. 7. Vertical foldover resulting from faulty condenser.

but also is part of the coupling network which feeds a negative pulse back from the horizontal output for the Synchroguide function. Thus, a defective C13A will have a serious effect on horizontal sync stability. A slight leakage is sufficient to cause sync instability, while a severe leakage will give total sync loss. The same holds true with C14 which must isolate the d.c. present in the damper circuit while transferring the negative pulse to the control tube.

The coupling capacitor to the horizontal output tube, C13B, can also

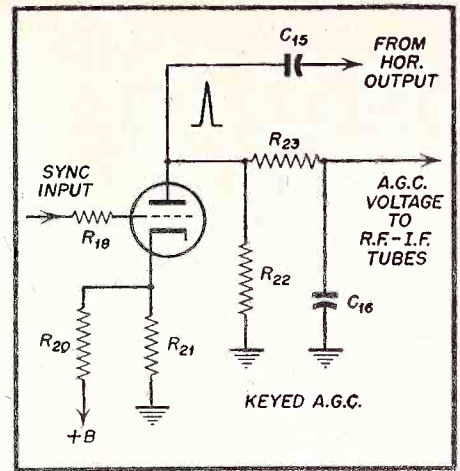

Fig. 10. Applications of coupling condensers in keyed a-g-c circuit.

cause considerable trouble if leaky. This can give rise to similar troubles encountered in the coupling capacitor to the vertical output tube. Leakage may not only cause foldover, but will reduce the bias to the output tube and thus cause excessive current flow. This could be a contributing cause to excessive tube failure in both the vertical and horizontal output systems. (With respect to the horizontal system, the drive control should also be kept at normal setting because overdrive will also shorten tube life as well as giving severe non-linearity.)

Another special circuit using coupling capacitors is the keyed a-g-c system shown in Fig. 10. Here C15 couples a positive pulse from the horizontal output to the plate of the a-g-c tube. This is the pulse which "keys" the tube into conduction simultaneously with the arrival of the sync pulse to the grid. A defective C15 will affect a-g-c function and thus the a-g-c voltage. Loss or reduction of a-g-c voltage will also cause excessive contrast because of the reduced bias on the r-f and picture i-f amplifier tubes. This will give an overly contrasty picture and will cause bending and picture pull.

Virtually similar symptoms can occur if defects arise in the d-c restorer circuit shown in Fig. 11. Here C19 is the coupling capacitor which feeds the signal to the d-c restorer tube. If this opens the average background of the picture will be very poor because of the loss of d-c restoration. At the same time the brilliancy control will have to be advanced more to compensate for the increase of bias which results when the restorer tube ceases to function. (C19 is charged with a polarity which puts the plus side toward the grid of the picture

[Continued on page 45]

U-H-F CONVERTERS

by **ALLAN LYTEL**

This installment on u-h-f converters deals with the P. R. Mallory unit which is similar in theory and operation to their model designed for v.h.f. The Inductuner principle is utilized in the design of this converter, and they are available in one, two, three and four section combinations.

THE P. R. Mallory & Co., Inc. organization manufactures both a separate u-h-f Inductuner as well as a complete converter. The tuner itself is similar in theory and operation to their model designed for v-h-f operation. The tuner is available in one, two, three, or four sections in the same case. *Fig. 1* is a three-unit model showing the dual inductor ele-

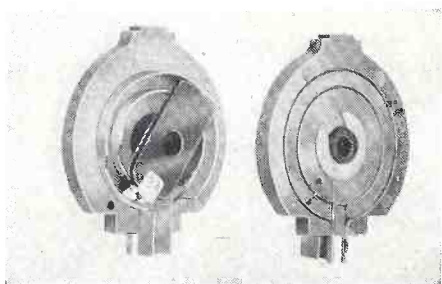

Fig. 2. Pre-Selector and antenna input. Latter shown at right.

ments and the wiper arm. The required tuning is accomplished in 270 degrees of rotation; the preselector or tuned input elements are shaped differently from each other and different from the oscillator tuning elements to provide adequate tracking. Output frequencies are available at approximately 40, 80, and 130 mc. The r-f range is from 460 to 910 mc. A special antenna coupling input is used for the 300 ohm line. In *Fig. 2* this balanced capacitive coupling to both sides of the variable inductance may be seen.

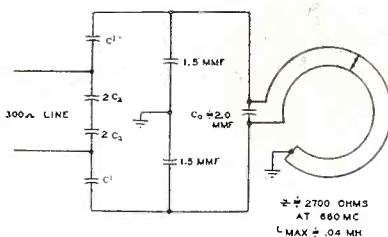

Fig. 3. Input circuit.

As the tuner arm is rotated, the insulated bakelite shaft moves the wiper arm or shorting bar so that it makes positive contact to both conductors at all times. These variable inductors may be thought of as sections of transmission line short circuited at the load end and operating so that they are electrically less than one-quarter of a wave length long.

In *Fig. 2*, the antenna input connections go to the two small arcs of ribbon which are 70 degree arcs. This provides balanced capacitive coupling through the dielectric material to the

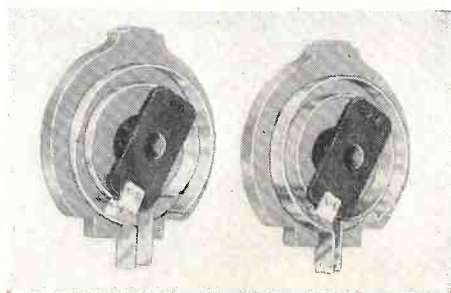

Fig. 4. R-F and mixer tuner elements. Different shapes are used.

preselector tuning inductance on the left of the figure. In *Fig. 3*, this balanced input is shown as a part of the input equivalent circuit. An impedance step-up is accomplished by means of capacities C_a ; thus the out of phase signals from across the balanced input line are applied across the tuning inductance so that they add. The two sides of the inductance are out of phase as is the input signal.

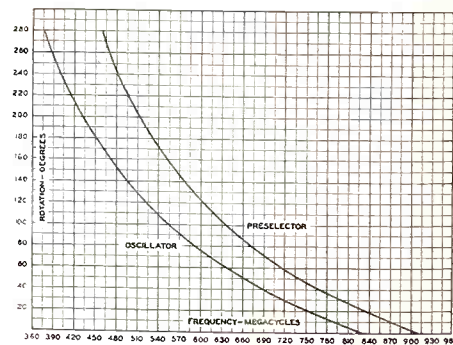

Fig. 5. Tuner tracking curves.

The tuning is by means of short-circuited lines less than a quarter wave length long which act as an inductance. The distributed capacity is about $2 \mu\text{mf}$ with a maximum inductance of $0.04 \mu\text{h}$. These values of course depend somewhat on the shape of the tuning element. They are designed to resonate over the u-h-f band, with a small amount of overtravel at each end, with an added capacity due to the tube of about $1.5 \mu\text{mf}$. This is the capacity between the grid and plate of the 6AF4 used as the local

Fig. 1. 3-Section u-h-f tuner showing dual inductor elements and wiper arm.

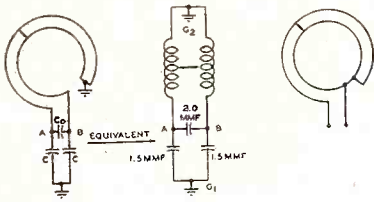
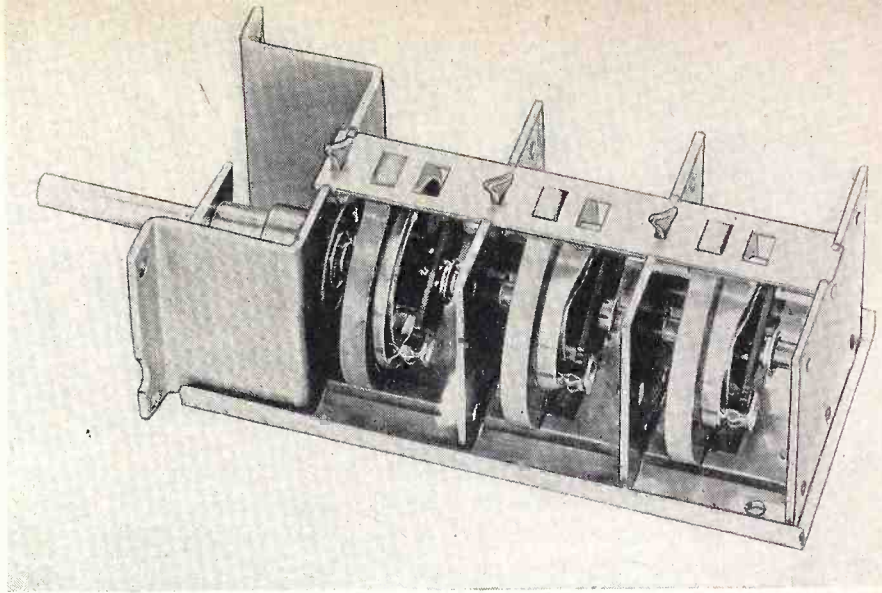

Fig. 6. Equivalent circuit of tuner.

oscillator. Fig. 4 illustrates the r-f and mixer sections of this tuner. Different shapes are needed because of the tracking problem, all of the wiper arms are connected to a single shaft providing single shaft control of the tuning. Fig. 5 illustrates the tracking expected with the i.f. of 82 mc when the converter is used on Channel 5 or 6 of the v-h-f receiver.

One important problem with u-h-f tuned circuits is the resonant "suck-out" which means unwanted resonant conditions usually associated with the tuning elements. As an example, the RCA u-h-f tuner uses a slug tuned high frequency l-f amplifier with the slugs attached to threaded brass screws. These screws are long enough to act as resonant circuits where their only circuit function is to allow the movement of the slugs. To prevent this resonance, which would take power from the tuned circuit, glass beads are

used to break up the screws into small sections which will be non-resonant. A problem with this Mallory Tuner is the shorted section of the tuned line. The section between the variable short and the fixed short should be electrically dead, that is, it is not a part of the tuned circuit which is alive from the open or feed end to the variable short only. Balanced operation

matic in Fig. 10 covers the complete band of channels from 14 to 83 with the oscillator operating on the low side of the carrier to prevent inversion of the sound and video signals. The unit has an overall gain of unity or actually somewhat less than one. A tuned input is used with an input impedance of 300 ohms and the unit has an output impedance of 300 ohms. A crystal mixer is used rather than a vacuum tube; the oscillator range is from 378 to 828 mc. Oscillator stability in field tests has been proved to be adequate with the inter-carrier sound type of receivers. Warm-up time is about one minute with receivers of this type; with the split sound type the warm-up time is three to five times as long. Careful grounding and separation of the tuned circuits from the heat-producing tubes helps provide oscillator stability.

Without a suitable u-h-f r-f amplifier, there is a loss in the input and a loss in the frequency conversion. At the same time, the u-h-f signals have a greater degree of attenuation as compared to v-h-f signals of the same power level. Thus, the signal to noise ratio of the i-f amplifier is most important. The input tube is a grounded cathode grid input which is coupled

[Continued on page 42]

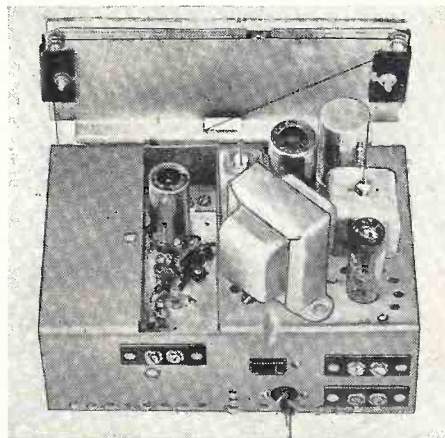

Fig. 8. Rear view of converter chassis. Notice maximum usage of available space.

is obtained where the fixed short and the mid-point between the capacitors as shown both are grounded. A voltage analysis of this circuit shows that there is an r-f voltage minimum at the short and an r-f voltage maximum at the load end where the two leads are out of phase. Thus a direct physical ground does not change the circuit operation. Proper choice of the capacities to ground eliminates this resonant "suck-out" condition problem. Above 760 mc the innermost conductor is grounded as shown in part B of Fig. 6.

The Complete Converter

Figures 7, 8, and 9 show the complete converter using the Mallory UHF Tuner. This unit, with its sche-

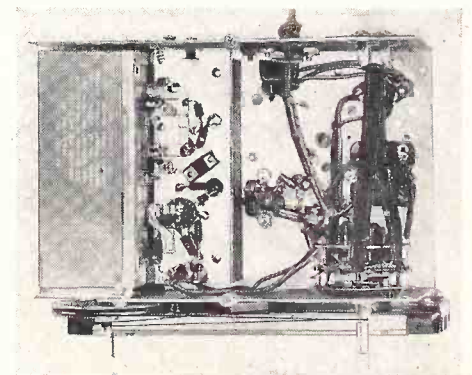

Fig. 9. Bottom view of converter chassis.

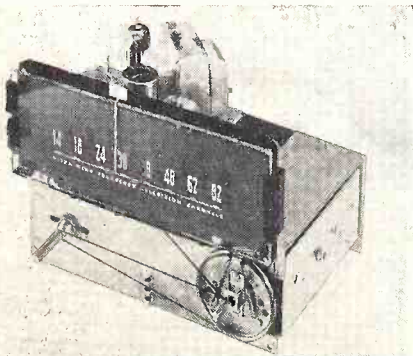

Fig. 7. Front view of converter chassis.

REACTANCE TUBE HORIZONTAL

by **SAMUEL L. MARSHALL**

(From a forthcoming book, "TV Service Techniques")

THE basic reason for an automatic frequency control (a-f-c) circuit in the horizontal sweep section of a TV receiver is to make certain that the "free-running" horizontal oscillator always operates at the exact frequency of the incoming station sync pulse. It should be emphasized that a.f.c. corrects frequency variations in the horizontal oscillator circuit and not in the incoming sync pulse. The frequency of the latter, which is controlled by the transmitter, can be considered to be fairly constant. Thus, if the frequency of the horizontal oscillator tends to increase above that of the incoming sync pulse, the a-f-c network acts to reduce the oscillator frequency to a point where it is once more equal to the incoming sync frequency. Similarly, a tendency on the part of the oscillator frequency to decrease is corrected by the a-f-c system so that this frequency is increased to a point where it is once more equal to the incoming sync frequency.

Basic Block Diagram of A.F.C. System

There are many types and variations of a-f-c circuits used in TV receivers. In order to understand them we must first analyze a general a-f-c system and learn the purpose of each unit or block which makes up the entire system. Thus, referring to *Fig. 1*, a typical a-f-c system, we observe three distinct blocks, the discriminator or phase detector, the oscillator control circuit, and the horizontal oscillator.

Notice that the sync pulse and a portion of the horizontal oscillator signal is fed into the discriminator or phase detector. The distinction between a discriminator and phase detector will be explained in a subsequent installment. It should suffice to point out now that both circuits con-

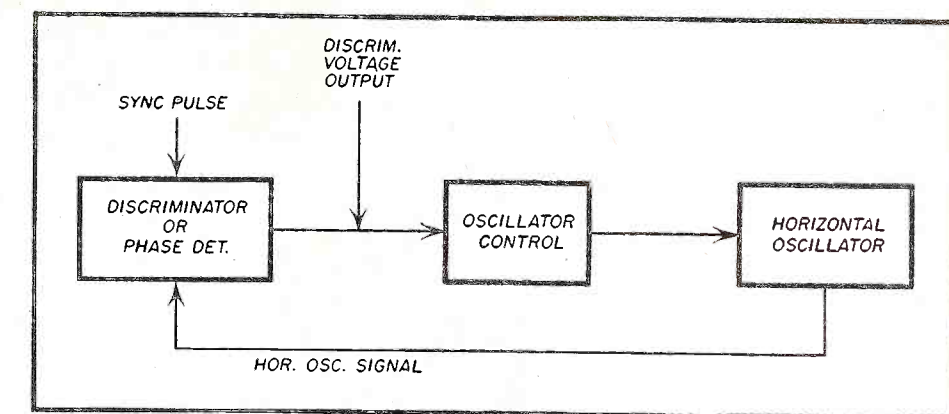

Fig. 1. Typical a-f-c system employing discriminator or phase detector, oscillator control, and horizontal osc.

vert frequency or phase differences into d-c output voltages. If the signals are of the same frequency or phase no output voltage will be present.

A control voltage appearing at the input of the oscillator control circuit causes it vary its equivalent inductance or capacitance. Thus, a varying control voltage is converted into a varying inductance or capacitance. This varying inductance or capacitance shunts the tuned circuit of the horizontal oscillator. Any change in inductance or capacitance produces a corresponding change in frequency.

The overall action of the system is such that if the oscillator frequency tends to vary, its frequency is no longer the same as that of the incoming sync frequency, and a corresponding voltage is produced at the output of the discriminator. This voltage, when applied to the oscillator control circuit, produces a change in inductance or capacitance across the tuned circuit which restores the horizontal oscillator frequency back to its original value. In this manner any tendency on the part of horizontal oscillator frequency to vary is counter-

acted by the discriminator and oscillator control circuits, and the horizontal oscillator frequency is maintained constant.

Purpose of Reactance Tube

As mentioned previously, there are many types of discriminator, oscillator control, and horizontal oscillator circuits. At the outset, it would be advantageous to analyze the action taking place in *oscillator control* circuits of these systems. To this end we will first begin with a study of oscillator control circuits using *reactance tubes*, which was one of the first methods employed, and is still considered one of the most effective.

A reactance tube provides or controls an inductance or capacitance across the tuned circuit of the horizontal oscillator should the latter change in frequency. The purpose of the added inductance or capacitance is to bring the horizontal oscillator back to its original frequency.

Reactance tube operation falls into three categories, that is, the circuit may take on the properties of a com-

APPLICATIONS IN A-F-C CIRCUITS

There are millions of receivers in use employing horizontal a-f-c circuits in which the oscillator control circuit is a reactance tube. In this article the author describes the basic theory of operation of various circuits employing reactance tubes. A knowledge of reactance tube operation will aid the technician considerably when service problems of this nature arise.

compensating inductance, capacitance, or resistance. Although a resistance has no direct effect on the resonant frequency of a circuit, it can, as will be shown in certain types of circuits, increase or decrease the effective capacitance in these circuits, thereby varying the frequency.

A simplified diagram of a reactance tube circuit is shown in Fig. 2. Here we observe that the reactance tube is connected directly across the tuned circuit of the horizontal oscillator.

The manner in which a reactance tube circuit takes on the properties of inductance will now be discussed. By definition, a pure inductance causes the current to lag the voltage across the inductance by 90 degrees. Where the circuit contains both resistance and inductance the current lag is less than 90 degrees by an amount proportional to the relative amount of resistance as compared to reactance ($X=2\pi fL$) in the circuit.

Current lag in an inductive circuit is caused by an initial back e.m.f. induced in the coil when the circuit is

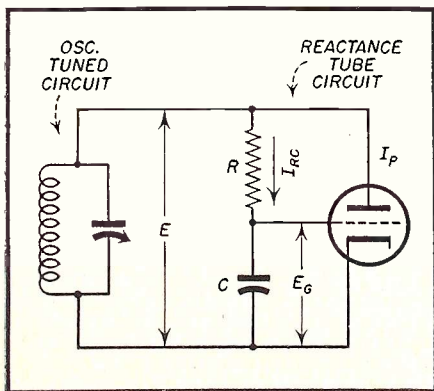

Fig. 2. Simplified diagram of a reactance tube circuit. I_p represents plate current flow in reactance tube.

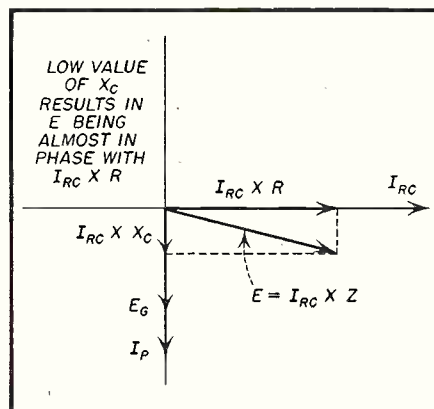

Fig. 3. Vector diagram showing phase relations of voltages and currents in various branches of the partial schematic of Fig. 2.

first closed. This back e.m.f. opposes the applied voltage, thereby retarding the initial current flow.

Just as an inductance results in a lagging current, a circuit in which a lagging current is made to flow is said to take on the properties of inductance. Therefore, if in Fig. 2 we can in some manner cause the plate current, i_p , to lag the oscillator voltage, the tube will look like an equivalent inductance as far as the tuned circuit is concerned.

Similarly, a pure capacitance causes the current to lead the voltage across a condenser by 90 degrees. This is caused by the action taking place in a condenser in which the voltage across the condenser does not reach a maximum until its plates are completely charged with electrons. The charge starts off as a maximum surge of electrons (current) and gradually decreases as the voltage across the condenser plates increases. Therefore, if we can cause the plate current to lead the oscillator voltage, the reactance

tube will look like a capacitor as far as the tuned circuit is concerned.

Reactance Tube As An Inductance

In Fig. 2 we obtain a lagging current or equivalent inductance in the following manner. A resistance-condenser combination (RC) is connected across the oscillator tuned circuit. The resistance R , is purposely made very much larger than the capacitive reactance X_c , across the condenser C . Because of the low capacitive reactance in the circuit, the voltage E , is practically in phase with the current. This is shown in the vector diagram in Fig. 3.

A voltage drop occurs across C (due to I_{RC}) which lags I_{RC} by 90° because of the capacitive circuit. Because plate current in a tube is in phase with the applied grid voltage we obtain the following conditions:

1. i_p is in phase with E_g (1)

Since the current I_{RC} , in the above circuit leads the voltage,

2. I_{RC} leads E_g by 90° (2)

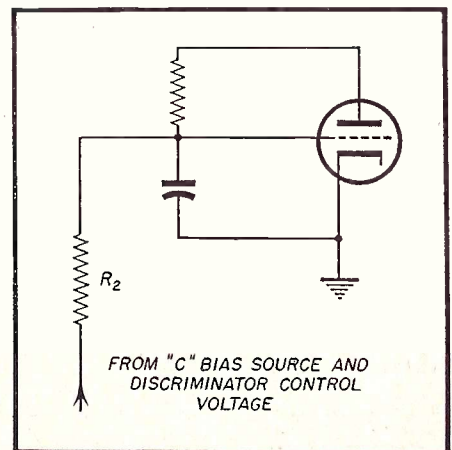

Fig. 4. Manner in which control voltage may be applied from discriminator or phase detector to the reactance tube.

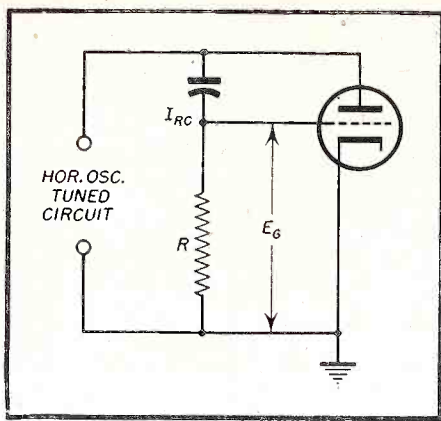

Fig. 5. Simplified diagram of reactance tube circuit in which X_c is much greater than R .

Since i_p is in phase with E_g , by combining (1) and (2),

$$3. I_{RC} \text{ leads } i_p \text{ by } 90^\circ \quad (3)$$

Also, since I_{RC} is almost in phase with E due to the high R -low X_c circuit,

$$4. E \text{ leads } i_p \text{ by almost } 90^\circ \quad (4)$$

Thus, the circuit shown in Fig. 2 is equivalent to an inductance, the basic requirement that the voltage lead the current by 90° having been met.

The amount of inductive effect this tube exerts can be controlled by the amount of grid bias placed on the tube. Thus, in an extreme case, if the bias is made very high the plate current is cut off and no inductive effect is obtained.

The amount of bias at which this tube operates is determined by the equivalent amount of inductance we need to produce the correct horizontal frequency. This bias is then varied by the output control voltage obtained from the discriminator or phase detector as explained previously.

Figure 4 shows how this voltage may be applied to the reactance tube. Notice that an isolating resistor R_2 is used between both circuits.

Reactance Tube As A Capacitor

As mentioned previously, a reactance tube can be made to take on the properties of capacitance as well as inductance. Thus, referring to Fig. 5 the capacitive reactance X_c , across

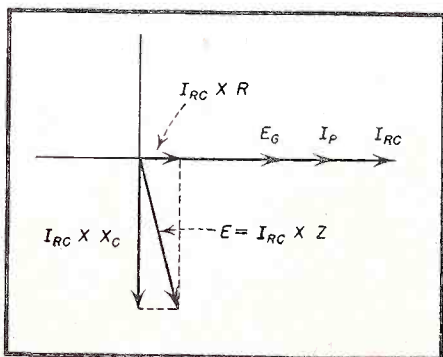

Fig. 6. Vector diagram of phase relations of voltages and currents in circuit branches of Fig. 5.

condenser C , is now made much larger than resistance R .

Examination of the vector diagram in Fig. 6 reveals that X_c is much larger than R . The oscillator voltage E , is applied across C and R producing a current I_{RC} . The total impedance of the circuit, Z , multiplied by this current is equal to E . E is almost in phase with X_c and therefore lags I_{RC} by almost 90° .

Applying these circuit conditions to Fig. 5 we obtain the following conditions:

$$1. i_p \text{ is in phase with } E_g \quad (5)$$

Since the voltage and current in a resistance are always in phase,

$$2. I_{RC} \text{ is in phase with } E_g \quad (6)$$

Combining (5) and (6),

$$3. i_p \text{ is in phase with } I_{RC} \quad (7)$$

Because the circuit has a high reactance and low resistance,

$$4. I_{RC} \text{ leads } E \text{ by almost } 90^\circ \quad (8)$$

Combining (7) and (8) we obtain,

$$5. i_p \text{ leads } E \text{ by almost } 90^\circ \quad (9)$$

Thus, the above circuit is equivalent to a capacitor, the current leading the voltage by almost 90° .

Commercial Circuit Employing A

Reactance Tube As A Capacitor

A commercial application of this circuit used in the RCA 630 models is shown in Fig. 7. The reactance network consists of a $.015 \mu\text{f}$ condenser (high reactance) and 10 ohm resistor (low resistance) connected across the horizontal oscillator coil. The $.0039 \mu\text{f}$ condenser blocks the B plus from the horizontal oscillator coil, and the $.05 \mu\text{f}$ condenser keeps the d-c grid bias (-3 volts) from being grounded through the 10 ohm resistor. The control voltage arrives at the grid from the discriminator tube through a noise filter which is not shown in the figure.

Reactance Tube as an Inductor

A commercial circuit in which the reactance tube is used to provide an equivalent inductance effect is shown in Fig. 8. This is a partial schematic of the reactance tube circuit used in the Crosley Model 9-422M-LD chassis. In this circuit the voltage drop across R (which is relatively low in value) is cathode fed into the reactance tube. As the current increases the cathode side of the resistor becomes more positive, making the ground or grid side more negative. Therefore, the grid voltage is 180° out of phase with the current I_{RC} . We may use Fig. 6 remembering that I_p and E_g are now reversed in direction.

Thus, since:

$$1. i_p \text{ is in phase with } E_g \quad (10)$$

And:

$$2. I_{RC} \text{ is } 180^\circ \text{ out of phase with } E_g \quad (11)$$

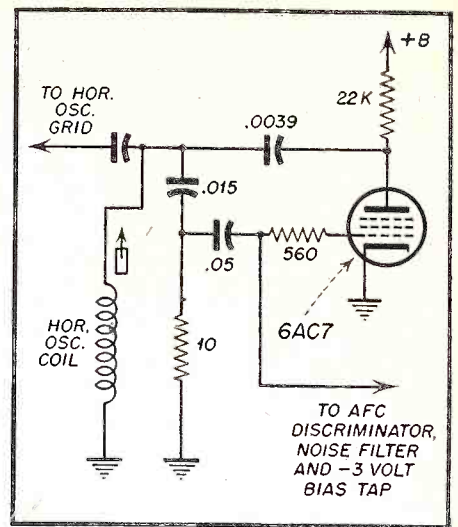

Fig. 7. Partial schematic of 630 type chassis showing capacitive type of reactance tube circuit.

Combining (10) and (11) we get:

$$3. I_{RC} \text{ is } 180^\circ \text{ out of phase}$$

$$\text{with } i_p \quad (12)$$

Due to the high X_c and low R circuit:

$$4. I_{RC} \text{ leads } E \text{ by almost } 90^\circ \quad (13)$$

Combining (12) and (13) we get:

$$5. E \text{ leads } i_p \text{ by almost } 90^\circ \quad (14)$$

Notice that E leads i_p by almost 90° . This is characteristic of an inductive circuit.

As a point of comparison between this circuit and the RCA 630 circuit, the reversal of a capacitive to an inductive effect is obtained by reversing the grid feed circuit (RCA) to the cathode feed circuit (Crosley).

Reactance Tube Circuit Utilizing The Tube As A Variable Resistance

A vacuum tube connected in the circuit shown in Fig. 9 becomes a variable resistance in series with a compensating capacitor C . The combination may then be connected across the tuned circuit of which L is the variable inductance. This tuned cir-

[Continued on page 44]

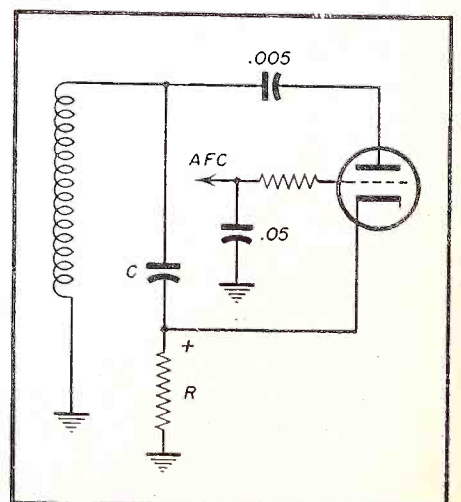

Fig. 8. Partial schematic of Crosley Model 9-422M-LD chassis.

A.G.C.

in

TV

Part 2

by Leonard Lieberman

LINEAR and average type a-g-c systems worked fine for a couple of years while most TV sets sales were made in primary transmission areas. There, the variations between signal strength were not great enough to materially vary the a.g.c. even though they were great enough to render the simple contrast (Fig. 1) system unusable.

As the reception areas extended further and further from the transmitters, the signal strength from station to station started to vary drastically. This variation could range from 6,000 microvolts at the receiver antenna from a nearby station to less than 100 microvolts on reception from a distant station. Noise pulses on weak stations also increased. This variation brought two flaws in average type a.g.c. which were masked when all stations were of a rather constant signal input. The two flaws were: 1) the effect of background brightness on the average d-c level on the detector, and 2) the effect of noise in the signal.

The biasing voltage in average type a.g.c. which is roughly analogous to the a.v.c. is, however, developed in a

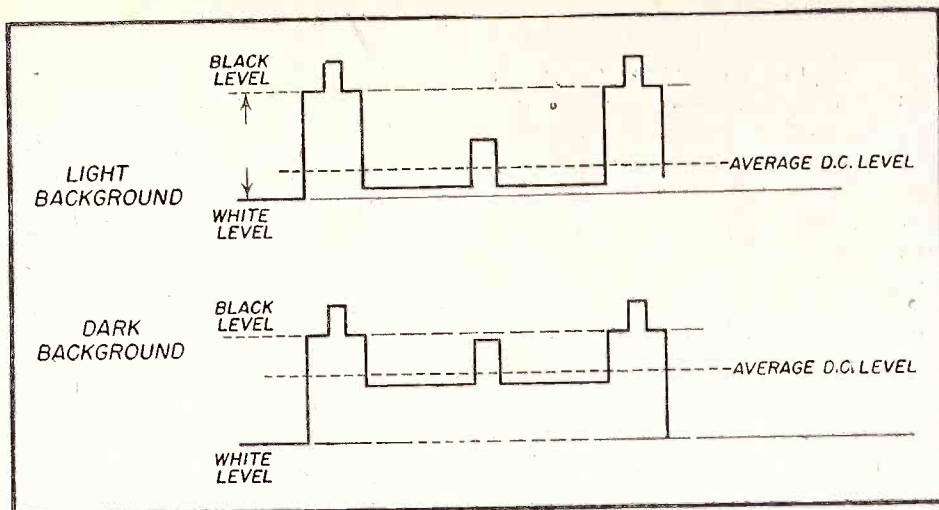

Fig. 8. Relation between brightness level and average d-c level. Carrier strength is constant.

In this second installment the author describes peak a-g-c circuits and applications in various types of receivers. Network time constants and their importance are also discussed. The third and final installment will appear in the March issue of RSD.

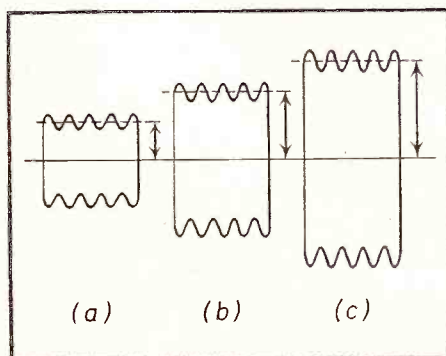

Fig. 7. Relation between a-c ripple and average d-c level with varying signal levels in AM reception.

- (a) weak signal strength waveform
 - (b) medium signal waveform
 - (c) strong signal waveform
- Arrow indicates aver. d-c level.

slightly different manner. The reason for this as shown in Fig. 7 is that in AM receiver reception the output of

the detector is a wave form which is basically a d-c voltage with an a-c ripple superimposed on it. The a-c ripple is the audio signal. The average d-c is related to the carrier level.

In TV reception, however, the average video voltage is not the result of only one signal, the video information, but also the d-c component whose amplitude depends on the brightness level of the scene being viewed. For the same object being shown as in Fig. 8 the video signal amplitude would be different if the background were light or dark. It can be shown, in Fig. 9, that we can have a situation where a strong signal input station presenting a program against a very light background and a weak signal input station presenting a program with a dark background could develop the same amount of a.g.c.

The same effect results from the presence of noise pulses in the pix with this additional drawback; noise is most likely to be present on weak signals inasmuch as the signal-to-noise ratio decreases as the signal strength decreases. When the noise is included as part of the a-c which is imposed on the a-g-c filter, the average d-c level increases. This results in additional bias which is then applied to the r-f amplifier further reducing the ability of this tube to amplify the weak signal.

However, there exists in the trans-

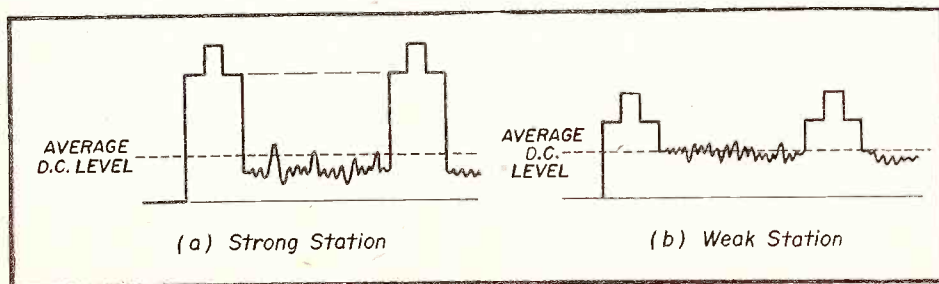

Fig. 9. Comparison of average d-c levels between strong station pix with light background and weak station pix with dark background.

mitted signal components which are related to the carrier level only. These can be used to derive a biasing signal which has a direct relationship to signal strength. The blanking and sync level are of fixed amplitude with reference to carrier level. They thereby directly reflect the strength of the carrier and can be used as a reference level for the a-g-c system.

Basically all other a-g-c systems utilize the amplitude of the sync pulse to develop a negative voltage across an RC network. This voltage is applied to the grids of the i-f amplifiers, the r-f amplifiers or both. The time constant of the a-g-c RC network is such that the charge on the condenser has hardly any chance to trickle off before the next sync pulse comes along to recharge the condenser to the peak value.

The i-f amplifiers are generally of the remote cutoff type so that there is no cross-talk at high bias voltage. The

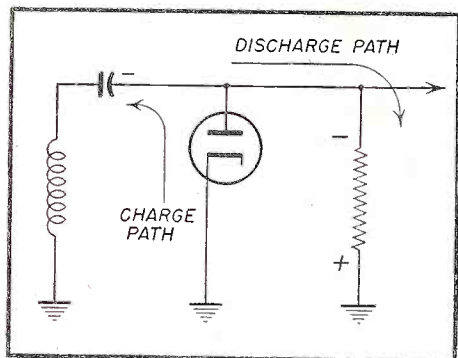

Fig. 10. Basic peak-type a-g-c network.

voltage to the r-f amplifier is generally dropped by means of a voltage divider. This is done so that the r-f amplification at low signal strength is not reduced appreciably.

Figure 10 shows the equivalent basic peak a-g-c circuit. When a positive going waveform appears across the transformer secondary the diode starts to conduct. The current path due to the high value of R is by way of C in the direction shown. When the input waveform goes negative the condenser discharges. The discharge path is through R and the input coil. This results in a negative voltage with respect to ground appearing at the junction of R and C . Due to the low impedance of the tube in the charging circuit, C charges to practically the peak value of the input waveform or in other words to the peak level of the sync pulse.

Due to the high value of R the charge on C has very little opportunity to discharge before the next positive going waveform appears across

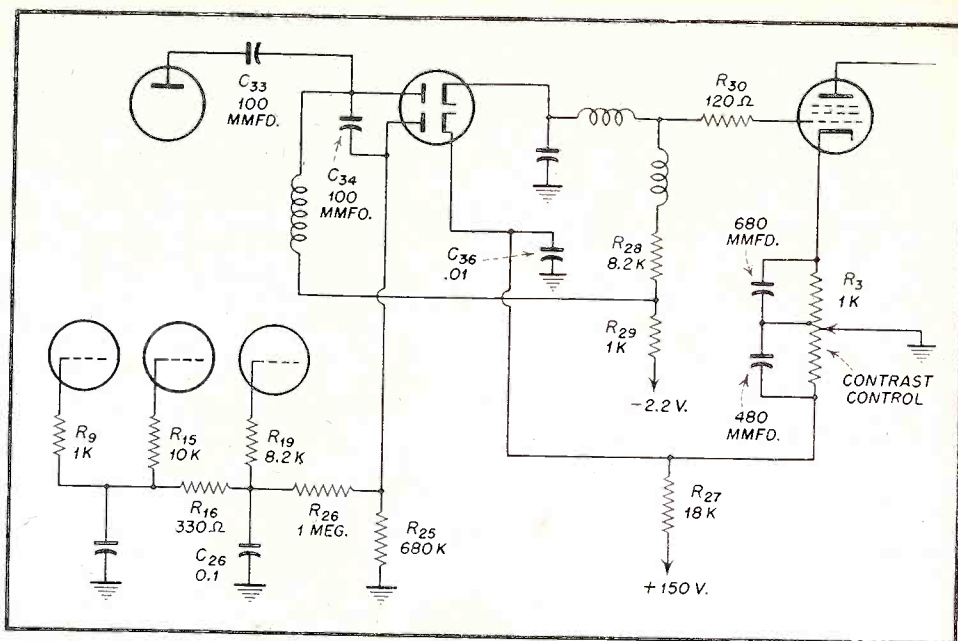

Fig. 11. Partial schematic of Air King Model 2017R

the coil. The tube cannot, however, start conduction immediately since the negative voltage still on C acts as a delay bias. Only when the peak starts to overcome the bias does the tube start to conduct. Thus the bias applied to the control stages is affected only by the amplitude of the peaks on the sync level.

In the commercial design of peak a-g-c systems, you will note that the engineers find it much simpler to develop a delay voltage than in the average type. The reason for this is that with the use of a separate diode the plate or cathode can be connected to a simple network which would apply either a negative or positive bias, as the case may be. In this manner,

the diode is prevented from conduction until the received signals are of a pre-determined amplitude. It can also be arranged in such a manner that this delayed voltage can be varied very simply.

Commercial Application

The Air-King Model #2017R Fig. 11 is an example of such a system. The cathode of the a-g-c rectifier is connected to the junction of $R3$ (1K) contrast control and $R27$ (18K) going to +150 volts. The arm of the contrast control is grounded.

With strong signal reception, the contrast control is generally set for its maximum resistance value in the cathode of the video amplifier. This position of the contrast control arm

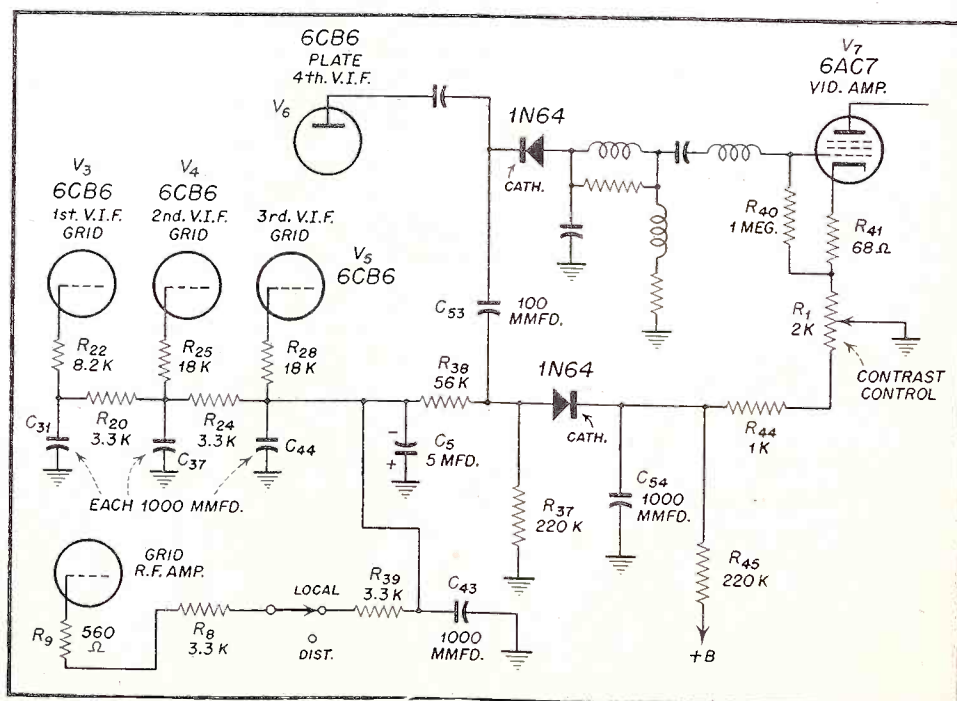

Fig. 12. Partial schematic of Arvin Model 2160

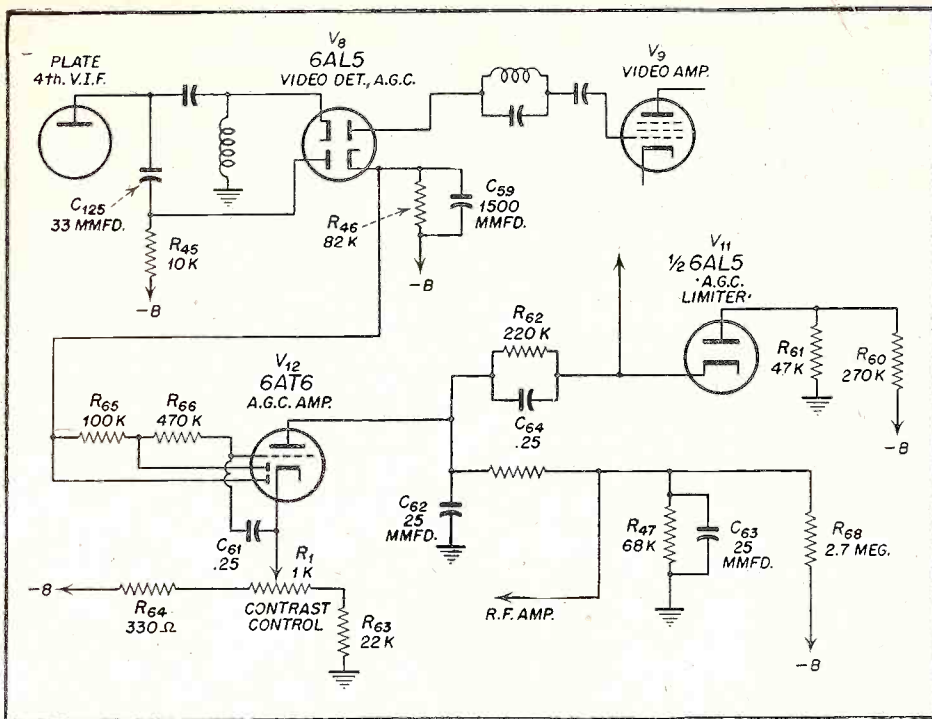

Fig. 13. Partial schematic of Capehart Model 461-P

brings the cathode of the detector to ground. In this position, no positive delay voltage is applied to it and it works as soon as the signal is applied.

With weak signal reception the contrast control arm is moved up in order to reduce the bias on the video amplifier cathode. This causes a positive voltage to appear at the junction of R3 and R27. This positive voltage causes C36 (.01) to charge. This charged voltage is then applied as a bias voltage to the rectifier cathode. As a result of this bias, the diode does not start to conduct until the amplitude of the waveform appearing across the video detector coil is greater than the bias voltage.

In this manner, in fringe reception areas, there is no a-g-c bias voltage developed until the received signal is strong enough to overcome the delay bias determined by the setting of the contrast control. When the signal is strong enough to cause the tube to conduct, C36 discharges through the tube. The a-g-c voltage is developed across R25 (680K).

Time Constants of Networks

In addition, there is in the above circuit another feature of interest. Note that we have in the network C34, R25, R26 and C26, two different time-constant networks. One consisting of C34 and R25 and the other made up of C26 and R26. The purpose of this arrangement can be better understood if we were to figure what the time constant of these RC networks are. Doing so, we would find the RC time for C34-R25 to be 68

micro-seconds, and for R26-C26 1,000 micro-seconds. Since the time-width of a horizontal pulse is 63 micro-seconds, we can see that C34-R25 would charge to the peak values of the horizontal sync pulses. If noise appears on the sync pulse, we would be in trouble. That is where the second network takes over. Since its time-constant is so long, it would take approximately 160 horizontal sync pulses to affect its value. Therefore, the noise which would appear on four or five pulses, does not effectively add to the a-g-c voltage.

In the Arvin Model #2160 (Fig. 12), the circuitry involved is similar to that in Fig. 11 with the further modification that there is a local-distance switch. When the switch is in the distant position, the minimum a.g.c. which is developed even at a minimum contrast control position is removed from the r-f amplifier grid.

In an endeavor to overcome the problem of dynamic range, in the a-g-c system (which we discussed in the previous article), two basic approaches were taken by design engineers. The first method which is shown in Fig. 13, of which there are a number of variations, is to take the a-g-c signal or the a-g-c level from the a-g-c detector, amplify it and apply it to the tube or tubes to be controlled. In the second approach shown in Figs. 13 and 14, instead of taking the rectified signal at the diode, the signal is taken off the output of a video amplifier, rectified, amplified further and then applied to the control tubes.

This system in addition to providing additional amplification, also tends to clip any noise pulses which might be riding on the sync pulse, itself. This is desirable as these pulses would cause an improper a-g-c voltage to be developed. Inasmuch as the system references itself on the peak voltage at the rectifier and the noise on the sync pulse would be the peak, the a.g.c. developed would not be related to the carrier level. Some of the noise clipping takes place in the video amplifier grid and the balance of it in the a-g-c system.

In (Fig. 13) we find that in the Capehart Model #461P, the a-g-c diode current flows through R45 (10K) and R46 (82K). The grid of the triode section of V12 (6AT6) is directly coupled to R65 (100K) and R66 (470K) to the cathode of V8, the a-g-c rectifier. The cathode of V12 is connected to the arm of a potentiometer R1 (1K) contrast control which is part of a negative supply bleeder. The plate returns to ground through R67 (27K) and R47 (68K). The plate circuit is shunted by a network consisting of R62 (220K) and C64 (.25μf) in series with the cathode of 1/2 of V11 (6AL5).

The tube current path for this tube returns to ground through R61 (47K). The purpose of this tube is to act as an a-g-c limiter for the entire string. The limiting action prevents the developed bias from driving the control tubes to cut-off.

As the signal is developed across R46 and R45, the voltage on the grid of V12 rises. This rise is rectified by the action of the two diodes in V12. As the voltages get more positive, they start to conduct through R65 and R66. The discharge path is through C61 and the cathode of V12.

This action sets a d-c bias between cathode and grid which is proportional to the signal. The condenser also helps overcome the degenerative action of the non-bypassed cathode resistor. The result is a d-c amplifier whose output is directly connected to the i-f grid returns and a dropped voltage to the r-f grid.

In the Fada Model #1025 (Fig. 14), we find another example of the second type of peak detector previously mentioned. In this circuit, V17 (1/2 6SN7) acts as the rectifier. The rectifier action is a result of the grid to cathode bias.

The principle of this rectifier action is similar to that utilized in AM radio plate detectors. The bias developed is a result of the voltage developed at the top of R75 (100K) with no signal

[Continued on page 43]

ASSOCIATION NEWS

Local, State, and National Associations are urgently requested to send in news of their activities so that we may print them in these columns.

Federation of Radio Servicemen's Association of Penna.

At the recent meeting of the Federation of Radio Servicemen's Association of Penna. which was held in Harrisburg, the delegates of its numerous Chapters went on record requesting this office to make the following statement to the industry and the press, to correct an apparent one-sided picture of Service Relations:

"Neither this body nor any of its Chapters are participating in or represented on the Joint Electronic Radio Committee on Service. Federation representatives were requested only to act on a sub-committee to help write the 50 Point Program which was submitted to the various segments of the industry.

"The Joint Electronic Radio Committee on Service's Chairman, Mr. Albert Steinberg did not invite the representatives, the organized associations of service technicians, to sit with the Joint Electronic Radio Committee on Service's main body. The Federation, feeling the refusal to give the servicemen's associations full and equal recognition on the Joint Electronic Radio Committee on Service main body (on which were representatives of the Radio-Television Manufacturers Ass'n, set distributors, parts manufacturers, Manufacturers Representatives, National Electronic Distributors Association and the Television Contractors Association), refused to participate further until this oversight has been completely rectified. Since an elected spokesman for the organized service committee, we, the Federation, refuse to allow a hand picked spokesman, Mr. Haas, of the Television Contractors Association, to represent the Federation or any of its membership, to speak for us. This does not preclude the possibility of ac-

tual and enthusiastic participation in any worthwhile program sponsored by the Joint Electronic Radio Committee on Service or any other group who would conscientiously promote the best interest of the service profession.

"The door is always open."

Dave Krantz

National Alliance of Television & Electronic Service Associations

Associated Radio & Television Service Dealers—Our Columbus, Ohio affiliate has just announced the election of Fred Colton as President. Congratulations and best wishes for his success.

Technician Training Program—John Graham of ARTSD told us of a very practical plan for technician training. He wire records a lecture and accompanies it with slide films reproduced by photography from various publications. Ohio has had great success with this plan and we believe other groups could do equally well. Why not drop John a letter?

St. Louis Better Business Bureau—Enclosed with this bulletin you will find NATESA's letter to Mr. Riehl of the St. Louis BBB. We believe the letter is self-explanatory. Under no condition is this letter meant to imply any wholesale opposition to the BBB's. In fact, most NATESA member associations are working very closely with their local BBB. This is particularly true of TISA in Chicago. We highly recommend such close liaison. The letter covers a case which we certainly believe was mishandled by Riehl.

OPS Ruling 45 — General Counsel Leventhal of OPS has just issued a ruling wherein he charges that the forced sale of parts warranties is a tie-in sale and therefore illegal. We are calling this ruling to the attention of the industry with the hope that corrections can be made without need of action through the Justice Department.

Television & Electronics Service Ass'n — The name of the Nebraska-Iowa's Television & Electronic Service Association has been changed to Television & Electronics Service Ass'n. This group has just elected Jim Hustnd, NATESA's Secretary General, to its Presidency for a second term. Congratulations!

Radio & Television Servicemen of New Jersey — This group has just elected Edmund Trefari to a directorship in NATESA. J. Palmer Murphy, Executive Secretary of this group has certainly done a big job in his territory against adverse publicity.

TISA-Chicago—Your President was reelected for his fifth term to the Presidency of TISA. Reelected with him was Morton Binder, Vice President Reuben Saxner, Secretary—Martin Reese, Treasurer. Most of the directors will remain the same. Burton Browne, the foremost advertising executive in the TV field, will address a dinner meeting of TISA to be held January 9th.

Dues—1952 membership dues are payable NOW. Mail your check to Bert Lewis at 22 Thornton Road—Rochester, New York. Membership Certificates will be issued to those of your members who are registered with this office.

Frank J. Moch

Radio & Television Technicians Guild Of Florida, Dade County Chapter

The regular monthly business meeting was held Tuesday, Dec. 4th, 7:30 P.M. at Old Saratoga Inn, Biscayne Blvd. at 76th St.

Well Guys—they're at it again. It seems Bob Considine had a bit to say about "TV Gyppers" in his Syndicated Column. This column is read by *MILLIONS* of people all over the Country—and if ever there was a time when Radio & TV men should stick together—this is it.

November has been a good month

[Continued on page 42]

SHOP NOTES

Write up any "tricks-of-the-trade" in radio servicing that you have discovered. We pay from \$1 to \$5 for such previously unpublished "SHOP NOTES" found acceptable. Send your data to "Shop Notes Editor."

Bendix 1950 Models-Pix Tube Spots

On some of the Bendix 1950 models a small rectangular spot roughly 1 sq. in. in area appeared a little to the left of center of the picture tube after several months of operation. This spot was brown in color and became very annoying when light objects were being televised, and became worse with continued use. Except for the fact that this spot was rectangular in shape and very defined it might be mistaken for an ordinary ion burn due to misadjustment of the ion trap. On investigation, however, it was found that when the set was turned off the current drain of the C.R.T. would be insufficient to discharge the high voltage capacitors completely and a bright rectangular spot would slide a bit to one side of tube face center and stay there for as much as a half minute.

Our advice to all our customers on other makes of receivers which might have the same trouble is to advance the brightness control just before turning off the receiver. This would kill the spot instantly when the set was turned off due to the added cathode current drain from the high voltage filter (most of which is the capacity between the outer and inner tube coatings). On the Bendix models we refer to the brightness control which is on the rear of the chassis, and the customer can not easily adjust it each time the set is turned on or off. We have devised the simple circuits shown below to eliminate the trouble. This will not eliminate the spot already formed, but will prevent it from getting worse, and will prevent it from appearing if not already there. Either of the two methods shown will work equally well. Note that in *Fig. 1* the

theory of operation is as follows (dotted lines show added parts):

When the set is turned on a total of 7000 ohms is shunted across the brightness control from *B* to *C*. Since this increases the voltage on the CRT cathode in a positive direction (effectively negative on the grid) it blanks out the picture tube. The procedure now is to adjust the brightness control for the same illumination that was present *before* the resistors were added. Now when the set is turned off, the added switch section opens at the same time the a-c switch is turned off, the resistors are cut out of the circuit, the brightness is momentarily increased (due to a less positive polarity on the cathode) and the capacitor charges are dissipated rapidly (2 secs.). Note, however, that at no time is there any visible increase in brightness when the set is turned off, since the low voltage supply is being quickly drained at the same time and the raster being so much larger than before the change made has less brightness per sq. in. of area. In operation the raster disappears gradually both in brightness and area, where before it dropped down quickly to one bright spot area.

Figure 2 shows the 2nd method. Here the switch must *close* when the set is turned off, shunting a resistor from cathode to ground. Since this makes the cathode of the CRT less positive (equivalent to a *more* positive polarity on the grid) it has the same effect as the description above of *Fig. 1*. Since the a-c switch is ganged with the volume control, it may be best to replace the control using a dual switch (d.p.s.t.) in *Fig. 1*, or a dual switch in *Fig. 2*, one opening as the other closes.

We have gone into considerable detail with reference to this small change because, pix tubes cost money, and if within warranty burns like these are hard to explain to the customer, and, many other receivers of various makes have the same trouble. The serviceman with a little ingenuity can devise other circuits to apply to various receivers to accomplish the same thing.

Submitted by
M. G. Goldberg
St. Paul, Minn.

GE Models 600, 601, 603, 604

Weak RF Oscillator. On early receivers, oscillator instability may be caused by a defective coupling winding on the L2 oscillator transformer. Remedy: Connect C15, 56 mmf., capacitor, as shown by dotted line in

[Continued on page 37]

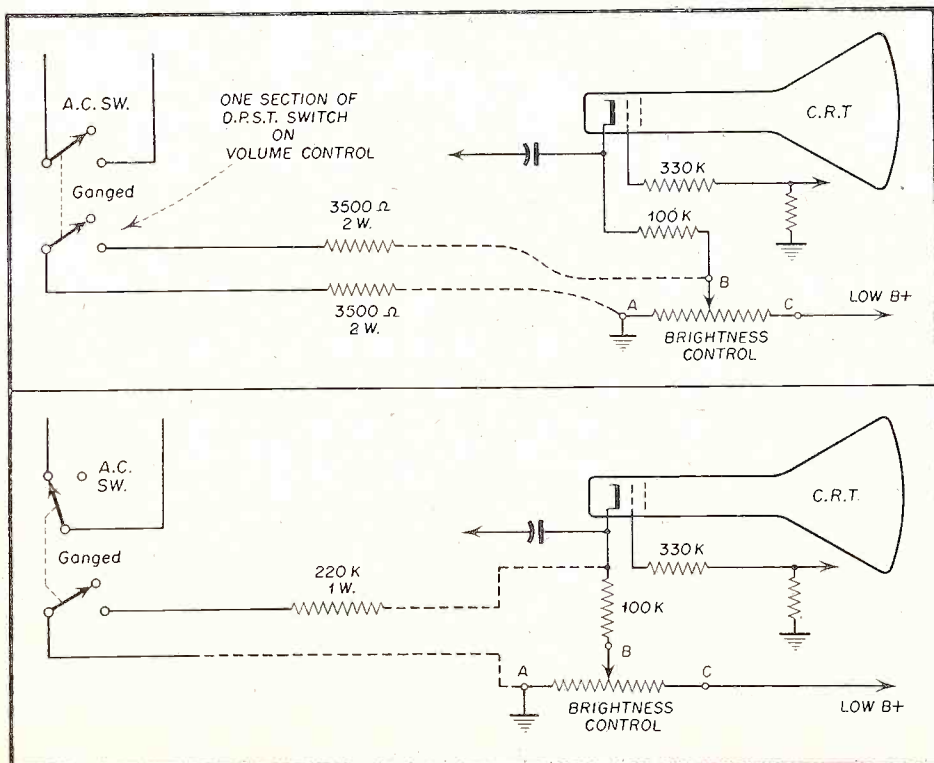

Fig. 1. (Top) Eliminating brown spot on pix tube (1st method)

Fig. 2. (Bottom) Eliminating brown spot on pix tube. (2nd method)

TRADE LITERATURE

Now available from *Standard Transformer Corporation*, Chicago, is the new *Stancor Output Transformer Chart (Stancor 375)* which lists 129 of the most frequently used output transformers and the tubes with which they should be used.

This handy Stancor guide simplifies the selection of the proper transformer for use as replacement in radio receivers or in the construction of audio amplifiers. In almost all cases more than one transformer is listed so that there is a choice of mounting types, and the application, class and operating characteristics of the tube and transformer are shown in ready reference form.

The chart lists tubes, use, class, watts, load resistance in ohms and the correct Stancor output transformer to be used with each tube.

* * *

The distributors of *John F. Rider Publisher, Inc.*, 480 Canal St., New York 13, N.Y., have received stock of the largest Rider Television volume yet published by the organization—*Television Manual Volume 8*.

Containing the equivalent of 2,688 (8½ x 11) pages, the new TV service data volume contains approximately 600 models, the productions of 52 manufacturers. The factory-authorized coverage is for the period June through September 1951. All pages in the 12 x 15 inches volume are systematically prefiled for immediate service bench use. As in previous editions, TV 8 contains a cumulative index for the complete set of eight Rider television volumes.

All manufacturers' production runs and chassis modifications are presented with original and modified schematics. Also included are chassis views, voltages, resistance readings, complete alignment procedures, trouble shooting test patterns, waveforms, complete parts lists and parts values, boosters, tuners, and a special section devoted to manufacturers' changes on earlier production runs. Additional time-saving features are unpacking and installation data and circuit action descriptions. TV8 is priced at \$24.00.

* * *

The 4th edition of the *Sprague TV Replacement Capacitor Manual*, just



"If you must shout advice to the wrestlers at least try to remember the children are present."

published, contains accurate, up-to-the-minute capacitor replacement data on a total of 1561 receiver models by 63 manufacturers.

Printed in dark brown ink to distinguish it from earlier editions, this serviceman's "bible" shows complete, set-by-set listings of original equipment capacitors and their recommended Sprague replacements. Rating data and manufacturer's part numbers are listed for the original capacitor, while Sprague catalog numbers and electrical specifications are given for the replacement unit. A condensed listing of all Sprague TV capacitors is also included in the manual.

A special section lists capacitor "Service Packages" which contain all the electrolytic capacitors necessary to service any particular brand of TV set. Sprague jobbers will supply these kits for over 22 of the most popular brands of TV receivers. Servicemen can thus purchase at one time a full stock of needed replacement capacitors for the sets they specialize in.

Free copies of the new manual, publication M-481, are available from local Sprague distributors, or may be obtained directly from *Sprague Products Company*, North Adams, Mass., on receipt of 10c to cover mailing and handling.

* * *

Brevity with clarity describes the new *Clarostat Catalog No. 51*. The usual sales blurb is eliminated in favor of concise technical data where necessary. Most of the space is devoted to exceptionally extensive listings of types and values of resistors and controls. Items listed are standard and therefore stocked by Clarostat distributors, including carbon and wire-

wound controls of various types and sizes, attachable shafts and switches, rotary switches, constant-impedance controls and sound-system attenuators, tube-type resistors and ballasts, line-voltage regulators, fixed and adjustable power resistors, power rheostats, glass-insulated flexible resistors, TV beam benders, and the Clarostat power resistor decade box. A copy is available on request from the Clarostat distributor or from *Clarostat Mfg., Co., Inc.*, Dover, N. H.

* * *

"*Servicing TV in the Customer's Home*," a handy pocket-size book for the TV service technician published by *Howard W. Sams & Co., Inc.*, Indianapolis, is now in distributors' hands.

The book, advance orders for which indicate that it will be one of the most popular published by the Photo-fact press, shows how to make successful on-the-spot repairs, providing practical, proved help to make outside TV servicing really effective and profitable, according to Howard W. Sams.

The book tells in simple easy-to-follow instructions, how to diagnose trouble using capacitor probe and VTVM, Sams said, and is intended to save time, work and chassis hauling.

"*Servicing TV in the Customer's Home*" contains a simple, effective method for tracing down trouble, using VTVM and a simple capacitor probe; methods for finding one's way around a strange circuit; how to "pull" tubes and diagnose trouble by observing audio and picture effects; how to judge TV set performance by analysis of the test pattern, and methods for making adjustments in the field.

In pocket size, with sturdy cover, "*Servicing TV in the Customer's Home*" sells for \$1.50.

* * *

The first color chart ever to include all the color-coding requirements of the entire electronic industry has been prepared by *Centralab Division of Globe-Union Inc.*, Milwaukee, Wisconsin.

Printed in eleven colors with over 3,300 color dots or marks, the new

[Continued on page 34]

CIRCUIT COURT

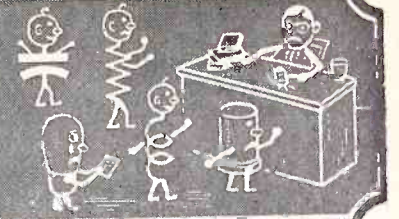

Radio Craftsman RC 100-A,

Vertical A.F.C.

In this circuit (Fig. 1), a pulse is taken from the vertical output transformer and is applied to the input of a phase detector. The sync pulse which kicks off the vertical oscillator is also applied to the detector. The voltages are so arranged that the vertical oscillator bias will vary thus causing it to start conduction sooner or later depending on whether the vertical oscillator frequency is slower or faster than the incoming sync pulse.

The sync pulse is fed into the grid of V17. The amplified signal is taken off both cathode and plate. The signals taken off are approximately equal since the plate and cathode resistors are equal. This voltage is fed through a resistor-condenser network to V18 a 6AL5. The plate signal voltage from V17 is fed to the cathode of 1/2 of V18. The cathode signal voltage from V17 is fed to the plate of the second half of V18.

A pulse is taken off the vertical output transformer and fed to the midpoint of R94 and R95 (470K each). If this pulse is in phase with the sync

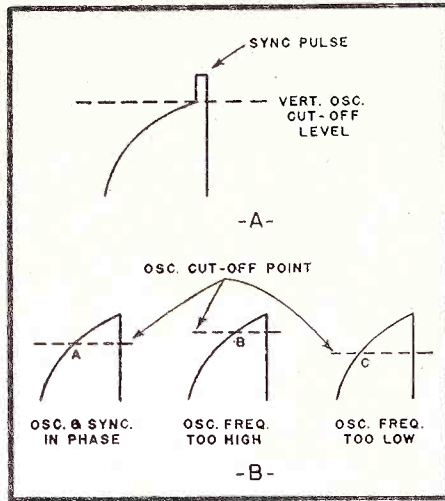

Fig. 2A. Sync pulse starts conduction.
Fig. 2B. How oscillator frequency is varied.

pulse, it will be cancelled out in the two detector circuits. If it is out of phase, it will vectorially add or subtract from the sync pulse. As a result of this vectorial addition, one section or the other of the detector will conduct more heavily.

The size of the output pulse deter-

mines how heavily the first half of V19 conducts. The first half of V19 acts as a d-c amplifier. In this type of operation, the plate current changes in response to variation in grid bias. This variation in plate current does not produce an a-c signal at the top of the load resistor but it does cause the d-c voltage at the signal take-off point to vary.

The second half of V19 works as a free-running blocking oscillator. In the usual type of vertical blocking oscillators, the grid is effectively cut off. It only goes into operation when the sync pulse arriving at the top of the charging wave-form brings it out of the cut-off condition (Fig. 2A). In the free-running type of oscillator, the charging pulse itself brings the tube out of cut-off. In the type of application of this oscillator, as used in the RC 100-A, the d-c bias level for the oscillator tube is varied by the phase relationship of the oscillator frequency and the sync pulse.

Figure 2B indicates how the phase detection of the two signals can cause the oscillator frequency to be varied.

[Continued on page 41]

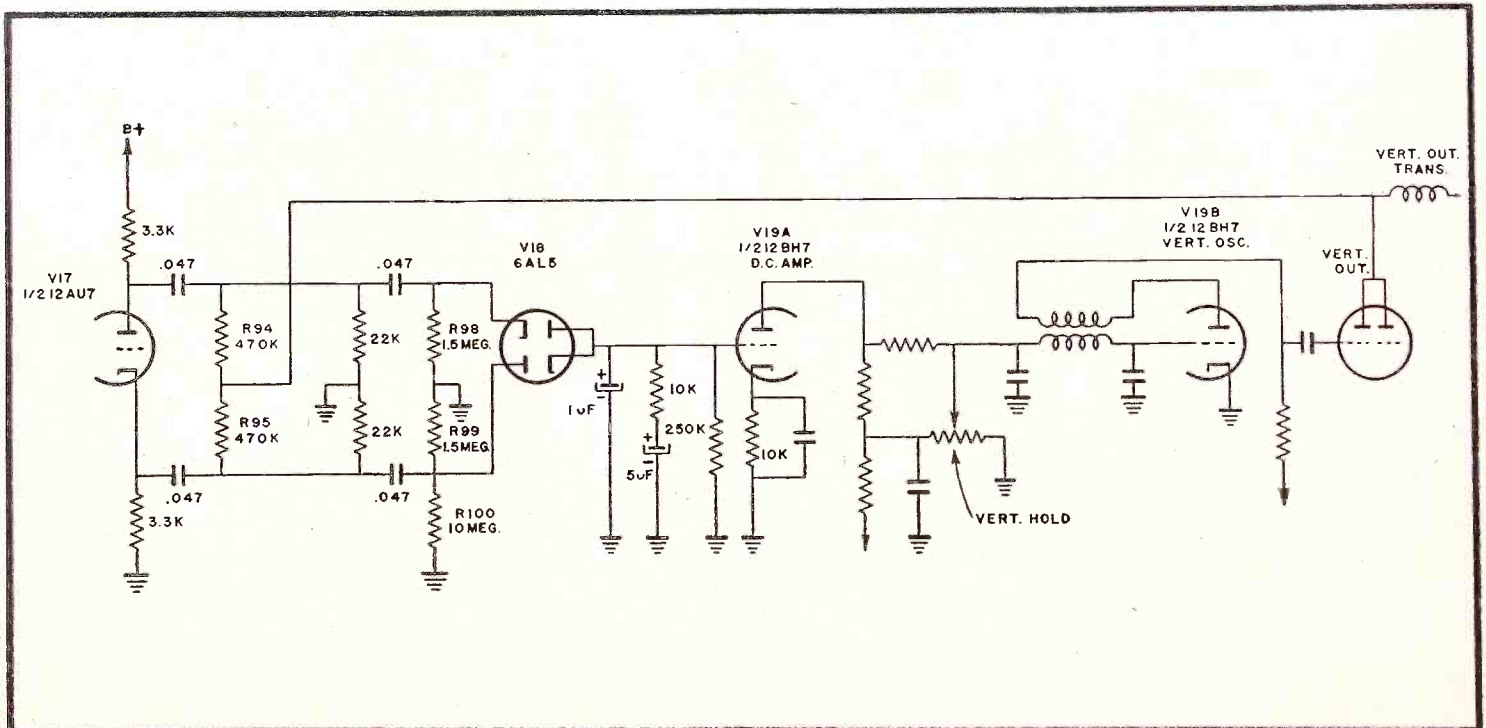

Fig. 1. Partial schematic of Craftsman RC 100-A vertical a-f-c circuit.

NEW PRODUCTS

5" SCOPE

Triplett Model 3441 provides wide frequency range for TV, FM and Industrial testing requirements. An illuminated Calibration Meter makes it possible to view the percentage of positive and negative peak-to-peak volts in addition to reading peak-to-peak voltage direct in 8 ranges from 0 to 1000 volts. This is a distinct advantage over a VTVM. Horizontal Amplifier-Frequency range flat within $\pm 20\%$ from 20 cycle to 150 KC. Deflection sensitivity .15 RMS Volt/Inch. Vertical Amplifier: Re-



sponse usable beyond 4 MC. Will show a square wave with no distortion. Sensitivity: .01 RMS Volt/Inch with switch in 2 MC position; .02 RMS Volt/Inch with switch in 4 MC position. Synchronizing and horizontal Sweep Selector combined in same control for simplicity in operation. High gain amplifier system available is ideal for tracing audio circuits and checking for noisy components. A phone jack connection on the panel makes a convenient way to familiarize the visual pattern with the familiar audio sounds. Push-Pull vertical and horizontal output amplifiers. Furnished in black suede finished metal case. 15-11/32" x 11-1/32" x 16". Accessories include Co-Axial cables, probe and instructions. A Crystal Signal Tracing Probe available as an extra accessory.

FLYBACK TRANSFORMER FOR 20" AND 21" TUBES

The new RCA-230T1 Horizontal-Deflection-Output and High-Voltage Transformer is capable of providing a no-load output voltage of 18 kilovolts. It is intended particularly for

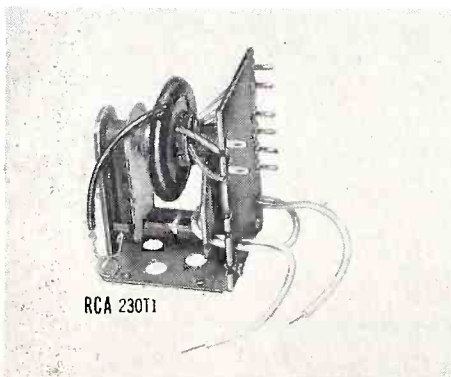

use with 20-inch and 21-inch picture tubes, such as the 20CP4 and 21AP4, having a horizontal deflection angle at 66°.

Utilizing a ferrite core for superior performance, the 230T1 is designed for use with a single, horizontal-deflection amplifier tube 6CD6-G; a single, high-voltage rectifier tube such as the 1B3-GT; and the RCA-211D1 Deflecting Yoke.

Operation characteristics of the 230T1 make possible the design of a horizontal-deflection system which operates efficiently with a dc power supply of 290 volts, and which provides full deflection of picture tubes having horizontal deflection angles of approximately 66° and operating at zero-load voltages of 18 kilovolts.

IMPROVED "CLOVER-V-BEAM" ANTENNA

The improved Telrex array is compactly folded, completely preassembled and speedily rigged by tightening two nuts. Servicemen who have installed the Telrex "Clover-V-Beam" have acclaimed its exceptional high gain performance and practical design.

The unusual characteristics of the "Clover-V-Beam" derive from the unique application of transposed co-linear elements in conjunction with stacked closed loop "Conical-V-Beam" dipoles. In operation, the interconnecting rods load the dipoles for low frequency channels and serve as transposed 1/2 wave transformers at the high channels. This provides the sensitivity of resonant closed loop conical dipoles at the

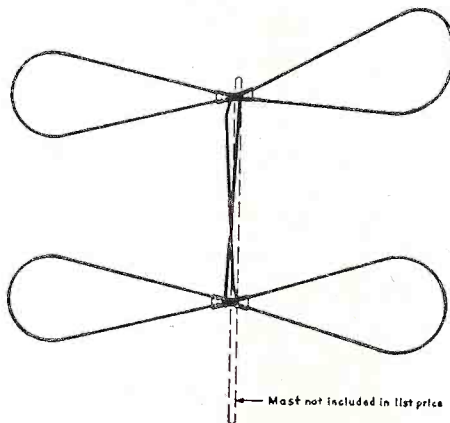

low frequencies, and long wire V-Beam operation with gain averaging 9 db at the high channels.

Due to its flat impedance characteristic and absence of lobe splitting, the "Clover-V-Beam" displays exceptional high gain and high signal to noise ratio over the entire TV and FM bands. Extremely low vertical angle of inception is obtained because of 1/2-wave stacking, thus minimizing ghosts, airplane flutter and interference originating above or below the antenna, while a front to back ratio of 2 to 1 results because of "Conical-V-Beam" dipoles.

Increased response to the "Clover-V-Beam" makes it possible to offer the improved model at the new low price of \$4.75 list.

The Telrex Engineering Department has devised many standard schemes and unusual applications for the "Clover-V-Beam". Infor-

mation will be gladly sent upon request. Direct your inquiry to Telrex, Inc., Engineering Department, Asbury Park, N. J.

SERVICING AID

A new TV servicing aid known as the Tele-lead is now being offered to servicemen through Du Mont Teletron Distributors by the Cathode-ray Tube Division of the Allen B Du Mont Laboratories, Inc., Clifton, N. J.

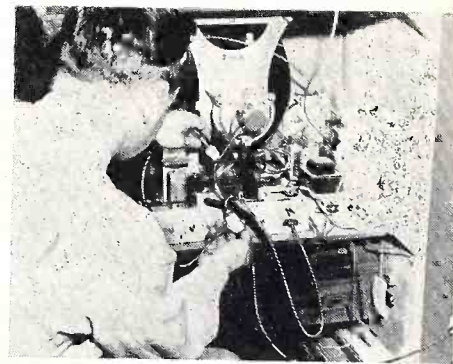

Available as a free premium with the purchase of every Du Mont Teletron, the Tele-lead serves a two-fold purpose for the busy serviceman. It serves as a jumper from the AC power outlet to the TV chassis when the protective back of the receiver is opened and the safety switch is broken, and also serves as a trouble light of convenient size. Constructed to withstand the hardest treatment as a service tool, the Tele-lead provides a six-foot lead from the standard Edison plug to a molded-rubber "T" junction. From this "T", an additional three-foot length of wire supplies power to the safety interlocking switch receptacle of the receiver. Another three-foot length of wire from the "T" terminates in a standard midget-base receptacle accommodating standard midget-base 110 volt bulb.

The Tele-lead is the latest item offered in the present Du Mont replacement campaign which was announced at the recent National Electronic Distributors Association Show in Cleveland. The premium offer has been made on all Du Mont Teletrons purchased between January 1st and February 29th, 1952.

27" METAL TUBE

Rauland Corporation, Chicago, has announced production of a new 27" rectangular picture tube with an extremely short metal-coned envelope.

The new tube, known as type 27QP4, is a rectangular electrostatic-focus, magnetic-deflection, direct view tube. It is shorter from face to back than a standard 20" tube by reason of using 90° deflection.

The screen of this new tube provides a picture area of approximately 390 square inches,

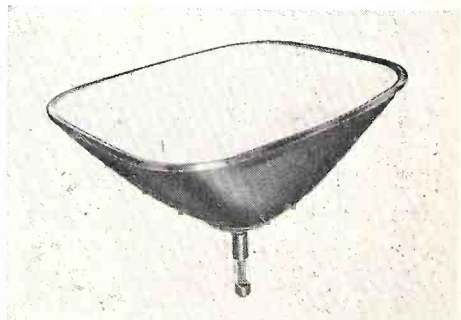

about 40 square inches bigger than the center spread of a tabloid newspaper.

The face plate of the tube is absorbent gray filter glass like that of the "black face" tube originated by Rauland. It is treated so that reflections from inner and outer surfaces is 97 1/2% eliminated.

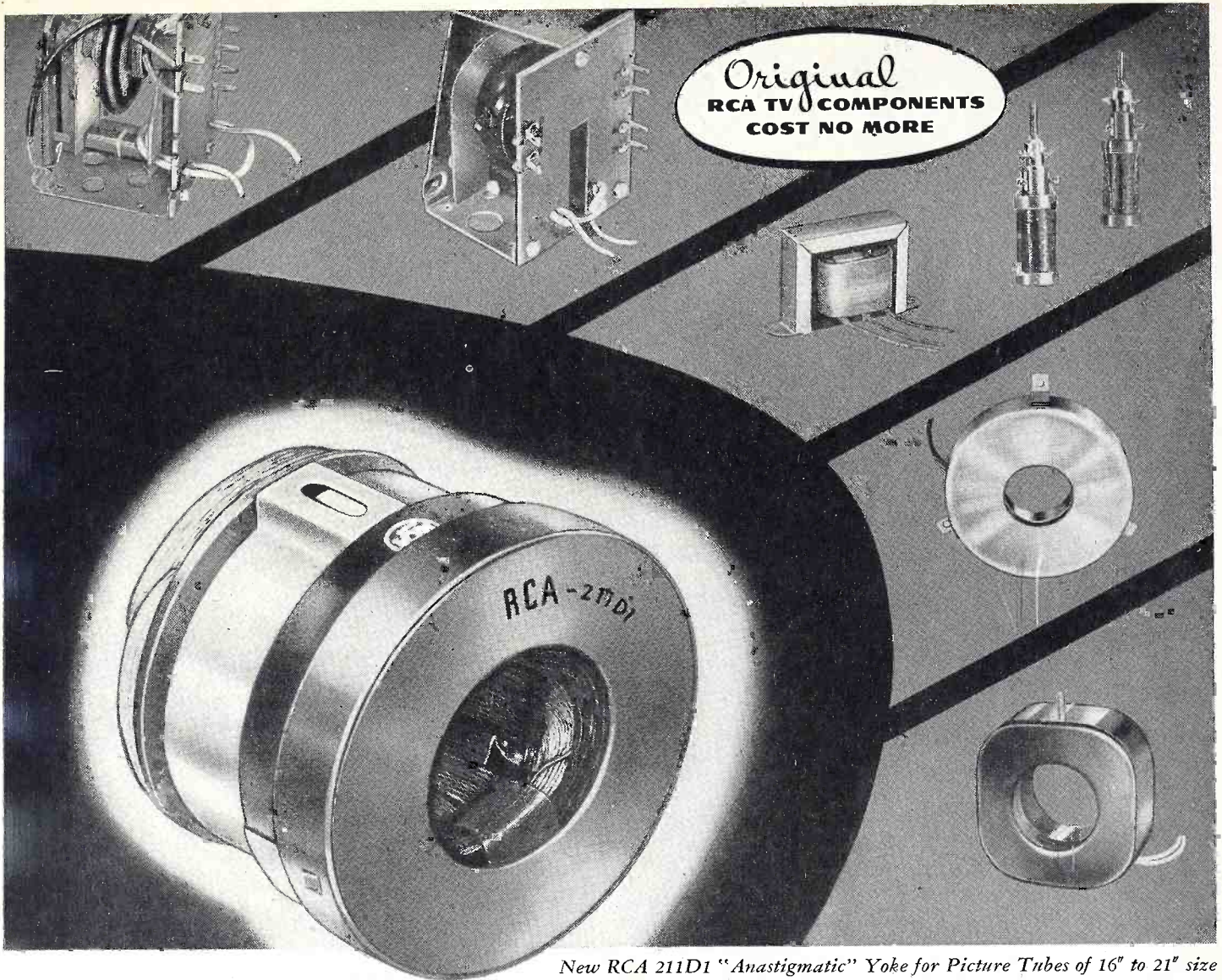

New RCA 211D1 "Anastigmatic" Yoke for Picture Tubes of 16" to 21" size

For best results use the yoke that's tailored to the tube

Check these features . . .

- ✓ Distributed windings of modified "cosine" design for sharp corner focus
- ✓ Negligible pattern distortion
- ✓ Freedom from insulation breakdown
- ✓ Terminals securely mounted
- ✓ Sturdy molded housing

Why take chances with "compromise" yokes when RCA "originals" cost no more?

Remember—RCA deflecting yokes set the engineering standards of the field. That's because RCA deflecting yokes and RCA picture tubes are designed to work as a team. Mechanically and electrically, RCA yokes "fit like a glove" . . . work best with the picture tubes they're specifically designed for.

Always the leader—RCA deflecting yokes were the first to use Ferrite cores . . . first to use distributed windings

providing negligible barrel and pin-cushion distortion. And . . . RCA yokes were the first to be constructed with a molded housing of solid plastic that affords increased insulation between windings and core, insures high resistance to humidity, and holds terminal lugs firmly.

RCA yokes are best fitted to restore original performance in the many makes of TV receivers you service. When a replacement is called for, play safe . . . use the yoke that "fits the tube." *That's RCA!*

See your local RCA Parts Distributor for "Original" RCA TV Components.



RADIO CORPORATION of AMERICA
ELECTRONIC COMPONENTS

HARRISON, N. J.

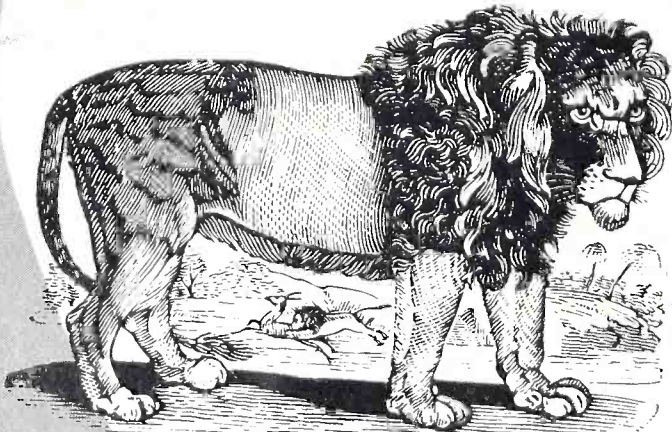

ELIMINATES ONE MAN!

The RADION "Metropolitan" outdoes our Friend Leo above . . . RADION eliminates one installer in many cases in areas where most TV set sales are made . . . but RADION saves you the valuable services of this eliminated installer to handle different installations or profitable repair work or even selling on the floor. Your RADION installations are fast, and economical and they save your customer a pretty penny on installation . . . in many cases saving the sale for you! Over 2,000,000 RADION installations prove RADION'S ability to deliver the goods while selling the goods for you. Write today!



Radion

The Radion Corp., 1130 Wisconsin Ave.
Dept. RSD-2, Chicago 14, Illinois
Send me free "8 ways to profit with Radion"

Name _____
Firm _____
Address _____

The tube employs Rauland's well-known Indicator Ion Trap Tilted Offset electrostatic gun with new "fine-line Focus." Fine-line Focus, the result of several improvements in gun design gives a brighter picture with 28% more "picture elements." It gives picture definition which is better both vertically and horizontally than before. It gives detail in the corners of the picture as good or better than that in the sharpest center area of previous tubes.

The 27QP4 can be used as a zero-voltage focus or can be focused to maximum sharpness with low-voltage supply from the set's regular power supply. A single external magnetic field must be used in conjunction with the indicator ion trap to prevent ion spot blemish.

SERVICE LIGHT

Columbia Wire & Supply Company, announces their new TV Service Light.

Every serviceman needs this handy television service light, which features a 7 watt 110 V bulb, non-breakable reflector for handy illumination, 6 foot cord with plug and a rubber suction cup which holds firmly to any flat surface.



The TV Service Light is ideal for servicing, takes very little room inside the TV cabinet, throws light where needed and leaves both hands free to work.

Each service light comes individually boxed in a light-weight durable container, easy to carry on service calls.

For details, write to—Columbia Wire & Supply Company, 2850 W. Irving Park Road, Chicago 18, Illinois.

FLEXIBLE LUBRICATORS

Village Vendors announce the distribution of the Inject-O-Lube, for use by radio and TV service men—and a new low price of two lubricators for \$1.

Six inches long overall, the slender flexible tube itself is 4½" thus allowing service men to easily get at remote points on radios, TV sets and record changers. Particularly valua-

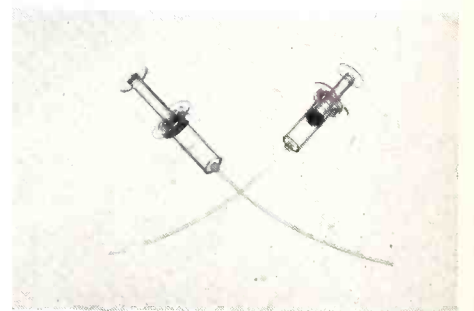

ble, where only one drop of oil at a time is required, the Inject-O-Lube is controlled by a visible plunger in the transparent cylinder case.

At the present time, Inject-O-Lubes are available only direct from Village Vendors, Box 14097, Los Angeles 49, Calif. Send only \$1. for 2 tubes, which includes postage.

HERE'S HOW & WHY

by **CHET JUR**

(Sales Engineer,

Merit Transformer Corp.)

Ringling Coil

TO develop the horizontal sweep for the cathode ray tube, several methods have been used. Basically, they develop the original signal from a conventional type oscillator (Hartley), a blocking oscillator or a multi-vibrator. Controlling the frequency of oscillation and synchronizing it to the station sync pulses so that the picture remains "locked in" horizontally calls for additional components and circuitry. This is necessary because the received signal level may vary considerably when the set is tuned from one station to the next. Sometimes, the set may even lose "sync" when the picture information changes, such as when a switch is made to the commercial announcement.

One of the least complex involves the use of a tuned circuit in a multi-vibrator. The coil in this tuned circuit is called a ringling coil. Operation is as follows—the multi-vibrator will oscillate or "free run" at a frequency determined by the size of the various resistors and condensers in the circuit.

Since time effects the various components in an electronic circuit (aging of tubes, etc.) it is necessary to provide a variable component which may be adjusted to correct for this condition. Early multi-vibrator circuits provided variable resistors which also were the horizontal "hold" controls.

Instead of the above method, a coil and condenser combination is inserted into the plate circuit of one of the tubes in the multi-vibrator system and tuned to the horizontal frequency by use of a slug. This tuned circuit or "ringling coil system" acts as a coarse horizontal holding control. Now, a variable resistor is placed in the grid of the other multi-vibrator tube and it acts as a "fine" holding control. This method enables the operator to "lock in" the set with less difficulty.

*Here's why
those in the know
—demand*

CANNON PLUGS

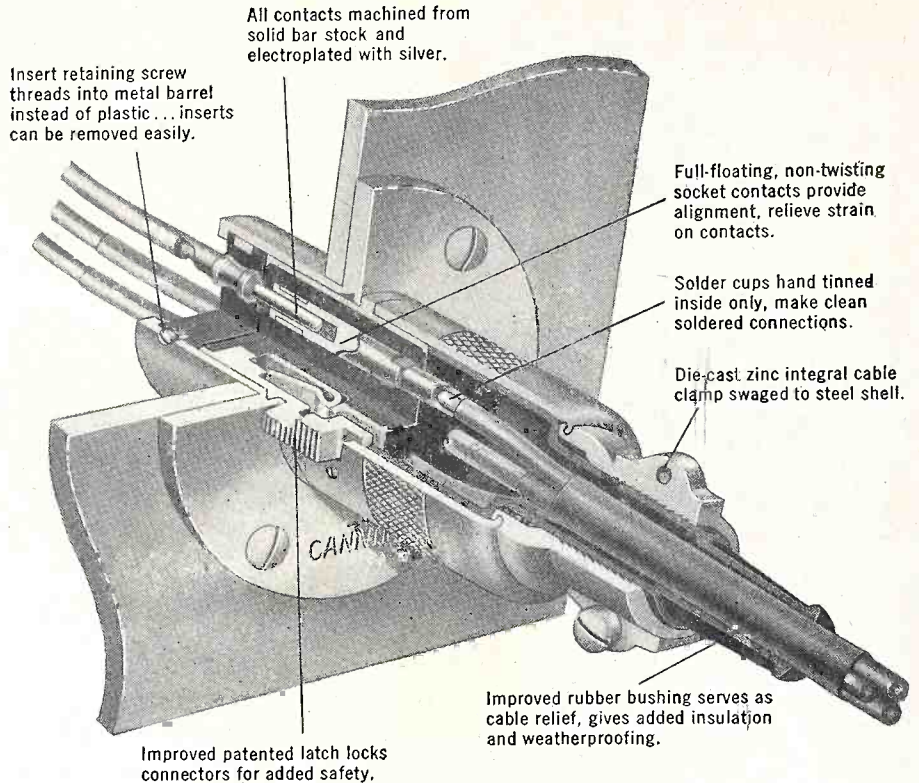

If you talk to sound technicians anywhere you'll find Cannon Type P connectors are the accepted standard of quality... taking a beating day in day out where frequent changes in circuits are required on all kinds of jobs up to 30 amp. capacity.

The close attention to important details called out in the above illustration is typical of the care used in the design and construction of all Cannon Plugs—the world's most complete line.

The above type series is distributed through selected franchise distributors. The line is fully described in the Type P Bulletin. Engineering bulletins describing each of the many basic types of Cannon Plugs will be sent on request.

Type P insert arrangements include 2-3-4-5-6 and 8 contacts. All contacts are 30 amp. capacity except those in P-8 layout which are 15 amp. Full scale layouts, front view pin insert, engaging side, shown at right.

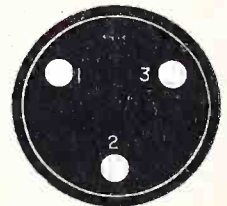

P-3

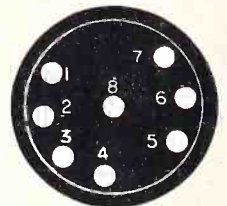

P-8

CANNON ELECTRIC

Since 1915

CANNON ELECTRIC COMPANY
LOS ANGELES 31, CALIFORNIA

Factories in Los Angeles, Toronto, New Haven. Representatives in principal cities. Address inquiries to Cannon Electric Company, Department B-127, P. O. Box 75, Lincoln Heights Station, Los Angeles 31, California.

**BE SAFE . . .
BE SURE . . .**

**INSTALL VEE-D-X
LIGHTNING ARRESTERS**



VEE-D-X lightning arresters provide your customers with the finest, safest arresters ever made for TV and FM—including both two and four wire installations.

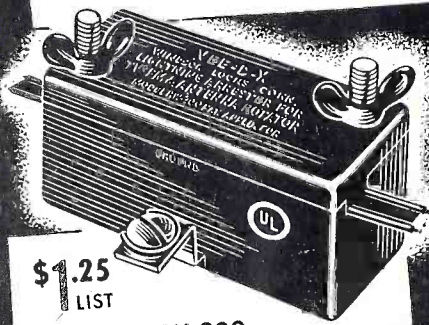

\$1.25
LIST

MODEL RW-200

Most popular full size arrester for standard 2-wire transmission line. Exclusive saw-tooth contact points assure positive electrical connection.

MODEL RW-204 \$1.50 LIST

For four-wire transmission. Same in appearance as the RW-200.

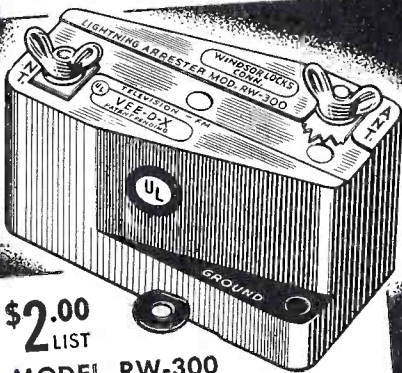

\$2.00
LIST

MODEL RW-300

For Extra Heavy Duty

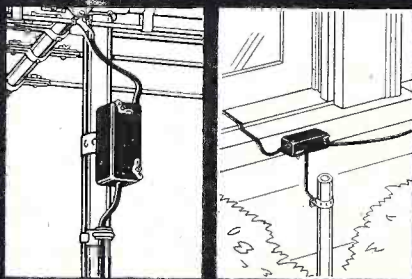

All models available with strap for mast or pipe mounting as well as standard models for wall or window ledge mounting. No wire stripping required on any VEE-D-X arrester.

THE LaPOINTE-PLASCOMOLD CORP.
Windsor Locks, Conn.

TRADE LIT

[from page 28]

color-code chart will be found useful by electronic engineers; in research and educational laboratories by purchasing and production men, by radio and TV service engineers, and by distributors of electronic equipment, according to W. S. Parsons, Centralab vice-president.

Color coding outlined on the new chart includes that of transformers, battery cables, antennae and ground leads, telephone switchboard cable, RTMA and JAN mica, paper and ceramic capacitor values, standard values of fixed composition resistors, miscellaneous capacitors and resistors, electro-dynamic speakers, and radio and television chasses.

Parsons said the new color-code chart would be extremely valuable as an educational aid and a technical reference in the electronics and affiliated fields.

He said the chart would be distributed initially through Centralab representatives and jobbers. Later it will be made available to anyone, at a nominal charge. The chart is 36 inches high by 30 inches wide.

* * *

"How Ward installation kits Cut Hidden Costs" is the title of a new bulletin of interest to distributors, dealers and servicemen. Describing contents of these new Ward antenna kits—antenna, mast, lead-in, stand-offs, etc.—the bulletin details specific ways in which kits save installation and sales costs.

Elimination of waste, accurate cost control and easier inventorying are some kit advantages cited. Others include: restricting pilferage, cleaner, easier handling, and simpler ordering. The complete package is reasonably priced at \$16.55 list, with all parts included.

Free copies of the bulletin may be obtained from distributors or from Ward Products Corp., Division of The Gabriel Co., 1523 East 45th Street, Cleveland, Ohio.

* * *

The Los Angeles Chapter of Representatives, Inc., has issued its 1952 Directory with 40 pages and covers, one which shows an 'area covered' map another with the national code of ethics.

Copies are available at the chapter publication office, 767 Castelar St., Los Angeles 12. Address the executive secretary-treasurer, Dr. Ralph I. Power.

In response to numerous trade requests, the RCA Tube Department has just made available to all radio service dealers a 48-page book "TV Servicing—Form No. TVS-1030".

TV Servicing is a collection of special articles prepared by RCA's well-known television authorities, John Meagher and Art Liebscher, and contains a comprehensive analysis of servicing problems. In addition to the Meagher articles on television servicing which appeared originally in RCA Radio Service News, the book also contains new articles on television servicing prepared by Mr. Meagher, and a new paper on television tuner alignment by Mr. Liebscher. Subjects covered include rf-if alignment, troubleshooting, and circuit analysis.

Regarded as an important addition to the radio service man's technical information library, TV Servicing (Form No. TVS-1030) can be obtained from RCA Tube Distributors, or by sending 35 cents to Commercial Engineering, RCA Tube Department, Harrison, N. J.

* * *

A new condensed 32-page catalog listing the firm's extensive line of electronic components, ranging from tip jacks to television arrays, is announced by the Insuline Corporation of America, 3602—35th Avenue, Long Island City 1, N. Y. Copies are available free of charge. Requests should specify catalogue No. C-652 and be addressed to Bernard L. Cahn, sales manager.

* * *

A new version of the Du Mont TV Picture Tube Selector introduced by the Cathode-Ray Tube Division of the Allen B. Du Mont Laboratories, Inc., Clifton, N. J., last September, is now being offered to TV servicemen through Du Mont Teletron distributors.

Proved in use by over 10,000 servicemen, the Selector has undergone improvements in design to facilitate easier use. In addition, the tube listings have been increased by utilizing both sides of the slide-wheel. A space has been provided for the imprinting of the Du Mont distributor's name.

The Du Mont Selector makes possible the selection of the proper tube type for the best replacement performance by merely dialing the type to be replaced. The correct modern replacement type appears along with the technical mechanical and electrical specs. The Selector also proves helpful in selection of tubes for conversion jobs where a larger tube is to replace a smaller one.

The Du Mont Selector has been

acclaimed as a real time-saver over former methods of charts and booklets that required much time to check the various specifications against each other.

* * *

The Industry will soon have at its fingertips a *reference work* covering more than fifty thousand field proved transformer designs accumulated by *Thordarson Mfg. Division* during fifty-six years of work as transformer specialists.

Eugene Daniel Powers Executive Vice President of Thordarson, announces that the herculean job of cross-indexing these 50,000 transformer designs will cover virtually the entire field of filters, chokes and transformers presently required by the industry.

All inquiries for special types or catalog items should be addressed to *Thordarson Meissner Manufacturing Division*, giant new quarters located in Mt. Carmel, Illinois.

* * *

A new, colorful *brochure* describing the JFD "Tuck-Away" Booster line has just been released by the advertising department of the *JFD Manufacturing Company, Inc.* of Brooklyn, N. Y.

In text and pictures, the four page piece describes both the VB and the SW models produced by JFD. Illustrations vividly present the attractive Hammertone finish of the "Tuck-Away" metal case while text and a self-explanatory graph indicate the technical superiority of these JFD Boosters.

The new "Tuck-Away" brochure can be obtained free by writing the advertising department, JFD Manufacturing Company, Inc., 6101 16th Avenue, Brooklyn 4, N. Y.

* * *

A *Jan Cross-Reference Guide*, showing joint Army-Navy components and their commercial equivalents, and also commercial-to-commercial equivalents, has been prepared for the benefit of buyers of electronic equipment by the *Hudson Radio & Television Corp.*, 48 West 48th St., New York 19, N.Y. Listing thousands of items, it is expected to save purchasing agents and engineers endless hours of searching through individual catalogs for critically needed parts and supplies. The guide will be kept up to date by the publication of supplementary charts, according to Adolph Gross, president of Hudson.

* * *

Twenty ways that tape recording is saving money, materials and manpower.

IT'S CARTRIDGE

Check-up TIME!

REPLACE INEFFICIENT PHONO-CARTRIDGES NOW with Modern, Lightweight, Compliant E-V CARTRIDGES

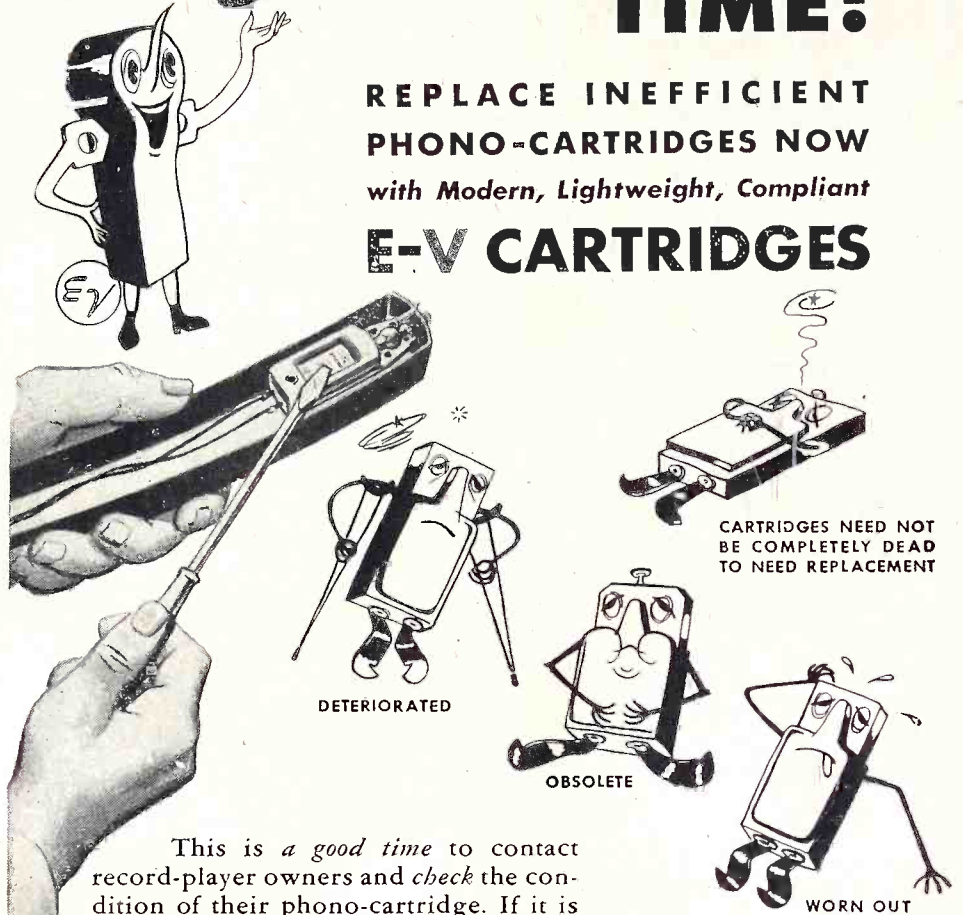

CARTRIDGES NEED NOT BE COMPLETELY DEAD TO NEED REPLACEMENT

DETERIORATED

OBSOLETE

WORN OUT

This is a good time to contact record-player owners and check the condition of their phono-cartridge. If it is not reproducing properly or is causing excess record and needle wear, chances are the cartridge has deteriorated or is obsolete—and should be replaced. You'll make new replacement sales, and open the way to other service business, too! A modern, lightweight, compliant E-V cartridge will give fullest record enjoyment and longer record life. You can demonstrate the difference. Remember, you can make most replacements with fewer E-V models!

MAKE THE FINGER-TIP COMPLIANCE TEST



Old-style stiff-acting needle system

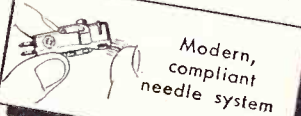

Modern, compliant needle system



FREE!

REPLACEMENT CHART
Large, Complete Replacement Chart. Gives handy cross-reference and valuable data. Tells when to replace a phono-cartridge. Ask your E-V Distributor or send for it now.

Electro-Voice INC.

412 CARROLL STREET • BUCHANAN, MICHIGAN
Export 13 East 40th St., New York 16, U.S.A. Cables: Arlab
TV BOOSTERS • MICROPHONES • HI-FI SPEAKERS • PHONO-PICKUPS

Electro-Voice, Inc., Dept. T2-52

412 Carroll St., Buchanan, Michigan

Send FREE Cartridge Replacement Chart.

Name..... (PLEASE PRINT)

Address.....

City..... Zone..... State.....

Service-Technician Dealer Record Fan

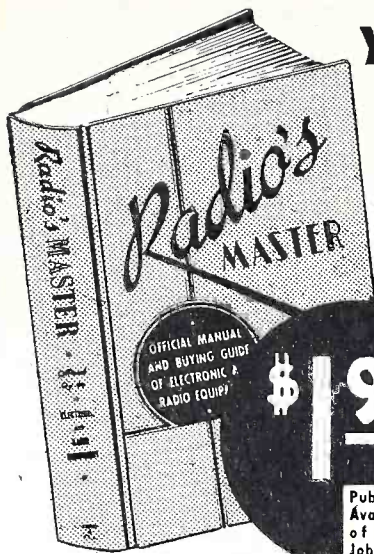

You'll find it
FASTER
in the
MASTER

\$1.95

Publisher's price \$6.50.
Available at special price
of \$1.95 thru Parts
Jobbers who absorb part
of cost for privilege of
printing ad on cover.

No More
Files of
Small
Catalogs and
Loose
Literature

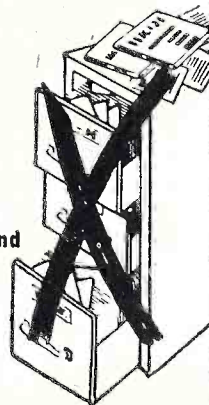

Industry's OFFICIAL
Buying Guide of Radio-
Electronic-Television
parts and equipment.

- 1100 Pages
- Hard Cover
- Fully Indexed
- Over 75,000 Items
- Over 7000 illustrations
- Weight—5 lbs.
- Size—8 1/4 x 10 3/4"
- Serving the Industry 16 years

When you **BUY--SELL--SPECIFY**
you must have the **MASTER**

This single volume replaces all other small catalogs

Over 90% of the products manufactured in the Radio-Electronic-Television Parts and Equipment Industry are catalogued in this BIG 1100 page MASTER Buying Guide. Complete descriptions, with specifications and illustrations are written and compiled by each manufacturer covering such products as: tubes, instruments, TV parts, transformers, capacitors, resistors, test equipment, relays, coils and antenna equipment. Also, recording and PA systems, intercoms, tools, hardware, switches and thousands of associated products. IT'S YOUR "RADIO BIBLE"—SAVES YOU TIME AND MONEY.

BE MASTER-Minded—GET your copy NOW

UNITED CATALOG PUBLISHERS, INC.
110 Lafayette St., New York 13, N. Y.

**NEW — 16th Edition available
from local Parts Distributor at
the special \$1.95 price.**

er for business and industry are listed in a new 16-page illustrated booklet available upon request from *Minnesota Mining and Mfg. Co.*, 900 Fauquier St., St. Paul 6, Minn.

Entitled "*Sound Ideas for Business and Industry*", it tells how tape recording has solved a variety of problems in record keeping, sales training, time and motion studies, communications, sales promotion, employee relations and educational programs.

It also shows how tape recording works and how tape can be edited, erased and re-used, making high-quality recording possible without expensive equipment or technical experience.

* * *

The new second edition of Donald G. Fink's *Television Engineering*, just published by the *McGraw-Hill Book Company*, covers both basic theory and all latest developments in TV systems' design and operation. This complete revision discusses the operating principles of various systems (both black-and-white and color), describes the design and functions of all equipment—from the studio camera to the receiver viewing screen—and tells how to install and service all components. There are 120 pages on the subject of color TV alone; in fact, publication of the entire volume was delayed until the full details of the six latest systems could be included.

Designed primarily as a working manual for engineers and technicians already in this field and for those in radio who wish to shift to TV, Fink's *Television Engineering* combines practice and theory in order to answer the question "Why is it done that way?" Starting from first principles it treats, in detail, all aspects peculiar to TV technology such as scanning and waveform analysis, illumination and colorimetry, camera tubes and picture tubes. Among the new developments described are: stagger tuning of i-f amplifiers, intercarrier sound reception, the keyed clamp circuit, distributed amplification, the offset-carrier method of reducing cochannel interference, and nonlinear amplifiers for tonal graduation correction. Latest available data is also given on reaction-type high-voltage power supplies and u-h-f and s-h-f transmission equipment.

Over 500 illustrations are included to clarify the intricacies of TV engineering. There are also practical working diagrams, complete with all values of parts, tube types, etc., of all TV equipment including studio, field and film cameras, relay transmitters, receivers, and so on. *Television Engi-*

THE JUNIOR SUPER-METER
THE MOST COMPLETE AND COMPACT
MULTI-SERVICE INSTRUMENT EVER DESIGNED!

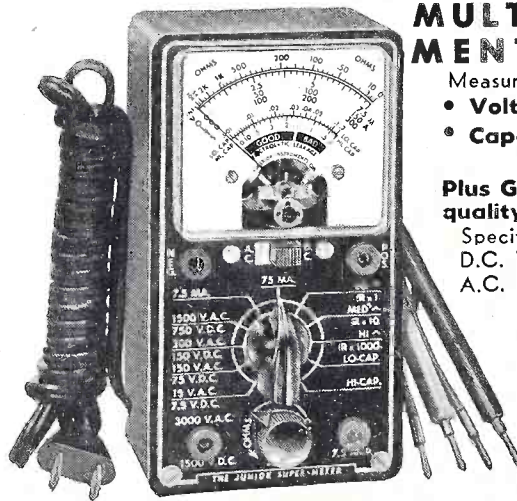

Measures:

- Voltage
- Current
- Resistance
- Capacity
- Reactance
- Inductance
- Decibels

Plus Good-Bad scale for checking the quality of electrolytic condensers.

Specifications:

D.C. Volts: 0-7.5/75/150/750/1500 Volts.
A.C. Volts: 0-15/150/300/1500/3000 Volts.

Resistance:

0-10,000/100,000 ohms. 0-10 Megs.
D.C. Current: 0-7.5/75 Ma. 0-7.5 amps.
Capacity: .001 Mfd.—2 Mfd. .1 Mfd.
—20 Mfd.

Electrolytic Leakage: Reads quality of electrolytics at 150 Volt test potential.
Decibels: — 10 Db. to + 18 Db. + 10 Db. to + 38 Db. + 38 Db. to + 58 Db.

Reactance: 15 ohms—25 K ohms 15 K ohms—2.5 Megohms.
Inductance: .5 Henry—50 Henries 30 Henries—10 K Henries.

Handsome round cornered molded bakelite case 3 3/8" x 5 7/8" x 2 1/4" complete with all test leads and instructions.

\$21.40

SOLD ON EASY PAYMENTS
AT THE NET CASH PRICE

No interest or carrying charges added, Simply remit \$5.40 with order, pay balance \$4.00 per month for four months.

MOSS ELECTRONIC DIST. CO., INC.

Dept. B-20, 38 Murray St., New York 7, N. Y.

neering also contains a full outline of the reasoning behind the TV transmission standards chosen in the U.S. and elsewhere in the world, plus 425 bibliographical references to periodical literature.

Donald G. Fink is Editor of *Electronics* magazine; Vice-Chairman, National Television System Committee; Fellow, Institute of Radio Engineers and American Institute of Electrical Engineers; and author of other important volumes in this field.

The price of *Television Engineering* is \$8.50. McGraw-Hill's Book Information Service, 327 West 41st Street, New York 18, N.Y., will supply further details.

* * *

Astron Corporation, designers and producers of a comprehensive line of capacitors and RF Interference Filters announce their new catalog. This new catalog is claimed to be radically different, presenting a new concept in the field. Under each major listing will be found the history of that type of component, its use and exact Astron specifications.

Under Metallized Paper Capacitors will be found test procedures, as well as other important data.

All requests or inquiries for this novel educational catalog should be directed to the Astron Corporation, 255 Grant Avenue, East Newark, New Jersey.

SHOP NOTES

[from page 27]

schematic to replace coupling winding, which should be disconnected. The accompanying drawing explains hook-up for L2, RLC-101.

Loose Speakers. Loose speakers due to broken cabinet studs may be re-

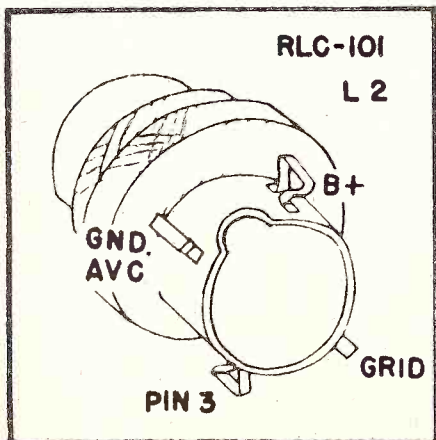

Fig. 2. Coil connections of L2, G.E. oscillator transformer.

paired in the field by heating the ends of the studs with a soldering iron and spreading them against the speaker frame.

Westinghouse-V-2170 Series

Chassis—Focus

Proper focusing cannot be obtained within the range of the focusing slugs if the magnetic field of the focalizer is too strong or too weak. If focus is approached, but not reached, when the focusing slugs are turned all the way out, the focalizer is too weak and should be replaced. If focus is approached, but not reached, when the

focusing slugs are turned all the way in, the focalizer is too strong. The strength of the focalizer can be reduced, however, and it is not necessary to replace an excessive strong focalizer. Take a $1\frac{1}{4}$ " x $1\frac{1}{8}$ " x $\frac{1}{8}$ " piece of cold-rolled steel and curve it to match the outer circumference of the focalizer. Then place the piece of steel over any convenient sector of the focalizer's circumference so that it extends across the air gap. The magnetic attraction of the focalizer will hold the steel firmly in place. A reduction in the strength of the magnetic field will result.

For Direct Drive Circuits... New STANCOR

TELEVISION REPLACEMENT COMPONENTS

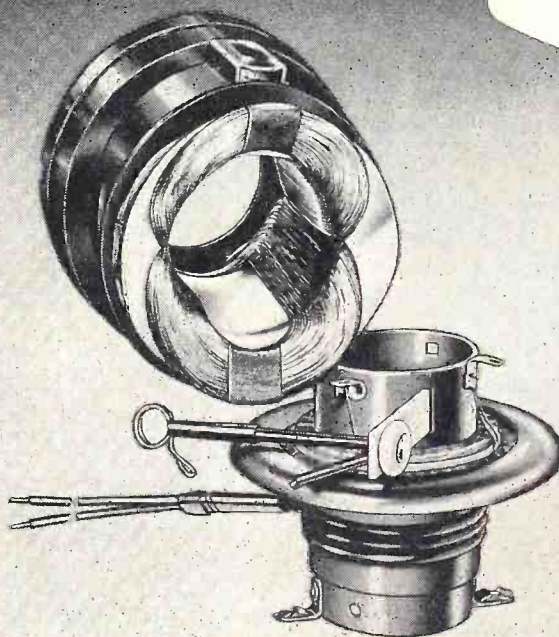

DY-10
ANTI-ASTIGMATIC REFLECTION YOKE
A high efficiency yoke with cosine distributed windings, ferrite core and nylon bobbins. Replacement in 34 RCA TV models, 30 Emerson models and 7 Capehart models.

A-8131 AIR CORE "FLYBACK"
Companion unit to DY-10 in direct drive circuits and used in same models. See Stancor Bulletin No. 389 for a complete list of these 71 models.

A-8140 VERTICAL OUTPUT TRANSFORMER
Has primary:secondary ratio of 44:1. Replaces RCA No. 74950 in 35 TV models, Emerson No. 738044 in 30 models and Capehart No. 650238A-1 in 7 models. These models are listed in Stancor Bulletin No. 390. Ask your distributor for a free copy.

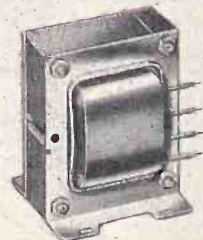

Stancor transformers are listed in Howard Sams' Photofacts Folders

STANDARD TRANSFORMER CORPORATION

3586 ELSTON AVENUE • CHICAGO 18, ILLINOIS



SAVE Up to \$1.00 each.

**Form a Group,
Service Dealers**

Subscribe to "RTSD"—

"The Professional Radio-Television man's Magazine"—published monthly. All articles are exclusive and timely. Practically every issue is worth what an entire 1 year subscription costs.

The more in a group the bigger the savings. 6 men in a group save \$1.00 each; 4 men groups save \$.75 per man. Present "RTSD" subscribers may participate in or form a group with co-workers, or even competitors. Still active subscriptions are automatically extended 1 year. Start a Group today! The timely and exclusive technical data appearing in future issues of "RTSD" will make this the best investment you ever made. The special Group Rate offer may be withdrawn at any time—so hurry.

Use This Coupon For Convenience

(The coupon below can be used for from 1 to 6 subscription orders. Use it today!)



TEAR OUT — MAIL TODAY

RADIO-TELEVISION SERVICE DEALER
67 West 44th Street, New York 18, N. Y.

Please enter 1 year subscription orders for the names given below. Our remittance is enclosed.

NOTE: If you do not wish to tear this order blank out, just print or type the information on a single sheet of paper, following the style given. Each subscriber's occupation must be clearly described.

	In U.S.A.	Foreign Rates
<input type="checkbox"/> One 1-year subscription	\$2.00	\$3.00
<input type="checkbox"/> Two 1-year subscriptions, each	1.75	2.75
<input type="checkbox"/> Three 1-year subscriptions, "	1.50	2.50
<input type="checkbox"/> Four 1-year subscriptions, "	1.25	2.25
<input type="checkbox"/> Five 1-year subscriptions, "	1.10	2.00
<input type="checkbox"/> Six 1-year subscriptions, "	1.00	1.50

Name

Address

Describe Title or Position and Type of Business

State whether a New Subscriber or Renewal Order

Name

Address

Describe Title or Position and Type of Business

State whether a New Subscriber or Renewal Order

Name

Address

Describe Title or Position and Type of Business

State whether a New Subscriber or Renewal Order

Name

Address

Describe Title or Position and Type of Business

State whether a New Subscriber or Renewal Order

Name

Address

Describe Title or Position and Type of Business

State whether a New Subscriber or Renewal Order

Name

Address

Describe Title or Position and Type of Business

State whether a New Subscriber or Renewal Order

TRADE FLASHES

[from page 12]

ture selenium rectifiers. The dispenser is designed to hold the assortment of rectifiers experience as shown to be the most popular at the distributor sales level. The unit will carry selenium rectifiers that will service 90 per cent of the existing television and radio receivers now equipped with this component.

Business Paper & Defense Execs Meet

Business Paper Editors and Publishers meet with defense production officials to discuss measures to relieve the critical scrap situation. Seated, left to right, front row: Manly Fleischmann, Administrator, DPA-NPA; Charles E. Wilson, Director of Defense Mobilization; Irwin Such, Chairman, NPA Business Press Advisory Committee on Scrap. Standing, left to right: Edward W. Sreb,

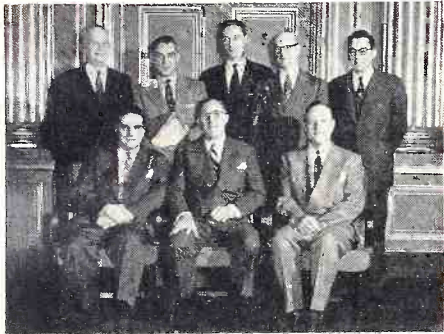

Director, Salvage Division, NPA; Tom C. Campbell, Editor, Iron Age; Edward K. Moss, Assistant Administrator for Public Information, DPA-NPA; Burnham Finney, Editor American Machinist; Robert Warner, Special Assistant to the Administrator in charge of Salvage Operations, DPA-NPA.

Sprague "Service Package"

A new "Service Package" system announced by the Sprague Products Company of North Adams, Massachusetts, makes it easy for TV repairmen to carry complete stocks of just the right replacement capacitors for the brands of TV sets they service most frequently. Sprague distributors now have available complete "Service Packages" of all the electrolytic capacitors necessary to service each of 22 of the most popular makes of TV receivers in use today, thus enabling servicemen to give prompt repair service without loss of time or unnecessary seldom-needed capacitor values.

A complete listing of the capacitors recommended for inclusion in the "Service Package" for each brand of TV set is included in the new brown-covered 4th edition of the Sprague TV Replacement Capacitor Manual,

M-481, available free through Sprague distributors, or directly from Sprague for 10c to cover handling and mailing costs.

Five Types Of Merit Cosine Yokes

Available

Merit Coil and Transformer Corporation, Chicago, has announced that they are now shipping a total of five different types of cosine wound deflection yokes for TV replacement and conversion.

These five types are: (1) The MDF 71, a high horizontal and high vertical inductance for 70° tubes from 12 to

24 inches. (2) The MDF 70 with low horizontal and high vertical inductance. (3) The MDF 30 with high horizontal and low vertical inductance. (4) The MD 13, a 53° yoke with high horizontal and high vertical inductance. (5) The MD 12, with low horizontal and high vertical inductance—a 53° yoke. All yokes are equipped with leads and network.

Sylvania Official Predicts

Good TV Year

There is no reason why the television industry can not sell about 4,500,000 sets to the public in 1952, if

MORE TV
OUTLETS
PER
DOLLAR!

AMPLIFIED, ALL-CHANNEL MASTER ANTENNA SYSTEMS FOR 2 TO 2000 TV SETS

NO Special connectors
NO Matching transformers
NO Engineers
NO Individual channel equipment

INSTALLED WITH THE
TURN OF
A SCREW



BLONDER-TONGUE systems are based on the use of "no loss" Distribution Amplifiers which split the signal from the antenna into the desired number of outlets... all having the same signal level and picture quality as though each TV set used the antenna alone.

The B-T Automatic, All-Channel systems, using three basic units in any desired number and combination, can be easily installed by any TV service man.

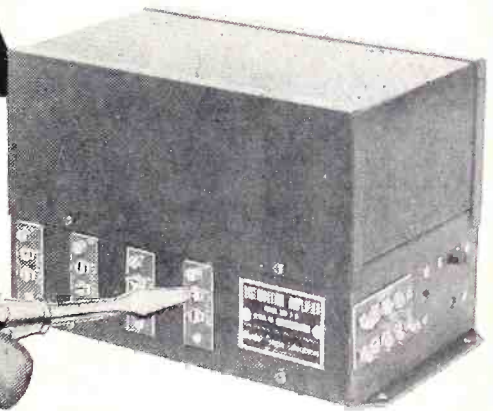

DISTRIBUTION AMPLIFIER, MODEL DA8-1-M
8 TV Outlets
Amplified and Isolated
List Price \$87.50

Combine these B-T units to serve up to 2,000 sets from 1 antenna.



Model #CA-1-M
Commercial Antensifier
(30 Times Gain)

Use As Pre-Amplifier, Line Amplifier or de-luxe Booster
List Price \$77.50



MODEL #DA2-1-M
Distribution Amplifier
2 TV Set Outlets
List Price \$39.50



B-T HOME ANTENSIFIER MODEL HA-2-M

Finest All-Channel TV Booster. Fully Automatic, 16 Times Gain. In Metal Cabinet
List Price \$57.50

FREE INSTRUCTION BROCHURE ON MASTER ANTENNA SYSTEMS..Write Today. Dept. K3

Blonder-Tongue Labs., Inc. Mt. Vernon, N. Y.

there are no major economic upsets, according to Frank W. Mansfield, director of sales research for Sylvania Electric Products Inc., who reported that the trend now points to a larger and larger percentage of sales for replacement and a smaller and smaller percentage for initial installation.

During his discussion of market potentials at Sylvania's National Distributor Sales Department Conference held at Hotel Hershey here Mansfield explained that, "the change in the trend of television sales is due to the fact that the television market is rapidly approaching saturation. At the

end of 1950, it was approximately 38% saturated on a national basis, although 35% of the population was located where television progress was slow. At the end of 1951 practically 40% of the country had attained an average saturation of 70%."

Walsco Expands

Growing sales activity in the Middle West and East has forced the Walter L. Schott Company, manufacturers of Walsco products, to expand its warehouse and service staff in Chicago. Mr. Schott, president of the Company, simultaneously announced the ap-

pointment of J. E. O'Donnell to the post of Chicago warehouse manager. According to Mr. Schott, "the objective of this expansion program is to insure prompt deliveries to jobbers in every region of the country. New, efficient methods of handling shipments are proving extremely effective".

RTMA Moves Headquarters Office

The Radio-Television Manufacturers Association, carrying out a program of increased activities and services authorized by the Board of Directors and inaugurated by President Glen McDaniel, on Saturday, Dec. 29, moves its headquarters office to larger quarters in the Wyatt Building at 777 Fourteenth St., N.W., Washington, D. C.

President McDaniel, General Manager James D. Secrest and the RTMA headquarters staff will have offices in Suite 800 in the new building. The new RTMA telephone number is National 3902.

New Rider Publication

TV and Electronics As A Career, a new publication of John F. Rider Publisher, Inc., was presented to the public at a literary press party given by the publishers at the Hotel Roose-

Insure BETTER Television Service to Your Customers! . . . Exclusively Designed

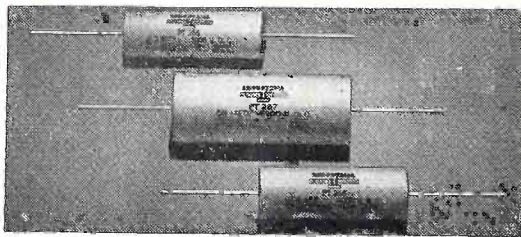

HIGH VOLTAGE AND ELECTROLYTIC TUBULAR TELEVISION CAPACITORS

Especially Engineered for Television Circuits by INDUSTRIAL CONDENSER CORP.

The economical quality line for replacement. Industrial Condenser Corp., manufacturers of Capacitors exclusively brings you highest quality for the particular requirements of Television at exceptionally attractive prices! Special Capacitors are Pyroteen impregnated for low power factor, high insulation resistance, high operating temperatures. Oil, Pyroteen, Wax and Electrolytic Capacitors. Finest materials throughout.

Ask Your Jobber for our Attractive Prices Today!

Or write for Bulletin 1095. Industrial makes quality Capacitors for Television, Radio, every electronic and industrial application—all types.

Send for Complete Catalog

INDUSTRIAL CONDENSER CORP.

3243 N. CALIFORNIA AVENUE CHICAGO 18, ILLINOIS
Sales offices in principal cities.

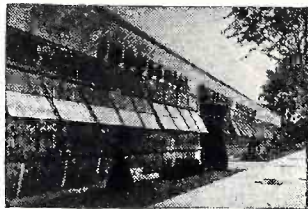

Modern plant built by Industrial Condenser Corp., for manufacture of Capacitors only.



velt in New York. Among those attending were the authors and publisher (l. to r.) Richard H. Dorf, Ira Kamen, John F. Rider, W. Hollender Bohlke, J. R. Poppele. Numerous other prominent figures in the electronics industry were present.

G. E. Develops New Power Rectifier

The General Electric Company here announced that it has developed a new power rectifier for television receivers, radios, and military electronic equipment. It is believed to be the most efficient commercial rectifier ever produced and employs germanium, a metal not critical in the mobilization effort.

Known as the G-10 germanium rectifier, the unit operates on the junction principle and is designed to supply 350 milliamperes at normal tele-

TV INSTALLERS! SAVE TIME—INCREASE PROFITS with MOSLEY PLUGS and SOCKETS



Cat. No. 301



Cat. No. 311



Cat. No. C-124

Time is money to TV installers! Today, installers are speeding up their work and eliminating the cause of possible future call-backs by using MOSLEY Low Loss TV Plugs and Sockets.

Available for every installation need, MOSLEY Plugs and Sockets are, in most cases, installed without solder. They are made of low loss acrylic plastic, have phosphor bronze contacts and will maintain exact line impedance. They can be depended upon to provide the very best electrical and mechanical connections.

Illustrated, are the popular MOSLEY 300 ohm Transmission Line Plug and mating Line Socket and the handy MOSLEY 4

Conductor Polarized Rotator Cable Plug and Base Socket Combination.

Get these and other MOSLEY products from your favorite jobber and ask him for MOSLEY Bulletin 51-51, a complete listing and description of the most popular MOSLEY products for the installer.

Use MOSLEY Plugs and Sockets on every job. You'll save time, you'll save money—and, your customers will appreciate it!

MOSLEY ELECTRONICS 2125 Lackland Road
Overland, Missouri

Address Change...

Subscribers to SERVICE DEALER should notify our Circulation Dept. at least 5 weeks in advance regarding any change in address. The Post Office Dept. does not forward magazines sent to a wrong destination unless you pay additional postage. We cannot duplicate copies sent to your old residence.

RADIO-TELEVISION SERVICE DEALER, 67 West 44th St., New York 18, N. Y.

vision receiver plate voltages in a 55 degree centigrade ambient. It has a peak inverse voltage rating of 400 volts, with rectification efficiencies up to 98 per cent, he said.

CIRCUIT COURT

[from page 29]

If the sync pulse and the feed-back pulse are in phase, the oscillator will trip at point *A*. If the oscillator frequency is too high, the two pulses will add in such a manner that the trip point will be delayed so that the oscillator will trip at point *B*. If the oscillator frequency is too low, the two pulses will add so that the oscillator will trip sooner at point *C*.

The d-c voltages are rather conventional and straightforward. *V17* is operated as a phase inverter circuit. *V18*, the phase detector, is so connected that the upper section pins 1 and 7 will conduct more heavily. This is due to the fact that the lower section pins 2 and 5 will be more heavily biased through *R90* and *R100* (1 and 10 megs, respectively) than the upper section whose plate current flows through *R102* (250K). *C5* (*a* & *b*) maintains the bias on *V18* and *V19* relatively constant. In this manner, noise pulses of short duration cannot interfere with the bias voltage. *V19B*, the vertical oscillator, is manually brought into sync by means of the grid leak resistance provided by *R4*, the vertical hold control.

Stromberg-Carlson No. 317 RPM

Retrace Blanking

IN the Stromberg-Carlson #317-RPM (*Fig. 3*), we find a novel circuit used to obtain blanking of retrace lines. In this circuit, instead of a blanking pulse being capacitively coupled from the horizontal output stage, a tube is used to derive the pulse. The reason for a tube being used is for isolation purposes.

The usual circuit consists of a negative pulse which is applied to the first

anode. In order to cut the first anode off, this pulse is usually in the order of several hundred volts. This pulse voltage in the first anode lead going to the CRT circuit has a tendency to spray. This spray is usually picked up by the signal lead to the CRT socket and causes distortion of the picture.

In the circuit being analyzed, *V15* is grid-leak biased through *R58* (1 meg). The pulse which triggers the keyed a-g-c amplifier tube also triggers *V15* through *C100* (.001) and *R51* (470K). This positive going pulse causes *V15* to conduct. The signal ap-

pears across *R53* (10K) amplified. This is a negative going pulse which is applied to the control grid of *V25*, the CRT.

Since this pulse is generated in the horizontal output transformer during retrace time, it can be utilized to blank out the retrace lines. Because the pulse is applied to the control grid, the voltage necessary to cut the tube off is much smaller than that needed to cut the tube off when applied to the first anode. The possibility of spray, therefore, is reduced very considerably.

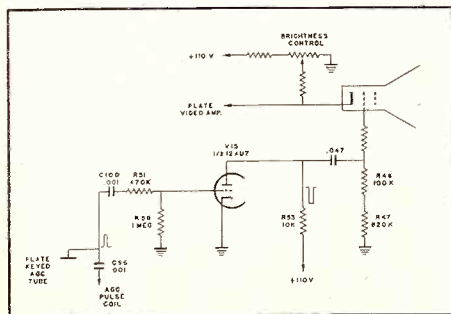

Fig. 3. Retrace blanking circuit used in Stromberg-Carlson Model 317-RPM.



"CONICAL-V-BEAMS"

*REGISTERED TRADE MARK

CHECK! your antenna requirements

WITH THESE THREE

Telrex FEATURES:

1. CONSERVATIVE FACTORY RATINGS
2. EXCEPTIONAL PICTURE QUALITY
3. WEATHER-DURABLE CONSTRUCTION

Guessing is costly on FRINGE AREA installations!



Make sure of picture quality in remote areas by installing the "famous for high gain" Telrex 8X-TV. IF THE 8X-TV does not provide a usable signal, TV reception is impractical!

There's no finer antenna at any price! Every model! — whether for high signal areas or remote locations — assures full audio and video bandpass, high gain and high signal to noise ratio. All materials used in their construction are weather-tested to insure maximum service life under the most gruelling climatic conditions. For finer pictures and lasting installations, install genuine Telrex "Conical-V-Beams"—your key to complete antenna satisfaction. Write for new catalogs, today!

"CONICAL-V-BEAMS" are covered by Patent No. 23,346
CANADIAN and FOREIGN PATENTS PENDING

telrex INC.

CONICAL-V-BEAMS

AMERICA'S OUTSTANDING TELEVISION BEAM

Be sure it's a "CONICAL-V-BEAM" — look for the

telrex

TRADE MARK

ASBURY PARK 5, N. J.

UHF

[from page 19]

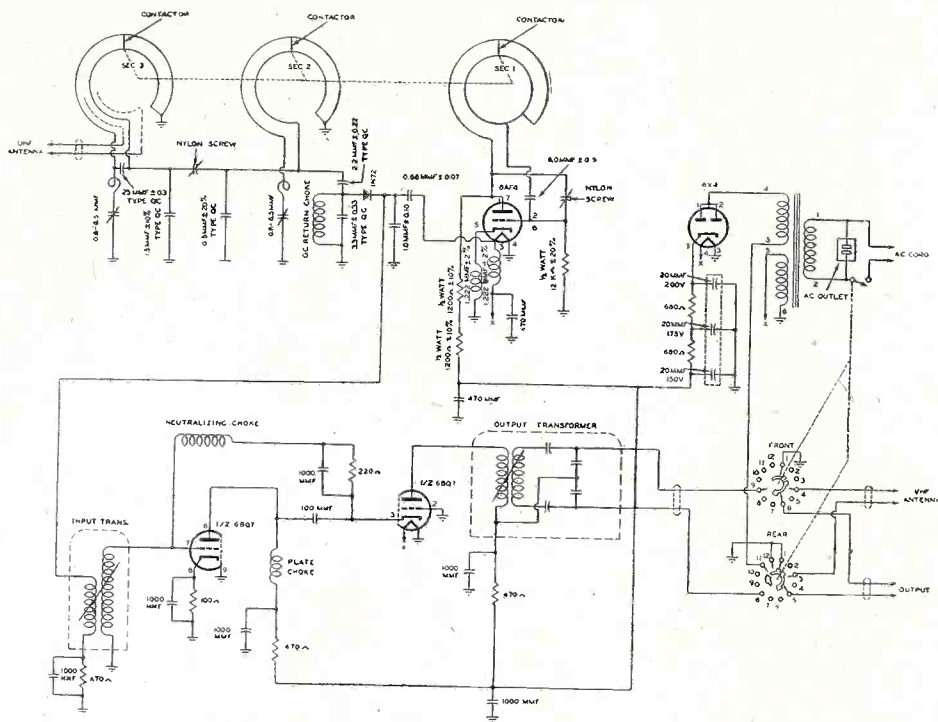

Fig. 10. Circuit diagram of Mallory U-H-F tuner.

to the grounded grid cathode output tube. The neutralizing choke is used to feed back noise and lower the noise figure of the amplifier.

The i-f amplifier has a 12 mc output at the half-power points at the center frequency of 82 mc. The gain of this stage is 6 but there is a conversion gain of 0.25 and a loss of 0.6 at the input. There is a total gain of this product of just less than one. Because of the lack of r-f amplification an increase in the i-f gain would not result in a better signal to noise ratio.

ASSOCIATIONS

[from page 26]

for meetings. Bob Middleton had a very good lecture at Electricians Hall. The use of test equipment as explained by Mr. Middleton is of utmost importance in the service of TV. Our thanks go to East Coast, Hermans, Walders, Electronic Supply and Mr. Van Dusen for sponsoring such a fine lecture.

RCA service clinic was on the ball again with their service info on the new super power chassis. Mr. Rosenkrantz came out with some very good items for the service of the new line.

THIS IS IT! THE RELAY
WITH *Interchangeable Coil*
FOR A WIDE RANGE OF RADIO APPLICATIONS

GUARDIAN Series 200

**Interchangeable
COIL and
CONTACT
Switch Assembly**

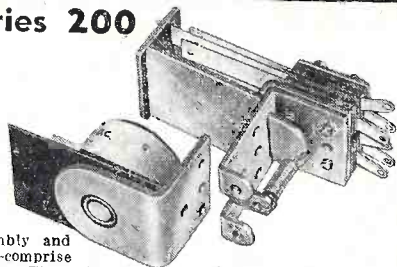

Two basic parts—a coil assembly and a contact switch assembly—comprise this simple, yet versatile relay. The coil assembly consists of the coil and field piece. The contact assembly consists of switch blades, armature, return spring and mounting bracket. The new Guardian Midget Contact Assembly which is interchangeable with the Standard Series 200 coil assembly, is also available in either single pole, double throw; or double pole, double throw.

CONTACT SWITCH ASSEMBLIES

CAT. NO.	TYPE	COMBINATION	
		Single Pole	Double Throw
200-1	Standard	Double Pole	Double Throw
200-2	Standard	Double Pole	Double Throw
200-3	Contact Switch Parts Kit		
200-4	Standard	Double Pole	Double Throw
200-M1	Midget	Single Pole	Double Throw
200-M2	Midget	Double Pole	Double Throw
200-M3	Midget Contact Switch Parts Kit		

13 COIL ASSEMBLIES

A.C. COILS*		D.C. COILS	
CAT. NO.	VOLTS	CAT. NO.	VOLTS
200-6A	5 A.C.	200-6D	6 D.C.
200-12A	12 A.C.	200-12D	12 D.C.
200-24A	24 A.C.	200-24D	24 D.C.
200-115A	115 A.C.	200-32D	32 D.C.
		200-110D	110 D.C.

*All A.C. coils available in 25 and 60 cycles

GUARDIAN ELECTRIC

1606-B W. WALNUT STREET

CHICAGO 12, ILLINOIS

A COMPLETE LINE OF RELAYS SERVING RADIO AMATEURS

HICKOK

Latest Design VACUUM TUBE VOLTMETER

features:

- Accurate Peak-to-Peak measurements
- Portable, shock-resistant case
- Large 5", easy-to-read meter
- Zero-Center scale



Model 215

INCLUDES:

Exclusive, New Single-Unit
AC-DC Probe

DC VOLTMETER

Volts: 0-1200 in 7 ranges
Input Resistance: 10 megohms

OHMMETER

Design Center: 10 ohms
Readability 0.2 ohm to 1000 meg.

AC VOLTMETER

AC, RMS: 0-1200 in 7 ranges
AC, Peak-to-Peak: 0-3200 in 7 ranges

Frequency Characteristics: 40 cps to 3.5 MC, and to 250 MC with crystal probe
Input Impedance: 30 meg. shunted by 150 uuf with dual-probe furnished.

Provides the sensitivity and ranges for quick, accurate measurements of sine or complex waves of electronic devices. Test leads are included. Write for full details today.

THE HICKOK ELECTRICAL INSTRUMENT COMPANY
10533 Dupont Avenue • Cleveland 8, Ohio

FOR THOSE
HOT SPOTS

**AEROVOX AFH
ELECTROLYTICS**



Especially for elevated temperatures and high ripple currents, particularly in TV applications.

Light weight. High capacitance. Compact container. And of course the handy twist-prong mounting and easily-wired terminals. Single-, dual-, triple- and quadruple-section units. Connections clearly indicated on rear label. Expanded listings provide outstanding selection of voltages, capacitances, combinations.

Ask your distributor for Aerovox AFH electrolytics. Consult the Aerovox expanded listings.



**FOR RADIO-ELECTRONIC
INDUSTRIAL APPLICATIONS
AEROVOX CORPORATION
NEW BEDFORD, MASS., U.S.A.**

In Canada: AEROVOX CANADA LTD., Hamilton, Ont.
Export: 41 E. 42nd St., New York 17, N. Y.

Sea Coast who sponsored the meeting gave to all those who attended a set of finger tip wrenches.

**Television Service Association
of Michigan**

The TSA of Michigan, of which E. J. Barton is president, sponsored a forum on TV service in Detroit on January 24. Its primary objective was to discuss TV service management and a program aimed at bettering customer relations, according to Barton. A general invitation had been sent out to all manufacturers' representatives, the NEDA, dealers' service managers, parts jobbers and independent service companies throughout the State to attend. Representatives of the press, boards of commerce, the BBB and city councils had also been asked to attend.

The TSA of Michigan sought through this conclave to obtain the cooperation of all segments of the TV industry in stabilizing TV service management and coordinating efforts to establish this vital phase of TV on a sounder footing as preliminary to developing better customer relations in Michigan.

Among the guest speakers who were slated to address this forum were Al M. Haas, president, and Paul V. Forte, executive secretary, of the TV Contractors Association (of Philadelphia) and Paul Wendel, director of the TV Technicians' Lecture Bureau.

Headquarters of the TSA of Michigan is located at 2238 Dime Building, Detroit 26, Michigan. The forum was held in the Detroit Edison auditorium at 2000 Third Ave., Detroit, at 8 P.M. January 24.

S. E. Sangster

A. G. C.

[from page 25]

on the grid. Any current flow through the cathode will cause the voltage at the top of the cathode resistor to become more positive in relation to the voltage source. Since the grid is at zero volts, the grid to cathode bias develops until just before cut-off. When a positive going signal is applied to the grid, the cathode can then conduct more heavily.

In the circuit under consideration, the voltage developed across $R75$ (100K) with virtually no current through it is sufficient to bring the tube to near cut-off. This voltage, while it is positive with relation to the grid is still negative with respect to the controlled tubes.

When a positive going signal is

**It's NEW... It's a
MONEY MAKER**

for
Every Serviceman!

**2 Service
Instruments**

for the
price of 

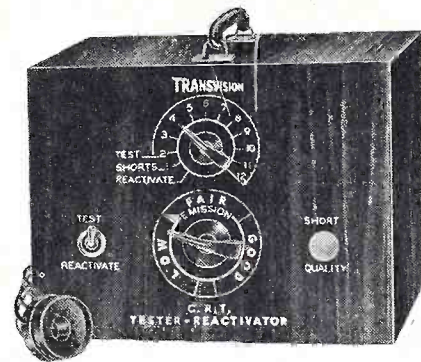

**TRANSVISION CR TUBE
TESTER - REACTIVATOR**

performs 2 vital functions:

- Tests Picture Tubes
- Renews Brightness of Many Dim Picture Tubes

It's a TESTER:

Without removing picture tube from set, you apply this precise instrument to:—

- Measure Cathode emission
- Locate shorts between elements
- Locate high resistance shorts or leakage as high as 3 megohms

It's a REACTIVATOR

for dim CR Picture Tubes

Revives dim TV Picture Tubes, without removal of tubes from sets. Works on a great many tubes with low light output, if there's no mechanical defect in tube. 110 V—60 cycles. Portable, weighs only 3 lbs. One or two applications pays for instrument.

SATISFACTION GUARANTEED
or money refunded if you return the instrument in 10 days in good condition. **\$19.95 NET**

**—RUSH THIS COUPON—
TRANSVISION, INC.**

DEPT. SD NEW ROCHELLE, N. Y.

() Send me ___ CR Tube Tester-Reactivator(s).

() Enclosed find \$___ deposit. Balance C.O.D.

() Enclosed find \$___ in full. Send prepaid.

Name _____

Address _____

City _____ State _____



VIKING speakers by Jensen

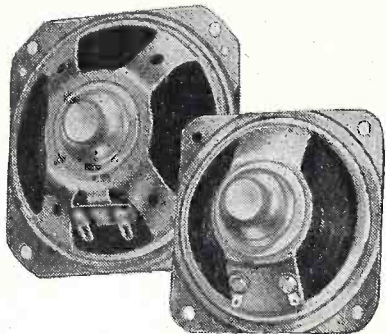

low cost replacement
speakers by Jensen . . .
makers of the World's
Finest Loudspeaker—
the G-610 Triaxial

Jensen

JENSEN MANUFACTURING COMPANY
DIVISION OF THE MUTER COMPANY
6601 S. LARAMIE AVENUE • CHICAGO 38, ILLINOIS

Viking speakers—
manufactured with the
same engineering and
production skills which go
into every Jensen product—
are designed especially for
low-cost replacement and
utility applications. The
Viking line includes 12
models from 3½" to 12"
with 4" x 6", 5" x 7" and
6" x 9" ovals, all P.M.
An accessory bracket,
designed especially for the
Viking series, solves
chassis and transformer
mounting problems.

BURTON BROWNE ADVERTISING

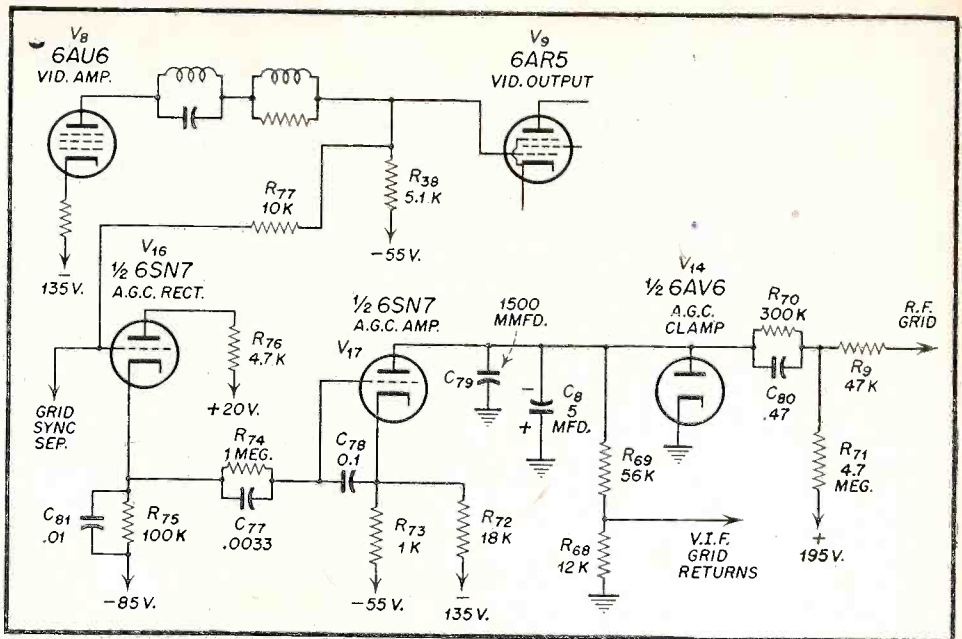

Fig. 14. Partial schematic of Fada Model 1025 a-g-c circuit.

applied to the grid of V_{17} , the cathode current increases. C_{81} (.01) filters out the a-c variations and the voltage developed is d.c. The increase in current causes the voltage at the junction of R_{74} and R_{75} to go less negative. The bias on the grid of V_{16} is thus made less negative and V_{16} conducts more heavily. The plate of V_{16} is connected to ground through R_{69} (56K) and R_{68} (42K). Thus variations in the peak voltage on the grid

of V_{17} causes the amount of current through R_{68} and R_{69} to vary.

C_8 (5 μ f) filters out any ripple which might be left and also holds the voltage on R_{68} and R_{69} until the next sync pulse arrives at the grid of V_{17} . The bias is applied to the i-f grids at the junction of R_{68} and R_{69} and to the r-f grids from the junction of V_{16} plate and R_{69} . The diode is hung across the circuit to prevent the a-g-c buss from going positive.

REACTANCE TUBE CIRCUITS

[from page 22]

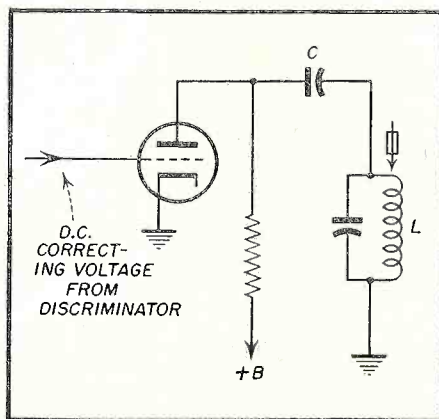

Fig. 9. Reactance tube circuit of variable resistance type.

circuit may well be the tank circuit of a horizontal oscillator.

If the grid bias is low enough the internal resistance of the tube is reduced and the shunting effect of C on L becomes considerable, thereby reducing the resonant frequency of the tank circuit. On the other hand a high grid bias increases the internal resistance of the tube, reducing the

shunting effect of C and L and increasing the resonant frequency.

A commercial application of this circuit is shown in *Fig. 10*. This is a partial schematic of the reactance tube circuit used in the G.E. Model 12K1 TV receiver.

The reactance tube ($\frac{1}{2}$ 12SN7) receives the d-c correction voltage from the discriminator through R_3 and R_4 . This correction voltage is developed by the combined effects of the station sync pulse and the horizontal sweep signal obtained from a tap on the horizontal output transformer.

A 4780 μ f capacitor in conjunction with the plate to cathode resistance of the reactance tube results in a variable capacitance across the tank circuit the capacitive reactance effect of which depends on the amount of d-c correction voltage obtained from the discriminator output and the initial bias on the tube. This initial bias is obtained from a tap on the voltage divider connected between grid and ground of the horizontal oscillator.

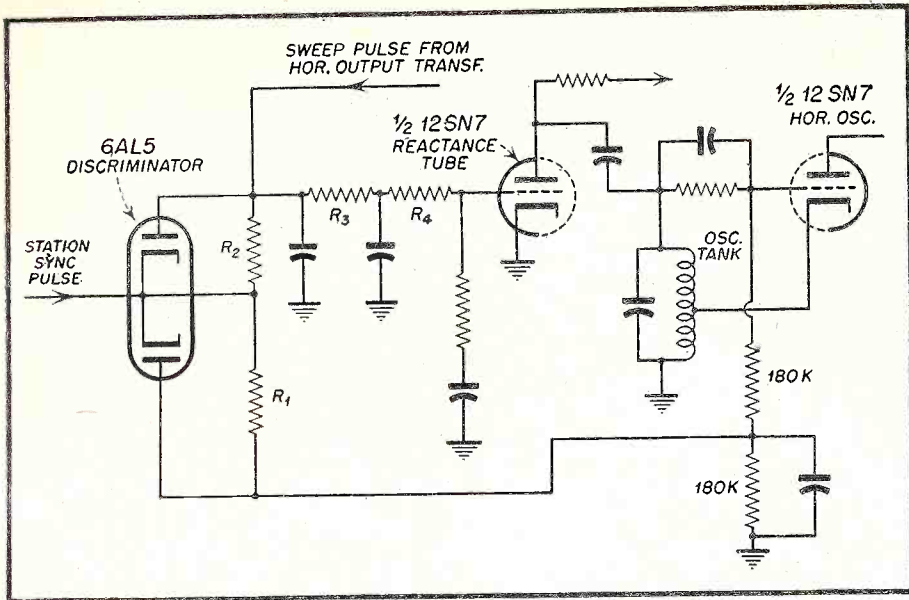

Fig. 10. Commercial application of variable resistance reactance tube circuit.

CAPACITOR TROUBLES

[from page 17]

tube. This generally reduces grid bias slightly.)

The other coupling capacitor shown in this circuit, *C17*, is very important because it isolates the plus "B" from the grid of the picture tube. Failure of this capacitor can cause serious defects. If the capacitor opens, it will cause picture loss, while if it shorts, plus voltage will be applied to the grid of the picture tube. This will cause excess current to flow in the picture tube and may eventually damage it. Brilliance will be unduly high and beyond normal regulation by the brilliance control.

Other coupling capacitors will, of course, be encountered besides the ones discussed herein. Each will give

specific symptoms when leakage or open-circuit conditions occur. A study of the symptoms which occur in a particular capacitor will aid in diagnosing and localizing the troubles as they occur in subsequent servicing work. Thus, the additional time involved in seeking out those which are even at the verge of causing trouble, will be well worth the time spent. You will do a better job on the receiver, regardless of its original complaint. At the same time it will prove more profitable and create better customer relations because fewer call-backs will be involved. These advantageous factors certainly make it worthwhile to keep these things in mind regardless of the routine nature of the repair job on the bench.

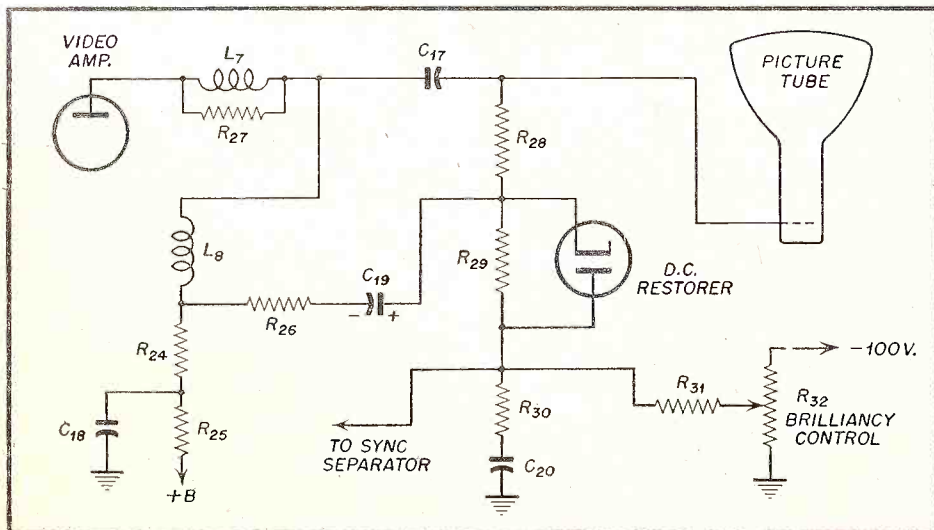
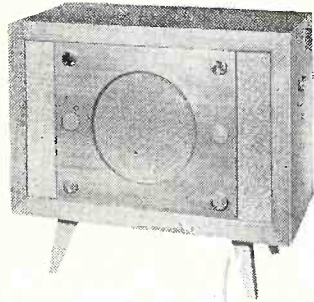
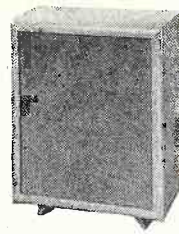

Fig. 11. Partial schematic of d-c restorer circuit illustrating where capacitor troubles might originate.

TYPE C BLONDE OR MAHOGANY FINISH—FOR 8" 12" OR 15" SPEAKERS
TYPE M BLONDE OR COPPOVAN MAHOGANY—FOR 15" SPEAKERS



acoustically-correct
handsomely styled
durably constructed

BASS REFLEX CABINETS by

Jensen

JENSEN MANUFACTURING COMPANY
DIVISION OF THE MUTER COMPANY
6601 S. LARAMIE AVENUE · CHICAGO 38, ILLINOIS

WRITE FOR
DATA SHEET 162

TYPE D WALNUT—FOR 12" OR 15" SPEAKERS

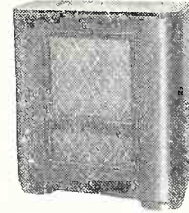

TYPE B BROWN LACQUER FINISH—FOR 12" SPEAKERS

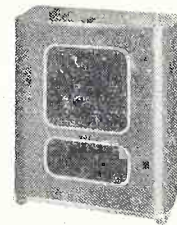

TYPE H BROWN LACQUER FINISH FOR 8" SPEAKERS



TYPE J WALL OR POST MOUNTING—BROWN LACQUER FINISH—FOR 6" OR 8" SPEAKERS



(PERIDYNAMIC TOTAL ENCLOSURE)

ATR

Makes
it easy
to DEMONSTRATE
AND TEST
D.C. APPARATUS
FROM A.C. LINES

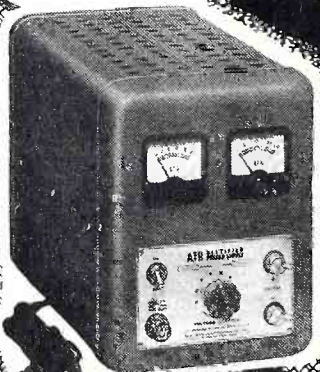

"A" BATTERY ELIMINATORS

For DEMONSTRATING AND TESTING
AUTO RADIOS

New Models . . . Designed for testing D.C.
Electrical Apparatus on Regular A.C. Lines.
Equipped with Full-Wave Dry Disc Type
Rectifier, Assuring Noise-less, Interfer-
ence-Free Operation and Extreme
Long Life and Reliability.

NEW MODELS
NEW DESIGNS
NEW LITERATURE

"A" BATTERY ELIMINATORS
DC-AC INVERTERS
AUTO RADIO VIBRATORS

See your jobber or write factory

AMERICAN TELEVISION & RADIO CO.
Quality Products Since 1931
SAINT PAUL 1, MINNESOTA-U.S.A.

PERSONNEL NOTES

H. A. Gumz, production manager of Webster-Chicago Corporation, has been named vice-president of the firm.

National Union's Renewal Sales Division announces the appointment of *John M. McGuire* as District Manager for the up-state New York territory including Erie, Pennsylvania.

Martin F. Shea, veteran Philco employee, has been named vice president Auto-Radio Division in charge of car radio manufacturing sales and head of Philco's Detroit operation.

Quam Nichols Co., Chicago speaker and electronics manufacturers, announced the appointment of *Marvin L. Bruckner* as assistant sales manager of the jobber division.

Announcement of the appointment of *H. S. Zebley* as sales manager of the Military Division of Snyder Manufacturing Company, Philadelphia TV, radio and automotive accessories firm, has been made by the company. Appointment of *Ben Hening* as sales representative for the same division has also been announced.

Electronic Instrument Co., Inc., has just confirmed the appointment of *Michael Scott* as the authorized EICO Sales Representative, for the territory of all the New England States.

Jules J. Bressler, of New York City, has been appointed by the La-Pointe Plascomold Corporation as Manufacturer's Representative for Vee-D-X products, it was announced by *Fred A. Hess*, Sales Manager. He will cover the Metropolitan New York territory.

Paul W. Nief announces the formation of Paul W. Nief Associates, 7 Greenridge Avenue, White Plains, New York, as Manufacturers' Representatives and Sales Consultants. They will specialize in representing manufacturers of Electronic Parts and Equipment and also Electrical Appliances, in the New England States and northern New York State.

Burlingame Associates, 103 Lafayette Street, New York, New York, leading representatives for manufacturers of electronic equipment announced the appointment of *R. N. Kellogg Jr.* as Advertising Director.

Robert E. Lee, manager of finance for the General Electric Tube Department here for the past four years,

IT'S A SALES NATURAL
Because It's
TIP-PROOF

JFD

Tip-Proof

Model No. TA 135

**INDOOR TV
ANTENNA**

Complete with
twin lead.

Closes TV set sales
on-the-spot. One reason
why over 1,000,000 have
already been sold!

See Your Jobber or
Write for Brochure No. 16

JFD

MANUFACTURING CO., INC.

6129 16th Ave. Brooklyn 4, New York

FIRST In Television Antennas and Accessories

CUTS SERVICE TIME

Big *New*
**WIRE CUTTER
AND
STRIPPER**
TIME SAVER

Snips wire to 18 gauge
... gets in hard to reach
places... perfect for hold-
ing wire or other small parts.
Contact your radio parts job-
ber or Jim Handy representa-
tive.

**Jim
HANDY**
EASY ACTION WIRE CUTTER
C & G Mfg. and Sales Co.
Box 1525 Columbus, O.

**\$1.00 to \$5.00 PAID
"for SHOP NOTES"**

Write up any "kinks" or "tricks-of-the-trade" in radio servicing that you have discovered. We will pay from \$1 to \$5 for such previously unpublished "SHOP NOTES" found acceptable. Send your data to "Shop Notes Editor," RADIO-TELEVISION SERVICE DEALER, 67 West 44 St., New York 18, N. Y. Unused manuscripts cannot be returned unless accompanied by stamped and addressed return envelope.

Columbia 

New TV Service Light-

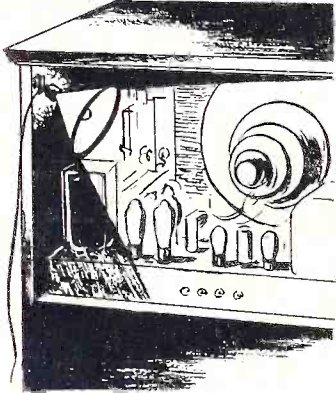

Every Serviceman needs this television service light!



INCLUDES:

- 7 watt—110 v bulb
- Non-breakable reflector for good illumination
- 6 foot cord with plug
- Rubber suction cup which holds firmly to any flat surface—ideal for servicing
- Takes very little room inside TV cabinet. Throws light just where you want it. Keeps both hands free to work.

INDIVIDUALLY BOXED

Each service light is packaged in light-weight durable box, easy to carry on service calls.

Have YOU seen our NEW Television SERVICE CORD?

"Columbia" Products are carried by leading Jobbers!

Columbia 
WIRE & SUPPLY CO.

2850 Irving Park Road • Chicago 18, Ill.

"National distributors and warehouse for ANACONDA deansheath television, and radio wires and cables"

has been appointed assistant manager of the company's cathode ray tube operations, with headquarters in Syracuse, N. Y.

Randolph M. Duncan of West Caldwell, N. J., has been named to succeed Mr. Lee as manager of finance.

From RCA we hear that *Douglas Y. Smith*, a veteran of nearly a quarter-century of service in the engineering, merchandising, and sales activities of RCA, has been promoted to Manager of Sales Operations for the Tube Department. Also, *Edwin Dorsey Foster* was elected Vice President and Director of Planning for the RCA Victor Division. In addition, *William F. Carolan* has been appointed General Sales Manager of the newly created air-conditioning department, of the RCA Victor Division.

W. L. ("Rothy") Rothenberger well-known in the radio and electronics industry, was congratulated recently on his completion of 30 years of continuous service with the Radio Corporation of America.

Louis J. Collins has been named director of sales of the Capehart-Farnsworth Corporation. Also, *William G. Frick* is the newly-appointed sales manager of the technical products division.

Sangamo Electric Company, Springfield, Illinois, announces the appointment of *John Gillner Twist* as Sales Manager of the Capacitor Division located at Marion, Illinois. He will make his headquarters at the Marion factory. Also announced was the appointment of *William W. Taylor* as Sales Promotion Manager of the Capacitor Division located at Marion, Illinois.

Permoflux Corporation, Chicago, recently announced the appointment of *Mr. Howard Roth* as Industrial Sales Representative. Also announced was the appointment of *George Adams* as Factory Superintendent. Mr. Adams will be in charge of the production of loudspeakers, transformers, headphones, as well as various electronic equipment manufactured by Permoflux. Other appointments are *Eugene Roeske* as head of the new transformer core division, and *Floyd J. Van Alstyne* as Jobber Sales Manager.

Appointment of *Maurice P. Fieldman* to the post of General Sales Manager of the Halldorson Company, manufacturers of transformers since 1913, has been announced by P. J. Halldorson, President of the firm which bears his name. Also announced was the appointment of *Larry A. Chambers* as Sales Representative effective January 1, 1952.

32

WAYS TO BETTER SERVICING...

Now, there are 32 fact-filled Tek-File packs . . . covering the latest sets of over 60 manufacturers! You get all the factory-authorized service data . . . and it matches the set you're working on! Complete data—right from Rider Manual TV8, a minimum of 128 8½ x 11 pages in each economical Tek-File pack.



RIDER MANUALS

TV 8
and
VOL. 22

Still the only complete source for accurate, authoritative servicing data. TV8, the biggest and best yet, covers all production runs and changes through September 1951. Volume 22 covers all manufacturers' AM-FM production runs through August 1951. (Also includes auto radios, record changers, tuners and recorders.)



see your jobber



JOHN F. RIDER

PUBLISHER, INC.

480 Canal Street, New York 13, N. Y.

PERFORMANCE
Not Size
IS WHAT COUNTS

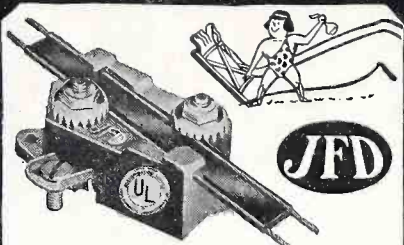

"LITTLE GIANT"
LIGHTNING
ARRESTER

PROTECTS
Against Lightning Hazards

No. AT 105 **\$1.25**
For ribbon-type and oval
jumbo twin lead. **LIST**

ONLY JFD Lightning Arresters offer you these
exclusive patented features...

1. Strain-relief Retaining Lip prevents pulling or straining of lead against contact points.
2. You actually see positive contact made with lead-in wire.
3. No wire stripping or cutting.

Write for Form No. 84 showing the damage lightning can do to a Television Installation.



JFD MANUFACTURING CO., Inc.
6125B 16th AVENUE, BROOKLYN 4, N. Y.
FIRST in Television Antennas and Accessories

Give!

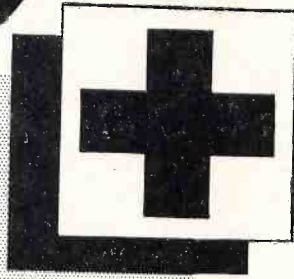

AD INDEX

Aerovox Corporation	43
American Phenolic Corp.	10
American Television & Radio Co.	46
Argos Products Co.	48
Astron Corporation	48
Blonder Tongue Labs	39
Bussmann Manufacturing Co.	13
Cannon Electric Company	33
C & G Mfg. & Sales Co.	46
Clear Beam Antennas	48
Columbia Wire & Supply Co.	47
Electro-Voice, Inc.	35
Guardian Elec. Mfg. Co.	42
Hickok Elec. Instrument Co.	42
Hytron Radio & Electronics Co. (Div. of CBS)	14
Industrial Condenser Co.	40
Jensen Manufacturing Co.	44, 45
JFD Manufacturing Co., Inc.	46, 48
LaPointe-Plascomold Corp.	34
Mallory, P. R. & Co., Inc.	Cover 3
Mosley Electronics	40
Moss Electronic Distr. Co., Inc.	36
Precision Apparatus Corp.	2
Radiart Corporation	5
Radion Corp., The	32
Rauland Corporation, The	Cover 2
RCA Tube Dept.	
RCA Electron Tubes	Cover 4
RCA Tv Components	31
RCA Institutes, Inc.	1
Rider, John F. Publisher, Inc.	47
Sams, Howard W. & Co., Inc.	4
Simpson Electric Company	7
Snyder Manufacturing Co.	12
Sprague Products Co.	6
Standard Transformer Corp.	37
Sylvania Electric Products, Inc.	8, 9
Telrex, Inc.	41
Transvision, Inc.	43
Triplett Elec. Instrument Co.	11
United Catalog Publishers	36

It's SENSATIONAL!

CLEAR BEAM'S
NEW ALL-CHANNEL
RHOMBIC

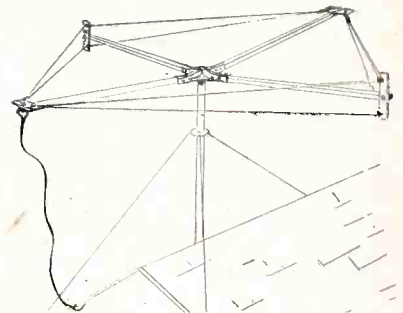

Electronically Engineered for
LONG DISTANCE
(DX) RECEPTION
and Unusually
SHARP DIRECTIVITY
Over the Entire TV Spectrum

Clear Beam
TV ANTENNAS & ACCESSORIES
100 PROSPECT AVE., BURBANK, CALIF.
ROckwell 9-2141 CHarleston 0-4886

It COUNTS
and **CARRIES**
your **TUBES**

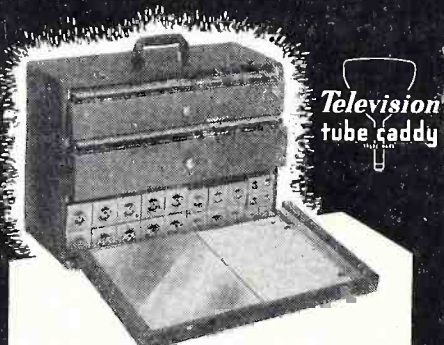

Television
tube caddy

Specially designed for the television
serviceman. Makes work easier
and quicker—and YOU more efficient.
You take **INVENTORY AT A GLANCE**
—and always have the right tube with you.
Thin, easy-to-carry leatherette cabinet,
20 1/2" x 14" x 9" deep. Holds up to 249 tubes,
or less with space for **TOOLS** and **METER**.
Clips in cover for price list or mirror.

\$13.50 Net to Dealer—Higher on West Coast
Also TV Cabinets, Wall Baffles
Ask your parts jobber how it can **PAY FOR ITSELF** in 3 WEEKS, or write

ARGOS PRODUCTS CO.
370 MAIN STREET • GENOA, ILLINOIS

ASTRON CAPACITORS



No shelf-warmers;
no comebacks—for
smooth, sweet SERVICE all the
way, use ASTRON capacitors on
your next job—they DO MORE!

Have YOU sent for our new Catalog AC-3 with its wealth of educational data? Write for this helpful material today.

ASTRON CORPORATION
255 Grant Ave. East Newark, N. J.

Rauland—the Original

LOW FOCUS VOLTAGE ELECTROSTATIC TUBE

**Perfected in Rauland Electronics Laboratories,
this tube that gives edge-to-edge sharpness of focus
without coils and magnets is proved and ready
as the materials pinch becomes painful**

BETTER in all ways! Gives better over-all focus—hair-line sharpness from edge-to-edge—with NO critical materials for focusing . . . and **STAYS SHARP** under considerable variation in line voltages.

REQUIRES NO re-engineering of present television chassis . . . NO added high voltage focus circuit . . . NO added receiver tubes . . . NO additional components except an inexpensive potentiometer or resistor.

FOCUSES by using D.C. voltage already available in the receiver.

ELIMINATES focusing coils and magnets . . . saves critically scarce copper and cobalt.

• • •

This new Rauland development is now available in substantial quantities in 17 and 20 inch rectangular tubes. For further information, address . . .

THE RAULAND CORPORATION



Perfection Through Research

4245 N. KNOX AVENUE • CHICAGO 41, ILLINOIS



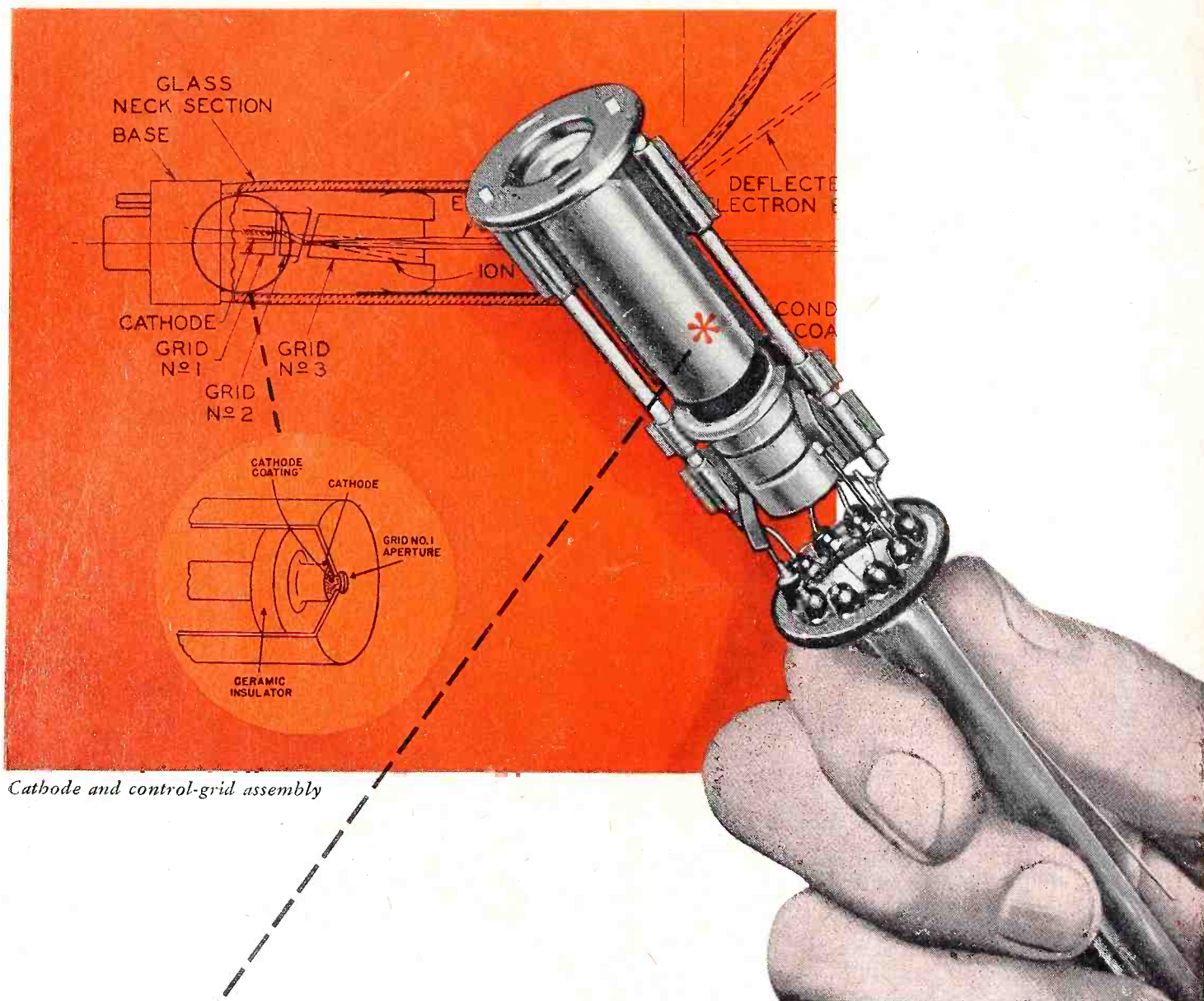

Cathode and control-grid assembly

The gun that looked 100% "perfect" ...yet never "fired a shot"

The electron gun you see looks perfect, but actually it "never fired a shot." You see, RCA rejected it because the spacing between grid No. 1 and the cathode was out of bounds. Only a 0.001" departure from the design value for this spacing is sufficient cause for gun rejections in RCA factories.

Why does RCA prescribe such a close tolerance? Simply because RCA engineers have found that if the cathode-to-grid spacing is too small, or too large, the grid would have faulty "control." Such tubes, when installed in TV receivers, may be

the cause of poor picture performance, and may result in troublesome and time-consuming service problems and call-backs.

RCA takes no chances with its reputation for quality. You get the benefit of RCA's quality reputation when you use RCA tubes. Constant vigilance and quality control at all stages of manufacture assure meeting RCA standards on the final production line. That's why RCA picture tubes are unmatched for reliability and uniformity.

In RCA picture tubes, the difference is

top-quality control. That's why, dollar for dollar, RCA picture tubes have no equal.

With RCA Receiving Tubes, as well as RCA kinescopes, TOP-QUALITY CONTROL makes the difference.



RADIO CORPORATION of AMERICA
ELECTRON TUBES
HARRISON, N. J.