

MAY, 1951

Radio-Television SERVICE DEALER



The Professional Radio-TVman's Magazine

IN THIS ISSUE:

The D-C Restorer, Its Function and Purpose
A Crystal-Calibrated Signal Generator for TV, FM I-F, and Inter-carrier
U.H.F. Transmission Line Tuned Circuits
A "Snow-Free" Tuner
Men of Radio, Part 3
Fit Your Customer Into These 23 Types
Looking For Trouble? Part 4

AM-FM-TV-SOUND

Total Distribution Of This Issue: Over 30,000

WHAT YOU GAIN WHEN YOU BUY...

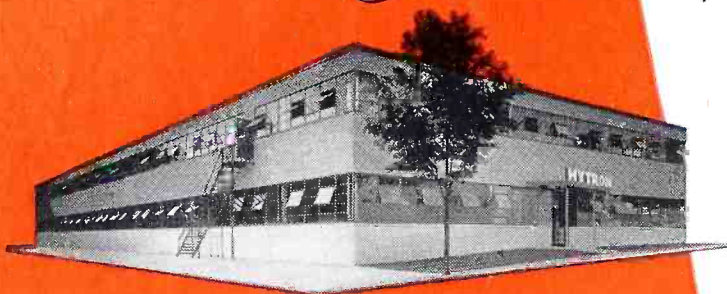

LEADING TV SET MANUFACTURERS PICK HYTRON RECTANGULARS:
ADMIRAL • AIR KING • BENDIX • CROSLEY • EMERSON
HALLICRAFTERS • HOFFMAN • MOTOROLA • NATIONAL
OLYMPIC • SENTINEL • SETCHELL-CARLSON • SPARTON
STROMBERG-CARLSON • TRAV-LER • WESTINGHOUSE
AND OTHERS

WATCH ALSO FOR THE
NEW HYTRON 14-, 17-
AND 20-INCH ELECTRO-
STATIC RECTANGULARS

HYTRON

Studio-Matched

RECTANGULARS

- 1 You get THE ORIGINAL.** The *studio-matched* rectangular tube is Hytron's baby. Its logically designed screen matches the 4 by 3 aspect ratio of the studio picture. Quite naturally, Hytron's new rectangular is fast becoming the most popular picture tube.
- 2 You get UNIFORMITY.** Hytron's new picture-tube plant is the most modern in the world. It was designed especially to mass-produce Hytron *studio-matched* rectangulars of uniform dependability.
- 3 You get A COMPLETE LINE.** Hytron offers you 14-, 16-, 17-, and 20-inch *studio-matched* rectangulars. All the popular rectangulars (and the popular types of round tubes too).
- 4 You get THE QUALITY LEADERS DEMAND.** Nine out of ten leading TV set makers choose Hytron. More and more leading service-dealers pick Hytron. Because their own experience proves Hytron *studio-matched* rectangulars give "amazingly clearer, sharper, more brilliant pictures." Demand this same performance for yourself. Demand original Hytron *studio-matched* rectangulars.

OLDEST MANUFACTURER OF RECEIVING TUBES
HYTRON
RADIO AND ELECTRONICS CORP.



MAIN OFFICE: SALEM, MASSACHUSETTS

RCA INSTITUTES

Announces...

HOME STUDY COURSE in TELEVISION SERVICING

... based on the experience of the RCA Service Company

Now available to the Industry

Here's *your* golden opportunity to take the time-tested RCA Service Company course on television receiver servicing... to earn a valuable RCA Institutes' certificate that can lead straight to a better job at higher pay.

Now, for the first time, *you* can take the same basic course that has already been given to the thousands of RCA's own servicemen... an easy-to-understand home-study course based on the actual experience of the RCA Service Company in servicing thousands of home television receivers.

Cost is *low*... only \$9 a unit for 10 units or \$90 total, on an easy pay-as-you-learn plan. And value is *high*... the certificate of completion issued by RCA Institutes is known and honored throughout the radio-electronics industry.

Never before available to anyone outside RCA. Now offered to *you* through RCA Institutes, one of America's oldest and most respected technical training schools. Course covers most major makes and types of TV receivers. Designed specially for men already in electronics; therefore no kits

or paraphernalia are required. Handled entirely by correspondence. Available *exclusively* to men in the radio-television-electronics field. Not offered to the general public, or under the G.I. Bill.

ENROLL NOW! Mail the coupon *today*. Don't miss your great opportunity to take this proven course. If you're just getting started in TV, it will make you a *good* serviceman. If you're already *good*, it can't help but make you *better*! Send the coupon... get on the reservation list... **NOW!**

LOWER RATES FOR GROUPS!

If any employer in the radio-electronic industry desires to enroll six or more of his employees for this course, lower rates will apply. A special group application form is available for employers desiring to take advantage of this offer.



RCA INSTITUTES, INC.

A SERVICE OF RADIO CORPORATION of AMERICA
350 WEST FOURTH STREET, NEW YORK 14, N.Y.

RADIO-TELEVISION SERVICE DEALER • MAY, 1951

MAIL COUPON TODAY!

RCA INSTITUTES, INC.
Home Study Department, RD-551
350 West Fourth Street
New York 14, N. Y.

Without obligation on my part, please reserve a place for me in your *home study course on television servicing* and send me full details. No salesman will call. I understand I must be employed in the radio-TV-electronics field to qualify for the course.

Name _____
(Please Print)

Address _____
(Street)

City _____ Zone _____ State _____

Snyder
PHILADELPHIA

Directronic*

MOTORLESS

TV AERIAL SYSTEM

360° ELECTRONICALLY SWITCHED BEAM

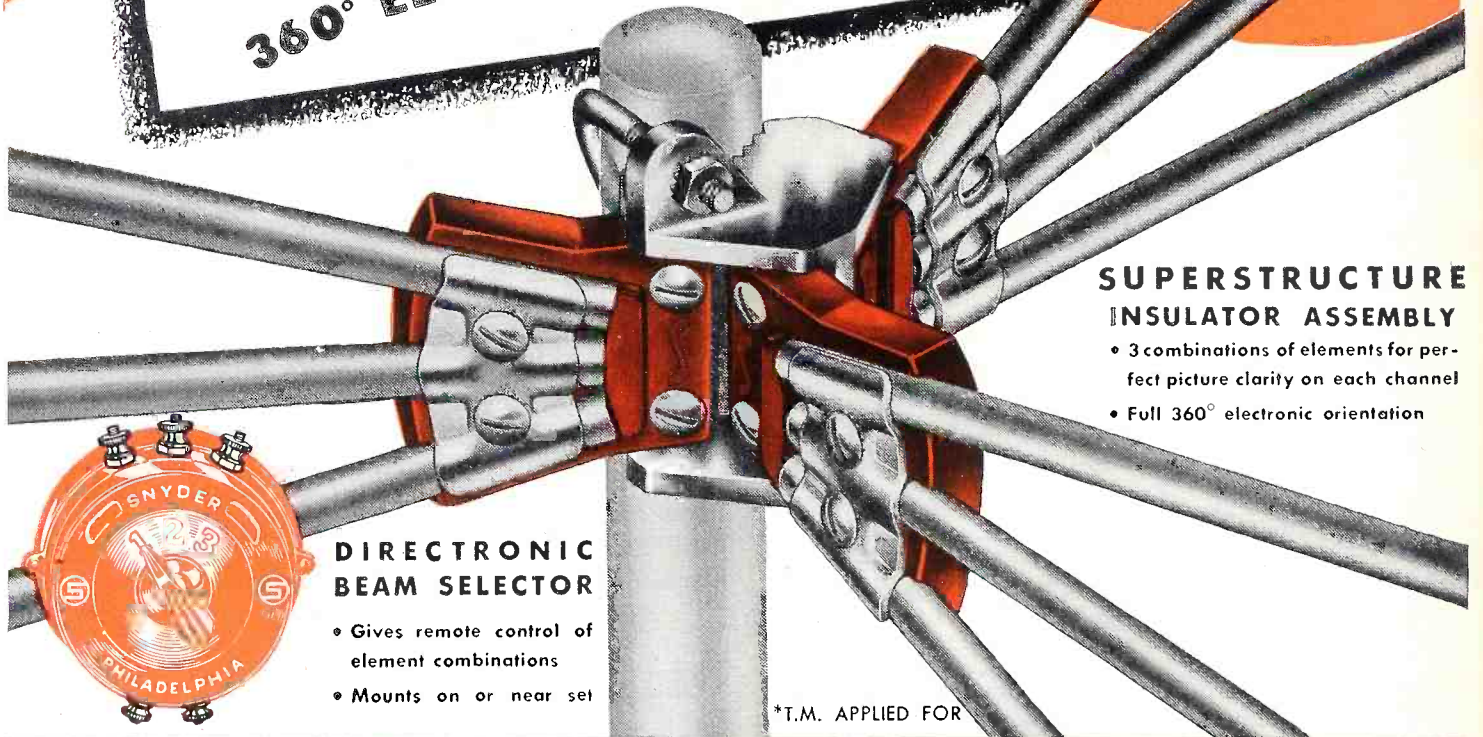

SUPERSTRUCTURE INSULATOR ASSEMBLY

- 3 combinations of elements for perfect picture clarity on each channel
- Full 360° electronic orientation

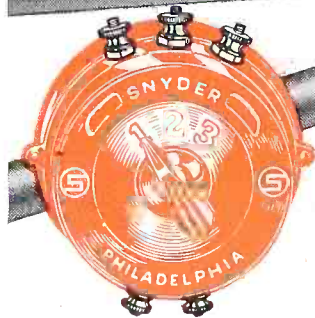

DIRECTRONIC BEAM SELECTOR

- Gives remote control of element combinations
- Mounts on or near set

*T.M. APPLIED FOR

<p>NO</p>	<p>NO</p>	<p>NO</p>	<p>NO</p>
<p>MOTORS OR MOVING PARTS</p>	<p>ROOF ORIENTATION</p>	<p>ELECTRIC POWER</p>	<p>GHOSTS</p>

SNYDER MFG. CO.

**ANTENNA ENGINEERS
PHILADELPHIA 40 • U. S. A.**

EXPORT: ROBURN AGENCIES, INC., NEW YORK 7, N. Y.

P. S. ONLY ONE LINE TO INSTALL

EDITORIAL

by S. R. COWAN

Licensing

No definite action on a Bill requiring technicians to be licensed in New York City has been taken as yet. However, such a Bill that we would consider satisfactory is reported in full in this issue's "Sync Pulses." Read it and let us have your comments, favorable or to the contrary. Bear in mind that if, as and when a license law is instituted in New York City, without doubt many other municipalities will immediately follow suit and promulgate almost identical laws.

Military Deferments

The Congress and our military leaders cannot seem to agree about UMT (universal military training) and technical course student deferment programs. One thing is certain,—some means should be found whereby such students now enrolled in schools may be enabled to complete such courses.

We even advocate that deferment be granted students taking courses in service and maintenance work. The foundation of any nation's progress is its ability to produce men who can create—and men who can maintain. In the broad sense of interpretation, a student taking a medical course, upon graduation becomes a doctor . . . and a doctor, literally speaking is nothing more than a person whose purpose it is to maintain well-being and good health. So, a student doctor, being nothing more than a potential health serviceman, is not entitled to preferential deferment as compared to a student radio serviceman or airplane mechanic. Nevertheless, all such men are entitled to the extra time needed to finish their studies as compared to student lawyers or student dairy farmers. Summarized, common sense should be the determinant as to who should be given a slight extension of time in which to complete his learning—and the basic factor should be: what such a person will ultimately contribute to the defense and well being of our country.

Good & Bad TV Laws

In New York State there is now a law which prohibits the attaching of any TV or radio antenna, or wires of any types to fire escapes or vent pipes extending above roof levels. Such a law is proper and justified. By the same token, the lawyers and politicians who are trying to pass a law which would make it illegal to have or operate a TVset in an automobile where it can be seen by the driver and thus possibly distract his attention are merely wasting their time and 'the tax payers' money. Likewise, instead of certain communities having local ordinances forbidding the erection of TV masts above certain heights (because they detract from the beauty of the community)—it would be much wiser if every community had a law requiring that all masts be properly guyed and that all roof installed TV antennas be periodically checked by a qualified technician. Falling TV antennas are dangerous.



Sanford R. Cowan
EDITOR & PUBLISHER

Samuel L. Marshall
MANAGING EDITOR

COWAN PUBLISHING CORP.
67 WEST 44TH ST.
NEW YORK 18, N. Y.



VOL. 12, No. 5

MAY, 1951

Editorial	2
Trade Flashes	6
Sync Pulses, by <i>San D'Arcy</i>	17
The D-C Restorer, Its Function and Purpose, by <i>Matthew Mandl</i>	23
Theory and applications of d-c restorers clearly explained.	
A Crystal-Calibrated Signal Generator for TV, FM I-F, and Intercarrier Alignment, by <i>M. Rabinowitz</i>	27
Construction of versatile alignment instrument.	
U.H.F. Transmission Line Tuned Circuits, by <i>Allan Lytel</i>	29
Explanation and applications of transmission lines as tuned circuits.	
A "Snow-Free" Tuner, by <i>Daniel Lerner</i>	32
The much discussed "Colorado" tuner analyzed by an expert.	
Men of Radio, Part 3, by <i>William R. Wellman</i>	36
The story of Guglielmo Marconi and his contributions to the radio Art.	
Fit Your Customer Into These 23 Types, by <i>David Markstein</i>	39
A breakdown of the various types of individuals you will encounter in your sales attempts, and methods of handling them.	
Looking For Trouble? Part 4, by <i>Cyrus Glickstein</i>	40
Servicing a G.E. Model 810 receiver in a novel and instructive manner.	
Trade Literature	42
Tube Topics, by <i>James Corey</i>	43
Shop Notes	44
New Products	45

SANFORD L. CAHN, Advertising Director
DAVID SALTMAN, Production Mgr.

HARRY N. REIZES, Advertising Manager
CHARLES LO CICERO, Circulation Mgr.

BRANCHES: H. A. METZGER, 230 S. Wells St., Chicago, Ill., WEbster 9-2666
A. H. ELSNER, 560 S. San Pedro St., Los Angeles 13, Cal., MIchigan 4352

RADIO-TELEVISION SERVICE DEALER is published Monthly by Cowan Pub. Corp., 67 West 44th St., New York 18, N. Y. Subscription price: \$2 per year in the United States, U.S. Poss. & Canada; elsewhere \$3. Single Copies: 25c. Reentered as second class matter Sept. 25, 1950 at the Post Office at New York, N. Y. under the Act of Mar. 3, 1879. Copyright 1951 Cowan Pub. Corp.

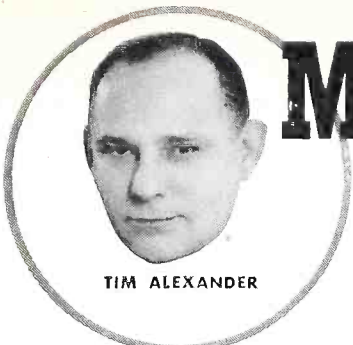

TIM ALEXANDER

Motorola



MAX SCHINKE

Admiral



FRANK SMOLEK

ZENITH



FLOYD MAKSTEIN

Emerson



NORM COOPER

hallicrafters

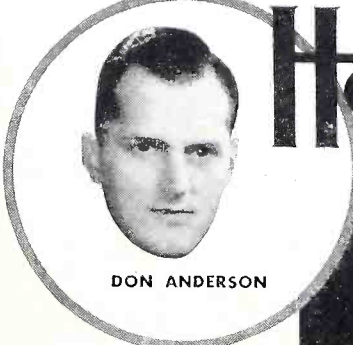

DON ANDERSON

Hoffman

Simpson ELECTRIC COMPANY

5200 West Kinzie Street • Chicago 44, Illinois • Phone: COLUMBUS 1-1221

In Canada: Bach-Simpson, Ltd., London, Ontario



LEADING EXPERTS
RECOMMEND

Simpson Model 480 GENESCOPE for TV-FM Servicing

These leading manufacturer's service managers agree — the Simpson Model 480 Genescope is perfectly designed for proper testing, servicing and alignment of all TV and FM receivers!

THE SIMPSON MODEL 479 TV-FM SIGNAL GENERATOR

Exactly the same circuits, ranges and functions as the Model 480, with the exception of the oscilloscope.

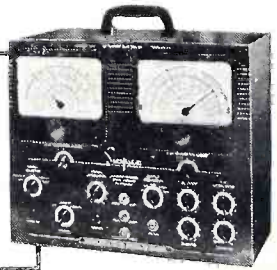

BURTON BROWNE ADVERTISING



AMPHENOL

in both civil and preparedness economies

Amphenol is understandably proud of its vast production facilities which have given you the "Inline" antenna—Twin Lead—Auto-Dial Rotator—and other outstanding TV accessories which you have accepted with such enthusiasm . . .

You too can take pride in the fact that this company, which supplies so many of your needs, is making a major contribution toward the ultimate goal of Preparedness Production—the continuing strength and greatness of our country!

Amphenol's large military production program has not halted the manufacture of civilian products—TV consumer items are being produced in quantity—perhaps not all that's required—but enough so that those who *insist* upon the best—the best antennas, the best rotators and other TV accessories—can still obtain Amphenol.

AMERICAN PHENOLIC CORPORATION

1830 SO. 54th AVENUE • CHICAGO 50, ILLINOIS



FREE!

This New TV REPLACEMENT Capacitor MANUAL by SPRAGUE

From A to Z, from Admiral to Zenith, this 16-page book is jam-packed with complete replacement recommendations for critical TV capacitors in 497 television sets from The Technical Service Division of Sprague, world's largest capacitor maker.

Get your copy FREE from your SPRAGUE DISTRIBUTOR or send 10c directly to Sprague to cover handling and mailing costs.

Remember! Avoid costly call-backs in your service work by sticking to Sprague — the capacitors you can depend upon.

SPRAGUE PRODUCTS COMPANY
DISTRIBUTORS' DIVISION OF THE SPRAGUE ELECTRIC COMPANY
 71 MARSHALL ST., NORTH ADAMS, MASS.

TRADE FLASHES

A "press-time" digest of production, distribution, and merchandizing activities

RTMA Statistics

Despite increasing shortages of strategic materials, production of both radio and television receivers increased in February over the preceding month and the corresponding month of 1950, the Radio-Television Manufacturers Association reported.

RTMA's estimates, which include production by members of the Association and non-members, indicated 1,313,015 radios and 679,319 TV sets were manufactured in February. This compares with production of 1,202,502 radios and 645,716 TV sets in January and 1,059,200 radios and 479,900 television receivers in February, 1950.

February radio production included 795,377 home sets, 79,859 portables, and 437,779 auto sets. Radio sets with FM reception facilities were estimated at 143,645. In addition, 66,108 TV receivers with FM audio circuits were produced, RTMA said.

Of the total February TV production, 641,086, or 94 percent, represented receivers with picture screens of 16 inches in size or larger. The report also showed a total of 2,499 sets with screens 22 inches and larger.

Sales of receiving tubes in February increased 48 percent over sales in the corresponding month of 1950, the Radio-Television Manufacturers Association reported. February sales totalled 36,821,794 as against 24,865,546 tubes in the corresponding month of 1950. February sales, however, were slightly below the 73,042,303 tubes sold in January of this year.

A breakdown of the RTMA tube report showed 24,578,991 tubes sold for new radio and TV sets; 2,355,356 tubes sold for new equipment other than radio or TV; 8,237,372 for replacements; 1,429,783 for export; and 220,292 tubes sold to Government agencies.

Industry Meets with NPA On Materials Allocations

The Electronic Parts Distributors Industry Advisory Committee met on April 9, with National Production

[Continued on page 10]

PHOTOFACT Users Write Our Best ADS!

Hundreds of unsolicited letters tell what the world's finest Radio & TV Data means to Service Technicians



Carl Schneider
609 Ohio St.
Jefferson City, Mo.

"You certainly have simplified the problems of the radio man. For accuracy and time saving, your method is tops... I will always insist on PHOTOFACT."



Bernard B. Bycer
2629 W. Lehigh Ave.
Philadelphia, Pa.

"We have all your PHOTOFACT Folders plus dial restringing, tube layout and TV tube layout books in our shop. Your books are earning money for our business."



David H. Mullenix
263 Fifth Street
Macon, Ga.

"We have been in the radio business here for more than 25 years and have had all the manuals we know of. We wish to compliment you on your service, which is very good."

NOW! GET THE PROOF FOR YOURSELF!

FREE We'll Send You a FREE Photofact Folder on any postwar receiver listed in the PF Index.

Learn for yourself—at our expense—how PHOTOFACT pays for itself by earning bigger repair profits for you! Ask for a FREE Folder covering any postwar AM, FM or TV receiver listed in the PHOTOFACT Cumulative Index. Examine it. Put it to work at your bench—then judge for yourself!

WRITE FOR FREE FOLDER TODAY!

HOWARD W. SAMS & CO., INC.
2201 East 46th Street • Indianapolis 5, Indiana

**THE FINEST IN
ELECTROSTATIC FOCUSING**

*Teletrons**

17FP4

20GP4



**complete
engineering data
on request**

DUMONT

TUBE DIVISION, ALLEN B. DU MONT LABORATORIES, INC., CLIFTON, N. J.

*Trade-mark.



*Largest
Selling Boston*

AT ANY PRICE!

Regency

TRADE FLASHES

[from page 6]

Authority, U. S. Department of Commerce and made a series of recommendations designed to assure that defense needs are met and at the same time keep a maximum number of radio, television and other electronic devices operating with a minimum demand upon critical materials.

NPA said the recommendations would be studied. The electronic parts industry will continue to face shortages in nickel, molybdenum, cobalt and other critical materials, NPA representatives told the committee. A plan to analyze and regulate steel processing schedules has been instituted and will provide an orderly handling of requirements and assist in the proper distribution of scarce alloy steels, NPA said.

NARDA Convention Date Set

The Mid-Year Convention of the National Appliance and Radio Dealers Association will be held June 25 at the Stevens Hotel, in Chicago, it was announced today by Mort Farr, NARDA President.

The one-day meeting, to cover sessions on sales, service, and management featuring the top men of the industry from all channels of distribution, was approved at a meeting of the Executive Board here this week.

Publishers and Mfrs. Establish "Bill of Rights"

A publishers' and manufacturers' "Bill of Rights" for the electronics parts industry recommending strict adherence to a code of ethics which clearly differentiates between paid space and publicity was set up by joint resolution of the Association of Electronic Parts and Equipment Manufacturers and the Sales Managers Club Eastern Group in separate meetings of the two groups here and in New York.

The joint resolution takes a firm stand against any pressure on the part of either manufacturers or publishers intended to influence editorial content in relation to the amount of advertising used by a company. The Sales Managers Club passed the resolution unanimously at its March meeting attended by a committee from EP&EM, and EP&EM ratified the resolution at its April meeting here today.

ESFETA Officially Joins NETSDA

Radio service technicians of New York voted their organization, the

Empire State Federation of Electronic Technicians Associations (ESFETA), into the new national radio service federation, the National Electronic Technicians and Service Dealers Associations (NETSDA), confirming a tentative decision made at an earlier meeting.

The decision to join the national federation was the most important business of the annual ESFETA meeting, which was held at the Arlington Hotel, Binghamton, New York. Twenty-five members were present, representing eight associations.

Other business included special measures to protect the rights of member associations of the State Federation who might not wish to join the new organization, discussion of the licensing situation, financial measures and notice of constitutional amendments.

Officers elected for the 1951 term were: president, Wayne Shaw, Binghamton; vice-president, Sid Gent, Endicott; recording secretary, Ed Fisk, Rochester; corresponding secretary, Don Lissow, Rochester; treasurer, Ben de Young, Ithaca. Jack Wheaton, Sam Marshall, Ken Bruneman and Sid Gent appointed delegates to the national organization.

Ken Hathaway Elected First Lifetime Member of "Reps"

Kenneth A. Hathaway, associated with the radio parts industry since 1918, has been unanimously elected as the first Honorary Lifetime Member of "The Representatives" of Radio Parts Manufacturers, Inc., announces James Y. Schoonmaker, national president of the association.

Western Union Enters TV Service & Installation Field

According to a N.Y. Times News item on April 18, 1951, "The Western Union Telegraph Company has formed a subsidiary to install and service television receivers. The new concern—Western Union Services, Inc.—will confine its initial operations to Essex, Passaic and Union Counties in New Jersey. The first maintenance center will open in East Orange on May 1.

The television service will be limited to DuMont sets in the early stages, either on a contract or "per call" basis. Authorization to install and service new or old receivers has been granted by the Allen B. DuMont Laboratories, Inc., which always has

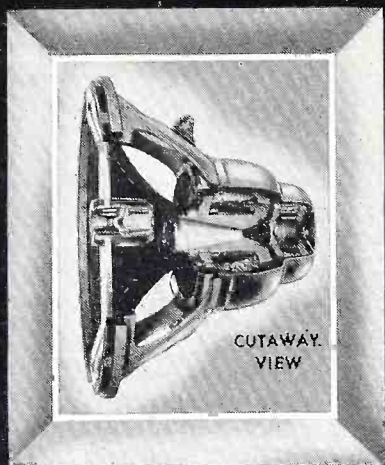

CUTAWAY VIEW

"no one has ever heard a G-610 who didn't want one!"

We believe this statement is literally true . . .

The Jensen G-610 Loudspeaker System brings you clear, clean, life-like reproduction with thrilling transport-to-the-original such as you have never heard before. Of course G-610's are in short supply, for the government has restricted cobalt for Alnico V magnets—and the G-610 has more magnetic energy than any speaker ever built. But when restrictions are relaxed and G-610's are again plentiful, then be sure you get a G-610 . . . NO ONE has ever heard one who didn't want one!

Furnished complete with Crossover and Control Network illustrated below.

Jensen

MANUFACTURING COMPANY
Division of The Muter Company

6601 So. Laramie Ave. • Chicago, 38, Illinois

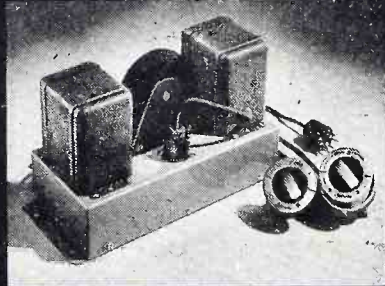

You get all five...with RCA Batteries

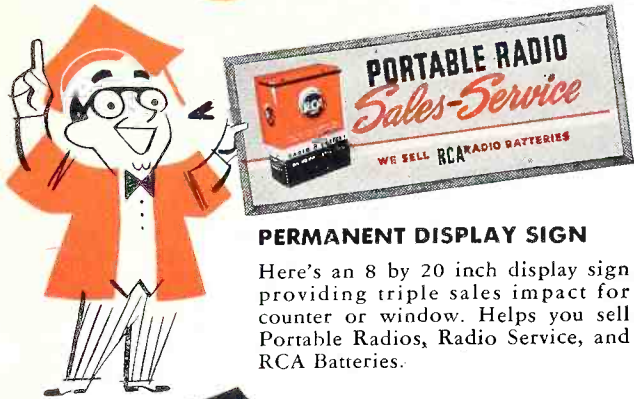

PERMANENT DISPLAY SIGN

Here's an 8 by 20 inch display sign providing triple sales impact for counter or window. Helps you sell Portable Radios, Radio Service, and RCA Batteries.



RCA BATTERY FACT-FINDER

A fast answer to quick battery sales. Just set index pointer, press the release—and the Fact-Finder opens with the battery information you want before you. Contains prices, techni-

cal data on the complete RCA line, interchangeability directory, and the Battery complement of 590 portable radios of 32 manufacturers...always at your fingertips.



ILLUMINATED GIANT BATTERY DISPLAY

A flashing beacon that attracts battery sales. Stands 12" high—comes complete with bulb, 6' cord, and detachable flasher-unit.



INTERCHANGEABLE TYPES AUTOMATIC PENCIL

Revolving mid-section tells at a glance the stock numbers on the ten fastest-moving, interchangeable types of four leading battery brands... the types that comprise 85% of your interchangeability problems!

1. Top Brand Acceptance
2. Unique Selling Aids
3. Radio Trade Distribution
4. Completely Rounded Line
5. Radio-Engineered quality

RCA is *first* with the greatest array of selling aids in the field... *all geared to the radio trade.*

And... *the selling power* of the RCA Trade-Mark makes it *easy* for you to move RCA Batteries. You gain a satisfied customer every time.

Remember, too, that RCA Batteries are *radio-engineered* for *extra* listening hours... with a type for practically every renewal requirement.

So—starting now—push RCA Batteries. Build a profitable repeat business with virtually no competition from non-radio outlets.

Learn how you can get these selling aids at no cost to you by contacting your RCA Battery Distributor today!



RADIO CORPORATION of AMERICA
RADIO BATTERIES
HARRISON, N. J.

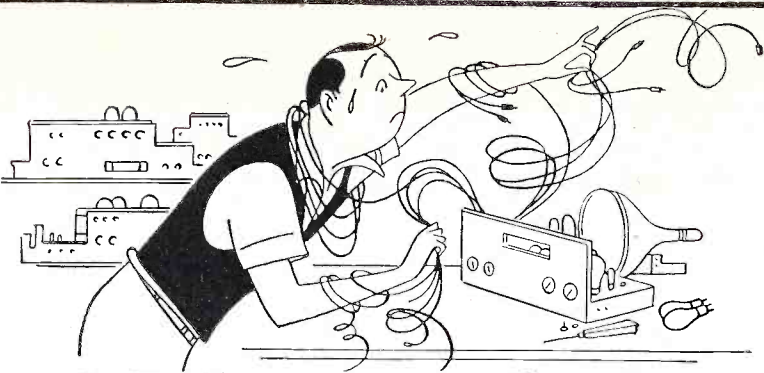

HELP! HELP! HELP!

Let John F. Rider help you untangle your servicing problems. RIDER MANUALS AND BOOKS have guided tens of thousands of servicemen on to better servicing and greater profits. They can be your "good right hand," too! Order from your Jobber today!

RIDER MANUALS

Now, more than ever, it is urgent that you have at your fingertips the priceless servicing data that can be found ONLY in RIDER MANUALS.

Rider TV Manual Vol. 6



ACCURATE... AUTHENTIC... FACTORY-AUTHORIZED TV servicing information DIRECT from 66 MANUFACTURERS. Big 12" x 15" page size, and all pages filed in place. Large, easy-to-read diagrams. Everything you need to speed servicing and satisfy your customers.

Exclusive Features:

- ALL TV production runs and changes from August, 1950 through January, 1951.
- Circuit action descriptions.
- Unpacking and installation material.
- Signal waveforms for troubleshooting.
- COMPLETE alignment data.
- COMPLETE parts list.
- Circuit changes.

Equivalent of 2320 pages (8 1/2" x 11") plus Cumulative Index Volumes 1 through 6... \$24.00. With all 6 RIDER MANUALS you will own the world's greatest compilation of TV servicing information. SEE YOUR JOBBER TODAY!

Now Available! RIDER MANUAL Vol. XXI



FACTORY-AUTHORIZED servicing material from 61 manufacturers... AM-FM-Auto Radios-Record Changers-Disc and Tape Recorders. Coverage from December, 1949 through October, 1950. 1,648 pages PLUS Cumulative Index Volumes XVI through XXI... \$21.00

Television Manual Volume 6 (Plus Index)	\$24.00
Television Manual Volume 5 (Plus Index)	24.00
Television Manual Volume 4 (Plus "How It Works" Book and Index)	24.00
Television Manual Volume 3 (Plus "How It Works" Book and Index)	24.00
Television Manual Volume 2—In new, larger page size 12" x 15". (Plus "How It Works" Book and Index)	24.00
Television Manual Volume 1 (Plus "How It Works" Book and Index)	19.80
Volume XXI	21.00
Volume XX	21.00
Volume XIX	22.50
Volume XVIII	22.50
Volume XVII	19.80
Volume XVI	9.90
Volume XV	22.50
Volume XIV to VII (each volume)	19.80
Volume VI	15.00
Abridged Manuals I to V (one volume)	19.80
Master Index, Covering Manuals Vol. I to XV	1.50
PA Equipment Manual, Volume I	18.00

RIDER BOOKS

Practical books, written by men with actual firing line experience... help you increase your knowledge... save you time and money.

BEAT THE TUBE SHORTAGE



RECEIVING TUBE SUBSTITUTION GUIDE BOOK
by H. A. Middleton
For TV-AM-FM Receivers and Allied Equipment

This amazing book shows you how to keep radio and TV sets working even though exact tube replacements are unavailable. 2500 radio and television tube substitutions listed, TV receiver filament wiring; heater substitution wiring instructions; tube types classified by functions... plus other important data you must have in order to keep receivers going. 224 pages, 8 1/2" x 11" durable paper cover... Only \$2.40

ENCYCLOPEDIA ON CATHODE-RAY OSCILLOSCOPES AND THEIR USES

by John F. Rider and Seymour D. Uslan



This is the ONLY book that so fully describes the oscilloscope... its application in servicing, engineering, research. It contains thousands of time-saving and work-saving references, charts, waveforms, etc. More than 70 different models are described with specifications and wiring diagrams. 992 pages, 8 1/2" x 11", 3000 illustrations. 22 chapters, completely indexed... Only \$9.00

TV INSTALLATION TECHNIQUES

by Samuel L. Marshall



Here are facts you should know about wind surfaces, mounting requirements, etc. Here is accurate data on receiver adjustment in the home. Here are municipal regulations in all major TV areas. Here is complete information on mechanical and electrical considerations. 330 pages, 5 1/2" x 8 1/2", 270 illustrations. Cloth bound... Only \$3.60

OTHER BOOKS FOR THE SERVICEMAN

TV Master Antenna Systems	\$5.00
TV and Other Receiving Antennas	\$6.00
Radio Operator's License Q & A Manual, 2nd Edition	\$6.60
The Business Helper	\$2.00
FM Transmission and Reception	\$3.60
TV Picture Projection & Enlargement	\$3.30
Broadcast Operator's Handbook	\$3.30
Understanding Vectors and Phase	Cloth Cover \$1.89 Paper Cover \$0.99
Inside the Vacuum Tube	\$4.50
Understanding Microwaves	\$6.00
Servicing by Signal Tracing	\$4.00
Installation and Servicing of Low Power Public Address Systems	\$4.00
Vacuum Tube Voltmeters (Revised)	\$1.89
Automatic Frequency Control Systems	\$4.50
	\$1.75

JOHN F. RIDER PUBLISHER, Inc. • 480 Canal St., New York 13, N. Y.

left this field to independent service companies.

A Western Union spokesman said the installation and service charges would be "uniform with existing rates." By DuMont recommendation, service companies now charge \$75 or more a year for such contracts, the amount depending upon the type of set in use.

Western Union said it would begin shortly to enlist dealers in the three New Jersey counties, offering them a 10 per cent fee for all service contracts they sell to set buyers.

There is nothing to prevent Western Union from eventually contracting with other manufacturers to service receivers, the company declared. The Western Union repair men, however, will get a study course in the DuMont plant to acquaint them with its sets. The new company is asking that its potential service staff members have three years of experience to qualify for jobs.

Western Union eventually may make its television service nationwide, although this depends on the outcome of the trial run. Thomas F. McMains, vice president and assistant to the president of Western Union, is head of the new subsidiary."

West Coast Directory

San Francisco and Los Angeles Councils of the West Coast Electronic Manufacturers' Assn. (WCEMA) have published the third edition of their Directory as a product index and membership roster of the three score organization members.

The brochure is well illustrated with over 30 pictures of California electronic plants, both exterior and interior.

Membership data includes names, addresses and phone numbers; products manufactured; year of establishment, number of employees and floor areas.

Distributed primarily to and by WCEMA members, a limited supply is available without charge at the Publication Office, 767 Castelar St., Los Angeles 12.

RCA UHF Converter

RCA Victor disclosed recently that large-scale experiments show that a converter is the best means of enabling present television sets to receive stations operating in the new higher frequency channels proposed by the Federal Communications Commission.

The Company also assured owners of two million RCA Victor television sets that while such service from UHF stations is not expected before late

[Continued on page 50]

Be Sure of Your Installations... Next Year

Use *Aptitude-Tested*
MIKE CABLE *Now*

Now, you can be sure of your installations with Belden Microphone Cables. They are *Aptitude-Tested* and rated to give you safe and complete knowledge of their characteristics. Furthermore, Belden Mike Cables are built for maximum service. Put them to work for you now—and be sure . . . specify Belden.

Belden Manufacturing Company
4639 W. Van Buren Street
Chicago 44, Illinois

No. 8411
Nominal Capacitance 37 mmf per ft. Use for lapel microphone.

No. 8401
Nominal Capacitance 25 mmf per ft. For crystal, ribbon, carbon microphones.

No. 8422
Nominal Capacitance 32 mmf per ft. Use for carbon microphones.

No. 8410
Nominal Capacitance 33 mmf per ft. Use for crystal, ribbon, and carbon microphones.

No. 8424
Use for Interconnecting power cable for all electronic uses. Also used as a microphone cable.

No. 8423
Nominal Capacitance 54 mmf per ft. Use for carbon microphones.

No. 8412
Nominal Capacitance 68 mmf per ft. Use for carbon microphones.

Belden
Radio **WIRE**

The
Aptitude-Tested **LINE**

New Round Shaft

Saves Valuable

Single Section Mallory Midgetrol

Now you can have the outstanding electrical characteristics of the *time-proved* Mallory Midgetrol . . . with two new time-saving features that make carbon control installation faster and simpler than ever before !

This sturdy $\frac{15}{16}$ " control is supplied with a *permanently fixed, tubular brass shaft*. It is easily cut to required length. It can be adapted for split-knurl or flatted type knobs in a few seconds by inserting one of the two steel shaft-ends packaged with every Mallory Midgetrol. It has been designed to give you utmost convenience—without sacrificing the important advantage of a stable, permanently secured shaft.

In addition, switch attachment is made simple and sure by positive indexing and a design that permits secure locking in position without removing the control housing.

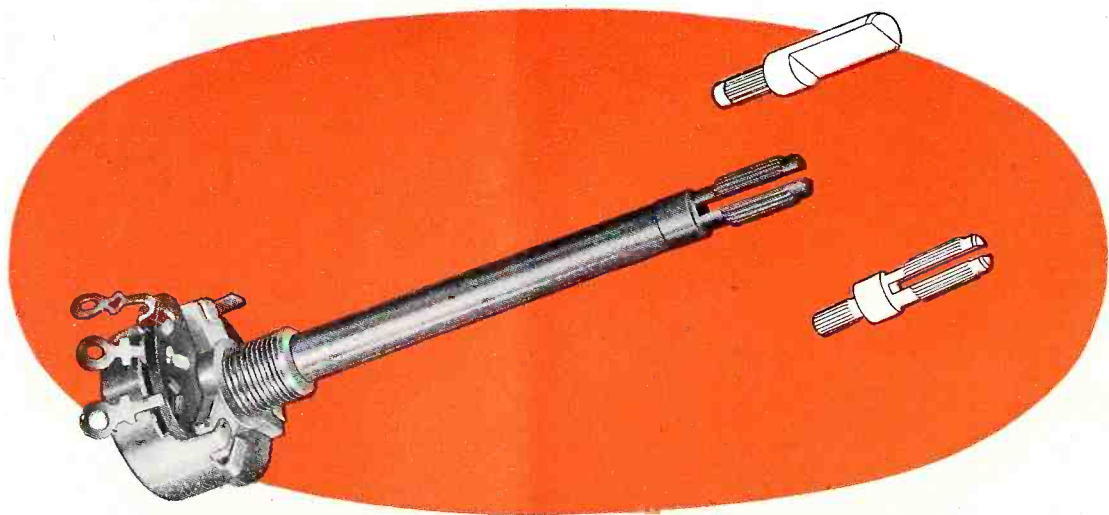

The Mallory Midgetrol gives you fast, sure, simple installation—with electrical characteristics specially engineered for critical applications in both television and radio. Precision-controlled carbon element assures smooth tapers, quiet operation, accurate resistance values and less drift in TV sets.

Make Sure! Make it Mallory!

Mallory Midgetrol*

Installation Time

Dual Concentric Mallory Midgetrol

This revolutionary new control can be assembled in five easy steps, in less than five minutes—makes it possible for you to match a wide range of combinations immediately from convenient distributor stocks, and without the high "time" costs involved in more complex assembly operations.

The "exploded" view below illustrates the parts and assembled control sections supplied with each control. Extremely simple, brief instructions show you how to assemble them quickly and surely—without soldering—with only the simplest of tools.

As with the single Mallory Midgetrol, an AC Switch can be attached quickly—with no question of proper position, without removing the control housing.

The control is so designed that both front and rear sections are *factory-assembled and carefully inspected*. You can be sure that your final dual assembly will give the performance you want!

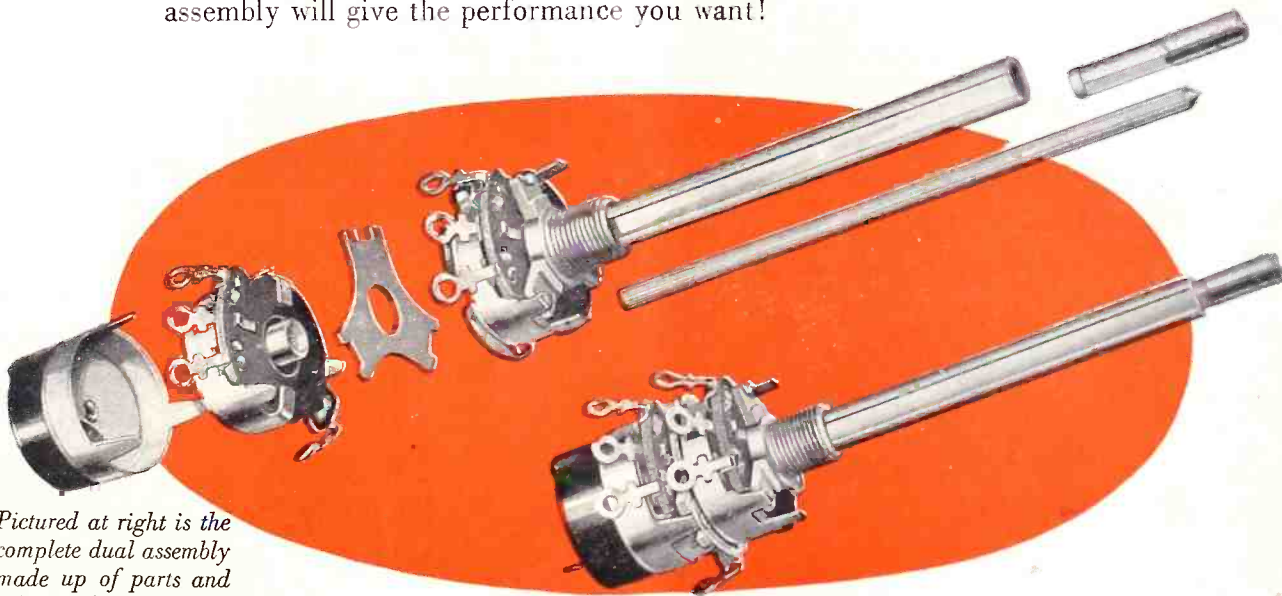

Pictured at right is the complete dual assembly made up of parts and sub-assemblies above.

P. R. MALLORY & CO. Inc.
MALLORY

CAPACITORS • CONTROLS • VIBRATORS • SWITCHES • RESISTORS
• RECTIFIERS • VIBRAPACK* POWER SUPPLIES • FILTERS

APPROVED PRECISION PRODUCTS

*Reg. U. S. Pat. Off.

P. R. MALLORY & CO., Inc., INDIANAPOLIS 6, INDIANA

Check with your Mallory Distributor right now about this important contribution to better, more profitable service work.

Recommended in the 2nd Edition Mallory Television Service Encyclopedia. Get your copy today!

**Trade Mark*



*We're Doing Our Best
to Keep Up With the Demand*



AND THE DEMAND IS PHENOMENAL — far beyond our material limitations
... but be patient and your order will be delivered. We are distributing
TELE-ROTORS uniformly throughout all TV areas ... so wait ... don't
compromise with quality. **YOU CAN'T BEAT A TELE-ROTOR!**

TELE-ROTOR

This heavy-duty TELE-ROTOR has no match! It's more powerful ... will turn any TV antenna array under any weather conditions. Easily installed ... it is trouble-free in performance. Easiest of all to operate!

MODEL TR-2 rotator with "compass control" cabinet having illuminated "perfect pattern" dial ... (uses 8 wire cable) \$49.95

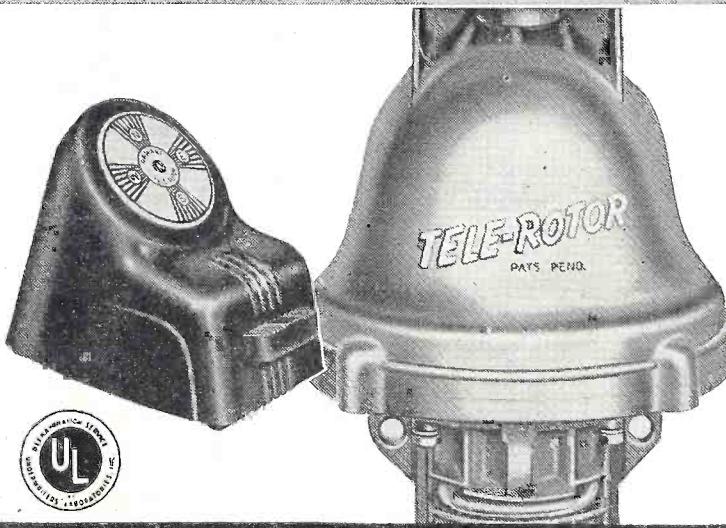

TELE-ROTOR

CUB

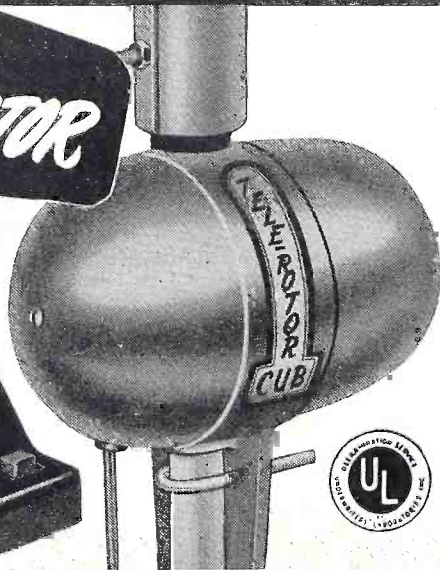
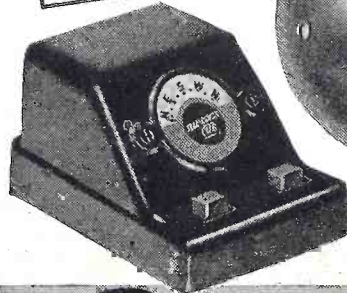

The new TELE-ROTOR "CUB" is ideal for average installations. The same husky motor as the Heavy-Duty model ... the "CUB" is the fastest and easiest of all rotators to install. All-In-Line design ... with true in-line thrust between antenna and mast. The 3/4" STEEL shaft rotates on a case hardened steel ball ... with inline reamed oilless bearings.

MODEL 502A rotator with plastic control cabinet having indicating meter for "hairline" tuning. (Uses 5 wire cable) \$44.95

MODEL 501A rotator with control cabinet having end-of-rotation signal. Light flashes every 7.2° showing antenna is turning. (Uses 5 wire cable) \$34.95



CORNELL-DUBILIER SOUTH PLAINFIELD, N. J.

THE RADIART CORPORATION CLEVELAND 2, OHIO



SYNC PULSES

by San D'Arcy

Acceptable and Practical License Laws are difficult to promulgate. However, in the City of New York, if a license bill along the following lines, suggested by Mr. Sussman and found acceptable by the Association of Radio Servicemen of New York, were to be submitted to the City Council for consideration and adoption—all parties, set owners and service dealers alike, would benefit.

AMENDMENTS PROPOSED BY MR. SUSSMAN

INTRODUCTION

It is hereby declared that the inhabitants of the City of New York are daily becoming the owners of a greater number of television and radio-television receivers and as a result thereof, a new business of servicing, maintaining and repairing said receivers has come into being. It is hereby declared that due to the method of operating said business, a great many inhabitants of the city have received poor and unskilled workmanship and have paid in advance sums of money for yearly service contracts and thereafter have failed to receive said service due either to the financial failure of the service organization or the failure of the non-servicing dealer to assume the rightful business obligations to his customer through the subcontracting methods he employed.

DEFINITIONS

Whenever used in this Article, the following terms shall mean and includes

1. *Servicing* and/or maintaining and/or repairing radio, television and/or radio television receivers, the installation of antennas, both indoor and outdoor, the testing of equipment and repairing same, either on the premises of the owner of the television and/or radio-television receiver, or at any other place and the furnishing and installation of replacement parts.

2. *Service Technician* - Any technician servicing and/or maintaining and/or repairing any radio and/or radio-television receiver either on the premises of the owner of the receiver or at any other place.

3. *Radio and/or Radio-Television Dealer* - Any Dealer contracting for servicing and/or maintaining and/or

The spotlight falls on
another Webster Electric first!

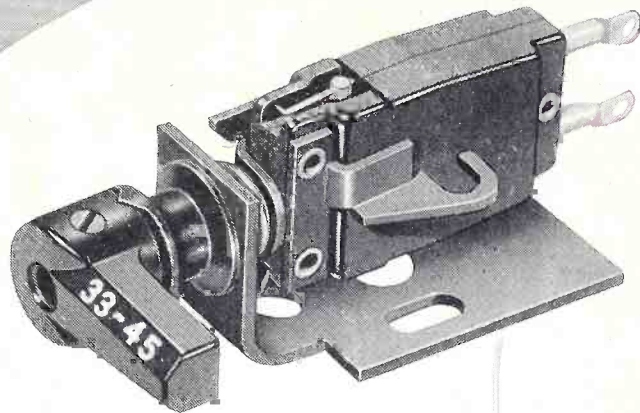

Introducing a **new** two-needle, three-speed Replacement Cartridge... the model **AX**

The new model AX cartridge replaces ninety percent of the two-needle, three-speed cartridges on the market today.

The model AX comes as a complete unit, including twist mechanism, cartridge, needles and instructions for installing in any standard 1/2" mounting. Twist mechanism is easily removed when cartridge is to be installed in tone arms in which twist mechanism is an integral part.

This new cartridge is double-protected against moisture by the Dri-Seal crystal and Dri-Pack packaging.

Tops in quality and competitively priced, the model AX eliminates the need for large and varied stocks of three-speed replacement cartridges... as well as the need for replacement charts. Just one cartridge to stock and to sell.

Available around June 15; write for descriptive folder.

WEBSTER  **ELECTRIC**
R A C I N E ♦ W I S C O N S I N

"Where Quality is a Responsibility and Fair Dealing an Obligation"



*We're Doing Our Best
to Keep Up With the Demand*



AND THE DEMAND IS PHENOMENAL — far beyond our material limitations . . . but be patient and your order will be delivered. We are distributing **TELE-ROTORS** uniformly throughout all TV areas . . . so wait . . . don't compromise with quality. **YOU CAN'T BEAT A TELE-ROTOR!**

TELE-ROTOR

This heavy-duty TELE-ROTOR has no match! It's more powerful . . . will turn any TV antenna array under any weather conditions. Easily installed . . . it is trouble-free in performance. Easiest of all to operate!

MODEL TR-2 rotator with "compass control" cabinet having illuminated "perfect pattern" dial . . . (uses 8 wire cable) . . . \$49.95

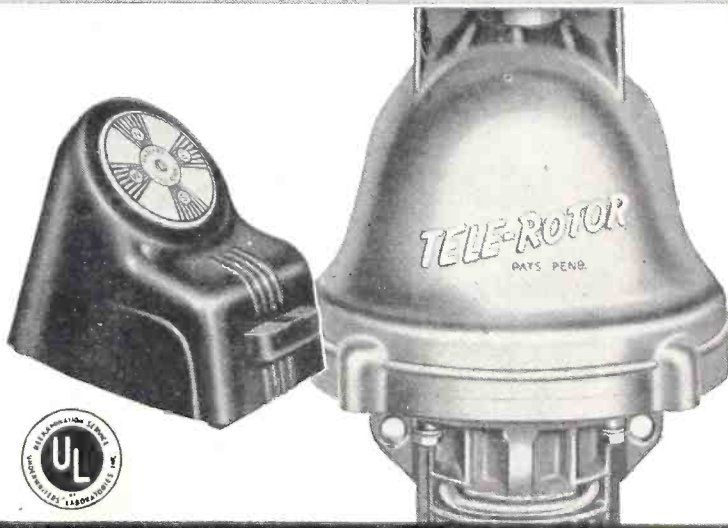

**TELE-ROTOR
CUB**



The new TELE-ROTOR "CUB" is ideal for average installations. The same husky motor as the Heavy-Duty model . . . the "CUB" is the fastest and easiest of all rotators to install. All-In-Line design . . . with true in-line thrust between antenna and mast. The 3/4" STEEL shaft rotates on a case hardened steel ball . . . with inline reamed oilless bearings.

MODEL 502A rotator with plastic control cabinet having indicating meter for "hairline" tuning. (Uses 5 wire cable) \$44.95

MODEL 501A rotator with control cabinet having end-of-rotation signal. Light flashes every 7.2° showing antenna is turning. (Uses 5 wire cable) \$34.95

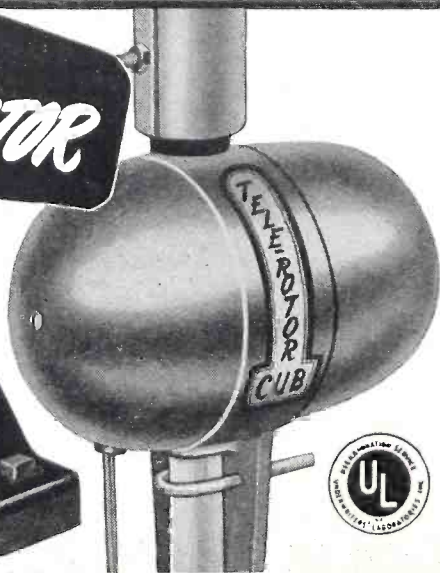

CORNELL-DUBILIER SOUTH PLAINFIELD, N. J.

THE RADIART CORPORATION CLEVELAND 2, OHIO

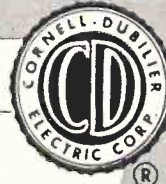

SYNC PULSES

by San D'Arcy

Acceptable and Practical License Laws are difficult to promulgate. However, in the City of New York, if a license bill along the following lines, suggested by Mr. Sussman and found acceptable by the Association of Radio Servicemen of New York, were to be submitted to the City Council for consideration and adoption—all parties, set owners and service dealers alike, would benefit.

AMENDMENTS PROPOSED BY MR. SUSSMAN

INTRODUCTION

It is hereby declared that the inhabitants of the City of New York are daily becoming the owners of a greater number of television and radio-television receivers and as a result thereof, a new business of servicing, maintaining and repairing said receivers has come into being. It is hereby declared that due to the method of operating said business, a great many inhabitants of the city have received poor and unskilled workmanship and have paid in advance sums of money for yearly service contracts and thereafter have failed to receive said service due either to the financial failure of the service organization or the failure of the non-servicing dealer to assume the rightful business obligations to his customer through the subcontracting methods he employed.

DEFINITIONS

Whenever used in this Article, the following terms shall mean and includes

1. *Servicing* and/or maintaining and/or repairing radio, television and/or radio television receivers, the installation of antennas, both indoor and outdoor, the testing of equipment and repairing same, either on the premises of the owner of the television and/or radio-television receiver, or at any other place and the furnishing and installation of replacement parts.

2. *Service Technician* - Any technician servicing and/or maintaining and/or repairing any radio and/or radio-television receiver either on the premises of the owner of the receiver or at any other place.

3. *Radio and/or Radio-Television Dealer* - Any Dealer contracting for servicing and/or maintaining and/or

The spotlight falls on
another Webster Electric first!

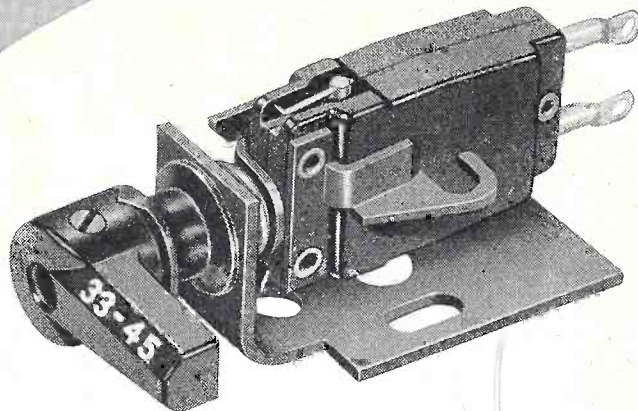

Introducing a **new**
two-needle, three-speed
Replacement Cartridge...

the model **AX**

The new model AX cartridge replaces ninety percent of the two-needle, three-speed cartridges on the market today.

The model AX comes as a complete unit, including twist mechanism, cartridge, needles and instructions for installing in any standard 1/2" mounting. Twist mechanism is easily removed when cartridge is to be installed in tone arms in which twist mechanism is an integral part.

This new cartridge is double-protected against moisture by the Dri-Seal crystal and Dri-Pack packaging.

Tops in quality and competitively priced, the model AX eliminates the need for large and varied stocks of three-speed replacement cartridges... as well as the need for replacement charts. Just one cartridge to stock and to sell.

Available around June 15; write for descriptive folder.

WEBSTER  **ELECTRIC**
R A C I N E ♦ W I S C O N S I N

"Where Quality is a Responsibility and Fair Dealing an Obligation"



**I SELL ONE OUT OF THREE
BY ASKING:**

**“When did you
last change your
Phono-Cartridge?”**

This is a typical experience of service-technicians who pop the \$70 (Million) question—because it's the cue to cartridge replacement sales.

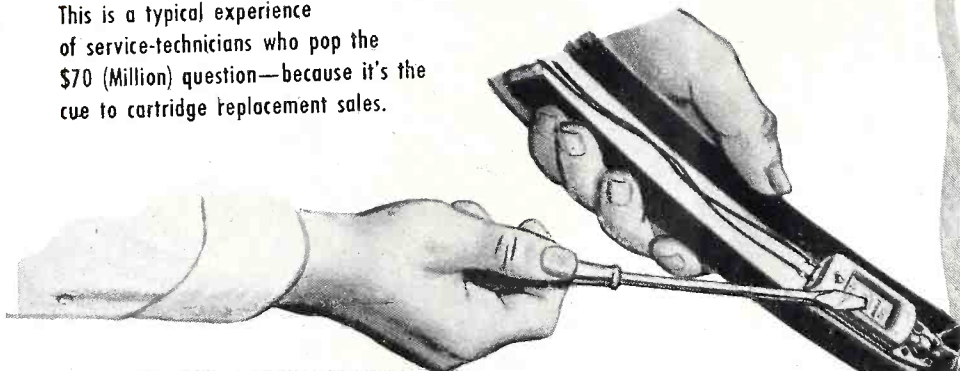

Make the Finger-Tip Compliance Test

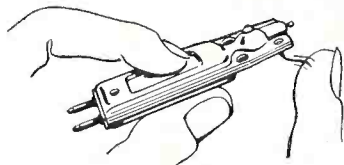

Old style, stiff-acting needle system

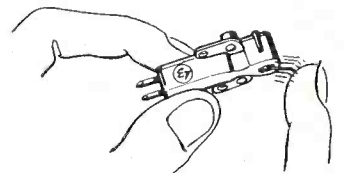

Modern, compliant needle system

It makes record-player owners aware of the importance of the cartridge. It gives you the opportunity to prove that a *modern, lightweight, compliant* cartridge will greatly improve reproduction and save records and needles.

Right now...10,000,000 old-style, heavy, stiff-acting phono-cartridges in existing players need replacing. Current cartridges that are inefficient should be replaced, too.

Follow the E-V plan — *it works*. Check the cartridge on every job — you'll make more sales, more profit!

repairing any radio and/or radio-television receiver on the premises of the owner of the receiver or at any other place.

4. *Service Organization or Contractor* - Any radio and/or radio-television service organization or contractor, contracting with either the general public direct or subcontracting through a radio and/or radio-television dealer for servicing and/or maintaining and/or repairing any radio and/or radio-television receiver either on the premises of the owner of the receiver or at any other place.

5. *Apprentice Service Technician* - Any apprentice technician working under the supervision of a service technician servicing and/or maintaining and/or repairing any radio and/or radio-television receiver either on the premises of the owner of the receiver or any other place.

6. *Technical Advisory Panel* - A Technical Advisory Panel shall be set up to consist of one representative of the Radio and/or Television Service Technicians Association, one representative of the radio and/or radio-television broadcasters and one representative of the radio-and/or radio-television manufacturers and/or electronic industry trade publication which panel shall meet in session at frequent intervals and shall be appointed by the City Council to act in an advisory capacity to the Commissioner relative to any violations of this law.

LICENSE AND PERMIT REQUIREMENTS

1. *Technician's License* - It shall be unlawful for any service technician to service, maintain or repair any radio and/or radio-television receiver without a license therefor issued by the Commissioner.

2. *Business License* - It shall be unlawful for any radio and/or radio-television dealer or any service contractor to service, maintain or repair any radio and/or radio-television receiver without a license therefor issued by the Commissioner.

3. *Apprentice Technician's Permit* - It shall be unlawful for any apprentice technician to service and/or maintain and/or repair any radio and/or radio-television receiver without a Permit therefor issued by the Commissioner.

1A. A technician's license shall be issued to an individual who can prove that has been working full time in radio and/or television repairing for a period of two years or an individual who has completed a course of study with a State accredited trade school - that course to consist of 2,000 hours of full-time training in radio and/or radio-television, and

You can make most cartridge replacements with fewer E-V models

Electro-Voice INC.

411 CARROLL STREET • BUCHANAN, MICHIGAN
Export: 13 East 40th St., New York 16, N.Y., U.S.A. Cables: Arlab

Electro-Voice, Inc., Dept. T5-51
412 Carroll St., Buchanan, Michigan

Send FREE Cartridge Replacement Chart

Name..... (PLEASE PRINT).....
Address.....
City..... Zone..... State.....
 Service-Technician Dealer Record Fan

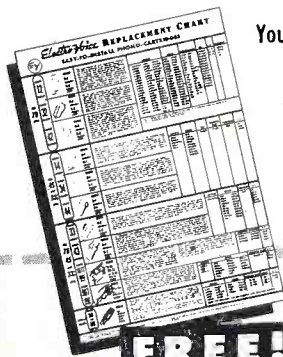

REPLACEMENT CHART
Large, Complete Replacement Chart. Gives handy cross-reference and valuable data. Tells when to replace a phono-cartridge. Ask your E-V Distributor or send for it now.

The **NEW** RCA WV-97A

Senior VoltOhmyst*
reading peak-to-peak voltages

ONLY \$67.50 Suggested
User Price

Includes direct probe and cable,
dc probe, ohms lead, and ground lead

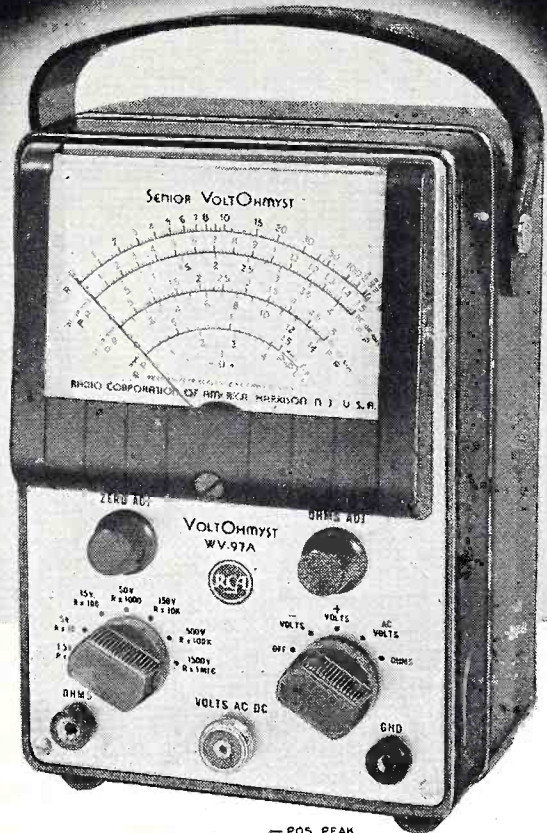

TEN WAYS BETTER!

1. Directly measures complex waves from 0.2 volt to 2000 volts, peak-to-peak.
2. Has an over-all accuracy for dc measurements of $\pm 3\%$ of full scale.
3. Measures dc voltages from 0.02 volt to 1500 volts.
4. Measures rms values of sine-wave voltages from 0.1 volt to 1500 volts.
5. Has 7 non-skip ranges for both resistance and voltage.
6. All full-scale voltage points increase in a uniform "3-to-1" ratio.
7. Frequency response flat from 30 cps to approximately 3 Mc.
8. Negative-feedback circuit provides better over-all stability.
9. Fully enclosed metal case shields sensitive electronic-bridge from rf fields.
10. More convenient to use because of smaller size and new slip-on probes.

The WV-97A measures peak-to-peak voltages directly. Hence, it quickly provides information essential for servicing TV receivers with their pulse-type waveforms.

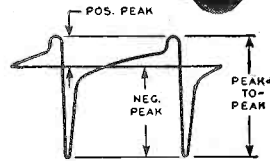

The WV-97A has a range of usefulness extending beyond that of any other instrument in the field. Its quality, dependability, and accuracy make it a true laboratory instrument; it is exactly what is needed for television in the design laboratory, factory, and service shop.

The new Senior VoltOhmyst measures dc voltages in high-impedance circuits, even with ac present. It reads the rms values of sine waves and the peak-to-peak values of complex waves or recurrent pulses, even in the presence of dc. Its electronic ohmmeter has a range of ten billion to one.

Like all RCA VoltOhmysts, it features high input resistance, electronic protection from meter burn-out, zero-center scale for discriminator alignment, molded-plastic meter case, a 1-megohm isolating resistor in the dc probe, and sturdy metal case for good rf shielding.

An outstanding feature is its usefulness as a television signal tracer . . . made possible by its high input resistance, wide frequency range, and direct reading of peak-to-peak voltages.

For complete information on the new RCA WV-97A Senior VoltOhmyst, see your RCA Test Equipment Distributor, or write RCA, Commercial Engineering, Section 55EX, Harrison, New Jersey.

*Reg. U. S. Pat. Off.

SPECIFICATIONS

DC VOLTMETER:

Seven continuous ranges 0 to 1.5, 5, 15, 50, 150, 500, 1500 volts

Input resistance (including 1 megohm in dc probe):

All ranges 11 megohms

Sensitivity for the 1.5 volt range 7.3 megohms-per-volt

Over-all Accuracy $\pm 3\%$ of full scale

AC VOLTMETER—Fourteen continuous ranges:

Peak-to-peak ranges 0 to 4, 14, 42, 140, 420, 1400, 4200 volts

Maximum peak-to-peak input voltage for complex waves, 2000 volts

RMS ranges (for sine waves) 0 to 1.5, 5, 15, 50, 150, 500, 1500 volts

Input Resistance and Capacitance with WG-218 Direct

Probe and Cable:

1.5, 5, 15, 50, 150-volt ranges . . . 0.83 megohm shunted by 70 μmf

500-volt range 1.3 megohms shunted by 60 μmf

1500-volt range 1.5 megohms shunted by 60 μmf

Frequency Response with WG-218 Direct Probe and Cable:

1.5, 5, 15, 50, 150, 500-volt ranges flat from 30 cps to 3 Mc for voltage source having 100-ohm impedance

Overall Accuracy:

1.5, 15, 50, 150, 500, 1500-volt ranges $\pm 5\%$ of full scale

OHMMETER:

Seven continuous ranges 0.2 ohm to 1000 megohms

Center scale values 10, 100, 1000, 10,000 ohms; 0.1, 1, 10 megohms

DIMENSIONS: 7 $\frac{1}{8}$ " high; 5 $\frac{1}{4}$ " wide, 4 $\frac{1}{2}$ " deep

AVAILABLE ACCESSORIES:

WG-264 Crystal Diode Probe. Extends range to 250 Mc

(\$7.75 suggested user price)

WG-289 High-Voltage Probe and WG-206 Resistor to extend range to 50,000 volts. (\$9.95 suggested user price)



Available from your RCA Test Equipment Distributor

RADIO CORPORATION of AMERICA

TEST EQUIPMENT

HARRISON, N. J.

who can satisfactorily pass a practical and theoretical technician's test therefor issued by the Commissioner.

2A. A business license shall be issued to an individual, firm or corporation with an established place of business and who can satisfactorily prove good business ethics and responsibility as requested by the Commissioner.

3A. An Apprentice Technician's Permit issued by the Commissioner shall be required by any individual desiring to enter the servicing industry without any technical test. Such individual shall be required to work under the supervision of a licensed technician who shall be responsible for his work.

3B. An Apprentice technician may apply for a service technician's license after two (2) years of full-time, practical training under the above regulations.

FEES AND TERM

Every license issued under this Article shall be for a period of one (1) year and shall expire on the 30th day of April, next, succeeding the date of issuance thereof.

TECHNICIAN'S LICENSE FEE:

Upon Issuance \$15.00
Upon renewal \$10.00

BUSINESS LICENSE FEE:

Upon Issuance \$25.00
Upon renewal \$15.00

APPRENTICE TECHNICIAN'S PERMIT FEE:

Upon Issuance \$10.00
Upon renewal \$5.00

LICENSE NOT TRANSFERABLE

No Technician's License or Permit issued under the provisions of this Article shall be transferred or assigned to any person, firm or corporation.

LICENSE TRANSFERABLE

A business license may be transferred to any other individual, firm or corporation and can be used at any other location, but only when so transferred with the consent of the Commissioner.

Every licensed dealer or licensed service contractor must have affixed in a prominent place on the front windows of the business establishment and on the panels or back of any vehicle used for service work the license number issued in letters not less than two inches high.

VIOLATIONS

The Commissioner, upon receiving three proven complaints of incompetent service in radio or radio-television repairing, from three different individuals, shall demand proof of competency from such technicians through an approved theoretical and practical test. Failure of technician to pass said test shall be reason for revocation of license. Technician may be relicensed by Commissioner subject to passing new test after an elapsed period of not less than six months.

Any licensed technician named in this Article who shall fail to comply with any provisions as herein stated can be punished by a fine of not more than \$50 for each offense or imprisonment for not more than 90 days and/or suspension and/or revocation of license.

Any licensed dealer or service contractor who shall fail to comply with any of the provisions of this Article can be punished by a fine of not more than \$1000 for each offense, or imprisonment for not more than one year and/or suspension and/or revocation of license.

TVset Price Slashes are rampant around the country. Last month, in Chicago, TVsets were being offered by leading dealers at discounts up to 50%. Now, in New York City, dealers are trying to move sets at discounts up to 60%. Most dealers are taking a bad licking as these sets are accumulated over-stock which isn't moving. A year ago most dealers were offering over \$100 for old type, used TVsets having the type 630 chassis, hoping to get such sets for conversion to large picture tubes and resale in the \$250 price class. Today used type 630 chassis TVsets are being offered at retail sale by dealers for \$49.50 to \$59.50. And there seem to be few takers, even at these prices.

Tenant vs. Landlord Problems are still making newspaper headlines. The following item, reprinted from the N.Y. Sun-Telegram editorial page of April 10th is typical:

HAZARDS OF TV ANTENNAS

"One of the burning questions of the day, involving tenants landlords and television antennas, reaches a fine point in a recent decision by the Appellate Term of Bronx Supreme Court.

A TV fan put up an antenna on the roof of an adjoining building that was not owned by the landlord of the building in which he lived. The court held that since the lead-in wire stretching from the roof over to his living room ran in part along his landlord's building—something like a square foot of masonry was concerned—the tenant was "squatting." The lead-in wire had to come down.

The sudden sprouting of metal jungles on the rooftops of the town pose other problems in this electronic age. For one, there is the new hazard to the safety of fire-fighters.

In many sections, firemen may fight fires efficiently from the roofs of nearby buildings. Moving quickly, on

[Continued on page 56]

POWERFUL

All Channel

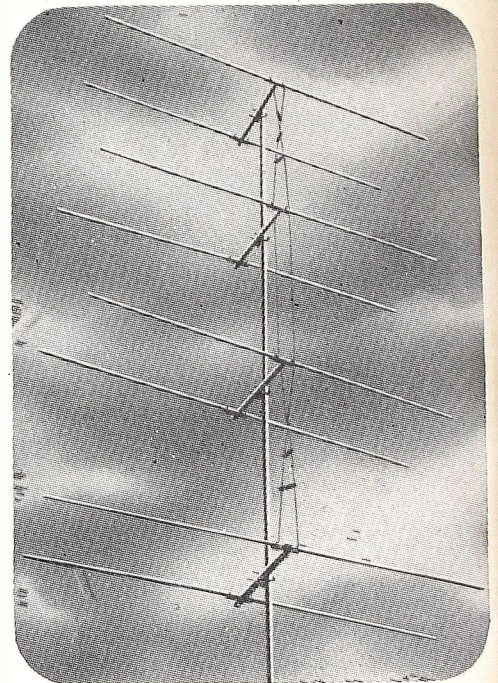

VEE-D-X COLINEAR

This exclusive VEE-D-X antenna was developed to fill the need for more powerful all-channel reception in primary as well as fringe areas. Besides producing higher gain throughout the TV spectrum, the Colinear may be cut to any single high channel for sharp directivity, yet will resonate on low channels regardless of high channel selected. Like the VEE-D-X JC Yagi, the Colinear is completely pre-assembled. It is also the lowest priced four-bay array ever manufactured. The LaPointe-Plascomold Corporation, Windsor Locks, Conn.

Another great

VEE-D-X

first

NEW STACKED ARRAYS

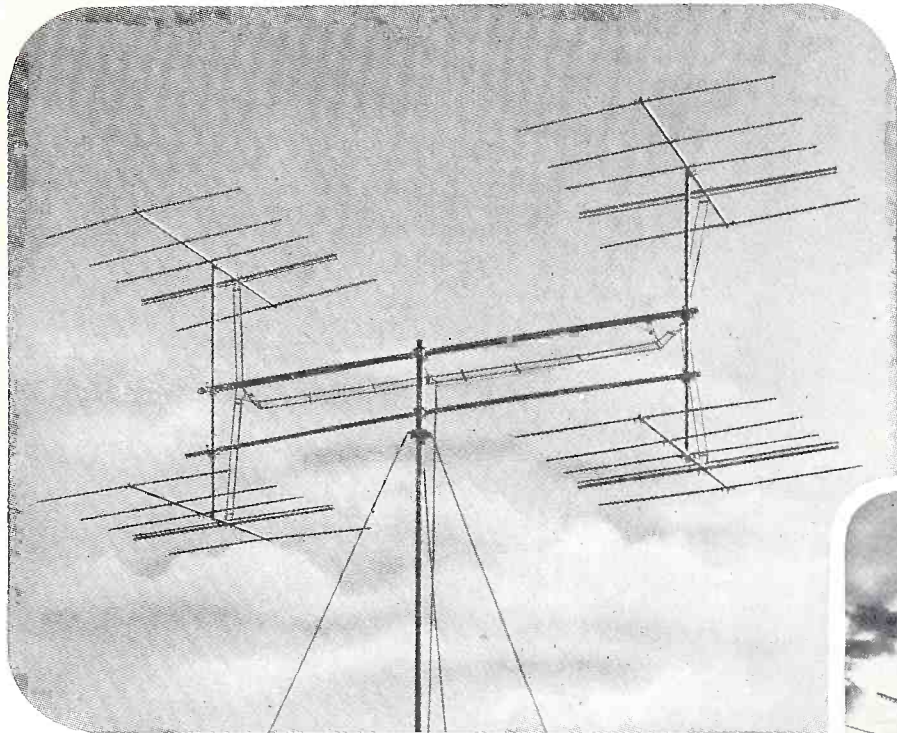

Four Stacked Side-by-side JC Array — a radically new type of array developed for highest gain in hilly and mountainous terrain. Provides powerful long distance reception.

OF THE **JC** YAGI

**PRODUCE SHARP,
CLEAR PICTURES
AT AMAZING DISTANCES**

SUPER POWERFUL

For Single Channel Performance

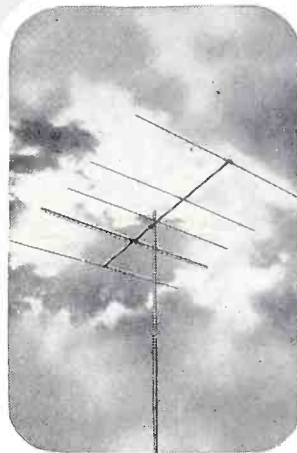

Standard JC Yagi Array — unsurpassed for all normal single-channel requirements.

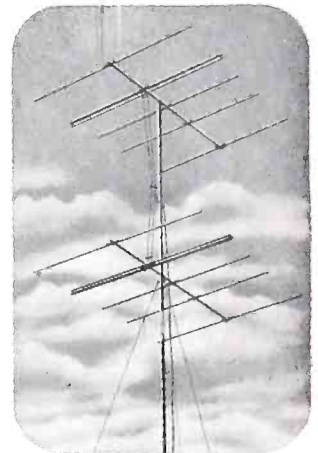

Double Stacked JC Array with half-wave spacing. Provides added gain and better signal-to-noise ratio.

VEE-D-X — largest producer of Yagis — brings you new stacked arrays that provide still higher gain and further reduce noise interference. Perfected by VEE-D-X engineers in collaboration with a foremost authority on wave propagation, these stacked arrays make a world of difference in picture quality. In addition to the already popular double stacked array with half-wave spacing, you can employ double stacked arrays with full-wave spacing and half-wave four stacked, either vertical or side-by-side. Choice of array depends on area terrain and reception conditions.

THE LAPOINTE PLASCOMOLD CORPORATION
Windsor Locks, Connecticut

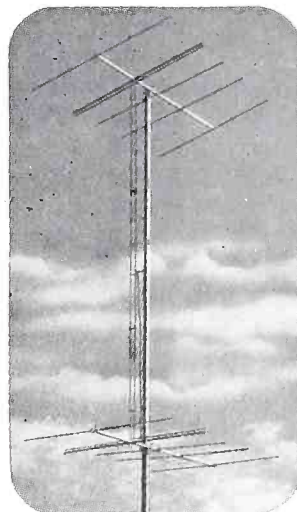

Double Stacked JC Array with full-wave spacing. Provides highest possible gain in low noise areas.

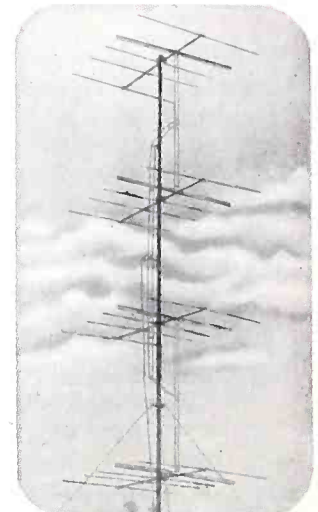

Four Stacked Vertical JC Array provides extremely high gain and excellent improvement of signal-to-noise ratio. Ideal for long distance reception areas with relatively flat terrain.

CHICAGO SHOW
BOOTH NO. 691
DISPLAY ROOM 660

VEE-D-X

BUILDERS OF THE WORLD'S MOST POWERFUL ANTENNAS



"HURRY, HURRY, HURRY!
DON'T MISS THIS NEW,
SIMPLIFIED SERVICING BOOK!"

FREE!

**only until May 31st ...
with the purchase of one
Sylvania Picture Tube!**

Don't let this offer expire without your getting a copy of this splendid, fact-packed servicing manual. Filled with time-saving shortcuts and valuable servicing hints.

Now it's yours absolutely FREE from your Sylvania Distributor with the purchase of just one Sylvania Picture Tube, of any type. But the offer expires May 31st. So, act NOW! Write or call your distributor TODAY!

**SAVES TIME! SAVES MONEY! SOLVES
SCORES OF SERVICING PROBLEMS!**

This book contains 48 pages of pictures, diagrams, and easy-to-follow instructions covering:

Radio Servicing . . . Signal Tracing, Alignment, AVC and AFC Checking, Measurement of Voltages, Signal Levels, Power Output, Band Width and much more.

TV Servicing . . . Signal Tracing, Bandwidth Measurements, Wavetrapp Checking, Sound Channel Tests and Alignment, Low and High Voltage Checks, Signal and Deflection Voltage Measurements, and numerous other subjects.

Audio Amplifier Servicing . . . DC, AC, and Signal Level Measurements; Tone Control, Fidelity, Gain Tests, Distortion, Power Output, and Noise Level Measurements; Signal Tracing, and Speaker Matching.

Miscellaneous Applications . . . 19 different applications of VTVM including Detecting Gassy Tubes, Checking Capacitors, Q Measurement, Turns Ratio Measurement, Impedance Checking.

Servicing Radio
and Television with
a Vacuum Tube
Voltmeter



"DON'T DELAY,
CALL YOUR
SYLVANIA DISTRIBUTOR
NOW!"



Sample pages showing detailed, easy-to-read diagrams.



SYLVANIA ELECTRIC

RADIO TUBES; TELEVISION PICTURE TUBES; ELECTRONIC PRODUCTS; ELECTRONIC TEST EQUIPMENT; FLUORESCENT TUBES, FIXTURES, SIGN TUBING, WIRING DEVICES; LIGHT BULBS; PHOTOLAMPS; TELEVISION SETS

RADIO-TELEVISION SERVICE DEALER • MAY, 1951

THE D-C RESTORER,

Its function and purpose

by **MATTHEW MANDL**
(Technical Institute, Temple University)

A comprehensive article on the theory of d-c restorers; commercial restoration methods; and common d-c restorer troubles and solutions. Among the commercial restoration methods discussed are the grid leak and condenser, the direct coupled, and the diode types of circuits. In the section on trouble-shooting helpful hints are given on quickly identifying troubles.

THE d-c restorer, because it is rather a simple and often misunderstood circuit in the television receiver, is quite frequently overlooked as the source of trouble during servicing. Yet the function of d-c restoration in video amplifiers is an important phase of good performance and the technician will do well to familiarize himself with the reasons for its inclusion in the circuit so he will be better equipped to cope with defects which occur in this system.

D-C restoration may be defined as the process whereby the d-c level of the signal is restored after it has been upset by capacity coupling between video amplifier stages. In television this is very important, for loss of d-c levels will result in retrace lines showing on the screen and will unbalance the average background and brightness of the transmitted scene. In comparison, the d-c levels of radio are relatively unimportant, even though both radio and video are amplitude modulated signals.

Basic Theory

The two drawings in *Fig. 1* will help make this clear. At "A" is shown the carrier amplitude changes for standard broadcast, where the audio signal at the transmitter causes the carrier variations shown. It will be

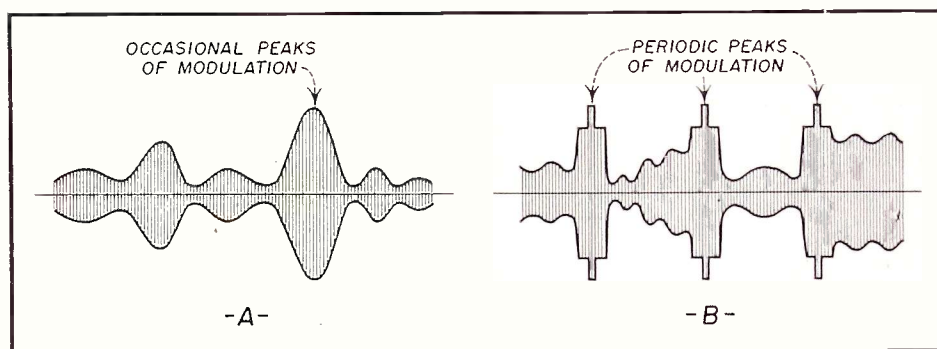

Fig. 1. Difference between standard broadcast modulated carrier and television modulated carrier. Both are amplitude modulated. Standard broadcast waveform is shown at the left and television waveform at the right.

noted that only occasionally does the carrier amplitude reach peaks of modulation—that is, only when a very loud tone is picked up by the microphone.

The television picture carrier at "B", however, reaches the peaks of modulation at regular intervals—every 63.5 micro-seconds to be exact. Thus, the sync tips and blanking levels are constant in amplitude, but the intervening picture information is varying in amplitude throughout the transmission.

Figure 2 shows what happens when the detected signal is passed through the coupling capacitors of audio amplifiers in radios and videos amplifiers

in television receivers. Drawings "A" and "B" show the result of an audio signal which is coupled by a capacitor. At "A" the signal is shown as it comes from the detector, which by the demodulation process rectifies the carrier and thus produces a d-c average level around which the a-c (signal) component varies. Soft, medium, and loud tones all vary around this level which represents average carrier strength. The d-c level which is shown prior to the audio variation represents the carrier in an unmodulated condition—that is, the radio-frequency power is being sent out on the air but no audio is entering the microphone.

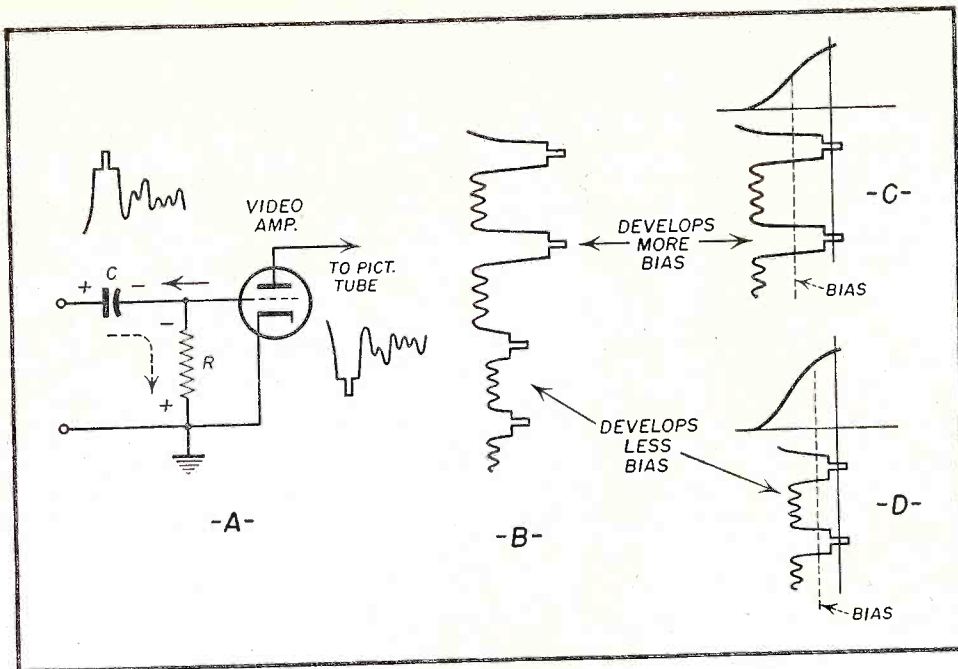

Fig. 3. One method of d-c restoration. In this circuit use is made of the time constant of C and R.

When the detected audio signal is coupled to the first audio amplifier grid through a coupling capacitor, the d-c level is lost (kept out by the capacitor) and the audio variations—now a.c. in character with variations above and below a zero level—appear at the grid. It will be noted that the d-c level is unimportant here, for the soft, medium and loud variations of signal are still present and have not been upset.

This is not the case with the video signal at "C" however, for if the d-c level is lost through a coupling capacitor as at "D", the sync tips and blanking levels will no longer be of identical amplitudes, but will group themselves around the zero line in relation to the average value of the a.c. represented. If this type of signal were now applied to the grid of the picture tube as shown at "F", not only would some of the signal amplitude fail to reach the cut-off (blanking level) of the tube, but the relative backgrounds for the various light and dark levels of the scene would be incorrect. This comes about because the average illumination of the picture tube no longer changes in proportion to the average scene brightness, due to the fact that the various background levels no longer have large relative amplitudes but are now grouped close together near the zero line.

For the reasons detailed above, methods must be utilized which will restore or "re-insert" the d-c level, so that blanking will occur when it should and in addition the background illumination will appear in

proportion to that picked up by the camera at the television studio. When this is done the signal on the grid is properly placed as shown at "E", with each blanking level reaching tube cut-off and thus eliminating the appearance of retrace lines on the screen.

Commercial Restoration Methods

If the signal on a video amplifier stage is positive-going, the method of d-c restoration shown in Fig. 3 is often employed. Here, C and R have a long time constant and the cathode of the tube is ground (zero bias). When the positive-going video signal is applied to this grid circuit, the grid will have a positive polarity and thus draw current.

The current flow is in the direction of the arrow at the grid in Fig. 3A and it will therefore charge the capacitor with a polarity which is minus toward the grid and positive toward the incoming signal. During the time between sync tips when the grid is not run positive, this capacitor will slowly discharge across the resistor in the direction indicated by the arrow beside the resistor. Inasmuch as this will cause a voltage drop across the resistor with a negative potential on the grid side, bias is furnished for the tube.

Because the sync tips through the coupling capacitor vary as shown in Fig. 3B owing to loss of the d-c level they will cause more or less grid current to flow, depending on their amplitude. This means, then, that the bias which is developed across the

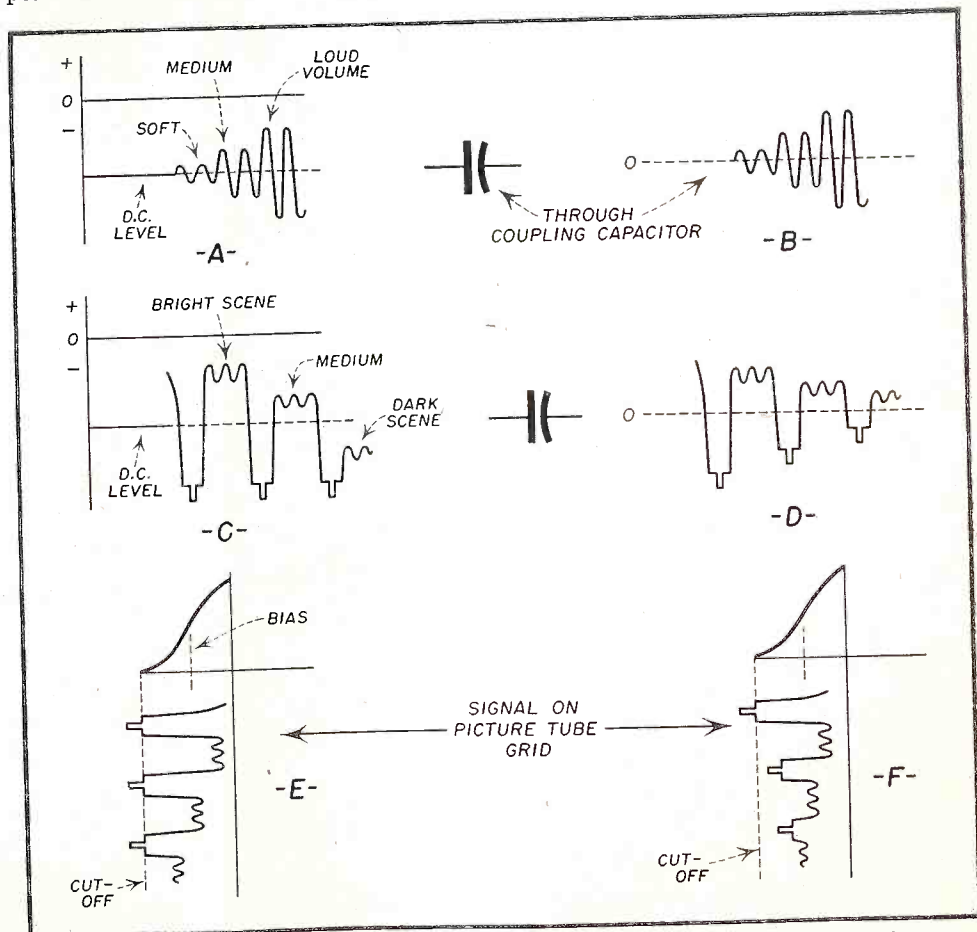

Fig. 2. How coupling capacitor destroys d-c level. At "A" signal is shown as it comes from the detector; at "B" the signal is shown coupled through a condenser; at "C" the video signal is shown together with its d-c component; at "D" the d-c component is removed; at "E" and "F" are the correct and incorrect pix grid signals.

grid resistor will depend on the sync tip amplitude—more negative bias for signals which have high amplitude, and less bias for low amplitude sync tips as shown at "C" and "D". With the bias thus changing for different levels, the blanking will be at a constant level when the output signal of this stage is applied to the picture tube. This assures tube cut-off during blanking intervals and a changing background on the screen of the picture tube which faithfully follows the changing scenes being televised.

Many receivers use this method (including the original RCA 630) besides the more familiar tube type described later in this article. While the d-c restorer tube is usually marked as such in the service schematics, the grid capacitor—resistor method is not usually designated and the technician is not aware that changes in the values of capacitor or resistor will upset d-c restoration and thus destroy its very useful function.

Inasmuch as d-c restoration is necessary because capacitive coupling is used, one might wonder why direct coupling would not be used exclusively and thus avoid loss of d-c level. While some manufacturers do utilize direct coupling, the latter necessitates a well-regulated power supply and a careful and critical balance between grid-cathode-plate voltages. Since direct coupling from the video amplifier plate to the picture tube grid will impress the plate voltage on the kinescope grid, a higher B plus voltage would have to be applied to the cath-

ode than appears on the grid in order that the grid will be negative with respect to the cathode (negative bias). The relative voltage proportions as shown in Fig. 4 are typical, and to avoid the costly and exacting voltage distribution this imposes in design and manufacture the majority of receivers utilize some form of d-c restoration.

Diode Restoration

When the video amplifier output tube is coupled to the picture tube with a coupling capacitor, a diode type of restorer is usually employed as shown in Fig. 5. A crystal diode is also used for this purpose with no change in schematic or function except for replacing the vacuum tube diode with the crystal.

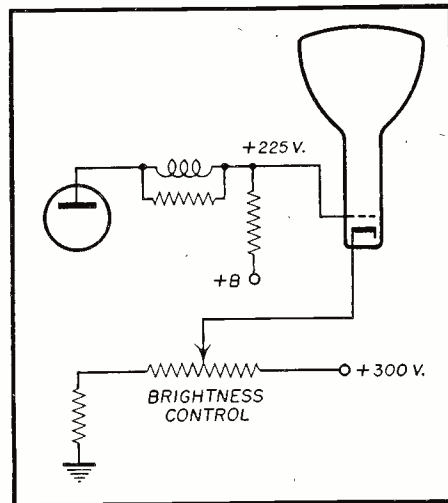

Fig. 4. Direct coupling requires a positive cathode so that the grid is relatively negative.

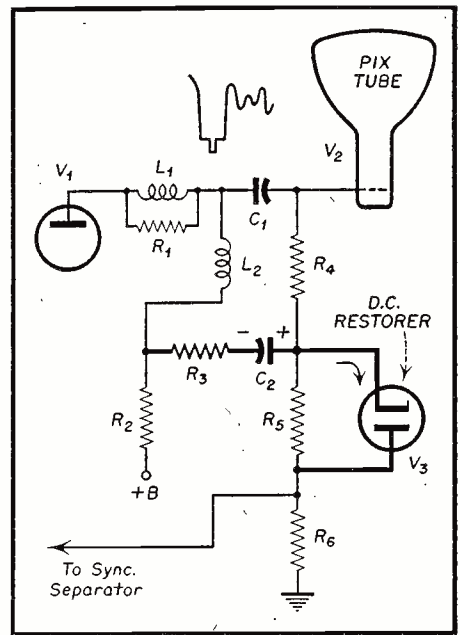

Fig. 5. Diode d-c restorer circuit the counterpart of which is found in many receivers.

V1 is a conventional video amplifier, in which L1 and L2 are the peaking coils, R2 the load resistor, and C1 the coupling capacitor. Instead of a single grid leak for the picture tube, we now have R4, R5 and R6 in series, with a tap on the lower resistor for picking off the signal so that the sync pulses may be applied to the separators and subsequently used to trigger the sweep systems.

The restorer tube system is across R5 and consists of R3, C2 and the diode tube V3. During the peak signal represented by the sync tips the diode conducts, inasmuch as the video signal is of negative polarity. During conduction in the direction indicated by the arrow, a charge is placed across C2 with a polarity as shown. This charge remains virtually at full value during the interval between sync tips because of the relatively large value of C2 (long time constant of C2 and associated resistors). Since this is a positive charge on the picture tube grid side, it will reduce the picture tube bias. Thus, if the average brightness is high more peak diode current flows and a greater plus charge appears across C2. This means a decrease in bias in exactly the same manner as shown in Fig. 3 for the first restoration method discussed herein. Less sync amplitude would mean a smaller charge across C2 and a greater negative bias (less bias reduction with smaller plus charge at C2).

This method is used extensively in modern receivers, though schematically it may be shown in a different physical layout even though the cir-

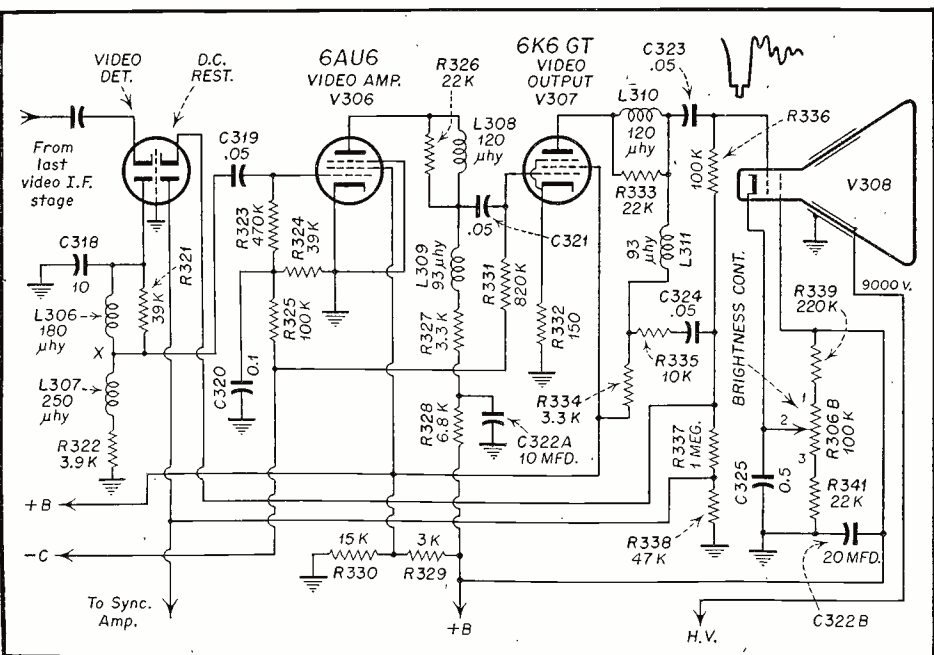

Fig. 6. Application of d-c restoration as employed in Admiral 30B1 chassis. One of the diodes of the 6AL5 duo-diode is used as the diode of the d-c restorer circuit.

uit is exactly the same. This is illustrated in *Fig. 6* where the Admiral 30B1 circuit diagram for the video strip is shown. Here, for convenience, a 6AL5 duo-diode is used and the video detector and d-c restorer are both in one tube envelope but are separate electronically. The second portion which is the restorer is wired into the circuit exactly the same as the previously discussed restorer illustrated in *Fig. 5* as will be evident if the cathode (pin 5) and plate (pin 2) are traced out. These two will be found connected across *R337* which corresponds to the identical resistor marked *R5* in the previous discussion.

Common DC Restorer Troubles

Common symptoms which appear on the picture tube screen when trouble occurs in the restorer circuit are:

1. Loss of picture
2. Visible retrace lines
3. Poor picture quality and background
4. Hum bar in the picture
5. Excessively dark picture

From this list it is evident that the restorer can cause symptoms on the screen which would also appear for troubles in other stages of the receiver. Quite often this misleading information on the picture tube causes considerable time loss while other circuits are checked. For this reason it would be well to check the relatively less complex restorer circuit first before extensive checks are made on the more complex stages when trouble occurs.

If, for instance, a filament-cathode short occurs in the d-c restorer tube, it will impress a 60 cycle a-c voltage across a portion of the picture tube grid leak. This will then shift the grid bias back and forth during the 60 cycle down-trace of the vertical sweep, causing a portion of the vertical scanning to be dark and another portion light, as shown in *Fig. 7*. Inasmuch as the sync signals are also

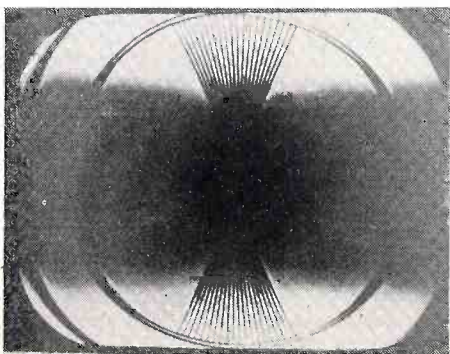

Fig. 7. Effect of hum on picture tube grid. Stationary bar occurs if hum is in phase with sync.

taken from this resistive network in many receivers, some of the hum potential will feed to the sweep circuits, causing a bending affect of the raster section which is affected. This bending affect pulls a portion of the raster to one side as the hum affects sweep. The black bar shown in *Fig. 7* will be stationary if the hum frequency is exactly in phase with the incoming sync. Otherwise, the bar will move slowly up or down the screen. The identical symptoms, however, will appear if a cathode-filament short develops in any of the tubes in the video strip.

Failure of the d-c restorer diode to conduct will increase the bias on the picture tube because of the removal of the positive polarity developed by the restoration action. Since this positive polarity is much less in value than the negative grid bias, the picture

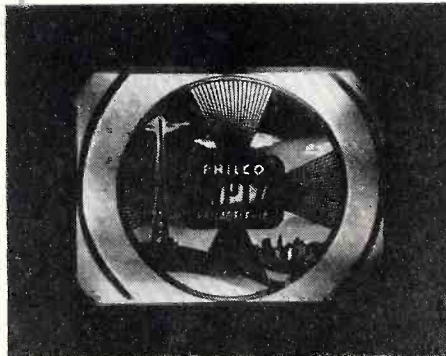

Fig. 8. Excessive bias darkens picture when restorer tube fails.

tube grid is always negative, but becomes more so when the restorer tube fails. If a picture is being viewed and the restorer tube filament suddenly opened, the increased bias would darken the picture as shown in *Fig. 8*. In some receivers the entire screen would go completely black due to the excessive bias developed. Readjustment of the brilliancy control (decreasing picture tube bias) will brighten the picture, but average background will be lost and the picture will have a wash-out appearance as shown in *Fig. 9*. Again, either the excessively darkened picture or the washed-out one could be indicative of troubles elsewhere, and often several circuits will have to be checked to locate the faulty tube or component of the system and the result would be. The darkened picture could, of course, be the result of an improperly adjusted AGC system or contrast control, as well as troubles in these circuits. The light picture could be the result of poor signal input due to antenna faults or low gain in the video i.f., tuner, or video amplifier sections.



Fig. 9. Washed out appearance of pix on readjusting brightness.

A shorted *C2* capacitor will apply plus B to the picture tube grid as would a shorted coupling capacitor as will be evident from an inspection of the circuit of *Fig. 5*. With these capacitors leaky or shorted the negative bias of the picture tube will be overcome resulting in excessive brilliance with a faint, washed-out picture.

A change in value of *R2*, *C2*, *R5* or the conduction of the diode, will alter the restoration characteristics of the system and the result would be retrace lines showing on the screen, as well as lack of variation in average background for various televised scenes. Inasmuch as few components are present in a restorer circuit, little trouble will be experienced localizing the exact component which is defective once the d-c restorer system is suspected. Tube testing or substitution should be the first procedure before a continuity or voltage check is made of the system. A voltmeter (VTVM) placed across the network of resistors from the grid of the picture tube to ground should indicate a change in the bias potential when a station is tuned in. This is a simple check and gives an immediate indication regarding whether or not the d-c restorer is functioning.

If, as in some receivers, the restorer tube is separate and not contained in the same envelope as the detector, removal of the restorer tube should cause an immediate darkening of the picture. If this does not occur the restorer system is not operating either because of a non-conducting diode or crystal, or because of some component failure.

Crystal restorers should be removed from the circuit and tested with an ohmmeter. Generally, the resistance read in one direction should be around 20 times higher than when the ohmmeter test prods are reversed. Since differences occur for various crystals, however, direct substitution is the best method for checking a suspected crystal restorer.

by **M. RABINOWITZ**
*Electronic Instructor, Temple
 University Technical Institute*

Fig. 3. Front view of Crystal-Calibrated Signal Generator. By connecting the points on the outer and inner half-circles calibration points at each .125 mc are obtained at the intersections.

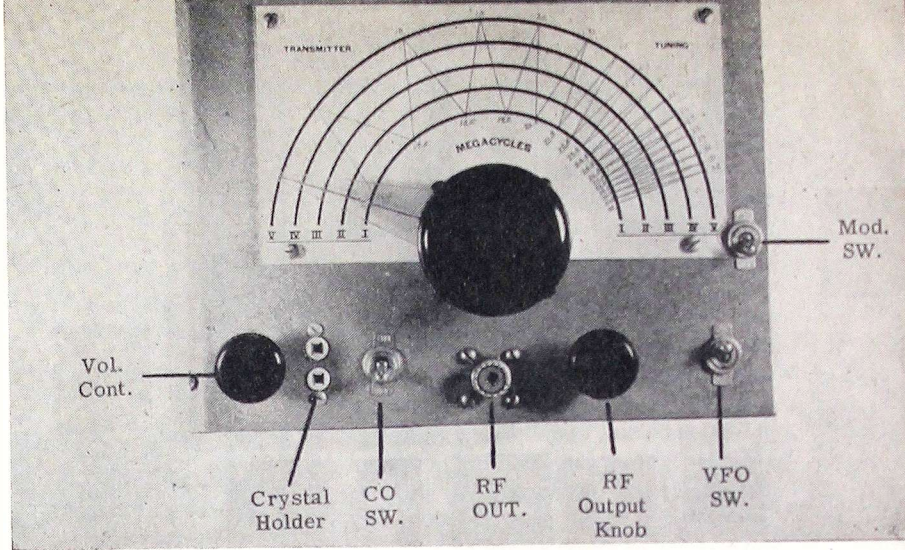

CRYSTAL-CALIBRATED SIGNAL GENERATOR

for

TV, FM I-F, & INTERCARRIER ALIGNMENT

MANY times I have had TV sets on the bench with the i-f stages (video and sound) out of adjustment. I gradually gathered together ideas on what I would want for a test instrument to actually do a satisfactory repair or conversion job without spending the time and trouble for sweep generator alignment, these are as follows:

1. A signal generator to cover TV-IF frequencies, variable to within a fraction of a megacycle and as accurate as a crystal, so that I can quickly align each stage of a stagger-tuned system to the exact frequency as called for in the schematic.

2. A crystal calibrator so that I could instantly check the accuracy of the dial calibrations without any additional connections.
3. A crystal controlled oscillator, rich in harmonics, for 4.5 mc, inter-carrier sound, 10.7 mc for FM-IF alignment, 5 mc for harmonic check every 5 mc, or any other I desire to use.
4. A 400 cycle audio oscillator to modulate either the VFO (variable frequency oscillator) or the CO (crystal oscillator) when needed.

All these requirements would have to be incorporated into a single unit.

I intended to purchase an instrument which would accomplish what I wanted, but on checking with the major test equipment manufacturers, I discovered that although some manufacturers did have equipment which covered many or all of the above requirements, the cost was prohibitive. The only thing I could do, as a last resort, was to design and construct an instrument which would accomplish all four items listed. After many trials and tribulations, the signal generator was completed the dial calibrated, and Brother! How it works! It performs far better than I anticipated.

Description of Circuit

As shown in *Fig. 1* a Hartley type VFO is employed using a type #7193 tube for appreciable power output, capacity coupled to a 6C4 triode mixer and cathode follower i-f output.

A Pierce CO circuit using a 6C4 triode also capacity coupled to the 6C4 mixer tube mentioned above.

An audio oscillator to modulate either the VFO or the CO, or both. Uses a 6C4 triode.

A 2-stage audio amplifier using a 6J6 tube and a 2" PM speaker to simplify zero beat calibration and re-checking with a continuously variable volume control.

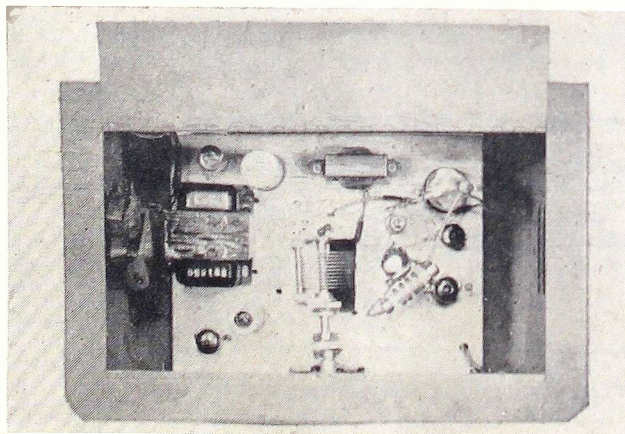

Fig. 2. Illustration of parts layout on top of chassis. The actual and exact layout depends on the parts used by the constructor.

A well filtered power supply using a 6X4 tube.

Individual switches are incorporated in the filament circuit of the VFO, the CO, and the modulator tubes so that any one of them can be switched off.

A 95 ohm co-axial cable is used for the r-f output leads. A terminal is brought out in the rear for connecting to a good signal generator for calibration and then later as a standard to check accuracy of other signal generators. The crystal holder is brought out on the front panel so that any frequency crystal can be used. The harmonics of the CO is used for spot calibrations and then zero beating a good signal generator with the VFO for in-between markings.

Almost all the parts used by the author were on hand so that the actual cash expenditure was very little. Construction details are not given as the actual layout and dimensions will depend upon the parts used. Inasmuch as most of the parts used are clearly marked in the schematic, a parts list is not necessary. An approximate layout of parts on the chassis and front panel is shown in separate illustrations, (see Fig. 2 and 3) but is still mostly dependent on the parts used by the constructor. The dial face is a sheet of transparent celluloid or plastic with the 5 semi-circular lines already on it, or which may be inked in.

Calibration

The calibration points on the outside semi-circular line is in megacycles, while the inside semi-circular line is in .5 megacycles. We then draw a line from the points on the outside line to the points on the inside line thereby giving us accurate markings at each .125 megacycle where the lines drawn intersect each succeeding semi-circular line.

Before we start with the actual calibration several things must be thoroughly understood so as not to be confused in our calibrating process. We must remember that the crystal oscillator and the VFO are both rich in harmonics thereby giving us many false zero beat points which may tend to confuse us. Always keep that in mind during the calibration process.

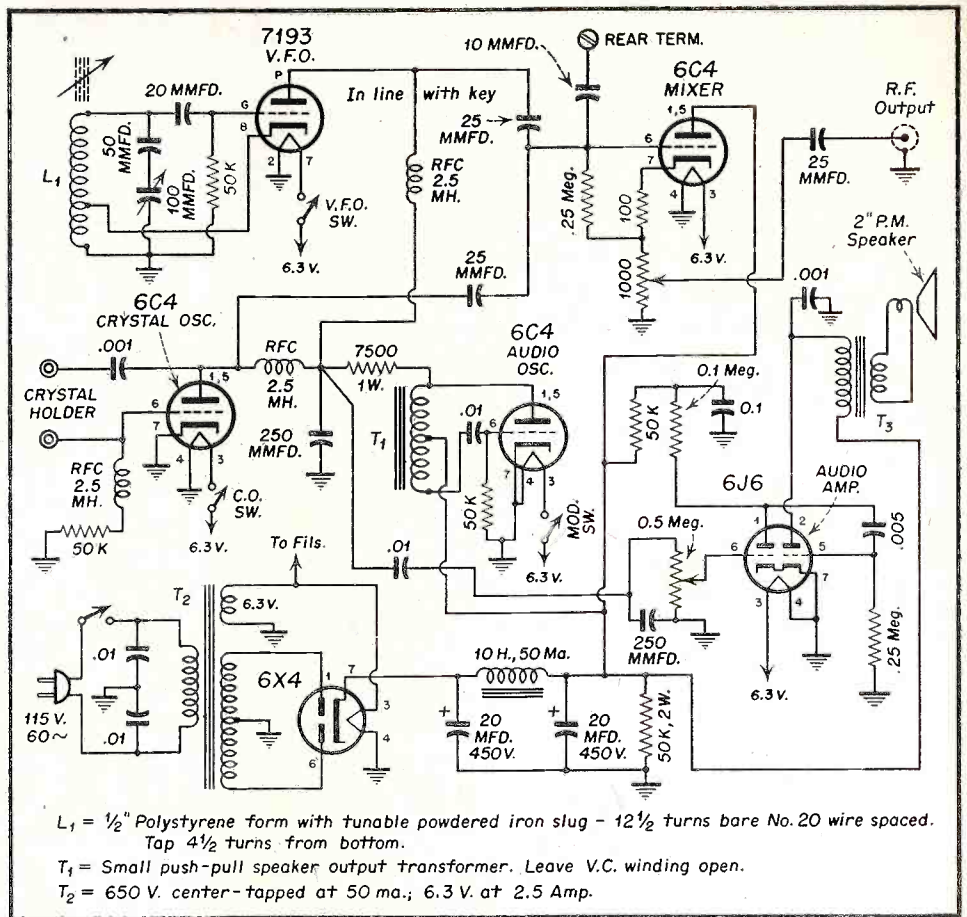

Fig. 1. Wiring diagram of Crystal-Calibrated Signal Generator described in this article. Hartley oscillator uses a 7193 tube. Crystal oscillator uses a Pierce circuit. Audio oscillator employs a 6C4, and a-f amplifier a 6J6.

It would be wise to obtain an even 5 mc crystal, a 10.7 mc crystal for FM-IF alignment, a 4.5 mc crystal for intercarrier sound alignment, and several commercial crystals of various frequencies for calibration purposes. Then make up a small chart as shown in Fig. 4.

Connect an unmodulated accurate signal generator to the rear binding post. Insert a 5.0 mc crystal in the crystal holder. Turn the CO on (leave VFO and Mod. switches off). Turn up the amplifier volume control and zero beat our external signal generator every 5 mc for accuracy. Note how far off the external signal generator is at the frequency range that our instrument will operate on, so that we can allow for this discrepancy. Now set the external signal generator at 15 mc by beating with the CO.

Turn the CO off and turn on the VFO. Set the pointer of our instrument to zero beat with the external signal generator and spot mark the outside semi-circle. By repeating the above all along the dial we can accurately calibrate our instrument. On rechecking our calibration during use, a slight shift can be compensated for by adjusting the permeability core slug in the VFO tuning coil.

Many TV sets manufactured today have video i-f stages in the 40 mc range. If the constructor so desires he can draw an additional scale in red pencil or ink on the dial using the 2nd harmonic of the VFO against the proper range of the external signal generator and higher harmonics of the crystal oscillator. This should give us an additional range of from 33 mc to 60 mc.

Crystal freq.	2nd har.	3rd har.	4th har.	5th har.	6th har.	7th har.	8th har.
4.5 MC	9.0	13.5	18.0	22.5	27.0	31.5	36.0
5.0	10.0	15.0	20.0	25.0	30.0	35.0	40.0
10.7	21.4	32.1	42.8	53.5	64.2	74.9	85.6
Other crystals							

Fig. 4. Chart of fundamentals and harmonics of the various crystal frequencies used with signal generator.



U. H. F.

TRANSMISSION LINE TUNED CIRCUITS

by **ALLAN LYTEL**

(From a forthcoming book, "VHF Fundamentals")

FIGURE 1 illustrates six common transmission line types including both the parallel wire of the coaxial variety. Part *A* is the commonly used shielded line or coaxial cable with its single inner conductor, the solid dielectric material, the copper wire braid and the protective outer jacket. In areas of high noise level, such transmission line is commonly used between the television antenna and the receiver. Part *B* is the coaxial air-space cable specifically designed for its low value of capacitance. The inner conductor is smaller in diameter than a standard coaxial type and the dielectric material is made of a thin hollow tube. A dielectric thread which is wound in the shape of a long spiral is used to keep the center conductor evenly spaced in its mounting through the dielectric cylinder. Thus, because of the dielectric thread in its spiral share and the circular hollow dielectric preventing contact to the outer braid, this line uses air as a part of the insulating material between the inner and outer conductors. In part *C*, the dual shielded line is shown whose construction is similar to the single coaxial line except that there are two conductors running through the solid dielectric material. A pair of single coaxial lines mounted in a common braid jacket is shown in part *D*.

A specialized type of coaxial line shown in Part *E* has the inner conductors spiraled around a cylindrical center of dielectric. This line is designed so that it is very much longer electrically than it is physically because of its specialized construction.

A basic discussion of UHF transmission lines as tuned circuit equivalents. The explanations offered by the author are first from the point of view of current and voltage flow in a circuit containing varying conditions of open and short circuits at the load end; and then from a mathematical point of view.

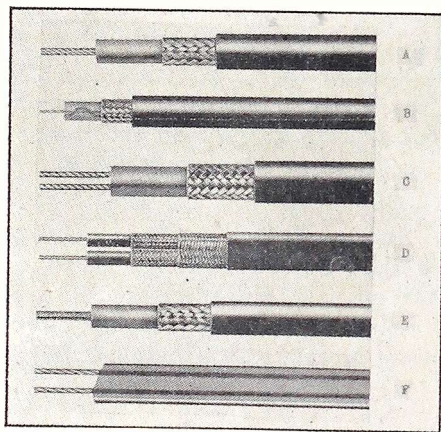

Fig. 1. Transmission Lines of various types.

Each foot of this line is equal to approximately 10 to 15 electrical feet of coaxial transmission line. A very popular type of parallel wire transmission line with a solid dielectric is in part *F*. This is the widely used parallel pair whose impedance is usually 300 ohms. In the above *Fig. 1*, these transmission lines may be used for connection between the antenna and the receiver or transmitter for low-powered work. As tuned circuit elements, the most commonly used types are similar to either the coaxial lines as in part *A* or the parallel wire type as in part *F*, although some types of

transmission line tuned circuits resemble the specialized types.

Coaxial line is commonly used to interconnect sections of UHF test equipment since there is no radiation from such lines. An exact knowledge of the characteristics and behavior of the transmission line connectors is necessary to obtain accurate results. *Figure 2* shows a calibrated coaxial line attenuator whose insertion loss is 10 DB. The characteristic impedance of this device is 70 ohms and it has six steps in the attenuator as shown; several of these may be used at the same time with appropriate switches thrown in the ON position so that any in-between value of attenuation may be obtained.

Transmission Line Tuned Circuits

A parallel wire transmission line can be used as a tuned circuit because of the inductance and capacitance which are actually a part of the electrical characteristics of such a line. Let a parallel wire transmission line be short circuited at the load end as in *Fig. 3* and by means of the current and voltage regulations in this line, its effect as a resonant circuit can be demonstrated. In the case of a short-circuited transmission line, energy is sent down the line from the radio frequency generator at the veloc-

ity of propagation. This energy represents voltage and current in phase which is the condition existing at the generator. However, when this energy reaches the short-circuit at the load, energy must be sent back to the generator or reflected because of the impedance mismatch. Energy travels along the conductors since at any instant there is an opposite polarity condition across the generator, that is, one output terminal is going positive while the other output terminal is going negative. Since a conductor is connected to each terminal of the generator, radio frequency energy in the form of current and voltage travels down the transmission line toward the short circuit.

However, a short circuit *cannot* absorb energy from the load because there is no possibility of power loss in the form of heat or IR drop. This short circuit must reflect or send energy back to the generator. Energy going from the short toward the generator is in the opposite direction to the initial energy and these two opposite motions add to and subtract from each other to create standing waves. Across the short circuit which is the line termination, there can be no potential difference, however there is a large current flow. It is assumed that this short circuit is physically the smallest possible making a direct and complete circuit across the transmission line. Under these conditions, there can not be a potential difference across the transmission line load, but there is a large current flow. This is illustrated as a maximum current condition and a minimum voltage condition. On the top wire, current is indicated as positive while on the bottom wire, current is indicated as negative showing direction of current



Fig. 2. Calibrated coaxial line attenuator with characteristic impedance of 70 ohms.

flow. In order to represent this graphically, positive is taken as above the line while negative is taken as below the line.

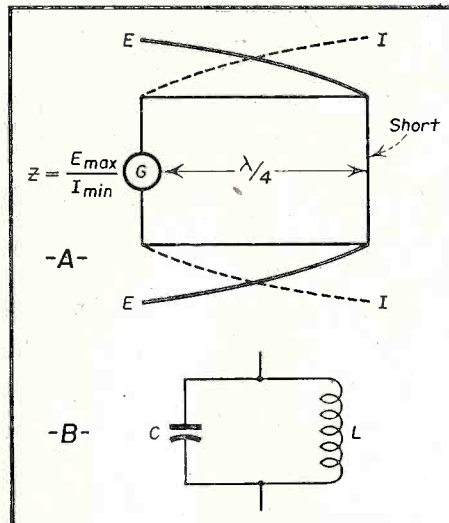

Fig. 3. A quarter-way transmission line shorted at the load end is equivalent to a high impedance.

Since radio frequency energy travels in the sinusoidal form or shape, the current flow will decrease in a sinusoidal manner from the short circuit going toward the generator. In the

same sense, voltage will increase from the short circuit toward the load. Because of the sinusoidal wave shape, the generator will "look" into the transmission line and see a high impedance. This transmission line section is drawn as a quarter wave length or 90 electrical degrees. In the figure, a dotted line represents current and a solid line represents voltage. Thus there is a current maximum and voltage minimum condition at the short circuit, and a voltage maximum and current minimum at the generator. The generator thus sees a high impedance because of the high voltage and low current, therefore the quarter wave transmission line appears as a high impedance or a parallel resonant circuit.

One must use extreme care in making analogies between transmission line tuned circuits and a low frequency equivalent. At a given resonant frequency, a $\frac{1}{4}$ wave transmission line and a low frequency equivalent are exactly the same electrical device. They both present a *high* series impedance to the operating frequency and they are resonant to one and only one frequency in this vicinity of resonance. However, as the frequency is increased, to a sufficiently high value, the $\frac{1}{4}$ wave parallel circuit will become $\frac{3}{4}$ of a wave length long and will *again* act as a parallel resonant circuit. At the third harmonic of this fundamental resonant frequency, the $\frac{1}{4}$ wave transmission line will be $\frac{3}{4}$ of a wave length long and again parallel resonant. However, at the third harmonic of this fundamental frequency, the low frequency parallel tuned circuit will no longer be resonant but it will be a capacitive reactance. Above resonance, in a parallel tuned circuit, the capacitive reactance becomes less and the inductive reactance becomes more but because more current flows through the lower reactance, the circuit will appear as a capacitive reactance.

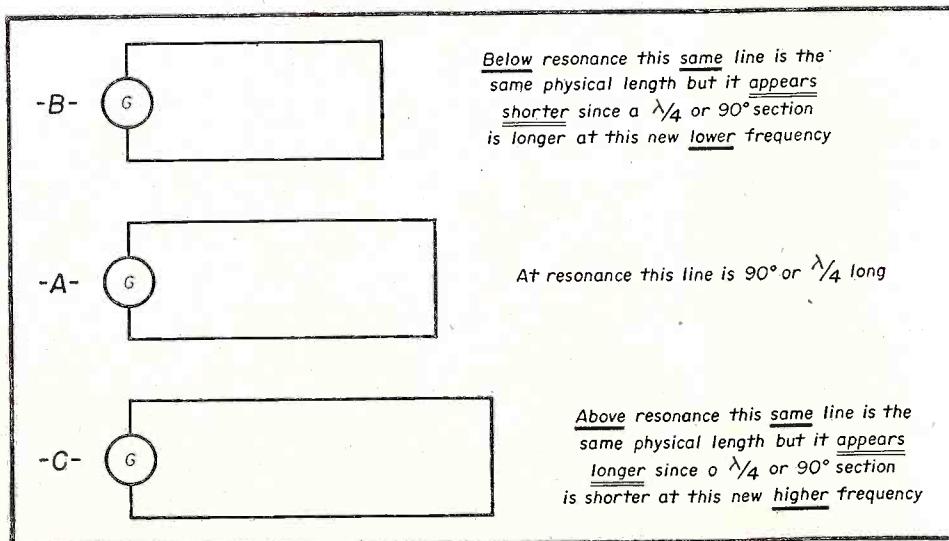

Fig. 4. Line Length as a function of frequency.

The behavior of a parallel wire

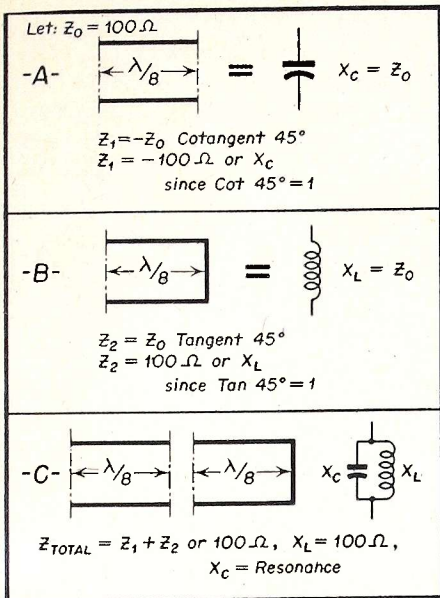

Fig. 5. Line length as reactance.

transmission line as the frequency is changed is illustrated in Fig. 4. In part A of this figure, a $\frac{1}{4}$ wave short circuited transmission line is shown at exactly its resonant length. If the frequency of operation is decreased the wave length at the new lower frequency is now longer since wave length and frequency are inversely related. The section of line is still exactly the same physical length but it appears to be shorter electrically since a quarter wave or 90 degrees section would have to be longer at this new frequency, hence the original line appears electrically shorter at a lower frequency.

As the frequency is increased, as in Part C of Fig. 4, the wave length becomes shorter since the wave length becomes shorter at the new higher frequency. Above resonance then, this original line is the same physical length but it appears longer because a $\frac{1}{4}$ wave or 90 degrees line section is shorter at this new high frequency. Thus the line section, whose length does not change, appears to be electrically longer at the higher or above resonant frequency.

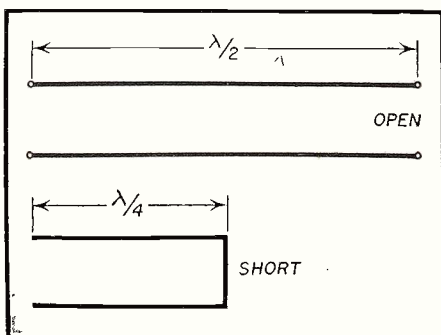

Fig. 7. Open half-wave lines and shorted $\frac{1}{4}$ lines are equivalent.

The actions of a transmission line as a function as a line length may be seen also from Fig. 5. The input reactance of an open circuited transmission line is given by.

$$Z_{IN} = -Z_0 \cotangent \phi$$

Where: Z_{IN} = Generator or input impedance

Z_0 = Characteristic impedance of the line

ϕ = Electrical length of the line measured in degrees. ($\lambda = 360^\circ$)

Thus a $\frac{1}{8}$ th wave length or 45 degree length line is a capacitive reactance equal to the characteristic impedance of the transmission line since cotangent of 45° is -1 .

The input impedance of a short circuited transmission line may be seen from the formula:

$$Z_{IN} = Z_0 \text{ tangent } \phi$$

Where the formula values are again

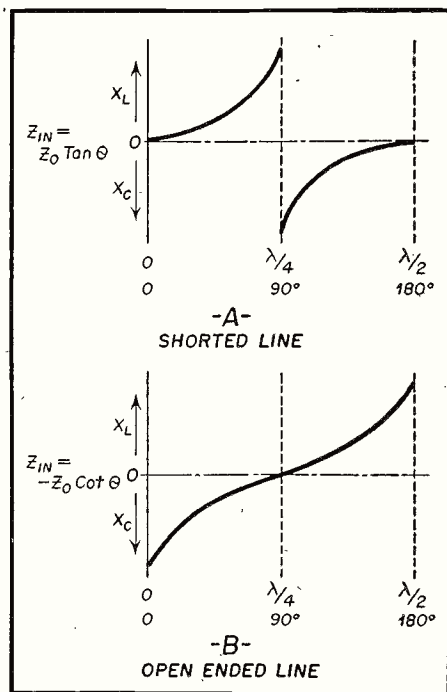

Fig. 6. Line length charts.

Curve A is $\tan \phi$

Curve B is $-\cot \phi$

defined as above. A negative Z_{IN} is a capacity and a positive Z_{IN} is an inductance.

Thus, the input impedance of a $\frac{1}{8}$ th wave length or 45 degrees long line is equal to the characteristic impedance and the line acts as an inductive reactance since tangent 45° is $+1$. Hence, if these two sections are combined, as in part C of the figure, the 45 degree open ($-$) and the 45 degree short-circuited conditions are combined to provide a parallel resonant condition. This appears because the input reactance now is equal to an inductive reactance in parallel with a capacitive reactance. Since these re-

actances are equal and opposite, a parallel resonant circuit results.

In Fig. 6, the input reactance of a line as its length is changed, is shown graphically by two charts. Part A is the input reactance of a short circuited line; as this line length is changed, from 0 to 90 degrees, the line is an inductive reactance which increases in value until at 90 degrees, the line is parallel resonant. Beyond this length, the line appears as a capacitive reactance decreasing in value until at exactly $\frac{1}{2}$ wave length or 180 degrees, the line is a series resonant circuit.

In part B the open ended transmission line is shown whose reactance varies in an opposite sense. As the line length is increased from 0 to 90 degrees, it becomes a decreasing value of capacitive reactance until at exactly at 90 degrees, it is a series resonant circuit. Between 90 degrees and 180 degrees, the line becomes an increasing value of inductive reactance until at exactly 180 degrees, the line is a parallel resonant circuit. Thus, as in Fig. 7, two of the fundamental transmission line tuned circuits are shown. Both the $\frac{1}{2}$ wave length transmission line, open circuited at the load end and the $\frac{1}{4}$ wave length transmission line short circuited at the load end, are effectively parallel resonant circuits.

Transmission lines as circuit elements have a wide variety of uses; we are concerned primarily here with such lines used as parallel resonant circuits. Since any oscillator or amplifier, for that matter, is designed to be as compact as possible, the shortest transmission line that will accomplish the purpose of tuning is usually used. Either the $\frac{1}{2}$ wave length open ended line or the $\frac{1}{4}$ wave length shorted line may be used as a parallel resonant circuit. Since tuning is accomplished by changing the length of the line, the open ended line is not feasible for most purposes. There are only two ways that such a line may have its length varied. Either sections are physically cut off, which is at best an awkward procedure, or the line is made so that it telescopes and the line length may be changed in this manner. Neither of these possibilities is very attractive but a short circuited line may have its effective length varied quite simply. The short circuit is moved along the line as in Fig. 8A and the distance from the input end to the short circuit is the effective electrical length of the transmission line. The portion which is left over,

[Continued on page 62]

A "Snow-Free" TUNER

by DANIEL LERNER

(Supervisor of Television Service — Philco Corporation, Philadelphia, Pa.)

RECENTLY Philco developed a new type of television tuner. While the mixer and oscillator circuits are identical to the company's previous semi-incremental tuner used in some 16 inch receivers, (same mixer and oscillator circuits) nevertheless the new tuner represents a radical departure in r-f amplifier design.

In past designs, the r-f amplifier tube was either a 6AG5, 6BC5, or 6CB6, all pentodes. It is well known

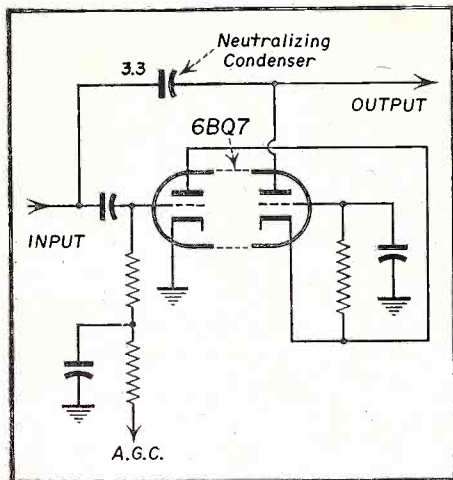

Fig. 1-Simplified diagram of r-f circuit used in snow free tuner. Note neutralizing condenser.

that some of the major factors to be considered in choosing a tube for an r-f amplifier are its induced grid noise, its internal tube (shot) noise, and its input impedance at the frequencies involved. Chart #1 shows some common tube characteristics.

It can be seen that the triode has a lower amount of shot noise (represented by R_{eq}) and a relatively higher input impedance (if properly neutralized) than most pentodes. However, it also has a much higher grid to plate capacity. Thus a grounded cathode, high gain triode amplifier is

Describing a new tuner which utilizes a new type tube, the 6BQ7. The method of coupling the both triodes in this tube is entirely unique, as is the tuner itself.

R-F TUBE TYPES					
	R_{eq} , OHMS	GM	C_{gp} (uuf)	C_{in} (uuf)	C_{out} (uuf)
6AK5	1780	5000	.02	4.0	2.8
6BH6	2280	3400	.0035	5.4	4.4
6AG5	1630	5100	.025	6.5	1.8
6J6 (each triode)	472	5300	1.6	2.2	0.4
6BA6	3530	4300	.0035	5.5	5.0
6AC7	720	9000	.015	11.0	5.0
6J4 (grounded grid)	208	11000	.24	8.3	4.0
6AU6	2520	3900	.0035	5.5	5.0

R_{eq} = fictitious resistor in series with grid of the tube. The noise produced by the tube is the same as if the tube were noiseless and the noise voltage produced by a resistor R_{eq} were impressed on the grid.

Triode has a lower amount of shot noise (represented by R_{eq}) and a relatively higher input impedance than most pentodes. However, it also has a much higher grid to plate capacitance, C_{gp}

Chart 1 - R-F tube types

difficult to use as an r-f amplifier, because of its poor stability.

However, a circuit using triodes as r-f amplifier can be used, and is used successfully in the new "snow-free" tuner.

Figure 1 shows a simplified diagram representation of the new r-f circuit. This consists of 2 triodes, the first triode being a grounded cathode tube with the input signal applied to the grid, and the second, a grounded grid

triode, with the input applied to the cathode. The cathode to ground impedance of the second section is the plate load impedance for the first tube. This impedance is in the order of 200 ohms. Some neutralization is used to improve the noise figure of the system. This is shown to be by an analysis of the circuit, and is verified on a practical basis. The voltage gain of the first tube is roughly equivalent to unity or 1. Naturally

this makes the stage extremely stable. However, gain may be realized from the first stage since it is an impedance matching device; that is matching the relatively high tuned circuit impedance to the low impedance of the second stage (grounded grid).

There is enough gain in this circuit to make the noise of the two tubes together about the equivalent of a single triode. The gain is actually as great as that of a well designed pentode r-f tube and yet its noise figure is as good as a triode.

The above feature really shows up in a fringe area where signal to noise ratio is a prime pre-requisite. The electrical circuit is shown in *fig. 2*.

The r-f section of the new Tuner uses a twin triode tube called the 6BQ7. It has very low interelectrode capacities and the two triode sections are effectively isolated by a grounded shield between them. *Chart 2* shows some of the characteristics of the 6BQ7.

The input signal is applied to the control grid of the first triode pin 7 through the 220 μf condenser C503. A-G-C voltage is applied to this grid through the decoupling resistor R503, 330 ohms. The cathode is grounded and the effective gain of this stage is unity. The condenser C504, 3.3 μf , is part of the neutralization circuit.

6BQ7	
MAXIMUM RATINGS	
Plate Voltage	250 Volts
Plate Dissipation	1.75 Watts
Cathode Current	.20 MA
OPERATING CHARACTERISTICS	
Plate Voltage	150 Volts
Cathode Impedance	240 Ohms
Amplification Factor	.35
Transconductance	6000
Plate Current	.90 MA

Chart 2- 6BQ7 Characteristics

C506 is a tracking adjustment used in alignment of the interstage network. The signal is fed from the plate of the first triode directly to the cathode of the second triode. Thus the first triode acts as a variable impedance in the cathode of the second triode. The amplified signal is then fed from the second plate to the injection grid of the mixer triode ($\frac{1}{2}$ 12AV7) through a capacity coupled broad band interstage network.

Very recently the r-f circuit was changed to allow for better operation under changing conditions of a-g-c bias. Under these conditions a large amount of a-g-c bias voltage change was required before the overall gain of the r-f system was substantially affected. This deteriorated perform-

ance at high signal level in strong signal areas.

Looking at *Fig. 3A* a simplified diagram of the old circuit is shown. The plate impedance of the first tube is the cathode impedance of the second tube. The plate impedance of the first tube represented as Z , is shown variable since the a-g-c voltage is connected to the first stage, changing its plate resistance in step with increases in a-g-c voltage. As can be seen the grid is tied back to the cathode through R504. The only bias on the second tube is that developed by high velocity electron flow (contact potential) through R504. Thus a large change in first tube impedance is reflected as a relatively small change in second tube gain. *Fig. 3B* shows the new circuit. The grid is connected to a voltage divider arrangement so that it is positive (above ground) by an amount always equal to 1/2 of the applied plate voltage. The cathode is driven more positive than the grid voltage as the AGC voltage is increased so that the grid referred to the cathode keeps getting more negative.

Chart 3 gives an idea of the effects of the a-g-c change.

It can be seen that before the a-g-c change a change in relative sensitivity of only 14 times occurs with an a-g-c

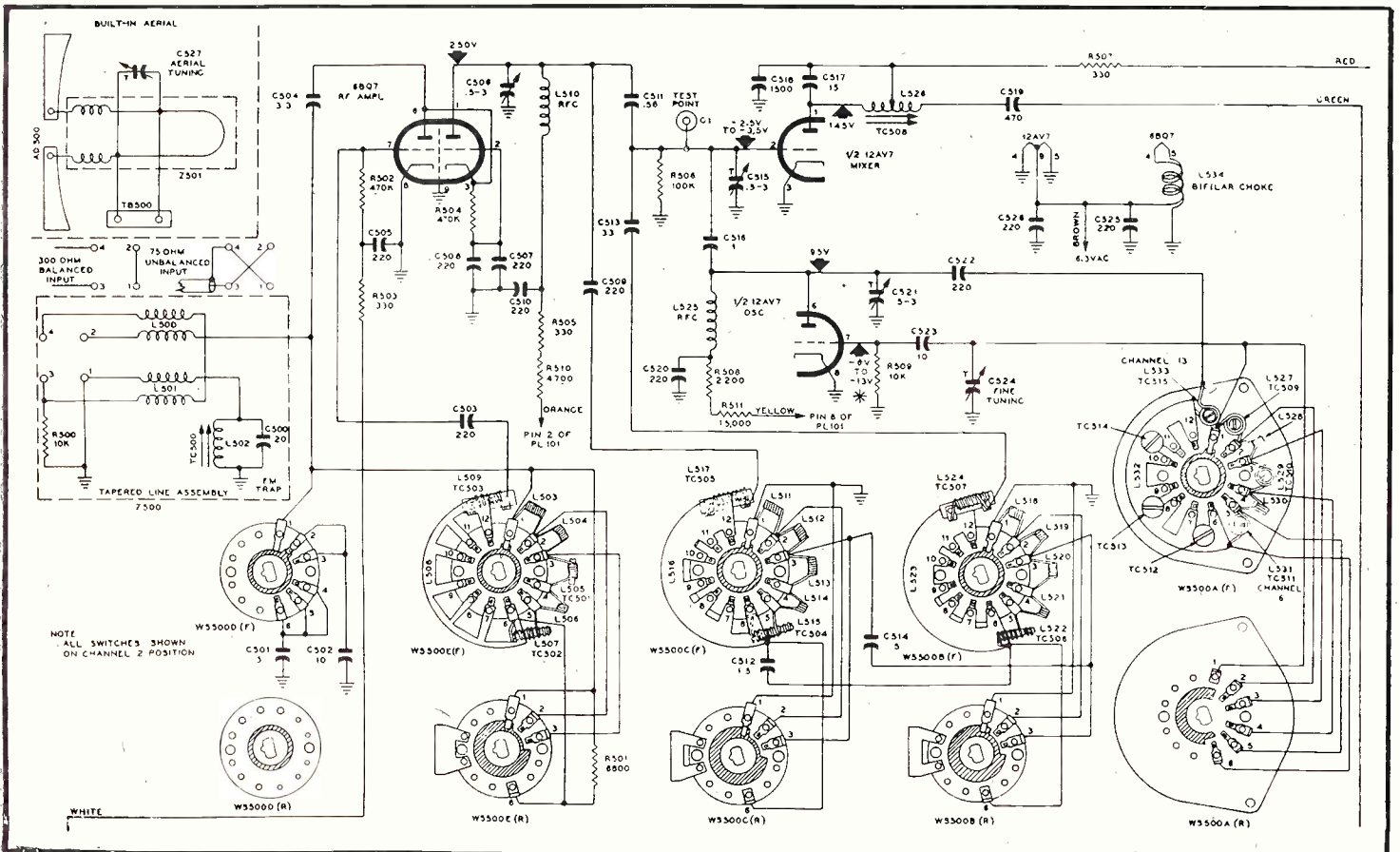

Fig. 2-Electrical circuit of snow free or "Colorado" tuner.

AGC BIAS (volts)	SENSITIVITY BEFORE	SENSITIVITY AFTER
0	750	750
3	410	190
5	170	9.5
7	55	.4

Chart 3- Effect of AGC change.

bias change of 7 volts. However, with the new circuit the same a-g-c voltage change produces a change in relative sensitivity of 1880 times.

Television Tuner Alignment

General Alignment Practices:

1. There must be a good bond between the receiver chassis and the test equipment. This is most easily obtained by having the top of the workbench metallic. The test equipment and television receiver chassis must make a good metal-to-metal contact with the bench top.

2. Never disconnect the picture tube, picture-tube yoke, or speaker, or remove the horizontal oscillator tube while the Receiver is turned on.

3. Allow the receiver and test equipment to warm up for 15 minutes before starting the alignment.

4. The marker (AM) signal generator should be calibrated accurately to the frequencies used and to the sound video r-f carriers of each channel used during alignment. If a Philco Model 7008 or another generator having crystal calibration is used, the built-in crystal calibrator provides an excellent means of calibration. An alternate method of calibrating the signal generator to the sound and video r-f carrier frequencies is to zero-beat the signal generator with the received signals.

Aerial Input Matching Network

Figure 4 shows an impedance-matching network for coupling the signal generator to the aerial input terminals of the receiver. This network, which is designed so that the input impedance is 75 ohms and the output impedance is 300-ohms, is used to match a 75 ohm generator to a 300-ohm aerial input circuit. The resistor used in this network should be of carbon composition construction, and should be chosen from a group to obtain values close to those indicated. An aerial matching jig, which consists of a matching transformer and connecting box may be used in place of the resistor network.

Television Tuner Alignment

Since the frequency of the local oscillator affects the tuner's response, the local oscillator alignment should be made first.

Oscillator Alignment—General

Beginning with Channel 13, every other coil is tunable, so that by adjusting the tuning cores, it is possible to place either of two adjacent channels exactly on frequency; that is, either Channels 13 or 12, or 10, 9 or 8 etc. The foregoing is based on the assumption that the oscillator has previously been tracked and that it is desired to compensate for small tracking errors on several different channels. It is also apparent that this adjustment procedure should be carried out with the highest channel first, since each channel will affect

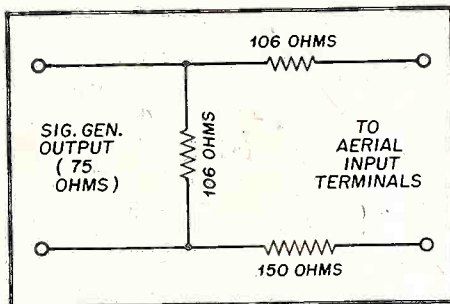

Fig. 4- Matching network

the channels below it in frequency. The Fine Tuning control should be preset for all adjustments. This is done by placing the stop on the fine tuning can at the center of the Channel 6 oscillator tuning core. See fig. 5.

Procedure Using Signal Generator

An r-f signal (unmodulated), at the oscillator frequency, is fed into the aerial input from an AM signal generator, and the oscillator tuning

cores adjusted for zero beat. The r-f signal should be accurate, preferable from a crystal source, or calibrated against the television station.

1. Connect a 3300-ohm resistor in series with the red lead from the tuner. Connect the "hot" lead of the oscilloscope to the junction of the red lead and the 3300-ohm resistor. High oscilloscope gain may be necessary to obtain a visual beat. In this instance, base-line hum may be ignored.

2. Connect the AM (marker) generator to the 300-ohm aerial input through the aerial input matching network. See fig. 4.

3. If the tuner is being aligned out of the chassis, connect the white lead to the negative terminal of a 1.5 volt battery. Ground the positive terminal.

4. Mechanically preset the fine tuning cam as shown in fig. 5.

5. Feed in an r-f signal (unmodulated), at the oscillator frequency for channel 13, (237.85 mc), with the Channel Selector set for Channel 13.

6. Adjust appropriate tuning core (see figure 5).

7. Adjust the tuning cores for Channel 11 and 9, respectively.

8. Check the Channel 8 oscillator frequency. If it is high, turn C517 for 76-5747 tuner, C521 for 76-6440-1 tuners, several turns clockwise; if the frequency is low, turn the appropriate condenser counterclockwise.

9. Repeat steps 5, 6, 7 and 8 until Channels 13, 11, 9 and 8 are within plus or minus 500 kc of the correct frequency.

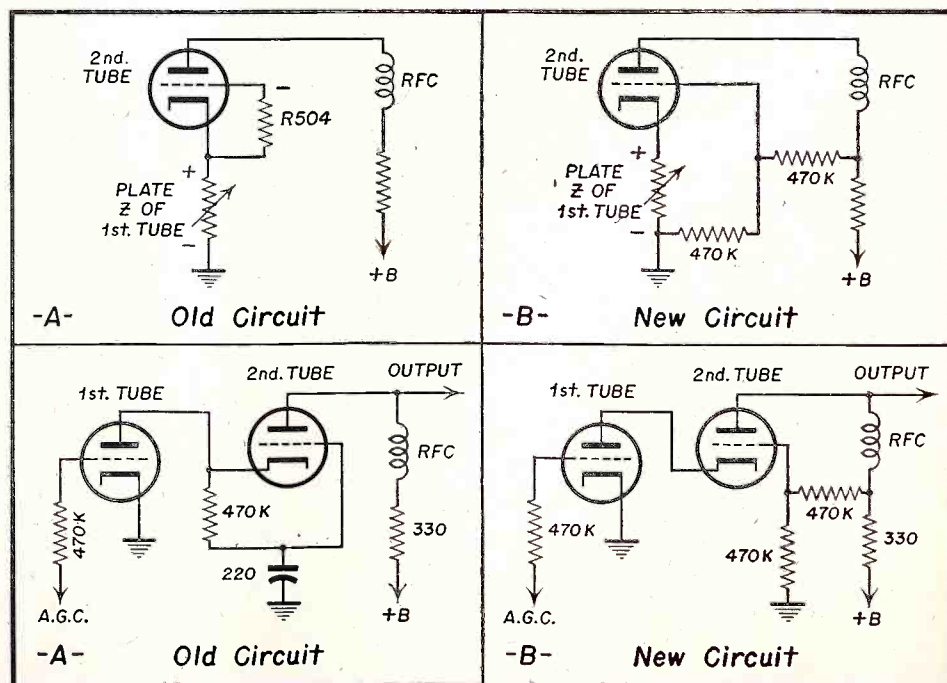

Fig. 3- Old and new circuits used in tuner

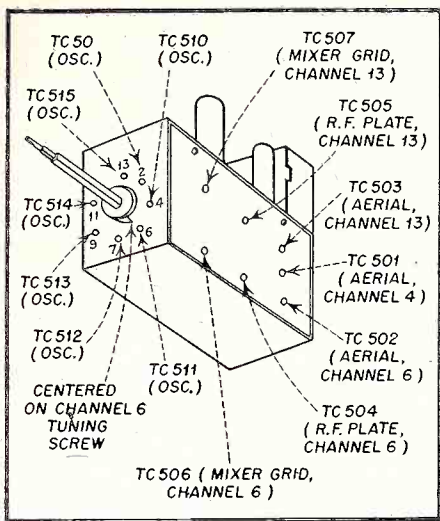

Fig. 5- Oblique view of tuner showing locations of various adjustments.

10. Feed in an r-f (unmodulated) signal, at the oscillator frequency for Channels 7, 6, 4, and 2, consecutively, and adjust the respective tuning cores. See fig. 5.

Oscillator Alignment

Procedure Using Station Signal

The following simplified procedure may be used to align the oscillator when the television i-f alignment is satisfactory and a station signal is available.

1. Mechanically preset the fine-tuning cam to the center of its range (see fig. 5).
2. Tune in the highest frequency channel to be received.
3. Tune the tuning core for that channel, or the next highest, for the best picture; that is, starting with sound in the picture, turn the tuning core until the sound disappears. NOTE: All the oscillator inductances are in series, and any adjustment on

one channel will affect all other channels below it.

Bandpass Alignment

General

The bandpass alignment consists of aligning the tuner at Channels 13, 6 and 4, and then making it track down to Channels 7 and 2 respectively.

During the alignment, a fixed bias of 1.5 volts is applied to the r-f amplifier tube.

An FM (sweep) signal is applied to the aerial input circuit, and an oscilloscope is connected to the mixer plate circuit. The oscilloscope gain should be as high as possible, consistent with hum level and "bounce" conditions. Hum conditions will cause

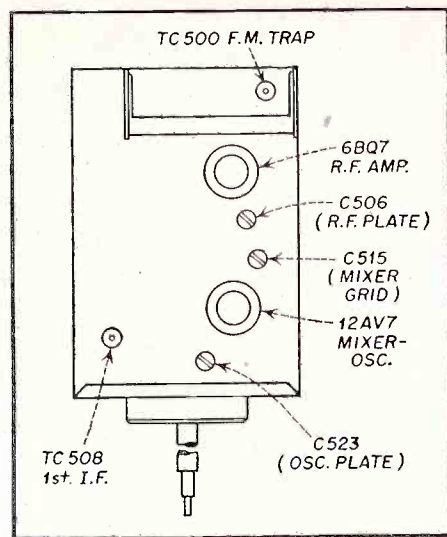

Fig. 7- Top view of tuner, showing location of adjustments.

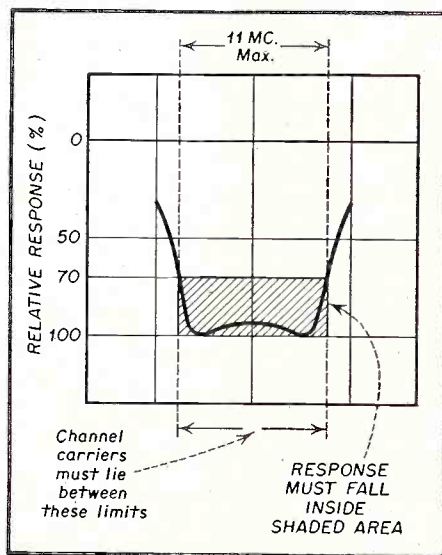

Fig. 6- Tuner response curve, showing band-pass limits.

distortion of the time base and response. Bounce conditions will cause the response and time base to jump up and down, and is caused by poor line

regulation. The use of too high an oscilloscope gain aggravates these conditions, whereas the use of too low a gain necessitates increasing the generator output to a point where the tuner may be overloaded. Overload may be checked by changing the generator output while observing the shape of the response curve; if the shape of the curve changes, this indicates overload, in which case, a lower generator output and higher oscilloscope gain must be used. A 330-ohm resistor is shunted across the 1st i-f coil, to eliminate the absorption effect of this coil on the response curve.

Equipment Connections

1. Disconnect the white (a-g-c) lead from the tuner, and connect it to the negative terminal of a 1.5 volt battery. Ground the positive terminal.
2. Connect a 3300-ohm resistor in series with the red lead from the tuner. Connect the "hot" lead of the oscilloscope to the junction of the red lead and the 3300-ohm resistor.
3. Connect a 330-ohm resistor from the green lead to ground.
4. Connect the FM (sweep) generator to the 300-ohm aerial input through aerial input matching network. See fig. 4.

Alignment Procedure

1. Set the Channel Selector and FM (sweep) generator to Channel 13 (213 mc). Adjust the generator for sufficient sweep to show the complete response curve.
2. Establish the channel limits (see fig. 6) by using the marker (AM r-f) signal generator to produce marker pips on the response curve; set the generator first to 210 mc, then to 216 mc.

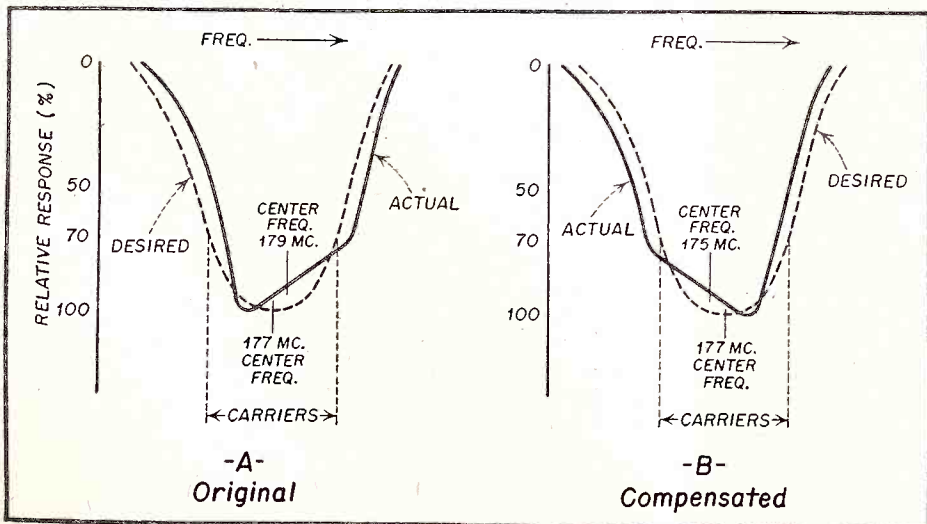

Fig. 8- Tuner response, showing tracking compensation.

[Continued on page 61]

MEN OF RADIO

PART 3

by WILLIAM R. WELLMAN

In this 3rd installment the author describes the work of Guglielmo Marconi in effecting the first Trans-Atlantic wireless broadcast. We again ask our readers to send in their reactions to this series of historical articles.

SITUATED as we are in mid-century and surrounded by a multitude of such developments as radar, television and world-wide communications, it is often difficult for us to realize that radio communication is only fifty years old and became a commercial reality, appropriately enough, just at the turn of the twentieth century.

Of course, much of the groundwork for the new industry had been laid by Hertz and others during the 1880's, but the real test of the value of the art, the utilization of radio waves for long-distance signaling, came toward the end of 1901.

Many things of great importance had taken place during that year. In September, Theodore Roosevelt entered the White House, succeeding the murdered McKinley. The Boer War was making headlines that year, and thousands of people were heading hopefully for Nome, Alaska and the great gold rush.

Guglielmo Marconi

On a hill in Newfoundland that December, another event was taking place; one that was destined to materially alter the future of commerce and industry and to effect profoundly the mode of living of everyone. An observer that December day might have seen a small group of men struggling to control the flight of a large kite, sent aloft from a rocky eminence at the entrance to St. John's harbor.

Trailing from the kite there is a wire which enters a nearby building. Inside, a young man is concentrating upon an assortment of electrical apparatus arranged on a table before him. As noon approaches, his expression become more intent. Twelve o'clock passes, then twelve-thirty. Very soon now, the strain will be over and he will know whether his work of the



Courtesy Harper & Brothers

Guglielmo Marconi
(1874-1937)

past six years will be climaxed by a supreme triumph. Tomorrow the newspapers of the world will either note that the young man has performed another of his interesting experiments or will hail him as a benefactor, the creator of a new mode of communication.

He continues to wait, a telephone receiver held tightly to his ear. Suddenly he hears something: three faint clicks in the receiver, repeated several times. There can be little doubt that his experiment has succeeded, yet he is ever the cautious scientist. Passing the receiver to his assistant for confirmation, he asks: "Can you hear anything, Mr. Kemp?" Kemp nods, indicating that he too has heard the three faint clicks. Thus was accomplished the twentieth-century miracle of long-distance wireless communication. The waves had spanned the Atlantic, traveling 1700 miles from Cornwall, in England. Since that time, countless numbers of children and students have asked parents and teachers the question: "Who invented radio?" and have received the answer: "Marconi."

To be technically correct, Marconi

did not "invent" radio. But he did produce the first commercially practicable system of wireless communication over long distances. His accomplishment was not the result of any single discovery or invention, but comprised, instead, the refinement and the adaptation to his purposes of existing apparatus: Hertz's wave generator Branly's coherer and his own ideas of an antenna and ground system.

Guglielmo Marconi, born April 25, 1874 at Marzabotto, near Bologna, Italy was the son of Giuseppe Marconi, a local banker, and Anna Jameson of Dublin, Ireland. Anna was the daughter of Andrew Jameson of the famous whiskey distilling family. She had met and married Giuseppe while studying music in Bologna.

As a child, the future great man of radio was rather lonely, had few friends. Perhaps this was because he had already developed a serious turn of mind that set him apart from other boys, or perhaps it was because of a language barrier. Although he was Italian-born, he was not too proficient in the language, and his few comrades ridiculed his accent; this was because his mother had always conversed with him in English.

Young Marconi attended no schools, but received all of his education under the guidance of private tutors in Italy and in England. To compensate for his lack of friends, he turned to books for companionship and soon became interested in science. At the age of twenty he had made a study of Hertz's experiments, became deeply interested and promptly decided that the waves could be used in sending messages over long distances.

For a start, he merely duplicated Hertz's equipment and techniques and his first few trials were failures.

He carefully studied his apparatus and procedure, found where his errors lay and after corrections had been made was able to send and receive messages over the length of the house.

He soon realized that further experimentation would take more money than he had; the next step was to interest his father. At first, Giuseppe was skeptical, but after witnessing a few demonstrations agreed to finance his son to the extent of about \$1,000. This was an extremely critical phase of Guglielmo's career, since it is probable that he would not have been able to continue experimenting without financial aid and it might have been difficult for him to interest investors in his scheme.

As noted earlier, his first experiments were based upon Hertz apparatus, including the spark coil generator and a spark gap provided with extended rods that functioned as antennae. At this juncture he made some changes in the apparatus that resulted in a startling improvement in results. Dispensing with the rod antennae, he now connected one terminal of the gap to an elevated antenna, consisting of a copper cylinder mounted on a tall mast. The opposite terminal of the gap was connected to the earth. It is interesting to note that for many years thereafter, the elevated antenna, together with the ground connection, remained a necessary part, and indeed a symbol of radio. A grounded antenna is referred to, even today, as a Marconi antenna. There was to be sure, a return to the Hertz antenna, but this was many years later. The grounded antenna, then, may be regarded as Marconi's first contribution to radio.

Although his antenna had materially extended the range of his apparatus, Marconi soon realized that there was little hope of real long-

distance communication without an improved receiving system; Hertz's receiving loop was far too insensitive. Soon he learned of the little tube of filings invented by Branly and used by Sir Oliver Lodge, and felt that this device, combined with his antenna system, offered real possibilities. Again his genius for refining and improving came to the fore; Branly's tube was made narrower, the metal plugs placed closer together and nickel and silver filings substituted for the original iron with the result that he was then able to receive signals from a mile away, with the transmitter located on a distant hill and the receiver at the house. Almost as important as the improvement in range was his discovery that signals could be picked up when the transmitter was placed on the far side of the hill, thus proving that the waves were capable of passing through obstacles.

Despite his success and the steady increase in range, Marconi's work had thus far attracted little attention. Aside from his family, Professor Righi of the University of Bologna and a few others, no one seemed to be interested. Yet the inventor was certain that his system had commercial, perhaps even military value. With this in mind, he offered the results of his research to the Italian government, but the offer was declined.

Disappointed, but not discouraged, he reasoned that his discoveries should be of greatest importance to a nation with broad maritime interests. Even at that early date, wireless seemed bound to the sea. The logical choice among world powers was, of course, England. This was dictated not alone because of England's naval and maritime power, but partly by the fact that his mother had influential friends in that country.

He arrived in England carrying letters of introduction to a number of important personages, including one to Sir William Preece, technical director of the British Post Office. In his position, Preece was responsible for the British telephone and telegraph network, and had once experimented with a form of wireless; the cable extending from the island of Mull to the mainland had parted and by laying parallel wires along the opposite shores Preece had maintained communication through a form of induction telegraph.

Marconi's arrival in England was attended by a rather serious incident that also had a humorous side. A customs inspector, upon examining his instruments, decided that they must be bombs or infernal machines and ordered that they be destroyed. The result of this stupid act was that the progress of radio was delayed for some weeks, until duplicate apparatus could be obtained.

Once established in England with his equipment, Marconi began a long series of experiments in communication over open stretches of country and congested city areas. Once more, it was clearly established that Hertzian waves were capable of passing through most ordinary obstacles. Shortly, the range was extended to nine miles. Just then, his work was almost interrupted by a notification from the Italian government, calling him to military service. Of course, he might have avoided service by renouncing his Italian citizenship and becoming a British subject, but he did not choose to do this. Finally, the situation was clarified by an arrangement which permitted him to continue his work as a military student attached to the Italian embassy.

On July 20, 1897, the first company, Wireless Telegraph and Signal Company, Ltd., was formed to acquire and develop his discoveries; Marconi became its chief engineer. Three years later the name was changed to Marconi's Wireless Telegraph Company, Ltd. and for many years thereafter the firm enjoyed a virtual monopoly of wireless communication on both sides of the Atlantic.

One of the first projects of the new company was the installation of apparatus in lightships and lighthouses, at the direction of Lloyd's Corporation. Two lighthouses, seven miles apart, were selected for the initial test, with gratifying results. This was probably the first practical application of wireless in history. The next year equally good results were obtained

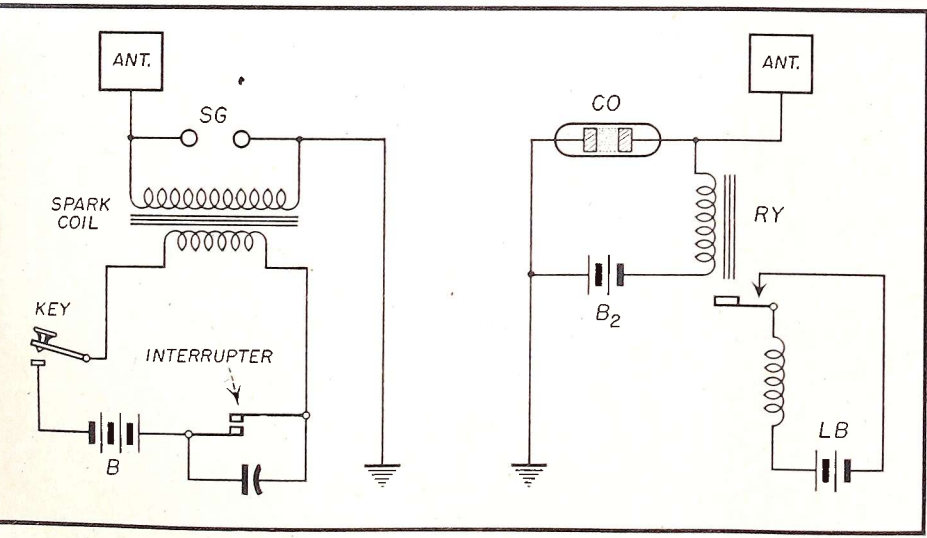

Fig. 1. Early Marconi transmitter and receiver.

between a fixed shore station and a moving vessel while 18 miles at sea.

In 1899 the French government invited him to conduct a cross-channel test which was highly successful. Newspaper reporters who witnessed the test gave Marconi much valuable publicity, a fact which probably was quite instrumental in directing public attention and support toward his ideas. Later that year, he clinched public acceptance of wireless communication by sending the results of the international yacht races from a tug, stationed at the Sandy Hook race course, to shore, probably the first instance of the use of wireless in covering a sports event. As the Shamrock and the Columbia, contenders for the famous American Cup sailed the course, Marconi followed, reporting the series in detail, transmitting hundreds of individual reports to shore. The Shamrock, entry of Sir Thomas Lipton, tea magnate and grand old man of yacht racing, lost the event.

During his visit to the United States, Marconi conducted a series of tests for the War and Navy departments; these tests eventually led to the adoption of his system by the military and naval services of a number of world powers.

Now only twenty-five years old, Marconi was well on the way toward international recognition as a scientist, but although he was the leader he was not the only one in search of a commercially acceptable method of wireless communication. The science had progressed to the point where signaling over a 200 mile range was feasible and a race had begun, to extend the range and improve reception. Among those pitted against him in this race were De Forest and Fessenden in the United States and Slaby in Germany. The Russian, Popoff, had achieved notable results as had Bose in India. But Marconi managed to keep far ahead of the field and as early as 1900 decided that even the Atlantic might not prove to be a barrier to wireless. His principal concern, however, continued to center upon communication between ships at sea and shore stations; he visualized powerful land stations on both sides of the ocean having a range great enough to maintain contact with a ship in mid-Atlantic; in this way, a ship would always be in touch with shore and much of the risk of ocean travel would be nullified.

Aside from more powerful sending apparatus and more sensitive receiving devices, the proper choice of a wavelength seemed to be very important in long-distance work. Fleming,

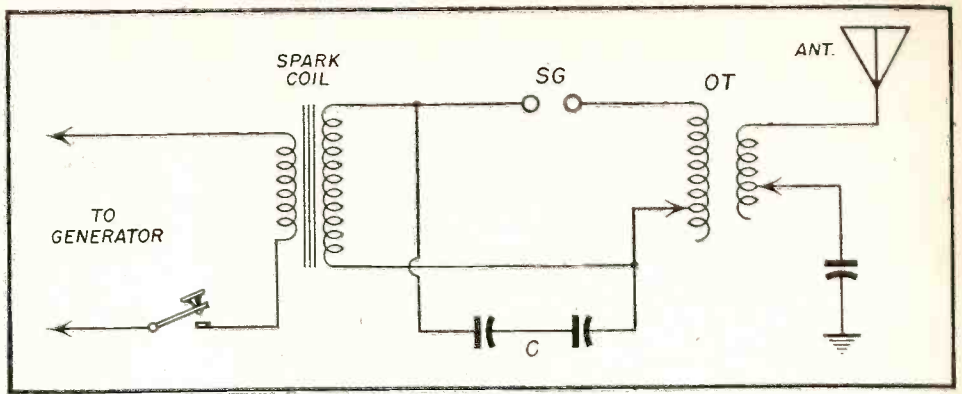

Fig. 2. Later Marconi Apparatus

who later invented the first vacuum tube, advised Marconi to use a longer wave. This was kept in mind when construction of the then most powerful station in the world was begun at Poldhu, Cornwall. According to Fleming, the wave emitted was about 1,000 meters. Another factor that seemed to affect the range of a transmitter was the antenna height; accordingly an elaborate antenna system was erected at Poldhu, supported by twenty masts arranged in a circle. Unfortunately, the impressive aerial was never used. Construction of the station proceeded during the summer of 1901 and in August, just when everything was ready for preliminary testing a sudden storm struck, wrecking the carefully built antenna. It was then too late to begin rebuilding in time for the contemplated trans-Atlantic test; thus it happened that the first wireless signals to span the ocean were radiated from a simple, single wire antenna.

Trans-Atlantic Broadcast

Marconi and his assistant, Kemp, left England at the end of November and began work at St. John's on December 9. The government authorities afforded him the use of a building on Signal Hill for housing his apparatus. Prior to the trans-Atlantic trial, Marconi's receiving equipment included a telegraph sounder, or in some cases a recorder which inked the dots and dashes on a moving strip of paper; in either case, the reproducing device was actuated by the coherer. A telephone receiver was known to be more sensitive and was used in the Poldhu-St. John's test in place of the sounder or recorder.

An interesting point arises concerning Marconi's use of a temporary type of receiving aerial, kept aloft by a kite in preference to a more elaborate installation. Seemingly, a kite antenna lessened his chances of success, but on the other hand the cost of erecting masts and a fixed antenna would have been quite heavy and

might have been a severe liability in the event of failure. This, together with the fact that much of the work at Newfoundland was shrouded in secrecy seems to give support to the view that he was not primarily interested in spanning the Atlantic. If he failed in the attempt Poldhu was still ideal for his original project of ship-to-shore communication. It is also possible that the trial was partly a master stroke to demonstrate beyond all doubt that his system was superior to all others.

When all was in readiness the Poldhu operator was contacted by cable and instructed to start sending at 11:30 A.M. and to continue until 2:30 P.M. each day, St. John's time. No complete message was to be sent, just the letter "S," repeated over and over. In the choice of time, it is evident that Marconi was extremely lucky, for it is now certain that darkness would have increased his chances of success. Considering the chosen time, and the temporary nature of his sending and receiving antennas, his success was almost miraculous.

When the first day's test was completed, the results were not immediately announced to government officials and the press. This would have been the usual procedure, and due to the careful prearrangement there was little doubt that the signals heard did originate in England but Marconi wanted to be sure and waited until a second test had been made on the following day. Perhaps this is one reason why some confusion exists concerning the actual date of the event. Most accounts give December 12 as the date, but his own statement to the press, released under date of December 14, states that the first signals were heard on Wednesday, December 11. In spite of his caution and reserve and the emphasis he placed on the embryonic state of the wireless art, his attorney said that in his opinion Marconi had released the

[Continued on page 60]

FIT YOUR CUSTOMER

into these 23 TYPES

by DAVID MARKSTEIN

An amusing yet truthful and factual breakdown of the type of individual you have to deal with in your daily grind--and how to deal effectively with him.

EVERY radio maintenance dealer on one occasion or another has lost a sale because, as he realized later when going over the conversation in detail, he played his customer wrong. He used the wrong appeals for the customer's particular personality and mental set-up. There is no way in the world to totally avoid making these errors of human judgment. But by the application of a little amateur psychology, it is possible to reduce them to a minimum. The trick is to decide early what psychological type your customer falls into, then play him in the way you know works for his type.

To be true, as most psychologists will hurriedly say, each person is an individual, with a temperament and a personality that is not exactly like that of any other person. But, as the same psychologists admit, most of us fall generally into types, although we tend to shift from one slot to another depending upon what we are doing at the moment. The man who is a tiger to the employees working under him, and a gruff bear to the salesman who call upon him, will often be a meek dove before the wrath of his wife. It's a fairly safe rule, however, to say that as customers they will remain in the same type groove almost all of the time.

Knowing these types, and the things which appeal to each, can be a great help in selling.

What, then, are the types of customers? Below is a list of twenty-three types into which astute salesmen separate their customers. The type names may not be those used tech-

nically in the psychological journals. But they are good, down to earth ways of describing the kinds of customers whom a radio service dealer meets.

1...*The grouch*. Acts as if everything was a vast conspiracy to make



his life miserable. One way to handle him is the soft soap. But a cringe before his aggressive grouch will get you nothing more than a new blast. Stand up—but be tactful and friendly.

2. *The touchy joe*. Gets his feelings hurt easily. Hard to suggest things to this type. Best handled with

butter—lots of praise, and tactful hints.

3. *The dumb guy*. This is the type to whom you laboriously tell the story of two-plus-two-equals-four, for a hundred times before it penetrates his thick scalp. When he does get something, however, he very seldom forgets it. Takes a lot of patience to sell him, but the patience can pay off because he will buy. Easy to oversell, which means you must be careful.

4. *Tightfisted*. What will it cost? Can I get by cheaper? Shave that down a little. These are the reactions of the tightwad whenever you try to sell him. Sometimes, he is a good guy to forget. But in competitive times, smart radio maintenance dealers just can't forget any prospect.

5. *Openmouth Arnold*. Anything you say to Openmouth Arnold is a source of amazement to him. He is not so much dumb as out of this world. Best handled with a big brother act.

6. *Skeptical Sam*. Arnold's exact opposite. Everything you say is subject to grave doubt. Have facts, figures and proof when you tackle Skeptical Sam.

7. *Openminded Othar*. He is the ideal customer. Not dumb by any means. Wants plenty of hard selling. Ready to buy if the proposition is right. Wants your best selling efforts.

8. *Chip on the shoulder Charlie*. Charlie is ready to fight at the drop of a suggestion. The merest unintended hint that he could be wrong, and he will fling himself out of the

[Continued on page 57]

LOOKING FOR *Trouble?*

No. 4

by **Cyrus Glickstein**

(Instructor, American Radio Institute)

FOR those who are playing this simple quiz game for the first time, the rules are simple. The quiz follows the usual steps taken in servicing a TV receiver on the bench. The object of the game is to put yourself in the shoes of the benchman, and to see if you can answer each question correctly and so find the trouble.

Each question should be answered before going on, since the answer to the previous question is usually found in the following one.

Answers and complete discussion follow.

Type of Receiver: G. E., Model 810, transformer-type low voltage supply, split sound (not inter-carrier) system.

Symptoms: Sound O.K., Raster O.K., (white rectangle of light visible on the screen), no picture information.

1. The first thing to do is:

- (a) Check antenna connection to receiver
- (b) Check for picture and sound reception on all channels
- (c) Rotate fine tuning control through its range
- (d) Turn contrast control to maximum
- (e) Check operation of brilliance control

2. The contrast control is turned to maximum. Fine tuning is varied through its range. All channels are tried. Sound is found O.K. on all channels, but no pix on any channel, with raster normal. The next step in trouble-shooting is to decide in what main section of the receiver the trouble is in on the basis of the information on the screen and from the speaker. Trouble is indicated in:

- (a) Front end (R.F. Osc., Mixer)
- (b) Audio strip (Audio i.f. discriminator, AF, speaker)

(c) Video strip (Video i-f, video det., video amp., CRT)

(d) Lo E supply

(e) Hi E supply

3. Trouble is evidently in the video strip. The next problem is to locate the defective stage. Since tubes are the most likely source of trouble, all the tubes in the video strip are taken out and known good tubes inserted. Picture still does not appear. With the chassis on the bench, the simplest method to isolate the dead stage in the video strip is:

(a) Use screwdriver to scratch grids

(b) Use signal generator to inject signals

(c) Feed in signals from the audio strip

(d) Use scope

(e) Take voltage and resistance readings of each stage in the video strip

4. The simplest method to check the video strip is to use signals from the functioning sound strip. One end of a clip lead is put to plate of audio output stage, pin 3, V20, 6K6. A .1 μ f condenser is hooked on to the other end of the clip lead. The free condenser pigtail is touched to pin 7, video detector, V8A, 6AL5. Several broad black horizontal bars appear on the screen varying in step with the sound. The clip lead is removed from the plate of the P.A. and connected to the grid of the last audio i-f stage, pin 4, Limiter, V18, 6SH7. The other end of the clip lead is fed directly to the grid of the 3rd video i-f stage, pin 1, V5, 6AU6. The fine tuning control is rotated through its range. Nothing but raster is visible on screen. With the other end left on the limiter grid, the clip lead is moved to the grid of the 2nd video i-f stage, pin 1, V4, 6AU6. Fine tuning again rotated through its range

and only raster is seen on screen. On the basis of these checks trouble is indicated in:

(a) CRT

(b) Video amplifier stages

(c) Video detector

(d) 3rd video i.f.

(e) 2nd video i.f.

5. On the basis of signal injection from the audio strip, the trouble appears to be in the 3rd video i-f stage. Voltage checks were taken around the socket and Ep was found to be zero.

The set was turned off and resistance readings were taken from each pin to ground and compared to schematic values (see Fig. 1) (B+ to ground is 32 K)

Rp - Infinite, Rsg - 55 K, Rg - 53 K, Rk - 0.

On the basis of the above readings, the most likely trouble is:

(a) Bad tube - shorted plate to suppressor grid

(b) Shorted C-24, screen by-pass condenser

(c) Shorted C-25, decoupling condenser

(d) Open R-18, decoupling resistor

(e) Open T-14, IF coil in plate circuit

ANSWERS & DISCUSSION

ANSWER—1d

In servicing TV receivers, the first step after the set is turned on and the trouble noted, is to check the operation of the control whose mis-setting might cause the indicated trouble. With sound and raster present and no picture, the first step is to turn the contrast control to maximum. Since the contrast control varies the strength of the picture information, it is important to make certain it is not set so low that pix information cannot come through. The second to maximum Fine Tuning is varied

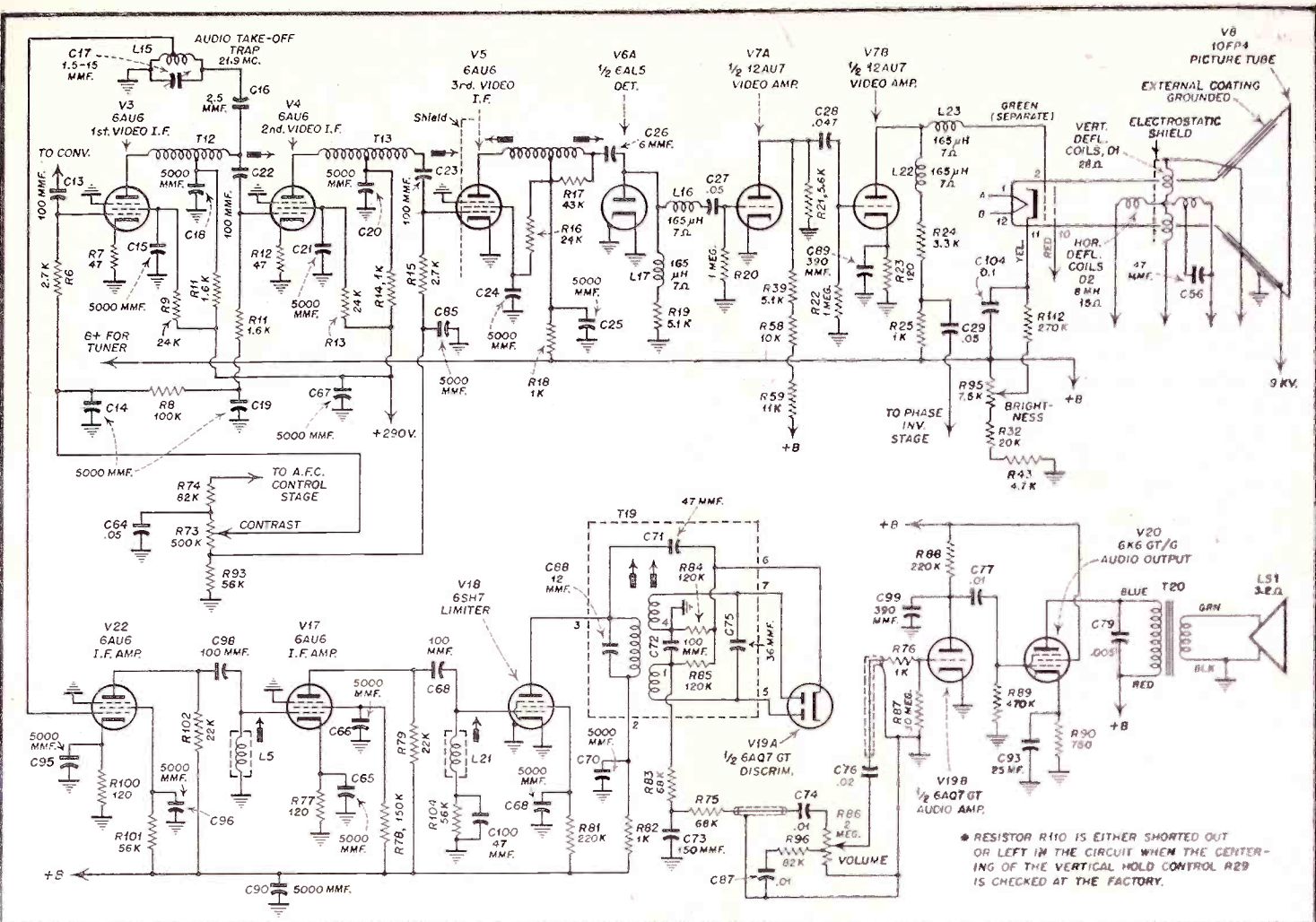

Fig. 1. Partial schematic of G.E. Model 810 TV Receiver.

step would then be to vary the fine tuning control through its range.

In split sound sets, such as this one, the sound is much more critical to tune in than the picture - that is, when sound is tuned in, there will normally be picture information. The purpose of rotating the fine tuning control is to check whether the pix is completely missing or whether it appears at some other point than the sound. If the second is true, it would indicate detuning of either the r-f oscillator or i-f circuits.

The third step is usually to check all channels to see if the picture is available on any of them.

A poor antenna connection to the set would not cause the picture to disappear entirely while allowing sound to be normal. It is possible that when one of the twin-lead wires is off an antenna terminal, there may be almost normal sound. However, the picture will be weak and snowy rather than missing entirely.

Answer 2-c

With sound and raster present and no pix on all channels, trouble is indicated in the video strip. The front end and audio strip must be working or no sound could come through. The

low voltage supply must be functioning or again there could be no sound and also no raster. The high voltage must be good or the screen would be blank. High voltage is necessary to accelerate electrons in the CRT enough to strike the screen hard enough to illuminate it.

Answer 3-c

When there is sound but no pix, the audio section can be used to check the video section. This is merely a simple method of signal injection, using audio frequencies to check the operation of the video detector and video amplifiers. By use of a clip lead and a .1 μ f condenser in series, signals can be fed from the plate of the PA stage in the audio strip to the grid of the second video amplifier. If this stage is working, horizontal black bars (sound bars) appear on the screen which vary in step with the audio information. If the screen continues blank, this is the defective stage and further checks - resistance and voltage - are made at this point. If sound bars appear, the condenser pigtail is moved to the grid of the 1st video amplifier stage. If no bars, the defective stage has been found. If they appear, the pigtail is moved to the

plate (or cathode) of the video detector. Again, if sound bars appear, circuit is O.K. from this point to CRT. Usually, this is the first check made to determine whether this part of the video strip is functioning. If not, the stage by stage check noted above is made.

It is also possible, in split sound systems only, to use the sound i-f system to check video i-f stages in cases where there is sound but no pix.

Suppose from the checks described above it is found that sound bars go through from the detector load. Trouble then is apparently in a video i-f stage. To isolate the specific stage, a clip lead is placed from the grid of the limiter in the sound strip to the grid of the 3rd video i-f stage. No coupling condenser is necessary where there is no difference in d-c potential. The set is tuned to a channel where sound comes in. The fine tuning control is varied through its range. If the 3rd video i-f stage is operating, either a picture or some video information will be seen on the screen, at some point of the fine tuning rotation.

To explain this, it should be remembered that varying the fine tuning

control varies the r-f oscillator frequency. Therefore varying the fine tuning will give a pix i.f. different from the correct one and closer to the usual sound i.f. This *picture* signal will then go through the *audio* i-f system which is operating and come through at high enough amplitude at the grid of the 3rd video i.f. to go on through (if the stage is functioning normally) to give some picture information. Of course, the quality of the picture will not be very good because of the limited band-pass of the audio i-f system, and the shunting effect of the connecting lead. In some receivers, no picture is seen but only some light, scrambled video information. The method serves very well however, for a quick check of the video i-f stages. If the 3rd video i-f stage is functioning, the lead can be moved to the grid of the 2nd video i-f., leaving the other end of the clip lead on the limiter grid.

Scratching grids in the video strip with a screwdriver does not give any useful information, although this method is helpful in checking the audio strip. A signal generator is a standard instrument for checking all the stages of the video strip. A 400 audio signal can be injected to check operation of stages between the video detector load and the CRT. Black horizontal bars are seen on the screen when the stages are functioning, while the screen remains blank when the stage is dead. An AM signal at the center video i-f frequency can be injected at the grids of the video i-f stages to check their functioning - again, 400 cycle bars would be seen on the screen if the stage is operating. Since the question asks for the simplest method, this choice was not counted as correct although it is a perfectly good method for finding trouble.

A 'scope is also a very useful troubleshooting instrument. It can be used to see the detected video signal from the detector load to the grid of the CRT. However, the 'scope cannot be used to check the functioning of each video i-f stage, unless there is a detector probe available with it.

To take voltage and resistance checks in every stage in the video strip would be a poor procedure at this point. It is unnecessarily time-consuming. Once the trouble is localized to one or perhaps two stages, then voltage and resistance checks can be made.

ANSWER—4d

Since a signal went through from the detector load, the video amplifier stages are good. When no signal goes through from the grid of the 3rd video

i.f., this indicates this stage is bad. In view of the type of circuit used, since a good detector tube was substituted, this eliminated almost all possibility of a bad detector stage. Once the 3rd video i-f stage does not pass a signal, it would be unnecessary and inconclusive to apply a signal to the grid of the 2nd video i.f.

ANSWER—5e

Trouble could not be a bad tube with plate to suppressor short. While this would show 0 v. on plate, screen voltage would also be 0. In addition, resistance from plate to ground would be 0 rather than infinity. In addition, question #3 noted that good tubes were substituted.

Shorted C-24, screen by-pass condenser would give 0 v. on screen and resistance reading of 0, instead of the screen readings actually found.



"You'll have to quit working in the atomic bomb factory, your teeth are becoming radio active."

Shorted C-25, decoupling condenser, would give a 0 voltage reading on both plate and screen. The resistance reading from screen to ground would be 24 K and plate to ground 0, instead of the readings found.

Open R-18, decoupling resistor, would give 0 voltage on both plate and screen, since both go to B+ through this resistor. Also, resistance readings of both would be infinite.

T-14, i-f coil in plate circuit, must be open between plate connection and center-tap. As a result, plate voltage is 0 since plate is open. All current through the tube goes to the screen and the increased current through the screen dropping resistor, R-16, 24 K, drops screen voltage below normal. Resistance readings confirm an open coil, T-14, when plate reads infinite and other pins show normal resistance readings to ground.

TRADE LITERATURE

The new 1951 catalog, including the complete line of VEE-D-X television antennas and accessories, has recently been issued by *The LaPointe-Plascomold Corporation*.

Also, considerable space has been devoted to such products as the VEE-D-X Lightning Arrester, the 3-way Switch Box, the new Mighty Match, and to VEE-D-X Towers, which have been given two full pages.

A new 48-page booklet with comprehensive information on the use of *vacuum tube voltmeters* in radio and television servicing has been announced by the *Radio Tube Division of Sylvania Electric Products Inc.*, 1740 Broadway, New York 19, New York.

The booklet is divided into five chapters of concise instructive text describing different types of vacuum tube voltmeters, their adjustment and application for: radio receiver tests and measurements, audio amplifier tests and measurements, television receiver tests and miscellaneous uses.

A new Bulletin No. 160 issued by *Electro-Voice, Inc.*, Buchanan, Michigan illustrates and describes the new E-V Model "636" Slimair Dynamic Microphone. Photos show the modern slim-trim design of the "636" and how easily it can be used on a stand or boom, vertically or tilted—or in the hand.

It also shows the E-V Acoustalloy diaphragm and the pop-proof head which insure smooth response and make the mike extra rugged for indoor and outdoor use, in all climates. Complete specifications and data are given.

A copy of Bulletin No. 160 may be obtained by writing to *Electro-Voice, Inc.*, Buchanan, Michigan.

James Sarayiotis, advertising manager of the *JFD Manufacturing Company*, Brooklyn, New York, announces the publication of the new *JFD Television Antenna and Accessories Catalog No. 58G*.

Embodying the complete line of *JFD* television antennas, brackets, mounts, screw eyes, lightning arresters, indoor

[Continued on page 57]

TUBE TOPICS

by JAMES COREY

A new regular department devoted to presentin gup-to-the-minute information to the Radio-TV Service Dealer on tube replacements and substitutions of all types, including picture tubes.

AT the time of this writing, the availability of tubes is very much in a state of flux. There's apparently a softening of the market with respect to many of the TV types currently used in set production, the extra tubes becoming available in the renewal market because of curtailment of manufacturing activities. Insofar as the types of tubes used in radio sets are concerned, the increased availability is nowhere as great. Moreover, there has been little change with respect to the strictly replacement tube types and not much change in the situation is expected during the next few months. It's entirely possible that some of these older types will become even shorter in supply.

Temporary Slump

The increased availability of TV receiving type tubes is expected to be temporary, for when late summer arrives, it is expected that TV set manufacture will be resumed with its former gusto. Add to this demand the increased military requirements which should be felt by next fall, and it's a question of where are all the necessary tubes coming from, in spite of plant expansion programs. Radio usually has been a seasonal business and there's no reason why television won't follow this pattern in somewhere near normal times.

Perhaps the matter of tube availability can be better understood by explaining how the radio tube industry functions in normal years. For a number of years a tube manufacturing capacity in excess of the market has existed (war years excepted). Capacity in recent years is in the vicinity of 250-million tubes when operations are at an efficient level with not too many different types of tubes to be produced. In 1948 and 1949 sales were on the order of 200 million with the industry operating at full capacity or more during the last four months of the year.

Effects of Seasonal Demand

When the industry is operating at less than full capacity, such means slack manufacturing periods occur, plus other factors that work in the favor of producing an adequate quantity of strictly replacement type tubes. Usually during the first six or seven months of the year tube manufacturers produce more tubes than they sell. This period, therefore, is utilized to produce many of the small-volume and slow-moving types



"Your S.O.S. is coming over much too weak. We'll be glad to work over your set for \$5.00 plus parts."

of tubes. Sometimes several years' supply are produced in order to maintain factory production at the highest possible level. Other replacement types having larger volume requirements are produced as well as tubes currently required to fill orders are produced, but often the total of all these is insufficient to keep the industry operating at full capacity and operations are curtailed the amount of curtailment being determined by the individual manufacturer's financial ability to increase his inventory of finished tubes, in anticipation of the market the latter part of the year.

Distributor Important in Maintaining Tube Availability

Come late summer and demand for tubes by equipment manufacturers is up tremendously and by early fall the demand for tubes by all portions of the industry is in excess of manufacturing capacity. The ability of the industry to meet the demand is in a large measure determined by the amount of inventory produced during the slack periods. The parts distributor also plays an important part in helping meet this demand, for in most cases the distributor lays in his stock of tubes just before the fall demand reaches its peak—and it is that stock that provides a cushion insofar as the serviceman and dealer are concerned.

But the industry did not follow this pattern in 1950. There was no slackening of tube requirements in the early months of 1950. Demand from both the new equipment field and the renewal field increase each month for the shortage was cumulative. Yet in 1950 the radio tube industry produced approximately 380 million tubes when it had a normal capacity of approximately 250 million tubes. This was accomplished by increasing the length of the work week and adding a second shift and sometimes a third shift.

Efficient Production With Fewer Types

Most efficient use of the manufacturing equipment was obtained by concentrating production on as few tube types as possible so as to avoid loss of output during changeovers and training periods which occur when tube types are changed. This accounts largely for the shortage of many of the older tube types. Had the manufacturers changed over equipment to produce more of the lower demand types, it's likely that for each of these tubes produced, there would have been a loss of production of 3 or 4 tubes of the large production volume. As long

[Continued on page 56]

SHOP NOTES

Write up any "tricks-of-the-trade" in radio servicing that you have discovered. We pay from \$1 to \$5 for such previously unpublished "SHOP NOTES" found acceptable. Send your data to "Shop Notes Editor".

Shorted Picture Tube-Using Separate Filament Transformer

Occasionally an otherwise satisfactory picture tube will develop a high resistance leak or even a short between the cathode and heater. This results in the brightness control having no effect. This loss of control comes as a result of the cathode being grounded through the heater

tion of standing waves and increasing the received signal strength.

With the added section of line between the booster and the receiver, (see Fig. 2) the reflections on the line are often so severe that picture definition as well as gain suffers. It may be necessary, in such instances, to use the tinfoil or slotted metal section at both places indicated on the drawing

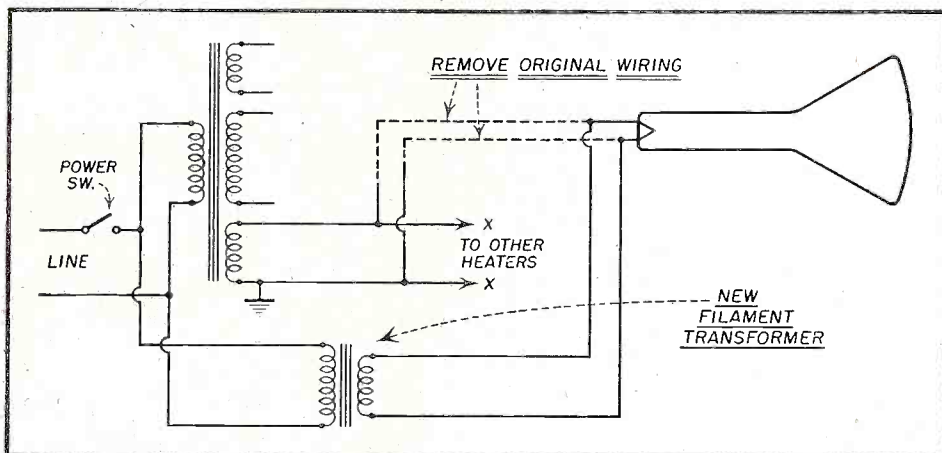

Fig. 1. Method of inserting additional CRT filament transformer in cases where it is desired to use shorted tube.

winding of the transformer. Thus, a fixed bias is effected between control grid and cathode. This seems to call for replacement of the picture tube. However, a method used successfully is to disconnect the heater of the picture tube from the transformer in the set and to provide a separate heater transformer for the picture tube alone (see Fig. 1). The secondary of this transformer must remain ungrounded.

Submitted by
Philip Cane
B'klyn, N.Y.

Improving Booster Performance

Failure of boosters to work satisfactorily (particularly on the higher channels) is quite often due to the standing waves set up on the transmission line feeding the booster and on the transmission line section between booster and receiver. The use of tinfoil or slotted metal sections available on the market for this purpose, will help materially in reduc-

—particularly if the section from booster to receiver is unduly lengthy. In this section a small piece of tinfoil measuring 2 x 4 inches should

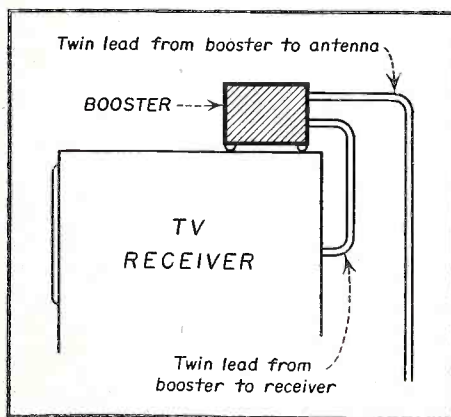

Fig. 2. Booster connections

be wrapped and adjusted to favor the poorest station by sliding it up and down. Another piece of tinfoil should be attached to the transmission line

going to the booster and adjusted to favor the weaker stations as the line may require.

Submitted by
Matthew Mandl
Trenton, N. J.

Salvaging Clipped Condensers

Here is a SHOP NOTE I find useful in that unique situation when

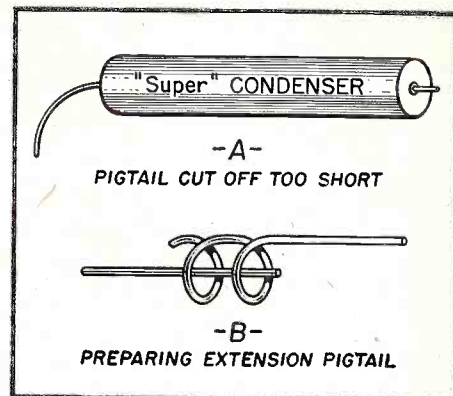

Fig. 3. Salvaging details servicing a set and making a snap diagnosis, I grab the diagonals and slash at the offending condenser, clipping it out of the circuit, sneering, "That's the culprit, all right" . . . But it isn't. The condenser tests fine. Then comes the problem of soldering it back into the circuit. But look at the pigtail—now reduced to a bobtail. Fig. 3A shows the shoddy looking remnant. What to do?

Comes now Fig. 3B. It's fairly simple. Using another scrap piece of wire of same diameter as the cut end for a form, wind a few turns of extension wire about the form, then slip it off, and carefully slip it on the condenser stub end. Pinch tight with long-nose pliers, spot with solder, and lo; a new pig-tail of any length desired.

Submitted by
David Gnessin
Columbus, Ohio

Bolt, Nut and Screw Kinks

When having trouble getting a nut in a bolt in a place where you cannot reach it with your fingers, put a small piece of friction tape or any other adhesive material inside the socket, it will serve two purposes, first, to hold the nut, second, to place the nut out near the end of the socket.

When I have broken off a small screw and find it hard to get out, I take a sharp phono needle and hold it at the same angle you would a large chisel on a large nut and tap it. The screw will, in most cases, come loose.

Submitted by
Samuel S. Slack
Belle, W. Va.

NEW PRODUCTS

TV HORIZONTAL HV TRANSFORMERS

The new Horizontal-Deflection-Output and High-Voltage Transformer RCA-225T1 is offered for use with the 17CP4, 19A-types, 20CP4, and similar picture tubes having a horizontal deflection angle of about 66° and operating at a zero-load anode potential of 16 kilovolts.

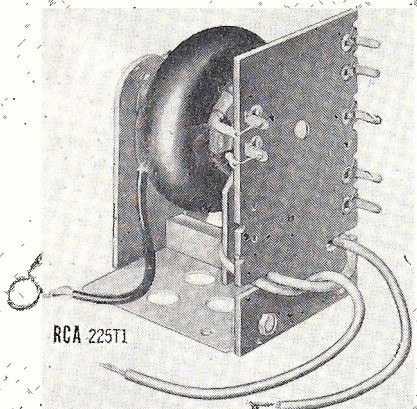

The 225T1, utilizing a ferrite core for high efficiency, light weight, and compactness, is designed for use with a single, horizontal-deflection amplifier tube which may be either a 6BQ6-GT or a 6AU5-GT; a single, high-voltage rectifier tube such as the 1B3-GT; and the magnetic deflecting yoke RCA-209D1 which also has a ferrite core. In properly designed circuits, the 225T1 can supply up to 16 kilovolts at no load, has good regulation, and can provide good deflection linearity.

500 MMF. 15,000 VOLT CERAMIC CAPACITORS

A new 500 mmf. 15,000 volt ceramic capacitor consisting of a ceramic slug encased in a sturdy molded rubber jacket has been introduced by the Sprague Products Company, North Adams, Mass. and is now available through Sprague parts distributors.

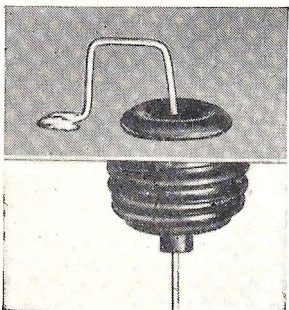

Known as the Sprague Type 510C1, the capacitor is rated for continuous operation at 85° C. and will withstand a 22,500 volt dielectric test. Its minimum insulation resistance is 10,000 megohms.

The composition of the special rubber jacket is such that it will withstand a corona atmosphere without physical deterioration. In addition, the rubber compound used is equal to or superior to Neoprene in its resistance to combustion.

A self-grommet permits easy mounting in chassis. Patents are pending on this unique feature.

Capacitance and voltage rating markings are molded into the black rubber body.

List price of the Type 510C1 is \$2.00.

TV ANTENNAS

As a highlight of their exhibit during the 1951 Parts Distributors Show at Chicago in May, Snyder Manufacturing Company of Philadelphia will introduce two new television aerials to the trade.

One of the new Snyder television aerials is the radically new "Directronic", a motorless TV aerial system with 360° electronically-switched beam. Said to give all the benefits of a motor-driven aerial without motors or

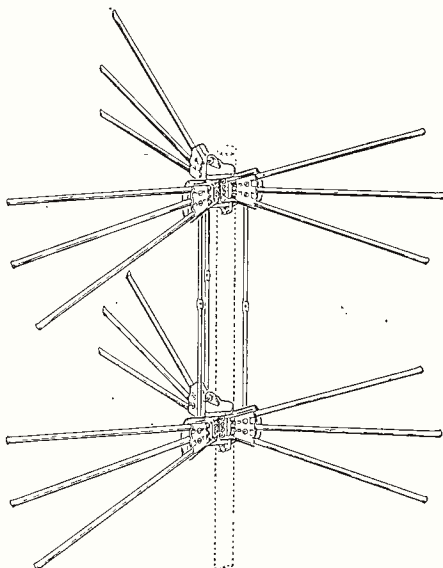

moving parts, the Directronic abolishes electric power, roof orientation and ghosts.

Second of the new Snyder aerials is the Yagi which is being incorporated into both the Redi-Mount and Head-Line series. In both high and low band aerials, the Snyder Yagis are completely preassembled and feature an exclusive space-saving design which allows easier and more economical handling and storage.

NEW RECORD CHANGERS

Webster-Chicago Corporation has introduced a new series of record changers for use in custom installations, as replacement units or as plug-in units. The series is made up of three models, all of which feature a new push-off type record changing system.

The key unit in the line is the model 106, for custom installations and replacement. It automatically plays all three speeds of records in all three sizes. No adapter is needed for the seven-inch records. The Webster-Chicago velocity-trip mechanism provides foolproof, jam-free record change with no lateral pressure on the side walls of the record grooves. The unit has an automatic needle-set down point controlled by the position of the record push-off shelf and an automatic stop that shuts off the motor and returns the pickup arm to rest position when the last record has been played. A muting switch that silences



the amplifier during the record changing process is also featured.

The Model 106 replaces the Model 356 record changer in the Webster-Chicago line.

The Model 106-27 is the same unit designed for the use of the variable reluctance pickup.

The plug-in unit in the series is the Model 107, which can be plugged into a radio or television set for sound reproduction through that unit's speaker. It has a base with rubber feet for easy portability and use on any cabinet or shelf.

SUB-MINIATURE VOLUME CONTROLS

No bigger than a dime! That immediately describes the miniaturization achieved in the Series 48 composition-element sub-miniature controls developed by Clarostat Mfg. Co., Inc., of Dover, N. H., and available only on special order.

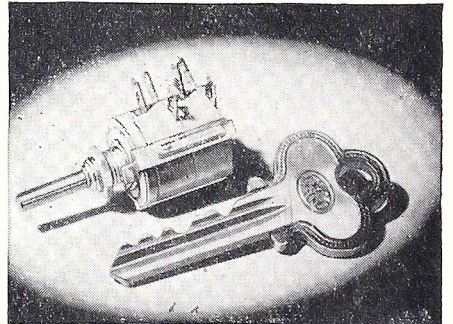

These controls are fit companions for sub-miniature tubes in ultra-compact electronic assemblies. Each unit, housed in a yellow low-loss bakelite case, measures only 5/8" in diameter by 3/8" deep. Two units can be nested together and held by metal straps for a dual-control combination. Series 48 units are available in resistance values up to 3 megohms linear, and in tapers up to 1 megohm. Round or slotted shafts are available, and also a shaft-locking arrangement. Despite greatly reduced size, these Clarostat sub-miniature controls are ruggedly built for dependable service.

FLYBACK TRANSFORMER

RAM Electronics, Inc., South Buckhout Street, Irvington-on-Hudson, New York, de-

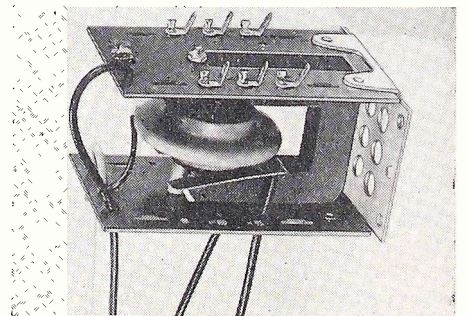

signers and manufacturers of Test Pattern Tested fly-back transformers, deflection yokes, linearity controls, width controls and other components for the television industry, have just announced the release of the new high-

efficiency RAM XO45 Flyback Transformer for replacement and conversion purposes.

Precision-constructed to the highest standards of efficiency, the new RAM XO45 is specifically designed as a perfect replacement transformer for all TV receivers originally using 1B3 or 6BG6 tubes. For 16" and 20" round and rectangular tubes, it generates 12.5-14 KV and 13.5 KV respectively, with horizontal sweep more than ample for 20" picture tube. Both regulation and linearity are excellent.

Ram Test Pattern, Tested components have long been specified as original equipment by leading TV receiver manufacturers. The new RAM XO45 is specified as replacement transformer for sets manufactured by General Electric, Magnavox and Tele-Tone.

For full information on the new XO45 and the rest of the RAM line of TV components, write directly to the manufacturer.

FIVE-WATT POWER RESISTORS

Clarostat PR 5 F Greenohms—5-watt fixed wire wound resistors with the characteristic

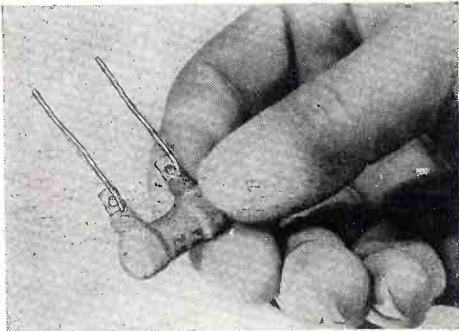

inorganic-cement coating—are now available in the increased resistance values of 8,000, 8,500, 9,000 and 10,000 ohms. Heretofore the top resistance value has been 7,500 ohms.

In the Series AC 10 F or 10-watt Greenohms, the 9,000 ohm value has been added between the 8,500 and 10,000 ohm numbers.

TV ANTENNA INSULATOR

The photograph is usual but the unit shown is not. This plastic insulator for television antennas is being manufactured by Radio Merchandise Sales, Inc. and cannot be cracked, broken, chipped or damaged even by heavy blows of a hammer!

Made of a new plastic, created by Monsanto, that has exceptionally high impact property, the plastic insulator will be featured on the RMS line of television antennas.

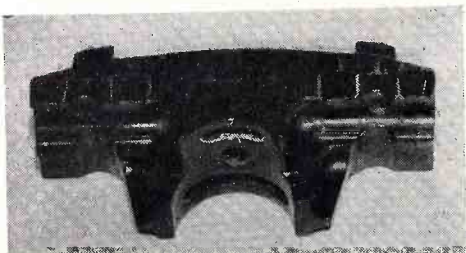

Use of this insulator affords adequate insulating qualities yet adds strength at the point where the elements are attached, or the point subject to the highest stresses in service.

HIGH TRANSCONDUCTANCE TUBE

National Union Radio Corporation of Orange, New Jersey, announces Type N.U. 5857, a secondary-emission, wide-band amplifier tube having a transconductance of 25,000 micromhos designed for use at frequencies up to 200 megacycles. The N.U. 5857, compact in size, is contained in the standard T-6½ miniature envelope and utilizes a 9-pin base.

In addition, the N.U. 5857 is useful as a square-wave generator, providing rise times



In a three-stage stagger-tuned 100-megacycle amplifier having a 20 megacycle band width, the N.U. 5857 will provide an overall voltage gain of 1200 as compared with 47 for the type 6AK5.

Typical characteristics of the N.U. 5857 are available on request.

SYLVANIA ELECTRIC ANNOUNCES ELECTROSTATIC FOCUS TV TUBES

A fourteen inch and a seventeen inch electrostatic focus TV picture tube have been announced by the Television Picture Tube Di-

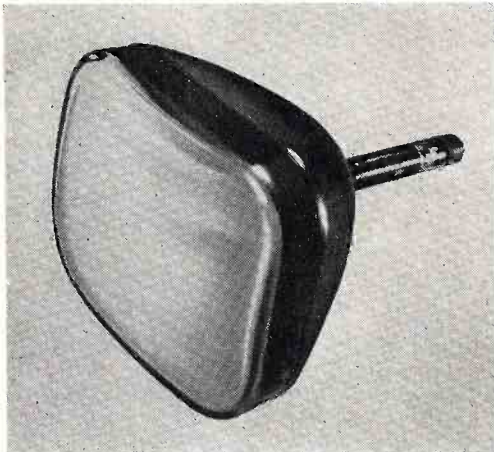

vision of Sylvania Electric Products Inc. for delivery to equipment manufacturers within the next sixty days. The two types, 14GP4 and 17FP4, provide set performance comparable to that of magnetically focussed types but eliminate need of focussing magnets requiring critical cobalt and nickel. An additional high voltage rectifier tube, potentiometer insulated for focus voltage and other circuit components are required.

Mechanical specifications of the 14GP4 include: overall length approximately 16¾"; diagonal bulb dimension 13 11/16", height 9 23/32", width 12 17/32". Its useful screen area is 8¾" x 11½". The 17FP4 has an overall length of approximately 19¼"; diagonal bulb dimension 16½", height 12¼", width 15½". Its useful screen area is 10¾" x 14¼".

H. V. TRANSFORMERS

Standard Transformer Corporation, Chicago, will introduce two new lines of plate transformers at the Parts Distributors Show here in May, according to Jerome J. Kahn, president.

The lines include five transformers in the



Stancor PT series and six in the Stancor PC series.

The PT mounting provides a direct protected path to the anodes of rectifier tubes with heavily insulated HV leads out of the top of the transformer and primary brought out of the bottom for concealed sub-chassis wiring. The PC mounting is for units requiring single-ended rectifiers for safety and convenience.

TUBE AND TOOL CASE

Telescopic Products Co., 262 Sullivan Place, B'klyn 25, N.Y. announces a new tube and tool case designed for the home servicing TV technician. The number of tubes that can be

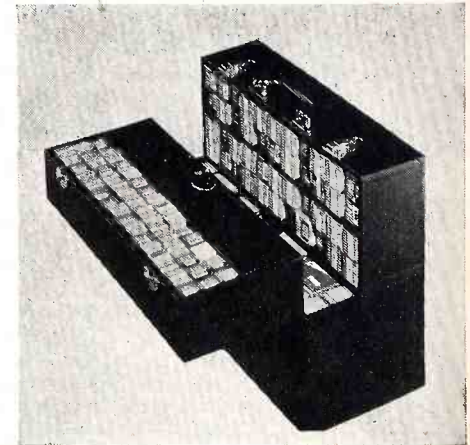

stored (45 miniature, 44 GT, and 18 large) was determined from a study of the tube complements of all post-war TV receivers to date. On opening the case all tubes are in an upright position and immediately visible. Tubes simply cannot flop about.

A spacious tool compartment designed to house the tools used by the home servicing technician is an added feature of this case. Of sturdy wood construction, covered with durable leatherette, the case adds to the serviceman's professional appearance. Priced at \$13.95, net.

REPLACEMENT CARTRIDGE

A new Astatic Cartridge especially designed as a replacement unit for 78 RPM snap-in Admiral Tone Arms is announced by William J. Doyle, general sales manager of The Astatic Corporation, Conneaut, Ohio.

Designated the 402-M Ceramic Cartridge,

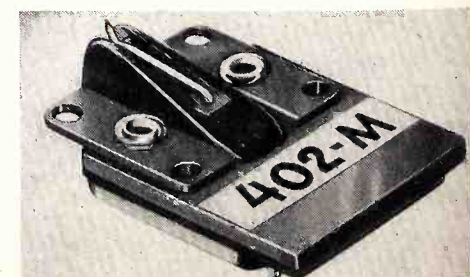

Licking co-channel ~~INTERFERENCE!~~

30 db

FRONT-TO-BACK RATIO

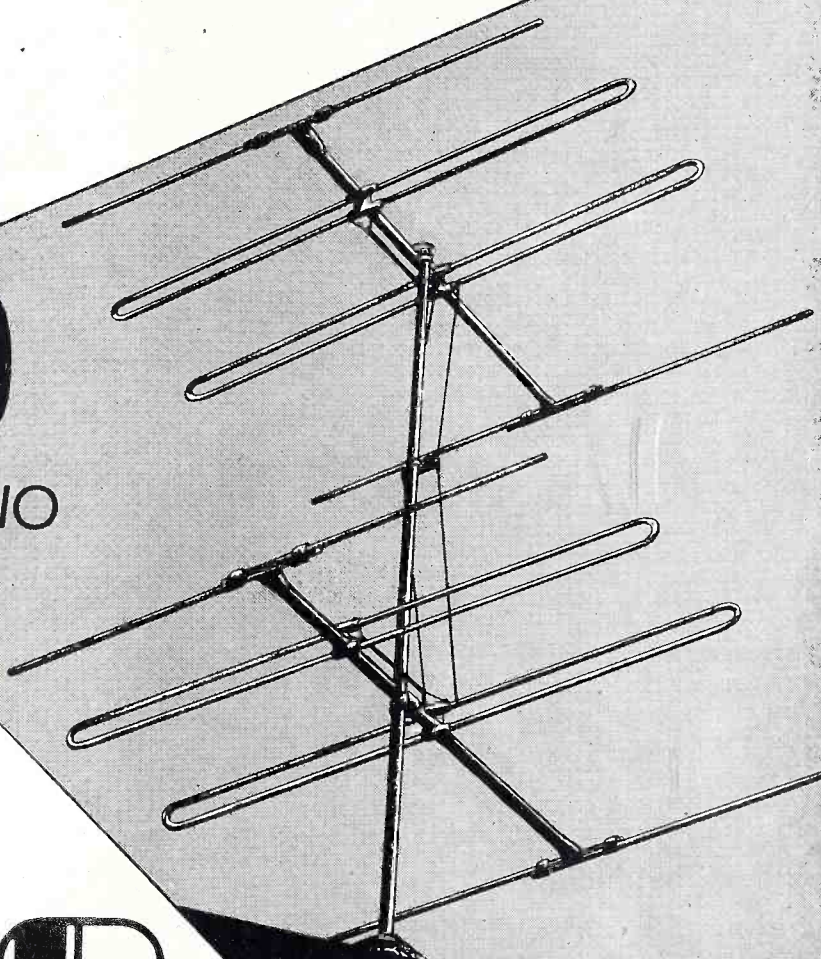

The New

TACOD

Special **TWIN-DRIVEN YAGI**

THIS IS IT—the answer to co-channel interference.

Better than twice the front-to-back ratio of previous antenna designs.

Gain comparable to regular Twin-Driven Yagi.

Pinpoint directivity eliminates

other forms of interference picked up at antenna.

Comes tuned for any low-band channel, either stacked or single.

TECHNICAL APPLIANCE CORPORATION

SEND FOR
ENGINEERING
BULLETIN
NO. 65

SHERBURNE, N. Y. IN CANADA: STROMBERG-CARLSON CO., LTD., TORONTO 4, ONT.

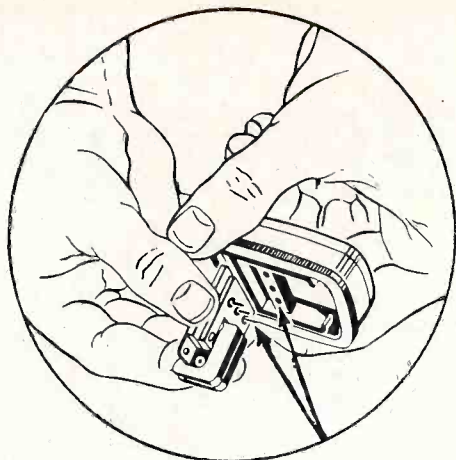

it replaces Admiral Cartridge Part No. A1372.

Installing the new Astatic Cartridge in the Admiral Arms for which it is designed is a simple matter of inserting the three-prong terminals with which the cartridge is equipped in the three snap-in receptacles found in the arms, Doyle declares. Snap-in action holds the cartridge in place and nothing else need be done, he says.

Output of the 402-M is given as 0.7 volt at 1,000 c.p.s. on Audio-Tone test record; frequency range, 50 to 10,000 c.p.s. Recommended minimum needle pressure is 12 grams, net weight of the cartridge eight grams.

The new unit employs Astatic's type "G" replaceable needle with three-mil precious metal tip. This needle slips from its special rubber chuck with a quarter-turn sideways.

VEST POCKET SIZE METAL FUSE

DISPENSER

For the fuse needs of the automotive service man, Littlefuse Inc. of Chicago now packages 5 fuses in an all-metal box dispenser. The sliding top is designed as a permanent part of the box. It eliminates such nuisances as loss of tops and as it slides back only far enough to release one fuse at a time, fuses cannot spill out.



As an added help in fast servicing, a fuse size guide has been printed on the back of the box. This guide makes proper replacement an easy and fast process of comparison with the chart. The easy-to-see signal green package is light and compact. Carry one or several in pocket or kit.

NEW ANTENNA ELIMINATES CO-CHANNEL INTERFERENCE

An antenna designed to minimize, and in most cases entirely eliminate co-channel interference is announced by Technical Appliance

Corporation, Sherburne, N.Y., manufacturers of Taco antenna equipment. It is claimed that the new antenna measures, by actual approved testing setups, a front-to-back ratio of 30 db.

Terminal impedance has been maintained at 300 ohms to match the standard lead-in. Mechanically, the new antenna is as rugged as the regular Taco Twin-Driven Yagi which has won wide acclaim throughout fringe areas over the entire television-covered country.

The Special Twin-Driven Yagi now makes possible clear reception in areas where the ordinary antenna causes "venetian blind" effect on the screen. In the many areas where coverages of two identical channels overlap, this new antenna is expected to be a big sales booster for TV receivers.

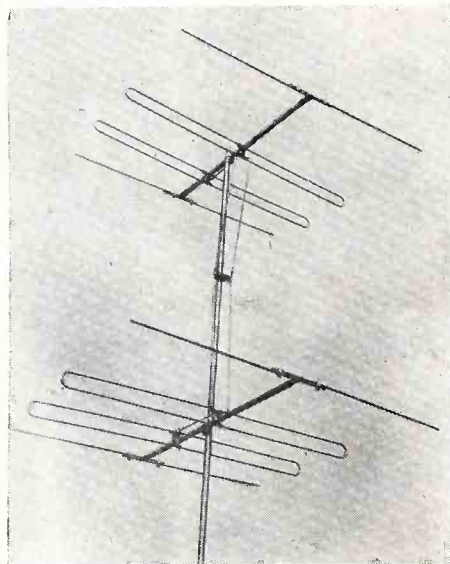

Available for anyone of the low-band channels, the Special Twin-Driven Yagi may be used as a single antenna, or as a stacked array. The elements consist of a director, two driven elements, and a reflector. The terminals are located at the rear folded dipole driven element.

JENSEN UNIVERSAL BRACKET

Jensen Manufacturing Company, well known loudspeaker manufacturers, have just announced a set of brackets for their "Viking" line of speaker models from 3½ inches to 6 inches in size.

The unit package is called the "Viking CTM Universal Bracket Set" and it solves the problem of mounting speakers to the chassis in small radio repair work, as well as providing transformer mounting facilities. A metal

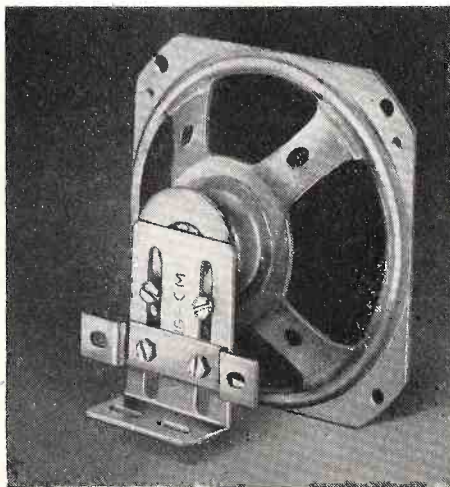

clamp strip with channels holds the speaker in position at any predetermined height above the chassis. The transformer mounting bracket is a separate piece which can be attached in

a variety of ways to solve most space problems.

An illustrated instruction sheet makes serviceman application of the Viking Universal Bracket set a quick and easy procedure.

BEACON ANTENNA

Now in production at the Workshop Associates is a new high gain antenna (beacon) for 450-470 mc., according to an announcement by K. S. Brock, Commercial Sales Manager.

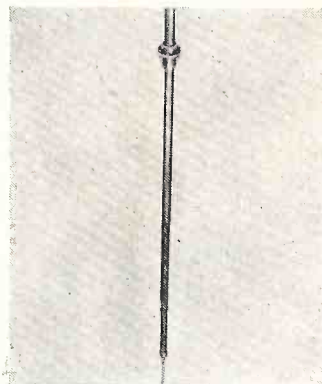

This new antenna, Model 6HW has exceeded design expectations, and is helping to provide dependable mobile communications at these higher frequencies. The Model 6HW consists of six half wave dipoles with an overall gain of nearly 3 db. The vertical radiation pattern is narrowed to concentrate energy on the horizon, enabling greater distance coverage, and horizontal radiation is non-directional. Impedance is 50 ohms with VSWR of less than 2 to 1.

The Model 6HW is based on Workshop beacon antenna patent, 2486597 and incorporates the design of the model 2HW for 108-144 mc., and the Model 3HW for 144-174 mcs. A specification sheet can be secured from the Workshop Associates, Incorporated, 135 Crescent Road, Needham Heights, Massachusetts. RSD 5

VEE-D-X ARRAYS

Jerome E. Respass, president of The Lapointe-Plascomold Corporation, Windsor Locks, Connecticut announced the development of two new methods of stacking the VEE-D-X JC Yagi. Special phasing harnesses have been manufactured in order to convert the regular JC Yagi into a horizontal or vertical 4-stacked antenna.

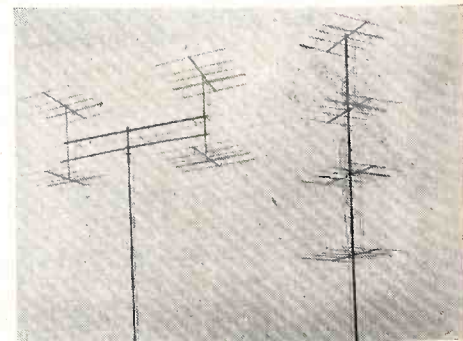

These new stacked arrays, Mr. Respass stated, were designed for long distance single channel reception . . . the vertical for flat terrain and the horizontal for hilly and mountainous areas. An amazingly clear picture, he said, may now be obtained in heretofore difficult reception areas.

TV LEAD-IN WIRE

JFD Mfg. Co., Bklyn 4, N.Y. announces the new JFD 4-Wire Flat Cable No. FW1000 especially useful for antenna rotators, and available at the special distributors net of \$25.00 per thousand ft. spool- 4 spools to a standard package.



DON'T LET HIM "PITCH" YOU

**BLACK
IS
WHITE...**

INSIST ON

Sheldon "Telegenic" Picture Tubes

where **BLACK IS BLACK-**

WHITE IS WHITE- *and between*

ALL THE NATURAL

INTERMEDIATE SHADING!

This FULL RANGE of picture tones seen only on Sheldon "Telegenic" Picture Tubes, makes possible MAXIMUM CONTRAST with CLARITY . . . with NO EYE STRAIN and NO GLARE . . . whether on a Velour Black or clear face screen . . . whether viewed in day-light or under artificial light.

Superior picture quality is the reason why Sheldon Picture Tube production has been stepped up to 5,000 daily! This production increase is made possible by another recent installation of the most modern in-line exhaust unit in the industry.

SHELDON ELECTRIC CO.

A Division of ALLIED ELECTRIC PRODUCTS INC.

68-98 Coit Street, Irvington 11, N. J.

Branch Offices & Warehouses:

CHICAGO 7, ILL., 426 S. Clinton St. • LOS ANGELES 26, CAL., 1755 Glendale Blvd

**Sheldon
NATURAL IMAGE**

**SOFT GLOW
Picture Tube**

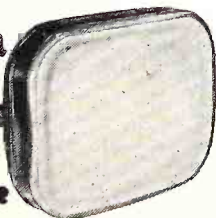

Manufacturers of

SHELDON TELEVISION PICTURE TUBES
CATHODE RAY TUBES • FLUORESCENT
LAMP STARTERS AND LAMP HOLDERS
SHELDON REFLECTOR & INFRA-RED
LAMPS • PHOTOFLOOD & PHOTOSPOT
LAMPS • TAPMASTER EXTENSION CORD
SETS & CUBE TAPS • SPRING-ACTION
PLUGS • RECTIFIER BULBS

**WRITE FOR VISUAL PROOF
OF SHELDON'S SUPERIOR PICTURE QUALITY!
MAIL COUPON TODAY**

Sheldon Electric Co., 68 Coit St., Irvington 11, N. J. B

Send Proof of Picture Quality
 "Characteristics and Dimensions" Wall Chart
 "Television Mis-Information"
 "Ion Burns—How to Prevent Them" Brochure
(They're free — but PLEASE PRINT)

Name _____ Title _____
 Company _____
 Street _____
 City _____ Zone _____ State _____

VISIT BOOTH NO. 201, PARTS DISTRIBUTOR SHOW, STEVENS HOTEL, CHICAGO, MAY 21-23.

© 1951—ALLIED ELECTRIC PRODUCTS INC.

TRADE FLASHES

[from page 12]

1952 or early 1953, a simple, high-quality converter will be made available so that telecasts can be received on ultra high frequency channels with quality comparable to those received from the very high frequency bands now in use.

Pointing out that every current television set, regardless of make, will require some modification to receive a UHF signal, Mr. Buck Vice-

President and General Mgr. of the RCA Victor Division, stated.

"No receiver currently manufactured has provision for conversion to UHF without additional cost for equipment and installation, normally including the addition of a special outdoor antenna."

Other points made by the RCA Victor executive were:

Final approval of the new UHF

channels has not as yet been given by FCC.

Assignments of the new channels to stations cannot be made until such final approval has been given by FCC.

RTSD Publisher Receives PRSMA Membership Card

Sandy Cowan, publisher of Radio-Television Service Dealer is shown below receiving an honorary membership card in the Philadelphia Radio



Servicemen's Association for services rendered to the servicing profession. Tom Middleton, President of PRSMA is presenting the card to Mr. Cowan.

Sylvania Develops New Permanent Magnets

The development of new permanent magnets containing only non-critical material for applications in radio and television receivers as well as other commercial and military equipment have been announced by the Metallurgical Laboratories of Sylvania Electric Products Inc., according to Walter E. Kingston, Manager of the Laboratories.

"The new permanent magnets" Kingston explained, "avoid the use of critical cobalt, nickel and aluminum and have suitable magnetic properties for applications in commercial radio and television receivers where the critical metals are now required."

Burton Browne Designs Defense Shield

Dr. Burton Browne, President of the Agency, Burton Browne Advertising, located at 619 North Michigan Avenue, Chicago, Illinois, has designed a shield for ad insertions during the defense effort and which he is making available to all advertisers interested in giving a portion of their paid advertising to the government.

Oxford's Best Year

At a recent annual meeting of the shareholders of the Oxford Electric Corporation, Chicago speaker manufacturer it was reported that the firm's total sales more than doubled the pre-

2 useful tools for reaching those cramped corners

MIGHTY HANDY

in a "tight spot"

WALSCO LUBRICATOR
 Designed to reach the many cramped and hidden points in radio, TV sets and record changers. Ideal for applying light greases and oils. Syringe-type plunger releases desired amount of lubricant.
 ONLY 48c DEALERS NET*

WALSCO CONTACTENE INJECTOR
 Permits application of contact chemicals to volume controls and switches without unsoldering connections or taking controls apart. Finest surgical-grade needle and oil-resistant, neoprene bulb.
 ONLY 45c DEALERS NET.*

... AND SPECIFY FAMOUS QUALITY WALSCO RADIO CHEMICALS

CONTACTENE **NO-OX**
WALSCOLUB "B" **TUNERLUB**

*SOLD EXCLUSIVELY THROUGH JOBBERS EVERYWHERE. PRICES SLIGHTLY HIGHER IN CANADA.

WALSCO

WALTER L. SCHOTT CO.

Los Angeles 18, California • Chicago 6, Illinois

Everybody's Tuning it!

"THE STANDARD BOOSTER"



Model B-51

in tune with the tuner

The new and improved "Standard TV Booster" is daily winning greater acceptance by dealers and customers alike in every Television market.

Here is the booster that gives real customer satisfaction, superior performance, trouble-free operation. The Model B-51 is engineered by a company that has demonstrated the greatest TV tuner know-how in the business.

Have your local distributor show you the outstanding features and money-making possibilities of this great new "Standard TV Booster."

Standard COIL PRODUCTS CO. INC.

CHICAGO • LOS ANGELES • BANGOR, MICHIGAN



Millions of
"Standard Tuners"
now in use.

The "Standard Tuner" is used by over 75 TV set manufacturers. Nearly 50% of the TV sets made today are equipped with this outstanding front-end.

See Us At Booth 680
Parts Show — Stevens Hotel

vious high in over twenty-five years of manufacturing. The net earnings also reached a new high.

Inventories at the end of the year were well balanced and sales thus far in 1951 are continuing at a record high level.

The following persons were elected as directors: Joseph D. Ceader, Floyd D. Cerf, David E. Davis, Herman Fine, Louis L. Kahn, Louis Pelton and Blaine Willenborg. The following officers were elected; Joseph D. Ceader as president, Hugo Sundberg as Vice-President and General Manager, and David E. Davis as sec./treas.

Oxford is marching ahead to retain its position as a leading speaker manufacturer. Further information is available from the general offices at 3911 South Michigan Avenue, Chicago.

Sheldon I. R. E. Exhibit Draws Large Crowd

Sheldon Electric Co. personnel played an important part in the success of its booth at the Radio Engineering Show at Grand Central palace New York, March 19-22, as evidenced by the thousands who visited it. They included, left to right—M. Kligman, E. Rodriguez, I. Gaines,



D. Quinn, R. Leader and R. Harris of (Sheldon's Philadelphia representatives), Charles Penk, Sheldon's Vice-President, H. Metzendorf of Corbin Advertising Agency, and Nathan Chirelstein, Sheldon's President, M. Henowitz, E. Frenchman, F. Ferdinand, H. Martin, D. Ravitz and P. Bonano.

National Union Offers Fluorescent Sign

A new indoor fluorescent sign that is both durable and permanent is being offered by National Union through its distributors

This new N.U. fluorescent sign measures 8" high and 25½" long and is provided with rubber feet so that it can be used on a counter or shelf. It is for use only on 105 - 125 volts A. C. 60 Cycles - employs a 20 watt Daylight fluorescent tube consuming approximately one cent worth of electricity in a 24 hour period, making it desirable to operate the sign all night. It is available from National Union distributors on a non-profit basis at only \$8.95 plus shipping charges.

Telrex Patent Reissued

The original Telrex Patent No. 2,518,297 which was issued for conical antennas has now been reissued by the United States Patent Office. Although the original patent has three claims, the reissue patent has seven claims which are very much broader in its terms.

The Reissue Patent bears No. 23,346 and is dated March 20, 1951. It is also assigned to Telrex, Inc.

Regency Booster Mfg. Expands

I.D.E.A., Inc., Manufacturers of Regency Boosters has recently expanded its production facilities by the addition of 25,000 square feet of floor space.

Here, Corwin Alexander, Jr., Production Manager for I.D.E.A. explains to President Ed. Tudor how the added floor space and assembly lines will speed up the output of the Regency TV Signal Booster.

Announcing the Sensational

Low Cost Telrex



VANGUARD SERIES

CONICAL-V-BEAMS*

OFFERING OUTSTANDING TELREX PERFORMANCE AND DEPENDABILITY

DESIGNED for results and profits! High performance, extra low priced, the VANGUARD will outperform and outsell any comparably priced TV antenna anywhere. Vanguard Conical-V-Beams have engineered design that guarantees finest reception, conservative ratings that assure top performance and super-rugged construction that means long, trouble-free service life. The next time you need antennas, order Vanguard by Telrex. Don't settle for less than the best—particularly when the price is right.

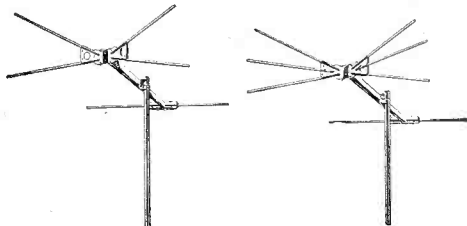

MODEL VM-2X
uni-directional, Conical-V-Beam with reflectors.

MODEL VU-2X
uni-directional, Modified Conical-V-Beam with reflectors.

MODEL VM-4X
uni-directional, Stacked Conical-V-Beam with reflectors.

MODEL VU-4X
uni-directional, Stacked, Modified Conical-V-Beam with reflectors.

Produced under re-issue Patent No. 23,346. Copyright 1951



Be sure it's a "CONICAL-V-BEAM" —Look for the TELREX* Trademark

* REGISTERED TRADE MARK

Telrex INC.

CONICAL-V-BEAMS*

ASBURY PARK 5, N. J.

AMERICA'S STANDARD OF COMPARISON

THERE MUST BE AN EASIER WAY TO MAKE A LIVING!!!

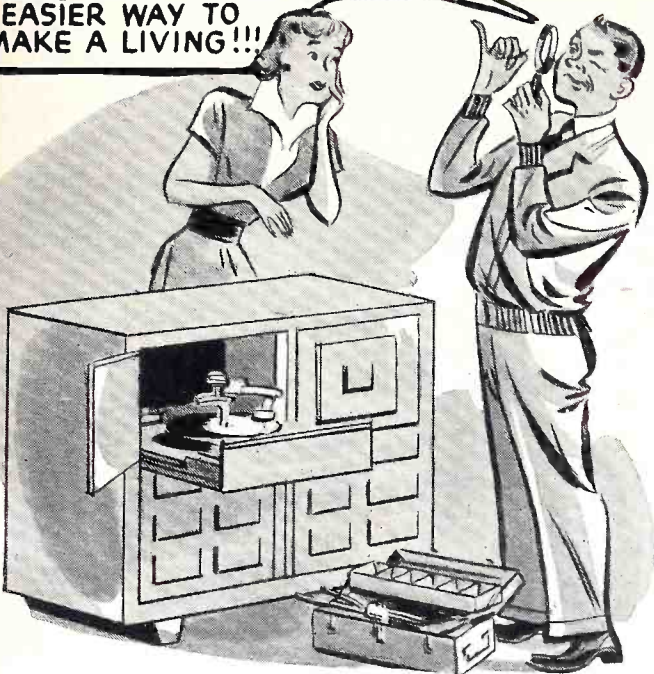

IT'S SO EASY SINCE I GOT PERMO'S "FACTS"



COMPLETE

Facts MAKE THE DIFFERENCE!

PERMO long-life phonograph and needle facts

GIVE YOU COMPLETE INFORMATION — MANUFACTURER BY MANUFACTURER.

"Facts" are authoritative—accurate—and issued individually as they are completed. The Admiral Section—currently available—covers 320 post-war Admiral Models; 21 types of record changers; 10 cartridges; 8 needles. Tells specifically what needle goes where. Bound to make you a best-seller of phono needles and accessories!

AND PERMO HELPS YOU **SELL** WHAT YOU BUY!

With Permo Long-Life you get the finest needles that can be produced—convenient packaging (complete even to installation tools, spare nuts and screws, where required)—designed for easy carrying—easy selling. You get the Complete Admiral Replacement Kit, with 8 needles and "Facts" for less than six dollars!



The Admiral Section — Release Number 1. Available free with the coupon below.

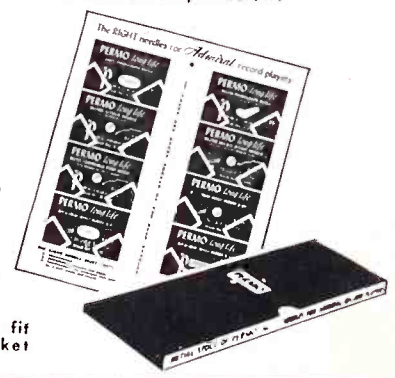

Display card folds to fit into convenient pocket packet.



SEND FOR YOUR FREE "FACTS" NOW!

PERMO, INC.—Dept. E
6401-33 N. RAVENSWOOD AVE.,
CHICAGO 26, ILLINOIS

_____ date

Please send me a FREE copy of the Admiral Section, Permo Long-Life Phonograph Needle Facts.

Name _____

Address _____

City _____ Zone _____ State _____

Name of Jobber from whom you usually order. _____

PERMO *Champion of Perfection*
INC.
6401-33 N. RAVENSWOOD AVE.
CHICAGO 26, ILLINOIS

New TV Service Form System

A typical Markem Service System installation to handle routine TV

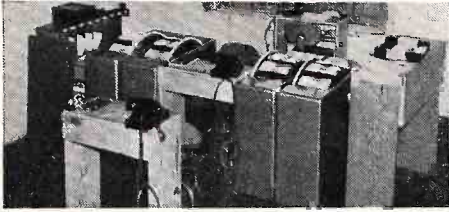

service paper work—Inquiries to Markem Printing Co., 145 Hudson St., N.Y. 13, N.Y.

TRADE LIT

[from page 42]

antennas, masts, insulators, transmission lines, guy and ground wire, the new catalog also includes the latest additions to the JFD line such as the latest "Long-Ranger" Yagi antennas.

Copies are available upon request to the manufacturer and its distributors.

A full line of modern Stabilized Crystals for every electronic application is illustrated and described in a new comprehensive catalog just released by James Knight Company.

A new 132-page catalog of radio—television—electronic components is now being offered by Sun Radio & Electronics Co., Inc., 122-124 Duane Street, New York City, distributors. Copies may be had by writing or visiting the Sun Radio establishment on Duane Street, New York City.

The new 1951 edition of the Stancor TV Transformer Catalog and Replacement Guide is now available from Standard Transformer Corporation, 3580 N. Elston Avenue, Chicago 18 Illinois or from any of their distributors. This 36-page guide contains replacement information on over 900 TV receiver models and chassis made by 71 manufacturers. Complete specifications, dimensions and prices of 75 Stancor transformers and related components for TV replacements and conversion are listed.

Zetka Television Tubes, Inc., of Clifton, New Jersey, is pleased to announce that its new two-color, twelve-page catalog is available to the trade, without cost.

The book covers thoroughly the 16", 17", 19" and 20" picture tubes made by this pioneer producer. Every tube shown is thoroughly detailed with descriptive copy and diagrammatic drawings.

Requests for the new Zetka Catalog should be addressed to Mr. Murray Shindel, Sales Manager, Zetka Television Tubes, Inc., 131-137 Getty Avenue, Clifton, New Jersey.

An informative, comprehensive booklet on color television in which the fundamentals of proposed systems are described in easy-to-understand text, diagrams and photographs, has been published by the Paul H. Wendel Publishing Co., Inc. of Indianapolis, Indiana, as a practical reference for experimenters, hobbyists and TV servicemen.

The notebook, written by Edward M. Noll, author of "Television for Radiomen" and a products consultant and lecturer of Temple University, Philadelphia, Pa. includes descriptions of the basic elements of color TV; the adaptation of standard TV receivers for black and white reception of color signals; adapters and converters for color signals; the CBS, RCA, CTI and other color TV sys-

1/6 the LOSS

WITH PERMANENT

OPEN LINE

By T. V. WIRE PRODUCTS

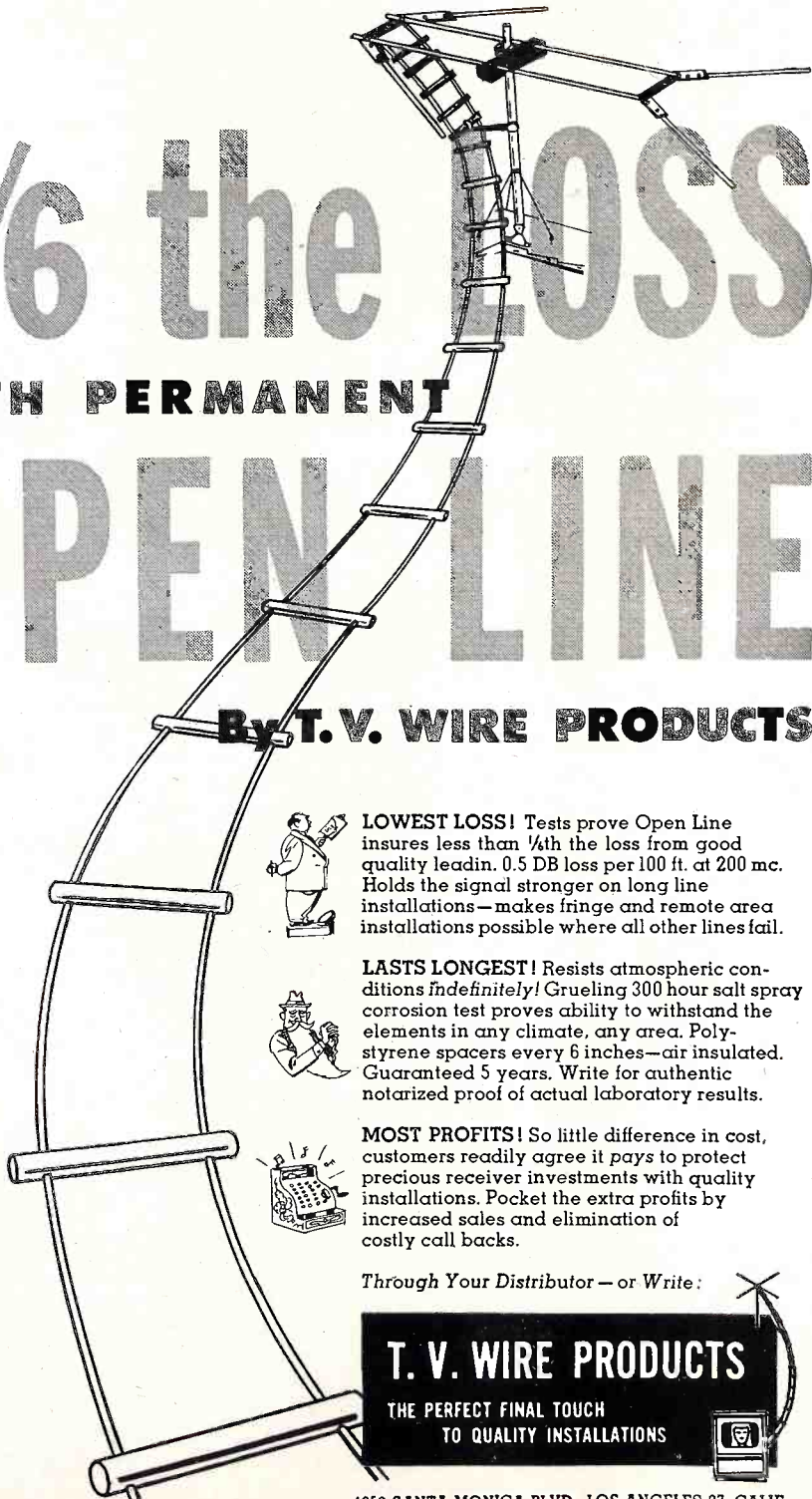

LOWEST LOSS! Tests prove Open Line insures less than 1/6th the loss from good quality leadin. 0.5 DB loss per 100 ft. at 200 mc. Holds the signal stronger on long line installations—makes fringe and remote area installations possible where all other lines fail.



LASTS LONGEST! Resists atmospheric conditions indefinitely! Grueling 300 hour salt spray corrosion test proves ability to withstand the elements in any climate, any area. Polystyrene spacers every 6 inches—air insulated. Guaranteed 5 years. Write for authentic notarized proof of actual laboratory results.



MOST PROFITS! So little difference in cost, customers readily agree it pays to protect precious receiver investments with quality installations. Pocket the extra profits by increased sales and elimination of costly call backs.

Through Your Distributor — or Write:

T. V. WIRE PRODUCTS
THE PERFECT FINAL TOUCH
TO QUALITY INSTALLATIONS

4852 SANTA MONICA BLVD., LOS ANGELES 27, CALIF.



SAVE Up to \$1.00 each.

**Form a Group,
Service Dealers**

Subscribe to "RTSD" -

The Professional Radio-Television man's "magazine"—published monthly. All articles are exclusive and timely. Practically every issue is worth what an entire 1 year subscription costs.

★ The more in a group the bigger the savings. 6 men in a group save \$1.00 each; 4 men groups save \$.75 per man. Present "RTSD" subscribers may participate in or form a group with co-workers, or even competitors. Still active subscriptions are automatically extended 1 year. Start a Group today! The timely and exclusive technical data appearing in future issues of "RTSD" will make this the best investment you ever made. The special Group Rate offer may be withdrawn at any time—so hurry.

Use This Coupon For Convenience

(The coupon below can be used for from 1 to 6 subscription orders. Use it today!)



TEAR OUT — MAIL TODAY

RADIO-TELEVISION SERVICE DEALER
57 West 44th Street, New York 18, N. Y.

Please enter 1 year subscription orders for the names given below. Our remittance is enclosed.

NOTE: If you do not wish to tear this order blank out, just print or type the information on a single sheet of paper, following the style given. Each subscriber's occupation must be clearly described.

	In U.S.A. & Canada	Foreign Rates
<input type="checkbox"/> One 1-year subscription	\$2.00	\$3.00
<input type="checkbox"/> Two 1-year subscriptions, each	1.75	2.75
<input type="checkbox"/> Three 1-year subscriptions, "	1.50	2.50
<input type="checkbox"/> Four 1-year subscriptions, "	1.25	2.25
<input type="checkbox"/> Five 1-year subscriptions, "	1.10	2.00
<input type="checkbox"/> Six 1-year subscriptions, "	1.00	1.50

Name

Address

Describe Title or Position and Type of Business

State whether a New Subscriber or Renewal Order

Name

Address

Describe Title or Position and Type of Business

State whether a New Subscriber or Renewal Order

Name

Address

Describe Title or Position and Type of Business

State whether a New Subscriber or Renewal Order

Name

Address

Describe Title or Position and Type of Business

State whether a New Subscriber or Renewal Order

Name

Address

Describe Title or Position and Type of Business

State whether a New Subscriber or Renewal Order

Name

Address

Describe Title or Position and Type of Business

State whether a New Subscriber or Renewal Order

tems; tricolor picture tubes; color wheel assembly and control units; tabular summaries of performance characteristics of different color TV systems; and a brief chronology of television development.

Text is supplemented with block and schematic drawings; tables of data and photographs pertaining to color phenomena, scanning systems, standard receiver modifications for color reception, scanning disc motor control, crispening circuits, waveforms, automatic phasing systems and other color TV data covered in the text.

The *TV Color Notebook*, which measures 8½ x 11 inches is provided with a durable cover, has been designed to lay flat for convenient reference and filing. Copies may be obtained by sending \$1.00 to the Paul H. Wendel Publishing Co. Inc., P. O. Box 1321, Indianapolis 6, Indiana.

• • •

General Electric's new *Radio and TV Replacement Parts Catalog*, listing parts for sets produced from 1945 to December 1, 1950 is now being sent to distributors, it was announced today by E. A. Malling, parts sales manager for the Receiver Division at

Electronics Park here.

The cloth-covered, 144-page, loose-leaf catalog includes a cross reference between drawing number and part number, making it possible to determine, from the drawing number alone, all the information about any part. This is a new feature of the catalog.

Further features, adopted after determining the needs of field salesmen, include alphabetical listing by part number, new and complete part descriptions, set models in which each part is used, list price, and a revision service to keep salesmen up to date.

Specified in the Best TV Sets for Years...

NOW it's RAM components for REPLACEMENT and CONVERSION!

Bigger, Faster PROFITS for You!

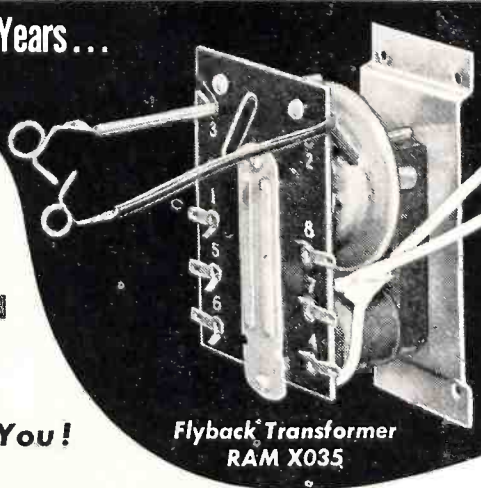

Flyback Transformer
RAM X035

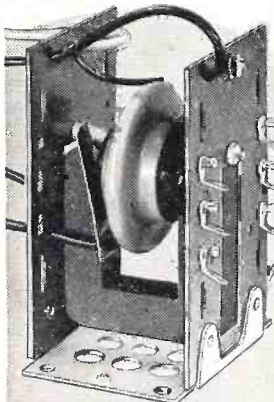

Flyback Transformer
RAM X045

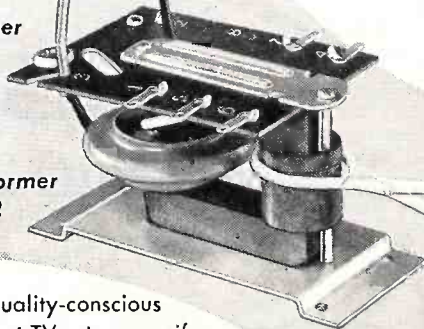

Flyback Transformer
RAM X032

HIGHEST EFFICIENCY! LOWEST COST! IMMEDIATE DELIVERY!

The famous TV set manufacturers who have for years specified RAM components as original equipment are an impressive list of industry leaders — Air King, DeWald, DuMont, Fada, Olympic, Scott, Starrett, Regal, Tech-Master, Tele-King, Tele-Tone, etc. Day after day, RAM Test-Pattern Tested components have far surpassed their every super-critical laboratory, production and field test. This is the proof of RAM superiority!

RAM now makes these identical quality components available to you—at the lowest costs in the industry, with immediate delivery—for your greater replacement and conversion profits!

Take a tip from the quality-conscious men who make the best TV sets—specify RAM! There's a RAM Test-Pattern Tested Flyback Transformer, Deflection Yoke, Width Control and Linearity Control for your every need. Ask your parts distributor for them—TODAY! Write NOW for free latest Catalog D-1.

Ram

ELECTRONICS, INC.
SOUTH BUCKHOUT STREET
IRVINGTON-ON-HUDSON, N. Y.
IRVINGTON 9-5700

Manufacturers of TEST-PATTERN TESTED Components for Television



Deflection Yoke
RAM Y-70

SYNC PULSES

[from page 20]

tricky footing, laden with heavy hose, they could be injured seriously, even pitched to death in the street, if they dashed against an antenna or stumbled over a wire, particularly in the dark or in screening billows of smoke.

Some experts are speculating on the possibility of outlawing individual antennas. They suggest that installations of master antennas be studied. One could serve all tenants in a building, littering of roofs would stop, the costs of maintenance could be shared equally and safeguards set up in the interests of firemen.

And perhaps there might be a satisfactory end to the vexing controversy over what it is worth to a TV set owner to use part of a landlord's roof."

If "the experts" had their way and all multi-dwelling tenants were required to use a master antenna system this would be just one more "thing" about which landlords and tenants would have occasion to scrap. However, in certain Long Island City apartment houses the tenants got together and voted that their landlord should install a master system, the cost of which was to be mutually shared, and it is working out nicely. On the other hand, probably the whole thing would have been unsatisfactory if the landlords had proposed the installation of the master systems. It's a case of "heads you lose, tails I win". One can never figure on what's in the other guy's mind.

TUBE TOPICS

[from page 43]

as all tubes produced are in demand, it doesn't make sense to lose a pro-

duction of 300 or 400 tubes to produce 100 tubes of some other type.

It would appear that with the slackening demand for certain types of tubes one could expect some of the scarcer types would be produced. Such will unquestionably occur in many instances. But it is expected that many of the replacement types will still be in short supply. This is because, changing a tube type in production is similar to changing an automobile production line. The production line is geared to produce one make of auto - likewise a tube manufacturing unit (group of equipment) is at any one time geared to produce one type or group of tube types. It is not possible to mix the types.

Manufacturing Equipment Limited to Types Produced

Therefore if a production unit is required to produce a type 6SN7GT, until it is possible to stop producing that type, the unit cannot be changed over to produce a 1A7GT, the unit will not produce both types simultaneously. As long as there is sizeable demand for the 6SN7GT even though the unit is operating at less than full capacity, no other type can be produced on the manufacturing except for possibly the 12SN7GT which is in the same family. Further, equipment set up to produce miniature tubes is not suitable for producing GT types; likewise metal-tube equipment will produce only metal tubes, and lock-in equipment the lock-in construction of tubes. Therefore, it often happens in normal periods that a factory is working overtime to meet the demand on certain types of construction of tubes, while other equipment is only in partial use, and in some cases actually shut down.

Accordingly, for many of the renewal type tubes to be produced, it will be necessary for the total tube demands on the industry be drastically reduced or that a very large expansion in capacity be made. Such is not expected to occur. Nothing has been mentioned of the possibility of material shortages as it is expected that sufficient materials will be available if substitutes are employed everywhere where practicable.

23 TYPES

[from page 39]

door without further ado. Almost anything can arouse Charlie's vile temper. There is no better way to handle and tame this type of beast, except

to get to know him and know his thousands of dislikes.

9. *Billy the believer.* He'll go hook, line and sinker for anything you tell or sell him. But he is not an easy customer at that. Because another salesman may unsell Billy. The truth and under rather than overselling can make a regular out of Billy.

10. *Boastful Bobby.* Anything you can do, he can do—or has done—better. Admit that he is the greatest, smartest, strongest, man in the world, and shout about it from Bobby's housetop, and Bobby will be putty in your hands.

11. *Envious Ernie.* Why do other

people always make out better than Ernie? Tell him how you can keep him up with—and even on top of—the Joneses, and Ernie is your boy.

12. *The looker.* He just wants to check prices. Just whose prices he is checking is uncertain, because this animal usually ends up causing trouble to a dozen dealers and giving the order to none. The obvious way to handle him is with a fast bum's rush out of your door. But that is dangerous. After all, he *might* buy one day, and in any case he is usually equipped with a long, wagging tongue which he uses to build up ill will among his friends for those who do not

Keep Picture Quality UP Keep Service Calls DOWN



JUST PRESS THE BUTTON,
SPRAY IT ON —
NO SPECIAL
EQUIPMENT NEEDED!

Spray on antenna and lead-in terminals

Krylon prevents corrosion and pitting, even in salt-spray areas. It seals antennas and connections in a waterproof acrylic (not vinyl) blanket. (When aluminum finish is desirable, use special aluminum Krylon.)

Spray on high voltage circuits

Spray Krylon on the high voltage coil and insulation . . . in the socket of the high voltage rectifier . . . on component parts of rectifier circuit. Helps prevent corona because of its high dielectric strength.

Two types—clear and non-conducting aluminum. Both have exactly the same qualities. Packed in 12 oz. aerosol spray cans. List prices: \$1.95 clear, \$2.25 aluminum. Also available in gallons for application by brushing or dipping. See your jobber, or write direct.

**KRYLON, INC., Dept. 505,
2601 No. Broad St., Philadelphia 32, Pa.**



Full-Vu TUBE and TOOL CASE

- Functionally designed to accommodate every tube used in all post-war TV receivers.
- Provisions for 45 miniature, 44 GT, and 18 large size tubes; totalling 107 tubes in all.
- All tubes are immediately placed in full view as soon as the case is opened. No hidden tubes.
- Snug fit and patented construction prevents tubes from falling out or flopping about.*
- Tool compartment contains 128 cubic inches; space enough to accommodate all the ordinary tools used by the technician on the home call.
- Sturdy wood frame construction; durable leatherette covering; overall dimensions: 16" x 14" x 7 1/2".

* Patent Applied for

Price — **\$13.95**
net

MFD. BY

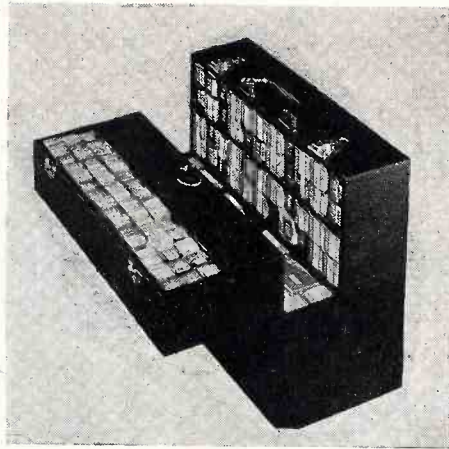
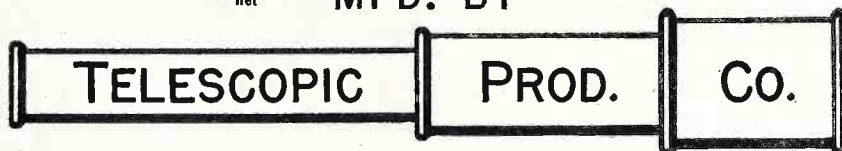

262 SULLIVAN PLACE

BROOKLYN 25, N. Y.

A MUST for every radio man

CQ is a monthly publication for Radio Amateurs, Technicians, Engineers, and Communications personnel. As radio-television servicemen you will be interested in knowing that the FCC has recently initiated both Novice and Technician Class licenses for radio amateurs. Since these licenses are easily obtained, many of you will undoubtedly be interested in preparing for them. (These are discussed fully in the March issue.)

For many years CQ has served radio amateurs and communication men throughout the world. Its articles are a constant reading necessity for all men in the radio profession.

Enter your subscription to CQ NOW!

1 Year \$3.00 **2 Years \$5.00**

Regular Subscription rates:

in U. S., U. S. Possessions, Canada and countries in the Pan American union. All others \$4.00 per year.

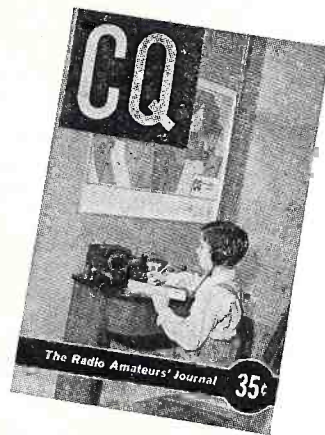

--- TEAR OUT --- MAIL TODAY ---

CQ Magazine

67 W. 44 St., New York 18, N. Y.

RS-1

Sirs: Here is my check (or money order) for \$..... for years
subscription to CQ.

Name (print carefully)

Address

City Zone State

jump to his call when he wants to look—but not to buy.

13. *The comparer.* He is like a woman shopping for a new hat, who goes into every store and tries on every hat before finally choosing one of the first she saw. Her idea—and his—is to be sure that there is not a better buy in town. A type increasingly common these buyer's market days. You can sell him by being actually eager in your willingness to serve him again after he has compared.

14. *Firm Frank.* Frank has never been in doubt about anything in his life. To him, some things are white, some things are black. Nothing is gray. Propositions are right, or they are wrong. If you sell Firm Frank the first time, he will remain firm in his conviction that you are the best repair man in town for the rest of his business life. A good kind of customer to get, because he is the sort who firmly recommends you to his friends. Matching his firmness with equal sureness of a right proposition is a sound way to sell Frank his first order. Don't even intimate a possibility that other dealers could sell for anywhere close to the price which you quote Firm Frank.

15. *The conclusion jumper.* You get as far as the first two sentences of your sales spiel, and then this character stops you. He knows what you are going to say. Usually, he has deduced the rest of it all wrong. But that does not mean he will give you the opportunity to set his jumbled notions straight. Even if he does let you talk, he is not listening. When he goes to a concert, this twirp hears the opening crash of a piano chord, and then stops listening; he has deduced the rest from that, and may as well go out for a smoke without wasting more time. Aside from bringing along a gag and slipping it into this joker's mouth, there is no sure way to keep him from jumping an opening thought into a wrong conclusion.

16. *"My cousin once bought from you and was dissatisfied."* This is a hard sort to bring around. One trick which works is to stress—along with regular talk about quality and price—a money back guarantee so the clown can't lose by ordering from you.

17. *"My cousin Joe once bought from you and DID like it."* Now, you are in like Flynn, or perhaps more accurately like Cousin Joe. Just keep playing him by using Joe for a lure. Good old Joe. You'll land this one without any doubt. It's a good idea to quote your Cousin Joe case histories

MEN OF RADIO

[from page 38]

news of the success too early. Evidently the original scheme of concentrating on ship-to-ship wireless was temporarily pigeonholed and the Marconi Company proceeded with plans for a two-way trans-Atlantic link. Of course, the first step in such a plan was the construction of a permanent station, preferably at St. John's, but this station was destined never to be built.

Immediately after the news reports appeared, the New York manager of the Marconi interests was interviewed by the press. One of the questions asked was whether he thought wireless would supplant the land tele-

graph, and he replied that this was a distinct possibility. Even without such a statement, the telegraph companies were already worried, and the interview resulted in genuine alarm. Some companies took the view that they were threatened with extinction, the value of telegraph and cable stocks dropped alarmingly and a fight for survival took shape. One result was that Marconi was served with legal papers prohibiting him from continuing operations within Newfoundland; the basis for this move lay in the fact that the company initiating the action maintained a monopoly over the sending and receiving of telegraph messages in that area and wireless was considered a form of telegraphy.

All plans for erecting a permanent station in St. John's were abandoned and operations were transferred to Glace Bay, Nova Scotia.

The new Glace Bay station was ready for operation by the end of 1902. In the meantime, many improvements had been made in apparatus and techniques. Lodge had contributed tuning methods which enabled an operator to separate wanted from unwanted signals, based upon his original research in the phenomena of resonance. Marconi had introduced the magnetic detector, regarded as a valuable improvement over the coherer, earlier in 1902 and the new detector was added to the installation. The first wireless message in the west to east direction was sent on December 17, and the era of commercially practicable wireless service had begun.

With this phenomenal start, it was not surprising that the Marconi system outdistanced all competitors and became the most important factor in commercial wireless. There were rivals, many of whom made very valuable contributions to progress, but for many years control of a major portion of the industry rested with the Marconi Company.

Guglielmo Marconi, designer of the first practicable wireless equipment and founder of a vast industry, went on to discover a system of concentrating radio waves into a directional beam, invented many improvements in radio apparatus and made valuable investigations of high-frequency radio waves. His yacht Elettra was virtually a floating laboratory and it was aboard this craft that he conducted many of his investigations. Many honors were conferred upon him, including decorations in Great Britain, Russia, Spain and The United States. In 1909 he received a Nobel prize for physics, in 1915 an Italian senatorship and the title of Marquis in 1929. He died in 1937.

From a technical point of view, the development of radio sending and receiving equipment during the first few years of the Marconi Company's existence was not only very important but rather interesting. During most of the period, the spark or induction coil continued in use as the principal, if not the only, method of generating radio waves. The input power to the coil was constantly increased however; where Hertz had used a relatively low-powered coil supplied by a wet cell battery, Marconi commercial apparatus employed coils having an input power ranging from perhaps 250 watts to several kilowatts. Obviously, it would have been impractical to operate such coils from a battery, hence the transition to a motor generator set as the source of power was soon made.

Insure BETTER Television Service to Your Customers! . . . Exclusively Designed



HIGH VOLTAGE AND
ELECTROLYTIC TUBULAR

TELEVISION CAPACITORS

Especially Engineered for Television Circuits by
INDUSTRIAL CONDENSER CORP.

The economical quality line for replacement. Industrial Condenser Corp., manufacturers of Capacitors exclusively brings you highest quality for the particular requirements of Television at exceptionally attractive prices! Special Capacitors are Pyroteen impregnated for low power factor, high insulation resistance, high operating temperatures. Oil, Pyroteen, Wax and Electrolytic Capacitors. Finest materials throughout.

Ask Your Jobber for our Attractive Prices Today!
Or write for Bulletin 1095. Industrial makes quality Capacitors for Television, Radio, every electronic and industrial application—all types.

Send for Complete Catalog

INDUSTRIAL CONDENSER CORP.

3243 N. CALIFORNIA AVENUE CHICAGO 18, ILLINOIS
Sales offices in principal cities.



Modern plant built by Industrial Condenser Corp., for manufacture of Capacitors only.

- Holds normal stock of 162 tubes, 221 total
- Compartments for fuses, small tools, etc.
- Designed especially for service technicians
- Everything in its place—Inventory at a glance
- Neat—Sturdy—Attractive—Businesslike
- Removable cover with space for mirror

Television
tube caddy

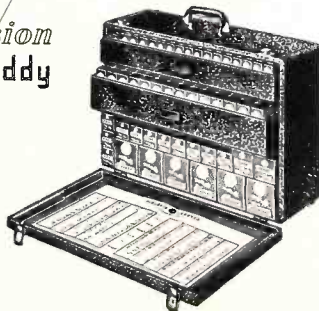

\$13⁵⁰
DEALER NET
AT YOUR FAVORITE JOBBER

ARGOS PRODUCTS CO., Inc. • 4753 N. Broadway • Chicago 40

An early Marconi transmitter and receiver are illustrated in *Fig. 1*. In this example, the coil is powered by a battery, *B* and the antenna and ground are directly connected to the spark gap, *SG*. At the receiver, the coherer, *CO* is connected between antenna and ground; note that no attempt is made to tune either the transmitter or the receiver. Direct current flow through the coherer energizes the relay, *RY*; closing of relay contacts provides a path for operation of the telegraph sounder *S* from the local battery *LB*. Of course, if a telephone receiver was used in place of the sounder, the relay was not needed. Due to the fact that the coherer filings tended to cling together even after the radio signal had ceased, some method of stopping current flow through the relay at the end of each wave train had to be provided. This was generally accomplished by means of a "decoherer", a device resembling an electric bell with the gong removed. Current flow through the coherer energized the bell magnet, causing the clapper to strike the coherer tube and automatically decohere the filings.

A most important improvement in

Marconi apparatus was the introduction of tuning methods applied to both transmitter and receiver; this was primarily the work of Sir Oliver Lodge. The procedure at first involved the use of metal cones or cylinders to provide the necessary capacitance; later, adjustable coils were used together with an early form of variable condenser. *Figure 2* shows a variation of Marconi equipment in which tuning is accomplished by

means of the transformer *OT*, which is provided with means of changing inductance through the use of spring clips. Originally, the condenser *C* consisted of two banks of large Leyden jars; later, a condenser having glass plate dielectric and sheet copper conductors was used. The use of mica as a condenser dielectric was not fully investigated until during World War I.

[To be continued]

A SNOW FREE TUNER

[from page 35]

3. Adjust *TC505* and *TC507* for a symmetrical, approximately centered passband. Set marker (AM) generator to 213 mc. Detune *TC507* counterclockwise until a single peak appears. Adjust *TC505* until the peak falls on the 213 mc marker. The output of the generator may have to be increased during this adjustment. Then adjust *TC503* for maximum curve height and symmetry of the single peak. The aerial circuit is now tuned for high channels.

4. Readjust *TC505* and *TC507* for

a symmetrical response centered about 213 mc.

5. Set Channel Selector and FM generator to Channel 7 (177 mc.)

6. Establish the channel limits by using the marker signal generator to produce marker pips on the response curve; set the generator first to 174 mc, then to 180 mc.

7. Note the response with respect to tilt and center frequency.

8. Adjust *C506* and *C515* (see *fig. 6*) to obtain a response curve which is the mirror image (tilt in the

BACK NUMBERS of "RTSD"

Order them now — the supply is low.

JANUARY 1949
Checking Video by CRO. Part 2.
Feedback & Phase Inversion
Tuned Filters

FEBRUARY 1949
Test Equip. Symposium Issue:
CROs - VTVMs - Sq. Wave
Generators - Markers - Multi-
meters - Kilovolters - High
Voltage Probes, etc.

JUNE 1949
Direct View Enlarging Lens
Modern Tape Recorders, Part 2
Custom Building High Fidelity
Circuits.

JULY 1949
Picture Tube High Voltage Sys-
tems

High Quality Tuner Analysis
Amateur TV Interference

SEPTEMBER 1949
Legality of TV "Policies" Clari-
fied

A Klystron TV Sweep Generator
High Quality Analysis Series,
Part 1.

APRIL 1950
Servicing Sync Separators
The TV Waveform & Its Com-
ponents
Understanding Push-Pull

MAY 1950
1-Man TV Antenna Orientation
Elements of TV Signal Distribu-
tion

TV Sync-Sweep Tracing
JULY 1950
Horizontal A-F-C Circuits,
Part 1
Theory of Tape Recording
Winch for Raising TV Towers

AUGUST 1950
Servicing FM Detector Systems
Horizontal A-F-C Circuits,
Part 2

Theory & Pract. of Video Detect
Circuits.

OCTOBER 1950
Know The Cathode Ray Tube,
Part 1

Comparing AM & FM Service
Problems
Reducing Losses in Trans. Lines
Band Selection Features of
Tuners

DECEMBER 1950
Operation & Service of Keyed
AGC Systems
Sampling Techniques Applied to
TV

RADIO-TELEVISION SERVICE DEALER
67 WEST 44th ST., NEW YORK 18, N. Y.

Please send me the back numbers checked here Dec. 1948 June 1949 May 1950
 Jan. 1949 July 1949 July 1950
The price is 35c for each copy unless 10 or more are ordered. If 10 or more are ordered the price is 25c each copy. Feb. 1949 Sept. 1949 Aug. 1950
 Mar. 1949 April 1950 Sept. 1950

I remit herewith \$..... for the copies ordered atc. each.

NAME
ADDRESS
CITY ZONE STATE

THIS IS IT! THE RELAY

WITH Interchangeable Coil

FOR A WIDE RANGE OF RADIO APPLICATIONS

GUARDIAN Series 200

Interchangeable

COIL and CONTACT

Switch Assembly

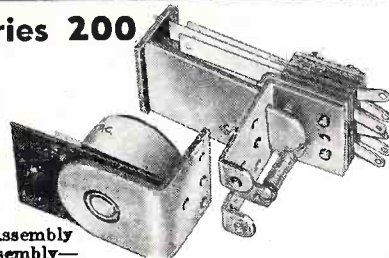

Two basic parts—a coil assembly and a contact switch assembly—comprise this simple, yet versatile relay. The coil assembly consists of the coil and field piece. The contact assembly consists of switch blades, armature, return spring and mounting bracket. The new Guardian Midget Contact Assembly which is interchangeable with the Standard Series 200 coil assembly, is also available in either single pole, double throw; or double pole, double throw.

CONTACT SWITCH ASSEMBLIES

Cat. No.	Type	Combination	
		Single Pole	Double Throw
200-1	Standard	Double Pole	Double Throw
200-2	Standard	Double Pole	Double Throw
200-3	Contact Switch		
	Parts Kit		
200-4	Standard	Double Pole	Double Throw
200-M1	Midget	Single Pole	Double Throw
200-M2	Midget	Double Pole	Double Throw
200-M3	Midget Contact Switch		

13 COIL ASSEMBLIES

A.C. COILS*		D.C. COILS	
Cat. No.	Volts	Cat. No.	Volts
200-6A	6 A.C.	200-6D	6 D.C.
200-12A	12 A.C.	200-12D	12 D.C.
200-24A	24 A.C.	200-24D	24 D.C.
200-115A	115 A.C.	200-32D	32 D.C.
		200-110D	110 D.C.

*All A.C. coils available in 25 and 60 cycles

GUARDIAN ELECTRIC

1606-F W. WALNUT STREET CHICAGO 12, ILLINOIS

A COMPLETE LINE OF RELAYS SERVING RADIO AMATEURS

Presenting
THE NEW
Mueller
NEEDLE CLIP

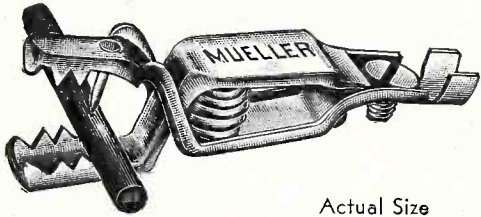

Actual Size

**PIERCES INSULATION
TO MAKE QUICK
CONTACT**

Solid bronze, non-corroding. Wire centers itself in notched jaw. Teeth on sides of jaw allow use for many other applications.

— USED IN —

- Electric and radio service shops
- Telephone and power company testing and maintenance
- Laboratory test work
- Hooking up truck trailer lights
- Field telephone and signal work

SEND FOR FREE SAMPLE & CATALOG 1905

Mueller Electric Co.

1605 East 31st St. Cleveland 14, Ohio

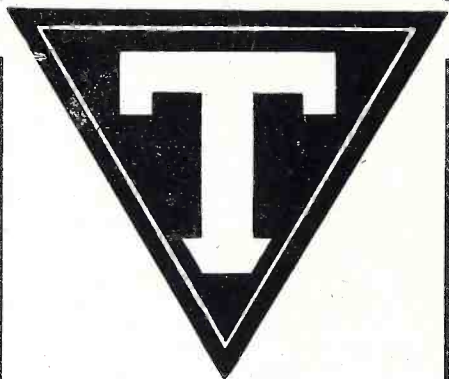

**Complete Line of Outdoor
and Indoor Antennas**

See the New P-38 Antenna

BOOTH No. 206

May Parts Show, Chicago

Tricraft Products Co.

1535 North Ashland Ave.

Chicago 22, Illinois

Manufacturers of a complete line of Television, FM & AM antennas and accessories

opposite direction) of the original. For example, if the Channel 7 response appeared as in *fig. 8A* then the trimmers should be adjusted to obtain a response as in *fig. 8B*.

9. Set the Channel Selector to Channel 13, and retune the generators. Readjust *TC505* and *TC507* for a symmetrically centered bandpass.

10. Set Channel Selector and generators to Channel 7, check the response for center frequency and symmetry. Repeat 8 and 9 as many times as necessary to obtain the best possible symmetrically centered response curves on Channels 13 and 7. Channels 8 through 12 will then be correctly aligned.

11. Set the Channel Selector and sweep (FM) generator to Channel 6 (85 mc).

12. Establish the Channel limits, using the marker generator to produce marker pips on the response curve; set the generator first to 82 mc, then to 88 mc.

13. Adjust *TC504* and *TC506* for symmetrical, approximately centered passband Set marker (AM) generator to 85 mc. Detune *TC506* counterclockwise until a single peak appears. Adjust *TC504* until the peak falls on the 85 mc. marker. The output of the generator may have to be increased during this adjustment. Then adjust *TC502* for maximum curve height and symmetry of the single peak. The aerial circuit is now tuned for channels 5 and 6.

14. Readjust *TC504* and *TC506* for a symmetrical response centered about 85 mc.

15. Set the Channel Selector and sweep (FM) generator to Channel 4 (69 mc.)

16. Establish the Channel limits, using the marker generator to produce marker pips on the response curve; set the generator first to 66 mc, then to 72 mc.

17. Adjust *TC501* for maximum curve height and symmetry.

UHF LINES

[from page 31]

that is, the portion behind the short circuit is simply not used but it is always there if the short must be moved to make the line longer. In this way, a movable short circuit is used to tune the shorted transmission line.

Acting as a parallel resonant circuit, the $\frac{1}{4}$ wave length shorted transmission line is then tuned by adjust-

You Won't be
"Caught - Short"
when you—



Specify "COLUMBIA"
for Your WIRE Needs!

Complete Stock of:

- Cord Sets
- Hook-up wire
- Wire and Antenna kits
- Plugs, Outlets, Connectors
- Intercom, telephone wire and cable
- Push-back wire
- Antenna wire

ANACONDA TELEVISION and RADIO WIRES and CABLES: Guy Wire, RG 59U Cable, Shielded TV Lines, 300 ohm line, Aluminum Ground Wire, and all types of plastic hook-up wire.

We specialize in Wire Harnesses, Cords and Cables for All Electronic Applications.

Order From Your Jobber!

Visit Booth #204 at the May Parts Show!

Columbia
WIRE & SUPPLY CO.

2850 Irving Park Rd., Chicago 18, Ill.

"National Distributors and Warehouse for Anaconda Densheath Television and Radio Wire and Cables"

**JFD "Little Giant"
TWIN LEAD
LIGHTNING ARRESTER**

Protects TV Sets Against
Lightning and Static Charges

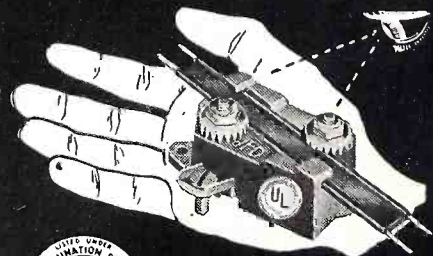

Underwriters
Laboratories
Approved

No. AT105

\$1.25
List

For Regular Twin Lead

SEEKING IS BELIEVING!

ONLY JFD Lightning Arresters offer you these exclusive patented features . . .

1. Patented strain-relief Retaining Lip which prevents pulling or straining against contact points.
2. You actually see positive contact made with lead-in wire.
3. Lead-in contact remains fully visible at all times.
4. No wire stripping. No Arrester Cover to Hide Poor Contacts!

At Your Jobber or Write Direct



MANUFACTURING CO., Inc.
6125E 16th AVENUE, BROOKLYN 4, N. Y.
FIRST in Television Antennas and Accessories

EICO

NEW EICO
Instruments and **KITS**

gives you Laboratory Precision at
Lowest Cost!

... with a complete line

Over 50,000 servicemen have bought one or more EICO Kits and Instruments. That's the proof of EICO's leadership in value to the serviceman!

For latest precision engineering, finest components, smart professional appearance, lifetime performance and rock-bottom economy—see and compare the EICO line at your jobber's today before you buy any higher-priced equipment! You'll agree, with over 50,000 others, that only EICO Kits and Instruments—no other—give you the industry's greatest values for the industry's lowest costs!

Read the full story on the complete EICO line. Write today for your free latest Catalog 5D.

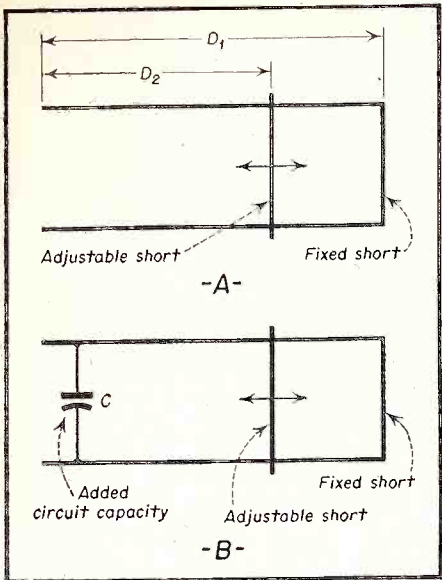

Fig. 8. Circuit tuning

ing its physical length. Either the $\frac{1}{4}$ wave length is first calculated and the short moved to make the line this long, or the circuit is actually tuned to resonance by means of meter indications as the short is moved back and forth 'till the point of maximum operation is obtained. In actual practice, the connecting leads used between the

- 221K VTVM Kit \$25.95
Wired \$49.95
- 625K Tube Tester Kit \$34.95
Wired \$49.95
- 320K Sig. Gen. Kit \$19.95
Wired \$29.95
- 145K Sig. Tracer Kit \$19.95
Wired \$28.95
- 435K 5" Scope Kit \$44.95
Wired \$70.05
- 315K Deluxe Sig. Gen. Kit \$39.95
Wired \$59.95
- HV Probe (wired only) \$6.95
- 511K VOM Kit \$14.05
Wired \$17.95
- 360K Sweep Gen. Kit \$34.95
Wired \$49.95
- C-5 5mc Crystal \$3.95
- RF Probe Kit \$3.75
Wired \$5.95
- 1040K Battery Elim. Kit \$25.95
Wired \$34.95

ELECTRONIC INSTRUMENT CO., Inc.
276 NEWPORT STREET, BROOKLYN 12, N. Y.

Due to unsettled conditions, prices and specifications are subject to change without notice. Prices 5% higher on West Coast.

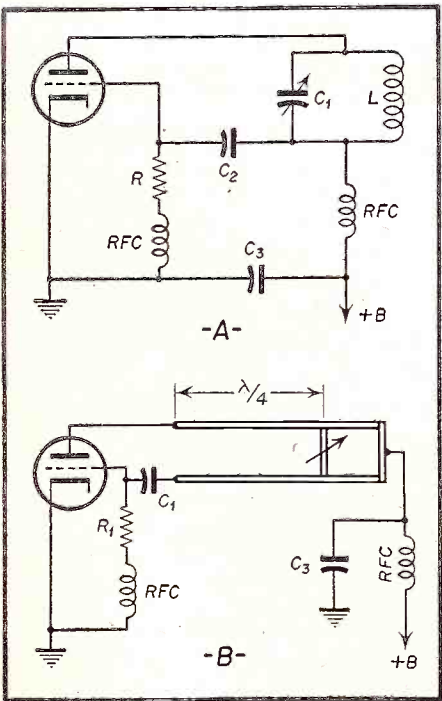
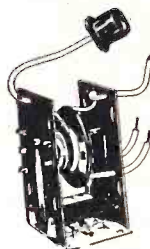

Fig. 9. High frequency oscillator

transmission line and the vacuum tube, form a part of the resonant circuit, indeed, the capacitance of the tube itself and the inductance of the tube leads also become a part of the resonant circuit as in Fig. 8B. All of this means that the $\frac{1}{4}$ wave length line acting as a parallel resonant circuit is almost always physically less

TV REPLACEMENTS

Terrific Values
Fully Guaranteed
Immediate Delivery



FLYBACK TRANSFORMERS

Universal type, Ferrite core, 14 KW, for C-R tubes \$4.75 each
incl. 19"



DEFLECTION YOKES—70°

Ferrite Core, for tubes up to and incl. 19" \$4.35 each



AUDIO OUTPUT TRANS.

($\frac{1}{2} \times \frac{1}{2}$) to match 50L6 tube, 2500 ohm imped. .55 each



100 ASSORTED RESISTORS

All popular values Uninsulated \$3.95 per 100



300 OHM TWIN LEAD

Pure Polythelyne, either black or clear, 7 strand copper wire 50 mil. Specify color wanted.

\$27.50 per M feet on 2500' Spools

\$28.00 per M feet on 1000' Spools



ANODE CONNECTORS

for 30 KV output.

34¢ each



TV LINE CORDS

UL Approved, with Breaker plug.

29¢ each



LINE CORDS

UL Approved 2/18-6'. Molded on plug.

23¢ each



ELECTROLYTIC CONDENSERS

150 V.D.C.

20-20	32c ea.	50-30	42c ea.
30-30	37c ea.	50-50	47c ea.
40-40	42c ea.	SINGLE 20	19c ea.

DALE INDUSTRIES

P. O. BOX 301
HARTSDALE, N. Y.

Minimum order \$4.00. All prices are net cash with order. We pay shipping charges.

**100 CUSTOMERS
5,000 CUSTOMERS
10,000 CUSTOMERS
50,000 CUSTOMERS**

Faster Service, Bigger Profits

**by Eliminating
Wasted Time, Motion,
and Money**

Investigate the possibility of installing the most modern, efficient, tried and proven

MARKEM Service System

for handling routine paper work in your service department.

Thousands of dollars have been saved by using the "MARKEM SERVICE SYSTEM", because it will:

- 1—Reduce a substantial amount of personnel immediately.
- 2—Eliminate duplicate calls.
- 3—Eliminate nuisance calls.
- 4—Offer very strict control of C.O.D. work.
- 5—Eliminate the expensive and untidy rewriting of all daily service records.

Forms are available in any quantity directly from stock. For further information, contact:

MARKEM PRINTING CO.

145 Hudson Street, New York 13, N. Y.
WA. 5-9581-96

New York, New Jersey, Pennsylvania covered by New York office. Other states covered by distributors.

TECHNICAL WRITERS WANTED

experienced in the field of radio-electronics, to write technical manuals, instruction books, etc. Must have good radio-electronics background. Experienced writers preferred. Write Box 51, Radio-Television Service Dealer, 67 W. 44 St., New York 18, N.Y.

than a $\frac{1}{4}$ wave length long because of these external inductance and capacitance effects.

In Fig. 9 a high frequency oscillator using only a parallel resonant circuit between the plate and grid of the triode is shown. A blocking capacitor serves both as a part of the RC grid leak and as a means to block the dc from the grid. Resistor *R* is the grid leak bias resistor across which the tube develops its own bias voltage by means of grid current.

The equivalent circuit using a $\frac{1}{4}$ wave length parallel resonance effect is also shown. Tuning is accomplished here by adjusting the shorting bar to change the length of the transmission line. Direct connection to the plate is made by the conducting properties of the transmission line just as with the more conventional oscillator above. The same coupling capacitor is used to isolate the grid circuit and act as a grid leak as before. In order to facilitate tuning, two shorting bars are used, one is fixed and the other is variable. Plate voltage is connected to the fixed shorting bar which prevents the connecting plate lead from dangling in space as the movable shorting bar is changed during tuning.

Be Safe! Be Sure!
with a FULL-SIZED
VEE-D-X ARRESTER



**COSTS NO MORE
THAN A MIDGET**

2 WIRE RW-200 \$125 LIST	4 WIRE RW-204 \$150 LIST
--	--

2-WIRE RW-300 \$200
LIST
For extra heavy duty. An air gap plus resistors provide double protection.

THE LaPOINTE-PLASCOMOLD CORP.
Windsor-Locks, Conn.

AD INDEX

American Phenolic Corp.....	5
Argos Products Company.....	60
Belden Manufacturing Co.....	13
Columbia Wire & Supply Co.....	62
Dale Industries.....	63
Du Mont, Allen B. Laboratories.....	7, Cover 3
Electronic Instrument Co., Inc.....	62
Electro-Voice, Inc.....	18
Guardian Elec. Mfg. Co.....	61
Hytron Radio & Electronics Corp.....	Cover 2
Industrial Condenser Co.....	60
International Electronics Co.....	64
Jensen Manufacturing Co.....	10
JFD Manufacturing Co., Inc.....	62
Krylon, Inc.....	57
La Pointe Plascomold Corp.....	20, 21, 64
Mallory, P. R. & Co., Inc.....	14, 15
Markem Printing Company.....	64
Mueller Electric Company.....	62
Permo, Inc.....	53
Radiart Corporation, The.....	16
Radio City Products Co., Inc.....	59
Ram Electronics, Inc.....	56
RCA Institute.....	1
RCA Tube Dept. RCA Batteries.....	11
RCA Kinescopes.....	Cover 4
RCA Test Equipment.....	19
Regency Div., I.D.E.A., Inc.....	8, 9
Rider, John F. Publisher, Inc.....	12
Sams, Howard W. & Co., Inc.....	6
Schott, Walter L. Co.....	50
Sheldon Electric Company.....	49
Simpson Electric Company.....	4
Snyder Manufacturing Company.....	2
Sprague Products Company.....	6
Standard Coil Products Co., Inc.....	51
Sylvania Electric Products, Inc.....	22
Taco.....	47
Telescopic Products.....	58
Telrex, Inc.....	52
Tricraft Products Co.....	62
TV Wire Products.....	54
Webster Electric Co.....	17

LOOK

Send for our
**Radio & Television
TUBE LIST**

International Electronics Co.
P.O. Box 6244 Pittsburgh 12, Pa.

**for better tv
performance**

DuMont Electronic Parts

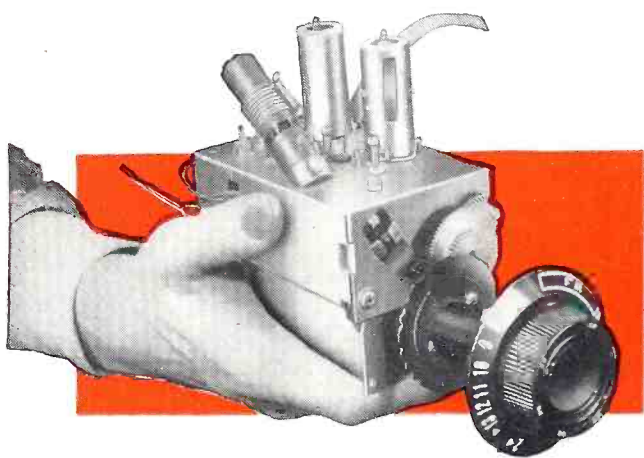

INPUTUNER* SERIES T3C

Four types offer more of everything you want in a TV tuner. Covers FM broadcast band in addition to TV channels. Employs continuous tuning action (Mallory-Ware Inductuner**) for utmost dependability, and detent action for quick channel selection. Mechanically and electrically a replacement for most switch-type tuners.

*RTM ABD Labs., Inc.
**RTM PRM Co., Inc.

DISTRIBUTED-WINDING DEFLECTION YOKES (Series Y2A)

Distributed-winding construction allows sharp focus over entire screen area. Compact design (overall length 2¾") lends itself for use with modern short-neck tubes. Retains shape of windings under extreme conditions of humidity and temperature. Will withstand 4000 volt d-c high potential between windings and between any winding and core, or any exposed metal contained in the yoke assembly. Available in several 70° deflection types, with or without matching networks.



DUMONT

FIRST WITH THE FINEST IN TV COMPONENTS

Electronic Parts

20th
YEAR
AS PIONEER

*Literature on request.
Available through
leading distributors.
Let us quote on
quantity requirements.*

ALLEN B. DUMONT LABORATORIES, INC.
ELECTRONIC PARTS DIVISION
EAST PATERSON, N. J.

THE QUALITY OF RCA TUBES IS UNQUESTIONED



RCA-17GP4

RCA-20GP4

RCA-14GP4

ANOTHER IMPORTANT RCA

Engineering Advance...

Electrostatic Focusing

for television picture tubes

... and how it will benefit you



Once again, RCA engineering has made an important technical advance that benefits the entire industry—by developing an improved method of electrostatic focusing. Electrostatic focusing has now been incorporated in three new RCA rectangular kinescopes.

The new tubes require no focusing coil or focusing magnet. They provide pictures of the same high quality obtained from magnetic-focus types.

It will be a while before you as a dealer or a serviceman will have occasion to stock these electrostatic-focus kinescopes. But... because these tubes permit important savings in critical materials, manufacturers can produce more television receivers upon which your future business will depend.

In the meantime, RCA is producing sufficient quantities of its magnetic-focus kinescopes to meet your current replacement requirements.

Keep informed... stay in touch with your RCA Tube Distributor



RADIO CORPORATION of AMERICA
ELECTRON TUBES

HARRISON, N. J.