

SEPTEMBER, 1950

*Radio-Television*  
**SERVICE  
DEALER**



The Professional Radio-TVman's Magazine

**IN THIS ISSUE:**

Mechanica Features of Tape Recorders  
Horizontal A.F.C. Circuits, Part 3  
R.C.A.'s New TV Chassis  
Looking For Trouble?  
Front Ends, Part 3

**AM-FM-TV-SOUND**

# Reserve Your Copy...Now!

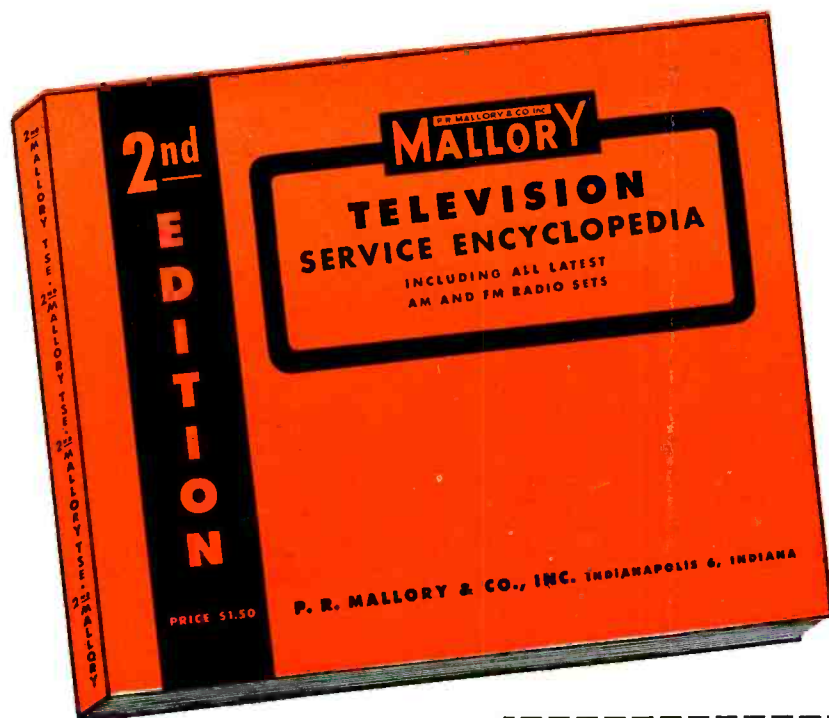

## Here's What You Get!

- Data on correct replacement parts.
- Tube complements and numbers.
- Servicing hints.
- Circuit information.
- IF peaks.
- Installation notes.
- References to Rider, with volume and page numbers.

## The 2nd Edition Mallory Television Service Encyclopedia

*Complete TV Listings  
Including  
All Current AM-FM Radios*

This new, bigger, 2nd Edition of the already popular Mallory Television Encyclopedia contains all the TV listings from the 1st Edition . . . plus a complete list of TV sets produced since that time . . . plus an up-to-date supplement for the 6th Edition of the Mallory Radio Service Encyclopedia.

This handy, authoritative reference book is written for you . . . in your language. The total of more than 175 pages includes over 400 TV sets, almost 2,000 AM-FM Radio sets, and more than 950 drawings and diagrams . . . in addition to sectional introductions and installation notes.

*No other book gives you all this information. See your Mallory distributor right away . . . ask him to reserve your copy. The supply is limited. The price is \$1.50.*

*The Service Technician's Standard Replacement Authority!*

**P. R. MALLORY & CO., Inc.**  
**MALLORY** CAPACITORS . . . CONTROLS . . . VIBRATORS . . .  
SWITCHES . . . RESISTORS . . . RECTIFIERS . . .  
VIBRAPACK\* POWER SUPPLIES . . . FILTERS  
\*Reg. U.S. Pat. Off.  
**APPROVED PRECISION PRODUCTS**

**P. R. MALLORY & CO., Inc., INDIANAPOLIS 6, INDIANA**



ASSURES YOU the most complete tests of all tubes including television.

ACTUALLY APPLIES 19 separate filament voltages—eliminates usual compromises.

TESTS OVER 700 tubes listed on roll chart—Many thousand tubes used to properly evaluate correct settings.

POSITIVE INDIVIDUAL test of each element.

SPECIAL CIRCUIT feature accurately compensates to provide correct voltages on each tube test.

IMPROVED LEVER switching originated by Triplet for complete control of each tube element.

EACH ELEMENT quickly and conclusively tested for shorts by a flip of the switch.

ILLUMINATED SPEED-ROLL chart with latest tube listings. Kept up-to-date.

LARGE 6" meter—RED-DOT Life-time Guaranteed.

FOR COUNTER or portable use.

TRIPLET  
MODEL 3413  
TUBE TESTER

Only  
\$69<sup>50</sup>

COMPLETE WITH ACCESSORIES  
AND INSTRUCTION MANUAL

In Canada: Triplet Instruments of Canada,  
Georgetown, Ontario

FOR THE MAN WHO TAKES PRIDE IN HIS WORK

**Triplet**

TRIPLET ELECTRICAL INSTRUMENT COMPANY · BLUFFTON, OHIO, U.S.A.

# PRE-SELLING

THE **RADIART** CORP.

**TELE-ROTOR**  
PATS PEND

**CORNELL-DUBILIER**



**CORNELL-DUBILIER SOUTH PLAINFIELD, N. J.**

**THE RADIART CORPORATION CLEVELAND 2, OHIO**

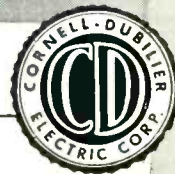

# TELE-ROTORS

with a **Startling Consumer Campaign**  
**on Key TV Stations**  
*In The Major TV Markets!*

**NOW!**  
**Your Customers**  
**See TELE-ROTOR Film**  
**Demonstrations In**  
**Their Own Homes**  
**of the**

Here are more and bigger profits for everybody in the TV field! Setting sensational sales records everywhere on merit alone . . . NOW — watch for even BIGGER sales starting with our NEW series of announcements on key TV stations in all the important markets. These film demonstrations will reach into millions of homes . . . ALL YOUR POTENTIAL CUSTOMERS . . . telling them of the advantages and superiority of the TELE-ROTOR! These will do a PRE-SELLING job for YOU . . . so get set NOW . . . for this big business ahead . . . by featuring the BEST . . . the TELE-ROTOR.

**ONLY Rotator with ALL the Important Features**

FEATURES	TELE-ROTOR		Rotator A	Rotator B	Rotator C	Rotator D	Rotator E	Rotator F
	TR-1	TR-2	Type 1	2				
TORQUE FT. LBS.	36	36	5½	4.5	6.75	2.25	4.5	6.00
TORQUE PER POUND OF ROTATOR	3.13	3.13	0.91	0.55	1.08	0.35	0.58	0.86
SIDE THRUST OVERLOAD (FT. LBS.) TO STOP ROTATION	325	325	94	50	83	88	110	160
WEATHER PROOFING	One piece "Water Shed" Dome Housing		Rubber Gasket	Metal Ring	Felt Washers	Rubber Gasket	Rubber Gasket	Rubber Gasket
ELECTRICAL TO MECHANICAL EFFICIENCY TORQUE PER WATTS CONSUMED	72%	38%	16.4%	16.3%	13%	11%	4%	11%
TYPE OF LOAD BEARING	Two 6½ in. dia. Ball Races		Double Sleeve	Sleeve & Ball 2 in. dia. Ball Race	Sleeve	Sleeve	Double Ball Race 1 in. dia. Ball Race	Double Sleeve.
MAST CAPACITY	2"	2"	1¾"	1¾"	2"	1¾"	2"	1½"
ALIGNMENT OF ROTATOR SUPPORT MAST AND ANTENNA MAST	In Line	In Line	Off Set	Off Set	Off Set	In Line	Off Set	In Line
MOUNTING VERSATILITY	Mast or Platform		Mast Only	Mast Only	Mast Only	Mast Only	Mast Only	Mast or Side Plate
TYPE OF DIRECTIONAL INDICATION	End of Rotation Light	Dial lights 8 Positions and end	End of Rotation Light	Meter	Meter	End of Rotation Light	Meter	Meter

# SYNC PULSES

by San D'Arcy

**Radiomakers Get Ultimatum.** F.C.C. Chairman Wayne Coy informed members of RTMA that unless they become more cooperative they are heading for serious trouble. It seems that, as Mr. Coy puts it, "Interference is caused in some areas and under certain circumstances by TV and FM receivers having excessive oscillator radiation." The radiation interference not only is spoiling TV entertainment for TV set owners located near unshielded sets, but in addition the interference may be affecting with deadly results commercial airlines' communications systems. Mr. Coy also contended that set makers have failed to release much valuable technical information that their work has brought to light and this contributes toward keeping the 'freeze' in effect longer than might otherwise be necessary. So, unless the radio makers correct their short-comings they may be forced to furnish an FCC transmitter license with each TV or FM set they sell, if it is to be operated near an airline communications center, and they may never get the ultra high frequencies opened, which in effect would hold down the sale potential of TV sets.

**Sounds, Too Personal.** Police in a New Jersey city were quite patient with an Evangelist to whom a permit for the use of a sound system had been granted even when many citizens complained about "his pious ejaculations in an extremely loud manner." But matters got past the breaking point recently when the soul-saver started pointing his finger at passers-by, at the same time yelling, "Heaven or Hell?" This was construed as being "an invasion of privacy" and the P-A user was told to stop at once "or else".

**HoTelevision.** A financial house recently offered to sell stock in an enterprise that would enable hotels to transmit TV programs from one master control to any number of its rooms. (A dozen of the largest hotels in key cities are already using the system, and the demand for additional installations by other hotels is impressive). The stock issue was sold quickly. Seems like investors have confidence in TV's future.

**TV Still Killing Laymen.** Another sad TV killing has occurred in Dayton, Ohio. A 31 year old laundry owner was installing his new TV antenna. He attached the antenna to a long metal pole, which when raised, touched a 6300 volt wire with deadly results. Falling, the pole touched a metal fence, charging it. The victim's 26 year old wife, running to his aid, touched the fence and she, too, died. Three children ranging from 7 months to 6 years survive. We professional servicemen **MUST** do something in the way of educational promotion with the aid of our local newspapers to teach the TV set buying public not to attempt to do its own TV installation and service work because it is a dangerous and treacherous past-time that can and will kill.

RADIO-TELEVISION SERVICE DEALER • SEPTEMBER, 1950



"My responsibility for the picture quality of the television set you have purchased prompts me to suggest that you insist upon an Amphenol **INLINE\*** Antenna when the installation is made.

Your service man will be glad to comply because although he pays a little more—he'll save installation and call back time and he, too, likes to be sure that you receive the best picture quality that the set can produce."

\*U. S. PAT. NO. 2,474,480

## SEND FOR THIS BOOK!...

An up to date, informative book of facts about TV antennas. Contains accurate information for selecting the best antenna for specific purposes and explains the various conditions that affect television antenna performance. This 16-page book is offered free as a service to the industry.



# AMPHENOL

**AMERICAN PHENOLIC CORPORATION**  
1830 SO. 54TH AVENUE • CHICAGO 50, ILLINOIS

# EDITORIAL

by S. R. COWAN

## TV Antennas Violate Laws

Fire department heads in areas having TV are now greatly disturbed by TV antenna installations which may soon be written onto the civic Law Statutes as being violations of fire or local building safety codes, and justly so. For example, a glance at the roof-edge of almost any large apartment house will show mast after mast, each set within a few feet of each other. Likewise you'll see a maze of antenna arms intertwining one another so that in effect a fireman attempting to get onto a roof from a ladder has to go through a picket fence of metal poles and bars.

Studying the situation from the roof itself one sees antenna arms poking out all over, and at varying heights, with transmission lines running helter-skelter, hither and yon, blocking fire-escapes and hatches. All these constitute a risk to firemen and law enforcement authorities who have the right to demand elimination of hazards which make their normally dangerous work even more treacherous.

It would seem to us that we of the service profession should establish our own code of safety ethics and abide by them before strict laws are put on the books which will force us to do what we should have done in the first place. Here's our proposal: 1) Never set a TV mast closer than 8 feet from the nearest mast. 2) Never set a TV antenna up in a place whereby the lowest arms will be closer than 8 feet off the ground to insure plenty of head clearance, even for firemen wearing helmets. 3) Never string transmission lines across roofs or open spaces unless 8 feet of head clearance is afforded. 4) Never allow transmission lines to block fire escapes or roof hatches. Or, put another way — make your installations conform to the way you'd want them to be if you were a fireman who had to get up onto roofs to fight fires, or if you were a policeman who was called upon to scramble across roofs in pursuit of law-breakers. Help the law—don't hinder it! In doing so you will at least be able to sleep nights knowing that the job you did will not cause injury to someone else.

## Extended TV Lines

The 208 mile underground coaxial cable for TV has been completed between Omaha and Kansas City. The link between Chicago and Omaha, running through Des Moines, is progressing on schedule, too. After a short period of testing the network will go into service. September 30th is the date scheduled. Hurrah! The vast area encompassed between St. Louis, Mo., Kansas City, Omaha and Chicago has avidly awaited this network tie-in with New York which is far and away the capitol of TV programming. To all service dealers and servicemen in the mid-west areas which will soon get TV, we say "Welcome and Good Luck!"



**Sanford R. Cowan**  
EDITOR & PUBLISHER

**Samuel L. Marshall**  
MANAGING EDITOR

**COWAN PUBLISHING Corp.**  
342 MADISON AVENUE  
NEW YORK 17, N. Y.

Vol. 11, No. 9

September, 1950

Mechanical Features of Tape Recorders, by C. A. Tuthill.....	15
Service work in tape recorders is primarily mechanical. The author analyzes various mechanical systems employed in tape recorders.	
Horizontal A.F.C. Circuits, Part 3, by Walter H. Buchsbaum.....	18
This concluding installment deals with the Synchroguide system of A.F.C.	
The Serviceman's TV Chassis, by Charles A. Hobbs, Jr.....	20
Describing the mechanical and electrical features of R.C.A.'s new TV chassis	
Looking for Trouble?, by Cyrus Glickstein.....	22
A "travelogue" on trouble shooting a TV receiver	
Front Ends, Part 3, by Samuel L. Marshall.....	25
TV mixer and oscillator circuits employed in various Front Ends are analyzed in this installment.	
Shop Notes.....	29
Western Auto D 2919—Instability and distortion on F.M. Westinghouse Model H-216—Picture distortion due to magnetism. Eye Lash curler picks up fine radio wire. Cleaning volume controls. Stromberg Carlson—Noisy r-f tuners. Sentinel Models 412, 413, 414, 415—to improve horizontal hold.	
Circuit Court.....	30
Magnavox CT 214. General Electric Model 805. Recordio Model 8J10	
New Products.....	31

SANFORD L. CAHN  
National Advertising Sales Manager

HARRY N. REIZES  
Advertising Manager

NATHAN BOYCE, Circulation Manager    DAVID SALTMAN, Adv. Production Manager

BRANCH: J. C. GALLOWAY    816 W. 5th St., Los Angeles 13, Calif.    Mutual 8335

RADIO-TELEVISION SERVICE DEALER is published Monthly by Cowan Pub. Corp., 342 Madison Ave., N. Y. 17, N. Y. Subscription price: \$2 per year in the United States, U. S. Poss. & Canada: elsewhere \$3 Single copies: 25c. Entered as second class matter Dec. 13, 1948 at the Post Office at New York, N. Y. under the Act of Mar. 3, 1879. Copyright 1950 by Cowan Pub. Corp.

# HERE'S YOUR REPLACEMENT



*No Other Control Gives You All These*

**59 IRC CONTROLS WITH AMAZING ADAPTABILITY MEET ALL YOUR NEEDS WITH LESS STOCK**

Compare the amazing adaptability of your IRC Q Control with any other. You'll agree no other control so closely meets all your servicing needs . . . no other gives you so much for your money! Feel its cushioned turn, examine its lustrous finish, study its practical design—ask your Distributor for IRC Q Controls, and you know you're buying the very best.

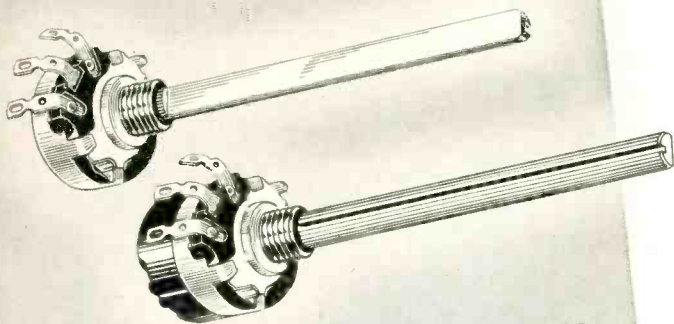

**KNOB MASTER FIXED SHAFT**  
Standard fixed shaft fits most knobs without alteration or inserts. Flatted, knurled and grooved. 3" length meets TV requirements. Ample cross-section prevents bending.

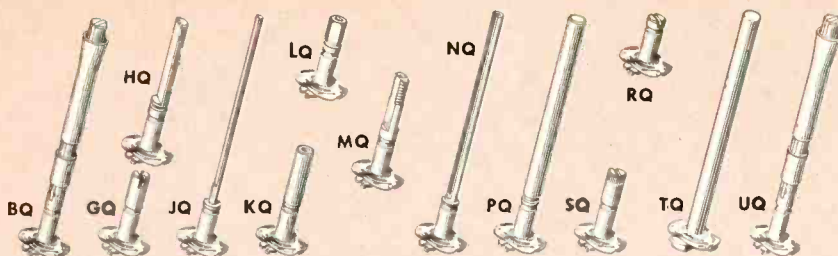

**INTERCHANGEABLE FIXED SHAFTS**  
Easy replacement of standard shaft with any of 13 special fixed shafts is made possible by exclusive IRC Resilient Retainer Ring. This revolutionary feature provides widest replacement control coverage.

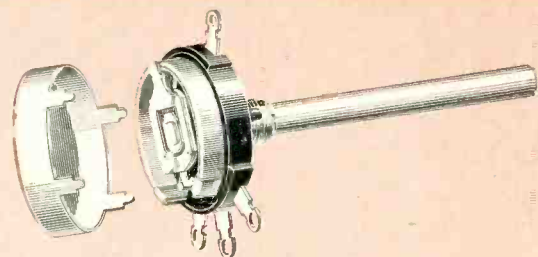

**WIRE WOUND CONTROLS**  
Dependable 2 watt controls available with center tap for TV centering. Specific TV values now available with Knob Master Shaft to accommodate both knurled and flatted knobs.



# No. 1 CONTROL

*Modern Servicing Features!*

- ★ Fits both flatted and knurled knobs
- ★ Separate switches
- ★ Modern small size
- ★ Fixed shaft convenience with complete shaft interchangeability
- ★ 23 tapped types
- ★ Shorter bushing
- ★ Sparkling appearance
- ★ 1/2 watt rating



**INTERNATIONAL  
RESISTANCE COMPANY**

401 N. BROAD STREET, PHILADELPHIA 8, PA.

*Wherever the Circuit Says* 

In Canada: International Resistance Co., Ltd., Toronto, Licensee

*Concentrikit*

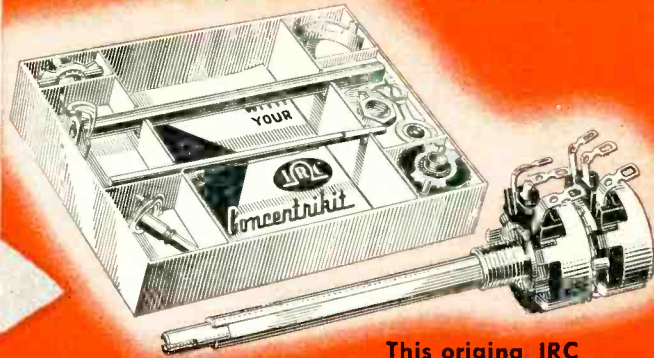

This original IRC feature provides a ready solution to your special control requirements. With this kit of parts you assemble practically any concentric dual control quickly and easily. In a matter of minutes you can prove the advantages of this practical IRC feature.

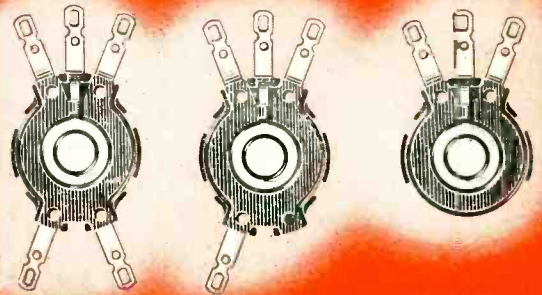

### INTERCHANGEABLE BASE-ELEMENTS

Principally intended for use with Concentrikit, this IRC innovation gives you limitless opportunities for adapting controls to specific requirements. Each unit includes molded base, element, terminals and collector ring—no loose parts. Available in 33 resistance values and a variety of taps.

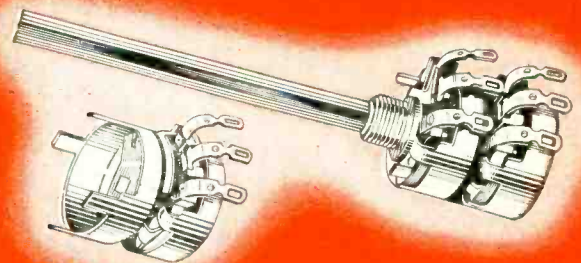

### *Multisections*

For standard duals, IRC Multisections are added to Q Controls like switches. 17 values provide over 11,000,000 variations of dual, triple and quadruple controls; accommodate switches, too!

### INTERNATIONAL RESISTANCE COMPANY

413 N. Broad St., Phila. 8, Pa.

Please send me additional IRC Q Control information checked below:

- Free Catalog Bulletin DC1A
- Enclosed find 25c in stamps or coin for comprehensive Concentric Dual Replacement Manual

Name \_\_\_\_\_

Company \_\_\_\_\_

Address \_\_\_\_\_

# Terrific FOR TELE-CIRCUITS!

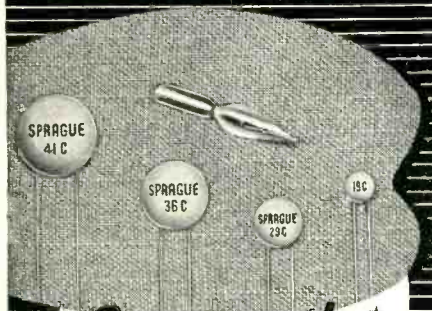

## Cera-mite<sup>\*</sup> CAPACITORS

ARE  
THE *First* COMPLETE  
DISC CERAMIC LINE

DEVELOPED especially for the television industry, Sprague Cera-mite Capacitors fill the bill for the alert service technician!

Temperature-compensating, general-use, and high-K bypass types fit every type of circuit application. The low self-inductance feature of the flat plate with uni-directional lead design gives better high frequency performance than the older tubular ceramics which they replace. And they're ideal as mica capacitor replacements, too!

Tiny and dependable, every Cera-mite is rated at 1000 volts test, 500 wvdc, and for operation at 185°F.

Cera-mites are clearly stamped with capacitance—no confusing color coding.

Stock up at your Sprague distributor without delay!

Write for Cera-mite Bulletin

<sup>\*</sup>Trademark

# SPRAGUE

## PRODUCTS COMPANY

DISTRIBUTORS' DIVISION OF THE SPRAGUE ELECTRIC COMPANY

71 MARSHALL ST., NORTH ADAMS, MASS.

# TRADE FLASHES

A "press-time" digest of production,  
distribution & merchandising activities

### 2nd Phila PRSMA Exhibit

The second annual Radio, Television and Electronics Exhibit sponsored by the Philadelphia Radio Service Men's Association will be held at Philadelphia's Broadwood Hotel from September 25-27, it was announced by David Krantz, Show Committee Chairman.

Purpose of the show is to acquaint service men, dealers and others in the servicing industry with the newest developments in electronics. For this purpose, many important educational seminars and lectures will be held during the daily sessions, which will begin at 7:00 p.m., September 25 and run from 10:00 a.m. to 10:00 p.m. on September 26 and 27.

### "No Parts Shortage"

"There is no immediate threat of a serious shortage of replacement parts for servicing television and radio receivers," President Robert C. Sprague of the Radio-Television Manufacturers Association said recently following a spot check in New York City where complaints of such a shortage have been reported recently.

"Distributors contacted by RTMA in New York reported that they are generally well stocked with replacement parts for TV requirements although they have had to allocate certain components because of unusual demands from dealers since the Korean outbreak," Mr. Sprague said.

"Allocations were brought on by a small minority of dealers and servicemen who were trying to hoard some of the components in short supply, he explained. Receiving tubes, resistors, antennas, television tubes, and condensers are being allocated by parts distributors at present in the New York area.

"The distributors seem to be handling a difficult situation very well and are trying to be fair in their allocation of components most in demand from dealers and servicemen," Mr. Sprague said.

"Despite heavy demands from set manufacturers who are at a peak pro-

duction pace and regardless of large anticipated military requirements for electronic components, the industry by reason of its expanded capacity can keep its distribution outlets adequately supplied for any normal requirements of set servicing, both in New York City and elsewhere.

"I am confident that most dealers and servicemen go along with the distributors, trying to treat the public favorably and avoid hoarding. However, a few unscrupulous dealers, if permitted to do so, could create shortages of components whose full production is required to meet normal requirements of manufacturers and distributors."

### N.Y. Offers Decal-Banner and Sign for Service-Dealer Use

National Union Radio Corporation has announced the release of a three-piece dealer sales promotion package available through N.U. distributors. This eye-catching three-piece sales-promotion package is ideal to stimulate sales during the late summer when the radio business often slows down. It includes one Giant Weather-proof Banner, size 23" x 48"; one Metal Flange Sign, size 24" x 8¾"; and one 7½" x 8" Door Decal, complete with the dealer's street number.

### Town Meetings Under Way

The Town Meetings of Television Dealers, financed and sponsored by 17 leading television manufacturers and the R-TMA, is being held in 60 cities throughout the country in August, September, and October. At the meetings dealers will be shown sound slide-films designed to help them re-examine their sales, merchandise, business-management, and service practices.

"These films," Ehle declared, "embrace the best principles of good business housekeeping we can gather from all segments of the television industry. They have been examined and approved by manufacturers, distributors, and dealers, to say nothing of professional managerial experts.

"They represent, we hope, a step



**"We doubled our  
store space...  
increased our staff"**

DEPENDABLE RADIO SERVICE BY CAREFULLY TRAINED EXPERTS

**BETTER RADIO INC.**  
136 W. Park Avenue  
ELMHURST, ILLINOIS  
Elmhurst 3228

April 28, 1950

Sylvania Electric Products Inc.  
Advertising Department  
Emporium, Pa.

Gentlemen:

During January, February and March, I sent 12,000 postal cards to each occupant of three suburban towns, Elmhurst, Villa Park, Lombard and countryside. I had a local letter service handle addressing and mailing at a cost of only 1/3¢ per card.

Business began to pour in soon after the first mailing. In January, it was up 33%, February 35% and March up 45% compared to service business in similar months in 1949. Yes, service business increased an average of 38% the first three months of this year, over last.

Due to the increased business we've had as a result of your campaign mailings, we have doubled our store space, increased our service staff from two to six bench positions, and added an outside staff for antenna installations.

Just thought you would like to know! Thanks for your help in the rapid growth of "Better Radio".

Cordially,  
*Howard J. Hitzeman*  
Howard J. Hitzeman  
President  
BETTER RADIO INC.

**Read this remarkable record!**

**Now let this SYLVANIA DEALER  
CAMPAIGN boost your business!**

The above letter is actual proof of how Sylvania's Service Dealer Campaigns step up sales.

Now the new fall campaign is ready for you. It's tied in with the advertising your customers will be seeing in the Saturday Evening Post, Life, Look, Collier's and Radio and Television Best. It's sure-fire, powerful and complete... from colorful window and counter displays to bright, business-pulling postal cards... even radio spot announcements and ad mats.

All yours ALL FREE... you pay only the postage (1¢ for each card). So don't delay, mail the coupon TODAY!

RADIO TUBES; TELEVISION PICTURE TUBES; ELECTRONIC PRODUCTS; ELECTRONIC TEST EQUIPMENT; FLUORESCENT LAMPS, FIXTURES, SIGN TUBING, WIRING DEVICES; LIGHT BULBS; PHOTOLAMPS; TELEVISION SETS

**SYLVANIA  
ELECTRIC**

Ran out of...  
I was watching an international beauty contest when suddenly...

Call Us for expert radio and TV service at reasonable prices...

We use and recommend SYLVANIA RADIO AND TELEVISION TUBES

DISPLAYS

You'll like our expert radio service and fair prices

WE USE AND RECOMMEND SYLVANIA RADIO AND TELEVISION TUBES

WINDOW STREAMERS

POSTAL CARDS

DEALER'S IMPRINT

RADIO SPOTS

Spot Radio Announcements

DEALER'S IMPRINT

AD MATS

Let us put your radio or television set in the shape for Christmas

DEALER'S IMPRINT

Sylvania Electric Products Inc.  
Dept. R-1609, Emporium, Pa.

Send full details about Sylvania's Fall Advertising Campaign for Radio-TV Service Dealers.

Name \_\_\_\_\_

Company \_\_\_\_\_

Street \_\_\_\_\_

City \_\_\_\_\_ Zone \_\_\_\_\_ State \_\_\_\_\_

*Anyone*  
**Can build a  
HEATHKIT**

VACUUM TUBE VOLTMETER  
with  
Oscilloscope  
Deflection

VACUUM TUBE VOLTMETER  
IN COMPANY BENTON HARBOR, MICH.



*Heathkit*  
**SIGNAL  
TRACER KIT**  
\$19.50



*Heathkit*  
**VACUUM TUBE  
VOLTMETER KIT**  
\$24.50



*Heathkit*  
**TUBE CHECKER KIT**  
\$29.50



*Heathkit*  
**BATTERY  
ELIMINATOR KIT**  
\$22.50



*Heathkit*  
**CONDENSER  
CHECKER KIT** \$19.50

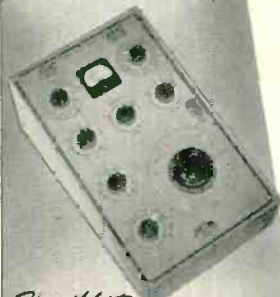

*Heathkit*  
**IMPEDANCE  
BRIDGE KIT** \$69.50



*Heathkit*  
**R. F. SIGNAL  
GEN. KIT**  
\$19.50



*Heathkit*  
**HANDITESTER  
KIT** ... \$13.50

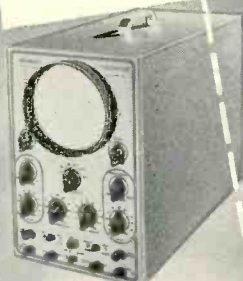

*Heathkit* 5"  
**OSCILLOSCOPE  
KIT**  
\$39.50

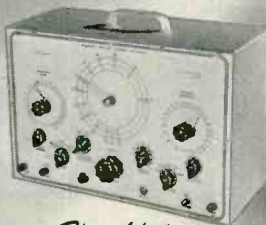

*Heathkit*  
**TELEVISION  
GEN. KIT** ...  
\$39.50



*Heathkit*  
**AUDIO GEN.  
KIT** ... \$34.50



*Heathkit*  
**ELECTRONIC  
SWITCH KIT**  
\$34.50

Heathkits are beautiful factory engineered quality service instruments supplied unassembled. The builder not only saves the assembly labor cost but learns a great deal about the construction and features of the instrument. This knowledge aids materially in the use and maintenance of the equipment. Heathkits are ideal for and used by leading universities and schools throughout the United States. Each kit is complete with cabinet, 110V 60 cycle transformer (except Handitester), all tubes, coils assembled and calibrated, panel all ready printed, chassis all punched, formed and plated, every part supplied. Each kit is provided with detailed instruction manual for assembly and use. Heathkits provide the perfect solution to the problem of affording complete service equipment on a limited budget. The basic three instruments — an Oscilloscope, the basic three instruments — an Oscilloscope, Vacuum Tube Voltmeter, and Signal Generator can be purchased in Heathkits for \$83.50, about the cost of a factory-built VTVM alone. Write for complete catalog.

**HEATH COMPANY**  
BENTON HARBOR 12,  
MICHIGAN

EXPORT DEPT., 13 E. 40th ST., NEW YORK 16, N.Y. CABLE ARLAB-N.Y.

toward greater solvency and greater profits for all."

In addition to distributors cooperating at local levels, Ehle declared, Committee representatives are finding television network, television stations, electrical associations and public utilities extremely cooperative.

Manufacturers underwriting the venture nationally include; Arvin; Avco Manufacturing corporation, Crosey Division; Belmont Radio Corporation, a division of Raytheon Manufacturing Company; Allen B. DuMont Laboratories, Inc.; Emerson Radio & Phonograph Corporation; General Electric Company; The Hallicrafters Company; Hoffman Radio Corporation; Industrial Television, Inc.; Motorola, Inc.; Packard-Bell Company; Philco Corporation; RCA Victor Division; Stromberg-Carlson Company; Wells-Gardner & Co.; Westinghouse Electric Corporation, and Zenith Radio Corporation.

**ESFETA Protests Jobbers Selling at Retail**

A regular meeting of ESFETA, Inc., was held on Sunday June 25th, 1950 at Bayville, Long Island. Guests in attendance were representatives of the several participating manufacturers of the 1949-1950 educational lecture series coordinated by ESFETA through the local technicians organization.

There was considerable discussion held relative to the practices prevalent within the industry especially those of retail customer and distributor. After much debate the following resolution was unanimously adopted.

"Resolved: The policy of Radio Jobbers and/or Distributors to sell to retail customers at wholesale prices is objectionable.

This practice deprives Technicians of their contact with a potential customer and consequently a loss of their legitimate income.

The member organizations of ESFETA representing some 3000 Radio & Television Technicians of New York State, recommend to the members of NEDA that this practice be eliminated to the betterment of relations of all groups of the Radio and TV Industry."

**Doyle Resigns as Alliance Prexy**

Mr. R. F. (Buss) Doyle has been associated with Alliance Mfg. Co. since its inception 25 years ago, and President of the firm since 1946, has resigned. Mr. Doyle's future business plans have not been announced as

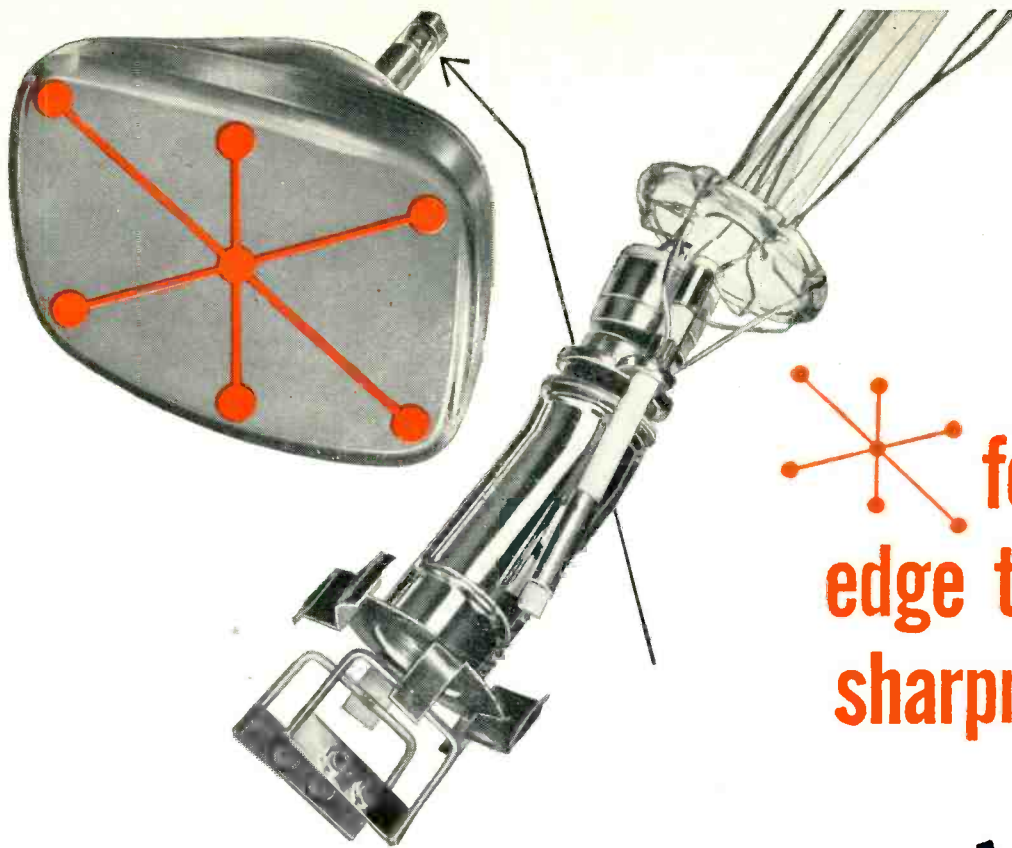

# the **New** Du Mont Bent-Gun

**U**niform sharpness of trace to the very edges of the screen distinguishes the new Du Mont Bent-Gun.

A higher degree of pre-focusing passes a smaller-diameter beam through the deflection field. Spot distortion is reduced and a uniform overall focus results. Other design changes are: Improved bulb spacer insures proper anode contact and electron gun centering; rounded corners on pertinent gun parts eliminates stray emission at higher anode voltages; new grid-cathode assembly allows a longer G-2 (second grid) without increasing overall length.

This new Du Mont Bent-Gun is now being incorporated in ALL Du Mont Teletrons. Therefore, whether planning a new TV receiver or modifying an old one, be sure to include the Du Mont Teletron for the best in TV pictures. Simply specify DU MONT.

RADIO-TELEVISION SERVICE DEALER • SEPTEMBER, 1950

FIRST WITH THE FINEST IN **T-V** TUBES

**DU MONT**

*Teletrons*\*

ALLEN B. DU MONT LABORATORIES, INC.,  
Tube Division, Clifton, N. J.

\*Trade-mark.

# NEW LOW PRICE

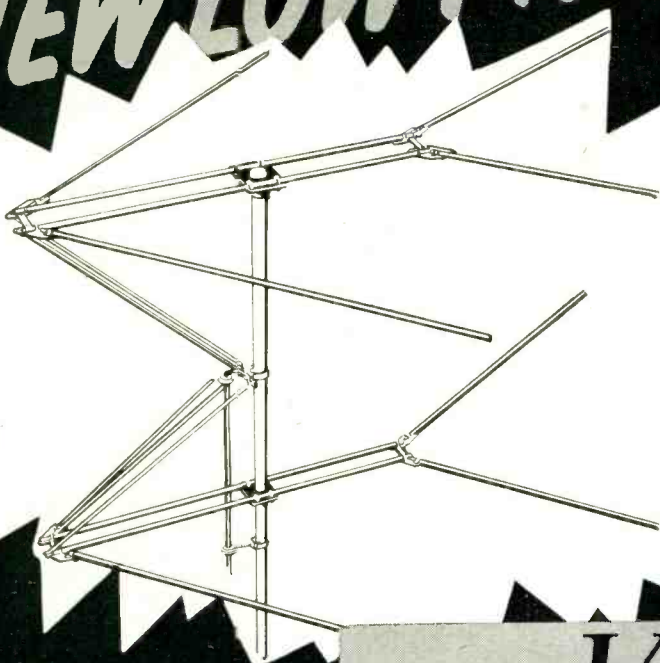

## WORKSHOP

### DUBL-VEE TV ANTENNA

PATENT  
PENDING

## Single . . . Double-Stacked plus Matching Bars

Now thoroughly proven in over 40,000 installations, the double-stack DUBL-VEE's new low price and outstanding all-channel reception is a combination you cannot match at any price. In addition, newly designed truss-angled matching bars provide extra strength and even better performance.

Write for Bulletin E

**Clearer Pictures**—higher gain brings in stronger signal — especially on higher channels

**Clearer Pictures** — narrow beam cuts down multi-path ghosts

**Clearer Pictures**—better impedance match on all channels maintains high signal strength

**Clearer Pictures** — true horizontal polarization—no out-of-phase ghosts

**Clearer Pictures**—no parasitic elements — all driven

**Clearer Pictures**—designed by the pioneers in the antenna industry

For the new low prices on

MODEL 2VV — Double Stack

MODEL VV — Single Bay

MODEL SK-2VV — Stacking Bars

call your distributor

## THE WORKSHOP ASSOCIATES, INC.

135 CRESCENT ROAD, NEEDHAM 94, MASS.

yet. However, he is still a stockholder and director of Alliance Mfg. Co.

### TV Installation Book Available

TV Installation Techniques, by Samuel L. Marshall the latest publication of John F. Rider Publisher, Inc., 480 Canal Street, New York 13, N. Y., is now available at Rider jobbers.

Every man who is actively engaged in the specialized field of operation of installing television antennas and receivers, or the man who contemplates entering it, needs this text to enable himself to successfully participate.

All phases of Television installation—construction, materials, methods, locations, installations, adjustments, municipal regulations, etc., are thoroughly discussed with the graphic assistance of 270 illustrations. Equal emphasis is devoted to metropolitan, suburban, and fringe area installations.

The book furnishes installation precautions concerning wind surfaces and ice loadings, the proper means of guying, in fact, all the factors necessary for the elimination of return calls due to improper antenna erection. It stresses the means whereby antenna installation can be accomplished in minimum time. It's a practical time-saving and money-making book from cover to cover. The text contains 336 pages in a cloth binding. It is priced at \$3.60.

### \$50,000,000 In TV Orders

Orders for the new line of 17 and 19-inch tube Telesets totaling \$51,700,000 have been placed by Du Mont distributors for fall delivery according to Walter L. Stickel, national sales manager of Allen B. Du Mont Laboratories, Inc.

### New Booklets

*RCA Receiving Tubes for AM, FM, and TV Broadcast* (revised)—Provides quick and easy reference to the characteristics and socket connections for more than 450 RCA receiving tubes and picture tubes, including more than 50 new tubes.

The new *RCA Receiving Tubes Booklet* (Form 1275-E) can be obtained from RCA Tube Distributors, or by sending 10 cents to Commercial Engineering, RCA Tube Department, Harrison, N. J.

*You Don't Have to be a Recording Expert*—How sound recording tape works; provides suggestions on care and use of sound tape; describes techniques of erasing and splicing tape. Minnesota Mining and Mfg. Co., 900 Fauquier St., St. Paul 6, Minn.



Here are some of the many reasons why there are more Simpson 260 high sensitivity volt-ohm-milliammeters in use today than all others combined. The Simpson 260 has earned world-wide acceptance because it was the first tester of its kind with all these "Firsts":

# Simpson 260 SET TESTER

## WORLD FAMOUS FOR ALL THESE "FIRSTS"

- First high sensitivity instrument to use a metal armature frame.
- First to use fully enclosed dust proof rotary switch with all contacts molded in place accurately and firmly.
- First to do away with harness wiring.
- First to provide separate molded recesses for resistors, batteries, etc.
- First to cover all resistors to prevent shorts and accidental damage and to protect against dust and dirt.
- First with a sturdy movement adapted to the rugged requirements of a wide range of service work or laboratory testing.
- First to provide easy means of replacing batteries.
- First to use all bakelite case and panels in volt-ohm-milliammeters.
- First volt-ohm-milliammeter at 20,000 ohms per volt with large 4 1/2" meter supplied in compact case (size 5 1/4" x 7" x 3 1/8").
- First and only one available with Simpson patented Roll Top Case.
- First to provide convenient compartment for test leads (Roll Top case).
- First to offer choice of colors.



The Model 260 also is available in the famous patented Roll Top safety case with built-in lead compartment. This sturdy, molded, bakelite case with Roll Top provides maximum protection for your 260 when used for servicing in the field or shop.

25,000 volt DC Probe for television servicing, complete, for use with 260, \$12.85

**SIMPSON ELECTRIC COMPANY** • 5200-18 W. Kinzie St., Chicago 44, Ill. • In Canada: Bach-Simpson, Ltd., London, Ont.

RADIO-TELEVISION SERVICE DEALER • SEPTEMBER, 1950

**RANGES**

20,000 Ohms per Volt DC, 1,000 Ohms per Volt AC

**VOLTS:** AC & DC—2.5, 10, 50, 250, 1,000, 5,000

**OUTPUT:** 2.5, 10, 50, 250, 1000

**MILLIAMPERES, DC:** 10, 100, 500

**MICROAMPERES, DC:** 100

**AMPERES, DC:** 10

**DECIBELS:** (5 ranges)—12 to +55 DB

**OHMS:** 0-2,000 (12 ohms center), 0-200,000 (1200 ohms center), 0-20 megohms (120,000 ohms center).

Prices: \$38.95 dealers net; Roll Top \$45.95 dealers net.

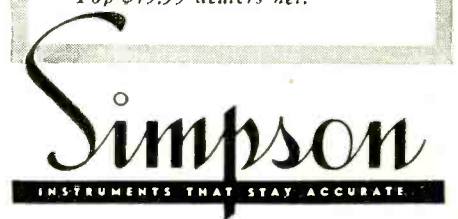

# NOW! A FULLY AUTOMATIC ANTENNA ROTATOR BY ALLIANCE

## The New **HIR**

with The Most Accurate Indicator On the Market!

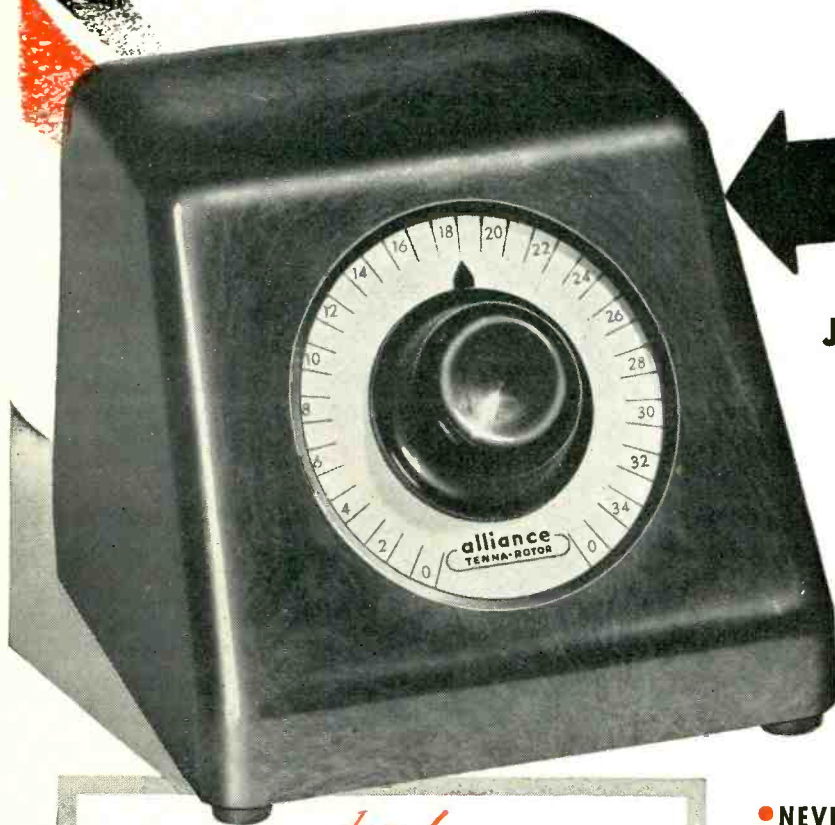

*And remember!*

Only ALLIANCE delivers a national TV campaign to five million viewers around 60 stations.

- Has more than 250,000 users
- Comes with special "Zip" feature 4-conductor cable.

The famous Model DIR also available with handy—North—South—East—West indicator. Approved by Underwriters' Laboratories—guaranteed for one year!

### JUST SET THE POINTER AND FORGET IT!

● **AUTOMATIC**—the new deluxe model HIR Alliance Tenna-Rotor is fully automatic! The antenna turns to any setting on the dial and stops.

● **FASTER INSTALLATION**—the only rotator where no orientation of antenna is required. Has special "Zip" feature—4-conductor cable.

● **NEVER OUT-OF-DATE**—station selector dial is erasable. May be marked for present or new channels at any time by viewer.

● **MOVING MYSTIC LIGHT**—light moves along dial—shows position while antenna rotates. Pointer indicates antenna direction *at all times!*

**Alliance Manufacturing Co.**  
Alliance, Ohio

Export Department: 401 Broadway, New York, N. Y., U. S. A.

**alliance**  
**TENNA · ROTOR**

(TV ANTENNA ROTATOR)



# Mechanical Features of TAPE RECORDERS

by C. A. TUTHILL

**G**OOD judgment will prompt private owners as well as operators of commercial tape recorders to become thoroughly familiar with the vital mechanical features of their machines. Since they are *machines*, and must be well built and maintained mechanically, details will be given here for the benefit of servicemen heretofore mainly versed in the circuit servicing of radios. In some cases discussion will pertain to a specific construction so as to effect a thorough coverage. Good design offers all components readily accessible. Quiet mechanical operation is essential. Certain basic requirements of *all* tape recording machines are:

1. **Stability** - A steady state of speed, free from vibration, is vital to all recording machines as regards flutter and pitch. Load variations due to the use of large and small tape reels, or temporary friction from bent or wharped reels, require adequate drive motor and capstan action to counteract resultant *drag*. Heavy duty induction motors, designed for constancy of speed over a wide range of voltage variations, are frequently used. Filtering mechanisms are sometimes inserted between motor and capstan to minimize speed variations. Generous flywheels replace the heavy platters of disc machines.

2. **Alignment** - Constancy of alignment of the entire tape width across the recorder and reproducer poles is necessary as a function of response. When one edge of either the gap or the tape is displaced, even a few thousandths of an inch, from its proper position, high frequency response will fall off.

**This article is the second in the series on Tape Recorders, the first appearing in the July issue of RSD under the title, "Theory of Tape Recording". The reader will find various recorders analyzed as to their mechanical features. This should prove of great interest to Service Dealers because many of the service troubles encountered in tape recorders are mechanical in nature.**

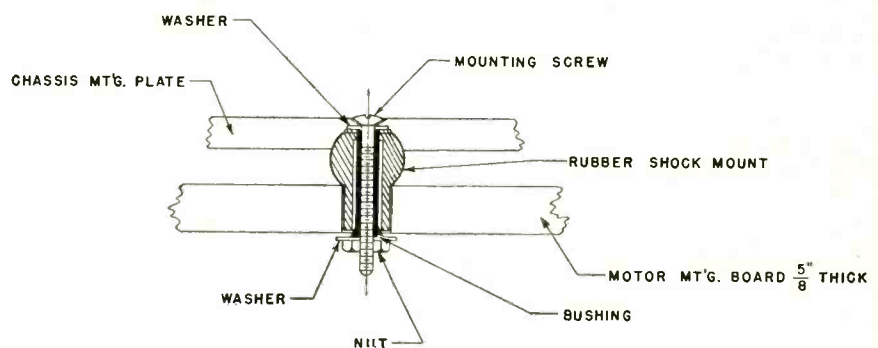

Fig. 1. Mounting details of Twin Trax chassis

3. **Constancy of Takeup** - A pressure roller and motor-driven capstan jointly serve to pull the tape toward the takeup reel at consistent and proper speed. A belt and pulley assembly or a dry-slipping clutch generally drives the takeup reel which actually is engaged by a friction-drive disc or washer to allow for slippage as the tape load circumference varies. Takeup tension should be great enough to wind the tape up evenly upon the takeup reel yet not great enough to drag the tape past the capstan beyond the desired rolling speed.

Several commercial treatments of tape handling are described under the heading *Tape Threading and Rewind*. Takeup components are detailed under *Mechanical Construction*.

4. **Shock-proof Mounts** - Freedom from vibration is essential to *any* recording machine. Protection against building rumble or local vibration is gained through mounting plate shock-mounts such as the *Twin Trax* example illustrated in *Fig. 1*. Rubber grommet motor mounts (*P 123*) and rubber drive roller (*A 181*) of the *Pentron* recorder are shown in *Fig. 2*. This rubber drive roller is carefully

- (63) Drive Motor
- (24) Amplifier Assembly
- (25) Neon Lamps
- (68) Motor Mounting Plate
- (75) Takeup Pulley
- (76) Takeup Spindle Ass'y
- (61) Drive Ass'y
- (74) Capstan & Takup Ass'y
- (69) Motor Switch
- (14) Record Head Adjustment Stud
- (12) Record Head
- (58) Pressure Roller Bracket Stud
- (38) Erase Magnet
- (48) Record Head Pressure Pad
- (52) Pressure Roller Spring
- (51) Pressure Pad Bracket Stud
- (49) Erase Head Pressure Pad
- (46) Pressure Pad Spring
- (13) Record Head Spring Adjustment
- (41) Tape Erase Lever
- (15) Record Head Shoulder Screw
- (47) Pressure Pad Bracket Assembly
- (60) Hex Holding Nut
- (10) Actuator Pressure Roller
- (53) Bracket Pressure Roller (Brack. Ass'y)
- (56) Bracket Pressure Roller
- (55) Pressure Roller Shaft
- (5) Control Panel
- (4) Control Knob

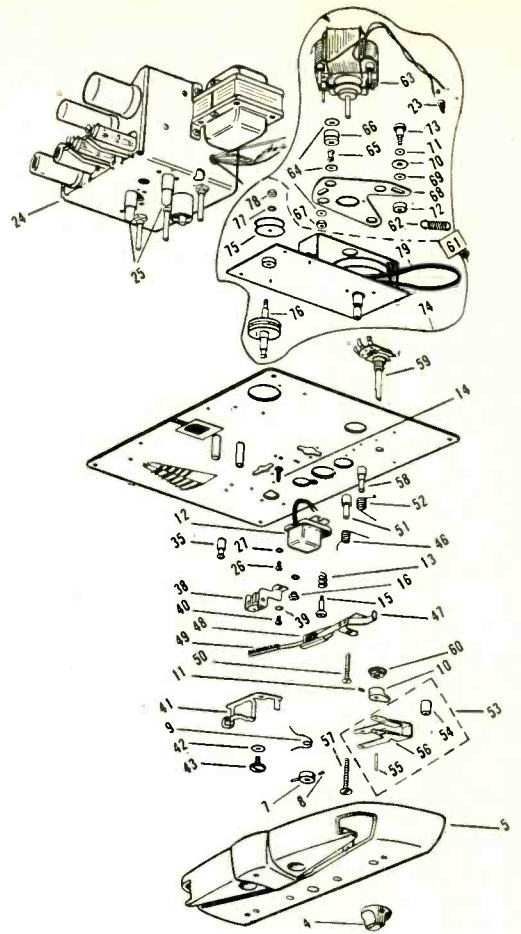

Fig. 3. Exploded view of Ampro Model 730 recorder.

adjusted for a firm contact with the main flywheel of the mechanism. Precision-ground rubber contacting surfaces are a *must*. Excessive pressure may prevent the motor from starting while insufficient pressure results in slippage and *wows*.

#### Mechanical Construction

Typical construction of a portable tape recorder, selling for less than \$100, is detailed in the exploded view of the Ampro Model 730, Fig. 3. Major components are identified. For reasons of simplicity, some spindles, washers and screws have been deleted. It is at once obvious that, if caution

be taken while dismantling for repair, much time and labor will be saved during re-assembly. Lay the parts out consecutively, as removed, upon a clean hard cloth.

The item number headings which follow correspond to the numbers given in Fig. 3.

**Item #5 - Control Panel and Guard** - This plastic control panel (3) is slotted for tape threading since it covers record and erase heads and their associated components. It is held in place by three Phillips head screws and is readily removed. An input jack in its center connects to microphone or other source. Four control knobs across the panel face control, (a) amplifier; (b) play-record-microphone switching; (c) volume control and (d) motor from left to right in that order. The larger holes above the threading slot house recording level and amplifier neon indicator lamps (#25 in amplifier ass'y).

**Item #53 - Pressure Roller Bracket Ass'y** - This bracket is adjusted to allow pressure roller (54) to turn freely. The pressure pads (48 and 49), for record head and erase head, are aligned to enter the slots in the heads. These pads are adjusted to bear firmly upon

the proper surfaces of the heads in such manner as to obtain proper contact and alignment between the recording tape and the heads. This is accomplished by a cam-operated lever assembly which is brought into action the instant the drive motor is switched to "On". One single knob performs the double-function. At once it starts the motor and swings pressure pads (48 and 49) into normal operating position. This introduces a load upon the motor, thus, uneven or jerky tape transport and possible tape damage is avoided.

When worn down to a thickness of 1/16" these pads should be removed, using Petroleum Naptha (140-210F) as a solvent. New pads are installed by using MMM cement (#EC-104) as a retainer which must be allowed to dry thoroughly before resumption of operations. The edge of the pads must be kept parallel to the edges of the pad brackets (47) and the ends of the pads must be flush with the ends of the brackets.

During disassembly or reassembly, care must be taken to avoid injury to the lightly constructed components. For example, - the pressure pads must introduce a proper degree of pres-

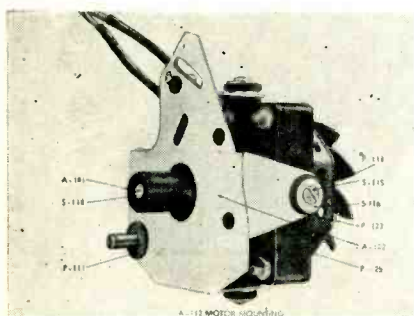

Fig. 2. Rubber grommet motor mounts and drive roller of pentron machine.

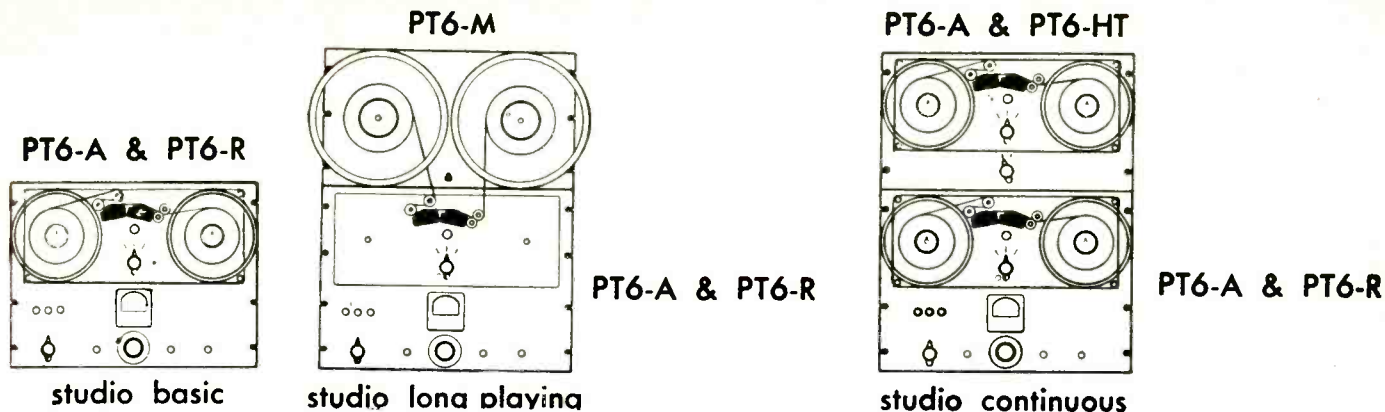

Fig. 5A (left)—Basic studio method of tape threading. Fig. 5B (center)—Auxiliary spooling mechanism. Fig. 5C (right)—Double load mechanism for continuous recording.

sure against the recording head and such control has been pre-determined at the factory. When spring tension is altered, due to bent springs or some other fault, correction is necessary prior to satisfactory operation. This points out the need for care when heads and pads are cleaned with cloths.

Proper alignment during reassembly must be reestablished. This applies not only to parts associated with tape travel but also to all mechanical components throughout the mechanism. Detent and leverage actions offer continual mechanical resistance to changes constantly made during normal operation. Therefore, the top panel knobs controlling such action must be tightly screwed to the flats of their shafts.

When the recorder is inactive, the motor control must never be left "On" or a dimple will develop in the pressure roller and cause "wows" during reproduction. The manufacturers of the above equipment call attention to the following:

Tape recorders will be turned over to servicemen for one of three reasons (a) unsatisfactory performance due to operational errors; (b) periodic inspection and maintenance, or, (c) unsatisfactory performance due to wear or failure of components.

Dirt is the cause of many irregularities. Therefore all parts in the path of the tape should be cleaned with a hard cloth dampened with carbon tetrachloride before attempting inspection or test of the equipment.

Owners have been instructed not to lubricate this machine but instead to refer to the service technician for this service which should occur only on an annual or 500 operating-hour basis. Only pure mineral instrument oil and light graphite grease should be used and then sparingly. Details are given in the Instruction Manuals where trouble shooting tables are included. It should be remembered that

this is a dual track device. Considerations therefore apply which were given concerning the Twin-Trax machine in Radio Service Dealer issues of May and June 1949.

#### Recorder Head Assembly

In Fig. 4, we see details of relationship between the Pentron recording head (A-106) and erase head (A-107) as regards tape guide and pressure facilities. For clarity, the

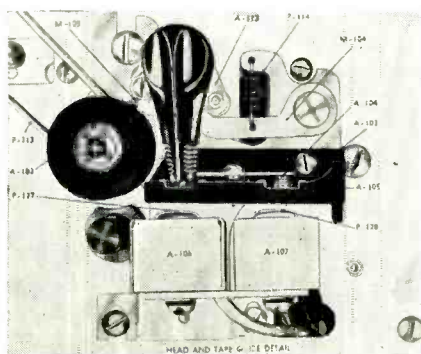

Fig. 4. Details of relationship between Pentron recording head and erase head.

heads are shown lowered from their operating positions. By means of screws in slotted holes in the head bracket, both heads are adjusted to enter into the tape guide block (A-105) until the pressure pads within the block (A-108) are depressed slightly less than 1/32 inch. Again this adjustment is pre-set at the factory and will persist during normal operation.

Tape pressure pads (A-103), within the tape guide block, (A-105) are pressed downward by phosphor bronze springs (A-104). These springs exert a pressure of 30 grams for each head when the recording tape is in operating contact. Too great a pressure at this point will create flutter. Correc-

of reels. A tape record library is liable to be obtained by loosening the screws holding the head-mounting bracket so that the head may be lowered slightly. Care must be observed not to disturb alignment of the recording head.

Final head adjustment is made by slowly turning the head until the air gap in its lamination or shoe is exactly at right angles to tape travel. This is best accomplished by playback of a constant level 3000 cycle tone record. The head is rotated for maximum response on an output meter and then locked into place by screws.

An open-circuited head must be replaced. Worn or damaged laminations (P-127 or P-128, Fig. 4) can be replaced. First, release the holding screws whereupon the two heads and bracket plates are released on one unit. Next, carefully pry out the laminations with a screwdriver. Then, new laminations can be pressed in with one's fingers until the laminations come up solidly against a bottom yoke. Care must be taken to have the steel portion of each lamination uppermost in the tape guide when the machine is in normal operating position.

#### Takeup Mechanism

The takeup pressure lever (A-113, Fig. 4) is normally set so that it is vertical when the control knob is in "Play-Record" position. Under this condition the arm adjusting plate (M-105) is set so that it clears pressure arm (M-104) by 1/64th inch. When the control knob is turned from "Off" to "Rewind", this machine has a rewind ratio of 20 to 1 against its recording speed of 7½ inches per second.

Takeup mechanisms should provide for interchangeability of various types

[Continued on page 33]



the operating point of this tube as well as the amount of current and thereby controls the cathode bias, which in turn is the error voltage.

Consider the voltage wave at *point (1)* in *Fig. 9*, again. If the synchronizing pulse would occur just before the steep portion of the sawtooth, the pip on top would obviously be broader. If the synchronizing pulse would occur slightly later, only the narrow feedback pulse from the damper tube would be perched on top of the sawtooth and this would mean a shorter current passing interval at the control tube. The appearance of the pulse pip is controlled by *C13*, usually labeled "Lock-In Range" control. This trimmer is part of the capacitive voltage divider *C3* and *C12*, and determines the pulse height and width. Once this adjustment is made it need not be touched unless major circuit changes are required. After the pulse width for normal operation is set through the adjustment of *C13*, the two separate windings in *T1* must be adjusted to oscillate at the proper frequency. If, for some reason the frequency of the oscillator changes slightly, the width of the pip on top of the sawtooth wave appearing at *point (1)* will vary. A variation in pulse width at the grid of the control triode results in a variation of the cathode bias of this tube. This cathode bias is actually the error voltage which controls the speed of the oscillator through *R7*, the grid resistor of the oscillator triode.

### Synchroguide Operation

As example for the operation of the synchroguide circuit consider the case when the oscillator seems at a lower frequency. The synchronizing pulse will occur slightly before the feedback pulse which will effectively broaden the pip. A wider pip results in longer conduction through the control tube and in a higher cathode bias. A higher cathode bias is equivalent to a more positive error voltage which means a reduction of the negative bias on the oscillator grid. Reducing the negative bias on the oscillator grid has the effect of increasing the oscillator frequency, bringing the oscillator back to the proper synchronizing pulse speed. Because of the pulse width feature, the synchroguide is effective only when the natural frequency of the oscillator is the same as that of the incoming pulses. The adjustment of *C13*, the Lock-In trimmer is also quite critical, since it sets the level of the controlling pulse and if the pulse is too small the error voltage developed will be insufficient to control the oscillator. If, on the other hand, the pulse is too strong, the error

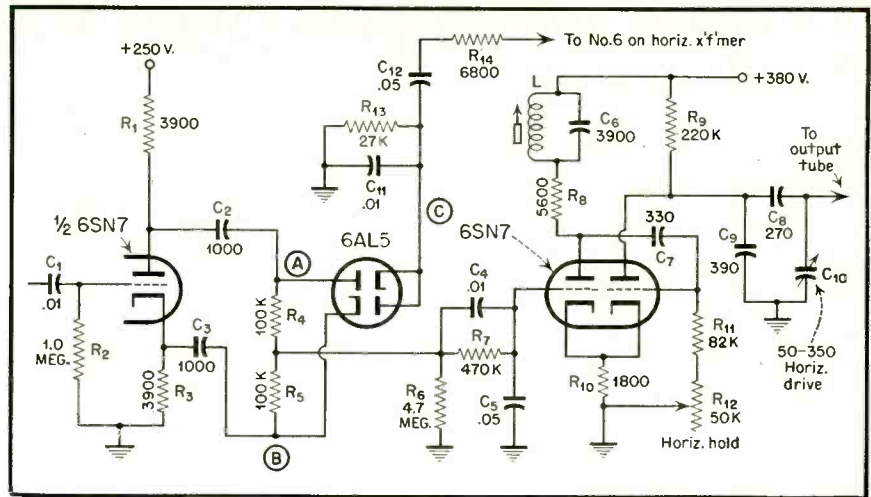

Fig. 5. Phase detector—AFC

(Erratum: Through an error the wrong diagram was run off as Fig. 5 in the first few thousand issues of the July RSD. Shown above is the correct Fig. 5.)

voltage will overcompensate, which also results in unsatisfactory performance.

The range of the hold control depends on the voltage across *R14*, and usually permits only a slight variation of the plate voltage of the control tube. In normal operation at midpoint setting the synchroguide will lock-in instantly when channels are switched. At either extreme setting the picture will not lose synch while the signal remains constant, but when stations are changed, synchronism may be lost. The horizontal drive trimmer acts in a manner similar to that in the phase detector and also influences the frequency of the oscillator somewhat.

Two different methods of adjustment are in use and either may be followed successfully. One method requires an oscilloscope and this is the more thorough approach. Usually the oscilloscope method is used only when a major repair has been made and *T1* must be completely re-adjusted. In using the oscilloscope a 10,000 ohm decoupling resistor should be connected in series with the "hot" side of the 'scope to avoid detuning the circuit with the 'scope input capacity. Below is a suggested procedure for aligning a synchroguide AFC system with an oscilloscope.

1. Set oscilloscope to approximately 15 kc and connect probe through 10,000 ohm resistor to last video amplifier. Adjust scope to give two cycles of synchronizing pulses.

2. Connect 'scope probe through the same resistor to *point (1)* in *Fig. 9*. Adjust the slug which tunes coil A-F until two sawtooth waves appear and stand still. Adjust *C13* to give a curve like the one shown in *Fig. 10*. Re-adjust the slug if necessary.

3. Set the horizontal hold control to approximately center and adjust *C14* for maximum width and brightness. Retune *T1* to obtain a locked-in picture and a 'scope as in *Fig. 10*.

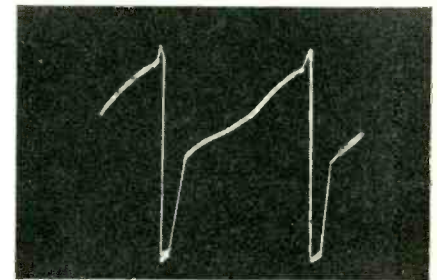

Fig. 10. Wave shape at point in Fig. 9; 30 volts peak to peak.

4. Short antenna terminals and connect 'scope lead to *point C* on *T1*. Adjust the slug of coil C-D for a pattern as in *Fig. 11*. Make sure a symmetrical sine wave appears between the sharp portions of the curve.

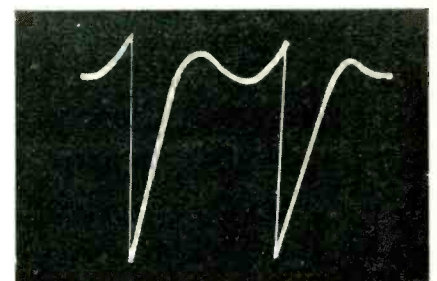

Fig. 11. Wave shape at point C on *T1* in Fig. 9; 125 volts p. to p.

5. Remove the oscilloscope lead, connect antenna properly and check

[Continued on page 39]

# The Serv TV CH

by CHARLES A. HOBBS J

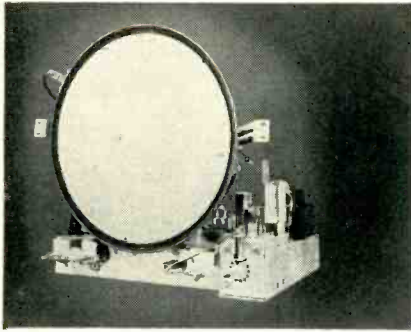

Fig. 1. Designed with 30 per cent fewer parts and 20 per cent fewer connections, the new RCA Victor "Million Proof" television chassis offers approximately 40 per cent greater sound power and brighter, sharper pictures, with approximately 50 per cent less power consumption.

Fig. 2. Simplicity epitomizes the new chassis, which is characterized by the consolidation of heretofore separated parts and components into pre-wired assemblies, arranged in functional order. Approximately 50 per cent of the standard installation procedures have been simplified by the accessibility of parts, and the serviceman can install the new receiver and perform all normal servicing work without removing the chassis from the cabinet.

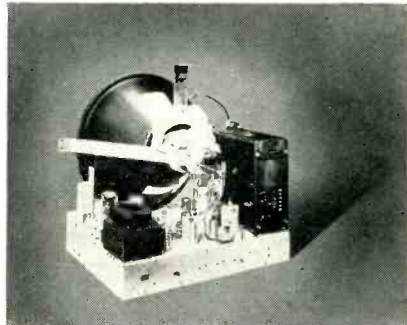

Fig. 3. As this underside view clearly illustrates, parts and connections in the RCA Victor "Million Proof" television chassis are easily accessible. A marked departure from conventional layer-built types, this new chassis features sub-assemblies secured with self-tapping screws for quick replacement.

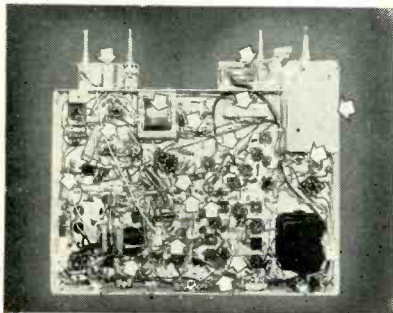

Fig. 4. New chassis design makes alignment of the horizontal oscillator a quick and easy operation. The horizontal adjustment has been located in a more accessible spot, at the back of the chassis.



Fig. 5. The Vernier focus control in the "Million Proof" chassis is now within easy reach, as this picture illustrates. Since the focus magnet is now pre-focused at the factory, the control is needed only for fine adjustments.

RECENT engineering advances and production economics have enabled RCA Victor to actually improve performance while reducing prices in the development of its new "Million Proof" line of television receivers and TV-radio-phonographs.

Use of improved and simplified circuits with new types of tubes and components has made practical a chassis with almost 30 per cent fewer parts and 20 per cent fewer connections, and one that consumes almost 50 per cent less power than previous models. Yet the new receiver is more powerful, more sensitive, and has a better signal-to-noise ratio and more sound power output than similar previous models.

Because the kinescope is mounted in the new chassis before shipment, and because picture centering controls have been simplified and the focus control made more accessible, it has been possible to reduce installation set-up time as much as 25 per cent.

These television chassis have also been designed with the serviceman in mind. All of the parts and connections are easily accessible. Many service jobs may be performed without taking the chassis out of the cabinet. For instance, the horizontal oscillator adjustment is now in a more accessible location, right at the back of the chassis. The new focus control is within easy reach, so that the adjustment can be easily made. The new type of picture centering control sets a new standard for ease of operation. The self-centering kinescope mask has a new dust seal. This will prevent dust from collecting between the kinescope face and the safety glass and eliminate the need to remove the kinescope in order to clean the inside of the glass.



# Serviceman's ASSIS

Engineering Editor, Technical  
Publications Dep't. RCA Service Co.

The high sensitivity of the new chassis is due partially to use of the new 6CB6 tube in the r-f and picture i-f stages. This tube, with its inherently higher gain, permits the reception of weaker signals than ever before. The picture i-f band width remains exceptionally wide, insuring excellent picture detail.

The receiver input circuits are very well balanced, which helps to prevent ghost signal pickup on the antenna transmission line from causing interference. The r-f unit is exceptionally well shielded. This, together with other design factors, insures an extremely low r-f oscillator radiation, reducing to a minimum the possibility of interference with other nearby sets which may be receiving weak signals.

A highly efficient "direct drive" horizontal sweep output deflection system provides greater deflection and more high voltage, with fewer circuit components and less power consumption than previous systems.

All receivers have built in antennas, either in the cabinet itself or in a stand designed for use with some table models.

It will be noted that throughout the chassis, while circuits have been simplified, making the servicing job simpler and faster, at no point has any sacrifice in quality been made. Although some circuits have been eliminated, the new chassis is actually superior to excellent chassis of earlier design. The new receivers represent a combination of three vital ingredients: the endless research and study of RCA engineers, high manufacturing quality standards, and invaluable information from the field. They are literally "Million Proof," because they are backed by the experience gained with more than a million RCA Victor home television receivers.

Fig. 6. The provision of an extension on the vernier focus control enables the serviceman to make adjustments while simultaneously checking the raster on the television screen. The vernier control covers a wide range, even under extreme line-voltage variations.

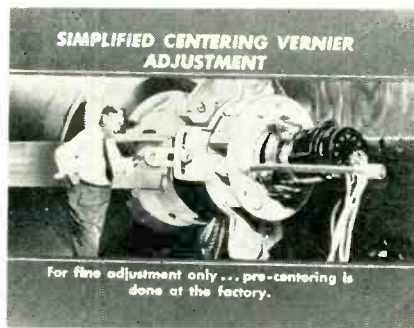

Fig. 7. The new and simplified centering vernier adjustment of the "Million Proof" chassis is a simple two-way lever that can be adjusted and locked in less than half the time normally required with standard adjustments.

Fig. 8. Another feature of the "serviceman's dream chassis" is the new wide-range width control which permits definite adjustment for full picture width, even under wide variations of AC line voltage. It, too, is easily accessible for rapid adjustment.

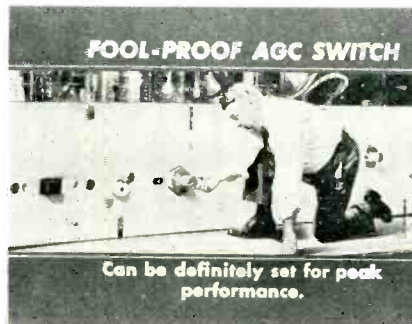
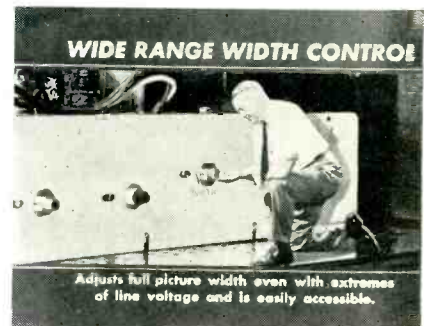

Fig. 9. The "Million Proof" chassis also features a fool-proof switch for automatic gain control. The switch controls three degrees of AGC action and will enable the serviceman to set the AGC for peak performance for a specific location.

Fig. 10. Indicative of the "keep-the-serviceman-in-mind" theme which underlined the development of the "Million Proof" chassis is the simplification of RF oscillator adjustments, the majority of which can now be made at the front of the set, via the channel selector switch. The formula is simple. Remove the escutcheon from the selector switch and flip the channel selector to the channel to be adjusted. The masking guide will automatically guide the serviceman to the proper adjustment.



# LOOKING FOR *Trouble?*

by **Cyrus Glickstein**

(American Radio Institute)

**Presenting a unique type of trouble-shooting article which attempts to go through the actual steps of servicing a TV receiver. This technique is designed to maintain interest while demonstrating and explaining actual service problems and principles. A number of these are planned for the future.**

**H**OW good are you at finding trouble when you go looking for it—in TV receivers, that is. Here's your chance for a quick check.

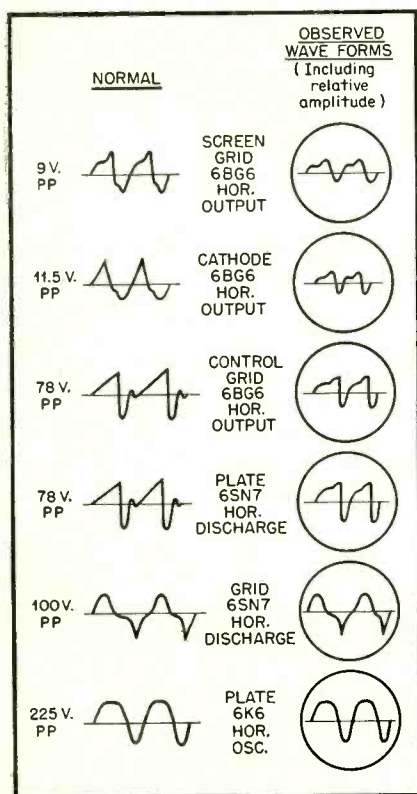

Fig. 2. (Left) Normal waveforms. (Right) Observed waveforms.

We're going to start with a trouble in the old standby—RCA 630—and go through the actual steps of servicing the set on the bench. You can follow along and contribute your opinion each step of the way.

Each question should be answered before going on to the next since some questions are given away in the following question. Answers and discussion follow the completion of these questions.

1. The first step in trouble-shooting teletests is generally to turn the set on and check the information present on the screen and coming from the speaker. The next step is usually manipulating appropriate controls to check if there is actual trouble or just misadjustment of controls or switches.

With a blank screen and normal sound, the most important control to check first would be: (Check one of the following)

- Fine tuning
- Horizontal drive
- Contrast
- Brilliance

2. The brilliance (brightness) control was varied through its entire range, after the contrast control was set at maximum. Rotation of the brilliance control gave a very dim picture at one point only—about  $\frac{3}{4}$  of maximum. All other points gave a blank screen. At the setting where the picture was visible, it did not fill the mask horizontally. Right side of

the picture had a bright line (fold-over) and ended 3 inches short of the right side of mask. Variation of horizontal drive control made picture disappear.

On the basis of screen and speaker information plus the data from manipulating controls such as mentioned above, the next step in trouble-shooting is to decide in what section or sections the trouble is most probably located, in order to make a further check there. In the basis of the above information, the fault most likely is in: (Check one of the following)

- Brilliance control and/or CRT circuit
- High voltage circuit
- Horizontal sweep circuit
- Low voltage system

3. All tubes in the horizontal circuit including the horizontal output tube, 6BG6, the damping tube, 5V4 and the high voltage rectifier, 1B3 were changed. No improvement.

The schematic of the set was referred to: Fig. 1

Since a scope was handy, the following waveform checks (Fig. 2) were made at the indicated points and compared to the correct waveshapes given in the manufacturer's service manual:

On the basis of comparing the observed with the normal waveforms, the trouble apparently is located between the following points: (Check one of the following)



# PULL MINIATURES PAINLESSLY!

WHY STRAIN, fry, and slice your fingers? Why break tubes? Pull or insert 7-pin miniatures the e-a-s-y way. With economical Hytron Tube Puller. Result of two years' research. Positive grip pulls first time from meanest sockets. Special Neoprene rubber resists heat. Does not harm tube. Adjusts automatically to varying tube diameters. Tube Puller works by suction and friction on top of tube. Removes even tiny 6AK5 and 6AL5 from shielded sockets. Reaches into tightest spots — to pull or insert. Only 75¢! You cannot afford to be without this temper-time-and-money saver. Get your Hytron Tube Pullers from your Hytron jobber today.

**It's Easy!** **TO PULL:** Push Tube Puller onto top of 7-pin miniature. Just enough for firm grip, and without depressing release button at top. Pull straight up and out; no need to bend pins by violent rocking. Hold tube securely in one hand. With other, push release button quickly. Compressed air pops out tube. Or, holding down release button, remove Tube Puller by rocking it. **To insert:** Align arrow on skirt of Tube Puller with keyway of tube. Push tube into Tube Puller. Using arrow as guide, insert tube. Push button quickly to release. Maintain pulling action at peak. Wipe inside of Puller occasionally with clean cloth to remove dirt and grease.



**HYTRON TUBE PULLER 75¢ net**

## THEY COST PENNIES, BUT SAVE DOLLARS!

OVER 50,000 SERVICEMEN know! These Hytron tools pay for themselves again and again. Save time . . . temper . . . dollars — daily. Read what they'll do for you. Write for complete Tool Catalogue. Better still — get these tools from your Hytron jobber today!



**PIN STRAIGHTENERS, 7-Pin and 9-Pin — 55¢ net ea.** You merely press tube gently into Hytron Straightener until button base seats squarely. Presto, pins are straight! Fast . . . safe. Avoiding one broken tube pays for Straightener twice over. Precise, stainless-steel insertion die. Comfortable knurled aluminum holder. For hand, bench, or tube tester use.



**AUTO RADIO TOOL — 24¢ net.** Substitutes for control cables of universal auto radio. Quickly, precisely turns set on/off, tunes, adjusts volume and tone, re-aligns dial. Square also fits spines. Vee fits spade and other key fittings. Minimum backlash. Compact. Bright-zinc plated. Non-rolling large handle for fine adjustments.



**SOLDERING AID — 49¢ net.** Fork tip effortlessly, quickly unwraps "mechanically solid" joints. Straddles wire, grips, unwraps, pulls it free. Guides new wire, holds it firm while soldering. Spade tip reams solder from lug hole, pushes other wires aside. Tips are hardened, twist-proof, insulated, hard-chromed to shed solder. Tool handles like pencil. Reaches tight spots. Has dozens of other uses.



**TUBE LIFTER — 15¢ net.** Lift 'em all the e-a-s-y prybar way: Tubes (GT, G, standard, lock-in, metal). Vibrators and plugs (Jones, Amphenol) — and knobs. A natural for compact auto radios, etc. Slotted end lifts lock-ins, snap-in trimounts . . . easily, safely. Of stainless steel with comfortable rolled edges.



**TUBE TAPPER — 5¢ net.** Handy combination pencil, eraser and tube tapper. Discovers microphonism, shorts, and opens in tubes, etc. Compact, non-metallic, rugged. Doubles in brass for writing orders, etc.

OLDEST MANUFACTURER OF RECEIVING TUBES  
**HYTRON**  
RADIO AND ELECTRONICS CORP.

MAIN OFFICE: SALEM, MASSACHUSETTS



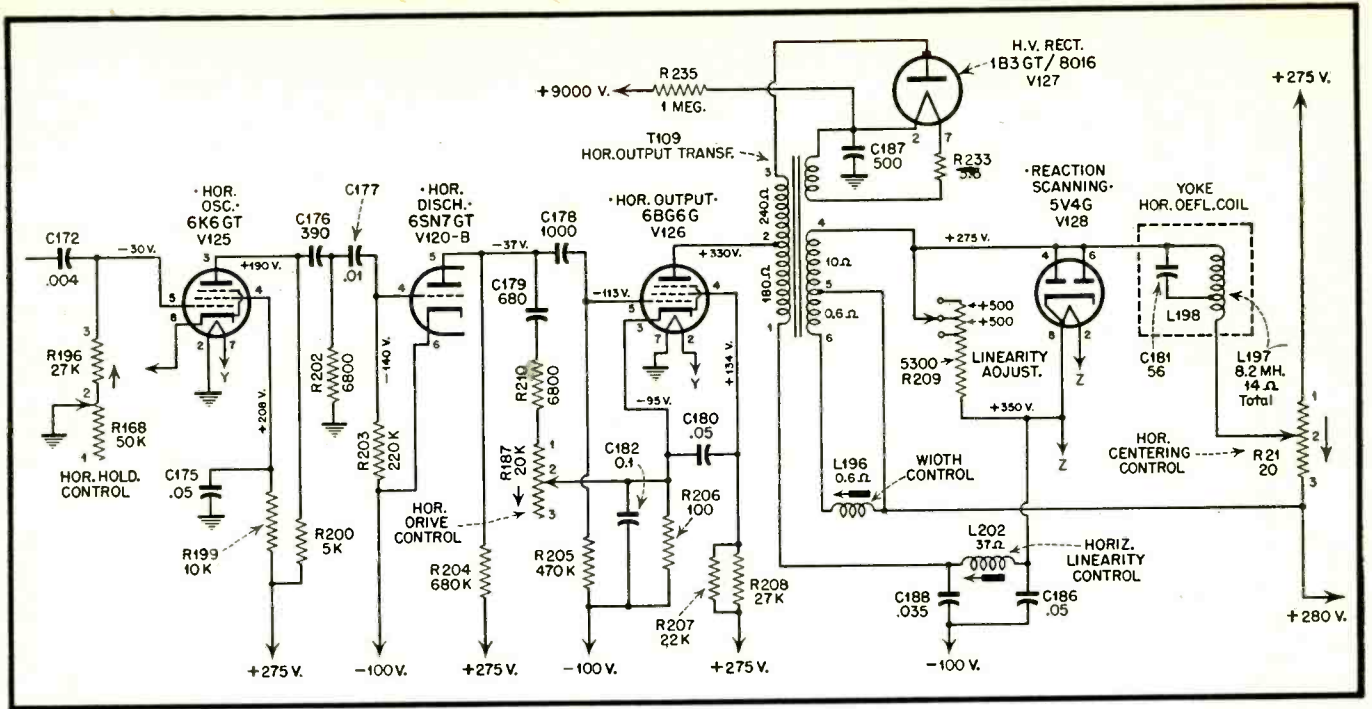

Fig. 1. Partial schematic of horizontal sweep and high voltage RCA 630TS

- Plate of the Horizontal Oscillator and Grid of Horizontal Discharge tube
- Grid of Horizontal Discharge and Plate of Horizontal Discharge tube
- Plate of Horizontal Discharge tube and grid of Horizontal Output tube
- Grid of Horizontal Output tube and screen of Horizontal Output tube

4. Voltage readings were taken around the Horizontal Discharge tube circuit, V120-B, 6SN7GT, with a VTVM. The following readings were noted: (and compared to values on schematic—Fig. 1 (B+ = normal)

$E_p = -75$  v.  
 $E_g = -138$  v.  
 $E_c = -100$  v.

These readings indicated: (Check one of the following)

- Too much current through the tube
- Too little current through the tube
- Too much current through the plate resistor, R-204
- Too little current through R-204

5. There were two main possibilities for the above voltage readings. To isolate the trouble further, if possible, resistance readings were taken from the indicated point to the -100 v. point instead of to the chassis, to simplify the readings. Because of a voltage divider across the low voltage B+ supply, resistance from +275 v. to -100 v. is 10 k ohms.

6BG6	Screen Grid	-20 K
	Control "	-500 K
	Cathode	-100
6SN7	Plate	-20 K
(Hor. Dis.)	Grid	-250 K
	Cathode	-0

These readings can be checked against schematic—Fig. 1.

What's the Trouble? (Check one of the following)

- Plate resistor R-204 shorted across or greatly reduced in value
- Coupling condenser C-173 shorted
- Sawtooth condenser C-179 shorted
- Coupling condenser C-178 open

### ANSWERS & DISCUSSION

Answer 1.—d:

Discussion

Brilliance control should be turned to maximum first to make raster visible, if present. Raster should be visible under normal operation even if contrast control is all the way down, if brightness control is at maximum. Turning up contrast control is for the purpose of bringing in picture information. Horizontal drive control has only a small effect in varying brightness. If sound is normal for a given channel, fine tuning adjustment can only detune sound and have little effect on unblanking screen.

Answer 2.—c:

Discussion

Picture that is dim at one point and blanked out at other points of brilliance control rotation can be caused by a defect in any of the following circuits: CRT, high voltage, horizontal sweep. However, the additional fact of foldover along the right edge usually points to trouble originating in the horizontal sweep circuit. That is, a non-linear horizontal sawtooth of low amplitude could cause both low high voltage foldover.

In normal operation, when brilliance is turned all the way up, picture blooms (expands) as it brightens. This is due to more current through the CRT because of reduced bias; more current through the large filter resistor, (R-235, Fig. 1) 1 megohm, in the high voltage system reduces the high voltage; sweep currents through the deflection coils therefore have more effect on the slower moving beam; and since deflection sensitivity is increased, the picture is larger. In this case, increasing the brightness control beyond the one critical point produced more current through the CRT and evidently reduced the already low high voltage to the point where there was no visibility.

Answer 3.—b:

Discussion

As usual in all methods of isolating trouble, the defective stage is between [Continued on page 35]

# FRONT ENDS

by Samuel L. Marshall

(From a forthcoming book, "Television Service Techniques")

## Part 3

In the last installment (July, 1950) we made mention of stagger tuning as one of the methods of obtaining wide band frequency response in Front Ends. We also illustrated how this was done by means of a block diagram and a hypothetical example. Figure 3-18 illustrates a simplified circuit diagram of the stagger-tuned r-f stages employed in the General Instrument Model 44 Electuner. Connections are shown for high band operation. In both high and low band operation the plate circuit of the 1st r-f amplifier provides the low frequency stagger component, and the plate circuit of the second r-f amplifier provides the high frequency stagger component. A sketch of a typical r-f pass band is shown in Fig. 3-19. If an r-f sweep input is applied to the antenna terminals and an oscilloscope connected to the point marked "scope" as shown in Fig. 3-18 the resultant overall response will appear as shown in Fig. 3-20.

Referring again to Fig. 3-18,  $L_{61}$  and  $L_{63}$  are the high frequency r-f transformers,  $C_{44}$  and  $C_{45}$  are conventional trimmers,  $C_{41}$  and  $C_{42}$  are the first and second sections of a 3-gang tuning condenser,  $C_{25}$  and  $C_{26}$  are fixed ceramic condensers which are

**This installment deals with the mixer and oscillator circuits found in modern Front Ends. Methods of converting a Front End from split-sound to intercarrier service are discussed as well as the usual types of oscillator circuits and the usual troubles encountered.**

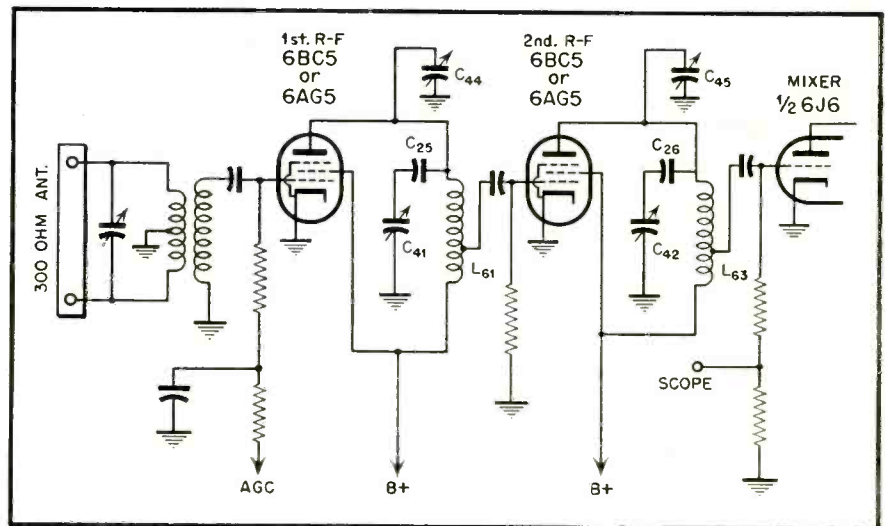

Fig. 3-18: Simplified circuit of G.L. Model 44 Electuner.

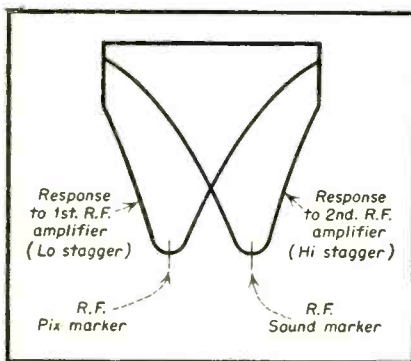

Fig. 3-19: R-F pass band.

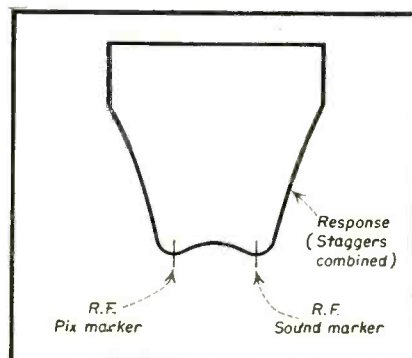

Fig. 3-20: Response on 'scope.

connected in series with the tuning condensers during high band operation.

In practice,  $C_{44}$  staggers the response characteristic toward the pix carrier, and  $C_{45}$  staggers the response towards the sound carrier. This adjustment is made on Channel 13. Channel 7 tracking is accomplished by adjusting coils  $L_{61}$  and  $L_{63}$ . Similarly, tracking of the low frequency channels is done by adjusting the additional coils switched into the circuit during operation on Channels 2 to 6. For purposes of simplifying the ex-

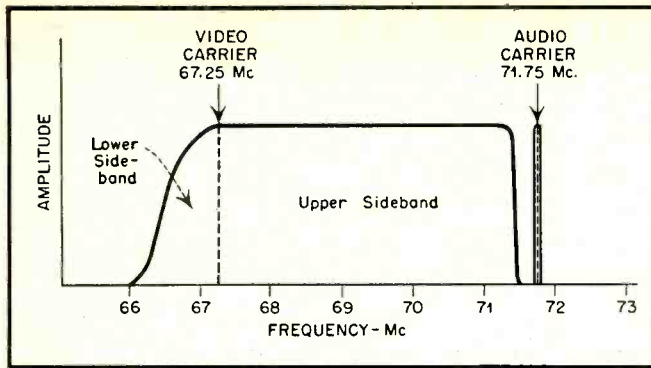

Fig. 3-21: R-F frequency distribution of Channel 4 signal entering converter stage.

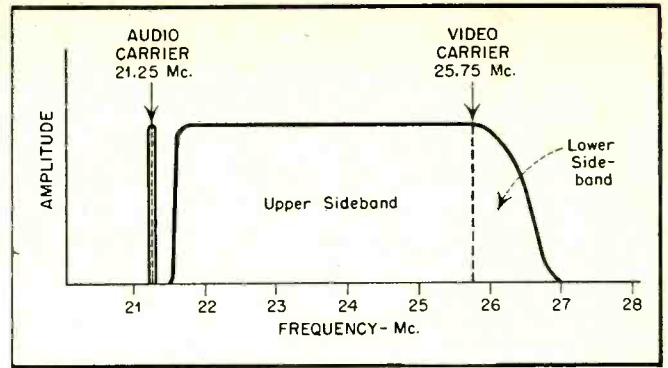

Fig. 3-22: I-F frequency distribution of Channel 4 signal leaving converter stage.

planation the switching circuit is not shown in the simplified diagram.

### Conversion of TV Signal

The purpose of the converter (mixer) and oscillator in a TV receiver is similar to that in an AM or FM receiver, that is, it reduces the incoming r-f signal to a lower (intermediate) frequency called the i-f. This is accomplished by combining or mixing the incoming r-f signal with another signal of a higher frequency locally produced in a separate r-f oscillator stage. (See RSD June 1950, Page 19, Fig. 3-1

The wide range of frequencies (6 mc) contained in any one TV channel must also appear in the plate circuit of the converter as part of the i-f signal. It would be appropriate at this point, therefore, to examine the frequency distribution of the signal before and after conversion.

Referring to Fig. 3-21, we observe the waveform of a typical r-f signal (Channel 4) as it enters the converter. The oscillator frequency must be equal to the sum of the video r-f carrier frequency (67.25 mc) and the video i-f carrier. Thus, assuming a video i-f carrier frequency of 25.75 mc, the oscillator frequency would have to be:

$$25.75 + 67.25 = 93 \text{ mc}$$

When this frequency beats against the sound r-f carrier (71.75 mc) the resulting sound i-f carrier frequency becomes:

$$93 - 71.75 = 21.25 \text{ mc}$$

The waveform of the signal in the plate circuit of the mixer appears as shown in Fig. 3-22. Notice that in comparison with the waveform at the grid or input (Fig. 3-21) the sound carrier is now lower in frequency than the video carrier.

As the receiver is tuned from channel to channel the oscillator frequency changes in step with each new r-f band, producing the same i-f frequency. Thus, referring to the table in Fig. 3-23, we observe that no matter what channel is tuned in, the video

and audio i-f carriers remain the same: 25-75 and 21.25 mc respectively.

### Converter Requirements

A good converter must provide high conversion gain, low input and output values of tube capacitance, and a high signal to noise ratio. High conversion gain and low input and output values of tube capacitance are obtained with specially designed tubes such as the 6J6, 6AG5, 6CB6, 7F8, etc. The use of triodes of the 6J6 type or pentodes of the 6CB6 types depends on the particular preference of the designer. While triodes have better noise characteristics, pentodes do not require neutralization, have somewhat better gain, and are more stable in operation.

Better signal to noise ratios, whether sought in triodes or pentodes, may be realized by operating these tubes at relatively low plate currents, and by keeping the signal injected by the oscillator at a reasonable value. As an example, General Instrument Corp. specifies 2 volts at the "Looker Points" if its Electuner (Fig. 3-18) measured with a Voltomyst through a 10,000 ohm resistor.

Coupling between the converter and the oscillator may be capacitive or inductive. Capacitive coupling is usually effected by means of a small capacitor of 1 or 2 uuf, although sometimes a gimmick, or even the capacity between wiring and components, is used to wholly or partially effect the desired energy transfer between oscillator and converter. If inductive coupling is used the oscillator and r-f coils may be wound on the same form, or near enough to each other for magnetic coupling to take place. A link winding may also be used between the mixer and oscillator circuits for this purpose as employed in the RCA 630 TS.

### Converter Output Circuit

The output circuit of the converter depends on whether the receiver is of the split-sound or intercarrier type. It must be recalled that in a split-sound receiver the sound and pix signals are separated at the output of the converter; this separation, in an intercarrier receiver, takes place at the output of the video amplifier. For example, in the simplified circuit of the Standard Tuner Model

CHANNEL No.	PIX R-F CARRIER FREQ. Mc.	SOUND R-F CARRIER FREQ. Mc.	OSC. FREQ. Mc.	PIX I-F CARRIER FREQ. Mc.	SOUND I-F CARRIER FREQ. Mc.
2	55.25	59.75	81	25.75	21.25
3	61.25	65.75	87	"	"
4	67.25	71.75	93	"	"
5	77.25	81.75	103	"	"
6	83.25	87.75	109	"	"
7	175.25	179.75	201	"	"
8	181.25	185.75	207	"	"
9	187.25	191.75	213	"	"
10	193.25	197.75	219	"	"
11	199.25	203.75	225	"	"
12	205.25	209.75	231	"	"
13	211.25	215.75	237	"	"

Fig. 3-23: Frequency relationships of Pix and sound carriers in r-f and i-f stages.

# TV-RADIO SERVICEMEN

**Here are 2 Big Ways Federal Helps  
You Make More Profits . . . and Keep Them!**



**1**

## Lead-in installations and replacements that save "FREE" Service Calls

—IN HIGH AND LOW NOISE LEVEL AREAS

Federal is America's leading manufacturer of solid dielectric coaxial cables!

Federal's K-1046 and K-111—300-ohm lead-in cables—are your answers to the problem of keeping service calls down and TV installation profits UP. K-1046, for low noise level conditions, is insulated with amazingly durable "silver" polyethylene . . . providing 30% more service life . . . plus numerous inherent features. K-111 is tops in noisy areas . . . minimizing noise, snow and ghosts due to transmission line pick-up. Pictures are clearer, brighter, steadier . . . *all the time!*

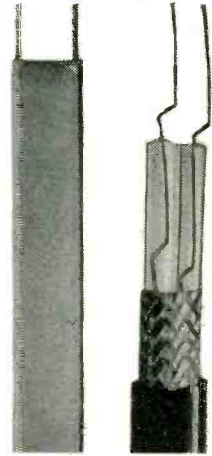

K-1046

K-111

**2**

## FEDERAL SELENIUM RECTIFIERS<sup>★</sup> for Replacement in TV and Radio sets

OVER 10,000,000 FEDERAL SELENIUM RECTIFIERS NOW IN SETS OF LEADING MAKERS

For servicemen everywhere this means a new and important replacement market . . . a steadily growing source of extra income!

Be ready for this new profit opportunity by being ready to replace selenium rectifiers with Federal . . . the *original* miniature selenium rectifier. Federal has the industry's *most complete line!*

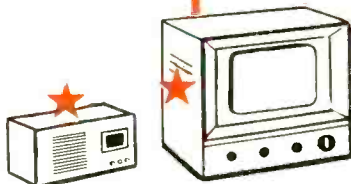

Every year, more and more millions of Federal selenium rectifiers are being installed in AC-DC, portable, table and console radios and TV receivers!

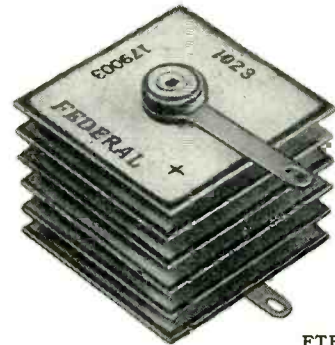

FTR-1023

Check your stock now—and call your distributor for Federal TV lead-in cables and Federal miniature selenium rectifiers. *It pays to install the best!*



*Federal Telephone and Radio Corporation*



SELENIUM and INTELIN DIVISION, 100 Kingsland Road, Clifton, New Jersey  
In Canada: Federal Electric Manufacturing Company, Ltd., Montreal, P. Q.  
Export Distributors: International Standard Electric Corp., 67 Broad St., N.Y.

TV-101 shown in Fig. 3-24,  $L_{12}$  and  $C_{15}$  constitute a combination sound trap and take-off coil - as used in split-sound receivers, and is tuned to 21.25 mc, the sound i-f carrier. This permits the sound signal to pass into the sound i-f section and at the same time keeps it out of the video i-f section. Coil  $L_{12}$  which is tuned to 21.8 mc is designed to accept the very high video modulating frequencies, which, it will be recalled from Figs. 3-21 and 3-22, extend toward the sound carrier. The manner in which the i-f section tunes in the full video range will be discussed in a later installment.

Some receivers do not take off the sound in the mixer plate circuit but do this in the plate circuit of the following i-f stage. Thus, the Westinghouse Model A 196, which is a split-sound receiver, employs an adjacent channel sound trap,  $L_{12}$ - $C_7$ , in the plate circuit of the converter as shown in the partial schematic of Fig. 3-25, and takes off its sound

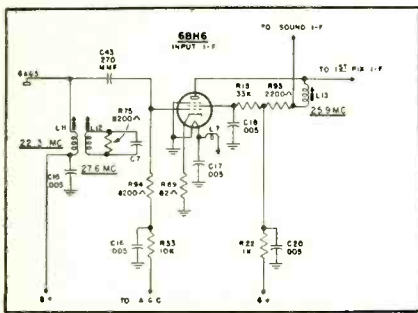

Fig. 3-25: Partial schematic of Westinghouse Model A 196, indicating sound and pix separation following first i-f tube.

signal in the plate circuit of the following video i-f stage.

Most commercial Front Ends can easily be used with split-sound or intercarrier receivers. Thus, referring to the Standard Tuner again, if we wish to use this Front End in conjunction with an intercarrier receiver we merely:

- 1) Disconnect the green lead from the trap on  $L_{12}$ .
- 2) If a 21.25 mc trap is not required in the first i-f transformer, remove  $C_{15}$  (68 uuf condenser). If a 19.75 mc trap (adjacent channel video carrier) is required, replace  $C_{15}$  with an 80 uuf condenser.
- 3) The 6AG5 then becomes the 1st intercarrier i-f amplifier.

#### A Popular TV Oscillator

Although a number of oscillator circuits are used in TV, the greater majority of modern receivers employs some form of modified Colpitts

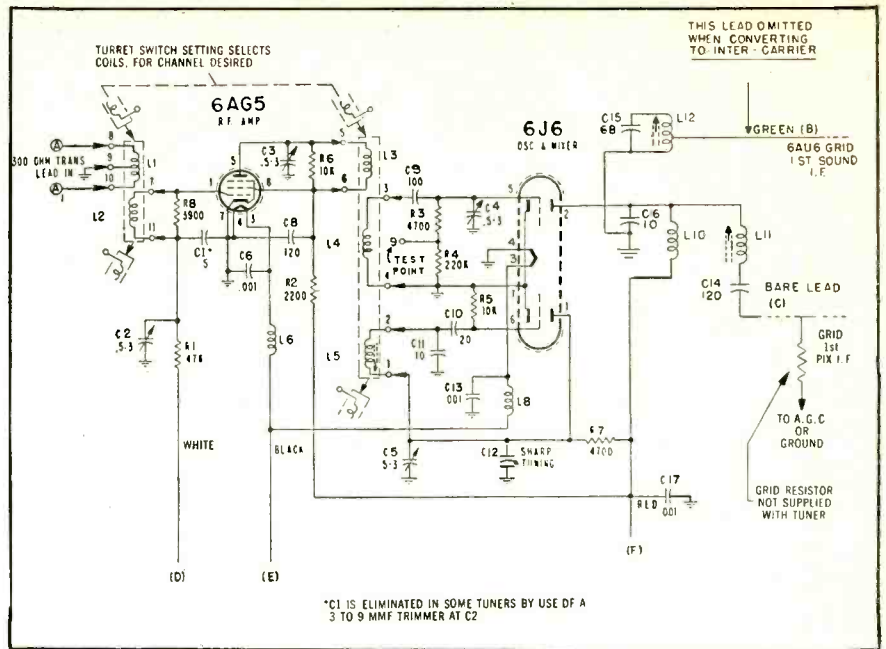

Fig. 3-24: Simplified schematic of Standard Tuner Model TV-101.

circuit utilizing a triode, so that our discussion will be principally confined to this type of oscillator. A basic Colpitts circuit is shown in Fig. 3-26, and operates briefly as follows: A properly phased feedback voltage is developed across  $C_2$  which excites the tuned circuit comprising  $L_T$ ,  $C_1$ , and  $C_2$ . Energy from the tuned circuit is amplified by the tube, and the feedback cycle is repeated. Condenser  $C_g$  and resistor  $R_g$  automatically provide the necessary 'C' bias for the tube for proper operation as an oscillator.

Referring to Fig. 3-27 which is a simplified version of the oscillator circuit employed in many G.E. receivers, we find that  $L_T$  is the oscillator tuning inductance,  $L_K$  is a cathode choke which isolates the cathode from ground and maintains its r-f potential above ground. Without this choke, the

feedback circuit represented by  $C_{pk}$  would be short-circuited and no oscillations would take place.

Capacitor  $C_p$  is a by-pass condenser between plate and ground.  $C_1$  and  $C_2$  shown in the basic Colpitts circuit (Fig. 3-26) are replaced by  $C_{pk}$  and  $C_p$ , the equivalent grid to cathode and plate to cathode interelectrode capacitances within the tube.

#### Temperature Compensating

Notice that an additional capacitor,  $C_t$ , is connected across the oscillator tuned circuit. This is a temperature compensating capacitor with a negative temperature coefficient characteristic. The latter is made necessary by the slight increase in capacity taking place in the various oscillator components because of their temperature rise. If left uncompensated for, this increase in capacitance, though small,

[Continued on page 36]

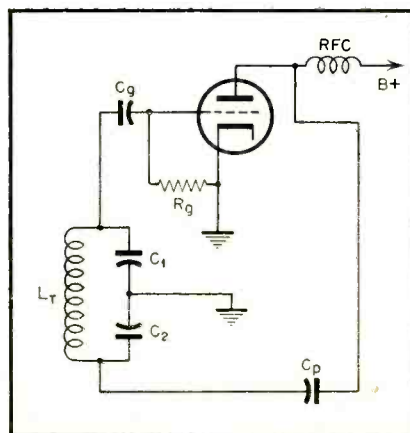

Fig. 3-26: Basic circuit of Colpitts oscillator.

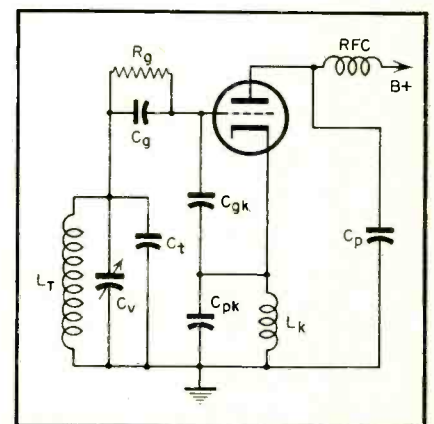

Fig. 3-27: Modified Colpitts oscillator circuit.

# SHOP NOTES

Write up any "tricks-of-the-trade" in radio servicing that you have discovered. We pay from \$1 to \$5 for such previously unpublished "SHOP NOTES" found acceptable. Send your data to "Shop Notes Editor".

## Western Auto D 2919—Instability and Distortion on F. M.

It is a good idea to first follow the service data given in Rider's manuals of replacing condenser C-29 with a larger unit and adjusting length of leads as described. This improves performance considerably especially in strong signal areas but where signal is weak there is still noticeable distortion caused by regeneration. We have found that by replacing condenser C-2 with about a 250  $\mu$ f unit instead of the 10  $\mu$ f used in the set has increased the gain and stability of the set remarkably. This condenser is used to couple the 300 ohm antenna to the Ant. coil. We arrived at the 250  $\mu$ f value by playing the set on a weak station and using an outside antenna, we shunted the 10  $\mu$ f condenser with different size mica units until we had the best reception. This value might not be the right value for all sets of the same model, but should be found experimentally using, if possible, the antenna and lead-in to be used with the set. This set had been returned to the factory for adjustment and when it was returned was no better than before. We drew the sweat provoking job of making it play right.

Submitted by:  
Wayne E. Lemons  
Buffalo, Mo.

## Westinghouse Model H-216—Picture Distortion Due to Magnetism

If a strong magnetic field is brought near the 16AP4 cathode ray tube, the metal cone of the tube can be magnetized sufficiently to cause objectionable distortion of the picture. The primary indication of this type of distortion is a kink in the edge of the raster.

Close contact of the tube's metal cone with any strong magnetic field must be avoided. The most likely cause of cone magnetization is contact of the metal cone with the frame of a PM speaker. Magnetized sections near the middle and small end of the cone produce the most disturbance. The magnetism is usually localized and can be detected with a pocket compass.

A magnetized cone can be demagnetized by the use of the AC magnetic field produced by a simple coil.

A suitable coil consists of approximately 1250 turns of No. 24 insulated copper wire wound on a form that is seven inches in diameter. Because such a coil will draw about 1 ampere at 117 volts AC, it will overheat if energized continuously; therefore, it should be used only intermittently. To demagnetize the cone, energize the coil and move its flat side over the magnetized area. Do not de-energize the coil until after it has been moved away from the cone.

Westinghouse  
Service Dept.

## Eye Lash Curler Picks Up Fine Radio Wire

When your long nose pliers will not hold a fine wire—such as found on R.F. and other coils, an eye lash curler will force the wire in the grooved jaws and hold.

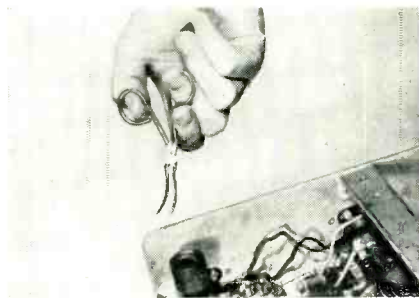

Such curlers are about 3 inches in length and sold at the dime stores.

Submitted by:  
H. Leeper  
Canton, Ohio

## Cleaning Volume Controls

In many instances a radio receiver has a special volume control which is difficult, if not impossible, to get, and the control is stiff, sounds harsh, makes static.

There's a way to stop this. Take the control completely apart if possible, removing the shaft by prying the "C" washer out of the shaft slot with a small screwdriver and a pair of needle-nose pliers.

Now, put a piece of clean, thin cloth over the end of your little finger, apply a small amount of lubriplate to the cloth, and run it back and forth along the carbon strip several times. This way you will remove all loose

particles of carbon which are causing the noise in the control.

A reasonable amount of care must be exercised in cleaning the carbon strip. Too heavy a pressure will remove too much of the carbon surface, affecting the control's efficient operation and attenuation.

Before re-assembling the control clean the shaft, contacts and the contact ring, putting a touch of lubriplate on the shaft and the contact ring. The control is now cleaned and lubricated and should give good service.

Never use carbon tet on a volume control. Not only does it put a coating on the strip, but it dissolves the carbon.

This cleaning method is not recommended for tone controls or other controls working on high voltage because of possibilities of arcing along the carbon strip.

Submitted by:  
J. Frederick Shane  
Spokane, Wash.

## Noisy RF Tuners—Stromberg Carlson

There have been a few cases of noise in the RF tuner of the TV-12 television receivers. The noise appears as a growl as the tuning shaft is rotated, making it difficult to tune in the desired station. This is especially true of the high frequency channels.

When this happens the tuner is in need of cleaning and re-lubrication which is done as follows:

1. Remove the cover from the ganged coils in a clean, dust-free location.
2. With a soft small brush and some carbon tetrachloride, clean all the turns of the coils, the end rings and the coil tracks.
3. Re-lubricate with a small amount of Lubriplate 105, covering all the surfaces just cleaned.
4. Replace the dust cover.

The Lubriplate 105 can be obtained from any hardware store or from Fiske Brothers Refining Company, Newark 5, New Jersey and Toledo, Ohio. Only Lubriplate 105 should be used.

Stromberg-Carlson  
Service Dept.

## Sentinel Models 412, 413, 414, 415 To Improve Horizontal Hold

Field reports indicate that with some types of tubes there was a tendency for the above models to require a different setting of the "Horizontal Hold Control" when the set was first turned on (cold) and after it was warmed up (hot).

To correct this, the following changes have been incorporated in chassis having "Series YG" ink stamped on the back of the chassis. They are not

[Continued on page 32]

# CIRCUIT COURT

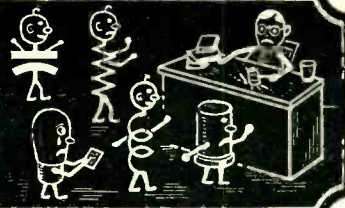

## Magnavox CT 214

One of the problems common to all makers of TV receivers is the protection of the audio output transformer during service operations. The speaker is generally mounted in the cabinet and does not come out with the chassis. It is common practice to use PM speakers with voice coil lead extending to the chassis where a detachable plug completed the circuit. The serviceman, understandably confused by the many shafts frequently turns up the audio volume in error and does not have the speaker connected to load the output transformer. Voltages of several times normal build up across the transformer under such circumstances.

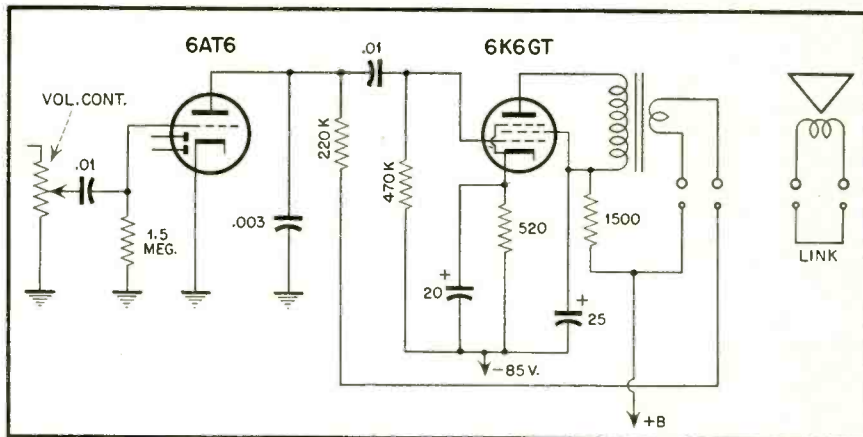

Magnavox CT 214 — Audio circuit

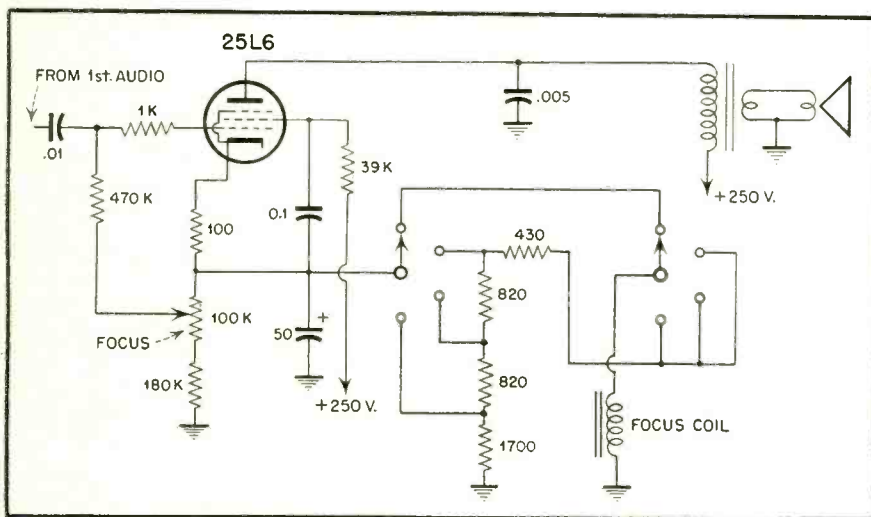

General Electric Model 805 — Obtaining focus coil current

ing focus coil current and adjustment. It is a general rule to connect the focus coil in some part of the power supply circuit, frequently as part of a voltage divider network. In this instrument the placement is in the audio output stage.

Reference to the partial schematic will show that the focus coil for the picture tube constitutes the bias resistor for the 25L6 output stage of the audio system. Some bias is developed across a 100 ohm fixed resistor, the remainder across the coil and whichever of several resistors may be switched into the circuit. A 50  $\mu$ f bypass capacitor is across all but the 100 ohm section.

Two focus adjustments are provided. A coarse adjustment is made by a four-point switch which permits

[Continued on page 32]

The Magnavox instrument under discussion, the schematic of which is shown, has solved this problem in a simple manner. It will be observed that the plate supply for the first audio stage, the triode section of a 6AT6, passes through a link on the speaker connecting plug. When this plug is withdrawn the plate voltage is removed from the tube and no amplification takes place in the audio channel. Thus, there will be no audio voltage appearing across the output transformer primary to cause it to break down.

## General Electric Model 805

This ten inch TV receiver makes use of an unusual method of provid-

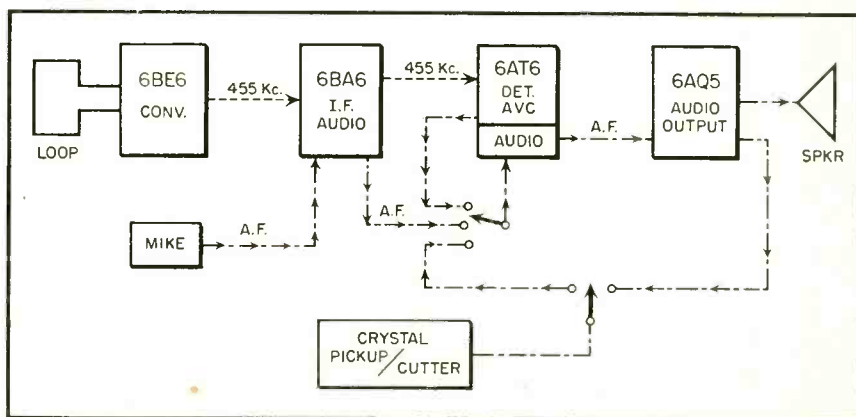

Recordio Model 8J10 — Block diagram



# NEW PRODUCTS

## HIGH-PASS FILTER

The Brach Manufacturing Corporation of 200 Central Avenue, Newark, New Jersey announces the development of a new 75 to 300 ohm matching transformer with high pass filter action.

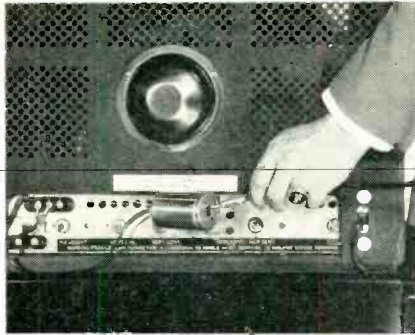

The new transformer Brach No. 72-300 is designed to be a perfect termination at channels 2-13 but offers a serious mismatch to diathermy and short wave interference transmissions in the i-f band. A coaxial fitting is provided with the transformer to make a low loss connection to RG59/U. The transformer has negligible loss over the complete TV band and a voltage gain of 2:1.

## BEAMAJUSTER

Perfection Electric Co., 829 South State St., Chicago 5, Ill. has recently introduced a control for centering television pictures that cuts out the time required for this operation to only 3 seconds.

The BeamaJuster, consisting of a pair of rotating aluminum plates, one of which holds

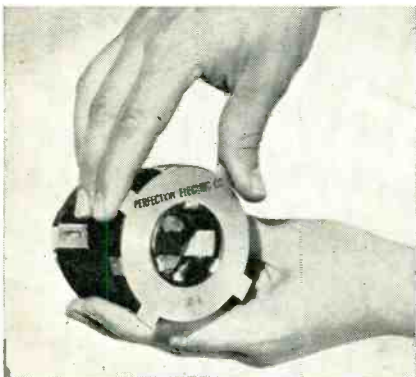

a permanent magnet, is installed by snapping it on the back cover of the TV tube yoke. It fits any standard yoke and is suitable for any size tube. The picture is centered by rotating the outer plate with the fingers as shown the outer plate up or down or to either side. Fine adjustments are made by moving. Once set, the picture will not drift. Full details may be obtained from Perfection Electric Company.

## WIDE BAND OSCILLOSCOPE

Jackson Electrical Inst. Co., Dayton, Ohio announces the Model CRO-2 Oscilloscope. Full five-inch 5UP1 CR tube. Wide band vertical amplifier response uniform from 20 cycles to 4.5 megacycles. Height Sensitivity .018 RMS volts-per-inch with response uniform to 100 KC. Vertical Input Impedance 1.5



Megohms, shunted by 20 mmf. Direct to plate balanced 6 Megohms shunted by 11 mmf. Horizontal Input Impedance 1.1 megohms.

Voltage calibration permits peak to peak voltage measurement of all waveforms. Switching arrangement provides Vertical pattern reversal. New electronic return trace blanking system.

Sweep Oscillator provides saw-tooth wave, 20 cycles to 50 kilocycles in 5 steps. Sine wave sweep of 60 cycles also available. Direct connection, through capacitors to CR tube deflection plates. Intensity Modulation, either external or internal 60 cycles. Removable calibration screen. Demodulation probe also available to use for signal tracing. All steel cabinet finished in gray Ham-R-Tex with leather carrying handle Size 13" high x 10 1/2" wide 15 1/8" deep. Net weight 26 lbs.

## BOOSTERS-BLONDE OR BRUNETTE

The Regency Television Signal Booster Model DB 400 can adapt to individual decorating tastes. Dick Mitchell, Sales Manager for I.D.E.A. Incorporated of Indianapolis, makers of the Regency Booster, poses with two models, one in an ivory plastic case and the other in a deep-tone mahogany.

Both Boosters measure 4 1/2 inches in height, 5 1/4 inches in width and 3 3/4 inches in depth.



Installation of the Regency Booster is uncomplicated. The TV set plugs into the Booster and the Booster plugs into the wall outlet. The easy-to-read dial face and single knob tuning make child's play of the channel tuning. Clear reception of both audio and video on all 12 channels is assured with the wide bandwidth.

## LOCKING SHAFT POTENTIOMETER

Ohmite 2-watt molded composition potentiometers with linear taper are now available from stock with a short screw driver shaft

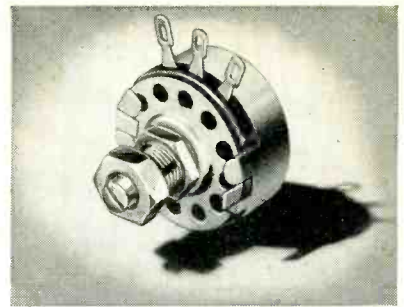

and locking nut. This new model is available in addition to the regular 2" long round shaft model, it was announced.

Known as the Type AB Locking Shaft potentiometer, the new unit is particularly useful in industrial and military applications where resistance adjustments are infrequent, and where tampering with the adjustment is discouraged.

For complete information, write for Bulletin 131A to Ohmite Manufacturing Company, 4974 West Flournoy Street, Chicago 44, Illinois.

## NEW ALL-CHANNEL BOOSTER

The TUNE-O-MATIC, a new high-gain, self-tuning television booster with all-channel broad band circuit and 4-stage amplification, is announced by Electro-Voice, Inc., Buchanan, Michigan.

This unique new Electro-Voice Booster completely simplifies installation and operation. Plugs in between the television receiver and electric outlet—and is turned ON or OFF automatically by the TV receiver switch.



Requires no separate tuning or adjustment after installation — you tune the television receiver controls only. Eliminates the problem of manual coordination of receiver and booster controls — performs the same alignment precisely, automatically. The Booster, therefore, can be concealed behind the TV set or on an interior cabinet shelf, or it can be placed in a convenient, unobtrusive position remote from the set.

For full information, write for TUNE-O-MATIC Booster, Bulletin No. 158 to: Electro-Voice, Inc., Buchanan, Michigan.

## SIGNAL GENERATOR KIT

In response to the consistent demand of great numbers of servicemen, engineers and "hams", Electronic Instrument Co., Inc., 276 Newport Street, Brooklyn 12, N.Y., has just released the widely accepted EICO Model 315 Deluxe RF Signal Generator in kit form. Called the Model 315-K, this modern professional laboratory-precision signal generator kit has all the accuracy and

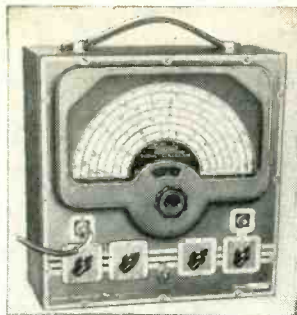

stability features for the most exacting alignment of TV, FM and AM receivers.

For further details on this and the rest of the complete EICO line, write directly to Electronic Instrument Co., Inc., 276 Newport St., Brooklyn 12, N. Y.

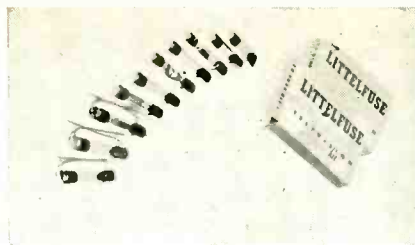

#### TV FUSE KIT

For quicker, more profitable and on-the-spot service, Littlefuse now packs 10 fuses in a kit measuring only 2¼ by 1½ inches. Extensive field testing has resulted in their decision to include the eight basic types needed most frequently. Two of the eight are duplicated.

## SHOP NOTES

[from page 29]

included in chassis stamped "Series YA, YB, YC, YD, YE and YF".

(a) The .005  $\mu$ f. condenser C-55 and the 470,000 Ohm resistor R-56 parallel filter in the output circuit of the 6AL5 Phase Detector have been removed from the circuit.

(b) The 100,000 Ohm resistors R-55 and R-59 in output circuit of the 6AL5 Phase Detector have been replaced by a series parallel resistor and condenser combination consisting of the following:

(1) The 100,000 Ohm resistors R-55 and 59 (see Fig. 2) have been changed to 470,000 Ohm  $\pm$  5% 1/2 Watt resistors, part No. 27E1009-25, list price \$.18.

(2) The .002  $\mu$ f. 200 V. condensers C-85 and C-86 (See Fig. 2) have been added in parallel with R-55 and R-59, part No. 23E205, list price \$.18.

(3) The 33,000 Ohm  $\pm$  10% 1/2 Watt resistors R-116 and R-117 (See Fig. 2), have been added in series with R-59 and pin #5 and in series with R-55 and pin #7 on the 6AL5 Phase Detector tube socket, part No. 27E333-2, list price \$.06.

Sentinel Radio Corporation  
Service Department

## Eliminates Messy Soldering Jobs!

**LYNN Lightning**  
**SOLDERLESS WIRE**  
**TERMINAL**  
**REPAIR KIT**

NO. 2090  
SERVICE KIT



Now you can get a positive, trouble-free connection on every terminal... as fast as you can close your hand. No messy soldering or waiting for an iron to heat! With a Lynn Lightning service kit you just strip primary wire from 10 to 22 gauge with handy, combination stripping and crimping tool... select the proper terminal... then *crimp* it on. Every job quick, clean, professional-looking! Kit comes complete with crimping tool, 10 different types of terminals plus insulation tubing in 11-bin, clear plastic box. Only... **\$7.95**

### Two New Television Screw Drivers

Reach hard-to-get-at spots with the new Vaco AT 510 non-metallic, fiber shank driver for critical tuning and aligning work... the 10" blade gives you all the length you need. Adjust the new type focalizers with specially designed Vaco Beryllium-copper drivers... non-magnetic, yet nearly as hard as steel for adequate torque without interference with the Ion trap field. Full information on other aligning tools, nut setters and special radio tool kits on request. Write for FREE catalog.



317 E. Ontario St., Chicago 11, Ill.  
In Canada: Vaco-Lynn Products Co., Ltd.  
1212 Notre Dame St., W., Montreal 3, Que.

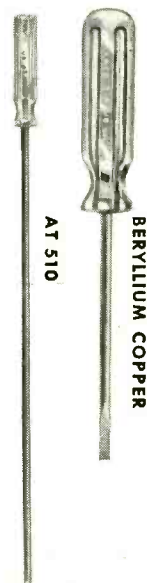

## CIRCUIT COURT

[from page 30]

adding resistors in series with, or across, the coil. Fine control is made by a 100K pot which is part of a voltage divider across the coil network. The arm of this pot determines the point on the bias to which the grid of the tube is returned. Thus, it is possible to control the plate current, and consequently the cathode voltage, of the tube over a narrow range.

With the two adjustments it is possible to control the current through the focus coil over a wide range but retain desirable ease of adjustment.

#### Recordio Model 8J10

This compact, portable, a-c operated instrument contains provision for ra-

dio reception, record reproduction and recording from either radio or mike sources. Only five tubes, including rectifier, are employed. In order to accomplish the several functions with so few tubes and components, interesting multiple uses are incorporated. A block diagram indicates the system.

In the radio position, the tube lineup is conventional, with 6BE6 converter, 6BA6 i.f., 6AT6 detector/-AVC/audio and 6AQ5 output. During record reproduction, the crystal pickup feeds a signal to the triode section of the 6AT6. Recording from the air is accomplished by feeding the audio output of the radio to the same crystal device, this time acting as a cutter.

Recording from the mike requires more audio gain than is possible in the usual two stages so an interesting reflex circuit is used. A partial schematic illustrates details of the combined i-f and a-f stage. A single 6BA6 pentode serves both functions. The .05  $\mu$ f capacitor which would ordinarily serve

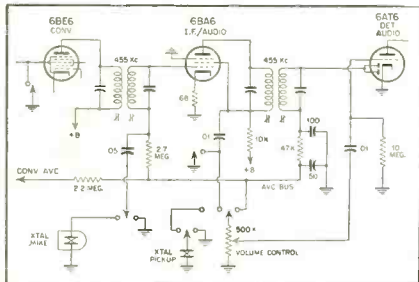

Partial Schematic of Recordio Model 8J10 receiver.

as by-pass for the a-v-c bus is switched from ground to the mike output. The weak output of the crystal mike is amplified in the tube, where it appears on the screen and plate, which are tied together for a-f signals by the i-f transformer primary. The r-f by-pass, .01  $\mu$ f., is cut from ground by a switch and the 10K resistor forms the plate load. The .01  $\mu$ f couples the signal to the triode grid of the 6AT6. Radio leak-through is prevented by grounding the converter grid.

## TAPE RECORDERS

[from page 17]

to include several types of reels which today are not playable on all machines. To this end, the NAB is attempting to standardize hubs and flanges and set up accepted reel sizes to allow for variation in footage loads.

### Tape Threading & Rewind

The *Magnecord* system exhibits a

flexibility of tape handling made possible when additional units are added to their PT6-R recording amplifier. In Fig. 5A, we see a basic studio or professional layout where in the method of tape threading is shown. In Fig. 5B, an auxiliary spooling mechanism is shown identically threaded to a basic unit. This arrangement records and plays programs of extended length and facilities are included which rewind a 1200 ft. reel in 40 seconds.

Threading through the double idlers, at the left of the sketch, assures stability of tape travel while the takeup pressure idlers are plainly visible at the right of the sketch. The arrangement in Fig. 5C, offers double load facility with continuous recording a reality. Ordinarily these units are designed for rack mounting with the exception of single channel remote equipment.

Tape threading of the more expensive *Ampex* machine is shown in

# World's Most Versatile TV Antenna

## Telrex UNIVERSAL CONICAL-V-BEAM\*

Copyright 1950

### 6 SUPER EFFICIENT ANTENNA TYPES IN ONE PACKAGE!

**The UNIVERSAL features this 3-slot element clamp for both driven and reflector elements — provides complete flexibility in element arrangement for any operating condition.**

Telrex engineers offer famous Conical-V-Beams in the Universal Series — the antenna with versatility, plus! Universal-V-Beams can be installed two ways — for standard all-channel service or modified for selective channel emphasis. The service man can "tailor" the antenna to the location right on the job — one antenna, in one complete package for highest possible performance under all local conditions. For fast installation and complete customer satisfaction, specify the new Universal by Telrex! See your distributor or write direct for information, now!

ALL ELEMENTS OF LASTING, SOLID DURAL ROD

MODEL U2X-TV (Single Bay).....	\$9.80 List
MODEL U4X-TV (Two-Bay, Stacked).....	21.10 List

\* REGISTERED TRADE MARK      Patents Pending

AVAILABLE IN ONE OR TWO BAY MODELS

ASSEMBLES AS STANDARD CONICAL-V-BEAM FOR BEST ALL CHANNEL RECEPTION

CAN BE USED AS MODIFIED CONICAL-V-BEAM HAVING 3 FINGERS

CENTER ELEMENTS MAY BE CUT TO ANY RECOMMENDED LENGTH FOR INDIVIDUAL CHANNEL EMPHASIS

Be sure it's a "CONICAL-V-BEAM" — Look for the TELREX\* Trademark

AMERICA'S STANDARD OF COMPARISON

**CONICAL-V-BEAMS\*** ASBURY PARK 5, N. J.

THE SKILL TO DESIGN

THE FACILITIES TO PRODUCE

THE ABILITY TO DELIVER

**You, Too, Can Profit  
from the Information  
Contained in This Book!**

**RADIO OPERATOR'S  
LICENSE Q & A MANUAL**

by MILTON KAUFMAN

This famous RIDER book has been acclaimed as best for all who are interested in obtaining FCC licenses as commercial or amateur radio operators. It is used in many radio communication courses. Thousands upon thousands of these books have been sold. In it you will find all the QUESTIONS and ANSWERS for the FCC examinations. However, the outstanding feature of this book is the THOROUGH FOLLOW-THROUGH . . . a carefully prepared discussion of the answer to the technical question, so necessary for an absolute understanding of the answer. This book also lists "extras" not ordinarily found in a volume of this type. These "extras" include Useful Appendices which take in Small Vessel Direction Finders and Automatic Alarm.

720 Pages, 205 Explanatory Diagrams **\$6.00**

**A Profitable Investment  
in Basic Knowledge!**

**INSIDE THE VACUUM  
TUBE**

by JOHN F. RIDER

Tubes are the "heart" of all electronic equipment. Without tubes, there would be no radio, no TV, no electronic communications. But, what about tubes? . . . How do they function? In INSIDE THE VACUUM TUBE, John F. Rider gives a concise, accurate, interesting account of the vacuum tube and its operation. In plain language . . . with the fascinating pictures and diagrams that really tell a story . . . you get a solid grounding in theory and a good working knowledge of basic tube types. No matter which branch of the electronic industry you may be preparing for, or working for, INSIDE THE VACUUM TUBE will prove its great value. It is the only book of its kind . . . the ONLY elementary text fully devoted to vacuum tubes. Order a copy today, and see for yourself.

420 Pages, Profusely Illustrated. **\$4.50**

**10-DAY FREE TRIAL**

Order these books today. Keep them for 10 days . . . if you are not completely satisfied, return them to us and your money will be refunded.

**RUSH THIS COUPON TODAY**

**JOHN F. RIDER PUBLISHER, INC.**

480 Canal Street New York 13, N. Y.

Please send me the following books on your 10-Day Money-Back Offer.

RADIO OPERATOR'S LICENSE Q AND A MANUAL.....\$.....

INSIDE THE VACUUM TUBE.....\$.....

NAME .....

ADDRESS .....

CITY .....ZONE.....STATE.....

Check for \$..... Money-Order for \$.....

Enclosed. 3

Fig. 6. Here also at the left we find two feed idlers; one small idler at the end of an arm mounted beneath a larger idler. Speed constancy is immediately introduced by a flywheel

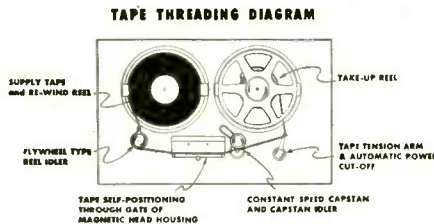

Fig. 6. Tape threading mechanism of Ampex recorder.

type of idler (large weighted idler) at this early moment of tape travel. The capstan and takeup pressure idlers at the right are smoothed mechanically by an electro-mechanical flywheel drive. In addition a safety device is included. Between the capstan and the takeup reel a power cutoff tension arm and idler protects the recording from damage. In the event of tape buckle or similar fault, whenever tape tension toward the takeup reel becomes unduly slack, the spring actuated tension arm will automatically cause a power cutoff until correction is made. Tape travel will not start unless the tape is properly threaded through this safety device.

During periods of rewind or fast forward roll to a cued section of the tape, the recording headhousing gate is opened to prevent unnecessary wear of tape surface. At such times the tape is merely slipped across pyrex guides at the ends of the housing. Less than 60 seconds are required for rewind of a full 10½ inch reel. With this equipment 15,000 playbacks are claimed for one tape.

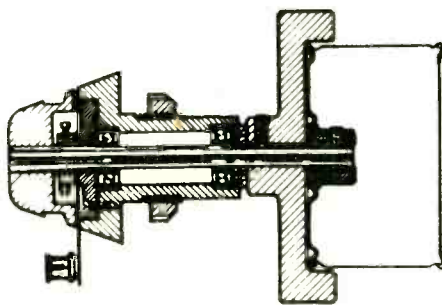

Fig. 7. Threading mechanism of Ampex recorder.

Normal threading derives benefit from the unique design of components in contact with the tape as shown in Fig. 7. The rounded and tapered skirtings of reel guards, idlers and capstans are so angled that the tape finds a natural threading around these



**FREE!**  
**MERIT TV  
"REPL" GUIDE**

MAY 1950 ISSUE  
63 MANUFACTURERS-575  
MODELS. MOST COMPLETE,  
UP-TO-DATE LISTING

Get this easy-to-use, time-saving guide to exact replacements for all popular television receivers. Simplifies servicing, cuts repair-bench time. Write us today for your free copy.

**USE MERIT TV!**  
ONE SOURCE FOR  
TV Tape-Marked Components:  
Powers, Blocking Oscillators,  
Vertical Outputs, Focus Coils,  
Deflection Yokes, Flybacks.

WATCH FOR  
Merit's future issues  
of the TV "Repl"  
Guide

**TAPE-MARKED TO HELP YOU!**  
Handy tape marking on every Merit Transformer shows permanent hookup data for quick reference.

**ORIGINATED BY MERIT**

**MERIT TRANSFORMER CORP.**  
SINCE 1924 FINE RADIO PARTS

**MERIT**

4441 NORTH CLARK ST., CHICAGO 40, ILL.

points of contact. It is claimed that tape snagging is next to impossible. One three-way manual switch controls the mode of tape transport. Its positions are, - *play-back*, *fast forward*, and *rewind*. One final switch selects one of two tape speeds and simultaneously cuts in proper mechanical and electrical equalization for the speed selected. No change in gearing or in other linkages is necessary as the two speed motor is switched for the speed chosen.

**Commercial Examples**

Some typical examples of what may be expected from properly equalized commercial machines are tabulated according to the manufacturer's literature.

Name	Tape Speed	Sig. to Noise	Response
Ampex	30" per Sec.	60db	200-30 15,000 CPS
"	15" " "	"	200-50 15,000 "
"	7.5" " "	"	200-90 7,500 "
Fairchild	30" " "	"	100-50 15,000 "
NCA (RT-11A)	15" " "	"	200-50 15,000 "
Magnecord (PT-6)	15" " "	"	200-40 15,000 "
"	7.5" " "	"	200-60 7,000 "
Twin Trax (dual tape)	15" " "	50db	200-30 15,000 "
"	7.5" " "	"	300-90 9,000 "

Chart of tape recorder characteristics of various types.

Naturally the above data is not derived from one set of readings under identical conditions. Some conform to the NAB sub-committee standards and some do not. They are merely representative of what may be expected from various tape machines ranging in price from below \$100 to above \$3,000.

**LOOKING FOR TROUBLE**

[from page 24]

the points where the signal is normal and where the signal is defective.

4.-c

Discussion

A higher negative voltage on the plate indicates either more current through *R-204* or a large increase of resistance, in both cases causing a larger voltage drop or difference of potential across it. However, an increase of resistance is not likely because while this would cause the sawtooth to be smaller because of the increased time constant, at the same time the wave would be linear. (The sloping portion of the wave would be straight rather than curved). The sawtooth condenser would be using less of its charging curve and would remain on the linear portion. Scope showed a definite non-linearity.

Now, while the increased current through *R-204* might be coming from

*Proving Ground*

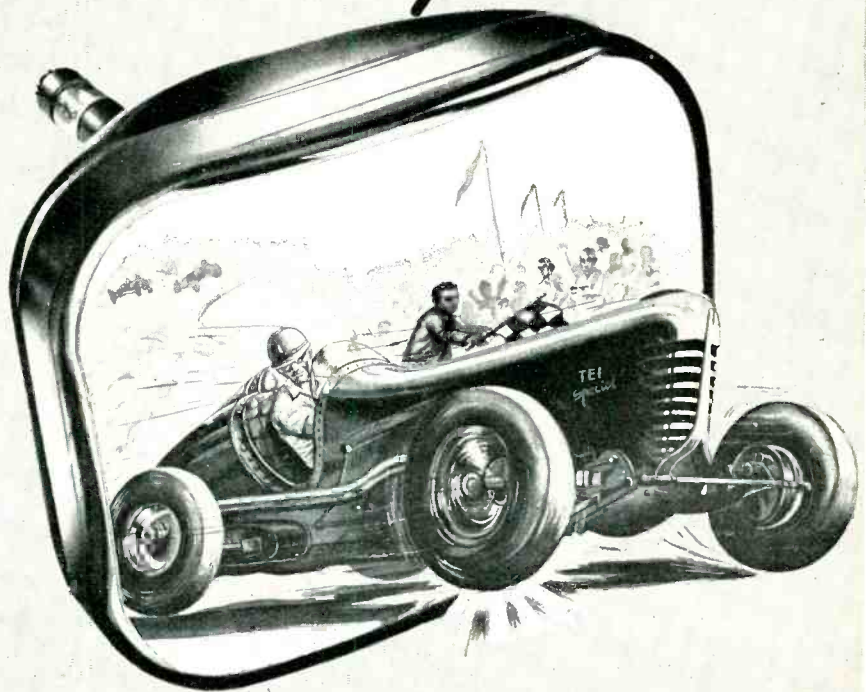

... each year at Indianapolis,

behind the roar of racing engines, a second and often ignored drama is unfolding — the battle of the drawing board and machine shop, birthplace of countless contributions to safer, more enjoyable motoring for all.

Thomas, too, maintains its own electronic research laboratory and proving ground as an integral part of its development program. Life tests, experiments and research projects of all types carried on here are uncovering better materials, better methods, more efficient production procedures for the constant improvement of the Thomas product.

*This is your assurance of the continued superiority of Thomas Television picture tubes — there are no finer;*



**THOMAS ELECTRONICS, Inc.**

118 Ninth Street

Passaic, New Jersey

**BACK NUMBERS of "RTSD"**

**RADIO-TELEVISION SERVICE DEALER**  
342 MADISON AVE., NEW YORK 17, N. Y.

Please send me the back numbers checked here  Dec. 1948  March 1949  Oct. 1949  
 Jan. 1949  June 1949  Nov. 1949  
 Feb. 1949  July 1949  Sept. 1949  Dec. 1949

I remit herewith \$..... for the .....copies ordered at .....c. each.

NAME .....

ADDRESS .....

CITY ..... ZONE ..... STATE .....

# EICO

gives you Laboratory Precision at  
**Lowest Cost!**

**NEW EICO**  
Instruments and **KITS**

...with a complete line

Over 50,000 servicemen have bought one or more EICO Kits and Instruments. That's the proof of EICO's leadership in value to the serviceman!

For latest precision engineering, finest components, smart professional appearance, lifetime performance and rock-bottom economy—see and compare the EICO line at your jobber's today before you buy any higher-priced equipment! You'll agree, with over 50,000 others, that only EICO Kits and Instruments—no other—give you the industry's greatest values for the industry's lowest costs!

Read the full story on the complete EICO line. Write today for your free latest Catalog D.



VACUUM TUBE VOLTMETER  
Model 221 K, KIT, only \$23.95  
Model 221, factory wired, \$49.95



TUBE TESTER  
Model 625 K, KIT, only \$29.95  
Model 625, factory wired, \$49.95



SIGNAL GENERATOR  
Model 320 K, KIT, only \$19.95  
Model 320, factory wired, \$29.95

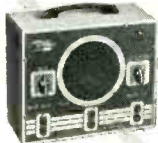

5" PUSH PULL OSCILLOSCOPE  
Model 425 K, KIT, only \$39.95  
Model 425, factory wired, \$69.95

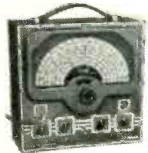

SIGNAL TRACER  
Model 145 K, KIT, only \$18.95  
Model 145, factory wired, \$28.95



VOLT-OHM MILLIAMMETER  
Model 511 K, KIT, only \$14.95  
Model 511, factory wired, \$17.95



SWEEP GENERATOR  
Model 360 K, KIT, only \$29.95  
Model 360, factory wired, \$39.95  
C-5 S MC Crystal \$3.95



DELUXE SIGNAL GENERATOR  
Model 315 K, KIT, only \$39.95  
Model 315, factory wired, \$59.95



HIGH VOLTAGE PROBE  
Model HVP-1, wired, only \$6.95



Battery Eliminator & Charger  
Model 1040-K, KIT only \$22.95  
Model 1040, factory wired \$29.95

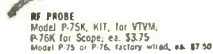

RF PROBE  
Model P-75K, KIT, for VTVM, P-76K for Scope, ex. \$3.75  
Model P-75 or P-76, factory wired, ea. \$7.50

**ELECTRONIC INSTRUMENT CO., Inc.**  
276 NEWPORT STREET, BROOKLYN 12, N. Y.

Prices 5% higher on West Coast.

the tube, this also is not probable. First, the bias has not changed substantially, according to the voltage check. Second, the signal input was the same, according to the scope. Third, the tube was O.K. (had been changed). These factors point to another path for the increased current through R-204.

5.—c

### Discussion

The two main possibilities for the increased current through R-204 are a shorted or leaky coupling condenser C-178 or sawtooth condenser C-179. Resistance reading showed C-179 shorted. (However, sometimes condensers break down only under voltage and check normal for resistance measurements with the power removed. In such cases, the suspected parts are removed and substitutions made.)

R-204 very much reduced in value could give 20 K ohms to B— but then there would be no such increase voltage drop across it as measured in preceding question.

C-178 shorted would give a much higher reading than 20 K going from plate thru C-178 through grid resistor to B—, together with the plate resistor in parallel.

## ELECTRONICS TECHNICIANS

For  
**RADAR, COMMUNICATIONS, TELEVISION RECEIVERS**

Needed By

**RCA SERVICE COMPANY, INC.**

A Radio Corporation of America Subsidiary  
For U. S. and Overseas

### REQUIREMENTS:

- Good Character
- Training in Installation or Maintenance of Radar, Communications or Television
- Give Full Details of Practical Experience

Qualified Candidates will be Interviewed Promptly.

### COMPENSATION:

Up to \$7,000.00 a year to start—For Overseas Assignment—With Periodic Review of Base Salary Thereafter Made up of—

- Base Salary
- Overseas Bonus
- Actual Living and other Expenses
- Accident, Hospitalization, and Life Insurance
- Vacation and Holiday Pay

Qualified technicians seeking connection with leading company having permanent program for installation and service of military equipment, AM, FM, TV transmitters and receivers, and electronic devices, such as electron microscopes, mobile and microwave communications, theatre TV, write full history to:

**RCA SERVICE COMPANY, INC.**  
Camden 2, New Jersey

## FRONT ENDS

[from page 28]

would result in a frequency drift large enough to cause loss of sound in a split-sound receiver. In inter-carrier receivers no loss of sound is experienced as a result of frequency drift of this nature. With the use of this capacitor and careful circuit planning, modern tuners have been able to keep this drift to well below 100 kc, even under extreme conditions of temperature change.

Other means of maintaining frequency stability in Front Ends are the use of special materials in their construction, such as mycalex, mica-filled low-loss bakelite, and polystyrene as coil forms, and silver alloys as contact materials.

Referring again to Fig. 3-27, a vernier condenser, C<sub>v</sub>, provides for fine tuning of the oscillator circuit. Most Front Ends employ a small variable capacitor of this type connected across the oscillator circuit, this condenser being brought out concentrically with the main switching mechanism, and which allows for fine or

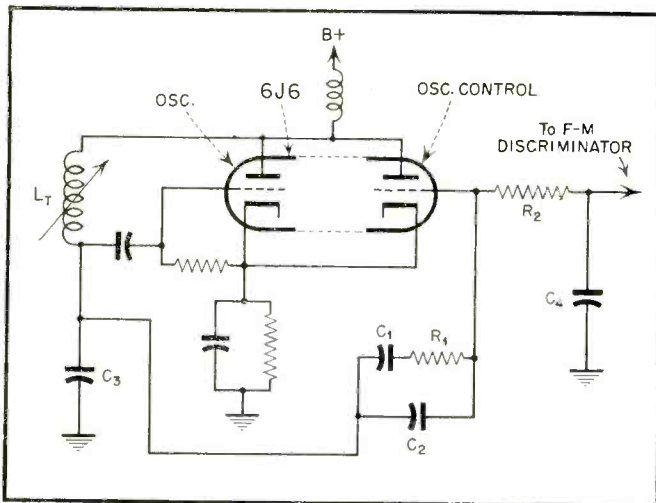

Fig. 3-28: Simplified A-F-C circuit used in r-f oscillator of Philco 49- receivers.

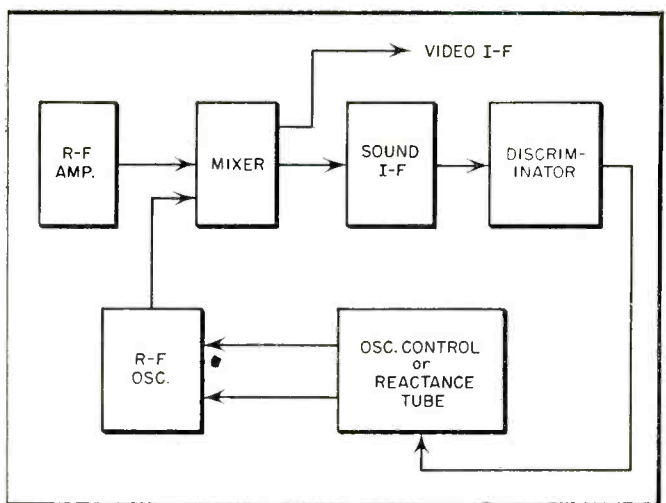

Fig. 3-29: Block diagram of A-F-C circuit employed in Philco 49- receivers.

vernier tuning of the receiver after the initial switching operation. Exceptions to this occur in continuously tuned Front Ends, where the very nature of the tuning mechanism precludes the need for this fine tuner.

#### Automatic Frequency Control

Many receivers employ AFC (Automatic Frequency Control) in the r-f oscillator to stabilize frequency drift tendencies. Fig. 3-28 illustrates in

partial form the circuit used by Philco in its 49-Model receivers. The block diagram in Fig. 3-29 will assist the reader in analyzing how this circuit operates. First, a shift in oscillator frequency, for any reason, reduces or increases the resultant sound i-f frequency. This produces an unbalance in the discriminator output voltage which is reflected back into the Oscillator Control tube as a change in grid bias. The Oscillator Control tube acts

effectively as a shunt capacitor across the complete r-f oscillator, the amount of this shunt capacitance being controlled by the "C" bias on the Oscillator Control tube. Thus, an initial change in r-f oscillator frequency reflects itself back into the Oscillator Control tube as a change in bias, which in turn produces a change in capacitance across the r-f oscillator—thereby bringing it back to its original frequency. R-F oscillator



**GUARDIAN CENTERING MAGNETS and FOCUS COILS** Insure Better Positioning of the Pattern in Popular TV Sets...

#### GUARDIAN CENTERING MAGNETS

The Guardian Centering Magnet compensates magnetically for any misalignment of the electronic beam of the focus coil assembly. Eliminates manual adjustment of the raster.



#### GUARDIAN FOCUS COILS

Over a million Focus Coils have rolled off Guardian's production lines into TV sets of leading manufacturers. With more than 75 types established as Guardian standard, speedy delivery to meet today's replacement needs is a matter of routine. Write.



**GUARDIAN ELECTRIC**  
1606-K W. WALNUT STREET CHICAGO 12, ILLINOIS  
A COMPLETE LINE OF RELAYS SERVING AMERICAN INDUSTRY

**HAYDU BROTHERS**  
PLAINFIELD, NEW JERSEY

Servicemen - Dealers

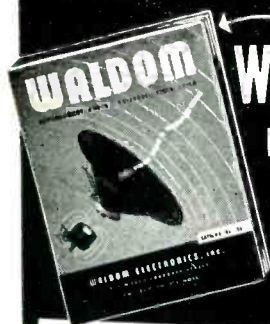

**WALDOM**  
Replacement  
Cone  
Manual  
Catalog No. 50

Write for your **FREE** copy Today!

Waldom's Free New 24-Page Replacement Cone Manual lists specific replacement data for over 75 different TV, FM, and AM Sets. This handy reference speeds-up your repair time — means more profit to You! Write today for your Free Copy. Just send your name and address to Dept. D.

For Finer Tone a Waldom Cone



Check these features:

- Hawley diaphragms — with the patented thin, tapering edge that assures maximum speaker efficiency and true low frequency response.
- The finest voice coils and spiders made with precision craftsmanship to exacting specifications.
- Unconditionally Guaranteed as to construction and performance.
- Carries the full R.M.A. Warranty.

**WALDOM ELECTRONICS, INC.**  
911 N. Larrabee St., Chicago 10, Ill.

**FREE! SEND FOR IT NOW!**

## ALLIED'S NEW 1951 CATALOG

**212 PAGES—  
EVERYTHING IN  
RADIO, TV AND  
ELECTRONICS**

Radio's Leading  
Buying Guide



Service Technicians and Engineers: ALLIED's complete 1951 Catalog brings you all the latest equipment and money-saving values—from the world's largest stocks of test instruments, amplifiers, P.A. systems and equipment, tubes, parts, tools, books and accessories—ready for instant expert shipment. Send today for your FREE 212-page ALLIED Catalog.

### ALLIED RADIO

ALLIED RADIO CORP., Dept. 26-J-O  
833 W. Jackson Blvd., Chicago 7, Ill.

Send **FREE** Catalog

Name.....

Address.....

City..... State.....

frequency changes brought on by temperature variations, mechanical vibrations, and electrical transients are thus automatically compensated for by this circuit.

#### Oscillator Radiation

Oscillator radiation is rapidly becoming a foremost consideration in the design of Front Ends because of the tremendous amount of complaints that have arisen as a result of its interfering effects in other receivers. This radiation may take place in one or more of three ways, 1) directly at the receiver if unshielded, 2) through the r-f stage and back into the antenna via the download, 3) through the power lines.

Much is being done in modern circuit design to reduce this effect to a minimum. This includes the use of more effectively shielded components and circuits, reduced operating potentials, and increased filtering.

#### Oscillator Troubles

Troubles in oscillator circuits, aside from circuit failures tube breakdown, switching defects, frequency drift and radiation, may arise as the result of certain conditions associated with very high frequency operation. These are:

1) Parasitics- these are very high frequency oscillations often caused by stray capacitances setting up feedback paths between components and wiring. Parasitic oscillations may also be generated by the inductive effects of lead present in the plate and grid circuits. Correct parts placement, lead dress, short wiring, and the use of plate and grid series resistors (10 to 20 ohms) are effective in reducing these parasitics.

2) Audio Flutter- this is a condition where a strong audio signal frequency modulates the oscillator through a high impedance path in the "B" supply. Good "B" line filtering is generally the cure for this condition.

3) Squegging -this is an interruption of the continuous operation of the oscillator caused by excessive oscillator amplitude pulses. Correct operating potentials as well as proper values of grid leak and condenser will generally eliminate this condition.

4) Microphonics- these are set up by sound vibrations from the speaker causing frequency modulation of the oscillator tube and other vibrating components. Special non-microphonic tubes such as the 6BC6, the use of weighted caps fitted over the oscillator tube, shock mounting of the oscillator tube, and correct speaker placement have proven effective means of reducing this effect.

[To Be Continued]

# Eliminate Noise!

(VISUAL AND AUDIBLE)



Use **OHMITE**  
**REPLACEMENTS**

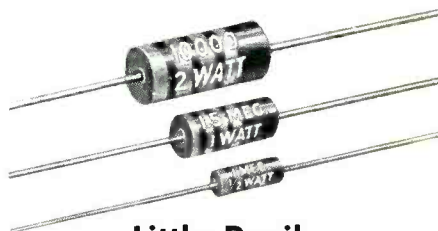

**Little Devil  
Composition Resistors**

Molded plastic construction completely seals and insulates these tiny, rugged units. They have an extremely low noise level. Resistance and wattage clearly marked on each unit. Available in 1/2, 1, and 2-watt sizes, in all RMA resistance values. Tolerances: ±5% and ±10%.

**Type AB  
Potentiometers**

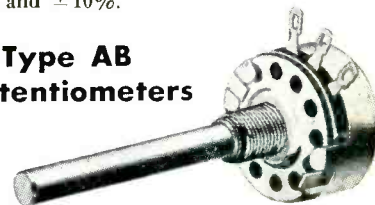

It's quiet! This Type AB Potentiometer has a resistance unit that's solid molded. As a result, the noise level often becomes less with use. Has a 2-watt rating with a good margin of safety. Is unaffected by extremes of heat, cold, or moisture. Available with either 2" round shaft, or short, locking screwdriver shaft.

**New Ohm's Law  
Calculator**

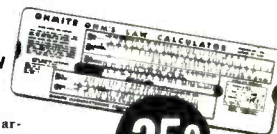

Solves Ohm's Law, parallel resistance problems. Also has slide rule scales.

**OHMITE MANUFACTURING CO.**

4846 Flournoy St.

Chicago 44, Illinois

*Be Right with*

## OHMITE

Reg. U. S. Pat. Off.

**RHEOSTATS • RESISTORS • TAP SWITCHES**



**\$1.00 to \$5.00 PAID  
for "SHOP NOTES"**

Write up any "kinks" or "tricks-of-the-trade" in radio servicing that you have discovered. We will pay from \$1 to \$5 for such previously unpublished "SHOP NOTES" found acceptable. Send your data to "Shop Notes Editor," RADIO SERVICE DEALER, 342 Madison Ave., New York 17, N. Y. Unused manuscripts cannot be returned unless accompanied by stamped and addressed return envelope.

**HOR. A.F.C.**

[from page 19]

the operation on a station. With the hold control in a midpoint position all stations should lock-in instantly. With the control set at one extreme, jitter may occur and when stations are switched the picture may be completely out of synchronism. At the other extreme setting the hold control may cause the picture to lose synchronism with no effective AFC action. If it appears that the correct setting for the horizontal hold control is not approximately at the midpoint, re-adjust the frequency controlling slug of *T1*, which is the slug tuning coil *A-F*. In some receivers a frequency control trimmer is used which is effectively across this coil. The adjustment of this trimmer is the same as the frequency slug.

If an oscilloscope is not available the following method is suggested:

1. Open all trimmer condensers and screw the slug which tunes coil *C-D* outward.

2. Set the horizontal hold control to approximate center and adjust the slug controlling the frequency of *T1*, coil *A-F*, until the picture appears to lock-in.

3. Adjust *C14*, until the overdrive bars disappear or until a linear and bright image is obtained.

4. Turn the horizontal hold control slowly and observe a jumping of the picture as it passes through the point of optimum lock-in action. Tighten trimmer *C13* until this jumping disappears and the picture slides smoothly from left to right as the hold control is turned.

5. Screw the slug tuning coil *C-D* on *T1* inwards until it throws the picture out of synchronism. Re-adjust the other slug on *T1* or the frequency control trimmer if used, to bring the picture back into synchronism.

6. Check the operation of the syn-

chroguide circuit as outlined in paragraph 5 for the oscilloscope method.

The operation of the synchroguide depends to a large extent on strong synchronizing pulses of constant amplitude. To obtain such pulses most

receivers using the synchroguide have two or more stages of synch pulse clippers, limiters and amplifiers, including in most cases a diode for maintaining constant amplitude. In the circuit shown in Fig. 9, the synch

**renew  
with N.U.  
premium quality tubes**

- RADIO and TELEVISION RECEIVING TUBES
- VIDEOTRON TELEVISION PICTURE TUBES
- PANEL LAMPS
- TRANSMITTING and SPECIAL PURPOSE TUBES

**NATIONAL UNION RADIO CORP.**

Main Office: ORANGE, N. J. — Plants: NEWARK, N. J.; HATBORO, PA.

**Insure BETTER Television Service to Your Customers! . . . Exclusively Designed**

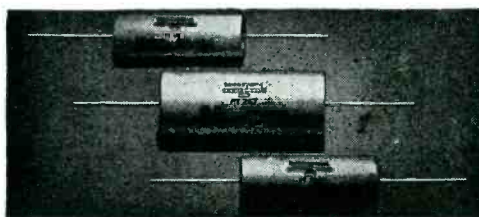

**HIGH VOLTAGE AND ELECTROLYTIC TUBULAR TELEVISION CAPACITORS**

**Especially Engineered for Television Circuits by INDUSTRIAL CONDENSER CORP.**

The economical quality line for replacement. Industrial Condenser Corp., manufacturers of Capacitors exclusively brings you highest quality for the particular requirements of Television at exceptionally attractive prices! Special Capacitors are Pyroteen impregnated for low power factor, high insulation resistance, high operating temperatures. Oil, Pyroteen, Wax and Electrolytic Capacitors. Finest materials throughout.

*Ask Your Jobber for our Attractive Prices Today!*

Or write for Bulletin 1095. Industrial makes quality Capacitors for Television, Radio, every electronic and industrial application—all types.

Send for Complete Catalog

**INDUSTRIAL CONDENSER CORP.**

3243 N. CALIFORNIA AVENUE CHICAGO 18, ILLINOIS  
Sales offices in all principal cities.



Modern plant built by Industrial Condenser Corp., for manufacture of Capacitors only.

# A BRAND NEW INVENTION!



**OAK RIDGE**  
"Miniature"  
Synchro-Sweep  
GENERATOR  
Model 104

dealers net \$39.95

**FOR TV SERVICING** — a simple rugged unit that tests all sets for linearity, sync, sweep, and hi-voltage. No test pattern or program needed, generates its own signals. A completely new invention in test equipment designed and manufactured exclusively by OAK RIDGE. \* T.M. reg. app. for Pat. app. for

### ENDORSED BY TV EXPERTS

Consensus of opinion among leading Servicing organizations, Parts Jobbers, Technical Schools: "Oak Ridge Miniatures introduce a new servicing technique that makes possible the speedy and profitable servicing of television sets, RIGHT IN THE HOME!"

### FOUR OAK RIDGE "MINIATURES"

Specially designed for fast accurate "On-The-Job" TV testing.

- Including Mod. 104 Synchro-Sweep Generator.
- Model 101 Substitution tester...dealers net \$16.25
- Model 102 High voltage meter...dealers net \$14.95
- Model 103 Signal Generator...dealers net \$29.95

Four instruments available in a sturdy carrying case, with table mounting bracket.

Mod. X-100 4 units permanently mounted in carrying case net \$99.50

Mod. A-100 4 units individually removable in carrying case net \$106.50



Write for complete information to —

**OAK RIDGE PRODUCTS**  
Mfg. Div. of VIDEO TELEVISION, Inc.  
37-01-D VERNON BOULEVARD  
LONG ISLAND CITY 1, N. Y.

## YOU NEED THIS NEW "W-J" CATALOG!

Thousands of Television  
Radio and Electronic Items  
Right At Your Finger-Tips!



- Fast, Easy Selection
- Saves Time
- Saves Trouble
- Simplifies Parts Procurement

### COMPLETE BUYING GUIDE FOR SERVICEMEN, DEALERS.

New TV accessories, TV installation equipment, TV test instruments, tubes, radio accessories and other electronic supplies. Thousands of repair parts cross-indexed for quick, easy selection. Standard brands. Exact duplicate replacements. Fast, same-day shipment. Profit Guide sent only to those entitled to wholesale prices.

SEND COUPON FOR YOUR FREE COPY NOW!

WALKER-JIMIESON, INC. 416  
311 S. Western Ave., Chicago 12, Illinois

Please Send Your 1950 Free Profit Guide.

Name .....

Company .....

Address .....

City ..... Zone ..... State .....

pulses are obtained from the cathode of the half of the 6SN7 at the left. The appearance of these pulses on the oscilloscope is shown in Fig. 12 and

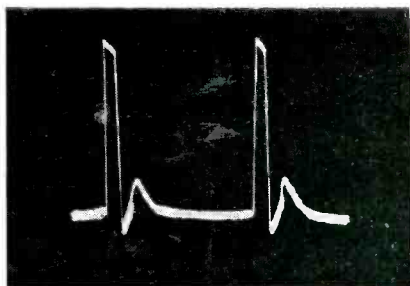

Fig. 12. Horizontal sync pulses on cathode of sync separator; 10 volt peak to peak.

one good check on the operation of the synch circuits is to keep the 'scope connected to the cathode while stations are switched and contrast is varied. The pattern on the 'scope should remain substantially the same for all stations and all contrast control settings.

In addition to the 6SN7 synchroguide tube and *T1* some of the critical parts are *R12*, *R7*, usually a 5% 1 watt resistor and *R6* and *R8*. Most of the resistors used in the synchroguide circuit should be at least 10% types and all condensers 600 volt paper or molded types with the smaller values 1000 volt micas. One particularly sensitive condenser is *C8* which is often subject to capacity variations due to temperature. The most desirable condenser for this application is a 600 volt molded or an oil-filled type.

The most frequent defect in the synchroguide circuit will be found due to a defective 6SN7. A shorted or open *T1* or a defective trimmer condenser are the next likely offenders. If none of these items seem to be at fault an exact resistance check will usually reveal the defective component. In a few cases it may be necessary to make a point to point check with the oscilloscope.

The synchroguide circuit described here is the one most widely used but several variations of it are found in older television models. One variation does not use the stabilizing coil *C-D* on *T1* in Fig. 9 but features a frequency control trimmer and slightly different resistor values. Another variation omits the feedback network *C12*. *R16*, without any apparent difference in performance. Still other variations of the synchroguide system use different resistor and condenser values. All these systems, however, operate on the same principle and are serviced and adjusted in the same manner.

## AD INDEX

Alliance Manufacturing Co.	14
Allied Radio Corp.	38
American Phenolic Corp.	4
Anchor Radio Corp.	Cover 3
Commercial Trades Institute	40
Cornell-Dubilier Elec. Corp.	
Radiart Div.	2, 3
DuMont Laboratories Inc., The A. B.	11
Electronic Instrument Co., Inc.	36
Federal Tele. & Radio Corp.	27
Guardian Electric	37
Haydu Brothers	37
Heath Company	10
Hytron Radio & Electronics Corp.	23
Industrial Condenser Corp.	39
International Resistance Co.	6, 7
Mallory & Co., Inc., P. R.	Cover 2
Merit Transformer Corp.	34
National Union Radio Corp.	39
Oak Ridge Products	40
Ohmite Manufacturing Co.	38
Radiart Corp., The	2, 3
RCA (Electron Tubes)	Cover 4
RCA Service Co., Inc.	36
Rider Publisher Inc., John F.	34
Simpson Electric Co.	13
Sprague Products Co.	8
Smith Co., R. B.	40
Sylvania Elec. Prods. Inc.	9
Telrex, Inc.	33
Thomas Electronics, Inc.	35
Triplet Elec'l Instru. Co.	1
Vaco Products Co.	32
Waldom Electronics, Inc.	38
Walker-Jimieson, Inc.	40
Workshop Associates, Inc., The	12

## HAVE YOU A JOB FOR A TRAINED TECHNICIAN?

We have a number of alert young men who have completed intensive training in Radio and Television Repairing. They learned their trades thoroughly by working on actual equipment under personal, expert supervision. If you need a trained man, we invite you to write for an outline of our course, and for a prospectus of the graduate. No fees, of course. Address:

Placement Manager, Dept. P105-9  
**COMMERCIAL TRADES INSTITUTE**  
1400 Greenleaf Chicago 26

## 8 drawers HEAVY DUTY



\$10<sup>95</sup> job DRAWERS

Get a starter set of these beauties, and then add to them as your needs increase. Size 23 1/2" X 9 1/2" X 12".

## 18 drawers



\$22<sup>50</sup> job

Each drawer is equipped with two cross dividers. Size 34" X 13 1/4" X 12".

A small parts "must".

**R. B. SMITH COMPANY**  
P. O. BOX 171, COLORADO SPRINGS, COLORADO



Sell an

# ANCHOR BOOSTER

for fast profits

and complete customer satisfaction...



PROFIT ON NEW TWO-STAGE BOOSTER \$1800

PROFIT ON NEW SINGLE-STAGE BOOSTER \$1320

## ON EVERY FRINGE INSTALLATION

Why High Towers,



Hazardous Installations



for your men as well as your customers? WHY spend so

many hours



on one installation when you CAN

make 3 or 4 calls



and more profits



per

installation in one afternoon?

You, the Service Dealers, are recognized as experts in your community. Your advice is often asked and usually followed. Your men are the *one group* in the electronics field who actually get into the home... right at the point of sale. It stands to reason then that an installation of one of the many fine simple-to-install antennas, plus an ANCHOR Single or Two-Stage Booster would make a faster and more profitable installation for YOU as well as a completely satisfied customer. REMEMBER, returned calls due to dis-satisfaction are costly.

**The New ANCHOR BOOSTERS Are Available. Order from your jobber Now.**

Only ANCHOR can provide your customers with ALL of the most Ultra-Modern advantages for consistent top-notch, long-range TV reception. Here's why!

- ANCHOR has the highest gain of any TWO-STAGE BOOSTER.
- ANCHOR has the highest Signal to Noise Ratio.
- ANCHOR is the only non-regenerative unit available. The unit that is *not* returned.
- ANCHOR'S Single Knob Construction is so convenient for Booster is turned on and can be switched and tuned all on the same knob.
- ANCHOR'S New and Revolutionary method of construction of the RF Stage (Pat. Pend.) is the only real engineering advance in Boosters in recent years.
- ANCHOR'S TWO-STAGE BOOSTER is modernly styled with streamlined plastic escutcheon, soft mahogany leatherette finish.
- IMPORTANT ANCHOR'S TWO-STAGE BOOSTER is often the answer to installation difficulties well within the normal TV areas where their New Single Stage Model fails to give complete satisfaction.

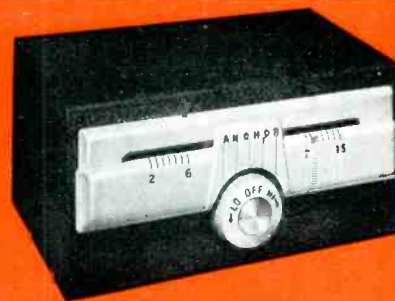

ANCHOR'S NEW SINGLE-STAGE BOOSTER, ARC-101-75, especially recommended for low signal areas in or near cities where there may be any number of interference problems. Assures consistently good reception up to 75 miles.

ANCHOR'S NEW TWO-STAGE BOOSTER, ARC-101-100, increases original TV signal strength more than 5 times and assures consistently good reception over 100 miles.

# ANCHOR RADIO CORP.

ANCHOR ENGINEERING ALWAYS A YEAR AHEAD  
2215 SOUTH ST. LOUIS AVENUE CHICAGO 23, ILLINOIS



THE QUALITY OF RCA TUBES IS UNQUESTIONED

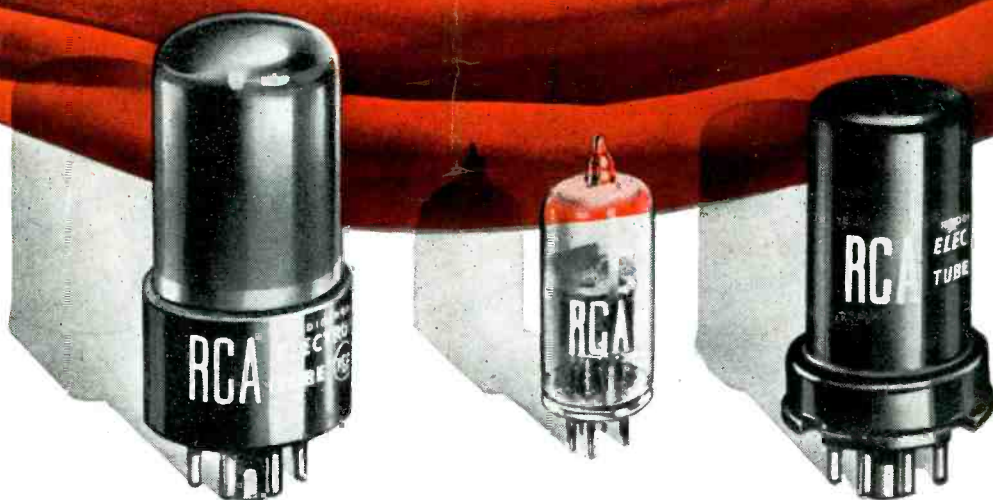

## *Seven of the Top Ten* are **RCA**

**... pioneered for AM, FM, and TV**

AMONG THE RECEIVING TUBES used *industry-wide* during 1949, seven of the top ten volume types were RCA pioneered. Of the remaining three, two were of basic RCA design. Almost one-half of these industry-wide leaders were also among the top ten volume types used in the radio and television *service business* during 1949.

Only tubes of unquestionable quality—both as to design and manufacture—could merit such acceptance by the industry. Here are leaders designed by the Leader—familiar types, such as the

RCA 6SN7-GT and 6AG5 . . . and more recently the 1B3-GT, 6BA6, 6J6, 6AU6, and 6AL5. Their widespread application has permitted production to be concentrated on fewer types . . . which, in turn, has accounted for lower costs, improved quality, and greater uniformity.

This is but one instance of how RCA's engineering leadership adds *value beyond price* to the RCA tubes you sell. It is a value shared alike by you and your customers.

*Always keep in touch with your RCA Tube Distributor*



**RADIO CORPORATION of AMERICA**  
ELECTRON TUBES

HARRISON, N. J.