

December

1940

Radio

SERVICE DEALER

This Month

STEREOPHONIC SOUND

RSD ANNUAL INDEX

SERVICING CHANGERS

CERTIFICATION PLAN

Price

25¢

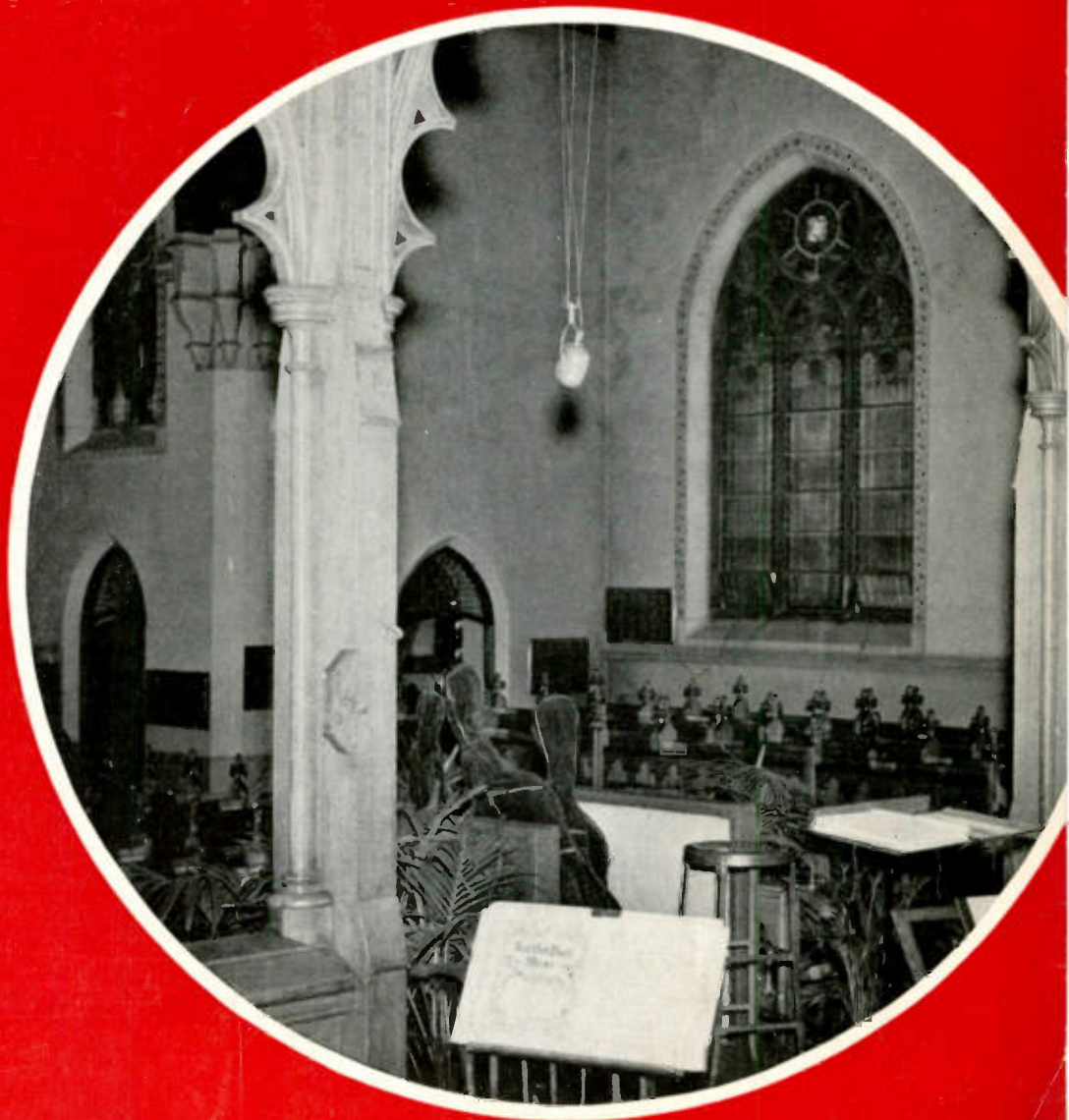



Centralab VOLUME CONTROLS

"Standard Equipment" in millions of receivers, Centralab Volume Controls are more than ever on the "MUST" list wherever a dependable control is indicated. For original equipment or replacement. SMOOTH — performs easier and better.

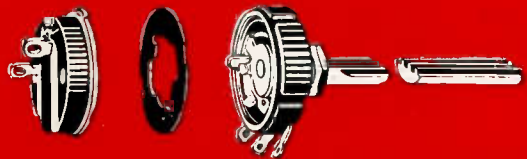

CENTRALAB STANDARD RADIOHM

WALL TYPE RESISTOR hugs inner circumference of black molded bakelite case. Exclusive non-rubbing contact band assures quiet, smooth rotation and long life. Case dimensions: 1 3/8" diameter x 9/16" deep. Soft aluminum shaft extends 3 3/4" from case; milled full length for push-on or set screw knob.



STANDARD MIDGET RADIOHM

Companion to the Standard Radiohm, the Midget is necessary to replace original controls in many current models using small controls for space savers. Molded bakelite case, 1 1/8" diameter. 1/4" soft aluminum shaft 3 3/4" long, milled for standard push-on or set screw knob.

... and the Famous ADASHAFT MIDGET RADIOHM

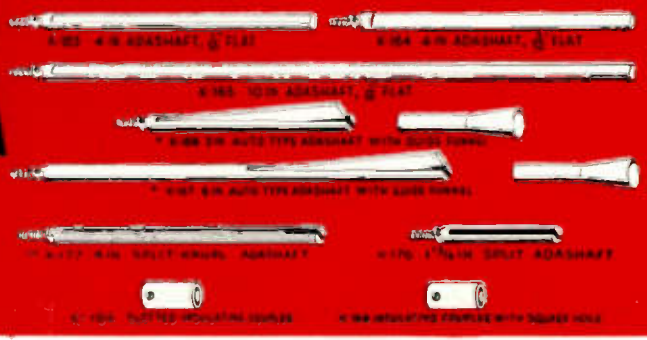
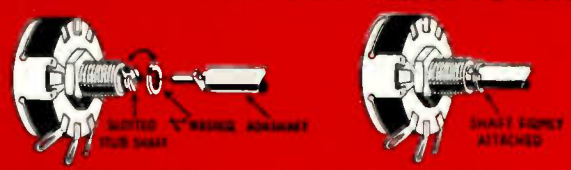

I'm in a jaunty mood as I end the year . . . in the second decade of my life. I still enjoy my reputation as an "old smoothie" and count as my friends the countless servicemen, technicians and set builders the world over who continue to boastfully admit that there is nothing finer than a Centralab part. Thanks.

- Ol' Man Centralab

CENTRALAB • Div. of Globe-Union Inc.
MILWAUKEE, WISCONSIN

Radio

SERVICE-DEALER

SOUNDMAN AND JOBBER

Reg. U. S. Pat. Off.

Ad Index

Aerovox Corporation	22
Dandee Electrolytic Condensers	
Brach Mfg. Corp., L. S.	24
Auto & Home Antennae	
Burgess Battery Co.	21
"A" and "B" Batteries	
Centralab	2nd Cover
Volume Controls	
DeWald Radio Mfg. Corp.	21
"Companionette" Receiver	
Meissner Mfg. Co.	20
The 1941 Analyst	
Park Metalware Co., Inc.	23
Hollow Shaft Nut Drivers	
Racon Electric Co.	3rd Cover
Horn Speakers	
Radolek Company, The	24
1941 Radio Profit Guide	
Raytheon Production Corp.	11
Tubes in Telegraphy	
RCA Manufacturing Co., Inc.	4th Cover
Junior VoltOhmyst	
Recoton Corp.	23
Recording Needles	
Rider, John F. Publisher	22
Rider Books	
Supreme Instruments Corp.	19
Model 589 Tube & Battery Tester	
Triplett Elec. Inst. Co., The	23
Model 1200-F Volt-Ohm-Milliammeter	

Contents

Transients (Editorial)	2
A Stereophonic Sound Transmission System	4
By Ifor Jones and Henry C. Knutson	
Set of the Month—	
RCA Radiola Model 510	6
Selling Your Services	7
Stewart-Warner Model J Record Changer	8
Serviceman's Diary	10
By J. P. Hollister	
Radio Service-Dealer Annual Index	12
Shop Notes:	
Hudson Motor SA-40, DB-40 Ant. Choke	14
RCA 354 Tube	14
RCA 10X Hum	14
RCA 12A6 Tube	14
RCA 14BT, 14BT-2, 14BK Distortion	14
RCA 16K, 16T2, 16T3, 16T4, 17K, 19K, V-205, V-405: Increasing Sensitivity	14
RCA 45X-11, -12, -13 Osc. Coil Connections	14
RCA 45X-11, -12, -13 (2nd Prod.) Circuit Revisions	15
RCA 156 Tube Tester—1T5GT Data	15
RCA BP-10 Lid Replacement	15
RCA K-80 Hum Modulation and Howl	15
RCA QU2C, QU2M, QU3C, QU3M Howl	15
Stewart-Warner 05-6N Hum	15
Stewart-Warner 11-5V Circuit Change	15
Stewart-Warner 11-7A Microphonics	15
Stewart-Warner 11-10A, 11-10A-Z Audio Howl	15
Stewart-Warner 12-4D Oscillation	15
Stewart-Warner '40 Changers—Spindle Squeak	9
Stromberg-Carlson 505, 515 Weak or no F-M Signal	15
Circuit Court:	
Cathode-Energized Filament Strings	16
F-M Improvements	16
Book Reviews:	
Practical Radio Communication	17
Radio Operating Questions & Answers	17
The Meter at Work	17
New Products	18
Bats Over Batteries	21
Appointments	22
New Literature	23

Cover Photo



★Packer Memorial Chapel, Lehigh University, Bethlehem, Pa., from which the music of the famed Bach Choir is transmitted by wire line to a nearby auditorium. Two channels are used, providing two-dimensional sound. See article on page 4.

Published Monthly by

COWAN PUBLISHING CORP.
11 WEST 42nd ST., NEW YORK, N. Y.
Telephone: CHickering 4-3278-9

M. L. MUHLEMAN, EDITOR
S. R. COWAN, ADV. MANAGER

Subscription rate, \$2.00 a year in U. S. and Canada; single copies, 25 cents. In foreign countries, \$4.00 a year. Editorial and advertising offices, 11 West 42nd St., New York, N. Y.

VOL. 1 No. 9 ★ DECEMBER, 1940

Transients

YEAREND . . . A new year will have rolled in from the beyond before you set eyes on another issue of RSD. This is a good time, then, to let our mind sweep over the panorama of radio and dish out whatever catches its fancy . . .

Life has gotten pretty damn complex. The threads of business relations, for instance, are tightly woven. No one group can make a move without materially affecting some other group, and that hasn't served to improve the national temper. Juke Boxes take money out of the pockets of musicians, so maybe the musicians would like to have the Juke Boxes pulled. But, if you pull the Juke Boxes, thousands of specialized servicemen are more than out of pocket—they're out of jobs. We in the radio business are plugging for three- and four-radio homes, plus a radio in the car and a fresh-air miniradio as a traveling companion. Maybe people will spend so much time listening to the radio that they won't have time to read magazines and go to the movies. So the magazines will suffer, and Hollywood stars will start using their real names again.

At first blush, it would seem that someone should rise up in a body and demand a live-and-let-live policy. But things don't work that way. The less you mess around with situations, the sooner they clarify themselves. All things have a way of seeking their own level. Water does, and so do business relations . . .

After experiencing "Fantasia," we've decided we'd like something of the sort in our own home. What we have planned in moments of thumb-twiddling is four loudspeakers facing into the living room from north, east, south and west, and a 360-degree fader control system that will permit us to sweep the room with Beethoven's Fifth or something like that there now. It might work out fine with his (Ludwig's) opus in which a guy blows a horn off in the distance and then the orchestra comes right back at him.

Somewhere in this phantasmic plan there's the germ of an idea as applied to phonograph music, but the germ is too microscopic for our mind's eye . . .

And speaking of that sort of thing—we've always meant to try a two-dimensional sound scheme that came to us while listening to the campaign speeches

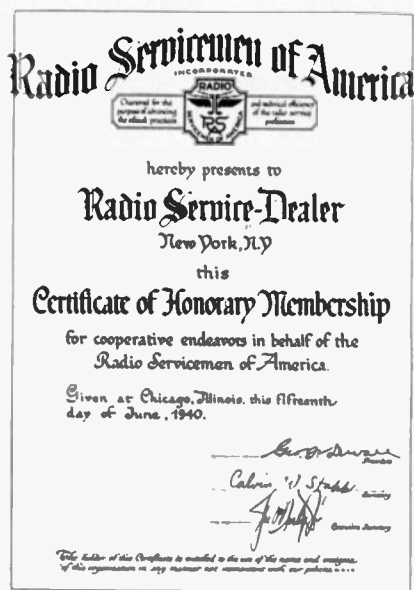

WE'RE PROUD of the Certificate of Honorary Membership bestowed on us by the Radio Servicemen of America, for our cooperative endeavors in their behalf. Our thanks to the RSA—and may we always be a member in good standing!

on the super-national hookups. The numerous chain mikes on the speaker's stand are fairly well separated and should provide some sort of stereophonic effect if one were to use two receivers a few feet apart, with one receiver tuned to, say, a Columbia Network station and the other receiver tuned to an NBC or Mutual Network station. The results (if any) obtained would depend upon the separation of the two mikes feeding the stations to which the receivers were tuned.

Will someone try it out and let us know if it works? If it does, we'd like to hear that Presidential chuckle in two dimensions . . .

As matters now stand in this area, you can hear a few of the many programs you'd like to hear and can hear on a.m. on f.m. also, plus the doubtful advantage of a new species of station announcer who is scared stiff, has a cold, or talks with his mouth full of hot dog. You can also hear all the flaws in the programs intended for a-m reproduction, and learn for the first time that your favorite commentator has a loose front tooth.

With many of the f-m stations going commercial the first of the year, let's

hope, for the sake of f.m., that sponsors will develop programs that can live up to the merits of the system . . .

You know, the doctors really haven't a thing on us. What Latin words have they got that can compare with "transconductance" and "pentagrid converter?" And what could be more confusing to the layman than "dynamically balanced phase inversion" or, for that matter, "motorboating?" Do you ever say to a customer, "Does your set motorboat?" If you do, you're nuts. Do the tubes go fishing? Does the oscillator neck? . . .

The coming year may bring a lot of servicing work on record changers, if estimated sales figures mean anything. And, according to local record dealers, the demand is almost entirely for DM and MM couplings in album sets—indicating a very large percentage of drop mechanism playing in this neck of the woods. To clinch matters, the record manufacturers are having a bit of a time keeping up with demand. So, brush up on record-changer servicing data—or file the stuff for ready reference if that's the way you do it . . .

What this country needs—and what a thought for the New Year!—is a good one-buck way of servicing midgets. If only the test-equipment boys could bring out a Midget Analyzer, designed, say, along the lines of a tube tester, that would jolly well tell you what was wrong in the shake of a lamb's tail, and without one having to peer and prod and fuss and fume. What a market that would open up! The nearest thing we have to it so far is the signal tracer—but, patience! . . .

With the yearend comes the Annual Index, which cramps us for space, but you'll find it of considerable value not only for reference purposes but also as a panorama of the year's doings and developments. It's good reading matter, even if you aren't looking for something special. Everything is cross-indexed, so you can get a pretty good picture of what's what.

We're sorry, of course, that the Index pushed out the Technical Service Portfolio, but TSF will be back in January.

Well, we-all wish you-all a very Merry Christmas and a particularly Happy New Year.

EDITOR

Announcement:

On and after FEBRUARY 1st, 1941
 RADIO SERVICE-DEALER'S 1 year
 subscription rate will be \$2.00
 2 year subscriptions will be \$3.00

Until Feb. 1st we will accept subscriptions at \$1.00 for 12 issues — \$2.00 for 24 issues
PAID SUBSCRIBERS MAY EXTEND THEIR PRESENT SUBSCRIPTIONS.
 Simply send \$1.00 for a 1 year or \$2.00 for a 2 year extension.

When RADIO SERVICE-DEALER was first conceived it was our opinion that the obligation of a radio service magazine to its readers should include a sincere effort to improve and strengthen the field in all ways. Subsequently we have published more and better text material than any other contemporary publication.

Our staff, working in close contact with the field will continue to give our subscribers just the type of authoritative, exclusive and timely data needed and not obtainable through any other trade paper.

Now RSD helps better progressive full-time radio servicing organizations win public recognition and a larger share of business through



A distinctive six-inch decalcomania lithographed in four colors (red, white, blue and gold) which will help your business, available FREE to all subscribers classified as independent radio service dealers on request.

our nation-wide Certification Plan. Our distinctive, four-color "Seal of Certification" is available without charge to any independent servicing organization which meets the rigid requirements but RSD subscribers whom we classify as "service-dealers" automatically qualify, for we, at our expense, confirm their eligibility before accepting their subscriptions.

It is a mark of distinction—it pays—to be numbered amongst RSD's paid subscribers. You cannot afford to miss the technical data we will publish or the active campaign now under way for Certified Service-Dealers. Take advantage of the money-saving offer still in effect. Send your check and become a paid subscriber today.

(TEAR OUT AND MAIL TODAY)

WORTH \$1.00—MAIL NOW!

Regular \$2.00 ANNUAL SUBSCRIPTION TO RSD COSTS BUT \$1.00 with this coupon. Good until Feb. 1, 1941.

RADIO SERVICE-DEALER, SOUNDMAN & JOBBER
 11 West 42nd Street, New York, N. Y.

Sirs: Enclosed herewith is my check (or money order) for \$..... Please enter my annual subscription order (12 issues) at \$1.00 for 1 year or \$2.00 for 2 years, (24 issues)—1/2 the regular price. Foreign subscriptions are \$2.00 yearly. I believe the information given below is accurate. IF MY SUBSCRIPTION IS REJECTED I EXPECT TO RECEIVE IMMEDIATELY A REFUND IN FULL FOR THE AMOUNT ENCLOSED HEREWITH.

Name (print carefully)

ADDRESS FIRM NAME Est. 19.....

CITY STATE YOUR POSITION

Please check whether firm is

- An independent servicing organization
- An independent service-dealer (engaged primarily in service work)
- A service-dealer (does servicing, but is primarily interested in retailing)
- Selling, renting or servicing Sound Equipment
- Jobber Any other classification
- Manufacturer (State it)

I belong to a serviceman's organization Yes No

We stock the following checked items:

- TUBES
- PARTS
- RECEIVERS
- BATTERIES, etc.
- SOUND EQUIP.
- ELEC. APP'L'S.

We own the following instruments:

- V-T Voltmeter
- Tube Checker
- Analyzer
- Oscillator
- Signal Generator
- Volt-Ohm Meter
- Others
- MANUALS

A STEREOPHONIC SOUND

THE annual May Festival of choral music by Johann Sebastian Bach, given by the Bach Choir of Bethlehem, Pennsylvania, in the beautiful Packer Chapel on the campus of Lehigh University, is considered one of the most significant musical events in America. Unfortunately, the seating capacity of the Chapel is far too limited to serve the increasingly large number of applicants for tickets. Those who cannot be accommodated sit on the lawns and try to hear the music through open windows. At the 1939 Festival, there were 1200 seated inside the Chapel and 1500 on the lawns.

To alleviate this condition it was suggested that the program be transmitted by an amplifying system from the Chapel to the auditorium of the Packard Laboratory of Electrical and Mechanical Engineering, which is located directly across the street from Packer Chapel. Such a project was approached with considerable trepidation. It was apparent that the nature and quality of the music would impose severe requirements on the transmission system. Another point to be considered was whether the attendance at a reproduced program would be sufficient to make the project self-supporting.

DUAL-CHANNEL SOUND

★ The accompanying article on two-dimensional sound is of more than academic interest. Covering as it does a specific installation and its psychological effect on audiences, it clearly points a way for the progressive soundman. Two-channel systems considerably less elaborate than the one outlined can be installed at low cost and with little difficulty. The results far outweigh the expenditure.

After a careful consideration of all factors involved, and with the active cooperation of Bell Telephone Laboratories, a system was finally devised which proved entirely satisfactory.

A survey of the equipment on the market showed that no complete system, which would satisfy all requirements, was available. The only possibility, therefore, was to design and assemble the transmission system locally. As a nucleus around which to build, Western Electric 119A and 118A amplifiers were

chosen since they would fulfill all the technical requirements. Because of their relatively low cost it was found possible to plan a two-channel system, thus providing the desired auditory perspective. The entire system was assembled and installed by the Electrical Engineering Department of Lehigh University, using stock Western Electric parts purchased through the local Graybar Company.

INSTALLATION FEATURES

Fig. 1 is a simplified block diagram of the transmission system as installed. The left and right microphones feed through individual 116A pre-amplifiers to the 119A amplifiers of the left and right channels respectively. The center microphone bridges the left and right channels through two 116A amplifiers. Type 30 volume indicators are connected across the outputs of each of the 119A amplifiers. For monitoring purposes a set of crystal headphones is arranged so that the left earpiece connects to the left channel and the right earpiece to the right channel.

To simplify the control of volume during the program, corresponding left and right volume controls are ganged in a control cabinet that also houses the volume indicators, i.e. V_L and V_R are dual potentiometers; similarly, V_{CL} and V_{CR} and V_{ML} and V_{MR} . To permit individual adjustment of gain to compensate for any amplifier unbalance, all the vol-

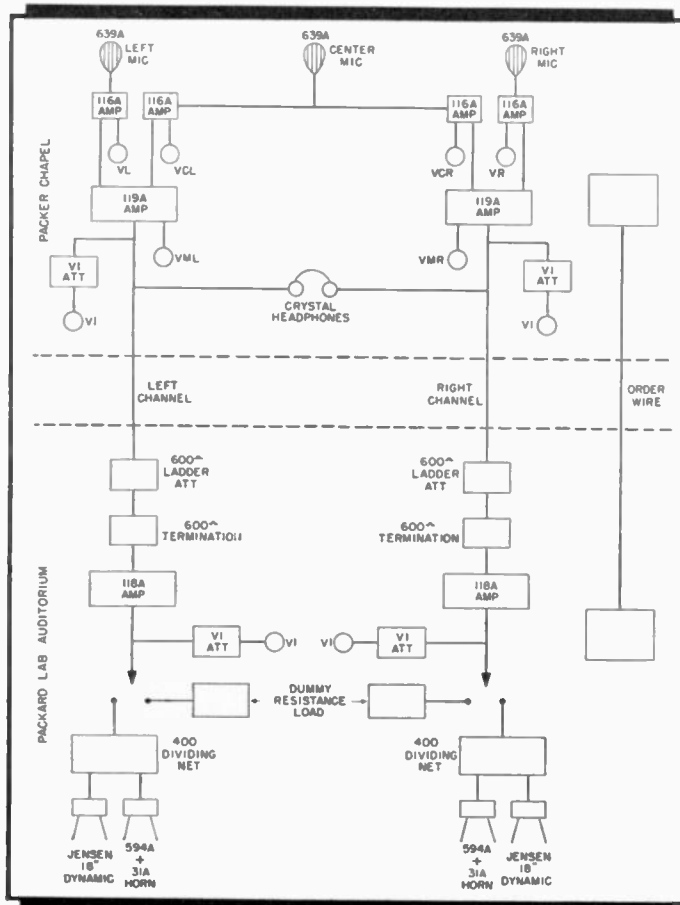
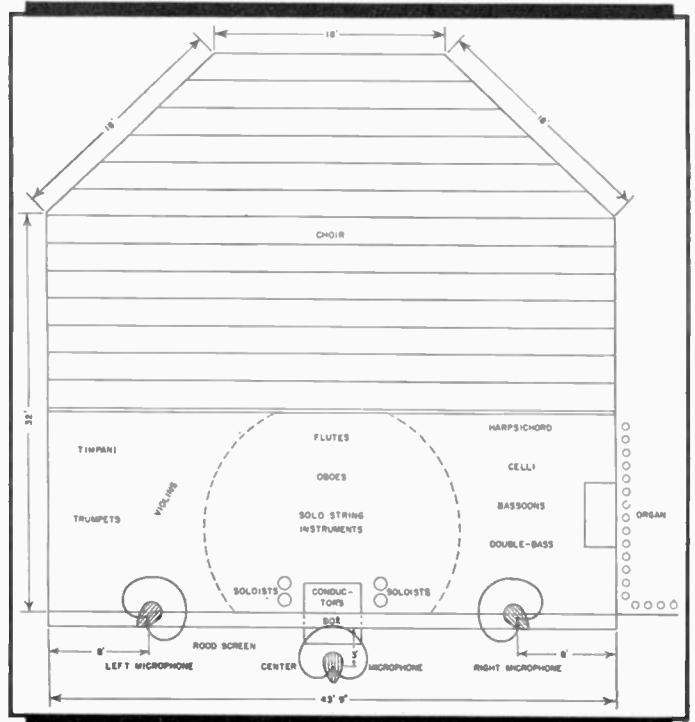

Fig. 1. Left: Block schematic of system. Fig. 2. Below: Horizontal arrangement of mikes.



TRANSMISSION SYSTEM

By IFOR JONES¹ and HENRY C. KNUTSON²

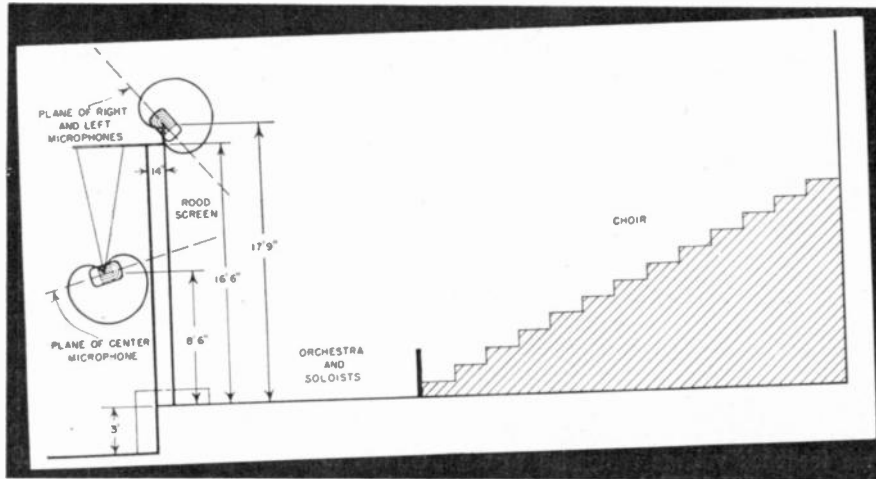

Fig. 3. Showing vertical arrangement of cardioid directional microphones in relation to orchestra and singers.
Diagrams from Western Electric Co.

ume controls have small series connected controls mounted on the amplifier cabinet.

For transmission lines between the two buildings, simple No. 14 weatherproof twisted pair run overhead is used. Inside the buildings all wiring is in steel conduit. Tests indicated that the noise introduced by the connecting lines is inaudible.

In Packard auditorium, the incoming lines as shown in Fig. 1, pass through 600-ohm attenuator volume controls to 600-ohm terminations. The 118A power amplifiers are bridged across these terminations. The 600-ohm attenuators are ganged together on a control cabinet that also houses two volume indicators connected across the output of the amplifiers. The volume controls on the 118A amplifiers themselves are used only as compensation controls for balancing purposes.

Normally, the 118A amplifiers feed into 400-cycle dividing networks and then to the loudspeakers. Each speaker consists of two units. The low-frequency unit is a Jensen 18-inch dynamic, while, the high-frequency unit is a Western Electric 594A loud speaking telephone with a 31A horn. Fig. 4 shows the arrangement of the speakers at the front of Packard Auditorium during the May Festival. The distance between speakers is approximately the same as that between the right and left microphones in the Chapel.

¹Ifor Jones, Conductor of the Bach Choir.

²Henry C. Knutson, Associate Professor of Electrical Engineering, Lehigh University, Bethlehem, Pa.

A dummy load to replace the loud speakers is provided as shown in Fig. 1. This permits last minute balancing and testing with oscillator tone even when the audience is present.

The order wire shown in Fig. 1 is terminated at each end in an ordinary headset and carbon microphone.

MICROPHONE PLACEMENT

One of the major problems involved was the placement of the microphones. The compact arrangement of the choir and orchestra as well as the effect of a massive oak rood screen separating the performers from the audience had to be considered. Fig. 2 shows the horizontal arrangement for the Festival, of the choir and orchestra, while Fig. 3 gives a vertical cross section. To add to the difficulties was the fact that at no time before the final dress rehearsal did the orchestra rehearse with the choir and soloists. For the choir alone a series of listening tests with the microphones in different positions indicated that the best reproduction was obtained with the right and left microphones in the plane of the rood screen. Ordinary microphones at this point would have resulted in the orchestra overbalancing the choir.

In Bach choral music the balance between the orchestra and the singers is critical, since both are equally important. It was hoped that the use of the cardioid pattern of the 639A microphones would give a satisfactory compromise. Bearing in mind this cardioid pattern, the left and right microphones were placed and tilted as shown in Figs. 2 and 3. To the gratification of everyone

concerned, the balance obtained at the dress rehearsal was so nearly perfect that no further adjustments of the microphones were necessary.

The effectiveness of these 639A microphones was strikingly demonstrated at a rehearsal of only the orchestra. It was noticed that in the reproduced music the double-basses which were immediately in front of the choir seemed to predominate, while the Novachord (operated at a harpsichord) directly below the right microphone was weak. By interchanging positions, i.e. placing the double-basses almost directly below the microphone and hence, nearer to its dead zone, and moving the Novachord towards the choir, an excellent balance was established. Full use was made of the three dimensional cardioid pattern of the 639A microphone on the right side. Since this microphone was rather close to the organ it was shifted about a vertical axis until the organ was nearly in the dead zone.

The center microphone (see front cover) was used for two purposes, first to pick up and give proper emphasis to the soloists, and second, to move forward the center of the virtual stage. Steinberg and Snow* have shown that in a two-channel auditory perspective system, the center of the reproduced stage recedes into the background. When they used a non-directional microphone at the center of the pickup stage and bridged this across the two channels, they found that the whole center of the stage moved into the foreground. In the Bach Festival system, the center microphone was set
(Turn to page 20)

* Physical Factors, J. C. Steinberg and W. B. Snow, *Electrical Engineering*, Jan. 1934; also in *Bell System Technical Journal*, Apr. 1934. This paper is one of a series in a Symposium on Wire Transmission of Symphonic Music and its Reproduction in Auditory Perspective.

Fig. 4. Arrangement of the two loudspeaker sets at the front of Packard Auditorium.

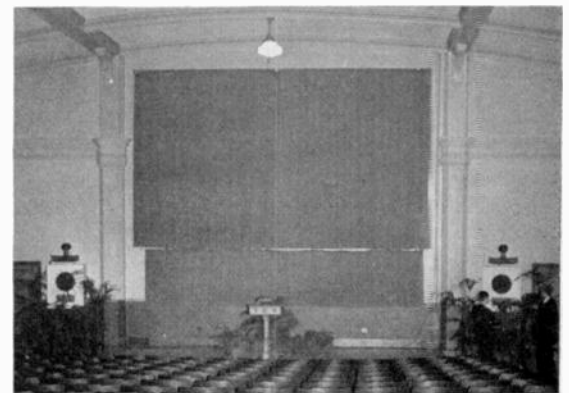

Set of the Month

RCA

RADIOLA 510



ILLUSTRATED is one of a series of new RCA Radiola receivers designed for servicemen to sell. The details are naturally of special interest.

The circuit and data apply to Models 510, 511, 512 and 513. Shown above is the 510.

These receivers are 5-tube ac-dc superhets with a tuning range from 550 to 1600 kc. The loudspeaker is a 5-inch electrodynamic. Power output is .8 watt undistorted, 1.3 watts maximum. All four models are Underwriters approved.

THE CIRCUIT

The loop antenna is wound of Litz wire which serves to improve the signal-to-noise ratio and the image ratio. Gain and selectivity are increased by the use of Magnetite core i-f transformers. Note that the volume control *R5* has a built-

in i-f filter to eliminate regeneration and reduce harmonics and whistles.

Control bias voltage is applied to the detector and i-f tubes. The triode section of the 12SQ7 is biased by means of the 10-megohm grid resistor *R6*. An inverse feedback voltage is applied to the grid of the 50L6GT beam-power output tube through condenser *C17*. This inverse voltage appears across the unby-passed cathode resistor *R9*.

ALIGNMENT

With gang condenser in full mesh, the pointer should be adjusted so that it is vertical.

If an electronic voltmeter is used as the output indicator, it should be connected to the avc bus, and the test-oscillator output adjusted to produce several volts avc.

For i-f alignment, connect the low side of the test oscillator to the receiver chassis through a .01-mfd condenser, and keep the output as low as possible. Carry out alignment in the following steps:

Step 1. Connect high side of test oscillator to 12SK7 grid in series with .01-mfd, tune oscillator to 455 kc, tune receiver to quiet point at 1600-kc end of dial, and adjust *C9* and *C10* on 2nd i-f transformer for maximum peak output.

Step 2. Connect high side of test oscillator to oscillator tuning condenser stator in series with .01-mfd and adjust *C7* and *C8* on 1st i-f transformer for maximum peak output.

Step 3. Connect high side of test oscillator to radiation loop consisting of 2 turns of wire 18 inches in diameter. Tune test oscillator to 1600 kc, turn re-

(Turn to page 21)

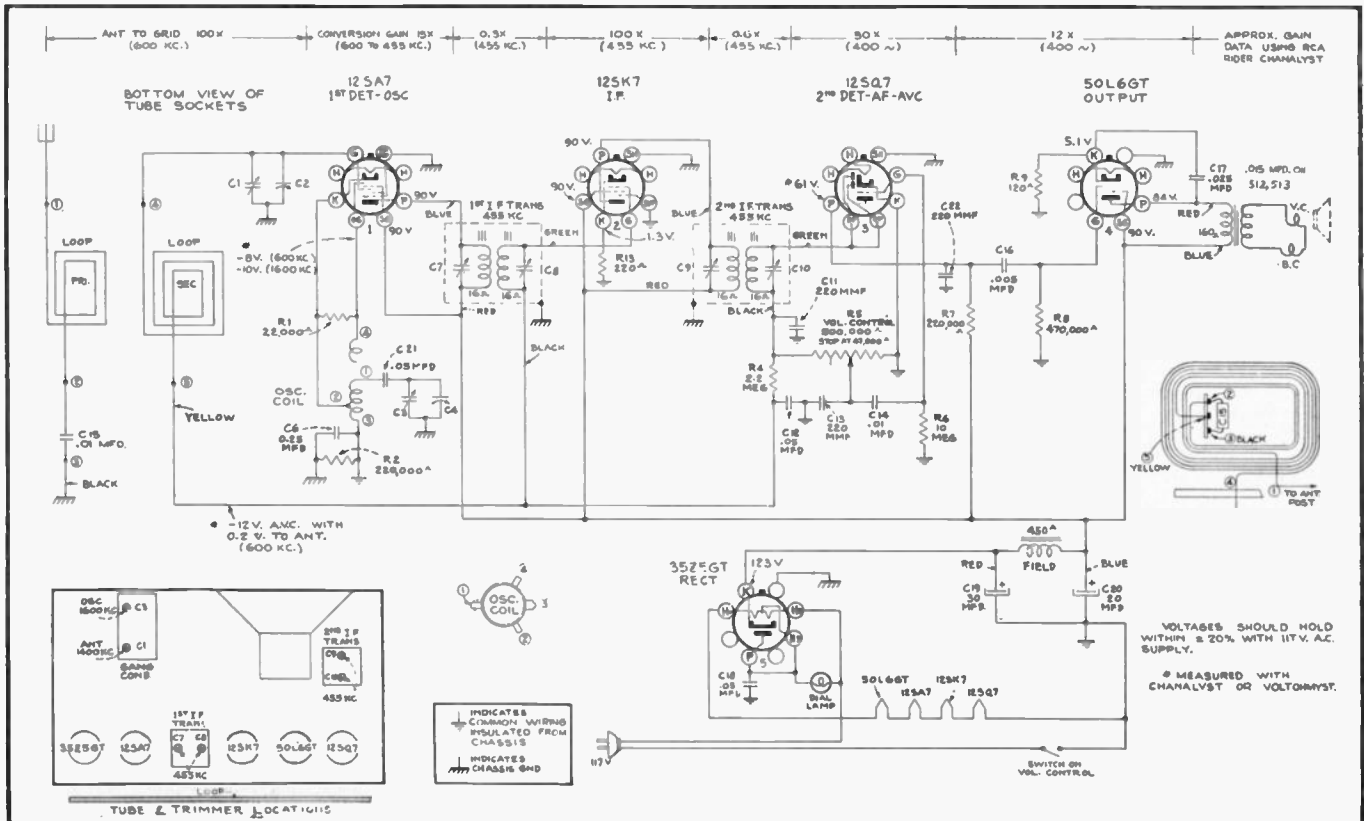

Selling YOUR SERVICES

THE money-making potentialities of radio service-dealers are brighter than ever before. There are many reasons, chief of which is the ever increasing number of radio receivers in the field. A few years ago there were only ten million receivers in the U.S.A. Today there are fifty million, of which over seven million are auto radios. The Joint Committee on Radio Research reports that nine out of every ten homes in this country have one radio receiver; four homes out of ten own two sets and two homes out of ten own four. Every third car on the highways is radio-equipped.

In January, 1940, over fifty thousand men were engaged in radio service work, either full or part time. Eight thousand radio retailers operated their own service departments and utilized the services of twelve thousand men. (In many cases the dealer was his own serviceman and could be classified as either a dealer or servicer.) In addition, there were sixteen thousand independent radio servicemen engaged in radio servicing on a full-time basis. Over thirty thousand other men did radio service work on a part-time basis.

THE "PART-TIME" MENACE

These 30,000 part-time radio servicemen were (and are) a most disturbing factor in several regards and they must be "cut out" like a cancerous growth. To begin with, though they accounted for less than 3% of all radio service work done, and sold less than 3% of all replacement tubes and parts; operating as they did, with practically no overhead, they held to no basic price schedule or minimum scale for services rendered. What few replacement tubes and parts they used were not turned over at list prices. They usually quoted ridiculously low prices to potential customers and thus took business away from legitimate full-time servicemen and radio retailers who could not compete on an equitable basis. Not all, but many of these part-timers frequently resorted to unethical practices. Many substituted reclaimed or unreliable replacement parts for nationally known and guaranteed brands. In addition, generally, their work was not properly done, nor did they back it up with a guarantee of satisfaction, a policy that legitimate service-dealers who are established in places of business *must* include as a part of their routine service.

Fortunately for all legitimate parts

First of a Series on the Certified Service-Dealer Plan

manufacturers, jobbers and service-dealers, part-timers and many of their demoralizing tactics are quickly passing out of the picture. Needless to state, re-employment and resumption of industrial hiring has gone a long way to help. The undesirable part-timer may never disappear entirely, but if a proper line of attack is used, the radio servicing industry can be made into a very profitable one for all men justly qualified to remain in it. The big job for legitimate servicers and particularly radio parts jobbers is to *get part-timers out and keep them out.*

JOBBER'S CAN HELP

Parts jobbers can do much good by inaugurating rigid discount policies. Any full-time servicemen and radio retailers who maintain definite business establishments should be given discount recognition. Even student servicemen should be barred from discounts. Make them serve apprenticeships as employees of legitimate servicing organizations until they go into business for themselves. Parts jobbers who adhere rigidly to this practice will gain much more than they lose. Their unit sales will increase, their credit losses be minimized. Less book-keeping and faster turnover amongst fewer accounts spells lower overhead and better profit margins. Part-timers absorb but a minute portion of a jobber's gross turnover . . . and the business that part-timers would fail to get if they could not obtain a full discount will be diverted to full-timers in any event, for full-time servicemen who do not have to parry with part-time, chiseling competition will have more time in which to aggressively go after more and better business.

It is our opinion that the lack of confidence in radio servicemen as a whole may be greatly blamed on the unbusiness-like methods used by students who are learning and by part-timers. The set-owning public has had many sad experiences and, like an elephant, once fooled, never forget. The onus unfortunately lies on good, reliable servicemen as well.

HOW MUCH BUSINESS?

As stated above, eight thousand dealers who maintain their own service departments and sixteen thousand full-time servicemen find themselves with a potential market of 50 million radio receivers



The new RSD Certification Seal—a distinctive six-inch decalcomania in red, white, blue and gold, which will help your business. Ask for yours now.

which may require servicing, new tubes, etc. Over 42 million sets are more than one year old and 36 million two or more years old.

Let us assume that as many as 10 million of these three year-or-older receivers are not worth repairing. There are still 26 million potential servicing jobs on "semi-obsolete" models and another 18 million "new" sets in the field. Thus, there are 44 million points of call left for 24 thousand service-dealers.

Theoretically, every individual radio service-dealer could anticipate having approximately 1850 service jobs within the next twelve months. There are more than 300 million radio tubes in daily operation. If only one in every ten were replaced during the next year, over 30 million replacement tubes would be sold, and every service-dealer would, on an average, sell 1250 replacement tubes.

Check your records against these figures. Did *you*, as an individual, service 1850 sets and did you sell over 1250 replacement tubes during the past twelve months? If you own a servicing organization and employ two servicemen, do your books show that your 3-man organization repaired 5550 receivers and sold over 3750 tubes this last year? If yours is an average servicing organization in an average city, the above figures should represent your calendar year's business.

LOOK TO YOURSELF

If you are getting more business than stated above, more power to you. Keep
(Turn to page 19)

STEWART-WARNER RECORD CHANGER

Service Data On Model J Unit, Used In Latest Combinations

THE Stewart-Warner Model J Record Changer plays and automatically changes 14 or less 10-inch records or 10 or less 12-inch records. The mechanism is used in the following sets:

Radio Chassis	Radio Models
11-6V	11-6V9
11-7A	11-7A8 and 11-7A9
11-8D	11-8D6, 11-8D7, 11-8D8, 11-8D9
11-8D-Z	11-8D6-Z, 11-8D7-D, 11-8D8-Z, 11-8D9-Z
11-10A	11-10A6, 11-10A8, 11-10A9, 11-10A10
11-10A-Z	11-10A6-Z, 11-10A8-Z, 11-10A9-Z, 11-10A10-Z

OPERATION

The Record Changer is started by turning the switch control knob 65 (Fig. 4) to "On". This starts the motor and moves trip rod 32 (Fig. 1) which rotates trip lever assembly 20 (Fig. 1) causing it to disengage from Engagement Clutch Cam 79 (Fig. 2). The Engagement Clutch Cam will then rotate due to tension from spring 27 (Fig. 1). This causes it to contact the pin on the top side of Drive Gear Assembly, 4 (Fig. 1) as it rotates, and in turn, moves the Drive Link Assembly, 31 (Fig. 1) and the Selector Shaft Crank Assembly #1 and #2 to the position shown in Fig. 2. Also the tone arm reset link 80 (Fig. 2) has moved to where it has released the latch 18 (Fig. 1), and carried the tone arm to its extreme outward position. The Tone Arm lifter link 81 (Fig. 2) has raised the tone arm to its

extreme height, by means of the Lifter Plate Assembly 21 (Fig. 1). The tone arm is kept from "floating" free by the friction of the Tone Arm Brake Spring which also compresses the tone arm booster spring 13 (Fig. 1) due to its very light tension.

The Drive Gear Assembly 4 (Fig. 1) continues to rotate which causes the top pin to disengage from the Automatic Engagement Clutch Cam which is moved back to latch with the tone arm trip lever, and the lower pin to engage the drive link assembly, moving it back to its initial position. This swings in the tone arm to either the 10-inch or 12-inch record playing position and lowers it to the record. At the same time it releases the Tone Arm Brake Spring allowing the Tone Arm Booster Spring to act.

LUBRICATION

Motor: The motor is equipped with oil-less bearing and requires no lubrication.

Turntable Spindle Bearings: These are lubricated at the factory and do not require any lubrication for one year. After one year they should be oiled with 1 or 2 drops of a light grade oil.

The top bearing can be oiled by lifting off turntable. Make sure when replacing turntable to see that pin in Turntable Spindle slips into slot on bottom surface of Turntable hub and also care should be taken not to injure Rubber Idler Drive Wheel.

Never under any circumstance allow oil to come in contact with Rubber Idler Drive Wheel.

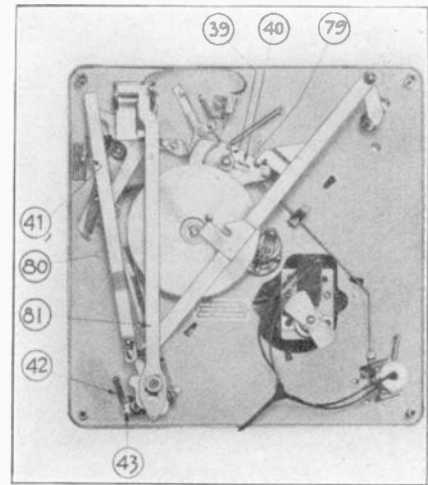

Fig. 2. Adjustment points below chassis.

SERVICE NOTES

ADJUSTMENT FOR REST POSITION OF TONE ARM

Swing tone arm outward until tone arm lever assembly 19 (Fig. 1) latches with tone arm latch lever 18 (Fig. 1) which is held to tone arm shaft 77 (Fig. 1) by two setscrews.

Make sure these setscrews are tight and that there is a slight play between the tone arm lever assembly and the panel 5 (Fig. 1). This will give proper clearance at ball race assembly 74 (Fig. 3).

The tone arm lever assembly 19 (Fig. 1) is held against tone arm latch lever 18 (Fig. 1) by the tension of tone arm locator lever spring 16 (Fig. 1).

Next loosen the clamping screw in the Swivel Bracket Assembly 46 (Fig. 3).

Now move tone arm 60 (Fig. 4) until its outside edge is $\frac{1}{8}$ " from the outside edge of the panel 5 (Fig. 1) and retighten screw securely.

RECORD CHANGER DOES NOT GO INTO ITS CHANGING CYCLE AT END OF RECORD

Worn or Damaged Stop Groove: If the stop groove in the record is worn out or damaged, discard such a record.

Cut-Off Adjustment May Be Incorrect: The Record Changer should go into its changing cycle when the needle enters the stop groove and has traveled to within a distance of $1\frac{1}{8}$ " from the center of the turntable shaft.

If the Record Changer does not go into its changing cycle when the needle has reached the above mentioned distance, the Tone Arm Trip Lever Shoe 23 (Fig. 1) should be moved toward the outside edge of the panel. To do this, it is necessary to loosen the thumb nut 22 (Fig. 1) and then retighten after adjustment has been made.

If the Record Changer goes into its changing cycle before the needle has reached a distance of $1\frac{1}{8}$ " from the center of the turntable, the Tone Arm Trip Lever Shoe should be moved inward toward the center of the Record Changer.

RECORD CHANGER DOES NOT GO INTO ITS CHANGING CYCLE WHEN SWITCH KNOB IS TURNED ON

When the switch is turned to "On" the

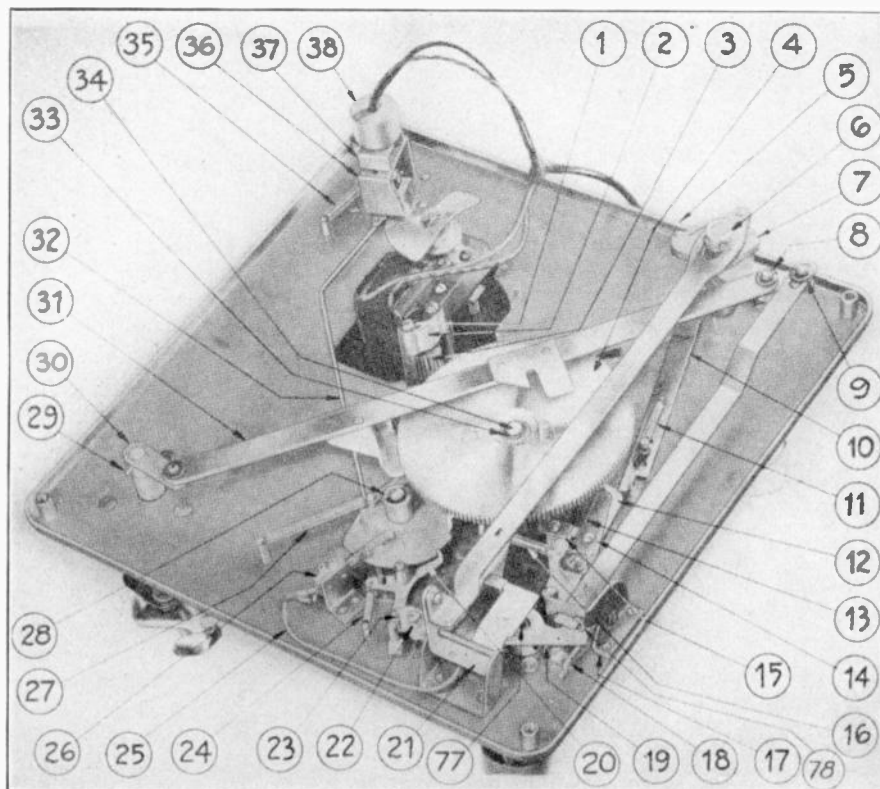

Fig. 1. Under-side view of the record changer chassis.

Record Changer should start its changing cycle. If it does not, the following points should be checked.

Make sure motor is running.

Check Trip Rod 32 (Fig. 1) to make sure it releases Trip Lever Assembly 20 (Fig. 1) from Engagement Clutch Cam Assembly 79 (Fig. 2) when Switch Knob is being turned on. If Trip Lever Assembly is not released, Trip rod should be shortened by bending until Trip Lever clears Engagement Clutch Cam Assembly, when Switch Knob is turned.

Make sure that Clutch Reset Pawl 40 (Fig. 2) clears Drive Link Assembly 31 (Fig. 1).

RECORD CHANGER CONTINUES TO REPEAT ITS CHANGING CYCLE WITHOUT PLAYING RECORDS

Trip Lever Assembly 20 (Fig. 1) does not latch in Engagement Clutch Cam Assembly 79 (Fig. 2) which may be due to causes listed below:

Trip Rod 32 (Fig. 1) may be bent so that it is too short, holding Trip Lever Assembly from contacting Engagement Clutch Cam Assembly.

Springs 24 or 35 (Fig. 1) may be disconnected.

NO SOUND WHEN NEEDLE IS ON MOVING RECORD

Muting switch 26 (Fig. 1) may be out of adjustment. The contacts of this switch should be open whenever its long blade is not resting on the shoe of the Engagement Clutch Cam Assembly 79 (Fig. 2). If the contacts remain closed after the long blade has left the shoe, they should be adjusted by bending until there is a separation of approximately 1/32".

Switch should be checked to make sure contacts are closed when long blade is resting on the shoe of the Engagement Clutch Cam Assembly.

The lugs on the Muting switch may have been bent together.

Pickup cartridge in Tone Arm may have been damaged or may be defective.

TONE ARM ADJUSTMENTS FOR 12" RECORDS

Turn both Control Knobs until the arrows marked "12" are pointing toward the center of the turntable.

Place a twelve-inch record on the turntable.

Start Record Changer and note where needle contacts record. Correct contacting is about 1/8" from the outside edge of record.

Set Rod 56 (Fig. 3) is operated by Selector Arm 61 (Fig. 4). The 12" Set Link 10 (Fig. 1) operates as a stop when Record Changer is set for 12" records. When Tone Arm Locator Assembly 12 (Fig. 1) contacts 12" Set Link the Tone Arm should be in the correct position to play a 12" record.

If at this point, the position of Tone Arm is incorrect, loosen the screw which holds the Tone Arm Locator Shoe 12" 14 (Fig. 1) and move in either direction as required and tighten screw.

TONE ARM ADJUSTMENTS FOR 10" RECORDS

Turn both Control Knobs until the arrows marked "10" are pointing toward the center of the turntable.

Place a 10" record on the turntable and start Record Changer.

Note where needle contacts record. Correct contacting is about 1/8" from the outside edge of record. If contacting of needle is not correct as mentioned, loosen the screw which holds Tone Arm Locator Shoe 10" 15 (Fig. 1) and slide shoe in or out as required, then tighten screw.

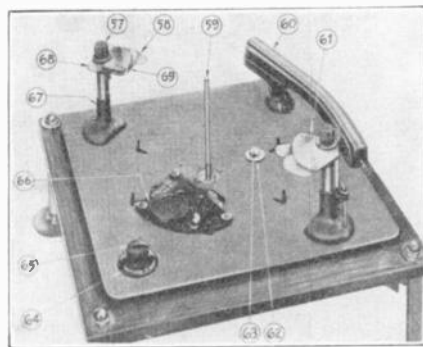

Fig. 4. Points of adjustment and operation above chassis.

TONE ARM HEIGHT ADJUSTMENTS

Set the Record Changer for ten-inch records, turn Switch to "On" and allow Record Changer to go through a changing cycle with no record on the Turntable. The clearance between Turntable and the bottom surface of the Tone Arm should be approximately 1/8". Usually this clearance can be obtained by adjusting the Tone Arm Adjustment Screw 70 (Fig. 3). It is well to check the following points before making any adjustment:

Check clearance between Roller 51 (Fig. 3) and Selector Crank Shaft Assembly 7 (Fig. 1). There should be approximately 1/32" clearance at this point. If the clearance is greater, it would be due to the pressure on the Spring Washer 50 (Fig. 3) being too great. This will prevent the Tone Arm Lifter Reset Spring 82 (Fig. 3) from returning the Tone Arm Lifter Link Assembly 81 (Fig. 2) sufficiently. To relieve the pressure on the Spring Washer, lower the Selector Shaft Collar 6 (Fig. 1) slightly.

TONE ARM LOWERS ON RECORD TOO SUDDENLY

If the Tone Arm lowers too suddenly, the Spring Washer 50 (Fig. 3) which is located between the Tone Arm Lifter Link

Assembly 81 (Fig. 2) and Selector Shaft Crank Assembly Post 7 (Fig. 1) is not under sufficient pressure. The setscrews in the Selector Shaft Collar 6 (Fig. 1) should be loosened and the Selector Shaft Collar pressed upward slightly and set screws tightened.

NEEDLE DRAGS ACROSS RECORD

If the needle drags across the record, the long portion of the Tone Arm Lever Assembly 19 (Fig. 1) is contacting the pin on the top side of the gear assembly 4 (Fig. 1) and is being moved by it. The remedy is to bend the long portion of the Tone Arm Lever Assembly upward so that it clears the pin. In some radio models the lever may be reached without removing the record changer from the cabinet; however, if easy access is not possible, removal of the complete record changer is recommended.

TONE ARM LANDS IMPROPERLY ON BOTH 10" AND 12" RECORDS

If the Tone Arm lands improperly on one size of record but properly on the other size, the Tone Arm adjustments for 12" or 10" records, previously described, should be made. Improper landing on both 12" and 10" records is due to a dislocated Tone Arm. This may be remedied by loosening the screw located on the Tone Arm Swivel Bracket 46 (Fig. 3) and moving the Tone Arm to the proper position and then retightening the screw. A rough check as to the proper position is to place the Tone Arm in its rest position and see if the outside of the Tone Arm is flush with the edge of the Motorboard. The two set screws on the Tone Arm Shaft 77 (Fig. 2) should be checked to see if they are tight.

STEWART-WARNER '40 CHANGERS

Spindle Squeak

Squeak due to records rubbing on turntable spindle in any of the Stewart-Warner 1940 Series Automatic Record Changers can be eliminated by gently lining up the stack of records.

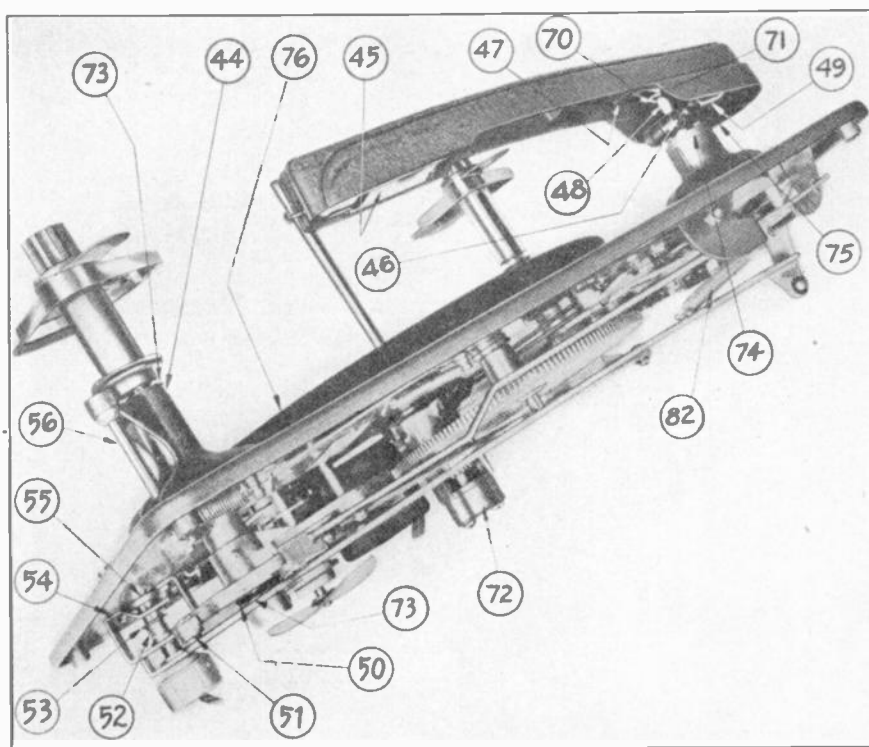

Fig. 3. Close-up view, showing points of adjustment.

Serviceman's Diary

By J. P. HOLLISTER

TUESDAY.—Teachers are usually a little bit nuts; especially men teachers. And when you run across one who teaches elocution—boy, you've struck something! At least, we did.

Jerry calls him Spouter—he talks so much. Myself, I hadn't met him until today. But the name fits.

It started about six months ago, when Jerry got the bright idea of running a recorder over to the guy's studio and making some records of pupil's voices. He sold Spouter on the idea of recording the progress of students by means of the records. In turn, Spouter, no dope, got three additional sales of recorders to doting mamas who wanted additional records of their kid's voices and, incidentally, of their own. And, today, another prospective sale.

Naturally, Jerry usually handles these jobs. He got the bird started. But he had to stop at the dentist's on the way and phoned me to run the recorder over to Spouter's studio.

The studio is in the residential section, in a private house. I expected to find it in an office building of some sort and nearly passed it by. But a sign "Voice Culture" in the front window caught my eye, so I knew I had the right place.

He answered the ring himself—a sort of skinny-looking guy with a small, black

mustache and some more hair spouting out of his chin. Not enough to call it a Vandyke beard, but a reasonably accurate facsimile.

He noticed I was lugging the recorder, and got excited right off the bat.

"Where's Jerry?" he shouted. "He knew I was depending upon him!" He sure seemed sore.

"Sorry, doctor, Jerry had to go to the dentist, but I assure you I am perfectly competent to hook up this recorder." I knew he was no doctor but handing out a title that way sometimes calms them down. Not this time, though.

"I know you can hook it up," he snapped. "I can hook it up. My secretary can hook it up. That's not the problem. Jerry helps my business, but he doesn't know it. But you—" He rushed to answer the phone.

I wished I had never seen the guy. Believe me, the next time Jerry tries to shove his dirt over on my side there's going to be trouble.

I unpacked the outfit and set it on the table. Then I plugged in the mike and started to make a test recording.

"One, two, three, four. Mary had a little lamb . . ." I muttered my little spiel into the mike. While playing it back, a girl entered the room. She tossed me a smile and a good morning and I

felt better. Tall, dark, lovely voice, it was nice to find at least one reasonably cordial person around. She was apparently the teacher's secretary.

"Why," she asked, "do you radiomen always use the same stereotyped test sentences? I noticed that Jerry had the same line."

"Jerry has a marvelous line," I assured her. "I really don't see how it could be improved." (It must have been good—she called him by his first name.)

"Your voice, I notice, records badly," she remarked.

"Thank you," I replied. "If the teacher were listening to this playback, he'd say the recording was magnificent but my voice was terrible."

"One never knows," she murmured. "Would you mind reading this into the mike?" She handed me a printed slip with Lincoln's Gettysburg address on it.

I spied off the lines. You know them—"Four score and seven years ago . . ." Then we listened to the playback.

"Terrible!" she exclaimed. And she rushed out of the room too.

There didn't seem to be any good reason why I should hang around any longer. I was getting plenty fed up with the place. I put on my coat and started out. But the teacher and his secretary stopped me in the hall.

"Wait!" he exclaimed. "I think I need you. Mary says you will be almost as good as Jerry!"

Oh, well. A fellow will try anything once. I took off my coat and followed them into the reception room. An old dowager was sitting there with a young high-school kid. The teacher introduced me to both, and invited us into the recording room.

"Now," old Spouter announced, "we shall have a demonstration of the recorder and of my methods. This young man will first read the Lincoln Gettysburg address." He handed me the slip I had before and I read it into the mike. Then he gave the same slip to the high-school kid and asked him to read it off. He seemed to put more into it than I did. On the playback there was no question about it; the kid's rendition ran rings around mine. The teacher seemed delighted.

"Madame," he said, "you have heard the untrained, untutored voice of this young man and that of your son. You cannot but appreciate the marvelous results of my course of training. For,

(Turn to page 20)



"Terrible!" she exclaimed, and rushed out of the room.

Postal Telegraph Steps up Service to Millions...

Raytheon engineers make an important contribution in overcoming delays caused by adverse weather conditions.

Postal Telegraph's headquarters station in Chicago. One of the largest operating rooms in the world. 28 RAYTHEON units installed here.

By Using

RAYTHEON TUBES

How to save seconds of time! How to counteract interruptions caused by snow, sleet, hail, electric storms and aurora borealis! How to improve service in every way! These are problems constantly before Postal Telegraph executives. Much time and money have been invested to solve them.

In cooperation with them, RAYTHEON engineers developed equipment, incorporating a Postal Telegraph invention, a revolutionary relay unit, in which RAYTHEON tubes play a vital part. These tubes are in constant service, 24 hours day in and day out. With their use, fading electric impulses are picked up, amplified, and messages speeded through faster than was ever before possible where weather is a factor.

Hundreds of these units have already been installed in Postal Telegraph offices throughout its nationwide system and millions of patrons are benefited thereby. During the severe electrical disturbance caused by aurora borealis on Easter Sunday, 1940, while ordinary circuits were disrupted the circuits equipped with RAYTHEON apparatus were unaffected. Thus Postal Telegraph rendered excellent service during a period in which other services were interrupted.

The same engineering genius which helped Postal Telegraph solve one of its baffling problems goes into every tube in the RAYTHEON LINE. That's why RAYTHEONS give such superb service wherever installed. And that's why RAYTHEON service-men and dealers everywhere are building goodwill, bigger business, and bigger tube profits by making replacements with RAYTHEONS.

These RAYTHEON advantages are now open to you . . . benefits you may enjoy with smaller stock of tubes, because you need only one line. For RAYTHEON makes them all . . . and they cost no more! Your RAYTHEON Distributor has an unusual tube deal for you. See him without delay.

One of the RAYTHEON units now standard equipment in hundreds of Postal Telegraph Stations. Note the 4 RAYTHEON Tubes.

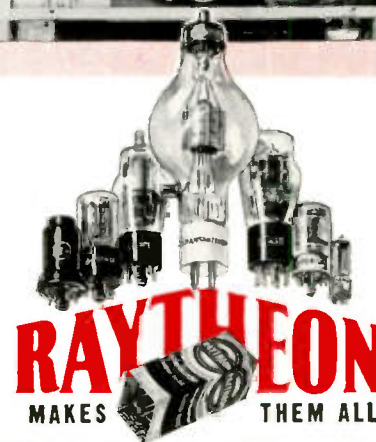

NEWTON, MASS. NEW YORK CHICAGO
SAN FRANCISCO ATLANTA

WORLD'S LARGEST EXCLUSIVE RADIO TUBE MANUFACTURERS

RADIO SERVICE-DEALER

April to December

	Issue	Page		Issue	Page
ALIGNMENT			CABINETS		
See "Servicing"			Test Your Lines For Profits, by J. P. Kennedy	May	18
ANTENNAS			Touch Up Those Cabinets	Sept.	10
Auto			CIRCUIT COURT		
Chrysler Skyway Antenna Installation	Aug.	21	Also see "Circuit Court"		
Hudson Vacuum Aerial	June	29	Audio		
Frequency Modulation			See "Audio Amplifiers"		
Stromberg-Carlson F-M, A-M Ant. Connections	July	17	Receiver		
Master			Emerson Model 365 Hi-Fi Receiver	Nov.	16
Master Antenna Systems, by Carl Goudy	June	4	Meissner F-M Receptor	Apr.	17
Loop			Motorola Model 40-60W	Sept.	14
Loop Feedback	Sept.	16	RCA Radiolas 510, 511, 512, 513	Dec.	6
Store Demonstration of Loop Sets	Nov.	18	RCA Victor BP-10 Personal	Aug.	6
Zenith Wavemagnet	May	22	Setchell Carlson "Dor-A-Fone"	Oct.	8
AUDIO AMPLIFIERS			Stromberg-Carlson No. 425 F-M Set	May	13
Applications			Wilcox-Gay A-70 Recordio	Apr.	22
Cathode Follower	Apr.	7	CIRCUIT COURT		
Impedance Matching, by Maurice Apstein	Nov.	5	Automatic Filament Feed	July	10
Practical Use of Inverse Feedback, Part I, by Maurice Apstein	Apr.	8	Battery Switching	Nov.	17
Practical Use of Inverse Feedback, Part II, by Maurice Apstein	May	14	Cathode-Energized Filament Strings	Dec.	16
Puppets Are Sound Sales Prospects	Aug.	14	Compensated Feedback	Oct.	16
Testing			Contact Potential Bias	Apr.	12
Checking Audio Circuits	Aug.	11	Degenerated Tone Control	Aug.	17
Checking Phase Inverters	June	15	Delayed AVC	July	10
Determining Amplifier Gain	Oct.	9	Direct-Coupled Push-Pull Circuit	May	34
Testing Audio Amplifiers	Sept.	11	Double Tone Control	Nov.	17
The Frequency Record as a Servicing Tool, by Zeh Bouck	Apr.	10	F-M Alignment	June	19
Circuits			F-M "Bandspread"	Oct.	16
Cathode Follower	Apr.	7	F-M Improvements	Dec.	16
Direct Coupling	May	34	F-M Tricks	Oct.	16
Dynamic Coupling	Nov.	11	Hum Neutralization	Sept.	16
Inverse Feedback	May	14	Loop Feedback	Sept.	16
Phase Inverters	Apr.	12	No Grid Condenser?	May	22
Phase Inverters	June	15	Oscillator Drift Correction	Aug.	17
BATTERIES			Phase Inverter	Apr.	12
Help Standardize Dry-Cell Types	June	8	Resistance-Coupled R. F.	May	22
BATTERY OPERATION			R-F Degeneration	Sept.	16
Automatic Battery-Line Switching	July	10	Simplified Tone Control	Aug.	17
Battery-Line Switching	Nov.	17	Speaker Protection	Apr.	13
BATTERY SETS			Termination Impedance	June	19
RCA Victor BP-10 Personal	Aug.	6	Tone Control	Apr.	13
BOOK REVIEWS			Tuned-Untuned R-F Stage	Nov.	17
Frequency Modulation, by John F. Rider	May	33	Volume Indicator	June	19
Perpetual Trouble Shooter's Manual, Vol. XI, by John F. Rider	Aug.	27	Wavemagnet	May	22
Practical Radio Communication, by Nilson and Hornung	Dec.	17	COMPENSATION		
Radio Operating Questions and Answers, by Nilson and Hornung	Dec.	17	See "Tone Compensation"		
RCA Ham Guide	Nov.	28	CONDENSERS		
RCA Receiving Tube Manual	May	34	Data on Condensers, by J. M. Borst	July	11
The Oscillator at Work, by John F. Rider	May	33	Electrolytic Symbols	Aug.	20
The Meter at Work, by John F. Rider	Dec.	17	Motorola Condenser Symbols	Sept.	18
BUSINESS ARTICLES			CUTTERS		
Go On Record With Sound Effects	Oct.	5	Instantaneous Sound Recording, Part II, by F. H. Goldsmith	June	6
Help Standardize Dry-Cell Types	June	8	Wilcox-Gay A-70 Recordio	Apr.	22
Now—"Certified Service-Dealers"	Nov.	14	FENCE CONTROLLERS		
Profits in Master Antenna Systems, by Carl Goudy	June	5	Electronic Gadgeteering in Fence Controllers	July	8
Puppets Are Sound Sales Prospects	Aug.	14	FREQUENCY MODULATION		
Selling Your Services	Dec.	7	Circuits		
Servicing Contacts, by R. G. Ellis	Oct.	13	F-M "Bandspread"	Oct.	16
Sound For Movie Makers, by H. M. Guthman	Aug.	8	F-M Tricks	Oct.	16
The Big Shift	Apr.	14	Meissner F-M Receptor	Apr.	17
The Show in Review	July	6	Oscillator Drift Correction	Aug.	17
They Need Needles	Apr.	5	Stromberg-Carlson No. 425 Receiver	May	13
Test Your Lines For Profit, by J. P. Kennedy	May	18	Servicing		
Touch Up Those Cabinets	Sept.	10	F-M Alignment	June	19
True Confession of a Service Engineer, by Edgar Jannivero	Nov.	6	Frequency Modulation Field Problems, by E. T. Higgons	May	12
Unique Radio Hospital	Oct.	23	Meissner F-M Receptor	Apr.	17
			Theory		
			Balanced Rectifier	Dec.	16
			Tuning Indicator	Dec.	16
			Double Limiter	Dec.	16
			Double Superheterodyne	Dec.	16
			F-M Improvements	Dec.	16
			Frequency Modulation Field Problems, by E. T. Higgons	May	12
			How Wide-Band F.M. Reduces Noise, by John H. Potts	Sept.	6
			IMPEDANCE MATCHING		
			Impedance Matching, by Maurice Apstein	Nov.	5
			Sound Facts For Sound Men, by J. P. Kennedy	Aug.	4
			Termination Impedance	June	19
			The Cathode Follower	Apr.	7
			Tubes and Circuits	Oct.	12
			INDICATORS		
			Testing		
			Frequency Modulation Field Problems, by E. T. Higgons	May	12
			Indicators For Signal Tracers and Analyzers, by Harper Johnson	Oct.	6
			Phono Servicing	July	4
			Servicing by Signal Tracing	May	7
			Stroboscope Disc	May	19
			Test Oscillator Applications	June	13
			Testing Audio Amplifiers	Sept.	11
			Vacuum-Tube Voltmeters	Aug.	9
			Volume		
			Instantaneous Sound Recording, Part II, by F. H. Goldsmith	June	6
			Speaker Protection	Apr.	13
			Volume Indicator	June	19
			Wilcox-Gay A-70 Recordio	Apr.	23
			INSTANTANEOUS RECORDING		
			See "Recording"		
			INVERSE FEEDBACK		
			Balanced Phase Inverter	Apr.	12
			Cathode Follower	Apr.	7
			Compensated Feedback	Oct.	16
			Degenerative Tone Controls	Aug.	17
			Inverse Feedback	Nov.	10
			Practical Use of Inverse Feedback, Part I, by Maurice Apstein	Apr.	8
			Practical Use of Inverse Feedback, Part II, by Maurice Apstein	May	14
			R-F Degeneration	Sept.	16
			MICROPHONES		
			Microphone Ratings	Sept.	13
			Setchell Carlson "Dor-A-Fone"	Oct.	8
			Wilcox-Gay A-70 Recordio	Apr.	23
			NEEDLES		
			See "Phonograph"		
			PHONOGRAPH		
			Compensation		
			See "Tone"		
			Motors		
			Eliminating Rumble	July	5
			Motorola B2RC, B3RC, B4RC Record Changers	Aug.	18
			RCA Model U-9	Apr.	20
			RCA Phono Motor Identifying Colors	Oct.	18
			RCA VA-21	Sept.	20
			RCA Victor Governor Controlled Motors	Apr.	21
			RCA Victor RP-152,-153 Record Changers	Oct.	17
			Stewart-Warner Model J Record Changer	Dec.	8
			Needles		
			Inserting Needle in RCA Top-Loading Pickups	Nov.	18
			They Need Needles	Apr.	5
			Records		
			Frequency Test Records	Apr.	10
			Instantaneous Records	May	4
			Phono Servicing	July	4
			Playing Sequences	Oct.	18
			Sound Effects Records	Oct.	5
			Record Players		
			Motorola B2RC, B3RC, B4RC Record Changers	Aug.	18
			RCA VA-21 Wireless Record Player	Sept.	20
			RCA Victor RP-152,-153 Record Changers	Oct.	17
			RCA Victrola Model U-9	Apr.	20
			Sound For Movie Makers, by H. M. Guthman	Aug.	8
			Stewart-Warner Model J Record Changer	Dec.	8
			PICKUPS		
			General		
			Mixing and Fading	Aug.	8
			Phono Servicing	July	4
			RCA Victor Top-Loading Pickups	Nov.	18
			Compensation		
			Emerson DV-364	Oct.	16

DEALER ANNUAL INDEX

Number Inclusive

	Issue	Page
Farnsworth AK-58, AK-59	Apr.	20
Phono Servicing	July	4
RCA Victor Tone Guard	Sept.	18
Stewart-Warner 01-6B9	May	24
Stromberg-Carlson No. 460-PF	June	21
Stromberg-Carlson No. 470	July	17
They Need Needles	Apr.	5
Tone Compensation	Aug.	20

Service Notes

Distortion	May	24
Motorola B2RC, B3RC, B4RC Record Changers	Aug.	18
Phono Servicing	July	4
RCA Top-Loading Pickups	Nov.	18
RCA Victor RP-152-153 Record Changers	Oct.	17
Stewart-Warner Model J Record Changer	Dec.	8
Stewart-Warner 01-6B9	May	24

PUBLIC ADDRESS

Cutting P-A Corners	Aug.	7
Dual-Turntable Record Player	Apr.	8
Frequency Records As Service Tools	Apr.	10
Go On Record With Sound Effects	Oct.	5
Impedance Matching, by Maurice Apstein	Nov.	5
Practical Use of Inverse Feedback, Part I, by Maurice Apstein	Apr.	8
Practical Use of Inverse Feedback, Part II, by Maurice Apstein	May	14
Puppets Are Sound Sales Prospects	Aug.	14
Sound Facts For Sound Men, by J. P. Kennedy	Aug.	4
Sound System at Elwood	Apr.	8
Speaker Protection	Apr.	13
Stereophonic Sound Transmission, by Jones and H. C. Knutson	Dec.	4
Testing Audio Amplifiers	Sept.	11
The Cathode Follower	Apr.	7

RECEIVERS

Emerson Model 365 Hi-Fi Receiver	Nov.	16
Meissner F-M Receptor	Apr.	17
Motorola Model 40-60W	Sept.	14
RCA Radiolas 510, 511, 512, 513	Dec.	6
RCA Victor BP-10 Personal	Aug.	6
Setchell Carlson "Dor-A-Fone"	Oct.	8
Wilcox-Gay A-70 Recordio	Apr.	22

RECORDS

See "Phonograph"

RECORD CHANGERS

See "Phonograph"

RECORD PLAYERS

See "Phonograph"

RECORDING

Instantaneous Sound Recording, Part I, by F. H. Goldsmith	May	4
Instantaneous Sound Recording, Part II, by F. H. Goldsmith	June	6
Stroboscope Disc For 33 1/2 & 78 RPM	May	19
Wilcox-Gay A-70 Recordio	Apr.	22

SERVICING

Equipment

Frequency Record as a Service Tool, by Zeh Bouck	Apr.	10
Indicators For Signal Tracers and Analyzers, by Harper Johnson	Oct.	6
Servicing Contacts With Cleaners, by R. G. Ellis	Oct.	13
Signal Tracers	May	7
Stroboscope Disc	May	19
Test Oscillator Applications	June	13
U-H-F Test Oscillator	May	12
Vacuum-Tube Voltmeters	Aug.	9

Methods

Aligning F-M Receivers	Apr.	17
F-M Receiver Alignment	May	12
Make Your Test Oscillator Pay, by Billy Parker	Sept.	5
Making Frequency Runs On A-F Amplifiers	Apr.	10
Servicing By Signal Tracing	May	7
Servicing With Test Oscillator	June	13
Servicing With V-T Voltmeters	Aug.	9
Signal Tracers and Signal Analyzers	Oct.	6
Simplified F-M Alignment	June	19
Using the Square-Wave Generator	Sept.	21

SET OF THE MONTH

See "Receivers"

SHOP NOTES

Crosley 689, 729 Alignment Precaution	June	21
Crosley J-7739, 7739 Differences	May	24
Electrolytic Symbols	Aug.	20
Emerson 8MT-574 Phono Converter	Oct.	19
Emerson EC, EM, DB, DL, DW Dial Cord Replacement	Aug.	20
Fada P58, PL58 Tube Substitution	July	17
Farnsworth AK-58, AK-59 Changes	Apr.	20
Farnsworth BC-72, 80 Improvements	Apr.	20
Galvin Motorola Aerial Check	May	24
Galvin Wireless Record Player Tuning Error	May	24
G.E. HJ-514 Alignment Precaution	Apr.	20
G.E. HM-80A, 85A, 136A Osc. Drift Correction	Aug.	20
G.E. J501-W, J502-W Changes	Oct.	19
Hudson Auto SA-40, DB-40 Sensitivity	Apr.	20
Hudson Motor SA-40, DB-40 Antenna Choke	Dec.	14
Miniature Tubes: Removal Precaution	Aug.	20
Motorola AC-DC Alignment	Apr.	20
Motorola Condenser Symbols	Sept.	18
New Tubes: 5W4GT, 11C5, 11C6, 11D5	Sept.	18
New Tubes: 384, 12A6	Dec.	14
Philco 37-38 Intermittent	Aug.	20
Philco 39-31—Dead	Nov.	18
Philco 40-110 Pushbutton Failure	Oct.	19
Philco 40-115, 124 Series—Squeals	Nov.	18
Philco 40-124—Dead	Oct.	19
Philco 41-90 Squeals	Aug.	20
Philco 41KR—Hum	Oct.	19
Philco 610 Distortion	Oct.	19
Philco Transitone PT25—Noisy	Oct.	19
Philco Transitone PT45—Dead	Oct.	19
Phono Xtal Pickup Distortion	May	24
RCA Gain Data	Sept.	18
RCA Little Nipper Speaker Adjustment	Sept.	18
RCA Loop Sets: Store Demonstration	Nov.	18
RCA Phono Motors	Oct.	18
RCA Power Transformer Replacement	Oct.	19
RCA Tone Guard	Sept.	18
RCA Victor Governor Phono Motor	Apr.	21
RCA Victor Top Loading Pickups	Nov.	18
RCA Victrola U-9 Phono Mechanism	Apr.	20
RCA BP-10 Lid Replacement	Dec.	15
RCA K-80 Hum Modulation	Dec.	15
RCA QU2C, QU2M, QU3C, QU3M	Dec.	15
Howl	Dec.	15
RCA QU5 Radio Breakthru on Phono	Nov.	18
RCA R-103-S Tone Compensation	Aug.	20
RCA RP-152 Record Changer Stalling	Dec.	14
RCA T63, U-48 Calibration	Apr.	20
RCA V-300, 1-2 Phono Gain	Nov.	18
RCA V-A-21 Wireless Record Player Motor Data	Sept.	20
RCA 10X Hum	Dec.	14
RCA 14BT, 14BT-2, 14BK Distortion	Dec.	14
RCA 15BP Fidelity change	Nov.	18
RCA 15BP Power Switch Replacement	Sept.	20
RCA 16K, 16T3 Police Band	Sept.	18
RCA 16K, 111K Oscillator Failure	Sept.	18
RCA 16K, 16T2, 16T3, 16T4, 17K, 19K, A-205, A-405—Increasing Sensitivity	Dec.	14
RCA 45X-11, -12, -13 Osc. Coil Connections	Dec.	14
RCA 45X-11, -12, -13 (2nd Production) Revisions	Dec.	15
RCA 46X-21, -23 Osc. Coil Connections	Nov.	18
RCA 156 Tube Tester	Dec.	15
RCA 1941 Receivers—Reducing Sensitivity	Sept.	18
Record-Playing Sequences	Oct.	18
Sparton 590-1 Circuit Change	Apr.	21
Stewart-Warner Loop Alignment	Sept.	20
Stewart-Warner Wiring Color Code	June	21
Stewart-Warner 01-5D Phono Precaution	May	24
Stewart-Warner 01-6B9 Phono Notes	May	24
Stewart-Warner 01-6C9 Tone Control Changes	June	21
Stewart-Warner 01-81, 08-81 Hum	Apr.	21
Stewart-Warner 02-42 Oscillation	Apr.	21
Stewart-Warner 03-6N Hum	Dec.	15
Stewart-Warner 07-31 Oscillation	May	24
Stewart-Warner 11-5V Circuit Change	Dec.	15
Stewart-Warner 11-7A Microphonics and Rumble	Dec.	15
Stewart-Warner 11-10A, 11-10A-Z	Dec.	15
Audio Howl	Dec.	15
Stewart-Warner 12-4D Oscillation	Dec.	15
Stromberg-Carlson FM-AM Antenna Connections	July	17
Stromberg-Carlson 400 Series Dial Pointer	July	17
Stromberg-Carlson 460-PF Phono Compensation	June	21
Stromberg-Carlson No. 470 Phono Compensation	July	17

	Issue	Page
Stromberg-Carlson 505, 515 F.M.—Weak or No Signal	Dec.	15
Stromberg-Carlson No. 509 Servicing Data	Oct.	19
Wells-Gardner Tuning Eye Distortion	May	24
Wells-Gardner 1A29 "B" Issue—Hum Modulation	May	24
Wells-Gardner 5D2, 6A26, 6A27	June	21
Hum Reduction	June	21
Zenith 1940 Advance Line Service Notes	Aug.	20
Zenith 1940 Line General Notes	July	17
Zenith 1941 Receiver Numbering System	Nov.	18
Zenith 1941 Receiver Service Notes	Sept.	20
Zenith 1941 Wavemagnets	Sept.	20

SIGNAL GENERATORS

See "Servicing Equipment"

SIGNAL TRACING

See "Servicing"

SOUND

See "Public Address"

SOUND EFFECTS

See "Phonograph Records"

TECHNICAL SERVICE PORTFOLIO

Section I—Servicing by Signal Tracing	May	7
Section II—Test Oscillator Applications	June	13
Section III—Data on Condensers	July	11
Section IV—V-T Voltmeters	Aug.	9
Section V—Testing Audio Amplifiers	Sept.	11
Section VI, Part I—Tubes and Circuits	Oct.	9
Section VI, Part II—Tubes and Circuits	Nov.	9

TESTING

See "Servicing"

TEST OSCILLATORS

See "Servicing Equipment"

TEST EQUIPMENT

See "Servicing Equipment"

TONE

Compensation

Compensated Feedback	Oct.	16
Degenerative Tone Compensation	Aug.	17
Emerson Model 365 Tone Compensation	Nov.	16
Feedback to Volume Control	Nov.	11
Phono Pickup Tone Compensation	Aug.	20
Phono Servicing	July	4
Practical Use of Inverse Feedback	May	14
They Need Needles	Apr.	5

Control

Degenerative Tone Controls	Aug.	17
Dual Tone Control	Nov.	17
Phono Tone Control	July	5
Tone Control	Apr.	13

TUBES

New

11C5	Sept.	18
11C6	Sept.	18
11D5	Sept.	18
384	Dec.	14
5W4GT	Sept.	18
6AE7GT	Nov.	12
12A6	Dec.	14
12K8	Apr.	20
12SR7	Apr.	20
117N7GT	Aug.	20
VR-75-30	Aug.	20

Operation

As Limiter	June	19
As V-T Voltmeter	Aug.	9
Cathode-Energized Filament Strings	Dec.	16
Converter Characteristics	Aug.	9
Direct Coupling	May	24
Load Characteristics	Nov.	5
Resistance-Coupled R-F Stages	May	22
The Cathode Follower	Apr.	7
Tubes and Circuits, Part I	Oct.	9
Tubes and Circuits, Part II	Nov.	9

V-T VOLTMETERS

See "Servicing Equipment"

Shop Notes

HUDSON MOTOR SA-40, DB-40 Installing Antenna Choke

The antenna noise choke (Stewart-Warner Part No. 118726, Hudson Part No. BO-161580) is a single layer choke coil wound on a ceramic body which looks like an insulated resistor. It is to be installed inside the control unit in place of the resistor connected in series with the antenna lead on early sets. Later sets already have the choke.

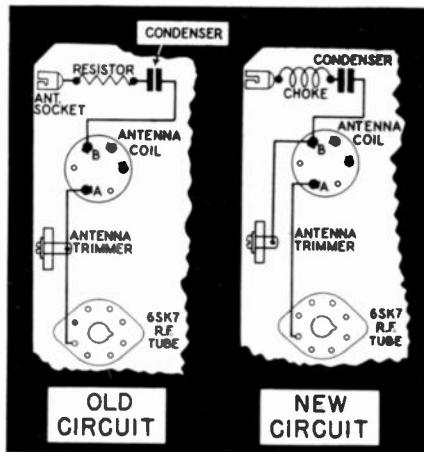

Remove the top cover of the control unit. Check whether a resistor or small choke connects to the blue antenna lead. (See accompanying sketch.) If it is a choke wound on a resistor body, the change has already been made. If you find a plain, insulated resistor connected to a terminal lug to which the blue wire from the antenna socket is connected, proceed with the change. This resistor has a value of 68 ohms and can be identified by its blue body, grey end and black dot.

Remove the resistor. Remove the two screws holding the antenna socket to the case.

The antenna trimmer must now be connected to a different terminal on the antenna coil. This trimmer is the one which can be adjusted through the side of the case. A bare wire runs from the antenna coil terminal *A*, through the top trimmer lug to the control grid of the 6SK7 tube.

Disconnect this wire from the antenna coil terminal and from the trimmer terminal. Slip a piece of spaghetti tubing over this wire and re-connect it to the same lug on the antenna coil. (Marked *A* in the sketch.)

Connect the trimmer condenser to the antenna coil terminal nearest the corner of the chassis. (Marked *B* in sketch.) This is the terminal to which the antenna series mica condenser connects.

Replace the antenna socket using the two mounting screws.

Solder the choke to the terminals from which you removed the resistor.

Check to see that the wiring of the unit has not been pushed over so as to interfere with the dial drive cord.

After this change is made, it is absolutely essential to realign the antenna trimmer. This must be done with a signal generator and an 80-mmfd. condenser in series

with the antenna lead and the signal generator. If any other capacity is used, adjustment will be incorrect.

The antenna trimmer can and should be aligned to the regular car aerial. To do this, connect the radio in the car so it will operate but without mounting the control unit in place on the instrument panel. Arrange it so you can get at the antenna trimmer easily. Tune in a weak station near 1400 kc on the dial and adjust the antenna trimmer for maximum volume.

RCA 10X

Hum

Keep heater lead wiring away from audio input circuit.

RCA 14BT, 14BT-2, 14BK

Distortion and Loss of Sensitivity

Some cases of loss of sensitivity and distortion have been associated with frequency drift. In such an event, correction may be made by connecting a 9 mmfd. condenser from the high side of the oscillator section, at the gang condenser, to ground, realigning the 1st detector and oscillator tuned circuits, and realigning the i-f circuits if necessary.

RCA 16K, 16T2, 16T3, 16T4, 17K, 19K, V-205, V-405

Increasing Sensitivity

These models have an untuned r-f stage which is resistance-coupled to the 1st-detector. The sensitivity may be increased by changing the r-f plate load resistor to a higher value, between 6,000 and 10,000 ohms. This change is not recommended in metropolitan localities owing to possibility of cross-modulation.

RCA 45X-11, -12, -13

Oscillator Coil Connections

The oscillator coil in the 2nd production of these models is different from the 1st production. The correct connections are

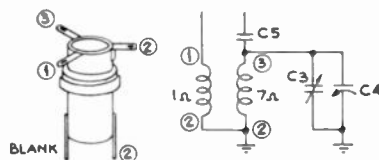

STOCK NO. 34443 OSC. COIL
USED IN FIRST PRODUCTION 45X11,12,13
(RC 459 AND 459A)

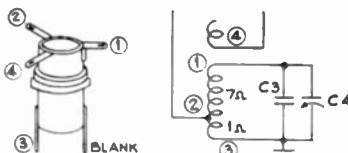

STOCK NO. 35579 OSC. COIL
USED IN SECOND PRODUCTION 45X11,12,13
(RC459D AND 459E)

shown below. Note that when installing a No. 34443 coil, it is necessary to connect a jumper from the bottom lug No. 2 to the top lug No. 2.

RCA TYPE 12A6 TUBE

The 12A6 is a beam power amplifier for use in ac/dc receivers with voltage doublers. The heater draws 0.15 ampere at 12.6 volts.

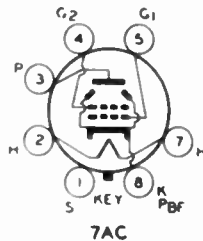

Used in Class A1 service, the 12A6 operating at a plate and screen voltage of 250 will provide an output of 2.5 watts with 10 percent total harmonic distortion.

A bottom view of socket connections for this tube is shown in the accompanying sketch.

RCA 3S4 TUBE

The 3S4 is intended for use in the output stage of light-weight ac/dc-battery-operated portable equipment. This new tube has essentially the same characteristics as the miniature type 1S4 but is de-

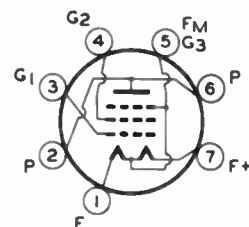

signed with a filament having a center tap to permit of either a series-filament or a parallel-filament operating arrangement. The series arrangement, requiring only 50 ma, has been provided especially for equipment utilizing a source of rectified power for the filament supply.

Socket connections (bottom view) are given in the accompanying sketch.

RCA RP-152 RECORD CHANGER

Stalling Going Into Cycle

The mechanism should be loaded with one record on the turntable. If stalling going into cycle takes place, it is probably due to insufficient tension in the main lever spring or booster spring (+3). An additional metal washer should be inserted between the spring and its guide.

Stalling Coming Out of Cycle

If the mechanism stalls just as it is coming out of cycle, that is, when the pickup is at its farthest distance laterally from the turntable, it is probable that there is too much tension in the booster spring. Any metal washers in this assembly should be removed.

Caution: The mechanism is designed to handle a total of 8—10-inch records or 7—12-inch records.

Shop Notes

RCA BP-10

Replacing Lid or Front Panels

When the molded lid (which contains the loop antenna), or the chrome front panel requires replacement, it is not necessary to replace the complete assembly of lid and front panel, as either one may be replaced separately in a few minutes by taking out the hinge pins as described below.

First remove the three self-tapping screws that hold the chassis in the center case, and remove the case. Unsolder the leads from the loop lugs.

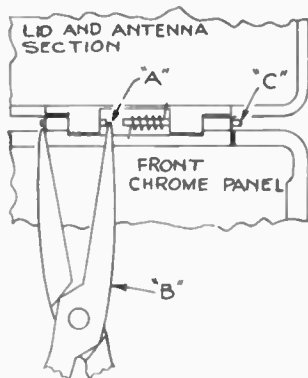

With lid closed, cut hinge pins at point "A" with sharp cutters.

Start removal of pin sections as shown, using long-nose pliers.

Grasp end of pin section with long-nose pliers and pull out of hinge.

Install new lid, or new front panel, using the replacement hinge pins and springs that are provided with replacement lids and panels. Arrange springs as shown. Apply a small amount of "Thermoplastic Cement" (G.E. ZV 5057) near outer end of each pin to insure tight and permanent fit.

Loose Control Knobs

If for any reason either the tuning or volume control knob on Model BP-10 should become loose on its shaft, it may be rigidly mounted in the following manner:

Remove the loose control knob from its shaft and scrape off the old cement from both shaft and control knob.

Apply a generous even coating of a good cement to the shaft region which is to engage the knob. G.E. Thermoplastic cement, ZV-5057, is excellent for this purpose; it is a green fluid, easily thinned with acetone if necessary.

Allow the cement on the shaft to air-dry, to evaporate any acetone present.

Apply a small amount of heat to the shaft, sufficient to soften the cement.

Mount knob on shaft while cement is still soft, and allow a few minutes for drying.

"A" Battery Polarity

In the battery layout diagram at the top left of page 2 of the BP-10 Service Note (1940, No. 32), the 1.5 v. "A" battery is shown incorrectly. The actual polarity is reverse to that shown, minus being at the top, and plus at the bottom.

RCA QU2C, QU2M, QU3C, QU3M

Howl

Howl on shortwave may sometimes be eliminated by changing capacitor C-41 from .007 to .005 mfd.

RCA 156 TUBE TESTER

1T5GT Data

There has been some question as to the correct settings for testing 1T5GT tubes. On charts earlier than that included in the 156-D and E, the information is incorrect. Correct test data follows:

Tube	Fil.	Class	Type	Test Buttons
1T5GT	1.5	A	21	3, 4, 5

RCA 45X11, 12, 13 (2ND PROD.)

Circuit Revisions

Schematic diagram for 2nd prod. 45X11, 12, and 13, given on page 233 of the 1939 RCA-Victor Service Notes Bound Volume has later revisions as follows:

R15 eliminated and a connection made from C16 direct to the 50L6GT grid.

Terminal DP1 (1st diode plate) of tube 12SQ7 (2nd Det.-A.F.-AVC) connected direct to ground instead of to its illustrated connection.

RCA K-80

Hum Modulation and Howl

Tendency of occasional receivers towards hum modulation and howl may be alleviated by:

Rubber-mounting the loudspeaker by means of rubber grommets (Stock No. 33774).

"Rigid-izing" loop antenna by taping winding in six places (2 each side, 1 top, and 1 bottom), using cellulose ("Scotch", tape.

STEWART-WARNER 12-4D CHASSIS

Oscillation

This is a 4-tube battery-operated superhet with antenna and ground connections rather than a loop.

Be sure the antenna and ground wires are pulled straight out from the set and that they do not pass close to the tubes. Failure to observe this precaution may cause oscillation and/or instability.

STEWART-WARNER 03-6N CHASSIS

Hum

If excessive hum is encountered, place a 40-mfd, 150-volt electrolytic condenser across the electrolytic condenser (55B in schematic diagram) connected from B plus to speaker field. Also change the value of the blocking condenser (33 in diagram) connected from the arm of the volume control to the 6SQ7 grid, from .004 mfd to .04 mfd.

STEWART-WARNER 11-10A, 11-10A-Z CHASSIS

Audio Howl

On chassis not stamped with the letter "S", tendency to howl or rumble may be eliminated in most cases by changing the value of the condenser (60 in diagram) connected from the mid-point of the two resistors forming the diode load to the contact on the phono-radio pushbutton switch, from .01 mfd to .002 mfd. Removing the rear rubber grommet on which the gang condenser is mounted and replacing it with a soft gum rubber grommet will also help. The washers and mounting bolt should not be replaced if this is done.

STEWART-WARNER 11-5V CHASSIS

Circuit Change

The following change was made in the circuit of Model 11-5V in order to meet Underwriters approval: The top of the

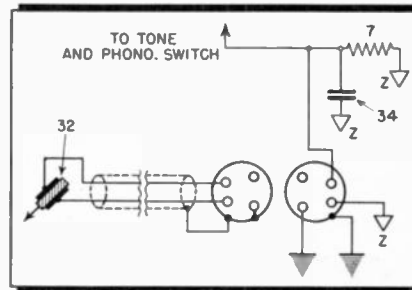

socket for the phono pickup has one of its terminals connected to the B minus return lead Z. All chassis are now wired with a 220,000-ohm 1/4-watt carbon resistor (7) connected between this socket terminal and Z, as shown in the accompanying diagram.

STEWART-WARNER 11-7A CHASSIS

Microphonics and Rumble

To eliminate microphonics and rumble at higher volume levels in this receiver, remove the bracket between the gang condenser and the metal dial plate on the push-button tuning unit.

This is most easily done by unscrewing the screw holding the bracket to the frame of the condenser, and bending the bracket back so it is clear of the condenser frame.

Condensers 41 and 47 associated with the grid circuit of the 6SQ7 should be .002 mfd; early sets had different values. Changing these condensers to .002 mfd eliminates rumble and microphonics.

STROMBERG-CARLSON 505, 515 RECEIVERS

Weak Or No F-M Signal

Low sensitivity or no signal on either of these receivers made prior to October 1st, 1940 may be caused by the 22,000-ohm resistor R8 connected between ground and the second f-m i-f transformer heating up and changing in value. In most cases, this condition can be rectified by simply removing this resistor from the circuit.

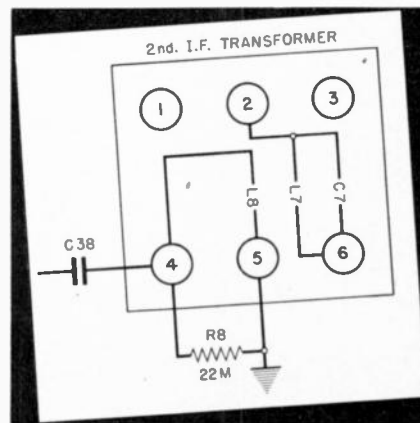

If regeneration or oscillation occurs after this resistor has been removed, connect a 22,000-ohm resistor between ground and the secondary of the second i-f transformer (terminals 4 and 5) as shown in the accompanying diagram.

Circuit Court

CATHODE-ENERGIZED FILAMENT STRINGS

THE 117N7-GT, a combination rectifier and beam power tube, was developed primarily for use in "a-c, d-c, battery" receivers where a filament string is to be operated by the cathode current of the power output tube. *RCA Application Note No. 109* deals with the performance of the 117N7-GT under these stringent conditions of operation. Basic circuit arrangements are shown in Fig. 1, where the filament string comprises four tubes of the 1.4-volt line. The voltage across the filament string is the control-grid bias for the power output unit of the 117N7-GT, i.e., -5.2 volts; this voltage gives a design value per filament of 1.3 volts when the receiver is operated from a 117-volt line.

The filament string for each circuit of Fig. 1 includes an 820-ohm shunt across the entire string, and a 330-ohm shunt across the filament of the 1H5-GT. The 820-ohm shunt is recommended when a 3Q5-GT is switched into use for battery operation. The 330-ohm shunt prevents excessive plate current from entering the 1H5-GT filament. The voltages impressed on the plate and screen of the 117N7-GT must be such that the cathode current develops 5.2 volts across the filament string when all tubes are operating. This condition obtains in the circuit of Fig. 1A with 84 plate volts and approximately 91 screen volts, the resistance of the choke being 500 ohms. These plate and screen voltages correspond to 96.5 volts across the second filter condenser.

The circuit of Fig. 1A may be modified to use a resistance-capacitance filter, as shown in Fig. 1B. The filament string is the same in both circuits. For purposes of comparison, values of plate voltage, screen voltage, and filament string voltage are shown in Fig. 2 for both cir-

cuits of Fig. 1 when the a-c line voltage is varied from 105 to 125 volts. Similarly, Fig. 3 shows filament string voltage, power output, and distortion when the load resistance is varied. While the power output curves show the circuit of Fig. 1B to be somewhat preferable to the circuit of Fig. 1A, the difference in power output is hardly enough to be an important factor in favor of Fig. 1B. Also, both circuits were tested in a typical receiver for noise and hum. For circuit 1A, the noise and hum was 47 db below the 600-milliwatt level used; for circuit 1B, the corresponding value was 44 db.

Since the performance of all tubes in the filament string depends upon the

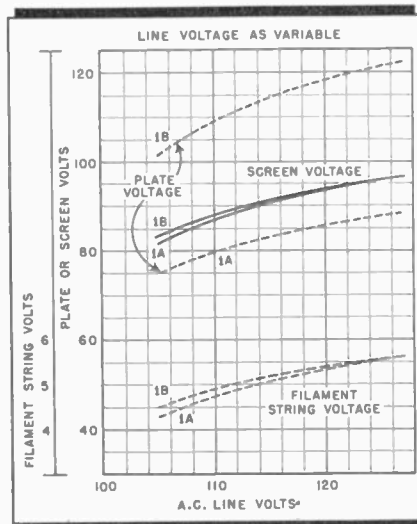

Fig. 2. Performance of 117N7-GT in the circuits of Fig. 1, A and B.

cathode current supplied by the beam power unit of the 117N7-GT, circuits 1A and 1B were compared on the basis of filament-string-voltage variations by

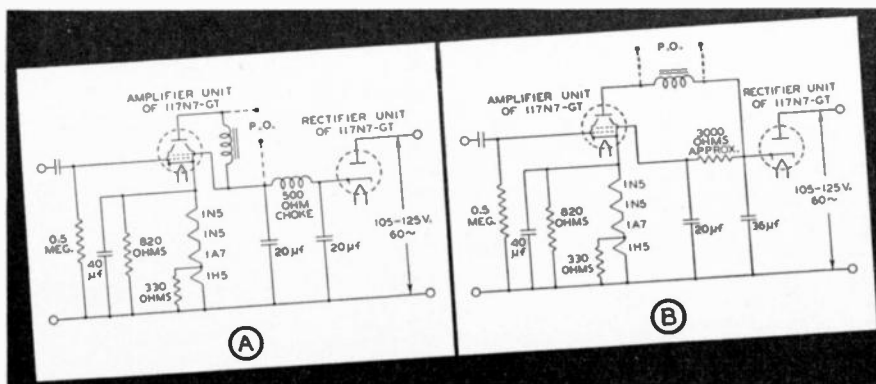

Fig. 1. Two arrangements for the operation of a filament string from a 117N7-GT. A plate-supply resistor of not less than 15 ohms is recommended for the rectifier unit of the 117N7-GT.

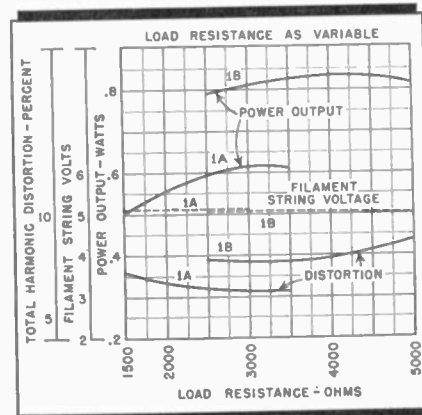

Fig. 3. Filament string voltage, power output and distortion when the 117N7-GT load resistance is varied.

testing a large number of 117N7-GT tubes in each circuit. The relative merit of these circuits was determined from spot diagrams which showed the filament string voltage for each of the many tubes tested. Comparison shows that the voltage spread for circuit 1B is 65% greater than that for circuit 1A. The reason for the better performance of circuit 1A is that, in this circuit, the combined plate and screen currents pass through the 500-ohm choke and, thus, cause the screen voltage to drop for a high-current tube and to increase for a low-current tube. Consequently, circuit 1A is preferable for operating a filament string from a 117N7-GT.

F-M IMPROVEMENTS

FREQUENCY MODULATION marches on. In a very short space of time, numerous improvements have been made in f-m receivers.

Early tuning indicators were not so hot, since they failed to denote the point where the receiver was tuned to the balance frequency of the discriminator circuit, which is quite a good deal different than the broad resonance of the i-f amplifier. To obviate noise and distortion, an f-m receiver must be tuned to the mid-frequency.

Both *Scott* and *Pilot* have solved this problem by employing any off-balance voltage developed in the discriminator, due to mistuning, as a bucking bias. *Pilot* employs an additional 6H6 connected across the output of the discriminator, the cathodes of this 6H6 being tied together. Mistuning either side of the mid-frequency will develop an off-balance dc voltage in the discriminator circuit—positive in one case, negative in the other. In either case, this results

(Turn to page 21)

BOOK REVIEWS

Rider's New Meter Book . . . Books For Defense Program Students

THE METER AT WORK, by John F. Rider. Stiff cloth cover, 5½" by 9", 152 pages, well illustrated. Published by John F. Rider Publisher, Inc., 404 Fourth Ave., New York, N. Y.

Written primarily for the serviceman and the student, *The Meter At Work* is a practical handbook dealing with the types of meters employed in the ever-growing field of electronics. Its purpose is to acquaint the reader with the theory, design and operation of low-power meters and their application in daily work. To this end, the author has covered the history of various types of meters and has used this effectively as the basis for later discourses on modern instruments which have their roots in the earlier designs. From there on the text flows from theory to practice, where special consideration is given to the application of single meters to a variety of uses.

The first chapter deals with the purpose of meters, types of meters, and their basic principles of operation. Succeeding chapters cover meters of the moving-iron, moving-coil and electrostatic types, and electro-dynamometers. Characteristics of meters are covered in Chapter 8. Chapter 9 deals with rectifiers and thermocouples. Practical applications of meters are given considerable space in the remaining chapter—a few of the subjects covered being, the choice of meters, use of shunts, extending meter ranges, construction of multipliers, checking meter accuracy, parallax, and general precautions.

This review would not be complete without some mention of the unique and highly effective mechanical construction of the book itself. In the usual form of textbook construction, if the text relating to an illustration is extensive, it may force the location of the illustration on a page which does not face the text so that it cannot be seen while its description is being read. This necessitates a repeated turning back and forth of pages so as to follow the subject matter.

In *The Meter At Work* this objection is overcome by the use of split pages. All illustrations are at the top, all reading matter below, and each page is cut side-wise so that a text page may be turned independently of the page carrying the illustration to which the text refers. Hence, the illustration is always before the eye and conveniently just above the

text one is reading. A tape marker keeps place for both text and illustrations.

M.L.M.

◆
PRACTICAL RADIO COMMUNICATION, by Arthur R. Nilson and J. L. Hornung. Semi-flexible binding. 750 pages, well illustrated. Published by McGraw-Hill Book Co., 330 W. 42nd St., New York, N. Y. Price \$5.00.

With so much activity in the training of radio operators and communications maintenance men for national defense, it seems timely to review the latest edition of this book, long a favorite with those studying for commercial radio operator's licenses. It is a "must" for both the instructor and the man who intends to enter any phase of communications work.

The book is divided into four main sections: Principles, Systems, Equipment and Operation. Under these sections are grouped fifteen chapters covering practically every phase of commercial communication from both the theoretical and practical standpoints. Of particular interest to commercial operators will be those chapters on transmitting circuit principles, control-room equipment and operation, communication transmitters, and radio aids to navigation.

There are also included a number of tables and two appendices, one containing technical information and the other operating data. It is always a difficult problem to combine a rigorous textbook treatment with an operating handbook and the authors have succeeded to an extent unusual in this field of literature. Because of this fact, and because of the detailed treatment of existing commercial apparatus, the book is to be highly recommended.

M.A.

◆
RADIO OPERATING QUESTIONS AND ANSWERS, Seventh Edition, 1940, by Arthur R. Nilson and J. L. Hornung. Semi-flexible binding, 415 pages, well illustrated. Published by McGraw-Hill Book Co., 330 W. 42nd St., New York, N. Y. Price \$2.50.

This book is a companion to *Practical Radio Communication*, by the same authors, and is meant to be used in preparation for the U. S. Government Examinations for commercial operating licenses.

With the advent of a change in the government examination procedure

(July 1939) an entirely new examination technique was instituted. It was to cover these changes in examination method that this edition was completely revised and rewritten. It provides a quick review of essential theory, mathematics and diagrams for those who are technically familiar with the information required by the government examiners.

There are 1426 questions taken verbatim from the government examinations and divided into six sections covering the various types of licenses. In addition, there are three appendices, listing operating abbreviations, rules governing commercial radio operators, and extracts from radio laws.

In combination with a suitable textbook or handbook, this is an invaluable aid to applicants for the examination discussed. It is to be regretted—though excusable under the circumstances—that in the effort to have the volume appear as soon as possible after the changes in regulations went into effect, a number of typographical errors were allowed to creep into the answers. With a reference book at hand however, this situation would not be as serious as at first it would seem. Hence, the work is to be recommended.

M.A.

◆
McPROUD QUADGET AND PADGET. Published by Norman B. Neely, 5334 Hollywood Blvd., Hollywood, Calif. Quadget, price \$1.50. Padget, Price \$1.25.

These two devices are ingenious arrangements of sliding charts intended to simplify the design of constant-impedance equalizers (Quadget) and attenuators (Padget) without resorting to extended calculations.

The Quadget determines at one setting the various values of inductance, capacity and resistance for any frequency-correcting network of either the equalizer or suppressor type. Although the values are given for 500-ohm circuits, data is furnished for conversion to other impedances.

The Padget performs the same function for the various types of pad attenuators. Those who have worked in fields requiring the precise transmission and control of sound at various levels and impedances will appreciate the great deal of time which can be saved by the use of these gadgets.

Presenting—

NEW PRODUCTS

RCA

Junior VoltOhmyst—A push-pull electronic voltmeter-ohmmeter having many of the features of the 163 VoltOhmyst, with the addition of an isolated ac voltmeter circuit. Has complete meter overload protection on the dc voltage and ohm scales.



The input resistance for measuring dc voltages is constant at 11 million ohms, allowing voltages to be read in high-resistance circuits. On the 3-volt scale this provides a meter sensitivity of 3,666,666 ohms per volt. This feature permits the reading of avc, f-m discriminator, and many other voltages which are not possible with the ordinary meter. A "signal tracing" type probe lead is provided.

The dc voltmeter circuit has six ranges—0 to 3, 10, 30, 100, 300, and 1000 volts. Isolated ac voltage ranges are 0 to 10, 30, 100, 300 and 1000 with a sensitivity of 1000 ohms per volt. By RCA Manufacturing Company, Inc., Camden, N. J. RADIO SERVICE-DEALER.

BELDEN

H-F Cable—No. 8219 high-frequency transmission cable of the 100-ohm twisted pair type, for f.m. and television applications. Consists of 18 gauge stranded tinned copper, celanese braid, rubber covered, color coded, twisted pair with fillers, celanese wrap, tinned copper shield, cotton wrap, and rubber sheath, with outer diameter of .350".



No. 8218 cable is similar but does not have the outer shield. Outer diameter is .270". By Belden Manufacturing Co., 4689 W. Van Buren St., Chicago, Ill. RADIO SERVICE-DEALER.

WALSCO

Staple Driver—For all types of line installations. Sets the staple in place by a stroke or two of the palm of the hand at the end of the driver. The head is so formed that it enables neat stapling around corners, moldings, behind radiators, etc. Possible to install wires on mortar or plaster walls. Speeds up work 50 percent. The Staple Driver holds strips of 24 staples. Takes only four seconds to reload. Staples come in three colors—ivory, brown

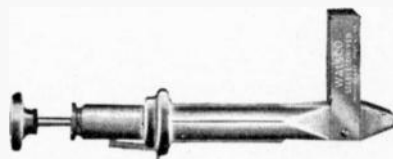

and blue, for wires or cables up to 1/4" in diameter. By Walter L. Schott Co., 5264 W. Pico Blvd., Los Angeles, Calif. RADIO SERVICE-DEALER.

SPRAGUE

Multi-Section Filter—The LF-2, a plug-in multi-section inductance and capacity filter for use on very troublesome sources of radio interference. Designed for installation at the power outlet to which the interfering device is connected.

The filter is designed for use on 115-volt, ac or dc lines only, for any electrical device drawing up to 1/2 ampere. Measures 2 1/2" x 1 3/4" x 1-7/16". Ground



connection provided. By Sprague Products Co., North Adams, Mass. RADIO SERVICE-DEALER.

PRECISION

Tube Tester—Series 914 mutual conductance type tube tester and set analyzer, featuring 7-inch swivel mounted meter



providing full-view test results from all positions. By Precision Apparatus Co., 647 Kent Ave., Brooklyn, N. Y. RADIO SERVICE-DEALER.

PHILCO

Test Stand—A Test Equipment Stand to improve the appearance and efficiency of radio repair benches at low cost.

Sturdily built of heavy gauge sheet metal and finished in blue enamel, the stands are so designed that any number of them can be bolted together to accom-



modate additional test instruments. Equipment can be removed instantly for use elsewhere. By Philco Radio & Television Corp., Philadelphia, Penna. RADIO SERVICE-DEALER.

ELECTRO PRODUCTS

A-B Power Unit—Model AD, converts portable and home battery sets into all-electric receivers. Will operate any 1 1/2-volt radio having 4, 5 or 6 tubes from a 105-125 volt, 50-60 cycle line, or 110-120 volt d-c line.



Provides 1.4 volts A power, and 90 volts B power at 18 ma. Measures 6 1/4" x 5 3/4" x 2 5/8" and fits battery space in most portables. By Electro Products Laboratories, 549 W. Randolph St., Chicago, Ill. RADIO SERVICE-DEALER.

SELLING SERVICE

(From page 7)

up the good work and try to do better. If you are getting less business than "average" you should immediately analyze the reasons for your failure to keep up with the average. And, having found the cause or causes, get off your fanny and *do something about it*. Regardless of your status, see your parts jobbers at once and try to line them up so they will immediately institute a policy of recognition and discounts to legitimate service-dealers *only*. That is the first and basic step to take and it paves the way for the sound, aggressive procedures which must follow.

Step two is obvious. Study your records and the potential market which surrounds you. For example: In a practical manner, figure for yourself just how many sets are in operation within your business area. How many of these "neighbors" are your steady customers? How many of their sets did you service these last three months? How many tubes are in all these sets . . . and how many of these tubes are two or three years old? Theoretically, how many are weak? How many replacement tubes did you sell during the past three months? Analyze, man, and you'll quickly realize that even if you are "an average service-dealer getting an average share of business" you did *not* sell anywhere near the total replacement tube volume that *you should* have. Again we say—study your business and compare it with what you should get and *can* get if you will but go about things in a practical, aggressive manner.

In this regard RADIO SERVICE DEALER will afford vast cooperation in a manner never before attempted by a radio publication. RSD will give you plenty of ammunition to shoot with—but it is *your* job to load your gun, take aim and fire. More important, you must *keep* aiming at the goal, which is More Business and More Profits, and you must *keep firing*. If you follow RSD's plan conscientiously, you cannot miss.

APPLY FOR CERTIFICATION SEAL

First thing to do is simple. Apply to RADIO SERVICE DEALER for recognition as a "Certified Service-Dealer." State your qualifications and obtain, if you meet the rigid requirements, one of the distinctive, four-color Decalcomanias which will, when applied in a prominent spot on your store window, distinguish you in your community and afford a basis upon which an aggressive campaign for increasing business can be made. Remember, these seals are available *without charge* to any independent serviceman, servicing organization, or dealer who

maintains a service department—subscribers and non-subscribers alike—providing the rigid requirements are met.

When your Seal or Certification is delivered and affixed to your window *get busy*. Make a direct mail campaign announcement to every customer now on your books and to a list of potential customers who reside within reasonable limits of your establishment. By means of photo offset printing, 500 letters can be printed in a dignified manner on nice stock for less than \$3.00. Envelopes cost about \$2.00 printed. Postage amounts to \$10.00, so the 500 initial announcements will cost approximately \$15.00. One

thousand announcements would cost approximately \$25. It hardly pays to print less than 500 at a time, the only saving involved in a smaller mailing being the postage, which is the biggest item in every case. Boys, if they can be relied upon, will probably be able to distribute your literature under doors, and in post boxes for less than the cost of postage. In many communities this direct delivery method violates city or local ordinances, so, before using it ask your local authorities and act accordingly.

Another advertising medium which "Certified Service-Dealers" should not neglect is the Telephone Company Classi-

A TUBE TESTER.. A BATTERY TESTER

All for Only
\$29⁹⁵



Terms: \$1.00 cash and 8 monthly payments of \$3.63

FREE
 TUBE SETTING SERVICE FOR ONE YEAR

IN producing Model 589 there has been no compromise in the circuit design or materials. The same manufacturing methods, careful inspection and accurate calibration are incorporated in this instrument as in all other SUPREME testers. It will pay you to investigate and see this tester before you buy. Its price is the lowest at which a GOOD tube tester can be built.

MODEL 589 TUBE AND BATTERY tester has a completely modernized circuit. The tube test sockets are not wired directly to the circuit, but, instead, pass through the patented SUPREME Double Floating Filament Return Selector system which automatically re-connects all tube elements to any possible tube base arrangement. Due to the fact that any or all elements of each socket can be rotated to any desired position, only one socket of each type is necessary. Tests every type of tube from 1.4 volts to full line voltage at its correct anode potential under proper load. Tests separate sections in multi-purpose tubes. Checks all leakages, shorts, open elements and filament continuity with a r-on lamp. A circuit insert is provided for checking noise, leakage, loose and bad connections.

The battery testing circuit of the Model 589 provides the proper load at which each battery is to operate, plainly marked on the panel, for all 1.5, 4.5, 6.0, 45 and 90 volt portable radio types. The condition of the battery is indicated on an English reading scale.

This is the fastest and easiest tester to operate. Just "follow the arrows"—you can't go wrong. Roller type tube chart with brass geared mechanism lists tubes in logical numerical order. Each tester carries a one year free tube setting service. SUPREME engineering and construction PLUS the best materials the market affords, make the 589 your biggest dollar value. You will be proud to own this instrument.

MODEL 599 TUBE AND SET TESTER is very similar in appearance to the Model 589, and includes all the features and advantages of this instrument. In addition, it provides the following ranges:

0.2 TO 1500 D.C. VOLTS—5 carefully selected ranges—0/6/15/150/600/1500 volts. 1000 ohms per volt STANDARD sensitivity.

0.2 TO 600 A.C. VOLTS—4 A.C. ranges—0/6/15/150/600 volts. Rectifier guaranteed with instrument and fully protected from overload damages.

0.2 M.A. TO 600 M.A.—3 direct current ranges 0/6/60/600 allow measurement of screen, plate, "B" supply and D.C. filament loads.

0.2 TO 600 OUTPUT VOLTS—0/6/15/150/600—ideal for alignment. No button to hold down—no external condenser necessary.

0.1 OHM TO 20 MEGOHMS—4 ranges 0/200/20,000 ohms, 0/2/20 megohms. A low range at high current with 3.5 ohms center scale.

ELECTROSTATIC—ELECTROLYTIC LEAKAGE TEST—Sensitive calibrated 20 megohm range provides excellent leakage test of paper and electrolytic condensers.

Just as the 589 is your best value in a tube and battery tester, the 599 is your best value in a combination tube tester, battery tester and set tester. Remember, you have all the features of the 589 PLUS a complete AC, DC volt, ohm, megohm, milliammeter, at a cost of only 47c per range.

Dealer Net Cash Price

\$39.50

Terms: \$4.50 cash; 9 payments of \$4.33.



Illustrated above is the Model 589 in a counter type metal case. This model is available with option of 7" or 9" illuminated meters. Has two neon lamps for sensitive or super-sensitive tests. Write for prices and information.

SUPREME

SUPREME INSTRUMENTS CORP.
 GREENWOOD, MISSISSIPPI, U. S. A.

New Catalog Just Off Press.
 Write for your copy Today!

Metal cabinets as illustrated for the Model 589 at left and 599 above are identical—can be used either in a horizontal position or vertical position by merely reversing the instrument panel. Write for prices and information.

Presenting the 1941



Meissner ANALYST

Incorporating a New, Direct-Reading
ELECTRONIC VOLTMETER

Save Time—Save Money—Handle service jobs faster with the assurance that they will "stay sold"! Almost Magical in its uncanny ability to ferret out obscure faults and lay them open for your inspection, the New Meissner ANALYST handles the receivers of yesterday, today and tomorrow—with equal efficiency and facility. Entirely fundamental in its testing procedure, it is one piece of equipment that will never become obsolete!

The New Meissner ANALYST locates faults by the "Signal Tracing" method—proven to be the fastest and most reliable. Five separate and distinct "channels" provide as many different functions, each in its own panel division with all controls accurately calibrated. Furnished with tubes and instructions, complete—ready to go to work!

No. 9-1040 New ANALYST **\$87.50**
Complete with Tubes, Net . . .

Limited Quantity of 1940 Models
Available at Reduced Price!

The same ANALYST that sold in kit form at \$100 list—now offered completely wired, with full set of 13 tubes—ready to operate! Similar to the New ANALYST described above except has electron-ray indicator instead of meter for DC measurements.

No. 9-1025 Net Price . . . \$69.50

Write for Free 1941 General Catalog

Dept. D-12



Servicemen—the unsung heroes of radio, said Tom Joyce, RCA Victor Vice President, at a recent round-table discussion broadcast over WFIL, under the auspices of The Philadelphia Radio Servicemen's Association. Mr. Joyce (third from left) brought along Dr. Morton, G. L. Beers and Dr. Olson, prominent RCA engineers.



fied Business Directory. Be sure, immediately after receiving your Seal, that you order your local phone company's business office to change your copy if you are a display space user. Your business cards and letterheads should also have the CSD Seal imprinted. Electro-types of the distinctive "Certified Service-Dealer" insignia are available in several sizes and at reasonable prices. Further information, prices, etc. will be sent on request to RADIO SERVICE-DEALER.

CONTACT CUSTOMERS

Personal calls are unquestionably the most effective means of consummating a sale. Once your Certification Seal has been awarded, plan your working schedule to provide at least 2 hours daily for calls on old customers whom you have not seen or done business with in several months. Study your files. Probably nine out of every ten customers on your books fall into this category. You'd be surprised how time flies and repeat business fails to materialize because of lost contact.

In planning a series of unsolicited home calls, do not work on a hit-or-miss basis. Study your daily drop-off or pick-up and group your intended calls for that day to fit adjacent neighborhoods. It is a perfectly accepted and not offensive practice to ring an old customer's door bell with the explanation, "I had to install a set at Mrs. So-and-So's around the corner and didn't want to pass by your house without checking up on the receiver I fixed up for you recently. It's a part of our routine service" . . . and so on! Remember, you are not out on social visits. Your primary purpose is to get an order. To do this you must get into the home, inspect the set or sets and try, if possible through casual conversation to ascertain whether or not any of your customer's friends or neighbors are in the market for a radio serviceman's services.

Keep in mind the axiom, "The earning capacity of a radio service-dealer depends upon his selling ability." If you don't see people you cannot sell them.

Whether you sell a bill of goods or a favorable impression makes no difference. Ultimately, both will result in your making a bank deposit.

SERVICEMAN'S DIARY

(From page 10)

when your son started, his voice sounded just as bad as . . ."

That was enough for me. I slipped out into the hall and got my coat on again. Then I noticed the girl had followed me.

"Don't be angry," she murmured. "I like your voice. The teacher did, too. That's why he wanted Jerry, whose voice is so rough. But, you see, you were so mad that you growled. And your voice didn't sound so good, then. And my name's Mary . . ."

Mary had a little lamb. Now Mary has a radioman.

STEREOPHONICS

(From page 5)

for the cardioid pattern and so tilted (Fig. 3) that its pickup was confined mostly to the front of the stage center. Since this microphone was closer to the artists than the side microphones, the 116A amplifiers associated with it were operated at a lower level than those of the side microphones. In this way, a very satisfactory auditory perspective was obtained with only two channels.

Immediately before each of the four sessions, the operators balanced the amplifiers as previously described and took a quick overall frequency run using the dummy resistance load. A minimum of monitoring was done during the program since the aim was to reproduce the program as faithfully as possible. In general the only adjustments made were a slight increase in level of the center microphone during solos. There was no need to compress the volume range, due to the excess output capacity available and the low noise level of the system.

EFFECT ON AUDIENCE

One of the best indices of the audience response to the installation was the attendance at each of the four sessions. No particular advance publicity had been given out regarding the installation since it was felt that the public should be allowed to form their own opinions. As a result, the attendance at the first session was poor. It was noticed, however, that the same people returned for the succeeding sessions and in each case brought friends with them. At the last session the auditorium was completely filled. At the end of each session the most favorable comments were heard. Many of these comments were particularly interesting. Everyone seemed to agree that after the first few minutes they were completely under the illusion of the choir and orchestra being hidden behind the curtain at the front of the auditorium. Those familiar with reproducing systems attributed this to the faithfulness of the reproduction with no audible distortion as well as to the stereophonic effect.

The behavior of the audience during the programs served as another index of the success of the installation. Complete absorption in the music was apparent. The slightest disturbing movement on the part of anyone drew silencing looks from his neighbors. Many followed the music note by note from open scores. During the magnificent crescendos in the B Minor Mass the audience would sit up almost breathless and when the music suddenly dropped to the barest whisper, one could hear audible sighs. This response of the audience was particularly striking in view of the altogether too common habit today of carrying on a conversation during any reproduced program.

F-M IMPROVEMENTS

(From page 16)

in a positive voltage on the paralleled cathodes of the additional 6H6. This positive voltage is employed to offset the negative voltage developed in the grid circuit of the limiter and which is used to actuate the tuning eye. Hence, the tuning eye remains open until the balance frequency is reached, at which time a potential difference no longer exists in the discriminator circuit. Therefore, no voltage is developed on the cathodes of the additional 6H6, the negative limiter voltage is released and closes the eye.

Both Scott and General Electric employ cascade limiters as a means of further reducing noise interference. The first limiter does the real dirty work, reducing the noise amplitudes to small values. The second limiter takes up where the first limiter left off, polishing off what remains in the way of noise pulses.

The new General Electric F-M Translator Model JFM-90 is a double superhet, with two converters instead of one converter and one r-f stage. Increased sensitivity is gained with this arrangement because the first converter reduces the signal frequency to about half its value with the result that the second converter tube can get in some real gain in front of the i-f amplifier. In effect, the conversion transconductance of the circuit is considerably increased.

RADIOLA 510

(From page 6)

ceiver dial pointer full clockwise and adjust the oscillator trimmer C3 for maximum output.

Step 4. Tune test oscillator to 1400 kc, tune receiver to oscillator frequency and adjust the antenna trimmer C1 for maximum output.

LEAD DRESS

Dress grid lead of 12SK7 close to chassis under condenser C12. Dress green and blue leads from i-f transformers close to chassis and away from each other. Dress leads from terminal board on loop support away from loop.

BATS OVER BATTERIES

Dere Mr. Editor:

On account of a peculya series of events, maybe you'd better change my address on your records. Thair is some talk goin' round that our street, up to now called "Washington Street" is gonna be re-named "Wanderer's Row"—and I, for one, think it's only right to do so. Either that or



Eureka!
He's done it again!

Homer G. Snoopshaw, B.R.S. (Battery Replacement Specialist), once more comes through in his capacity as Replacement Adviser in Bud's Radio Shop.

After studying this troublesome mail-order Dynamic DeLuxe for only four days, he is able to state emphatically that the correct battery for this portable is Burgess No. 4GA42. A call to the Burgess Distributor and the customer is satisfied and on his way.

How could Homer's employer possibly get along without him?*

*By getting a free copy of the Burgess replacement guide from his local distributor, or writing direct to the Burgess Battery Company, Freeport, Illinois.

BURGESS
The Complete Replacement Line



Gift Yourself
RADIO SERVICE-DEALER
For Christmas

DEWALD

presents

"COMPANIONETTE"
a money-making 4 pounder
ideal for service-dealers

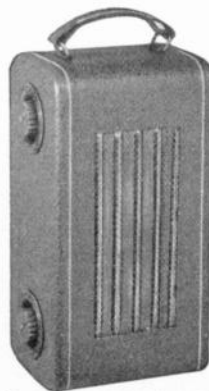

JOBBERS

write for details of new, profit-making merchandising plan.

*These gorgeous streamlined 4 tube, 4 lb. miniature battery portables are "naturals" for Service-Dealers. Display them in windows, on counters—carry them on service calls. THEY SELL QUICKLY—afford a neat profit on a small investment and build steady replacement battery business. Model 410 illustrated LIST PRICE \$19.95 complete with batteries.

*FEATURES: 4 tube superhet; powerful P.M. dynamic speaker; AVC; iron core High Gain I-F transformer; self-contained Loopenna, 2 flash light cells "A" supply last 15 hours, "B" battery 50 hours. Case of simulated cow hide with saddle stitching. Range 170 to 555 meters.

DEWALD RADIO MFG. CORP.
440 LAFAYETTE STREET NEW YORK, N. Y.

new*

* Webster defines "new" as: "Lately made. Lately discovered. Renewed. Different." All of these descriptions apply to the Rider Books listed below. They have all been recently published. They all bear on lately discovered developments or currently revived subjects—and they are all different—in approach, handling and even in physical make-up. Order the ones you need—TODAY.



new MAKE-UP OF BOOK

Embodies a new feature exclusive to Rider Books. Pages are split so that the upper parts (containing diagrams and charts) can be turned without disturbing the lower parts of the pages (containing text.) Obvious advantage in the reading and study of "Meters at Work." Only \$1.25.

OUT DEC. 18th—ORDER YOURS TODAY

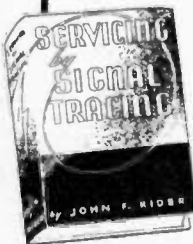

new SERVICING TECHNIQUE

Servicing by Signal Tracing is being used by an ever increasing number of professional radio servicemen for locating troubles in every conceivable type of radio communication system. It is the most fundamental method—free from every limiting factor heretofore encountered. 360 pages—188 illus.—\$2.00

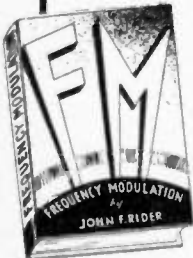

new DEVELOPMENT IN RADIO

Frequency Modulation is not just a coming thing—it is here! This book explains transmission and reception of F-M signals—discusses the new F-M sets 136 pages—Illustrated—\$1.00

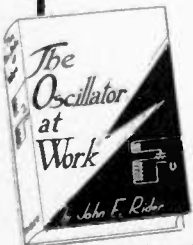

new EXPLANATION OF THEORY

Know all about Oscillators. Get your money's worth out of them. Know how to test them—repair them. Protect the investment you have in oscillator equipment and make any future investment in the light

of the knowledge this book gives you. 256 pages—167 illus.—\$1.50

JOHN F. RIDER PUBLISHER, INC.

404 Fourth Avenue, New York City
Export Division: Rocke-International Elec. Corp.,
100 Varick St., New York City. Cable: ARLAB

Read RIDER BOOKS

"Portable Promenade." You see, it's all on account of these here portable radios and batteries. Me and Elmer Spangler—he runs the "Nev-r-Sleep Radio Shop"—well, we were talking to Tom Howard, down at his place—"Howard's Radio Hospital," and we all three says it's really something. You see, when we first started selling portables a couple years ago, we sold quite a few and made money on 'em—& on batteries, too. I sold the Consolidated line, Tom had Argonaut, and Elmer was selling Dynamics. We made money and got along together fine. Then all of a sudden Argonaut brought out a AC-DC set, using a 6-volt "A" Battery, and at the same time, Consolidated put out a 4½-volt—90-volt pack for their new set. Then Dynamic decided to use a smaller 1½-volt "A" and a special 60-volt "B" and also a long strung out style 7½-volt "A". This was rather confusing and I had to add a extry shelf for battery stock. Then Tom got in a set that used a 88½-volt "B" and 7 flashlight batteries—and my new line required a 4-prong 6-volt "A", a 8-prong pack, a 7½-volt "A", a 30-volt "B" and a new shape 1½-volt "A". I cut off half my service bench and shifted my equipment around & made room for the new batteries. Then a tourist one day brought in a set that couldn't have used any battery I ever saw. As near as I could dope it out it had originally been equipped with a weak 6-volt "A", a telephone dry cell, a penlight cell, a heavy-duty B&C pack and a couple of double-edge razor blades. The owner of this remarkable set sed it was won on a punch board last summer. After looking quite a while, I was surprised to find Consolidated's name plate on it. I wrote them and after some correspondence found that they were sorry, but that set was a discontinued model—a early fore-runner of their famous "Play Day" model. This made the party quite angry and he junked his set—hard—on the sidewalk.

I tried telling my customers to stick to reasonable style batteries, but you know how some of 'em are. Why, I know one fella here in town has 3 portables, all in good condition, but cant get batteries for 'em for love nor money. Well, to make a long story short, you wouldnt reckonise our street now, the sidewalks are always full of folks carrying portables in and out of radio shops. It looks like we're busy, and we are—busy telling folks we're "fresh out of 11-prong 9-volt 75-volt packs—try Tom, he had some last week."

"Wanderer's Row"—that sounds allright to me. Or maybe we should call it "Battery Park" sein how many of those screwy batteries park on our shelves. Anyway, youre gonna hafta change my address before long—and maybe it will be care of the county home (or the asylum).

By the way, is thair any truth in the rumor that the reason Consolidated went busted is because Mr. Consolidated went nuts trying to figure out a new tube and battery hook-up? I heard so.

Well so long till later. Your old bud,
Puzzled Pete

APPOINTMENTS

RCA-Dobbs—Fred Dobbs, well known throughout Texas and the Southwest as a Tube and Parts salesman attached to the RCA Manufacturing Company's Dallas district office, has been transferred to the New York RCA office to take over similar duties there.

Mr. Dobb's duties in Dallas have been assumed by A. B. Chapman, formerly of the RCA field engineer force in Texas.

Subscribe Now To RADIO SERVICE-DEALER

while the dollar-saving
½ Regular Price

SUBSCRIPTION RATE

—12 Issues for \$1.00—

is still in effect

(Use the coupon on page 3)



Reach for a DANDEE!

● If ever there was a condenser that could qualify as a so-called universal or general-utility replacement, it's the new PRS 450-8 Aerovox Dandee. It's the most compact midget metal-can dry electrolytic on the market . . . a genuine hermetically-sealed job properly vented . . . full-rated capacity and voltage . . . colored polarity-indicating ends . . . spun-over jacket preventing shorts and grounds—in a word, a real good electrolytic.

And now, for your convenience, these PRS 450-8 Dandees come packed five to the box. Buy a box. Pack it in your old kit bag. And when it comes to those quick servicing jobs, just reach for a Dandee! Also packed individually.

Ask Your Jobber . . . Ask for a carton of Dandees. Always have a box on hand. Also ask for latest catalog on condensers. Or write us direct.



IN CANADA: AEROVOX CANADA, Limited, Hamilton, Ont.

XCELITE
QUALITY PRODUCTS

**HOLLOW SHAFT
NUT DRIVERS**



Here's the ideal tool for installing and removing volume controls and other panel equipment. Easily tightens or loosens nut without damage to panel. A real time, labor and temper saver for every radio man!

Available in seven nut sizes from 5/16" to 5/8". If your parts jobber cannot supply you, write for new complete catalog.

ALL XCELITE blades are made from S.A.E. 6.50 Chrome Vanadium Steel that matches the quality of XCELITE famous shockproof, guaranteed handles.

**PARK METALWARE
COMPANY, INC.**
ORCHARD PARK, NEW YORK

RECOTON
Recording
Needles



MAKE BETTER RECORDINGS

Because

- Diamond-dust Polished
- Absolutely Uniform
- Swedish Steel Alloy

Write for price list . . . also ask about our Sapphire Cutting Needles.



RECOTON
CORPORATION
178 Prince St. New York, N. Y.

RCA-Brisbin—For 12 years associated with the RCA installation and service division, M. M. Brisbin has been transferred to the Advertising Department at Camden headquarters to handle test equipment advertising and sales promotion.

In addition, he will also edit "RCA Radio Service News", a nationally-circulated journal for servicemen.

Webber-Smith—The Earl Webber Company, Chicago, have appointed O. P. "Opie" Smith as their sales representative in Chicago, Northern Illinois and Southern Wisconsin territory.

Utah-Walker—Utah Radio Products Co. have appointed C. L. "Chet" Walker to the post of Assistant Chief Engineer. Mr. Walker was for years with United American Bosch Corp.

ClaroStat-Youngblood—The appointment of I. J. (Jim) Youngblood as sales engineer in the Indiana territory is announced by ClaroStat Mfg. Co., Inc.

Jim will work out of temporary quarters at 1002 W. 5th St., Marion, Ind., but will shortly locate in Indianapolis.

NEW LITERATURE

Phototube Applications—Complete information on phototubes and their applications is being distributed throughout the country by RCA transmitting-tube distributors. The material, in simplified form, is presented in a 16-page booklet prepared by the RCA Manufacturing Company.

The phototube's usefulness in light-operated relays, color discriminating devices, automatic counters, for light measuring, and for film sound reproduction, is explained in detail. The discussion of phototube theory is backed up by numerous circuits, characteristics curves, charts, etc.

Auto-Antenna Guide—The Ward Products Corp., Cleveland, Ohio, will supply upon request an antenna guide (Form No. WA-107) of 1941 auto antenna installations.

Capacitor Catalog—Now available is the Cornell-Dubilier 1941 Radio Capacitor Bulletin No. 185A in which are listed and illustrated all types of capacitors for radio applications, including mica, paper, wet and dry electrolytics, Dykanol, etc. Complete information on each type includes full ratings, sizes with dimensional drawings, and prices.

Copies may be obtained from dealers, or by writing direct to Cornell-Dubilier Electric Corp., South Plainfield, N. J.

Test Equipment Catalog—The 1941 edition of the RCA Radio and Television Test Equipment Catalog, No. 105, is now available.

The catalog of 28 pages, printed in two colors, presents the RCA Dynamic Demonstrator, and new test equipment such as the Junior VoltOhmyst, Deluxe Tube Tester and Pre-heater, the 3-inch Cathode-Ray Oscillograph, and the A-C Test Oscillator.

Recordisc Brochure—"Snapshots in Sound", a new brochure issued by The Recordisc



TRIPLET
Model 1200-F
Push-Button Type

Dealer Net Price
\$27.84

Push-button switching by a new, simpler way makes the Model 1200-F an entirely automatic Volt-Ohm-Milliammeter with maximum speed and minimum switching. Only one button need be pressed for any range and test setting. Ranges: DC, 0-10-50-250-500-1000 at 25,000 ohms per volt . . . AC, 0-10-50-250-500-1000 at 1000 ohms per volt . . . DC Milliampere, 0-1-10-50-250 . . . DC Microampere, 0-50 . . . Resistance, 0-1000. Low ohms, shunt type circuit; 0-300,000 ohms; 0-3 and 0-30 megohms, series type circuit. Self-contained batteries for all ranges. RED•DOT Lifetime Guaranteed Instrument, rectifier type. Attractive metal case with rich brown suede enamel finish. Panel with new three-tone finish. Dealer Net Price \$27.84

Model 1200-A—Selector switch operated . . . 2000 Ohms per Volt DC . . . Volt-Ohm-Milliammeter . . . Dealer Net Price \$21.84

Model 1200-C—Selector Switch Operated . . . 5000 Ohms per Volt DC . . . Volt-Ohm-Milliammeter . . . Dealer Net Price \$22.84

Model 1200-E—Selector switch operated . . . 25,000 Ohms per Volt DC . . . Volt-Ohm-Milliammeter . . . Dealer Net Price \$25.84

Write for Catalog—Section 4712 Harmon Drive

THE TRIPLET ELECTRICAL INSTRUMENT CO.
Bluffton, Ohio

**FREE! NEW 1941
PROFIT GUIDE
Everything in
RADIO!**

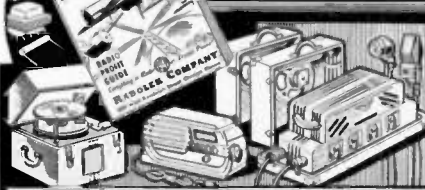

Complete Selections . . . Guaranteed Quality

Replacement Parts



Everything you need in exact duplicate or universal replacement or repair parts. Tubes, condensers, resistors, transformers, hardware, tools, etc. Leading brands.

Latest Radio Sets



A model for every purse and purpose. Auto Sets, Midgets, Battery Portables, Table Models, Consoles, Phono-Radio and recorder combinations—for operation on AC or DC.

Public Address Equipment



A complete line of amplifiers, microphones, baffles, recording equipment and accessories for every type of installation—permanent, portable and mobile, from 5 to 100 watts.

Newest Electric Appliances



Extra profits for you! Standard Brand Electric Irons, Grills, Toasters, Percolators, Waffle Irons, Vacuum Cleaners, Clocks, Mixers and many others, all at lowest prices.

YOU SAVE MONEY AT RADOLEK

MAIL THIS COUPON TODAY

The RADOLEK CO.

601 W. Randolph St., Chicago, Dept. SD-49
Send the New 1941 Radio Profit Guide **FREE**.

Name
Address Dealer?
Experimenter? . . . Serviceman? . . . Amateur? . . .

Corp., 395 Broadway, New York, N. Y., manufacturers of home recording blanks. Literature lists 3 grades, the Semi-professional, the Economical and the Amateur lines, in both nitrate and non-inflammable coatings. Also accessories. Interesting data on recording practice is included.

Available through distributors or direct from RecordDisc.

Carron 1941 Catalog—New 60-page catalog covering replacement cones and voice coils, r-f and i-f coils, pickup coils, etc. Of special interest are the new Carron frequency modulation kit and components.

Copy free on request to Carron Manufacturing Co., 415 So. Aberdeen St., Chicago, Ill.

Shure Catalog—No. 153. Has 12 pages. Includes such new items as the "Stratoliner" microphones, magnetic recording head, etc. Shure Brothers, 225 W. Huron St., Chicago, Ill.

Precision Catalog—New 12-page catalog covering the 1941 line of Precision Apparatus test equipment. Precision Apparatus Co., 647 Kent Ave., Brooklyn, N. Y.

Allied Dictionary—A Dictionary of Radio Terms, containing definitions of approximately 800 radio terms and abbreviations. Also schematic symbols, tips on reading circuit diagrams, color codes, etc.

Has 36 pages with grey and maroon cover. Measures 6 by 9 inches. Copy may be had for 10 cents from Allied Radio Corp., 833 West Jackson Blvd., Chicago, Ill.

**BRACH
Antennae**

Automobile
Home — All types
F-M Systems
Television
Police • Marine
Multiple Systems
Complete Kits
Accessories

Made by World's Oldest and Largest
Manufacturers of Radio Aerial Systems

L. S. BRACH MFG. CORP.
55 DICKERSON STREET
NEWARK, N. J.

Mr. Radio Serviceman:

RSA MEANS BUSINESS!

New business promotion plans and new member-helps spell increased profits for RSA members at the start of the new season. Watch for the RSA Replacement Parts Guide—New Broadcast Promotions—New Member Helps! Don't be the last man in your neighborhood to join RSA. Send the coupon Today!

MAIL THIS COUPON NOW!

RADIO SERVICEMEN OF AMERICA, INC.
304 S. Dearborn St.,
Chicago, Illinois

I am interested in RSA Membership. Tell me about it.

Name

Address

City State

RS-1240

Let's Grow Together
in 1940!



**RADIO SERVICEMEN
OF AMERICA, Inc.**

Reliable Service Assured
JOE MARTY, JR., EXECUTIVE SECRETARY
304 S. DEARBORN STREET, CHICAGO, U.S.A.



**A NATION-WIDE
ORGANIZATION
WITH
NATION-WIDE DISTRIBUTION
AND A
WORLD-WIDE REPUTATION**

RACON—the oldest, largest and foremost manufacturer of air-column speakers in the world produces speaker and horn units of all types for every kind of sound installation. It is the only complete line made. Ask your jobber for a new catalog or write direct to the main office in New York.

There are several types of horns, speakers and trumpets on the market which resemble genuine RACONS. RACON's patented, exclusive features such as stormproof, weatherproof acoustic material and our line of unbreakable horns cannot be duplicated. Also, every RACON speaker delivers maximum output and response obtainable for the size of driving unit used. From coast to coast and on the seas RACONS are specified by leading soundmen for better, more dependable and profitable sound installations because the Racon Elec. Co. is a nation-wide organization, with nation-wide distribution and a world-wide reputation.

MARINE HORN SPEAKERS

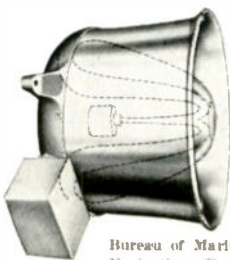

Re-entrant type speakers using horn type units for marine and general P-A applications — may be used as loud-speaker or as a microphone. Miniature and regular sizes approved by the

Bureau of Marine Inspection and Navigation, Department of Commerce, for marine work. In all sizes, miniature, midjet, regular and bull, handling from 5 to 50 watts.



**Super
Giant
P. M.
Horn Unit**

Operating capacity 12-15 watts. Other P.M. units available, from "baby unit" of 5 watts to "bull unit" with an operating capacity of 50 watts. Efficiencies of the highest order obtainable with the finest magnetic material and steel utilized.



PAGING HORN

A small, extremely efficient 2-foot trumpet speaker, for use where highly concentrated sound is required to override high noise levels, such as in factories, outdoors, etc. Uses a small, very efficient Permanent Magnet unit. Particularly adaptable for paging systems, hotel lobbies, trucks, etc.

**Re-Entrant
Trumpets**



A compact trumpet of the double re-entrant type. Occupies but a small space, nevertheless has a long air column enabling it to deliver highly concentrated sound of the greatest efficiency over long distances. Base and inside cone arm made of aluminum castings, outside bell of heavy gauge aluminum spinning, center section of RACON 'ACOUSTIC' material to prevent resonant effects. Available in 6', 4½', 3½', and 3' air column units.

RACON ELECTRIC CO. 52 EAST 19th ST. NEW YORK, N. Y.

LOOK HOW MUCH YOU GET!

...Look How Little You Pay!

NEW RCA JUNIOR VOLTOHMYST

D. C. Electronic
Push-Pull Volt-Ohmmeter
plus isolated A. C. Voltmeter!

ONLY
\$34.95
COMPLETE
Stock No. 165



No Other Instrument Gives You So Much for So Little!

11,000,000 ohms, constant input resistance for D. C. Volts . . . 6 D. C. Voltmeter Ranges: 0-3, 10, 30, 100, 300, 1,000 volts . . . 5 Ohmmeter Steps: 0.1 ohm to 1,000 megohms . . . Meter automatically protected against D. C. Volts overload . . . No Zero Reset when changing Ohmmeter Scales . . . 1,000 Ohms per volt Rectifier A. C. Voltmeter . . . Stable—no Grid Current—Independent of line voltage changes . . . Checks Insulation Resistance . . . Checks Bias Cells—A. V. C. and A. F. C. Voltages . . . Checks Voltages with signal present using Special Signal Tracing Type Probe . . . Famous Rider VoltOhmyst Circuit . . . A Perfect Output Meter.



More than 4,000 owners of RCA Rider
Chanalysts—ask the man who owns one!

HAVE you been stymied on tough jobs because you couldn't measure voltages without loading the circuit? Now the kind of instrument you've always wanted—a D. C. Electronic Push-Pull Volt-Ohmmeter—is priced scarcely higher than an ordinary volt-ohmmeter!

Now you can check oscillator voltages at the grid of the tube, with the signal present . . . with the circuit functioning! Read AVC, AFC and FM discriminator voltages . . . check bias-cells without harmful drain . . . D. C. voltages in high-resistance photocell circuits . . . television circuits! See how much time you can save on both routine and special jobs, with a meter that offers a constant input resistance of 11,000,000 ohms—sensitivity as high as 3,666,666 ohms per volt!

And the Ohmmeter side of the Volt-Ohmyst story! 0.1 Ohms to 1,000 Megohms

Resistance-Readings! No leads to short—no zero-point resetting as you switch in five steps over the ranges that let you read accurately resistance from 0.1 to 1,000 megohms—a range of ten billion to one! Check coil resistances . . . or insulation and condenser leakages . . . accurately, easily, quickly!

Plus an A. C. Voltmeter! For extra convenience, an A. C. meter, too! Rugged copper-oxide rectifier type, 1,000 ohms per volt, reading up to 1,000 volts A. C. . . . See the new RCA Junior VoltOhmyst at your RCA Distributor's—it's the test instrument you've been waiting for!



Test Equipment

RCA MANUFACTURING COMPANY, INC., CAMDEN, N. J.
A Service of the Radio Corporation of America